

# ESP32-C2

## ESP-AT User Guide



Release  
gff7bc283eb  
Espressif Systems  
Dec 31, 2024

v2.3.0.0-esp32c3-834-

# Table of contents

<b>Table of contents</b>	<b>i</b>
<b>1 Get Started</b>	<b>3</b>
1.1 What is ESP-AT	3
1.2 Technology Selection	4
1.2.1 Hardware Selection	4
1.2.2 AT Software Solution Selection	4
1.2.3 Initial Project Preparation	6
1.3 Hardware Connection	6
1.3.1 What You Need	7
1.3.2 ESP32C2-4MB Series	8
1.3.3 ESP32C2-2MB Series	8
1.4 Downloading Guide	10
1.4.1 Download AT Firmware	10
1.4.2 Flash AT Firmware into Your Device	11
1.4.3 Check Whether AT Works	13
<b>2 AT Binary Lists</b>	<b>17</b>
2.1 Released Firmware	17
2.1.1 Disclaimer	17
2.1.2 ESP32-C2 2MB Series	17
2.1.3 ESP32-C2 4MB Series	17
2.1.4 Subscribe to AT Releases	18
2.2 Brief Introduction to AT Firmware	18
<b>3 AT Command Set</b>	<b>19</b>
3.1 Basic AT Commands	19
3.1.1 Introduction	20
3.1.2 AT: Test AT Startup	20
3.1.3 AT+RST: Restart a Module	20
3.1.4 AT+GMR: Check Version Information	21
3.1.5 AT+CMD: List all AT commands and types supported in current firmware	21
3.1.6 AT+GSLP: Enter Deep-sleep Mode	22
3.1.7 ATE: Configure AT Commands Echoing	22
3.1.8 AT+RESTORE: Restore Factory Default Settings	23
3.1.9 AT+SAVETRANSLINK: Set Whether to Enter Wi-Fi/Bluetooth LE Passthrough Mode on Power-up	23
3.1.10 AT+TRANSINTVL: Set the Data Transmission Interval in Passthrough Mode	25
3.1.11 AT+UART_CUR: Current UART Configuration, Not Saved in Flash	26
3.1.12 AT+UART_DEF: Default UART Configuration, Saved in Flash	27
3.1.13 AT+SLEEP: Set the Sleep Mode	28
3.1.14 AT+SYSRAM: Query Current Remaining Heap Size and Minimum Heap Size	30
3.1.15 AT+SYSMMSG: Query/Set System Prompt Information	30
3.1.16 AT+SYSMMSGFILTER: Enable or Disable the system message Filter	32
3.1.17 AT+SYSMMSGFILTERCFG: Query/Set the system message Filters	33
3.1.18 AT+SYSFLASH: Query/Set User Partitions in Flash	36
3.1.19 AT+SYSMFG: Query/Set manufacturing nvs User Partitions	37

3.1.20	AT+RFPOWER: Query/Set RF TX Power	40
3.1.21	Note	41
3.1.22	AT+SYSROLLBACK: Roll Back to the Previous Firmware	41
3.1.23	AT+SYSTIMESTAMP: Query/Set Local Time Stamp	41
3.1.24	AT+SYSLOG: Enable or Disable the AT Error Code Prompt	42
3.1.25	AT+SLEEPWKCFG: Set the Light-sleep Wakeup Source and Awake GPIO	44
3.1.26	AT+SYSSTORE: Query/Set Parameter Store Mode	44
3.1.27	AT+SYSREG: Read/Write the Register	45
3.2	Wi-Fi AT Commands	46
3.2.1	Introduction	47
3.2.2	AT+CWINIT: Initialize or Deinitialize Wi-Fi Driver	47
3.2.3	AT+CWMODE: Query/Set the Wi-Fi Mode (Station/SoftAP/Station+SoftAP)	48
3.2.4	AT+CWSTATE: Query the Wi-Fi state and Wi-Fi information	49
3.2.5	AT+CWJAP: Connect to an AP	49
3.2.6	AT+CWRECONNCFG: Query/Set the Wi-Fi Reconnecting Configuration	52
3.2.7	AT+CWLAPOPT: Set the Configuration for the Command AT+CWLAP	53
3.2.8	AT+CWLAP: List Available APs	54
3.2.9	AT+CWQAP: Disconnect from an AP	55
3.2.10	AT+CWSAP: Query/Set the configuration of an ESP32-C2 SoftAP	56
3.2.11	AT+CWLIF: Obtain IP Address of the Station That Connects to an ESP32-C2 SoftAP	57
3.2.12	AT+CWQIF: Disconnect Stations from an ESP32-C2 SoftAP	57
3.2.13	AT+CWDHCP: Enable/Disable DHCP	58
3.2.14	AT+CWDHCPS: Query/Set the IPv4 Addresses Allocated by an ESP32-C2 SoftAP DHCP Server	59
3.2.15	AT+CWAUTOCONN: Query/Set Automatic Connection to an AP When Powered on	60
3.2.16	AT+CWAPPROTO: Query/Set the 802.11 b/g/n Protocol Standard of SoftAP Mode	61
3.2.17	AT+CWSTAPROTO: Query/Set the 802.11 b/g/n Protocol Standard of Station Mode	61
3.2.18	AT+CIPSTAMAC: Query/Set the MAC Address of an ESP32-C2 Station	62
3.2.19	AT+CIPAPMAC: Query/Set the MAC Address of an ESP32-C2 SoftAP	63
3.2.20	AT+CIPSTA: Query/Set the IP Address of an ESP32-C2 Station	64
3.2.21	AT+CIPAP: Query/Set the IP Address of an ESP32-C2 SoftAP	65
3.2.22	AT+CWSTARTSMART: Start SmartConfig	66
3.2.23	AT+CWSTOPSMART: Stop SmartConfig	67
3.2.24	AT+WPS: Enable the WPS Function	67
3.2.25	AT+MDNS: Configure the mDNS Function	68
3.2.26	AT+CWJEAP: Connect to a WPA2 Enterprise AP	69
3.2.27	AT+CWHOOSTNAME: Query/Set the Host Name of an ESP32-C2 Station	71
3.2.28	AT+CWCOUNTRY: Query/Set the Wi-Fi Country Code	72
3.3	TCP/IP AT Commands	73
3.3.1	Introduction	73
3.3.2	AT+CIPV6: Enable/disable the network of Internet Protocol Version 6 (IPv6)	74
3.3.3	AT+CIPSTATE: Obtain the TCP/UDP/SSL Connection Information	74
3.3.4	AT+CIPSTATUS (deprecated): Obtain the TCP/UDP/SSL Connection Status and Information	75
3.3.5	AT+CIPDOMAIN: Resolve a Domain Name	76
3.3.6	AT+CIPSTART: Establish TCP Connection, UDP Transmission, or SSL Connection	76
3.3.7	AT+CIPSTARTEX: Establish TCP connection, UDP transmission, or SSL connection with an Automatically Assigned ID	80
3.3.8	[Data Mode Only] +++: Exit from Data Mode	80
3.3.9	AT+CIPSEND: Send Data in the Normal Transmission Mode or Wi-Fi Passthrough Mode	81
3.3.10	AT+CIPSENDL: Send Long Data in Paraller in the Normal Transmission Mode.	82
3.3.11	AT+CIPSENDLCFG: Set the Configuration for the Command AT+CIPSENDL	83
3.3.12	AT+CIPSENDEX: Send Data in the Normal Transmission Mode in Expanded Ways	84
3.3.13	AT+CIPCLOSE: Close TCP/UDP/SSL Connection	85
3.3.14	AT+CIFSR: Obtain the Local IP Address and MAC Address	86
3.3.15	AT+CIPMUX: Enable/disable Multiple Connections	87
3.3.16	AT+CIPSERVER: Delete/create a TCP/SSL Server	88
3.3.17	AT+CIPSERVERMAXCONN: Query/Set the Maximum Connections Allowed by a Server	89

3.3.18	AT+CIPMODE: Query/Set the Transmission Mode	90
3.3.19	AT+CIPSTO: Query/Set the local TCP/SSL Server Timeout	91
3.3.20	AT+CIPSNTPCFG: Query/Set the Time Zone and the SNTP Server	92
3.3.21	AT+CIPSNTPTIME: Query the SNTP Time	93
3.3.22	AT+CIPSNTPINTV: Query/Set the SNTP time synchronization interval	94
3.3.23	AT+CIPFWVER: Query the Existing AT Firmware Version on the Server	94
3.3.24	AT+CIUPDATE: Upgrade Firmware Through Wi-Fi	95
3.3.25	AT+CIPDINFO: Set "+IPD" Message Mode	97
3.3.26	AT+CIPSSLCCONF: Query/Set SSL Clients	98
3.3.27	AT+CIPSSLCCN: Query/Set the Common Name of the SSL Client	99
3.3.28	AT+CIPSSLCSNI: Query/Set SSL Client Server Name Indication (SNI)	100
3.3.29	AT+CIPSSLCALPN: Query/Set SSL Client Application Layer Protocol Negotiation (ALPN)	100
3.3.30	AT+CIPSSLCPSK: Query/Set SSL Client Pre-shared Key (PSK) in String Format	101
3.3.31	AT+CIPSSLCPSKHEX: Query/Set SSL Client Pre-shared Key (PSK) in Hexadecimal Format	102
3.3.32	AT+CIPRECONNINTV: Query/Set the TCP/UDP/SSL reconnection Interval for the Wi-Fi Passthrough Mode	102
3.3.33	AT+CIPRECVMODE: Query/Set Socket Receiving Mode	103
3.3.34	AT+CIPRECVDATA: Obtain Socket Data in Passive Receiving Mode	104
3.3.35	AT+CIPRECVLEN: Obtain Socket Data Length in Passive Receiving Mode	105
3.3.36	AT+PING: Ping the Remote Host	106
3.3.37	AT+CIPDNS: Query/Set DNS Server Information	107
3.3.38	AT+CIPTCPOPT: Query/Set the Socket Options	108
3.4	Bluetooth® Low Energy AT Commands	109
3.4.1	Introduction	110
3.4.2	AT+BLEINIT: Bluetooth LE Initialization	111
3.4.3	AT+BLEADDR: Query/Set Bluetooth LE Device Address	112
3.4.4	AT+BLENAME: Query/Set Bluetooth LE Device Name	113
3.4.5	AT+BLESCANPARAM: Query/Set Parameters of Bluetooth LE Scanning	113
3.4.6	AT+BLESCAN: Enable Bluetooth LE Scanning	114
3.4.7	AT+BLESCANRSPDATA: Set Bluetooth LE Scan Response	115
3.4.8	AT+BLEADVPARAM: Query/Set Parameters of Bluetooth LE Advertising	116
3.4.9	AT+BLEADVDATA: Set Bluetooth LE Advertising Data	118
3.4.10	AT+BLEADVDATAEX: Automatically Set Bluetooth LE Advertising Data	118
3.4.11	AT+BLEADVSTART: Start Bluetooth LE Advertising	119
3.4.12	AT+BLEADVSTOP: Stop Bluetooth LE Advertising	120
3.4.13	AT+BLECONN: Establish Bluetooth LE Connection	121
3.4.14	AT+BLECONNPARAM: Query/Update Parameters of Bluetooth LE Connection	122
3.4.15	AT+BLEDISCONN: End Bluetooth LE Connection	123
3.4.16	AT+BLECFGMTU: Set Bluetooth LE MTU Length	124
3.4.17	AT+BLEGATTSSRV: GATTS Discovers Services	124
3.4.18	AT+BLEGATTSSCHAR: GATTS Discovers Characteristics	125
3.4.19	AT+BLEGATTSENTFY: Notify a Client of the Value of a Characteristic Value from the Server	126
3.4.20	AT+BLEGATTSSIND: Indicate the Characteristic Value from the Server to a Client	126
3.4.21	AT+BLEGATTSSSETATTR: GATTS Sets Characteristics	127
3.4.22	AT+BLEGATTCPRIMSRV: GATTC Discovers Primary Services	128
3.4.23	AT+BLEGATTCCINCLSRV: GATTC Discovers Included Services	129
3.4.24	AT+BLEGATTCCCHAR: GATTC Discovers Characteristics	130
3.4.25	AT+BLEGATTCCRD: GATTC Reads Characteristics	130
3.4.26	AT+BLEGATTCCWR: GATTC Writes Characteristics	131
3.4.27	AT+BLESPPCFG: Query/Set Bluetooth LE SPP Parameters	132
3.4.28	AT+BLESPPE: Enter Bluetooth LE SPP Mode	133
3.4.29	AT+BLESECPARAM: Query/Set Bluetooth LE Encryption Parameters	134
3.4.30	AT+BLEENC: Initiate Bluetooth LE Encryption Request	135
3.4.31	AT+BLEKEYREPLY: Reply the Key Value to the Peer Device	136
3.4.32	AT+BLECONFREPLY: Reply the Confirm Value to the Peer Device in the Legacy Connection Stage	137

3.4.33	AT+BLEENCDEV: Query Bonded Bluetooth LE Encryption Device List	137
3.4.34	AT+BLEENCCLEAR: Clear Bluetooth LE Encryption Device List	138
3.4.35	AT+BLESETKEY: Set Bluetooth LE Static Pair Key	138
3.4.36	AT+BLUFI: Start or Stop BluFi	139
3.4.37	AT+BLUFINAME: Query/Set BluFi Device Name	140
3.4.38	AT+BLUFISEND: Send User-Customized Data over BluFi	141
3.4.39	AT+BLEPERIODICDATA: Set Bluetooth LE periodic advertising data	142
3.4.40	AT+BLEPERIODICSTART: Start Bluetooth LE periodic advertising	142
3.4.41	AT+BLEPERIODICSTOP: Stop Bluetooth LE periodic advertising	143
3.4.42	AT+BLESYNCSTART: Start to synchronize with periodic advertising	143
3.4.43	AT+BLESYNCSTOP: Stop synchronizing with periodic advertising	144
3.4.44	AT+BLEREADPHY: Query the current transmitter PHY	144
3.4.45	AT+BLESETPHY: Set the current transmitter PHY	145
3.5	MQTT AT Commands	146
3.5.1	Introduction	146
3.5.2	AT+MQTTUSERCFG: Set MQTT User Configuration	146
3.5.3	AT+MQTTLONGCLIENTID: Set MQTT Client ID	147
3.5.4	AT+MQTTLONGUSERNAME: Set MQTT Username	148
3.5.5	AT+MQTTLONGPASSWORD: Set MQTT Password	148
3.5.6	AT+MQTTCONNCFG: Set Configuration of MQTT Connection	149
3.5.7	AT+MQTTALPN: Set MQTT Application Layer Protocol Negotiation (ALPN)	149
3.5.8	AT+MQTTSNI: Set MQTT Server Name Indication (SNI)	150
3.5.9	AT+MQTTCONN: Connect to MQTT Brokers	151
3.5.10	AT+MQTTPUB: Publish MQTT Messages in String	152
3.5.11	AT+MQTTPUBRAW: Publish Long MQTT Messages	153
3.5.12	AT+MQTTSUB: Subscribe to MQTT Topics	153
3.5.13	AT+MQTTUNSUB: Unsubscribe from MQTT Topics	154
3.5.14	AT+MQTTCLEAN: Close MQTT Connections	155
3.5.15	MQTT AT Error Codes	155
3.5.16	MQTT AT Notes	157
3.6	HTTP AT Commands	157
3.6.1	Introduction	157
3.6.2	AT+HTTPCLIENT: Send HTTP Client Request	157
3.6.3	AT+HTTPGETSIZE: Get HTTP Resource Size	159
3.6.4	AT+HTTPCGET: Get HTTP Resource	159
3.6.5	AT+HTTPCPOST: Post HTTP data of specified length	160
3.6.6	AT+HTTPCPUT: Put HTTP data of specified length	160
3.6.7	AT+HTTPURLCFG: Set/Get long HTTP URL	161
3.6.8	AT+HTTPCHEAD: Set/Query HTTP Request Headers	162
3.6.9	HTTP AT Error Codes	163
3.7	FileSystem AT Commands	164
3.7.1	Introduction	164
3.7.2	AT+FS: Filesystem Operations	164
3.7.3	AT+FSMOUNT: Mount/Unmount Filesystem	165
3.8	WebSocket AT Commands	166
3.8.1	Introduction	166
3.8.2	AT+WSCFG: Set the WebSocket Configuration	166
3.8.3	AT+WSHEAD: Set/Query WebSocket Request Headers	167
3.8.4	AT+WSOPEN: Query/Open a WebSocket Connection	168
3.8.5	AT+WSEND: Send Data to a WebSocket Connection	169
3.8.6	AT+WSCLOSE: Close a WebSocket Connection	170
3.9	Signaling Test AT Commands	170
3.9.1	Introduction	170
3.9.2	AT+FACTPLCP: Send with Long or Short PLCP	170
3.10	Web Server AT Commands	171
3.10.1	Introduction	171
3.10.2	AT+WEBSERVER: Enable/disable Wi-Fi connection configuration via Web server	171
3.11	Driver AT Commands	172

3.11.1	Introduction	172
3.11.2	AT+DRVADC: Read ADC Channel Value	172
3.11.3	AT+DRVPWMINIT: Initialize PWM Driver	173
3.11.4	AT+DRVPWMDUTY: Set PWM Duty	174
3.11.5	AT+DRVPWMFADE: Set PWM Fade	175
3.11.6	AT+DRVI2CINIT: Initialize I2C Master Driver	175
3.11.7	AT+DRVI2CRD: Read I2C Data	176
3.11.8	AT+DRVI2CWRDATA: Write I2C Data	176
3.11.9	AT+DRVI2CWRBYTES: Write No More Than 4 Bytes I2C Data	177
3.11.10	AT+DRVSPICONFGPIO: Configure SPI GPIO	178
3.11.11	AT+DRVSPIINIT: Initialize SPI Master Driver	178
3.11.12	AT+DRVSPIRD: Read SPI Data	179
3.11.13	AT+DRVSPIWR: Write SPI Data	180
3.12	User AT Commands	181
3.12.1	Introduction	181
3.12.2	AT+USERRAM: Operate user's free RAM	181
3.12.3	AT+USEROTA: Upgrade the Firmware According to the Specified URL	182
3.12.4	AT+USERWKMCUCFG: Configure How AT Wakes Up MCU	184
3.12.5	AT+USERMCUSLEEP: MCU Indicates Its Sleep State	185
3.12.6	AT+USERDOCS: Query the ESP-AT User Guide for Current Firmware	185
3.13	AT Command Types	186
3.14	AT Commands with Configuration Saved in the Flash	187
3.15	AT Messages	187
<b>4</b>	<b>AT Command Examples</b>	<b>191</b>
4.1	AT Response Message Format Control Examples	191
4.1.1	Enable the system message filter to download files in HTTP passthrough mode	191
4.2	TCP/IP AT Examples	193
4.2.1	ESP32-C2 as a TCP client in single connection	194
4.2.2	ESP32-C2 as a TCP server in multiple connections	195
4.2.3	UDP transmission with fixed remote IP address and port	197
4.2.4	UDP transmission with changeable remote IP address and port	199
4.2.5	ESP32-C2 as an SSL client in single connection	201
4.2.6	ESP32-C2 as an SSL server in multiple connections	202
4.2.7	ESP32-C2 as an SSL client to create a single connection with mutual authentication	204
4.2.8	ESP32-C2 as an SSL server to create multiple connections with mutual authentication	206
4.2.9	UART Wi-Fi passthrough transmission when the ESP32-C2 works as a TCP client in single connection	208
4.2.10	UART Wi-Fi passthrough transmission when the ESP32-C2 works as a TCP server	210
4.2.11	UART Wi-Fi passthrough transmission when the ESP32-C2 works as a softAP in UDP transparent transmission	212
4.2.12	ESP32-C2 obtains socket data in passive receiving mode	214
4.3	Bluetooth LE AT Examples	215
4.3.1	Introduction	215
4.3.2	Bluetooth LE client reads and write services	217
4.3.3	Encrypt Bluetooth LE connection	220
4.3.4	Establish SPP connection between two ESP32-C2 development boards and transmit data in UART-Bluetooth LE Passthrough Mode	224
4.3.5	Establish SPP connection between ESP32-C2 and mobile phone and transmit data in UART-Bluetooth LE passthrough mode	227
4.3.6	Establish Bluetooth LE connection and pairing between ESP32-C2 and mobile phone	229
4.4	MQTT AT Examples	231
4.4.1	MQTT over TCP (with a local MQTT broker)(suitable for a small amount of data)	231
4.4.2	MQTT over TCP (with a local MQTT broker)(suitable for large amounts of data)	233
4.4.3	MQTT over TLS (with a local MQTT broker)	234
4.4.4	MQTT over WSS	236
4.5	MQTT AT Examples for Cloud	238
4.5.1	Obtain certificates and endpoints from AWS IoT	238

4.5.2	Connect to AWS IoT based on mutual authentication with MQTT AT commands . . . . .	238
4.6	Web Server AT Example . . . . .	240
4.6.1	Wi-Fi Provisioning Using a Browser . . . . .	240
4.6.2	OTA Firmware Upgrade Using a Browser . . . . .	248
4.6.3	Wi-Fi Provisioning Using a WeChat Applet . . . . .	253
4.6.4	OTA Firmware Upgrade Using a WeChat Applet . . . . .	264
4.6.5	ESP32-C2 Using Captive Portal . . . . .	264
4.7	HTTP AT Examples . . . . .	265
4.7.1	The HEAD method of HTTP client . . . . .	265
4.7.2	The GET method of HTTP client . . . . .	266
4.7.3	The POST method of HTTP client (suitable for POST small amount of data) . . . . .	267
4.7.4	The POST method of HTTP client (recommended method) . . . . .	268
4.7.5	The PUT method of HTTP client (suitable for no data put) . . . . .	270
4.7.6	The PUT method of HTTP client (recommended method) . . . . .	271
4.7.7	The DELETE method of HTTP client . . . . .	273
4.8	Sleep AT Examples . . . . .	274
4.8.1	Introduction . . . . .	274
4.8.2	Set Modem-sleep mode in Wi-Fi mode . . . . .	275
4.8.3	Set Light-sleep mode in Wi-Fi mode . . . . .	276
4.8.4	Set Deep-sleep mode . . . . .	277
<b>5</b>	<b>ESP-AT Versions . . . . .</b>	<b>279</b>
5.1	Releases . . . . .	279
5.2	Which Version Should I Start With? . . . . .	279
5.3	Versioning Scheme . . . . .	279
5.3.1	ESP-AT Firmware Release Management . . . . .	279
5.3.2	ESP-AT Branch Release Management . . . . .	280
5.4	Support Periods . . . . .	280
5.5	Check the Current AT Firmware Version . . . . .	281
5.6	Subscribe to AT Releases . . . . .	281
5.6.1	Step 1: Log in to Your GitHub Account . . . . .	282
5.6.2	Step 2: Choose Customized Notifications . . . . .	282
5.6.3	Step 3: Apply for Release Notifications . . . . .	282
<b>6</b>	<b>How to Compile and Develop Your Own AT Project . . . . .</b>	<b>285</b>
6.1	Compile ESP-AT Project Locally . . . . .	285
6.1.1	Detailed Steps . . . . .	285
6.1.2	Step 1. Get Started with ESP-IDF . . . . .	285
6.1.3	Step 2. Get ESP-AT . . . . .	286
6.1.4	Step 3. Install Environment . . . . .	286
6.1.5	Step 4. Connect Your Device . . . . .	287
6.1.6	Step 5. Configure . . . . .	287
6.1.7	Step 6. Build the Project . . . . .	287
6.1.8	Step 7. Flash onto the Device . . . . .	288
6.1.9	build.py Advanced Usage . . . . .	288
6.2	Compile ESP-AT Project on the GitHub Webpage . . . . .	288
6.2.1	Detailed Steps . . . . .	288
6.2.2	Step 1. Log in to your GitHub account . . . . .	289
6.2.3	Step 2. Fork the ESP-AT project . . . . .	289
6.2.4	Step 3. Enable GitHub Actions . . . . .	289
6.2.5	Step 4. Configure the secrets required to compile the ESP-AT project . . . . .	291
6.2.6	Step 5. Use the github.dev editor to modify and submit the code . . . . .	293
6.2.7	Step 6. Compile the AT firmware using GitHub Actions . . . . .	302
6.3	How to Set AT Port Pins . . . . .	302
6.3.1	ESP32-C2 Series . . . . .	302
6.4	How to add user-defined AT commands . . . . .	303
6.4.1	Define AT Commands . . . . .	303
6.4.2	Register AT Commands . . . . .	305

6.4.3	Give it a try	305
6.4.4	Define Return Values	306
6.4.5	Access Command Parameters	307
6.4.6	Omit Command Parameters	307
6.4.7	Block Command Execution	310
6.4.8	Access Input Data from AT Command Port	310
6.5	How to Improve ESP-AT Throughput Performance	313
6.5.1	[Simple] Quick Configuration	314
6.5.2	[Recommended] Understand Data Stream and Make the Precise Configuration	315
6.6	How to Update mfg_nvs Partition	317
6.6.1	mfg_nvs Partition	317
6.6.2	Generate mfg_nvs.bin	317
6.7	How to Update Factory Parameters	318
6.7.1	Factory Parameter Configuration	318
6.8	How to Update PKI Configuration	319
6.8.1	Introduction to PKI Configuration	319
6.9	How to Customize Bluetooth® LE Services	320
6.9.1	Bluetooth LE Service Source File	321
6.9.2	Customize Bluetooth LE Services during Compilation	322
6.10	How to Customize Partitions	323
6.10.1	Modify at_customize.csv	324
6.10.2	Generate at_customize.bin	324
6.10.3	Flash at_customize.bin into ESP32-C2 Device	324
6.10.4	Example	325
6.11	How to Add Support for a Module	325
6.11.1	Add Module to factory_param_data.csv	327
6.11.2	Modify esp_at_module_info Structure	327
6.11.3	Configure the Module	328
6.12	SPI AT Guide	328
6.12.1	Overview	328
6.12.2	How to Use SPI AT?	329
6.12.3	SPI AT Throughput	332
6.13	How to Implement OTA Upgrade	332
6.13.1	Comparison Among OTA Commands and Their Application Scenarios	333
6.13.2	Perform OTA Upgrade with ESP-AT OTA Commands	334
6.14	How to Update the ESP-IDF Version	337
6.15	ESP-AT Firmware Differences	340
6.15.1	ESP32-C2 Series	340
6.16	How to Download the Latest Temporary Version of AT Firmware from GitHub	342
6.17	at.py Tool	342
6.17.1	Detailed Steps	347
6.17.2	Step 1: Install Python	347
6.17.3	Step 2: Download at.py	347
6.17.4	Step 3: Use at.py	348
6.17.5	Step 4: Examples: Modify Firmware Configurations with at.py	348
6.18	AT API Reference	351
6.18.1	Header File	351
6.18.2	Functions	351
6.18.3	Structures	354
6.18.4	Macros	356
6.18.5	Type Definitions	357
6.18.6	Enumerations	357
6.18.7	Header File	360
6.18.8	Functions	360
6.18.9	Macros	360
6.18.10	Enumerations	360







<b>8</b>	<b>AT FAQ</b>	<b>365</b>
8.1	AT Firmware	366
8.1.1	There is no released firmware for my module. Where can I get the firmware for it?	366
8.1.2	How to get the source code of AT firmware?	366
8.1.3	How to download the AT firmware on Espressif's official website?	366
8.1.4	How to combine all the bin files compiled by ESP-AT?	366
8.1.5	Does the AT firmware shipped in modules support flow control?	366
8.2	AT Commands and Responses	366
8.2.1	What is the reason why AT prompts busy?	366
8.2.2	Why does the ESP-AT firmware always return the following message after the I powered up the device and sent the first command?	367
8.2.3	What commands are supported by the default ESP-AT firmware on different modules, and from which version are they supported?	367
8.2.4	When the host MCU sends an AT command to the ESP32-C2 device, there is no response. What is the reason?	367
8.2.5	Why is Wi-Fi disconnected (WIFI_DISCONNECT printed)?	367
8.2.6	What are the common Wi-Fi compatibility issues?	367
8.2.7	Do AT commands support ESP-WIFI-MESH?	368
8.2.8	Does AT support websocket commands?	368
8.2.9	Can AT command set Bluetooth LE transmit power?	368
8.2.10	How to support commands that are not supported by the default firmware but can be supported after configuring and compiling the ESP-AT project?	368
8.2.11	How to handle special characters in AT commands?	368
8.2.12	Can the serial port baudrate be modified in AT Commands? (Default: 115200)	368
8.2.13	After ESP32-C2 enters the passthrough mode using AT commands, can ESP32-C2 give a message if the connected hotspot is disconnected?	368
8.2.14	How to enable the notify and indicate functions on Bluetooth LE clients?	368
8.3	Hardware	369
8.3.1	How big is the chip flash required for ESP-AT firmware on different modules?	369
8.3.2	How to view the error log of AT firmware?	369
8.3.3	The UART1 communication pin used by ESP-AT on the ESP32-C2 module is inconsistent with the default UART1 pin described in the ESP32-C2 module's datasheet?	369
8.4	Performance	369
8.4.1	How long does it take for the AT to connect to Wi-Fi?	369
8.4.2	Is it possible to change the TCP send window size in AT firmware?	369
8.4.3	How to test and optimize the throughput of ESP32-C2 AT?	370
8.5	Other	370
8.5.1	What interfaces of ESP32-C2 chips can be used to transmit AT commands?	370
8.5.2	How does ESP-AT conduct BQB certification?	370
8.5.3	How do I specify the TLS protocol version for ESP32-C2 AT?	370
8.5.4	How to modify the number of TCP connections in AT?	370
8.5.5	Does ESP32-C2 AT support PPP?	370
8.5.6	How to enable debug log for AT?	370
<b>9</b>	<b>Index of Abbreviations</b>	<b>373</b>
<b>10</b>	<b>Disclaimer</b>	<b>379</b>
10.1	Application Scenario Verification	379
10.2	Compatibility	379
10.3	Server Upgrade Considerations	379
10.4	Wireless Solution Issue Handling	379
10.5	Usage Restrictions	380
10.6	Limitation of Liability	380
10.7	Third-Party Software and Technology	380
10.8	Data Protection	380
10.9	Version Updates and Maintenance	380
10.10	Disclaimer Updates	380
10.11	User Responsibility	380

<b>11 About</b>	<b>381</b>
<b>Index</b>	<b>383</b>
<b>Index</b>	<b>383</b>

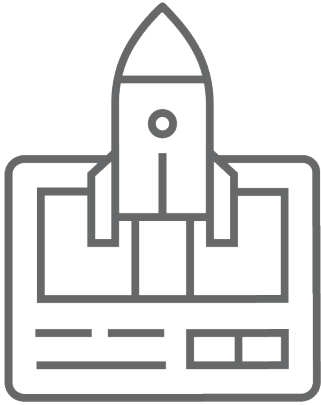

This is the documentation for [ESP-AT Development Framework](#). ESP-AT project was started and powered by [Espressif Systems](#) as an official project, for the [ESP32](#), [ESP32-C2](#), [ESP32-C3](#), [ESP32-C6](#), and [ESP32-S2 Series SoCs](#) provided for Windows, Linux, and macOS.

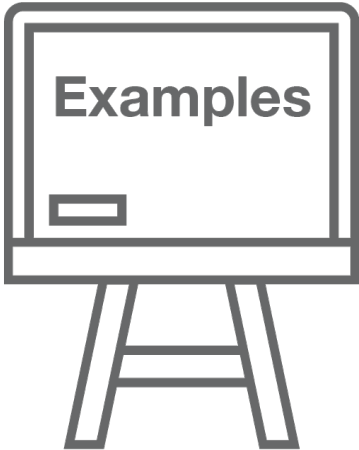
**This document describes using ESP-AT with the ESP32-C2 SoC.**

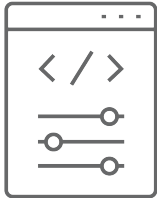
		
<p><a href="#">Get Started</a></p>	<p><a href="#">AT Binary Lists</a></p>	<p><a href="#">AT Command Set</a></p>
		
<p><a href="#">AT Command Examples</a></p>	<p><a href="#">Compile and Develop</a></p>	<p><a href="#">Customized AT Commands and Firmware</a></p>



# Chapter 1

## Get Started

This Get Started guide provides users with detailed information on what is ESP-AT, technology selection, how to connect hardware, and how to download and flash AT firmware. It consists of the following parts:

### 1.1 What is ESP-AT

---

**Important:** Before using the ESP-AT, please read the [Disclaimer](#) carefully and comply with its terms and precautions.

---

ESP-AT is a solution developed by Espressif to integrate connectivity into customers' products, which can be quickly moved to mass production. It aims to reduce software development costs and quickly form products. With ESP-AT commands, you can quickly join the wireless network, connect to the cloud platform, realize data transmission and remote control functions, and realize the interconnection of everything through wireless communication easily.

ESP-AT is a project based on ESP-IDF. It makes an ESP32-C2 board work as a slave, and an MCU as a host. The host MCU sends AT commands to the ESP32-C2 chip and receives AT responses back. ESP-AT provides a wide range of AT commands with different functions, such as Wi-Fi commands, TCP/IP commands, Bluetooth LE commands, Bluetooth commands, MQTT commands, HTTP commands, and Ethernet commands.

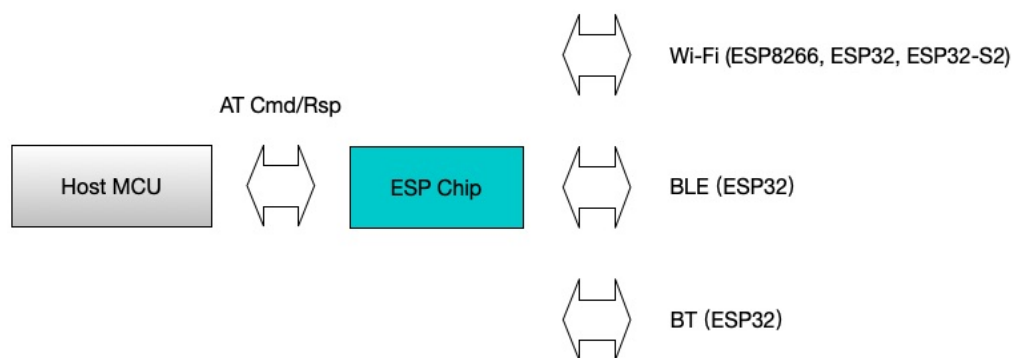

Fig. 1: ESP-AT Overview

AT commands start with “AT” , which stand for “Attention” , and end with a new line (CR LF). Every time you send a command, you will receive an OK or ERROR, which indicates the final execution status of the current command. Please be noted that all commands are executed serially, which means only one AT command can be executed at a time. Therefore, you should wait for the previous command to be executed before sending out the next one. Otherwise, you will receive `busy p . . .`. For more details about AT commands, please refer to [AT Command Set](#).

By default, the host MCU connects to the ESP32-C2 board via UART, and sends/receives AT commands/responses through UART. But you can also use other interfaces, such as SDIO, according to your actual use scenario.

You can develop your own AT commands based on our ESP-AT project and implement more features according to your actual use scenario.

## 1.2 Technology Selection

This document mainly introduces how to choose the right Espressif hardware product, AT software solution, and the initial preparation for your project.

---

**Important:** If you have any questions regarding the selection of Espressif hardware products or AT software solutions, please contact [Espressif Sales](#) or [Technical Support](#).

---

### 1.2.1 Hardware Selection

Before using ESP-AT, you need to select a suitable Espressif chip to integrate into your product, empowering it with wireless capabilities. Hardware selection is a complex process that requires consideration of various factors such as functionality, power consumption, cost, size, etc. Please read the following content to help you choose the hardware.

- [Product Selector Tool](#) can help you understand the hardware differences of different Espressif products.
- [Datasheets](#) can help you understand the hardware capabilities supported by the chip/module.
- [Board Selection Guide](#) can help you compare the differences between chips, modules, and development boards and provide selection guidance.

---

**Note:** The datasheets indicate the maximum hardware capabilities and do not represent the capabilities of the AT software. For example, the ESP32-C6 chip supports Zigbee 3.0 and Thread 1.3, but the existing AT software solutions do not support these two wireless protocols.

---

### 1.2.2 AT Software Solution Selection

AT software solution is the AT firmwares provided by Espressif for different chips, which can help you quickly implement wireless functionality.

- If you want to know the detailed AT software capabilities of ESP32-C2 chip, please refer to the [AT Command Set](#).
- If you want to compare the different AT firmware functionalities of ESP32-C2 chip, please refer to the [ESP-AT Firmware Differences](#).

The table below shows a brief comparison of the AT firmware for different chips.

Chip	Wireless	AT Firmware	Description
ESP32-C6	<b>Wi-Fi 6</b> + BLE 5.0	v4.0.0.0	
ESP32-C3	Wi-Fi 4 + BLE 5.0	v3.3.0.0	
ESP32-C2	Wi-Fi 4 (or BLE 5.0)	v3.3.0.0	
ESP32	Wi-Fi 4 + BLE v4.2 (+ <b>BT</b> )	v3.4.0.0	
ESP32-S2	Wi-Fi 4	v3.4.0.0	It is recommended to use the more cost-effective ESP32-C series.

- (or BLE 5.0) indicates that Bluetooth LE functionality is supported in the AT software solution, but it is not included in the released firmware.
- (+ BT) indicates that Classic Bluetooth functionality is supported in the AT software solution, but it is not included in the released firmware.

**Note:** The modules or chips from the factory are not preloaded with AT firmware. If you have mass production requirements, please contact the corresponding business personnel or [sales@espressif.com](mailto:sales@espressif.com) in a timely manner, and we will provide customized production.

### Which Type of AT Firmware Shall I Choose?

ESP-AT firmware has the following types. Among them, the workload of downloading or preparing firmware increases from top to bottom, and so does the number of supported module types.

- *Officially Released Firmware (Recommended)*
- *GitHub Temporary Firmware*
- *Firmware with Updated Parameters*
- *Self-Compiled Firmware*

**Officially Released Firmware (Recommended)** Officially released firmware, also known as “released firmware”, “official firmware” or “default firmware”, has passed testing and periodically released by Espressif’s official team according to the internal development plan. It can be upgraded directly based on the Espressif OTA server. If it fully matches your project needs, it is recommended to choose it over the other types of firmware. If it does not support your module, you can select a firmware that has a similar hardware configuration to your module according to *Hardware Differences* for testing and verification.

- How to obtain firmware: *ESP32-C2 AT firmware*
- Pros:
  - Stable
  - Reliable
  - Small workload of obtaining firmware
- Cons:
  - Long update cycle
  - A limited number of supported modules
- Reference documentation:
  - *Hardware connection*
  - *Firmware Downloading and Flash*
  - For which chip series are supported and unsupported by ESP-AT firmware, please refer to ESP-AT GitHub home page [readme.md](#)



**GitHub Temporary Firmware** **GitHub temporary firmware** is compiled by GitHub whenever code is pushed to GitHub and yet does not reach the firmware release cycle. In other words, it is the firmware in development, including the temporary versions of **officially released firmware** and supported firmware that is not planned for release. The former can be upgraded directly based on the Espressif OTA server.

- How to obtain firmware: Please refer to [How to Download the Latest Temporary Version of AT Firmware from GitHub](#).
- Pros:
  - Real-time integration of new features and bug fixes.
  - Covering some unofficially released firmware, such as firmware based on SDIO communication and firmware based on SPI communication.
  - Small workload of obtaining firmware.
- Cons: As the firmware compiled based on commits that are not for official release has not been thoroughly tested, there may be some risks. You need to do a complete test by yourself.

**Firmware with Updated Parameters** The **firmware with updated parameters** is generated by updating the parameter area and you do not need to compile the firmware. It is suitable for the case where the firmware function meets the project requirements, but only some parameters do not, such as the UART baud rate and UART GPIO pins. This type of firmware can be directly upgraded based on the Espressif OTA server.

- For how to modify those parameters, please refer to [at.py Tool](#).
- Pros:
  - No need to recompile the firmware.
  - The firmware is stable and reliable.
- Cons: Requiring modification to released firmware, long update cycle, and a limited number of supported modules.

**Self-Compiled Firmware** When you need to conduct secondary development, you can compile the firmware by yourself. To support the OTA function, you need to deploy your own OTA server.

- For how to compile the firmware by yourself, please refer to [Compile ESP-AT Project Locally](#).
- Pros: You can control functions and cycles.
- Cons: You need to set up the compilation environment.

If stability is your priority, it is recommended to develop your AT firmware based on the latest released version corresponding to the chip. If you want more new features, it is recommended to develop your AT firmware based on the [master branch](#).

### 1.2.3 Initial Project Preparation

During the initial project preparation phase, it is **strongly recommended** that you choose [Espressif development boards](#) to start your project. In the early stages of the project, it can help you quickly validate prototypes, evaluate hardware and software capabilities, and reduce project risks. In the middle stages of the project, it can help you quickly integrate and verify functions, optimize performance, and improve development efficiency. In the later stages of the project, it can help you quickly simulate and locate issues, and achieve rapid product iteration.

If you are using [Self-Compiled Firmware](#), it is recommended to prioritize using Linux as the development environment.

## 1.3 Hardware Connection

This document introduces what hardware you need to prepare and how to connect them in order to download AT firmware, send AT commands, and receive AT responses.

The commands supported by each series of AT firmware vary, and its compatibility with modules or chips also differs. For more information, refer to [ESP-AT Firmware Differences](#).

If you don't want to use the default AT pin, you can refer to the [How to Set AT Port Pins](#) document to change the pin.

### 1.3.1 What You Need

Table 1: List of Components Required for ESP-AT Testing

Component	Function
ESP32-C2 board	Slave MCU.
USB cable (ESP32-C2 board to PC)	Download/Log output connection.
PC	Act as Host MCU. Download firmware to Slave MCU.
USB cable (PC to serial port converter)	AT command/response connection.
USB to serial port converter	Convert between USB signals and TTL signals.
Jumper wires (serial port converter to ESP32-C2 board)	AT command/response connection.

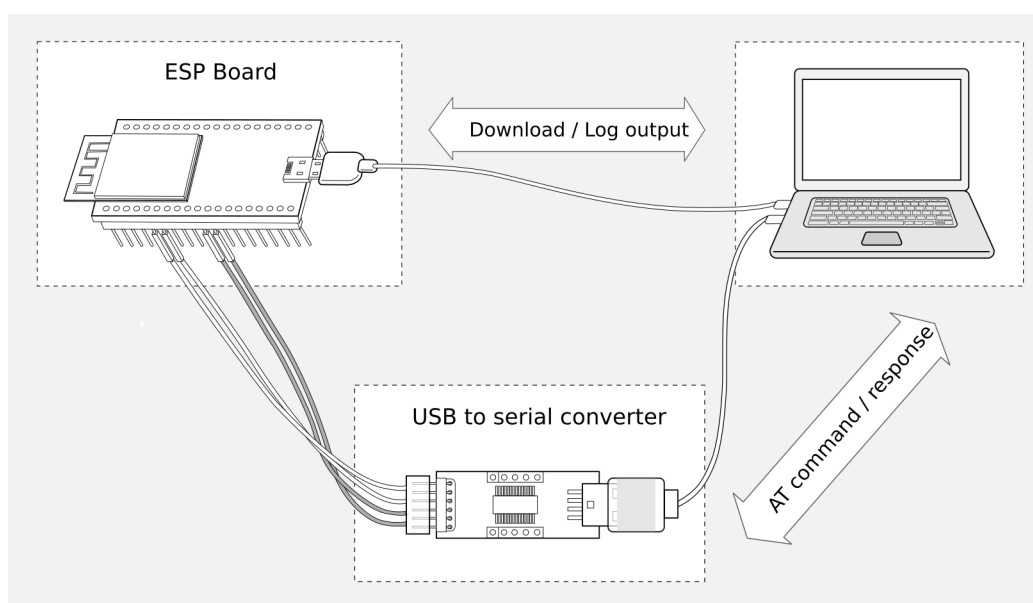

Fig. 2: Connection of Components for ESP-AT Testing

Note:

- The official default [AT Binary Lists](#) only supports 26 MHz crystal oscillator. If your crystal oscillator of ESP32-C2 is 40 MHz, please refer to [Compile ESP-AT Project Locally](#) document to compile ESP32-C2 AT firmware, and configurate in the step 5:

```
python build.py menuconfig -> Component config -> Hardware Settings -> Main
↳ XTAL Config -> Main XTAL frequency -> 40 MHz
```

- In the above picture, four jump wires are used to connect the ESP32-C2 board and USB to serial converter. If you do not use hardware flow control, two wires connecting TX/RX and a simpler converter will be enough.
- If you use an ESP32-C2 module instead of a development board and flash firmware via UART, you need to reserve the UART pins (refer to [https://www.espressif.com/sites/default/files/documentation/esp8684\\_datasheet\\_en.pdf](https://www.espressif.com/sites/default/files/documentation/esp8684_datasheet_en.pdf) > Section Pin Description for more details) and one of the following conditions needs to be met:
  - Reserve the Strapping pins (refer to [https://www.espressif.com/sites/default/files/documentation/esp8684\\_datasheet\\_en.pdf](https://www.espressif.com/sites/default/files/documentation/esp8684_datasheet_en.pdf) > Section Strapping Pins for more details), and enter the download mode by controlling the Strapping pin level.
  - Enter the download mode by sending `AT+RST=1,1` command.

### 1.3.2 ESP32C2-4MB Series

ESP32C2-4MB series refer to the module or board that has a built-in ESP32-C2/ESP8684 chip with a 4 MB flash, such as ESP32-C2 MINI series device and ESP32-C2 WROOM series device.

ESP32C2-4MB AT uses two UART ports: UART0 is used to download firmware and log output; UART1 is used to send AT commands and receive AT responses. Both UART0 and UART1 use 115200 baud rate for communication by default.

Table 2: ESP32C2-4MB Series Hardware Connection Pinout

Function of Connection	ESP32C2-4MB Board or Module Pins	Other Device Pins
Download/Log output <sup>1</sup>	<b>UART0</b> <ul style="list-style-type: none"> <li>• GPIO19 (RX)</li> <li>• GPIO20 (TX)</li> </ul>	<b>PC</b> <ul style="list-style-type: none"> <li>• TX</li> <li>• RX</li> </ul>
AT command/response <sup>2</sup>	<b>UART1</b> <ul style="list-style-type: none"> <li>• GPIO6 (RX)</li> <li>• GPIO7 (TX)</li> <li>• GPIO5 (CTS)</li> <li>• GPIO4 (RTS)</li> </ul>	<b>USB to serial converter</b> <ul style="list-style-type: none"> <li>• TX</li> <li>• RX</li> <li>• RTS</li> <li>• CTS</li> </ul>

**Note 1:** Connection between individual pins of the ESP32C2-4MB board and the PC is already established internally on the ESP32C2-4MB board. You only need to provide USB cable between the board and PC.

**Note 2:** Connection between CTS/RTS is optional, depending on whether you want to use hardware flow control.

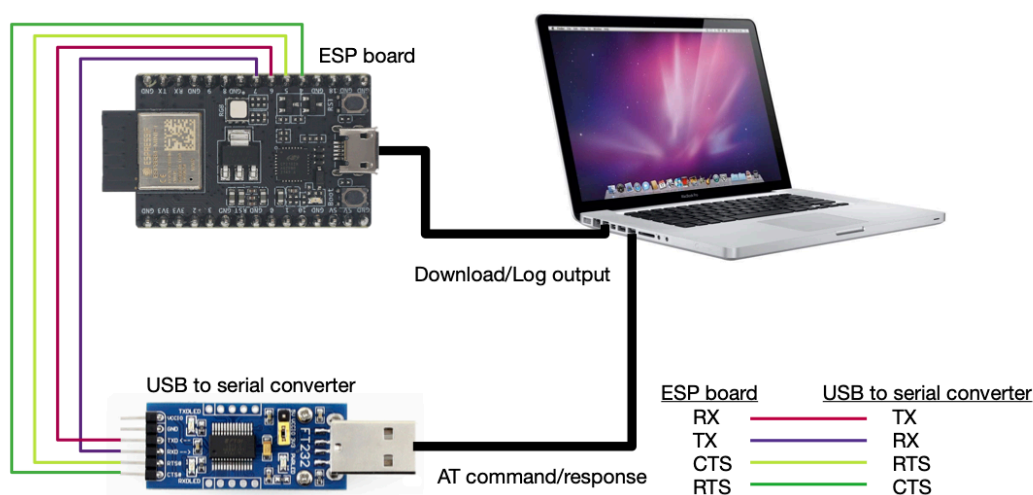

Fig. 3: ESP32C2-4MB Series Hardware Connection

If you want to connect your device directly with ESP32C2-4MB module rather than the ESP32C2-4MB board that integrates it, please refer to the corresponding module [datasheet](#) for more details.

### 1.3.3 ESP32C2-2MB Series

ESP32C2-2MB series refers to the module or board that has a built-in ESP32-C2/ESP8684 chip with a 2 MB flash.

ESP32C2-2MB AT uses two UART ports: UART0 is used to download firmware and log output; UART1 is used to send AT commands and receive AT responses. Both UART0 (GPIO8, used to output log) and UART1 use 115200 baud rate for communication by default. The log is outputted at 74880 baud rate at the ROM stage, so if you need to view the ROM log, please open UART0 (TX: GPIO20) at 74880 baud rate.

Table 3: ESP32C2-2MB Series Hardware Connection Pinout

Function of Connection	ESP32C2-2MB Board or Module Pins	Other Device Pins
Download/Log output <sup>1</sup>	<b>UART0</b> <ul style="list-style-type: none"> <li>GPIO19 (RX)</li> <li>GPIO20 (TX)</li> </ul>	<b>PC</b> <ul style="list-style-type: none"> <li>TX</li> <li>RX</li> </ul>
AT command/response <sup>2</sup>	<b>UART1</b> <ul style="list-style-type: none"> <li>GPIO6 (RX)</li> <li>GPIO7 (TX)</li> <li>GPIO5 (CTS)</li> <li>GPIO4 (RTS)</li> </ul>	<b>USB to serial converter</b> <ul style="list-style-type: none"> <li>TX</li> <li>RX</li> <li>RTS</li> <li>CTS</li> </ul>
Log output	<b>UART0</b> <ul style="list-style-type: none"> <li>GPIO8 (TX)</li> </ul>	<b>USB to serial converter</b> <ul style="list-style-type: none"> <li>RX</li> </ul>

**Note 1:** Connection between individual pins of the ESP32C2-2MB board and the PC is already established internally on the ESP32C2-2MB board. You only need to provide USB cable between the board and PC.

**Note 2:** Connection between CTS/RTS is optional, depending on whether you want to use hardware flow control.

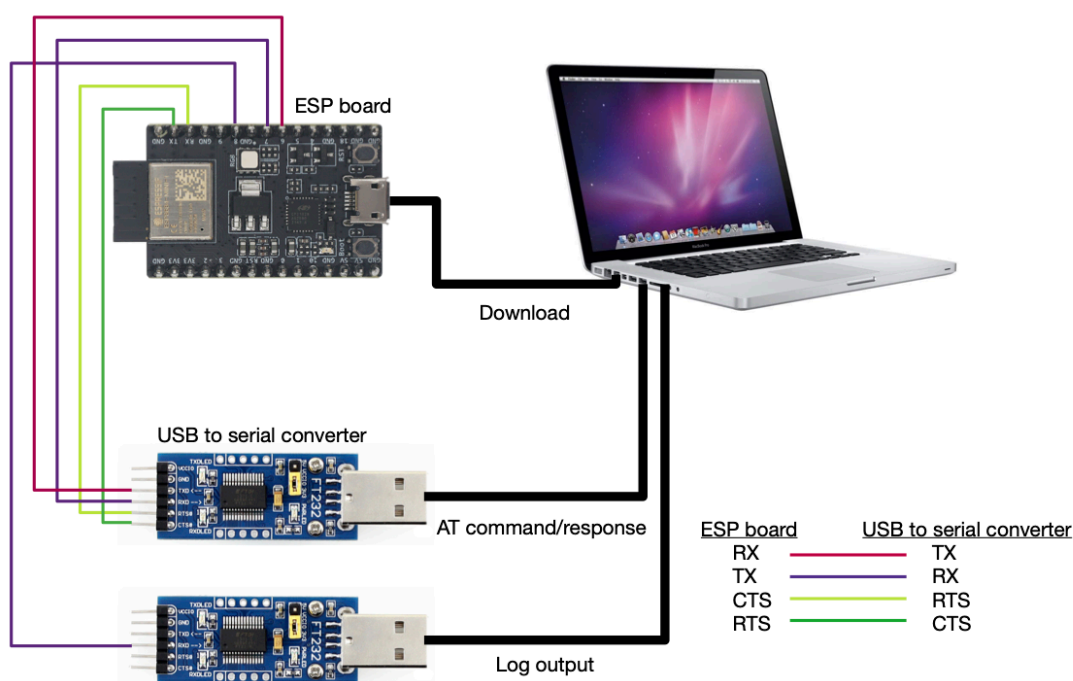

Fig. 4: ESP32C2-2MB Series Hardware Connection

If you want to connect your device directly with ESP32C2-2MB module rather than the ESP32C2-2MB board that integrates it, please refer to the corresponding module [datasheet](#) for more details.

## 1.4 Downloading Guide

This Guide demonstrates how to download AT firmware and flash it into an ESP8684-MINI-1 device by taking ESP8684-MINI-1 as an example. The Guide is also applicable to other ESP32-C2 modules.

Before you start, please make sure you have already connected your hardware. For more details, see [Hardware Connection](#).

For different series of modules, the commands supported by AT firmware are different. Please refer to [ESP-AT Firmware Differences](#) for more details.

### 1.4.1 Download AT Firmware

To download AT firmware to your computer, please do as follows:

- Navigate to [AT Binary Lists](#)
- Find the firmware for your device
- Click the link to download it

Here, we download ESP32C2-4MB-AT-V3.3.0.0 for ESP8684-MINI-1. The list below describes the structure of this firmware and what each bin file contains. Other AT firmware has similar structure and bin files.

```

.
├── at_customize.bin           // secondary partition table
├── bootloader                 // bootloader
│   └── bootloader.bin
├── customized_partitions     // AT customized binaries
│   ├── mfg_nvs.csv           // raw data of manufacturing nvs partition
│   └── mfg_nvs.bin           // manufacturing nvs partition binary
├── download.config           // configuration of downloading
├── esp-at.bin                 // AT application binary
├── esp-at.elf
├── esp-at.map
├── factory                   // A combined bin for factory downloading
│   └── factory_XXX.bin
├── flasher_args.json         // flasher arguments
├── ota_data_initial.bin      // ota data parameters
├── partition_table           // primary partition table
│   └── partition-table.bin
└── sdkconfig                 // compilation configuration for AT firmware

```

The file `download.config` contains the configuration to flash the firmware into multiple addresses:

```

--flash_mode dio --flash_freq 60m --flash_size 4MB
0x0 bootloader/bootloader.bin
0x8000 partition_table/partition-table.bin
0xd000 ota_data_initial.bin
0x1e000 at_customize.bin
0x1f000 customized_partitions/mfg_nvs.bin
0x60000 esp-at.bin

```

- `--flash_mode dio` means the firmware is compiled with flash DIO mode.
- `--flash_freq 60m` means the firmware's flash frequency is 60 MHz.
- `--flash_size 4MB` means the firmware is using flash size 4 MB.

- `0xd000 ota_data_initial.bin` means downloading `ota_data_initial.bin` into the address `0xd000`.

## 1.4.2 Flash AT Firmware into Your Device

Follow the instructions below for your operating system.

### Windows

Before starting to flash, you need to download [Flash Download Tools for Windows](#). For more details about the tools, please see the `doc` folder in the zip folder.

- Open the ESP32-C2 Flash Download Tool.
- Select `chipType`. (Here, we select `ESP32-C2`.)
- Select a `workMode` according to your need. (Here, we select `Developer Mode`.)
- Select a `loadMode` according to your need. (Here, we select `uart`.)

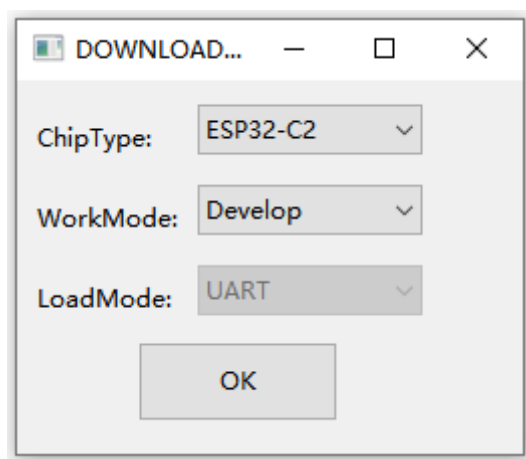

Fig. 5: Firmware Download Configurations

- Flash AT firmware into your device. You can select either of the two ways below.
  - To download one combined factory bin (namely, `factory_XXX.bin` in the `build/factory` directory) to address 0, select “DoNotChgBin” to use the default configuration of the factory bin.
  - To download multiple bins separately to different addresses, set up the configurations according to the file `download.config` and do NOT select “DoNotChgBin”.

In case of flashing issues, please verify what the COM port number of download interface of the ESP32-C2 board is and select it from “COM:” dropdown list. If you do not know the port number, you can refer to [Check port on Windows](#) for details.

When you finish flashing, please [Check Whether AT Works](#).

### Linux or macOS

Before you start to flash, you need to install `esptool.py`.

You can select either of the two ways below to flash AT firmware into your device.

- To download the bins separately into multiple addresses, enter the following command and replace `PORTNAME` and `download.config`:

```
esptool.py --chip auto --port PORTNAME --baud 115200 --before default_reset --
↪after hard_reset write_flash -z download.config
```

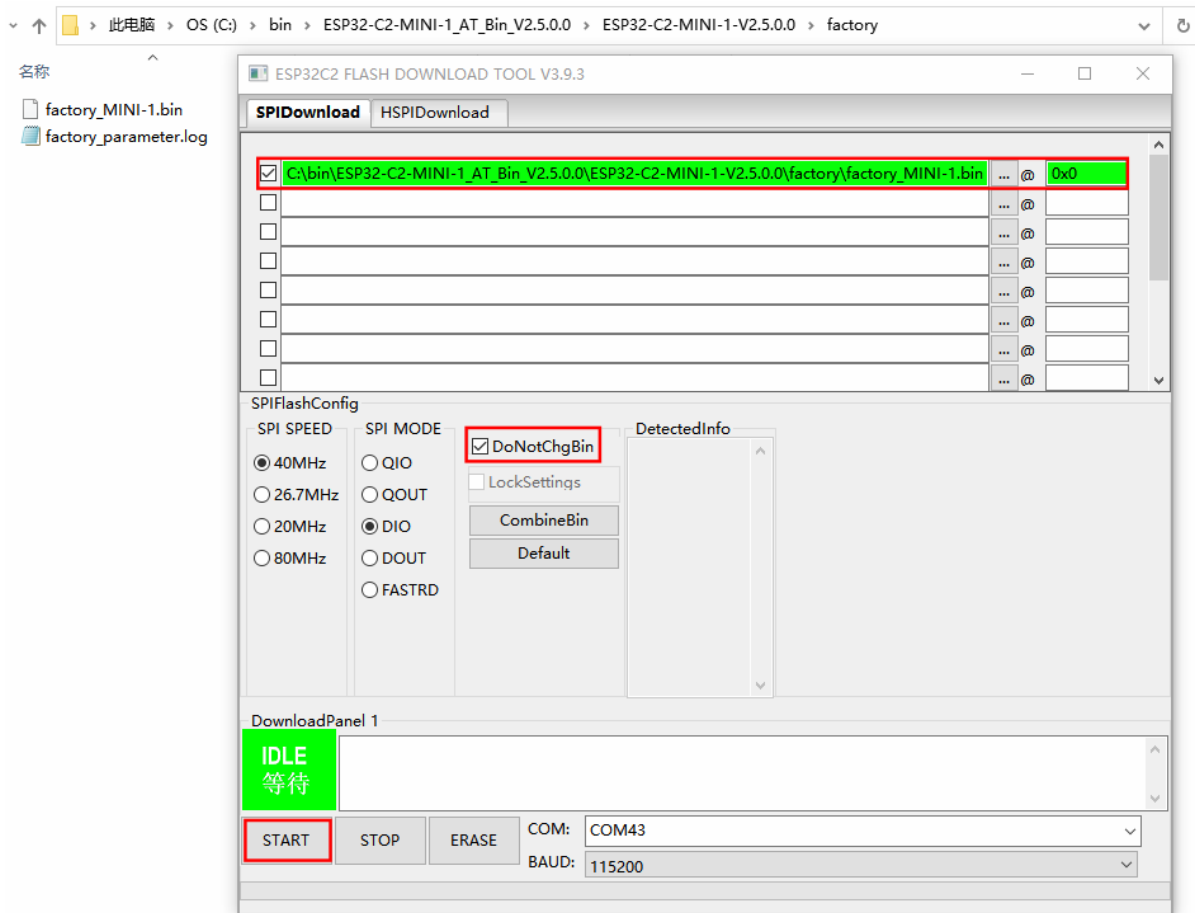

Fig. 6: Download to One Address (click to enlarge)

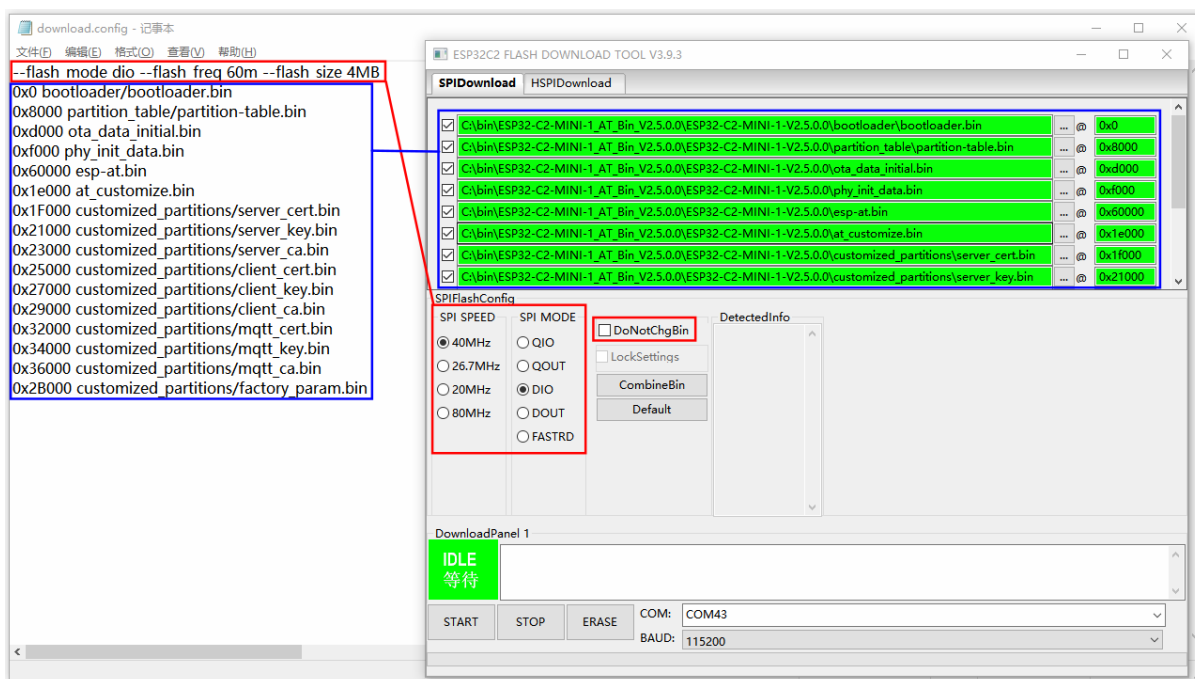

Fig. 7: Download to Multiple Addresses (click to enlarge)

Replace `PORTNAME` with your port name. If you do not know it, you can refer to [Check port on Linux and macOS](#) for details.

Replace `download.config` with the content inside the file.

Below is the example command for ESP8684-MINI-1.

```
esptool.py --chip auto --port /dev/tty.usbserial-0001 --baud 115200 --
↳before default_reset --after hard_reset write_flash -z --flash_mode_
↳dio --flash_freq 60m --flash_size 4MB 0x0 bootloader/bootloader.bin_
↳0x60000 esp-at.bin 0x8000 partition_table/partition-table.bin 0xd000_
↳ota_data_initial.bin 0x1e000 at_customize.bin 0x1f000 customized_
↳partitions/mfg_nvs.bin
```

- To download the bins together to one address, enter the following command and replace `PORTNAME` and `FILEDIRECTORY`:

```
esptool.py --chip auto --port PORTNAME --baud 115200 --before default_reset --
↳after hard_reset write_flash -z --flash_mode dio --flash_freq 40m --flash_
↳size 4MB 0x0 FILEDIRECTORY
```

Replace `PORTNAME` with your port name. If you do not know it, you can refer to [Check port on Linux and macOS](#) for details.

Replace `FILEDIRECTORY` with the file directory you would flash to the address `0x0`. It is normally `factory/XXX.bin`.

Below is the example command for ESP8684-MINI-1.

```
esptool.py --chip auto --port /dev/tty.usbserial-0001 --baud 115200 --
↳before default_reset --after hard_reset write_flash -z --flash_mode_
↳dio --flash_freq 60m --flash_size 4MB 0x0 factory/factory_ESP32C2-
↳4MB.bin
```

When you finish flashing, please [Check Whether AT Works](#).

### 1.4.3 Check Whether AT Works

To check whether AT works, do as follows:

- Open a serial port tool, such as SecureCRT;
- Select the Port attached to “AT command/response” line (see [Hardware Connection](#) for details);
- Set Baudrate to 115200;
- Set Data Bits to 8;
- Set Parity to None;
- Set Stop Bits to 1;
- Set Flow Type to None;
- Enter the command “AT+GMR” with a new line (CR LF).

If the response is OK as shown below, AT works.

```
AT+GMR
AT version:3.3.0.0(3b13d04 - ESP32C2 - May 8 2024 08:21:45)
SDK version:v5.0.6-dirty
compile time(be332568):May 8 2024 08:50:59
Bin version:v3.3.0.0(ESP32C2-4MB)

OK
```

Otherwise, you need to check your ESP32-C2 startup log in one of the following ways:

#### Method 1:

- Open a serial port tool, such as SecureCRT;
- Select the port attached to the “Download/Log output” line. For more information on this line, see [Hardware Connection](#).
- Set Baudrate to 115200;



- Set Data Bits to 8;
- Set Parity to None;
- Set Stop Bits to 1;
- Set Flow Type to None;
- Press the RST key of the board directly. If it is like the log below, it means that ESP-AT firmware have been initialized correctly.

**Method 2:**

- Open two serial port tools, such as SecureCRT;
- In one serial port tool, select the port attached to the “AT command/response” line. In the other tool, select the port attached to the “Download/Log output” line. For more information on these lines, see [Hardware Connection](#).
- Set Baudrate to 115200;
- Set Data Bits to 8;
- Set Parity to None;
- Set Stop Bits to 1;
- Set Flow Type to None;
- Enter the command `AT+RST` with a new line (CR LF) to the “AT command/response” line. If the serial log from the “Download/Output log” line is like the log below, it means that ESP-AT firmware have been initialized correctly.

**ESP32-C2 startup log:**

```

ESP-ROM:esp8684-api2-20220127
Build:Jan 27 2022
rst:0x1 (POWERON),boot:0xc (SPI_FAST_FLASH_BOOT)
SPIWP:0xee
mode:DIO, clock div:1
load:0x3fcd6108,len:0x18b0
load:0x403ae000,len:0x854
load:0x403b0000,len:0x2724
entry 0x403ae000
I (32) boot: ESP-IDF v5.0-dev-5949-g885e501d99-dirty 2nd stage bootloader
I (32) boot: compile time 11:05:11
I (32) boot: chip revision: v1.0
I (36) boot.esp32c2: MMU Page Size : 64K
I (41) boot.esp32c2: SPI Speed      : 60MHz
I (46) boot.esp32c2: SPI Mode      : DIO
I (50) boot.esp32c2: SPI Flash Size : 4MB
I (55) boot: Enabling RNG early entropy source...
I (61) boot: Partition Table:
I (64) boot: ## Label                Usage            Type ST Offset   Length
I (71) boot:  0 otadata              OTA data         01 00 0000d000 00002000
I (79) boot:  1 phy_init              RF data          01 01 0000f000 00001000
I (86) boot:  2 nvs                   WiFi data        01 02 00010000 0000e000
I (94) boot:  3 at_customize          unknown          40 00 0001e000 00042000
I (101) boot:  4 ota_0                OTA app          00 10 00060000 001d0000
I (109) boot:  5 ota_1                OTA app          00 11 00230000 001d0000
I (116) boot: End of partition table
I (121) esp_image: segment 0: paddr=00060020 vaddr=3c0e0020 size=288c8h (166088) ↵
↵map
I (167) esp_image: segment 1: paddr=000888f0 vaddr=3fca6010 size=02c18h ( 11288) ↵
↵load
I (170) esp_image: segment 2: paddr=0008b510 vaddr=40380000 size=04b08h ( 19208) ↵
↵load
I (178) esp_image: segment 3: paddr=00090020 vaddr=42000020 size=d444ch (869452) ↵
↵map
I (378) esp_image: segment 4: paddr=00164474 vaddr=40384b08 size=01508h ( 5384) ↵
↵load
I (382) boot: Loaded app from partition at offset 0x60000
I (383) boot: Disabling RNG early entropy source...

```

(continues on next page)

(continued from previous page)

```
at param mode: 1
AT cmd port:uart1 tx:7 rx:6 cts:5 rts:4 baudrate:115200
module_name: ESP32C2-4MB
max tx power=78, ret=0
3.0.0
```

To learn more about ESP-AT, please read [What is ESP-AT](#).

Help you select hardware and software

To get started with ESP-AT, please read [Technology Selection](#) first to help you select hardware and software, and then read [Hardware Connection](#) to learn what hardware to prepare and how to connect them. Then, you can download and flash AT firmware into your device according to [Downloading Guide](#).



## Chapter 2

# AT Binary Lists

### 2.1 Released Firmware

It is recommended to use the latest version of firmware. Currently, Espressif releases AT firmware for the following ESP32-C2 series of modules.

---

**Note:**

- If there is no released firmware for your module, you can either use the firmware for the module that has the same hardware configuration as yours (see *ESP-AT Firmware Differences* for which module has the same configuration), or if you need to modify the following configurations, you can generate a new firmware for your module by modifying the released firmware using the *at.py Tool*.

- *Modify UART Configuration*
  - *Modify Wi-Fi Configuration*
  - *Modify Certificate and Key Configuration*
  - *Modify GATTS Configuration*
- 

#### 2.1.1 Disclaimer

Before using the AT firmware below, please read the *Disclaimer* carefully and comply with its terms and precautions.

#### 2.1.2 ESP32-C2 2MB Series

- v3.3.0.0 [ESP32-C2-2MB-AT-V3.3.0.0.zip](#) (Recommended)
- v3.1.0.0 [ESP32-C2-2MB-AT-V3.1.0.0.zip](#)
- v3.0.0.0 [ESP32-C2-2MB-AT-V3.0.0.0.zip](#)

#### 2.1.3 ESP32-C2 4MB Series

- v3.3.0.0 [ESP32-C2-4MB-AT-V3.3.0.0.zip](#) (Recommended)
- v3.1.0.0 [ESP32-C2-4MB-AT-V3.1.0.0.zip](#)
- v3.0.0.0 [ESP32-C2-4MB-AT-V3.0.0.0.zip](#)

## 2.1.4 Subscribe to AT Releases

Please refer to the [Subscribe to AT Releases](#) documentation to subscribe to our version release notifications and stay updated on the latest releases.

This document covers the following sections:

- [Download ESP32-C2 AT Released Firmware](#)
- [Brief Introduction to AT Firmware](#): What binary files the AT firmware contains and their functions

---

**Note:** To download AT firmware for other chip series, please go to the drop-down list on the upper left corner of this page and select a chip series to navigate to the documentation of that chip for downloading.

---

## 2.2 Brief Introduction to AT Firmware

The ESP-AT firmware package contains several binary files for specific functionalities:

```
build
├─ at_customize.bin          // Secondary partition table (user partition table,
↪listing the start address and size of the mfg_nvs partition and fatfs partition)
├─ bootloader
|   └─ bootloader.bin       // Bootloader
├─ customized_partitions
|   └─ mfg_nvs.bin          // Factory configuration parameters, parameter values
↪are listed in the mfg_nvs.csv file in the same directory
├─ esp-at.bin               // AT application firmware
├─ factory
|   └─ factory_xxx.bin      // Collection of binary files for specific
↪functionalities. You can burn only this file to the flash space with a starting
↪address of 0, or burn several binary files to the flash space corresponding to
↪the starting address according to the information in the download.config file.
├─ partition_table
|   └─ partition-table.bin  // Primary partition table (system partition table)
└─ ota_data_initial.bin     // OTA data initialization file
```

## Chapter 3

# AT Command Set

Here is a list of AT commands.

### 3.1 Basic AT Commands

- *Introduction*
- *AT*: Test AT startup.
- *AT+RST*: Restart a module.
- *AT+GMR*: Check version information.
- *AT+CMD*: List all AT commands and types supported in current firmware.
- *AT+GSLP*: Enter Deep-sleep mode.
- *ATE*: Configure AT commands echoing.
- *AT+RESTORE*: Restore factory default settings of the module.
- *AT+SAVETRANSLINK*: Set whether to enter *Passthrough Mode* on power-up.
- *AT+TRANSINTVL*: Set the data transmission interval in the *Passthrough Mode*.
- *AT+UART\_CUR*: Current UART configuration, not saved in flash.
- *AT+UART\_DEF*: Default UART configuration, saved in flash.
- *AT+SLEEP*: Set the sleep mode.
- *AT+SYSRAM*: Query current remaining heap size and minimum heap size.
- *AT+SYSMMSG*: Query/Set System Prompt Information.
- *AT+SYSMMSGFILTER*: Enable or disable the *system message* filter.
- *AT+SYSMMSGFILTERCFG*: Query/Set the *system message* filters.
- *AT+SYSFLASH*: Query/Set User Partitions in Flash.
- *AT+SYSMFG*: Query/Set *manufacturing nvs* User Partitions.
- *AT+RFPOWER*: Query/Set RF TX Power.
- *AT+SYSROLLBACK*: Roll back to the previous firmware.
- *AT+SYSTIMESTAMP*: Query/Set local time stamp.
- *AT+SYSLOG*: Enable or disable the AT error code prompt.
- *AT+SLEEPWKCFG*: Query/Set the light-sleep wakeup source and awake GPIO.
- *AT+SYSSTORE*: Query/Set parameter store mode.
- *AT+SYSREG*: Read/write the register.

### 3.1.1 Introduction

---

**Important:** The default AT firmware supports all the AT commands mentioned on this page.

---

### 3.1.2 AT: Test AT Startup

#### Execute Command

**Command:**

AT

**Response:**

OK

### 3.1.3 AT+RST: Restart a Module

#### Execute Command

**Command:**

AT+RST

**Response:**

OK

#### Set Command

**Command:**

AT+RST=<mode>

**Response:**

OK

#### Parameter

- **<mode>**:
  - 0: Restart ESP32-C2 and the chip enters normal running mode.
  - 1: Restart ESP32-C2 and the chip enters firmware downloading mode.

#### Note

- If you want to achieve the firmware download, you could send this set command to let ESP32-C2 enter the download mode, so that you can save Boot pins on the hardware.

### 3.1.4 AT+GMR: Check Version Information

#### Execute Command

##### Command:

```
AT+GMR
```

##### Response:

```
<AT version info>  
<SDK version info>  
<compile time>  
<Bin version>
```

```
OK
```

#### Parameters

- **<AT version info>**: information about the esp-at core library version, which is under the directory: esp-at/components/at/lib/. Code is closed source, no plan to open.
- **<SDK version info>**: information about the esp-at platform sdk version, which is defined in file: esp-at/module\_config/module\_{platform}\_default/IDF\_VERSION
- **<compile time>**: the time to compile the firmware.
- **<Bin version>**: esp-at firmware version. Version information can be modified in menuconfig. (python build.py menuconfig->Component config->AT->AT firmware version.)

#### Note

- If you have any issues on esp-at firmware, please provide AT+GMR version information firstly.

#### Example

```
AT+GMR  
AT version:2.2.0.0-dev(ca41ec4 - ESP32-C2 - Sep 16 2020 11:28:17)  
SDK version:v4.0.1-193-ge7ac221b4  
compile time(98b95fc):Oct 29 2020 11:23:25  
Bin version:2.1.0(MINI-1)
```

```
OK
```

### 3.1.5 AT+CMD: List all AT commands and types supported in current firmware

#### Query Command

##### Command:

```
AT+CMD?
```

##### Response:

```
+CMD:<index>,<AT command name>,<support test command>,<support query command>,  
-><support set command>,<support execute command>
```

```
OK
```



### Parameters

- **<index>**: AT command sequence number.
- **<AT command name>**: AT command name.
- **<support test command>**: 0 means not supported, 1 means supported.
- **<support query command>**: 0 means not supported, 1 means supported.
- **<support set command>**: 0 means not supported, 1 means supported.
- **<support execute command>**: 0 means not supported, 1 means supported.

### 3.1.6 AT+GSLP: Enter Deep-sleep Mode

#### Set Command

##### Command:

```
AT+GSLP=<time>
```

##### Response:

```
<time>
```

```
OK
```

#### Parameter

- **<time>**: The duration when the device stays in Deep-sleep. Unit: millisecond. When the time is up, the device automatically wakes up, calls Deep-sleep wake stub, and then proceeds to load the application.
  - 0 means restarting right now

#### Notes

- The theoretical and actual time of Deep-sleep may be different due to external factors.

### 3.1.7 ATE: Configure AT Commands Echoing

#### Execute Command

##### Command:

```
ATE0
```

or

```
ATE1
```

##### Response:

```
OK
```

#### Parameters

- **ATE0**: Switch echo off.
- **ATE1**: Switch echo on.

### 3.1.8 AT+RESTORE: Restore Factory Default Settings

#### Execute Command

##### Command:

```
AT+RESTORE
```

##### Response:

```
OK
```

#### Notes

- The execution of this command will restore all parameters saved in flash to factory default settings of the module.
- The device will be restarted when this command is executed.

### 3.1.9 AT+SAVETRANSLINK: Set Whether to Enter Wi-Fi/Bluetooth LE Passthrough Mode on Power-up

- *For TCP/SSL Single Connection*
- *For UDP Transmission*
- *For BLE Connection*

#### For TCP/SSL Single Connection

##### Set Command Command:

```
AT+SAVETRANSLINK=<mode>,<"remote host">,<remote port>[,<"type">,<keep_alive>]
```

##### Response:

```
OK
```

#### Parameters

- **<mode>**:
  - 0: ESP32-C2 will NOT enter Wi-Fi *Passthrough Mode* on power-up.
  - 1: ESP32-C2 will enter Wi-Fi *Passthrough Mode* on power-up.
- **<" remote host" >**: IPv4 address, IPv6 address, or domain name of remote host. The maximum length is 64 bytes.
- **<remote port>**: the remote port number.
- **<" type" >**: string parameter showing the type of transmission: "TCP", "TCPv6", "SSL", or "SSLv6". Default: "TCP".
- **<keep\_alive>**: It configures the `SO_KEEPALIVE` option for socket. Unit: second.
  - Range: [0,7200].
    - \* 0: disable keep-alive function (default).
    - \* 1 ~ 7200: enable keep-alive function. `TCP_KEEPIDLE` value is **<keep\_alive>**, `TCP_KEEPINTVL` value is 1, and `TCP_KEEPCNT` value is 3.
  - This parameter of this command is the same as the `<keep_alive>` parameter of `AT+CIPTCPOPT` command. It always takes the value set later by either of the two commands. If it is omitted or not set, the last configured value is used by default.

### Notes

- This command will save the Wi-Fi *Passthrough Mode* configuration in the NVS area. If <mode> is set to 1, ESP32-C2 will enter the Wi-Fi *Passthrough Mode* in the next power on. The configuration will take effect after ESP32-C2 reboots.

### Example

```
AT+SAVETRANSLINK=1, "192.168.6.110", 1002, "TCP"
AT+SAVETRANSLINK=1, "www.baidu.com", 443, "SSL"
AT+SAVETRANSLINK=1, "240e:3a1:2070:11c0:55ce:4e19:9649:b75", 8080, "TCPv6"
AT+SAVETRANSLINK=1, "240e:3a1:2070:11c0:55ce:4e19:9649:b75", 8080, "SSLv6"
```

### For UDP Transmission

#### Set Command Command:

```
AT+SAVETRANSLINK=<mode>, <"remote host">, <remote port>, [<"type">, <local port>]
```

#### Response:

```
OK
```

### Parameters

- <mode>:
  - 0: ESP32-C2 will NOT enter Wi-Fi *Passthrough Mode* on power-up.
  - 1: ESP32-C2 will enter Wi-Fi *Passthrough Mode* on power-up.
- <" remote host" >: IPv4 address, IPv6 address, or domain name of remote host. The maximum length is 64 bytes.
- <remote port>: the remote port number.
- <" type" >: string parameter showing the type of transmission: "UDP" or "UDPv6" . Default: "TCP" .
- <local port>: local port when UDP Wi-Fi passthrough is enabled on power-up.

### Notes

- This command will save the Wi-Fi *Passthrough Mode* configuration in the NVS area. If <mode> is set to 1, ESP32-C2 will enter the Wi-Fi *Passthrough Mode* in the next power on. The configuration will take effect after ESP32-C2 reboots.
- To establish an UDP transmission based on an IPv6 network, do as follows:
  - Make sure that the AP supports IPv6
  - Set *AT+CIPV6=1*
  - Obtain an IPv6 address through the *AT+CWJAP* command
  - (Optional) Check whether ESP32-C2 has obtained an IPv6 address using the *AT+CIPSTA?* command

### Example

```
AT+SAVETRANSLINK=1, "192.168.6.110", 1002, "UDP", 1005
AT+SAVETRANSLINK=1, "240e:3a1:2070:11c0:55ce:4e19:9649:b75", 8081, "UDPv6", 1005
```

### For BLE Connection

#### Set Command Command:

```
AT+SAVETRANSLINK=<mode>, <role>, <tx_srv>, <tx_char>, <rx_srv>, <rx_char>, <peer_addr>
```

**Response:**

OK

**Parameters**

- **<mode>**:
  - 0: ESP32-C2 will NOT enter BLE *Passthrough Mode* on power-up.
  - 2: ESP32-C2 will enter BLE *Passthrough Mode* on power-up.
- **<role>**:
  - 1: client role.
  - 2: server role.
- **<tx\_srv>**: tx service' s index. It can be queried with command *AT+BLEGATTCPRIMSRV=<conn\_index>* if AT works as GATTC role or with command *AT+BLEGATTSSRV?* if AT works as GATTS role.
- **<tx\_char>**: tx characteristic' s index. It can be queried with command *AT+BLEGATTCCHAR=<conn\_index>,<srv\_index>* if AT works as GATTC role or with command *AT+BLEGATTSSCHAR?* if AT works as GATTS role.
- **<rx\_srv>**: rx service' s index. It can be queried with command *AT+BLEGATTCPRIMSRV=<conn\_index>* if AT works as GATTC role or with command *AT+BLEGATTSSRV?* if AT works as GATTS role.
- **<rx\_char>**: rx characteristic' s index. It can be queried with command *AT+BLEGATTCCHAR=<conn\_index>,<srv\_index>* if AT works as GATTC role or with command *AT+BLEGATTSSCHAR?* if AT works as GATTS role.
- **<peer\_addr>**: remote Bluetooth LE address.

**Notes**

- This command will save the BLE *Passthrough Mode* configuration in the NVS area. If <mode> is set to 2, ESP32-C2 will enter the Bluetooth LE *Passthrough Mode* in the next power on. The configuration will take effect after ESP32-C2 reboots.

**Example**

AT+SAVETRANSLINK=2,2,1,7,1,5,"26:a2:11:22:33:88"

**3.1.10 AT+TRANSINTVL: Set the Data Transmission Interval in Passthrough Mode****Query Command****Command:**

AT+TRANSINTVL?

**Response:**

+TRANSINTVL:&lt;interval&gt;

OK

**Set Command****Command:**

AT+TRANSINTVL=&lt;interval&gt;

**Response:**

```
OK
```

### Parameter

- **<interval>**: Data transmission interval. Unit: milliseconds. Default value: 20. Range: [0,1000].

### Note

- In passthrough mode, if the data received by ESP32-C2 reaches or exceeds 2920 bytes, the data will be immediately sent in chunks of 2920 bytes. Otherwise, it will wait for **<interval>** milliseconds before being sent.
- To optimize data transmission in cases where the data size is small and the data transmission interval is short, adjusting **<interval>** can be useful. A smaller **<interval>** reduces the delay in sending data to the protocol stack, but this may increase the number of times the protocol stack sends data to the network, thereby potentially decreasing the throughput performance to some extent.

### Example

```
// Set to send immediately upon receiving data
AT+TRANSINTVL=0
```

## 3.1.11 AT+UART\_CUR: Current UART Configuration, Not Saved in Flash

### Query Command

#### Command:

```
AT+UART_CUR?
```

#### Response:

```
+UART_CUR:<baudrate>,<databits>,<stopbits>,<parity>,<flow control>
```

```
OK
```

### Set Command

#### Command:

```
AT+UART_CUR=<baudrate>,<databits>,<stopbits>,<parity>,<flow control>
```

#### Response:

```
OK
```

### Parameters

- **<baudrate>**: UART baud rate
  - For ESP32-C2 devices, the supported range is 80 ~ 5000000.
- **<databits>**: data bits
  - 5: 5-bit data
  - 6: 6-bit data

- 7: 7-bit data
- 8: 8-bit data
- **<stopbits>**: stop bits
  - 1: 1-bit stop bit
  - 2: 1.5-bit stop bit
  - 3: 2-bit stop bit
- **<parity>**: parity bit
  - 0: None
  - 1: Odd
  - 2: Even
- **<flow control>**: flow control
  - 0: flow control is not enabled
  - 1: enable RTS
  - 2: enable CTS
  - 3: enable both RTS and CTS

### Notes

- The Query Command will return actual values of UART configuration parameters, which may have minor differences from the set value because of the clock division.
- The configuration changes will NOT be saved in flash.
- To use hardware flow control, you need to connect CTS/RTS pins of your ESP32-C2. For more details, please refer to [Hardware Connection](#) or components/customized\_partitions/raw\_data/factory\_param/factory\_param\_data.csv.

### Example

```
AT+UART_CUR=115200,8,1,0,3
```

## 3.1.12 AT+UART\_DEF: Default UART Configuration, Saved in Flash

### Query Command

#### Command:

```
AT+UART_DEF?
```

#### Response:

```
+UART_DEF:<baudrate>,<databits>,<stopbits>,<parity>,<flow control>
```

```
OK
```

### Set Command

#### Command:

```
AT+UART_DEF=<baudrate>,<databits>,<stopbits>,<parity>,<flow control>
```

#### Response:

```
OK
```

### Parameters

- **<baudrate>**: UART baud rate
  - For ESP32-C2 devices, the supported range is 80 ~ 5000000.
- **<databits>**: data bits
  - 5: 5-bit data
  - 6: 6-bit data
  - 7: 7-bit data
  - 8: 8-bit data
- **<stopbits>**: stop bits
  - 1: 1-bit stop bit
  - 2: 1.5-bit stop bit
  - 3: 2-bit stop bit
- **<parity>**: parity bit
  - 0: None
  - 1: Odd
  - 2: Even
- **<flow control>**: flow control
  - 0: flow control is not enabled
  - 1: enable RTS
  - 2: enable CTS
  - 3: enable both RTS and CTS

### Notes

- The configuration changes will be saved in the NVS area, and will still be valid when the chip is powered on again.
- To use hardware flow control, you need to connect CTS/RTS pins of your ESP32-C2. For more details, please refer to [Hardware Connection](#) or `components/customized_partitions/raw_data/factory_param/factory_param_data.csv`.

### Example

```
AT+UART_DEF=115200,8,1,0,3
```

## 3.1.13 AT+SLEEP: Set the Sleep Mode

### Query Command

#### Command:

```
AT+SLEEP?
```

#### Response:

```
+SLEEP:<sleep mode>
```

```
OK
```

### Set Command

#### Command:

```
AT+SLEEP=<sleep mode>
```

**Response:**

```
OK
```

**Parameter**

- **<sleep mode>:**
  - 0: Disable the sleep mode.
  - 1: Modem-sleep mode.
    - \* Only Wi-Fi mode.
      - RF will be periodically closed according to AP `DTIM`.
    - \* Only BLE mode.
      - When Bluetooth LE is advertising, RF will be periodically closed according to advertising interval.
      - When Bluetooth LE is connected, RF will be periodically closed according to connection interval.
  - 2: Light-sleep mode.
    - \* Null Wi-Fi mode.
      - CPU will automatically sleep and RF will be closed.
    - \* Only Wi-Fi mode.
      - CPU will automatically sleep and RF will be periodically closed according to `listen interval` set by [AT+CWJAP](#).
    - \* Only Bluetooth mode.
      - When Bluetooth LE is advertising, CPU will automatically sleep and RF will be periodically closed according to advertising interval of Bluetooth.
      - When Bluetooth LE is connected, CPU will automatically sleep and RF will be periodically closed according to connection interval of Bluetooth.
  - Wi-Fi and Bluetooth coexistence mode.
    - \* CPU will automatically sleep and RF will be periodically closed according to power management module.
  - 3: Modem-sleep listen interval mode.
    - \* Only Wi-Fi mode.
      - RF will be periodically closed according to `listen interval` set by [AT+CWJAP](#).
    - \* Only BLE mode.
      - When Bluetooth LE is advertising, RF will be periodically closed according to advertising interval.
      - When Bluetooth LE is connected, RF will be periodically closed according to connection interval.

**Note**

- When sleep mode is disabled, you cannot initialize Bluetooth LE. When Bluetooth LE is initialized, you cannot disable sleep mode.
- Modem-sleep mode and Light-sleep mode can be set under Wi-Fi mode or BLE mode, but in Wi-Fi mode, these two modes can only be set in `station mode`.
- Before setting the Light-sleep mode, it is recommended to set the wakeup source in advance through the command [AT+SLEEPWKCFG](#), otherwise ESP32-C2 can't wake up and will always be in sleep mode.
- After setting the Light-sleep mode, if the Light-sleep wakeup condition is not met, ESP32-C2 will automatically enter the sleep mode. When the Light-sleep wakeup condition is met, ESP32-C2 will automatically wake up from sleep mode.
- For Light-sleep mode in BLE mode, users must ensure external 32KHz crystal oscillator, otherwise the Light-sleep mode will work in Modem-sleep mode.
- For more examples, please refer to [Sleep AT Examples](#).



**Example**

```
AT+SLEEP=0
```

**3.1.14 AT+SYSRAM: Query Current Remaining Heap Size and Minimum Heap Size****Query Command****Command:**

```
AT+SYSRAM?
```

**Response:**

```
+SYSRAM:<remaining RAM size>,<minimum heap size>  
OK
```

**Parameters**

- **<remaining RAM size>**: current remaining heap size. Unit: byte.
- **<minimum heap size>**: minimum available heap size in the runtime. Unit: byte. When the parameter's value is less than or close to 10 KB, the Wi-Fi and BLE functions of ESP32-C2 may be affected.

**Example**

```
AT+SYSRAM?  
+SYSRAM:148408,84044  
OK
```

**3.1.15 AT+SYSMMSG: Query/Set System Prompt Information****Query Command****Function:**

Query the current system prompt information state.

**Command:**

```
AT+SYSMMSG?
```

**Response:**

```
+SYSMMSG:<state>  
OK
```

**Set Command****Function:**

Configure system prompt information. If you need more fine-grained management of AT messages, please use the [AT+SYSMMSGFILTER](#) command.

**Command:**

```
AT+SYSMSG=<state>
```

**Response:**

```
OK
```

**Parameter**

- **<state>**:
  - Bit0: Prompt information when quitting Wi-Fi *Passthrough Mode*, Bluetooth LE SPP and Bluetooth SPP.
    - \* 0: Print no prompt information when quitting Wi-Fi *Passthrough Mode*, Bluetooth LE SPP and Bluetooth SPP.
    - \* 1: Print +QUITT when quitting Wi-Fi *Passthrough Mode*, Bluetooth LE SPP and Bluetooth SPP.
  - Bit1: Connection prompt information type.
    - \* 0: Use simple prompt information, such as XX, CONNECT.
    - \* 1: Use detailed prompt information, such as +LINK\_CONN:status\_type,link\_id,ip\_type,terminal\_type,remote\_ip,remote\_port,local\_port.
  - Bit2: Connection status prompt information for Wi-Fi *Passthrough Mode*, Bluetooth LE SPP and Bluetooth SPP.
    - \* 0: Print no prompt information.
    - \* 1: Print one of the following prompt information when Wi-Fi, socket, Bluetooth LE or Bluetooth status is changed:

```
- "CONNECT\r\n" or the message prefixed with "+LINK_CONN:"
- "CLOSED\r\n"
- "WIFI CONNECTED\r\n"
- "WIFI GOT IP\r\n"
- "WIFI GOT IPv6 LL\r\n"
- "WIFI GOT IPv6 GL\r\n"
- "WIFI DISCONNECT\r\n"
- "+ETH_CONNECTED\r\n"
- "+ETH_DISCONNECTED\r\n"
- the message prefixed with "+ETH_GOT_IP:"
- the message prefixed with "+STA_CONNECTED:"
- the message prefixed with "+STA_DISCONNECTED:"
- the message prefixed with "+DIST_STA_IP:"
- the message prefixed with "+BLECONN:"
- the message prefixed with "+BLEDISCONN:"
```

**Notes**

- The configuration changes will be saved in the NVS area if AT+SYSSTORE=1.
- If you set Bit0 to 1, it will prompt “+QUITT” when you quit Wi-Fi *Passthrough Mode*.
- If you set Bit1 to 1, it will impact the information of command *AT+CIPSTART* and *AT+CIPSERVER*. It will supply “+LINK\_CONN:status\_type,link\_id,ip\_type,terminal\_type,remote\_ip,remote\_port,local\_port” instead of “XX,CONNECT” .

**Example**

```
// print no prompt info when quitting Wi-Fi passthrough mode
// print detailed connection prompt info
// print no prompt info when the connection status is changed
AT+SYSMSG=2
```

or

```
// In the transparent transmission mode, a prompt message will be printed when the  
↔Wi-Fi, socket, Bluetooth LE or Bluetooth status changes  
AT+SYMSMSG=4
```

### 3.1.16 AT+SYMSMSGFILTER: Enable or Disable the system message Filter

#### Query Command

##### Function:

Query the current *system message* filtering state.

##### Command:

```
AT+SYMSMSGFILTER?
```

##### Response:

```
+SYMSMSGFILTER:<enable>  
  
OK
```

#### Set Command

##### Function:

Enable or disable the *system message* filter.

##### Command:

```
AT+SYMSMSGFILTER=<enable>
```

##### Response:

```
OK
```

#### Parameter

- **<enable>**:
  - 0: Disable system message filtering. System default value. When disabled, system messages will not be filtered by the set filter.
  - 1: Enable system message filtering. When it is enabled, the data matching the regular expression will be filtered out by AT, and MCU will not receive it, whereas the unmatched data will be sent to the MCU as it is.

#### Notes

- Please use *AT+SYMSMSGFILTERCFG* to set up system message filters. Then, use this command to enable the system message filtering to achieve more sophisticated system message management.
- Please use the *AT+SYMSMSGFILTER=1* command with caution. It is recommended that you disable the system message filtering promptly after enabling it to prevent the over-filtering of AT system messages.
- Before entering the *Passthrough Mode*, it is strongly recommended to use the *AT+SYMSMSGFILTER=0* command to disable system message filtering.
- If you are working on secondary development of AT project, please use the following APIs to transmit data via the AT command port.

```
// Data transmission via native AT command port. Data will not be filtered by
↳AT+SYSMSGFILTER command, and AT will not actively wake up MCU before sending
↳data (MCU wake-up function is set by AT+USERWKMUCCFG).
int32_t esp_at_port_write_data_without_filter(uint8_t data, int32_t len);

// Data transmission via AT command port with a filtering function. Data will be
↳filtered by AT+SYSMSGFILTER command (if enabled), and AT will not actively wake
↳up MCU before sending data (MCU wake-up function is set by AT+USERWKMUCCFG
↳command).
int32_t esp_at_port_write_data(uint8_t data, int32_t len);

// Data transmission via AT command port with wake-up MCU function. Data will not
↳be filtered by AT+SYSMSGFILTER command, and AT will actively wake up MCU before
↳sending data (MCU wake-up function is set by AT+USERWKMUCCFG command).
int32_t esp_at_port_active_write_data_without_filter(uint8_t data, int32_t len);

// Data transmission via AT command port with wake-up MCU function and filtering
↳function. Data will be filtered by AT+SYSMSGFILTER command (if enabled), and AT
↳will actively wake up MCU before sending data (MCU wake-up function is set by
↳AT+USERWKMUCCFG command).
int32_t esp_at_port_active_write_data(uint8_t data, int32_t len);
```

**Example** For detailed examples, refer to [system message filtering example](#).

### 3.1.17 AT+SYSMSGFILTERCFG: Query/Set the system message Filters

- [Query the Filters](#)
- [Clear all the Filters](#)
- [Add a Filter](#)
- [Delete a Filter](#)

#### Query the Filters

**Query Command**    **Command:**

```
AT+SYSMSGFILTERCFG?
```

**Response:**

```
+SYSMSGFILTERCFG:<index>,"<head_regexp>","<tail_regexp>"
OK
```

#### Parameters

- **<index>**: The index of filters.
- **<" head\_regexp" >**: The regular expression of header.
- **<" tail\_regexp" >**: The regular expression of tail.

#### Clear all the Filters

**Set Command**    **Command:**

```
AT+SYSMSGFILTERCFG=<operator>
```

**Response:**

```
OK
```

### Parameter

- **<operator>**:
  - 0: Clear all the filters. After clearing, you can free some heap size occupied by the filters.

### Example

```
// Clear all the filters
AT+SYMSMSGFILTERCFG=0
```

### Add a Filter

#### Set Command Command:

```
AT+SYMSMSGFILTERCFG=<operator>,<head_regexp_len>,<tail_regexp_len>
```

#### Response:

```
OK
>
```

The symbol > indicates that AT is ready for receiving regular expressions from AT command port. You should enter the head regular expression and the tail regular expression. When the length reaches the <head\_regexp\_len> + <tail\_regexp\_len> value, the regular expression integrity check starts.

If the regular expression integrity check fails or the addition of filter fails, AT returns:

```
ERROR
```

If the integrity of the regular expression is verified successfully and the filter is added successfully, AT returns:

```
OK
```

### Parameters

- **<operator>**:
  - 1: Add a filter. A filter contains a header regular expression and a tail regular expression.
- **<head\_regexp\_len>**: The length of the header regular expression. Range: [0,64]. If it is set to 0, the matching of the regular expression in the header is ignored, and <tail\_regexp\_len> cannot be 0.
- **<tail\_regexp\_len>**: The length of the tail regular expression. Range: [0,64]. If it is set to 0, the matching of the regular expression in the tail is ignored, and <head\_regexp\_len> cannot be 0.

### Notes

- Please use this command to set up system message filters. Then, use *AT+SYMSMSGFILTER* to enable the system message filtering to achieve more sophisticated system message management.
- For more details about header and tail regular expression format, refer to [POSIX Basic Regular Expression \(BRE\)](#).
- In order to avoid *system message* (TX data of AT command port) being filtered incorrectly, it is **strongly recommended** that the header regular expression starts with ^ and the tail regular expression ends with \$.
- Only when the system message matches both the header regular expression and the tail regular expression **at the same time** is the system message filtered. After filtering, the data matching the regular expression will be filtered out by AT, and MCU will not receive it, whereas the unmatched data will be sent to the MCU as it is.
- When the system message matches one filter, it will not continue to match other filters.

- When the system message matches the filter, the system message will not be cached, that is, the previous system message and the current system message will not be combined for matching.
- For devices with large throughput, it is **strongly recommended** that you limit the number of filters and disable system message filtering using the `AT+SYMSGFILTER=0` command in time.

### Example

```
// Set the filter to filter out the "WIFI CONNECTED" system message report
AT+SYMSGFILTERCFG=1,17,0
// After the command returns OK and >, enter "^WIFI CONNECTED\r\n" (Note: \r\n are
↳2 bytes, corresponding to 0D 0A in ASCII code)

// Enable system message filtering
AT+SYMSGFILTER=1

// Test filtering function
AT+CWMODE=1
AT+CWJAP="ssid", "password"
// AT no longer outputs "WIFI CONNECTED" system message report
```

For more examples of filtering system messages, refer to [system message filter example](#).

### Delete a Filter

#### Set Command Command:

```
AT+SYMSGFILTERCFG=<operator>,<head_regexp_len>,<tail_regexp_len>
```

#### Response:

```
OK
>
```

The symbol > indicates that AT is ready for receiving regular expressions from AT command port. You should enter the head regular expression and the tail regular expression. When the length reaches the <head\_regexp\_len> + <tail\_regexp\_len> value, the regular expression integrity check starts.

If the regular expression integrity check fails or the addition of filter fails, AT returns:

```
ERROR
```

If the integrity of the regular expression is verified successfully and the filter is added successfully, AT returns:

```
OK
```

### Parameters

- **<operator>**:
  - 2: Delete a filter.
- **<head\_regexp\_len>**: The length of the header regular expression. Range: [0,64]. If it is set to 0, the <tail\_regexp\_len> cannot be 0.
- **<tail\_regexp\_len>**: The length of the header regular expression. Range: [0,64]. If it is set to 0, the <head\_regexp\_len> cannot be 0.

### Notes

- The filter to be deleted should be in the added filters.

**Example**

```
// Delete the filter added above
AT+SYMSGFILTERCFG=2,17,0
// After the command returns OK and >, enter "^WIFI CONNECTED\r\n" (Note: \r\n are ↵
↵2 bytes, corresponding to 0D 0A in ASCII code)

// Test filtering function
AT+CWMODE=1
AT+CWJAP="ssid", "password"
// AT will output "WIFI CONNECTED" system message report again
```

**3.1.18 AT+SYSFLASH: Query/Set User Partitions in Flash****Query Command****Function:**

Query user partitions in flash.

**Command:**

```
AT+SYSFLASH?
```

**Response:**

```
+SYSFLASH:<partition>,<type>,<subtype>,<addr>,<size>
OK
```

**Set Command****Function:**

Read/write the user partitions in flash.

**Command:**

```
AT+SYSFLASH=<operation>,<partition>,<offset>,<length>
```

**Response:**

```
+SYSFLASH:<length>,<data>
OK
```

**Parameters**

- **<operation>**:
  - 0: erase sector
  - 1: write data into the user partition
  - 2: read data from the user partition
- **<partition>**: name of user partition
- **<offset>**: offset of user partition
- **<length>**: data length
- **<type>**: type of user partition
- **<subtype>**: subtype of user partition
- **<addr>**: address of user partition
- **<size>**: size of user partition

## Notes

- Please make sure that you have downloaded `at_customize.bin` before using this command. For more details, please refer to [How to Customize Partitions](#).
- When erasing a partition, please erase the target partition in its entirety. This can be done by omitting the parameters `<offset>` and `<length>`. For example, command `AT+SYSFLASH=0,"mfg_nvs"` can erase the entire “mfg\_nvs” user partition.
- The introduction to partitions is in [ESP-IDF Partition Tables](#).
- If the operator is `write`, wrap `return >` after the write command, then you can send the data that you want to write. The length should be parameter `<length>`.
- If the operator is `write`, please make sure that you have already erased this partition.
- If you want to modify some data in the “mfg\_nvs” partition, please use the `AT+SYSMFG` command (key-value pairs operation). If you want to modify total “mfg\_nvs” partition, please use the `AT+SYSFLASH` command (partition operation).

## Example

```
// erase the "mfg_nvs" partition in its entirety.
AT+SYSFLASH=0,"mfg_nvs",4096,8192

// write a new "mfg_nvs" partition (size: 0x1C000) at offset 0 of the "mfg_nvs"
↵partition.
AT+SYSFLASH=1,"mfg_nvs",0,0x1C000
```

### 3.1.19 AT+SYSMFG: Query/Set manufacturing nvs User Partitions

#### Query Command

##### Function:

Query all namespaces of *manufacturing nvs* user partitions.

##### Command:

```
AT+SYSMFG?
```

##### Response:

```
+SYSMFG:<"namespace">
OK
```

#### Erase a namespace or key-value pair

##### Set Command Command:

```
AT+SYSMFG=<operation>,<"namespace">[,<"key">]
```

##### Response:

```
OK
```

#### Parameters

- `<operation>`:
  - 0: erase operation



- 1: read operation
- 2: write operation
- **<" namespace" >**: namespace name.
- **<" key" >**: key name. If this parameter is omitted, all key-value pairs of current **<"namespace">** will be erased. Otherwise, only the current key-value pair is erased.

### Note

- Please refer to the [Non-Volatile Storage \(NVS\)](#) documentation to understand the concept of namespace and key-value pairs.

### Example

```
// Erase all key-value pairs of client_cert namespace (That is, erase all client_
↪certificates)
AT+SYSMFG=0, "client_cert"

// Erase the client_cert.0 key-value pair of client_cert namespace (That is, erase_
↪the first client certificate)
AT+SYSMFG=0, "client_cert", "client_cert.0"
```

### Read a namespace or key-value pair

#### Set Command Command:

```
AT+SYSMFG=<operation>[, <"namespace">] [, <"key">] [, <offset>, <length>]
```

#### Response:

When **<"namespace">** and subsequent parameters are omitted, it returns:

```
+SYSMFG:<"namespace">
OK
```

When **<"key">** and subsequent parameters are omitted, it returns:

```
+SYSMFG:<"namespace">, <"key">, <type>
OK
```

In other cases, it returns:

```
+SYSMFG:<"namespace">, <"key">, <type>, <length>, <value>
OK
```

### Parameters

- **<operation>**:
  - 0: erase operation
  - 1: read operation
  - 2: write operation
- **<" namespace" >**: namespace name.
- **<" key" >**: key name.
- **<offset>**: The offset of the value.
- **<length>**: The length of the value.
- **<type>**: The type of the value.

- 1: u8
  - 2: i8
  - 3: u16
  - 4: i16
  - 5: u32
  - 6: i32
  - 7: string
  - 8: binary
- **<value>**: The data of the value.

### Note

- Please refer to the [Non-Volatile Storage \(NVS\)](#) documentation to understand the concept of namespace and key-value pairs.

### Example

```
// Read all namespaces
AT+SYSMFG=1

// Read all key-value pairs of client_cert namespace
AT+SYSMFG=1,"client_cert"

// Read the value of client_cert.0 key in client_cert namespace
AT+SYSMFG=1,"client_cert","client_cert.0"

// Read the value of client_cert.0 key in client_cert namespace, from offset: 100_
↳place, read 200 bytes
AT+SYSMFG=1,"client_cert","client_cert.0",100,200
```

### Write a key-value pair to a namespace

#### Set Command Command:

```
AT+SYSMFG=<operation>,<"namespace">,<"key">,<type>,<value>
```

#### Response:

```
OK
```

### Parameters

- **<operation>**:
  - 0: erase operation
  - 1: read operation
  - 2: write operation
- **<" namespace" >**: namespace name.
- **<" key" >**: key name.
- **<type>**: The type of the value.
  - 1: u8
  - 2: i8
  - 3: u16
  - 4: i16
  - 5: u32
  - 6: i32
  - 7: string
  - 8: binary

- **<value>**: It means differently depending on the parameter **<type>**:
  - If **<type>** is between 1-6, **<value>** represents the real value.
  - If **<type>** is between 7-8, **<value>** represents the length of the value. After you send the command, AT will return **>**. This symbol indicates that AT is ready for receiving data. You should enter the data of designated length. When the data length reaches the **<value>** value, the key-value pair will be written to the namespace immediately.

### Note

- Please refer to the [Non-Volatile Storage \(NVS\)](#) documentation to understand the concept of namespace and key-value pairs.
- Before writing, you do not need to manually erase namespaces or key-value pairs (NVS will automatically erase key-value pairs as needed).
- If you want to modify some data in the “mfg\_nvs” partition, please use the [AT+SYSMFG](#) command (key-value pairs operation). If you want to modify total “mfg\_nvs” partition, please use the [AT+SYSFLASH](#) command (partition operation).

### Example

```
// Write a new value for client_cert.0 key into client_cert namespace (That is, ↵
↵update the 0th client certificate)
AT+SYSMFG=2, "client_cert", "client_cert.0", 8, 1164

// Wait until AT command port returns ``>``, and then write 1164 bytes
```

## 3.1.20 AT+RFPOWER: Query/Set RF TX Power

### Query Command

#### Function:

Query the RF TX Power.

#### Command:

```
AT+RFPOWER?
```

#### Response:

```
+RFPOWER:<wifi_power>
OK
```

### Set Command

#### Command:

```
AT+RFPOWER=<wifi_power>
```

#### Response:

```
OK
```

## Parameters

- **<wifi\_power>**: the unit is 0.25 dBm. For example, if you set the value to 78, the actual maximum RF Power value is  $78 * 0.25 \text{ dBm} = 19.5 \text{ dBm}$ . After you configure it, please confirm the actual value by entering the command `AT+RFPOWER?`.
  - For ESP32-C2 devices, the range is [40,84]:

set value	get value	actual value	actual dBm
[40,80]	<set value>	<set value>	<set value> * 0.25
[81,84]	<set value>	80	20

### 3.1.21 Note

- When Wi-Fi is turned off or not initialized, the `AT+RFPOWER` command cannot set or query the RF TX Power of Wi-Fi. Similarly, when Bluetooth LE is not initialized, the command cannot set or query that of Bluetooth LE, either.
- Since the RF TX Power is actually divided into several levels, and each level has its own value range, the `wifi_power` value queried by the `esp_wifi_get_max_tx_power` may differ from the value set by `esp_wifi_set_max_tx_power` and is no larger than the set value.
- It is recommended to set the two parameters `<ble_scan_power>` and `<ble_conn_power>` to the same value as the `<ble_adv_power>` parameter. Otherwise, they will be automatically adjusted to the value of `<ble_adv_power>`.

### 3.1.22 AT+SYSROLLBACK: Roll Back to the Previous Firmware

#### Execute Command

##### Command:

```
AT+SYSROLLBACK
```

##### Response:

```
OK
```

#### Note

- ESP32C2-4MB AT firmware supports this command, but ESP32C2-2MB AT firmware does not due to the compressed OTA firmware.
- This command will not upgrade via OTA. It only rolls back to the firmware which is in the other OTA partition.

### 3.1.23 AT+SYSTIMESTAMP: Query/Set Local Time Stamp

#### Query Command

##### Function:

Query the time stamp.

##### Command:

```
AT+SYSTIMESTAMP?
```

##### Response:

```
+SYSTIMESTAMP:<Unix_timestamp>  
OK
```

### Set Command

#### Function:

Set local time stamp. It will be the same as SNTP time when the SNTP time is updated.

#### Command:

```
AT+SYSTIMESTAMP=<Unix_timestamp>
```

#### Response:

```
OK
```

### Parameter

- **<Unix-timestamp>**: Unix timestamp. Unit: second.

### Example

```
AT+SYSTIMESTAMP=1565853509 //2019-08-15 15:18:29
```

## 3.1.24 AT+SYSLOG: Enable or Disable the AT Error Code Prompt

### Query Command

#### Function:

Query whether the AT error code prompt is enabled or not.

#### Command:

```
AT+SYSLOG?
```

#### Response:

```
+SYSLOG:<status>
```

```
OK
```

### Set Command

#### Function:

Enable or disable the AT error code prompt.

#### Command:

```
AT+SYSLOG=<status>
```

#### Response:

```
OK
```

### Parameter

- **<status>**: enable or disable
  - 0: disable
  - 1: enable

### Example

```
// enable AT error code prompt
AT+SYSLOG=1

OK
AT+FAKE
ERR CODE:0x01090000

ERROR
```

```
// disable AT error code prompt
AT+SYSLOG=0

OK
AT+FAKE
// No `ERR CODE:0x01090000`

ERROR
```

The error code is a 32-bit hexadecimal value and defined as follows:

category	subcategory	extension
bit32 ~ bit24	bit23 ~ bit16	bit15 ~ bit0

- **category**: stationary value 0x01.
- **subcategory**: error type.

Table 1: Subcategory of Error Code

Error Type	Error Code	Description
ESP_AT_SUB_OK	0x00	OK
ESP_AT_SUB_COMMON_ERROR	0x01	reserved
ESP_AT_SUB_NO_TERMINATOR	0x02	terminator character not found ("rn" expected)
ESP_AT_SUB_NO_AT	0x03	Starting AT not found (or at, At or aT entered)
ESP_AT_SUB_PARA_LENGTH_MISMATCH	0x04	parameter length mismatch
ESP_AT_SUB_PARA_TYPE_MISMATCH	0x05	parameter type mismatch
ESP_AT_SUB_PARA_NUM_MISMATCH	0x06	parameter number mismatch
ESP_AT_SUB_PARA_INVALID	0x07	the parameter is invalid
ESP_AT_SUB_PARA_PARSE_FAIL	0x08	parse parameter fail
ESP_AT_SUB_UNSUPPORT_CMD	0x09	the command is not supported
ESP_AT_SUB_CMD_EXEC_FAIL	0x0A	the command execution failed
ESP_AT_SUB_CMD_PROCESSING	0x0B	processing of previous command is in progress
ESP_AT_SUB_CMD_OP_ERROR	0x0C	the command operation type is error

- **extension:** error extension information. There are different extensions for different subcategory. For more information, please see the `components/at/include/esp_at.h`.

For example, the error code `ERR_CODE:0x01090000` means the command is not supported.

### 3.1.25 AT+SLEEPWKCFG: Set the Light-sleep Wakeup Source and Awake GPIO

#### Set Command

##### Command:

```
AT+SLEEPWKCFG=<wakeup source>,<param1>[,<param2>]
```

##### Response:

```
OK
```

#### Parameters

- **<wakeup source>:**
  - 0: reserved, not supported now.
  - 1: reserved, not supported now.
  - 2: wakeup by GPIO.
- **<param1>:**
  - If the wakeup source is a timer, it means the time before wakeup. Unit: millisecond.
  - If the wakeup source is GPIO, it means the GPIO number.
- **<param2>:**
  - If the wakeup source is GPIO, it means the wakeup level:
  - 0: low level.
  - 1: high level.

#### Example

```
// GPIO12 wakeup, low level
AT+SLEEPWKCFG=2,12,0
```

### 3.1.26 AT+SYSSTORE: Query/Set Parameter Store Mode

#### Query Command

##### Function:

Query the AT parameter store mode.

##### Command:

```
AT+SYSSTORE?
```

##### Response:

```
+SYSSTORE:<store_mode>
```

```
OK
```

## Set Command

### Command:

```
AT+SYSSTORE=<store_mode>
```

### Response:

```
OK
```

### Parameter

- **<store\_mode>**:
  - 0: command configuration is not stored into flash.
  - 1: command configuration is stored into flash. (Default)

### Note

- This command affects set commands only. Query commands are always fetched from RAM.
- Affected commands:

- *AT+SYMSMSG*
- *AT+CWMODE*
- *AT+CIPV6*
- *AT+CWJAP*
- *AT+CWSAP*
- *AT+CWRECONNCFG*
- *AT+CIPAP*
- *AT+CIPSTA*
- *AT+CIPAPMAC*
- *AT+CIPSTAMAC*
- *AT+CIPDNS*
- *AT+CIPSSLCCONF*
- *AT+CIPRECONNINTV*
- *AT+CIPTCPOPT*
- *AT+CWDHCPS*
- *AT+CWDHCP*
- *AT+CWSTAPROTO*
- *AT+CWAPPROTO*
- *AT+CWJEAP*

### Examples

```
AT+SYSSTORE=0
AT+CWMODE=1 // Not stored into flash
AT+CWJAP="test","1234567890" // Not stored into flash

AT+SYSSTORE=1
AT+CWMODE=3 // Stored into flash
AT+CWJAP="test","1234567890" // Stored into flash
```

## 3.1.27 AT+SYSREG: Read/Write the Register



## Set Command

### Command:

```
AT+SYSREG=<direct>,<address>[,<write value>]
```

### Response:

```
+SYSREG:<read value> // Only in read mode
OK
```

### Parameters

- **<direct>**: read or write register.
  - 0: read register.
  - 1: write register.
- **<address>**: (uint32) register address. You can refer to Technical Reference Manuals.
- **<write value>**: (uint32) write value (only in write mode).

### Note

- AT does not check address. Make sure that the registers you are operating on are valid.

## 3.2 Wi-Fi AT Commands

- *Introduction*
- *AT+CWINIT*: Initialize/Deinitialize Wi-Fi driver.
- *AT+CWMODE*: Set the Wi-Fi mode (Station/SoftAP/Station+SoftAP).
- *AT+CWSTATE*: Query the Wi-Fi state and Wi-Fi information.
- *AT+CWJAP*: Connect to an AP.
- *AT+CWRECONNCFG*: Query/Set the Wi-Fi reconnecting configuration.
- *AT+CWLAPOPT*: Set the configuration for the command *AT+CWLAP*.
- *AT+CWLAP*: List available APs.
- *AT+CWQAP*: Disconnect from an AP.
- *AT+CWSAP*: Query/Set the configuration of an ESP32-C2 SoftAP.
- *AT+CWLIF*: Obtain IP address of the station that connects to an ESP32-C2 SoftAP.
- *AT+CWQIF*: Disconnect stations from an ESP32-C2 SoftAP.
- *AT+CWDHCP*: Enable/disable DHCP.
- *AT+CWDHCPS*: Query/Set the IPv4 addresses allocated by an ESP32-C2 SoftAP DHCP server.
- *AT+CWAUTOCONN*: Connect to an AP automatically when powered on.
- *AT+CWAPPROTO*: Query/Set the 802.11 b/g/n protocol standard of SoftAP mode.
- *AT+CWSTAPROTO*: Query/Set the 802.11 b/g/n protocol standard of station mode.
- *AT+CIPSTAMAC*: Query/Set the MAC address of an ESP32-C2 station.
- *AT+CIPAPMAC*: Query/Set the MAC address of an ESP32-C2 SoftAP.
- *AT+CIPSTA*: Query/Set the IP address of an ESP32-C2 station.
- *AT+CIPAP*: Query/Set the IP address of an ESP32-C2 SoftAP.
- *AT+CWSTARTSMART*: Start SmartConfig.
- *AT+CWSTOPSMART*: Stop SmartConfig.
- *AT+WPS*: Enable the WPS function.
- *AT+MDNS*: Configure the mDNS function.
- *AT+CWJEAP*: Connect to a WPA2 Enterprise AP.
- *AT+CWHOSTNAME*: Query/Set the host name of an ESP32-C2 station.
- *AT+CWCOUNTRY*: Query/Set the Wi-Fi Country Code.

### 3.2.1 Introduction

**Important:** The default AT firmware supports all the AT commands except *AT+CWJEP* mentioned on this page. If you need to modify the commands supported by ESP32-C2 by default, please compile the ESP-AT project by following the steps in *Compile ESP-AT Project Locally* documentation. In the project configuration during the fifth step, make the following selections (Each item below is independent. Choose it according to your needs):

- Enable EAP commands (*AT+CWJEP*): Component config->AT->AT WPA2 Enterprise command support
  - Disable WPS commands (*AT+WPS*): Component config->AT->AT WPS command support
  - Disable mDNS commands (*AT+MDNS*): Component config->AT->AT MDNS command support
  - Disable smartconfig commands (*AT+CWSTARTSMART* and *AT+CWSTOPSMART*): Component config->AT->AT smartconfig command support
  - Disable all Wi-Fi commands (Not recommended. Once disabled, all Wi-Fi and above functions will be unusable, and you will need to implement these AT commands yourself): Component config->AT->AT wifi command support
- 

### 3.2.2 AT+CWINIT: Initialize or Deinitialize Wi-Fi Driver

#### Query Command

**Function:**

Query the Wi-Fi initialization status of ESP32-C2 device.

**Command:**

```
AT+CWINIT?
```

**Response:**

```
+CWINIT:<init>
OK
```

#### Set Command

**Function:**

Initialize or deinitialize Wi-Fi driver of ESP32-C2 device.

**Command:**

```
AT+CWINIT=<init>
```

**Response:**

```
OK
```

#### Parameters

- **<init>**:
  - 0: Deinitialize Wi-Fi driver of ESP32-C2 device.
  - 1: Initialize Wi-Fi driver of ESP32-C2 device. (Default value)

**Note**

- This setting is not saved to flash and will revert to the default value of 1 after restarting.
- When you run out of RAM resources and Wi-Fi is not used, you can use this command to clean up the Wi-Fi driver to free up RAM resources.

**Example**

```
// Deinitialize Wi-Fi driver
AT+CWINIT=0
```

### 3.2.3 AT+CWMODE: Query/Set the Wi-Fi Mode (Station/SoftAP/Station+SoftAP)

**Query Command****Function:**

Query the Wi-Fi mode of ESP32-C2.

**Command:**

```
AT+CWMODE?
```

**Response:**

```
+CWMODE:<mode>
OK
```

**Set Command****Function:**

Set the Wi-Fi mode of ESP32-C2.

**Command:**

```
AT+CWMODE=<mode>[,<auto_connect>]
```

**Response:**

```
OK
```

**Parameters**

- **<mode>**:
  - 0: Null mode. Wi-Fi RF will be disabled.
  - 1: Station mode.
  - 2: SoftAP mode.
  - 3: SoftAP+Station mode.
- **<auto\_connect>**: Enable or disable automatic connection to an AP when you change the mode of the ESP32-C2 from the SoftAP mode or null mode to the station mode or the SoftAP+Station mode. Default: 1. If you omit the parameter, the default value will be used, i.e. automatically connecting to an AP.
  - 0: The ESP32-C2 will not automatically connect to an AP.
  - 1: The ESP32-C2 will automatically connect to an AP if the configuration to connect to the AP has already been saved in flash before.

**Note**

- The configuration changes will be saved in the NVS area if *AT+SYSSTORE=1*.

**Example**

```
AT+CWMODE=3
```

### 3.2.4 AT+CWSTATE: Query the Wi-Fi state and Wi-Fi information

**Query Command****Function:**

Query the Wi-Fi state and Wi-Fi information of ESP32-C2.

**Command:**

```
AT+CWSTATE?
```

**Response:**

```
+CWSTATE:<state>,<"ssid">
```

```
OK
```

**Parameters**

- **<state>**: current Wi-Fi state.
  - 0: ESP32-C2 station has not started any Wi-Fi connection.
  - 1: ESP32-C2 station has connected to an AP, but does not get an IPv4 address yet.
  - 2: ESP32-C2 station has connected to an AP, and got an IPv4 address.
  - 3: ESP32-C2 station is in Wi-Fi connecting or reconnecting state.
  - 4: ESP32-C2 station is in Wi-Fi disconnected state.
- **<"ssid">**: the SSID of the target AP.

**Note**

- When ESP32-C2 station is not connected to an AP, it is recommended to use this command to query Wi-Fi information; after ESP32-C2 station is connected to an AP, it is recommended to use *AT+CWJAP* to query Wi-Fi information.

### 3.2.5 AT+CWJAP: Connect to an AP

**Query Command****Function:**

Query the AP to which the ESP32-C2 Station is already connected.

**Command:**

```
AT+CWJAP?
```

**Response:**

```
+CWJAP:<ssid>,<bssid>,<channel>,<rssi>,<pci_en>,<reconn_interval>,<listen_interval>  
↔,<scan_mode>,<pmf>  
OK
```

### Set Command

#### Function:

Connect an ESP32-C2 station to a targeted AP.

#### Command:

```
AT+CWJAP=[<ssid>],[<pwd>][,<bssid>][,<pci_en>][,<reconn_interval>][,<listen_  
↔interval>][,<scan_mode>][,<jap_timeout>][,<pmf>]
```

#### Response:

```
WIFI CONNECTED  
WIFI GOT IP  
  
OK  
[WIFI GOT IPv6 LL]  
[WIFI GOT IPv6 GL]
```

or

```
+CWJAP:<error code>  
ERROR
```

### Execute Command

#### Function:

Connect an ESP32-C2 station to a targeted AP with last Wi-Fi configuration.

#### Command:

```
AT+CWJAP
```

#### Response:

```
WIFI CONNECTED  
WIFI GOT IP  
  
OK  
[WIFI GOT IPv6 LL]  
[WIFI GOT IPv6 GL]
```

or

```
+CWJAP:<error code>  
ERROR
```

### Parameters

- **<ssid>**: the SSID of the target AP.
  - Escape character syntax is needed if SSID or password contains special characters, such `,` `"`, or `\\`.
  - Chinese SSID is supported. Chinese SSID of some routers or hotspots is not encoded in UTF-8 encoding format. You can scan SSID first, and then connect using the scanned SSID.

- **<pwd>**: password, MAX: 63-byte ASCII.
- **<bssid>**: the MAC address of the target AP. It cannot be omitted when multiple APs have the same SSID.
- **<channel>**: channel.
- **<rssi>**: signal strength.
- **<pci\_en>**: PCI Authentication.
  - 0: The ESP32-C2 station will connect APs with all encryption methods, including OPEN and WEP.
  - 1: The ESP32-C2 station will connect APs with all encryption methods, except OPEN and WEP.
- **<reconn\_interval>**: the interval between Wi-Fi reconnections. Unit: second. Default: 1. Maximum: 7200.
  - 0: The ESP32-C2 station will not reconnect to the AP when disconnected.
  - [1,7200]: The ESP32-C2 station will reconnect to the AP at the specified interval when disconnected.
- **<listen\_interval>**: the interval of listening to the AP's beacon. Unit: AP beacon intervals. Default: 3. Range: [1,100].
- **<scan\_mode>**:
  - 0: fast scan. It will end after finding the targeted AP. The ESP32-C2 station will connect to the first scanned AP.
  - 1: all-channel scan. It will end after all the channels are scanned. The device will connect to the scanned AP with the strongest signal.
- **<jap\_timeout>**: maximum timeout for *AT+CWJAP* command. Unit: second. Default: 15. Range: [3,600].
- **<pmf>**: Protected Management Frames. Default: 1.
  - 0 means disable PMF.
  - bit 0: PMF capable, advertizes support for protected management frame. Device will prefer to connect in PMF mode if other device also advertizes PMF capability.
  - bit 1: PMF required, advertizes that protected management frame is required. Device will not associate to non-PMF capable devices.
- **<error code>**: (for reference only)
  - 1: connection timeout.
  - 2: wrong password.
  - 3: cannot find the target AP.
  - 4: connection failed.
  - others: unknown error occurred.

## Notes

- The configuration changes will be saved in the NVS area if *AT+SYSSTORE=1*.
- This command requires Station mode to be enabled.
- After ESP32-C2 station is connected to an AP, it is recommended to use this command to query Wi-Fi information; when ESP32-C2 station is not connected to an AP, it is recommended to use *AT+CWSTATE* to query Wi-Fi information.
- The parameter *<reconn\_interval>* of this command is the same as *<interval\_second>* of the command *AT+CWRECONNCFG*. Therefore, if you omit *<reconn\_interval>* when running this command, the interval between Wi-Fi reconnections will use the default value 1.
- If the *<ssid>* and *<password>* parameter are omitted, AT will use the last configuration.
- Execute command has the same maximum timeout to setup command. The default value is 15 seconds, but you can change it by setting the parameter *<jap\_timeout>*.
- The authentication method via *WAPI* is not supported for connecting to the router.
- To get an IPv6 address, you need to set *AT+CIPV6=1*.
- Response OK means that the IPv4 network is ready, but not the IPv6 network. At present, ESP-AT is mainly based on IPv4 network, supplemented by IPv6 network.
- *WIFI GOT IPV6 LL* represents that the linklocal IPv6 address has been obtained. This address is calculated locally through EUI-64 and does not require the participation of the AP. Because of the parallel timing, this print may be before or after OK.
- *WIFI GOT IPV6 GL* represents that the global IPv6 address has been obtained. This address is combined by the prefix issued by AP and the suffix calculated internally, which requires the participation of the AP. Because of the parallel timing, this print may be before or after OK, or it may not be printed because the AP does not support IPv6.

**Example**

```
// If the target AP's SSID is "abc" and the password is "0123456789", the command
↳should be:
AT+CWJAP="abc", "0123456789"

// If the target AP's SSID is "ab\,c" and the password is "0123456789"\, the
↳command should be:
AT+CWJAP="ab\\,c", "0123456789\\"

// If multiple APs all have the SSID of "abc", the target AP can be found by BSSID:
AT+CWJAP="abc", "0123456789", "ca:d7:19:d8:a6:44"

// If esp-at is required that connect to a AP by protected management frame, the
↳command should be:
AT+CWJAP="abc", "0123456789",,,,,,,,,,3
```

**3.2.6 AT+CWRECONNCFG: Query/Set the Wi-Fi Reconnecting Configuration****Query Command****Function:**

Query the configuration of Wi-Fi reconnect.

**Command:**

```
AT+CWRECONNCFG?
```

**Response:**

```
+CWRECONNCFG:<interval_second>,<repeat_count>
OK
```

**Set Command****Function:**

Set the configuration of Wi-Fi reconnect.

**Command:**

```
AT+CWRECONNCFG=<interval_second>,<repeat_count>
```

**Response:**

```
OK
```

**Parameters**

- **<interval\_second>**: the interval between Wi-Fi reconnections. Unit: second. Default: 0. Maximum: 7200.
  - 0: The ESP32-C2 station will not reconnect to the AP when disconnected.
  - [1,7200]: The ESP32-C2 station will reconnect to the AP at the specified interval when disconnected.
- **<repeat\_count>**: the number of attempts the ESP32-C2 makes to reconnect to the AP. This parameter only works when the parameter <interval\_second> is not 0. Default: 0. Maximum: 1000.
  - 0: The ESP32-C2 station will always try to reconnect to AP.
  - [1,1000]: The ESP32-C2 station will attempt to reconnect to AP for the specified times.

### Example

```
// The ESP32-C2 station tries to reconnect to AP at the interval of one second for
↪100 times.
AT+CWRECONNCFG=1,100

// The ESP32-C2 station will not reconnect to AP when disconnected.
AT+CWRECONNCFG=0,0
```

### Notes

- The parameter `<interval_second>` of this command is the same as the parameter `[<reconn_interval>]` of the command `AT+CWJAP`.
- This command works for passive disconnection from APs, Wi-Fi mode switch, and Wi-Fi auto connect after power on.

## 3.2.7 AT+CWLAPOPT: Set the Configuration for the Command AT+CWLAP

### Set Command

#### Command:

```
AT+CWLAPOPT=<reserved>,<print mask>[,<rssi filter>][,<authmode mask>]
```

#### Response:

```
OK
```

or

```
ERROR
```

### Parameters

- **<reserved>**: reserved item.
- **<print mask>**: determine whether the following parameters are shown in the result of `AT+CWLAP`. Default: 0x7FFF. If you set them to 1, it means showing the corresponding parameters; if you set them as 0, it means NOT showing the corresponding parameters.
  - bit 0: determine whether `<ecn>` will be shown.
  - bit 1: determine whether `<ssid>` will be shown.
  - bit 2: determine whether `<rssi>` will be shown.
  - bit 3: determine whether `<mac>` will be shown.
  - bit 4: determine whether `<channel>` will be shown.
  - bit 5: determine whether `<freq_offset>` will be shown.
  - bit 6: determine whether `<freqcal_val>` will be shown.
  - bit 7: determine whether `<pairwise_cipher>` will be shown.
  - bit 8: determine whether `<group_cipher>` will be shown.
  - bit 9: determine whether `<bgn>` will be shown.
  - bit 10: determine whether `<wps>` will be shown.
- **[<rssi filter>]**: determine whether the result of the command `AT+CWLAP` will be filtered according to `rssi filter`. In other words, the result of the command will **NOT** show the APs whose signal strength is below `rssi filter`. Unit: dBm. Default: -100. Range: [-100,40].
- **[<authmode mask>]**: determine whether APs with the following authmodes are shown in the result of `AT+CWLAP`. Default: 0xFFFF. If you set bit `x` to 1, the APs with the corresponding authmode will be shown. If you set bit `x` to 0, the APs with the corresponding authmode will NOT be shown;
  - bit 0: determine whether APs with `OPEN` authmode will be shown.



- bit 1: determine whether APs with WEP authmode will be shown.
- bit 2: determine whether APs with WPA\_PSK authmode will be shown.
- bit 3: determine whether APs with WPA2\_PSK authmode will be shown.
- bit 4: determine whether APs with WPA\_WPA2\_PSK authmode will be shown.
- bit 5: determine whether APs with WPA2\_ENTERPRISE authmode will be shown.
- bit 6: determine whether APs with WPA3\_PSK authmode will be shown.
- bit 7: determine whether AP with WPA2\_WPA3\_PSK authmode will be shown.
- bit 8: determine whether AP with WAPI\_PSK authmode will be shown.
- bit 9: determine whether AP with OWE authmode will be shown.

### Example

```
// The first parameter is 1, meaning that the result of the command AT+CWLAP will
↳be ordered according to RSSI;
// The second parameter is 31, namely 0x1F, meaning that the corresponding bits of
↳<print mask> are set to 1. All parameters will be shown in the result of
↳AT+CWLAP.
AT+CWLAPOPT=1,31
AT+CWLAP

// Just show the AP which authmode is OPEN
AT+CWLAPOPT=1,31,-100,1
AT+CWLAP
```

## 3.2.8 AT+CWLAP: List Available APs

### Set Command

#### Function:

Query the APs with specified parameters, such as the SSID, MAC address, or channel.

#### Command:

```
AT+CWLAP=[<ssid>,<mac>,<channel>,<scan_type>,<scan_time_min>,<scan_time_max>]
```

### Execute Command

#### Function:

List all available APs.

#### Command:

```
AT+CWLAP
```

#### Response:

```
+CWLAP:<ecn>,<ssid>,<rssi>,<mac>,<channel>,<freq_offset>,<freqcal_val>,<pairwise_
↳cipher>,<group_cipher>,<bgn>,<wps>
OK
```

### Parameters

- <ecn>: encryption method.
  - 0: OPEN
  - 1: WEP

- 2: WPA\_PSK
- 3: WPA2\_PSK
- 4: WPA\_WPA2\_PSK
- 5: WPA2\_ENTERPRISE
- 6: WPA3\_PSK
- 7: WPA2\_WPA3\_PSK
- 8: WAPI\_PSK
- 9: OWE
- **<ssid>**: string parameter showing SSID of the AP.
- **<rssi>**: signal strength.
- **<mac>**: string parameter showing MAC address of the AP.
- **<channel>**: channel.
- **<scan\_type>**: Wi-Fi scan type. Default: 0.
  - 0: active scan
  - 1: passive scan
- **<scan\_time\_min>**: the minimum active scan time per channel. Unit: millisecond. Range [0,1500]. If the scan type is passive, this parameter is invalid.
- **<scan\_time\_max>**: the maximum active scan time per channel. Unit: millisecond. Range [0,1500]. If this parameter is 0, the firmware will use the default time: 120 ms for active scan; 360 ms for passive scan.
- **<freq\_offset>**: frequency offset (reserved item).
- **<freqcal\_val>**: frequency calibration value (reserved item).
- **<pairwise\_cipher>**: pairwise cipher type.
  - 0: None
  - 1: WEP40
  - 2: WEP104
  - 3: TKIP
  - 4: CCMP
  - 5: TKIP and CCMP
  - 6: AES-CMAC-128
  - 7: Unknown
- **<group\_cipher>**: group cipher type, same enumerated value to **<pairwise\_cipher>**.
- **<bgn>**: 802.11 b/g/n. If the corresponding bit is 1, the corresponding mode is enabled; if the corresponding bit is 0, the corresponding mode is disabled.
  - bit 0: bit to identify if 802.11b mode is enabled or not
  - bit 1: bit to identify if 802.11g mode is enabled or not
  - bit 2: bit to identify if 802.11n mode is enabled or not
- **<wps>**: wps flag.
  - 0: WPS disabled
  - 1: WPS enabled

### Example

```
AT+CWLAP="Wi-Fi", "ca:d7:19:d8:a6:44", 6, 0, 400, 1000

// Search for APs with a designated SSID:
AT+CWLAP="Wi-Fi"
```

## 3.2.9 AT+CWQAP: Disconnect from an AP

### Execute Command

#### Command:

```
AT+CWQAP
```

#### Response:

OK

### 3.2.10 AT+CWSAP: Query/Set the configuration of an ESP32-C2 SoftAP

#### Query Command

**Function:**

Query the configuration parameters of an ESP32-C2 SoftAP.

**Command:**

AT+CWSAP?

**Response:**

+CWSAP:<ssid>,<pwd>,<channel>,<ecn>,<max conn>,<ssid hidden>  
OK

#### Set Command

**Function:**

Set the configuration of an ESP32-C2 SoftAP.

**Command:**

AT+CWSAP=<ssid>,<pwd>,<chl>,<ecn>[,<max conn>][,<ssid hidden>]

**Response:**

OK

#### Parameters

- <ssid>: string parameter showing SSID of the AP.
- <pwd>: string parameter showing the password. Length: 8 ~ 63 bytes ASCII.
- <channel>: channel ID.
- <ecn>: encryption method; WEP is not supported.
  - 0: OPEN
  - 2: WPA\_PSK
  - 3: WPA2\_PSK
  - 4: WPA\_WPA2\_PSK
- [<max conn>]: maximum number of stations that ESP32-C2 SoftAP can connect. Range: refer to [max\\_connection description](#).
- [<ssid hidden>]:
  - 0: broadcasting SSID (default).
  - 1: not broadcasting SSID.

#### Notes

- This command works only when *AT+CWMODE=2* or *AT+CWMODE=3*.
- The configuration changes will be saved in the NVS area if *AT+SYSTORE=1*.
- The default SSID varies from devices to device as it consists of the MAC address of the device. You can use *AT+CWSAP?* to query the default SSID.

### Example

```
AT+CWSAP="ESP", "1234567890", 5, 3
```

## 3.2.11 AT+CWLIF: Obtain IP Address of the Station That Connects to an ESP32-C2 SoftAP

### Execute Command

#### Command:

```
AT+CWLIF
```

#### Response:

```
+CWLIF:<ip addr>,<mac>
```

```
OK
```

### Parameters

- **<ip addr>**: IP address of the station that connects to the ESP32-C2 SoftAP.
- **<mac>**: MAC address of the station that connects to the ESP32-C2 SoftAP.

### Note

- This command cannot get a static IP. It works only when DHCP of both the ESP32-C2 SoftAP and the connected station are enabled.

## 3.2.12 AT+CWQIF: Disconnect Stations from an ESP32-C2 SoftAP

### Execute Command

#### Function:

Disconnect all stations that are connected to the ESP32-C2 SoftAP.

#### Command:

```
AT+CWQIF
```

#### Response:

```
OK
```

### Set Command

#### Function:

Disconnect a specific station from the ESP32-C2 SoftAP.

#### Command:

```
AT+CWQIF=<mac>
```

**Response:**

OK

**Parameter**

- **<mac>**: MAC address of the station to disconnect.

### 3.2.13 AT+CWDHCP: Enable/Disable DHCP

**Query Command**

**Command:**

AT+CWDHCP?

**Response:**

+CWDHCP:<state>  
OK

**Set Command**

**Function:**

Enable/disable DHCP.

**Command:**

AT+CWDHCP=<operate>,<mode>

**Response:**

OK

**Parameters**

- **<operate>**:
  - 0: disable
  - 1: enable
- **<mode>**:
  - Bit0: Station DHCP
  - Bit1: SoftAP DHCP
- **<state>**: the status of DHCP
  - Bit0:
    - \* 0: Station DHCP is disabled.
    - \* 1: Station DHCP is enabled.
  - Bit1:
    - \* 0: SoftAP DHCP is disabled.
    - \* 1: SoftAP DHCP is enabled.
  - Bit2:
    - \* 0: Ethernet DHCP is disabled.
    - \* 1: Ethernet DHCP is enabled.

## Notes

- The configuration changes will be saved in the NVS area if `AT+SYSTORE=1`.
- This Set Command correlates with the commands that set static IP, such as `AT+CIPSTA` and `AT+CIPAP`:
  - If DHCP is enabled, static IPv4 address will be disabled;
  - If static IPv4 address is enabled, DHCP will be disabled;
  - The last configuration overwrites the previous configuration.

## Example

```
// Enable Station DHCP. If the last DHCP mode is 2, the current DHCP mode will be
↪3.
AT+CWDHCP=1,1

// Disable SoftAP DHCP. If the last DHCP mode is 3, the current DHCP mode will be
↪1.
AT+CWDHCP=0,2
```

### 3.2.14 AT+CWDHCPs: Query/Set the IPv4 Addresses Allocated by an ESP32-C2 SoftAP DHCP Server

#### Query Command

##### Command:

```
AT+CWDHCPs?
```

##### Response:

```
+CWDHCPs:<lease time>,<start IP>,<end IP>
OK
```

#### Set Command

##### Function:

Set the IPv4 address range of the ESP32-C2 SoftAP DHCP server.

##### Command:

```
AT+CWDHCPs=<enable>,<lease time>,<start IP>,<end IP>
```

##### Response:

```
OK
```

#### Parameters

- **<enable>**:
  - 1: Enable DHCP server settings. The parameters below have to be set.
  - 0: Disable DHCP server settings and use the default IPv4 address range.
- **<lease time>**: lease time. Unit: minute. Range [1,2880].
- **<start IP>**: start IPv4 address of the IPv4 address range that can be obtained from ESP32-C2 SoftAP DHCP server.
- **<end IP>**: end IPv4 address of the IPv4 address range that can be obtained from ESP32-C2 SoftAP DHCP server.

## Notes

- The configuration changes will be saved in the NVS area if `AT+SYSTORE=1`.
- This AT command works only when both SoftAP and DHCP server are enabled for ESP32-C2.
- The IPv4 address should be in the same network segment as the IPv4 address of ESP32-C2 SoftAP.

## Example

```
AT+CWDHCPS=1,3,"192.168.4.10","192.168.4.15"  
AT+CWDHCPS=0 // Disable the settings and use the default IPv4 address range.
```

## 3.2.15 AT+CWAUTOCONN: Query/Set Automatic Connection to an AP When Powered on

### Query Command

#### Command:

```
AT+CWAUTOCONN?
```

#### Response:

```
+CWAUTOCONN:<enable>  
OK
```

### Set Command

#### Command:

```
AT+CWAUTOCONN=<enable>
```

#### Response:

```
OK
```

### Parameters

- **<enable>**:
  - 1: Enable automatic connection to an AP when powered on. (Default)
  - 0: Disable automatic connection to an AP when powered on.

### Note

- The configuration changes will be saved in the NVS area.

## Example

```
AT+CWAUTOCONN=1
```

### 3.2.16 AT+CWAPPROTO: Query/Set the 802.11 b/g/n Protocol Standard of SoftAP Mode

#### Query Command

**Command:**

```
AT+CWAPPROTO?
```

**Response:**

```
+CWAPPROTO:<protocol>  
OK
```

#### Set Command

**Command:**

```
AT+CWAPPROTO=<protocol>
```

**Response:**

```
OK
```

#### Parameters

- **<protocol>**:
  - bit0: 802.11b protocol standard.
  - bit1: 802.11g protocol standard.
  - bit2: 802.11n protocol standard.

#### Note

- See [Wi-Fi Protocol Mode](#) for the PHY mode supported by the ESP32-C2 device.
- By default, PHY mode of ESP32-C2 is 802.11bgn mode.

### 3.2.17 AT+CWSTAPROTO: Query/Set the 802.11 b/g/n Protocol Standard of Station Mode

#### Query Command

**Command:**

```
AT+CWSTAPROTO?
```

**Response:**

```
+CWSTAPROTO:<protocol>  
OK
```



### Set Command

#### Command:

```
AT+CWSTAPROTO=<protocol>
```

#### Response:

```
OK
```

### Parameters

- **<protocol>**:
  - bit0: 802.11b protocol standard.
  - bit1: 802.11g protocol standard.
  - bit2: 802.11n protocol standard.

### Note

- See [Wi-Fi Protocol Mode](#) for the PHY mode supported by the ESP32-C2 device.
- By default, PHY mode of ESP32-C2 is 802.11bgn mode.

## 3.2.18 AT+CIPSTAMAC: Query/Set the MAC Address of an ESP32-C2 Station

### Query Command

#### Function:

Query the MAC address of the ESP32-C2 Station.

#### Command:

```
AT+CIPSTAMAC?
```

#### Response:

```
+CIPSTAMAC:<mac>  
OK
```

### Set Command

#### Function:

Set the MAC address of an ESP32-C2 station.

#### Command:

```
AT+CIPSTAMAC=<mac>
```

#### Response:

```
OK
```

### Parameters

- **<mac>**: string parameter showing MAC address of an ESP32-C2 station.

## Notes

- The configuration changes will be saved in the NVS area if *AT+SYSTORE=1*.
- The MAC address of ESP32-C2 Station is different from that of the ESP32-C2 SoftAP. Please make sure that you do not set the same MAC address for both of them.
- Bit 0 of the ESP32-C2 MAC address CANNOT be 1. For example, a MAC address can be “1a:…” but not “15:…” .
- FF:FF:FF:FF:FF:FF and 00:00:00:00:00:00 are invalid MAC address and cannot be set.

## Example

```
AT+CIPSTAMAC="1a:fe:35:98:d3:7b"
```

### 3.2.19 AT+CIPAPMAC: Query/Set the MAC Address of an ESP32-C2 SoftAP

#### Query Command

##### Function:

Query the MAC address of the ESP32-C2 SoftAP.

##### Command:

```
AT+CIPAPMAC?
```

##### Response:

```
+CIPAPMAC:<mac>  
OK
```

#### Set Command

##### Function:

Set the MAC address of the ESP32-C2 SoftAP.

##### Command:

```
AT+CIPAPMAC=<mac>
```

##### Response:

```
OK
```

#### Parameters

- **<mac>**: string parameter showing MAC address of the ESP32-C2 SoftAP.

## Notes

- The configuration changes will be saved in the NVS area if *AT+SYSTORE=1*.
- The MAC address of ESP32-C2 SoftAP is different from that of the ESP32-C2 station. Please make sure that you do not set the same MAC address for both of them.

- Bit 0 of the ESP32-C2 MAC address CANNOT be 1. For example, a MAC address can be “18:…” but not “15:…” .
- FF:FF:FF:FF:FF:FF and 00:00:00:00:00:00 are invalid MAC and cannot be set.

### Example

```
AT+CIPAPMAC="18:fe:35:98:d3:7b"
```

## 3.2.20 AT+CIPSTA: Query/Set the IP Address of an ESP32-C2 Station

### Query Command

#### Function:

Query the IP address of the ESP32-C2 Station.

#### Command:

```
AT+CIPSTA?
```

#### Response:

```
+CIPSTA:ip:<"ip">
+CIPSTA:gateway:<"gateway">
+CIPSTA:netmask:<"netmask">
+CIPSTA:ip6ll:<"ipv6 addr">
+CIPSTA:ip6gl:<"ipv6 addr">
```

```
OK
```

### Set Command

#### Function:

Set the IPv4 address of the ESP32-C2 station.

#### Command:

```
AT+CIPSTA=<"ip">[,<"gateway">,<"netmask">]
```

#### Response:

```
OK
```

### Parameters

- <" ip" >: string parameter showing the IPv4 address of the ESP32-C2 station.
- <" gateway" >: gateway.
- <" netmask" >: netmask.
- <" ipv6 addr" >: string parameter showing the IPv6 address of the ESP32-C2 station.

### Notes

- For the query command, only when the ESP32-C2 station is connected to an AP or the static IP address is configured can its IP address be queried.
- The configuration changes will be saved in the NVS area if *AT+SYSSSTORE=1*.

- The Set Command correlates with the commands that set DHCP, such as *AT+CWDHCP*.
  - If static IPv4 address is enabled, DHCP will be disabled;
  - If DHCP is enabled, static IPv4 address will be disabled;
  - The last configuration overwrites the previous configuration.

### Example

```
AT+CIPSTA="192.168.6.100", "192.168.6.1", "255.255.255.0"
```

## 3.2.21 AT+CIPAP: Query/Set the IP Address of an ESP32-C2 SoftAP

### Query Command

#### Function:

Query the IP address of the ESP32-C2 SoftAP.

#### Command:

```
AT+CIPAP?
```

#### Response:

```
+CIPAP:ip:<"ip">
+CIPAP:gateway:<"gateway">
+CIPAP:netmask:<"netmask">
+CIPAP:ip6ll:<"ipv6 addr">
```

```
OK
```

### Set Command

#### Function:

Set the IPv4 address of the ESP32-C2 SoftAP.

#### Command:

```
AT+CIPAP=<"ip">[,<"gateway">,<"netmask">]
```

#### Response:

```
OK
```

### Parameters

- <"ip" >: string parameter showing the IPv4 address of the ESP32-C2 SoftAP.
- <" gateway" >: gateway.
- <" netmask" >: netmask.
- <" ipv6 addr" >: string parameter showing the IPv6 address of the ESP32-C2 SoftAP.

### Notes

- The set command is just applied to the IPv4 network, but not the IPv6 network.
- The configuration changes will be saved in the NVS area if *AT+SYSSSTORE=1*.
- The set command correlates with the commands that set DHCP, such as *AT+CWDHCP*.

- If static IPv4 address is enabled, DHCP will be disabled;
- If DHCP is enabled, static IPv4 address will be disabled;
- The last configuration overwrites the previous configuration.

### Example

```
AT+CIPAP="192.168.5.1", "192.168.5.1", "255.255.255.0"
```

## 3.2.22 AT+CWSTARTSMART: Start SmartConfig

### Execute Command

#### Function:

Start SmartConfig of the type ESP-TOUCH+AirKiss.

#### Command:

```
AT+CWSTARTSMART
```

### Set Command

#### Function:

Start SmartConfig of a designated type.

#### Command:

```
AT+CWSTARTSMART=<type>[, <auth floor>][, <"esptouch v2 key">]
```

#### Response:

```
OK
```

### Parameters

- **<type>**:
  - 1: ESP-TOUCH
  - 2: AirKiss
  - 3: ESP-TOUCH+AirKiss
  - 4: ESP-TOUCH v2
- **<auth floor>**: Wi-Fi authentication mode floor. ESP-AT will not connect to the AP whose authmode is lower than this floor.
  - 0: OPEN (Default)
  - 1: WEP
  - 2: WPA\_PSK
  - 3: WPA2\_PSK
  - 4: WPA\_WPA2\_PSK
  - 5: WPA2\_ENTERPRISE
  - 6: WPA3\_PSK
  - 7: WPA2\_WPA3\_PSK
- **<" esptouch v2 key" >**: ESP-TOUCH v2 decrypt key. It is used to decrypt Wi-Fi password and reserved data. Length: 16 bytes.

## Notes

- For more details on SmartConfig, please see [ESP-TOUCH User Guide](#).
- SmartConfig is only available in the ESP32-C2 station mode.
- The message `Smart get Wi-Fi info` means that SmartConfig has successfully acquired the AP information. ESP32-C2 will try to connect to the target AP.
- Message `+SCRD:<length>,<rvd data>` means that ESP-Touch v2 has successfully acquired the reserved data information.
- Message `Smartconfig connected Wi-Fi` is printed if the connection is successful.
- When AT returns `Smartconfig connected Wi-Fi`, it is recommended to delay more than 6 seconds before executing `AT+CWSTOPSMART` because the ESP32-C2 needs to synchronize the SmartConfig results to the mobile phone.
- Use command `AT+CWSTOPSMART` to stop SmartConfig before running other commands. Please make sure that you do not execute other commands during SmartConfig.

## Example

```
AT+CWMODE=1
AT+CWSTARTSMART
```

### 3.2.23 AT+CWSTOPSMART: Stop SmartConfig

#### Execute Command

##### Command:

```
AT+CWSTOPSMART
```

##### Response:

```
OK
```

#### Note

- Irrespective of whether SmartConfig succeeds or not, please always call `AT+CWSTOPSMART` before executing any other AT commands to release the internal memory taken up by SmartConfig.

## Example

```
AT+CWMODE=1
AT+CWSTARTSMART
AT+CWSTOPSMART
```

### 3.2.24 AT+WPS: Enable the WPS Function

#### Set Command

##### Command:

```
AT+WPS=<enable>[,<auth floor>]
```

##### Response:

```
OK
```

### Parameters

- **<enable>**:
  - 1: Enable WPS (Wi-Fi Protected Setup) that uses PBC (Push Button Configuration) mode.
  - 0: Disable WPS that uses PBC mode.
- **<auth floor>**: Wi-Fi authentication mode floor. ESP-AT will not connect to the AP whose authmode is lower than this floor.
  - 0: OPEN (Default)
  - 1: WEP
  - 2: WPA\_PSK
  - 3: WPA2\_PSK
  - 4: WPA\_WPA2\_PSK
  - 5: WPA2\_ENTERPRISE
  - 6: WPA3\_PSK
  - 7: WPA2\_WPA3\_PSK

### Notes

- WPS can only be used when the ESP32-C2 station is enabled.
- WPS does not support WEP (Wired-Equivalent Privacy) encryption.

### Example

```
AT+CWMODE=1
AT+WPS=1
```

## 3.2.25 AT+MDNS: Configure the mDNS Function

### Set Command

#### Command:

```
AT+MDNS=<enable>[, <hostname>, <service_name>, <port>]
```

#### Response:

```
OK
```

### Parameters

- **<enable>**:
  - 1: Enable the mDNS function. The following three parameters need to be set.
  - 0: Disable the mDNS function. The following three parameters does not need to be set.
- **<hostname>**: mDNS host name.
- **<service\_name>**: mDNS service name.
- **<port>**: mDNS port.

### Example

```
AT+CWMODE=1
AT+CWJAP="1234567890", "1234567890"
AT+MDNS=1, "espressif", "_iot", 8080
AT+MDNS=0
```

## 3.2.26 AT+CWJEAP: Connect to a WPA2 Enterprise AP

### Query Command

#### Function:

Query the configuration information of the Enterprise AP to which the ESP32-C2 station is already connected.

#### Command:

```
AT+CWJEAP?
```

#### Response:

```
+CWJEAP:<ssid>,<method>,<identity>,<username>,<password>,<security>
OK
```

### Set Command

#### Function:

Connect to the targeted Enterprise AP.

#### Command:

```
AT+CWJEAP=<ssid>,<method>,<identity>,<username>,<password>,<security>[,<jeap_
↪timeout>]
```

#### Response:

```
OK
```

or

```
+CWJEAP:Timeout
ERROR
```

### Parameters

- **<ssid>**: the SSID of the Enterprise AP.
  - Escape character syntax is needed if SSID or password contains any special characters, such as , , " , or \\.
- **<method>**: WPA2 Enterprise authentication method.
  - 0: EAP-TLS.
  - 1: EAP-PEAP.
  - 2: EAP-TTLS.
- **<identity>**: identity for phase 1. String limited to 1 ~ 32.
- **<username>**: username for phase 2. Range: 1 ~ 32 bytes. For the EAP-PEAP and EAP-TTLS method, you must set this parameter. For the EAP-TLS method, you do not need to.
- **<password>**: password for phase 2. Range: 1 ~ 32 bytes. For the EAP-PEAP and EAP-TTLS method, you must set this parameter. For the EAP-TLS method, you do not need to.



- **<security>**:
  - Bit0: Client certificate.
  - Bit1: Server certificate.
- **[<jeap\_timeout>]**: maximum timeout for *AT+CWJEAP* command. Unit: second. Default: 15. Range: [3,600].

### Example

```
// Connect to EAP-TLS mode Enterprise AP, set identity, verify server certificate,
↳and load client certificate
AT+CWJEAP="dlink11111",0,"example@espressif.com",,,3

// Connect to EAP-PEAP mode Enterprise AP, set identity, username and password,
↳not verify server certificate and not load client certificate
AT+CWJEAP="dlink11111",1,"example@espressif.com","espressif","test11",0
```

### Error Code:

The WPA2 Enterprise error code will be prompt as ERR CODE:0x<%08x>.

AT_EAP_MALLOC_FAILED	0x8001
AT_EAP_GET_NVS_CONFIG_FAILED	0x8002
AT_EAP_CONN_FAILED	0x8003
AT_EAP_SET_WIFI_CONFIG_FAILED	0x8004
AT_EAP_SET_IDENTITY_FAILED	0x8005
AT_EAP_SET_USERNAME_FAILED	0x8006
AT_EAP_SET_PASSWORD_FAILED	0x8007
AT_EAP_GET_CA_LEN_FAILED	0x8008
AT_EAP_READ_CA_FAILED	0x8009
AT_EAP_SET_CA_FAILED	0x800A
AT_EAP_GET_CERT_LEN_FAILED	0x800B
AT_EAP_READ_CERT_FAILED	0x800C
AT_EAP_GET_KEY_LEN_FAILED	0x800D
AT_EAP_READ_KEY_FAILED	0x800E
AT_EAP_SET_CERT_KEY_FAILED	0x800F
AT_EAP_ENABLE_FAILED	0x8010
AT_EAP_ALREADY_CONNECTED	0x8011
AT_EAP_GET_SSID_FAILED	0x8012
AT_EAP_SSID_NULL	0x8013
AT_EAP_SSID_LEN_ERROR	0x8014
AT_EAP_GET_METHOD_FAILED	0x8015
AT_EAP_CONN_TIMEOUT	0x8016
AT_EAP_GET_IDENTITY_FAILED	0x8017
AT_EAP_IDENTITY_LEN_ERROR	0x8018
AT_EAP_GET_USERNAME_FAILED	0x8019
AT_EAP_USERNAME_LEN_ERROR	0x801A
AT_EAP_GET_PASSWORD_FAILED	0x801B
AT_EAP_PASSWORD_LEN_ERROR	0x801C
AT_EAP_GET_SECURITY_FAILED	0x801D
AT_EAP_SECURITY_ERROR	0x801E
AT_EAP_METHOD_SECURITY_UNMATCHED	0x801F
AT_EAP_PARAMETER_COUNTS_ERROR	0x8020
AT_EAP_GET_WIFI_MODE_ERROR	0x8021
AT_EAP_WIFI_MODE_NOT_STA	0x8022
AT_EAP_SET_CONFIG_FAILED	0x8023
AT_EAP_METHOD_ERROR	0x8024

**Note**

- The configuration changes will be saved in the NVS area if `AT+SYSSTORE=1`.
- This command requires Station mode to be active.
- TLS mode will use client certificate. Please make sure it is enabled.

**3.2.27 AT+CWHOSTNAME: Query/Set the Host Name of an ESP32-C2 Station****Query Command****Function:**

Query the host name of ESP32-C2 Station.

**Command:**

```
AT+CWHOSTNAME?
```

**Response:**

```
+CWHOSTNAME:<hostname>
```

```
OK
```

**Set Command****Function:**

Set the host name of ESP32-C2 Station.

**Command:**

```
AT+CWHOSTNAME=<hostname>
```

**Response:**

```
OK
```

If the Station mode is not enabled, the command will return:

```
ERROR
```

**Parameters**

- **<hostname>**: the host name of the ESP32-C2 Station. Maximum length: 32 bytes.

**Note**

- The configuration changes are not saved in the flash.

**Example**

```
AT+CWMODE=3
AT+CWHOSTNAME="my_test"
```

### 3.2.28 AT+CWCOUNTRY: Query/Set the Wi-Fi Country Code

#### Query Command

**Function:**

Query Wi-Fi country code information.

**Command:**

```
AT+CWCOUNTRY?
```

**Response:**

```
+CWCOUNTRY:<country_policy>,<country_code>,<start_channel>,<total_channel_count>
OK
```

#### Set Command

**Function:**

Set the Wi-Fi country code information.

**Command:**

```
AT+ CWCOUNTRY=<country_policy>,<country_code>,<start_channel>,<total_channel_count>
```

**Response:**

```
OK
```

#### Parameters

- **<country\_policy>**:
  - 0: will change the county code to be the same as the AP that the ESP32-C2 is connected to.
  - 1: the country code will not change, always be the one set by command.
- **<country\_code>**: country code. Maximum length: 3 characters. Refer to [ISO 3166-1 alpha-2](#) for country codes.
- **<start\_channel>**: the channel number to start. Range: [1,14].
- **<total\_channel\_count>**: total number of channels.

#### Note

- See [Wi-Fi Country Code](#) for more details.
- The configuration changes are not saved in the flash.

#### Example

```
AT+CWMODE=3
AT+CWCOUNTRY=1, "CN", 1, 13
```

## 3.3 TCP/IP AT Commands

- *Introduction*
- *AT+CIPV6*: Enable/disable the network of Internet Protocol Version 6 (IPv6).
- *AT+CIPSTATE*: Obtain the TCP/UDP/SSL connection information.
- *AT+CIPSTATUS (deprecated)*: Obtain the TCP/UDP/SSL connection status and information.
- *AT+CIPDOMAIN*: Resolve a Domain Name.
- *AT+CIPSTART*: Establish TCP connection, UDP transmission, or SSL connection.
- *AT+CIPSTARTEX*: Establish TCP connection, UDP transmission, or SSL connection with an automatically assigned ID.
- *[Data Mode Only] +++*: Exit from the *data mode*.
- *AT+SAVETRANSLINK*: Set whether to enter Wi-Fi *Passthrough Mode* on power-up.
- *AT+CIPSEND*: Send data in the *normal transmission mode* or Wi-Fi *normal transmission mode*.
- *AT+CIPSENDL*: Send long data in parallel in the *normal transmission mode*.
- *AT+CIPSENDLCFG*: Set the configuration for the command *AT+CIPSENDL*.
- *AT+CIPSENDEX*: Send data in the *normal transmission mode* in expanded ways.
- *AT+CIPCLOSE*: Close TCP/UDP/SSL connection.
- *AT+CIFSR*: Obtain the local IP address and MAC address.
- *AT+CIPMUX*: Enable/disable the multiple connections mode.
- *AT+CIPSERVER*: Delete/create a TCP/SSL server.
- *AT+CIPSERVERMAXCONN*: Query/Set the maximum connections allowed by a server.
- *AT+CIPMODE*: Query/Set the transmission mode.
- *AT+CIPSTO*: Query/Set the local TCP Server Timeout.
- *AT+CIPSNTPCFG*: Query/Set the time zone and SNTP server.
- *AT+CIPSNTPTIME*: Query the SNTP time.
- *AT+CIPSNTPINTV*: Query/Set the SNTP time synchronization interval.
- *AT+CIPFWVER*: Query the existing AT firmware version on the server.
- *AT+CIUPDATE*: Upgrade the firmware through Wi-Fi.
- *AT+CIPDINFO*: Set “+IPD” message mode.
- *AT+CIPSSLCCONF*: Query/Set SSL clients.
- *AT+CIPSSLCCN*: Query/Set the Common Name of the SSL client.
- *AT+CIPSSLCSNI*: Query/Set SSL client Server Name Indication (SNI).
- *AT+CIPSSLCALPN*: Query/Set SSL client Application Layer Protocol Negotiation (ALPN).
- *AT+CIPSSLCP SK*: Query/Set SSL client Pre-shared Key (PSK) in string format.
- *AT+CIPSSLCP SKHEX*: Query/Set SSL client Pre-shared Key (PSK) in hexadecimal format.
- *AT+CIPRECONNINTV*: Query/Set the TCP/UDP/SSL reconnection interval for the Wi-Fi *normal transmission mode*.
- *AT+CIPRECVMODE*: Query/Set socket receiving mode.
- *AT+CIPRECVDATA*: Obtain socket data in passive receiving mode.
- *AT+CIPRECVMODE*: Obtain socket data length in passive receiving mode.
- *AT+PING*: Ping the remote host.
- *AT+CIPDNS*: Query/Set DNS server information.
- *AT+CIPTCPOPT*: Query/Set the socket options.

### 3.3.1 Introduction

**Important:** The default AT firmware supports all the AT commands mentioned on this page. If you need to modify the commands supported by ESP32-C2 by default, please compile the ESP-AT project by following the steps in [Compile ESP-AT Project Locally](#) documentation. In the project configuration during the fifth step, make the following selections (Each item below is independent. Choose it according to your needs):

- Disable OTA commands (*AT+CIUPDATE* and *AT+CIPFWVER*): Component config->AT->AT OTA command support
- Disable PING commands (*AT+PING*): Component config->AT->AT ping command support

- Disable TCP/IP commands (Not recommended. Once disabled, all TCP/IP functions will be unavailable and you will need to implement these AT commands yourself): `Component config -> AT -> AT net command support`
- 

### 3.3.2 AT+CIPV6: Enable/disable the network of Internet Protocol Version 6 (IPv6)

#### Query Command

**Function:**

Query whether IPv6 is enabled.

**Command:**

```
AT+CIPV6?
```

**Response:**

```
+CIPV6:<enable>  
OK
```

#### Set Command

**Function:**

Enable/Disable IPv6 network.

**Command:**

```
AT+CIPV6=<enable>
```

**Response:**

```
OK
```

#### Parameters

- **<enable>**: status of IPv6 network. Default: 0.
  - 0: disable IPv6 network.
  - 1: enable IPv6 network.

#### Notes

- You should enable IPv6 network before using IPv6 related upper layer AT commands (TCP/UDP/SSL/PING/DNS based on IPv6 network, also known as TCP6/UDP6/SSL6/PING6/DNS6 or TCPv6/UDPv6/SSLv6/PINGv6/DNSv6).

### 3.3.3 AT+CIPSTATE: Obtain the TCP/UDP/SSL Connection Information

#### Query Command

**Command:**

```
AT+CIPSTATE?
```

**Response:**

When there is a connection, AT returns:

```
+CIPSTATE:<link ID>,<"type">,<"remote IP">,<remote port>,<local port>,<tetype>
OK
```

When there is no connection, AT returns:

```
OK
```

**Parameters**

- **<link ID>**: ID of the connection (0~4), used for multiple connections.
- **<" type" >**: string parameter showing the type of transmission: "TCP", "TCPv6", "UDP", "UDPv6", "SSL", or "SSLv6".
- **<" remote IP" >**: string parameter showing the remote IPv4 address or IPv6 address.
- **<remote port>**: the remote port number.
- **<local port>**: the local port number.
- **<tetype>**:
  - 0: ESP32-C2 runs as a client.
  - 1: ESP32-C2 runs as a server.

### 3.3.4 AT+CIPSTATUS (deprecated): Obtain the TCP/UDP/SSL Connection Status and Information

**Execute Command****Command:**

```
AT+CIPSTATUS
```

**Response:**

```
STATUS:<stat>
+CIPSTATUS:<link ID>,<"type">,<"remote IP">,<remote port>,<local port>,<tetype>
OK
```

**Parameters**

- **<stat>**: status of the ESP32-C2 station interface.
  - 0: The ESP32-C2 station is not initialized.
  - 1: The ESP32-C2 station is initialized, but not started a Wi-Fi connection yet.
  - 2: The ESP32-C2 station is connected to an AP and its IP address is obtained.
  - 3: The ESP32-C2 station has created a TCP/SSL transmission.
  - 4: All of the TCP/UDP/SSL connections of the ESP32-C2 station are disconnected.
  - 5: The ESP32-C2 station started a Wi-Fi connection, but was not connected to an AP or disconnected from an AP.
- **<link ID>**: ID of the connection (0~4), used for multiple connections.
- **<" type" >**: string parameter showing the type of transmission: "TCP", "TCPv6", "UDP", "UDPv6", "SSL", or "SSLv6".
- **<" remote IP" >**: string parameter showing the remote IPv4 address or IPv6 address.
- **<remote port>**: the remote port number.

- **<local port>**: the local port number.
- **<tetype>**:
  - 0: ESP32-C2 runs as a client.
  - 1: ESP32-C2 runs as a server.

### Notes

- It is recommended to use *AT+CWSTATE* command to query Wi-Fi state and *AT+CIPSTATE* command to query TCP/UDP/SSL state.

## 3.3.5 AT+CIPDOMAIN: Resolve a Domain Name

### Set Command

#### Command:

```
AT+CIPDOMAIN=<"domain name">[,<ip network>]
```

#### Response:

```
+CIPDOMAIN:<"IP address">
```

```
OK
```

### Parameter

- **<" domain name" >**: the domain name.
- **<ip network>**: preferred IP network. Default: 1.
  - 1: preferred resolution of IPv4 address
  - 2: resolve IPv4 address only
  - 3: resolve IPv6 address only
- **<" IP address" >**: the resolved IPv4 address or IPv6 address.

### Example

```
AT+CWMODE=1 // set the station mode
AT+CWJAP="SSID", "password" // access to the internet
AT+CIPDOMAIN="iot.espressif.cn" // Domain Name Resolution function

// Domain Name Resolution Function for IPv4 address only
AT+CIPDOMAIN="iot.espressif.cn",2

// Domain Name Resolution Function for IPv6 address only
AT+CIPDOMAIN="ipv6.test-ipv6.com",3

// Domain Name Resolution Function for compatible IP address
AT+CIPDOMAIN="ds.test-ipv6.com",1
```

## 3.3.6 AT+CIPSTART: Establish TCP Connection, UDP Transmission, or SSL Connection

- *Establish TCP Connection*
- *Establish UDP Transmission*
- *Establish SSL Connection*

## Establish TCP Connection

### Set Command Command:

```
// Single connection (AT+CIPMUX=0):
AT+CIPSTART=<"type">,<"remote host">,<remote port>[,<keep_alive>][,<"local IP">]

// Multiple Connections (AT+CIPMUX=1):
AT+CIPSTART=<link ID>,<"type">,<"remote host">,<remote port>[,<keep_alive>][,<
↪"local IP">]
```

### Response:

For single connection, it returns:

```
CONNECT
OK
```

For multiple connections, it returns:

```
<link ID>,CONNECT
OK
```

### Parameters

- **<link ID>**: ID of network connection (0~4), used for multiple connections. The range of this parameter depends on two configuration items in `menuconfig`. One is `AT_SOCKET_MAX_CONN_NUM` of the AT component, and its default value is 5. The other is `LWIP_MAX_SOCKETS` of the LWIP component, and its default value is 10. To modify the range of this parameter, you need to set `AT_SOCKET_MAX_CONN_NUM` and make sure it is no larger than the value of `LWIP_MAX_SOCKETS`. (See [Compile ESP-AT Project Locally](#) for details on configuring and build ESP-AT projects.)
- **<" type" >**: string parameter showing the type of transmission: "TCP", or "TCPv6". Default: "TCP".
- **<" remote host" >**: IPv4 address, IPv6 address, or domain name of remote host. The maximum length is 64 bytes. If you need to use a domain name and the length of the domain name exceeds 64 bytes, use the [AT+CIPDOMAIN](#) command to obtain the IP address corresponding to the domain name, and then use the IP address to establish a connection.
- **<remote port>**: the remote port number.
- **<keep\_alive>**: It configures the [SO\\_KEEPALIVE](#) option for socket. Unit: second.
  - Range: [0,7200].
    - \* 0: disable keep-alive function (default).
    - \* 1 ~ 7200: enable keep-alive function. `TCP_KEEPIDLE` value is **<keep\_alive>**, `TCP_KEEPINTVL` value is 1, and `TCP_KEEPCNT` value is 3.
  - This parameter of this command is the same as the `<keep_alive>` parameter of [AT+CIPTCPOPT](#) command. It always takes the value set later by either of the two commands. If it is omitted or not set, the last configured value is used by default.
- **<" local IP" >**: the local IPv4 address or IPv6 address that the connection binds. This parameter is useful when you are using multiple network interfaces or multiple IP addresses. By default, it is disabled. If you want to use it, you should specify it first. Null is also valid.

### Notes

- To establish a TCP connection based on an IPv6 network, do as follows:
  - Make sure that the AP supports IPv6
  - Set [AT+CIPV6=1](#)
  - Obtain an IPv6 address through the [AT+CWJAP](#) command
  - (Optional) Check whether ESP32-C2 has obtained an IPv6 address using the [AT+CIPSTA?](#) command



**Example**

```

AT+CIPSTART="TCP", "iot.espressif.cn", 8000
AT+CIPSTART="TCP", "192.168.101.110", 1000
AT+CIPSTART="TCP", "192.168.101.110", 2500, 60
AT+CIPSTART="TCP", "192.168.101.110", 1000, , "192.168.101.100"
AT+CIPSTART="TCPv6", "test-ipv6.com", 80
AT+CIPSTART="TCPv6", "fe80::860d:8eff:fe9d:cd90", 1000, , "fe80::411c:1fdb:22a6:4d24"

// esp-at has obtained an IPv6 global address by AT+CWJAP before
AT+CIPSTART="TCPv6", "2404:6800:4005:80b::2004", 80, ,
↪ "240e:3a1:2070:11c0:32ae:a4ff:fe80:65ac"

```

**Establish UDP Transmission****Set Command Command:**

```

// Single connection (AT+CIPMUX=0):
AT+CIPSTART=<"type">, <"remote host">, <remote port>[, <local port>, <mode>, <"local IP
↪">]

// Multiple connections (AT+CIPMUX=1):
AT+CIPSTART=<link ID>, <"type">, <"remote host">, <remote port>[, <local port>, <mode>, <
↪"local IP">]

```

**Response:**

For single connection, it returns:

```

CONNECT
OK

```

For multiple connections, it returns:

```

<link ID>, CONNECT
OK

```

**Parameters**

- **<link ID>**: ID of network connection (0~4), used for multiple connections.
- **<" type" >**: string parameter showing the type of transmission: "UDP" , or "UDPv6" . Default: "TCP"
- **<" remote host" >**: IPv4 address, IPv6 address, or domain name of remote host. The maximum length is 64 bytes. If you need to use a domain name and the length of the domain name exceeds 64 bytes, use the [AT+CIPDOMAIN](#) command to obtain the IP address corresponding to the domain name, and then use the IP address to establish a connection.
- **<remote port>**: remote port number.
- **<local port>**: UDP port of ESP32-C2.
- **<mode>**: In the UDP Wi-Fi passthrough, the value of this parameter has to be 0.
  - 0: After UDP data is received, the parameters <"remote host"> and <remote port> will stay unchanged (default).
  - 1: Only the first time that UDP data is received from an IP address and port that are different from the initially set value of parameters <remote host> and <remote port>, will they be changed to the IP address and port of the device that sends the data.
  - 2: Each time UDP data is received, the <"remote host"> and <remote port> will be changed to the IP address and port of the device that sends the data.

- **<" local IP" >**: the local IPv4 address or IPv6 address that the connection binds. This parameter is useful when you are using multiple network interfaces or multiple IP addresses. By default, it is disabled. If you want to use it, you should specify it first. Null is also valid.

### Notes

- If the remote host over the UDP is an IPv4 multicast address (224.0.0.0 ~ 239.255.255.255), the ESP32-C2 will send and receive the UDPv4 multicast.
- If the remote host over the UDP is an IPv4 broadcast address (255.255.255.255), the ESP32-C2 will send and receive the UDPv4 broadcast.
- If the remote host over the UDP is an IPv6 multicast address (FF00:0:0:0:0:0 ~ FFFF:FFFF:FFFF:FFFF:FFFF:FFFF:FFFF:FFFF), the ESP32-C2 will send and receive the UDP multicast based on IPv6 network.
- To use the parameter `<mode>`, parameter `<local port>` must be set first.
- To establish an UDP transmission based on an IPv6 network, do as follows:
  - Make sure that the AP supports IPv6
  - Set `AT+CIPV6=1`
  - Obtain an IPv6 address through the `AT+CWJAP` command
  - (Optional) Check whether ESP32-C2 has obtained an IPv6 address using the `AT+CIPSTA?` command
- If you want to receive a UDP packet longer than 1460 bytes, please compile the firmware on your own by following [Compile ESP-AT Project](#) and choosing the following configurations in the Step 5. Configure: Component config->LWIP->Enable reassembly incoming fragmented IP4 packets.

### Example

```
// UDP unicast
AT+CIPSTART="UDP", "192.168.101.110", 1000, 1002, 2
AT+CIPSTART="UDP", "192.168.101.110", 1000, , , "192.168.101.100"

// UDP unicast based on IPv6 network
AT+CIPSTART="UDPv6", "fe80::32ae:a4ff:fe80:65ac", 1000, , , "fe80::5512:f37f:bb03:5d9b"

// UDP multicast based on IPv6 network
AT+CIPSTART="UDPv6", "FF02::FC", 1000, 1002, 0
```

### Establish SSL Connection

#### Set Command Command:

```
// Single connection (AT+CIPMUX=0):
AT+CIPSTART=<"type">,<"remote host">,<remote port>[,<keep_alive>,<"local IP">]

// Multiple connections (AT+CIPMUX=1):
AT+CIPSTART=<link ID>,<"type">,<"remote host">,<remote port>[,<keep_alive>,<"local_
->IP">]
```

#### Response:

For single connection, it returns:

```
CONNECT
OK
```

For multiple connections, it returns:

```
<link ID>,CONNECT
OK
```

## Parameters

- **<link ID>**: ID of network connection (0~4), used for multiple connections.
- **<" type" >**: string parameter showing the type of transmission: "SSL", or "SSLv6". Default: "TCP".
- **<" remote host" >**: IPv4 address, IPv6 address, or domain name of remote host. The maximum length is 64 bytes. If you need to use a domain name and the length of the domain name exceeds 64 bytes, use the [AT+CIPDOMAIN](#) command to obtain the IP address corresponding to the domain name, and then use the IP address to establish a connection.
- **<remote port>**: the remote port number.
- **<keep\_alive>**: It configures the [SO\\_KEEPALIVE](#) option for socket. Unit: second.
  - Range: [0,7200].
    - \* 0: disable keep-alive function (default).
    - \* 1 ~ 7200: enable keep-alive function. [TCP\\_KEEPIIDLE](#) value is **<keep\_alive>**, [TCP\\_KEEPIIDLE](#) value is 1, and [TCP\\_KEEPCNT](#) value is 3.
  - This parameter of this command is the same as the **<keep\_alive>** parameter of [AT+CIPTCP](#) command. It always takes the value set later by either of the two commands. If it is omitted or not set, the last configured value is used by default.
- **<" local IP" >**: the local IPv4 address or IPv6 address that the connection binds. This parameter is useful when you are using multiple network interfaces or multiple IP addresses. By default, it is disabled. If you want to use it, you should specify it first. Null is also valid.

## Notes

- The number of SSL connections depends on available memory and the maximum number of connections.
- SSL connection needs a large amount of memory. Insufficient memory may cause the system reboot.
- If the [AT+CIPSTART](#) is based on an SSL connection and the timeout of each packet is 10 s, the total timeout will be much longer depending on the number of handshake packets.
- To establish a SSL connection based on an IPv6 network, do as follows:
  - Make sure that the AP supports IPv6
  - Set [AT+CIPV6=1](#)
  - Obtain an IPv6 address through the [AT+CWJAP](#) command
  - (Optional) Check whether ESP32-C2 has obtained an IPv6 address using the [AT+CIPSTA?](#) command

## Example

```
AT+CIPSTART="SSL", "iot.espressif.cn", 8443
AT+CIPSTART="SSL", "192.168.101.110", 1000, , "192.168.101.100"

// esp-at has obtained an IPv6 global address by AT+CWJAP before
AT+CIPSTART="SSLv6", "240e:3a1:2070:11c0:6972:6f96:9147:d66d", 1000, ,
↪ "240e:3a1:2070:11c0:55ce:4e19:9649:b75"
```

### 3.3.7 AT+CIPSTARTEX: Establish TCP connection, UDP transmission, or SSL connection with an Automatically Assigned ID

This command is similar to [AT+CIPSTART](#) except that you do not need to assign an ID by yourself in multiple connections mode ([AT+CIPMUX=1](#)). The system will assign an ID to the new connection automatically.

### 3.3.8 [Data Mode Only] +++: Exit from Data Mode

#### Special Execute Command

##### Function:

Exit from *Data Mode* and enter the *Command Mode*.

##### Command:

```
// Only for data mode  
+++
```

### Notes

- This special execution command consists of three identical + characters (0x2b ASCII), and no CR-LF appends to the command tail.
- Make sure there is more than 20 ms interval before the first + character, more than 20 ms interval after the third + character, less than 20 ms interval among the three + characters. Otherwise, the + characters will be sent out as normal data.
- This command returns no reply.
- Please wait for at least one second before sending the next AT command.

## 3.3.9 AT+CIPSEND: Send Data in the Normal Transmission Mode or Wi-Fi Passthrough Mode

### Set Command

#### Function:

Set the data length to be send in the *Normal Transmission Mode*. If the length of data you need to send exceeds 8192 bytes, please use the *AT+CIPSENDL* command.

#### Command:

```
// Single connection: (AT+CIPMUX=0)  
AT+CIPSEND=<length>  
  
// Multiple connections: (AT+CIPMUX=1)  
AT+CIPSEND=<link ID>,<length>  
  
// Remote host and port can be set for UDP transmission:  
AT+CIPSEND=[<link ID>,<length>[,<"remote host">,<remote port>]
```

#### Response:

```
OK  
  
>
```

This response indicates that AT is ready for receiving serial data. You should enter the data, and when the data length reaches the <length> value, the transmission of data starts.

If the connection cannot be established or is disrupted during data transmission, the system returns:

```
ERROR
```

If the data has been successfully sent to the protocol stack (It does not mean that the data has been sent to the opposite end), the system returns:

```
SEND OK
```

### Execute Command

#### Function:

Enter the Wi-Fi *Passthrough Mode*.

#### Command:

```
AT+CIPSEND
```

**Response:**

```
OK
>
```

or

```
ERROR
```

Enter the Wi-Fi *Passthrough Mode*. The ESP32-C2 can receive 8192 bytes and send 2920 bytes at most each time. If the data received by ESP32-C2 reaches or exceeds 2920 bytes, the data will be immediately sent in chunks of 2920 bytes. Otherwise, it will wait for 20 milliseconds before being sent (You can configure this interval using *AT+TRANSINTVL* command). When a single packet containing *+++* is received, the ESP32-C2 will exit the data sending mode under the Wi-Fi *Passthrough Mode*. Please wait for at least one second before sending the next AT command.

This command can only be used for single connection in the Wi-Fi *Passthrough Mode*. For UDP Wi-Fi passthrough, the *<mode>* parameter has to be 0 when using *AT+CIPSTART*.

**Parameters**

- **<link ID>**: ID of the connection (0~4), for multiple connections.
- **<length>**: data length. Maximum: 8192 bytes.
- **<" remote host" >**: IPv4 address, IPv6 address, or domain name of remote host. It can be set in UDP transmission.
- **<remote port>**: the remote port number.

**Notes**

- You can use *AT+CIPTCPOPT* command to configure socket options for each TCP connection. For example, setting *<so\_sndtimeo>* to 5000 will enable TCP send operation to return results within 5 seconds, regardless of success or failure. This can save the time that the MCU waits for AT command response.

**3.3.10 AT+CIPSENDL: Send Long Data in Paraller in the Normal Transmission Mode.****Set Command****Function:**

In the *Normal Transmission Mode*, set the data length to be sent, and then send data to remote host in parallel (the AT command port receives data in parallel with the AT sending data to the remote host). You can use the *AT+CIPSENDLCFG* command to configure this command. If the length of data you need to send is less than 8192 bytes, you also can use the *AT+CIPSEND* command.

**Command:**

```
// Single connection: (AT+CIPMUX=0)
AT+CIPSENDL=<length>

// Multiple connections: (AT+CIPMUX=1)
AT+CIPSENDL=<link ID>,<length>

// Remote host and port can be set for UDP transmission:
AT+CIPSENDL=[<link ID>,<length>[,<"remote host">,<remote port>]
```

**Response:**

```
OK
>
```

This response indicates that AT enters the *Data Mode* and AT command port is ready to receive data. You can enter the data now. Once the port receives data, it will be pushed to underlying protocol stack and the transmission starts.

If the transmission starts, the system reports message according to *AT+CIPSENDLCFG* configuration:

```
+CIPSENDL:<had sent len>,<port rcv len>
```

If the transmission is cancelled by `+++` command, the system returns:

```
SEND CANCELLED
```

If not all the data has been sent out, the system finally returns:

```
SEND FAIL
```

If the data has been successfully sent to the protocol stack (It does not mean that the data has been sent to the opposite end), the system finally returns:

```
SEND OK
```

When the connection is disconnected, you can send `+++` command to cancel the transmission, then the ESP32-C2 will exit from the *Data Mode*, otherwise, the *Data Mode* will not end until the AT command port receives all the data of the specified `<length>`.

### Parameters

- **<link ID>**: ID of the connection (0~4), for multiple connections.
- **<length>**: data length. Maximum:  $2^{31} - 1$  bytes.
- **<" remote host" >**: IPv4 address, IPv6 address, or domain name of remote host. It can be set in UDP transmission.
- **<remote port>**: the remote port number.
- **<had sent len>**: the length of data successfully sent to the underlying protocol stack.
- **<port rcv len>**: data length received by AT command port.

### Notes

- It is recommended to use UART flow control, because if the UART receives data at a faster rate than the network sends, data loss may occur.
- You can use *AT+CIPTCPOPT* command to configure socket options for each TCP connection. For example, setting `<so_sndtimeo>` to 5000 will enable TCP send operation to return results within 5 seconds, regardless of success or failure. This can save the time that the MCU waits for AT command response.

## 3.3.11 AT+CIPSENDLCFG: Set the Configuration for the Command AT+CIPSENDL

### Query Command

#### Function:

Query the configuration of *AT+CIPSENDL*.

#### Command:

```
AT+CIPSENDLCFG?
```

**Response:**

```
+CIPSENDLCFG:<report size>,<transmit size>
```

```
OK
```

**Set Command****Function:**

Set the configuration of *AT+CIPSENDL*.

**Command:**

```
AT+CIPSENDLCFG=<report size>[,<transmit size>]
```

**Response:**

```
OK
```

**Parameters**

- **<report size>**: report block size for *AT+CIPSENDL*. Default: 1024. Range: [100,2<sup>20</sup>]. For example, set *<report size>* to 100, *<had sent len>* report sequence in the response of *AT+CIPSENDL* will be (100, 200, 300, 400, ...). The final *<had sent len>* report is always equal to the data length that had been sent out.
- **<transmit size>**: transmit block size of *AT+CIPSENDL*. It specifies the size of the data block sent to the underlying protocol stack. Default: 2920. Range: [100,2920]. If the data received by ESP32-C2 reaches or exceeds *<transmit size>* bytes, the data will be immediately sent in chunks of *<transmit size>* bytes. Otherwise, it will wait for 20 milliseconds before being sent (You can configure this interval using *AT+TRANSINTVL* command).

**Note**

- For devices with small throughput but high real-time requirements, it is recommended to set a smaller *<transmit size>*. It is also recommended to set TCP\_NODELAY by *AT+CIPTCPOPT* command.
- For devices with large throughput, it is recommended to set a larger *<transmit size>*. It is also recommended to read *How to Improve ESP-AT Throughput Performance* first.

**3.3.12 AT+CIPSENDEX: Send Data in the Normal Transmission Mode in Expanded Ways****Set Command****Function:**

Set the data length to be send in *Normal Transmission Mode*, or use \0 (0x5c, 0x30 ASCII) to trigger data transmission.

**Command:**

```
// Single connection: (AT+CIPMUX=0)
AT+CIPSENDEX=<length>

// Multiple connections: (AT+CIPMUX=1)
AT+CIPSENDEX=<link ID>,<length>
```

(continues on next page)

(continued from previous page)

```
// Remote host and port can be set for UDP transmission:
AT+CIPSENDEX=[<link ID>,<length>[,<"remote host">,<remote port>]
```

**Response:**

```
OK
>
```

This response indicates that AT is ready for receiving data. You should enter the data of designated length. When the data length reaches the <length> value, or when the string \0 appears in the data, the transmission starts.

If the connection cannot be established or gets disconnected during transmission, the system returns:

```
ERROR
```

If the data has been successfully sent to the protocol stack (It does not mean that the data has been sent to the opposite end), the system returns:

```
SEND OK
```

**Parameters**

- **<link ID>**: ID of the connection (0~4), for multiple connections.
- **<length>**: data length. Maximum: 8192 bytes.
- **<" remote host" >**: IPv4 address, IPv6 address, or domain name of remote host. It can be set in UDP transmission.
- **<remote port>**: remote port can be set in UDP transmission.

**Notes**

- When the requirement of data length is met, or when the string \0 (0x5c, 0x30 in ASCII) appears, the transmission of data starts. Go back to the normal command mode and wait for the next AT command.
- If the data contains the <any>, it means that drop backslash symbol and only use <any> character.
- When sending \0, please use a backslash to escape it as \\0.
- You can use *AT+CIPTCPOPT* command to configure socket options for each TCP connection. For example, setting <so\_sndtimeo> to 5000 will enable TCP send operation to return results within 5 seconds, regardless of success or failure. This can save the time that the MCU waits for AT command response.

**3.3.13 AT+CIPCLOSE: Close TCP/UDP/SSL Connection****Set Command****Function:**

Close TCP/UDP/SSL connection in the multiple connections mode.

**Command:**

```
AT+CIPCLOSE=<link ID>
```

**Response:**

```
<link ID>,CLOSED
OK
```



### Execute Command

#### Function:

Close TCP/UDP/SSL connection in the single connection mode.

```
AT+CIPCLOSE
```

#### Response:

```
CLOSED
```

```
OK
```

### Parameter

- **<link ID>**: ID of the connection that you want to close. If you set it to 5, all connections will be closed.

## 3.3.14 AT+CIFSR: Obtain the Local IP Address and MAC Address

### Execute Command

#### Command:

```
AT+CIFSR
```

#### Response:

```
+CIFSR:APIP,<"APIP">  
+CIFSR:APIP6LL,<"APIP6LL">  
+CIFSR:APIP6GL,<"APIP6GL">  
+CIFSR:APMAC,<"APMAC">  
+CIFSR:STAIP,<"STAIP">  
+CIFSR:STAIP6LL,<"STAIP6LL">  
+CIFSR:STAIP6GL,<"STAIP6GL">  
+CIFSR:STAMAC,<"STAMAC">  
+CIFSR:ETHIP,<"ETHIP">  
+CIFSR:ETHIP6LL,<"ETHIP6LL">  
+CIFSR:ETHIP6GL,<"ETHIP6GL">  
+CIFSR:ETHMAC,<"ETHMAC">
```

```
OK
```

### Parameters

- **<" APIP" >**: IPv4 address of Wi-Fi softAP interface
- **<" APIP6LL" >**: Linklocal IPv6 address of Wi-Fi softAP interface
- **<" APIP6GL" >**: Global IPv6 address of Wi-Fi softAP interface
- **<" APMAC" >**: MAC address of Wi-Fi softAP interface
- **<" STAIP" >**: IPv4 address of Wi-Fi station interface
- **<" STAIP6LL" >**: Linklocal IPv6 address of Wi-Fi station interface
- **<" STAIP6GL" >**: Global IPv6 address of Wi-Fi station interface
- **<" STAMAC" >**: MAC address of Wi-Fi station interface
- **<" ETHIP" >**: IPv4 address of ethernet interface
- **<" ETHIP6LL" >**: Linklocal IPv6 address of ethernet interface
- **<" ETHIP6GL" >**: Global IPv6 address of ethernet interface
- **<" ETHMAC" >**: MAC address of ethernet interface

**Note**

- Only when the ESP32-C2 has the valid interface information can you query its IP address and MAC address.

**3.3.15 AT+CIPMUX: Enable/disable Multiple Connections****Query Command****Function:**

Query the connection type.

**Command:**

```
AT+CIPMUX?
```

**Response:**

```
+CIPMUX:<mode>  
OK
```

**Set Command****Function:**

Set the connection type.

**Command:**

```
AT+CIPMUX=<mode>
```

**Response:**

```
OK
```

**Parameter**

- **<mode>**: connection mode. Default: 0.
  - 0: single connection.
  - 1: multiple connections.

**Notes**

- This mode can only be changed after all connections are disconnected.
- If you want to set the multiple connections mode, ESP32-C2 should be in the *Normal Transmission Mode* (*AT+CIPMODE=0*).
- If you want to set the single connection mode when the TCP/SSL server is running, you should delete the server first. (*AT+CIPSERVER=0*).

**Example**

```
AT+CIPMUX=1
```

### 3.3.16 AT+CIPSERVER: Delete/create a TCP/SSL Server

#### Query Command

**Function:**

Query the TCP/SSL server status.

**Command:**

```
AT+CIPSERVER?
```

**Response:**

```
+CIPSERVER:<mode>[,<port>,<"type">][,<CA enable>]
```

```
OK
```

#### Set Command

**Command:**

```
AT+CIPSERVER=<mode>[,<param2>][,<"type">][,<CA enable>]
```

**Response:**

```
OK
```

#### Parameters

- **<mode>**:
  - 0: delete a server.
  - 1: create a server.
- **<param2>**: It means differently depending on the parameter <mode>:
  - If <mode> is 1, <param2> represents the port number. Default: 333.
  - If <mode> is 0, <param2> represents whether the server closes all connections. Default: 0.
    - 0: shutdown the server and keep existing connections.
    - 1: shutdown the server and close all connections.
- **<" type" >**: server type: "TCP" , "TCPv6" , "SSL" , or "SSLv6" . Default: "TCP" .
- **<CA enable>**:
  - 0: disable CA.
  - 1: enable CA.

#### Notes

- A TCP/SSL server can only be created when multiple connections are activated (*AT+CIPMUX=1*).
- A server monitor will be created automatically when the server is created. Only one server can be created at most.
- When a client is connected to the server, it will take up one connection and be assigned an ID.
- If you want to create a TCP/SSL server based on IPv6 network, set *AT+CIPV6=1* first, and obtain an IPv6 address.
- Parameters <"type"> and <CA enable> must be omitted when delete a server.

**Example**

```
// To create a TCP server
AT+CIPMUX=1
AT+CIPSERVER=1,80

// To create an SSL server
AT+CIPMUX=1
AT+CIPSERVER=1,443,"SSL",1

// To create an SSL server based on IPv6 network
AT+CIPMUX=1
AT+CIPSERVER=1,443,"SSLv6",0

// To delete an server and close all clients
AT+CIPSERVER=0,1
```

### 3.3.17 AT+CIPSERVERMAXCONN: Query/Set the Maximum Connections Allowed by a Server

**Query Command****Function:**

Obtain the maximum number of clients allowed to connect to the TCP/SSL server.

**Command:**

```
AT+CIPSERVERMAXCONN?
```

**Response:**

```
+CIPSERVERMAXCONN:<num>
OK
```

**Set Command****Function:**

Set the maximum number of clients allowed to connect to the TCP/SSL server.

**Command:**

```
AT+CIPSERVERMAXCONN=<num>
```

**Response:**

```
OK
```

**Parameter**

- **<num>**: the maximum number of clients allowed to connect to the TCP/SSL server. Range: [1,5]. For how to change the upper limit of this range, please refer to the description of the `<link ID>` parameter of the [AT+CIPSTART](#) command.

**Note**

- You should call the command `AT+CIPSERVERMAXCONN=<num>` before creating a server.

**Example**

```
AT+CIPMUX=1
AT+CIPSERVERMAXCONN=2
AT+CIPSERVER=1,80
```

### 3.3.18 AT+CIPMODE: Query/Set the Transmission Mode

**Query Command****Function:**

Query the transmission mode.

**Command:**

```
AT+CIPMODE?
```

**Response:**

```
+CIPMODE:<mode>
OK
```

**Set Command****Function:**

Set the transmission mode.

**Command:**

```
AT+CIPMODE=<mode>
```

**Response:**

```
OK
```

**Parameter**

- **<mode>**:
  - 0: *Normal Transmission Mode*.
  - 1: Wi-Fi *Passthrough Receiving Mode*, or called transparent receiving transmission, which can only be enabled in TCP single connection mode, UDP mode when the remote host and port do not change, or SSL single connection mode.

**Notes**

- The configuration changes will NOT be saved in flash.
- After the ESP32-C2 enters the Wi-Fi *Passthrough Receiving Mode*, no Bluetooth function can be used.

**Example**

```
AT+CIPMODE=1
```

**3.3.19 AT+CIPSTO: Query/Set the local TCP/SSL Server Timeout****Query Command****Function:**

Query the local TCP/SSL server timeout.

**Command:**

```
AT+CIPSTO?
```

**Response:**

```
+CIPSTO:<time>  
OK
```

**Set Command****Function:**

Set the local TCP/SSL server timeout.

**Command:**

```
AT+CIPSTO=<time>
```

**Response:**

```
OK
```

**Parameter**

- **<time>**: local TCP/SSL server timeout. Unit: second. Range: [0,7200].

**Notes**

- When a TCP/SSL client does not communicate with the ESP32-C2 server within the **<time>** value, the server will terminate this connection.
- If you set **<time>** to 0, the connection will never timeout. This configuration is not recommended.
- When the client initiates a communication with the server or the server initiate a communication with the client within the set time, the timer will restart. After the timeout expires, the client is closed.

**Example**

```
AT+CIPMUX=1  
AT+CIPSERVER=1,1001  
AT+CIPSTO=10
```

### 3.3.20 AT+CIPSNTPCFG: Query/Set the Time Zone and the SNTP Server

#### Query Command

##### Command:

```
AT+CIPSNTPCFG?
```

##### Response:

```
+CIPSNTPCFG:<enable>,<timezone>,<SNTP server1>[,<SNTP server2>,<SNTP server3>]  
OK
```

#### Set Command

##### Command:

```
AT+CIPSNTPCFG=<enable>,<timezone>[,<SNTP server1>,<SNTP server2>,<SNTP server3>]
```

##### Response:

```
OK
```

#### Parameters

- **<enable>**: configure the SNTP server:
  - 1: the SNTP server is configured.
  - 0: the SNTP server is not configured.
- **<timezone>**: support the following two formats:
  - The first format range is [-12,14]. It marks most of the time zones by offset from Coordinated Universal Time (UTC) in **whole hours** (UTC-12:00 to UTC+14:00).
  - The second format is UTC offset. The UTC offset specifies the time value you must add to the UTC time to get a local time value. It has syntax like [+|-] [hh]mm. This is negative if the local time zone is on the west of the Prime Meridian and positive if it is on the east. The hour(hh) must be between -12 and 14, and the minute(mm) between 0 and 59. For example, if you want to set the timezone to New Zealand (Chatham Islands) which is in UTC+12:45, you should set the parameter <timezone> to 1245. Please refer to [UTC offset wiki](#) for more information.
- [**<SNTP server1>**]: the first SNTP server.
- [**<SNTP server2>**]: the second SNTP server.
- [**<SNTP server3>**]: the third SNTP server.

#### Note

- If the three SNTP servers are not configured, one of the following default servers will be used: “cn.ntp.org.cn” , “ntp.sjtu.edu.cn” , and “us.pool.ntp.org” .
- For the query command, <timezone> parameter in the response may be different from the <timezone> parameter in set command. Because the <timezone> parameter supports the second UTC offset format, for example, set AT+CIPSNTPCFG=1,015, for query command, ESP-AT ignores the leading zero of the <timezone> parameter, and the valid value is 15. It does not belong to the first format, so it is parsed according to the second UTC offset format, that is, UTC+00:15, that is, timezone is 0 in the response.
- Since SNTP operates over the UDP protocol for sending requests and receiving replies, if there is packet loss in the network, the time synchronization of ESP32-C2 may be delayed. Once the AT command output shows *+TIME\_UPDATED*, it indicates that the time has been synchronized, and you can then send the *AT+CIPSNTPTIME?* command to query the current time.

### Example

```
// Enable SNTP server, set timezone to China (UTC+08:00)
AT+CIPSNTPCFG=1,8,"cn.ntp.org.cn","ntp.sjtu.edu.cn"
or
AT+CIPSNTPCFG=1,800,"cn.ntp.org.cn","ntp.sjtu.edu.cn"

// Enable SNTP server, set timezone to New York of the United States (UTC-05:00)
AT+CIPSNTPCFG=1,-5,"0.pool.ntp.org","time.google.com"
or
AT+CIPSNTPCFG=1,-500,"0.pool.ntp.org","time.google.com"

// Enable SNTP server, set timezone to New Zealand (Chatham Islands, UTC+12:45)
AT+CIPSNTPCFG=1,1245,"0.pool.ntp.org","time.google.com"
```

### 3.3.21 AT+CIPSNTPTIME: Query the SNTP Time

#### Query Command

##### Command:

```
AT+CIPSNTPTIME?
```

##### Response:

```
+CIPSNTPTIME:<asctime style time>
OK
```

#### Note

- The asctime style time is defined at [asctime man page](#).
- When ESP32-C2 enters Light-sleep or Deep-sleep mode and then wakes up, the system time may become inaccurate. It is recommended to resend the [AT+CIPSNTPCFG](#) command to obtain the new time from the NTP server.
- The time obtained from SNTP is currently not supported to be stored in the RTC area, so it will be reset to 1970 after a software reset (chip does not lose power).

#### Example

```
AT+CWMODE=1
AT+CWJAP="1234567890","1234567890"
AT+CIPSNTPCFG=1,8,"cn.ntp.org.cn","ntp.sjtu.edu.cn"
AT+CIPSNTPTIME?
+CIPSNTPTIME:Tue Oct 19 17:47:56 2021
OK

or

AT+CWMODE=1
AT+CWJAP="1234567890","1234567890"
AT+CIPSNTPCFG=1,530
AT+CIPSNTPTIME?
+CIPSNTPTIME:Tue Oct 19 15:17:56 2021
OK
```



### 3.3.22 AT+CIPSNTPINTV: Query/Set the SNTP time synchronization interval

#### Query Command

**Command:**

```
AT+CIPSNTPINTV?
```

**Response:**

```
+CIPSNTPINTV:<interval second>
```

```
OK
```

#### Set Command

**Command:**

```
AT+CIPSNTPINTV=<interval second>
```

**Response:**

```
OK
```

#### Parameters

- **<interval second>**: the SNTP time synchronization interval. Unit: second. Range: [15,4294967].

#### Notes

- It configures interval for synchronization, which means that it sets interval how often ESP32-C2 connects to NTP servers to get new time.

#### Example

```
AT+CIPSNTPCFG=1,8,"cn.ntp.org.cn","ntp.sjtu.edu.cn"
```

```
OK
```

```
// synchronize SNTP time every hour
```

```
AT+CIPSNTPINTV=3600
```

```
OK
```

### 3.3.23 AT+CIPFWVER: Query the Existing AT Firmware Version on the Server

#### Query Command

**Function:**

Query the existing ESP32-C2 AT firmware version on the server.

**Command:**

```
AT+CIPFWVER?
```

**Response:**

```
+CIPFWVER:<"version">  
OK
```

**Parameters**

- <"version">: ESP32-C2 AT firmware version.

**Notes**

- When selecting the OTA version to be upgraded, it is strongly not recommended to upgrade from a high version to a low version.

### 3.3.24 AT+CIUPDATE: Upgrade Firmware Through Wi-Fi

ESP-AT upgrades firmware at runtime by downloading the new firmware from a specific server through Wi-Fi and then flash it into some partitions.

**Query Command****Function:**

Query ESP32-C2 upgrade status.

**Command:**

```
AT+CIUPDATE?
```

**Response:**

```
+CIPUPDATE:<state>  
OK
```

**Execute Command****Function:**

Upgrade OTA the latest version of firmware via TCP from the server in blocking mode.

**Command:**

```
AT+CIUPDATE
```

**Response:**

Please refer to the [response](#) in the set command.

**Set Command****Function:**

Upgrade the specified version of firmware from the server.

**Command:**

```
AT+CIUPDATE=<ota mode>[, <version>][, <firmware name>][, <nonblocking>]
```

**Response:**

If OTA succeeds in blocking mode, the system returns:

```
+CIPUPDATE:1
+CIPUPDATE:2
+CIPUPDATE:3
+CIPUPDATE:4

OK
```

If OTA succeeds in non-blocking mode, the system returns:

```
OK
+CIPUPDATE:1
+CIPUPDATE:2
+CIPUPDATE:3
+CIPUPDATE:4
```

If OTA fails in blocking mode, the system returns:

```
+CIPUPDATE:<state>

ERROR
```

If OTA fails in non-blocking mode, the system returns:

```
OK
+CIPUPDATE:<state>
+CIPUPDATE:-1
```

**Parameters**

- **<ota mode>:**
  - 0: OTA via HTTP.
  - 1: OTA via HTTPS. If it does not work, please check whether `./build.py menuconfig>Component config>AT>OTA based upon ssl` is enabled. For more information, please refer to [Compile ESP-AT Project Locally](#).
- **<version>:** AT version, such as, v1.2.0.0, v1.1.3.0, v1.1.2.0.
- **<firmware name>:** firmware to upgrade, such as, ota, mqtt\_ca, client\_ca or other custom partition in `at_customize.csv`.
- **<nonblocking>:**
  - 0: OTA by blocking mode (In this mode, you can not send AT command until OTA completes successfully or fails.)
  - 1: OTA by non-blocking mode (You need to manually restart after upgrade done (+CIPUPDATE:4).)
- **<state>:**
  - 1: Server found.
  - 2: Connected to the server.
  - 3: Got the upgrade version.
  - 4: Upgrade done.
  - -1: OTA fails in non-blocking mode.

**Notes**

- The speed of the upgrade depends on the network status.

- If the upgrade fails due to unfavorable network conditions, AT will return ERROR. Please wait for some time before retrying.
- If you use Espressif's AT BIN, AT+CIUPDATE will download a new AT BIN from the Espressif Cloud.
- If you use a user-compiled AT BIN, you need to implement your own AT+CIUPDATE FOTA function or use [AT+USEROTA](#) or [AT+WEBSERVER](#) command. ESP-AT project provides an example of [FOTA](#).
- After you upgrade the AT firmware, you are suggested to call the command [AT+RESTORE](#) to restore the factory default settings.
- The timeout of OTA process is 3 minutes.
- The response OK in non-blocking mode does not necessarily come before the response +CIPUPDATE:<state>. It may be output before +CIPUPDATE:<state> or after it.
- Downgrading to an older version is not recommended due to potential compatibility issues and the risk of operational failure. If you still prefer downgrading to an older version, please test and verify the functionality based on your product.
- Please refer to [How to Implement OTA Upgrade](#) for more OTA commands.

### Example

```
AT+CWMODE=1
AT+CWJAP="1234567890", "1234567890"
AT+CIUPDATE
AT+CIUPDATE=1
AT+CIUPDATE=1, "v1.2.0.0"
AT+CIUPDATE=1, "v2.2.0.0", "mqtt_ca"
AT+CIUPDATE=1, "v2.2.0.0", "ota", 1
AT+CIUPDATE=1,,, 1
AT+CIUPDATE=1,,, "ota", 1
AT+CIUPDATE=1, "v2.2.0.0", , 1
```

## 3.3.25 AT+CIPDINFO: Set “+IPD” Message Mode

### Query Command

#### Command:

```
AT+CIPDINFO?
```

#### Response:

```
+CIPDINFO:true
OK
```

or

```
+CIPDINFO:false
OK
```

### Set Command

#### Command:

```
AT+CIPDINFO=<mode>
```

#### Response:

```
OK
```

### Parameters

- **<mode>**:
  - 0: does not show the remote host and port in “+IPD” and “+CIPRECVDATA” messages.
  - 1: show the remote host and port in “+IPD” and “+CIPRECVDATA” messages.

### Example

```
AT+CIPDINFO=1
```

## 3.3.26 AT+CIPSSLCONF: Query/Set SSL Clients

### Query Command

#### Function:

Query the configuration of each connection where the ESP32-C2 runs as an SSL client.

#### Command:

```
AT+CIPSSLCONF?
```

#### Response:

```
+CIPSSLCONF:<link ID>,<auth_mode>,<pki_number>,<ca_number>  
OK
```

### Set Command

#### Command:

```
// Single connection: (AT+CIPMUX=0)  
AT+CIPSSLCONF=<auth_mode>[,<pki_number>][,<ca_number>]  
  
// Multiple connections: (AT+CIPMUX=1)  
AT+CIPSSLCONF=<link ID>,<auth_mode>[,<pki_number>][,<ca_number>]
```

#### Response:

```
OK
```

### Parameters

- **<link ID>**: ID of the connection (0 ~ max). For multiple connections, if the value is max, it means all connections. By default, max is 5.
- **<auth\_mode>**:
  - 0: no authentication. In this case <pki\_number> and <ca\_number> are not required.
  - 1: the client provides the client certificate for the server to verify.
  - 2: the client loads CA certificate to verify the server’s certificate.
  - 3: mutual authentication.
- **<pki\_number>**: the index of certificate and private key. If there is only one certificate and private key, the value should be 0.
- **<ca\_number>**: the index of CA. If there is only one CA, the value should be 0.

## Notes

- If you want this configuration to take effect immediately, run this command before establishing an SSL connection.
- The configuration changes will be saved in the NVS area. If you set the command `AT+SAVETRANSLINK` to enter SSL Wi-Fi *Passthrough Mode* on power-up, the ESP32-C2 will establish an SSL connection based on this configuration when powered up next time.
- If you want to use your own certificate or use multiple sets of certificates, please refer to *How to Update PKI Configuration*.
- If `<auth_mode>` is configured to 2 or 3, in order to check the server certificate validity period, please make sure ESP32-C2 has obtained the current time before sending the `AT+CIPSTART` command. (You can send `AT+CIPSNTPCFG` command to configure SNTP and obtain the current time, and send `AT+CIPSNPTIME?` command to query the current time.)

### 3.3.27 AT+CIPSSLCCN: Query/Set the Common Name of the SSL Client

#### Query Command

##### Function:

Query the common name of the SSL client of each connection.

##### Command:

```
AT+CIPSSLCCN?
```

##### Response:

```
+CIPSSLCCN:<link ID>,<"common name">
OK
```

#### Set Command

##### Command:

```
// Single connection: (AT+CIPMUX=0)
AT+CIPSSLCCN=<"common name">

// Multiple connections: (AT+CIPMUX=1)
AT+CIPSSLCCN=<link ID>,<"common name">
```

##### Response:

```
OK
```

#### Parameters

- **<link ID>**: ID of the connection (0 ~ max). For the single connection, the link ID is 0. For multiple connections, if the value is max, it means all connections. Max is 5 by default.
- **<"common name">**: this parameter is used to verify the Common Name in the certificate sent by the server. The maximum length of `common name` is 64 bytes.

#### Note

- If you want this configuration to take effect immediately, run this command before establishing the SSL connection.

### 3.3.28 AT+CIPSSLCSNI: Query/Set SSL Client Server Name Indication (SNI)

#### Query Command

**Function:**

Query the SNI configuration of each connection.

**Command:**

```
AT+CIPSSLCSNI?
```

**Response:**

```
+CIPSSLCSNI:<link ID>,<"sni">  
OK
```

#### Set Command

**Command:**

```
Single connection: (AT+CIPMUX=0)  
AT+CIPSSLCSNI=<"sni">  
  
Multiple connections: (AT+CIPMUX=1)  
AT+CIPSSLCSNI=<link ID>,<"sni">
```

**Response:**

```
OK
```

#### Parameters

- **<link ID>**: ID of the connection (0 ~ max). For the single connection, the link ID is 0. For multiple connections, if the value is max, it means all connections. Max is 5 by default.
- **<"sni">**: the Server Name Indication in ClientHello. The maximum length of `sni` is 64 bytes.

#### Notes

- If you want this configuration to take effect immediately, run this command before establishing the SSL connection.

### 3.3.29 AT+CIPSSLCALPN: Query/Set SSL Client Application Layer Protocol Negotiation (ALPN)

#### Query Command

**Function:**

Query the ALPN configuration of each connection where the ESP32-C2 runs as an SSL client.

**Command:**

```
AT+CIPSSLCALPN?
```

**Response:**

```
+CIPSSLCALPN:<link ID>[,<"alpn">][,<"alpn">][,<"alpn">]
```

```
OK
```

## Set Command

### Command:

```
// Single connection: (AT+CIPMUX=0)
AT+CIPSSLCALPN=<counts>[,<"alpn">][,<"alpn">][,<"alpn">]

// Multiple connections: (AT+CIPMUX=1)
AT+CIPSSLCALPN=<link ID>,<counts>[,<"alpn">][,<"alpn">][,<"alpn">]
```

### Response:

```
OK
```

## Parameters

- **<link ID>**: ID of the connection (0 ~ max). For the single connection, the link ID is 0. For multiple connections, if the value is max, it means all connections. Max is 5 by default.
- **<counts>**: the number of ALPNs. Range: [0,5].
- 0: clean the ALPN configuration.
- [1,5]: set the ALPN configuration.
- **<" alpn" >**: a string parameter showing the ALPN in ClientHello. The maximum length of alpn is limited by the command length.

## Note

- If you want this configuration to take effect immediately, run this command before establishing the SSL connection.

## 3.3.30 AT+CIPSSLCPSK: Query/Set SSL Client Pre-shared Key (PSK) in String Format

### Query Command

#### Function:

Query the PSK configuration of each connection where the ESP32-C2 runs as an SSL client.

#### Command:

```
AT+CIPSSLCPSK?
```

#### Response:

```
+CIPSSLCPSK:<link ID>,<"psk">,<"hint">
OK
```



## Set Command

### Command:

```
// Single connection: (AT+CIPMUX=0)
AT+CIPSSLCPK=<"psk">,<"hint">

// Multiple connections: (AT+CIPMUX=1)
AT+CIPSSLCPK=<link ID>,<"psk">,<"hint">
```

### Response:

```
OK
```

### Parameters

- **<link ID>**: ID of the connection (0 ~ max). For single connection, <link ID> is 0. For multiple connections, if the value is max, it means all connections, max is 5 by default.
- **<" psk" >**: PSK identity in string format. Maximum length: 32. Please use [AT+CIPSSLCPKH](#) command if your <"psk"> parameter contains \0 characters.
- **<" hint" >**: PSK hint. Maximum length: 32.

### Notes

- If you want this configuration to take effect immediately, run this command before establishing the SSL connection.

### 3.3.31 AT+CIPSSLCPKH: Query/Set SSL Client Pre-shared Key (PSK) in Hexadecimal Format

#### Note

- Similar to the [AT+CIPSSLCPK](#) command, this command also sets or queries the SSL Client PSK, but its <"psk"> is in hexadecimal format rather than in string format. So, \0 in the <"psk"> parameter means 00.

#### Example

```
// Single connection: (AT+CIPMUX=0), PSK identity is "psk", PSK hint is "myhint".
AT+CIPSSLCPKH="70736b","myhint"

// Multiple connections: (AT+CIPMUX=1), PSK identity is "psk", PSK hint is "myhint"
↪ ".
AT+CIPSSLCPKH=0,"70736b","myhint"
```

### 3.3.32 AT+CIPRECONNINTV: Query/Set the TCP/UDP/SSL reconnection Interval for the Wi-Fi Passthrough Mode

#### Query Command

##### Function:

Query the automatic connect interval for the Wi-Fi *Passthrough Mode*.

##### Command:

```
AT+CIPRECONNINTV?
```

**Response:**

```
+CIPRECONNINTV:<interval>  
OK
```

**Set Command****Function:**

Set the automatic reconnecting interval when TCP/UDP/SSL transmission breaks in the Wi-Fi *Passthrough Mode*.

**Command:**

```
AT+CIPRECONNINTV=<interval>
```

**Response:**

```
OK
```

**Parameter**

- **<interval>**: the duration between automatic reconnections. Unit: 100 milliseconds. Default: 1. Range: [1,36000].

**Note**

- The configuration changes will be saved in the NVS area if *AT+SYSTORE=1*.

**Example**

```
AT+CIPRECONNINTV=10
```

### 3.3.33 AT+CIPRECVMODE: Query/Set Socket Receiving Mode

**Query Command****Function:**

Query the socket receiving mode.

**Command:**

```
AT+CIPRECVMODE?
```

**Response:**

```
+CIPRECVMODE:<link ID>,<mode>  
OK
```

## Set Command

### Command:

```
// Single connection: (AT+CIPMUX=0)
AT+CIPRECVMODE=<mode>

// Multiple connections: (AT+CIPMUX=1)
AT+CIPRECVMODE=<link ID>,<mode>
```

### Response:

```
OK
```

### Parameter

- **<link ID>**: ID of the connection (0 ~ max). For a single connection, <link ID> is 0. For multiple connections, if the value is max, it means all connections. Max is 5 by default.
- **<mode>**: the receive mode of socket data. Default: 0.
  - 0: active mode. ESP-AT will send all the received socket data instantly to the host MCU with the header “+IPD” . (The socket receive window is 5760 bytes by default. The maximum valid bytes sent to MCU is 2920 bytes each time.)
  - 1: passive mode. ESP-AT will keep the received socket data in an internal buffer (socket receive window, 5760 bytes by default), and wait for the host MCU to read. If the buffer is full, the socket transmission will be blocked for TCP/SSL connections, or data will be lost for UDP connections.

### Notes

- The configuration can not be used in the Wi-Fi *Passthrough Mode*. If it is a UDP transmission in passive mode, data will be lost when the buffer is full.
- When ESP-AT receives socket data in passive mode, it will prompt the following messages in different scenarios:
  - For multiple connections mode (AT+CIPMUX=1), the message is +IPD, <link ID>, <len>.
  - For single connection mode (AT+CIPMUX=0), the message is +IPD, <len>.
- <len> is the total length of socket data in the buffer.
- You should read data by running *AT+CIPRECVDATA* once there is a +IPD reported. Otherwise, the next +IPD will not be reported to the host MCU until the previous +IPD has been read.
- In case of disconnection, the buffered socket data will still be there and can be read by the MCU until you send *AT+CIPCLOSE* (AT as client) or *AT+CIPSERVER=0,1* (AT as server). In other words, if +IPD has been reported, the message CLOSED of this connection will never come until you send *AT+CIPCLOSE* or *AT+CIPSERVER=0,1* or read all data by command *AT+CIPRECVDATA*.
- When a large amount of network data is expected to be received and the MCU cannot process it timely, you can refer to *example* and use the passive receive data mode.

### Example

```
// Set passive mode in single connection mode
AT+CIPRECVMODE=1

// Set all connections to passive mode in multiple connections mode
AT+CIPRECVMODE=5,1
```

### 3.3.34 AT+CIPRECVDATA: Obtain Socket Data in Passive Receiving Mode

## Set Command

### Command:

```
// Single connection: (AT+CIPMUX=0)
AT+CIPRECVDATA=<len>

// Multiple connections: (AT+CIPMUX=1)
AT+CIPRECVDATA=<link_id>,<len>
```

### Response:

```
+CIPRECVDATA:<actual_len>,<data>
OK
```

or

```
+CIPRECVDATA:<actual_len>,<"remote IP">,<remote port>,<data>
OK
```

### Parameters

- **<link\_id>**: connection ID in multiple connections mode.
- **<len>**: the max value is 0x7ffffff. If the actual length of the received data is less than len, the actual length will be returned.
- **<actual\_len>**: length of the data you actually obtain.
- **<data>**: the data you want to obtain.
- **<"remote IP">**: string parameter showing the remote IPv4 address or IPv6 address, enabled by the command [AT+CIPDINFO=1](#).
- **<remote port>**: the remote port number, enabled by the command [AT+CIPDINFO=1](#).

### Example

```
AT+CIPRECVMODE=1

// For example, if host MCU gets a message of receiving 100-byte data in
↔connection with No.0,
// the message will be "+IPD,0,100".
// Then you can read those 100-byte data by using the command below.
AT+CIPRECVDATA=0,100
```

## 3.3.35 AT+CIPRECLEN: Obtain Socket Data Length in Passive Receiving Mode

### Query Command

#### Function:

Query the length of the entire data buffered for the connection.

#### Command:

```
AT+CIPRECLEN?
```

#### Response:

```
+CIPRECLEN:<data length of link0>,<data length of link1>,<data length of link2>,<data length of link3>,<data length of link4>
OK
```

### Parameters

- **<data length of link>**: length of the entire data buffered for the connection.

### Note

- For SSL connections, the data length returned by ESP-AT may be less than the actual data length.

### Example

```
AT+CIPRECVLEN?  
+CIPRECVLEN:100,,,,,  
OK
```

## 3.3.36 AT+PING: Ping the Remote Host

### Set Command

#### Function:

Ping the remote host.

#### Command:

```
AT+PING=<"host">
```

#### Response:

```
+PING:<time>  
OK
```

or

```
+PING:TIMEOUT // esp-at returns this response only when the domain name  
↪ resolution failure or ping timeout  
ERROR
```

### Parameters

- **<" host" >**: string parameter showing the host IPv4 address or IPv6 address or domain name.
- **<time>**: the response time of ping. Unit: millisecond.

### Notes

- To ping a remote host based on an IPv6 network, do as follows:
  - Make sure that the AP supports IPv6
  - Set *AT+CIPV6=1*
  - Obtain an IPv6 address through the *AT+CWJAP* command
  - (Optional) Check whether ESP32-C2 has obtained an IPv6 address using the *AT+CIPSTA?* command
- If the remote host is a domain name string, ping will first resolve the domain name (IPv4 address preferred) from DNS (domain name server), and then ping the remote IP address.

### Example

```
AT+PING="192.168.1.1"  
AT+PING="www.baidu.com"  
  
// China Future Internet Engineering Center  
AT+PING="240c::6666"
```

## 3.3.37 AT+CIPDNS: Query/Set DNS Server Information

### Query Command

**Function:**

Query the current DNS server information.

**Command:**

```
AT+CIPDNS?
```

**Response:**

```
+CIPDNS:<enable>[,<"DNS IP1">][,<"DNS IP2">][,<"DNS IP3">]  
OK
```

### Set Command

**Function:**

Set DNS server information.

**Command:**

```
AT+CIPDNS=<enable>[,<"DNS IP1">][,<"DNS IP2">][,<"DNS IP3">]
```

**Response:**

```
OK
```

or

```
ERROR
```

### Parameters

- **<enable>**: configure DNS server settings
  - 0: Enable automatic DNS server settings from DHCP. The DNS will be restored to 208.67.222.222 and 8.8.8.8. Only when the ESP32-C2 station completes the DHCP process, the DNS server of the ESP32-C2 station could be updated.
  - 1: Enable manual DNS server settings. If you do not set a value for <DNS IPx>, it will use 208.67.222.222 and 8.8.8.8 by default.
- **<" DNS IP1" >**: the first DNS server IP address. For the set command, this parameter only works when you set <enable> to 1, i.e. enable manual DNS settings. If you set <enable> to 1 and a value for this parameter, the ESP-AT will return this parameter as the current DNS setting when you run the query command.
- **<" DNS IP2" >**: the second DNS server IP address. For the set command, this parameter only works when you set <enable> to 1, i.e. enable manual DNS settings. If you set <enable> to 1 and a value for this parameter, the ESP-AT will return this parameter as the current DNS setting when you run the query command.

- <" DNS IP3" >: the third DNS server IP address. For the set command, this parameter only works when you set <enable> to 1, i.e. enable manual DNS settings. If you set <enable> to 1 and a value for this parameter, the ESP-AT will return this parameter as the current DNS setting when you run the query command.

### Notes

- The configuration changes will be saved in the NVS area if *AT+SYSSTORE=1*.
- The three parameters cannot be set to the same server.
- When <enable> is set to 1, the DNS server may change according to the configuration of the router which the ESP32-C2 is connected to.

### Example

```
AT+CIPDNS=0
AT+CIPDNS=1, "208.67.222.222", "114.114.114.114", "8.8.8.8"

// first DNS Server based on IPv6: China Future Internet Engineering Center
// second DNS Server based on IPv6: google-public-dns-a.google.com
// third DNS Server based on IPv6: main DNS Server based on IPv6 in JiangSu
↳Province, China
AT+CIPDNS=1, "240c::6666", "2001:4860:4860::8888", "240e:5a::6666"
```

## 3.3.38 AT+CIPTCPOPT: Query/Set the Socket Options

### Query Command

#### Function:

Query current socket options.

#### Command:

```
AT+CIPTCPOPT?
```

#### Response:

```
+CIPTCPOPT:<link_id>,<so_linger>,<tcp_nodelay>,<so_sndtimeo>,<keep_alive>
OK
```

### Set Command

#### Command:

```
// Single TCP connection (AT+CIPMUX=0):
AT+CIPTCPOPT=[<so_linger>],[<tcp_nodelay>],[<so_sndtimeo>][,<keep_alive>]

// Multiple TCP Connections (AT+CIPMUX=1):
AT+CIPTCPOPT=<link ID>,[<so_linger>],[<tcp_nodelay>],[<so_sndtimeo>][,<keep_alive>]
```

#### Response:

```
OK
```

or

```
ERROR
```

## Parameters

- **<link\_id>**: ID of the connection (0 ~ max). For multiple connections, if the value is max, it means all connections. By default, max is 5.
- **<so\_linger>**: configure the `SO_LINGER` options for the socket (refer to [SO\\_LINGER description](#)). Unit: second. Default: -1.
  - = -1: off
  - = 0: on, linger time = 0
  - > 0: on, linger time = <so\_linger>
- **<tcp\_nodelay>**: configure the `TCP_NODELAY` option for the socket (refer to [TCP\\_NODELAY description](#)). Default: 0.
  - 0: disable `TCP_NODELAY`
  - 1: enable `TCP_NODELAY`
- **<so\_sndtimeo>**: configure the `SO_SNDTIMEO` option for socket (refer to [SO\\_SNDTIMEO description](#)). Unit: millisecond. Default: 0.
- **<keep\_alive>**: configure the `SO_KEEPALIVE` option for socket. Unit: second.
  - Range: [0,7200].
    - \* 0: disable keep-alive function (default).
    - \* 1 ~ 7200: enable keep-alive function. `TCP_KEEPIDLE` value is <keep\_alive>, `TCP_KEEPINTVL` value is 1, and `TCP_KEEPCNT` value is 3.
  - This parameter of this command is the same as the <keep\_alive> parameter of `AT+CIPSTART` command. It always takes the value set later by either of the two commands. If it is omitted or not set, the last configured value is used by default.

## Notes

- Before configuring these socket options, **please make sure you fully understand the function of them and the possible impact after configuration.**
- The `SO_LINGER` option is not recommended to be set to a large value. For example, if you set `SO_LINGER` value to 60, then `AT+CIPCLOSE` command will block for 60 seconds if ESP32-C2 cannot receive TCP FIN packet from the remote TCP peer due to network issues, so ESP32-C2 is unable to respond to any other AT commands. Therefore, it is recommended to keep the default value of the `SO_LINGER` option.
- The `TCP_NODELAY` option is used for situations with small throughput but high real-time requirements. If this option is enabled, `LwIP` will speed up TCP transmission, but in a poor network environment, the throughput will be reduced due to retransmission. Therefore, it is recommended to keep the default value of the `TCP_NODELAY` option.
- The `SO_SNDTIMEO` option is used for situations where the keepalive parameter is not configured in `AT+CIPSTART` command. After this option is configured, `AT+CIPSEND`, `AT+CIPSENDL`, and `AT+CIPSENDEX` commands will exit within this timeout, regardless of whether data are sent successfully or not. Here, `SO_SNDTIMEO` is recommended to be set to 5 ~ 10 seconds.
- The `SO_KEEPALIVE` option is used for actively and regularly detecting whether the connection is disconnected. It is generally recommended to configure this option when AT is used as a TCP server. After this option is configured, additional network bandwidth will be cost. Recommended value of `SO_KEEPALIVE` should be not less than 60 seconds.

## 3.4 Bluetooth® Low Energy AT Commands

- [Introduction](#)
- `AT+BLEINIT`: Bluetooth LE initialization.
- `AT+BLEADDR`: Query/Set Bluetooth LE device address.
- `AT+BLENAME`: Query/Set Bluetooth LE device name.
- `AT+BLESCANPARAM`: Query/Set parameters of Bluetooth LE scanning.
- `AT+BLESCAN`: Enable Bluetooth LE scanning.



- *AT+BLESCANRSPDATA*: Set Bluetooth LE scan response.
- *AT+BLEADVPARAM*: Query/Set parameters of Bluetooth LE advertising.
- *AT+BLEADVDATA*: Set Bluetooth LE advertising data.
- *AT+BLEADVDATAEX*: Automatically set Bluetooth LE advertising data.
- *AT+BLEADVSTART*: Start Bluetooth LE advertising.
- *AT+BLEADVSTOP*: Stop Bluetooth LE advertising.
- *AT+BLECONN*: Establish Bluetooth LE connection.
- *AT+BLECONNPARAM*: Query/Update parameters of Bluetooth LE connection.
- *AT+BLEDISCONN*: End Bluetooth LE connection.
- *AT+BLECFGMTU*: Set Bluetooth LE MTU length.
- *AT+BLEGATTSSRV*: GATTS discovers services.
- *AT+BLEGATTSSCHAR*: GATTS discovers characteristics.
- *AT+BLEGATTSENTFY*: Notify a client of the value of a characteristic value from the server.
- *AT+BLEGATTSSIND*: Indicate the characteristic value from the server to a client.
- *AT+BLEGATTSSSETATTR*: GATTS sets characteristics.
- *AT+BLEGATTCPRIMSRV*: Generic Attributes Client (GATTC) discovers primary services.
- *AT+BLEGATTCCINCLSRV*: GATTC discovers included services.
- *AT+BLEGATTCCCHAR*: GATTC discovers characteristics.
- *AT+BLEGATTCCRD*: GATTC reads characteristics.
- *AT+BLEGATTCCWR*: GATTC writes characteristics.
- *AT+BLESPPCFG*: Query/Set Bluetooth LE SPP parameters.
- *AT+BLESP*: Enter Bluetooth LE SPP mode.
- *AT+BLESECPARAM*: Query/Set Bluetooth LE encryption parameters.
- *AT+BLEENC*: Initiate Bluetooth LE encryption request.
- *AT+BLEKEYREPLY*: Reply the key value to the peer device.
- *AT+BLECONFREPLY*: Reply the confirm value to the peer device in the legacy connection stage.
- *AT+BLEENCDEV*: Query bonded Bluetooth LE encryption device list.
- *AT+BLEENCCLEAR*: Clear Bluetooth LE encryption device list.
- *AT+BLESETKEY*: Set Bluetooth LE static pair key.
- *AT+BLUFI*: Start or Stop BluFi.
- *AT+BLUFINAME*: Query/Set BluFi device name.
- *AT+BLUFISEND*: Send user-customized data over BluFi.
- *AT+BLEPERIODICDATA*: Set Bluetooth LE periodic advertising data.
- *AT+BLEPERIODICSTART*: Start Bluetooth LE periodic advertising.
- *AT+BLEPERIODICSTOP*: Stop Bluetooth LE periodic advertising.
- *AT+BLESYNCSTART*: Start to synchronize with periodic advertising.
- *AT+BLESYNCSTOP*: Stop synchronizing with periodic advertising.
- *AT+BLEREADPHY*: Query the current transmitter PHY.
- *AT+BLESETPHY*: Set the current transmitter PHY.

### 3.4.1 Introduction

Currently, AT firmware for ESP32-C2 supports [Bluetooth® Core Specification Version 5.0](#).

---

**Important:** The default ESP32C2-4MB AT firmware supports BluFi functionality, while the ESP32C2-2MB AT firmware does not. The lack of BluFi support in the ESP32C2-2MB AT firmware is due to the insufficient 2 MB flash size to support Wi-Fi, BluFi, and OTA functionality simultaneously.

---

---

**Important:** The default ESP32C2-4MB AT firmware and ESP32C2-2MB AT firmware do not support Bluetooth LE functionality. If you need to support Bluetooth LE functionality, please refer to the [Compile ESP-AT Project Locally](#) documentation and choose ESP32C2-BLE-2MB during the environment installation in step 3.

Due to the limited memory of ESP32-C2, Wi-Fi and Bluetooth LE functionalities cannot be supported simultaneously in a single firmware.

---

## 3.4.2 AT+BLEINIT: Bluetooth LE Initialization

### Query Command

**Function:**

Check the initialization status of Bluetooth LE.

**Command:**

```
AT+BLEINIT?
```

**Response:**

If Bluetooth LE is initialized, AT will return:

```
+BLEINIT:<role>  
OK
```

If Bluetooth LE is not initialized, AT will return:

```
+BLEINIT:0  
OK
```

### Set Command

**Function:**

Initialize the role of Bluetooth LE.

**Command:**

```
AT+BLEINIT=<init>
```

**Response:**

```
OK
```

### Parameter

- **<init>**:
- 0: deinit Bluetooth LE
- 1: client role
- 2: server role

### Notes

- When using Bluetooth LE function, if you do not need to use SoftAP mode, it is recommended to set Wi-Fi mode to NULL or station mode by using [AT+CWMODE](#).
- Before using other Bluetooth LE AT commands, you should run this command first to trigger the initialization process.
- After the initialization, the Bluetooth LE role cannot be changed unless you run [AT+RST](#) to restart the system first and then re-initialize the Bluetooth LE role.
- Before you deinitialize the Bluetooth stack, it is recommended to stop broadcasting, stop scanning, and disconnect all existing connections.
- If Bluetooth LE is initialized, [AT+CIPMODE](#) cannot be set to 1.

**Example**

```
AT+BLEINIT=1
```

**3.4.3 AT+BLEADDR: Query/Set Bluetooth LE Device Address****Query Command****Function:**

```
Query the Bluetooth LE Random Address.
```

**Command:**

```
AT+BLEADDR?
```

**Response:**

```
+BLEADDR:<BLE_random_addr>  
OK
```

**Set Command****Function:**

Set the Bluetooth LE address type.

**Command:**

```
AT+BLEADDR=<addr_type>
```

**Response:**

```
OK
```

**Parameter**

- **<addr\_type>**:
- 0: Public Address
- 1: Random Address

**Note**

- A Static Address should meet the following requirements:
- The two most significant bits of the address should be equal to 1.
- At least one bit of the random part of the address should be 0.
- At least one bit of the random part of the address should be 1.
- The configuration changes will be saved in the NVS area.

**Example**

```
AT+BLEADDR=1 // Set Random Device Address, Private Address
```

### 3.4.4 AT+BLENAM: Query/Set Bluetooth LE Device Name

#### Query Command

**Function:**

Query the Bluetooth LE device name.

**Command:**

```
AT+BLENAM?
```

**Response:**

```
+BLENAM:<device_name>  
OK
```

#### Set Command

**Function:**

Set the Bluetooth LE device name.

**Command:**

```
AT+BLENAM=<device_name>
```

**Response:**

```
OK
```

#### Parameter

- **<device\_name>**: the Bluetooth LE device name. The maximum length is 32. Default: “ESP-AT” .

#### Note

- The configuration changes will be saved in the NVS area if *AT+SYSSTORE=1*.
- After setting the device name with this command, it is recommended that you execute the *AT+BLEADVDATA* command to add the device name into the advertising data.

#### Example

```
AT+BLENAM="esp_demo"
```

### 3.4.5 AT+BLESCANPARAM: Query/Set Parameters of Bluetooth LE Scanning

#### Query Command

**Function:**

Query the parameters of Bluetooth LE scanning.

**Command:**

```
AT+BLESCANPARAM?
```

**Response:**

```
+BLESCANPARAM:<scan_type>,<own_addr_type>,<filter_policy>,<scan_interval>,<scan_
↵window>
OK
```

**Set Command****Function:**

Set the parameters of Bluetooth LE scanning.

**Command:**

```
AT+BLESCANPARAM=<scan_type>,<own_addr_type>,<filter_policy>,<scan_interval>,<scan_
↵window>
```

**Response:**

```
OK
```

**Parameters**

- **<scan\_type>**:
  - 0: passive scan
  - 1: active scan
- **<own\_addr\_type>**:
  - 0: Public Address
  - 1: Random Address
  - 2: RPA Public Address
  - 3: RPA Random Address
- **<filter\_policy>**:
  - 0: BLE\_SCAN\_FILTER\_ALLOW\_ALL
  - 1: BLE\_SCAN\_FILTER\_ALLOW\_ONLY\_WLST
  - 2: BLE\_SCAN\_FILTER\_ALLOW\_UND\_RPA\_DIR
  - 3: BLE\_SCAN\_FILTER\_ALLOW\_WLIST\_PRA\_DIR
- **<scan\_interval>**: scan interval. It should be more than or equal to the value of **<scan\_window>**. The range of this parameter is [0x0004,0x4000]. The scan interval equals this parameter multiplied by 0.625 ms, so the range for the actual scan interval is [2.5,10240] ms.
- **<scan\_window>**: scan window. It should be less than or equal to the value of **<scan\_interval>**. The range of this parameter is [0x0004,0x4000]. The scan window equals this parameter multiplied by 0.625 ms, so the range for the actual scan window is [2.5,10240] ms.

**Example**

```
AT+BLEINIT=1 // Role: client
AT+BLESCANPARAM=0,0,0,100,50
```

### 3.4.6 AT+BLESCAN: Enable Bluetooth LE Scanning

**Set Command****Function:**

Enable/disable scanning.

**Command:**

```
AT+BLES SCAN=<enable>[,<duration>][,<filter_type>,<filter_param>]
```

**Response:**

```
+BLES SCAN:<addr>,<rssi>,<adv_data>,<scan_rsp_data>,<addr_type>
OK
+BLES CANDONE
```

**Parameters**

- **<enable>**:
  - 1: enable continuous scanning.
  - 0: disable continuous scanning.
- [**<duration>**]: optional parameter. Unit: second.
- If you want to disable the scanning, this parameter should be omitted.
- If you want to enable the scanning, set a value for this parameter:
  - When you set it to 0, it means that scanning is continuous.
  - When set it to a value other than 0, for example, `AT+BLES SCAN=1,3`, it means that scanning will last for 3 seconds and then stop automatically. The scanning results will be returned.
- [**<filter\_type>**]: filtering option.
  - 1: “MAC” .
  - 2: “NAME” .
- **<filter\_param>**: filtering parameter showing the remote device MAC address or remote device name.
- **<addr>**: Bluetooth LE address.
- **<rssi>**: signal strength.
- **<adv\_data>**: advertising data.
- **<scan\_rsp\_data>**: scan response data.
- **<addr\_type>**: the address type of broadcasters.

**Notes**

- The response OK does not necessarily come before the response `+BLES SCAN:<addr>,<rssi>,<adv_data>,<scan_rsp_data>,<addr_type>`. It may be output before `+BLES SCAN:<addr>,<rssi>,<adv_data>,<scan_rsp_data>,<addr_type>` or after it.
- To obtain the scan response data, use the `AT+BLES SCANPARAM` command to set the scan type to active scan (`AT+BLES SCANPARAM=1,0,0,100,50`), and the peer device needs to set the `scan_rsp_data`.

**Example**

```
AT+BLEINIT=1 // Role: client
AT+BLES SCAN=1 // start scanning
AT+BLES SCAN=0 // stop scanning
AT+BLES SCAN=1,3,1,"24:0A:C4:96:E6:88" // start scanning, filter type is MAC address
AT+BLES SCAN=1,3,2,"ESP-AT" // start scanning, filter type is device name
```

### 3.4.7 AT+BLES SCANRSPDATA: Set Bluetooth LE Scan Response

**Set Command****Function:**

Set scan response.

**Command:**

```
AT+BLESCANRSPDATA=<scan_rsp_data>
```

**Response:**

```
OK
```

**Parameter**

- **<scan\_rsp\_data>**: scan response data is a HEX string. For example, if you want to set the response data to "0x11 0x22 0x33 0x44 0x55" , the command should be AT+BLESCANRSPDATA="1122334455".

**Example**

```
AT+BLEINIT=2 // Role: server
AT+BLESCANRSPDATA="1122334455"
```

### 3.4.8 AT+BLEADVPARAM: Query/Set Parameters of Bluetooth LE Advertising

**Query Command****Function:**

Query the parameters of advertising.

**Command:**

```
AT+BLEADVPARAM?
```

**Response:**

```
+BLEADVPARAM:<adv_int_min>,<adv_int_max>,<adv_type>,<own_addr_type>,<channel_map>,<adv_filter_policy>,<peer_addr_type>,<peer_addr>,<primary_phy>,<secondary_phy>
OK
```

**Set Command****Function:**

Set the parameters of advertising.

**Command:**

```
AT+BLEADVPARAM=<adv_int_min>,<adv_int_max>,<adv_type>,<own_addr_type>,<channel_map>
↵ [<adv_filter_policy>] [<peer_addr_type>,<peer_addr>] [<primary_phy>,<secondary_
↵ phy>]
```

**Response:**

```
OK
```

## Parameters

- **<adv\_int\_min>**: minimum advertising interval. The range of this parameter is [0x0020,0x4000]. The actual advertising interval equals this parameter multiplied by 0.625 ms, so the range for the actual minimum interval is [20, 10240] ms. It should be less than or equal to the value of <adv\_int\_max>.
- **<adv\_int\_max>**: maximum advertising interval. The range of this parameter is [0x0020,0x4000]. The actual advertising interval equals this parameter multiplied by 0.625 ms, so the range for the actual maximum interval is [20, 10240] ms. It should be more than or equal to the value of <adv\_int\_min>.
- **<adv\_type>**:
  - 0: ADV\_TYPE\_IND
  - 1: ADV\_TYPE\_DIRECT\_IND\_HIGH
  - 2: ADV\_TYPE\_SCAN\_IND
  - 3: ADV\_TYPE\_NONCONN\_IND
  - 4: ADV\_TYPE\_DIRECT\_IND\_LOW
  - 5: ADV\_TYPE\_EXT\_NOSCANNABLE\_IND
  - 6: ADV\_TYPE\_EXT\_CONNECTABLE\_IND
  - 7: **ADV\_TYPE\_EXT\_SCANNABLE\_IND**
    - When <adv\_type> is set to 0-4, the maximum allowed size for advertising data using the *AT+BLEADVDATA* command is 31 bytes. If the advertising data exceeds the maximum limit of this command, use command *AT+BLESCANRSPDATA*.
    - When <adv\_type> is set to 5-7, the maximum allowed size for advertising data using the *AT+BLEADVDATA* command is 119 bytes.
- **<own\_addr\_type>**: own Bluetooth LE address type.
  - 0: BLE\_ADDR\_TYPE\_PUBLIC
  - 1: BLE\_ADDR\_TYPE\_RANDOM
- **<channel\_map>**: channel of advertising.
  - 1: ADV\_CHNL\_37
  - 2: ADV\_CHNL\_38
  - 4: ADV\_CHNL\_39
  - 7: ADV\_CHNL\_ALL
- **[<adv\_filter\_policy>]**: filter policy of advertising.
  - 0: ADV\_FILTER\_ALLOW\_SCAN\_ANY\_CON\_ANY
  - 1: ADV\_FILTER\_ALLOW\_SCAN\_WLST\_CON\_ANY
  - 2: ADV\_FILTER\_ALLOW\_SCAN\_ANY\_CON\_WLST
  - 3: ADV\_FILTER\_ALLOW\_SCAN\_WLST\_CON\_WLST
- **[<peer\_addr\_type>]**: remote Bluetooth LE address type.
  - 0: PUBLIC
  - 1: RANDOM
- **[<peer\_addr>]**: remote Bluetooth LE address.
- **[<primary\_phy>]**: advertising primary PHY. Default: 1M PHY.
  - 1: 1M PHY
  - 3: Coded PHY
- **[<secondary\_phy>]**: advertising secondary PHY. Default: 1M PHY.
  - 1: 1M PHY
  - 2: 2M PHY
  - 3: Coded PHY

## Note

- If `peer_addr` is not set, the query result will be all zero.
- The `primary_phy` and `secondary_phy` must be set together, otherwise, the default 1M PHY is used for unconfigured parameter.



**Example**

```
AT+BLEINIT=2 // Role: server
AT+BLEADVPARAM=50,50,0,0,4,0,1,"12:34:45:78:66:88"
AT+BLEADVPARAM=32,32,6,0,7,0,0,"62:34:45:78:66:88",1,3
```

**3.4.9 AT+BLEADVDATA: Set Bluetooth LE Advertising Data****Set Command****Function:**

Set advertising data.

**Command:**

```
AT+BLEADVDATA=<adv_data>
```

**Response:**

```
OK
```

**Parameter**

- **<adv\_data>**: advertising data in HEX string. For example, to set the advertising data to “0x11 0x22 0x33 0x44 0x55” , the command should be `AT+BLEADVDATA="1122334455"`. The maximum length is 119 bytes.

**Note**

- If advertising data is preset by command `AT+BLEADVDATAEX=<dev_name>,<uuid>,<manufacturer_data>,<include_power>`, it will be overwritten by this command.
- If you run this command to modify the device name, it is recommended to also execute the `AT+BLENAME` command to set the same device name afterwards.
- Please set the Bluetooth LE advertising parameters by the `AT+BLEADVPARAM` command before you use the `AT+BLEADVDATA` command.
- When the `<adv_type>` is set to 0-4 by the `AT+BLEADVPARAM` command, the maximum allowed size for advertising data using the `AT+BLEADVDATA` command is 31 bytes. If the advertising data exceeds the maximum limit of this command, use command `AT+BLESANRSPDATA`.
- When the `<adv_type>` is set to 5-7 by the `AT+BLEADVPARAM` command, the maximum allowed size for advertising data using the `AT+BLEADVDATA` command is 119 bytes.

**Example**

```
AT+BLEINIT=2 // Role: server
AT+BLEADVDATA="1122334455"
```

**3.4.10 AT+BLEADVDATAEX: Automatically Set Bluetooth LE Advertising Data****Query Command****Function:**

Query the parameters of advertising data.

**Command:**

```
AT+BLEADVDATAEX?
```

**Response:**

```
+BLEADVDATAEX:<dev_name>,<uuid>,<manufacturer_data>,<include_power>
```

```
OK
```

**Set Command****Function:**

Set the advertising data and start advertising.

**Command:**

```
AT+BLEADVDATAEX=<dev_name>,<uuid>,<manufacturer_data>,<include_power>
```

**Response:**

```
OK
```

**Parameters**

- **<dev\_name>**: string parameter showing a device name. For example, if you want to set the device name to “just-test”, the command should be `AT+BLEADVSTARTEX="just-test",<uuid>,<manufacturer_data>,<include_power>`.
- **<uuid>**: string parameter. For example, if you want to set the UUID to “0xA002”, the command should be `AT+BLEADVSTARTEX=<dev_name>,"A002",<manufacturer_data>,<include_power>`.
- **<manufacturer\_data>**: manufacturer data in HEX string. For example, if you set the manufacturer data to “0x11 0x22 0x33 0x44 0x55”, the command should be `AT+BLEADVSTARTEX=<dev_name>,<uuid>,"1122334455",<include_power>`.
- **<include\_power>**: If you need to include the TX power in the advertising data, you should set the parameter to 1. Otherwise, set it to 0.

**Note**

- If advertising data is preset by command `AT+BLEADVDATA=<adv_data>`, it will be overwritten by this command.
- This command automatically changes the adv type previously set using `AT+BLEADVPARAM` to 0.

**Example**

```
AT+BLEINIT=2 // Role: server
AT+BLEADVDATAEX="ESP-AT","A002","0102030405",1
```

### 3.4.11 AT+BLEADVSTART: Start Bluetooth LE Advertising

**Execute Command****Function:**

Start advertising.

**Command:**

```
AT+BLEADVSTART
```

**Response:**

```
OK
```

**Notes**

- You must set the advertisement parameters using the `AT+BLEADVPARAM=<adv_parameter>` command before advertisement is started.
- If advertising data is NOT set by command `AT+BLEADVDATA=<adv_data>`, the advertising payload will be empty.
- If advertising data is preset by command `AT+BLEADVDATA=<adv_data>`, it will be overwritten by `AT+BLEADVDATAEX=<dev_name>,<uuid>,<manufacturer_data>,<include_power>` and vice versa.
- After the start of Bluetooth LE advertisement, if no connection is established, the advertisement will keep going on; if a connection is established, the advertisement will automatically end.

**Example**

```
AT+BLEINIT=2 // Role: server
AT+BLEADVPARAM=50,50,0,0,7,0,,
AT+BLEADVSTART
```

### 3.4.12 AT+BLEADVSTOP: Stop Bluetooth LE Advertising

**Execute Command****Function:**

Stop advertising.

**Command:**

```
AT+BLEADVSTOP
```

**Response:**

```
OK
```

**Note**

- After the start of advertising, if the Bluetooth LE connection is established successfully, it will stop advertising automatically. In such a case, this command does NOT need to be called.

**Example**

```
AT+BLEINIT=2 // Role: server
AT+BLEADVPARAM=50,50,0,0,7,0,,
AT+BLEADVSTART
AT+BLEADVSTOP
```

### 3.4.13 AT+BLECONN: Establish Bluetooth LE Connection

#### Query Command

**Function:**

Query the Bluetooth LE connection.

**Command:**

```
AT+BLECONN?
```

**Response:**

```
+BLECONN:<conn_index>,<remote_address>  
OK
```

If the connection has not been established, there will be no <conn\_index> and <remote\_address> in the response.

#### Set Command

**Function:**

Establish the Bluetooth LE connection.

**Command:**

```
AT+BLECONN=<conn_index>,<remote_address>[,<addr_type>,<timeout>]
```

**Response:**

If the connection is established successfully, it will prompt:

```
+BLECONN:<conn_index>,<remote_address>  
OK
```

If the connection fails, it will prompt:

```
+BLECONN:<conn_index>,-1  
ERROR
```

If the connection fails due to parameters error or other reasons, it will prompt:

```
ERROR
```

#### Parameters

- **<conn\_index>**: index of Bluetooth LE connection. Range: [0,1].
- **<remote\_address>**: remote Bluetooth LE address.
- **[<addr\_type>]**: the address type of broadcasters:
  - 0: Public Address
  - 1: Random Address
- **[<timeout>]**: the timeout for the connection command. Unit: second. Range: [3,30].

## Notes

- It is recommended to scan devices by running *AT+BLESCAN* before initiating a new connection to ensure that the target device is in the broadcast state.
- The maximum timeout for connection is 30 seconds.
- If the Bluetooth LE server is initialized and the connection is established successfully, you can use this command to discover the services in the peer device (GATTC). The following GATTC commands can also be used:
  - *AT+BLEGATTCPRIMSRV*
  - *AT+BLEGATTCINCLSRV*
  - *AT+BLEGATTCCHAR*
  - *AT+BLEGATTCRD*
  - *AT+BLEGATTCWR*
  - *AT+BLEGATTSIND*
- If the *AT+BLECONN?* is executed when the Bluetooth LE is not initialized (*AT+BLEINIT=0*), the system will not output *+BLECONN:<conn\_index>,<remote\_address>*.

## Example

```
AT+BLEINIT=1 // Role: client
AT+BLECONN=0, "24:0a:c4:09:34:23", 0, 10
```

## 3.4.14 AT+BLECONNPARAM: Query/Update Parameters of Bluetooth LE Connection

### Query Command

#### Function:

Query the parameters of Bluetooth LE connection.

#### Command:

```
AT+BLECONNPARAM?
```

#### Response:

```
+BLECONNPARAM:<conn_index>,<min_interval>,<max_interval>,<cur_interval>,<latency>,<timeout>
↔
OK
```

### Set Command

#### Function:

Update the parameters of Bluetooth LE connection.

#### Command:

```
AT+BLECONNPARAM=<conn_index>,<min_interval>,<max_interval>,<latency>,<timeout>
```

#### Response:

```
OK
```

If the setting fails, it will prompt the message below:

```
+BLECONNPARAM: <conn_index>,-1
```

### Parameters

- **<conn\_index>**: index of Bluetooth LE connection. Range: [0,2].
- **<min\_interval>**: minimum connecting interval. It should be less than or equal to the value of **<max\_interval>**. The range of this parameter is [0x0006,0x0C80]. The actual connecting interval equals this parameter multiplied by 1.25 ms, so the range for the actual minimum interval is [7.5,4000] ms.
- **<max\_interval>**: maximum connecting interval. It should be more than or equal to the value of **<min\_interval>**. The range of this parameter is [0x0006,0x0C80]. The actual connecting interval equals this parameter multiplied by 1.25 ms, so the range for the actual maximum interval is [7.5,4000] ms.
- **<cur\_interval>**: current connecting interval.
- **<latency>**: latency. Range: [0x0000,0x01F3].
- **<timeout>**: timeout. The range of this parameter is [0x000A,0x0C80]. The actual timeout equals this parameter multiplied by 10 ms, so the range for the actual timeout is [100,32000] ms.

### Note

- This command supports client or server roles when updating its connection parameters. Of course, the connection has to be established first.

### Example

```
AT+BLEINIT=1 // Role: client
AT+BLECONN=0, "24:0a:c4:09:34:23"
AT+BLECONNPARAM=0,12,14,1,500
```

## 3.4.15 AT+BLEDISCONN: End Bluetooth LE Connection

### Execute Command

#### Function:

End the Bluetooth LE connection.

#### Command:

```
AT+BLEDISCONN=<conn_index>
```

#### Response:

```
OK // The AT+BLEDISCONN command is received.
+BLEDISCONN:<conn_index>,<remote_address> // The command is successful.
```

### Parameters

- **<conn\_index>**: index of Bluetooth LE connection. Range: [0,2].
- **<remote\_address>**: remote Bluetooth LE address.

### Example

```
AT+BLEINIT=1 // Role: client
AT+BLECONN=0, "24:0a:c4:09:34:23"
AT+BLEDISCONN=0
```

### 3.4.16 AT+BLECFGMTU: Set Bluetooth LE MTU Length

#### Query Command

**Function:**

Query the length of the maximum transmission unit (MTU).

**Command:**

```
AT+BLECFGMTU?
```

**Response:**

```
+BLECFGMTU:<conn_index>,<mtu_size>
OK
```

#### Set Command

**Function:**

Set the length of the maximum transmission unit (MTU).

**Command:**

```
AT+BLECFGMTU=<conn_index>
```

**Response:**

```
OK // The command is received.
```

#### Parameters

```
- **<conn_index>**: index of Bluetooth LE connection. Range: [0,1].
```

#### Notes

- Bluetooth LE connection has to be established first.
- Only the client can call this command to **set** the length of MTU.

#### Example

```
AT+BLEINIT=1 // Role: client
AT+BLECONN=0,"24:0a:c4:09:34:23"
AT+BLECFGMTU=0
```

### 3.4.17 AT+BLEGATTSSRV: GATTS Discovers Services

#### Query Command

**Function:**

GATTS discovers services.

**Command:**

```
AT+BLEGATTSSRV?
```

**Response:**

```
+BLEGATTSSRV:<srv_index>,<start>,<srv_uuid>,<srv_type>
OK
```

**Parameters**

- **<srv\_index>**: service' s index starting from 1.
- **<start>**:
  - 0: the service has not started.
  - 1: the service has already started.
- **<srv\_uuid>**: service' s UUID.
- **<srv\_type>**: service' s type.
  - 0: not primary service.
  - 1: primary service.

**Example**

```
AT+BLEINIT=2 // Role: server
AT+BLEGATTSSRV?
```

### 3.4.18 AT+BLEGATTSSCHAR: GATTS Discovers Characteristics

**Query Command****Function:**

GATTS discovers characteristics.

**Command:**

```
AT+BLEGATTSSCHAR?
```

**Response:**

The response for a characteristic:

```
+BLEGATTSSCHAR:"char",<srv_index>,<char_index>,<char_uuid>,<char_prop>
```

The response for a descriptor:

```
+BLEGATTSSCHAR:"desc",<srv_index>,<char_index>,<desc_index>
OK
```

**Parameters**

- **<srv\_index>**: service' s index starting from 1.
- **<char\_index>**: characteristic' s index starting from 1.
- **<char\_uuid>**: characteristic' s UUID.
- **<char\_prop>**: characteristic' s properties.
- **<desc\_index>**: descriptor' s index.
- **<desc\_uuid>**: descriptor' s UUID.



### Example

```
AT+BLEINIT=2 // Role: server
AT+BLEGATTCHAR?
```

## 3.4.19 AT+BLEGATTSENTFY: Notify a Client of the Value of a Characteristic Value from the Server

### Set Command

#### Function:

Notify a client of the value of a characteristic value from the server.

#### Command:

```
AT+BLEGATTSENTFY=<conn_index>,<srv_index>,<char_index>,<length>
```

#### Response:

```
>
```

The symbol > indicates that AT is ready for receiving serial data, and you can enter data now. When the requirement of data length determined by the parameter <length> is met, the notification starts.

If the data transmission is successful, AT returns:

```
OK
```

### Parameters

- **<conn\_index>**: index of Bluetooth LE connection. Range: [0,2].
- **<srv\_index>**: service's index. It can be queried with command [AT+BLEGATTCHAR?](#).
- **<char\_index>**: characteristic's index. It can be queried with command [AT+BLEGATTCHAR?](#).
- **<length>**: data length. The maximum length is ( :ref:`MTU <cmd-BMTU>` - 3).

### Example

```
AT+BLEINIT=2 // Role: server.
AT+BLEADVPARAM=50,50,0,0,7,0,,
AT+BLEADVSTART // Start advertising. After the client is connected, it must be
↳ configured to receive notifications.
AT+BLEGATTCHAR? // Query the characteristics which the client will be notified
↳ of.
// For example, to notify of 4-byte data using the 6th characteristic in the 3rd
↳ service, use the following command:
AT+BLEGATTSENTFY=0,3,6,4
// After the symbol ">" shows, enter the 4-byte data, such as "1234". Then the
↳ data will be transmitted automatically.
```

## 3.4.20 AT+BLEGATTSEND: Indicate the Characteristic Value from the Server to a Client

### Set Command

#### Function:

Indicate the characteristic value from the server to a client.

**Command:**

```
AT+BLEGATTSIND=<conn_index>,<srv_index>,<char_index>,<length>
```

**Response:**

```
>
```

The symbol > indicates that AT is ready for receiving serial data and you can enter data now. When the requirement of data length determined by the parameter <length> is met, the indication starts.

If the data transmission is successful, AT returns:

```
OK
```

**Parameters**

- **<conn\_index>**: index of Bluetooth LE connection. Range: [0,2].
- **<srv\_index>**: service' s index. It can be queried with command *AT+BLEGATTSCHAR?*.
- **<char\_index>**: characteristic' s index; it can be fetched with command *AT+BLEGATTSCHAR?*.
- **<length>**: data length. The maximum length is (*MTU* - 3).

**Example**

```
AT+BLEINIT=2 // Role: server
AT+BLEADVPARAM=50,50,0,0,7,0,,
AT+BLEADVSTART // Start advertising. After the client is connected, it must be
↳ configured to receive indications.
AT+BLEGATTSCHAR? // Query the characteristics which the client can receive
↳ indications.
// For example, to indicate 4 bytes of data using the 7th characteristic in the
↳ 3rd service, use the following command:
AT+BLEGATTSIND=0,3,7,4
// After the symbol ">" shows, input 4 bytes of data, such as "1234". Then the
↳ data will be transmitted automatically.
```

### 3.4.21 AT+BLEGATTSSETATTR: GATTS Sets Characteristics

**Set Command**

**Function:**

GATTS sets its characteristic (descriptor).

**Command:**

```
AT+BLEGATTSSETATTR=<srv_index>,<char_index>,<length>
```

**Response:**

```
>
```

The symbol > indicates that AT is ready for receiving serial data and you can enter data now. When the requirement of data length determined by the parameter <length> is met, the setting starts.

If the setting is successful, AT returns:

```
OK
```

### Parameters

- **<srv\_index>**: service's index. It can be queried with command `AT+BLEGATTSSCHAR?`.
- **<char\_index>**: characteristic's index; it can be fetched with command `AT+BLEGATTSSCHAR?`.
- **[<desc\_index>]**: descriptor's index.
- If it is set, this command is used to set the value of the descriptor.
- Otherwise, this command is used to set the value of the characteristic.
- **<length>**: data length.

### Note

- If the value of `<length>` is larger than the maximum length allowed, the setting will fail. The service table is defined in [gatts\\_data.csv](#).
- The characteristic descriptor value cannot be set.

### Example

```
AT+BLEINIT=2 // Role: server.
AT+BLEGATTSSCHAR?
// For example, to set 1 byte of data of the 1st characteristic in the 1st service,
↪ use the following command:
AT+BLEGATTSSSETATTR=1,1,1
// After the symbol ">" shows, input 1 byte of data, such as "8". Then the setting
↪ starts.
```

## 3.4.22 AT+BLEGATTCPRIMSRV: GATTC Discovers Primary Services

### Query Command

#### Function:

Generic Attributes Client (GATTC) discovers primary services.

#### Command:

```
AT+BLEGATTCPRIMSRV=<conn_index>
```

#### Response:

```
+BLEGATTCPRIMSRV:<conn_index>,<srv_index>,<srv_uuid>,<srv_type>
OK
```

### Parameters

- **<conn\_index>**: index of Bluetooth LE connection. Range: [0,2].
- **<srv\_index>**: service's index starting from 1.
- **<srv\_uuid>**: service's UUID.
- **<srv\_type>**: service's type.
- 0: not primary service.
- 1: primary service.

**Note**

- The Bluetooth LE connection has to be established first.

**Example**

```
AT+BLEINIT=1 // Role: client
AT+BLECONN=0, "24:12:5f:9d:91:98"
AT+BLEGATTCPRIMSRV=0
```

### 3.4.23 AT+BLEGATTCINCLSRV: GATTC Discovers Included Services

**Set Command****Function:**

GATTC discovers included services.

**Command:**

```
AT+BLEGATTCINCLSRV=<conn_index>,<srv_index>
```

**Response:**

```
+BLEGATTCINCLSRV:<conn_index>,<srv_index>,<srv_uuid>,<srv_type>,<included_srv_uuid>
↔,<included_srv_type>
OK
```

**Parameters**

- **<conn\_index>**: index of Bluetooth LE connection. Range: [0,2].
- **<srv\_index>**: service's index. It can be queried with command *AT+BLEGATTCPRIMSRV=<conn\_index>*.
- **<srv\_uuid>**: service's UUID.
- **<srv\_type>**: service's type.
- 0: not primary service.
- 1: primary service.
- **<included\_srv\_uuid>**: included service's UUID.
- **<included\_srv\_type>**: included service's type.
- 0: not primary service.
- 1: primary service.

**Note**

- The Bluetooth LE connection has to be established first.

**Example**

```
AT+BLEINIT=1 // Role: client
AT+BLECONN=0, "24:12:5f:9d:91:98"
AT+BLEGATTCPRIMSRV=0
AT+BLEGATTCINCLSRV=0,1 // set a specific index according to the result of the
↔previous command
```

### 3.4.24 AT+BLEGATTCHAR: GATT Discover Characteristics

#### Set Command

##### Function:

GATT discovers characteristics.

##### Command:

```
AT+BLEGATTCHAR=<conn_index>,<srv_index>
```

##### Response:

The response for a characteristic:

```
+BLEGATTCHAR:"char",<conn_index>,<srv_index>,<char_index>,<char_uuid>,<char_prop>
```

The response for a descriptor:

```
+BLEGATTCHAR:"desc",<conn_index>,<srv_index>,<char_index>,<desc_index>,<desc_uuid>
OK
```

#### Parameters

- **<conn\_index>**: index of Bluetooth LE connection. Range: [0,2].
- **<srv\_index>**: service's index. It can be queried with command *AT+BLEGATTCPRIMSRV=<conn\_index>*.
- **<char\_index>**: characteristic's index starting from 1.
- **<char\_uuid>**: characteristic's UUID.
- **<char\_prop>**: characteristic's properties.
- **<desc\_index>**: descriptor's index.
- **<desc\_uuid>**: descriptor's UUID.

#### Note

- The Bluetooth LE connection has to be established first.

#### Example

```
AT+BLEINIT=1 // Role: client
AT+BLECONN=0,"24:12:5f:9d:91:98"
AT+BLEGATTCPRIMSRV=0
AT+BLEGATTCHAR=0,1 // set a specific index according to the result of the
↳previous command
```

### 3.4.25 AT+BLEGATTCRD: GATT Reads Characteristics

#### Set Command

##### Function:

GATT reads a characteristic or descriptor.

##### Command:

```
AT+BLEGATTCRD=<conn_index>,<srv_index>,<char_index>[,<desc_index>]
```

**Response:**

```
+BLEGATTCRD:<conn_index>,<len>,<value>
OK
```

**Parameters**

- **<conn\_index>**: index of Bluetooth LE connection. Range: [0,2].
- **<srv\_index>**: service's index. It can be queried with command `AT+BLEGATTCPRIMSRV=<conn_index>`.
- **<char\_index>**: characteristic's index; it can be fetched with command `AT+BLEGATTCCHAR=<conn_index>,<srv_index>`.
- **[<desc\_index>]**: descriptor's index.
- If it is set, the value of the target descriptor will be read.
- if it is not set, the value of the target characteristic will be read.
- **<len>**: data length.
- **<value>**: <char\_value> or <desc\_value>.
- **<char\_value>**: characteristic's value. String format is read by command `AT+BLEGATTCRD=<conn_index>,<srv_index>,<char_index>`. For example, if the response is `+BLEGATTCRD:0,1,0`, it means that the value length is 1, and the content is "0".
- **<desc\_value>**: descriptor's value. String format is read by command `AT+BLEGATTCRD=<conn_index>,<srv_index>,<char_index>,<desc_index>`. For example, if the response is `+BLEGATTCRD:0,4,0123`, it means that the value length is 4, and the content is "0123".

**Notes**

- The Bluetooth LE connection has to be established first.
- If the target characteristic cannot be read, it will return "ERROR".

**Example**

```
AT+BLEINIT=1 // Role: client.
AT+BLECONN=0,"24:12:5f:9d:91:98"
AT+BLEGATTCPRIMSRV=0
AT+BLEGATTCCHAR=0,3 // Set a specific index according to the result of the
↳previous command.
// For example, to read 1st descriptor of the 2nd characteristic in the 3rd
↳service, use the following command:
AT+BLEGATTCRD=0,3,2,1
```

**3.4.26 AT+BLEGATTCWR: GATTC Writes Characteristics****Set Command****Function:**

GATTC writes characteristics or descriptors.

**Command:**

```
AT+BLEGATTCWR=<conn_index>,<srv_index>,<char_index>[,<desc_index>],<length>
```

**Response:**

```
>
```

The symbol > indicates that AT is ready for receiving serial data and you can enter data now. When the requirement of data length determined by the parameter <length> is met, the writing starts.

If the setting is successful, AT returns:

```
OK
```

### Parameters

- **<conn\_index>**: index of Bluetooth LE connection. Range: [0,2].
- **<srv\_index>**: service's index. It can be queried with command `AT+BLEGATTCPRIMSRV=<conn_index>`.
- **<char\_index>**: characteristic's index; it can be fetched with command `AT+BLEGATTCCHAR=<conn_index>,<srv_index>`.
- **[<desc\_index>]**: descriptor's index.
- If it is set, the value of the target descriptor will be written.
- If it is not set, the value of the target characteristic will be written.
- **<length>**: data length. The value range of this parameter is subject to `gatts_data.csv` in `val_max_len` parameter.

### Notes

- The Bluetooth LE connection has to be established first.
- If the target characteristic cannot be written, it will return "ERROR".

### Example

```
AT+BLEINIT=1 // Role: client.
AT+BLECONN=0,"24:12:5f:9d:91:98"
AT+BLEGATTCPRIMSRV=0
AT+BLEGATTCCHAR=0,3 // Set a specific index according to the result of the
↳previous command.
// For example, to write 6 bytes of data to the 4th characteristic in the 3rd
↳service, use the following command:
AT+BLEGATTCWR=0,3,4,,6
// After the symbol ">" shows, input 6 bytes of data, such as "123456". Then the
↳writing starts.
```

## 3.4.27 AT+BLESPPCFG: Query/Set Bluetooth LE SPP Parameters

### Query Command

#### Function:

Query the parameters of Bluetooth LE Serial Port Profile (SPP).

#### Command:

```
AT+BLESPPCFG?
```

#### Response:

```
+BLESPPCFG:<tx_service_index>,<tx_char_index>,<rx_service_index>,<rx_char_index>,
↳<auto_conn>
OK
```

## Set Command

### Function:

Set or reset the parameters of Bluetooth LE SPP.

### Command:

```
AT+BLESPPCFG=<cfg_enable>[,<tx_service_index>,<tx_char_index>,<rx_service_index>,<rx_char_index>][,<auto_conn>]
```

### Response:

```
OK
```

## Parameters

- **<cfg\_enable>**:
  - 0: all the SPP parameters will be reset, and the following parameters do not need input.
  - 1: you should input the following parameters.
- **<tx\_service\_index>**: tx service's index. It can be queried with command [AT+BLEGATTCPRMSRV=<conn\\_index>](#) and [AT+BLEGATTSSRV?](#).
- **<tx\_char\_index>**: tx characteristic's index. It can be queried with command [AT+BLEGATTCCCHAR=<conn\\_index>,<srv\\_index>](#) and [AT+BLEGATTSSCHAR?](#).
- **<rx\_service\_index>**: rx service's index. It can be queried with command [AT+BLEGATTCPRMSRV=<conn\\_index>](#) and [AT+BLEGATTSSRV?](#).
- **<rx\_char\_index>**: rx characteristic's index. It can be queried with command [AT+BLEGATTCCCHAR=<conn\\_index>,<srv\\_index>](#) and [AT+BLEGATTSSCHAR?](#).
- **<auto\_conn>**: Bluetooth LE SPP auto-reconnection flag. By default, automatic reconnection is enabled.
  - 0: disable Bluetooth LE SPP automatic reconnection.
  - 1: enable Bluetooth LE SPP automatic reconnection

## Notes

- In Bluetooth LE client, the property of tx characteristic must be `write with response` or `write without response`, and the property of rx characteristic must be `indicate` or `notify`.
- In Bluetooth LE server, the property of tx characteristic must be `indicate` or `notify`, and the property of rx characteristic must be `write with response` or `write without response`.
- If the automatic reconnection function is disabled, when the connection is disconnected, a disconnection message is displayed (depending on AT+SYMSMSG), you need to send the connection command again; If this function is enabled, the connection will be automatically reconnected after disconnection, and the MCU side will not be aware of the disconnection. If the MAC of the peer end changes, the connection will fail.

## Example

```
AT+BLESPPCFG=0           // reset Bluetooth LE SPP parameters
AT+BLESPPCFG=1,3,5,3,7  // set Bluetooth LE SPP parameters
AT+BLESPPCFG?           // query Bluetooth LE SPP parameters
```

## 3.4.28 AT+BLESPP: Enter Bluetooth LE SPP Mode

### Execute Command

#### Function:

Enter Bluetooth LE SPP mode.



**Command:**

```
AT+BLESP
```

**Response:**

```
OK
>
```

This response indicates that AT has entered Bluetooth LE SPP mode and can send and receive data.

If the Bluetooth LE SPP status is wrong ( Notifications are not enabled at the opposite end after the Bluetooth LE connection is established ), the system returns:

```
ERROR
```

**Notes**

- During the SPP transmission, AT will not prompt any exit the Bluetooth LE SPP passthrough mode information unless Bit0 of *AT+SYMSG* is 1.
- During the SPP transmission, AT will not prompt any connection status changes unless Bit2 of *AT+SYMSG* is 1.
- When the packet which only contains +++ is received, the device returns to normal command mode. Please wait for at least one second before sending the next AT command.

**Example**

```
AT+BLESP // enter Bluetooth LE SPP mode
```

### 3.4.29 AT+BLESECPARAM: Query/Set Bluetooth LE Encryption Parameters

**Query Command****Function:**

Query the parameters of Bluetooth LE SMP.

**Command:**

```
AT+BLESECPARAM?
```

**Response:**

```
+BLESECPARAM:<auth_req>,<iocap>,<enc_key_size>,<init_key>,<rsp_key>,<auth_option>
OK
```

**Set Command****Function:**

Set the parameters of Bluetooth LE SMP.

**Command:**

```
AT+BLESECPARAM=<auth_req>,<iocap>,<enc_key_size>,<init_key>,<rsp_key>[,<auth_
->option>]
```

**Response:**

OK

**Parameters**

- **<auth\_req>**: authentication request.
- 0: NO\_BOND
- 1: BOND
- 4: MITM
- 8: SC\_ONLY
- 9: SC\_BOND
- 12: SC\_MITM
- 13: SC\_MITM\_BOND
- **<iocap>**: input and output capability.
- 0: DisplayOnly
- 1: DisplayYesNo
- 2: KeyboardOnly
- 3: NoInputNoOutput
- 4: Keyboard display
- **<enc\_key\_size>**: encryption key size. Range: [7,16]. Unit: byte.
- **<init\_key>**: initial key represented in bit combinations.
- **<rsp\_key>**: response key represented in bit combinations.
- **<auth\_option>**: authentication option of security.
- 0: Select the security level automatically.
- 1: If it cannot follow the preset security level, the connection will disconnect.

**Note**

- The bit pattern for parameters **<init\_key>** and **<rsp\_key>** is:
- Bit0: Used to exchange the encryption key in the init key & response key.
- Bit1: Used to exchange the IRK key in the init key & response key.
- Bit2: Used to exchange the CSRK key in the init key & response key.
- Bit3: Used to exchange the link key (only used in the Bluetooth LE & BR/EDR coexist mode) in the init key & response key.

**Example**

AT+BLESECPARAM=1,4,16,3,3,0

### 3.4.30 AT+BLEENC: Initiate Bluetooth LE Encryption Request

**Set Command****Function:**

Start a pairing request

**Command:**

AT+BLEENC=<conn\_index>,<sec\_act>

**Response:**

```
OK
```

### Parameters

- **<conn\_index>**: index of Bluetooth LE connection. Range: [0,2].
- **<sec\_act>**:
- 0: SEC\_NONE
- 1: SEC\_ENCRYPT
- 2: SEC\_ENCRYPT\_NO\_MITM
- 3: SEC\_ENCRYPT\_MITM

### Note

- Before running this command, please set the security parameters and connection with remote devices.

### Example

```
AT+RESTORE
AT+BLEINIT=2
AT+BLEADDR?
AT+BLESECPARAM=1,0,16,3,3
AT+BLESETKEY=123456
AT+BLEADVPARAM=50,50,0,0,7,0,,
AT+BLEADVSTART
// Use your Bluetooth LE debugging app as a client to establish a Bluetooth LE
↪connection with the ESP32-C2
AT+BLEENC=0,3
```

## 3.4.31 AT+BLEKEYREPLY: Reply the Key Value to the Peer Device

### Set Command

#### Function:

Reply a pairing key.

#### Command:

```
AT+BLEKEYREPLY=<conn_index>,<key>
```

#### Response:

```
OK
```

### Parameters

- **<conn\_index>**: index of Bluetooth LE connection. Range: [0,2].
- **<key>**: pairing key.

### Example

```
AT+BLEKEYREPLY=0,649784
```

### 3.4.32 AT+BLECONFREPLY: Reply the Confirm Value to the Peer Device in the Legacy Connection Stage

#### Set Command

##### Function:

Reply a pairing result.

##### Command:

```
AT+BLECONFREPLY=<conn_index>,<confirm>
```

##### Response:

```
OK
```

#### Parameters

- **<conn\_index>**: index of Bluetooth LE connection. Range: [0,2].
- **<confirm>**:
  - 0: No
  - 1: Yes

#### Example

```
AT+BLECONFREPLY=0,1
```

### 3.4.33 AT+BLEENCDEV: Query Bonded Bluetooth LE Encryption Device List

#### Query Command

##### Function:

Query bonded Bluetooth LE encryption device list.

##### Command:

```
AT+BLEENCDEV?
```

##### Response:

```
+BLEENCDEV:<enc_dev_index>,<mac_address>  
OK
```

#### Parameters

- **<enc\_dev\_index>**: index of the bonded devices. This parameter is not necessarily equal to the `conn_index` parameter in the Bluetooth LE connection list queried by the command *AT+BLECONN*. Range: [0,14].
- **<mac\_address>**: MAC address.

#### Note

- ESP-AT allows a maximum of 15 devices to be bonded. If the number of bonded devices exceeds 15, the newly bonded device information will sequentially (from 0 to 14) overwrite the previous device information according to the binding order.

### Example

```
AT+BLEENCDEV?
```

## 3.4.34 AT+BLEENCCLEAR: Clear Bluetooth LE Encryption Device List

### Set Command

#### Function:

Remove a device from the security database list with a specific index.

#### Command:

```
AT+BLEENCCLEAR=<enc_dev_index>
```

#### Response:

```
OK
```

### Execute Command

#### Function:

Remove all devices from the security database.

#### Command:

```
AT+BLEENCCLEAR
```

#### Response:

```
OK
```

### Parameter

- <enc\_dev\_index>: index of the bonded devices.

### Example

```
AT+BLEENCCLEAR
```

## 3.4.35 AT+BLESETKEY: Set Bluetooth LE Static Pair Key

### Query Command

#### Function:

```
Query the Bluetooth LE static pair key.
```

#### Command:

```
AT+BLESETKEY?
```

#### Response:

```
+BLESETKEY:<static_key>
OK
```

### Set Command

#### Function:

Set a Bluetooth LE static pair key for all Bluetooth LE connections.

#### Command:

```
AT+BLESETKEY=<static_key>
```

#### Response:

```
OK
```

### Parameter

- **<static\_key>**: static Bluetooth LE pair key.

### Example

```
AT+BLESETKEY=123456
```

## 3.4.36 AT+BLUFI: Start or Stop BluFi

### Query Command

#### Function:

Query the status of BluFi.

#### Command:

```
AT+BLUFI?
```

#### Response:

If BluFi is not started, it will return:

```
+BLUFI:0
OK
```

If BluFi is started, it will return:

```
+BLUFI:1
OK
```

### Set Command

**Function:**

Start or stop BluFi.

**Command:**

```
AT+BLUFI=<option>[,<auth floor>]
```

**Response:**

```
OK
```

### Parameter

- **<option>:**
  - 0: stop BluFi
  - 1: start BluFi
- **<auth floor>:** Wi-Fi authentication mode floor. ESP-AT will not connect to the AP whose authmode is lower than this floor.
  - 0: OPEN (Default)
  - 1: WEP
  - 2: WPA\_PSK
  - 3: WPA2\_PSK
  - 4: WPA\_WPA2\_PSK
  - 5: WPA2\_ENTERPRISE
  - 6: WPA3\_PSK
  - 7: WPA2\_WPA3\_PSK

### Example

```
AT+BLUFI=1
```

## 3.4.37 AT+BLUFINAME: Query/Set BluFi Device Name

### Query Command

**Function:**

Query the BluFi name.

**Command:**

```
AT+BLUFINAME?
```

**Response:**

```
+BLUFINAME:<device_name>  
OK
```

### Set Command

**Function:**

Set the BluFi device name.

**Command:**

```
AT+BLUFINAME=<device_name>
```

**Response:**

```
OK
```

**Parameter**

- **<device\_name>**: the name of BluFi device.

**Notes**

- If you need to set BluFi name, please set it before command *AT+BLUFI=1*. Otherwise, it will use the default name `BLUFI_DEVICE`.
- The maximum length of BluFi name is 26 bytes.
- The BluFi APP can be downloaded from the app store.

**Example**

```
AT+BLUFINAME="BLUFI_DEV"  
AT+BLUFINAME?
```

### 3.4.38 AT+BLUISEND: Send User-Customized Data over BluFi

**Set Command****Function:**

Send user-customized data from the ESP side to a phone over BluFi.

**Command:**

```
AT+BLUISEND=<length>
```

**Response:**

```
>
```

The symbol `>` indicates that AT is ready for receiving serial data and you can enter data now. When the requirement of data length determined by the parameter `<length>` is met, the transmission starts.

If the data transmission is successful, AT returns:

```
OK
```

**Parameters**

- **<length>**: customized data length. Unit: byte.

**Notes**

- The length of customized data cannot exceed 600 bytes.
- If your ESP chip receives customized data from the phone, the data will be printed in the form of `+BLUFI-DATA:<len>,<data>`.



**Example**

```
AT+BLUFISEND=4
// After the symbol ">" shows, input 4 bytes of data, such as "1234". Then the
↵data will be transmitted automatically.
```

**3.4.39 AT+BLEPERIODICDATA: Set Bluetooth LE periodic advertising data****Set Command****Function:**

Set periodic advertising data.

**Command:**

```
AT+BLEPERIODICDATA=<periodic_data>
```

**Response:**

```
OK
```

**Parameter**

- **<periodic\_data>**: Periodic advertising data in HEX string. For example, to set the periodic advertising data to "0x11 0x22 0x33 0x44 0x55" , the command should be AT+BLEPERIODICDATA="1122334455".

**Example**

```
AT+BLEINIT=2 // Role: server
AT+BLEPERIODICDATA="1122334455"
```

**3.4.40 AT+BLEPERIODICSTART: Start Bluetooth LE periodic advertising****Execute Command****Function:**

Start periodic advertising.

**Command:**

```
AT+BLEPERIODICSTART
```

**Response:**

```
OK
```

**Notes**

- The extended advertising should be started before the start of periodic advertising, and the adv type should be ADV\_TYPE\_EXT\_NOSCANNABLE\_IND.

**Example**

```
AT+BLEINIT=2 // Role: server
AT+BLEPERIODICDATA="1122334455" // Set periodic adv data
AT+BLEADVPARAM=32,32,5,0,7,0 // Set extended advertising parameters
AT+BLEADVSTART // Start Extend advertising
AT+BLEPERIODICSTART // Start periodic advertising
```

**3.4.41 AT+BLEPERIODICSTOP: Stop Bluetooth LE periodic advertising****Execute Command****Function:**

Stop periodic advertising.

**Command:**

```
AT+BLEPERIODICSTOP
```

**Response:**

```
OK
```

**Example**

```
AT+BLEPERIODICSTOP // Stop periodic advertising
```

**3.4.42 AT+BLESYNCSTART: Start to synchronize with periodic advertising****Set Command****Function:**

Synchroize with the target device and get the periodic advertising data.

**Command:**

```
AT+BLESYNCSTART=<target_address>
```

**Response:**

```
+BLESYNC:<addr>,<rssi>,<periodic_adv_data>
OK
```

**Parameters**

- **<addr>**: Bluetooth LE address.
- **<rssi>**: signal strength.
- **<periodic\_adv\_data>**: periodic advertising data.

**Notes**

- Before you start to synchronize with the remote device, the ble scan must be start.

**Example**

```
AT+BLEINIT=1 // Role: client
AT+BLESCAN=1 // start Bluetooth LE scan
AT+BLESYNCSTART="24:0a:c4:09:34:23" // try to Synchronoze with the remote device
```

**3.4.43 AT+BLESYNCSTOP: Stop synchronizing with periodic advertising****Execute Command****Function:**

Stop synchronizing with the target device.

**Command:**

```
AT+BLESYNCSTOP
```

**Response:**

```
OK
```

**Notes**

- If you stop blescan with AT+BLESCAN=0 command, the synchronization will be stopped automatically.

**Example**

```
AT+BLEINIT=1 // Role: client
AT+BLESCAN=1 // start Bluetooth LE scan
AT+BLESYNCSTART="24:0a:c4:09:34:23" // try to synchronize with the remote device
AT+BLESYNCSTOP // Stop Synchronoze with the remote device
```

**3.4.44 AT+BLERADPHY: Query the current transmitter PHY****Set Command****Function:**

Query the current transmitter PHY.

**Command:**

```
AT+BLERADPHY=<conn_index>
```

**Response:**

If the query succeeds, it will return:

```
+BLERADPHY:<device_addr>,<tx_PHY>,<rx_PHY>
OK
```

If the query fails, it will return:

```
+BLERADPHY:-1
OK
```

### Parameters

- **<device\_addr>**: remote device address.
- **<tx\_PHY>**:
  - 1: 1M PHY.
  - 2: 2M PHY.
  - 3: Coded PHY.
- **<rx\_PHY>**:
  - 1: 1M PHY.
  - 2: 2M PHY.
  - 3: Coded PHY.

### Example

```
AT+BLEINIT=1 // Role: client
AT+BLECONN=0, "24:0a:c4:09:34:23"
AT+BLEREADPHY=0 // query current transmitter PHY
```

## 3.4.45 AT+BLESETPHY: Set the current transmitter PHY

### Set Command

#### Function:

Set the current transmitter PHY.

#### Command:

```
AT+BLESETPHY=<conn_index>, <tx_rx_phy>
```

#### Response:

If the query succeeds, it will return:

```
+BLESETPHY:<device_addr>, <tx_PHY>, <rx_PHY>
OK
```

If the query fails, it will return:

```
+BLESETPHY:-1
OK
```

### Parameters

- **<device\_addr>**: remote device address.
- **<tx\_rx\_phy>**:
  - 1: 1M PHY.
  - 2: 2M PHY.
  - 3: Coded PHY.

### Example

```
AT+BLEINIT=1 // Role: client
AT+BLECONN=0, "24:0a:c4:09:34:23"
AT+BLESETPHY=0, 1
```

## 3.5 MQTT AT Commands

- *Introduction*
- *AT+MQTTUSERCFG*: Set MQTT user configuration
- *AT+MQTTLONGCLIENTID*: Set MQTT client ID
- *AT+MQTTLONGUSERNAME*: Set MQTT username
- *AT+MQTTLONGPASSWORD*: Set MQTT password
- *AT+MQTTCONNCFG*: Set configuration of MQTT connection
- *AT+MQTTALPN*: Set MQTT Application Layer Protocol Negotiation (ALPN)
- *AT+MQTTSNI*: Set MQTT Server Name Indication (SNI)
- *AT+MQTTCONN*: Connect to MQTT Brokers
- *AT+MQTTPUB*: Publish MQTT Messages in string
- *AT+MQTTPUBRAW*: Publish long MQTT messages
- *AT+MQTTSUB*: Subscribe to MQTT topics
- *AT+MQTTUNSUB*: Unsubscribe from MQTT topics
- *AT+MQTTCLEAN*: Close MQTT connections
- *MQTT AT Error Codes*
- *MQTT AT Notes*

### 3.5.1 Introduction

**Important:** The default AT firmware supports all the AT commands mentioned on this page. If you don't need ESP32-C2 to support MQTT commands, you can compile the ESP-AT project by following the steps in [Compile ESP-AT Project Locally](#) documentation. In the project configuration during the fifth step, make the following selections:

- Disable Component config -> AT -> AT MQTT command support

### 3.5.2 AT+MQTTUSERCFG: Set MQTT User Configuration

#### Set Command

#### Function:

Set MQTT User Configuration.

#### Command:

```
AT+MQTTUSERCFG=<LinkID>,<scheme>,<"client_id">,<"username">,<"password">,<cert_key_
↵ID>,<CA_ID>,<"path">
```

#### Response:

```
OK
```

#### Parameters

- **<LinkID>**: currently only supports link ID 0.
- **<scheme>**:
  - 1: MQTT over TCP.
  - 2: MQTT over TLS (no certificate verify).
  - 3: MQTT over TLS (verify server certificate).
  - 4: MQTT over TLS (provide client certificate).
  - 5: MQTT over TLS (verify server certificate and provide client certificate).

- 6: MQTT over WebSocket (based on TCP).
- 7: MQTT over WebSocket Secure (based on TLS, no certificate verify).
- 8: MQTT over WebSocket Secure (based on TLS, verify server certificate).
- 9: MQTT over WebSocket Secure (based on TLS, provide client certificate).
- 10: MQTT over WebSocket Secure (based on TLS, verify server certificate and provide client certificate).
- **<client\_id>**: MQTT client ID. Maximum length: 256 bytes.
- **<username>**: the username to login to the MQTT broker. Maximum length: 64 bytes.
- **<password>**: the password to login to the MQTT broker. Maximum length: 64 bytes.
- **<cert\_key\_ID>**: certificate ID. Currently, ESP-AT only supports one certificate for ID 0.
- **<CA\_ID>**: CA ID. Currently, ESP-AT only supports one CA for ID 0.
- **<path>**: the path of the resource. Maximum length: 32 bytes.

#### Note

- The length of the entire AT command should be less than 256 bytes.
- If **<scheme>** is configured to 3, 5, 8, or 10, in order to check the server certificate validity period, please make sure ESP32-C2 has obtained the current time before sending the *AT+MQTTCONN* command. (You can send *AT+CIPSNTPCFG* command to configure SNTP and obtain the current time, and send *AT+CIPSNPTIME?* command to query the current time.)

### 3.5.3 AT+MQTTLONGCLIENTID: Set MQTT Client ID

#### Set Command

##### Function:

Set MQTT Client ID.

##### Command:

```
AT+MQTTLONGCLIENTID=<LinkID>,<length>
```

##### Response:

```
OK
>
```

This response indicates that AT is ready for receiving MQTT Client ID. You should enter the Client ID, and when the Client ID length reaches the **<length>** value, the system returns:

```
OK
```

#### Parameters

- **<LinkID>**: currently only supports link ID 0.
- **<length>**: MQTT client ID length. Range: [1,1024].

#### Notes

- The command *AT+MQTTUSERCFG* can also set MQTT client ID. The differences between the two commands include:
  - You can use *AT+MQTTLONGCLIENTID* to set a relatively long client ID since there is a limitation on the length of the *AT+MQTTUSERCFG* command.
  - You should set *AT+MQTTLONGCLIENTID* after setting the *AT+MQTTUSERCFG* command.

### 3.5.4 AT+MQTTLONGUSERNAME: Set MQTT Username

#### Set Command

**Function:**

Set MQTT username.

**Command:**

```
AT+MQTTLONGUSERNAME=<LinkID>,<length>
```

**Response:**

```
OK
```

```
>
```

This response indicates that AT is ready for receiving MQTT username. You should enter the MQTT username, and when the MQTT username length reaches the `<length>` value, the system returns:

```
OK
```

#### Parameters

- **<LinkID>**: only supports link ID 0 currently.
- **<length>**: MQTT username length. Range: [1,1024].

#### Notes

- The command *AT+MQTTUSERCFG* can also set MQTT username. The differences between the two commands include:
  - You can use *AT+MQTTLONGUSERNAME* to set a relatively long username since there is a limitation on the length of the *AT+MQTTUSERCFG* command.
  - You should set *AT+MQTTLONGUSERNAME* after setting the command *AT+MQTTUSERCFG*.

### 3.5.5 AT+MQTTLONGPASSWORD: Set MQTT Password

#### Set Command

**Function:**

Set MQTT password.

**Command:**

```
AT+MQTTLONGPASSWORD=<LinkID>,<length>
```

**Response:**

```
OK
```

```
>
```

This response indicates that AT is ready for receiving MQTT password. You should enter the MQTT password, and when the MQTT password length reaches the `<length>` value, the system returns:

```
OK
```

### Parameters

- **<LinkID>**: only supports link ID 0 currently.
- **<length>**: MQTT password length. Range: [1,1024].

### Notes

- The command `AT+MQTTUSERCFG` can also set MQTT password. The differences between the two commands include:
  - You can use `AT+MQTTLONGPASSWORD` to set a relatively long password since there is a limitation on the length of the `AT+MQTTUSERCFG` command.
  - You should set `AT+MQTTLONGPASSWORD` after setting the command `AT+MQTTUSERCFG`.

## 3.5.6 AT+MQTTCONNCFG: Set Configuration of MQTT Connection

### Set Command

#### Function:

Set configuration of MQTT Connection.

#### Command:

```
AT+MQTTCONNCFG=<LinkID>,<keepalive>,<disable_clean_session>,<"lwt_topic">,<"lwt_msg
↵">,<lwt_qos>,<lwt_retain>
```

#### Response:

```
OK
```

### Parameters

- **<LinkID>**: only supports link ID 0 currently.
- **<keepalive>**: timeout of MQTT ping. Unit: second. Range [0,7200]. The default value is 0, which will be force-changed to 120 s.
- **<disable\_clean\_session>**: set MQTT clean session. For more details about this parameter, please refer to the section [Clean Session](#) in *MQTT Version 3.1.1*.
  - 0: enable clean session.
  - 1: disable clean session.
- **<lwt\_topic>**: LWT (Last Will and Testament) message topic. Maximum length: 128 bytes.
- **<lwt\_msg>**: LWT message. Maximum length: 128 bytes.
- **<lwt\_qos>**: LWT QoS, which can be set to 0, 1, or 2. Default: 0.
- **<lwt\_retain>**: LWT retain, which can be set to 0 or 1. Default: 0.

## 3.5.7 AT+MQTTALPN: Set MQTT Application Layer Protocol Negotiation (ALPN)

### Set Command

#### Function:

Set MQTT Application Layer Protocol Negotiation (ALPN).

#### Command:

```
AT+MQTTALPN=<LinkID>,<alpn_counts>[,<"alpn">][,<"alpn">][,<"alpn">]
```

#### Response:



OK

### Parameters

- **<LinkID>**: only supports link ID 0 currently.
- **<alpn\_counts>**: the number of **<" alpn" >** parameters. Range: [0,5].
- 0: clean the MQTT ALPN configuration.
- [1,5]: set the MQTT ALPN configuration.
- **<" alpn" >**: you can send more than one ALPN in ClientHello to the server.

### Notes

- The length of the entire AT command should be less than 256 bytes.
- MQTT ALPN will be effective only if the MQTT connection is based on TLS or WSS.
- You should set *AT+MQTTALPN* after setting the command *AT+MQTTUSERCFG*.

### Example

```
AT+CWMODE=1
AT+CWJAP="ssid", "password"
AT+CIPSNTPCFG=1, 8, "ntp1.aliyun.com", "ntp2.aliyun.com"
AT+MQTTUSERCFG=0, 5, "ESP32-C2", "espressif", "1234567890", 0, 0, ""
AT+MQTTALPN=0, 2, "mqtt-ca.cn", "mqtt-ca.us"
AT+MQTTCONN=0, "192.168.200.2", 8883, 1
```

## 3.5.8 AT+MQTTSNI: Set MQTT Server Name Indication (SNI)

### Set Command

#### Function:

Set MQTT Server Name Indication (SNI).

#### Command:

AT+MQTTSNI=<LinkID>, <"sni">

#### Response:

OK

### Parameters

- **<LinkID>**: only supports link ID 0 currently.
- **<" sni" >**: MQTT Server Name Indication. You can send it in ClientHello to the server.

### Notes

- The length of the entire AT command should be less than 256 bytes.
- MQTT SNI will be effective only if the MQTT connection is based on TLS or WSS.
- You should set *AT+MQTTSNI* after setting the command *AT+MQTTUSERCFG*.

**Example**

```

AT+CWMODE=1
AT+CWJAP="ssid","password"
AT+CIPSNTPCFG=1,8,"ntp1.aliyun.com","ntp2.aliyun.com"
AT+MQTTUSERCFG=0,5,"ESP32-C2","espressif","1234567890",0,0,""
AT+MQTTSNI=0,"my_specific_prefix.iot.my_aws_region.amazonaws.com"
AT+MQTTCONN=0,"my_specific_prefix.iot.my_aws_region.amazonaws.com",8883,1

```

**3.5.9 AT+MQTTCONN: Connect to MQTT Brokers****Query Command****Function:**

Query the MQTT broker that ESP32-C2 are connected to.

**Command:**

```
AT+MQTTCONN?
```

**Response:**

```
+MQTTCONN:<LinkID>,<state>,<scheme><"host">,<port>,<"path">,<reconnect>
OK
```

**Set Command****Function:**

Connect to an MQTT broker.

**Command:**

```
AT+MQTTCONN=<LinkID>,<"host">,<port>,<reconnect>
```

**Response:**

```
OK
```

**Parameters**

- **<LinkID>**: only supports link ID 0 currently.
- **<host>**: MQTT broker domain. Maximum length: 128 bytes.
- **<port>**: MQTT broker port. Maximum: port 65535.
- **<path>**: path. Maximum length: 32 bytes.
- **<reconnect>**:
  - 0: MQTT will not reconnect automatically. If MQTT connection established and then disconnected, you cannot use this command to reestablish MQTT connection. Please send *AT+MQTTCLEAN=0* command to clean MQTT connection first, reconfigure the connection parameters, and then establish a new MQTT connection.
  - 1: MQTT will reconnect automatically. It takes more resources.
- **<state>**: MQTT state.
  - 0: MQTT uninitialized.
  - 1: already set *AT+MQTTUSERCFG*.
  - 2: already set *AT+MQTTCONNCFG*.
  - 3: connection disconnected.

- 4: connection established.
- 5: connected, but did not subscribe to any topic.
- 6: connected, and subscribed to MQTT topics.
- **<scheme>**:
  - 1: MQTT over TCP.
  - 2: MQTT over TLS (no certificate verify).
  - 3: MQTT over TLS (verify server certificate).
  - 4: MQTT over TLS (provide client certificate).
  - 5: MQTT over TLS (verify server certificate and provide client certificate).
  - 6: MQTT over WebSocket (based on TCP).
  - 7: MQTT over WebSocket Secure (based on TLS, verify no certificate).
  - 8: MQTT over WebSocket Secure (based on TLS, verify server certificate).
  - 9: MQTT over WebSocket Secure (based on TLS, provide client certificate).
  - 10: MQTT over WebSocket Secure (based on TLS, verify server certificate and provide client certificate).

### 3.5.10 AT+MQTTPUB: Publish MQTT Messages in String

#### Set Command

##### Function:

Publish MQTT messages in string to a defined topic. If the amount of data you publish is relatively large, and the length of a single AT command has exceeded the threshold of 256, please use the *AT+MQTTPUBRAW* command.

##### Command:

```
AT+MQTTPUB=<LinkID>,<"topic">,<"data">,<qos>,<retain>
```

##### Response:

```
OK
```

#### Parameters

- **<LinkID>**: only supports link ID 0 currently.
- **<topic>**: MQTT topic. Maximum length: 128 bytes.
- **<data>**: MQTT message in string.
- **<qos>**: QoS of message, which can be set to 0, 1, or 2. Default: 0.
- **<retain>**: retain flag.

#### Notes

- The length of the entire AT command should be less than 256 bytes.
- This command cannot send data \0. If you need to send \0, please use the command *AT+MQTTPUBRAW* instead.

#### Example

```
AT+CWMODE=1
AT+CWJAP="ssid","password"
AT+MQTTUSERCFG=0,1,"ESP32-C2","espressif","1234567890",0,0,""
AT+MQTTCONN=0,"192.168.10.234",1883,0
AT+MQTTPUB=0,"topic","\{"timestamp\":"20201121085253\"}\","",0,0 // When sending
↪this command, please pay attention to whether special characters need to be
↪escaped.
```

### 3.5.11 AT+MQTTPUBRAW: Publish Long MQTT Messages

#### Set Command

##### Function:

Publish long MQTT messages to a defined topic. If the amount of data you publish is relatively small, and the length of a single AT command is not greater than the threshold of 256, you also can use the *AT+MQTTPUB* command.

##### Command:

```
AT+MQTTPUBRAW=<LinkID>,<"topic">,<length>,<qos>,<retain>
```

##### Response:

```
OK  
>
```

The symbol > indicates that AT is ready for receiving serial data, and you can enter the data now. When the requirement of message length determined by the parameter <length> is met, the transmission starts.

If the transmission is successful, AT returns:

```
+MQTTPUB:OK
```

Otherwise, it returns:

```
+MQTTPUB:FAIL
```

#### Parameters

- <LinkID>: only supports link ID 0 currently.
- <topic>: MQTT topic. Maximum length: 128 bytes.
- <length>: length of MQTT message. The maximum length is limited by available memory.
- <qos>: QoS of the published message, which can be set to 0, 1, or 2. Default is 0.
- <retain>: retain flag.

### 3.5.12 AT+MQTTSUB: Subscribe to MQTT Topics

#### Query Command

##### Function:

List all MQTT topics that have been already subscribed.

##### Command:

```
AT+MQTTSUB?
```

##### Response:

```
+MQTTSUB:<LinkID>,<state>,<"topic1">,<qos>  
+MQTTSUB:<LinkID>,<state>,<"topic2">,<qos>  
+MQTTSUB:<LinkID>,<state>,<"topic3">,<qos>  
...  
OK
```

## Set Command

### Function:

Subscribe to defined MQTT topics with defined QoS. It supports subscribing to multiple topics.

### Command:

```
AT+MQTTSUB=<LinkID>,<"topic">,<qos>
```

### Response:

```
OK
```

When AT receives MQTT messages of the subscribed topic, it will prompt:

```
+MQTTSUBRECV:<LinkID>,<"topic">,<data_length>,data
```

If the topic has been subscribed before, it will prompt:

```
ALREADY SUBSCRIBE
```

## Parameters

- **<LinkID>**: only supports link ID 0 currently.
- **<state>**: MQTT state.
  - 0: MQTT uninitialized.
  - 1: already set *AT+MQTTUSERCFG*.
  - 2: already set *AT+MQTTCONNCFG*.
  - 3: connection disconnected.
  - 4: connection established.
  - 5: connected, but subscribe to no topic.
  - 6: connected, and subscribed to MQTT topics.
- **<topic>**: the topic that is subscribed to.
- **<qos>**: the QoS that is subscribed to.

### 3.5.13 AT+MQTTUNSUB: Unsubscribe from MQTT Topics

#### Set Command

#### Function:

Unsubscribe the client from defined topics. This command can be called multiple times to unsubscribe from different topics.

#### Command:

```
AT+MQTTUNSUB=<LinkID>,<"topic">
```

#### Response:

```
OK
```

If the topic has not been subscribed, AT will prompt:

```
NO UNSUBSCRIBE
```

```
OK
```

### Parameters

- **<LinkID>**: only supports link ID 0 currently.
- **<topic>**: MQTT topic. Maximum length: 128 bytes.

### 3.5.14 AT+MQTTCLEAN: Close MQTT Connections

#### Set Command

##### Function:

Close the MQTT connection and release the resource.

##### Command:

```
AT+MQTTCLEAN=<LinkID>
```

##### Response:

```
OK
```

#### Parameter

- **<LinkID>**: only supports link ID 0 currently.

### 3.5.15 MQTT AT Error Codes

The MQTT Error code will be prompted as `ERR CODE:0x<%08x>`.

Error Type	Error Code
AT_MQTT_NO_CONFIGURED	0x6001
AT_MQTT_NOT_IN_CONFIGURED_STATE	0x6002
AT_MQTT_UNINITIATED_OR_ALREADY_CLEAN	0x6003
AT_MQTT_ALREADY_CONNECTED	0x6004
AT_MQTT_MALLOC_FAILED	0x6005
AT_MQTT_NULL_LINK	0x6006
AT_MQTT_NULL_PARAMTER	0x6007
AT_MQTT_PARAMETER_COUNTS_IS_WRONG	0x6008
AT_MQTT_TLS_CONFIG_ERROR	0x6009
AT_MQTT_PARAM_PREPARE_ERROR	0x600A
AT_MQTT_CLIENT_START_FAILED	0x600B
AT_MQTT_CLIENT_PUBLISH_FAILED	0x600C
AT_MQTT_CLIENT_SUBSCRIBE_FAILED	0x600D
AT_MQTT_CLIENT_UNSUBSCRIBE_FAILED	0x600E
AT_MQTT_CLIENT_DISCONNECT_FAILED	0x600F
AT_MQTT_LINK_ID_READ_FAILED	0x6010
AT_MQTT_LINK_ID_VALUE_IS_WRONG	0x6011
AT_MQTT_SCHEME_READ_FAILED	0x6012
AT_MQTT_SCHEME_VALUE_IS_WRONG	0x6013
AT_MQTT_CLIENT_ID_READ_FAILED	0x6014
AT_MQTT_CLIENT_ID_IS_NULL	0x6015
AT_MQTT_CLIENT_ID_IS_OVERLENGTH	0x6016
AT_MQTT_USERNAME_READ_FAILED	0x6017
AT_MQTT_USERNAME_IS_NULL	0x6018

continues on next page

Table 3 – continued from previous page

Error Type	Error Code
AT_MQTT_USERNAME_IS_OVERLENGTH	0x6019
AT_MQTT_PASSWORD_READ_FAILED	0x601A
AT_MQTT_PASSWORD_IS_NULL	0x601B
AT_MQTT_PASSWORD_IS_OVERLENGTH	0x601C
AT_MQTT_CERT_KEY_ID_READ_FAILED	0x601D
AT_MQTT_CERT_KEY_ID_VALUE_IS_WRONG	0x601E
AT_MQTT_CA_ID_READ_FAILED	0x601F
AT_MQTT_CA_ID_VALUE_IS_WRONG	0x6020
AT_MQTT_CA_LENGTH_ERROR	0x6021
AT_MQTT_CA_READ_FAILED	0x6022
AT_MQTT_CERT_LENGTH_ERROR	0x6023
AT_MQTT_CERT_READ_FAILED	0x6024
AT_MQTT_KEY_LENGTH_ERROR	0x6025
AT_MQTT_KEY_READ_FAILED	0x6026
AT_MQTT_PATH_READ_FAILED	0x6027
AT_MQTT_PATH_IS_NULL	0x6028
AT_MQTT_PATH_IS_OVERLENGTH	0x6029
AT_MQTT_VERSION_READ_FAILED	0x602A
AT_MQTT_KEEPA_LIVE_READ_FAILED	0x602B
AT_MQTT_KEEPA_LIVE_IS_NULL	0x602C
AT_MQTT_KEEPA_LIVE_VALUE_IS_WRONG	0x602D
AT_MQTT_DISABLE_CLEAN_SESSION_READ_FAILED	0x602E
AT_MQTT_DISABLE_CLEAN_SESSION_VALUE_IS_WRONG	0x602F
AT_MQTT_LWT_TOPIC_READ_FAILED	0x6030
AT_MQTT_LWT_TOPIC_IS_NULL	0x6031
AT_MQTT_LWT_TOPIC_IS_OVERLENGTH	0x6032
AT_MQTT_LWT_MSG_READ_FAILED	0x6033
AT_MQTT_LWT_MSG_IS_NULL	0x6034
AT_MQTT_LWT_MSG_IS_OVERLENGTH	0x6035
AT_MQTT_LWT_QOS_READ_FAILED	0x6036
AT_MQTT_LWT_QOS_VALUE_IS_WRONG	0x6037
AT_MQTT_LWT_RETAIN_READ_FAILED	0x6038
AT_MQTT_LWT_RETAIN_VALUE_IS_WRONG	0x6039
AT_MQTT_HOST_READ_FAILED	0x603A
AT_MQTT_HOST_IS_NULL	0x603B
AT_MQTT_HOST_IS_OVERLENGTH	0x603C
AT_MQTT_PORT_READ_FAILED	0x603D
AT_MQTT_PORT_VALUE_IS_WRONG	0x603E
AT_MQTT_RECONNECT_READ_FAILED	0x603F
AT_MQTT_RECONNECT_VALUE_IS_WRONG	0x6040
AT_MQTT_TOPIC_READ_FAILED	0x6041
AT_MQTT_TOPIC_IS_NULL	0x6042
AT_MQTT_TOPIC_IS_OVERLENGTH	0x6043
AT_MQTT_DATA_READ_FAILED	0x6044
AT_MQTT_DATA_IS_NULL	0x6045
AT_MQTT_DATA_IS_OVERLENGTH	0x6046
AT_MQTT_QOS_READ_FAILED	0x6047
AT_MQTT_QOS_VALUE_IS_WRONG	0x6048
AT_MQTT_RETAIN_READ_FAILED	0x6049
AT_MQTT_RETAIN_VALUE_IS_WRONG	0x604A
AT_MQTT_PUBLISH_LENGTH_READ_FAILED	0x604B
AT_MQTT_PUBLISH_LENGTH_VALUE_IS_WRONG	0x604C
AT_MQTT_RECV_LENGTH_IS_WRONG	0x604D

continues on next page

Table 3 – continued from previous page

Error Type	Error Code
AT_MQTT_CREATE_SEMA_FAILED	0x604E
AT_MQTT_CREATE_EVENT_GROUP_FAILED	0x604F
AT_MQTT_URI_PARSE_FAILED	0x6050
AT_MQTT_IN_DISCONNECTED_STATE	0x6051
AT_MQTT_HOSTNAME_VERIFY_FAILED	0x6052

### 3.5.16 MQTT AT Notes

- In general, AT MQTT commands responds within 10 s, except the command *AT+MQTTCONN*. For example, if the router fails to access the Internet, the command *AT+MQTTPUB* will respond within 10 s. But the command *AT+MQTTCONN* may need more time due to packet retransmission in a bad network environment.
- If the *AT+MQTTCONN* is based on a TLS connection, the timeout of each packet is 10 s, and the total timeout will be much longer depending on the handshake packets count.
- When the MQTT connection ends, it will prompt the message `+MQTTDISCONNECTED:<LinkID>`.
- When the MQTT connection established, it will prompt the message `+MQTTCONNECTED:<LinkID>,<scheme>,<"host">,<port>,<"path">,<reconnect>`.

## 3.6 HTTP AT Commands

- *Introduction*
- *AT+HTTPCLIENT*: Send HTTP Client Request
- *AT+HTTPGETSIZE*: Get HTTP Resource Size
- *AT+HTTPCGET*: Get HTTP Resource
- *AT+HTTPCPOST*: Post HTTP data of specified length
- *AT+HTTPCPUT*: Put HTTP data of specified length
- *AT+HTTPURLCFG*: Set/Get long HTTP URL
- *AT+HTTPCHEAD*: Set/Query HTTP request headers
- *HTTP AT Error Codes*

### 3.6.1 Introduction

**Important:** The default ESP32C2-4MB AT firmware supports HTTP functionality, while the ESP32C2-2MB AT firmware does not. If you need ESP32C2-2MB to support HTTP commands, you can compile the ESP-AT project by following the steps in *Compile ESP-AT Project Locally* documentation. In the project configuration during the fifth step, make the following selections:

- Enable Component config->AT->AT http command support

### 3.6.2 AT+HTTPCLIENT: Send HTTP Client Request

#### Set Command

#### Command:

```
AT+HTTPCLIENT=<opt>,<content-type>,<"url">,[<"host">],[<"path">],<transport_type>[,<data">],[<"http_req_header">],[<"http_req_header">][...]
```

#### Response:



```
+HTTPCLIENT:<size>,<data>
```

```
OK
```

## Parameters

- **<opt>**: method of HTTP client request.
  - 1: HEAD
  - 2: GET
  - 3: POST
  - 4: PUT
  - 5: DELETE
- **<content-type>**: data type of HTTP client request.
  - 0: application/x-www-form-urlencoded
  - 1: application/json
  - 2: multipart/form-data
  - 3: text/xml
- **<" url" >**: HTTP URL. The parameter can override the **<host>** and **<path>** parameters if they are null.
- **<" host" >**: domain name or IP address.
- **<" path" >**: HTTP Path.
- **<transport\_type>**: HTTP Client transport type. Default: 1.
  - 1: HTTP\_TRANSPORT\_OVER\_TCP
  - 2: HTTP\_TRANSPORT\_OVER\_SSL
- **<" data" >**: If **<opt>** is a POST request, this parameter holds the data you send to the HTTP server. If not, this parameter does not exist, which means there is no need to input a comma to indicate this parameter.
- **<http\_req\_header>**: you can send more than one request header to the server.

## Notes

- If the length of the entire command containing the URL exceeds 256 bytes, please use the [AT+HTTPURLCFG](#) command to preset the URL first, and then set the **<"url">** parameter of this command to "".
- If the **url** parameter is not null, HTTP client will use it and ignore the **host** parameter and **path** parameter; If the **url** parameter is omitted or null string, HTTP client will use **host** parameter and **path** parameter.
- In some released firmware, HTTP client commands are not supported (see [ESP-AT Firmware Differences](#)), but you can enable it by `./build.py menuconfig>Component config>AT>AT http command support` and build the project (see [Compile ESP-AT Project Locally](#)).
- The command does not support redirection. After getting the status code 301 (permanent redirection) or 302 (temporary redirection) from the server, AT will not automatically redirect to the new URL address. You can use some tools to get the actual URL, and then access it using this command.
- If the length of the entire command containing the **<"data">** exceeds 256 bytes, please use the [AT+HTTPCPOST](#) command.
- To set more HTTP request headers, use the [AT+HTTPCHEAD](#) command.

## Example

```
// HEAD Request
AT+HTTPCLIENT=1,0,"http://httpbin.org/get","httpbin.org","/get",1

// GET Request
AT+HTTPCLIENT=2,0,"http://httpbin.org/get","httpbin.org","/get",1

// POST Request
AT+HTTPCLIENT=3,0,"http://httpbin.org/post","httpbin.org","/post",1,"field1=value1&
↵field2=value2"
```

### 3.6.3 AT+HTTPGETSIZE: Get HTTP Resource Size

#### Set Command

##### Command:

```
AT+HTTPGETSIZE=<"url">[,<tx size>][,<rx size>][,<timeout>]
```

##### Response:

```
+HTTPGETSIZE:<size>
```

```
OK
```

#### Parameters

- <" url" >: HTTP URL. It is a string parameter and should be enclosed with quotes.
- <tx size>: HTTP send buffer size. Unit: byte. Default: 2048. Range: [0,10240].
- <rx size>: HTTP receive buffer size. Unit: byte. Default: 2048. Range: [0,10240].
- <timeout>: Network timeout. Unit: millisecond. Default: 5000. Range: [0,180000].
- <size>: HTTP resource size.

#### Note

- If the length of the entire command containing the URL exceeds 256 bytes, please use the [AT+HTTPURLCFG](#) command to preset the URL first, and then set the <"url"> parameter of this command to "".
- To set HTTP request headers, use the [AT+HTTPHEAD](#) command to set them.

#### Example

```
AT+HTTPGETSIZE="http://www.baidu.com/img/bdlogo.gif"
```

### 3.6.4 AT+HTTPCGET: Get HTTP Resource

#### Set Command

##### Command:

```
AT+HTTPCGET=<"url">[,<tx size>][,<rx size>][,<timeout>]
```

##### Response:

```
+HTTPCGET:<size>,<data>
```

```
OK
```

#### Parameters

- <" url" >: HTTP URL. It is a string parameter and should be enclosed with quotes.
- <tx size>: HTTP send buffer size. Unit: byte. Default: 2048. Range: [0,10240].
- <rx size>: HTTP receive buffer size. Unit: byte. Default: 2048. Range: [0,10240].
- <timeout>: Network timeout. Unit: millisecond. Default: 5000. Range: [0,180000].

**Note**

- If the length of the entire command containing the URL exceeds 256 bytes, please use the *AT+HTTPURLCFG* command to preset the URL first, and then set the `<"url">` parameter of this command to "".
- To set HTTP request headers, use the *AT+HTTPHEAD* command to set them.

**3.6.5 AT+HTTPCPOST: Post HTTP data of specified length****Set Command****Command:**

```
AT+HTTPCPOST=<"url">,<length>[,<http_req_header_cnt>][,<http_req_header>..<http_
↵req_header>]
```

**Response:**

```
OK
>
```

The symbol > indicates that AT is ready for receiving serial data, and you can enter the data now. When the requirement of message length determined by the parameter `<length>` is met, the transmission starts.

If the transmission is successful, AT returns:

```
SEND OK
```

Otherwise, it returns:

```
SEND FAIL
```

**Parameters**

- `<"url">`: HTTP URL. It is a string parameter and should be enclosed with quotes.
- `<length>`: HTTP data length to POST. The maximum length is equal to the system allocable heap size.
- `<http_req_header_cnt>`: the number of `<http_req_header>` parameters.
- `[<http_req_header>]`: HTTP request header. You can send more than one request header to the server.

**Note**

- If the length of the entire command containing the URL exceeds 256 bytes, please use the *AT+HTTPURLCFG* command to preset the URL first, and then set the `<"url">` parameter of this command to "".
- the default type of `content-type` is `application/x-www-form-urlencoded` for this command.
- To set HTTP request headers, use the *AT+HTTPHEAD* command to set them.

**3.6.6 AT+HTTPCPUT: Put HTTP data of specified length****Set Command****Command:**

```
AT+HTTPCPUT=<"url">,<length>[,<http_req_header_cnt>][,<http_req_header>..<http_req_
↵header>]
```

**Response:**

```
OK
>
```

The symbol > indicates that AT is ready for receiving serial data, and you can enter the data now. When the requirement of message length determined by the parameter <length> is met, the transmission starts.

If the transmission is successful, AT returns:

```
SEND OK
```

Otherwise, it returns:

```
SEND FAIL
```

### Parameters

- <" url" >: HTTP URL. It is a string parameter and should be enclosed with quotes.
- <length>: HTTP data length to PUT. The maximum length is equal to the system allocable heap size.
- <http\_req\_header\_cnt>: the number of <http\_req\_header> parameters.
- [<http\_req\_header>]: HTTP request header. You can send more than one request header to the server.

### Note

- If the length of the entire command containing the URL exceeds 256 bytes, please use the [AT+HTTPURLCFG](#) command to preset the URL first, and then set the <"url"> parameter of this command to "".
- To set HTTP request headers, use the [AT+HTTPHEAD](#) command to set them.

## 3.6.7 AT+HTTPURLCFG: Set/Get long HTTP URL

### Query Command

#### Command:

```
AT+HTTPURLCFG?
```

#### Response:

```
[+HTTPURLCFG:<url length>,<data>]
OK
```

### Set Command

#### Command:

```
AT+HTTPURLCFG=<url length>
```

#### Response:

```
OK
>
```

This response indicates that AT is ready for receiving serial data. You should enter the URL now, and when the URL length reaches the <url length> value, the system returns:

```
SET OK
```

### Parameters

- **<url length>**: HTTP URL length. Unit: byte.
  - 0: clean the HTTP URL configuration.
  - [8,8192]: set the HTTP URL configuration.
- **<data>**: HTTP URL data.

## 3.6.8 AT+HTTPCHEAD: Set/Query HTTP Request Headers

### Query Command

#### Command:

```
AT+HTTPCHEAD?
```

#### Response:

```
+HTTPCHEAD:<index>,<"req_header">  
OK
```

### Set Command

#### Command:

```
AT+HTTPCHEAD=<req_header_len>
```

#### Response:

```
OK  
>
```

The > symbol indicates that AT is ready to receive AT command data. At this point, you can enter the HTTP request header (in the format of `key: value`). When the data length reaches the value of parameter `<req_header_len>`, AT returns:

```
OK
```

### Parameters

- **<index>**: Index value of HTTP request header.
- **<" req\_header" >**: HTTP request header.
- **<req\_header\_len>**: HTTP request header length. Unit: byte.
  - 0: Clear all set HTTP request headers.
  - Other values: Set a new HTTP request header.

### Note

- This command can only set one HTTP request header at a time, but it can be set multiple times to support multiple different HTTP request headers.

- The HTTP request headers configured by this command are global. Once set, all HTTP commands will carry these request headers.
- If the `key` in the HTTP request header set by this command is the same as that of other HTTP commands, the HTTP request header set by this command will be used.

### Example

```
// Set the request header
AT+HTTPCHEAD=18

// After receiving the ">" symbol, enter the Range request header below to
↳download only the first 256 bytes of the resource
Range: bytes=0-255

// Download HTTP resource
AT+HTTPCGET="https://docs.espressif.com/projects/esp-at/en/latest/esp32c2/index.
↳html"
```

### 3.6.9 HTTP AT Error Codes

- HTTP Client:

HTTP Client Error Code	Description
0x7000	Failed to Establish Connection
0x7190	Bad Request
0x7191	Unauthorized
0x7192	Payment Required
0x7193	Forbidden
0x7194	Not Found
0x7195	Method Not Allowed
0x7196	Not Acceptable
0x7197	Proxy Authentication Required
0x7198	Request Timeout
0x7199	Conflict
0x719a	Gone
0x719b	Length Required
0x719c	Precondition Failed
0x719d	Request Entity Too Large
0x719e	Request-URI Too Long
0x719f	Unsupported Media Type
0x71a0	Requested Range Not Satisfiable
0x71a1	Expectation Failed

- HTTP Server:

HTTP Server Error Code	Description
0x71f4	Internal Server Error
0x71f5	Not Implemented
0x71f6	Bad Gateway
0x71f7	Service Unavailable
0x71f8	Gateway Timeout
0x71f9	HTTP Version Not Supported

- HTTP AT:
  - The error code of command `AT+HTTPCLIENT` will be `0x7000+Standard HTTP Error Code` (For more details about Standard HTTP/1.1 Error Code, see [RFC 2616](#)).

- For example, if AT gets the HTTP error 404 when calling command AT+HTTPCLIENT, it will respond with error code of 0x7194 (hex (0x7000+404)=0x7194).

## 3.7 FileSystem AT Commands

- [Introduction](#)
- [AT+FS](#): Filesystem Operations.
- [AT+FSMOUNT](#): Mount/Unmount Filesystem.

### 3.7.1 Introduction

---

**Important:** The default AT firmware does not support the AT commands listed on this page. If you need ESP32-C2 to support Filesystem commands, you can compile the ESP-AT project by following the steps in [Compile ESP-AT Project Locally](#) documentation. In the project configuration during the fifth step, make the following selections:

- Enable Component config->AT->AT FS command support
- 

### 3.7.2 AT+FS: Filesystem Operations

#### Set Command

##### Command:

```
AT+FS=<type>,<operation>,<filename>,<offset>,<length>
```

##### Response:

```
OK
```

#### Parameters

- **<type>**: only FATFS is currently supported.
  - 0: FATFS
- **<operation>**:
  - 0: delete file.
  - 1: write file.
  - 2: read file.
  - 3: query the size of the file.
  - 4: list files in a specific directory. Only root directory is currently supported.
- **<offset>**: apply to writing and reading operations only.
- **<length>**: data length, applying to writing and reading operations only.

#### Notes

- This command will automatically mount the filesystem. After the [AT+FS](#) filesystem operation is all done, it is strongly recommended to use the [AT+FSMOUNT=0](#) command to unmount the filesystem to free a large amount of RAM space.
- Please make sure that you have downloaded [at\\_customize.bin](#) before using this command. For more details, refer to [ESP-IDF Partition Tables](#) and [How to Customize Partitions](#).

- If the length of the read data is greater than the actual file length, only the actual data length of the file will be returned.
- If the operator is `write`, wrap return `>` after the write command, then you can send the data that you want to write. The length should be parameter `<length>`.

### Example

```
// delete a file.
AT+FS=0,0,"filename"

// write 10 bytes to offset 100 of a file.
AT+FS=0,1,"filename",100,10

// read 100 bytes from offset 0 of a file.
AT+FS=0,2,"filename",0,100

// list all files in the root directory.
AT+FS=0,4,"."
```

## 3.7.3 AT+FSMOUNT: Mount/Unmount Filesystem

### Set Command

#### Command:

```
AT+FSMOUNT=<mount>
```

#### Response:

```
OK
```

### Parameters

- **<mount>**:
  - 0: Unmount filesystem
  - 1: Mount filesystem

### Notes

- After the `AT+FS` filesystem operation is all done, it is strongly recommended to use the `AT+FSMOUNT=0` command to unmount the filesystem to free a large amount of RAM space.

### Example

```
// unmount the filesystem manually
AT+FSMOUNT=0

// mount the filesystem manually
AT+FSMOUNT=1
```



## 3.8 WebSocket AT Commands

- *Introduction*
- *AT+WSCFG*: Set the WebSocket configuration.
- *AT+WSHEAD*: Set/Query WebSocket request headers
- *AT+WSOOPEN*: Query/Open a WebSocket connection.
- *AT+WSENDD*: Send data to a WebSocket connection.
- *AT+WSCLOSE*: Close a WebSocket connection.

### 3.8.1 Introduction

---

**Important:** The default AT firmware does not support the AT commands listed on this page. If you need ESP32-C2 to support WebSocket commands, you can compile the ESP-AT project by following the steps in [Compile ESP-AT Project Locally](#) documentation. In the project configuration during the fifth step, make the following selections:

- Enable Component config->AT->AT WebSocket command support
- 

### 3.8.2 AT+WSCFG: Set the WebSocket Configuration

#### Set Command

##### Command:

```
AT+WSCFG=<link_id>,<ping_intv_sec>,<ping_timeout_sec>[,<buffer_size>]
```

##### Response:

```
OK
```

or

```
ERROR
```

#### Parameters

- **<link\_id>**: ID of the WebSocket connection. Range: [0,2], which means that AT can support up to three WebSocket connections.
- **<ping\_intv\_sec>**: WebSocket Ping interval. Unit: second. Range: [1,7200]. Default: 10, which means that WebSocket Ping packets are sent every 10 seconds by default.
- **<ping\_timeout\_sec>**: WebSocket Ping timeout. Unit: second. Range: [1,7200]. Default: 120, which means that by default, if the WebSocket Pong packet is not received within 120 seconds, the connection will be closed.
- **<buffer\_size>**: WebSocket buffer size. Unit: byte. Range: [1,8192]. Default: 1024.

#### Notes

- This command should be configured before *AT+WSOOPEN* command. Otherwise, it will not take effect.

#### Example

```
// Set the ping interval to 30 seconds, ping timeout to 60 seconds, and buffer_
↪size to 4096 bytes for link_id: 0.
AT+WSCFG=0,30,60,4096
```

### 3.8.3 AT+WSHEAD: Set/Query WebSocket Request Headers

#### Query Command

##### Command:

```
AT+WSHEAD?
```

##### Response:

```
+WSHEAD:<index>,<"req_header">
```

```
OK
```

#### Set Command

##### Command:

```
AT+WSHEAD=<req_header_len>
```

##### Response:

```
OK
```

```
>
```

The > symbol indicates that AT is ready to receive AT command data. At this point, you can enter the WebSocket request header (in the format of `key: value`). When the data length reaches the value of parameter `<req_header_len>`, AT returns:

```
OK
```

#### Parameters

- **<index>**: Index value of WebSocket request header.
- **<" req\_header" >**: WebSocket request header.
- **<req\_header\_len>**: WebSocket request header length. Unit: byte.
  - 0: Clear all set WebSocket request headers.
  - Other values: Set a new WebSocket request header.

#### Notes

- This command can only set one WebSocket request header at a time, but it can be set multiple times to support multiple different WebSocket request headers.
- The WebSocket request headers configured by this command are global. Once set, all WebSocket commands will carry these request headers.

### Example

```
// Set the request header
AT+WSHEAD=49

// After receiving the ">" symbol, enter the authorization request header below.
AUTHORIZATION: Basic QTIzMzIyMDE5OTk6MTIzNDU2Nzg=

// Open a WebSocket connection
AT+WSOPEN=0, "wss://demo.piesocket.com/v3/channel_123?api_
↵key=VCXCEuvhGcBDP7XhiJJUDvR1e1D3eiVjgZ9VRiaV&notify_self"
```

## 3.8.4 AT+WSOPEN: Query/Open a WebSocket Connection

### Query Command

#### Command:

```
AT+WSOPEN?
```

#### Response:

When there is a connection, AT returns:

```
+WSOPEN:<link_id>,<state>,<"uri">
OK
```

When there is no connection, AT returns:

```
OK
```

### Set Command

#### Command:

```
AT+WSOPEN=<link_id>,<"uri">[,<"subprotocol">][,<timeout_ms>][,<"auth">]
```

#### Response:

```
+WS_CONNECTED:<link_id>
OK
```

or

```
ERROR
```

### Parameters

- **<link\_id>**: ID of the WebSocket connection. Range: [0,2], which means that AT can support up to three WebSocket connections.
- **<state>**: The state of WebSocket connections.
  - 0: The WebSocket connection is closed.
  - 1: The WebSocket connection is reconnecting.
  - 2: The WebSocket connection is established.
  - 3: Receiving WebSocket Pong timeout or reading connection data error, waiting for reconnection.

- 4: The WebSocket connection Received close frame from the server side and is sending close frame to the server.
- **<" uri" >**: Uniform resource identifier of WebSocket server.
- **<" subprotocol" >**: The subprotocol of WebSocket (refer to [RFC6455 1.9 part](#) for more details).
- **<timeout\_ms>**: Timeout for establishing a WebSocket connection. Unit: millisecond. Range: [0,180000]. Default: 15000.
- **<" auth" >**: The authorization of WebSocket (refer to [RFC6455 4.1.12 part](#) for more details).

### Example

```
// uri parameter comes from https://www.piesocket.com/websocket-tester
AT+WSOOPEN=0, "wss://demo.piesocket.com/v3/channel_123?api_
↔key=VCXCEuvhGcBDP7XhiJJUDvR1e1D3eiVjgZ9VRiaV&notify_self"
```

## 3.8.5 AT+WSEND: Send Data to a WebSocket Connection

### Set Command

#### Command:

```
AT+WSEND=<link_id>,<length>[,<opcode>][,<timeout_ms>]
```

#### Response:

```
OK
```

```
>
```

This response indicates that AT is ready for receiving data from AT port. You should enter the data, and when the data length reaches the `<length>` value, the transmission of data starts.

If the connection cannot be established or is disrupted during data transmission, the system returns:

```
ERROR
```

If data is transmitted successfully, the system returns:

```
SEND OK
```

### Parameters

- **<link\_id>**: ID of the WebSocket connection. Range: [0,2].
- **<length>**: Length of data to send. Unit: byte. The maximum length that can be sent is determined by subtracting the value of `<buffer_size>` in `AT+WSCFG <cmd-WSCFG>` by 10 and the size of the heap space that the system can allocate (taking the smaller value of the two).
- **<opcode>**: The opcode in the WebSocket frame sent. Range: [0,0xF]. Default: 1, which means text frame. For details about opcode, please refer to [RFC6455 5.2 section](#).
  - 0x0: continuation frame
  - 0x1: text frame
  - 0x2: binary frame
  - 0x3 - 0x7: reserved for further non-control frames
  - 0x8: connection close frame
  - 0x9: ping frame
  - 0xA: pong frame
  - 0xB - 0xF: reserved for further control frames
- **<timeout\_ms>**: Send timeout. Unit: millisecond. Range: [0,60000]. Default: 10000.

### 3.8.6 AT+WSCLOSE: Close a WebSocket Connection

#### Set Command

##### Command:

```
AT+WSCLOSE=<link_id>
```

##### Response:

```
OK
```

#### Parameters

- **<link\_id>**: ID of the WebSocket connection. Range: [0,2].

#### Example

```
// Close the WebSocket connection whose link_id is 0
AT+WSCLOSE=0
```

## 3.9 Signaling Test AT Commands

- [Introduction](#)
- [AT+FACTPLCP](#): Send with long or short PLCP (Physical Layer Convergence Procedure)

### 3.9.1 Introduction

---

**Important:** The default AT firmware supports all the AT commands mentioned on this page. If you don't need ESP32-C2 to support signaling test commands, you can compile the ESP-AT project by following the steps in [Compile ESP-AT Project Locally](#) documentation. In the project configuration during the fifth step, make the following selections:

- Disable Component config->AT->AT signaling test command support
- 

### 3.9.2 AT+FACTPLCP: Send with Long or Short PLCP

#### Set Command

##### Command:

```
AT+FACTPLCP=<enable>,<tx_with_long>
```

##### Response:

```
OK
```

## Parameters

- **<enable>**: Enable or disable manual configuration.
  - 0: Disable manual configuration. The default value for the parameter `<tx_with_long>` will be used.
  - 1: Enable manual configuration. The type of PLCP that AT sends depends on `<tx_with_long>`.
- **<tx\_with\_long>**: Send with long PLCP or short PLCP.
  - 0: Send with short PLCP (default).
  - 1: Send with long PLCP.

## 3.10 Web Server AT Commands

- [Introduction](#)
- **AT+WEBSERVER**: Enable/disable Wi-Fi connection configuration via Web server.

### 3.10.1 Introduction

---

**Important:** The default AT firmware does not support the AT commands listed on this page. If you need ESP32-C2 to support web server commands, you can compile the ESP-AT project by following the steps in [Compile ESP-AT Project Locally](#) documentation. In the project configuration during the fifth step, make the following selections:

- Enable Component config -> AT -> AT Web Server command support
- 

### 3.10.2 AT+WEBSERVER: Enable/disable Wi-Fi connection configuration via Web server

#### Set Command

##### Command:

```
AT+WEBSERVER=<enable>,<server_port>,<connection_timeout>
```

##### Response:

```
OK
```

#### Parameters

- **<enable>**: Enable or disable Web server.
  - 0: Disable the Web server and release related resources.
  - 1: Enable Web server, which means that you can use WeChat or a browser to configure Wi-Fi connection information.
- **<server\_port>**: The Web server port number.
- **<connection\_timeout>**: The timeout for the every connection. Unit: second. Range:[21,60].

#### Notes

- There are two ways to provide the HTML files needed by the Web server. One is to use FAT file system, and you need to enable AT FS command at this time. The other is to use the embedded file to store HTML files (default setting).

- The default HTML file is [index.html](#) . If you need to customize the display format or text of the HTML file, you can directly modify this file. If you need to customize other content of the HTML file (e.g., add a field), you need to modify the corresponding source code file [at\\_web\\_server\\_cmd.c](#) .
- Please make sure that the maximum number of open sockets is not less than 12, you may change the number by `./build.py menuconfig>Component config>LWIP>Max number of open sockets` and compile the project (see [Compile ESP-AT Project Locally](#)).
- The default firmware does not support Web server AT commands (see [ESP-AT Firmware Differences](#)), but you can enable it by `./build.py menuconfig>Component config>AT>AT WEB Server command support` and compile the project (see [Compile ESP-AT Project Locally](#)).
- ESP-AT supports captive portals in ESP32-C2 series of devices. See [example](#).
- For more examples, please refer to [Web Server AT Example](#).
- The command implementation is open-source. See the source code in [at/src/at\\_web\\_server\\_cmd.c](#).
- Please refer to [How to Implement OTA Upgrade](#) for more OTA commands.

### Example

```
// Enable the Web server with port 80, and the timeout for the every connection is
->50 seconds
AT+WEBSERVER=1,80,50

// Disable the Web server
AT+WEBSERVER=0
```

## 3.11 Driver AT Commands

- [Introduction](#)
- [AT+DRVADC](#): Read ADC channel value.
- [AT+DRVPWMINIT](#): Initialize PWM driver.
- [AT+DRVPWMDUTY](#): Set PWM duty.
- [AT+DRVPWMFADE](#): Set PWM fade.
- [AT+DRVI2CINIT](#): Initialize I2C master driver.
- [AT+DRVI2CRD](#): Read I2C data.
- [AT+DRVI2CWRDATA](#): Write I2C data.
- [AT+DRVI2CWRBYTES](#): Write no more than 4 bytes I2C data.
- [AT+DRVSPICONFGPIO](#): Configure SPI GPIO.
- [AT+DRVSPIINIT](#): Initialize SPI master driver.
- [AT+DRVSPIRD](#): Read SPI data.
- [AT+DRVSPIWR](#): Write SPI data.

### 3.11.1 Introduction

**Important:** The default AT firmware does not support the AT commands listed on this page. If you need ESP32-C2 to support driver commands, you can compile the ESP-AT project by following the steps in [Compile ESP-AT Project Locally](#) documentation. In the project configuration during the fifth step, make the following selections:

- Enable `Component config->AT->AT driver command support`

### 3.11.2 AT+DRVADC: Read ADC Channel Value

## Set Command

### Command:

```
AT+DRVADC=<channel>,<atten>
```

### Response:

```
+DRVADC:<raw data>
```

```
OK
```

## Parameters

- **<channel>**: ADC1 channel.
- For ESP32-C2 devices, the range is [0,4].

CHANNEL	GPIO
0	GPIO0
1	GPIO1
2	GPIO2
3	GPIO3
4	GPIO4

- **<atten>**: attenuation.
- 0: 0 dB attenuation, effective measurement range is [0, 750] mV.
- 1: 2.5 dB attenuation, effective measurement range is [0, 1050] mV.
- 2: 6 dB attenuation, effective measurement range is [0, 1300] mV.
- 3: 11 dB attenuation, effective measurement range is [0, 2500] mV.
- **<raw data>**: ADC channel value.

## Notes

- ESP-AT only supports ADC1.
- ESP32-C2 support 12-bit width.
- For details on how to convert the channel value into voltage, please refer to [ADC Conversion](#).

## Example

```
// For ESP32-C2, 0 dB attenuation, effective measurement range is [0, 750] mV
// The returned 2048 means the voltage is 2048 / 4095 * 750 = 375.09 mV
AT+DRVADC=0,0
+DRVADC:2048
OK
```

### 3.11.3 AT+DRVPWMINIT: Initialize PWM Driver

#### Set Command

#### Command:

```
AT+DRVPWMINIT=<freq>,<duty_res>,<ch0_gpio>[,...,<ch3_gpio>]
```



**Response:**

```
OK
```

**Parameters**

- **<freq>**: LEDC timer frequency. Unit: Hz. Range: 1 Hz ~ 8 MHz.
- **<duty\_res>**: LEDC channel duty resolution. Range: 0 ~ 20 bits.
- **<chx\_gpio>**: LEDC output GPIO number of channel x. For example, if you want to use GPIO16 as channel 0, set **<ch0\_gpio>** to 16.

**Notes**

- AT can support a maximum of 4 channels.
- The number of channels that you initialize using this command will determine how many channels you can set using other PWM commands, including *AT+DRVPWMDUTY* and *AT+DRVPWMFADE*. For example, if you initialize two channels, you can only change the two channels' PWM duty using command *AT+DRVPWMDUTY*.
- The frequency and the duty resolution are interdependent. See [Supported Range of Frequency and Duty Resolutions](#) for more details.

**Example**

```
AT+DRVPWMINIT=5000,13,17,16,18,19 // set 4 channels; frequency: 5 kHz; duty_
↵resolution: 13 bits
AT+DRVPWMINIT=10000,10,17 // only use channel 0, frequency: 10 kHz; duty_
↵resolution: 10 bits; other PMW commands can only set one channel
```

### 3.11.4 AT+DRVPWMDUTY: Set PWM Duty

**Set Command****Command:**

```
AT+DRVPWMDUTY=<ch0_duty>[, ..., <ch3_duty>]
```

**Response:**

```
OK
```

**Parameter**

- **<duty>**: LEDC channel duty. Range: [0,2<sup>duty\_resolution</sup>].

**Notes**

- AT can support a maximum of 4 channels.
- If you do not want to set **<duty>** for a specific channel, just omit it.

**Example**

```
AT+DRVPWMDUTY=255,512 // set channel 0 to duty 255, set channel 1 to duty 512
AT+DRVPWMDUTY=,,0 // set channel 2 to duty 0
```

### 3.11.5 AT+DRVPWMFADE: Set PWM Fade

#### Set Command

##### Command:

```
AT+DRVPWMFADE=<ch0_target_duty>,<ch0_fade_time>[, ..., <ch3_target_duty>,<ch3_fade_
↳time>]
```

##### Response:

```
OK
```

#### Parameters

- **<target\_duty>**: target duty of fading. Range: [0, 2<sup>duty\_resolution-1</sup>].
- **<fade\_time>**: the maximum time of fading. Unit: millisecond.

#### Notes

- AT can support a maximum of 4 channels.
- If you do not want to set **<target\_duty>** and **<fade\_time>** for a specific channel, just omit them.

#### Example

```
AT+DRVPWMFADE=,,0,1000 // use one second to change channel 1 duty to 0
AT+DRVPWMFADE=1024,1000,0,2000, // use one second time to change channel 0 duty_
↳to 1024, two seconds to change channel 1 duty to 0
```

### 3.11.6 AT+DRVI2CINIT: Initialize I2C Master Driver

#### Set Command

##### Command:

```
AT+DRVI2CINIT=<num>,<scl_io>,<sda_io>,<clock>
```

##### Response:

```
OK
```

#### Parameters

- **<num>**: I2C port number. Range: 0 ~ 1. If the following parameters are not set, AT will deinitialize the I2C port.
- **<scl\_io>**: GPIO number for I2C SCL signal.
- **<sda\_io>**: GPIO number for I2C SDA signal.
- **<clock>**: I2C clock frequency for master mode. Unit: Hz. Maximum: 1 MHz.

**Note**

- This command only supports I2C masters.

**Example**

```
AT+DRVI2CINIT=0,25,26,1000 // initialize I2C0; GPIO25 is SCL; GPIO26 is SDA; I2C
↪clock is 1 kHz
AT+DRVI2CINIT=0 // deinitialize I2C0
```

**3.11.7 AT+DRVI2CRD: Read I2C Data****Set Command****Command:**

```
AT+DRVI2CRD=<num>,<address>,<length>
```

**Response:**

```
+DRVI2CRD:<read data>
OK
```

**Parameters**

- **<num>**: I2C port number. Range: 0 ~ 1.
- **<address>**: I2C slave device address.
  - 7-bit address: 0 ~ 0x7F.
  - 10-bit address: The first seven bits of the first byte are the combination 1111 0XX of which the last two bits (XX) are the two Most Significant Bits (MSBs) of the 10-bit address. For example, if the 10-bit address is 0x2FF (b' 101111111), the input address should be 0x7AFF (b' 11110101111111).
- **<length>**: I2C data length. Range: 1 ~ 2048.
- **<read data>**: I2C data.

**Note**

- I2C transmission timeout is one second.

**Example**

```
AT+DRVI2CRD=0,0x34,1 // I2C0 reads one byte data from address 0x34
AT+DRVI2CRD=0,0x7AFF,1 // I2C0 reads one byte data from 10-bit address 0x2FF

// I2C0 reads address 0x34, register address 0x27, read 2 bytes
AT+DRVI2CWRBYTES=0,0x34,1,0x27 // I2C0 first writes device address 0x34,
↪register address 0x27
AT+DRVI2CRD=0,0x34,2 // I2C0 reads 2 bytes
```

**3.11.8 AT+DRVI2CWRDATA: Write I2C Data****Set Command****Command:**

```
AT+DRVI2CWRDATA=<num>,<address>,<length>
```

**Response:**

```
OK  
>
```

This response indicates that you should enter the data you want to write. When the requirement of data length is met, the data transmission starts.

If the data is transmitted successfully, AT returns:

```
OK
```

If the data transmission fails, AT returns:

```
ERROR
```

**Parameters**

- **<num>**: I2C port number. Range: 0 ~ 1.
- **<address>**: I2C slave device address.
  - 7-bit address: 0 ~ 0x7F.
  - 10-bit address: The first seven bits of the first byte are the combination 1111 0XX of which the last two bits (XX) are the two Most Significant Bits (MSBs) of the 10-bit address. For example, if the 10-bit address is 0x2FF (b' 1011111111), the input address should be 0x7AFF (b' 11110101111111).
- **<length>**: I2C data length. Range: 1 ~ 2048.

**Note**

- I2C transmission timeout is one second.

**Example**

```
AT+DRVI2CWRDATA=0,0x34,10 // I2C0 writes 10 bytes data to address 0x34
```

### 3.11.9 AT+DRVI2CWRBYTES: Write No More Than 4 Bytes I2C Data

**Set Command****Command:**

```
AT+DRVI2CWRBYTES=<num>,<address>,<length>,<data>
```

**Response:**

```
OK
```

**Parameters**

- **<num>**: I2C port number. Range: 0 ~ 1.
- **<address>**: I2C slave device address.
  - 7-bit address: 0 ~ 0x7F.

- 10-bit address: The first seven bits of the first byte are the combination 1111 0XX of which the last two bits (XX) are the two Most Significant Bits (MSBs) of the 10-bit address. For example, if the 10-bit address is 0x2FF (b' 101111111), the input address should be 0x7AFF (b' 11110101111111).
- **<length>**: the length of the I2C data you want to write. Range: 1 ~ 4 bytes.
- **<data>**: the data of <length> long. Range: 0 ~ 0xFFFFFFFF.

**Note**

- I2C transmission timeout is one second.

**Example**

```
AT+DRVI2CWRBYTES=0,0x34,2,0x1234 // I2C0 writes 2 bytes data 0x1234 to address_
↪0x34
AT+DRVI2CWRBYTES=0,0x7AFF,2,0x1234 // I2C0 writes 2 bytes data 0x1234 to 10-bit_
↪address 0x2FF

// I2C0 writes address 0x34; register address: 0x27; data: c0xFF
AT+DRVI2CWRBYTES=0,0x34,2,0x27FF
```

**3.11.10 AT+DRVSPICONFGPIO: Configure SPI GPIO****Set Command****Command:**

```
AT+DRVSPICONFGPIO=<mosi>,<miso>,<sclk>,<cs>
```

**Response:**

```
OK
```

**Parameters**

- **<mosi>**: GPIO pin for Master Out Slave In signal.
- **<miso>**: GPIO pin for Master In Slave Out signal, or -1 if not used.
- **<sclk>**: GPIO pin for SPI Clock signal.
- **<cs>**: GPIO pin for slave selection signal, or -1 if not used.

**3.11.11 AT+DRVSPINIIT: Initialize SPI Master Driver****Set Command****Command:**

```
AT+DRVSPINIIT=<clock>,<mode>,<cmd_bit>,<addr_bit>,<dma_chan>[,bits_msb]
```

**Response:**

```
OK
```

### Parameters

- **<clock>**: Clock speed, divisors of 80 MHz. Unit: Hz. Maximum: 40 MHz.
- **<mode>**: SPI mode. Range: 0 ~ 3.
- **<cmd\_bit>**: Default amount of bits in command phase. Range: 0 ~ 16.
- **<addr\_bit>**: Default amount of bits in address phase. Range: 0 ~ 64.
- **<dma\_chan>**: Either channel 1 or 2, or 0 in the case when no DMA is required.
- **<bits\_msb>**: SPI data format:
  - Bit0:
    - \* 0: Transmit MSB first (default).
    - \* 1: Transmit LSB first.
  - Bit1:
    - \* 0: Receive data MSB first (default).
    - \* 1: Receive data LSB first.

### Note

- You should configure SPI GPIO before SPI initialization.

### Example

```
AT+DRVSPiINIT=102400,0,0,0,0,3 // SPI clock: 100 kHz; mode: 0; both command and
↔address bits are 0; not use DMA; transmit and receive LSB first
OK
AT+DRVSPiINIT=0 // delete SPI Driver
OK
```

## 3.11.12 AT+DRVSPiRD: Read SPI Data

### Set Command

#### Command:

```
AT+DRVSPiRD=<data_len>[, <cmd>, <cmd_len>] [, <addr>, <addr_len>]
```

#### Response:

```
+DRVSPiRD:<read data>
OK
```

### Parameters

- **<data\_len>**: length of SPI data you want to read. Range: 1 ~ 4092 bytes.
- **<cmd>**: command data. The length of the data is set in **<cmd\_len>**.
- **<cmd\_len>**: command length in this transaction. Range: 0 ~ 2 bytes.
- **<addr>**: command address. The length of the address is set in **<addr\_len>**.
- **<addr\_len>**: The address length in this transaction. Range: 0 ~ 4 bytes.

### Note

- If you do not use DMA, the maximum **<data\_len>** you can set is 64 bytes each time.

**Example**

```

AT+DRVSPIRD=2 // read 2 bytes data
+DRVI2CREAD:ffff
OK

AT+DRVSPIRD=2,0x03,1,0x001000,3 // read 2 bytes data; <cmd> is 0x03; <cmd_len> is 1
->1 byte; <addr> is 0x1000; <addr_len> is 3 bytes
+DRVI2CREAD:ffff
OK

```

**3.11.13 AT+DRVSPWR: Write SPI Data****Set Command****Command:**

```
AT+DRVSPWR=<data_len>[,<cmd>,<cmd_len>][,<addr>,<addr_len>]
```

**Response:**

When <data\_len> is larger than 0, AT returns:

```
OK
>
```

This response indicates that you should enter the data you want to write. When the requirement of data length is met, the data transmission starts.

If the data is transmitted successfully, AT returns:

```
OK
```

When <data\_len> is equal to 0, which means AT transmits commands and addresses only, and no SPI data, AT returns:

```
OK
```

**Parameters**

- <data\_len>: SPI data length. Range: 0 ~ 4092.
- <cmd>: command data. The length of the data is set in <cmd\_len>.
- <cmd\_len>: command length in this transaction. Range: 0 ~ 2 bytes.
- <addr>: command address. The length of the address is set in <addr\_len>.
- <addr\_len>: The address length in this transaction. Range: 0 ~ 4 bytes.

**Note**

- If you do not use DMA, the maximum <data\_len> you can set is 64 bytes each time.

**Example**

```

AT+DRVSPWR=2 // write 2 bytes data
OK
> // begin receiving serial data

```

(continues on next page)

(continued from previous page)

```
OK
AT+DRVSPIWR=0,0x03,1,0x001000,3 // write 0 byte data; <cmd> is 0x03; <cmd_len> is
↪1 byte; <addr> is 0x1000; <addr_len> is 3 bytes
OK
```

## 3.12 User AT Commands

- *Introduction*
- *AT+USERRAM*: Operate user's free RAM.
- *AT+USEROTA*: Upgrade the firmware according to the specified URL.
- *AT+USERWKMCFG*: Configure how AT wakes up MCU.
- *AT+USERMCUSLEEP*: MCU indicates its sleep state.
- *AT+USERDOCS*: Query the ESP-AT user guide for current firmware.

### 3.12.1 Introduction

**Important:** The default AT firmware supports all the AT commands mentioned on this page. If you don't need ESP32-C2 to support user commands, you can compile the ESP-AT project by following the steps in [Compile ESP-AT Project Locally](#) documentation. In the project configuration during the fifth step, make the following selections:

- Disable Component config->AT->AT user command support

### 3.12.2 AT+USERRAM: Operate user's free RAM

#### Query Command

**Function:**

Query the current available user's RAM size.

**Command:**

```
AT+USERRAM?
```

**Response:**

```
+USERRAM:<size>
OK
```

#### Set Command

**Function:**

Operate user's free RAM

**Command:**

```
AT+USERRAM=<operation>,<size>[,<offset>]
```

**Response:**



```
+USERAM:<length>,<data> // esp-at returns this response only when the operator
↳is ``read``
OK
```

### Parameters

- **<operation>**:
  - 0: release user' s RAM
  - 1: malloc user' s RAM
  - 2: write user' s RAM
  - 3: read user' s RAM
  - 4: clear user' s RAM
- **<size>**: the size to malloc/read/write
- **<offset>**: the offset to read/write. Default: 0

### Notes

- Please malloc the RAM size before you perform any other operations.
- If the operator is `write`, wrap return > after the write command, then you can send the data that you want to write. The length should be parameter <length>.
- If the operator is `read` and the length is bigger than 1024, ESP-AT will reply multiple times in the same format, each reply can carry up to 1024 bytes of data, and eventually end up with `\r\nOK\r\n`.

### Example

```
// malloc 1 KB user's RAM
AT+USERAM=1,1024

// write 500 bytes to RAM (offset: 0)
AT+USERAM=2,500

// read 64 bytes from RAM offset 100
AT+USERAM=3,64,100

// free the user's RAM
AT+USERAM=0
```

### 3.12.3 AT+USEROTA: Upgrade the Firmware According to the Specified URL

ESP-AT upgrades firmware at runtime by downloading the new firmware from a specific URL.

#### Set Command

##### Function:

Upgrade to the firmware version specified by the URL.

##### Command:

```
AT+USEROTA=<url len>
```

##### Response:

```
OK
>
```

This response indicates that AT is ready for receiving URL. You should enter the URL, and when the URL length reaches the `<url len>` value, the system returns:

```
Recv <url len> bytes
```

After AT outputs the above information, the upgrade process starts. If the upgrade process is complete, the system return:

```
OK
```

If the parameter is wrong or firmware upgrades fails, the system returns:

```
ERROR
```

### Parameters

- `<url len>`: URL length. Maximum: 8192 bytes.

### Note

- You can [Download AT firmware from GitHub Actions](#), or you can generate AT firmware from [Compile ESP-AT Project](#) as well.
- If you use ESP32C2-2MB module config, OTA firmware is `build/custom_ota_binaries/esp-at.bin.xz.packed`. If you use ESP32C2-4MB module config, OTA firmware is `build/esp-at.bin`.
- The speed of the upgrade depends on the network status.
- If the upgrade fails due to unfavorable network conditions, AT will return `ERROR`. Please wait for some time before retrying.
- Downgrading to an older version is not recommended due to potential compatibility issues and the risk of operational failure. If you still prefer downgrading to an older version, please test and verify the functionality based on your product.
- After you upgrade the AT firmware, you are suggested to call the command `AT+RESTORE` to restore the factory default settings.
- `AT+USEROTA` supports `HTTP` and `HTTPS`.
- After AT outputs the `>` character, the special characters in the URL does not need to be escaped through the escape character, and it does not need to end with a new line(`CR-LF`).
- When the URL is `HTTPS`, SSL verification is not recommended. If SSL verification is required, you need to generate your own PKI files and download them into the corresponding partition, and then load the certificates in the code implemented by the `AT+USEROTA` command. Please refer to [How to Update PKI Configuration](#) for PKI files. For `AT+USEROTA` command, ESP-AT project provides an example of `USEROTA`.
- Please refer to [How to Implement OTA Upgrade](#) for more OTA commands.

### Example

```
AT+USEROTA=36
OK
>
Recv 36 bytes
OK
```

### 3.12.4 AT+USERWKMCUCFG: Configure How AT Wakes Up MCU

#### Set Command

##### Function:

This command configures how AT checks whether MCU is in awake state and how to wake it up.

- If MCU is in awake state, AT will directly send the data to it without waking it up.
- If MCU is in sleep state and AT is ready to actively send the data to MCU (the data sent actively is same to *ESP-AT Message Reports*), AT will send wake signals to wake it up first and then send the data to it. Wake signals will be cleared after MCU is waked up or timeout.

##### Command:

```
AT+USERWKMCUCFG=<enable>,<wake mode>,<wake number>,<wake signal>,<delay time>[,
↪<check mcu awake method>]
```

##### Response:

```
OK
```

#### Parameters

- **<enable>**: Enable or disable wake-up configuration.
  - 0: Disable wake-up configuration
  - 1: Enable wake-up configuration
- **<wake mode>**: wake mode.
  - 1: GPIO wake-up
  - 2: UART wake-up
- **<wake number>**: It means differently depending on the parameter **<wake mode>**.
  - If **<wake mode>** is 1, **<wake number>** represents GPIO number for wake-up. You need to ensure that the configured GPIO wake-up pin is not used for other purposes. Otherwise, you need to perform compatibility processing.
  - If **<wake mode>** is 2, **<wake number>** represents UART number. Currently, only 1 is supported for **<wake number>**, which means only UART1 can wake up MCU.
- **<wake signal>**: It means differently depending on the parameter **<wake mode>**.
  - If **<wake mode>** is 1, **<wake signal>** represents wake-up level.
    - \* 0: low level
    - \* 1: high level
  - If **<wake mode>** is 2, **<wake signal>** represents wake-up byte. Range: [0,255].
- **<delay time>**: Maximum waiting time. Unit: milliseconds. Range: [0,60000]. It means differently depending on the parameter **<wake mode>**.
  - If **<wake mode>** is 1, the **<wake signal>** level will be held on during the **<delay time>**. After the **<delay time>** is reached, the **<wake signal>** level is reversed.
  - If **<wake mode>** is 2, AT will send **<wake signal>** byte immediately and wait until timeout.
- **<check mcu awake method>**: AT checks whether MCU is in awake state.
  - Bit 0: Whether to enable *AT+USERMCUSLEEP* command linkage. Enabled by default. That is, when receiving *AT+USERMCUSLEEP=0* command from MCU, AT knows that MCU is in awake state; when receiving *AT+USERMCUSLEEP=1* command, AT knows that MCU is in sleep.
  - Bit 1: Whether to enable *AT+SLEEP=0/1/2/3* command linkage. Disabled by default. That is, when receiving *AT+SLEEP=0* command, AT knows that MCU is in awake state; when receiving *AT+SLEEP=1/2/3* command, AT knows that MCU is in sleep.
  - Bit 2: Whether to enable the function of indicating MCU state after **<delay time>** timeout. Disabled by default. That is, when disabled, it indicates that MCU is in sleep after **<delay time>**; when enabled, it indicates that MCU is in awake state after **<delay time>**.
  - Bit 3 (not implemented yet): Whether to enable the function of indicating MCU state via GPIO. Unsupported by default.

## Notes

- This command needs to be configured only once.
- Each time before the AT actively sends data to MCU, it will send a wake-up signal first and then enter the waiting time. When `<delay time>` is reached, it will directly send data. This wait timeout will reduce the transmission efficiency with MCU.
- If AT receives any wake-up event in `<check mcu wake method>` before `<delay time>`, it will immediately clear the wake-up state; otherwise, the wake-up state will be cleared automatically after the `<delay time>` timeout.

## Example

```
// Enable wake-up MCU configuration. Before each time the AT sends data to the MCU,
↪ it will first use the GPIO18 pin of the Wi-Fi module to wake up the MCU at a
↪ high level and hold on the high level for 10 seconds.
AT+USERWKMUCCFG=1,1,18,1,10000,3

// Enable wake-up configuration
AT+USERWKMUCCFG=0
```

### 3.12.5 AT+USERMCUSLEEP: MCU Indicates Its Sleep State

#### Set Command

##### Function:

This command can only be taken effect when the `<check mcu wake method>` Bit 0 of the `AT+USERWKMUCCFG` command is configured. It used to inform AT that the current MCU sleep state.

##### Command:

```
AT+USERMCUSLEEP=<state>
```

##### Response:

```
OK
```

#### Parameters

- `<state>`:
  - 0: Indicates that MCU is in awake state.
  - 1: Indicates that MCU is in sleep state.

#### Example

```
// MCU tells AT that the current MCU is in awake state
AT+USERMCUSLEEP=0
```

### 3.12.6 AT+USERDOCS: Query the ESP-AT User Guide for Current Firmware

#### Query Command

##### Function:

Query the ESP-AT English and Chinese user guide for current running firmware.

**Command:**

```
AT+USERDOCS?
```

**Response:**

```
+USERDOCS:<"en url">
+USERDOCS:<"cn url">

OK
```

**Parameters**

- <" en url" >: the URL for English document
- <" cn url" >: the URL for Chinese document

**Example**

```
AT+USERDOCS?
+USERDOCS:"https://docs.espressif.com/projects/esp-at/en/latest/esp32c2/index.html"
+USERDOCS:"https://docs.espressif.com/projects/esp-at/zh_CN/latest/esp32c2/index.
↵html"

OK
```

It is strongly recommended to read the following sections for some common information on AT commands before you dive into the details of each command.

- [AT Command Types](#)
- [AT Commands with Configuration Saved in the Flash](#)
- [AT Messages](#)

## 3.13 AT Command Types

Generic AT command has four types:

Type	Command Format	Description
Test Command	AT+<CommandName>	Query the Set Commands' internal parameters and their range of values.
Query Command	AT+<CommandName>R	Return the current value of parameters.
Set Command	AT+<CommandName>S<...>	Set the value of user-defined parameters in commands, and run these commands.
Execute Command	AT+<CommandName>R	Run commands with no user-defined parameters.

- Not all AT commands support all of the four types mentioned above.
- Currently, only strings and integer numbers are supported as input parameters in AT commands.
- Angle brackets < > designate parameters that can not be omitted.
- Square brackets [ ] designate optional parameters that can be omitted. The default value of the parameter will be used instead when you omit it. Below are examples of entering the command [AT+CWJAP](#) with some parameters omitted.

```
AT+CWJAP="ssid","password"
AT+CWJAP="ssid","password","11:22:33:44:55:66"
```

- If the parameter you want to omit is followed by a parameter(s), you must give a , to indicate it.

```
AT+CWJAP="ssid","password",,1
```

- String values need to be included in double quotation marks.

```
AT+CWSAP="ESP756290","21030826",1,4
```

- Escape character syntax is needed if a string contains special characters, such as , , " , or \ :
  - \ : escape the backslash itself
  - \ , : escape comma which is not used to separate each parameter
  - \ " : escape double quotation mark which is not used to mark string input
  - \ <any> : escape <any> character means that drop backslash symbol and only use <any> character
- Escape is needed in AT commands only, not elsewhere. For example, when AT command port prints > and wait for your input, the input does not need to be escaped.

```
AT+CWJAP="comma\,backslash\\ssid","1234567890"
AT+MQTTPUB=0,"topic","\"{\\"sensor\":012}\"",1,0
```

- The default baud rate of AT command is 115200.
- The length of each AT command should be no more than 256 bytes.
- AT commands end with a new-line (CR-LF), so the serial tool should be set to “New Line Mode” .
- Definitions of AT command error codes are provided in *AT API Reference*:
  - [esp\\_at\\_error\\_code](#)
  - [esp\\_at\\_para\\_parse\\_result\\_type](#)
  - [esp\\_at\\_result\\_code\\_string\\_index](#)

## 3.14 AT Commands with Configuration Saved in the Flash

Configuration settings entered by the following AT Commands will always be saved in the flash NVS Area, so they can be automatically restored on reset:

- **AT+UART\_DEF**: AT+UART\_DEF=115200,8,1,0,3
- **AT+SAVETRANSLINK**: AT+SAVETRANSLINK=1,"192.168.6.10",1001
- **AT+CWAUTOCONN**: AT+CWAUTOCONN=1

Saving of configuration settings by several other commands can be switched on or off with **AT+SYSSSTORE** command, which is mentioned in the Note section of these commands.

---

**Note:** The parameters of AT commands are saved based on [NVS](#) library. Therefore, if the command is configured with the same parameter value, flash will not be written; If the command is configured with the different parameter value, flash will not be erased frequently.

---

## 3.15 AT Messages

There are two types of ESP-AT messages returned from the ESP-AT command port:

- ESP-AT Response Messages (passive)  
Each ESP-AT command input returns response messages to tell the sender the result of the ESP-AT command. The last message in the response is either OK or ERROR.

Table 4: ESP-AT Response Messages

AT Response Messages	Description
OK	AT command process done and return OK
ERROR	AT command error or error occurred during the execution
SEND OK	Data has been sent to the protocol stack (specific to <i>AT+CIPSEND</i> and <i>AT+CIPSENDEX</i> command). It doesn't mean that the data has been sent to the opposite end
SEND FAIL	Error occurred during sending the data to the protocol stack (specific to <i>AT+CIPSEND</i> and <i>AT+CIPSENDEX</i> command)
SET OK	The URL has been set successfully (specific to <i>AT+HTTTPURLCFG</i> command)
+<Command Name>: . . .	Response to the sender that describes AT command process results in details

- ESP-AT Message Reports (active)  
ESP-AT will report important state changes or messages in the system.

Table 5: ESP-AT Message Reports

ESP-AT Message Report	Description
ready	The ESP-AT firmware is ready
busy p...	Busy processing. The system is in process of handling the previous command, thus CANNOT accept the new input
ERR CODE:<0x%08x>	Error code for different commands
Will force to restart!!!	Module restart right now
smartconfig type:<xxx>	Smartconfig type
Smart get wifi info	Smartconfig has got the SSID and PASSWORD information
+SCRD:<length>,"<reserved data>"	ESP-Touch v2 has got the reserved information
smartconfig connected wifi	Smartconfig done. ESP-AT has connected to the Wi-Fi
WIFI CONNECTED	Wi-Fi station interface has connected to an AP
WIFI GOT IP	Wi-Fi station interface has got the IPv4 address
WIFI GOT IPv6 LL	Wi-Fi station interface has got the IPv6 LinkLocal address
WIFI GOT IPv6 GL	Wi-Fi station interface has got the IPv6 Global address
WIFI DISCONNECT	Wi-Fi station interface has disconnected from an AP
+ETH_CONNECTED	Ethernet interface has connected
+ETH_GOT_IP	Ethernet interface has got the IPv4 address
+ETH_DISCONNECTED	Ethernet interface has disconnected
[<conn_id>],CONNECT	A network connection of which ID is <conn_id> is established (ID=0 by default)
[<conn_id>],CLOSED	A network connection of which ID is <conn_id> ends (ID=0 by default)
+LINK_CONN	Detailed connection information of TCP/UDP/SSL
+STA_CONNECTED: <sta_mac>	A station has connected to the Wi-Fi softAP interface of ESP-AT
+DIST_STA_IP: <sta_mac>,<sta_ip>	The Wi-Fi softAP interface of ESP-AT distributes an IP address to the station
+STA_DISCONNECTED: <sta_mac>	A station disconnected from the Wi-Fi softAP interface of ESP-AT
>	ESP-AT is waiting for more data to be received
Recv <xxx> bytes	ESP-AT has already received <xxx> bytes from the ESP-AT command port

continues on next page

Table 5 – continued from previous page

ESP-AT Message Report	Description
+IPD	<p>ESP-AT received the data from the network when AT is not in <i>Passthrough Mode</i>. The message formats are as follows:</p> <ul style="list-style-type: none"> <li>- +IPD,&lt;length&gt; will be outputted if AT+CIPMUX=0 and AT+CIPRECVMODE=1.</li> <li>- +IPD,&lt;link_id&gt;,&lt;length&gt; will be outputted if AT+CIPMUX=1 and AT+CIPRECVMODE=&lt;link_id&gt;,1.</li> <li>- +IPD,&lt;length&gt;:&lt;data&gt; will be outputted if AT+CIPMUX=0, AT+CIPRECVMODE=0, and AT+CIPDINFO=0.</li> <li>- +IPD,&lt;link_id&gt;,&lt;length&gt;:&lt;data&gt; will be outputted if AT+CIPMUX=1, AT+CIPRECVMODE=&lt;link_id&gt;,0, and AT+CIPDINFO=0.</li> <li>- +IPD,&lt;length&gt;,&lt;"remote_ip"&gt;,&lt;remote_port&gt;:&lt;data&gt; will be outputted if AT+CIPMUX=0, AT+CIPRECVMODE=0, and AT+CIPDINFO=1.</li> <li>- +IPD,&lt;link_id&gt;,&lt;length&gt;,&lt;"remote_ip"&gt;,&lt;remote_port&gt;:&lt;data&gt; will be outputted if AT+CIPMUX=1, AT+CIPRECVMODE=&lt;link_id&gt;,0, and AT+CIPDINFO=1.</li> </ul> <p>The link_id represents the connection ID, length indicates the data length, remote_ip refers to the remote IP address, remote_port represents the remote port number, and data denotes the actual data.</p> <p>Note: In the case of a SSL connection, in passive receive mode (AT+CIPRECVMODE=1), the length in the AT command response may not match the actual readable SSL data length. This is because AT prioritizes returning the readable data length at the SSL layer. If the SSL layer has no readable data, AT will return the readable data length at the socket layer.</p>
The Data in <i>Passthrough Mode</i>	ESP-AT received the data from the network or Bluetooth when AT is in <i>Passthrough Mode</i>
SEND Canceled	Cancel to send in <i>Wi-Fi normal sending mode</i>
Have <xxx> Connections	Has reached the maximum connection counts for server
+QUIT	ESP-AT quits from the Wi-Fi <i>Passthrough Mode</i>
NO CERT FOUND	No valid device certificate found in custom partition
NO PRVT_KEY FOUND	No valid private key found in custom partition
NO CA FOUND	No valid CA certificate found in custom partition
+TIME_UPDATED	The system time has been updated. Only after sending the <i>AT+CIPSNTPCFG</i> command or power on will this message be outputted if the module fetches a new time from the SNTP server.

continues on next page



Table 5 – continued from previous page

ESP-AT Message Report	Description
+MQTTCONNECTED	MQTT connected to the broker
+MQTTDISCONNECTED	MQTT disconnected from the broker
+MQTTSUBRECV	MQTT received the data from the broker
+MQTTPUB:FAIL	MQTT failed to publish data
+MQTTPUB:OK	MQTT publish data done
+BLECONN	A Bluetooth LE connection established
+BLEDISCONN	A Bluetooth LE connection ends
+READ	A read operation from Bluetooth LE connection
+WRITE	A write operation from Bluetooth LE connection
+NOTIFY	A notification from Bluetooth LE connection
+INDICATE	An indication from Bluetooth LE connection
+BLESECNTFYKEY	Bluetooth LE SMP key
+BLESECREQ:<conn_index>	Received encryption request which index is <conn_index>
+BLEAUTHCMPL:<conn_index>,<enc_result>	Bluetooth LE SMP pairing completed
+BLUFIDATA:<len>,<data>	The ESP device received customized data from the phone over BluFi
+WS_DISCONNECTED:<link_id>	The WebSocket connection of ID <link_id> is disconnected.
+WS_CONNECTED:<link_id>	The WebSocket connection of ID <link_id> is established.
+WS_DATA:<link_id>,<data_len>,<data>	The Websocket connection of ID <link_id> has received the data.
+WS_CLOSED:<link_id>	The WebSocket connection of ID <link_id> is closed.
+BLESCANDONE	Scan finished
+BLESECKEYREQ:<conn_index>	The peer has accepted the pairing request, and the ESP device can enter the key.

## Chapter 4

# AT Command Examples

### 4.1 AT Response Message Format Control Examples

- *Enable the system message filter to download files in HTTP passthrough mode*

#### 4.1.1 Enable the system message filter to download files in HTTP passthrough mode

This example describes how to download an image file in PNG format. The image link is <https://www.espressif.com/sites/default/files/home/hardware.png>.

1. Restore your device to factory settings.

Command:

```
AT+RESTORE
```

Response:

```
OK
```

2. Set the Wi-Fi mode to station.

Command:

```
AT+CWMODE=1
```

Response:

```
OK
```

3. Connect to the router.

Command:

```
AT+CWJAP="espressif", "1234567890"
```

Response:

```
WIFI CONNECTED  
WIFI GOT IP
```

```
OK
```

Note:

- The SSID and password you entered may be different from those in the above command. Please replace the SSID and password with those of your router settings.

4. Configure the first system message filter to filter out the header and tail from each HTTP data.

Command:

```
AT+SYMSMGFILTERCFG=1,18,3
```

Response:

```
OK
```

```
>
```

Enter `^+HTTPCGET:[0-9]*`, (18 bytes in total) and `\r\n$` (3 bytes in total, the `\r\n` character corresponds to carriage return and line feed character, i.e. 0D 0A). Response:

```
OK
```

Note:

- `^+HTTPCGET:[0-9]*`, is the regular expression for headers. It means the string starts with `+HTTPCGET:`, followed by a string of numbers, and ends with a comma.
- `\r\n$` is the regular expression of tail. It means the string ends with `\r\n`.

5. Configure the second system message filter to filter out the OK system message returned after the picture is downloaded.

Command:

```
AT+SYMSMGFILTERCFG=1,0,7
```

Response:

```
OK
```

```
>
```

At this time, enter `\r\nOK\r\n$` (7 bytes in total, where `\r\n` corresponds to line feed and carriage return in ASCII code, i.e. 0D 0A). Response:

```
OK
```

Note:

- `\r\nOK\r\n$` is the regular expression for tails. It means the string ends with `\r\nOK\r\n`.

6. Enable system message filter

Command:

```
AT+SYMSMGFILTER=1
```

Response:

```
OK
```

Note:

- The filters set above will take effect only after system message filtering is enabled.

7. Turn off echo

Command:

```
ATE0
```

Response:

```
OK
```

8. Download the picture

Set the sending and receiving buffer size to 2048 bytes, and set the network timeout to 5000 ms. Note that the network timeout is not the command timeout. The 5-second network timeout means closing the network connection if no data is received from the server side for 5 consecutive seconds. In a poor network environment

where the server-side data is received every second, the network connection will not be closed, resulting in a long command timeout.

Command:

```
AT+HTTPGET="https://www.espressif.com/sites/default/files/home/hardware.png",
→2048,2048,5000
```

Response:

```
// Here, the MCU transparently receives the entire picture resource from
→https://www.espressif.com/sites/default/files/home/hardware.png.
```

Note:

- If the picture download fails, AT will still send a `\r\nERROR\r\n` (9 bytes in total) system message to MCU.

#### 9. Clear the filter

Command:

```
AT+SYMSGFILTERCFG=0
```

Response:

```
OK
```

#### 10. Disable the system message filter

Command:

```
AT+SYMSGFILTER=0
```

Response:

```
OK
```

#### 11. Switch echo on

Command:

```
ATE1
```

Response:

```
OK
```

## 4.2 TCP/IP AT Examples

This document provides detailed command examples to illustrate how to utilize *TCP/IP AT Commands* on ESP32-C2.

- *ESP32-C2 as a TCP client in single connection*
- *ESP32-C2 as a TCP server in multiple connections*
- *UDP transmission with fixed remote IP address and port*
- *UDP transmission with changeable remote IP address and port*
- *ESP32-C2 as an SSL client in single connection*
- *ESP32-C2 as an SSL server in multiple connections*
- *ESP32-C2 as an SSL client to create a single connection with mutual authentication*
- *ESP32-C2 as an SSL server to create multiple connections with mutual authentication*
- *UART Wi-Fi passthrough transmission when the ESP32-C2 works as a TCP client in single connection*
- *UART Wi-Fi passthrough transmission when the ESP32-C2 works as a TCP server*
- *UART Wi-Fi passthrough transmission when the ESP32-C2 works as a softAP in UDP transparent transmission*
- *ESP32-C2 obtains socket data in passive receiving mode*

### 4.2.1 ESP32-C2 as a TCP client in single connection

1. Set the Wi-Fi mode to station.

Command:

```
AT+CWMODE=1
```

Response:

```
OK
```

2. Connect to the router.

Command:

```
AT+CWJAP="espressif", "1234567890"
```

Response:

```
WIFI CONNECTED
WIFI GOT IP
OK
```

Note:

- The SSID and password you entered may be different from those in the above command. Please replace the SSID and password with those of your router settings.

3. Query the device's IP address.

Command:

```
AT+CIPSTA?
```

Response:

```
+CIPSTA:ip:"192.168.3.112"
+CIPSTA:gateway:"192.168.3.1"
+CIPSTA:netmask:"255.255.255.0"
OK
```

Note:

- The query results you obtained may be different from those in the above response.

4. Connect the PC to the same router which ESP32-C2 is connected to.

Use a network tool on the PC to create a TCP server. For example, the TCP server on PC is 192.168.3.102, and the port is 8080.

5. Connect ESP32-C2 to the TCP server as a client over TCP. The server's IP address is 192.168.3.102, and the port is 8080.

Command:

```
AT+CIPSTART="TCP", "192.168.3.102", 8080
```

Response:

```
CONNECT
OK
```

6. Send 4 bytes of data.

Command:

```
AT+CIPSEND=4
```

Response:

```
OK
>
```

Input 4 bytes, for example, `test`, then AT will respond the following message.

```
Recv 4 bytes
```

```
SEND OK
```

Note:

- If the number of bytes inputted are more than the length (n) set by `AT+CIPSEND`, the system will reply `busy p . . .`, and send the first n bytes. And after sending the first n bytes, the system will reply `SEND OK`.

7. Receive 4 bytes of data.

Assume that the TCP server sends 4 bytes of data (data is `test`), the system will prompt:

```
+IPD,4:test
```

## 4.2.2 ESP32-C2 as a TCP server in multiple connections

When ESP32-C2 works as a TCP server, multiple connections should be enabled by `AT+CIPMUX=1` command, because in most cases more than one client needs to be connected to the ESP32-C2 server.

Below is an example showing how a TCP server is established when ESP32-C2 works in the softAP mode. If ESP32-C2 works as a station, you can set up a server in the same way mentioned above after connecting ESP32-C2 to the router.

1. Set the Wi-Fi mode to softAP.

Command:

```
AT+CWMODE=2
```

Response:

```
OK
```

2. Enable multiple connections.

Command:

```
AT+CIPMUX=1
```

Response:

```
OK
```

3. Set softAP.

Command:

```
AT+CWSAP="ESP32_softAP","1234567890",5,3
```

Response:

```
OK
```

4. Query softAP information.

Command:

```
AT+CIPAP?
```

Response:

```
AT+CIPAP?
+CIPAP:ip:"192.168.4.1"
+CIPAP:gateway:"192.168.4.1"
+CIPAP:netmask:"255.255.255.0"
```

```
OK
```

Note:

- The address you obtained may be different from that in the above response.
- Set up a TCP server, the default port is 333.

Command:

```
AT+CIPSERVER=1
```

Response:

```
OK
```

- Connect the PC to the ESP32-C2 softAP.

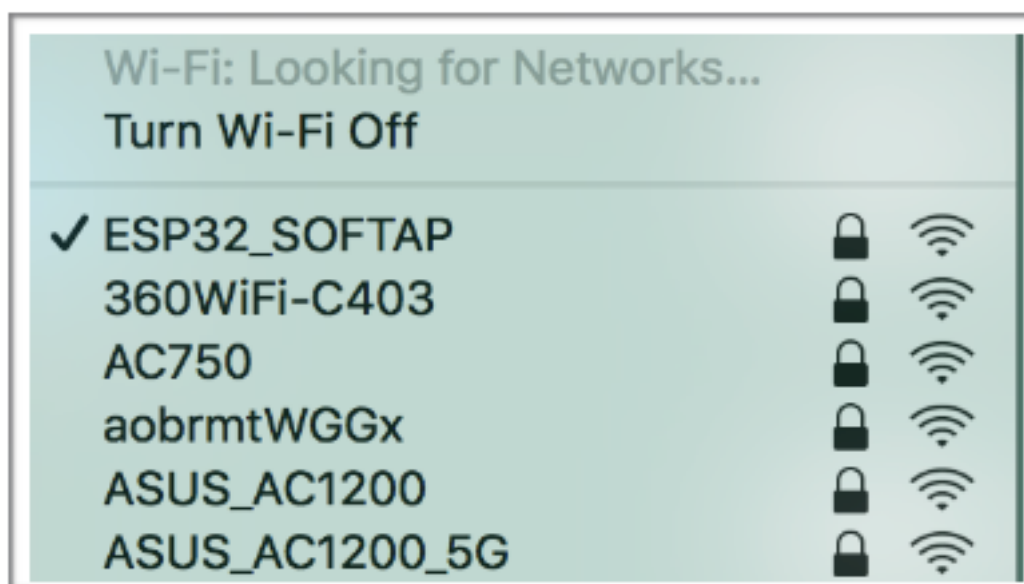

- Use a network tool on PC to create a TCP client and connect it to the TCP server that ESP32-C2 has created.
- Send 4 bytes of data to connection link 0.

Command:

```
AT+CIPSEND=0,4
```

Response:

```
OK
```

```
>
```

Input 4 bytes, for example, `test`, then AT will respond the following messages.

```
Recv 4 bytes
```

```
SEND OK
```

Note:

- If the number of bytes inputted are more than the length (n) set by `AT+CIPSEND`, the system will reply `busy p...`, and send the first n bytes. And after sending the first n bytes, the system will reply `SEND OK`.
- Receive 4 bytes of data from connection link 0.  
Assume that the TCP server sends 4 bytes of data (data is `test`), the system will prompt:

```
+IPD,0,4:test
```

- Close TCP connection.

Command:

```
AT+CIPCLOSE=0
```

Response:

```
0, CLOSED  
OK
```

### 4.2.3 UDP transmission with fixed remote IP address and port

1. Set the Wi-Fi mode to station.

Command:

```
AT+CWMODE=1
```

Response:

```
OK
```

2. Connect to the router.

Command:

```
AT+CWJAP="espressif", "1234567890"
```

Response:

```
WIFI CONNECTED  
WIFI GOT IP  
OK
```

Note:

- The SSID and password you entered may be different from those in the above command. Please replace the SSID and password with those of your router settings.

3. Query the device's IP address.

Command:

```
AT+CIPSTA?
```

Response:

```
+CIPSTA:ip:"192.168.3.112"  
+CIPSTA:gateway:"192.168.3.1"  
+CIPSTA:netmask:"255.255.255.0"  
OK
```

Note:

- The query results you obtained may be different from those in the above response.

4. Connect the PC to the same router which ESP32-C2 is connected to.  
Use a network tool on the PC to create UDP transmission. For example, the PC's IP address is 192.168.3.102, and the port is 8080.

5. Enable multiple connections.

Command:

```
AT+CIPMUX=1
```

Response:

```
OK
```

6. Create a UDP transmission. The connection link is 4, the remote host's IP address is 192.168.3.102, the remote port is 8080, the local port is 1112, and the mode is 0.



**Important:** In UDP transmission, whether the remote IP address and port are fixed or not is determined by the `mode` parameter of `AT+CIPSTART`. If the parameter is 0, a specific connection link ID will be given to ensure that the remote IP address and port are fixed and the data sender and receiver will not be replaced by other devices.

Command:

```
AT+CIPSTART=4,"UDP","192.168.3.102",8080,1112,0
```

Response:

```
4,CONNECT
```

```
OK
```

Note:

- "192.168.3.102" and 8080 are the remote IP address and port of UDP transmission on the remote side, i.e., the UDP configuration set by PC.
- 1112 is the local port number of ESP32-C2. You can define this port number, or else, a random port will be used.
- 0 means that the remote IP address and port are fixed and cannot be changed. For example, when there is another PC creating a UDP entity and sending data to ESP32-C2 port 1112, ESP32-C2 will still receive the data from UDP port 1112, and if the AT command `AT+CIPSEND=4,X` is used, the data will still be sent to the first PC end. However, if the parameter is not set as 0, the data will be sent to the new PC.

7. Send 7 bytes of data to connection link 4.

Command:

```
AT+CIPSEND=4,7
```

Response:

```
OK
```

```
>
```

Input 7 bytes, for example, `abcdefg`, then AT will respond the following messages.

```
Recv 7 bytes
```

```
SEND OK
```

Note:

- If the number of bytes inputted are more than the length (`n`) set by `AT+CIPSEND`, the system will reply `busy p...`, and send the first `n` bytes. And after sending the first `n` bytes, the system will reply `SEND OK`.

8. Receive 4 bytes of data from connection link 4.

Assume that the PC sends 4 bytes of data (data is `test`), the system will prompt:

```
+IPD,4,4:test
```

9. Close UDP connection link 4.

Command:

```
AT+CIPCLOSE=4
```

Response:

```
4,CLOSED
```

```
OK
```

## 4.2.4 UDP transmission with changeable remote IP address and port

1. Set the Wi-Fi mode to station.

Command:

```
AT+CWMODE=1
```

Response:

```
OK
```

2. Connect to the router.

Command:

```
AT+CWJAP="espressif","1234567890"
```

Response:

```
WIFI CONNECTED
WIFI GOT IP
OK
```

Note:

- The SSID and password you entered may be different from those in the above command. Please replace the SSID and password with those of your router settings.

3. Query the device's IP address.

Command:

```
AT+CIPSTA?
```

Response:

```
+CIPSTA:ip:"192.168.3.112"
+CIPSTA:gateway:"192.168.3.1"
+CIPSTA:netmask:"255.255.255.0"
OK
```

Note:

- The query results you obtained may be different from those in the above response.

4. Connect the PC to the same router which ESP32-C2 is connected to.

Use a network tool on the PC to create UDP transmission. For example, the PC's IP address is 192.168.3.102, and the port is 8080.

5. Enable single connections.

Command:

```
AT+CIPMUX=0
```

Response:

```
OK
```

6. Create a UDP transmission. The remote host's IP address is 192.168.3.102, the remote port is 8080, the local port is 1112, and the mode is 2.

Command:

```
AT+CIPSTART="UDP","192.168.3.102",8080,1112,2
```

Response:

```
CONNECT
OK
```

Note:

- "192.168.3.102" and 8080 are the remote IP address and port of UDP transmission on the remote side, i.e., the UDP configuration set by PC.
- 1112 is the local port number of ESP32-C2. You can define this port number, or else, a random port will be used.
- 2 means the opposite terminal of UDP transmission can be changed. The remote IP address and port will be automatically changed to those of the last UDP connection to ESP32-C2.

## 7. Send 4 bytes of data.

Command:

```
AT+CIPSEND=4
```

Response:

```
OK
>
```

Input 4 bytes, for example, `test`, then AT will respond the following messages.

```
Recv 4 bytes
SEND OK
```

Note:

- If the number of bytes inputted are more than the length (n) set by `AT+CIPSEND`, the system will reply `busy p . . .`, and send the first n bytes. And after sending the first n bytes, the system will reply `SEND OK`.

## 8. Send data to any other UDP terminal. For example, you can send 4 bytes of data with the remote host's IP address as 192.168.3.103 and the remote port as 1000.

If you want to send data to any other UDP terminal, please designate the IP address and port of the target terminal in the command.

Command:

```
AT+CIPSEND=4,"192.168.3.103",1000
```

Response:

```
OK
>
```

Input 4 bytes, for example, `test`, then AT will respond the following messages.

```
Recv 4 bytes
SEND OK
```

## 9. Receive 4 bytes of data.

Assume that the PC sends 4 bytes of data (data is `test`), the system will prompt:

```
+IPD,4:test
```

## 10. Close UDP connection.

Command:

```
AT+CIPCLOSE
```

Response:

```
CLOSED
OK
```

## 4.2.5 ESP32-C2 as an SSL client in single connection

1. Set the Wi-Fi mode to station.

Command:

```
AT+CWMODE=1
```

Response:

```
OK
```

2. Connect to the router.

Command:

```
AT+CWJAP="espressif","1234567890"
```

Response:

```
WIFI CONNECTED
WIFI GOT IP
OK
```

Note:

- The SSID and password you entered may be different from those in the above command. Please replace the SSID and password with those of your router settings.

3. Query the device's IP address.

Command:

```
AT+CIPSTA?
```

Response:

```
+CIPSTA:ip:"192.168.3.112"
+CIPSTA:gateway:"192.168.3.1"
+CIPSTA:netmask:"255.255.255.0"
OK
```

Note:

- The query results you obtained may be different from those in the above response.

4. Connect the PC to the same router which ESP32-C2 is connected to.
5. Use the OpenSSL command on the PC to create an SSL server. For example, the SSL server on PC is 192.168.3.102, and the port is 8070.

Command:

```
openssl s_server -cert /home/esp-at/components/customized_partitions/raw_data/
↪server_cert/server_cert.crt -key /home/esp-at/components/customized_
↪partitions/raw_data/server_key/server.key -port 8070
```

Response:

```
ACCEPT
```

6. Connect the ESP32-C2 to the SSL server as a client over SSL. The server's IP address is 192.168.3.102, and the port is 8070.

Command:

```
AT+CIPSTART="SSL","192.168.3.102",8070
```

Response:

```
CONNECT
OK
```

7. Send 4 bytes of data.

Command:

```
AT+CIPSEND=4
```

Response:

```
OK
>
```

Input 4 bytes, for example, `test`, then AT will respond the following message.

```
Recv 4 bytes
SEND OK
```

Note:

- If the number of bytes inputted are more than the length (n) set by `AT+CIPSEND`, the system will reply `busy p . . .`, and send the first n bytes. And after sending the first n bytes, the system will reply `SEND OK`.
8. Receive 4 bytes of data.  
Assume that the SSL server sends 4 bytes of data (data is `test`), the system will prompt:

```
+IPD,4:test
```

## 4.2.6 ESP32-C2 as an SSL server in multiple connections

When ESP32-C2 works as an SSL server, multiple connections should be enabled by `AT+CIPMUX=1` command, because in most cases more than one client needs to be connected to the ESP32-C2 server.

Below is an example showing how an SSL server is established when ESP32-C2 works in the softAP mode. If ESP32-C2 works as a station, after connecting to the router, follow the steps for establishing a connection to an SSL server in this example.

1. Set the Wi-Fi mode to softAP.

Command:

```
AT+CWMODE=2
```

Response:

```
OK
```

2. Enable multiple connections.

Command:

```
AT+CIPMUX=1
```

Response:

```
OK
```

3. Configure the ESP32-C2 softAP.

Command:

```
AT+CWSAP="ESP32_softAP","1234567890",5,3
```

Response:

```
OK
```

4. Query softAP information.

Command:

```
AT+CIPAP?
```

Response:

```
AT+CIPAP?  
+CIPAP:ip:"192.168.4.1"  
+CIPAP:gateway:"192.168.4.1"  
+CIPAP:netmask:"255.255.255.0"  
  
OK
```

Note:

- The address you obtained may be different from that in the above response.

5. Set up an SSL server.

Command:

```
AT+CIPSERVER=1,8070,"SSL"
```

Response:

```
OK
```

6. Connect the PC to the ESP32-C2 softAP.

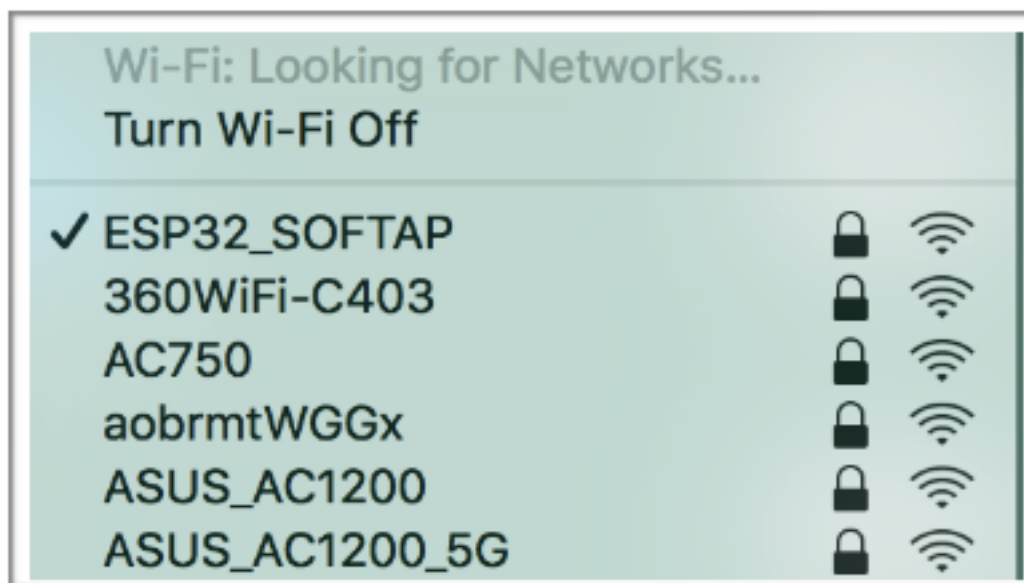

7. Use the OpenSSL command on PC to create an SSL client and connect it to the SSL server that ESP32-C2 has created.

Command:

```
openssl s_client -host 192.168.4.1 -port 8070
```

Response on the ESP32-C2:

```
CONNECT
```

8. Send 4 bytes of data to connection link 0.

Command:

```
AT+CIPSEND=0,4
```

Response:

```
OK
```

```
>
```

Input 4 bytes, for example, `test`, then AT will respond the following messages.

```
Recv 4 bytes
SEND OK
```

Note:

- If the number of bytes inputted are more than the length (n) set by `AT+CIPSEND`, the system will reply `busy p . . .`, and send the first n bytes. And after sending the first n bytes, the system will reply `SEND OK`.

9. Receive 4 bytes of data from connection link 0.

Assume that the SSL server sends 4 bytes of data (data is `test`), the system will prompt:

```
+IPD,0,4:test
```

10. Close SSL connection.

Command:

```
AT+CIPCLOSE=0
```

Response:

```
0,CLOSED
OK
```

#### 4.2.7 ESP32-C2 as an SSL client to create a single connection with mutual authentication

In this example, the certificate used is the default certificate in `esp-at`. You can also use your own certificate:

- To use your own SSL client certificate, replace the default certificate according to the [How to Update PKI Configuration](#) document.
- To use your own SSL server certificate, replace the SSL server certificate path below with your own certificate path.

1. Set the Wi-Fi mode to station.

Command:

```
AT+CWMODE=1
```

Response:

```
OK
```

2. Connect to the router.

Command:

```
AT+CWJAP="espressif","1234567890"
```

Response:

```
WIFI CONNECTED
WIFI GOT IP
OK
```

Note:

- The SSID and password you entered may be different from those in the above command. Please replace the SSID and password with those of your router settings.

3. Set the SNTP server.

Command:

```
AT+CIPSNTPCFG=1,8,"cn.ntp.org.cn","ntp.sjtu.edu.cn"
```

Response:

```
OK
```

Note:

- You can set the SNTP server according to your country's time zone.

4. Query the SNTP time.

Command:

```
AT+CIPSNTPTIME?
```

Response:

```
+CIPSNTPTIME:Mon Oct 18 20:12:27 2021
OK
```

Note:

- You can check whether the SNTP time matches the real-time time to determine whether the SNTP server you set takes effect.

5. Query the device's IP address.

Command:

```
AT+CIPSTA?
```

Response:

```
+CIPSTA:ip:"192.168.3.112"
+CIPSTA:gateway:"192.168.3.1"
+CIPSTA:netmask:"255.255.255.0"
OK
```

Note:

- The query results you obtained may be different from those in the above response.

6. Connect the PC to the same router which ESP32-C2 is connected to.

7. Use the OpenSSL command on the PC to create an SSL server. For example, the SSL server on PC is 192.168.3.102, and the port is 8070.

Command:

```
openssl s_server -CAfile /home/esp-at/components/customized_partitions/raw_
↵data/server_ca/server_ca.crt -cert /home/esp-at/components/customized_
↵partitions/raw_data/server_cert/server_cert.crt -key /home/esp-at/components/
↵customized_partitions/raw_data/server_key/server.key -port 8070 -verify_
↵return_error -verify_depth 1 -Verify 1
```

Response on the ESP32-C2:

```
CONNECT
```

Note:

- The certificate path in the command can be adjusted according to the location of your certificate.

8. The ESP32-C2 sets up the SSL client mutual authentication configuration.

Command:

```
AT+CIPSSLCONF=3,0,0
```

Response:

```
OK
```

9. Connect the ESP32-C2 to the SSL server as a client over SSL. The server's IP address is 192.168.3.102, and the port is 8070.

Command:

```
AT+CIPSTART="SSL", "192.168.3.102", 8070
```

Response:



```
CONNECT
```

```
OK
```

- Send 4 bytes of data.

Command:

```
AT+CIPSEND=4
```

Response:

```
OK
```

```
>
```

Input 4 bytes, for example, `test`, then AT will respond the following message.

```
Recv 4 bytes
```

```
SEND OK
```

Note:

- If the number of bytes inputted are more than the length (n) set by `AT+CIPSEND`, the system will reply `busy p . . .`, and send the first n bytes. And after sending the first n bytes, the system will reply `SEND OK`.

- Receive 4 bytes of data.

Assume that the SSL server sends 4 bytes of data (data is `test`), the system will prompt:

```
+IPD,4:test
```

### 4.2.8 ESP32-C2 as an SSL server to create multiple connections with mutual authentication

When ESP32-C2 works as an SSL server, multiple connections should be enabled by `AT+CIPMUX=1` command, because in most cases more than one client needs to be connected to the ESP32-C2 server.

Below is an example showing how an SSL server is established when ESP32-C2 works in the station mode. If ESP32-C2 works as a softAP, refer to the example of [ESP32-C2 as an SSL server in multiple connections](#).

- Set the Wi-Fi mode to station.

Command:

```
AT+CWMODE=1
```

Response:

```
OK
```

- Connect to the router.

Command:

```
AT+CWJAP="espressif","1234567890"
```

Response:

```
WIFI CONNECTED
```

```
WIFI GOT IP
```

```
OK
```

Note:

- The SSID and password you entered may be different from those in the above command. Please replace the SSID and password with those of your router settings.

3. Query the device's IP address.

Command:

```
AT+CIPSTA?
```

Response:

```
+CIPSTA:ip:"192.168.3.112"  
+CIPSTA:gateway:"192.168.3.1"  
+CIPSTA:netmask:"255.255.255.0"
```

OK

Note:

- The query results you obtained may be different from those in the above response.

4. Enable multiple connections.

Command:

```
AT+CIPMUX=1
```

Response:

OK

5. Set up an SSL server.

Command:

```
AT+CIPSERVER=1,8070,"SSL",1
```

Response:

OK

6. Connect the PC to the ESP32-C2 softAP.

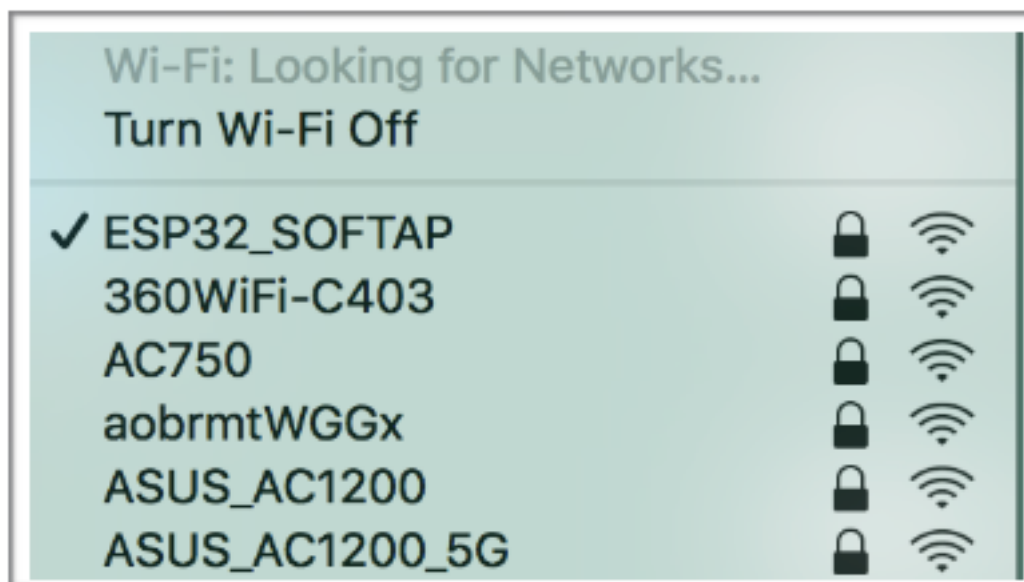

7. Use the OpenSSL command on PC to create an SSL client and connect it to the SSL server that ESP32-C2 has created.

Command:

```
openssl s_client -CAfile /home/esp-at/components/customized_partitions/raw_  
→data/client_ca/client_ca_00.crt -cert /home/esp-at/components/customized_  
→partitions/raw_data/client_cert/client_cert_00.crt -key /home/esp-at/  
→components/customized_partitions/raw_data/client_key/client_key_00.key -host_  
→192.168.3.112 -port 8070
```

Response on the ESP32-C2:

```
0,CONNECT
```

- Send 4 bytes of data to connection link 0.

Command:

```
AT+CIPSEND=0,4
```

Response:

```
OK
```

```
>
```

Input 4 bytes, for example, `test`, then AT will respond the following messages.

```
Recv 4 bytes
```

```
SEND OK
```

Note:

- If the number of bytes inputted are more than the length (`n`) set by `AT+CIPSEND`, the system will reply `busy p . . .`, and send the first `n` bytes. And after sending the first `n` bytes, the system will reply `SEND OK`.

- Receive 4 bytes of data from connection link 0.

Assume that the SSL server sends 4 bytes of data (data is `test`), the system will prompt:

```
+IPD,0,4:test
```

- Close SSL connection.

Command:

```
AT+CIPCLOSE=0
```

Response:

```
0,CLOSED
```

```
OK
```

- Close SSL server.

Command:

```
AT+CIPSERVER=0
```

Response:

```
OK
```

### 4.2.9 UART Wi-Fi passthrough transmission when the ESP32-C2 works as a TCP client in single connection

- Set the Wi-Fi mode to station.

Command:

```
AT+CWMODE=1
```

Response:

```
OK
```

- Connect to the router.

Command:

```
AT+CWJAP="espressif","1234567890"
```

Response:

```
WIFI CONNECTED
WIFI GOT IP

OK
```

Note:

- The SSID and password you entered may be different from those in the above command. Please replace the SSID and password with those of your router settings.

3. Query the device's IP address.

Command:

```
AT+CIPSTA?
```

Response:

```
+CIPSTA:ip:"192.168.3.112"
+CIPSTA:gateway:"192.168.3.1"
+CIPSTA:netmask:"255.255.255.0"

OK
```

Note:

- The query results you obtained may be different from those in the above response.

4. Connect the PC to the same router which ESP32-C2 is connected to.

Use a network tool on the PC to create a TCP server. For example, the TCP server on PC is 192.168.3.102, and the port is 8080.

5. Connect the ESP32-C2 to the TCP server as a TCP client over TCP. The server's IP address is 192.168.3.102, and the port is 8080.

Command:

```
AT+CIPSTART="TCP","192.168.3.102",8080
```

Response:

```
CONNECT

OK
```

6. Enable the UART Wi-Fi *Passthrough Receiving Mode*.

Command:

```
AT+CIPMODE=1
```

Response:

```
OK
```

7. Enter the UART Wi-Fi *Passthrough Mode* and send data.

Command:

```
AT+CIPSEND
```

Response:

```
OK
>
```

8. Stop sending data.

When receiving a packet that contains only +++, the UART Wi-Fi passthrough transmission process will be stopped. Then please wait at least 1 second before sending the next AT command. Please note that if you input +++ directly by typing, the +++ may not be recognized as three consecutive + because of the prolonged typing duration. For more details, please refer to [\[Passthrough Mode Only\] +++](#).

**Important:** The aim of ending the packet with +++ is to exit *Passthrough Mode* and to accept normal AT commands, while TCP still remains connected. However, you can also use command AT+CIPSEND to go back into *Passthrough Mode*.

---

- Exit the UART Wi-Fi *Passthrough Receiving Mode*.

Command:

```
AT+CIPMODE=0
```

Response:

```
OK
```

- Close TCP connection.

Command:

```
AT+CIPCLOSE
```

Response:

```
CLOSED
```

```
OK
```

#### 4.2.10 UART Wi-Fi passthrough transmission when the ESP32-C2 works as a TCP server

- Set the Wi-Fi mode to station.

Command:

```
AT+CWMODE=1
```

Response:

```
OK
```

- Connect to the router.

Command:

```
AT+CWJAP="espressif","1234567890"
```

Response:

```
WIFI CONNECTED
```

```
WIFI GOT IP
```

```
OK
```

Note:

- The SSID and password you entered may be different from those in the above command. Please replace the SSID and password with those of your router settings.

- Enable multiple connections.

Command:

```
AT+CIPMUX=1
```

Response:

```
OK
```

Note:

- TCP server can be created only in multiple connections.

- Set the maximum number of TCP server connections to 1.

Command:

```
AT+CIPSERVERMAXCONN=1
```

Response:

```
OK
```

Note:

- The passthrough mode is point-to-point, so the maximum number of connections to the TCP server can only be 1.

5. Create TCP server.

Command:

```
AT+CIPSERVER=1,8080
```

Response:

```
OK
```

Note:

- Set the TCP server port to 8080. You can also set it to other port.

6. Query the device's IP address.

Command:

```
AT+CIPSTA?
```

Response:

```
+CIPSTA:ip:"192.168.3.112"  
+CIPSTA:gateway:"192.168.3.1"  
+CIPSTA:netmask:"255.255.255.0"
```

```
OK
```

Note:

- The query results you obtained may be different from those in the above response.

7. Connect the PC to the ESP32-C2 TCP server

Connect the PC to the same router which ESP32-C2 is connected to.

Use a network tool on the PC to create a TCP client and connect to the ESP32-C2 TCP server. The remote address is 192.168.3.112, and the port is 8080.

AT Response:

```
0,CONNECT
```

8. Enable the UART Wi-Fi *Passthrough Receiving Mode*.

Command:

```
AT+CIPMODE=1
```

Response:

```
OK
```

9. Enter the UART Wi-Fi *Passthrough Mode* and send data.

Command:

```
AT+CIPSEND
```

Response:

```
OK
```

```
>
```

10. Stop sending data.

When receiving a packet that contains only +++, the UART Wi-Fi passthrough transmission process will be stopped. Then please wait at least 1 second before sending the next AT command. Please note that if you

input +++ directly by typing, the +++ may not be recognized as three consecutive + because of the prolonged typing duration. For more details, please refer to [\[Passthrough Mode Only\] +++](#).

**Important:** The aim of ending the packet with +++ is to exit *Passthrough Mode* and to accept normal AT commands, while TCP still remains connected. However, you can also use command AT+CIPSEND to go back into *Passthrough Mode*.

11. Exit the UART Wi-Fi *Passthrough Receiving Mode*.

Command:

```
AT+CIPMODE=0
```

Response:

```
OK
```

12. Close TCP connection.

Command:

```
AT+CIPCLOSE
```

Response:

```
CLOSED
```

```
OK
```

#### 4.2.11 UART Wi-Fi passthrough transmission when the ESP32-C2 works as a softAP in UDP transparent transmission

1. Set the Wi-Fi mode to softAP.

Command:

```
AT+CWMODE=2
```

Response:

```
OK
```

2. Set softAP.

Command:

```
AT+CWSAP="ESP32_softAP", "1234567890", 5, 3
```

Response:

```
OK
```

3. Connect the PC to the ESP32-C2 softAP.

4. Create a UDP endpoint.

Use a network tool on PC to create a UDP endpoint. For example, the PC's IP address is 192.168.4.2 and the port is 8080.

5. Create a UDP transmission between ESP32-C2 and the PC with a fixed remote IP address and port. The remote host's IP address is 192.168.4.2, the remote port is 8080, the local port is 2233, and the mode is 0.

Command:

```
AT+CIPSTART="UDP", "192.168.4.2", 8080, 2233, 0
```

Response:

```
CONNECT
```

```
OK
```



6. Enter the UART Wi-Fi *Passthrough Receiving Mode*.

Command:

```
AT+CIPMODE=1
```

Response:

```
OK
```

7. Enter the UART Wi-Fi *Passthrough Mode* and send data.

Command:

```
AT+CIPSEND
```

Response:

```
OK
```

```
>
```

8. Stop sending data.

When receiving a packet that contains only +++, the UART Wi-Fi passthrough transmission process will be stopped. Then please wait at least 1 second before sending the next AT command. Please note that if you input +++ directly by typing, the +++ may not be recognized as three consecutive + because of the prolonged typing duration. For more details, please refer to [\[Passthrough Mode Only\] +++](#).

**Important:** The aim of ending the packet with +++ is to exit *Passthrough Mode* and to accept normal AT commands, while TCP still remains connected. However, you can also use command AT+CIPSEND to go back into *Passthrough Mode*.

9. Exit the UART Wi-Fi *Passthrough Receiving Mode*.

Command:

```
AT+CIPMODE=0
```

Response:

```
OK
```

10. Close TCP connection.

Command:



```
AT+CIPCLOSE
```

Response:

```
CLOSED  
OK
```

#### 4.2.12 ESP32-C2 obtains socket data in passive receiving mode

When a large amount of network data is expected to be received and the MCU cannot process it timely, you can refer to this example and use the passive receive data mode.

1. Set the Wi-Fi mode to station.

Command:

```
AT+CWMODE=1
```

Response:

```
OK
```

2. Connect to the router.

Command:

```
AT+CWJAP="espressif", "1234567890"
```

Response:

```
WIFI CONNECTED  
WIFI GOT IP  
OK
```

Note:

- The SSID and password you entered may be different from those in the above command. Please replace the SSID and password with those of your router settings.

3. Query the device's IP address.

Command:

```
AT+CIPSTA?
```

Response:

```
+CIPSTA:ip:"192.168.3.112"  
+CIPSTA:gateway:"192.168.3.1"  
+CIPSTA:netmask:"255.255.255.0"  
OK
```

Note:

- The query results you obtained may be different from those in the above response.

4. Connect the PC to the same router which ESP32-C2 is connected to.

Use a network tool on the PC to create a TCP server. For example, the TCP server on PC is 192.168.3.102, and the port is 8080.

5. Connect ESP32-C2 to the TCP server as a client over TCP. The server's IP address is 192.168.3.102, and the port is 8080.

Command:

```
AT+CIPSTART="TCP", "192.168.3.102", 8080
```

Response:

```
CONNECT
```

```
OK
```

6. ESP32-C2 sets the socket receiving mode to passive mode.

Command:

```
AT+CIPRECVMODE=1
```

Response:

```
OK
```

7. The TCP server sends 4 bytes of data (data is `test`).

Note:

- The device replies with `+IPD, 4`. If it receives server data again later, please refer to the note section of [AT+CIPRECVMODE](#) for whether it will reply with `+IPD, .`

8. ESP32-C2 obtains socket data length in passive receiving mode.

Command:

```
AT+CIPRECVMLEN?
```

Response:

```
+CIPRECVMLEN:4
OK
```

9. ESP32-C2 obtains socket data in passive receiving mode.

Command:

```
AT+CIPRECVDATA=4
```

Response:

```
+CIPRECVDATA:4,test
OK
```

## 4.3 Bluetooth LE AT Examples

This document provides an introduction and detailed command examples to illustrate how to utilize [Bluetooth® Low Energy AT Commands](#) on ESP32-C2.

- [Introduction](#)
- [Bluetooth LE client reads and write services](#)
- [Encrypt Bluetooth LE connection](#)
- [Establish SPP connection between two ESP32-C2 development boards and transmit data in UART-Bluetooth LE Passthrough Mode](#)
- [Establish SPP connection between ESP32-C2 and mobile phone and transmit data in UART-Bluetooth LE passthrough mode](#)
- [Establish Bluetooth LE connection and pairing between ESP32-C2 and mobile phone](#)

### 4.3.1 Introduction

ESP-AT currently only supports **Bluetooth LE 4.2 protocol specification**, and the description in this document is only for **Bluetooth LE 4.2 protocol specification**. Please refer to [Core Specification 4.2](#) for more details.

### Bluetooth LE protocol architecture

Bluetooth LE protocol stack is divided into several layers from bottom to top: Physical Layer (PHY), Link Layer (LL), Host Controller Interface (HCI), Logical Link Control and Adaptation Protocol Layer (L2CAP), Attribute Protocol (ATT), Security Manager Protocol (SMP), Generic Attribute Profile (GATT), Generic Access Profile (GAP).

- PHY: the PHY layer is responsible for transmitting and receiving packets of information on the physical channel. Bluetooth LE uses 40 RF channels. Frequency Range: 2402 MHz to 2480 MHz.
- LL: the LL layer is responsible for the creation, modification and release of logical links (and, if required, their associated logical transports), as well as the update of parameters related to physical links between devices. It controls the Link Layer state machine in one of the five states of `standby`, `advertising`, `scanning`, `initiating` and `connected`.
- HCI: the HCI layer provides a standardized interface to host and controller. This layer can be implemented by software API or controlled by hardware interfaces UART, SPI and USB.
- L2CAP: the L2CAP layer is responsible for protocol multiplexing capability, segmentation, and reassembly operation for data exchanged between the host and the protocol stack.
- ATT: the ATT layer implements the peer-to-peer protocol between an attribute server and an attribute client. The ATT client sends commands, requests, and confirmations to the ATT server. The ATT server sends responses, notifications and indications to the client.
- SMP: the SMP layer is the peer-to-peer protocol used to generate encryption keys and identity keys. The SMP also manages storage of the encryption keys and identity keys and is responsible for generating random addresses and resolving random addresses to known device identities.
- GATT: the GATT layer represents the functionality of the attribute server and, optionally, the attribute client. The profile describes the hierarchy of services, characteristics and attributes used in the attribute server. The layer provides interfaces for discovering, reading, writing and indicating of service characteristics and attributes.
- GAP: the GAP represents the base functionality common to all Bluetooth devices such as modes and access procedures used by the transports, protocols and application profiles. GAP services include device discovery, connection modes, security, authentication, association models and service discovery.

### Bluetooth LE role division

There are different roles in different levels of the Bluetooth LE protocol architecture. These divisions are not affected by each other.

- LL: devices can be divided into `master` and `slave`, the `slave` advertises, and the `master` initiates a connection.
- GAP: GAP defines four specific roles: `broadcaster`, `observer`, `peripheral`, and `central`.
- GATT: devices can be divided into `server` and `client`.

---

#### Important:

- The Bluetooth LE server and Bluetooth LE client described in this document are both GATT layer roles.
  - At present, ESP-AT supports the existence of Bluetooth LE server and Bluetooth LE client at the same time.
  - No matter ESP-AT is initialized as Bluetooth LE server or Bluetooth LE client, the maximum number of devices connected at the same time is 3.
- 

GATT is actually an attribute transmission protocol, which can be regarded as an application layer protocol for attribute transmission. The structure of this attribute is very simple. It is composed of `services`, each `service` is composed of different numbers of `characteristics`, and each `characteristic` is composed of many other elements.

GATT `server` and GATT `client` roles exist after the Bluetooth LE connection is established. The GATT server stores the data transported over the Attribute Protocol and accepts Attribute Protocol requests, commands and confirmations from the GATT client. In short, the end that provides data is called GATT `server`, and the end that accesses data is called GATT `client`.

### 4.3.2 Bluetooth LE client reads and write services

Below is an example of using two ESP32-C2 development boards, one as a Bluetooth LE server (only as Bluetooth LE server role), the other one as a Bluetooth LE client (only as Bluetooth LE client role). The example shows how to use Bluetooth LE functions with AT commands.

**Important:** In the following steps, the operations starting with `ESP32-C2 Bluetooth LE server` only need to be executed at ESP32-C2 Bluetooth LE server, and the operations starting with `ESP32-C2 Bluetooth LE client` only need to be executed at ESP32-C2 Bluetooth LE client.

1. Bluetooth LE initialization.

ESP32-C2 Bluetooth LE server:

Command:

```
AT+BLEINIT=2
```

Response:

```
OK
```

ESP32-C2 Bluetooth LE client:

Command:

```
AT+BLEINIT=1
```

Response:

```
OK
```

2. ESP32-C2 Bluetooth LE server gets Bluetooth LE address.

Command:

```
AT+BLEADDR?
```

Response:

```
+BLEADDR: "24:0a:c4:d6:e4:46"  
OK
```

Note:

- The address you obtain may be different from that in the above response. Keep yours handy as you will need it in one of the following steps.

1. ESP32-C2 Bluetooth LE server discovers characteristics.

Command:

```
AT+BLEGATTSCHAR?
```

Response:

```
+BLEGATTSCHAR: "char", 1, 1, 0xC300  
+BLEGATTSCHAR: "char", 1, 2, 0xC301  
+BLEGATTSCHAR: "char", 1, 3, 0xC302  
+BLEGATTSCHAR: "char", 1, 4, 0xC303  
+BLEGATTSCHAR: "char", 1, 5, 0xC304  
+BLEGATTSCHAR: "char", 1, 6, 0xC305  
+BLEGATTSCHAR: "char", 1, 7, 0xC306  
+BLEGATTSCHAR: "char", 1, 8, 0xC307  
+BLEGATTSCHAR: "char", 2, 1, 0xC400  
+BLEGATTSCHAR: "char", 2, 2, 0xC401  
  
OK
```

2. ESP32-C2 Bluetooth LE server starts advertising, then the ESP32-C2 Bluetooth LE client starts scanning and lasts for 3 s.

ESP32-C2 Bluetooth LE server:

Command:

```
AT+BLEADVSTART
```

Response:

```
OK
```

ESP32-C2 Bluetooth LE client:

Command:

```
AT+BLESCAN=1,3
```

Response:

```
OK
+BLESCAN:"5b:3b:6c:51:90:49",-87,02011a020a0c0aff4c001005071c3024dc,,1
+BLESCAN:"c4:5b:be:93:ec:66",-84,0201060303111809095647543147572d58020a03,,0
+BLESCAN:"24:0a:c4:d6:e4:46",-29,,,0
```

Note:

- The scan results you obtain may be different from those in the above response.

### 3. Establish the Bluetooth LE connection.

ESP32-C2 Bluetooth LE client:

Command:

```
AT+BLECONN=0,"24:0a:c4:d6:e4:46"
```

Response:

```
+BLECONN:0,"24:0a:c4:d6:e4:46"
```

```
OK
```

Note:

- When entering the above command, replace the address with your ESP32-C2 Bluetooth LE server address.
- If the Bluetooth LE connection is established successfully, message `+BLECONN:0,"24:0a:c4:d6:e4:46"` will be prompted.
- If the Bluetooth LE connection is broken, message `+BLECONN:0,-1` will be prompted.

### 4. ESP32-C2 Bluetooth LE client discovers services.

Command:

```
AT+BLEGATTCPRIMSRV=0
```

Response:

```
+BLEGATTCPRIMSRV:0,1,0x1800,1
+BLEGATTCPRIMSRV:0,2,0x1801,1
+BLEGATTCPRIMSRV:0,3,0xA002,1
+BLEGATTCPRIMSRV:0,4,0xA003,1
```

```
OK
```

Note:

- When discovering services, the ESP32-C2 Bluetooth LE client will get two more default services (UUID: 0x1800 and 0x1801) than what the ESP32-C2 Bluetooth LE server will get. So, for the same service, the `<srv_index>` received by the ESP32-C2 Bluetooth LE client equals the `<srv_index>` received by the ESP32-C2 Bluetooth LE server + 2. For example, for service 0xA002, the `<srv_index>` queried on the ESP32-C2 Bluetooth LE client is 3, if the ESP32-C2 Bluetooth LE server is queried through the command `AT+BLEGATTSSRV?`, then `<srv_index>` is 1.

### 5. ESP32-C2 Bluetooth LE client discovers characteristics.

Command:

```
AT+BLEGATTCCHAR=0,3
```

Response:

```
+BLEGATTCCHAR:"char",0,3,1,0xC300,0x02
+BLEGATTCCHAR:"char",0,3,2,0xC301,0x02
+BLEGATTCCHAR:"char",0,3,3,0xC302,0x08
+BLEGATTCCHAR:"char",0,3,4,0xC303,0x04
+BLEGATTCCHAR:"char",0,3,5,0xC304,0x08
+BLEGATTCCHAR:"char",0,3,6,0xC305,0x10
+BLEGATTCCHAR:"desc",0,3,6,1,0x2902
+BLEGATTCCHAR:"char",0,3,7,0xC306,0x20
+BLEGATTCCHAR:"desc",0,3,7,1,0x2902
+BLEGATTCCHAR:"char",0,3,8,0xC307,0x02

OK
```

#### 6. ESP32-C2 Bluetooth LE client reads a characteristic.

Command:

```
AT+BLEGATTCRD=0,3,1
```

Response:

```
+BLEGATTCRD:0,1,0

OK
```

Note:

- Please note that the target characteristic's property has to support the read operation.
- If the ESP32-C2 Bluetooth LE client reads the characteristic successfully, message `+READ:0,"7c:df:a1:b3:8d:de"` will be prompted on the ESP32-C2 Bluetooth LE Server side.

#### 7. ESP32-C2 Bluetooth LE client writes a characteristic.

Command:

```
AT+BLEGATTCWR=0,3,3,,2
```

Response:

```
>
```

The symbol `>` indicates that AT is ready for receiving serial data and you can enter data now. When the requirement of data length determined by the parameter `<length>` is met, the writing starts.

```
OK
```

Note:

- If the ESP32-C2 Bluetooth LE client writes the characteristic successfully, message `+WRITE:<conn_index>,<srv_index>,<char_index>,[<desc_index>],<len>,<value>` will be prompted on the ESP32-C2 Bluetooth LE server side.

#### 8. Indicate a characteristic.

ESP32-C2 Bluetooth LE client:

Command:

```
AT+BLEGATTCWR=0,3,7,1,2
```

Response:

```
>
```

The symbol `>` indicates that AT is ready for receiving serial data and you can enter data now. When the requirement of data length determined by the parameter `<length>` is met, the writing starts.

To receive data from ESP32-C2 Bluetooth LE server (through the `notify` or the `indicate` method), the ESP32-C2 Bluetooth LE client needs to register with the server in advance. Write the value `0x0001` to use the `notify` method, and `0x0002` to use the `indicate` method. This example writes the `0x0002` to use the `indicate` method.

```
OK
```

Note:

- If the ESP32-C2 Bluetooth LE client writes the descriptor successfully, message `+WRITE:<conn_index>,<srv_index>,<char_index>,<desc_index>,<len>,<value>` will be prompted on the ESP32-C2 Bluetooth LE server side.

ESP32-C2 Bluetooth LE server:

Command:

```
AT+BLEGATTSIND=0,1,7,3
```

Response:

```
>
```

The symbol `>` indicates that AT is ready for receiving serial data and you can enter data now. When the requirement of data length determined by the parameter `<length>` is met, the indication starts.

```
OK
```

Note:

- If the ESP32-C2 Bluetooth LE client receives the indication, message `+INDICATE:<conn_index>,<srv_index>,<char_index>,<len>,<value>` will be prompted.
- For the same service, the `<srv_index>` on the ESP32-C2 Bluetooth LE client side equals the `<srv_index>` on the ESP32-C2 Bluetooth LE server side + 2.
- For the permissions of the characteristics in the services, please refer to [How to Customize Bluetooth® LE Services](#).

### 4.3.3 Encrypt Bluetooth LE connection

Below is an example of using two ESP32-C2 development boards, one as a Bluetooth LE server (only as Bluetooth LE server role), the other one as a Bluetooth LE client (only as Bluetooth LE client role). The example shows how to encrypt Bluetooth LE connection.

---

#### Important:

- In the following steps, the operations starting with ESP32-C2 Bluetooth LE server only need to be executed at ESP32-C2 Bluetooth LE server, and the operations starting with ESP32-C2 Bluetooth LE client only need to be executed at ESP32-C2 Bluetooth LE client.
  - Encryption and bonding are two different concepts. bonding is just a long-term key stored locally after successful encryption.
  - ESP-AT allows a maximum of 10 devices to be bonded.
- 

#### 1. Bluetooth LE initialization.

ESP32-C2 Bluetooth LE server:

Command:

```
AT+BLEINIT=2
```

Response:

```
OK
```

ESP32-C2 Bluetooth LE client:

Command:

```
AT+BLEINIT=1
```

Response:

```
OK
```

## 2. ESP32-C2 Bluetooth LE server gets Bluetooth LE address.

Command:

```
AT+BLEADDR?
```

Response:

```
+BLEADDR: "24:0a:c4:d6:e4:46"  
OK
```

Note:

- The address you obtain may be different from that in the above response. Keep yours handy as you will need it in one of the following steps.

## 1. ESP32-C2 Bluetooth LE server discovers characteristics.

Command:

```
AT+BLEGATTSCHAR?
```

Response:

```
+BLEGATTSCHAR: "char", 1, 1, 0xC300  
+BLEGATTSCHAR: "char", 1, 2, 0xC301  
+BLEGATTSCHAR: "char", 1, 3, 0xC302  
+BLEGATTSCHAR: "char", 1, 4, 0xC303  
+BLEGATTSCHAR: "char", 1, 5, 0xC304  
+BLEGATTSCHAR: "char", 1, 6, 0xC305  
+BLEGATTSCHAR: "char", 1, 7, 0xC306  
+BLEGATTSCHAR: "char", 1, 8, 0xC307  
+BLEGATTSCHAR: "char", 2, 1, 0xC400  
+BLEGATTSCHAR: "char", 2, 2, 0xC401  
  
OK
```

## 2. ESP32-C2 Bluetooth LE server starts advertising, then the ESP32-C2 Bluetooth LE client starts scanning and lasts for 3 s.

ESP32-C2 Bluetooth LE server:

Command:

```
AT+BLEADVSTART
```

Response:

```
OK
```

ESP32-C2 Bluetooth LE client:

Command:

```
AT+BLESCAN=1, 3
```

Response:

```
OK  
+BLESCAN: "5b:3b:6c:51:90:49", -87, 02011a020a0c0aff4c001005071c3024dc, , 1  
+BLESCAN: "c4:5b:be:93:ec:66", -84, 0201060303111809095647543147572d58020a03, , 0  
+BLESCAN: "24:0a:c4:d6:e4:46", -29, , , 0
```

Note:

- The scan results you obtain may be different from those in the above response.

## 3. Establish the Bluetooth LE connection.

ESP32-C2 Bluetooth LE client:

Command:



```
AT+BLECONN=0, "24:0a:c4:d6:e4:46"
```

Response:

```
+BLECONN:0, "24:0a:c4:d6:e4:46"
```

OK

Note:

- When entering the above command, replace the address with your ESP32-C2 Bluetooth LE server address.
  - If the Bluetooth LE connection is established successfully, message `+BLECONN:0, "24:0a:c4:d6:e4:46"` will be prompted.
  - If the Bluetooth LE connection is broken, message `+BLECONN:0, -1` will be prompted.
4. ESP32-C2 Bluetooth LE client discovers services.

Command:

```
AT+BLEGATTCPRIMSRV=0
```

Response:

```
+BLEGATTCPRIMSRV:0,1,0x1800,1
+BLEGATTCPRIMSRV:0,2,0x1801,1
+BLEGATTCPRIMSRV:0,3,0xA002,1
+BLEGATTCPRIMSRV:0,4,0xA003,1
```

OK

Note:

- When discovering services, the ESP32-C2 Bluetooth LE client will get two more default services (UUID: 0x1800 and 0x1801) than what the ESP32-C2 Bluetooth LE server will get. So, for the same service, the `<srv_index>` received by the ESP32-C2 Bluetooth LE client equals the `<srv_index>` received by the ESP32-C2 Bluetooth LE server + 2. For example, for service 0xA002, the `<srv_index>` queried on the ESP32-C2 Bluetooth LE client is 3, if the ESP32-C2 Bluetooth LE server is queried through the command `AT+BLEGATTSSRV?`, then `<srv_index>` is 1.
5. ESP32-C2 Bluetooth LE client discovers characteristics.

Command:

```
AT+BLEGATTCCHAR=0,3
```

Response:

```
+BLEGATTCCHAR:"char",0,3,1,0xC300,0x02
+BLEGATTCCHAR:"char",0,3,2,0xC301,0x02
+BLEGATTCCHAR:"char",0,3,3,0xC302,0x08
+BLEGATTCCHAR:"char",0,3,4,0xC303,0x04
+BLEGATTCCHAR:"char",0,3,5,0xC304,0x08
+BLEGATTCCHAR:"char",0,3,6,0xC305,0x10
+BLEGATTCCHAR:"desc",0,3,6,1,0x2902
+BLEGATTCCHAR:"char",0,3,7,0xC306,0x20
+BLEGATTCCHAR:"desc",0,3,7,1,0x2902
+BLEGATTCCHAR:"char",0,3,8,0xC307,0x02
```

OK

6. Set Bluetooth LE encryption parameters. Set `auth_req` to `SC_MITM_BOND`, `server's iocap` to `KeyboardOnly`, `client's iocap` to `KeyboardDisplay`, `key_size` to 16, `init_key` to 3, `rsp_key` to 3.

ESP32-C2 Bluetooth LE server:

Command:

```
AT+BLESECPARAM=13,2,16,3,3
```

Response:

```
OK
```

ESP32-C2 Bluetooth LE client:

Command:

```
AT+BLESECPARAM=13,4,16,3,3
```

Response:

```
OK
```

Note:

- In this example, ESP32-C2 Bluetooth LE server enters the pairing code and ESP32-C2 Bluetooth LE client displays the pairing code.
- ESP-AT supports Legacy Pairing and Secure Connections encryption methods, but the latter has a higher priority. If the peer also supports Secure Connections, then Secure Connections will be used for encryption.

7. ESP32-C2 Bluetooth LE client initiates encryption request.

Command:

```
AT+BLEENC=0,3
```

Response:

```
OK
```

Note:

If the ESP32-C2 Bluetooth LE server successfully receives the encryption request, message +BLESECREQ:0 will be prompted on the ESP32-C2 Bluetooth LE server side.

1. ESP32-C2 Bluetooth LE server replies pairing code.

Command:

```
AT+BLEKEYREPLY=0,793718
```

Response:

```
OK
```

After running this command, there will be corresponding messages prompt on both the ESP32-C2 Bluetooth LE server and the ESP32-C2 Bluetooth LE client.

ESP32-C2 Bluetooth LE server:

```
+BLESECKEYTYPE:0,16
+BLESECKEYTYPE:0,1
+BLESECKEYTYPE:0,32
+BLESECKEYTYPE:0,2
+BLEAUTHCmpl:0,0
```

ESP32-C2 Bluetooth LE client:

```
+BLESECNTIFYKEY:0,793718
+BLESECKEYTYPE:0,2
+BLESECKEYTYPE:0,16
+BLESECKEYTYPE:0,1
+BLESECKEYTYPE:0,32
+BLEAUTHCmpl:0,0
```

You can ignore the message starting with +BLESECKEYTYPE. In terms of the second parameter in the message +BLEAUTHCmpl:0,0,0 means encryption is successful, and 1 means encryption fails.

### 4.3.4 Establish SPP connection between two ESP32-C2 development boards and transmit data in UART-Bluetooth LE Passthrough Mode

Below is an example of using two ESP32-C2 development boards, one as a Bluetooth LE server (only as Bluetooth LE server role), the other one as a Bluetooth LE client (only as Bluetooth LE client role). The example shows how to build Bluetooth LE SPP (Serial Port Profile, UART-Bluetooth LE passthrough mode) with AT commands.

**Important:** In the following steps, the operations starting with ESP32-C2 Bluetooth LE server only need to be executed at ESP32-C2 Bluetooth LE server, and the operations starting with ESP32-C2 Bluetooth LE client only need to be executed at ESP32-C2 Bluetooth LE client.

1. Bluetooth LE initialization.

ESP32-C2 Bluetooth LE server:

Command:

```
AT+BLEINIT=2
```

Response:

```
OK
```

ESP32-C2 Bluetooth LE client:

Command:

```
AT+BLEINIT=1
```

Response:

```
OK
```

1. ESP32-C2 Bluetooth LE server gets Bluetooth LE address.

Command:

```
AT+BLEADDR?
```

Response:

```
+BLEADDR: "24:0a:c4:d6:e4:46"  
OK
```

Note:

- The address you obtain may be different from that in the above response. Keep yours handy as you will need it in one of the following steps.

2. ESP32-C2 Bluetooth LE server sets advertising parameters.

Command:

```
AT+BLEADVPARAM=50,50,0,0,7,0,,
```

Response:

```
OK
```

3. ESP32-C2 Bluetooth LE server sets advertising data.

Command:

```
AT+BLEADVDATA="0201060A09457370726573736966030302A0"
```

Response:

```
OK
```

4. ESP32-C2 Bluetooth LE server starts advertising.

Command:

```
AT+BLEADVSTART
```

Response:

```
OK
```

5. ESP32-C2 Bluetooth LE client enables a scanning for three seconds.

Command:

```
AT+BLESCAN=1,3
```

Response:

```
OK
+BLESCAN:"24:0a:c4:d6:e4:46",-78,0201060a09457370726573736966030302a0,,0
+BLESCAN:"45:03:cb:ac:aa:a0",-62,0201060aff4c001005441c61df7d,,1
+BLESCAN:"24:0a:c4:d6:e4:46",-26,0201060a09457370726573736966030302a0,,0
```

Note:

- The scan results you obtain may be different from those in the above response.

6. Establish the Bluetooth LE connection.

ESP32-C2 Bluetooth LE client:

Command:

```
AT+BLECONN=0,"24:0a:c4:d6:e4:46"
```

Response:

```
+BLECONN:0,"24:0a:c4:d6:e4:46"
```

```
OK
```

Note:

- When entering the above command, replace the address your ESP32-C2 Bluetooth LE server address.
- If the Bluetooth LE connection is established successfully, message `+BLECONN:0,"24:0a:c4:d6:e4:46"` will be prompted.
- If the Bluetooth LE connection is broken, message `+BLECONN:0,-1` will be prompted.

7. ESP32-C2 Bluetooth LE server discovers local services.

Command:

```
AT+BLEGATTSSRV?
```

Response:

```
+BLEGATTSSRV:1,1,0xA002,1
+BLEGATTSSRV:2,1,0xA003,1
```

```
OK
```

8. ESP32-C2 Bluetooth LE server discovers local characteristics.

Command:

```
AT+BLEGATTSSCHAR?
```

Response:

```
+BLEGATTSSCHAR:"char",1,1,0xC300
+BLEGATTSSCHAR:"char",1,2,0xC301
+BLEGATTSSCHAR:"char",1,3,0xC302
+BLEGATTSSCHAR:"char",1,4,0xC303
+BLEGATTSSCHAR:"char",1,5,0xC304
+BLEGATTSSCHAR:"char",1,6,0xC305
+BLEGATTSSCHAR:"char",1,7,0xC306
+BLEGATTSSCHAR:"char",1,8,0xC307
+BLEGATTSSCHAR:"char",2,1,0xC400
```

(continues on next page)

(continued from previous page)

```
+BLEGATTSSCHAR:"char",2,2,0xC401
```

```
OK
```

**9. ESP32-C2 Bluetooth LE client discovers services.**

Command:

```
AT+BLEGATTCPRIMSRV=0
```

Response:

```
+BLEGATTCPRIMSRV:0,1,0x1800,1
+BLEGATTCPRIMSRV:0,2,0x1801,1
+BLEGATTCPRIMSRV:0,3,0xA002,1
+BLEGATTCPRIMSRV:0,4,0xA003,1
```

```
OK
```

Note:

- When discovering services, the ESP32-C2 Bluetooth LE client will get two more default services (UUID: 0x1800 and 0x1801) than what the ESP32-C2 Bluetooth LE server will get. So, for the same service, the <srv\_index> received by the ESP32-C2 Bluetooth LE client equals the <srv\_index> received by the ESP32-C2 Bluetooth LE server + 2. For example, for service 0xA002, the <srv\_index> queried on the ESP32-C2 Bluetooth LE client is 3, if the ESP32-C2 Bluetooth LE server is queried through the command *AT+BLEGATTSSRV?*, then <srv\_index> is 1.

**10. ESP32-C2 Bluetooth LE client discovers characteristics.**

Command:

```
AT+BLEGATTCCHAR=0,3
```

Response:

```
+BLEGATTCCHAR:"char",0,3,1,0xC300,0x02
+BLEGATTCCHAR:"char",0,3,2,0xC301,0x02
+BLEGATTCCHAR:"char",0,3,3,0xC302,0x08
+BLEGATTCCHAR:"char",0,3,4,0xC303,0x04
+BLEGATTCCHAR:"char",0,3,5,0xC304,0x08
+BLEGATTCCHAR:"char",0,3,6,0xC305,0x10
+BLEGATTCCHAR:"desc",0,3,6,1,0x2902
+BLEGATTCCHAR:"char",0,3,7,0xC306,0x20
+BLEGATTCCHAR:"desc",0,3,7,1,0x2902
+BLEGATTCCHAR:"char",0,3,8,0xC307,0x02
```

```
OK
```

**11. ESP32-C2 Bluetooth LE client Configures Bluetooth LE SPP.**

Set a characteristic that enables writing permission to TX channel for sending data. Set another characteristic that supports notification or indication to RX channel for receiving data.

Command:

```
AT+BLESPPCFG=1,3,5,3,7
```

Response:

```
OK
```

**12. ESP32-C2 Bluetooth LE client enables Bluetooth LE SPP.**

Command:

```
AT+BLESPP
```

Response:

```
OK
```

```
>
```

This response indicates that AT has entered Bluetooth LE SPP mode and can send and receive data.

Note:

- After the ESP32-C2 Bluetooth LE client enables Bluetooth LE SPP, data received from serial port will be transmitted to the Bluetooth LE server directly.

#### 13. ESP32-C2 Bluetooth LE server Configures Bluetooth LE SPP.

Set a characteristic that supports notification or indication to TX channel for sending data. Set another characteristic that enables writing permission to RX channel for receiving data.

Command:

```
AT+BLESPPCFG=1,1,7,1,5
```

Response:

```
OK
```

#### 14. ESP32-C2 Bluetooth LE server enables Bluetooth LE SPP.

Command:

```
AT+BLESPP
```

Response:

```
OK
```

```
>
```

This response indicates that AT has entered Bluetooth LE SPP mode and can send and receive data.

Note:

- After the ESP32-C2 Bluetooth LE server enables Bluetooth LE SPP, the data received from serial port will be transmitted to the Bluetooth LE client directly.
- If the ESP32-C2 Bluetooth LE client does not enable Bluetooth LE SPP first, or uses other device as Bluetooth LE client, then the Bluetooth LE client needs to listen to the notification or indication first. For example, if the ESP32-C2 Bluetooth LE client does not enable Bluetooth LE SPP first, then it should use command `AT+BLEGATTCWR=0,3,7,1,1` to enable listening function first, so that the ESP32-C2 Bluetooth LE server can transmit successfully.
- For the same service, the `<srv_index>` on the ESP32-C2 Bluetooth LE client side equals the `<srv_index>` on the ESP32-C2 Bluetooth LE server side + 2.

### 4.3.5 Establish SPP connection between ESP32-C2 and mobile phone and transmit data in UART-Bluetooth LE passthrough mode

The example shows how to establish SPP connection between an ESP32-C2 development board (only serving as the Bluetooth LE server role) and a mobile phone (only serve as the Bluetooth LE client role) and how to transmit data between them in UART-Bluetooth LE passthrough mode.

---

**Important:** In the following steps, the operations starting with ESP32-C2 Bluetooth LE server only need to be executed at ESP32-C2 Bluetooth LE server, and those starting with ESP32-C2 Bluetooth LE client only need to be executed on the Bluetooth debugging assistant of the mobile phone.

---

1. First, you need to download the Bluetooth LE debugging assistant on the mobile phone, such as LightBlue.
2. Bluetooth LE initialization.

ESP32-C2 Bluetooth LE server:

Command:

```
AT+BLEINIT=2
```

Response:

```
OK
```

1. ESP32-C2 Bluetooth LE server gets its MAC address.

Command:

```
AT+BLEADDR?
```

Response:

```
+BLEADDR: "24:0a:c4:d6:e4:46"  
OK
```

Note:

- The address you obtain may be different from that in the above response. Keep yours handy as you will need it in one of the following steps.

2. ESP32-C2 Bluetooth LE server sets advertising parameters.

Command:

```
AT+BLEADVPARAM=50,50,0,0,7,0,,
```

Response:

```
OK
```

3. ESP32-C2 Bluetooth LE server sets advertising data.

Command:

```
AT+BLEADVDATA="0201060A09457370726573736966030302A0"
```

Response:

```
OK
```

4. ESP32-C2 Bluetooth LE server starts advertising.

Command:

```
AT+BLEADVSTART
```

Response:

```
OK
```

5. Establish the Bluetooth LE connection.

Open the LightBlue application on your mobile phone, and click `SCAN` to start scanning. When you find the MAC address of the ESP32-C2 Bluetooth LE server, click `CONNECT`. Then, ESP32-C2 should print the log similar to `+BLECONN:0,"60:51:42:fe:98:aa"`, which indicates that Bluetooth LE connection has been established.

6. ESP32-C2 Bluetooth LE server discovers local services.

Command:

```
AT+BLEGATTSSRV?
```

Response:

```
+BLEGATTSSRV:1,1,0xA002,1  
+BLEGATTSSRV:2,1,0xA003,1  
  
OK
```

7. ESP32-C2 Bluetooth LE server discovers local characteristics.

Command:

```
AT+BLEGATTCHAR?
```

Response:

```
+BLEGATTSSCHAR:"char",1,1,0xC300
+BLEGATTSSCHAR:"char",1,2,0xC301
+BLEGATTSSCHAR:"char",1,3,0xC302
+BLEGATTSSCHAR:"char",1,4,0xC303
+BLEGATTSSCHAR:"char",1,5,0xC304
+BLEGATTSSCHAR:"char",1,6,0xC305
+BLEGATTSSCHAR:"char",1,7,0xC306
+BLEGATTSSCHAR:"char",1,8,0xC307
+BLEGATTSSCHAR:"char",2,1,0xC400
+BLEGATTSSCHAR:"char",2,2,0xC401

OK
```

8. ESP32-C2 Bluetooth LE client discovers characteristics.  
Click the button of the service feature whose Properties is NOTIFY or INDICATE in the mobile phone LightBlue client (here ESP-AT default Properties The service characteristics of NOTIFY or INDICATE are 0xC305 and 0xC306) and start to listen for the service characteristics of NOTIFY or INDICATE.
9. ESP32-C2 Bluetooth LE server configures Bluetooth LE SPP.  
Set a characteristic that supports notification or indication to TX channel for sending data. Set another characteristic that enables writing permission to RX channel for receiving data.

Command:

```
AT+BLESPPCFG=1,1,7,1,5
```

Response:

```
OK
```

10. ESP32-C2 Bluetooth LE server enables Bluetooth LE SPP.

Command:

```
AT+BLESPP
```

Response:

```
OK
```

```
>
```

This response indicates that AT has entered Bluetooth LE SPP mode and can send and receive data.

11. Bluetooth LE client sends data.  
In the LightBlue client, select the 0xC304 service characteristic value and send the data `test` to the ESP32-C2 Bluetooth LE server. Then, the ESP32-C2 Bluetooth LE server can receive the `test`.
12. ESP32-C2 Bluetooth LE server sends data.  
The ESP32-C2 Bluetooth LE server sends `test`, and then the LightBlue client can receive `test`.

### 4.3.6 Establish Bluetooth LE connection and pairing between ESP32-C2 and mobile phone

This example shows how to establish a Bluetooth LE connection between the ESP32-C2 development board (only as a Bluetooth LE server role) and a mobile phone (only as a Bluetooth LE client role) and enter the passkey to complete the pairing.

---

**Important:** In the following steps, the operations starting with `ESP32-C2 Bluetooth LE server` only need to be executed at ESP32-C2 Bluetooth LE server, and those starting with `ESP32-C2 Bluetooth LE client` only need to be executed on the Bluetooth debugging assistant of the mobile phone.

---

1. First, you need to download the Bluetooth LE debugging assistant on the mobile phone, such as LightBlue.
2. Bluetooth LE initialization.  
ESP32-C2 Bluetooth LE server:



Command:

```
AT+BLEINIT=2
```

Response:

```
OK
```

1. ESP32-C2 Bluetooth LE server gets its MAC address.

Command:

```
AT+BLEADDR?
```

Response:

```
+BLEADDR: "24:0a:c4:d6:e4:46"  
OK
```

Note:

- The address you obtain may be different from that in the above response. Keep yours handy as you will need it in one of the following steps.
2. ESP32-C2 Bluetooth LE server sets advertising parameters.

Command:

```
AT+BLEADVPARAM=50,50,0,0,7,0,,
```

Response:

```
OK
```

3. ESP32-C2 Bluetooth LE server sets advertising data.

Command:

```
AT+BLEADVDATA="0201060A09457370726573736966030302A0"
```

Response:

```
OK
```

4. ESP32-C2 Bluetooth LE server sets encryption parameters.

Command:

```
AT+BLESECPARAM=13,2,16,3,3
```

Response:

```
OK
```

5. ESP32-C2 Bluetooth LE server starts advertising.

Command:

```
AT+BLEADVSTART
```

Response:

```
OK
```

6. Establish the Bluetooth LE connection.

Open the LightBlue application on your mobile phone, and click `SCAN` to start scanning. When you find the MAC address of the ESP32-C2 Bluetooth LE server, click `CONNECT`. Then, ESP32-C2 should print the log similar to `+BLECONN:0,"60:51:42:fe:98:aa"`, which indicates that Bluetooth LE connection has been established.

7. ESP32-C2 Bluetooth LE server initiates encryption request.

Command:

```
AT+BLEENC=0,3
```

Response:

```
OK
```

8. Bluetooth LE client accepts pairing.

The pairing information (including the pairing key, for example: 231518) will pop up on the Bluetooth LE connection page that has just been successfully created on the LightBlue, and then click “Pairing”. At this time, the ESP32-C2 Bluetooth LE server should print a log similar to `+BLESECKEYREQ:0`, indicating that the phone has responded to pairing, and the ESP32-C2 Bluetooth LE server can enter the key.

9. ESP32-C2 Bluetooth LE server replies with the pairing key.

At this time, the key that the Bluetooth LE server should reply with is the key (231518) contained in the pairing information that popped up on LightBlue in the previous step.

Command:

```
AT+BLEKEYREPLY=0,231518
```

Response:

```
OK
```

At this time, the ESP32-C2 Bluetooth LE server will print a log similar to the following, which means that the ESP32-C2 Bluetooth LE server has successfully paired with the phone Bluetooth LE client.

```
+BLESECKEYTYPE:0,16
+BLESECKEYTYPE:0,1
+BLESECKEYTYPE:0,32
+BLESECKEYTYPE:0,2
+BLEAUTHCMPL:0,0
```

## 4.4 MQTT AT Examples

This document provides detailed command examples to illustrate how to utilize *MQTT AT Commands* on ESP32-C2.

- *MQTT over TCP (with a local MQTT broker)(suitable for a small amount of data)*
- *MQTT over TCP (with a local MQTT broker)(suitable for large amounts of data)*
- *MQTT over TLS (with a local MQTT broker)*
- *MQTT over WSS*

### Important:

- The examples described in this document are based on the situation that Wi-Fi has been connected.

### 4.4.1 MQTT over TCP (with a local MQTT broker)(suitable for a small amount of data)

Below is an example of using two ESP32-C2 development boards, one as a MQTT publisher (only as MQTT publisher role), the other one as a MQTT subscriber (only as MQTT subscriber role).

The example shows how to establish MQTT connections over TCP. You need to first create a local MQTT broker. For example, the MQTT broker’s IP address is 192.168.3.102, and the port is 8883.

**Important:** In the step, the operations starting with `ESP32-C2 MQTT publisher` only need to be executed at ESP32-C2 MQTT publisher, and the operations starting with `ESP32-C2 MQTT subscriber` only need to be executed at ESP32-C2 MQTT subscriber. If the operation is not specified on which side it is executed, it needs to be executed on both the publisher side and the subscriber side.

1. Set MQTT user configuration.

ESP32-C2 MQTT publisher:

Command:

```
AT+MQTTUSERCFG=0,1,"publisher","espressif","123456789",0,0,""
```

Response:

```
OK
```

ESP32-C2 MQTT subscriber:

Command:

```
AT+MQTTUSERCFG=0,1,"subscriber","espressif","123456789",0,0,""
```

Response:

```
OK
```

2. Connect to MQTT brokers.

Command:

```
AT+MQTTCONN=0,"192.168.3.102",8883,1
```

Response:

```
+MQTTCONNECTED:0,1,"192.168.3.102","8883","","1
```

```
OK
```

Note:

- The MQTT broker domain or MQTT broker IP address you enter may be different from those in the above command.

3. Subscribe to MQTT topics.

ESP32-C2 MQTT subscriber:

Command:

```
AT+MQTTSUB=0,"topic",1
```

Response:

```
OK
```

4. Publish MQTT messages in string.

ESP32-C2 MQTT publisher:

Command:

```
AT+MQTTPUB=0,"topic","test",1,0
```

Response:

```
OK
```

Note:

- If the ESP32-C2 MQTT publisher successfully publishes the message, following message will be prompted on the ESP32-C2 MQTT subscriber.

```
+MQTTSUBRECV:0,"topic",4,test
```

5. Close MQTT connections.

Command:

```
AT+MQTTCLEAN=0
```

Response:

```
OK
```

## 4.4.2 MQTT over TCP (with a local MQTT broker)(suitable for large amounts of data)

Below is an example of using two ESP32-C2 development boards, one as a MQTT publisher (only as MQTT publisher role), the other one as a MQTT subscriber (only as MQTT subscriber role).

The example shows how to establish MQTT connections over TCP. You need to first create a local MQTT broker. For example, the MQTT broker's IP address is 192.168.3.102, and the port is 8883.

If the amount of data you publish is relatively large, and the length of a single AT command has exceeded the threshold of 256, it is recommended that you use the `AT+MQTTPUBRAW` command.

**Important:** In the step, the operations starting with ESP32-C2 MQTT publisher only need to be executed at ESP32-C2 MQTT publisher, and the operations starting with ESP32-C2 MQTT subscriber only need to be executed at ESP32-C2 MQTT subscriber. If the operation is not specified on which side it is executed, it needs to be executed on both the publisher side and the subscriber side.

1. Set MQTT user configuration.

ESP32-C2 MQTT publisher:

Command:

```
AT+MQTTUSERCFG=0,1,"publisher","espressif","123456789",0,0,""
```

Response:

```
OK
```

ESP32-C2 MQTT subscriber:

Command:

```
AT+MQTTUSERCFG=0,1,"subscriber","espressif","123456789",0,0,""
```

Response:

```
OK
```

2. Connect to MQTT brokers.

Command:

```
AT+MQTTCONN=0,"192.168.3.102",8883,1
```

Response:

```
+MQTTCONNECTED:0,1,"192.168.3.102","8883","",",1
```

```
OK
```

Note:

- The MQTT broker domain or MQTT broker IP address you enter may be different from those in the above command.

3. Subscribe to MQTT topics.

ESP32-C2 MQTT subscriber:

Command:

```
AT+MQTTSUB=0,"topic",1
```

Response:

```
OK
```

4. Publish MQTT messages in string.

Assume the data you want to publish is as follows, length is 427 bytes.

```
{
  "headers": {
    "Accept": "application/json",
    "Accept-Encoding": "gzip, deflate",
    "Accept-Language": "en-US,en;q=0.9,zh-CN;q=0.8,zh;q=0.7",
    "Content-Length": "0",
    "Host": "httpbin.org",
    "Origin": "http://httpbin.org",
    "Referer": "http://httpbin.org/",
    "User-Agent": "Mozilla/5.0 (X11; Linux x86_64) AppleWebKit/537.36 (KHTML, like Gecko) Chrome/91.0.4472.114 Safari/537.36",
    "X-Amzn-Trace-Id": "Root=1-6150581e-1ad4bd5254b4bf5218070413"
  }
}
```

(continued from previous page)

ESP32-C2 MQTT publisher:

Command:

```
AT+MQTTPUBRAW=0, "topic", 427, 0, 0
```

Response:

OK

&gt;

This response indicates that AT is ready for receiving serial data. You should enter the data, and when the data length reaches the <length> value, the transmission of data starts.

```
+MQTTPUB:OK
```

Note:

- After AT outputs the > character, the special characters in the data does not need to be escaped through the escape character, and it does not need to end with a new line(CR-LF).
- If the ESP32-C2 MQTT publisher successfully publishes the message, following message will be prompted on the ESP32-C2 MQTT subscriber.

```
+MQTTSUBRECV:0, "topic", 427, {"headers": {"Accept": "application/json",
↪ "Accept-Encoding": "gzip, deflate", "Accept-Language": "en-US,en;q=0.9,zh-
↪ CN;q=0.8,zh;q=0.7", "Content-Length": "0", "Host": "httpbin.org", "Origin":
↪ "http://httpbin.org", "Referer": "http://httpbin.org/", "User-Agent":
↪ "Mozilla/5.0 (X11; Linux x86_64) AppleWebKit/537.36 (KHTML, like Gecko)
↪ Chrome/91.0.4472.114 Safari/537.36", "X-Amzn-Trace-Id": "Root=1-6150581e-
↪ 1ad4bd5254b4bf5218070413"}}}
```

#### 5. Close MQTT connections.

Command:

```
AT+MQTTCLEAN=0
```

Response:

OK

### 4.4.3 MQTT over TLS (with a local MQTT broker)

Below is an example of using two ESP32-C2 development boards, one as a MQTT publisher (only as MQTT publisher role), the other one as a MQTT subscriber (only as MQTT subscriber role).

The example shows how to establish MQTT connections over TLS. You need to first create a local MQTT broker. For example, the MQTT broker's IP address is 192.168.3.102, and port is 8883.

**Important:** In the step, the operations starting with ESP32-C2 MQTT publisher only need to be executed at ESP32-C2 MQTT publisher, and the operations starting with ESP32-C2 MQTT subscriber only need to be executed at ESP32-C2 MQTT subscriber. If the operation is not specified on which side it is executed, it needs to be executed on both the publisher side and the subscriber side.

#### 1. Set the time zone and the SNTP server.

Command:

```
AT+CIPSNTPCFG=1,8, "ntp1.aliyun.com"
```

Response:

```
OK
```

2. Query the SNTP time.

Command:

```
AT+CIPSNTPTIME?
```

Response:

```
+CIPSNTPTIME:Thu Sep  2 18:57:03 2021
OK
```

Note:

- The time you obtained may be different from that in the above response.
- Please make sure that the SNTP time must be a real and valid time and cannot be the time in 1970 or before.
- The purpose of setting the time is to verify the validity period of the certificates during TLS authentication.

3. Set MQTT user configuration.

ESP32-C2 MQTT publisher:

Command:

```
AT+MQTTUSERCFG=0,4,"publisher","espressif","123456789",0,0,""
```

Response:

```
OK
```

ESP32-C2 MQTT subscriber:

Command:

```
AT+MQTTUSERCFG=0,4,"subscriber","espressif","123456789",0,0,""
```

Response:

```
OK
```

4. Set configuration of MQTT connection.

Command:

```
AT+MQTTCONNCFG=0,0,0,"lwtt","lwtm",0,0
```

Response:

```
OK
```

5. Connect to MQTT brokers.

Command:

```
AT+MQTTCONN=0,"192.168.3.102",8883,1
```

Response:

```
+MQTTCONNECTED:0,4,"192.168.3.102","8883","","1
```

```
OK
```

Note:

- The MQTT broker domain or MQTT broker IP address you enter may be different from those in the above command.

6. Subscribe to MQTT topics.

ESP32-C2 MQTT subscriber:

Command:

```
AT+MQTTSUB=0,"topic",1
```

Response:

```
OK
```

#### 7. Publish MQTT messages in string.

ESP32-C2 MQTT publisher:

Command:

```
AT+MQTTPUB=0,"topic","test",1,0
```

Response:

```
OK
```

Note:

- If the ESP32-C2 MQTT publisher successfully publishes the message, following message will be prompted on the ESP32-C2 MQTT subscriber.

```
+MQTTSUBRECV:0,"topic",4,test
```

#### 8. Close MQTT connections.

Command:

```
AT+MQTTCLEAN=0
```

Response:

```
OK
```

### 4.4.4 MQTT over WSS

Below is an example of using two ESP32-C2 development boards, one as a MQTT publisher (only as MQTT publisher role), the other one as a MQTT subscriber (only as MQTT subscriber role).

The example shows how to establish MQTT connections over WSS and how to communicate with a MQTT broker. For example, the MQTT broker's domain name is `mqtt.eclipseprojects.io`, the path is `mqtt`, and the port is 443.

---

**Important:** In the step, the operations starting with `ESP32-C2 MQTT publisher` only need to be executed at ESP32-C2 MQTT publisher, and the operations starting with `ESP32-C2 MQTT subscriber` only need to be executed at ESP32-C2 MQTT subscriber. If the operation is not specified on which side it is executed, it needs to be executed on both the publisher side and the subscriber side.

---

#### 1. Set the time zone and the SNTP server.

Command:

```
AT+CIPSNTPCFG=1,8,"ntp1.aliyun.com"
```

Response:

```
OK
```

#### 2. Query the SNTP time.

Command:

```
AT+CIPSNTPTIME?
```

Response:

```
+CIPSNTPTIME:Thu Sep 2 18:57:03 2021
OK
```

Note:

- The time you obtained may be different from that in the above response.

- Please make sure that the SNTP time must be a real and valid time and cannot be the time in 1970 or before.
  - The purpose of setting the time is to verify the validity period of the certificates during TLS authentication.
3. Set MQTT user configuration.

ESP32-C2 MQTT publisher:

Command:

```
AT+MQTTUSERCFG=0,7,"publisher","espressif","1234567890",0,0,"mqtt"
```

Response:

```
OK
```

ESP32-C2 MQTT subscriber:

Command:

```
AT+MQTTUSERCFG=0,7,"subscriber","espressif","1234567890",0,0,"mqtt"
```

Response:

```
OK
```

4. Connect to MQTT brokers.

Command:

```
AT+MQTTCONN=0,"mqtt.eclipseprojects.io",443,1
```

Response:

```
+MQTTCONNECTED:0,7,"mqtt.eclipseprojects.io","443","/mqtt",1
```

```
OK
```

Note:

- The MQTT broker domain or MQTT broker IP address you enter may be different from those in the above command.

5. Subscribe to MQTT topics.

ESP32-C2 MQTT subscriber:

Command:

```
AT+MQTTSUB=0,"topic",1
```

Response:

```
OK
```

6. Publish MQTT messages in string.

ESP32-C2 MQTT publisher:

Command:

```
AT+MQTTPUB=0,"topic","test",1,0
```

Response:

```
OK
```

Note:

- If the ESP32-C2 MQTT publisher successfully publishes the message, following message will be prompted on the ESP32-C2 MQTT subscriber.

```
+MQTTSUBRECV:0,"topic",4,test
```

7. Close MQTT connections.

Command:

```
AT+MQTTCLEAN=0
```

Response:



OK

## 4.5 MQTT AT Examples for Cloud

This document mainly describes how to connect your ESP32-C2 to AWS IoT with MQTT AT commands.

---

**Important:** For details on how to use MQTT AT commands, please refer to [MQTT AT Commands](#). You need to become familiar with the AWS IoT by reading the [AWS IoT Development Guide](#).

---

Please follow the steps below to connect your ESP32-C2 to AWS IoT with ESP-AT.

- [Obtain certificates and endpoints from AWS IoT](#)
  - [Connect to AWS IoT based on mutual authentication with MQTT AT commands](#)

### 4.5.1 Obtain certificates and endpoints from AWS IoT

1. Sign in to your AWS IoT Console account and switch to the IoT Core services.
2. Create an AWS IoT policy, thing, and certificates following the instructions in [Create AWS IoT Resources](#).

Make sure you have got the following certificate and key files:

- `device.pem.crt` (Device certificate)
  - `private.pem.key` (Private key)
  - `Amazon-root-CA-1.pem` (Root CA certificate)
3. Get the endpoint and bind the thing to the policy through the certificate according to the documentation [Set up the policy](#).

The endpoint value has the format of `xxx-ats.iot.us-east-2.amazonaws.com`.

---

**Note:** It is strongly recommended to familiarize yourself with the [AWS IoT Developer Guide](#). Below are some key points from this Guide that are worth noting.

- All devices must have a device certificate, private key, and root CA certificate installed in order to communicate with AWS IoT.
  - Information on how to activate certificates.
  - Select Ohio as your region.
- 

### 4.5.2 Connect to AWS IoT based on mutual authentication with MQTT AT commands

#### Replace certificates

Open your local ESP-AT project and do the following:

- Replace `customized_partitions/raw_data/mqtt_ca/mqtt_ca.crt` with `Amazon-root-CA-1.pem`.
- Replace `customized_partitions/raw_data/mqtt_cert/mqtt_client.crt` with `device.pem.crt`.
- Replace `customized_partitions/raw_data/mqtt_key/mqtt_client.key` with `private.pem.key`.

### Compile and flash the AT firmware

Compile the ESP-AT project to build the AT firmware, and flash the firmware to your ESP32-C2. For more information, please refer to [Compile ESP-AT Project Locally](#).

---

**Note:** If you do not want to compile the ESP-AT project to replace certificates, you can directly use the AT command to replace certificates in the firmware. For more information, please refer to [How to Update PKI Configuration](#).

---

### Use AT commands to connect to AWS IoT

1. Set the Wi-Fi mode to station.

Command:

```
AT+CWMODE=1
```

Response:

```
OK
```

2. Connect to the AP.

Command:

```
AT+CWJAP=<ssid>,<password>
```

Response:

```
OK
```

3. Set the SNTP server.

Command:

```
AT+CIPSNTPCFG=1,8,"pool.ntp.org"
```

Response:

```
OK
```

4. Query the SNTP time.

Command:

```
AT+CIPSNTPTIME?
```

Response:

```
+CIPSNTPTIME:<asctime style time>  
OK
```

Note:

- The <asctime style time> obtained at this time must be the real-time time of the set time zone, otherwise the connection will fail due to the validity period of the certificate.

5. Set MQTT user properties.

Command:

```
AT+MQTTUSERCFG=0,5,"esp32","espressif","1234567890",0,0,""
```

Response:

```
OK
```

Note:

- If the second parameter of AT+MQTTUSERCFG is 5, it is authenticated by both sides and cannot be changed.

6. Connect to AWS IoT.

Command:

```
AT+MQTTCONN=0, "<endpoint>", 8883, 1
```

Response:

```
+MQTTCONNECTED:0, 5, <endpoint>, "8883", "", 1
OK
```

Note:

- Please fill in your endpoint value in the *<endpoint>* parameter.
- The port 8883 cannot be changed.

7. Subscribe to messages.

Command:

```
AT+MQTTSUB=0, "topic/esp32at", 1
```

Response:

```
OK
```

8. Publish a message.

Command:

```
AT+MQTTPUB=0, "topic/esp32at", "hello aws!", 1, 0
```

Response:

```
+MQTTSUBRECV:0, "topic/esp32at", 10, hello aws!
OK
```

### Example log

Log for normal interaction is as follows:

1. Log on the ESP32 side
2. Log on the AWS side

## 4.6 Web Server AT Example

This document mainly introduces the use of AT web server, mainly involving the following applications:

- [Wi-Fi Provisioning Using a Browser](#)
- [OTA Firmware Upgrade Using a Browser](#)
- [Wi-Fi Provisioning Using a WeChat Applet](#)
- [OTA Firmware Upgrade Using a WeChat Applet](#)
- [ESP32-C2 Using Captive Portal](#)

---

**Note:** The default firmware does not support web server AT commands, please refer to [Web Server AT Commands](#) to enable the web server.

---

### 4.6.1 Wi-Fi Provisioning Using a Browser

```
[20:12:43:217] AT+CWMODE=1
[20:12:43:217] OK
[20:12:43:217] OK
[20:12:56:684] AT+CWJAP="MERCURY_407",""
[20:12:58:234] WIFI CONNECTED
[20:12:58:937] WIFI GOT IP
[20:12:58:937] OK
[20:12:58:937] OK
[20:13:01:892] AT+CIPSNTPCFG=1,8,"ntp1.aliyun.com"
[20:13:01:892] OK
[20:13:01:892] OK
[20:13:10:854] AT+CIPSNTPTIME?
[20:13:10:854] +CIPSNTPTIME:Wed Jan 19 20:13:10 2022
[20:13:10:854] OK
[20:13:15:716] AT+MQTTUSERCFG=0,5,"esp32","espressif","1234567890",0,0,""
[20:13:15:716] OK
[20:13:15:716] OK
[20:13:23:030] AT+MQTTCONN=0,"a108b8vm1g634q-ats.iot.us-east-2.amazonaws.com",8883,1
[20:13:31:479] +MQTTCONNECTED:0,5,"a108b8vm1g634q-ats.iot.us-east-2.amazonaws.com","8883","",1
[20:13:31:479] OK
[20:13:31:479] OK
[20:13:34:275] AT+MQTTSUB=0,"topic/esp32at",1
[20:13:35:521] OK
[20:13:35:521] OK
[20:13:41:959] AT+MQTTPUB=0,"topic/esp32at","hello aws!",1,0
[20:13:42:422] +MQTTSUBRECV:0,"topic/esp32at",10,hello aws!
[20:13:42:422] OK
[20:13:42:422] OK
[20:13:49:335] +MQTTSUBRECV:0,"topic/esp32at",45,{
[20:13:49:335] "message": "Hello from AWS IoT console"
[20:13:49:335] }
```

MQTT client Info Connected as lotconsole-1642593579651-0

Subscriptions	topic/esp32at	Export	Clear	Pause
<p>Subscribe to a topic</p> <p>Publish to a topic</p> <p><b>topic/esp32at</b> ✕</p>	<p><b>Publish</b> Specify a topic and a message to publish with a QoS of 0.</p> <p>topic/esp32at <span>Publish to topic</span></p> <pre> 1   2   "message": "Hello from AWS IoT console" 3                       </pre>			
	<p>topic/esp32at</p> <pre>{   "message": "Hello from AWS IoT console" }</pre>	January 19, 2022, 20:13:49 (UTC+0800)	Export	Hide
	<p>topic/esp32at</p> <p>We cannot display the message as JSON, and are instead displaying it as UTF-8 String.</p> <pre>hello aws!</pre>	January 19, 2022, 20:13:42 (UTC+0800)	Export	Hide

## Introduction

With the web server, mobile phone or PC is able to control ESP32-C2's Wi-Fi provisioning service. You can use a mobile phone or computer to connect to the SoftAP of the ESP32-C2, open the web pages via browser, start provisioning service, and then the ESP32-C2 can connect to the target router as you set.

## Introduction to Operation Steps

The whole process can be divided into the following three steps:

- *Use STA Device to Connect to ESP32-C2 Device*
- *Use the Browser to Send Wi-Fi Connection Information*
- *Get the Result of Wi-Fi Connection*

**Use STA Device to Connect to ESP32-C2 Device** Firstly, ESP32-C2 needs to be configured to softAP + STA mode, and creates a web server to wait for Wi-Fi provisioning messages. In this case, a mobile phone or a PC can connect to the ESP32-C2 softAP as a station. The corresponding AT commands are as follows:

1. Clear the previous Wi-Fi provisioning information.

- Command

```
AT+RESTORE
```

2. Set the Wi-Fi mode to Station+SoftAP.

- Command

```
AT+CWMODE=3
```

3. Set the configuration of an ESP32-C2 SoftAP. (For example, set the default connection ssid to “pos\_softap”, Wi-Fi without password.)

- Command

```
AT+CWSAP="pos_softap","",11,0,3
```

4. Enable multiple connections.

- Command

```
AT+CIPMUX=1
```

5. Create a web server, port: 80, connection timeout: 25 s (default maximum is 60 s).

- Command

```
AT+WEBSERVER=1,80,25
```

After starting the web sever according to the above commands, you can turn on the Wi-Fi connection function on your STA device, and connect it to the softAP of the ESP32-C2:

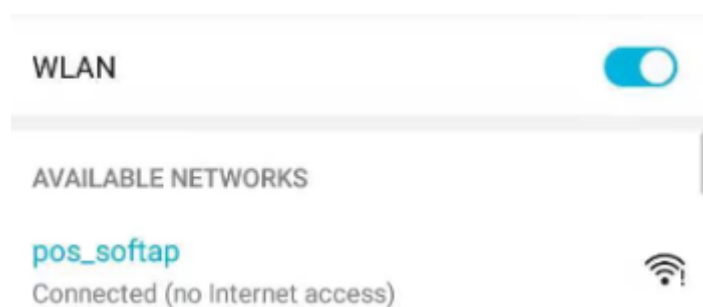

Fig. 1: Connection to the ESP32-C2 AP

**Use the Browser to Send Wi-Fi Connection Information** After your STA device connected to the ESP32-C2 softAP, it can send Wi-Fi connection information to ESP32-C2 in an HTTP request. Please note that if your target AP is the hotspot of the device which opens the web pages, you may not receive the Wi-Fi connection result. You can enter the default IP address of the web server in the browser (the default IP is 192.168.4.1, or you can query the current SoftAP IP address by command AT+CIPAP?), open the Wi-Fi provisioning interface, and enter the ssid and password of the router to be connected, click “Connect” to let ESP32-C2 start connecting to the router:

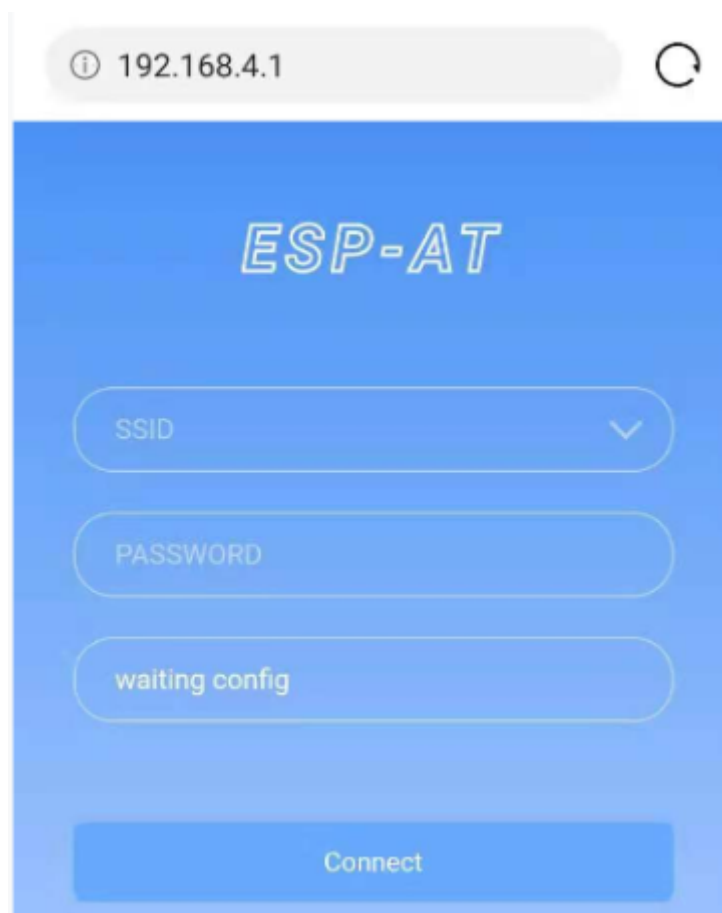

Fig. 2: Opening the Wi-Fi Provisioning Interface

Or you can click the drop-down box of SSID to list all APs nearby, select the target AP and enter the password, and then click “Connect” to let the ESP32-C2 start connecting to the router:

**Get the Result of Wi-Fi Connection** After the Wi-Fi connection is established successfully, the web page will be displayed as follows:

**Note 1:** After the Wi-Fi connection is established successfully, the webpage will be closed automatically. If you want to continue to access the webpage, please re-enter the IP address of the ESP32-C2 and reopen the webpage.

At the same time, the following messages will be returned from the ESP-AT command port:

```
+WEBSERVERRSP:1      // meaning that ESP32-C2 has received Wi-Fi connection.
↪information
WIFI CONNECTED      // meaning that ESP32-C2 is connecting
WIFI GOT IP         // meaning that ESP32-C2 connect successfully to the
↪destination router
+WEBSERVERRSP:2      // meaning that STA device has received Wi-Fi connection.
↪result, and web resources can be released
```

If the ESP32-C2 fails to connect to the router, the web page will display:

At the same time, the following messages will be returned from the ESP-AT command port:

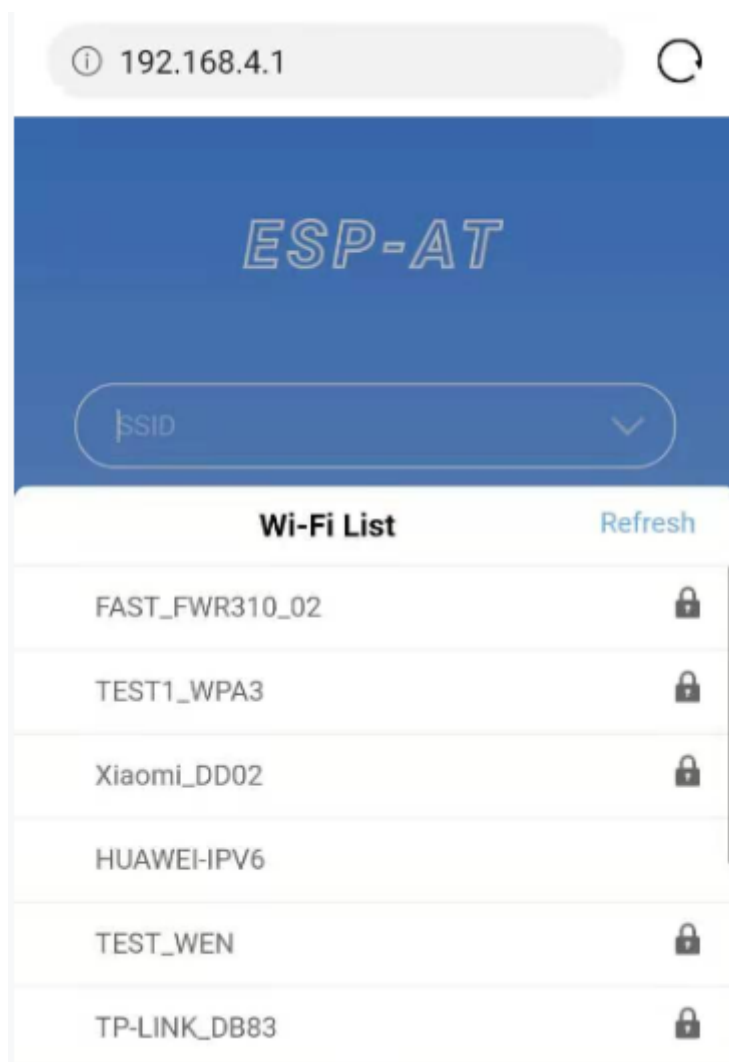

Fig. 3: Schematic Diagram Of Browser Obtaining Wi-Fi AP List



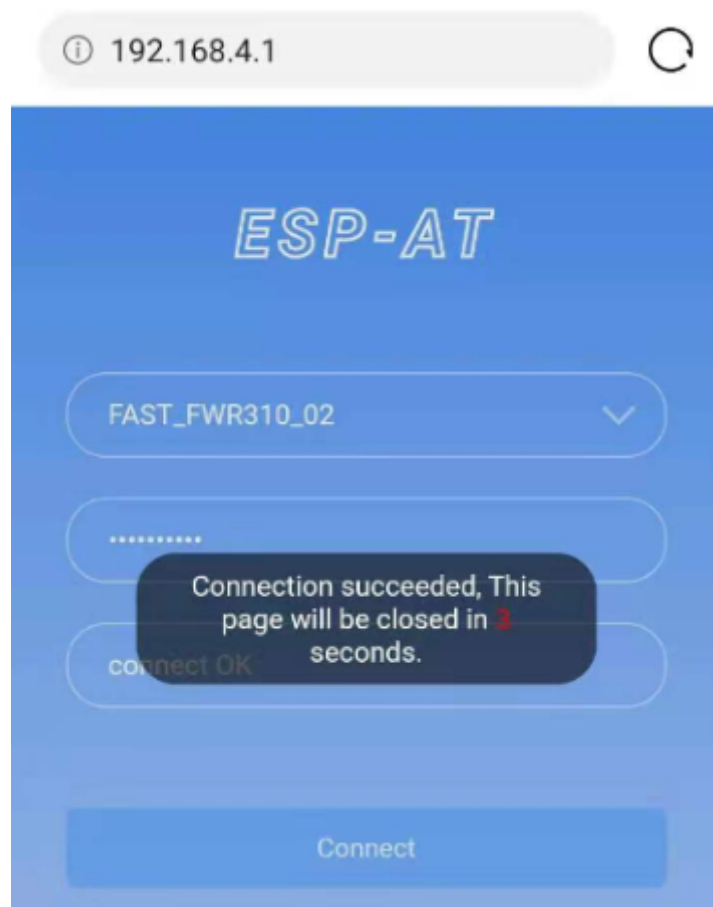

Fig. 4: Wi-Fi Connection Established Successfully

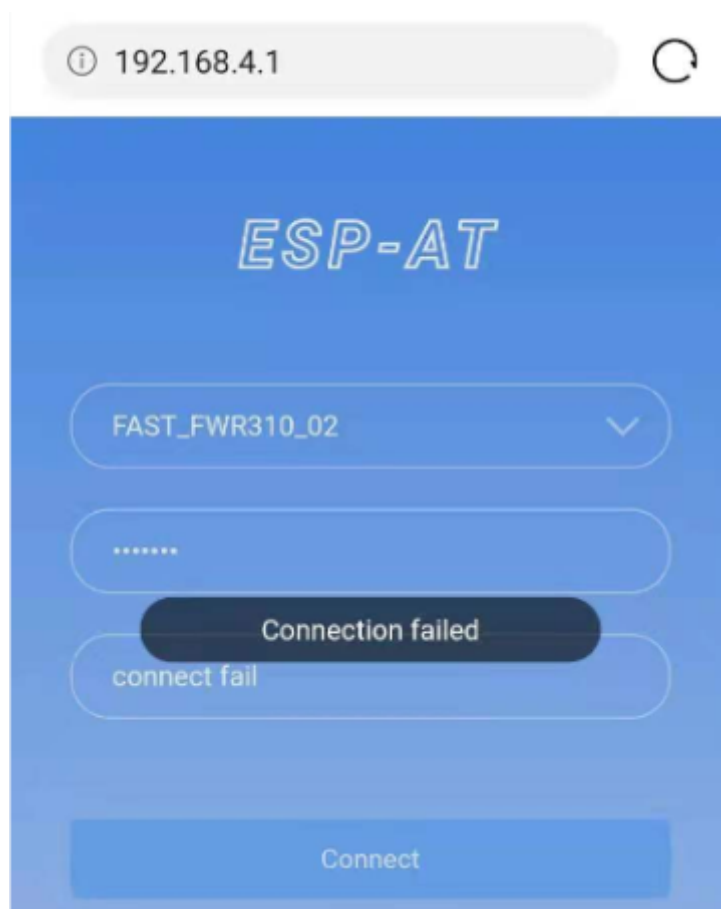

Fig. 5: Failed Connection to the Router

```
+WEBSERVERRSP:1 // meaning that ESP32-C2 has received Wi-Fi connection_
↪information, but failed to connect to the router.
```

## Troubleshooting

**Note 1:** The network configuration page received a prompt “Connection failed” . Please check whether the Wi-Fi AP of the ESP32-C2 module is correctly turned on, and the relevant configuration of the AP, and confirm that the correct AT command has been entered to successfully enable the web server.

## 4.6.2 OTA Firmware Upgrade Using a Browser

### Introduction

After the browser opens the web page of the web server, you can choose to enter the OTA upgrade page to upgrade the firmware in the app partitions or the certificate binaries in other partitions (please refer to [How to Update PKI Configuration](#) for more about certificate information).

### Introduction to Operation Steps

- [Open the OTA Configuration Page](#)
- [Selecting the Partition to Upgrade](#)
- [Send the New Firmware](#)
- [Get the Result of OTA](#)

**Open the OTA Configuration Page** As shown in the figure, click on the “OTA” option in the lower right corner of the web page, and after opening the OTA configuration page, you can view the current firmware version and AT Core version:

**Note 1:** The configuration interface can only be opened when the STA device is connected to the AP of the ESP32-C2, or the STA device accessing the OTA configuration page is connected to the ESP32-C2 in the same subnet.

**Note 2:** The “current app version” displayed on the webpage is the version number of the application. You can change the version number through `./build.py menuconfig->Component config->AT->AT firmware version` (see [Compile ESP-AT Project Locally](#)). In this case, you can manage your application firmware version.

**Selecting the Partition to Upgrade** As shown in the figure, click the drop-down box of “Partition” to obtain all partitions that can be upgraded:

**Send the New Firmware** As shown in the figure, click the “Browse” button on the page and select the new firmware to be sent:

Then you can click “OTA upgrade” button to send the firmware.

**Note 1:** For the `ota` partition, the web page will check the selected firmware. The suffix of the firmware name must be `.bin`. Please make sure that the firmware size does not exceed the size of the `ota` partition defined in the `partitions_at.csv` file. For more information on this file, please refer to [How to Add Support for a Module](#).

**Note 2:** For other partitions, the web page will check the selected firmware. The suffix of the firmware name must be `.bin`. Please make sure that the firmware size does not exceed the size defined in the `at_customize.csv` file. For more information on this file, please refer to [How to Customize Partitions](#).

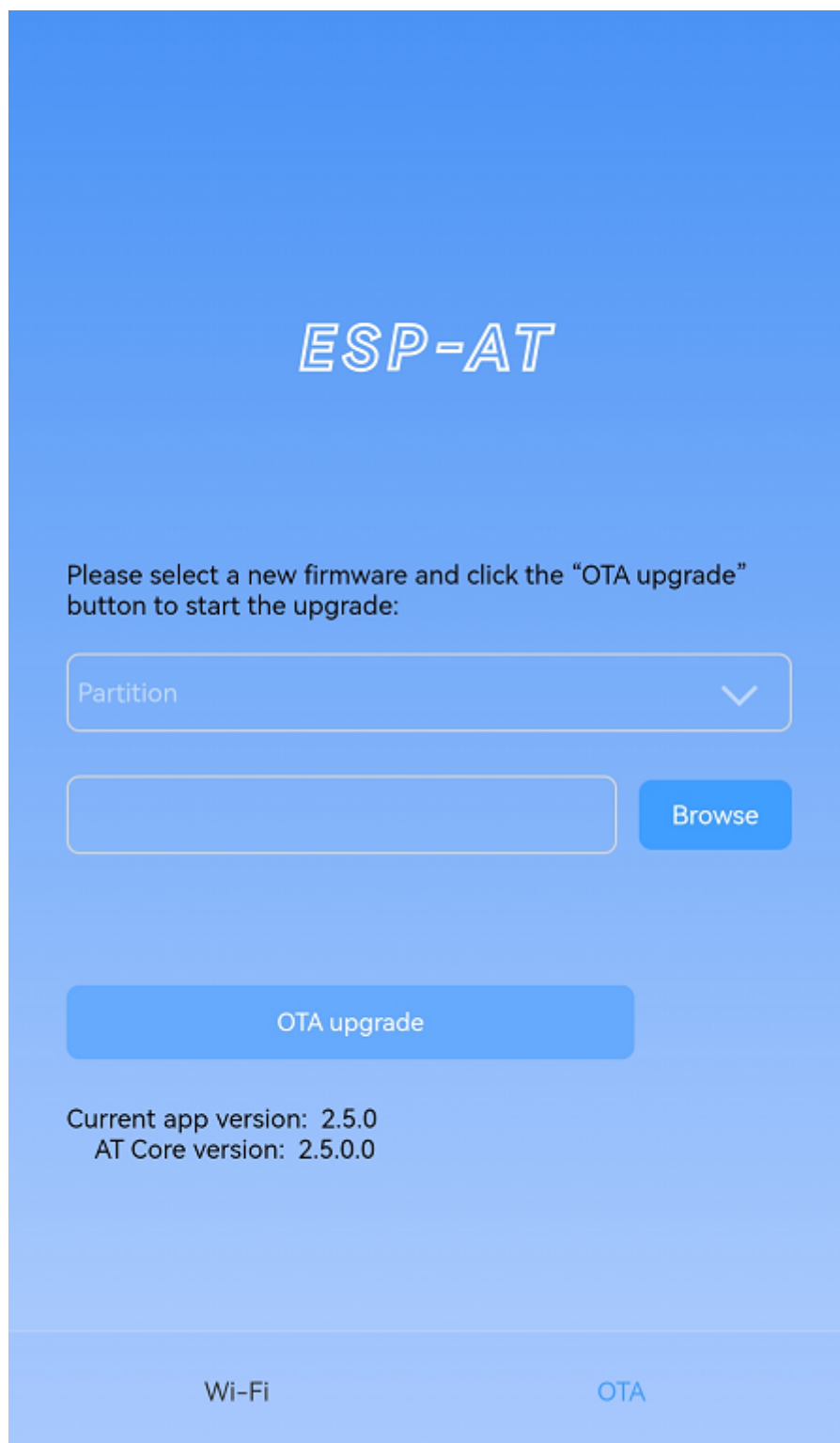

Fig. 6: OTA Configuration Page

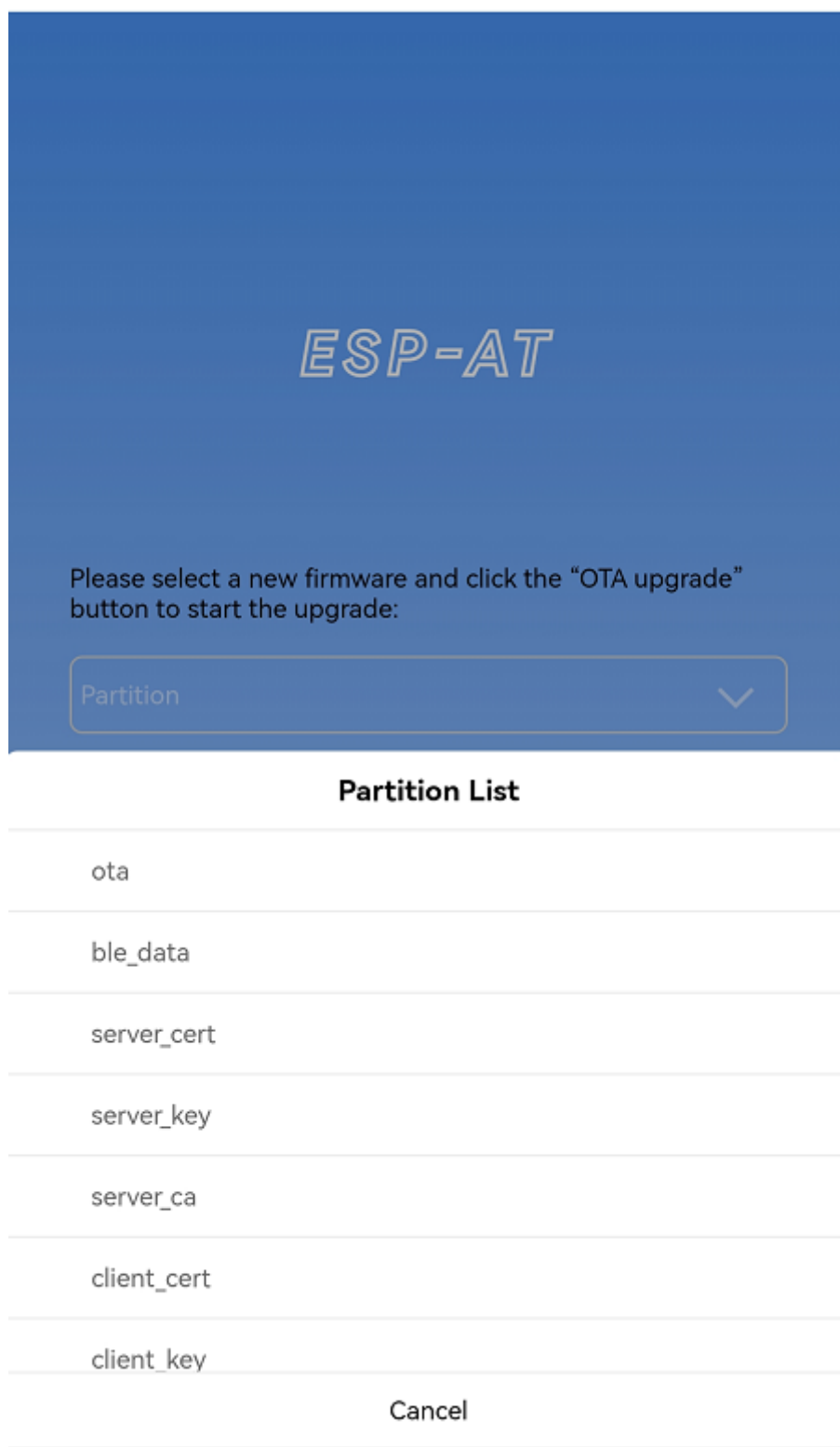

Fig. 7: Obtaining All Partitions That Can Be Upgraded

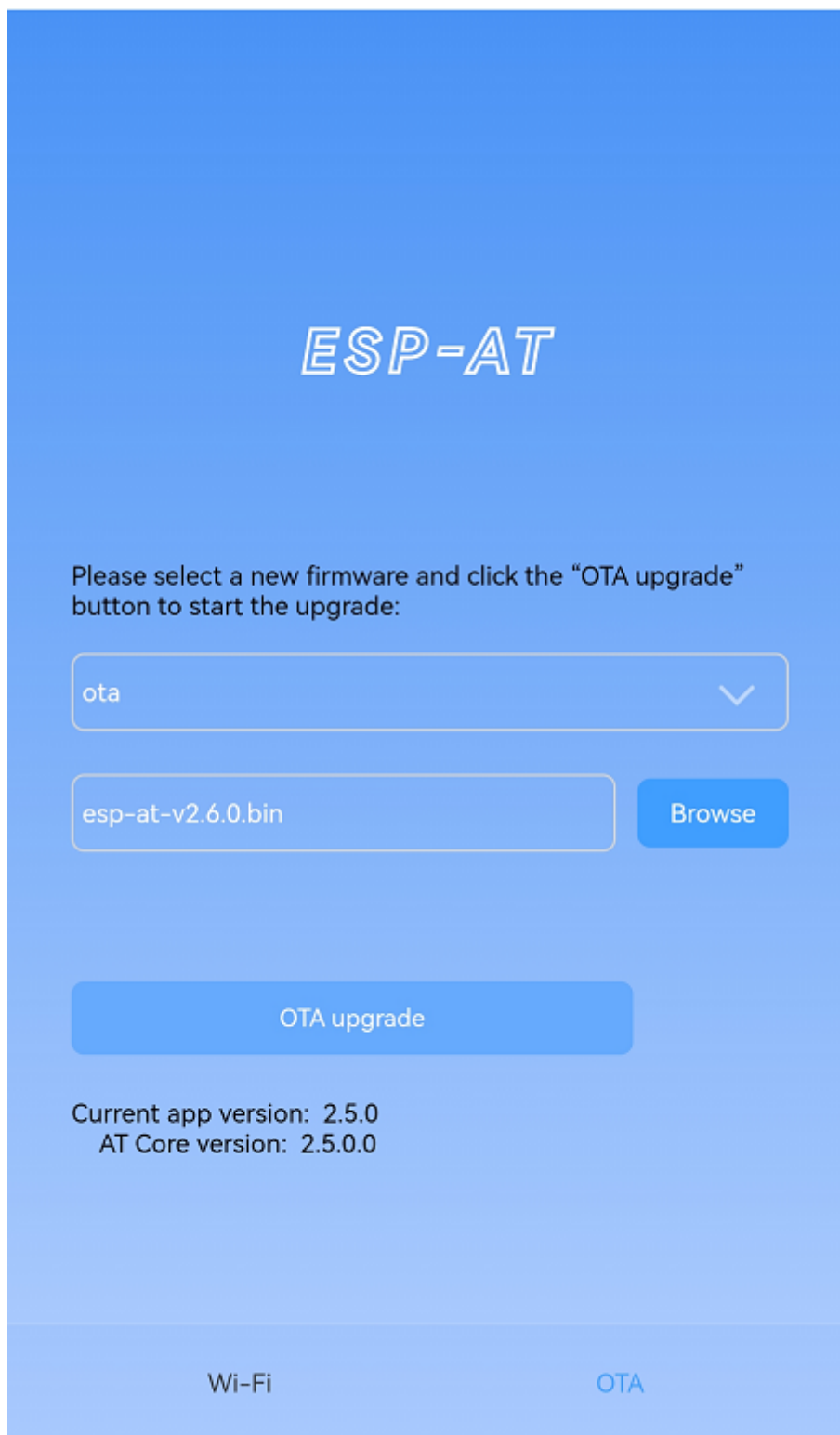

Fig. 8: Selecting the New Firmware to Be Sent

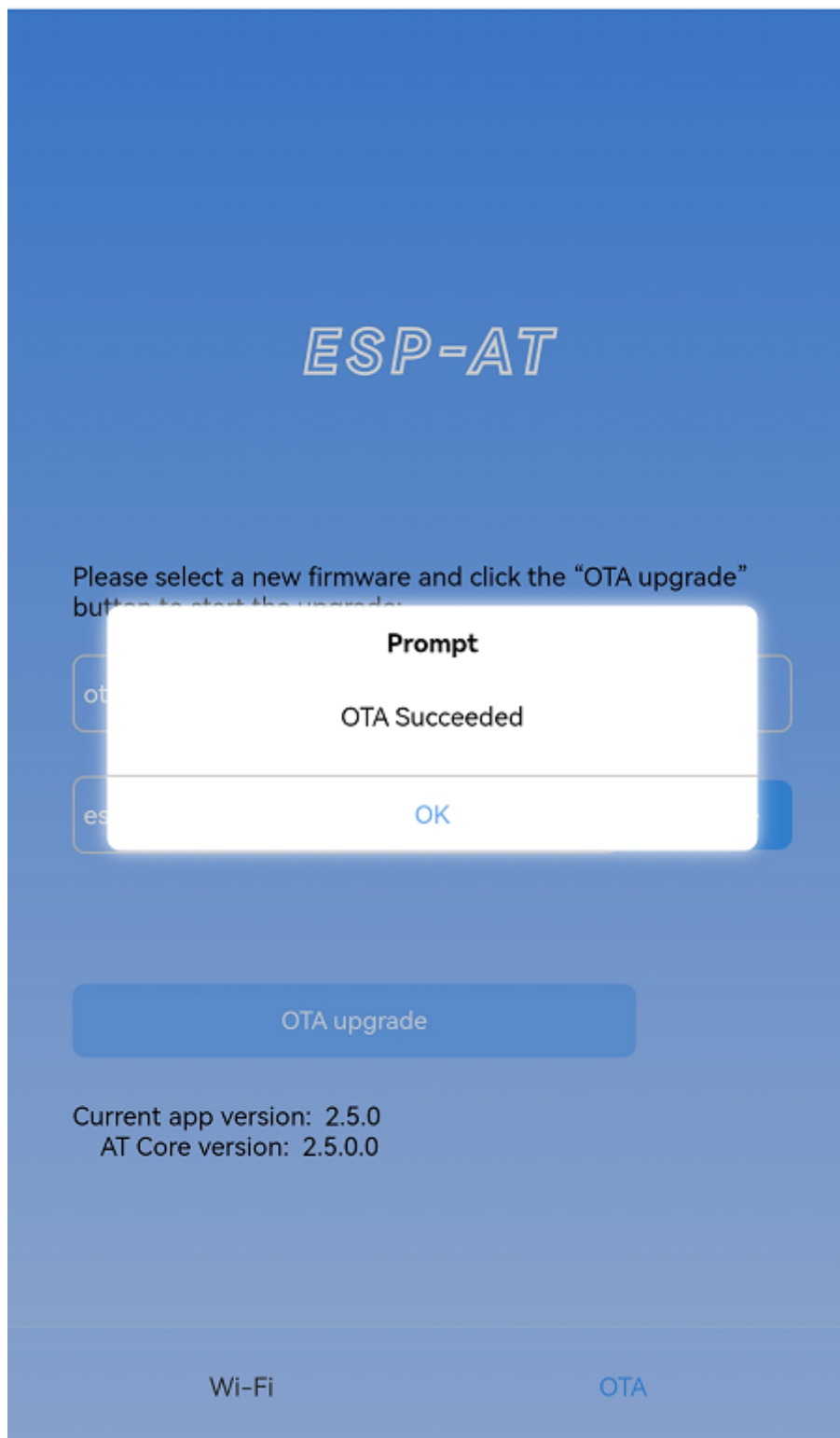

Fig. 9: The New Firmware Sent Successfully

**Get the Result of OTA** As shown in the figure, if the ESP32-C2 OTA successfully, it will prompt “OTA Succeeded” :

At the same time, the following messages will be returned from the ESP-AT command port:

```
+WEBSEVERRSP:3 // meaning that ESP32-C2 begin to receive OTA data
+WEBSEVERRSP:4 // meaning that ESP32-C2 has received all firmware data
```

If the ESP32-C2 OTA failed, it will prompt “OTA Failed” :

At the same time, the following message will be received on the serial port:

```
+WEBSEVERRSP:3 // meaning that ESP32-C2 begin to receive OTA data
+WEBSEVERRSP:5 // meaning a failure of receiving OTA data failed. You can
↳ choose to reopen the OTA configuration interface and follow the above steps to
↳ restart the firmware upgrade
```

**Note 1:** For the ota partition, you need to execute *AT+RST* to restart the ESP32-C2 to apply the new firmware.

**Note 2:** ESP32-C2 will only verify the received ota firmware content. The firmware data received by other partitions will not be verified, so please make sure its content is correct.

### 4.6.3 Wi-Fi Provisioning Using a WeChat Applet

#### Introduction

The WeChat applet can automatically connect to the WiFi AP of the ESP32-C2, and then send the ssid and password required by the ESP32-C2 to connect to the network.

#### Introduction to Operation Steps

The whole process can be divided into the following four steps:

- *Configure ESP32-C2 Device Parameters*
- *Load WeChat Applet*
- *Target AP Selection*
- *Use the WeChat Applet to Send Wi-Fi Connection Information*

**Configure ESP32-C2 Device Parameters** Firstly, ESP32-C2 needs to be configured to softAP + STA mode, and creates a web server to wait for Wi-Fi provisioning messages. In this case, a mobile phone or a PC can connect to the ESP32-C2 softAP as a station. The corresponding AT commands are as follows:

1. Clear the previous Wi-Fi provisioning information.

- Command

```
AT+RESTORE
```

2. Set the Wi-Fi mode to Station+SoftAP.

- Command

```
AT+CWMODE=3
```

3. Set the configuration of an ESP32-C2 SoftAP. (For example, set the default connection ssid to “pos\_softap”, and password to “espressif” .)

- Command

```
AT+CWSAP="pos_softap","espressif",11,3,3
```



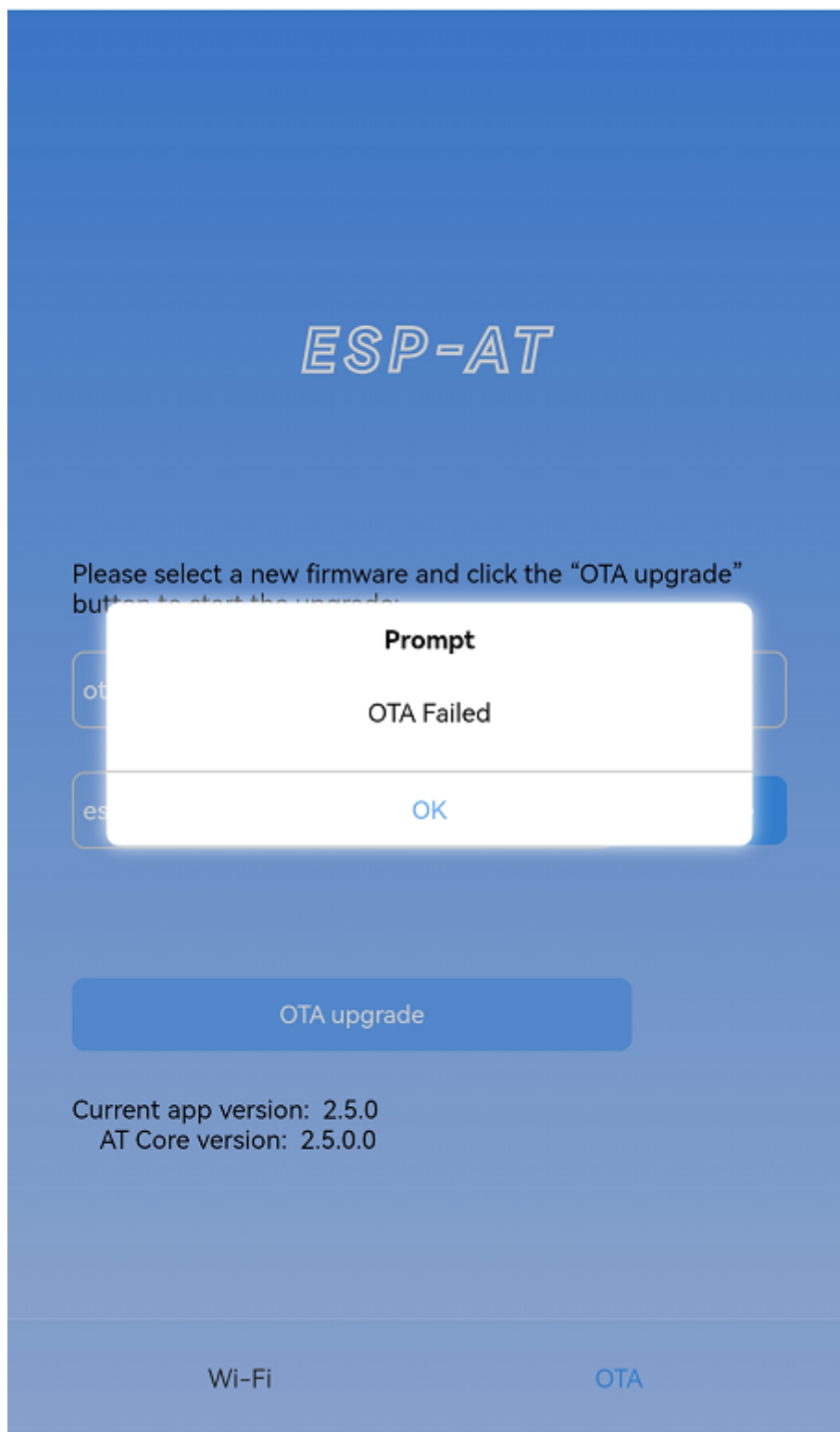

Fig. 10: Failed Sending of the New Firmware

**Note:** By default, the WeChat applet initiates a connection to the SoftAP whose ssid is *pos\_softap* and password is *espressif*. Please make sure to set the parameters of the ESP32-C2 according to the above configuration.

1. Enable multiple connections.

- Command

```
AT+CIPMUX=1
```

2. Create a web server, port: 80, connection timeout: 40 s (default maximum is 60 s).

- Command

```
AT+WEBSERVER=1,80,40
```

**Load WeChat Applet** Open the mobile phone WeChat, scan the following QR code:



Fig. 11: Getting the QR Code of the Applet

Open the WeChat applet and enter the Wi-Fi provisioning interface:

**Target AP Selection** After loading the WeChat applet, there are two situations according to different target AP:

Situation 1. If your target AP is the hotspot of the mobile phone which running the WeChat applet, please select the “Local phone hotspot” option box on the WeChat applet page.

Situation 2. If your target AP is just another AP, not as the special situation one as above, then please do not select the “Local phone hotspot” option box.

### Use the WeChat Applet to Send Wi-Fi Connection Information

**The target AP to be accessed is not the hotspot provided by the mobile phone which loading the WeChat applet.** Here, take connecting to a router as an example, the process of Wi-Fi Connection configuration is introduced:

1. Turn on the mobile Wi-Fi and connect to the router:

2. Open the WeChat applet, you can see that the applet page has automatically displayed the ssid of the current router as “FAST\_FWR310\_02” .

Note: If the ssid of the connected router is not displayed on the current page, please click “Re-enter applet” in the following figure to refresh the current page:

3. After entering the password of the router, click “Connect” .

4. After the Wi-Fi connection is established successfully, the web page will be displayed as follows:

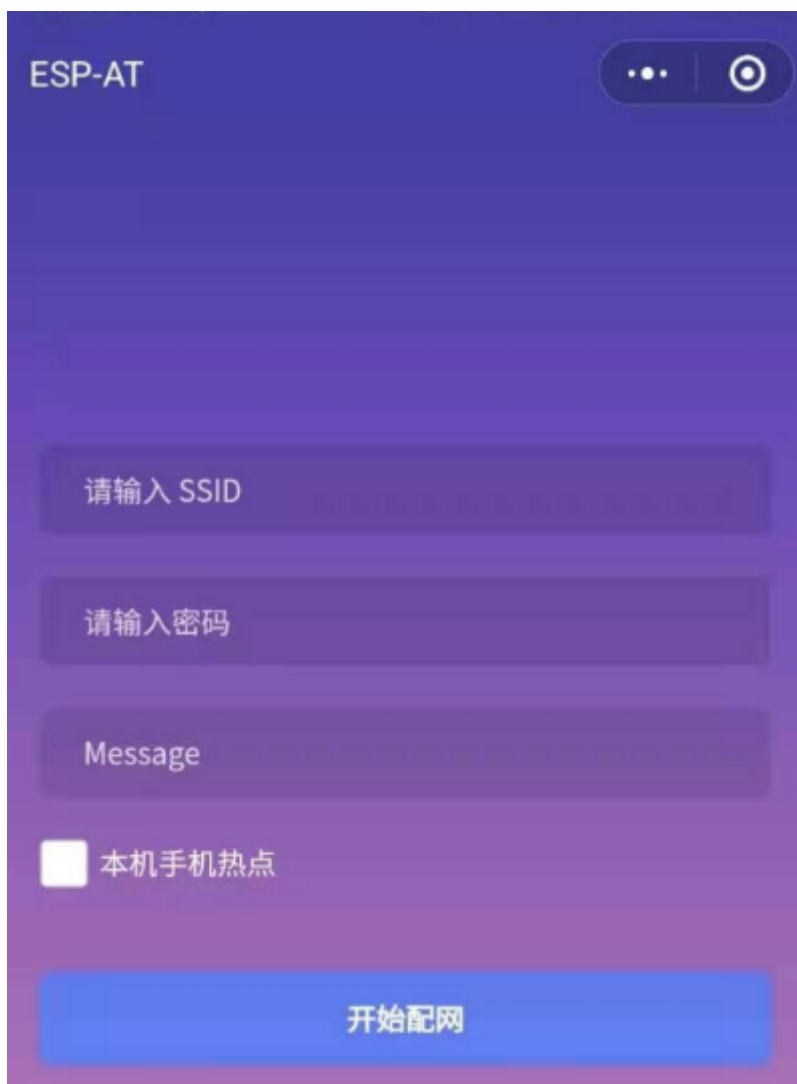

Fig. 12: Wi-Fi Provisioning Interface



Fig. 13: Connection to the Router



Fig. 14: Getting Router Information

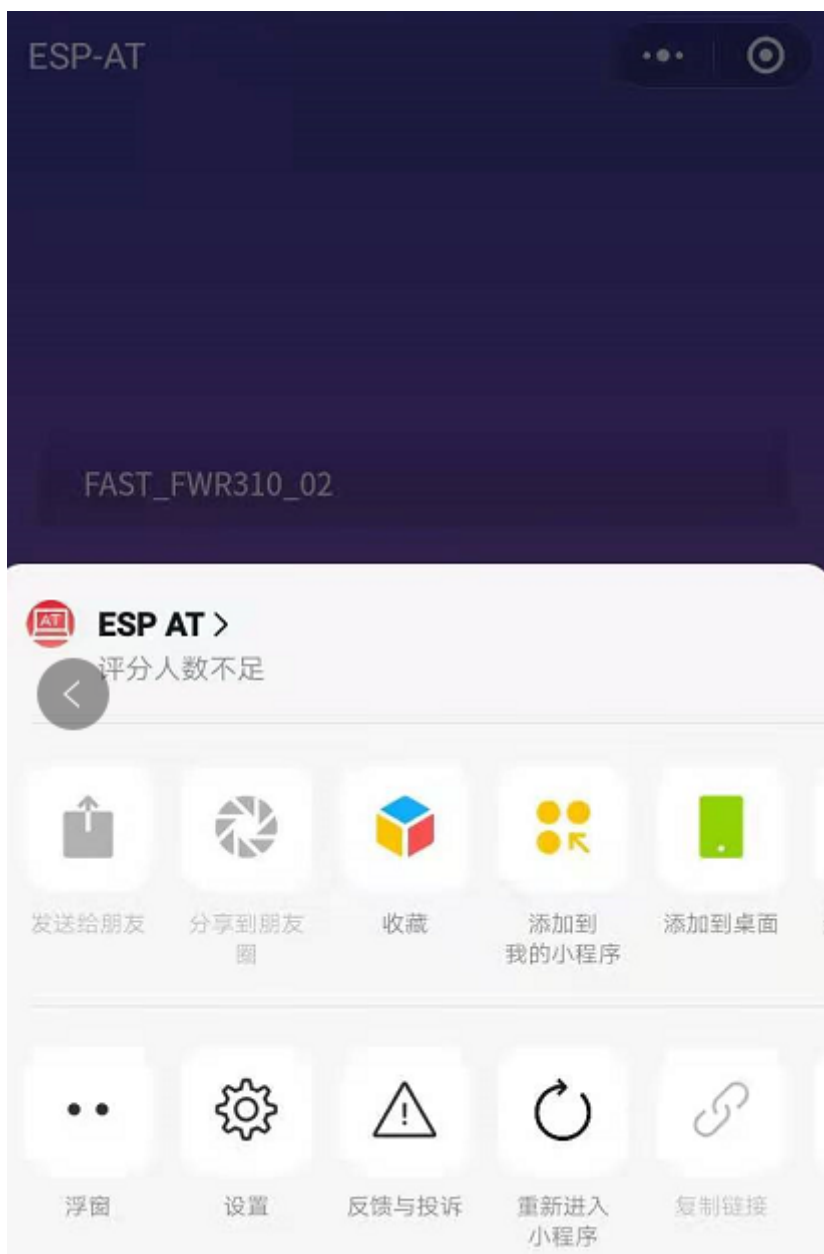

Fig. 15: Re-entering the Applet



Fig. 16: Connection to the Router via the Applet



Fig. 17: Successfully connection to the Router via the Applet

At the same time, the following messages will be returned from the ESP-AT command port:

```
+WEBSERVERRSP:1      // meaning that ESP32-C2 has received Wi-Fi connection.
↳information
WIFI CONNECTED      // meaning that ESP32-C2 is connecting
WIFI GOT IP         // meaning that ESP32-C2 connect successfully to the
↳destination router
+WEBSERVERRSP:2     // meaning that STA device has received Wi-Fi connection.
↳result, and web resources can be released
```

5.If the ESP32-C2 fails to connect to the router, the page will display:



Fig. 18: Failed Connection to the Router via the Applet

At the same time, the following messages will be returned from the ESP-AT command port:

```
+WEBSERVERRSP:1      // meaning that ESP32-C2 has received Wi-Fi connection.
↳information, but failed to connect to the router.
```

**The target AP to be accessed is the hotspot provided by the mobile phone which loading the WeChat applet.** If the target AP to be accessed is the hotspot provided by the mobile phone which loading the WeChat applet, it is not necessary to enter the ssid, but only needs to enter the password of the AP, and turn on the mobile AP in time according to the prompts.



---

**Note:** To use this function, keep at least the first five bytes of the phone's Personal Hotspot MAC address the same as those of the WLAN MAC address.

---

1. Select the “Local phone hotspot” option box on the WeChat applet page, enter the password of the local hotspot, and click “Connect” .

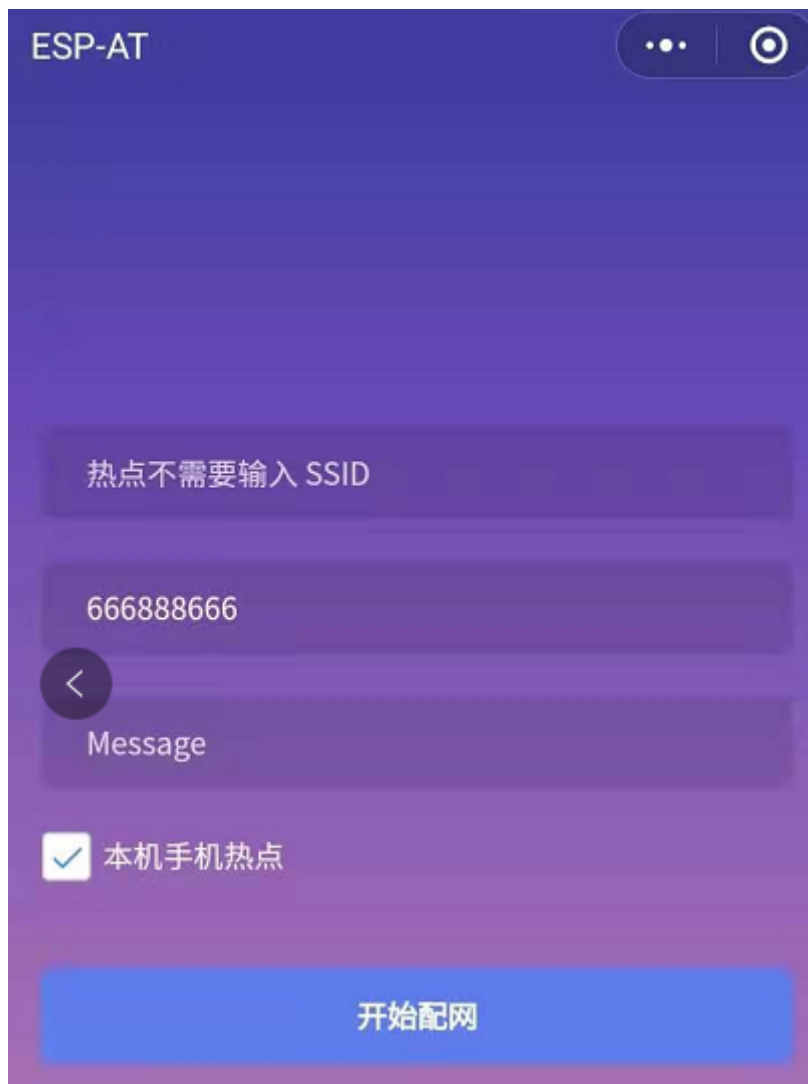

Fig. 19: Entering the Password of the AP

2. After receiving the prompt “Connecting to the mobile phone hotspot” , please check that the local mobile phone hotspot is turned on. At this time, the ESP32-C2 will automatically scan the surrounding hotspots and initiate a connection.

3. The display of the WiFi connection results on the applet page and the data output from the serial port are the same as the above-mentioned “The target AP to be accessed is not the hotspot provided by the mobile phone which loading the WeChat applet.” , please refer to the above.

### Troubleshooting

**Note 1:** The Wi-Fi provisioning page received a prompt “Data transmission failed” . Please check whether the Wi-Fi AP of the ESP32-C2 is correctly turned on, and the relevant configuration of the AP, and confirm that the correct AT command has been entered to successfully enable the web server.

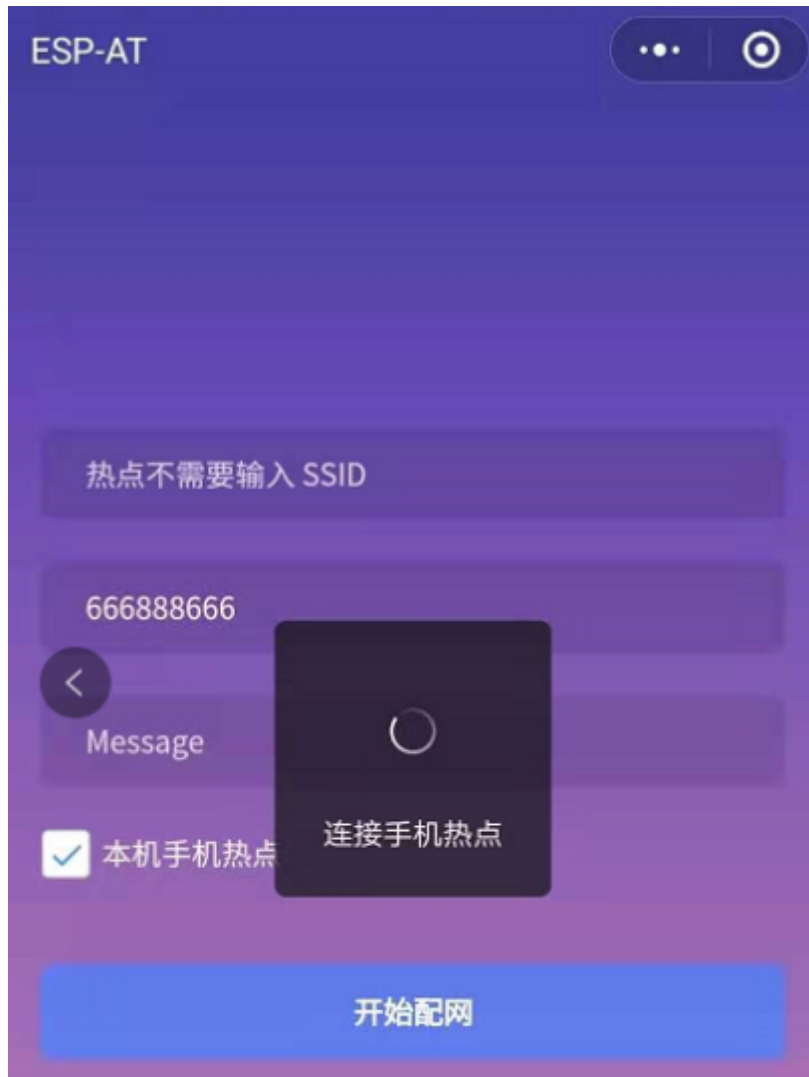

Fig. 20: Starting Connection to the AP

**Note 2:** The Wi-Fi provisioning page receives a prompt “Failed to connect to the AP” . Please check whether the Wi-Fi connection function of the mobile phone is turned on, check whether the Wi-Fi AP of the ESP32-C2 is correctly turned on, and whether the ssid and password of the AP are configured according to the above steps.

**Note 3:** The Wi-Fi provisioning page receives a prompt “The Wi-Fi provisioning saved by the system expired” . Please manually connect the ESP32-C2 AP with a mobile phone, and confirm that the ssid and password of the ESP32-C2 module have been configured according to the above steps.

#### 4.6.4 OTA Firmware Upgrade Using a WeChat Applet

The WeChat applet support online firmware upgrade , please refer to the above-described [Configure ESP32-C2 Device Parameters](#) specific steps performed ESP32-C2 configuration (if the configuration has been completed, do not repeat configuration). Once configured, the device performs OTA firmware upgrade processes is similar as [OTA Firmware Upgrade Using a Browser](#) .

#### 4.6.5 ESP32-C2 Using Captive Portal

##### Introduction

Captive Portal is commonly used to present a specified page to newly connected devices of a Wi-Fi or wired network. For more information about Captive Portal, please refer to [Captive Portal Wiki](#) .

---

**Note:** The default firmware does not support web server Captive Portal, you may enable it by `./build.py menuconfig>Component config>AT>AT WEB Server command support>AT WEB captive portal support` and build the project (see [Compile ESP-AT Project Locally](#)). In addition, enabling this feature may cause page skipping when using wechat applet for Wi-Fi provisioning or OTA firmware upgrade. It is recommended that this feature be enabled only when accessing at web using browser.

---

##### Introduction to Operation Steps

After Enable Captive Portal support, please refer to [Use STA Device to Connect to ESP32-C2 Device](#) to complete the configuration of the ESP32-C2, and then connect to the AP of the ESP32-C2:

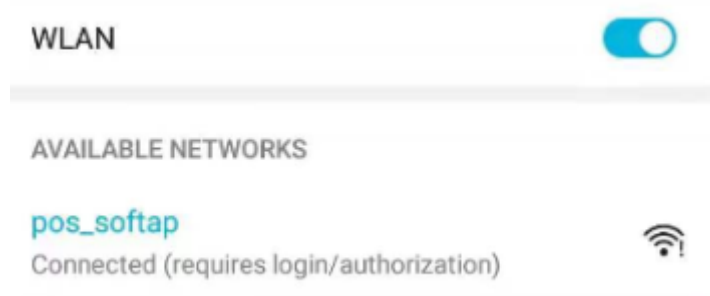

Fig. 21: Connection to the AP with Captive Portal Enabled

As shown in the figure above, after the Station device is connected to the AP of the ESP32-C2 with the Captive Portal function enabled, it will prompt “requires login/authentication” , and then the browser will automatically open and jump to the main interface of AT Web. If it cannot be redirected automatically, please follow the instructions of the Station device, click “Authentication” or click the name of the “pos\_softap” hotspot in the figure above to manually trigger the Captive Portal to automatically open the browser and enter the main interface of AT Web.

## Troubleshooting

**Note 1:** Both Station device and AP device support the Captive Portal function to ensure the normal use of this function. Therefore, if the device is connected to the AP of the ESP32-C2, but it does not prompt “Login/Authentication”, it may be that the Station device does not support this function. In this case, please refer to the specific steps of [Use the Browser to Send Wi-Fi Connection Information](#) above to open the main interface of AT Web.

## 4.7 HTTP AT Examples

This document provides detailed command examples to illustrate how to utilize [HTTP AT Commands](#) on ESP32-C2.

- *The HEAD method of HTTP client*
- *The GET method of HTTP client*
- *The POST method of HTTP client (suitable for POST small amount of data)*
- *The POST method of HTTP client (recommended method)*
- *The PUT method of HTTP client (suitable for no data put)*
- *The PUT method of HTTP client (recommended method)*
- *The DELETE method of HTTP client*

**Important:** Currently ESP-AT only supports some HTTP client functions.

### 4.7.1 The HEAD method of HTTP client

In this example, the HTTP server is <http://httpbin.org>.

1. Restore factory default settings of the module.

Command:

```
AT+RESTORE
```

Response:

```
OK
```

2. Set the Wi-Fi mode to station.

Command:

```
AT+CWMODE=1
```

Response:

```
OK
```

3. Connect to the router.

Command:

```
AT+CWJAP="espressif", "1234567890"
```

Response:

```
WIFI CONNECTED
WIFI GOT IP
OK
```

Note:

- The SSID and password you entered may be different from those in the above command. Please replace the SSID and password with those of your router settings.
4. Send an HTTP HEAD request. Set `opt` to 1 (HEAD method), `url` to `http://httpbin.org/get` and `transport_type` to 1 (HTTP\_TRANSPORT\_OVER\_TCP).

Command:

```
AT+HTTPCLIENT=1,0,"http://httpbin.org/get",,,1
```

Response:

```
+HTTPCLIENT:35, Date: Sun, 26 Sep 2021 06:59:13 GMT
+HTTPCLIENT:30, Content-Type: application/json
+HTTPCLIENT:19, Content-Length: 329
+HTTPCLIENT:22, Connection: keep-alive
+HTTPCLIENT:23, Server: gunicorn/19.9.0
+HTTPCLIENT:30, Access-Control-Allow-Origin: *
+HTTPCLIENT:38, Access-Control-Allow-Credentials: true
```

OK

Note:

- The HTTP header information you obtain may be different from those in the above response.

## 4.7.2 The GET method of HTTP client

This example describes how to download an image file in JPG format. The image link is <https://www.espressif.com/sites/all/themes/espressif/images/about-us/solution-platform.jpg>.

1. Restore factory default settings of the module.

Command:

```
AT+RESTORE
```

Response:

OK

2. Set the Wi-Fi mode to station.

Command:

```
AT+CWMODE=1
```

Response:

OK

3. Connect to the router.

Command:

```
AT+CWJAP="espressif","1234567890"
```

Response:

```
WIFI CONNECTED
WIFI GOT IP
```

OK

Note:

- The SSID and password you entered may be different from those in the above command. Please replace the SSID and password with those of your router settings.
4. Send an HTTP GET request. Set `opt` to 2 (GET method), `url` to `https://www.espressif.com/sites/all/themes/espressif/images/about-us/solution-platform.jpg` and `transport_type` to 2 (HTTP\_TRANSPORT\_OVER\_SSL).

Command:

```
AT+HTTPCLIENT=2,0,"https://www.espressif.com/sites/all/themes/espressif/images/
↳about-us/solution-platform.jpg",,,2
```

Response:

```
+HTTPCLIENT:512,<0xff><0xd8><0xff><0xe2><0x0c>XICC_PROFILE<break>
<0x01><0x01><break>
<break>
<0x0c>HLino<0x02><0x10><break>
<break>
mnrRGB XYZ <0x07><0xce><break>
<0x02><break>
...
+HTTPCLIENT:512,<0xeb><0xe2>v<0xcb><0x98>-<0xf8><0x8a><0xae><0xf3><0xc8><0xb6>
↳<0xaa><0x86><0x02>j<0x06><0xe2>
"<0xaa>*p<0x7f>2",h<0x12>N<0xa5><0x1e><0xd2>bp<0xea><0x1e><0xf5><0xa3>x<0xa6>J
↳<0x14>Ti<0xc3>m<0x1a>m<0x94>T<0xe1>I<0xb6><0x90><0xdc>_<0x11>QU;<0x94><0x97>
↳<0xcb><0xdd><0xc7><0xc6><0x85><0xd7>U<0x02><0xc9>W<0xa4><0xaa><0xa1><0xa1>
↳<0x08>hB<0x1a><0x10><0x86><0x84>!<0xa1><0x08>hB<0x1a><0x10><0x9b><0xb9>K
↳<0xf5>5<0x95>5-=<0x8a><0xcb><0xce><0xe0><0x91><0xf0>m<0xa9><0x04>C<0xde>k
↳<0xe7><0xc2>v<H|<0xaf><0xb8>L<0x91>=<0xda>_<0x94><0xde><0xd0><0xa9><0xc0>
↳<0xdd>8<0x9a>B<0xaa><0x1a><0x10><0x86><0x84>$<0xf4><0xd6><0xf2><0xa3><0x92>
↳<0xe7><0xa8>I<0xa3>b<0x1f>) <0xe1>z<0xc4>y<0xae><0xca><0xed><0xec><0x1e>|^
↳<0xd7>E<0xa2>_<0x13><0x9e>;{|<0xb5>Q<0x97><0xa5>P<0xdf><0xa1>#3vn<0x1b><0xc3>
↳-<0x92><0xe2>dIn<0x9c><0xb8>
<0xc7><0xa9><0xc6>(<0xe0><0xd3>i-<0x9e>@<0xbb><0xcc><0x88><0xd5>K<0xe3><0xf0>O
↳<0x9f>Km<0xb3>h<0xa8>omR<0xfe><0x8b><0xf9><0xa4><0xa6><0xff><break>
aU<0xdf><0xf3><0xa3>:A<0xe2>UG<0x04>k<0xaa>*<0xa1><0xa1><0x0b><0xca><0xec>
↳<0xd8>Q<0xfb><0xbc>yqY<0xec><0xfb>?<0x16>CM<0xf6>|}<0xae><0xf3><0x1e><0xdf>%
↳<0xf8><0xe8><0xb1>B<0x8f>[<0xb3>><0x04><0xec><0xeb>f<0x06><0x1c><0xe8><0x92>
↳<0xc9><0x8c><0xb0>I<0xd1><0x8b>%<0x99><0x04><0xd0><0xbb>s<0x8b>xj<0xe2>4f
↳<0xa0><0x8e>+E<0xda><0xab><0xc7>=<0xab><0xc7><0xb9>xz1f<0xba><0xfd>_e6<0xff>
↳<break>
(w<0xa7>b<0xe3>m<0xf0>|<0x82><0xc9><0xfb><0x8b><0xac>r<0x95><0x94><0x96><0xd9>i
↳<0xe9>RVA<0x91><0x83><0x8b>M'<0x86><0x8f><0xa3>A<0xd8><0xd8>"r"<0x8a><0xa8>
↳<0x9e>z1=<0xcd><0x16><0x07>D<0xa2><0xd0>u(<0xc2><0x8b><0x0b><0xc4><0xf1>
↳<0x87><0x9c><0x93><0x8f><0xe3><0xd5>U<0x12>]<0x8e><0x91>]<0x91><0x06>#1<0xbe>
↳<0xf4>t0?<0xd7><0x85><GEM<0xb1>%<0xee>UUT<0xe7><0xdf><0xa0><0xb9><0xce><0xe2>
↳U@<0x03><0x82>S<0xe9>*<0xa8>hB<0x1a><0x10><0xa1><0xaf>V<0x19>U<0x9d><0xb3>x
↳<0xa6><0xc7><0xe2><0x86><0x8e>d[<0x89>e<0x05>1<0x80>H<0x91>#<0xd2><0x8c>
↳<0xe1>j<0x1b>rH<0x04><0x89><0x98><0xd3>lZW]q<0xc2><'<0x93><0xb4><0xf5>&
↳<0x9d><0xa0>^Wp<0xa9>6`<0xe2>T<0xa2><0xc2><0xb1>*<0xbc><0x13><0x13><0xa0>
↳<0xc4>)<0x83><0xb6><0xbe><0x86><0xb9><0x88>-<0x1a>
```

OK

### 4.7.3 The POST method of HTTP client (suitable for POST small amount of data)

In this example, the HTTP server is <http://httpbin.org> and the data type is application/json.

1. Restore factory default settings of the module.

Command:

```
AT+RESTORE
```

Response:

```
OK
```

2. Set the Wi-Fi mode to station.

Command:

```
AT+CWMODE=1
```

Response:

```
OK
```

### 3. Connect to the router.

Command:

```
AT+CWJAP="espressif","1234567890"
```

Response:

```
WIFI CONNECTED
WIFI GOT IP

OK
```

Note:

- The SSID and password you entered may be different from those in the above command. Please replace the SSID and password with those of your router settings.

### 4. Send an HTTP POST request. Set `opt` to 3 (POST method), `url` to `http://httpbin.org/post`, `content-type` to 1 (application/json) and `transport_type` to 1 (HTTP\_TRANSPORT\_OVER\_TCP).

Command:

```
AT+HTTPCLIENT=3,1,"http://httpbin.org/post",,,1,"{\\"form\\":{\\"purpose\\":\\"test\\
↪\\"}}"
```

Response:

```
+HTTPCLIENT:282,{
  "args": {},
  "data": "{\\"form\\":{\\"purpose\\":\\"test\\"}}",
  "files": {},
  "form": {},
  "headers": {
    "Content-Length": "27",
    "Content-Type": "application/json",
    "Host": "httpbin.org",
    "User-Agent": "ESP32 HTTP Client/1.0",
    "X-Amzn-Trace-Id": "Root=
+HTTPCLIENT:173,1-61503a3f-4b16b71918855b97614c5dfb"
  },
  "json": {
    "form": {
      "purpose": "test"
    }
  },
  "origin": "20.187.154.207",
  "url": "http://httpbin.org/post"
}

OK
```

Note:

- The results you obtain may be different from those in the above response.

## 4.7.4 The POST method of HTTP client (recommended method)

If the amount of data you post is relatively large, and the length of a single AT command has exceeded the threshold of 256, it is recommended that you use the `AT+HTTPCPOST` command.

In this example, the HTTP server is <http://httpbin.org> and the data type is `application/json`.

1. Restore factory default settings of the module.

Command:

```
AT+RESTORE
```

Response:

```
OK
```

2. Set the Wi-Fi mode to station.

Command:

```
AT+CWMODE=1
```

Response:

```
OK
```

3. Connect to the router.

Command:

```
AT+CWJAP="espressif","1234567890"
```

Response:

```
WIFI CONNECTED
```

```
WIFI GOT IP
```

```
OK
```

Note:

- The SSID and password you entered may be different from those in the above command. Please replace the SSID and password with those of your router settings.

4. Post HTTP data of specified length. The command specifies that the number of HTTP header fields is 2, which are connection field and content-type field respectively. connection is keep-alive and content-type is application/json.

Assume the JSON data you want to post is of 427 bytes as follows.

```
{ "headers": { "Accept": "application/json", "Accept-Encoding": "gzip, deflate",
→ "Accept-Language": "en-US,en;q=0.9,zh-CN;q=0.8,zh;q=0.7", "Content-Length": "0
→", "Host": "httpbin.org", "Origin": "http://httpbin.org", "Referer": "http://
→httpbin.org/", "User-Agent": "Mozilla/5.0 (X11; Linux x86_64) AppleWebKit/537.
→36 (KHTML, like Gecko) Chrome/91.0.4472.114 Safari/537.36", "X-Amzn-Trace-Id
→": "Root=1-6150581e-1ad4bd5254b4bf5218070413"} }
```

Command:

```
AT+HTTPCPOST="http://httpbin.org/post",427,2,"connection: keep-alive","content-
→type: application/json"
```

Response:

```
OK
```

```
>
```

This response indicates that AT is ready for receiving serial data. You should enter the 427-byte data mentioned above, and when the data length reaches the `<length>` value, data transmission starts.

```
+HTTPCPOST:281,{
  "args": {},
  "data": "{ \"headers\": { \"Accept\": \"application/json\", \"Accept-Encoding\"
→: \"gzip, deflate\", \"Accept-Language\": \"en-US,en;q=0.9,zh-CN;q=0.8,zh;
→q=0.7\", \"Content-Length\": \"0\", \"Host\": \"httpbin.org\", \"Origin\": \"
→http://httpbin.org\", \"Referer\": \"htt
```

(continues on next page)



(continued from previous page)

```

+HTTPCPOST:512,p://httpbin.org/\",\"User-Agent\": \"Mozilla/5.0 (X11; Linux_
↪x86_64) AppleWebKit/537.36 (KHTML, like Gecko) Chrome/91.0.4472.114 Safari/
↪537.36\", \"X-Amzn-Trace-Id\": \"Root=1-6150581e-1ad4bd5254b4bf5218070413\"}}
↪",
  "files": {},
  "form": {},
  "headers": {
    "Content-Length": "427",
    "Content-Type": "application/json",
    "Host": "httpbin.org",
    "User-Agent": "ESP32 HTTP Client/1.0",
    "X-Amzn-Trace-Id": "Root=1-61505e76-278b5c267aaf55842bd58b32"
  },
  "json": {
    "headers": {
+HTTPCPOST:512,"Accept": "application/json",
  "Accept-Encoding": "gzip, deflate",
  "Accept-Language": "en-US,en;q=0.9,zh-CN;q=0.8,zh;q=0.7",
  "Content-Length": "0",
  "Host": "httpbin.org",
  "Origin": "http://httpbin.org",
  "Referer": "http://httpbin.org/",
  "User-Agent": "Mozilla/5.0 (X11; Linux x86_64) AppleWebKit/537.36 (KHTML,
↪ like Gecko) Chrome/91.0.4472.114 Safari/537.36",
  "X-Amzn-Trace-Id": "Root=1-6150581e-1ad4bd5254b4bf5218070413"
    }
  },
  "origin": "20.187.154
+HTTPCPOST:45,.207",
  "url": "http://httpbin.org/post"
}

SEND OK

```

**Note:**

- After AT outputs the > character, the special characters in the HTTP body do not need to be escaped using the escape character, and the data do not need to end with a new line (CR-LF).

### 4.7.5 The PUT method of HTTP client (suitable for no data put)

In this example, the HTTP server is <http://httpbin.org>. PUT request supports [Query String Parameters](#) mode.

1. Restore factory default settings of the module.

Command:

```
AT+RESTORE
```

Response:

```
OK
```

2. Set the Wi-Fi mode to station.

Command:

```
AT+CWMODE=1
```

Response:

```
OK
```

3. Connect to the router.

Command:

```
AT+CWJAP="espressif","1234567890"
```

Response:

```
WIFI CONNECTED
WIFI GOT IP

OK
```

Note:

- The SSID and password you entered may be different from those in the above command. Please replace the SSID and password with those of your router settings.
4. Send an HTTP PUT request. Set `opt` to 4 (PUT method), `url` to `http://httpbin.org/put`, and `transport_type` to 1 (HTTP\_TRANSPORT\_OVER\_TCP).

Command:

```
AT+HTTPCLIENT=4,0,"http://httpbin.org/put?user=foo",,,1
```

Response:

```
+HTTPCLIENT:282,{
  "args": {
    "user": "foo"
  },
  "data": "",
  "files": {},
  "form": {},
  "headers": {
    "Content-Length": "0",
    "Content-Type": "application/x-www-form-urlencoded",
    "Host": "httpbin.org",
    "User-Agent": "ESP32 HTTP Client/1.0",
    "X-Amzn-Trace-Id": "R
+HTTPCLIENT:140,oot=1-61503d41-1dd8cbe0056190f721ab1912"
  },
  "json": null,
  "origin": "20.187.154.207",
  "url": "http://httpbin.org/put?user=foo"
}

OK
```

Note:

- The results you obtain may be different from those in the above response.

## 4.7.6 The PUT method of HTTP client (recommended method)

In this example, the HTTP server is <http://httpbin.org> and the data type is `application/json`.

1. Restore factory default settings of the module.

Command:

```
AT+RESTORE
```

Response:

```
OK
```

2. Set the Wi-Fi mode to station.

Command:

```
AT+CWMODE=1
```

Response:

```
OK
```

### 3. Connect to the router.

Command:

```
AT+CWJAP="espressif","1234567890"
```

Response:

```
WIFI CONNECTED
WIFI GOT IP
```

```
OK
```

Note:

- The SSID and password you entered may be different from those in the above command. Please replace the SSID and password with those of your router settings.

### 4. PUT HTTP data of specified length. The command specifies that the number of HTTP header fields is 2, which are connection field and content-type field respectively. connection is keep-alive and content-type is application/json.

Assume the JSON data you want to post is of 427 bytes as follows.

```
{ "headers": { "Accept": "application/json", "Accept-Encoding": "gzip, deflate",
↪ "Accept-Language": "en-US,en;q=0.9,zh-CN;q=0.8,zh;q=0.7", "Content-Length": "0
↪", "Host": "httpbin.org", "Origin": "http://httpbin.org", "Referer": "http://
↪httpbin.org/", "User-Agent": "Mozilla/5.0 (X11; Linux x86_64) AppleWebKit/537.
↪36 (KHTML, like Gecko) Chrome/91.0.4472.114 Safari/537.36", "X-Amzn-Trace-Id
↪": "Root=1-6150581e-1ad4bd5254b4bf5218070413"} }
```

Command:

```
AT+HTTPCPUT="http://httpbin.org/put",427,2,"connection: keep-alive","content-
↪type: application/json"
```

Response:

```
OK
```

```
>
```

This response indicates that AT is ready for receiving serial data. You should enter the 427-byte data mentioned above, and when the data length reaches the <length> value, data transmission starts.

```
+HTTPCPUT:281,{
  "args": {},
  "data": "{ \"headers\": { \"Accept\": \"application/json\", \"Accept-Encoding\"
↪: \"gzip, deflate\", \"Accept-Language\": \"en-US,en;q=0.9,zh-CN;q=0.8,zh;
↪q=0.7\", \"Content-Length\": \"0\", \"Host\": \"httpbin.org\", \"Origin\": \"
↪http://httpbin.org/\", \"Referer\": \"htt
+HTTPCPUT:512,p://httpbin.org/\", \"User-Agent\": \"Mozilla/5.0 (X11; Linux x86_
↪64) AppleWebKit/537.36 (KHTML, like Gecko) Chrome/91.0.4472.114 Safari/537.
↪36\", \"X-Amzn-Trace-Id\": \"Root=1-6150581e-1ad4bd5254b4bf5218070413\"} }",
  "files": {},
  "form": {},
  "headers": {
    "Content-Length": "427",
    "Content-Type": "application/json",
    "Host": "httpbin.org",
    "User-Agent": "ESP32 HTTP Client/1.0",
    "X-Amzn-Trace-Id": "Root=1-635f7009-681be2d5478504dc5b83624a"
  },
}
```

(continues on next page)

(continued from previous page)

```

"json": {
  "headers": {
+HTTPCPU:512,"Accept": "application/json",
    "Accept-Encoding": "gzip, deflate",
    "Accept-Language": "en-US,en;q=0.9,zh-CN;q=0.8,zh;q=0.7",
    "Content-Length": "0",
    "Host": "httpbin.org",
    "Origin": "http://httpbin.org",
    "Referer": "http://httpbin.org/",
    "User-Agent": "Mozilla/5.0 (X11; Linux x86_64) AppleWebKit/537.36 (KHTML,
→ like Gecko) Chrome/91.0.4472.114 Safari/537.36",
    "X-Amzn-Trace-Id": "Root=1-6150581e-1ad4bd5254b4bf5218070413"
  }
},
"origin": "52.246.135
+HTTPCPU:43,.57",
"url": "http://httpbin.org/put"
}

SEND OK

```

Note:

- After AT outputs the > character, the special characters in the HTTP body do not need to be escaped using the escape character, and the data do not need to end with a new line (CR-LF).

## 4.7.7 The DELETE method of HTTP client

In this example, the HTTP server is <http://httpbin.org>. The DELETE method is used to delete resources on a server. The exact use of DELETE requests depends on the server implementation.

1. Restore factory default settings of the module.

Command:

```
AT+RESTORE
```

Response:

```
OK
```

2. Set the Wi-Fi mode to station.

Command:

```
AT+CWMODE=1
```

Response:

```
OK
```

3. Connect to the router.

Command:

```
AT+CWJAP="espressif","1234567890"
```

Response:

```

WIFI CONNECTED
WIFI GOT IP

OK

```

Note:

- The SSID and password you entered may be different from those in the above command. Please replace the SSID and password with those of your router settings.
4. Send an HTTP DELETE request. Set `opt` to 5 (DELETE method), `url` to `http://httpbin.org/delete`, and `transport_type` to 1 (HTTP\_TRANSPORT\_OVER\_TCP).

Command:

```
AT+HTTPCLIENT=5,0,"https://httpbin.org/delete",,,1
```

Response:

```
+HTTPCLIENT:282,{
  "args": {},
  "data": "",
  "files": {},
  "form": {},
  "headers": {
    "Content-Length": "0",
    "Content-Type": "application/x-www-form-urlencoded",
    "Host": "httpbin.org",
    "User-Agent": "ESP32 HTTP Client/1.0",
    "X-Amzn-Trace-Id": "Root=1-61504289-468a41"
  }
+HTTPCLIENT:114,737b0d251672acec9d"
},
"json": null,
"origin": "20.187.154.207",
"url": "https://httpbin.org/delete"
}

OK
```

Note:

- The results you obtain may be different from those in the above response.

## 4.8 Sleep AT Examples

This document provides an introduction and detailed command examples to illustrate how to utilize AT commands to set sleep modes on ESP32-C2 series of products.

- [Introduction](#)
- [Set Modem-sleep mode in Wi-Fi mode](#)
- [Set Light-sleep mode in Wi-Fi mode](#)
- [Set Deep-sleep mode](#)

### 4.8.1 Introduction

With the use of advanced power-management technologies, ESP32-C2 series can switch between different power modes. Currently, ESP-AT supports the following four power consumption modes (for more sleep modes, please refer to the datasheet):

1. **Active Mode:** CPU and chip radio are powered on. The chip can receive, transmit, or listen.
2. **Modem-sleep Mode:** The CPU is operational and the clock speed can be reduced. Wi-Fi baseband, Bluetooth LE baseband, and radio are disabled, but Wi-Fi and Bluetooth LE connection can remain active.
3. **Light-sleep Mode:** The CPU is paused. Any wake-up events (MAC, host, RTC timer, or external interrupts) will wake up the chip. Wi-Fi and Bluetooth LE connection can remain active.
4. **Deep-sleep Mode:** CPU and most peripherals are powered down. Only the RTC memory is powered on.

By default, ESP32-C2 will enter `Active` mode after system reset. When the CPU does not need to work all the time, such as waiting for external activities to wake up, the system can enter low-power modes.

For current consumption of ESP32-C2, please refer to [ESP32-C2 Series Datasheet](#).

---

**Note:**

- Setting ESP32-C2 to sleep modes in Wi-Fi mode and Bluetooth LE mode will be described separately.
  - In single Wi-Fi mode, only `station` mode supports `Modem-sleep` mode and `Light-sleep` mode.
  - For `Light-sleep` mode in Bluetooth LE mode, please ensure that there is an external 32 KHz crystal oscillator. If there is no external 32 KHz crystal oscillator, ESP-AT will work as the `Modem-sleep` mode.
- 

### Measurement Method

In order to avoid some unnecessary interference during the power consumption test process, it is recommended to use the Espressif modules that integrate the chip for the test.

Refer to the following figure for hardware connection. (Note that the development board below only has the ESP32-C2 module on board, and all other peripheral components have been removed.)

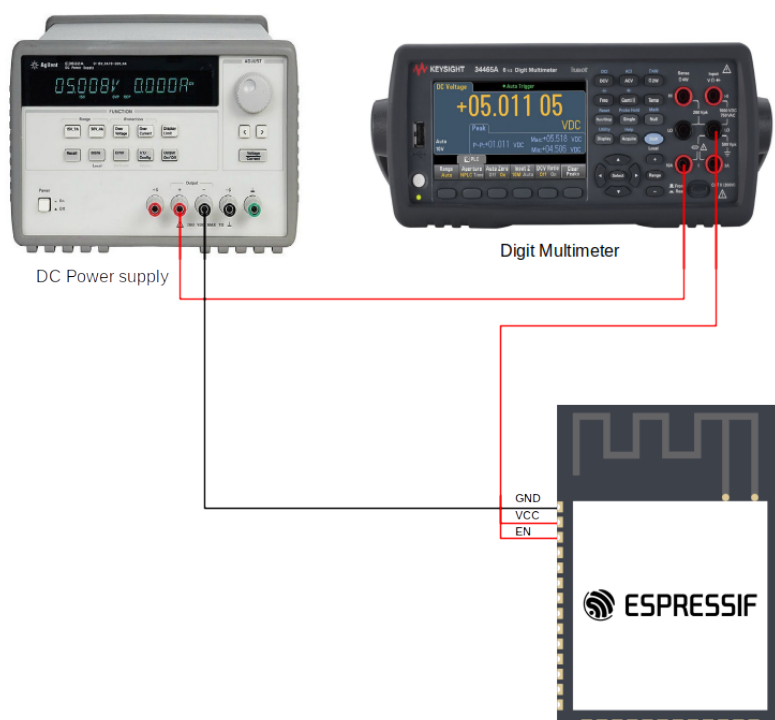

Fig. 22: ESP32-C2 Hardware Connection

### 4.8.2 Set Modem-sleep mode in Wi-Fi mode

1. Set the Wi-Fi mode to station mode.

Command:

```
AT+CWMODE=1
```

Response:

```
OK
```

2. Connect to an router.

Command:

```
AT+CWJAP="espressif","1234567890"
```

Response:

```
WIFI CONNECTED
WIFI GOT IP
OK
```

Note:

- The SSID and password you entered may be different from those in the above command. Please replace the SSID and password with those of your router settings.

3. Set the sleep mode to Modem-sleep mode.

Command:

```
AT+SLEEP=1
```

Response:

```
OK
```

---

**Note:**

- RF will be periodically closed according to AP DTIM (routers generally set DTIM to 1).
- 

### 4.8.3 Set Light-sleep mode in Wi-Fi mode

1. Set the Wi-Fi mode to station mode.

Command:

```
AT+CWMODE=1
```

Response:

```
OK
```

2. Connect to an router. Set listen interval to 3.

Command:

```
AT+CWJAP="espressif","1234567890",,,3
```

Response:

```
WIFI CONNECTED
WIFI GOT IP
OK
```

Note:

- The SSID and password you entered may be different from those in the above command. Please replace the SSID and password with those of your router settings.

3. Set the sleep mode to Light-sleep mode.

Command:

```
AT+SLEEP=2
```

Response:

```
OK
```

---

**Note:**

- CPU will automatically sleep and RF will be periodically closed according to listen interval set by *AT+CWJAP*.
- 

#### 4.8.4 Set Deep-sleep mode

1. Set the sleep mode to Deep-sleep mode. Set the deep-sleep time to 3600000 ms.

Command:

```
AT+GSLP=3600000
```

Response:

```
OK
```

**Note:**

- When the time is up, the device automatically wakes up, calls Deep-sleep wake stub, and then proceeds to load the application.
- For Deep-sleep mode, the only wake-up method is timed wake-up.





# Chapter 5

## ESP-AT Versions

This document mainly introduces ESP-AT versions, how to select a version, versioning scheme, support periods, viewing versions, and subscribing to AT releases.

### 5.1 Releases

The full history of ESP-AT releases can be found on the GitHub repository [Release page](#). There you can find the AT firmwares, release notes, links to each version of the documentation, and instructions for obtaining each version.

### 5.2 Which Version Should I Start With?

Please read [AT software solution selection](#).

### 5.3 Versioning Scheme

#### 5.3.1 ESP-AT Firmware Release Management

ESP-AT release is specific to a chip and usually refers to the release of one or more AT firmwares for that chip. The AT command set supported by the released AT firmware is usually backward compatible. This means that you can update the new version of the AT firmware to devices with older versions.

The firmware released by ESP-AT follows a similar version management method as [Semantic Versioning](#). You can understand the differences of each version from the literal meaning. For example, `v3.3.0.0`, `v` represents version, followed by the version number in the following format:

```
<major>.<minor>.<patch>.<custom>
```

Where:

- `<major>` is the major version. For example, `v4.0.0.0` represents a major update, usually including the introduction of new chip support, new features, and bug fixes.
- `<minor>` is the minor version. For example, `v3.3.0.0` represents an important update, usually including new features, ESP-IDF version upgrade, and bug fixes.
- `<patch>` is the patch version, also known as the bugfix version. For example, `v2.4.2.0` represents only bug fixes without adding any new features.
- `<custom>` is the custom version. It is usually used for downstream distributors or customized project versions.

### 5.3.2 ESP-AT Branch Release Management

When ESP-AT releases AT firmware, if there are major or minor version updates, a new [release branch](#) will be created.

The release branches of ESP-AT follow a similar version management method as [Semantic Versioning](#). You can understand the differences of each version from the literal meaning. For example, `release/v3.3.0.0`, `release` represents the release branch, `v` represents the version of the release branch, followed by the version number in the following format:

```
<major>.<minor>.0.0
```

Where:

- `<major>` is the major version. For example, `release/v4.0.0.0` represents a major update, usually including the introduction of new chip support, new features, and bug fixes.
- `<minor>` is the minor version. For example, `release/v3.3.0.0` represents an important update, usually including new features, ESP-IDF version upgrade, and bug fixes.

In general, the AT firmware to be released will undergo multiple rounds of testing on the release branch until there are no major issues. Then, the AT firmware will be released, and the release branch will be synchronized to GitHub.

- New feature development usually takes place on the master branch and is not merged into the release branch.
- Bug fixes usually take place on the master branch and, if the issue is severe, will be merged into the release branch.

## 5.4 Support Periods

Each ESP-IDF major and minor release version has an associated support period. After this period, the release is End of Life and no longer supported. Since ESP-AT is a project based on ESP-IDF, the support period of ESP-AT is limited by the support period of ESP-IDF. The current information of each version of ESP-AT is as follows:

AT Version (Release Date)	Supported Chips	IDF Version	IDF EOL Date	AT New Version Plan
<b>v4.0.0.0</b> (2023.12.29)	ESP32-C6	<a href="#">v5.1.2</a>	2025.12.30	2025.7.30 - 2025.9.30
<b>v3.4.0.0</b> (2024.6.7)	<ul style="list-style-type: none"> <li>• ESP32</li> <li>• ESP32-S2</li> </ul>	<a href="#">v5.0.6</a>	2025.5.29	2024.12.29 - 2025.2.28
<b>v3.3.0.0</b> (2024.5.9)	<ul style="list-style-type: none"> <li>• ESP32-C2</li> <li>• ESP32-C3</li> </ul>	<a href="#">v5.0.6</a>	2025.5.29	2024.12.29 - 2025.2.28
<b>v3.2.0.0</b> (2023.7.28)	<ul style="list-style-type: none"> <li>• ESP32</li> <li>• ESP32-C3</li> </ul>	~v5.0.3 ( <a href="#">24b9d38</a> )	2025.5.29	<ul style="list-style-type: none"> <li>• New version v3.4.0.0 released for ESP32</li> <li>• New version v3.3.0.0 released for ESP32-C3</li> </ul>

**Support periods for each released version of ESP-AT are as follows:**

- Service Period of Support Period  
Usually, it starts from the release of the AT firmware for the chip and lasts until the planned release of the next AT version for that chip. The release time of the next AT version is usually a few

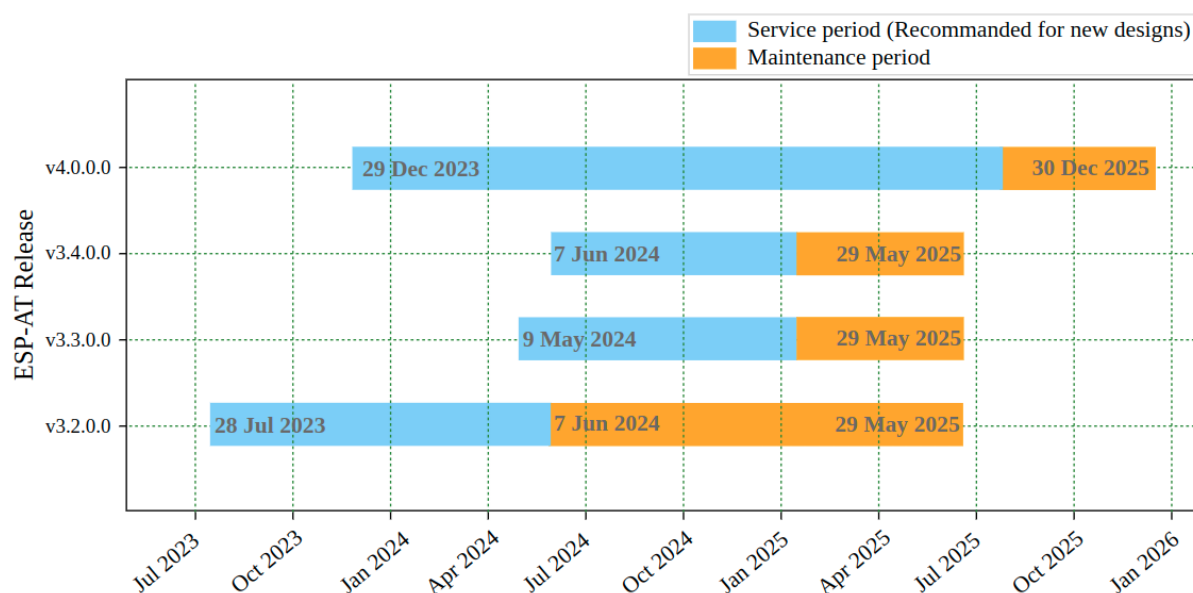

Fig. 1: ESP-AT Version Support Periods

months before the end of the corresponding [ESP-IDF support period](#) (the AT release notes provide information about the ESP-IDF version corresponding to the chip).

- **Maintenance Period of Support Period**

Usually, it starts after the service period ends and lasts until the end of the corresponding [ESP-IDF support period](#) for the chip (the AT release notes provide information about the ESP-IDF version corresponding to the chip). For example, if the support period of ESP-IDF v5.0 is until May 29, 2025, then the maintenance period for ESP-AT v3.0 ~ v3.3 will also be until May 29, 2025.

In general:

- Once a new version of AT is released, the service period of the support period for the old version ends and enters the maintenance period of the support period.  
For example, when AT releases version v3.3.0.0 (for ESP32-C2 and ESP32-C3 chips), the service period of the support period for version v3.2.0.0 of ESP32-C3 ends and enters the maintenance period of the support period; the service period of the support period for version v3.1.0.0 of ESP32-C2 ends and enters the maintenance period of the support period.
- If you have a GitHub account, please [Subscribe to AT releases](#). GitHub will notify you when a new version is released. When a bugfix version of the AT firmware you are using is released, please plan to upgrade to that bugfix version.
- Please make sure to plan the upgrade to a new version before the version you are using stops receiving updates and support.
- Being within the support period means that the ESP-AT team will continue to perform important bug fixes, security fixes, etc. on the release branch on GitHub, and periodically release new bugfix versions as needed.

## 5.5 Check the Current AT Firmware Version

Please send the `AT+GMR` command to check the AT firmware version information. Refer to the parameter description under the `AT+GMR` command for more information.

## 5.6 Subscribe to AT Releases

- *Step 1: Log in to Your GitHub Account*
- *Step 2: Choose Customized Notifications*

- *Step 3: Apply for Release Notifications*

### 5.6.1 Step 1: Log in to Your GitHub Account

Before you start, please [sign in your GitHub account](#), as you need login permission to subscribe to AT releases.

### 5.6.2 Step 2: Choose Customized Notifications

Visit the [ESP-AT repository](#), click on Watch in the upper right corner of the page, and then click on Custom.

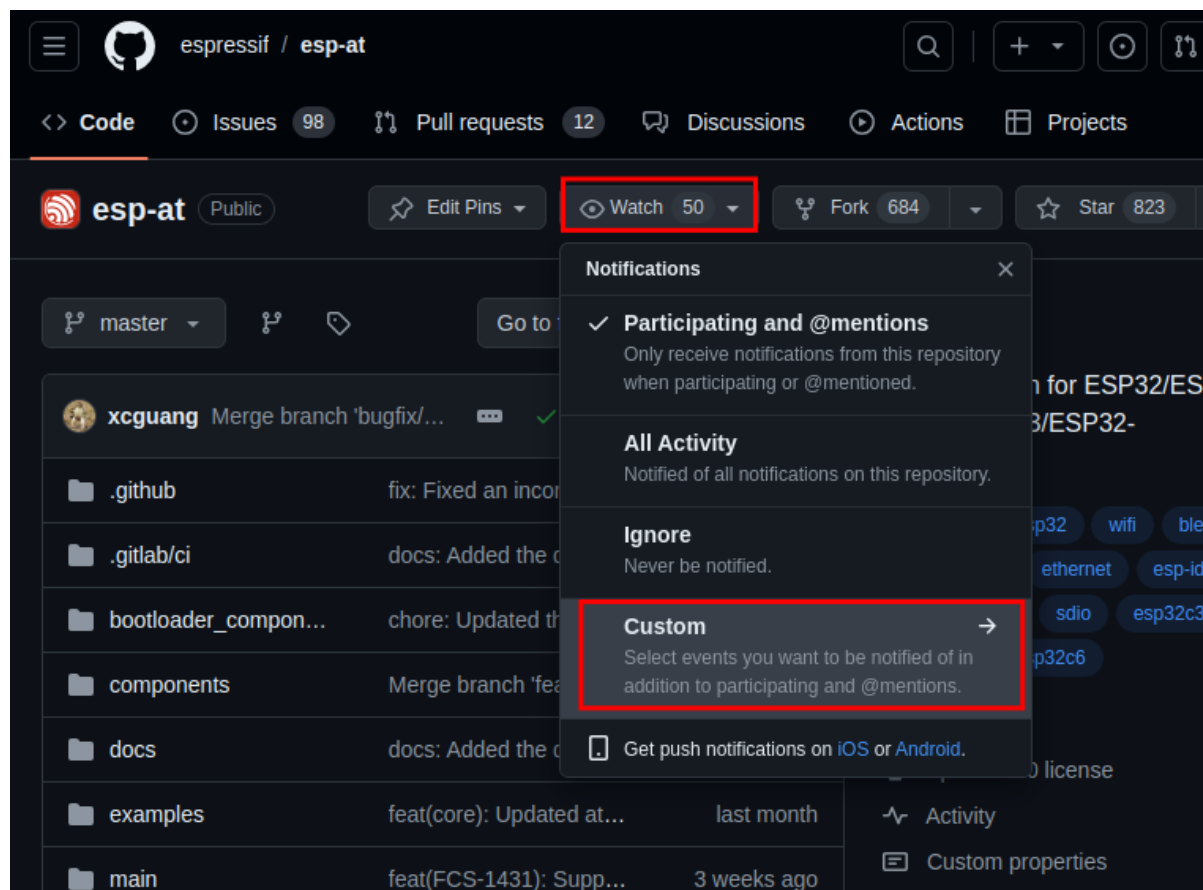

Fig. 2: Customized Notifications (click to enlarge)

### 5.6.3 Step 3: Apply for Release Notifications

Check [Releases](#) and click on [Apply](#).

This completes the process of subscribing to AT releases. You will receive notifications from GitHub when a new AT version is released.

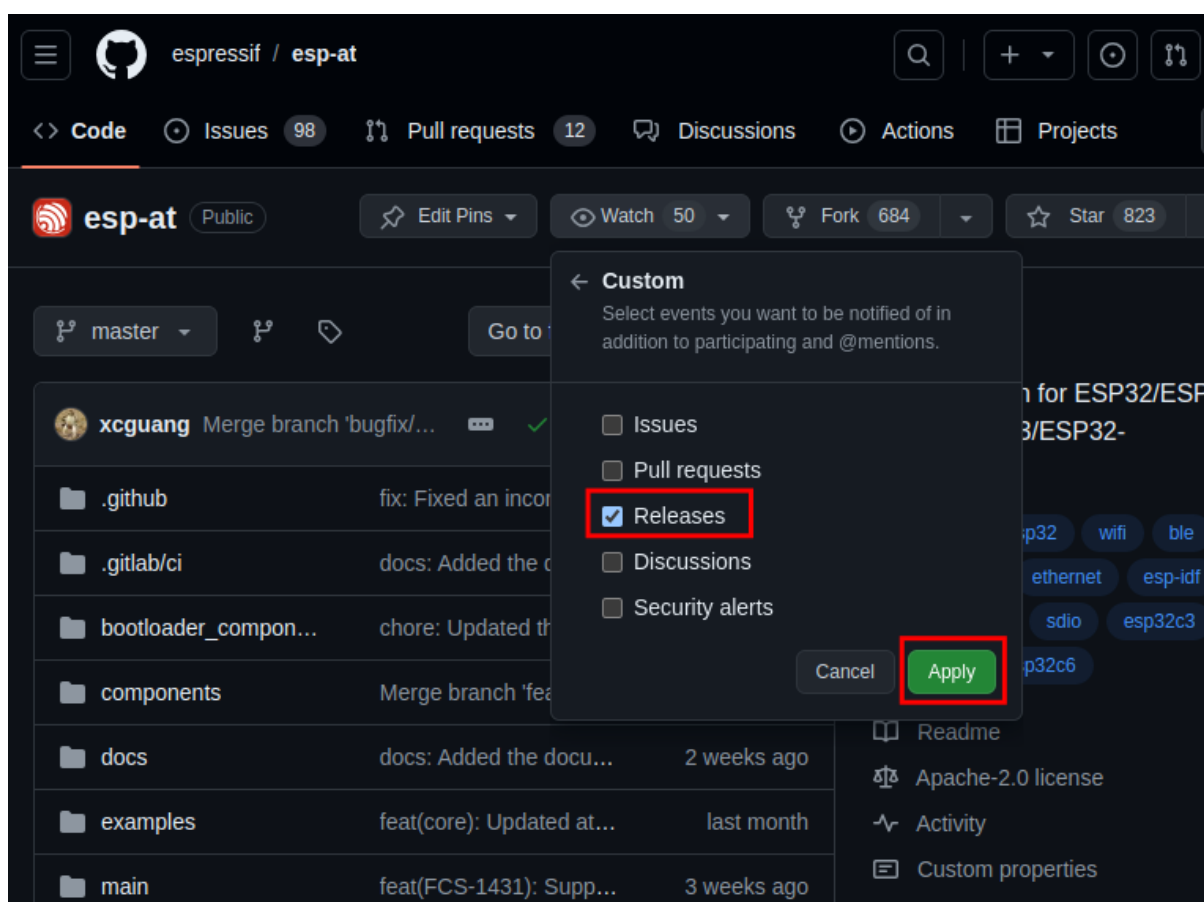

Fig. 3: Apply for Release Notifications (click to enlarge)



## Chapter 6

# How to Compile and Develop Your Own AT Project

### 6.1 Compile ESP-AT Project Locally

This document details how to build your own ESP-AT project locally and flash the generated firmware into your ESP32-C2. It comes in handy when the *official released firmware* cannot meet your needs, for example, to customize the *AT port pins* and *partitions*, and so on.

If you have difficulties in compiling ESP-AT project locally, or you only need to modify a small amount of code, we recommend that you use *Compile ESP-AT Project on the GitHub Webpage*.

#### 6.1.1 Detailed Steps

Please follow the detailed steps below to set up your environment and build the project. **It is recommended that you develop the esp-at project on Linux system.**

- *Step 1. Get Started with ESP-IDF*
- *Step 2. Get ESP-AT*
- *Step 3. Install Environment*
- *Step 4. Connect Your Device*
- *Step 5. Configure*
- *Step 6. Build the Project*
- *Step 7. Flash onto the Device*
- *build.py Advanced Usage*

#### 6.1.2 Step 1. Get Started with ESP-IDF

Get started with ESP-IDF before compiling an ESP-AT project, because ESP-AT is developed based on ESP-IDF.

Please follow [ESP-IDF v5.0 Get Started](#) guide, configure, build, flash onto the ESP32-C2 device of the `hello_world` example.

---

**Note:** This step is not a must, but if you are a beginner, you are strongly recommended to complete it in order to familiarize yourself with ESP-IDF and ensure smooth proceeding with the following steps.

---



After you complete the ESP-IDF get started in the step above, now you can proceed to compile an ESP-AT project according to the following steps.

### 6.1.3 Step 2. Get ESP-AT

To compile an ESP-AT project, you need the software libraries provided by Espressif in the ESP-AT repository.

To get ESP-AT, navigate to your installation directory and clone the repository with `git clone`, following instructions below specific to your operating system.

- Linux or macOS

```
cd ~/esp
git clone --recursive https://github.com/espressif/esp-at.git
```

- Windows

For ESP32-C2 series of modules, it is recommended that you run [ESP-IDF 5.0 CMD](#) as an administrator first.

```
cd %userprofile%\esp
git clone --recursive https://github.com/espressif/esp-at.git
```

If you are located in China or have difficulties to access GitHub, you can also use `git clone https://jihulab.com/esp-mirror/espressif/esp-at.git` or `git clone https://gitee.com/EspressifSystems/esp-at.git` to get ESP-AT, which may be faster.

ESP-AT will be downloaded into `~/esp/esp-at` on Linux or macOS, or `%userprofile%\esp\esp-at` on Windows.

---

**Note:** This guide uses the directory `~/esp` on Linux or macOS, or `%userprofile%\esp` on Windows as an installation folder for ESP-AT. You can use any directory, but you will need to adjust paths for the commands respectively. Keep in mind that ESP-AT does not support spaces in paths.

---

### 6.1.4 Step 3. Install Environment

Run the project tool `install` to install the environment. This tool will automatically install Python packages, ESP-IDF repository, and the compiler and tools used by ESP-IDF.

- Linux or macOS

```
./build.py install
```

- Windows

```
python build.py install
```

Select the following configuration options for your ESP32-C2 if it is your first time.

- Select the `Platform` name for your ESP32-C2. For example, select `PLATFORM_ESP32C2` for ESP32-C2 series of products. `Platform` name is defined in [factory\\_param\\_data.csv](#).
- Select the `Module` name for your ESP32-C2. For example, select `ESP32C2-4MB` for the ESP8684-MINI-1 4MB module. `Module` name is defined in [factory\\_param\\_data.csv](#).
- Enable or disable `silence` mode. If enabled, it will remove some logs and reduce the firmware size. Generally, it should be disabled.
- The above three option items will not appear if the file `build/module_info.json` exists. So please delete it if you want to reconfigure the module information.

### 6.1.5 Step 4. Connect Your Device

Connect your ESP32-C2 device to the PC with a USB cable to download firmware and print log. See [Hardware Connection](#) for more information. Note that you do not need to set up the “AT command/response” connection if you do not send AT commands and receive AT responses during the compiling process. You can change default port pins referring to [How to Set AT Port Pins](#).

### 6.1.6 Step 5. Configure

Run the project configuration utility `menuconfig` to configure.

- Linux or macOS

```
./build.py menuconfig
```

- Windows

```
python build.py menuconfig
```

If the previous steps have been done correctly, the following menu pops up:

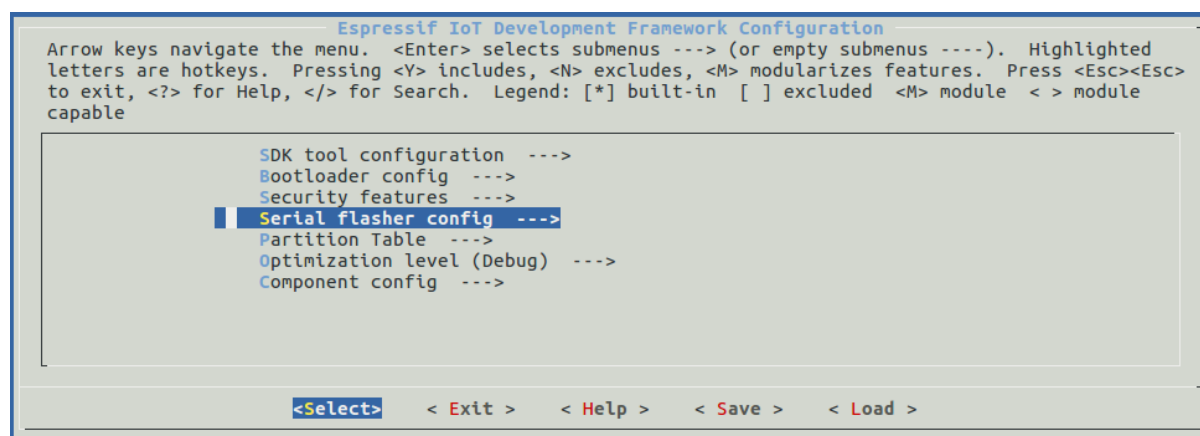

Fig. 1: Project configuration - Home window

You are using this menu to set up project-specific configuration, e.g. changing AT port pins, enabling Classic Bluetooth function, etc. If you made no changes, it will run with the default configuration.

### 6.1.7 Step 6. Build the Project

Build the project by running:

- Linux or macOS

```
./build.py build
```

- Windows

```
python build.py build
```

If Bluetooth feature is enabled, the firmware size will be much larger. Please make sure it does not exceed the OTA partition size.

After compiled, the combined factory bin will be created in `build/factory`. See [ESP-AT Firmware Differences](#) for more information.

### 6.1.8 Step 7. Flash onto the Device

Flash the firmware that you just compiled onto your ESP32-C2 by running:

- Linux or macOS

```
./build.py -p (PORT) flash
```

- Windows

```
python build.py -p (PORT) flash
```

Note that you need to replace (PORT) with your ESP32-C2's serial port name. Or you can follow the printed instructions to download the bin files into flash. Note that you also need to replace the (PORT).

If the ESP-AT bin fails to boot and prints “ota data partition invalid”, you should run `python build.py erase_flash` to erase the entire flash, and then reflash the AT firmware.

### 6.1.9 build.py Advanced Usage

The script `build.py` is based on `idf.py`, which means that all `idf.py <cmd>` features should be included in `build.py <cmd>`. You can run the following command for more details.

- Linux or macOS

```
./build.py --help
```

- Windows

```
python build.py --help
```

## 6.2 Compile ESP-AT Project on the GitHub Webpage

This document provides a detailed guide on how to compile the ESP-AT project through a web page. When the default *officially released firmware* does not satisfy your requirements, for example, you want to enable *WebSocket functionality* and disable *mDNS functionality*, you will need to compile the ESP-AT project. Usually we recommend you to *Compile ESP-AT Project Locally*. However, if you have difficulties building the project locally, please refer to this document to compile the ESP-AT project through the webpage.

**Attention: The AT firmware compiled from webpages needs to be tested and verified for functionality based on your own product.**

**Please save the firmware and download link, for possible issue debugging in the future.**

### 6.2.1 Detailed Steps

Please follow the detailed steps below to complete the Fork, environment configuration, code modification, and compilation of the ESP-AT project.

- *Step 1. Log in to your GitHub account*
- *Step 2. Fork the ESP-AT project*
- *Step 3. Enable GitHub Actions*
- *Step 4. Configure the secrets required to compile the ESP-AT project*
- *Step 5. Use the github.dev editor to modify and submit the code*
- *Step 6. Compile the AT firmware using GitHub Actions*

## 6.2.2 Step 1. Log in to your GitHub account

Before starting, please [log in to your GitHub account](#) as compile and firmware download require login credentials.

## 6.2.3 Step 2. Fork the ESP-AT project

Visit the [ESP-AT repository](#) and click `FORK` in the upper right corner of the page.

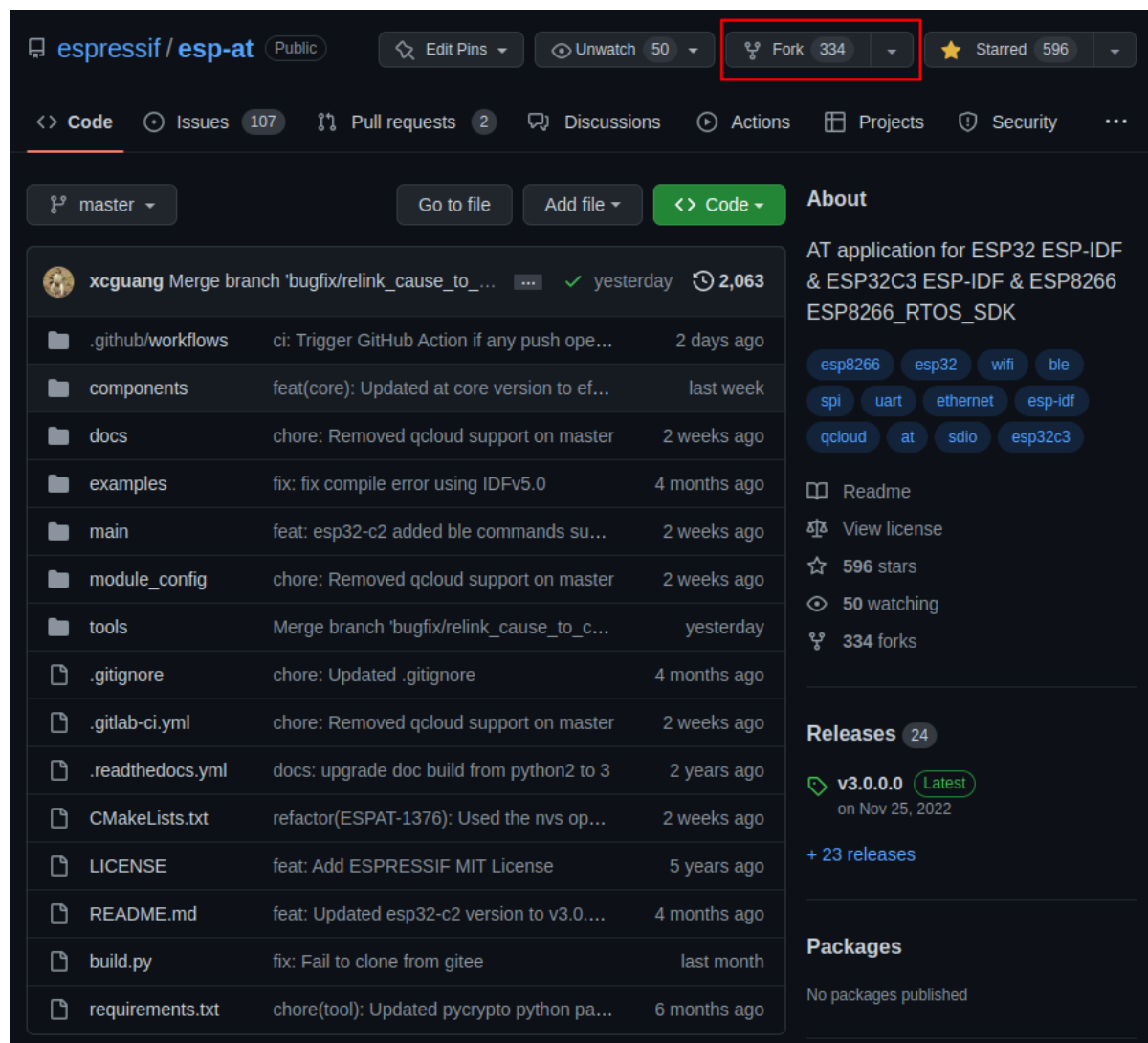

Fig. 2: Click Fork

Click `Create fork` to copy the repository to your GitHub account. The default Fork only copies the master branch. If you need to modify the code based on a specific branch, uncheck `Copy the master branch only`.

## 6.2.4 Step 3. Enable GitHub Actions

Under the repository, click `Actions` to enter the GitHub Actions page.

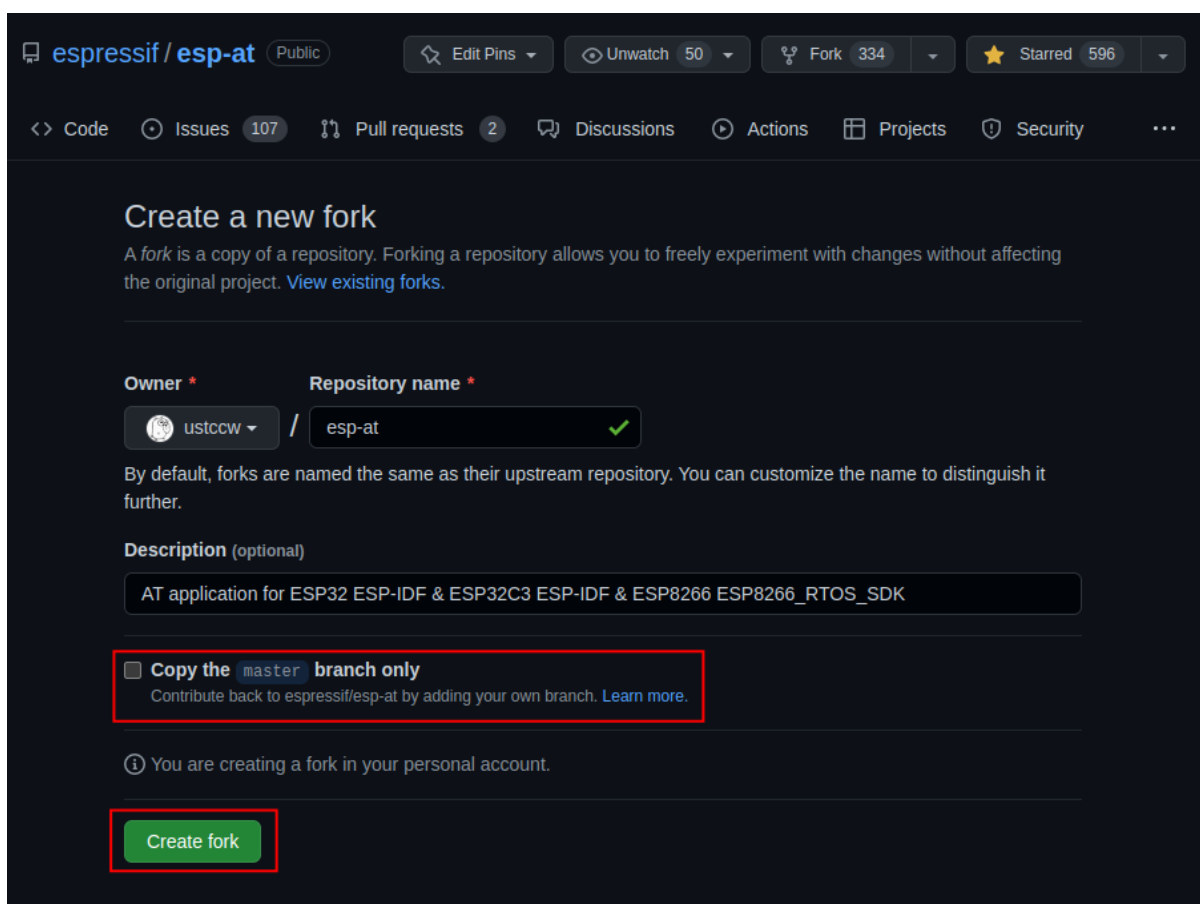

Fig. 3: Create Fork

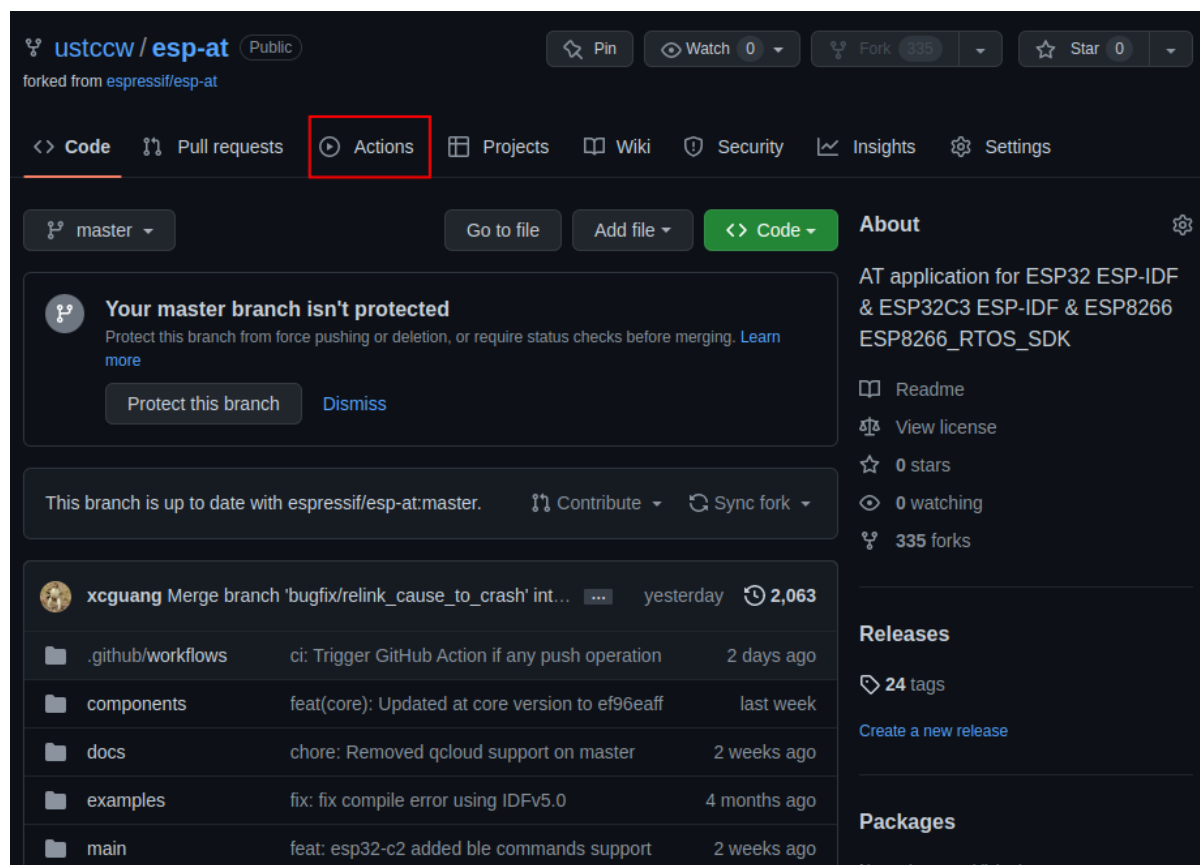

Fig. 4: Click Actions

Click `I understand my workflows`, go ahead and enable them to enable GitHub Actions.

GitHub Actions is now enabled.

### 6.2.5 Step 4. Configure the secrets required to compile the ESP-AT project

If you have an account and an OTA token of [the Espressif OTA server](#), and you need to upgrade the AT firmware by using the `AT+CIUPDATE` command, you need to complete this step. Otherwise, it is recommended to disable `CONFIG_AT_OTA_SUPPORT` (see [Step 5. Use the github.dev editor to modify and submit the code](#) for details) or skip this step.

Under the repository, click `Setting` to enter the settings page.

Click on `Settings -> Secrets and variables -> Actions` to access the Action configuration page.

Click `New repository secret` to enter the secret creation page.

Enter `Name and Secrets`, and click `Add secret` to create a new secret. This secret is the OTA token.

All the possible secret names that need to be configured are as follows:

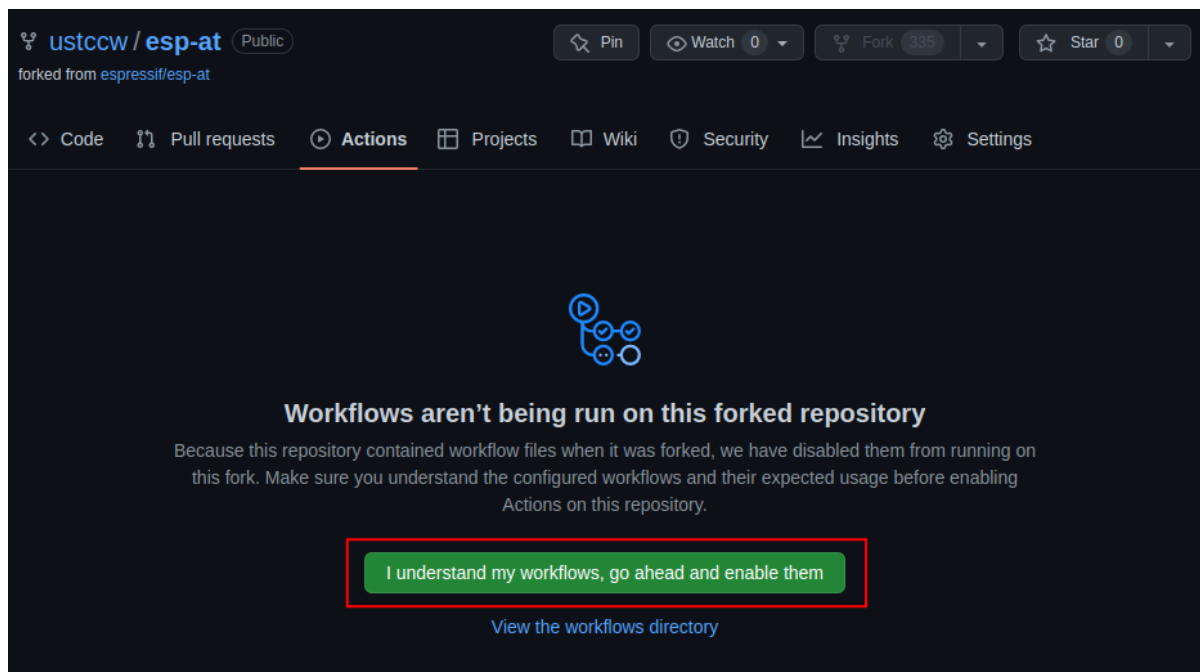

Fig. 5: Enable GitHub Actions

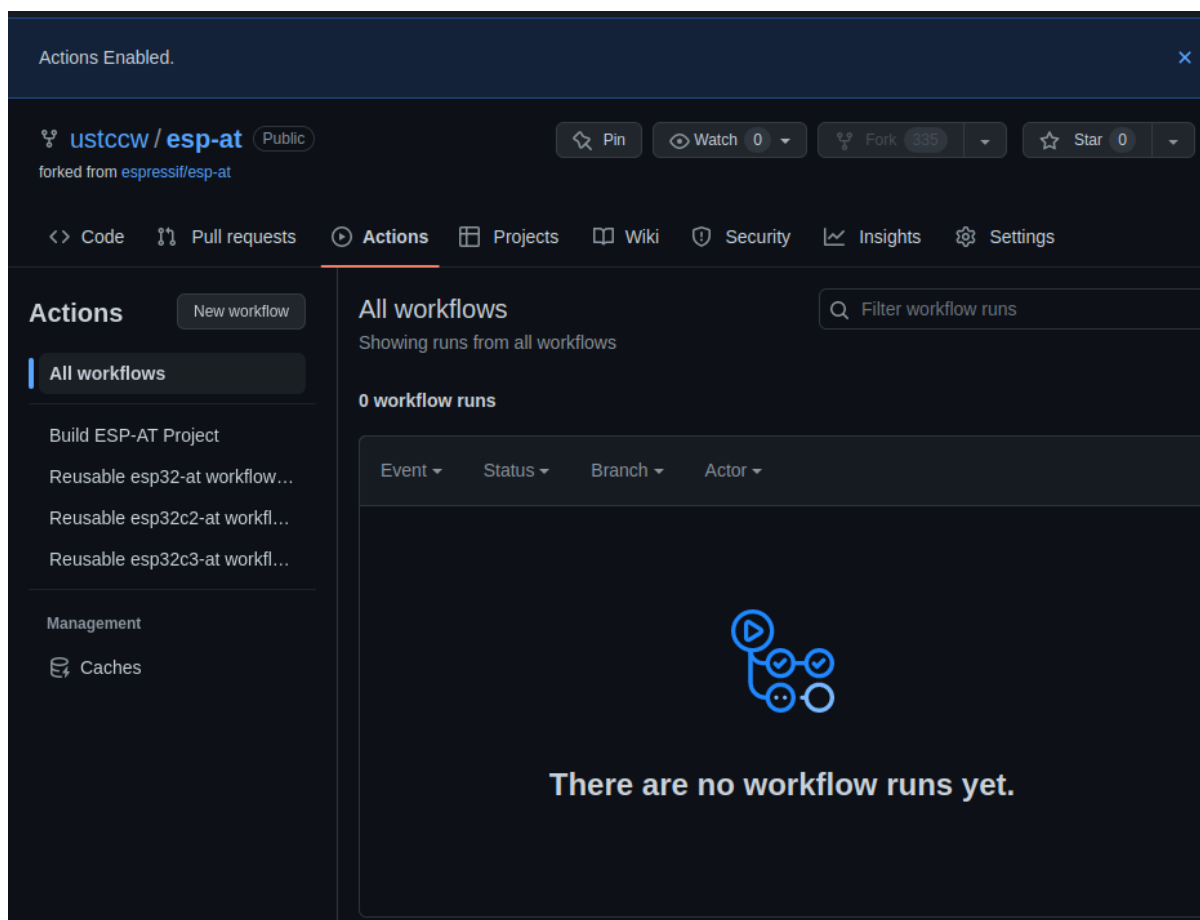

Fig. 6: GitHub Actions Enabled Successfully

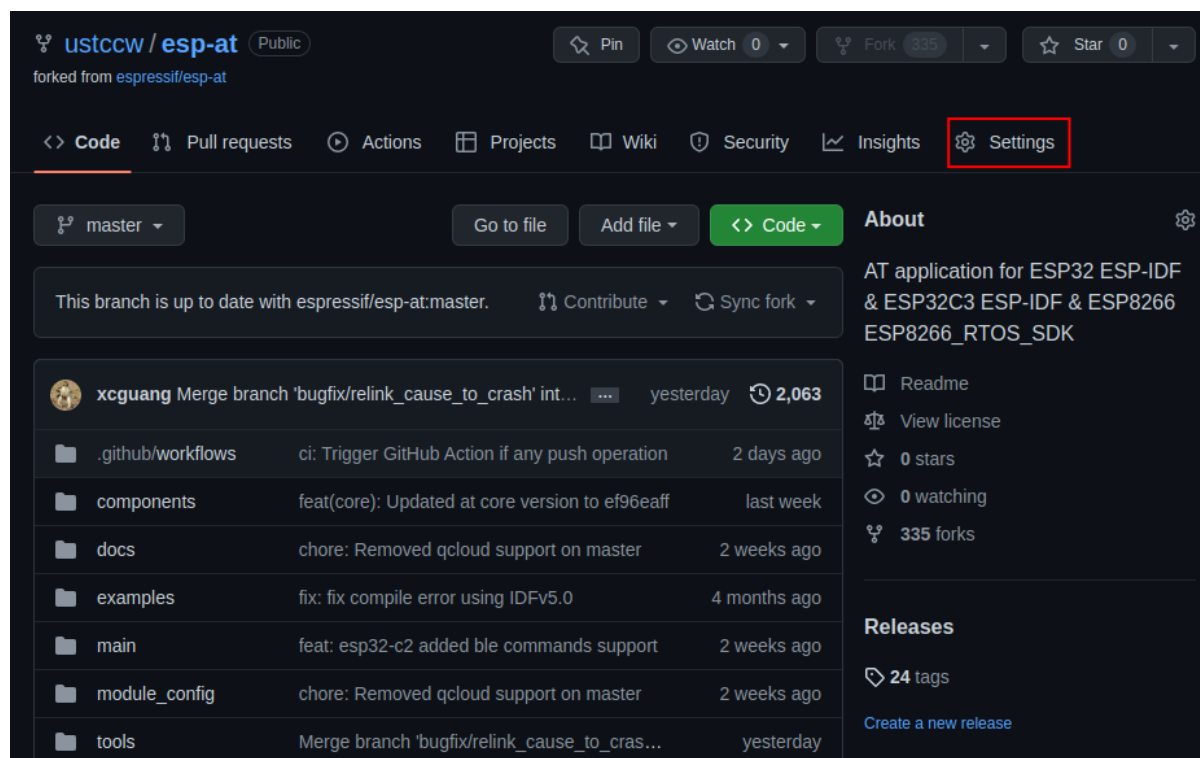

Fig. 7: Click on Settings

```

AT_OTA_TOKEN_WROOM32
AT_OTA_TOKEN_WROVER32
AT_OTA_TOKEN_ESP32_MINI_1
AT_OTA_TOKEN_ESP32_PICO_D4
AT_OTA_TOKEN_ESP32_SOLO_1
AT_OTA_TOKEN_ESP32C3_MINI
ESP32C2_2MB_TOKEN
ESP32C2_4MB_TOKEN
ESP32C6_4MB_TOKEN

```

If you need to support AT firmware upgrades for more modules, please repeat the above steps and add different keys again. After creating all the secrets, you will have the following page.

## 6.2.6 Step 5. Use the github.dev editor to modify and submit the code

For how to use the github.dev editor, please refer to the official [github.dev document](#). The example process is shown below.

### 5.1 Open the github.dev editor

Go back to the repository homepage and select the branch name that you want to modify.

Press the `.` key on the keyboard to open the branch code using the github.dev editor.



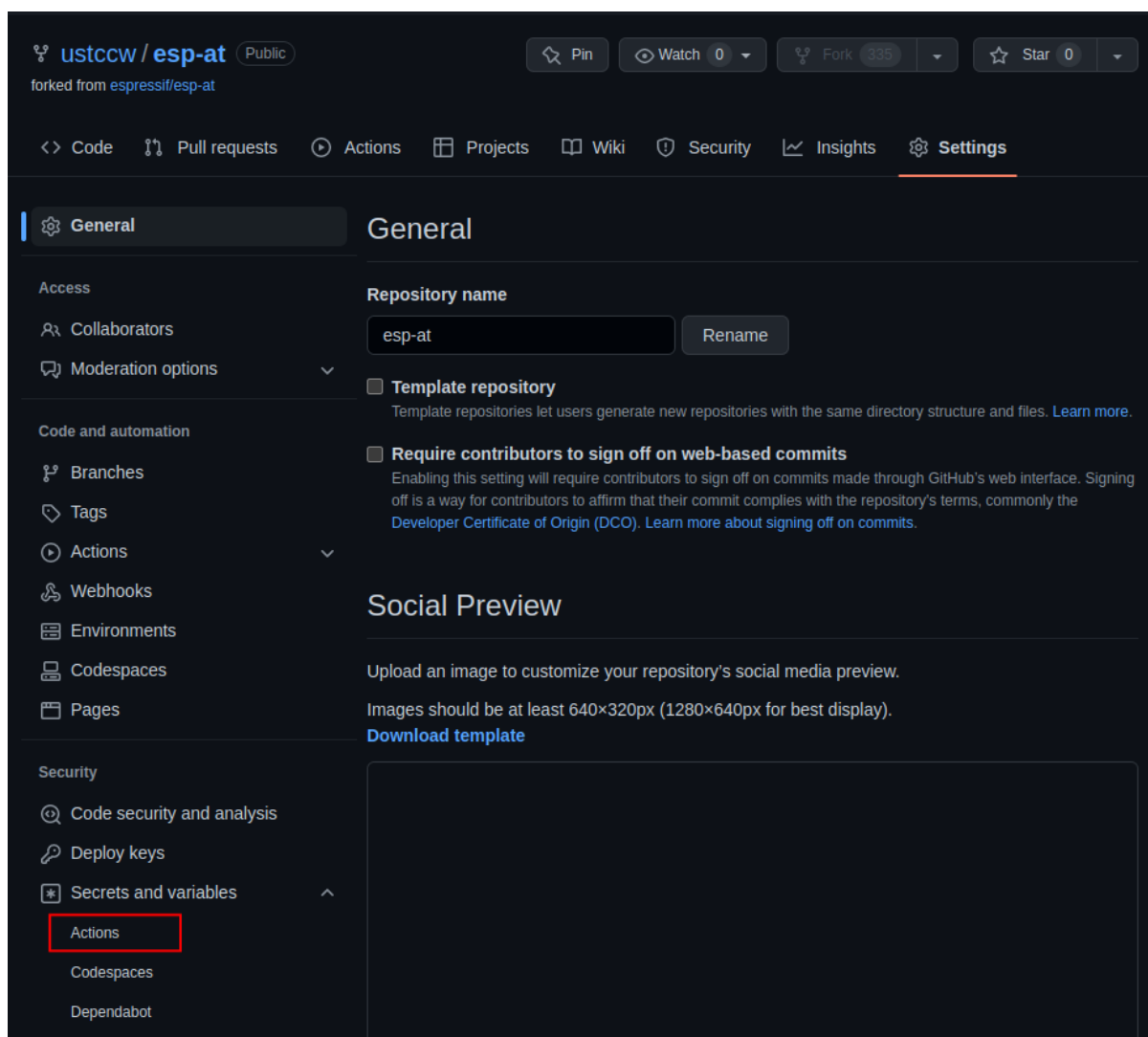

Fig. 8: Enter Actions Configuration Page

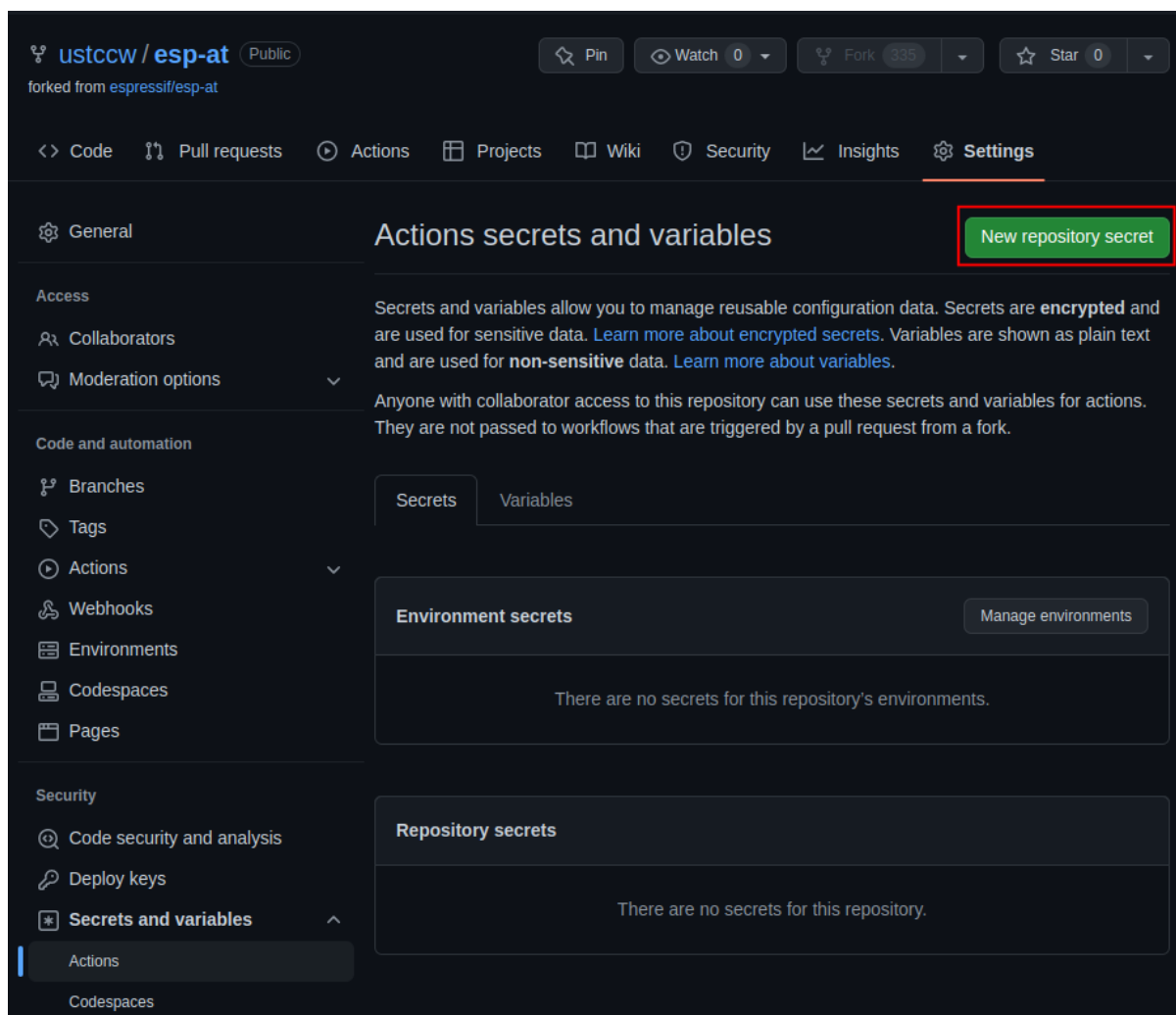

Fig. 9: Create Secret Page

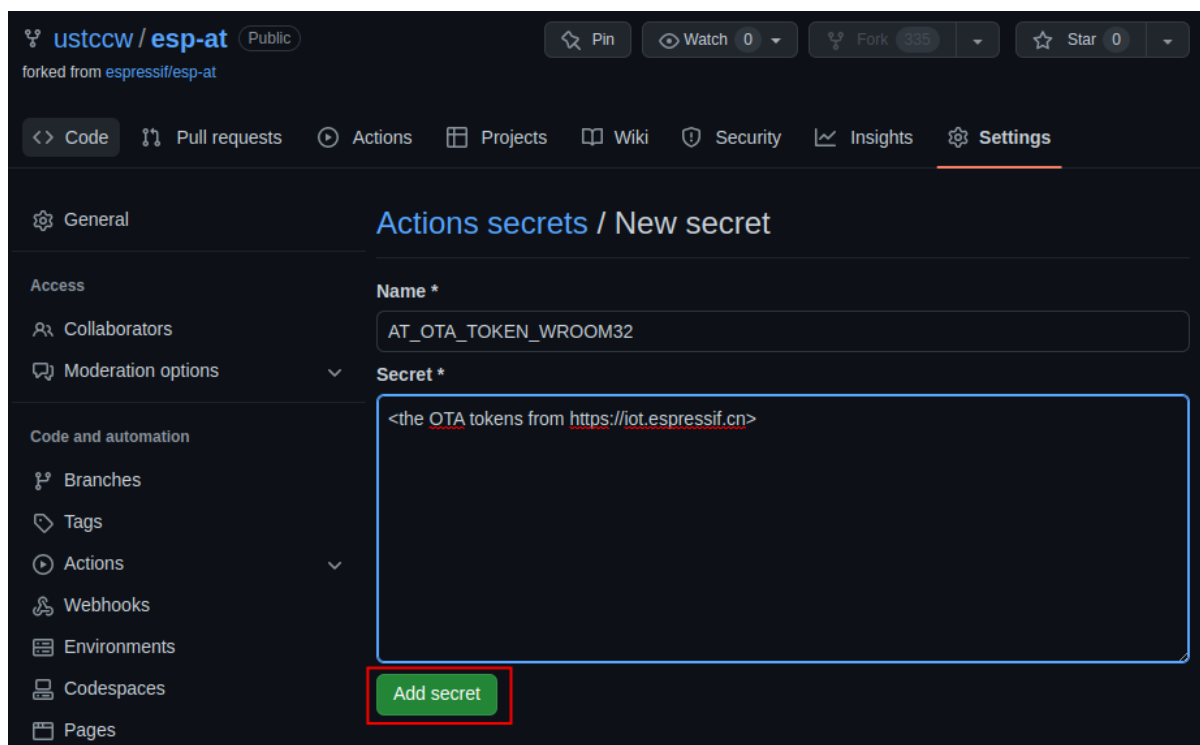

Fig. 10: Create Secret

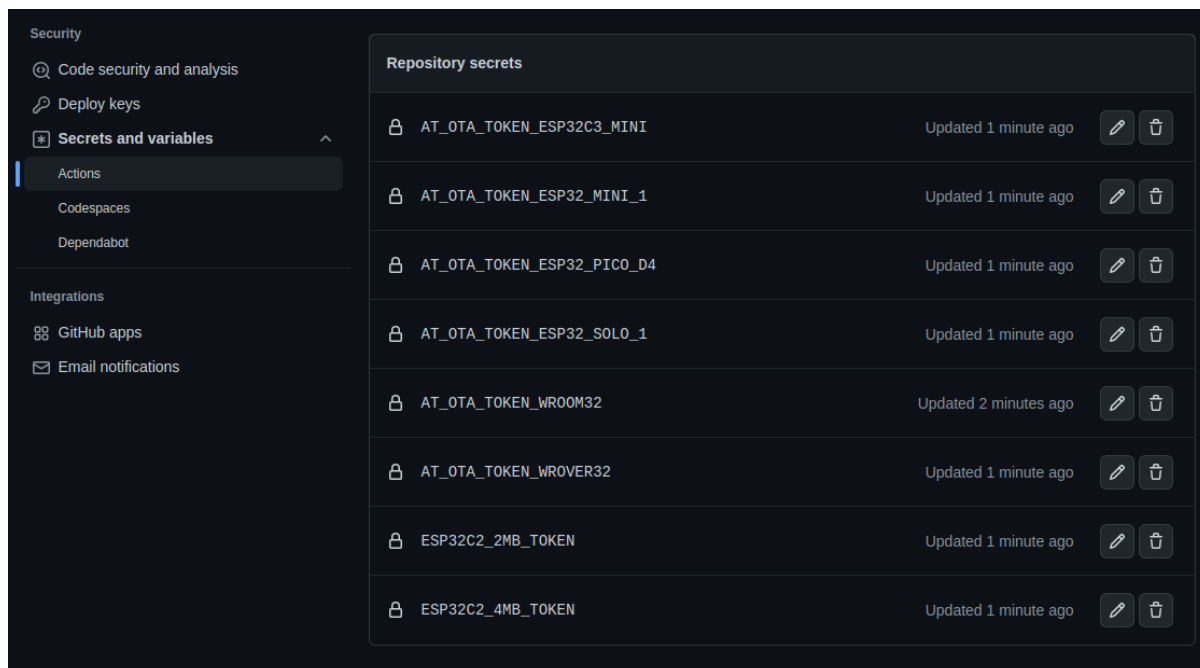

Fig. 11: Create Secrets Completed

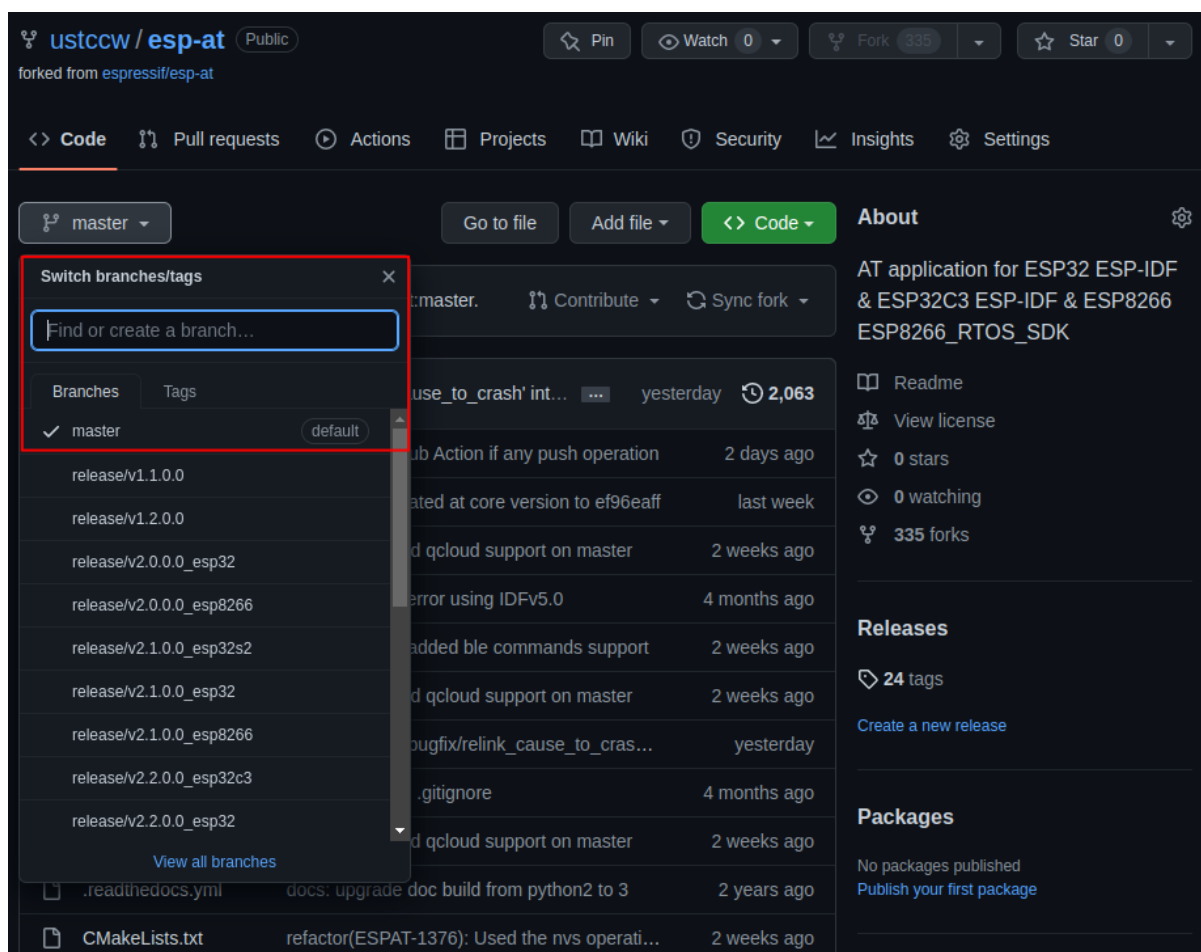

Fig. 12: Select Branch

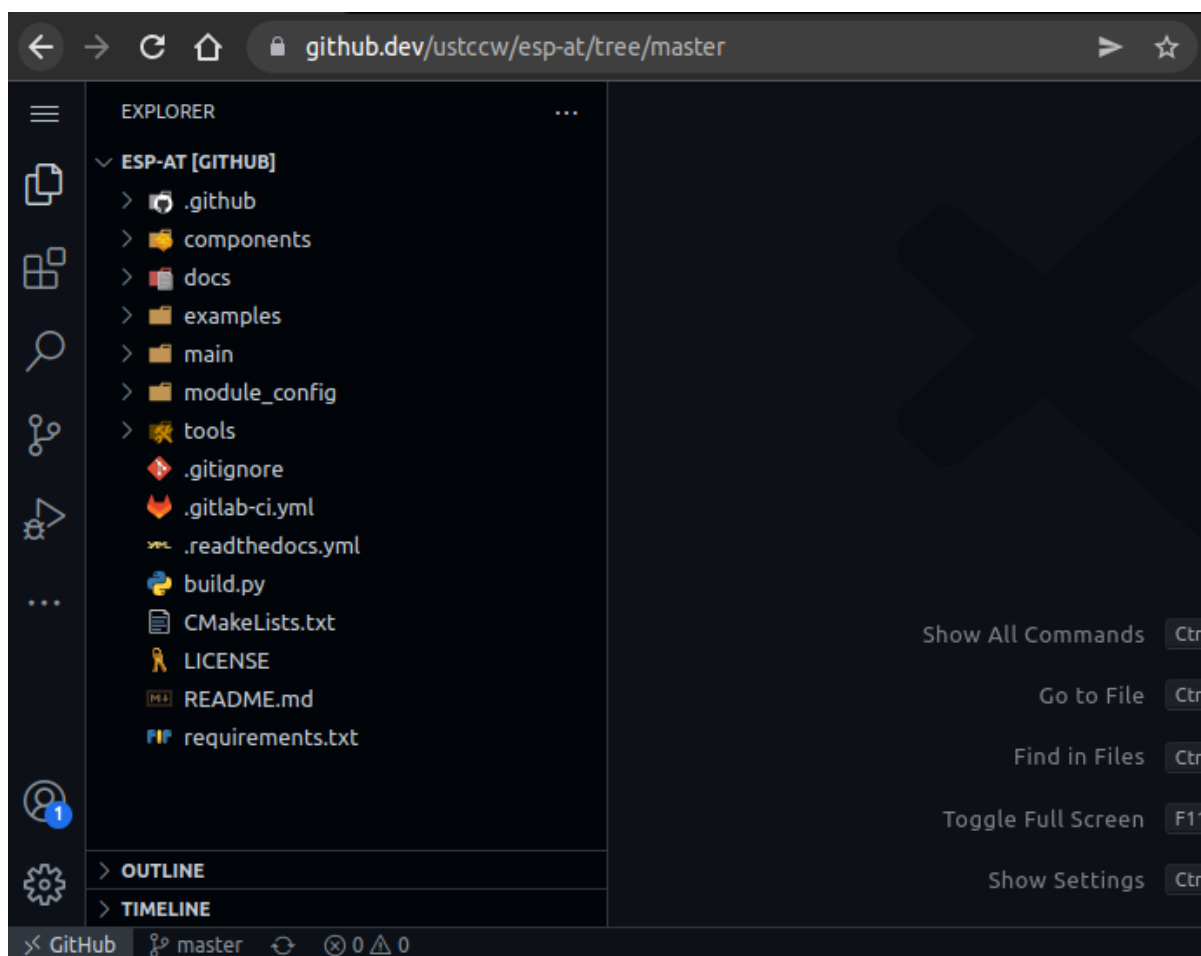

Fig. 13: Open Branch Code

## 5.2 Create a new branch

At the bottom of the editor, click the branch name in the status bar. In the dropdown, enter the name for a new branch and click `Create new branch`.

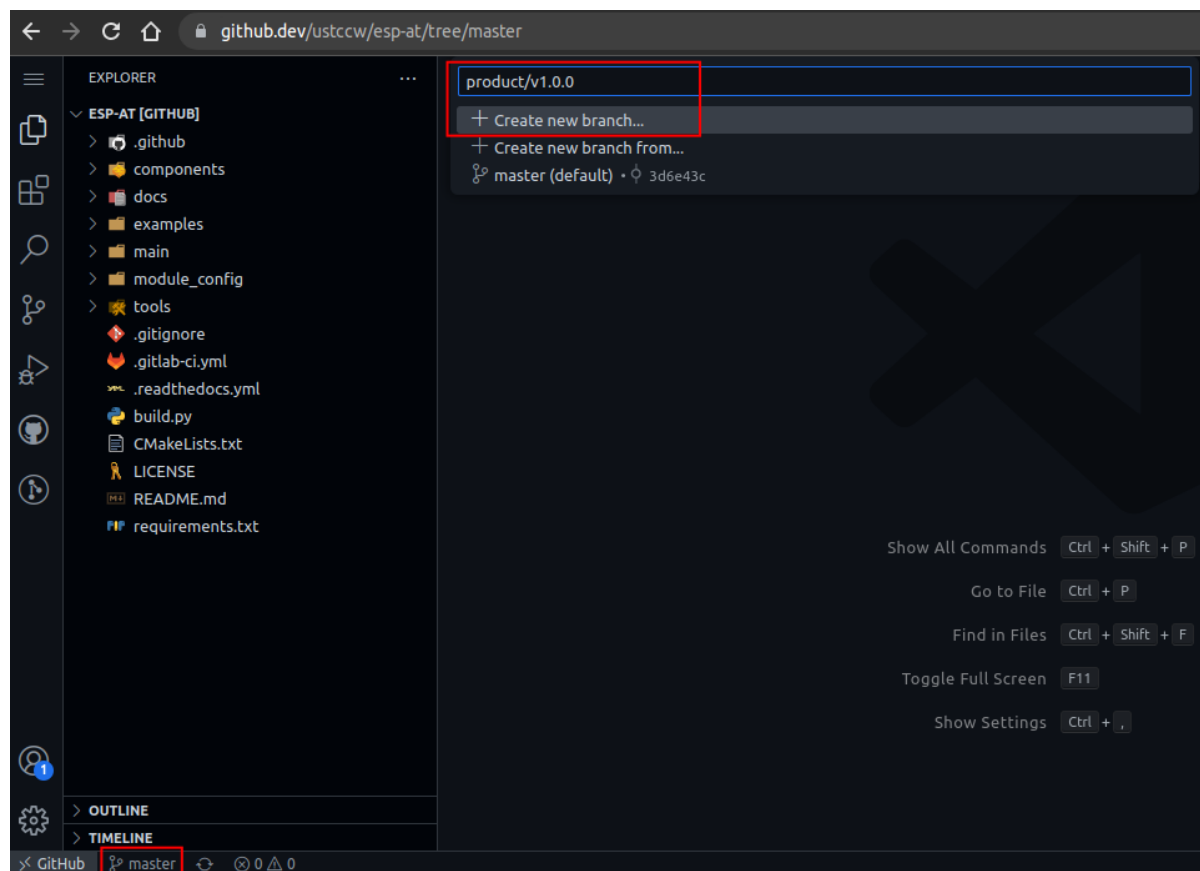

Fig. 14: Create New Branch (Click to Enlarge)

Click `Switch to Branch` to create the branch.

The branch has been created.

## 5.3 Commit changes

Modify the code in the github.dev editor. For example, to enable *WebSocket functionality* and disable *mDNS functionality*, open the configuration file `esp-at/module_config/<your_module_name>/sdkconfig.defaults` and add the following lines:

```
CONFIG_AT_WS_COMMAND_SUPPORT=y
CONFIG_AT_MDNS_COMMAND_SUPPORT=n
```

In the activity bar, click the `Source Control` view. Click the plus sign `+` next to the file that has been modified to stage the changes.

Enter a commit message to describe the changes you have made. Click `Commit & Push` to submit the changes.

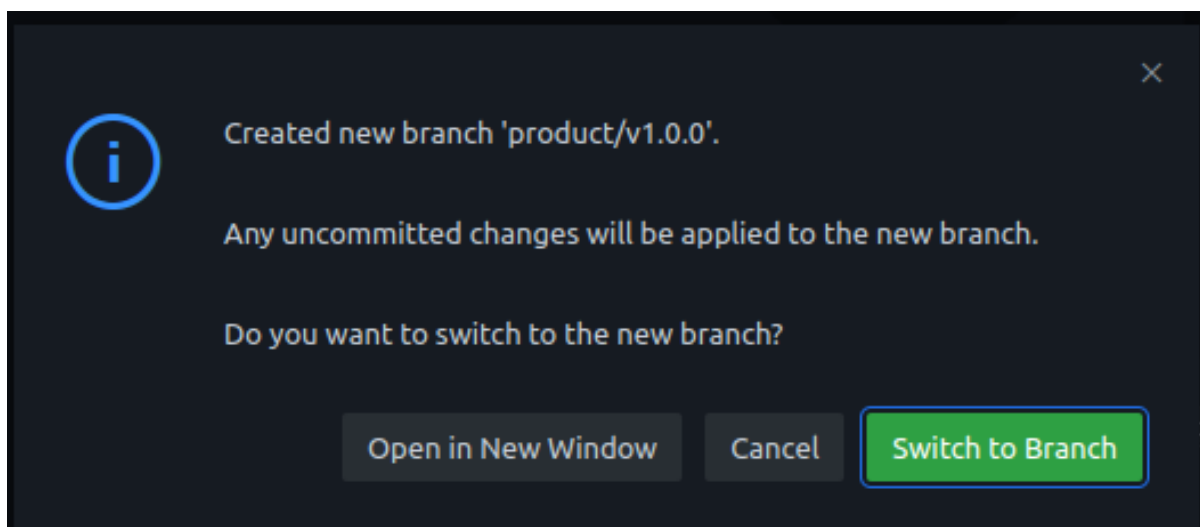

Fig. 15: Confirm Branch Creation

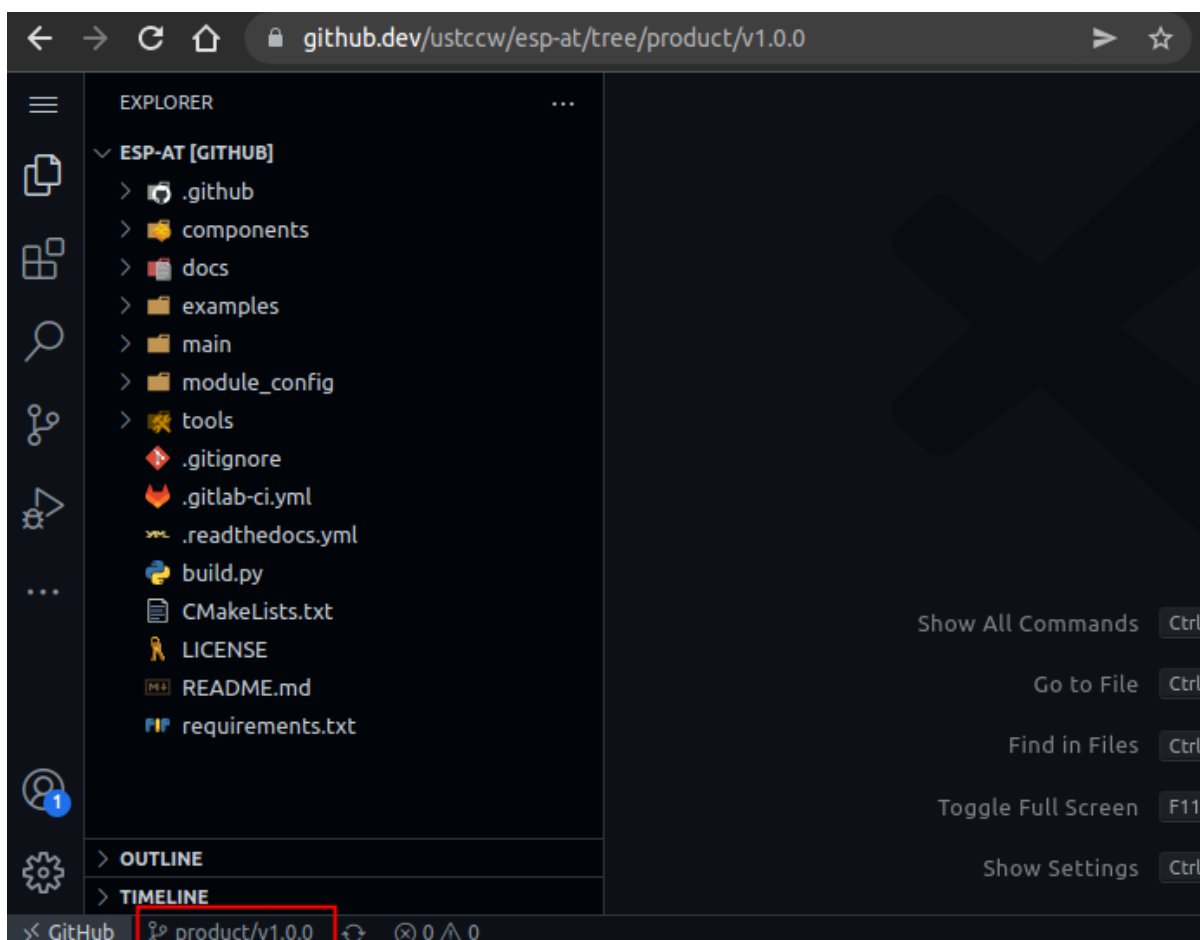

Fig. 16: Branch Created

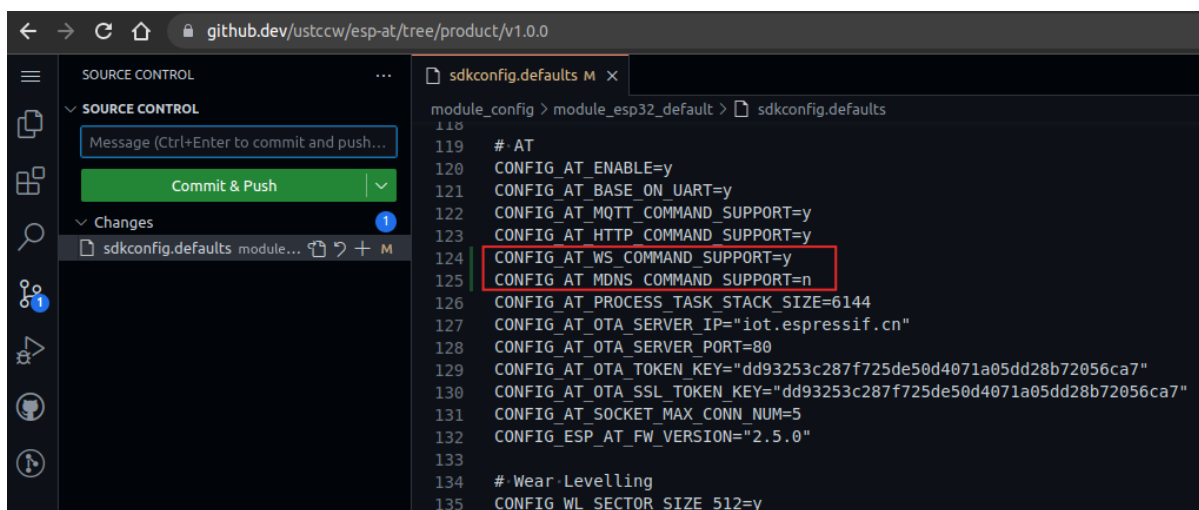

Fig. 17: Add WebSocket Command Support and Disable mDNS Functionality (Click to Enlarge)

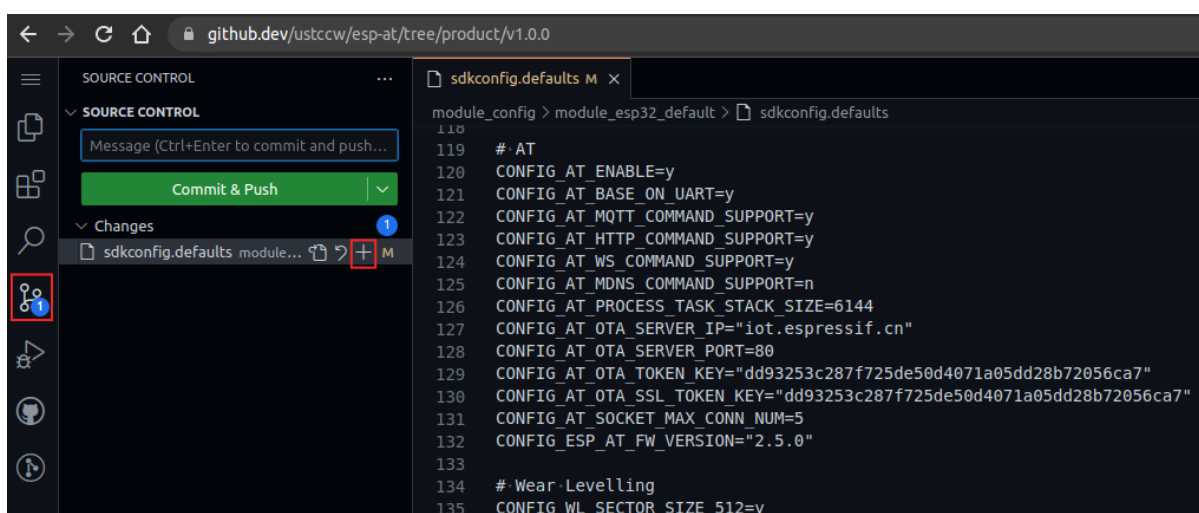

Fig. 18: Stage Changes (Click to Enlarge)

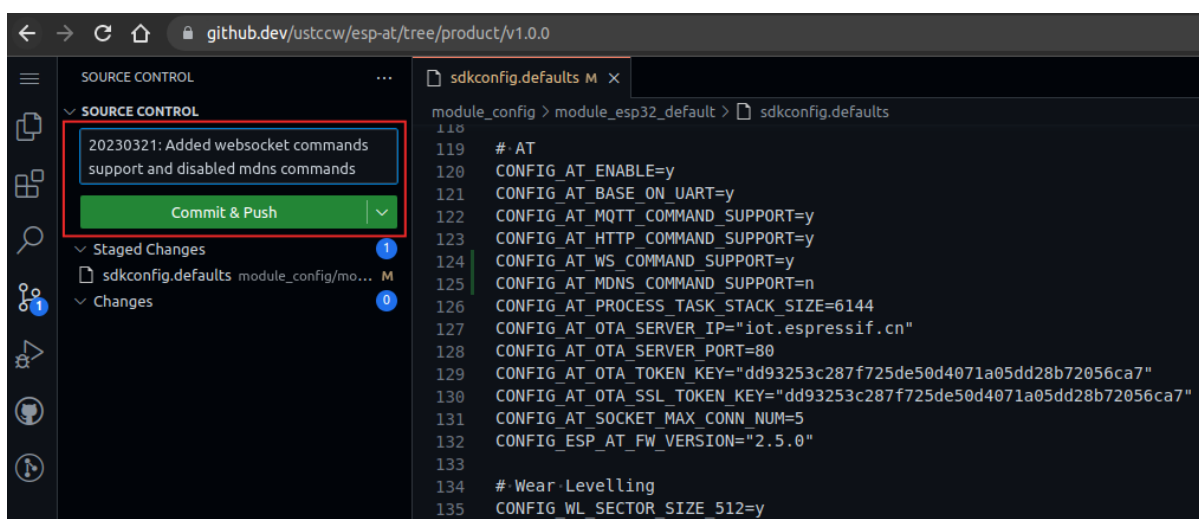

Fig. 19: Submit Changes (Click to Enlarge)



### 6.2.7 Step 6. Compile the AT firmware using GitHub Actions

After you complete the above steps, GitHub Actions will automatically trigger the compilation of your ESP-AT firmware. After compilation, please refer to [How to Download the Latest Temporary Version of AT Firmware from GitHub](#) to download the AT firmware you need. Note that the firmware is generated based on your own esp-at project, not the <https://github.com/espressif/esp-at> project.

## 6.3 How to Set AT Port Pins

This document introduces how to modify *AT port* pins in the firmware for ESP32-C2 series of products. By default, ESP-AT uses two UART interfaces as AT ports: one is to output logs (named as log port below) and the other to send AT commands and receive responses (named as command port below).

To modify the AT port pins of your ESP32-C2, you should:

- *clone the ESP-AT project*;
- modify the pins either in the menuconfig utility or the factory\_param\_data.csv table;
- *compile the project* to generate the new bin in build/customized\_partitions/factory\_param.bin;
- *flash the new bin to your device*.

This document focuses on modifying the pins. Click the links above for details of other steps.

---

**Note:** To use other interfaces as the AT command port, please refer to [AT through SDIO](#) , [AT through SPI](#) , or [AT through socket](#) for more details.

---

### 6.3.1 ESP32-C2 Series

The log port and command port pins of ESP32-C2 AT firmware can be user-defined to other pins. Refer to [ESP32-C2 Technical Reference Manual](#) for the pins you can use.

#### Modify Log Port Pins

By default, the ESP32-C2 AT firmware provided by Espressif uses the following UART0 pins to output log:

- TX: GPIO20
- RX: GPIO19

When compiling your ESP-AT project, you can modify them to other pins with the menuconfig utility:

- `./build.py menuconfig -> Component config -> ESP System Settings -> Channel for console output -> Custom UART`
- `./build.py menuconfig -> Component config -> ESP System Settings -> UART TX on GPIO#`
- `./build.py menuconfig -> Component config -> ESP System Settings -> UART RX on GPIO#`

## Modify Command Port Pins

By default, UART1 is used to send AT commands and receive AT responses, and its pins are defined in Column `uart_port`, `uart_tx_pin`, `uart_rx_pin`, `uart_cts_pin`, and `uart_rts_pin` of the [factory\\_param\\_data.csv](#).

You can change them directly in your `factory_param_data.csv` table:

- Open your local `factory_param_data.csv` file.
- Locate the row of your module.
- Set `uart_port` as needed. (If you want to use the AT log port as the AT command port as well, you need to modify this line, and ensure that the `uart_tx_pin` and `uart_rx_pin` below have the same pins as the AT log port)
- Set `uart_tx_pin` and `uart_rx_pin` as needed. (Make sure that the pins you are going to modify are not being used by other functions, including the AT log port)
- Set `uart_cts_pin` and `uart_rts_pin` to be -1 if you do not use the hardware flow control function.
- Save the table.

## 6.4 How to add user-defined AT commands

This document details how to add a user-defined AT command based on the [ESP-AT](#) project. It uses the AT+TEST command as an example to show the sample code for each step.

Customizing a basic and well-functioned command requires at least the two steps below:

- [Define AT Commands](#)
- [Register AT Commands](#)

This step checks how the newly defined command works out.

- [Give it a try](#)

The remaining steps are for relatively complex AT commands and are optional depending on your needs.

- [Define Return Values](#)
- [Access Command Parameters](#)
- [Omit Command Parameters](#)
- [Block Command Execution](#)
- [Access Input Data from AT Command Port](#)

The source code of AT command set is not open-source, and is provided in the form of [library file](#). It is also the basis to parse user-defined AT commands.

### 6.4.1 Define AT Commands

Before defining any AT command, you should first decide on the name and type of the command.

#### Command naming rules:

- It should start with the + character.
- Alphabetic characters (A~Z, a~z), numeric characters (0~9), and some other characters (!, %, -, ., /, :, \_) are supported. See [AT Command Types](#) for more information.

#### Command types:

Each AT command can have up to four types: Test Command, Query Command, Set Command, and Execute Command. See [AT Command Types](#) for more information.

Then, define desired type of command. Assuming that AT+TEST supports all the four types. Below is the sample code to define each type.

Test Command:

```
uint8_t at_test_cmd_test(uint8_t *cmd_name)
{
    uint8_t buffer[64] = {0};

    snprintf((char *)buffer, 64, "this cmd is test cmd: %s\r\n", cmd_name);

    esp_at_port_write_data(buffer, strlen((char *)buffer));

    return ESP_AT_RESULT_CODE_OK;
}
```

Query Command:

```
uint8_t at_query_cmd_test(uint8_t *cmd_name)
{
    uint8_t buffer[64] = {0};

    snprintf((char *)buffer, 64, "this cmd is query cmd: %s\r\n", cmd_name);

    esp_at_port_write_data(buffer, strlen((char *)buffer));

    return ESP_AT_RESULT_CODE_OK;
}
```

Set Command:

```
uint8_t at_setup_cmd_test(uint8_t para_num)
{
    int32_t para_int_1 = 0;
    uint8_t *para_str_2 = NULL;
    uint8_t num_index = 0;
    uint8_t buffer[64] = {0};

    if (esp_at_get_para_as_digit(num_index++, &para_int_1) != ESP_AT_PARA_PARSE_
↳RESULT_OK) {
        return ESP_AT_RESULT_CODE_ERROR;
    }

    if (esp_at_get_para_as_str(num_index++, &para_str_2) != ESP_AT_PARA_PARSE_
↳RESULT_OK) {
        return ESP_AT_RESULT_CODE_ERROR;
    }

    snprintf((char *)buffer, 64, "this cmd is setup cmd and cmd num is: %u\r\n",
↳para_num);
    esp_at_port_write_data(buffer, strlen((char *)buffer));

    memset(buffer, 0, 64);
    snprintf((char *)buffer, 64, "first parameter is: %d\r\n", para_int_1);
    esp_at_port_write_data(buffer, strlen((char *)buffer));

    memset(buffer, 0, 64);
    snprintf((char *)buffer, 64, "second parameter is: %s\r\n", para_str_2);
    esp_at_port_write_data(buffer, strlen((char *)buffer));

    return ESP_AT_RESULT_CODE_OK;
}
```

Execute Command:

```

uint8_t at_exe_cmd_test(uint8_t *cmd_name)
{
    uint8_t buffer[64] = {0};

    snprintf((char *)buffer, 64, "this cmd is execute cmd: %s\r\n", cmd_name);

    esp_at_port_write_data(buffer, strlen((char *)buffer));

    return ESP_AT_RESULT_CODE_OK;
}

```

Finally, call `esp_at_cmd_struct` to define the name and type(s) that your AT command supports. The sample code below defined the name +TEST (omitting AT) and all the four types.

```

static esp_at_cmd_struct at_custom_cmd[] = {
    {"+TEST", at_test_cmd_test, at_query_cmd_test, at_setup_cmd_test, at_exe_cmd_
    ↪test},
};

```

If you do not want to define a particular type, set it to NULL.

## 6.4.2 Register AT Commands

Call API `esp_at_custom_cmd_array_regist()` to register your AT command. Below is the sample code to register AT+TEST:

```

esp_at_custom_cmd_array_regist(at_custom_cmd, sizeof(at_custom_cmd) / sizeof(at_
    ↪custom_cmd[0]));

```

**Note:** `esp_at_custom_cmd_array_regist` is recommended to be added to the `at_custom_init()` in `app_main()`.

## 6.4.3 Give it a try

If you have finished the above two steps, the command should work after you build the ESP-AT project and flash the firmware to your device. Give it a try!

Below is how AT+TEST works out.

### Test Command:

```
AT+TEST=?
```

### Response:

```

AT+TEST=?
this cmd is test cmd: +TEST

OK

```

### Query Command:

```
AT+TEST?
```

### Response:

```
AT+TEST?
this cmd is query cmd: +TEST

OK
```

**Set Command:**

```
AT+TEST=1,"espressif"
```

**Response:**

```
AT+TEST=1,"espressif"
this cmd is setup cmd and cmd num is: 2
first parameter is: 1
second parameter is: espressif

OK
```

**Execute Command:**

```
AT+TEST
```

**Response:**

```
AT+TEST
this cmd is execute cmd: +TEST

OK
```

## 6.4.4 Define Return Values

ESP-AT has defined return values in [esp\\_at\\_result\\_code\\_string\\_index](#). See [AT Messages](#) for more return values.

In addition to output return values through the return mode, you can also use API [esp\\_at\\_response\\_result\(\)](#) to output the execution result of the command. [ESP\\_AT\\_RESULT\\_CODE\\_SEND\\_OK](#) and [ESP\\_AT\\_RESULT\\_CODE\\_SEND\\_FAIL](#) can be used with the API in code.

For example, when you send data to the server or MCU with the Execute Command of AT+TEST, you can use [esp\\_at\\_response\\_result\(\)](#) to output the sending result, and the return mode to output the command execution result. Below is the sample code:

```
uint8_t at_exe_cmd_test(uint8_t *cmd_name)
{
    uint8_t buffer[64] = {0};

    snprintf((char *)buffer, 64, "this cmd is execute cmd: %s\r\n", cmd_name);

    esp_at_port_write_data(buffer, strlen((char *)buffer));

    // user-defined operation of sending data to server or MCU
    send_data_to_server();

    // output SEND OK
    esp_at_response_result(ESP_AT_RESULT_CODE_SEND_OK);

    return ESP_AT_RESULT_CODE_OK;
}
```

How it works out:

```

AT+TEST
this cmd is execute cmd: +TEST

SEND OK

OK

```

## 6.4.5 Access Command Parameters

ESP-AT provides two APIs to access command parameters:

- `esp_at_get_para_as_digit()` obtains digital parameters.
- `esp_at_get_para_as_str()` obtains string parameters.

See *Set Command* for an example.

## 6.4.6 Omit Command Parameters

This section describes how to provide optional command parameters:

- *Omit the First or Middle Parameter*
- *Omit the Last Parameter*

### Omit the First or Middle Parameter

Let's say you want to make `<param_2>` and `<param_3>` of AT+TEST optional. `<param_2>` is a digital parameter, and `<param_3>` a string parameter.

```
AT+TEST=<param_1>[,<param_2>][,<param_3>],<param_4>
```

Below is the sample code to achieve it:

```

uint8_t at_setup_cmd_test(uint8_t para_num)
{
    int32_t para_int_1 = 0;
    int32_t para_int_2 = 0;
    uint8_t *para_str_3 = NULL;
    uint8_t *para_str_4 = NULL;
    uint8_t num_index = 0;
    uint8_t buffer[64] = {0};
    esp_at_para_parse_result_type parse_result = ESP_AT_PARA_PARSE_RESULT_OK;

    snprintf((char *)buffer, 64, "this cmd is setup cmd and cmd num is: %u\r\n",
↳para_num);
    esp_at_port_write_data(buffer, strlen((char *)buffer));

    parse_result = esp_at_get_para_as_digit(num_index++, &para_int_1);
    if (parse_result != ESP_AT_PARA_PARSE_RESULT_OK) {
        return ESP_AT_RESULT_CODE_ERROR;
    } else {
        memset(buffer, 0, 64);
        snprintf((char *)buffer, 64, "first parameter is: %d\r\n", para_int_1);
        esp_at_port_write_data(buffer, strlen((char *)buffer));
    }

    parse_result = esp_at_get_para_as_digit(num_index++, &para_int_2);
    if (parse_result != ESP_AT_PARA_PARSE_RESULT_OMITTED) {
        if (parse_result != ESP_AT_PARA_PARSE_RESULT_OK) {

```

(continues on next page)

```

        return ESP_AT_RESULT_CODE_ERROR;
    } else {
        // sample code
        // user needs to customize the operation
        memset(buffer, 0, 64);
        snprintf((char *)buffer, 64, "second parameter is: %d\r\n", para_int_
↪2);
        esp_at_port_write_data(buffer, strlen((char *)buffer));
    }
} else {
    // sample code
    // the second parameter is omitted
    // user needs to customize the operation
    memset(buffer, 0, 64);
    snprintf((char *)buffer, 64, "second parameter is omitted\r\n");
    esp_at_port_write_data(buffer, strlen((char *)buffer));
}

parse_result = esp_at_get_para_as_str(num_index++, &para_str_3);
if (parse_result != ESP_AT_PARA_PARSE_RESULT_OMITTED) {
    if (parse_result != ESP_AT_PARA_PARSE_RESULT_OK) {
        return ESP_AT_RESULT_CODE_ERROR;
    } else {
        // sample code
        // user needs to customize the operation
        memset(buffer, 0, 64);
        snprintf((char *)buffer, 64, "third parameter is: %s\r\n", para_str_3);
        esp_at_port_write_data(buffer, strlen((char *)buffer));
    }
} else {
    // sample code
    // the third parameter is omitted
    // user needs to customize the operation
    memset(buffer, 0, 64);
    snprintf((char *)buffer, 64, "third parameter is omitted\r\n");
    esp_at_port_write_data(buffer, strlen((char *)buffer));
}

parse_result = esp_at_get_para_as_str(num_index++, &para_str_4);
if (parse_result != ESP_AT_PARA_PARSE_RESULT_OK) {
    return ESP_AT_RESULT_CODE_ERROR;
} else {
    memset(buffer, 0, 64);
    snprintf((char *)buffer, 64, "fourth parameter is: %s\r\n", para_str_4);
    esp_at_port_write_data(buffer, strlen((char *)buffer));
}

return ESP_AT_RESULT_CODE_OK;
}

```

---

**Note:** If the string parameter input is "", it is not omitted.

---

### Omit the Last Parameter

Let's say you want to make the string parameter <param\_3> of AT+TEST optional, which is also the last parameter.

```
AT+TEST=<param_1>,<param_2>[,<param_3>]
```

There are two cases of omission:

- AT+TEST=<param\_1>,<param\_2>
- AT+TEST=<param\_1>,<param\_2>,

Below is the sample code to achieve it:

```

uint8_t at_setup_cmd_test(uint8_t para_num)
{
    int32_t para_int_1 = 0;
    uint8_t *para_str_2 = NULL;
    uint8_t *para_str_3 = NULL;
    uint8_t num_index = 0;
    uint8_t buffer[64] = {0};
    esp_at_para_parse_result_type parse_result = ESP_AT_PARA_PARSE_RESULT_OK;

    snprintf((char *)buffer, 64, "this cmd is setup cmd and cmd num is: %u\r\n",
↳para_num);
    esp_at_port_write_data(buffer, strlen((char *)buffer));

    parse_result = esp_at_get_para_as_digit(num_index++, &para_int_1);
    if (parse_result != ESP_AT_PARA_PARSE_RESULT_OK) {
        return ESP_AT_RESULT_CODE_ERROR;
    } else {
        memset(buffer, 0, 64);
        snprintf((char *)buffer, 64, "first parameter is: %d\r\n", para_int_1);
        esp_at_port_write_data(buffer, strlen((char *)buffer));
    }

    parse_result = esp_at_get_para_as_str(num_index++, &para_str_2);
    if (parse_result != ESP_AT_PARA_PARSE_RESULT_OK) {
        return ESP_AT_RESULT_CODE_ERROR;
    } else {
        memset(buffer, 0, 64);
        snprintf((char *)buffer, 64, "second parameter is: %s\r\n", para_str_2);
        esp_at_port_write_data(buffer, strlen((char *)buffer));
    }

    if (num_index == para_num) {
        memset(buffer, 0, 64);
        snprintf((char *)buffer, 64, "third parameter is omitted\r\n");
        esp_at_port_write_data(buffer, strlen((char *)buffer));
    } else {
        parse_result = esp_at_get_para_as_str(num_index++, &para_str_3);
        if (parse_result != ESP_AT_PARA_PARSE_RESULT_OMITTED) {
            if (parse_result != ESP_AT_PARA_PARSE_RESULT_OK) {
                return ESP_AT_RESULT_CODE_ERROR;
            } else {
                // sample code
                // user needs to customize the operation
                memset(buffer, 0, 64);
                snprintf((char *)buffer, 64, "third parameter is: %s\r\n", para_
↳str_3);
                esp_at_port_write_data(buffer, strlen((char *)buffer));
            }
        } else {
            // sample code
            // the third parameter is omitted
            // user needs to customize the operation
            memset(buffer, 0, 64);
            snprintf((char *)buffer, 64, "third parameter is omitted\r\n");
            esp_at_port_write_data(buffer, strlen((char *)buffer));
        }
    }
}

```

(continues on next page)



(continued from previous page)

```

return ESP_AT_RESULT_CODE_OK;
}

```

**Note:** If the string parameter input is "", it is not omitted.

### 6.4.7 Block Command Execution

Sometimes you want to block the execution of one command to wait for another execution result, and the system may return different values according to the result.

Generally, this kind of command needs to synchronize the results of other tasks.

semaphore is recommended to handle synchronization.

The sample code is as follows:

```

xSemaphoreHandle at_operation_sema = NULL;

uint8_t at_exe_cmd_test(uint8_t *cmd_name)
{
    uint8_t buffer[64] = {0};

    snprintf((char *)buffer, 64, "this cmd is execute cmd: %s\r\n", cmd_name);

    esp_at_port_write_data(buffer, strlen((char *)buffer));

    // sample code
    // users do not have to create semaphores here
    at_operation_sema = xSemaphoreCreateBinary();
    assert(at_operation_sema != NULL);

    // block command execution
    // wait for another execution result
    // other tasks can call xSemaphoreGive to release the semaphore
    xSemaphoreTake(at_operation_sema, portMAX_DELAY);

    return ESP_AT_RESULT_CODE_OK;
}

```

### 6.4.8 Access Input Data from AT Command Port

ESP-AT supports accessing input data from AT Command port. It provides two APIs for this purpose.

- `esp_at_port_enter_specific()` sets the callback function which will be called by AT port after receiving the input data.
- `esp_at_port_exit_specific()` deletes the callback function set by `esp_at_port_enter_specific`.

Approaches to access the data vary depending on whether the data length has been specified or not.

#### Input Data of Specified Length

Assuming that you have specified the data length in `<param_1>` as follows:

```
AT+TEST=<param_1>
```

Below is the sample to access the input data of `<param_1>` length from AT Command Port:

```

static xSemaphoreHandle at_sync_sema = NULL;

void wait_data_callback(void)
{
    xSemaphoreGive(at_sync_sema);
}

uint8_t at_setup_cmd_test(uint8_t para_num)
{
    int32_t specified_len = 0;
    int32_t received_len = 0;
    int32_t remain_len = 0;
    uint8_t *buf = NULL;
    uint8_t buffer[64] = {0};

    if (esp_at_get_para_as_digit(0, &specified_len) != ESP_AT_PARA_PARSE_RESULT_
↳OK) {
        return ESP_AT_RESULT_CODE_ERROR;
    }

    buf = (uint8_t *)malloc(specified_len);
    if (buf == NULL) {
        memset(buffer, 0, 64);
        snprintf((char *)buffer, 64, "malloc failed\r\n");
        esp_at_port_write_data(buffer, strlen((char *)buffer));
    }

    // sample code
    // users do not have to create semaphores here
    if (!at_sync_sema) {
        at_sync_sema = xSemaphoreCreateBinary();
        assert(at_sync_sema != NULL);
    }

    // output input prompt ">"
    esp_at_port_write_data((uint8_t *)>", strlen(">"));

    // set the callback function which will be called by AT port after receiving
↳the input data
    esp_at_port_enter_specific(wait_data_callback);

    // receive input data
    while(xSemaphoreTake(at_sync_sema, portMAX_DELAY)) {
        received_len += esp_at_port_read_data(buf + received_len, specified_len -
↳received_len);

        if (specified_len == received_len) {
            esp_at_port_exit_specific();

            // get the length of the remaining input data
            remain_len = esp_at_port_get_data_length();
            if (remain_len > 0) {
                // sample code
                // if the remaining data length > 0, the actual input data length
↳is greater than the specified received data length
                // users can customize the operation to process the remaining data
                // here is just a simple print out of the remaining data
                esp_at_port_recv_data_notify(remain_len, portMAX_DELAY);
            }

            // sample code
            // output received data

```

(continues on next page)

(continued from previous page)

```

    memset(buffer, 0, 64);
    snprintf((char *)buffer, 64, "\r\nreceived data is: ");
    esp_at_port_write_data(buffer, strlen((char *)buffer));

    esp_at_port_write_data(buf, specified_len);

    break;
}
}

free(buf);

return ESP_AT_RESULT_CODE_OK;
}

```

So, if you set AT+TEST=5 and the input data is 1234567890, the ESP-AT output is as follows.

```

AT+TEST=5
>67890
received data is: 12345
OK

```

### Input Data of Unspecified Length

This scenario is similar to the Wi-Fi *Passthrough Mode*. You do not specify the data length.

```
AT+TEST
```

Assuming that ESP-AT ends the execution of the command and returns the execution result, the sample code is as follows:

```

#define BUFFER_LEN (2048)
static xSemaphoreHandle at_sync_sema = NULL;

void wait_data_callback(void)
{
    xSemaphoreGive(at_sync_sema);
}

uint8_t at_exe_cmd_test(uint8_t *cmd_name)
{
    int32_t received_len = 0;
    int32_t remain_len = 0;
    uint8_t *buf = NULL;
    uint8_t buffer[64] = {0};

    buf = (uint8_t *)malloc(BUFFER_LEN);
    if (buf == NULL) {
        memset(buffer, 0, 64);
        snprintf((char *)buffer, 64, "malloc failed\r\n");
        esp_at_port_write_data(buffer, strlen((char *)buffer));
    }

    // sample code
    // users do not have to create semaphores here
    if (!at_sync_sema) {
        at_sync_sema = xSemaphoreCreateBinary();
        assert(at_sync_sema != NULL);
    }
}

```

(continues on next page)

(continued from previous page)

```

}

// output input prompt ">"
esp_at_port_write_data((uint8_t *)>", strlen(">"));

// set the callback function which will be called by AT port after receiving
↳the input data
esp_at_port_enter_specific(wait_data_callback);

// receive input data
while(xSemaphoreTake(at_sync_sema, portMAX_DELAY)) {
    memset(buf, 0, BUFFER_LEN);

    received_len = esp_at_port_read_data(buf, BUFFER_LEN);
    // check whether to exit the mode
    // the exit condition is the "+++" string received
    if ((received_len == 3) && (strncmp((const char *)buf, "+++", 3)) == 0) {
        esp_at_port_exit_specific();

        // sample code
        // if the remaining data length > 0, it means that there is still data
↳left in the buffer to be processed
        // users can customize the operation to process the remaining data
        // here is just a simple print out of the remaining data
        remain_len = esp_at_port_get_data_length();
        if (remain_len > 0) {
            esp_at_port_rcv_data_notify(remain_len, portMAX_DELAY);
        }

        break;
    } else if (received_len > 0) {
        // sample code
        // users can customize the operation to process the received data
        // here is just a simple print received data
        memset(buffer, 0, 64);
        snprintf((char *)buffer, 64, "\r\nreceived data is: ");
        esp_at_port_write_data(buffer, strlen((char *)buffer));

        esp_at_port_write_data(buf, strlen((char *)buf));
    }
}

free(buf);

return ESP_AT_RESULT_CODE_OK;
}

```

So, if the first input data is 1234567890, and the second input data is +++, the ESP-AT output is as follows:

```

AT+TEST
>
received data is: 1234567890
OK

```

## 6.5 How to Improve ESP-AT Throughput Performance

By default, UART is used for communication between ESP-AT and the host MCU, so the maximum throughput speed will not exceed its default configuration, that is, 115200 bps. If users want ESP-AT to achieve high throughput,

it is necessary to understand this document and choose the appropriate configuration method. Taking ESP32-C2 as an example, this document introduces how to improve the throughput performance of ESP-AT.

**Note:** This document describes general methods to improve TCP/UDP/SSL throughput performance when ESP-AT is in *Passthrough Mode*.

Users could choose one of the following methods to improve throughput performance:

- [\[Simple\] Quick Configuration](#)
- [\[Recommended\] Understand Data Stream and Make the Precise Configuration](#)

## 6.5.1 [Simple] Quick Configuration

### 1. Configure system, LWIP, Wi-Fi parameters

Copy the following code snippet and append to tail of `module_config/module_esp32c2_default/sdkconfig.defaults` file. For other ESP32-C2 series devices, please modify the `sdkconfig.defaults` file in the corresponding folder.

```
# System
CONFIG_ESP_SYSTEM_EVENT_TASK_STACK_SIZE=4096
CONFIG_FREERTOS_UNICORE=n
CONFIG_FREERTOS_HZ=1000
CONFIG_ESP_DEFAULT_CPU_FREQ_MHZ_120=y
CONFIG_ESP_DEFAULT_CPU_FREQ_MHZ=120
CONFIG_ESPTOOLPY_FLASHMODE_QIO=y
CONFIG_ESPTOOLPY_FLASHFREQ_60M=y

# LWIP
CONFIG_LWIP_TCP_SND_BUF_DEFAULT=65534
CONFIG_LWIP_TCP_WND_DEFAULT=65534
CONFIG_LWIP_TCP_RECVMBOX_SIZE=12
CONFIG_LWIP_UDP_RECVMBOX_SIZE=12
CONFIG_LWIP_TCPIP_RECVMBOX_SIZE=64

# Wi-Fi
CONFIG_ESP32_WIFI_STATIC_RX_BUFFER_NUM=16
CONFIG_ESP32_WIFI_DYNAMIC_RX_BUFFER_NUM=64
CONFIG_ESP32_WIFI_DYNAMIC_TX_BUFFER_NUM=64
CONFIG_ESP32_WIFI_TX_BA_WIN=32
CONFIG_ESP32_WIFI_RX_BA_WIN=32
CONFIG_ESP32_WIFI_AMPDU_TX_ENABLED=y
CONFIG_ESP32_WIFI_AMPDU_RX_ENABLED=y
```

### 2. Enlarge UART buffer size

Copy the following code snippet and replace the `uart_driver_install()` line of `at_uart_task.c` file.

```
uart_driver_install(esp_at_uart_port, 1024 * 16, 1024 * 16, 100, &esp_at_
↪uart_queue, 0);
```

### 3. Delete, Build, Flash, Run

```
rm -rf build sdkconfig
./build.py build
./build.py flash monitor
```

### 4. Increase UART baud rate before entering passthrough mode

A typical ESP-AT commands sequence is as follows:

```

AT+CWMODE=1
AT+CWJAP="ssid", "password"
AT+UART_CUR=3000000, 8, 1, 0, 3
AT+CIPSTART="TCP", "192.168.105.13", 3344
AT+CIPSEND
// data transmission

```

This simple and quick configuration method can improve the throughput to a certain extent, but sometimes it might not meet the expectations of users. In addition, some configurations may not hit the bottleneck of throughput. Higher configurations may sacrifice memory resources or power consumption. Therefore, users could also familiarize themselves with the following recommended method and make the precise configuration.

## 6.5.2 [Recommended] Understand Data Stream and Make the Precise Configuration

The factors that generally affect ESP-AT throughput are illustrated in the following figure:

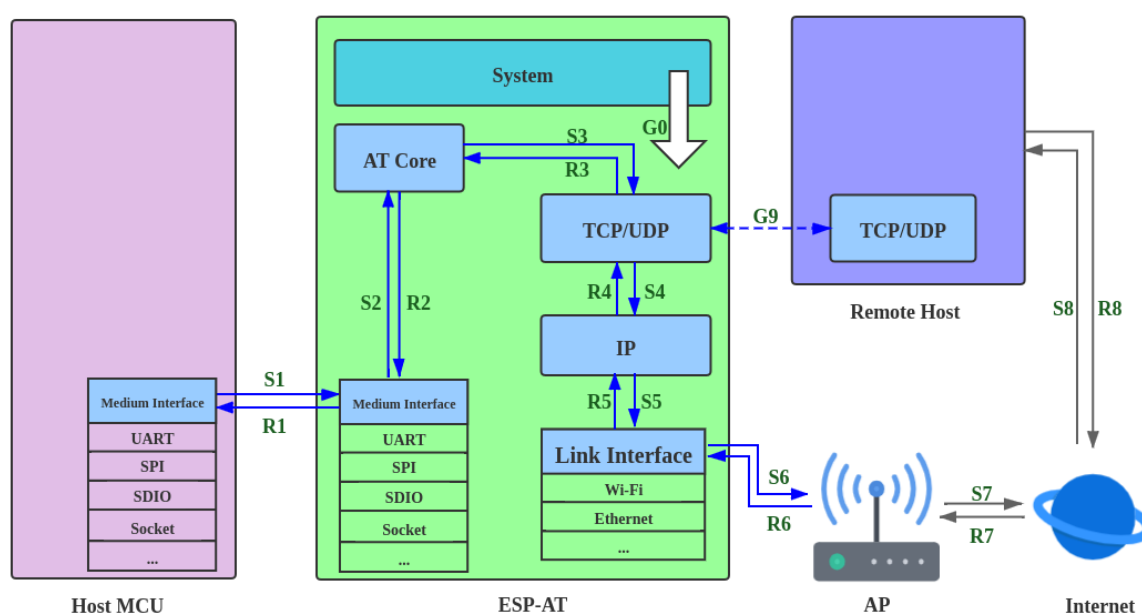

Fig. 20: Data Stream in Throughput

As shown by the arrows in the figure:

- The Data stream sent by ESP-AT is (TX): S1 -> S2 -> S3 -> S4 -> S5 -> S6 -> S7 -> S8
- The Data stream received by ESP-AT is (RX): R8 -> R7 -> R6 -> R5 -> R4 -> R3 -> R2 -> R1

The data stream of throughput is similar to water flow. In order to improve throughput, it is necessary to consider optimizing between nodes with low data flow rate rather than making additional configuration between nodes with expected data flow rate, so as to avoid unnecessary waste of resources. In actual products, usually, users only need to improve the throughput of one data stream. So here, users need to configure it according to the following instructions.

**Note:** The following configurations are based on sufficient available memory. Users can query the available memory through the AT command: `AT+SYSRAM`.

### 1. G0 throughput optimization

G0 is a part of the system that can be optimized. The recommended configuration is as follows:

```

CONFIG_ESP_SYSTEM_EVENT_TASK_STACK_SIZE=4096
CONFIG_FREERTOS_UNICORE=n
CONFIG_FREERTOS_HZ=1000
CONFIG_ESP_DEFAULT_CPU_FREQ_MHZ_120=y
CONFIG_ESP_DEFAULT_CPU_FREQ_MHZ=120
CONFIG_ESPTOOLPY_FLASHMODE_QIO=y
CONFIG_ESPTOOLPY_FLASHFREQ_60M=y

```

## 2. S1, R1 throughput optimization

Generally, S1 and R1 are the key to the throughput of ESP-AT. Because UART is used for communication between ESP-AT and the host MCU by default, and the baud rate is 115200. On the hardware, the baud rate upper limit is 5 Mbps. Therefore, if the throughput is expected to be less than 5 Mbps, the user can use the default UART as the communication medium with the host MCU, and the following optimization methods can be carried out.

### 2.1 Enlarge UART buffer size

Copy the following code snippet and replace the `uart_driver_install()` line of `at_uart_task.c` file.

- Improve UART TX throughput

```

uart_driver_install(esp_at_uart_port, 1024 * 16, 8192, 100, &esp_at_
↪uart_queue, 0);

```

- Improve UART RX throughput

```

uart_driver_install(esp_at_uart_port, 2048, 1024 * 16, 100, &esp_at_
↪uart_queue, 0);

```

- Improve UART TX and RX throughput

```

uart_driver_install(esp_at_uart_port, 1024 * 16, 1024 * 16, 100, &esp_
↪at_uart_queue, 0);

```

### 2.2 Increase UART baud rate before entering passthrough mode

A typical ESP-AT commands sequence is as follows:

```

AT+CWMODE=1
AT+CWJAP="ssid", "password"
AT+UART_CUR=3000000,8,1,0,3
AT+CIPSTART="TCP", "192.168.105.13", 3344
AT+CIPSEND
// data transmission

```

---

**Note:** The user needs to ensure that the UART of the host MCU can support such a high rate, and the UART connection between the host MCU and ESP-AT is as short as possible.

---

**Note:** If the user expects the throughput rate to be greater than or close to 5 Mbps, then SPI, SDIO, Socket or other methods can be considered. Please refer to:

- SPI: [SPI AT Guide](#)
  - Socket: [Socket AT Guide](#)
- 

## 3. S2, R2, R3, S3 throughput optimization

Generally, S2, R2, R3, S3 are not the bottleneck of ESP-AT throughput. Because AT core transfers data between UART buffer and the transport layer of communication protocol, where has minimal and non-time-consuming application logic, there is no need to optimize them.

## 4. S4, R4, S5, R5, S6, R6 throughput optimization

If UART is used for communication between ESP-AT and host MCU, S4, R4, S5, R5, S6, R6 need not be optimized. If other transmission media are used, S4, R4, S5, R5, S6, R6 should be a factor affecting throughput.

S4, R4, S5, R5, S6, R6 is the data stream between the transport layer, network layer and data link layer of the communication protocol. Users need to read [How to improve Wi-Fi performance](#) in ESP-IDF to understand the principle and make reasonable configuration. These configurations can be configured in `./build.py menuconfig`.

- Improve throughput of S4 -> S5 -> S6: [TX direction](#)
- Improve throughput of R6 -> R5 -> R4: [RX direction](#)

### 5. S6, R6 throughput optimization

S6 and R6 are the data link layers of the communication protocol. ESP32-C2 can use Wi-Fi or ethernet as the transmission medium. In addition to the optimization methods described above, Wi-Fi throughput optimization may also need users' attention:

- Improve RF Power  
The default RF power is usually not the bottleneck of throughput. Users could query and set RF power through AT command: [AT+RFPOWER](#).
- Set 802.11 b/g/n protocol  
The default Wi-Fi mode is 802.11 b/g/n protocol. Users could query and set 802.11 b/g/n protocol through AT command: [AT+CWSTAPROTO](#). The configuration is bidirectional. Therefore, it is recommended that the Wi-Fi mode of AP is configured as 802.11 b/g/n protocol and the bandwidth mode of AP is configured as HT20/HT40 (20/40 MHz) mode.

### 6. S7, R7, S8, R8 throughput optimization

Generally, S7, R7, S8, R8 are not the scope of ESP-AT throughput optimization because this is related to the actual network bandwidth, network routing, physical distance, etc.

## 6.6 How to Update mfg\_nvs Partition

### 6.6.1 mfg\_nvs Partition

`mfg_nvs` (*manufacturing nvs*) partition is defined in `esp-at/module_config/{module_name}/at_customize.csv` file. This partition stores the following configurations of factory firmware:

- Factory parameter configurations (Wi-Fi configurations, UART configurations, module configurations): Please refer to [Factory Parameter Configuration](#).
- PKI configurations (various certificate and key configurations): Please refer to [Introduction to PKI Configuration](#).
- GATTS configuration (Bluetooth LE services): Please refer to [Bluetooth LE Service Source File](#).

When you need to modify the factory parameter configurations, PKI configurations, or GATTS configurations, you can recompile the ESP-AT project to generate a new `mfg_nvs.bin` file; Alternatively, through [at.py Tool](#) modify the firmware to generate a new firmware for your module. This article introduces the former.

### 6.6.2 Generate mfg\_nvs.bin

After the configuration modifications are completed, [re-build the project](#). During the compilation stage, the `mfg_nvs.py` script is automatically used to generate the `build/customized_partitions/mfg_nvs.csv` file (which contains the namespace, key, type, and value information for all configurations). Then, the



nvs\_partition\_gen.py script in esp-idf is used to generate the build/customized\_partitions/mfg\_nvs.bin file (which represents the structure of the NVS library ([NVS flash API reference](#))). Then, you can download the mfg\_nvs.bin file to the device.

### Download mfg\_nvs.bin

You can download the mfg\_nvs.bin in one of the following ways.

- Download the recompiled ESP-AT firmware. See [Step 7. Flash onto the Device](#) for more information.
- Download mfg\_nvs.bin only. This way only updates the mfg\_nvs area in the device.
  - Windows
 

Please download the Windows [Flash Download Tool](#). Refer to the readme.pdf or the documentation in the doc directory for instructions. Download the build/customized\_partitions/mfg\_nvs.bin file to ESP32-C2. You can use the [AT+SYSFLASH?](#) command to query the download address of mfg\_nvs.bin.
  - Linux or macOS
 

Please use [esptool.py](#).  
You can execute the following command in the ESP-AT root directory to download the mfg\_nvs.bin file.

```
esptool.py --chip auto --port PORTNAME --baud 921600 --before default_
↪reset --after hard_reset write_flash -z --flash_mode dio --flash_freq_
↪40m --flash_size 4MB ADDRESS mfg_nvs.bin
```

Replace PORTNAME with your serial port name. Replace ADDRESS with the address for downloading the mfg\_nvs.bin file. You can use the [AT+SYSFLASH?](#) command to query the download address.

- MCU sends the [AT+SYSFLASH](#) command to update the mfg\_nvs partition of ESP32-C2.

```
# Erase the mfg_nvs partition
AT+SYSFLASH=0, "mfg_nvs", 0, MFG_NVS_SIZE

# Write the mfg_nvs.bin file
AT+SYSFLASH=1, "mfg_nvs", 0, MFG_NVS_SIZE
```

Replace MFG\_NVS\_SIZE with the size of the downloaded mfg\_nvs.bin file. Different modules have different partition sizes. You can use the [AT+SYSFLASH?](#) command to query the partition size.

## 6.7 How to Update Factory Parameters

This document describes how to update the default factory parameter configuration for ESP-AT. The factory parameter configuration includes some Wi-Fi configurations, UART configurations, and module configurations.

- [Factory Parameter Configuration](#)

### 6.7.1 Factory Parameter Configuration

The default factory parameters are configured in the source file `customized_partitions/raw_data/factory_param/factory_param_data.csv`, as shown below:

Function	Current Configuration	Related AT Commands
Wi-Fi Configuration	<ul style="list-style-type: none"> <li>• <code>max_tx_power</code> (Wi-Fi maximum transmission power for ESP32-C2, see <a href="#">ESP32-C2 Transmit Power</a> for the setting range)</li> <li>• <code>country_code</code> (country code)</li> <li>• <code>start_channel</code> (starting Wi-Fi channel)</li> <li>• <code>channel_num</code> (total number of Wi-Fi channels)</li> </ul>	All AT commands requiring Wi-Fi functionality
UART Configuration	<ul style="list-style-type: none"> <li>• <code>uart_port</code> (UART port used for sending AT commands and receiving AT responses)</li> <li>• <code>uart_baudrate</code> (UART baud rate)</li> <li>• <code>uart_tx_pin</code> (UART TX pin)</li> <li>• <code>uart_rx_pin</code> (UART RX pin)</li> <li>• <code>uart_cts_pin</code> (UART CTS pin)</li> <li>• <code>uart_rts_pin</code> (UART RTS pin)</li> </ul>	All AT commands requiring UART functionality
Module Name	<code>module_name</code>	<a href="#">AT+GMR</a>

Please modify the factory parameters configurations according to your own needs and generate `mfg_nvs.bin` file.

### Generate `mfg_nvs.bin`

Please refer to [Generate `mfg\_nvs.bin`](#) document to generate the `mfg_nvs.bin` file with the factory parameters configurations.

### Download `mfg_nvs.bin`

Please refer to [Download `mfg\_nvs.bin`](#) document.

## 6.8 How to Update PKI Configuration

This document describes how to update the default *PKI* configuration provided by ESP-AT. The PKI configuration includes certificates and keys for TLS clients, TLS servers, MQTT clients, and WPA2 Enterprise clients.

- [Introduction to PKI Configuration](#)

### 6.8.1 Introduction to PKI Configuration

The source file for the current default PKI configuration is located in the `customized_partitions/raw_data` directory, as shown below:

Function	Current Configuration	Related AT Commands
TLS client	Set 0 client configuration <ul style="list-style-type: none"> <li>• client_ca_00.crt</li> <li>• client_cert_00.crt</li> <li>• client_key_00.key</li> </ul> Set 1 client configuration <ul style="list-style-type: none"> <li>• client_ca_01.crt</li> <li>• client_cert_01.crt</li> <li>• client_key_01.key</li> </ul>	<ul style="list-style-type: none"> <li>• <i>AT+CIPSTART</i></li> <li>• <i>AT+CIPSSLCONF</i></li> </ul>
TLS server	<ul style="list-style-type: none"> <li>• server_ca.crt</li> <li>• server_cert.crt</li> <li>• server.key</li> </ul>	<i>AT+CIPSERVER</i>
MQTT client	<ul style="list-style-type: none"> <li>• mqtt_ca.crt</li> <li>• mqtt_client.crt</li> <li>• mqtt_client.key</li> </ul>	<i>AT+MQTTUSERCFG</i>
WPA2 Enterprise client	<ul style="list-style-type: none"> <li>• wpa2_ca.pem</li> <li>• wpa2_client.crt</li> <li>• wpa2_client.key</li> </ul>	<i>AT+CWJEAP</i>

Please modify the PKI configurations according to your own needs and generate `mfg_nvs.bin` file.

### Generate `mfg_nvs.bin`

Please refer to [Generate `mfg\_nvs.bin`](#) document to generate the `mfg_nvs.bin` file with the PKI configurations.

### Download `mfg_nvs.bin`

Please refer to [Download `mfg\_nvs.bin`](#) document.

## 6.9 How to Customize Bluetooth® LE Services

This document describes how to customize Bluetooth LE services on your ESP32-C2 with the Bluetooth LE service source file provided by ESP-AT.

- [Bluetooth LE Service Source File](#)
- [Customize Bluetooth LE Services during Compilation](#)
  - [Modify the Bluetooth LE Service Source File](#)
  - [Generate `mfg\_nvs.bin`](#)
  - [Download `mfg\_nvs.bin`](#)

The Bluetooth LE services are defined as a multivariate array of GATT structures, and the array contains at least one primary service whose attribute type is defined as 0x2800. Each service always consists of a service definition and several characteristics. Each characteristic always consists of a value and optional descriptors. Please refer to Part Generic Attribute Profile (GATT) of [Bluetooth Core Specification](#) for more information.

## 6.9.1 Bluetooth LE Service Source File

The ESP-AT project creates Bluetooth LE services based on its Bluetooth LE service source file. It is located in `customized_partitions/raw_data/ble_data/gatts_data.csv`. The table below shows the default source file.

index	uuid_len	uuid	perm	val_max_len	val_cur_len	value
0	16	0x2800	0x01	2	2	A002
1	16	0x2803	0x01	1	1	2
2	16	0xC300	0x01	1	1	30
3	16	0x2901	0x11	1	1	30
...	...	...	...	...	...	...

Below are descriptions of the table above.

- perm field describes the permission. Its definition in the ESP-AT project is as follows:

```

/* relate to BTA_GATT_PERM_xxx in bta/bta_gatt_api.h */
/**
 * @brief Attribute permissions
 */
#define ESP_GATT_PERM_READ (1 << 0) /* bit 0 - 0x0001 */
↪ /* relate to BTA_GATT_PERM_READ in bta/bta_gatt_api.h */
#define ESP_GATT_PERM_READ_ENCRYPTED (1 << 1) /* bit 1 - 0x0002 */
↪ /* relate to BTA_GATT_PERM_READ_ENCRYPTED in bta/bta_gatt_api.h */
#define ESP_GATT_PERM_READ_ENC_MITM (1 << 2) /* bit 2 - 0x0004 */
↪ /* relate to BTA_GATT_PERM_READ_ENC_MITM in bta/bta_gatt_api.h */
#define ESP_GATT_PERM_WRITE (1 << 4) /* bit 4 - 0x0010 */
↪ /* relate to BTA_GATT_PERM_WRITE in bta/bta_gatt_api.h */
#define ESP_GATT_PERM_WRITE_ENCRYPTED (1 << 5) /* bit 5 - 0x0020 */
↪ /* relate to BTA_GATT_PERM_WRITE_ENCRYPTED in bta/bta_gatt_api.h */
#define ESP_GATT_PERM_WRITE_ENC_MITM (1 << 6) /* bit 6 - 0x0040 */
↪ /* relate to BTA_GATT_PERM_WRITE_ENC_MITM in bta/bta_gatt_api.h */
#define ESP_GATT_PERM_WRITE_SIGNED (1 << 7) /* bit 7 - 0x0080 */
↪ /* relate to BTA_GATT_PERM_WRITE_SIGNED in bta/bta_gatt_api.h */
#define ESP_GATT_PERM_WRITE_SIGNED_MITM (1 << 8) /* bit 8 - 0x0100 */
↪ /* relate to BTA_GATT_PERM_WRITE_SIGNED_MITM in bta/bta_gatt_api.h */
#define ESP_GATT_PERM_READ_AUTHORIZATION (1 << 9) /* bit 9 - 0x0200 */
#define ESP_GATT_PERM_WRITE_AUTHORIZATION (1 << 10) /* bit 10 - 0x0400 */

```

- The first line of table is the service definition with a UUID of 0xA002.
- The second line is the declaration of a characteristic. UUID 0x2803 means the characteristic declaration. The value 2 sets the permission. The length of permission is 8 bits, and each bit represents permission for an operation. 1 indicates that the operation is supported, and 0 indicates not supported.

Bit	Permission
0	BROADCAST
1	READ
2	WRITE WITHOUT RESPONSE
3	WRITE
4	NOTIFY
5	INDICATE
6	AUTHENTICATION SIGNED WRITES
7	EXTENDED PROPERTIES

- The third line defines a characteristic of the service. UUID of this line is the characteristic's UUID, and value is the characteristic's value.
- The fourth line defines a descriptor of the characteristic (optional).

For more information about UUID, please refer to [Bluetooth Special Interest Group \(SIG\) Assigned Numbers](#).

If you use the default source file on your ESP32-C2 without any modification and establish a Bluetooth LE connection, you will get the following result after querying the server service on the client side.

**Unknown Service**  
 UUID: 0000a002-0000-1000-8000-00805f9b34fb  
 PRIMARY SERVICE

**Unknown Characteristic**   
 UUID:  
 0000c300-0000-1000-8000-00805f9b34fb  
 Properties: READ  
 Value: (0x) 30, "0"

**Descriptors:**  
 Characteristic User Description    
 UUID: 0x2901  
 Value: 0

## 6.9.2 Customize Bluetooth LE Services during Compilation

If you want to customize the Bluetooth LE services, follow the steps below.

- *Modify the Bluetooth LE Service Source File*
- *Generate mfg\_nvs.bin*
- *Download mfg\_nvs.bin*

### Modify the Bluetooth LE Service Source File

You can define more than one service. For example, if you want to define three services (*Server\_A*, *Server\_B* and *Server\_C*), these three services need to be arranged in order. Since the definition of each service is similar, here we define one service as an example, and then you can define others one by one accordingly.

1. Add the service definition.

In this example, we define a primary service with a value of 0xFF01.

index	uuid_len	uuid	perm	val_max_len	val_cur_len	value
31	16	0x2800	0x01	2	2	FF01

2. Add the characteristic declaration and characteristic value.

In this example, we define a readable and writable characteristic with UUID 0xC300, and set its value to 0x30.

index	uuid_len	uuid	perm	val_max_len	val_cur_len	value
32	16	0x2803	0x11	1	1	0A
33	16	0xC300	0x11	1	1	30

3. Add the characteristic descriptor (optional).

In this example, we add client characteristic configuration. Its value 0x0000 represents notifications and indications are disabled.

index	uuid_len	uuid	perm	val_max_len	val_cur_len	value
34	16	0x2902	0x11	2	2	0000

After the above steps, the customized Bluetooth LE service has been defined as follows.

index	uuid_len	uuid	perm	val_max_len	val_cur_len	value
31	16	0x2800	0x01	2	2	FF01
32	16	0x2803	0x11	1	1	0A
33	16	0xC300	0x11	1	1	30
34	16	0x2902	0x11	2	2	0000

Please modify the GATTS configurations according to your own needs and generate `mfg_nvs.bin` file.

### Generate `mfg_nvs.bin`

Please refer to [Generate `mfg\_nvs.bin`](#) document to generate the `mfg_nvs.bin` file with the Low Energy Bluetooth services.

### Download `mfg_nvs.bin`

Please refer to [Download `mfg\_nvs.bin`](#) document.

After the download is complete, re-establish the Bluetooth LE connection. Query the server service on the client side as follows:



## 6.10 How to Customize Partitions

This document describes how to customize the partitions in your ESP32-C2 by modifying the `at_customize.csv` table provided by ESP-AT. There are two partition tables: the primary partition and the secondary partition table.

The primary partition table `partitions_at.csv` is for system usage, based on which the `partitions_at.bin` file is generated. If the primary partition table goes wrong, the system will fail to startup. Therefore, it is not recommended to modify the `partitions_at.csv`.

ESP-AT provides a secondary partition table `at_customize.csv` that you can customize to store self-defined blocks of data. It is based on the primary partition table.

To modify the partition in your ESP32-C2, please follow the first three steps. The fourth section illustrates the three steps with an example.

- [Modify at\\_customize.csv](#)
- [Generate at\\_customize.bin](#)
- [Flash at\\_customize.bin into ESP32-C2 Device](#)
- [Example](#)

### 6.10.1 Modify at\_customize.csv

Find the at\_customize.csv for your module with reference to the following table.

Table 1: at\_customize.csv paths

Platform	Module	Path
ESP32-C2	ESP32C2-2MB (all ESP32-C2 (ESP8684) series with 2 MB flash)	module_config/module_esp32c2-2mb/at_customize.csv
ESP32-C2	ESP32C2-4MB (all ESP32-C2 (ESP8684) series with 4 MB flash)	module_config/module_esp32c2_default/at_customize.csv

Then, follow the rules below when modifying at\_customize.csv.

- Do not change the Name and Type of the user partitions that have already been defined in it, while SubType, Offset, and Size can be changed.
- If you need to add a new user partition, please check if it has already been defined in the ESP-IDF (esp\_partition.h) first.
  - If yes, you should keep the Type value the same as that of ESP-IDF.
  - If no, please set the Type to 0x40.
- A user partition's Name should not be longer than 16 bytes.
- The default size of the entire at\_customize partition is defined in the partitions\_at.csv table. Please do not exceed the range when adding new user partitions.

### 6.10.2 Generate at\_customize.bin

After having modified the at\_customize.csv, you can either recompile the ESP-AT project to generate the at\_customize.bin file, or use the python script gen\_esp32part.py.

If you use the script, execute the following command under the root directory of ESP-AT project and replace INPUT and OUTPUT:

```
python esp-idf/components/partition_table/gen_esp32part.py <INPUT> [OUTPUT]
```

- Replace INPUT with the path to at\_customize.csv or the binary file to parse.
- Replace OUTPUT with the path to output converted binary or CSV file. Stdout will be used if omitted.

### 6.10.3 Flash at\_customize.bin into ESP32-C2 Device

Download the at\_customize.bin into flash. Please refer to [Flash AT Firmware into Your Device](#) for how to flash bin files into ESP32-C2 device and the following table for the download address for your module.

Table 2: Download Address of at\_customize.bin in Modules

Platform	Module	Address	Size
ESP32-C2	ESP32C2-2MB (all ESP32-C2 (ESP8684) series with 2 MB flash)	0x1A000	0x26000
ESP32-C2	ESP32C2-4MB (all ESP32-C2 (ESP8684) series with 4 MB flash)	0x1E000	0x42000

There are cases where at\_customize.bin must be downloaded to flash in order to use certain AT commands:

- *AT+SYSFLASH: Query/Set User Partitions in Flash*
- *AT+FS: Filesystem Operations*
- SSL server relevant commands
- BLE server relevant commands

### 6.10.4 Example

The section demonstrates how to add a 4 KB partition named `test` into the ESP8684-MINI-1 4MB module.

Firstly, find the `at_customize.csv` table for ESP8684-MINI-1 4MB and set the Name, Type, Subtype, Offset, and Size of the new partition:

```
# Name, Type, SubType, Offset, Size
... ..
test, 0x40, 15, 0x3E000, 4K
fatfs, data, fat, 0x47000, 100K
```

Secondly, recompile the ESP-AT project, or execute the python script in the ESP-AT root directory to generate `at_customize.bin`.

```
python esp-idf/components/partition_table/gen_esp32part.py -q ./module_config/
↳module_esp32c2_default/at_customize.csv at_customize.bin
```

Then, the `at_customize.bin` will be generated in the ESP-AT root directory.

Thirdly, download the `at_customize.bin` to flash.

Execute the following command under the root directory of ESP-AT project and replace `PORT` and `BAUD`.

```
python esp-idf/components/esptool_py/esptool/esptool.py -p PORT -b BAUD --before_
↳default_reset --after hard_reset --chip auto write_flash --flash_mode dio --
↳flash_size detect --flash_freq 40m 0x1E000 ./at_customize.bin
```

- Replace `PORT` with your port name.
- Replace `BAUD` with the baud rate.

## 6.11 How to Add Support for a Module

The ESP-AT project supports multiple modules, and provides configuration for them in the `factory_param_data.csv` table and the files in the `module_config` folder. See the table below for the supported platforms (chip series) and modules, as well as locations of the default configuration files.



Table 3: default configuration files

Platform	Module	Default
ESP32	<ul style="list-style-type: none"> <li>• WROOM-32</li> <li>• PICO-D4</li> <li>• SOLO-1</li> <li>• MINI-1</li> </ul>	<ul style="list-style-type: none"> <li>• <a href="#">module_config/module_esp32_default/sdkconfig.defaults</a></li> <li>• <a href="#">module_config/module_esp32_default/sdkconfig_silence.defaults</a></li> </ul>
ESP32	WROVER-32	<ul style="list-style-type: none"> <li>• <a href="#">module_config/module_wrover-32/sdkconfig.defaults</a></li> <li>• <a href="#">module_config/module_wrover-32/sdkconfig_silence.defaults</a></li> </ul>
ESP32	ESP32-D2WD	<ul style="list-style-type: none"> <li>• <a href="#">module_config/module_esp32-d2wd/sdkconfig.defaults</a></li> <li>• <a href="#">module_config/module_esp32-d2wd/sdkconfig_silence.defaults</a></li> </ul>
ESP32-C2	ESP32C2-2MB (all ESP32-C2 (ESP8684) series with 2 MB flash)	<ul style="list-style-type: none"> <li>• <a href="#">module_config/module_esp32c2-2mb/sdkconfig.defaults</a></li> <li>• <a href="#">module_config/module_esp32c2-2mb/sdkconfig_silence.defaults</a></li> </ul>
ESP32-C2	ESP32C2-4MB (all ESP32-C2 (ESP8684) series with 4 MB flash)	<ul style="list-style-type: none"> <li>• <a href="#">module_config/module_esp32c2_default/sdkconfig.defaults</a></li> <li>• <a href="#">module_config/module_esp32c2_default/sdkconfig_silence.defaults</a></li> </ul>
ESP32-C3	MINI-1	<ul style="list-style-type: none"> <li>• <a href="#">module_config/module_esp32c3_default/sdkconfig.defaults</a></li> <li>• <a href="#">module_config/module_esp32c3_default/sdkconfig_silence.defaults</a></li> </ul>
ESP32-C6	ESP32C6-4MB (all ESP32-C6 series with 4 MB flash)	<ul style="list-style-type: none"> <li>• <a href="#">module_config/module_esp32c6_default/sdkconfig.defaults</a></li> <li>• <a href="#">module_config/module_esp32c6_default/sdkconfig_silence.defaults</a></li> </ul>

**Note:**

- When the `silence` mode in `./build.py menuconfig` is 0, the default `sdkconfig` corresponding to the module is `sdkconfig.defaults`.
- When the `silence` mode in `./build.py menuconfig` is 1, the default `sdkconfig` corresponding to the module is `sdkconfig_silence.defaults`.

If you want to add support for an ESP32-C2 module in your ESP-AT project, you need to modify those configuration files. The “ESP32-C2 module” here means:

- Modules that the ESP-AT project has not supported yet, including those of supported platform and not supported platform. However, adding support for the latter requires extra huge work, thus not recommended and not explained in this document.
- Modules that the ESP-AT project supports, but you want to modify the default configuration.

The document uses an example to explain how to add support for an ESP32-C2 module in the ESP-AT project. The example module is ESP32-WROOM-32 that uses SDIO instead of the default UART interface.

- [Add Module to `factory\_param\_data.csv`](#)
- [Modify `esp\_at\_module\_info` Structure](#)
- [Configure the Module](#)

### 6.11.1 Add Module to `factory_param_data.csv`

Open your local `factory_param_data.csv`, insert a new row at the end, set the parameters as needed. In the example, we set `platform` to `PLATFORM_ESP32`, `module_name` to `WROOM32-SDIO`, as well as other parameters as follows (see *Factory Parameter Configuration* for what each parameter represents):

- `platform`: `PLATFORM_ESP32`
- `module_name`: `WROOM32-SDIO`
- `description`:
- `version`: 4
- `max_tx_power`: 78
- `uart_port`: 1
- `start_channel`: 1
- `channel_num`: 13
- `country_code`: CN
- `uart_baudrate`: -1
- `uart_tx_pin`: -1
- `uart_rx_pin`: -1
- `uart_cts_pin`: -1
- `uart_rts_pin`: -1

### 6.11.2 Modify `esp_at_module_info` Structure

Add customized module information in the `esp_at_module_info` structure in `at/src/at_default_config.c`.

The `esp_at_module_info` structure provides OTA upgrade verification token:

```
typedef struct {
    char* module_name;
    char* ota_token;
    char* ota_ssl_token;
} esp_at_module_info_t;
```

If you do not want to use OTA features, member 2 `ota_token` and member 3 `ota_ssl_token` should be set to `NULL`. Member 1 `module_name` must correspond to the field `module_name` in the `factory_param_data.csv` file.

The modified `esp_at_module_info` structure is as follows:

```
static const esp_at_module_info_t esp_at_module_info[] = {
#ifdef CONFIG_IDF_TARGET_ESP32
    ...
#endif

#ifdef CONFIG_IDF_TARGET_ESP32C3
    ...
#endif

#ifdef CONFIG_IDF_TARGET_ESP32C2
    ...
#endif

#ifdef CONFIG_IDF_TARGET_ESP32C6
    ...
#endif

#ifdef CONFIG_IDF_TARGET_ESP32C2
    {"MY_MODULE", CONFIG_ESP_AT_OTA_TOKEN_MY_MODULE, CONFIG_ESP_AT_OTA_
    ↪SSL_TOKEN_MY_MODULE }, // MY_MODULE
#endif
};
```

Macro `CONFIG_ESP_AT_OTA_TOKEN_MY_MODULE` and macro `CONFIG_ESP_AT_OTA_SSL_TOKEN_MY_MODULE` are defined in the header file [at/private\\_include/at\\_ota\\_token.h](#).

```
#if defined(CONFIG_IDF_TARGET_ESP32C2)
...
#define CONFIG_ESP_AT_OTA_TOKEN_MY_MODULE          CONFIG_ESP_AT_OTA_TOKEN_DEFAULT

...
#define CONFIG_ESP_AT_OTA_SSL_TOKEN_MY_MODULE      CONFIG_ESP_AT_OTA_SSL_TOKEN_
↳DEFAULT
```

### 6.11.3 Configure the Module

Firstly, enter `module_config` folder, and create a new folder to store all the configuration files for your module. Note that the folder name should be in lower case. Then, add the configuration files in the new folder: `IDF_VERSION`, `at_customize.csv`, `partitions_at.csv`, `sdkconfig.defaults`, and `sdkconfig_silence.defaults`.

In this example, we copy the `module_esp32_default` folder as well as the files within it and rename it as `module_wroom32-sdio`. The copied `IDF_VERSION`, `at_customize.csv`, and `partitions_at.csv` do not need any modification in our case. We only need to modify the `sdkconfig.defaults` and `sdkconfig_silence.defaults`:

- Modify the two files to use the partition table in the `module_wroom32-sdio` folder as follows:

```
CONFIG_PARTITION_TABLE_CUSTOM_FILENAME="module_config/module_wroom32-sdio/
↳partitions_at.csv"
CONFIG_PARTITION_TABLE_FILENAME="module_config/module_wroom32-sdio/partitions_
↳at.csv"
CONFIG_AT_CUSTOMIZED_PARTITION_TABLE_FILE="module_config/module_wroom32-sdio/
↳at_customize.csv"
```

- Modify the two files to use the SDIO configuration and remove the UART configuration as follows:
  - Remove the UART configuration

```
CONFIG_AT_BASE_ON_UART=n
```

- Add the SDIO configuration

```
CONFIG_AT_BASE_ON_SDIO=y
```

After finishing the above steps, you can recompile the ESP-AT project to generate the firmware for your module. In this example, we choose `PLATFORM_ESP32` and `WROOM32-SDIO` when configuring the project to generate the firmware for it.

## 6.12 SPI AT Guide

This document mainly introduces the implementation and use of SPI AT, mainly involving the following aspects:

- [Overview](#)
- [How to Use SPI AT?](#)
- [SPI AT Throughput](#)

### 6.12.1 Overview

SPI AT is based on ESP-AT project and uses SPI protocol for data communication. When SPI AT is used, MCU works as SPI master and ESP32-C2 AT device works as SPI slave. Both sides of communication exchange data based on AT command through SPI protocol.

## Why SPI AT?

ESP-AT project uses UART protocol for data communication by default, but UART protocol is not applicable in some application scenarios that need high-speed data transmission. In this case, the SPI protocol which supports a higher transmission rate is a better choice.

## How to enable SPI AT?

You can configure and enable SPI AT through the following steps:

1. `./build.py menuconfig->Component config->AT->communicate method for AT command->AT through SPI to enable SPI AT.`
2. `./build.py menuconfig->Component config->AT->communicate method for AT command->AT SPI Data Transmission Mode to choose the SPI data transmission mode.`
3. `./build.py menuconfig->Component config->AT->communicate method for AT command->AT SPI GPIO settings to change the default pin assignments for SPI AT.`
4. `./build.py menuconfig->Component config->AT->communicate method for AT command->AT SPI driver settings to choose the SPI slave mode, and config the buffer size for data transmission.`
5. Recompile the `esp-at` project(see [Compile ESP-AT Project Locally](#)), download AT bin into flash.

## The Default Pin Assignment

The following pin assignments are used by default:

Table 4: The Default Pins for SPI AT

Signal	GPIO Number
SCLK	6
MISO	2
MOSI	7
CS	10
HANDSHAKE	3
GND	GND
QUADWP (qio/qout) <sup>1</sup>	8
QUADHD (qio/qout) <sup>1</sup>	9

**Note 1:** QUADWP and QUADHD signals are only used for 4-bit (qio/qout) transactions.

You can change the default pin assignments by `./build.py menuconfig>Component config>AT>communicate method for AT command>AT through SPI>AT SPI GPIO settings` and compile the project (see [Compile ESP-AT Project Locally](#)).

### 6.12.2 How to Use SPI AT?

When SPI AT is used, ESP32-C2 works in SPI half-duplex mode as a slave.

#### Handshake Pin

Since SPI is a master-slave model, all transmission is initiated by the master, and the slave cannot actively transmit data. However, when AT command is used for data interaction, ESP32-C2 (slave) is required to actively report some information. Therefore, a handshake line is added between SPI master and slave to achieve the purpose.

When the slave needs to transfer data, it pulls up the handshake pin, generating a rising edge GPIO interrupt on the master side. Then, the master initiates communication with the slave. After the data is transferred, the slave pulls down the handshake pin to end this communication.

The specific methods of using the handshake line are as follows:

- When master sends AT commands to slave via SPI, the workflow with an extra handshake line is as follows:
  1. The master sends a request for data transmission to the slave, and then waits for the signal sent by the slave to the handshake line to allow data transmission.
  2. After the master detects the permission signal sent by the slave on the handshake line, it starts to send data.
  3. After sending the data, the master notifies slave that the data transmission is finished.
- When slave sends AT responses to master via SPI, the workflow with an extra handshake line is as follows:
  1. The slave sends a signal through the handshake line to inform the master to start receiving data.
  2. The master receives data and notifies slave that the data transmission is finished after receiving all data.

### Communication Formats

The communication format used by SPI AT is CMD+ADDR+DUMMY+DATA (Read or Write). When using SPI AT, some communication messages used by SPI master are described as follows:

- The message used by the master to send data to slave:

Table 5: Master write data to slave

CMD (1 byte)	ADDR (1 byte)	DUMMY (1 byte)	DATA (Up to 4092 bytes)
0x3	0x0	0x0	data_buffer

- The message used by the master to inform the slave all data has been sent:

Table 6: Master write data done

CMD (1 byte)	ADDR (1 byte)	DUMMY (1 byte)	DATA
0x7	0x0	0x0	null

- The message used by the master to receive data from the slave:

Table 7: Master read data from slave

CMD (1 byte)	ADDR (1 byte)	DUMMY (1 byte)	DATA (Up to 4092 bytes)
0x4	0x0	0x0	data_buffer

- The message used by the master to inform the slave all data has been received:

Table 8: Master read data done

CMD (1 byte)	ADDR (1 byte)	DUMMY (1 byte)	DATA
0x8	0x0	0x0	null

- The message used by the master to send a request to send data:

Table 9: Master request to send data

CMD (1 byte)	ADDR (1 byte)	DUMMY (1 byte)	DATA (4 bytes)
0x1	0x0	0x0	data_info

The 4-byte length `data_info` contains the information about the packet to be sent. The specific format is as follows:

1. 0~15 bits: the length of the data that the master want to send to the slave.
2. 16~23 bits: the sequence number of the packet sent by the master to the slave.

3. 24~31 bits: the magic num, and default value is 0xFE.

- After receiving the signal from the handshake line, the master can send the message to query the read or write status of the slave:

Table 10: Master query the read/write status of the slave

CMD (1 byte)	ADDR (1 byte)	DUMMY (1 byte)	DATA (4 bytes)
0x2	0x4	0x0	slave_status

After sending the query request, the slave's status returned will be stored in the 4-byte length `slave_status`, the specific format is as follows:

1. 0~15 bits: the length of the data the slave wants to send to the master. This field is valid only when the slave is readable.
2. 16~23 bits: the sequence number of the packet to be sent. The maximum sequence number is 0xFF, and if the number is reached, the sequence number is incremented by 1 from 0.
3. 24~31 bits: the slave status (readable/writable). 0x1 means readable, and 0x2 means writable.

### SPI AT Workflow

The workflows mainly includes two aspects:

- When master sends AT commands to slave, the workflow is as follows:

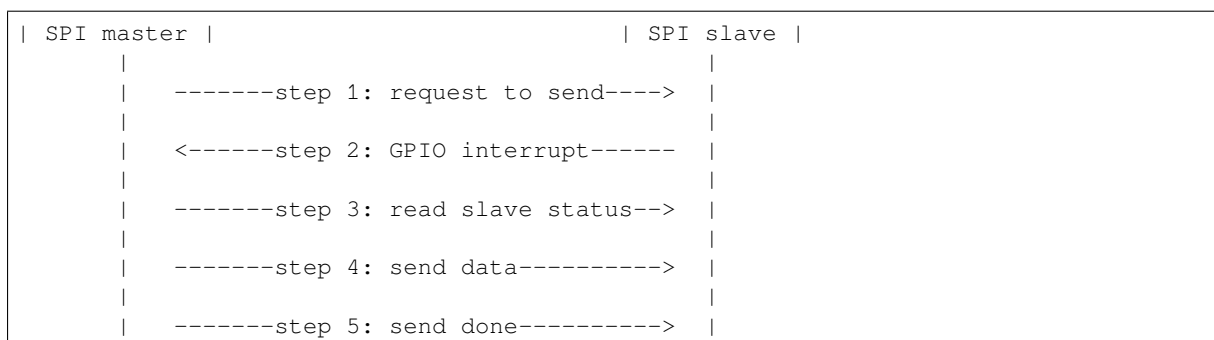

The specific description of each step is as follows:

step 1. The master sends a request for data transmission to the slave. step 2. The slave receives the request from the master. If the master is allowed to send data, the slave sets the status register, and then triggers the GPIO interrupt on the master through the handshake line. step 3. After receiving the interrupt, master will query the status register of slave. If the query result shows that the slave is in the writable state, the master starts to send data. step 4. The master send data to the slave. step 5. After sending the data, the master notifies slave that the data transmission is finished.

- When master receives AT responses from slave, the workflow is as follows:

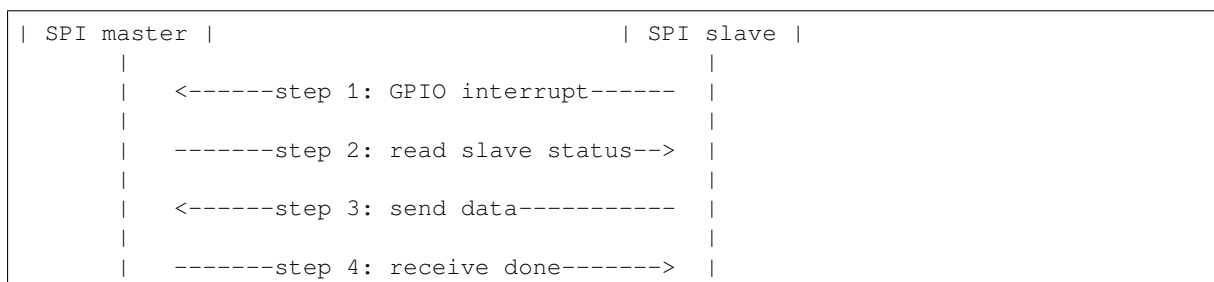

The specific description of each step is as follows:

step 1. The slave sets the status register, and then triggers the GPIO interrupt on the master through the handshake line. step 2. After receiving the interrupt, master will query the status register of slave. If the query result shows that

the slave is in the readable state, the master starts to receive data. step 3. The master receives the data send by the slave. step 4. After receiving all data, the master notifies the slave that the data transmission is finished.

**Note 1.** To facilitate understanding, the [at\\_spi\\_master/spi/esp32\\_c\\_series/README.md](#) provides all the interaction workflow and logic analyzer data involved in the communication by taking sending an AT command as an example.

### Sample Code of SPI Master for SPI AT

SPI AT is used as the SPI slave. For a code example of communication between the SPI master and the SPI slave, please refer to [at\\_spi\\_master/spi/esp32\\_c\\_series](#).

**Note 1.** Before developing with MCU, it is highly recommended to run this example using ESP32-C3 or ESP32 emulated MCU as SPI master to make it easier to debug problems.

## 6.12.3 SPI AT Throughput

### Introduction of the Test

- An ESP32 or ESP32-C3 development board is been used as SPI master. The application runs in the board can be found under the directory [at\\_spi\\_master/spi/esp32\\_c\\_series](#) of the *ESP-AT* project. Some related configurations are described below:
  1. Hardware configuration: The frequency of CPU is 240 MHz, flash SPI mode is in QIO mode with 40 MHz.
  2. Software configuration: The *ESP-IDF* version is v4.3. The size of streambuffer is 8192 bytes.
- An ESP32-C2-DevKitC development board is been used as SPI slave. Please refer to *Compile ESP-AT Project Locally* to build your own ESP-AT project and flash the generated binary files into the board. The board works in the TCP passthrough mode, and some related configurations are described below:
  1. Hardware configuration: The frequency of CPU is 160 MHz.
  2. Software configuration: The size of streambuffer is 8192 bytes, the sdkconfig is [sdkconfig.defaults.esp32c3](#).

### Reference Results

The table below shows the throughput results we got in a shield box.

Table 11: SPI AT Wi-Fi TCP Throughput

Clock	SPI mode	master->slave	slave->master
10 M	Standard	0.95 MByte/s	1.00 MByte/s
10 M	Dual	1.37 MByte/s	1.29 MByte/s
10 M	Quad	1.43 MByte/s	1.31 MByte/s
20 M	Standard	1.41 MByte/s	1.30 MByte/s
20 M	Dual	1.39 MByte/s	1.30 MByte/s
20 M	Quad	1.39 MByte/s	1.30 MByte/s
40 M	Standard	1.37 MByte/s	1.30 MByte/s
40 M	Dual	1.40 MByte/s	1.31 MByte/s
40 M	Quad	1.48 MByte/s	1.31 MByte/s

**Note 1:** When SPI clock frequency is high, due to the limitation of upper network components, the communication rate of Dual or Quad mode is not significantly improved compared with Standard mode.

**Note 2:** For more information about SPI communication, please refer to the [Technical Reference Manuals](#).

## 6.13 How to Implement OTA Upgrade

This document introduces how to implement OTA upgrade on ESP32-C2 series of modules. Currently, ESP-AT provides the following three OTA commands targeting at different scenarios. You could choose one command according to your needs.

1. [AT+USEROTA](#)
2. [AT+CIUPDATE](#)
3. [AT+WEBSERVER](#)

The structure of this document is as follows:

- [Comparison Among OTA Commands and Their Application Scenarios](#)
- [Perform OTA Upgrade with ESP-AT OTA Commands](#)

### 6.13.1 Comparison Among OTA Commands and Their Application Scenarios

#### AT+USEROTA

This command implements OTA upgrade through a URL. You can upgrade to the firmware placed on the HTTP server. Currently, the command only supports the upgrade of app partitions. For more information on this command, please refer to [AT+USEROTA](#) for more details.

Since this command is a user-defined command, you can modify the implementation of this command by modifying the `at/src/at_user_cmd.c` source code.

The application scenarios of this command are as follows:

1. **You have your own HTTP server.**
2. **You need to specify the URL.**

---

#### Important:

- If the firmware you upgrade is not officially released by Espressif, you may no longer be able to use AT+CIUPDATE command to upgrade after the upgrade is complete, unless you create your own device according to [OTA Upgrade with AT+CIUPDATE](#).
- 

#### AT+CIUPDATE

This command uses `iot.espressif.cn` as the default HTTP server. It can upgrade both the app partition and the user-defined partitions that are defined in the `at_customize.csv`. If you are using the version released by Espressif, it will only upgrade to the version released by Espressif. For more information on this command, please refer to [AT+CIUPDATE](#) for more details.

To upgrade the customized bin file with this command, please select one of the following ways.

1. **replace `iot.espressif.cn` with the your own HTTP server and implement the interactive process.** For how to implement your own AT+CIUPDATE command, please refer to [at/src/at\\_ota\\_cmd.c](#).
2. **create a devices on `iot.espressif.cn` and upload customized AT firmware on it. (The premise is that the firmware running in the module already corresponds to the device you created on the Espressif server.)** For more information, please refer to [OTA Upgrade with AT+CIUPDATE](#).

The application scenarios of this command are as follows:

1. **You only use the firmware released by Espressif, and only want to upgrade to the firmware released by Espressif.**
2. **You want to upgrade the customized bin file, but do not have an HTTP server.**
3. **You have your own HTTP server. In addition to the app partition, you also want to upgrade the user-defined partitions in `at_customize.csv`.**



## AT+WEBSERVER

This command upgrades AT firmware with a browser or WeChat applet. Currently, this command only supports the upgrade of app partitions. Before starting the upgrade, please enable the web server command and copy the AT firmware to the computer or mobile phone in advance. For more information, you can refer to [AT+WEBSERVER](#) and [Web Server AT Example](#).

To implement your own HTML page, please refer to the example of [fs\\_image/index.html](#). To implement your own AT+WEBSERVER command, please refer to the example of [at/src/at\\_web\\_server\\_cmd.c](#).

The application scenarios of this command are as follows:

1. **You need a more convenient and faster OTA upgrade that does not rely on network status.**

### Important:

- If the firmware you upgrade is not officially released by Espressif, you may no longer be able to use AT+CIUPDATE command to upgrade after the upgrade is complete, unless you create your own device according to [OTA Upgrade with AT+CIUPDATE](#).

## 6.13.2 Perform OTA Upgrade with ESP-AT OTA Commands

### OTA Upgrade with AT+USEROTA

Please refer to [AT+USEROTA](#): for more details.

### OTA Upgrade with AT+CIUPDATE

To upgrade the customized bin file with [AT+CIUPDATE](#) command, the first thing to do is to upload the bin file to the [iot.espressif.cn](#) and obtain the **token** value. The following steps describe how to create a device on [iot.espressif.cn](#) and upload the bin file to it.

1. Open the website <http://iot.espressif.cn> or <https://iot.espressif.cn>.



Fig. 21: Open [iot.espressif.cn](#) website

2. Click “Join” in the upper right corner of the webpage, and enter your name, email address, and password.



Fig. 22: Join iot.espressif.cn website

**Note:**

- The Join function is currently not open to new users. If you want to use it, please contact [Espressif](#).

3. Click on “Device” in the upper left corner of the webpage, and click on “Create” to create a device.

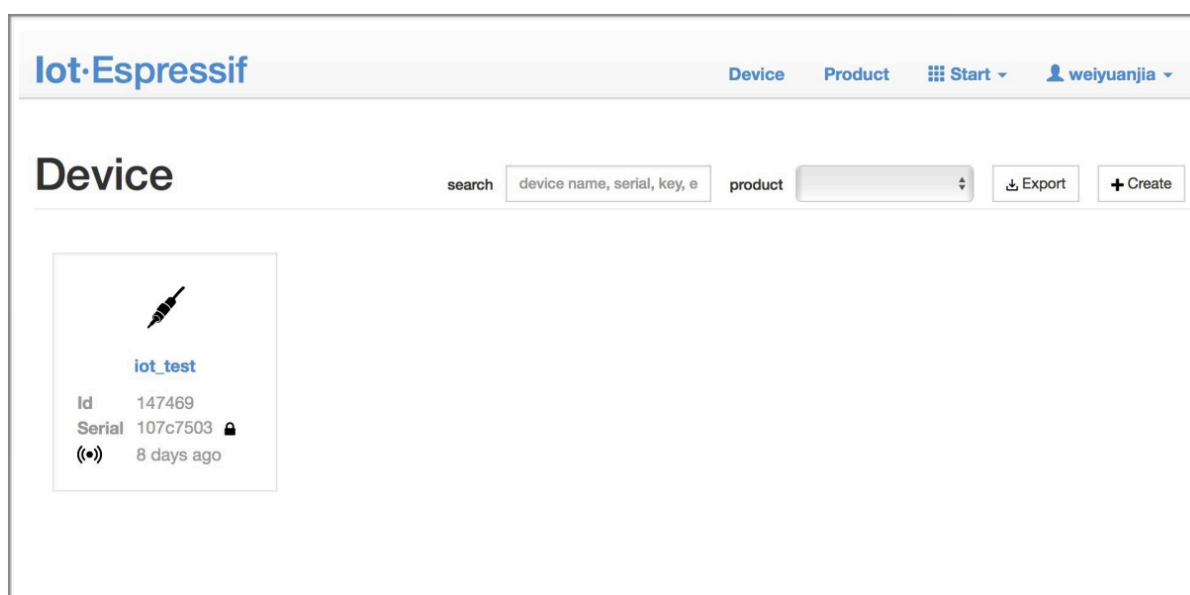

Fig. 23: Click on “Device”

4. A key is generated when the device is successfully created, as the figure below shows.
5. Use the key to compile your own OTA bin file. The process of configuring the AT OTA token key is as follows:

**Note:**

- If using SSL OTA, the option “The SSL token for AT OTA” also needs to be configured.

6. Click on “Product” to enter the webpage, as shown below. Click on the device created. Enter version and corename under “ROM Deploy” . Rename the bin file in Step 5 as “ota.bin” and save the configuration.

**Note:**

- If you want to upgrade the user-defined partition defined in the `at_customize.csv`, just replace

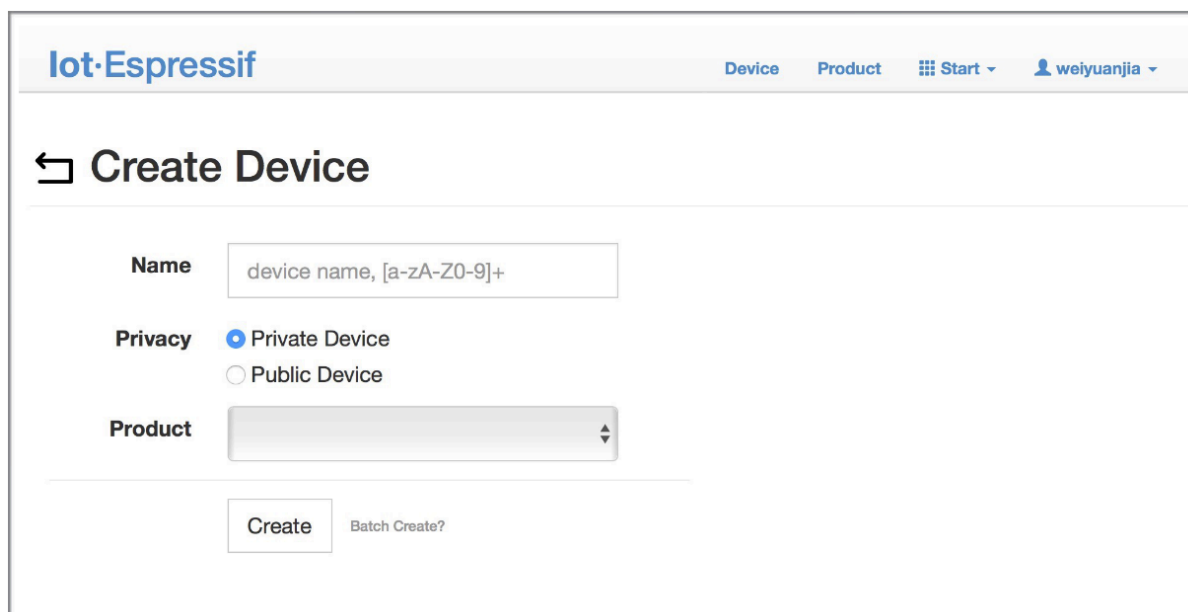

Fig. 24: Click on “Create”

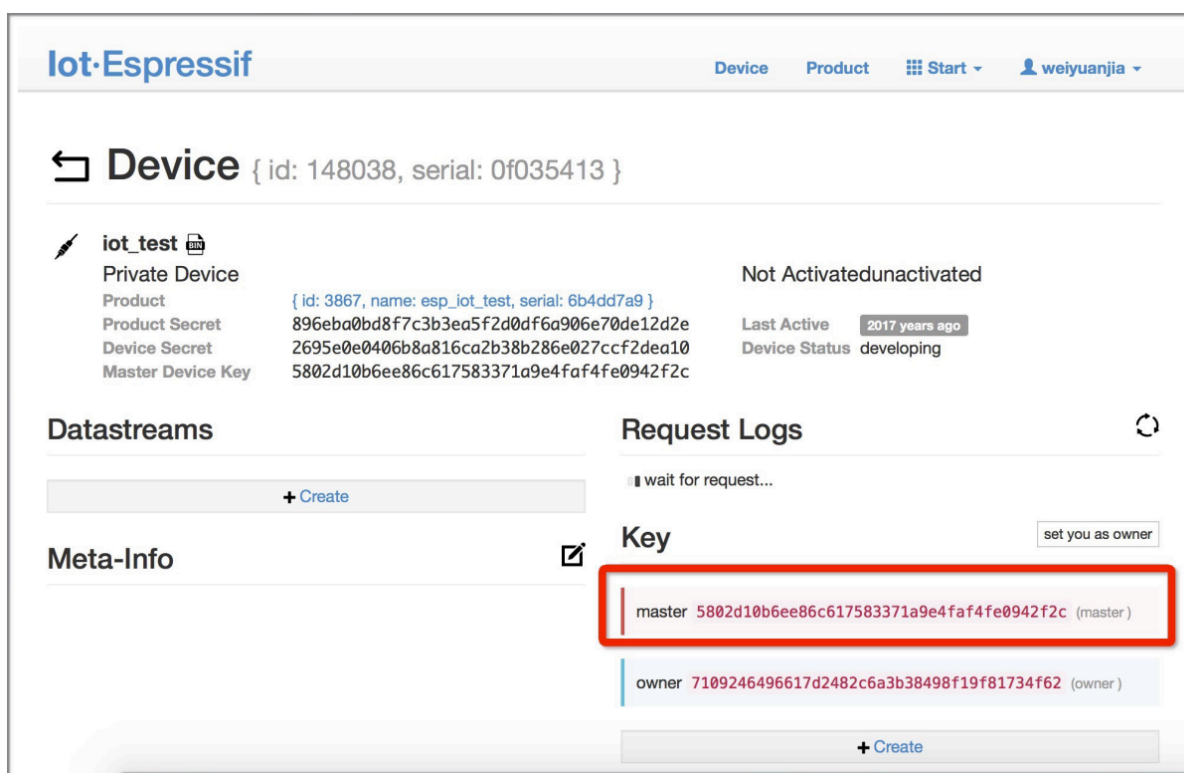

Fig. 25: A key has been generated

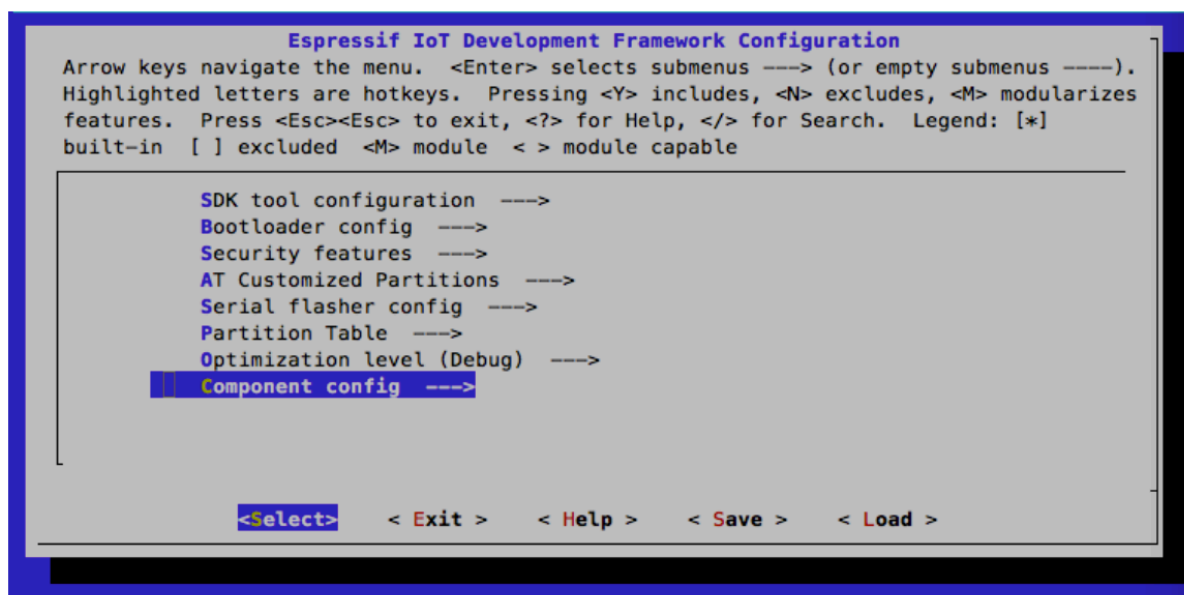

Fig. 26: Configuring the AT OTA token key - Step 1

ota.bin with the bin of the user-defined partition.

- For the field `corename`, the purpose of this field is only to help you distinguish bin files.

7. Click on the ota.bin to save it as the current version.
8. Run the command `AT+USEROTA` on the ESP32-C2. If the network is connected, OTA upgrade will begin.

### Important:

- When setting the name of bin files uploaded to the `iot.espressif.cn`, please follow the rules below:
  - If you upgrade app partitions, set the bin file name to `ota.bin`.
  - If you upgrade a user-defined partition, set the bin file name as the Name field in the `at_customize.csv`. For example, if you upgrade `factory_param` partition, please set it to `factory_param.bin`.
- ESP-AT stores the new firmware in a spare OTA partition. In this way, even if OTA fails due to unexpected reasons, the original ESP-AT firmware can still run. But for user-defined partitions, because ESP-AT has no backup measures, please upgrade it carefully.
- **If you intend to upgrade only customized bin file at the beginning, please set the OTA token to your own token value when the initial version is released.**

### OTA Upgrade with AT+WEBSERVER

Please refer to `AT+WEBSERVER` and `Web Server AT Example` for more details.

## 6.14 How to Update the ESP-IDF Version

ESP-AT firmware is based on the Espressif IoT Development Framework (ESP-IDF), and each version of ESP-AT firmware corresponds to a specific ESP-IDF version. It is strongly recommended to use the default ESP-IDF version of the ESP-AT project, and **NOT** recommended to update it, because the inconsistency between the underlying ESP-IDF versions of `libesp32c2_at_core.a` and the ESP-AT project may cause incorrect operation of the firmware.

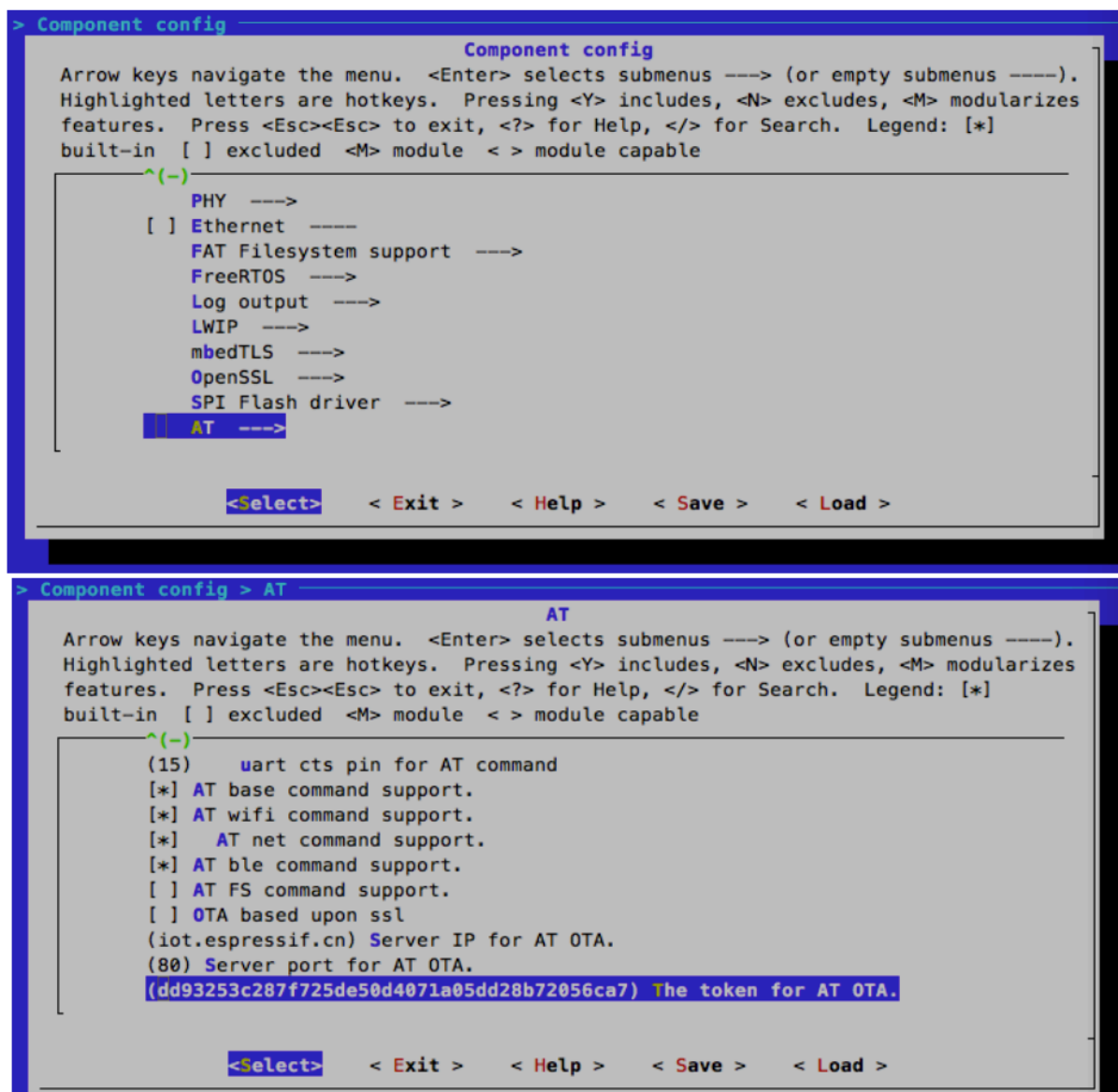

Fig. 27: Configuring the AT OTA token key - Step 2 and 3

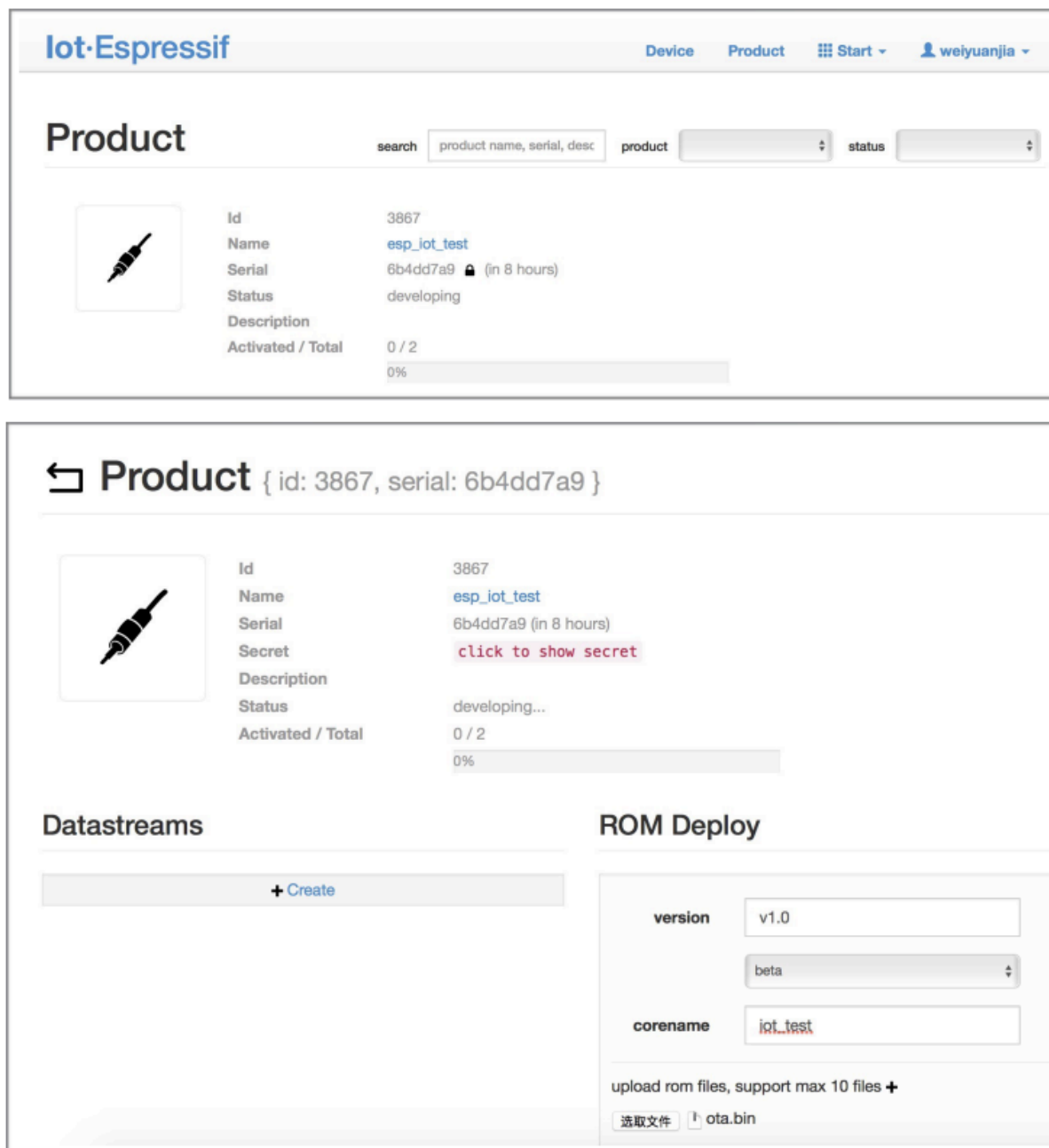

Fig. 28: Enter version and corename

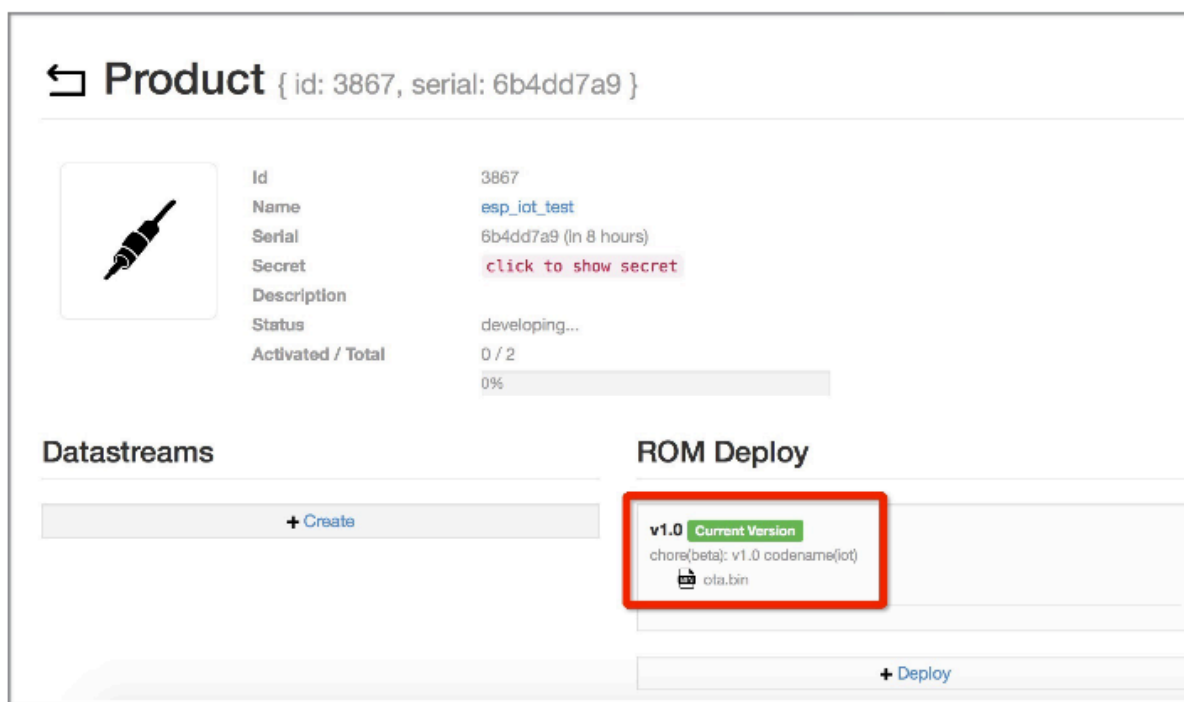

Fig. 29: Save the current version of ota.bin

However, in some special cases, a minor updated ESP-IDF version may be also able to work with the ESP-AT project. In case you should update it, this document can be a reference.

The ESP-IDF version that a specific ESP-AT firmware corresponds to is recorded in the `IDF_VERSION` files, which are distributed in different module folders under the `module_config` folder. The file describes the branch, commit ID, and repository URL of the ESP-IDF that a module firmware is based on. For example, the `IDF_VERSION` of the ESP32C2-4MB module of PLATFORM\_ESP32C2 platform is located at `module_config/module_esp32c2_default/IDF_VERSION`.

If you want to update the ESP-IDF version for your ESP-AT firmware, please follow the steps:

- Find the `IDF_VERSION` file for your module.
- Update the branch, commit ID, repository as needed.
- Delete the original `esp-idf` under the `esp-at` root directory, so that the ESP-IDF of the version specified in `IDF_VERSION` will be cloned first in the next compilation.
- Recompile the ESP-AT project.

Note that when the ESP-AT version and the ESP-IDF version do not match, the following error will be reported when compiling:

```
Please wait for the update to complete, which will take some time
```

## 6.15 ESP-AT Firmware Differences



This document compares the differences among AT firmwares of a certain ESP32-C2 series in terms of the supported commands set, hardware, and supported modules.

### 6.15.1 ESP32-C2 Series

This section describes the differences among AT firmwares of ESP32-C2 series, including



- ESP32C2-2MB-AT-Vx.x.x.x.zip (referred to as **ESP32C2-2MB Bin** in this section);
- ESP32C2-4MB-AT-Vx.x.x.x.zip (referred to as **ESP32C2-4MB Bin** in this section);
- ESP32C2-BLE-2MB Bin (firmware is not released, but you can download the `esp32c2-ble-2mb-at` firmware from [GitHub Actions](#), or *Compile ESP-AT Project Locally* <[How\\_to\\_clone\\_project\\_and\\_compile\\_it](#)> by yourself);

### Supported Command Set

The table lists which command set is supported by default in the official AT firmware applicable to ESP32-C2 series of modules (marked with ) , which is not supported by default but can be supported after configuration of the ESP-AT project (marked with ) , and which is not supported at all (marked with ) . Note that the command set that is not shown in this table is not supported either. Applicable firmware that has not been *officially released* requires compilation by yourself. Those self-compiled firmware cannot be upgraded OTA from Espressif official server.

Command Set	ESP32C2-2MB Bin	ESP32C2-4MB Bin	ESP32C2-BLE-2MB Bin
base			
user			
Wi-Fi			
TCP-IP			
mDNS			
WPS			
SmartConfig			
ping			
MQTT			
HTTP			
Bluetooth LE			
BluFi			
FileSystem			
driver			
WPA2 enterprise			
WEB server			
WebSocket			
OTA			



### Hardware Differences















Hardware	ESP32C2-2MB Bin	ESP32C2-4MB Bin	ESP32C2-BLE-2MB Bin
Flash	2 MB	4 MB	2 MB
PSRAM			
UART Pins <sup>1</sup>	TX: 7 RX: 6 CTS: 19 RTS: 20	TX: 7 RX: 6 CTS: 5 RTS: 4	TX: 7 RX: 6 CTS: 5 RTS: 4

<sup>1</sup> UART pins can be customized. See [How to Set AT Port Pins](#) for details.



## Supported Modules

The table below lists the modules or chips that are default supported by the officially released ESP32-C2 series AT firmware (indicated by ) , the modules that are not supported by default but can be modified to be supported using the *at.py Tool* (indicated by ) , and the modules that are not supported at all (indicated by ) . For modules that are not supported at all, you can refer to *Compile ESP-AT Project Locally* to modify the configuration as needed for support.

Module/Chip	ESP32C2-2MB Bin	ESP32C2-4MB Bin	ESP32C2-BLE-2MB Bin
ESP8684-MINI-1/1U			
ESP8684-WROOM-02C/02UC			
ESP8684-WROOM-03			
ESP8684-WROOM-05			
ESP8684-WROOM-07			

## 6.16 How to Download the Latest Temporary Version of AT Firmware from GitHub

As ESP-AT enables CI (Continuous Integration) on GitHub, temporary versions of ESP-AT firmware is generated every time when the code is pushed to GitHub.

**Attention: the latest temporary version of AT firmware downloaded from webpages needs to be tested and verified for functionality based on your own product.**

**Please save the firmware and download link**, for possible issue debugging in the future.

The following steps guide you on how to download the latest temporary version of AT firmware from GitHub.

1. Sign in your GitHub account  
Before you start, **please sign in your GitHub account**, as you need login permission to download firmware.
2. Open the website <https://github.com/espressif/esp-at>
3. Click “Actions” to enter the “Actions” page
4. Click the branch and choose the specified branch  
Default branch is master. If you want to download the temporary firmware of the specified branch, click “Branch” to enter the workflow page of the specified branch.
5. Click the latest workflow and enter the latest workflow page
6. Scroll the page to the end, select the corresponding module on the *Artifacts* page
7. Click to download the temporary version of AT firmware for modules

---

**Note:** If you do not find the firmware of the corresponding module on the *Artifacts* page, you can refer to *ESP-AT Firmware Differences* to select a similar firmware to download.

---

## 6.17 at.py Tool

The `at.py` tool is used to modify various parameter configurations in the official release firmware, GitHub temporary firmware, and 2MB/4MB firmware of ESP-AT. These configurations include Wi-Fi configurations, certificate and key configurations, UART configurations, GATTS configurations, and more. When the default firmware does not meet your requirements, you can use the `at.py` tool to modify these parameter configurations in the firmware.

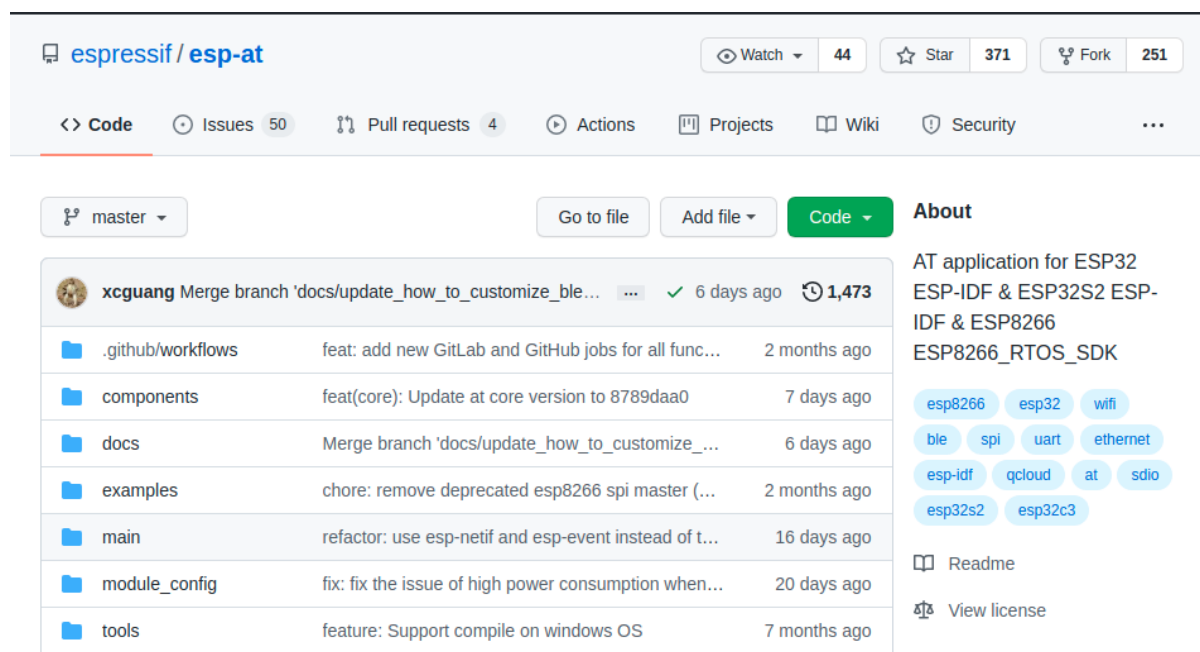

Fig. 30: ESP-AT GitHub Home Page

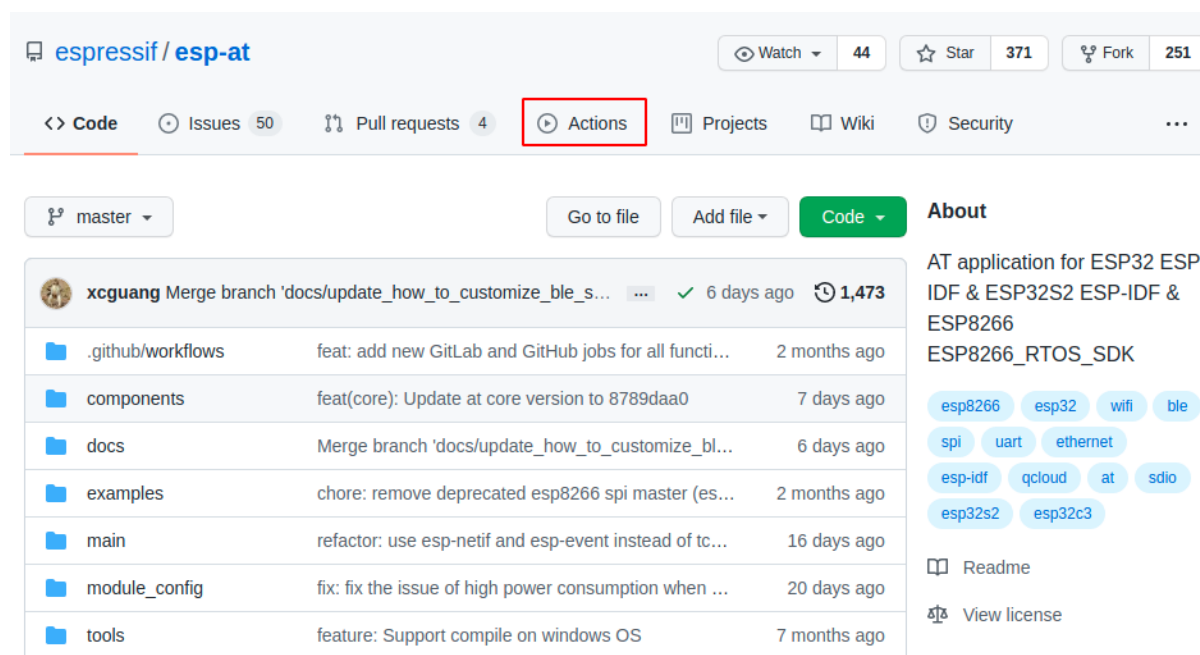

Fig. 31: Click Actions

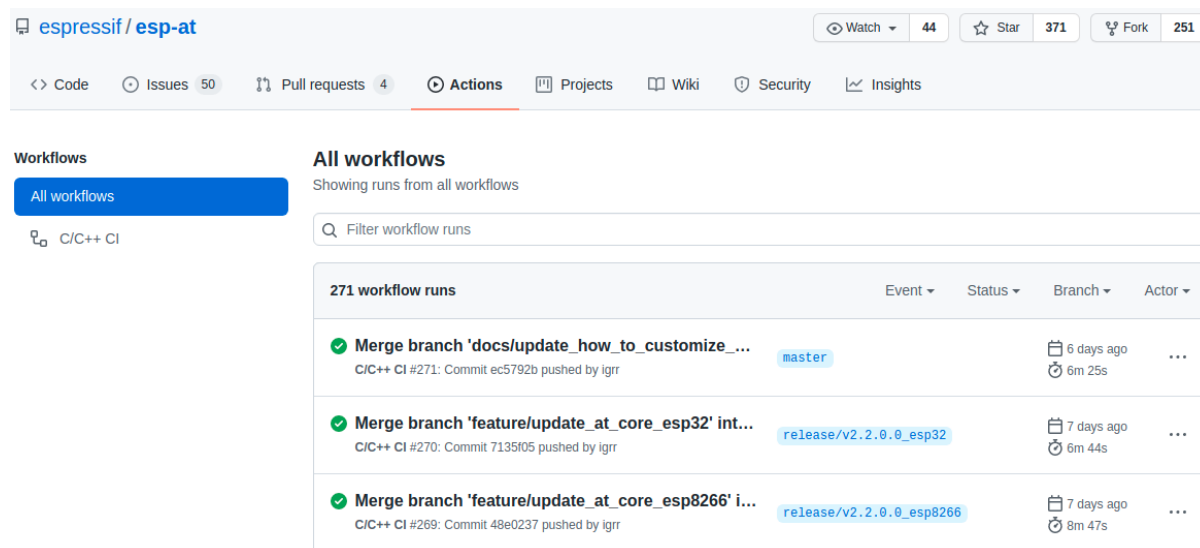

Fig. 32: Actions Page

### All workflows

Showing runs from all workflows

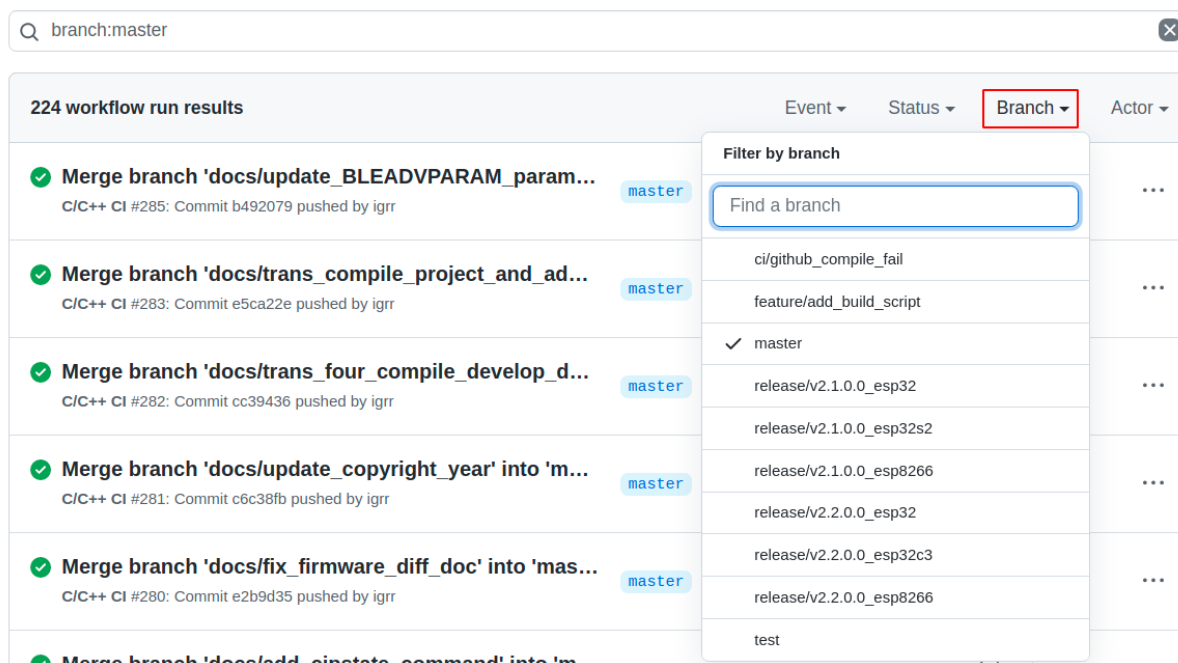

Fig. 33: Click the Branch

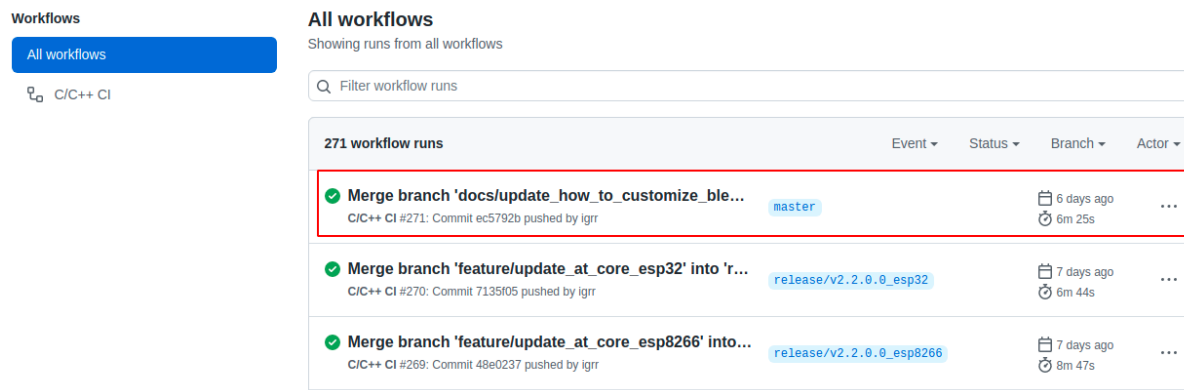

Fig. 34: Click the Latest Workflow

✔ Merge branch 'docs/update\_how\_to\_customize\_ble\_services' into 'master' C/C++ CI #271

**Summary**

Jobs

- ✔ build-esp32-wroom-at
- ✔ build-esp32-wrover-at
- ✔ build-esp32-pico-d4-at
- ✔ build-esp32-solo-at
- ✔ build-esp32-d2wd-at
- ✔ build-esp32-mini-1-at
- ✔ build-esp32-qcloud
- ✔ build-esp32-at-full-function-test
- ✔ build-esp32c3-mini-1-at
- ✔ build-esp32c3-at-full-function-test
- ✔ build-esp32c3-qcloud

Triggered via push 6 days ago	Status	Total duration	Artifacts
igrr pushed → ec5792b <span style="background-color: #444; color: white; padding: 2px;">master</span>	<b>Success</b>	<b>6m 25s</b>	<b>11</b>

**main.yml**  
on: push

- ✔ build-esp32-wroom-at 4m 33s
- ✔ build-esp32-wrover-at 5m 40s
- ✔ build-esp32-pico-d4-at 5m 30s
- ✔ build-esp32-solo-at 5m 18s
- ✔ build-esp32-d2wd-at 5m 27s
- ✔ build-esp32-mini-1-at 5m 25s
- ✔ build-esp32-qcloud 5m 30s
- ✔ build-esp32-at-full-functi... 5m 46s
- ✔ build-esp32c3-mini-1-at 5m 1s
- ✔ build-esp32c3-at-full-fun... 6m 11s
- ✔ build-esp32c3-qcloud 5m 32s

Fig. 35: Latest Workflow Page











<b>Artifacts</b>	
Produced during runtime	
Name	Size
 <b>esp32-at-full-function-test</b>	35.8 MB
 <b>esp32-d2wd-at</b>	26.2 MB
 <b>esp32-mini-1-at</b>	28.3 MB
 <b>esp32-pico-d4-at</b>	28.3 MB
 <b>esp32-qcloud</b>	29.2 MB
 <b>esp32-solo-1-at</b>	28.3 MB
 <b>esp32-wroom-at</b>	28.3 MB
 <b>esp32-wrover-at</b>	30.2 MB
 <b>esp32c3-at-full-function-test</b>	29.7 MB
 <b>esp32c3-mini-1-at</b>	27.5 MB
 <b>esp32c3-qcloud</b>	28.5 MB

Fig. 36: Artifacts Page

### 6.17.1 Detailed Steps

Please follow the detailed steps below to download the `at.py` tool, modify the configurations in the firmware, and flash the firmware. **It is recommended to use a Linux system for development.**

- *Step 1: Install Python*
- *Step 2: Download `at.py`*
- *Step 3: Use `at.py`*
- *Step 4: Examples: Modify Firmware Configurations with `at.py`*
- *Step 5: Flash onto the Device*

### 6.17.2 Step 1: Install Python

If you have already installed Python on your local machine, you can skip this step. Otherwise, please download and install Python according to the official [Python documentation](#). **It is recommended to use Python 3.8.0 or later versions.**

After the installation is complete, you can open a command line and enter `python --version` to check the Python version.

### 6.17.3 Step 2: Download `at.py`

Visit the [at.py](#) webpage, click the “Download raw file” button to download the `at.py` file to your local machine.

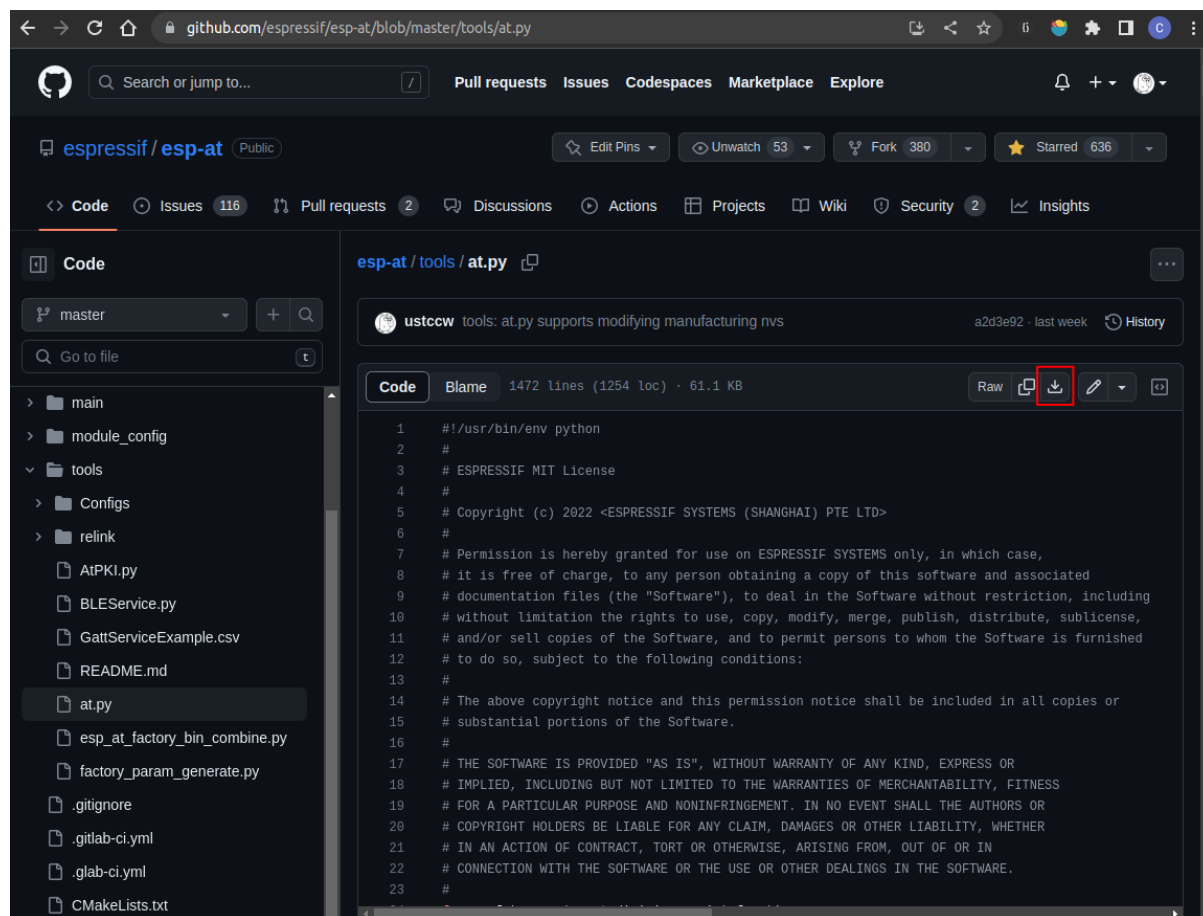

Fig. 37: Download `at.py` File

### 6.17.4 Step 3: Use `at.py`

Currently, `at.py` supports modifying parameter configurations in the firmware. To view the supported usage and instructions, enter `python at.py modify_bin --help` in the command line for more details.

### 6.17.5 Step 4: Examples: Modify Firmware Configurations with `at.py`

- [Modify Wi-Fi Configuration](#)
- [Modify Certificate and Key Configuration](#)
- [Modify UART Configuration](#)
- [Modify GATTS Configuration](#)

---

#### Note:

- You can modify the parameter configurations of multiple functions at one go. For example, you can modify both Wi-Fi configuration and certificate and key configuration at the same time.
  - The script does not check the validity of the modified parameter configurations. Please ensure that the input configurations are valid.
  - The modified parameter configurations will have corresponding records in the `mfg_nvs.csv` file under the current `mfg_nvs` directory.
- 

#### Modify Wi-Fi Configuration

The currently modifiable Wi-Fi parameter configurations are shown in the following table:

Parameter	Function	Description
<code>--tx_power</code>	Maximum transmission power of Wi-Fi	See <a href="#">ESP32-C2 Maximum transmission power</a> for more details.
<code>--country_code</code>	Wi-Fi country code	See the <code>cc</code> field of <a href="#">Wi-Fi Country Code</a>
<code>--start_channel</code>	Wi-Fi starting channel	See the <code>schan</code> field of <a href="#">Wi-Fi Country Code</a>
<code>--channel_number</code>	Total number of Wi-Fi channels	See the <code>nchan</code> field of <a href="#">Wi-Fi Country Code</a>

For example, you can use the following command to modify the maximum transmission power of Wi-Fi to 18 dBm, set the country code to US, starting channel to 1, and total channel number to 11:

```
python at.py modify_bin --tx_power 72 --country_code "US" --start_channel 1 --
↪channel_number 11 --input factory_XXX.bin
```

- `--tx_power 72`: The unit is 0.25 dBm, and 72 represents 18 dBm.
- `--input factory_XXX.bin`: The input firmware file.

#### Modify Certificate and Key Configuration

The currently modifiable certificate and key configurations are shown in the following table:

Parameter	Function	Original File
--server_ca	CA certificate for TLS server	server_ca.crt
--server_cert	Certificate for TLS server	server_cert.crt
--server_key	Key for TLS server	server.key
--client_ca0	CA certificate for client 0	client_ca_00.crt
--client_cert0	Certificate for client 0	client_cert_00.crt
--client_key0	Key for client 0	client_key_00.key
--client_ca1	CA certificate for client 1	client_ca_01.crt
--client_cert1	Certificate for client 1	client_cert_01.crt
--client_key1	Key for client 1	client_key_01.key
--mqtt_ca	CA certificate for MQTT client	mqtt_ca.crt
--mqtt_cert	Certificate for MQTT client	mqtt_client.crt
--mqtt_key	Key for MQTT client	mqtt_client.key
--wpa2_ca	CA certificate for WPA2-Enterprise client	wpa2_ca.pem
--wpa2_cert	Certificate for WPA2-Enterprise client	wpa2_client.crt
--wpa2_key	Key for WPA2-Enterprise client	wpa2_client.key

For example, you can use the following command to modify the CA certificate, certificate, and key for the MQTT client:

```
python at.py modify_bin --mqtt_ca mqtt/mqtt_ca.crt --mqtt_cert mqtt/mqtt.crt --
↪mqtt_key mqtt/mqtt.key --input factory_XXX.bin
```

- **--input factory\_XXX.bin:** The input firmware file.

### Modify UART Configuration

The modifiable UART configuration includes only the UART configuration for the *AT command port*. The configurable parameter configurations are shown in the following table:

Parameter	Function	Description
--uart_num	UART number for the AT command port	Only needs to be modified if the AT command port is also used as the AT log port. Ensure that the <code>tx_pin</code> and <code>rx_pin</code> below have the same pins as the <i>AT log port</i> .
--baud	Baud rate of the AT command port	Original value: 115200
--tx_pin	TX pin of the AT command port	Please ensure that the set pin is not used by other functions.
--rx_pin	RX pin of the AT command port	Please ensure that the set pin is not used by other functions.
--cts_pin	CTS pin of the AT command port	Please ensure that the set pin is not used by other functions. If flow control is not used, set this parameter to -1.
--rts_pin	RTS pin of the AT command port	Please ensure that the set pin is not used by other functions. If flow control is not used, set this parameter to -1.

For example, you can use the following command to modify the baud rate to 921600, set the TX pin to GPIO17, the RX pin to GPIO16, and disable flow control for the AT command port:

```
python at.py modify_bin --baud 921600 --tx_pin 17 --rx_pin 16 --cts_pin -1 --rts_
↪pin -1 --input factory_XXX.bin
```



- `--input factory_XXX.bin`: The input firmware file.

### Modify GATTS Configuration

Before making modifications, please read the *How to Customize Bluetooth® LE Services* document to understand the meaning of each field in the GATTS configuration file `gatts_data.csv`.

The currently modifiable GATTS configurations are shown in the following table:

Parameter	Function
<code>--gatts_cfg0</code>	Update the row with index 0 in the <code>gatts_data.csv</code> file
<code>--gatts_cfg1</code>	Update the row with index 1 in the <code>gatts_data.csv</code> file
<code>--gatts_cfg2</code>	Update the row with index 2 in the <code>gatts_data.csv</code> file
<code>--gatts_cfg3</code>	Update the row with index 3 in the <code>gatts_data.csv</code> file
<code>--gatts_cfg4</code>	Update the row with index 4 in the <code>gatts_data.csv</code> file
<code>--gatts_cfg5</code>	Update the row with index 5 in the <code>gatts_data.csv</code> file
<code>--gatts_cfg6</code>	Update the row with index 6 in the <code>gatts_data.csv</code> file
<code>--gatts_cfg7</code>	Update the row with index 7 in the <code>gatts_data.csv</code> file
<code>--gatts_cfg8</code>	Update the row with index 8 in the <code>gatts_data.csv</code> file
<code>--gatts_cfg9</code>	Update the row with index 9 in the <code>gatts_data.csv</code> file
<code>--gatts_cfg10</code>	Update the row with index 10 in the <code>gatts_data.csv</code> file
<code>--gatts_cfg11</code>	Update the row with index 11 in the <code>gatts_data.csv</code> file
<code>--gatts_cfg12</code>	Update the row with index 12 in the <code>gatts_data.csv</code> file
<code>--gatts_cfg13</code>	Update the row with index 13 in the <code>gatts_data.csv</code> file
<code>--gatts_cfg14</code>	Update the row with index 14 in the <code>gatts_data.csv</code> file
<code>--gatts_cfg15</code>	Update the row with index 15 in the <code>gatts_data.csv</code> file
<code>--gatts_cfg16</code>	Update the row with index 16 in the <code>gatts_data.csv</code> file
<code>--gatts_cfg17</code>	Update the row with index 17 in the <code>gatts_data.csv</code> file
<code>--gatts_cfg18</code>	Update the row with index 18 in the <code>gatts_data.csv</code> file
<code>--gatts_cfg19</code>	Update the row with index 19 in the <code>gatts_data.csv</code> file
<code>--gatts_cfg20</code>	Update the row with index 20 in the <code>gatts_data.csv</code> file
<code>--gatts_cfg21</code>	Update the row with index 21 in the <code>gatts_data.csv</code> file
<code>--gatts_cfg22</code>	Update the row with index 22 in the <code>gatts_data.csv</code> file
<code>--gatts_cfg23</code>	Update the row with index 23 in the <code>gatts_data.csv</code> file
<code>--gatts_cfg24</code>	Update the row with index 24 in the <code>gatts_data.csv</code> file
<code>--gatts_cfg25</code>	Update the row with index 25 in the <code>gatts_data.csv</code> file
<code>--gatts_cfg26</code>	Update the row with index 26 in the <code>gatts_data.csv</code> file
<code>--gatts_cfg27</code>	Update the row with index 27 in the <code>gatts_data.csv</code> file
<code>--gatts_cfg28</code>	Update the row with index 28 in the <code>gatts_data.csv</code> file
<code>--gatts_cfg29</code>	Update the row with index 29 in the <code>gatts_data.csv</code> file
<code>--gatts_cfg30</code>	Update the row with index 30 in the <code>gatts_data.csv</code> file

For example, you can use the following command to modify the “perm” permission of the row with index 0:

```
python at.py modify_bin --gatts_cfg0 "0,16,0x2800,0x011,2,2,A002" --input factory_
↪XXX.bin
```

- `--input factory_XXX.bin`: The input firmware file.

**Attention:** The AT firmware modified by `at.py` needs to be tested and verified for functionality based on your own product.

Please save the firmware before and after modification, and the download link, for possible issue debugging in the future.

**Step 5: Flash onto the Device** Please follow the [Flash firmware](#) to complete it.

## 6.18 AT API Reference

### 6.18.1 Header File

- [components/at/include/esp\\_at\\_core.h](#)

### 6.18.2 Functions

void **esp\_at\_module\_init** (const uint8\_t \*custom\_version)

This function should be called only once.

**Parameters** **custom\_version** –version information by custom

*esp\_at\_para\_parse\_result\_type* **esp\_at\_get\_para\_as\_digit** (int32\_t para\_index, int32\_t \*value)

Parse digit parameter from command string.

**Parameters**

- **para\_index** –the index of parameter
- **value** –the value parsed

**Returns**

- ESP\_AT\_PARA\_PARSE\_RESULT\_OK : succeed
- ESP\_AT\_PARA\_PARSE\_RESULT\_FAIL : fail
- ESP\_AT\_PARA\_PARSE\_RESULT\_OMITTED : this parameter is OMITTED

*esp\_at\_para\_parse\_result\_type* **esp\_at\_get\_para\_as\_float** (int32\_t para\_index, float \*value)

Parse float parameter from command string.

**Parameters**

- **para\_index** –the index of parameter
- **value** –the value parsed

**Returns**

- ESP\_AT\_PARA\_PARSE\_RESULT\_OK : succeed
- ESP\_AT\_PARA\_PARSE\_RESULT\_FAIL : fail
- ESP\_AT\_PARA\_PARSE\_RESULT\_OMITTED : this parameter is OMITTED

*esp\_at\_para\_parse\_result\_type* **esp\_at\_get\_para\_as\_str** (int32\_t para\_index, uint8\_t \*\*result)

Parse string parameter from command string.

**Parameters**

- **para\_index** –the index of parameter
- **result** –the pointer that point to the result.

**Returns**

- ESP\_AT\_PARA\_PARSE\_RESULT\_OK : succeed
- ESP\_AT\_PARA\_PARSE\_RESULT\_FAIL : fail
- ESP\_AT\_PARA\_PARSE\_RESULT\_OMITTED : this parameter is OMITTED

void **esp\_at\_port\_recv\_data\_notify\_from\_isr** (int32\_t len)

Calling the `esp_at_port_recv_data_notify_from_isr` to notify at module that at port received data. When received this notice, at task will get data by calling `get_data_length` and `read_data` in `esp_at_device_ops`. This function MUST be used in isr.

**Parameters** **len** –data length

bool **esp\_at\_port\_recv\_data\_notify** (int32\_t len, uint32\_t msec)

Calling the `esp_at_port_recv_data_notify` to notify at module that at port received data. When received this notice, at task will get data by calling `get_data_length` and `read_data` in `esp_at_device_ops`. This function MUST NOT be used in isr.

**Parameters**

- **len** –data length
- **msec** –timeout time,The unit is millisecond. It waits forever,if msec is port-MAX\_DELAY.

**Returns**

- true : succeed
- false : fail

void **esp\_at\_transmit\_terminal\_from\_isr** (void)

terminal transparent transmit mode,This function MUST be used in isr.

void **esp\_at\_transmit\_terminal** (void)

terminal transparent transmit mode,This function MUST NOT be used in isr.

bool **esp\_at\_custom\_cmd\_array\_regist** (const *esp\_at\_cmd\_struct* \*custom\_at\_cmd\_array, uint32\_t cmd\_num)

regist at command set, which defined by custom,

**Parameters**

- **custom\_at\_cmd\_array** –at command set
- **cmd\_num** –command number

void **esp\_at\_device\_ops\_regist** (*esp\_at\_device\_ops\_struct* \*ops)

regist device operate functions set,

**Parameters ops** –device operate functions set

bool **esp\_at\_custom\_net\_ops\_regist** (int32\_t link\_id, *esp\_at\_custom\_net\_ops\_struct* \*ops)

bool **esp\_at\_custom\_ble\_ops\_regist** (int32\_t conn\_index, *esp\_at\_custom\_ble\_ops\_struct* \*ops)

void **esp\_at\_custom\_ops\_regist** (*esp\_at\_custom\_ops\_struct* \*ops)

regist custom operate functions set interacting with AT,

**Parameters ops** –custom operate functions set

uint32\_t **esp\_at\_get\_version** (void)

get at module version number,

**Returns** at version bit31~bit24: at main version bit23~bit16: at sub version bit15~bit8 : at test version bit7~bit0 : at custom version

void **esp\_at\_response\_result** (uint8\_t result\_code)

response AT process result,

**Parameters result\_code** –see esp\_at\_result\_code\_string\_index

int32\_t **esp\_at\_port\_write\_data** (uint8\_t \*data, int32\_t len)

write data into device,

**Parameters**

- **data** –data buffer to be written
- **len** –data length

**Returns**

- $\geq 0$  : the real length of the data written
- others : fail.

int32\_t **esp\_at\_port\_active\_write\_data** (uint8\_t \*data, int32\_t len)

call pre\_active\_write\_data\_callback() first and then write data into device,

**Parameters**

- **data** –data buffer to be written
- **len** –data length

**Returns**

- `>= 0` : the real length of the data written
- others : fail.

`int32_t esp_at_port_read_data (uint8_t *data, int32_t len)`

read data from device,

**Parameters**

- **data** –data buffer
- **len** –data length

**Returns**

- `>= 0` : the real length of the data read from device
- others : fail

`bool esp_at_port_wait_write_complete (int32_t timeout_msec)`

wait for transmitting data completely to peer device,

**Parameters** `timeout_msec` –timeout time,The unit is millisecond.

**Returns**

- true : succeed,transmit data completely
- false : fail

`int32_t esp_at_port_get_data_length (void)`

get the length of the data received,

**Returns**

- `>= 0` : the length of the data received
- others : fail

`bool esp_at_custom_cmd_line_terminator_set (uint8_t *terminator)`

Set AT command terminator, by default, the terminator is “`\r\n`” You can change it by calling this function, but it just supports one character now.

**Parameters** `terminator` –the line terminator

**Returns**

- true : succeed,transmit data completely
- false : fail

`uint8_t *esp_at_custom_cmd_line_terminator_get (void)`

Get AT command line terminator,by default, the return string is “`\r\n`” .

**Returns** the command line terminator

`const esp_partition_t *esp_at_custom_partition_find (esp_partition_type_t type,  
esp_partition_subtype_t subtype, const char  
*label)`

Find the partition which is defined in `at_customize.csv`.

**Parameters**

- **type** –the type of the partition
- **subtype** –the subtype of the partition
- **label** –Partition label

**Returns** pointer to `esp_partition_t` structure, or NULL if no partition is found. This pointer is valid for the lifetime of the application

`void esp_at_port_enter_specific (esp_at_port_specific_callback_t callback)`

Set AT core as specific status, it will call callback if receiving data. for example:

```
static void wait_data_callback (void)
{
    xSemaphoreGive(sync_sema);
}
```

(continues on next page)

(continued from previous page)

```

void process_task(void* para)
{
    vSemaphoreCreateBinary(sync_sema);
    xSemaphoreTake(sync_sema, portMAX_DELAY);
    esp_at_port_write_data((uint8_t *) ">", strlen(">"));
    esp_at_port_enter_specific(wait_data_callback);
    while(xSemaphoreTake(sync_sema, portMAX_DELAY)) {
        len = esp_at_port_read_data(data, data_len);
        // TODO:
    }
}

```

**Parameters** `callback` –which will be called when received data from AT port

void `esp_at_port_exit_specific` (void)

Exit AT core as specific status.

const uint8\_t\* `esp_at_get_current_cmd_name` (void)

Get current AT command name.

int32\_t `esp_at_get_core_version` (char \*buffer, uint32\_t size)

Get the version of the AT core library.

#### Parameters

- **buffer** –buffer to store the version string
- **size** –size of the buffer

#### Returns

- > 0 : the real length of the version string
- others : fail

void `at_handle_result_code` (*esp\_at\_result\_code\_string\_index* code, void \*pbuf)

### 6.18.3 Structures

struct `esp_at_cmd_struct`

*esp\_at\_cmd\_struct* used for define at command

#### Public Members

char \*`at_cmdName`

at command name

uint8\_t (\*`at_testCmd`)(uint8\_t \*cmd\_name)

Test Command function pointer

uint8\_t (\*`at_queryCmd`)(uint8\_t \*cmd\_name)

Query Command function pointer

uint8\_t (\*`at_setupCmd`)(uint8\_t para\_num)

Setup Command function pointer

uint8\_t (\***at\_exeCmd**)(uint8\_t \*cmd\_name)

Execute Command function pointer

struct **esp\_at\_device\_ops\_struct**

*esp\_at\_device\_ops\_struct* device operate functions struct for AT

### Public Members

int32\_t (\***read\_data**)(uint8\_t \*data, int32\_t len)

read data from device

int32\_t (\***write\_data**)(uint8\_t \*data, int32\_t len)

write data into device

int32\_t (\***get\_data\_length**)(void)

get the length of data received

bool (\***wait\_write\_complete**)(int32\_t timeout\_msec)

wait write finish

struct **esp\_at\_custom\_net\_ops\_struct**

*esp\_at\_custom\_net\_ops\_struct* custom socket callback for AT

### Public Members

int32\_t (\***recv\_data**)(uint8\_t \*data, int32\_t len)

callback when socket received data

void (\***connect\_cb**)(void)

callback when socket connection is built

void (\***disconnect\_cb**)(void)

callback when socket connection is disconnected

struct **esp\_at\_custom\_ble\_ops\_struct**

*esp\_at\_custom\_ble\_ops\_struct* custom ble callback for AT

### Public Members

int32\_t (\***recv\_data**)(uint8\_t \*data, int32\_t len)

callback when ble received data

void (\***connect\_cb**)(void)

callback when ble connection is built

`void (*disconnect_cb)(void)`  
callback when ble connection is disconnected

struct **esp\_at\_custom\_ops\_struct**  
esp\_at\_ops\_struct some custom function interacting with AT

### Public Members

`void (*status_callback)(esp_at_status_type status)`  
callback when AT status changes

`void (*pre_sleep_callback)(at_sleep_mode_t mode)`  
callback before enter modem sleep and light sleep

`void (*pre_deepsleep_callback)(void)`  
callback before enter deep sleep

`void (*pre_restart_callback)(void)`  
callback before restart

`void (*pre_active_write_data_callback)(at_write_data_fn_t)`  
callback before write data

## 6.18.4 Macros

**at\_min** (x, y)

**at\_max** (x, y)

**ESP\_AT\_ERROR\_NO** (subcategory, extension)

**ESP\_AT\_CMD\_ERROR\_OK**

No Error

**ESP\_AT\_CMD\_ERROR\_NON\_FINISH**

terminator character not found ( “\r\n” expected)

**ESP\_AT\_CMD\_ERROR\_NOT\_FOUND\_AT**

Starting “AT” not found (or at, At or aT entered)

**ESP\_AT\_CMD\_ERROR\_PARA\_LENGTH** (which\_para)

parameter length mismatch

**ESP\_AT\_CMD\_ERROR\_PARA\_TYPE** (which\_para)

parameter type mismatch

**ESP\_AT\_CMD\_ERROR\_PARA\_NUM** (need, given)

parameter number mismatch

**ESP\_AT\_CMD\_ERROR\_PARA\_INVALID** (which\_para)

the parameter is invalid

**ESP\_AT\_CMD\_ERROR\_PARA\_PARSE\_FAIL** (which\_para)  
parse parameter fail

**ESP\_AT\_CMD\_ERROR\_CMD\_UNSUPPORTED**  
the command is not supported

**ESP\_AT\_CMD\_ERROR\_CMD\_EXEC\_FAIL** (result)  
the command execution failed

**ESP\_AT\_CMD\_ERROR\_CMD\_PROCESSING**  
processing of previous command is in progress

**ESP\_AT\_CMD\_ERROR\_CMD\_OP\_ERROR**  
the command operation type is error

### 6.18.5 Type Definitions

```
typedef int32_t (*at_read_data_fn_t)(uint8_t *data, int32_t len)
```

```
typedef int32_t (*at_write_data_fn_t)(uint8_t *data, int32_t len)
```

```
typedef int32_t (*at_get_data_len_fn_t)(void)
```

```
typedef void (*esp_at_port_specific_callback_t)(void)  
AT specific callback type.
```

### 6.18.6 Enumerations

```
enum esp_at_status_type  
esp_at_status some custom function interacting with AT
```

*Values:*

```
enumerator ESP_AT_STATUS_NORMAL  
Normal mode. Now mcu can send AT command
```

```
enumerator ESP_AT_STATUS_TRANSMIT  
Transparent Transmission mode
```

```
enum at_sleep_mode_t
```

*Values:*

```
enumerator AT_DISABLE_SLEEP
```

```
enumerator AT_MIN_MODEM_SLEEP
```

```
enumerator AT_LIGHT_SLEEP
```



enumerator **AT\_MAX\_MODEM\_SLEEP**

enumerator **AT\_SLEEP\_MAX**

enum **esp\_at\_module**

module number, Now just AT module

*Values:*

enumerator **ESP\_AT\_MODULE\_NUM**

AT module

enum **esp\_at\_error\_code**

subcategory number

*Values:*

enumerator **ESP\_AT\_SUB\_OK**

OK

enumerator **ESP\_AT\_SUB\_COMMON\_ERROR**

reserved

enumerator **ESP\_AT\_SUB\_NO\_TERMINATOR**

terminator character not found ( “\r\n” expected)

enumerator **ESP\_AT\_SUB\_NO\_AT**

Starting “AT” not found (or at, At or aT entered)

enumerator **ESP\_AT\_SUB\_PARA\_LENGTH\_MISMATCH**

parameter length mismatch

enumerator **ESP\_AT\_SUB\_PARA\_TYPE\_MISMATCH**

parameter type mismatch

enumerator **ESP\_AT\_SUB\_PARA\_NUM\_MISMATCH**

parameter number mismatch

enumerator **ESP\_AT\_SUB\_PARA\_INVALID**

the parameter is invalid

enumerator **ESP\_AT\_SUB\_PARA\_PARSE\_FAIL**

parse parameter fail

enumerator **ESP\_AT\_SUB\_UNSUPPORT\_CMD**

the command is not supported

enumerator **ESP\_AT\_SUB\_CMD\_EXEC\_FAIL**

the command execution failed

enumerator **ESP\_AT\_SUB\_CMD\_PROCESSING**  
processing of previous command is in progress

enumerator **ESP\_AT\_SUB\_CMD\_OP\_ERROR**  
the command operation type is error

enum **esp\_at\_para\_parse\_result\_type**  
the result of AT parse

*Values:*

enumerator **ESP\_AT\_PARA\_PARSE\_RESULT\_FAIL**  
parse fail,Maybe the type of parameter is mismatched,or out of range

enumerator **ESP\_AT\_PARA\_PARSE\_RESULT\_OK**  
Successful

enumerator **ESP\_AT\_PARA\_PARSE\_RESULT\_OMITTED**  
the parameter is OMITTED.

enum **esp\_at\_result\_code\_string\_index**  
the result code of AT command processing

*Values:*

enumerator **ESP\_AT\_RESULT\_CODE\_OK**  
“OK”

enumerator **ESP\_AT\_RESULT\_CODE\_ERROR**  
“ERROR”

enumerator **ESP\_AT\_RESULT\_CODE\_FAIL**  
“ERROR”

enumerator **ESP\_AT\_RESULT\_CODE\_SEND\_OK**  
“SEND OK”

enumerator **ESP\_AT\_RESULT\_CODE\_SEND\_FAIL**  
“SEND FAIL”

enumerator **ESP\_AT\_RESULT\_CODE\_IGNORE**  
response nothing, just change internal status

enumerator **ESP\_AT\_RESULT\_CODE\_PROCESS\_DONE**  
response nothing, just change internal status

enumerator **ESP\_AT\_RESULT\_CODE\_OK\_AND\_INPUT\_PROMPT**

enumerator **ESP\_AT\_RESULT\_CODE\_MAX**

### 6.18.7 Header File

- `components/at/include/esp_at.h`

### 6.18.8 Functions

const char \***esp\_at\_get\_current\_module\_name** (void)  
get current module name

const char \***esp\_at\_get\_module\_name\_by\_id** (uint32\_t id)  
get module name by index

uint32\_t **esp\_at\_get\_module\_id** (void)  
get current module id

void **esp\_at\_set\_module\_id** (uint32\_t id)  
Set current module id.

**Parameters** `id` –[in] the module id to set

void **esp\_at\_set\_module\_id\_by\_str** (const char \*buffer)  
Get module id by module name.

**Parameters** `buffer` –[in] pointer to a module name string

void **esp\_at\_main\_preprocess** (void)  
some workarounds for esp-at project

*at\_mfg\_params\_storage\_mode\_t* **at\_get\_mfg\_params\_storage\_mode** (void)  
get storage mode of mfg parameters

**Returns** `at_mfg_params_storage_mode_t`

void **esp\_at\_ready\_before** (void)  
Do some things before esp-at is ready.

---

**Note:** This function can be overridden with custom implementation. For example, you can override this function to: a) execute some preset AT commands by calling `at_exe_cmd()` API. b) do some initializations by calling APIs from `esp-idf` or `esp-at`.

---

### 6.18.9 Macros

**ESP\_AT\_PORT\_TX\_WAIT\_MS\_MAX**

**AT\_BUFFER\_ON\_STACK\_SIZE**

### 6.18.10 Enumerations

enum `at_mfg_params_storage_mode_t`

*Values:*

enumerator **AT\_PARAMS\_NONE**

enumerator **AT\_PARAMS\_IN\_MFG\_NVS**

enumerator **AT\_PARAMS\_IN\_PARTITION**



## **Chapter 7**

# **Customized AT Commands and Firmware**



## Chapter 8

# AT FAQ

- *AT Firmware*
  - *There is no released firmware for my module. Where can I get the firmware for it?*
  - *How to get the source code of AT firmware?*
  - *How to download the AT firmware on Espressif's official website?*
  - *How to combine all the bin files compiled by ESP-AT?*
  - *Does the AT firmware shipped in modules support flow control?*
- *AT Commands and Responses*
  - *What is the reason why AT prompts busy?*
  - *Why does the ESP-AT firmware always return the following message after the I powered up the device and sent the first command?*
  - *What commands are supported by the default ESP-AT firmware on different modules, and from which version are they supported?*
  - *When the host MCU sends an AT command to the ESP32-C2 device, there is no response. What is the reason?*
  - *Why is Wi-Fi disconnected (WIFI\_DISCONNECT printed)?*
  - *What are the common Wi-Fi compatibility issues?*
  - *Do AT commands support ESP-WIFI-MESH?*
  - *Does AT support websocket commands?*
  - *Can AT command set Bluetooth LE transmit power?*
  - *How to support commands that are not supported by the default firmware but can be supported after configuring and compiling the ESP-AT project?*
  - *How to handle special characters in AT commands?*
  - *Can the serial port baudrate be modified in AT Commands? (Default: 115200)*
  - *After ESP32-C2 enters the passthrough mode using AT commands, can ESP32-C2 give a message if the connected hotspot is disconnected?*
  - *How to enable the notify and indicate functions on Bluetooth LE clients?*
- *Hardware*
  - *How big is the chip flash required for ESP-AT firmware on different modules?*
  - *How to view the error log of AT firmware?*
  - *The UART1 communication pin used by ESP-AT on the ESP32-C2 module is inconsistent with the default UART1 pin described in the ESP32-C2 module's datasheet?*
- *Performance*
  - *How long does it take for the AT to connect to Wi-Fi?*
  - *Is it possible to change the TCP send window size in AT firmware?*
  - *How to test and optimize the throughput of ESP32-C2 AT?*
- *Other*
  - *What interfaces of ESP32-C2 chips can be used to transmit AT commands?*
  - *How does ESP-AT conduct BQB certification?*
  - *How do I specify the TLS protocol version for ESP32-C2 AT?*



- [How to modify the number of TCP connections in AT?](#)
- [Does ESP32-C2 AT support PPP?](#)
- [How to enable debug log for AT?](#)

## 8.1 AT Firmware

### 8.1.1 There is no released firmware for my module. Where can I get the firmware for it?

If there is no released firmware for your module in the [AT Binary Lists](#) chapter, please consider the following options:

- Use the firmware for the module that has the same hardware configuration as yours (see [ESP-AT Firmware Differences](#) for which module has the same configuration).
- Refer to [Which Type of AT Firmware Shall I Choose?](#).

### 8.1.2 How to get the source code of AT firmware?

The esp-at project is distributed as a combination of source code and pre-compiled libraries in this repository. The pre-compiled core libraries (under the directory: `esp-at/components/at/lib/`) are closed-source, and there is no plan for open-sourcing them.

### 8.1.3 How to download the AT firmware on Espressif's official website?

- Download the flash tool: [Flash Download Tools](#).
- See [AT Downloading Guide](#) for the download address.

### 8.1.4 How to combine all the bin files compiled by ESP-AT?

You can use the **combine** button of the [Flash Download Tools](#).

### 8.1.5 Does the AT firmware shipped in modules support flow control?

- Hardware flow control is supported, but software flow control is not.
- To enable or disable hardware flow control, run `AT+UART_CUR` or `AT+UART_DEF`.
- See [Hardware connection](#) for more details.

## 8.2 AT Commands and Responses

### 8.2.1 What is the reason why AT prompts busy?

- The “busy” prompt indicates that the previous command is being executed, and the system cannot respond to the current input. The processing mechanism of the AT commands is serial, i.e. one command at a time.
- Any input through serial ports is considered to be a command input, so the system will also prompt “busy” or “ERROR” when there is any extra invisible character input.
  - Serial input AT+GMR (change character CR LF) (space character), because AT+GMR (change character CR LF) is already a complete AT command, the system will execute the command. At this time, if the system has not completed the AT+GMR operation, it has received the following space character, which will be regarded as a new command input, and the system will prompt “busy” . But if the system has completed the AT+GMR operation, and then receives the following space character, the space character will be regarded as an error command, and the system will prompt “ERROR” .

- After the MCU sends AT+CIPSEND and receives the busy p.. response, the MCU needs to resend the data. Because busy p.. represents the previous command is being executed, the current input is invalid. It is recommended to wait for the response of the last AT command before the MCU sends a new command again.

### 8.2.2 Why does the ESP-AT firmware always return the following message after the I powered up the device and sent the first command?

```
ERR CODE:0x010b0000
busy p...
```

- This message means that the previous command is being executed.
- Normally only “busy p...” is displayed. The ERR CODE is displayed because the error code prompt is enabled.
- If you receive this message after sending the first command on power-up, the possible reasons are: the command is followed by the unnecessary newline/space/other symbols; or two or more AT commands are sent in succession.

### 8.2.3 What commands are supported by the default ESP-AT firmware on different modules, and from which version are they supported?

- To learn what commands are supported by the default ESP-AT firmware on different modules, please refer to [ESP-AT Firmware Differences](#).
- To learn from which version a command is supported and what issues are fixed in each version, please refer to [release notes](#).

### 8.2.4 When the host MCU sends an AT command to the ESP32-C2 device, there is no response. What is the reason?

A terminator ( “AT\r\n” ) must be added after an AT command when the host MCU sending AT commands to an ESP32-C2 device. Please see [Check Whether AT Works](#).

### 8.2.5 Why is Wi-Fi disconnected (WIFI\_DISCONNECT printed)?

You can check the Wi-Fi disconnection reason code on the *AT log port*, which usually prints `wifi disconnected, rc:<reason_code>`. The `<reason_code>` here refers to [Wi-Fi Reason Code](#).

### 8.2.6 What are the common Wi-Fi compatibility issues?

- AMPDU compatibility issue.
  - If the router does not support AMPDU, ESP32-C2 will automatically disable the AMPDU function when interacting with the router.
  - If the router supports AMPDU but there is a compatibility issue with AMPDU transmission between the router and ESP32-C2, it is recommended to disable the function on the router or ESP32-C2. For information on how to disable it on ESP32-C2, please refer to [Compile ESP-AT Project Locally](#) and select the following options in the fifth step of configuring the project:
    - \* Disable Component config->Wi-Fi->WiFi AMPDU TX
    - \* Disable Component config->Wi-Fi->WiFi AMPDU RX
- Phy mode compatibility issue. If there is a compatibility issue with the phy mode between the router and ESP32-C2, it is recommended to switch it on the router or ESP32-C2. For how to switch it on ESP32-C2, please refer to the [AT+CWSTAPROTO](#) command.

### 8.2.7 Do AT commands support ESP-WIFI-MESH?

Currently, AT commands do not support ESP-WIFI-MESH.

### 8.2.8 Does AT support websocket commands?

- Not supported in the default firmware.
- It can be implemented by custom commands. See [websocket](#) and [How to add user-defined AT commands](#) for more information.

### 8.2.9 Can AT command set Bluetooth LE transmit power?

Yes, the [AT+RFPOWER](#) command can set Bluetooth LE transmit power. ESP32-C2 Wi-Fi and Bluetooth LE share the same antenna.

### 8.2.10 How to support commands that are not supported by the default firmware but can be supported after configuring and compiling the ESP-AT project?

For example, if you need to support the WPA2 Enterprise function on the ESP32-C2 series, configure and compile the firmware by yourself. Open the WPA2 Enterprise function in menuconfig when compiling: `./build.py menuconfig>Component config>AT>[*]AT WPA2 Enterprise command support.`

### 8.2.11 How to handle special characters in AT commands?

Please refer to the escape character syntax described in the [AT Command Types](#) section.

### 8.2.12 Can the serial port baudrate be modified in AT Commands? (Default: 115200)

Yes, you can use either of the two ways below to modify it:

- Use the command [AT+UART\\_CUR](#) or [AT+UART\\_DEF](#).
- Re-compile the AT firmware: [establish the compiling environment](#) and [change the UART baudrate](#).

### 8.2.13 After ESP32-C2 enters the passthrough mode using AT commands, can ESP32-C2 give a message if the connected hotspot is disconnected?

- Yes, you can configure it with [AT+SYSMSG](#), i.e., set `AT+SYSMSG=4`. In this way, the serial port will report `WIFI_DISCONNECT\r\n` when the connected hotspot is disconnected.
- Note that this command is added after AT v2.1.0. It is not available for v2.1.0 and earlier versions.

### 8.2.14 How to enable the notify and indicate functions on Bluetooth LE clients?

- Besides the read and write properties, Bluetooth LE characteristics also have the `notify` and `indicate` properties, which allow the server to send data to the client, but the client must first register for notification by writing the value of “CCCD” .
- To enable `notify`, write `0x01`. To enable `indicate`, write `0x02` (for the descriptor “0x2902”). To enable both `notify` and `indicate`, write `0x03`.
- The example below demonstrates how to enable the `notify` and `indicate` properties for the descriptor `0x2902` under the services `0xC305` and `0xC306` respectively. The two services are default services in ESP-AT, of which `0xC305` can be notified and `0xC306` can be indicated.

```
AT+BLEGATTCWR=0,3,6,1,2
>
// Write 0x01
OK
// Server: +WRITE:0,1,6,1,2,<0x01>,<0x00>
AT+BLEGATTCWR=0,3,7,1,2
>
// Write 0x02
OK
// Server: +WRITE:0,1,6,1,2,<0x02>,<0x00>
// Writing ccc is a prerequisite for the server to be able to send notify_
↪and indicate
```

## 8.3 Hardware

### 8.3.1 How big is the chip flash required for ESP-AT firmware on different modules?

- For ESP32-C2 series modules, please refer to [ESP-AT Firmware Differences](#).

### 8.3.2 How to view the error log of AT firmware?

- For ESP32-C2, the error log is output through the download port. By default, UART0 is GPIO21 and GPIO20.
- See [Hardware Connection](#) for more details.

### 8.3.3 The UART1 communication pin used by ESP-AT on the ESP32-C2 module is inconsistent with the default UART1 pin described in the ESP32-C2 module's datasheet?

- ESP32-C2 supports IO matrix. When compiling ESP-AT, you can configure UART1 pins in menuconfig, so they may be inconsistent with the pins described in the module datasheet.
- See [factory\\_param\\_data.csv](#) for more details.

## 8.4 Performance

### 8.4.1 How long does it take for the AT to connect to Wi-Fi?

- In an office scenario, the connection time is 5 seconds. However, in actual practice, Wi-Fi connection time depends on the router performance, network environment, module antenna performance, etc.
- The maximum timeout time can be set by the `<jap_timeout>` parameter of `AT+CWJAP`.

### 8.4.2 Is it possible to change the TCP send window size in AT firmware?

- Currently, it cannot be changed by AT commands, but you can configure and compile the ESP-AT project to generate a new firmware.
- You can configure the menuconfig parameter: Component config > LWIP > TCP > Default send buffer size.

### 8.4.3 How to test and optimize the throughput of ESP32-C2 AT?

- Many factors are affecting the AT throughput test. It is recommended to use the iperf example in esp-idf for testing. While testing, please use the passthrough mode, adjust the data length to 1460 bytes, and send data continuously.
- If the test rate does not meet your requirements, please refer to [How to Improve ESP-AT Throughput Performance](#).

## 8.5 Other

### 8.5.1 What interfaces of ESP32-C2 chips can be used to transmit AT commands?

- ESP32-C2 can transmit AT commands through UART and SPI.
- The default firmware uses UART for transmission. If you need SDIO or SPI interface to transmit AT commands, you can configure it through `./build.py menuconfig > Component config > AT` when compiling the ESP-AT project by yourself.
- See [AT through SDIO](#) , [AT through SPI](#) , or [AT through socket](#) for more details.

### 8.5.2 How does ESP-AT conduct BQB certification?

Please contact [Espressif](#) for solutions.

### 8.5.3 How do I specify the TLS protocol version for ESP32-C2 AT?

When compiling the esp-at project, you can disable the unwanted versions in the `./build.py menuconfig > Component config > mbedTLS`.

### 8.5.4 How to modify the number of TCP connections in AT?

- At present, the maximum number of TCP connections of the AT default firmware is 5.
- The ESP32-C2 AT supports a maximum of 16 TCP connections, which can be configured in menuconfig as follows:
  - `./build.py menuconfig > Component config > AT > (16)AT socket maximum connection number`
  - `./build.py menuconfig > LWIP > (16)Max number of open sockets`

### 8.5.5 Does ESP32-C2 AT support PPP?

- Not supported, please refer to [pppos\\_client](#) demos for your own implementation.

### 8.5.6 How to enable debug log for AT?

- Enable log level: `./build.py menuconfig > Component Config > Log output > Default log verbosity set to Debug.`
  - Enable Wi-Fi debug: `./build.py menuconfig > Component config > Wi-Fi > Wi-Fi debug log level set to Debug.`
  - Enable TCP/IP debug: `./build.py menuconfig > Component config > LWIP > Enable LWIP Debug > Set the log level of the specific part you want to debug to Debug.`

- **Enable Bluetooth LE debug:** `./build.py menuconfig>Component config>Bluetooth >Bluedroid Options>Disable BT debug logs>BT DEBUG LOG LEVEL>Set the log level of the specific part you want to debug to Debug.`



## Chapter 9

# Index of Abbreviations

**A2DP** Advanced Audio Distribution Profile

高级音频分发框架

**ADC** Analog-to-Digital Converter

模拟数字转换器

**ALPN** Application Layer Protocol Negotiation

应用层协议协商

**AT** AT stands for “attention” .

AT 是 attention 的缩写。

**AT command port** The port that is used to send AT commands and receive responses. More details are in the *AT port* introduction.

**AT 命令端口** 也称为 AT 命令口，用于发送 AT 命令和接收响应的端口。更多介绍请参考 *AT 端口*。

**AT log port** The port that is used to output log. More details are in the *AT port* introduction.

**AT 日志端口** 也称为 AT 日志口，用于输出 AT 日志的端口。更多介绍请参考 *AT 端口*。

**AT port** AT port is the general name of AT log port (that is used to output log) and AT command port (that is used to send AT commands and receive responses). Please refer to *Hardware Connection* for default AT port pins and *How to Set AT Port Pins* for how to customize them.

**AT 端口** AT 端口是 AT 日志端口（用于输出日志）和 AT 命令端口（用于发送 AT 命令和接收响应）的总称。请参考 *Hardware Connection* 了解默认的 AT 端口管脚，参考 *How to Set AT Port Pins* 了解如何自定义 AT 端口管脚。

**Bluetooth LE** Bluetooth Low Energy

低功耗蓝牙

**BluFi** Wi-Fi network configuration function via Bluetooth channel

BluFi 是一款基于蓝牙通道的 Wi-Fi 网络配置功能

**Command Mode** Default operating mode of AT. In the command mode, any character received by the AT command port will be treated as an AT command, and AT returns the command execution result to the AT command port. AT enters *Data Mode* from *Command Mode* in the following cases.

- After sending the *AT+CIPSEND* set command successfully and returns >.
- After sending the *AT+CIPSEND* execute command successfully and returns >.
- After sending the *AT+CIPSENDL* set command successfully and returns >.
- After sending the *AT+CIPSENDEX* set command successfully and returns >.
- After sending the *AT+SAVETRANSLINK* set command successfully and sending the *AT+RST* command and restart the module.

In the data mode, send the *+++* command, AT will exit from *Data Mode* and enter the *Command Mode*.

**命令模式** AT 的默认工作模式。在命令模式下，AT 命令端口收到的任何字符都会被当作 AT 命令进行处理，同时 AT 会在命令端口回复命令执行结果。AT 在下列情况下，会从 *命令模式* 进入 *数据模式*。

- 发送 *AT+CIPSEND* 设置命令成功，回复 > 之后
- 发送 *AT+CIPSEND* 执行命令成功，回复 > 之后
- 发送 *AT+CIPSENDL* 设置命令成功，回复 > 之后
- 发送 *AT+CIPSENDEX* 设置命令成功，回复 > 之后
- 发送 *AT+SAVETRANSLINK* 设置命令成功，再发送 (*AT+RST*) 命令，模组重启之后



在数据模式下，发送+++ 命令，会从数据模式退出，进入命令模式。

**Data Mode** In the data mode, any character received by the AT command port will be treated as data (except for special +++) instead of the AT command, and these data will be sent to the opposite end without modification. AT enters *Data Mode* from *Command Mode* in the following cases.

- After sending the *AT+CIPSEND* set command successfully and returns >.
- After sending the *AT+CIPSEND* execute command successfully and returns >.
- After sending the *AT+CIPSENDL* set command successfully and returns >.
- After sending the *AT+CIPSENDEX* set command successfully and returns >.
- After sending the *AT+SAVETRANSLINK* set command successfully and sending the *AT+RST* command and restart the module.

In the data mode, send the +++ command, AT will exit from *Data Mode* and enter the *Command Mode*.

**数据模式** 在数据模式下，AT 命令端口收到的任何字符都会被当作数据（除了特殊的+++），而不是 AT 命令，这些数据会无修改的发往对端。AT 在下列情况下，会从命令模式进入数据模式。

- 发送*AT+CIPSEND* 设置命令成功，回复 > 之后
- 发送*AT+CIPSEND* 执行命令成功，回复 > 之后
- 发送*AT+CIPSENDL* 设置命令成功，回复 > 之后
- 发送*AT+CIPSENDEX* 设置命令成功，回复 > 之后
- 发送*AT+SAVETRANSLINK* 设置命令成功，再发送*AT+RST* 命令，模组重启之后

在数据模式下，发送+++ 命令，会从数据模式退出，进入命令模式。

**DHCP** Dynamic Host Configuration Protocol

动态主机配置协议

**DNS** Domain Name System

域名系统

**DTIM** Delivery Traffic Indication Map

延迟传输指示映射

**GATT** Generic Attributes client

GATT 客户端

**GATTS** Generic Attributes server

GATT 服务器

**HID** Human Interface Device

人机接口设备

**I2C** Inter-Integrated Circuit

集成电路总线

**ICMP** Internet Control Message Protocol

因特网控制报文协议

**LwIP** A Lightweight TCP/IP stack

一个轻量级的 TCP/IP 协议栈

**LWT** Last Will and Testament

遗嘱

**MAC** Media Access Control

MAC 地址

**mDNS** Multicast Domain Name System

多播 DNS

**manufacturing nvs** Manufacturing Non-Volatile Storage. manufacturing nvs stores all certificates, private keys, GATTS data, module information, Wi-Fi configurations, UART configurations, etc. The default values of these configurations are defined in *raw\_data*. These configurations are finally built into the *mfg\_nvs.bin* file and downloaded to the flash at the address defined in *at\_customize.csv*.

一个适用于量产的 NVS。manufacturing nvs 中存储了 AT 固件默认所用到的所有证书、私钥、GATTS 数据、模组信息、Wi-Fi 配置、UART 配置等。这些配置信息，默认值在 *raw\_data* 里，最终生成了 *mfg\_nvs.bin*，烧录到 *at\_customize.csv* 中定义的位置。

**MSB** Most Significant Bit

最高有效位

**MTU** maximum transmission unit

最大传输单元

**NVS** Non-Volatile Storage

非易失性存储器

**Normal Transmission Mode** Default Transmission Mode

In normal transmission mode, users can send AT commands. For examples, users can send MCU data received by AT command port to the opposite end of transmission by *AT+CIPSEND*; and the data received from the opposite end of transmission will also be returned to MCU through AT command port with additional prompt: *+IPD*.

During a normal transmission, if the connection breaks, ESP32-C2 will give a prompt and will not attempt to reconnect.

More details are in *Transmission Mode Shift Diagram*.

**普通传输模式** 默认传输模式

在普通传输模式下，用户可以发送 AT 命令。例如，用户可以通过 *AT+CIPSEND* 命令，发送 AT 命令口收到的 MCU 数据到传输对端。从传输对端收到的数据，会通过 AT 命令口返回给 MCU，同时会附带 *+IPD* 信息。

普通传输模式时，如果连接断开，ESP32-C2 不会重连，并提示连接断开。

更多介绍请参考 *Transmission Mode Shift Diagram*。

**OWE** Opportunistic Wireless Encryption. OWE is a Wi-Fi standard which ensures that the communication between each pair of endpoints is protected from other endpoints.

More details are in [Wikipedia](#).

机会性无线加密。OWE 是一种 Wi-Fi 标准，它确保每对端点之间的通信受到保护，不受其他端点的影响。

更多介绍请参考 [维基百科](#)。

**Passthrough Mode** Also called as “Passthrough Sending & Receiving Mode” .

In passthrough mode, users cannot send AT commands except special *+++* command. All MCU data received by AT command port will be sent to the opposite end of transmission without any modification; and the data received from the opposite end of transmission will also be returned to MCU through AT command port without any modification.

During the Wi-Fi passthrough transmission, if the connection breaks, ESP32-C2 (as client) will keep trying to reconnect until *+++* is input to exit the passthrough transmission; ESP32-C2 (as server) will shutdown the old connection and listen new connection until *+++* is input to exit the passthrough transmission.

More details are in *Transmission Mode Shift Diagram*.

**透传模式** 也称为“透传发送接收模式”。

在透传模式下，用户不能发送其它 AT 命令，除了特别的 *+++* 命令。AT 命令口收到的所有的 MCU 数据都将无修改地，发送到传输对端。从传输对端收到的数据也会通过 AT 命令口无修改地，返回给 MCU。

Wi-Fi 透传模式传输时，如果连接断开，ESP32-C2 作为客户端时，会不停地尝试重连，此时单独输入 *+++* 退出透传，则停止重连；ESP32-C2 作为服务器时，会关闭连接同时监听新的连接，此时单独输入 *+++* 退出透传。

更多介绍请参考 *Transmission Mode Shift Diagram*。

**Transmission Mode Shift Diagram**

Fig. 1: Transmission Mode Shift Diagram

More details are in the following introduction.

- *Normal Transmission Mode* (普通传输模式)
- *Passthrough Receiving Mode* (透传接收模式)
- *Passthrough Mode* (透传模式)
- *AT+CIPMODE*
- *AT+CIPSEND*
- *+++*
- *AT+SAVETRANSLINK*

**Passthrough Receiving Mode** The temporary mode between *Normal Transmission Mode* and *Passthrough Mode*.

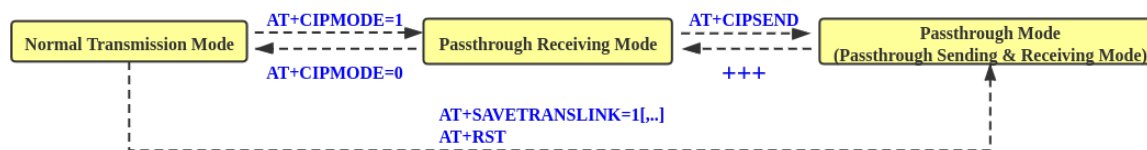
In passthrough receiving mode, AT cannot send any data to the opposite end of transmission; but the data

received from the opposite end of transmission can be returned to MCU through AT command port without any modification. More details are in [Transmission Mode Shift Diagram](#).

**透传接收模式** 在普通传输模式和透传模式之间的一个临时模式。

在透传接收模式，AT 不能发送数据到传输对端；但 AT 可以收到来自传输对端的数据，通过 AT 命令口无修改地返回给 MCU。更多介绍请参考 [Transmission Mode Shift Diagram](#)。

**PBC** Push Button Configuration

按钮配置

**PCI Authentication** Payment Card Industry Authentication. In ESP-AT project, it refers to all Wi-Fi authentication modes except OPEN and WEP.

PCI 认证，在 ESP-AT 工程中指的是除 OPEN 和 WEP 以外的 Wi-Fi 认证模式。

**PKI** A public key infrastructure (PKI) is a set of roles, policies, hardware, software and procedures needed to create, manage, distribute, use, store and revoke digital certificates and manage public-key encryption.

更多介绍请参考 [Public Key Infrastructure](#)。

公开密钥基础设施建设。公开密钥基础设施建设 (PKI) 是一组由硬件、软件、参与者、管理政策与流程组成的基础架构，其目的在于创造、管理、分配、使用、存储以及撤销数字证书。

更多介绍请参考 [公开密钥基础设施建设](#)。

**PLCP** Physical Layer Convergence Procedure

PLCP 协议，即物理层会聚协议

**PMF** protected management frame

受保护的管理帧

**PSK** Pre-shared Key

预共享密钥

**PWM** Pulse-Width Modulation

脉冲宽度调制

**QoS** Quality of Service

服务质量

**RTC** Real Time Controller. A group of circuits in SoC that keeps working in any chip mode and at any time.

实时控制器，为 SoC 中的一组电路，在任何芯片模式下都能随时保持工作。

**SMP** Security Manager Protocol

安全管理协议

**SNI** Server Name Indication

服务器名称指示

**SNTP** Simple Network Time Protocol

简单网络时间协议

**SPI** Serial Peripheral Interface

串行外设接口

**SPP** Serial Port Profile

SPP 协议，即串口协议

**SSL** Secure Sockets Layer

SSL 协议，即安全套接字协议

**system message** Data sent via AT command port to MCU. Each system message usually ends with `\r\n`. Detailed system message descriptions are available at [AT Messages](#).

**系统消息** AT 命令口发往 MCU 的数据。每条系统消息通常以 `\r\n` 结尾。详细的系统消息说明见 [AT 消息](#)。

**TLS** Transport Layer Security

TLS 协议，即传输层安全性协议

**URC** Unsolicited Result Code

非请求结果码，一般为模组给 MCU 的串口返回

**UTC** Coordinated Universal Time

协调世界时

**UUID** universally unique identifier

通用唯一识别码

**WEP** Wired-Equivalent Privacy

WEP 加密方式，即有线等效加密

**WPA** Wi-Fi Protected Access

Wi-Fi 保护访问

**WPA2** Wi-Fi Protected Access II

Wi-Fi 保护访问 II

**WPS** Wi-Fi Protected Setup  
Wi-Fi 保护设置



# Chapter 10

## Disclaimer

Thank you for choosing to use [Solution/Firmware ESP-AT]. To ensure the safe, legal, and effective use of this solution (firmware), please carefully read the following Disclaimer. This Disclaimer aims to clarify the terms and precautions that users must follow when using this solution (firmware). By continuing to use this solution (firmware), you indicate your acceptance and agreement to comply with these terms.

### 10.1 Application Scenario Verification

This solution (firmware) is a general version. Despite extensive testing across various scenarios, there remains a risk that certain use cases may not be covered. Prior to making commercial production decisions based on this solution (firmware), please conduct thorough and comprehensive validation tailored to your specific application scenarios.

### 10.2 Compatibility

Given the rapid advancement of technology, the emergence of new technologies, solutions, or standards may lead to compatibility issues. Users are advised to conduct appropriate testing and validation based on their products and to stay informed about new version releases of this solution (firmware)

### 10.3 Server Upgrade Considerations

When upgrading servers, including but not limited to operating system upgrades, tool upgrades, and certificate upgrades, it is essential to conduct testing and validation prior to any formal upgrades to prevent connectivity issues arising from server changes.

### 10.4 Wireless Solution Issue Handling

Wireless solutions are susceptible to external factors and can present complex issue diagnostics. Users should plan remote OTA and remote issue information retrieval solutions in conjunction with their products and cloud platforms. Otherwise, users may need to provide on-site logs, data packets, and other necessary information for problem analysis.

## 10.5 Usage Restrictions

Users must not utilize this solution (firmware) for illegal activities or purposes that violate applicable laws and regulations. Users are responsible for ensuring that their use of this solution (this firmware) complies with all relevant laws and regulations. We accept no responsibility for any consequences arising from illegal use of this solution (firmware).

## 10.6 Limitation of Liability

We shall not be liable for any direct, indirect, incidental, special, or consequential damages (including but not limited to data loss, profit loss, business interruption, etc.) resulting from the use of this solution (firmware), even if we have been advised of the possibility of such damages.

## 10.7 Third-Party Software and Technology

This solution (firmware) may contain third-party software or technology. We assume no responsibility for the applicability and compliance of such third-party software or technology. Users should adhere to the licensing agreements and usage terms of third parties.

## 10.8 Data Protection

Users are solely responsible for the protection and backup of any data generated during the use of this solution (firmware). We accept no liability for any losses resulting from data loss or leakage.

## 10.9 Version Updates and Maintenance

This solution (firmware) will undergo periodic maintenance updates and version releases. Users are encouraged to monitor version status, and no separate notification will be provided.

## 10.10 Disclaimer Updates

The terms of this Disclaimer may be updated periodically without prior notice.

## 10.11 User Responsibility

Users are strongly encouraged to read and strictly adhere to the terms of this Disclaimer. Any risks arising from non-compliance shall be borne by the user.

Thank you for your understanding and cooperation!

# Chapter 11

## About

This is documentation of [ESP-AT](#), a solution developed by Espressif to quickly and easily interface with ESP32-C2 products.

Espressif Wi-Fi and Bluetooth chipsets are often used as add-on modules to seamlessly integrate wireless connectivity features into new and existing products. In an effort to facilitate this and cut down on engineering costs, Espressif Systems has developed [AT firmware](#) as well as a rich set of [AT commands](#) that can be used to interface with Espressif products.



Fig. 1: ESP-AT Solution

The AT firmware allows for rapid integration by providing:

- In-built TCP/IP stack and data buffering
- Easy integration with resource-constrained host platforms
- Easy-to-parse command-response protocols
- Customized, user-defined AT commands
- genindex





Fig. 2: ESP-AT Commands

# Index

## A

A2DP, [373](#)  
ADC, [373](#)  
ALPN, [373](#)  
AT, [373](#)  
AT command port, [373](#)  
AT log port, [373](#)  
AT port, [373](#)  
AT 命令端口, [373](#)  
AT 日志端口, [373](#)  
AT 端口, [373](#)  
AT\_BUFFER\_ON\_STACK\_SIZE (C macro), [360](#)  
at\_get\_data\_len\_fn\_t (C++ type), [357](#)  
at\_get\_mfg\_params\_storage\_mode (C++ function), [360](#)  
at\_handle\_result\_code (C++ function), [354](#)  
at\_max (C macro), [356](#)  
at\_mfg\_params\_storage\_mode\_t (C++ enum), [360](#)  
at\_mfg\_params\_storage\_mode\_t::AT\_PARAMS\_IN\_PARTITION (C++ enumerator), [360](#)  
at\_mfg\_params\_storage\_mode\_t::AT\_PARAMS\_IN\_PARTITION (C++ enumerator), [361](#)  
at\_mfg\_params\_storage\_mode\_t::AT\_PARAMS\_NONE (C++ enumerator), [360](#)  
at\_min (C macro), [356](#)  
at\_read\_data\_fn\_t (C++ type), [357](#)  
at\_sleep\_mode\_t (C++ enum), [357](#)  
at\_sleep\_mode\_t::AT\_DISABLE\_SLEEP (C++ enumerator), [357](#)  
at\_sleep\_mode\_t::AT\_LIGHT\_SLEEP (C++ enumerator), [357](#)  
at\_sleep\_mode\_t::AT\_MAX\_MODEM\_SLEEP (C++ enumerator), [357](#)  
at\_sleep\_mode\_t::AT\_MIN\_MODEM\_SLEEP (C++ enumerator), [357](#)  
at\_sleep\_mode\_t::AT\_SLEEP\_MAX (C++ enumerator), [358](#)  
at\_write\_data\_fn\_t (C++ type), [357](#)

## B

Bluetooth LE, [373](#)  
BluFi, [373](#)

## C

Command Mode, [373](#)

## D

Data Mode, [374](#)  
DHCP, [374](#)  
DNS, [374](#)  
DTIM, [374](#)

## E

ESP\_AT\_CMD\_ERROR\_CMD\_EXEC\_FAIL (C macro), [357](#)  
ESP\_AT\_CMD\_ERROR\_CMD\_OP\_ERROR (C macro), [357](#)  
ESP\_AT\_CMD\_ERROR\_CMD\_PROCESSING (C macro), [357](#)  
ESP\_AT\_CMD\_ERROR\_CMD\_UNSUPPORTED (C macro), [357](#)  
ESP\_AT\_CMD\_ERROR\_NON\_FINISH (C macro), [356](#)  
ESP\_AT\_CMD\_ERROR\_NOT\_FOUND\_AT (C macro), [356](#)  
ESP\_AT\_CMD\_ERROR\_PARAM\_ERROR\_OK (C macro), [356](#)  
ESP\_AT\_CMD\_ERROR\_PARAM\_INVALID (C macro), [356](#)  
ESP\_AT\_CMD\_ERROR\_PARAM\_LENGTH (C macro), [356](#)  
ESP\_AT\_CMD\_ERROR\_PARAM\_NUM (C macro), [356](#)  
ESP\_AT\_CMD\_ERROR\_PARAM\_PARSE\_FAIL (C macro), [356](#)  
ESP\_AT\_CMD\_ERROR\_PARAM\_TYPE (C macro), [356](#)  
esp\_at\_cmd\_struct (C++ struct), [354](#)  
esp\_at\_cmd\_struct::at\_cmdName (C++ member), [354](#)  
esp\_at\_cmd\_struct::at\_exeCmd (C++ member), [354](#)  
esp\_at\_cmd\_struct::at\_queryCmd (C++ member), [354](#)  
esp\_at\_cmd\_struct::at\_setupCmd (C++ member), [354](#)  
esp\_at\_cmd\_struct::at\_testCmd (C++ member), [354](#)  
esp\_at\_custom\_ble\_ops\_regist (C++ function), [352](#)  
esp\_at\_custom\_ble\_ops\_struct (C++ struct), [355](#)  
esp\_at\_custom\_ble\_ops\_struct::connect\_cb (C++ member), [355](#)  
esp\_at\_custom\_ble\_ops\_struct::disconnect\_cb (C++ member), [355](#)

- esp\_at\_custom\_ble\_ops\_struct::recv\_data (C++ member), 355  
 esp\_at\_custom\_cmd\_array\_regist (C++ function), 352  
 esp\_at\_custom\_cmd\_line\_terminator\_get (C++ function), 353  
 esp\_at\_custom\_cmd\_line\_terminator\_set (C++ function), 353  
 esp\_at\_custom\_net\_ops\_regist (C++ function), 352  
 esp\_at\_custom\_net\_ops\_struct (C++ struct), 355  
 esp\_at\_custom\_net\_ops\_struct::connect\_cb (C++ member), 355  
 esp\_at\_custom\_net\_ops\_struct::disconnect\_cb (C++ member), 355  
 esp\_at\_custom\_net\_ops\_struct::recv\_data (C++ member), 355  
 esp\_at\_custom\_ops\_regist (C++ function), 352  
 esp\_at\_custom\_ops\_struct (C++ struct), 356  
 esp\_at\_custom\_ops\_struct::pre\_active\_write\_data\_cb (C++ member), 356  
 esp\_at\_custom\_ops\_struct::pre\_deepsleep\_callback (C++ member), 356  
 esp\_at\_custom\_ops\_struct::pre\_restart\_callback (C++ member), 356  
 esp\_at\_custom\_ops\_struct::pre\_sleep\_callback (C++ member), 356  
 esp\_at\_custom\_ops\_struct::status\_callback (C++ member), 356  
 esp\_at\_custom\_partition\_find (C++ function), 353  
 esp\_at\_device\_ops\_regist (C++ function), 352  
 esp\_at\_device\_ops\_struct (C++ struct), 355  
 esp\_at\_device\_ops\_struct::get\_data\_length (C++ member), 355  
 esp\_at\_device\_ops\_struct::read\_data (C++ member), 355  
 esp\_at\_device\_ops\_struct::wait\_write\_complete (C++ member), 355  
 esp\_at\_device\_ops\_struct::write\_data (C++ member), 355  
 esp\_at\_error\_code (C++ enum), 358  
 esp\_at\_error\_code::ESP\_AT\_SUB\_CMD\_EXEC\_FAIL (C++ enumerator), 358  
 esp\_at\_error\_code::ESP\_AT\_SUB\_CMD\_OP\_ERROR (C++ enumerator), 359  
 esp\_at\_error\_code::ESP\_AT\_SUB\_CMD\_PROCESSING (C++ enumerator), 358  
 esp\_at\_error\_code::ESP\_AT\_SUB\_COMMON\_ERROR (C++ enumerator), 358  
 esp\_at\_error\_code::ESP\_AT\_SUB\_NO\_AT (C++ enumerator), 358  
 esp\_at\_error\_code::ESP\_AT\_SUB\_NO\_TERMINATOR (C++ enumerator), 358  
 esp\_at\_error\_code::ESP\_AT\_SUB\_OK (C++ enumerator), 358  
 esp\_at\_error\_code::ESP\_AT\_SUB\_PARAM\_INVALID (C++ enumerator), 358  
 esp\_at\_error\_code::ESP\_AT\_SUB\_PARAM\_LENGTH\_MISMATCH (C++ enumerator), 358  
 esp\_at\_error\_code::ESP\_AT\_SUB\_PARAM\_NUM\_MISMATCH (C++ enumerator), 358  
 esp\_at\_error\_code::ESP\_AT\_SUB\_PARAM\_PARSE\_FAIL (C++ enumerator), 358  
 esp\_at\_error\_code::ESP\_AT\_SUB\_PARAM\_TYPE\_MISMATCH (C++ enumerator), 358  
 esp\_at\_error\_code::ESP\_AT\_SUB\_UNSUPPORTED\_CMD (C++ enumerator), 358  
 ESP\_AT\_ERROR\_NO (C macro), 356  
 esp\_at\_get\_core\_version (C++ function), 354  
 esp\_at\_get\_current\_cmd\_name (C++ function), 354  
 esp\_at\_get\_current\_module\_name (C++ function), 360  
 esp\_at\_get\_module\_id (C++ function), 360  
 esp\_at\_get\_module\_name\_by\_id (C++ function), 360  
 esp\_at\_get\_param\_as\_digit (C++ function), 351  
 esp\_at\_get\_param\_as\_float (C++ function), 351  
 esp\_at\_get\_param\_as\_str (C++ function), 351  
 esp\_at\_get\_version (C++ function), 352  
 esp\_at\_main\_preprocess (C++ function), 360  
 esp\_at\_module (C++ enum), 358  
 esp\_at\_module::ESP\_AT\_MODULE\_NUM (C++ enumerator), 358  
 esp\_at\_module\_init (C++ function), 351  
 esp\_at\_para\_parse\_result\_type (C++ enum), 359  
 esp\_at\_para\_parse\_result\_type::ESP\_AT\_PARAM\_PARSE\_FAIL (C++ enumerator), 359  
 esp\_at\_para\_parse\_result\_type::ESP\_AT\_PARAM\_PARSE\_OK (C++ enumerator), 359  
 esp\_at\_para\_parse\_result\_type::ESP\_AT\_PARAM\_PARSE\_TIMEOUT (C++ enumerator), 359  
 esp\_at\_port\_active\_write\_data (C++ function), 352  
 esp\_at\_port\_enter\_specific (C++ function), 353  
 esp\_at\_port\_exit\_specific (C++ function), 354  
 esp\_at\_port\_get\_data\_length (C++ function), 353  
 esp\_at\_port\_read\_data (C++ function), 353  
 esp\_at\_port\_recv\_data\_notify (C++ function), 351  
 esp\_at\_port\_recv\_data\_notify\_from\_isr (C++ function), 351  
 esp\_at\_port\_specific\_callback\_t (C++ type), 357  
 ESP\_AT\_PORT\_TX\_WAIT\_MS\_MAX (C macro), 360  
 esp\_at\_port\_wait\_write\_complete (C++

- function*), [353](#)
- `esp_at_port_write_data` (C++ *function*), [352](#)
- `esp_at_ready_before` (C++ *function*), [360](#)
- `esp_at_response_result` (C++ *function*), [352](#)
- `esp_at_result_code_string_index` (C++ *enum*), [359](#)
- `esp_at_result_code_string_index::ESP_AT_RESULT_CODE_ERROR` (C++ *enumerator*), [359](#)
- `esp_at_result_code_string_index::ESP_AT_RESULT_CODE_FAIL` (C++ *enumerator*), [359](#)
- `esp_at_result_code_string_index::ESP_AT_RESULT_CODE_IGNORE` (C++ *enumerator*), [359](#)
- `esp_at_result_code_string_index::ESP_AT_RESULT_CODE_MAX` (C++ *enumerator*), [359](#)
- `esp_at_result_code_string_index::ESP_AT_RESULT_CODE_OK` (C++ *enumerator*), [359](#)
- `esp_at_result_code_string_index::ESP_AT_RESULT_CODE_OK_AND_INPUT_PROMPT` (C++ *enumerator*), [359](#)
- `esp_at_result_code_string_index::ESP_AT_RESULT_CODE_PROCESS_DONE` (C++ *enumerator*), [359](#)
- `esp_at_result_code_string_index::ESP_AT_RESULT_CODE_SEND_FAIL` (C++ *enumerator*), [359](#)
- `esp_at_result_code_string_index::ESP_AT_RESULT_CODE_SEND_OK` (C++ *enumerator*), [359](#)
- `esp_at_set_module_id` (C++ *function*), [360](#)
- `esp_at_set_module_id_by_str` (C++ *function*), [360](#)
- `esp_at_status_type` (C++ *enum*), [357](#)
- `esp_at_status_type::ESP_AT_STATUS_NORMAL` (C++ *enumerator*), [357](#)
- `esp_at_status_type::ESP_AT_STATUS_TRANSMIT` (C++ *enumerator*), [357](#)
- `esp_at_transmit_terminal` (C++ *function*), [352](#)
- `esp_at_transmit_terminal_from_isr` (C++ *function*), [352](#)
- ## G
- GATTC, [374](#)
- GATTS, [374](#)
- ## H
- HID, [374](#)
- ## I
- I2C, [374](#)
- ICMP, [374](#)
- ## L
- LwIP, [374](#)
- LWT, [374](#)
- ## M
- MAC, [374](#)
- manufacturing nvs, [374](#)
- mDNS, [374](#)
- MSB, [374](#)
- MTU, [374](#)
- ## N
- Normal Transmission Mode, [375](#)
- NVS, [374](#)
- ## O
- OWE, [375](#)
- ## P
- Passthrough Mode, [375](#)
- Passthrough Receiving Mode, [375](#)
- PBC, [376](#)
- PCI Authentication, [376](#)
- PKI, [376](#)
- PLCP, [376](#)
- PMF, [376](#)
- PSK, [376](#)
- PWM, [376](#)
- ## Q
- QoS, [376](#)
- ## R
- RTC, [376](#)
- ## S
- SMP, [376](#)
- SNI, [376](#)
- SNTP, [376](#)
- SPI, [376](#)
- SPP, [376](#)
- SSL, [376](#)
- system message, [376](#)
- ## T
- TLS, [376](#)
- Transmission Mode Shift Diagram, [375](#)
- ## U
- URC, [376](#)
- UTC, [376](#)
- UUID, [376](#)
- ## W
- WEP, [376](#)
- WPA, [376](#)
- WPA2, [376](#)
- WPS, [377](#)
- ❓ 命令模式, [373](#)
- ❓ 数据模式, [374](#)
- ❓ 普通传输模式, [375](#)
- ❓ 系统消息, [376](#)



透传接收模式, [376](#)  
透传模式, [375](#)