

# ESP32-S2

## ESP-IDF Programming Guide



Release v5.0.7-223-gc5eb3eaf5  
Espressif Systems  
Sep 21, 2024

# Table of contents

<b>Table of contents</b>	<b>i</b>
<b>1 Get Started</b>	<b>3</b>
1.1 Introduction	3
1.2 What You Need	3
1.2.1 Hardware	3
1.2.2 Software	8
1.3 Installation	8
1.3.1 IDE	9
1.3.2 Manual Installation	9
1.4 Build Your First Project	37
1.5 Uninstall ESP-IDF	38
<b>2 API Reference</b>	<b>39</b>
2.1 API Conventions	39
2.1.1 Error handling	39
2.1.2 Configuration structures	39
2.1.3 Private APIs	40
2.1.4 Components in example projects	40
2.1.5 API Stability	41
2.2 Application Protocols	42
2.2.1 ASIO port	42
2.2.2 ESP-Modbus	42
2.2.3 ESP-MQTT	43
2.2.4 ESP-TLS	58
2.2.5 ESP HTTP Client	74
2.2.6 ESP Local Control	89
2.2.7 ESP Serial Slave Link	98
2.2.8 ESP x509 Certificate Bundle	112
2.2.9 HTTP Server	114
2.2.10 HTTPS Server	142
2.2.11 ICMP Echo	145
2.2.12 mDNS Service	150
2.2.13 Mbed TLS	151
2.2.14 IP Network Layer	152
2.3 Error Codes Reference	152
2.4 Networking APIs	159
2.4.1 Wi-Fi	159
2.4.2 Ethernet	281
2.4.3 Thread	314
2.4.4 ESP-NETIF	320
2.4.5 IP Network Layer	352
2.4.6 Application Layer	354
2.5 Peripherals API	355
2.5.1 Analog to Digital Converter (ADC) Oneshot Mode Driver	355
2.5.2 Analog to Digital Converter (ADC) Continuous Mode Driver	364
2.5.3 Analog to Digital Converter (ADC) Calibration Driver	372

2.5.4	Clock Tree	374
2.5.5	Digital To Analog Converter (DAC)	381
2.5.6	GPIO & RTC GPIO	386
2.5.7	General Purpose Timer (GPTimer)	406
2.5.8	Dedicated GPIO	418
2.5.9	Hash-based Message Authentication Code (HMAC)	424
2.5.10	Digital Signature (DS)	428
2.5.11	Inter-Integrated Circuit (I2C)	433
2.5.12	Inter-IC Sound (I2S)	450
2.5.13	LCD	474
2.5.14	LED Control (LEDC)	492
2.5.15	Pulse Counter (PCNT)	510
2.5.16	Remote Control Transceiver (RMT)	525
2.5.17	SD SPI Host Driver	552
2.5.18	Sigma-Delta Modulation (SDM)	557
2.5.19	SPI Master Driver	562
2.5.20	SPI Slave Driver	583
2.5.21	SPI Slave Half Duplex	589
2.5.22	Temperature Sensor	597
2.5.23	Touch Sensor	600
2.5.24	Touch Element	628
2.5.25	Two-Wire Automotive Interface (TWAI)	655
2.5.26	Universal Asynchronous Receiver/Transmitter (UART)	673
2.5.27	USB Device Driver	697
2.5.28	USB Host	701
2.6	Project Configuration	738
2.6.1	Introduction	738
2.6.2	Project Configuration Menu	738
2.6.3	Using sdkconfig.defaults	738
2.6.4	Kconfig Formatting Rules	738
2.6.5	Backward Compatibility of Kconfig Options	739
2.6.6	Configuration Options Reference	739
2.7	Provisioning API	1004
2.7.1	Protocol Communication	1004
2.7.2	Unified Provisioning	1018
2.7.3	Wi-Fi Provisioning	1025
2.8	Storage API	1043
2.8.1	FAT Filesystem Support	1043
2.8.2	Manufacturing Utility	1051
2.8.3	Non-volatile Storage Library	1055
2.8.4	NVS Partition Generator Utility	1077
2.8.5	SD/SDIO/MMC Driver	1082
2.8.6	SPI Flash API	1095
2.8.7	SPIFFS Filesystem	1131
2.8.8	Virtual filesystem component	1135
2.8.9	Wear Levelling API	1151
2.9	System API	1154
2.9.1	App Image Format	1154
2.9.2	Application Level Tracing	1159
2.9.3	Call function with external stack	1164
2.9.4	Chip Revision	1166
2.9.5	Console	1168
2.9.6	eFuse Manager	1177
2.9.7	Error Codes and Helper Functions	1205
2.9.8	ESP HTTPS OTA	1208
2.9.9	Event Loop Library	1214
2.9.10	FreeRTOS (Overview)	1227
2.9.11	FreeRTOS (ESP-IDF)	1229

2.9.12	FreeRTOS (Supplemental Features)	1346
2.9.13	Heap Memory Allocation	1366
2.9.14	Heap Memory Debugging	1379
2.9.15	High Resolution Timer (ESP Timer)	1390
2.9.16	Internal and Unstable APIs	1396
2.9.17	Interrupt allocation	1397
2.9.18	Logging library	1403
2.9.19	Miscellaneous System APIs	1410
2.9.20	Over The Air Updates (OTA)	1425
2.9.21	Performance Monitor	1438
2.9.22	Power Management	1440
2.9.23	POSIX Threads Support	1446
2.9.24	Random Number Generation	1450
2.9.25	Sleep Modes	1453
2.9.26	SoC Capabilities	1465
2.9.27	System Time	1476
2.9.28	The Async memcpy API	1482
2.9.29	ULP Coprocessor programming	1485
2.9.30	ULP RISC-V Coprocessor programming	1523
2.9.31	Watchdogs	1527
<b>3</b>	<b>Hardware Reference</b>	<b>1535</b>
3.1	Chip Series Comparison	1535
3.1.1	Related Documents	1538
<b>4</b>	<b>API Guides</b>	<b>1539</b>
4.1	Application Level Tracing library	1539
4.1.1	Overview	1539
4.1.2	Modes of Operation	1539
4.1.3	Configuration Options and Dependencies	1540
4.1.4	How to Use This Library	1541
4.2	Application Startup Flow	1549
4.2.1	First stage bootloader	1549
4.2.2	Second stage bootloader	1550
4.2.3	Application startup	1550
4.3	Bootloader	1551
4.3.1	Bootloader compatibility	1552
4.3.2	Log Level	1552
4.3.3	Factory reset	1552
4.3.4	Boot from Test Firmware	1553
4.3.5	Rollback	1553
4.3.6	Watchdog	1553
4.3.7	Bootloader Size	1554
4.3.8	Fast boot from Deep Sleep	1554
4.3.9	Custom bootloader	1554
4.4	Build System	1555
4.4.1	Overview	1555
4.4.2	Using the Build System	1555
4.4.3	Example Project	1557
4.4.4	Project CMakeLists File	1558
4.4.5	Component CMakeLists Files	1559
4.4.6	Component Configuration	1562
4.4.7	Preprocessor Definitions	1562
4.4.8	Component Requirements	1562
4.4.9	Overriding Parts of the Project	1566
4.4.10	Configuration-Only Components	1567
4.4.11	Debugging CMake	1567
4.4.12	Example Component CMakeLists	1567



4.4.13	Custom sdkconfig defaults	1571
4.4.14	Flash arguments	1572
4.4.15	Building the Bootloader	1572
4.4.16	Writing Pure CMake Components	1573
4.4.17	Using Third-Party CMake Projects with Components	1573
4.4.18	Using Prebuilt Libraries with Components	1574
4.4.19	Using ESP-IDF in Custom CMake Projects	1574
4.4.20	ESP-IDF CMake Build System API	1575
4.4.21	File Globbing & Incremental Builds	1579
4.4.22	Build System Metadata	1579
4.4.23	Build System Internals	1580
4.4.24	Migrating from ESP-IDF GNU Make System	1581
4.5	Core Dump	1583
4.5.1	Overview	1583
4.5.2	Configurations	1583
4.5.3	Save core dump to flash	1584
4.5.4	Print core dump to UART	1584
4.5.5	ROM Functions in Backtraces	1585
4.5.6	Dumping variables on demand	1585
4.5.7	Running <code>espcoredump.py</code>	1585
4.6	Deep Sleep Wake Stubs	1586
4.6.1	Rules for Wake Stubs	1588
4.6.2	Implementing A Stub	1588
4.6.3	Loading Code Into RTC Memory	1589
4.6.4	Loading Data Into RTC Memory	1589
4.6.5	CRC Check For Wake Stubs	1590
4.6.6	Example	1590
4.7	Device Firmware Upgrade via USB	1590
4.7.1	USB Connection	1590
4.8	Building the DFU Image	1591
4.9	Flashing the DFU Image	1591
4.9.1	Udev Rule (Linux only)	1591
4.9.2	USB Drivers (Windows only)	1592
4.9.3	Common Errors and Known Issues	1592
4.10	Error Handling	1592
4.10.1	Overview	1592
4.10.2	Error codes	1593
4.10.3	Converting error codes to error messages	1593
4.10.4	<code>ESP_ERROR_CHECK</code> macro	1593
4.10.5	<code>ESP_ERROR_CHECK_WITHOUT_ABORT</code> macro	1594
4.10.6	<code>ESP_RETURN_ON_ERROR</code> macro	1594
4.10.7	<code>ESP_GOTO_ON_ERROR</code> macro	1594
4.10.8	<code>ESP_RETURN_ON_FALSE</code> macro	1594
4.10.9	<code>ESP_GOTO_ON_FALSE</code> macro	1594
4.10.10	CHECK MACROS Examples	1594
4.10.11	Error handling patterns	1595
4.10.12	C++ Exceptions	1596
4.11	ESP-WIFI-MESH	1596
4.11.1	Overview	1596
4.11.2	Introduction	1596
4.11.3	ESP-WIFI-MESH Concepts	1598
4.11.4	Building a Network	1603
4.11.5	Managing a Network	1608
4.11.6	Data Transmission	1611
4.11.7	Channel Switching	1613
4.11.8	Performance	1616
4.11.9	Further Notes	1617
4.12	Event Handling	1617

4.12.1	Wi-Fi, Ethernet, and IP Events	1617
4.12.2	Mesh Events	1618
4.12.3	Bluetooth Events	1619
4.13	Fatal Errors	1619
4.13.1	Overview	1619
4.13.2	Panic Handler	1619
4.13.3	Register Dump and Backtrace	1620
4.13.4	GDB Stub	1622
4.13.5	RTC Watchdog Timeout	1623
4.13.6	Guru Meditation Errors	1623
4.13.7	Other Fatal Errors	1625
4.14	Flash Encryption	1627
4.14.1	Introduction	1628
4.14.2	Relevant eFuses	1628
4.14.3	Flash Encryption Process	1629
4.14.4	Flash Encryption Configuration	1630
4.14.5	Possible Failures	1637
4.14.6	ESP32-S2 Flash Encryption Status	1638
4.14.7	Reading and Writing Data in Encrypted Flash	1638
4.14.8	Updating Encrypted Flash	1639
4.14.9	Disabling Flash Encryption	1640
4.14.10	Key Points About Flash Encryption	1640
4.14.11	Limitations of Flash Encryption	1641
4.14.12	Flash Encryption and Secure Boot	1641
4.14.13	Advanced Features	1641
4.14.14	External RAM	1643
4.14.15	Technical Details	1643
4.15	Hardware Abstraction	1643
4.15.1	Architecture	1643
4.15.2	LL (Low Level) Layer	1644
4.15.3	HAL (Hardware Abstraction Layer)	1645
4.16	High-Level Interrupts	1646
4.16.1	Interrupt Levels	1646
4.16.2	Notes	1647
4.17	JTAG Debugging	1647
4.17.1	Introduction	1648
4.17.2	How it Works?	1648
4.17.3	Selecting JTAG Adapter	1649
4.17.4	Setup of OpenOCD	1649
4.17.5	Configuring ESP32-S2 Target	1649
4.17.6	Launching Debugger	1655
4.17.7	Debugging Examples	1655
4.17.8	Building OpenOCD from Sources	1655
4.17.9	Tips and Quirks	1660
4.17.10	Related Documents	1664
4.18	Linker Script Generation	1689
4.18.1	Overview	1689
4.18.2	Quick Start	1689
4.18.3	Linker Script Generation Internals	1692
4.19	lwIP	1699
4.19.1	Supported APIs	1699
4.19.2	BSD Sockets API	1699
4.19.3	Netconn API	1703
4.19.4	lwIP FreeRTOS Task	1703
4.19.5	IPv6 Support	1704
4.19.6	esp-lwip custom modifications	1704
4.19.7	Performance Optimization	1706
4.20	Memory Types	1707

4.20.1	DRAM (Data RAM)	1707
4.20.2	IRAM (Instruction RAM)	1708
4.20.3	IROM (code executed from flash)	1709
4.20.4	DROM (data stored in flash)	1709
4.20.5	RTC Slow memory	1709
4.20.6	RTC FAST memory	1710
4.20.7	DMA Capable Requirement	1710
4.20.8	DMA Buffer in the stack	1710
4.21	OpenThread	1711
4.21.1	Modes of the OpenThread stack	1711
4.21.2	How to Write an OpenThread Application	1711
4.21.3	The OpenThread Border Router	1713
4.22	Partition Tables	1713
4.22.1	Overview	1713
4.22.2	Built-in Partition Tables	1713
4.22.3	Creating Custom Tables	1714
4.22.4	Generating Binary Partition Table	1716
4.22.5	Partition Size Checks	1716
4.22.6	Flashing the partition table	1717
4.22.7	Partition Tool (parttool.py)	1717
4.23	Performance	1719
4.23.1	How to Optimize Performance	1719
4.23.2	Guides	1719
4.24	RF calibration	1735
4.24.1	Partial calibration	1735
4.24.2	Full calibration	1735
4.24.3	No calibration	1735
4.24.4	PHY initialization data	1735
4.24.5	API Reference	1736
4.25	Secure Boot V2	1738
4.25.1	Background	1739
4.25.2	Advantages	1739
4.25.3	Secure Boot V2 Process	1739
4.25.4	Signature Block Format	1740
4.25.5	Secure Padding	1740
4.25.6	Verifying a Signature Block	1741
4.25.7	Verifying an Image	1741
4.25.8	Bootloader Size	1741
4.25.9	eFuse usage	1741
4.25.10	How To Enable Secure Boot V2	1742
4.25.11	Restrictions after Secure Boot is enabled	1743
4.25.12	Generating Secure Boot Signing Key	1743
4.25.13	Remote Signing of Images	1743
4.25.14	Secure Boot Best Practices	1744
4.25.15	Key Management	1744
4.25.16	Multiple Keys	1744
4.25.17	Key Revocation	1745
4.25.18	Technical Details	1745
4.25.19	Secure Boot & Flash Encryption	1746
4.25.20	Signed App Verification Without Hardware Secure Boot	1746
4.25.21	Advanced Features	1747
4.26	Support for External RAM	1747
4.26.1	Introduction	1747
4.26.2	Hardware	1747
4.26.3	Configuring External RAM	1747
4.26.4	Restrictions	1749
4.26.5	Failure to initialize	1749
4.26.6	Encryption	1749

4.27	Thread Local Storage . . . . .	1749
4.27.1	Overview . . . . .	1749
4.27.2	FreeRTOS Native API . . . . .	1750
4.27.3	Pthread API . . . . .	1750
4.27.4	C11 Standard . . . . .	1750
4.28	Tools . . . . .	1750
4.28.1	IDF Frontend - idf.py . . . . .	1750
4.28.2	IDF Docker Image . . . . .	1754
4.28.3	IDF Windows Installer . . . . .	1756
4.28.4	IDF Component Manager . . . . .	1757
4.28.5	IDF Clang Tidy . . . . .	1758
4.28.6	Downloadable Tools . . . . .	1759
4.29	Unit Testing in ESP32-S2 . . . . .	1773
4.29.1	Normal Test Cases . . . . .	1773
4.29.2	Multi-device Test Cases . . . . .	1774
4.29.3	Multi-stage Test Cases . . . . .	1775
4.29.4	Tests For Different Targets . . . . .	1775
4.29.5	Building Unit Test App . . . . .	1776
4.29.6	Running Unit Tests . . . . .	1776
4.29.7	Timing Code with Cache Compensated Timer . . . . .	1777
4.29.8	Mocks . . . . .	1778
4.30	Unit Testing on Linux . . . . .	1780
4.30.1	Embedded Software Tests . . . . .	1780
4.30.2	IDF Unit Tests on Linux Host . . . . .	1781
4.31	USB OTG Console . . . . .	1782
4.31.1	Hardware Requirements . . . . .	1782
4.31.2	Software Configuration . . . . .	1782
4.31.3	Uploading the Application . . . . .	1782
4.31.4	Limitations . . . . .	1783
4.32	Wi-Fi Driver . . . . .	1784
4.32.1	ESP32-S2 Wi-Fi Feature List . . . . .	1784
4.32.2	How To Write a Wi-Fi Application . . . . .	1784
4.32.3	ESP32-S2 Wi-Fi API Error Code . . . . .	1785
4.32.4	ESP32-S2 Wi-Fi API Parameter Initialization . . . . .	1785
4.32.5	ESP32-S2 Wi-Fi Programming Model . . . . .	1785
4.32.6	ESP32-S2 Wi-Fi Event Description . . . . .	1786
4.32.7	ESP32-S2 Wi-Fi Station General Scenario . . . . .	1789
4.32.8	ESP32-S2 Wi-Fi AP General Scenario . . . . .	1792
4.32.9	ESP32-S2 Wi-Fi Scan . . . . .	1792
4.32.10	ESP32-S2 Wi-Fi Station Connecting Scenario . . . . .	1799
4.32.11	ESP32-S2 Wi-Fi Station Connecting When Multiple APs Are Found . . . . .	1806
4.32.12	Wi-Fi Reconnect . . . . .	1806
4.32.13	Wi-Fi Beacon Timeout . . . . .	1806
4.32.14	ESP32-S2 Wi-Fi Configuration . . . . .	1806
4.32.15	Wi-Fi Easy Connect™ (DPP) . . . . .	1812
4.32.16	Wireless Network Management . . . . .	1813
4.32.17	Radio Resource Measurement . . . . .	1813
4.32.18	Fast BSS Transition . . . . .	1814
4.32.19	Wi-Fi Location . . . . .	1814
4.32.20	ESP32-S2 Wi-Fi Power-saving Mode . . . . .	1814
4.32.21	ESP32-S2 Wi-Fi Throughput . . . . .	1816
4.32.22	Wi-Fi 80211 Packet Send . . . . .	1817
4.32.23	Wi-Fi Sniffer Mode . . . . .	1818
4.32.24	Wi-Fi Multiple Antennas . . . . .	1819
4.32.25	Wi-Fi Channel State Information . . . . .	1820
4.32.26	Wi-Fi Channel State Information Configure . . . . .	1822
4.32.27	Wi-Fi HT20/40 . . . . .	1822
4.32.28	Wi-Fi QoS . . . . .	1822

4.32.29	Wi-Fi AMSDU	1823
4.32.30	Wi-Fi Fragment	1823
4.32.31	WPS Enrollee	1823
4.32.32	Wi-Fi Buffer Usage	1823
4.32.33	How to Improve Wi-Fi Performance	1824
4.32.34	Wi-Fi Menuconfig	1828
4.32.35	Troubleshooting	1830
4.33	Wi-Fi Security	1833
4.33.1	ESP32-S2 Wi-Fi Security Features	1833
4.33.2	Protected Management Frames (PMF)	1836
4.33.3	WiFi Enterprise	1837
4.33.4	WPA3-Personal	1837
4.33.5	Wi-Fi Enhanced Open™	1838
4.34	Reproducible Builds	1838
4.34.1	Introduction	1839
4.34.2	Reasons for non-reproducible builds	1839
4.34.3	Enabling reproducible builds in ESP-IDF	1839
4.34.4	How reproducible builds are achieved	1839
4.34.5	Reproducible builds and debugging	1839
4.34.6	Factors which still affect reproducible builds	1840
4.35	Low Power Mode User Guide	1840
<b>5</b>	<b>Migration Guides</b>	<b>1841</b>
5.1	ESP-IDF 5.x Migration Guide	1841
5.1.1	Migration from 4.4 to 5.0	1841
<b>6</b>	<b>Libraries and Frameworks</b>	<b>1871</b>
6.1	Cloud Frameworks	1871
6.1.1	ESP RainMaker	1871
6.1.2	AWS IoT	1871
6.1.3	Azure IoT	1871
6.1.4	Google IoT Core	1871
6.1.5	Aliyun IoT	1871
6.1.6	Joylink IoT	1871
6.1.7	Tencent IoT	1872
6.1.8	Tencentyun IoT	1872
6.1.9	Baidu IoT	1872
6.2	Espressif's Frameworks	1872
6.2.1	Espressif Audio Development Framework	1872
6.2.2	ESP-CSI	1872
6.2.3	Espressif DSP Library	1872
6.2.4	ESP-WIFI-MESH Development Framework	1873
6.2.5	ESP-WHO	1873
6.2.6	ESP RainMaker	1873
6.2.7	ESP-IoT-Solution	1873
6.2.8	ESP-Protocols	1873
6.2.9	ESP-BSP	1874
<b>7</b>	<b>Contributions Guide</b>	<b>1875</b>
7.1	How to Contribute	1875
7.2	Before Contributing	1875
7.3	Pull Request Process	1875
7.4	Legal Part	1876
7.5	Related Documents	1876
7.5.1	Espressif IoT Development Framework Style Guide	1876
7.5.2	Install pre-commit Hook for ESP-IDF Project	1883
7.5.3	Documenting Code	1884
7.5.4	Creating Examples	1889
7.5.5	API Documentation Template	1890

7.5.6	Contributor Agreement . . . . .	1892
7.5.7	Copyright Header Guide . . . . .	1894
7.5.8	ESP-IDF Tests with Pytest Guide . . . . .	1895
<b>8</b>	<b>ESP-IDF Versions</b>	<b>1905</b>
8.1	Releases . . . . .	1905
8.2	Which Version Should I Start With? . . . . .	1905
8.3	Versioning Scheme . . . . .	1905
8.4	Support Periods . . . . .	1906
8.5	Checking the Current Version . . . . .	1907
8.6	Git Workflow . . . . .	1908
8.7	Updating ESP-IDF . . . . .	1908
8.7.1	Updating to Stable Release . . . . .	1909
8.7.2	Updating to a Pre-Release Version . . . . .	1909
8.7.3	Updating to Master Branch . . . . .	1909
8.7.4	Updating to a Release Branch . . . . .	1910
<b>9</b>	<b>Resources</b>	<b>1911</b>
9.1	PlatformIO . . . . .	1911
9.1.1	What is PlatformIO? . . . . .	1911
9.1.2	Installation . . . . .	1911
9.1.3	Configuration . . . . .	1912
9.1.4	Tutorials . . . . .	1912
9.1.5	Project Examples . . . . .	1912
9.1.6	Next Steps . . . . .	1912
9.2	Useful Links . . . . .	1912
<b>10</b>	<b>Copyrights and Licenses</b>	<b>1913</b>
10.1	Software Copyrights . . . . .	1913
10.1.1	Firmware Components . . . . .	1913
10.1.2	Documentation . . . . .	1914
10.2	ROM Source Code Copyrights . . . . .	1914
10.3	Xtensa libhal MIT License . . . . .	1915
10.4	TinyBasic Plus MIT License . . . . .	1915
10.5	TJpgDec License . . . . .	1915
<b>11</b>	<b>About</b>	<b>1917</b>
<b>12</b>	<b>Switch Between Languages</b>	<b>1919</b>
	<b>Index</b>	<b>1921</b>
	<b>Index</b>	<b>1921</b>



This is the documentation for Espressif IoT Development Framework ([esp-idf](#)). ESP-IDF is the official development framework for the [ESP32](#), [ESP32-S](#) and [ESP32-C Series SoCs](#).

This document describes using ESP-IDF with the ESP32-S2 SoC.

		
<a href="#">Get Started</a>	<a href="#">API Reference</a>	<a href="#">API Guides</a>





# Chapter 1

## Get Started

This document is intended to help you set up the software development environment for the hardware based on the ESP32-S2 chip by Espressif. After that, a simple example will show you how to use ESP-IDF (Espressif IoT Development Framework) for menu configuration, then for building and flashing firmware onto an ESP32-S2 board.

---

**Note:** This is documentation for branch `release/v5.0` of ESP-IDF. Other *ESP-IDF Versions* are also available.

---

### 1.1 Introduction

ESP32-S2 is a system on a chip that integrates the following features:

- Wi-Fi (2.4 GHz band)
- High performance single core Xtensa® 32-bit LX7 CPU
- Ultra Low Power co-processor running either RISC-V or FSM core
- Multiple peripherals
- Built-in security hardware
- USB OTG interface

Powered by 40 nm technology, ESP32-S2 provides a robust, highly integrated platform, which helps meet the continuous demands for efficient power usage, compact design, security, high performance, and reliability.

Espressif provides basic hardware and software resources to help application developers realize their ideas using the ESP32-S2 series hardware. The software development framework by Espressif is intended for development of Internet-of-Things (IoT) applications with Wi-Fi, Bluetooth, power management and several other system features.

### 1.2 What You Need

#### 1.2.1 Hardware

- An **ESP32-S2** board.
- **USB cable** - USB A / micro USB B.
- **Computer** running Windows, Linux, or macOS.

---

**Note:** Currently, some of the development boards are using USB Type C connectors. Be sure you have the correct cable to connect your board!

---

If you have one of ESP32-S2 official development boards listed below, you can click on the link to learn more about the hardware.

### ESP32-S2-Saola-1

This user guide provides information on ESP32-S2-Saola-1, a small-sized [ESP32-S2 Datasheet](#) based development board produced by Espressif.

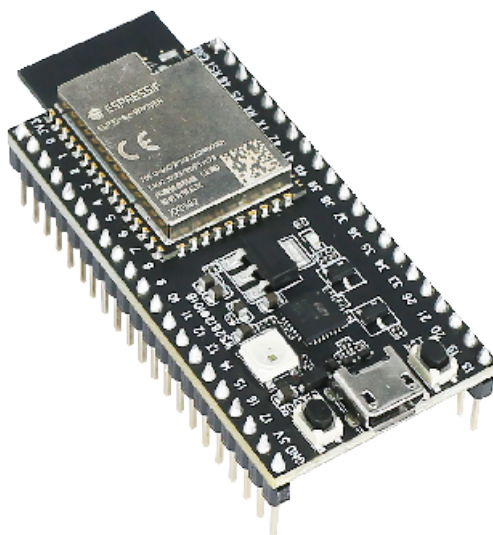

Fig. 1: ESP32-S2-Saola-1

The document consists of the following major sections:

- [Getting started](#): Provides an overview of the ESP32-S2-Saola-1 and hardware/software setup instructions to get started.
- [Hardware reference](#): Provides more detailed information about the ESP32-S2-Saola-1's hardware.
- [Hardware Revision Details](#): Revision history, known issues, and links to user guides for previous versions (if any) of ESP32-S2-Saola-1.
- [Related Documents](#): Gives links to related documentation.

**Getting Started** This section describes how to get started with ESP32-S2-Saola-1. It begins with a few introductory sections about the ESP32-S2-Saola-1, then Section [Start Application Development](#) provides instructions on how to get the ESP32-S2-Saola-1 ready and flash firmware into it.

**Overview** ESP32-S2-Saola-1 is a small-sized ESP32-S2 based development board produced by Espressif. Most of the I/O pins are broken out to the pin headers on both sides for easy interfacing. Developers can either connect peripherals with jumper wires or mount ESP32-S2-Saola-1 on a breadboard.

To cover a wide range of users' needs, ESP32-S2-Saola-1 supports:

- [ESP32-S2-WROVER](#)
- [ESP32-S2-WROVER-I](#)
- [ESP32-S2-WROOM](#)
- [ESP32-S2-WROOM-I](#)

In this guide, we take ESP32-S2-Saola-1 equipped with ESP32-S2-WROVER as an example.

### Contents and Packaging

**Retail orders** If you order a few samples, each ESP32-S2-Saola-1 comes in an individual package in either antistatic bag or any packaging depending on your retailer.

For retail orders, please go to <https://www.espressif.com/en/contact-us/get-samples>.

**Wholesale Orders** If you order in bulk, the boards come in large cardboard boxes.

For wholesale orders, please go to <https://www.espressif.com/en/contact-us/sales-questions>.

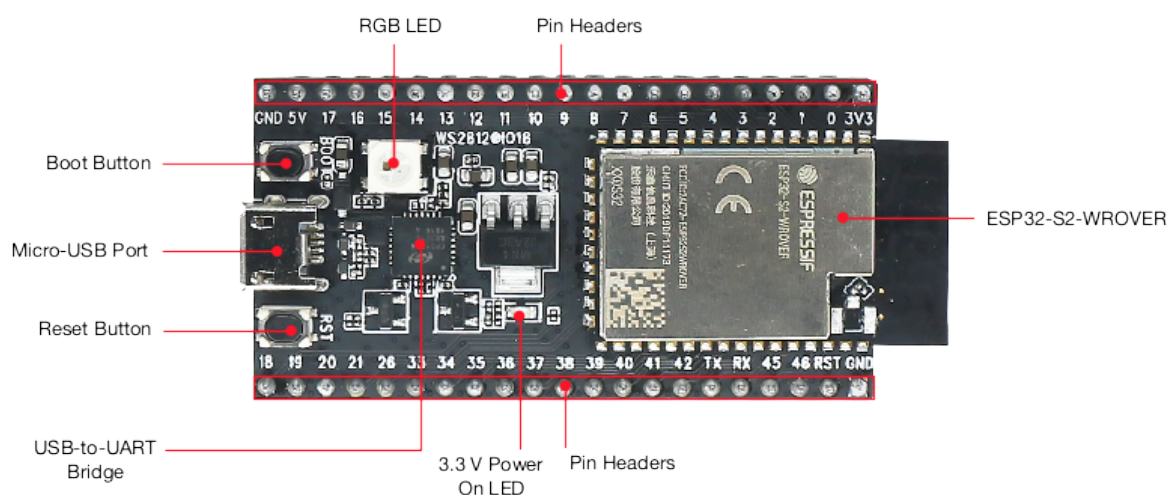

Fig. 2: ESP32-S2-Saola-1 - front

**Description of Components** The key components of the board are described in a clockwise direction.

Key Component	Description
ESP32-S2-WROVER	ESP32-S2-WROVER is a powerful, generic Wi-Fi MCU module that integrates ESP32-S2. It has a PCB antenna, a 4 MB external SPI flash and an additional 2 MB PSRAM.
Pin Headers	All available GPIO pins (except for the SPI bus for flash and PSRAM) are broken out to the pin headers on the board. Users can program ESP32-S2 chip to enable multiple functions such as SPI, I2S, UART, I2C, touch sensors, PWM etc.
3.3 V Power On LED	Turns on when the USB power is connected to the board.
USB-to-UART Bridge	Single USB-UART bridge chip provides transfer rates up to 3 Mbps.
Reset Button	Reset button.
Micro-USB Port	USB interface. Power supply for the board as well as the communication interface between a computer and the ESP32-S2 chip.
Boot Button	Download button. Holding down <b>Boot</b> and then pressing <b>Reset</b> initiates Firmware Download mode for downloading firmware through the serial port.
RGB LED	Addressable RGB LED (WS2812), driven by GPIO18.

**Start Application Development** Before powering up your ESP32-S2-Saola-1, please make sure that it is in good condition with no obvious signs of damage.

### Required Hardware

- ESP32-S2-Saola-1
- USB 2.0 cable (Standard-A to Micro-B)
- Computer running Windows, Linux, or macOS

**Note:** Be sure to use an appropriate USB cable. Some cables are for charging only and do not provide the needed data lines nor work for programming the boards.

**Software Setup** Please proceed to [Get Started](#), where Section [Installation](#) will quickly help you set up the development environment and then flash an application example into your ESP32-S2-Saola-1.

**Note:** ESP32-S2 series of chips only supports ESP-IDF master or version v4.2 and higher.

## Hardware Reference

**Block Diagram** A block diagram below shows the components of ESP32-S2-Saola-1 and their interconnections.

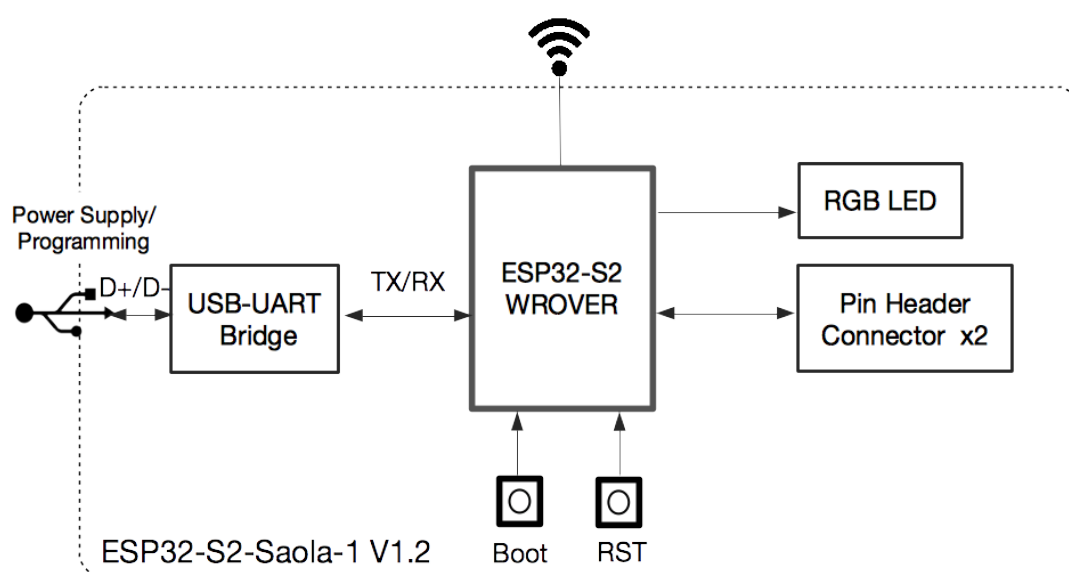

Fig. 3: ESP32-S2-Saola-1 (click to enlarge)

**Power Supply Options** There are three mutually exclusive ways to provide power to the board:

- Micro-USB port, default power supply
- 5V and GND pin headers
- 3V3 and GND pin headers

It is recommended to use the first option: Micro-USB Port.

**Header Block** The two tables below provide the **Name** and **Function** of the pin headers on both sides of the board (J2 and J3). The pin header names are shown in [ESP32-S2-Saola-1 - front](#). The numbering is the same as in the [ESP32-S2-Saola-1 Schematics](#) (PDF).

**J2**

No.	Name	Type <sup>Page 7, 1</sup>	Function
1	3V3	P	3.3 V power supply
2	IO0	I/O	GPIO0, Boot
3	IO1	I/O	GPIO1, ADC1_CH0, TOUCH_CH1
4	IO2	I/O	GPIO2, ADC1_CH1, TOUCH_CH2
5	IO3	I/O	GPIO3, ADC1_CH2, TOUCH_CH3
6	IO4	I/O	GPIO4, ADC1_CH3, TOUCH_CH4
7	IO5	I/O	GPIO5, ADC1_CH4, TOUCH_CH5
8	IO6	I/O	GPIO6, ADC1_CH5, TOUCH_CH6
9	IO7	I/O	GPIO7, ADC1_CH6, TOUCH_CH7
10	IO8	I/O	GPIO8, ADC1_CH7, TOUCH_CH8
11	IO9	I/O	GPIO9, ADC1_CH8, TOUCH_CH9
12	IO10	I/O	GPIO10, ADC1_CH9, TOUCH_CH10
13	IO11	I/O	GPIO11, ADC2_CH0, TOUCH_CH11
14	IO12	I/O	GPIO12, ADC2_CH1, TOUCH_CH12
15	IO13	I/O	GPIO13, ADC2_CH2, TOUCH_CH13
16	IO14	I/O	GPIO14, ADC2_CH3, TOUCH_CH14
17	IO15	I/O	GPIO15, ADC2_CH4, XTAL_32K_P
18	IO16	I/O	GPIO16, ADC2_CH5, XTAL_32K_N
19	IO17	I/O	GPIO17, ADC2_CH6, DAC_1
20	5V0	P	5 V power supply
21	GND	G	Ground

**J3**

No.	Name	Type	Function
1	GND	G	Ground
2	RST	I	CHIP_PU, Reset
3	IO46	I	GPIO46
4	IO45	I/O	GPIO45
5	IO44	I/O	GPIO44, U0RXD
6	IO43	I/O	GPIO43, U0TXD
7	IO42	I/O	GPIO42, MTMS
8	IO41	I/O	GPIO41, MTDI
9	IO40	I/O	GPIO40, MTDO
10	IO39	I/O	GPIO39, MTCK
11	IO38	I/O	GPIO38
12	IO37	I/O	GPIO37
13	IO36	I/O	GPIO36
14	IO35	I/O	GPIO35
16	IO34	I/O	GPIO34
17	IO33	I/O	GPIO33
17	IO26	I/O	GPIO26
18	IO21	I/O	GPIO21
19	IO20	I/O	GPIO20, ADC2_CH9, USB_D+
20	IO19	I/O	GPIO19, ADC2_CH8, USB_D-
21	IO18	I/O	GPIO18, ADC2_CH7, DAC_2, RGB LED

**Pin Layout**

**Hardware Revision Details** This is the first revision of this board released.

<sup>1</sup> P: Power supply; I: Input; O: Output; T: High impedance.

# ESP32-S2-Saola-1

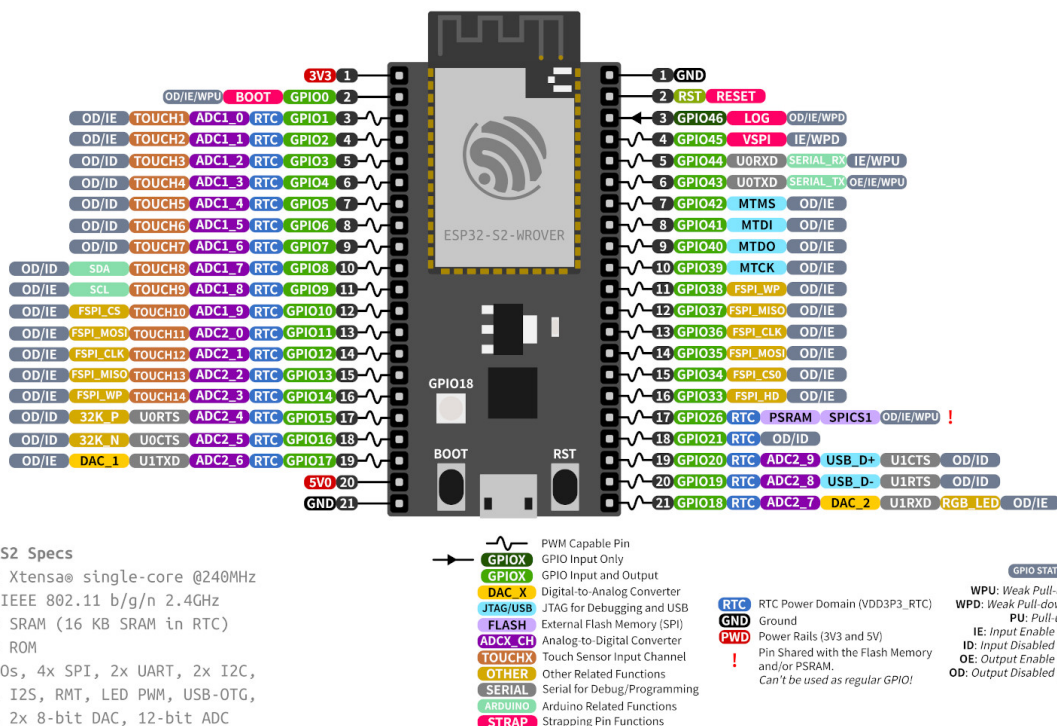

Fig. 4: ESP32-S2 Saola-1 Pin Layout (click to enlarge)

## Related Documents

- [ESP32-S2-Saola-1 Schematics \(PDF\)](#)
- [ESP32-S2-Saola-1 Dimensions \(PDF\)](#)
- [ESP32-S2 Datasheet \(PDF\)](#)
- [ESP32-S2-WROVER and ESP32-S2-WROVER-I Datasheet \(PDF\)](#)
- [ESP32-S2-WROOM and ESP32-S2-WROOM-I Datasheet \(PDF\)](#)
- [ESP Product Selector](#)

For other design documentation for the board, please contact us at [sales@espressif.com](mailto:sales@espressif.com).

## 1.2.2 Software

To start using ESP-IDF on **ESP32-S2**, install the following software:

- **Toolchain** to compile code for ESP32-S2
- **Build tools** - CMake and Ninja to build a full **Application** for ESP32-S2
- **ESP-IDF** that essentially contains API (software libraries and source code) for ESP32-S2 and scripts to operate the **Toolchain**

## 1.3 Installation

To install all the required software, we offer some different ways to facilitate this task. Choose from one of the available options.

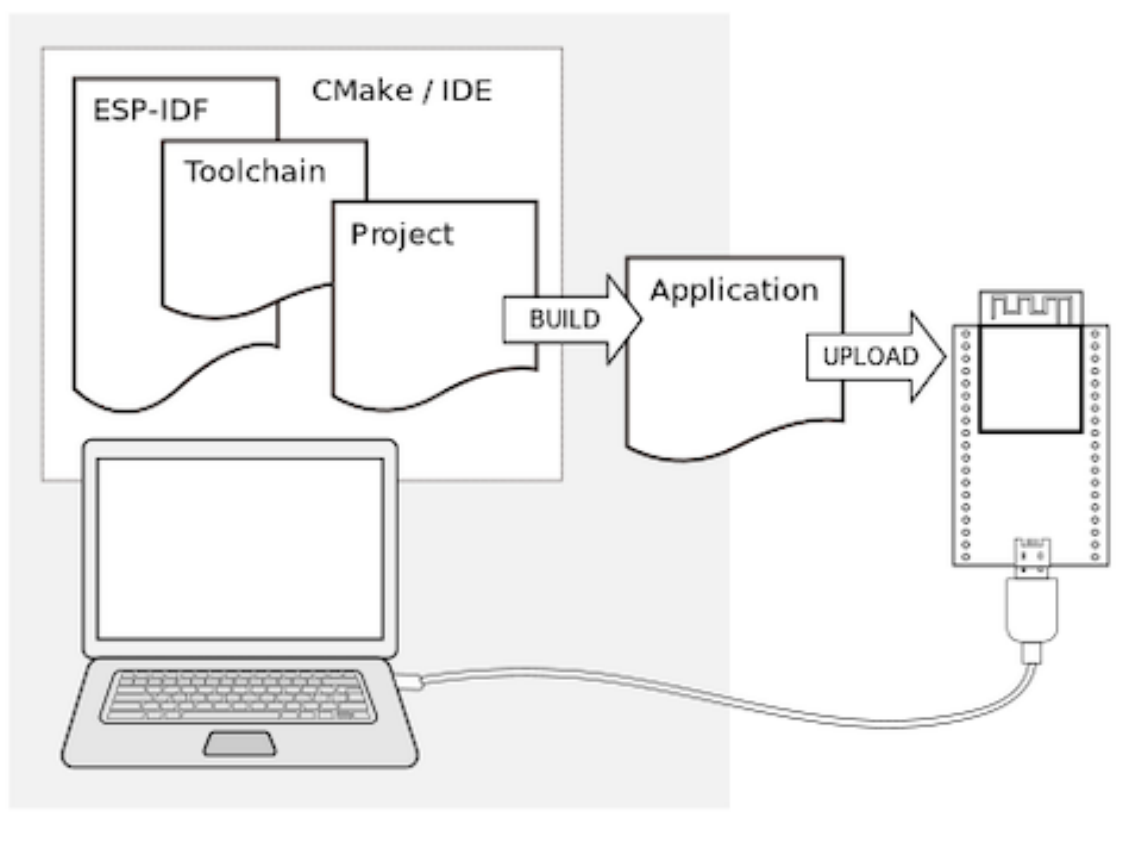

### 1.3.1 IDE

**Note:** We highly recommend installing the ESP-IDF through your favorite IDE.

- [Eclipse Plugin](#)
- [VSCode Extension](#)

### 1.3.2 Manual Installation

For the manual procedure, please select according to your operating system.

#### Standard Setup of Toolchain for Windows

**Introduction** ESP-IDF requires some prerequisite tools to be installed so you can build firmware for supported chips. The prerequisite tools include Python, Git, cross-compilers, CMake and Ninja build tools.

For this Getting Started we're going to use the Command Prompt, but after ESP-IDF is installed you can use [Eclipse Plugin](#) or another graphical IDE with CMake support instead.

**Note:** Limitations: - The installation path of ESP-IDF and ESP-IDF Tools must not be longer than 90 characters. Too long installation paths might result in a failed build. - The installation path of Python or ESP-IDF must not contain



white spaces or parentheses. - The installation path of Python or ESP-IDF should not contain special characters (non-ASCII) unless the operating system is configured with “Unicode UTF-8” support.

System Administrator can enable the support via Control Panel - Change date, time, or number formats - Administrative tab - Change system locale - check the option “Beta: Use Unicode UTF-8 for worldwide language support” - Ok and reboot the computer.

---

**ESP-IDF Tools Installer** The easiest way to install ESP-IDF’s prerequisites is to download one of ESP-IDF Tools Installers.



**What is the usecase for Online and Offline Installer** Online Installer is very small and allows the installation of all available releases of ESP-IDF. The installer will download only necessary dependencies including [Git For Windows](#) during the installation process. The installer stores downloaded files in the cache directory `%userprofile%\expressif`.

Offline Installer does not require any network connection. The installer contains all required dependencies including [Git For Windows](#).

**Components of the installation** The installer deploys the following components:

- Embedded Python
- Cross-compilers
- OpenOCD
- [CMake](#) and [Ninja](#) build tools
- ESP-IDF

The installer also allows reusing the existing directory with ESP-IDF. The recommended directory is `%userprofile%\Desktop\esp-idf` where `%userprofile%` is your home directory.

**Launching ESP-IDF Environment** At the end of the installation process you can check out option Run ESP-IDF PowerShell Environment or Run ESP-IDF Command Prompt (`cmd.exe`). The installer will launch ESP-IDF environment in selected prompt.

Run ESP-IDF PowerShell Environment:

Run ESP-IDF Command Prompt (`cmd.exe`):

**Using the Command Prompt** For the remaining Getting Started steps, we’re going to use the Windows Command Prompt.

ESP-IDF Tools Installer also creates a shortcut in the Start menu to launch the ESP-IDF Command Prompt. This shortcut launches the Command Prompt (`cmd.exe`) and runs `export.bat` script to set up the environment variables (`PATH`, `IDF_PATH` and others). Inside this command prompt, all the installed tools are available.

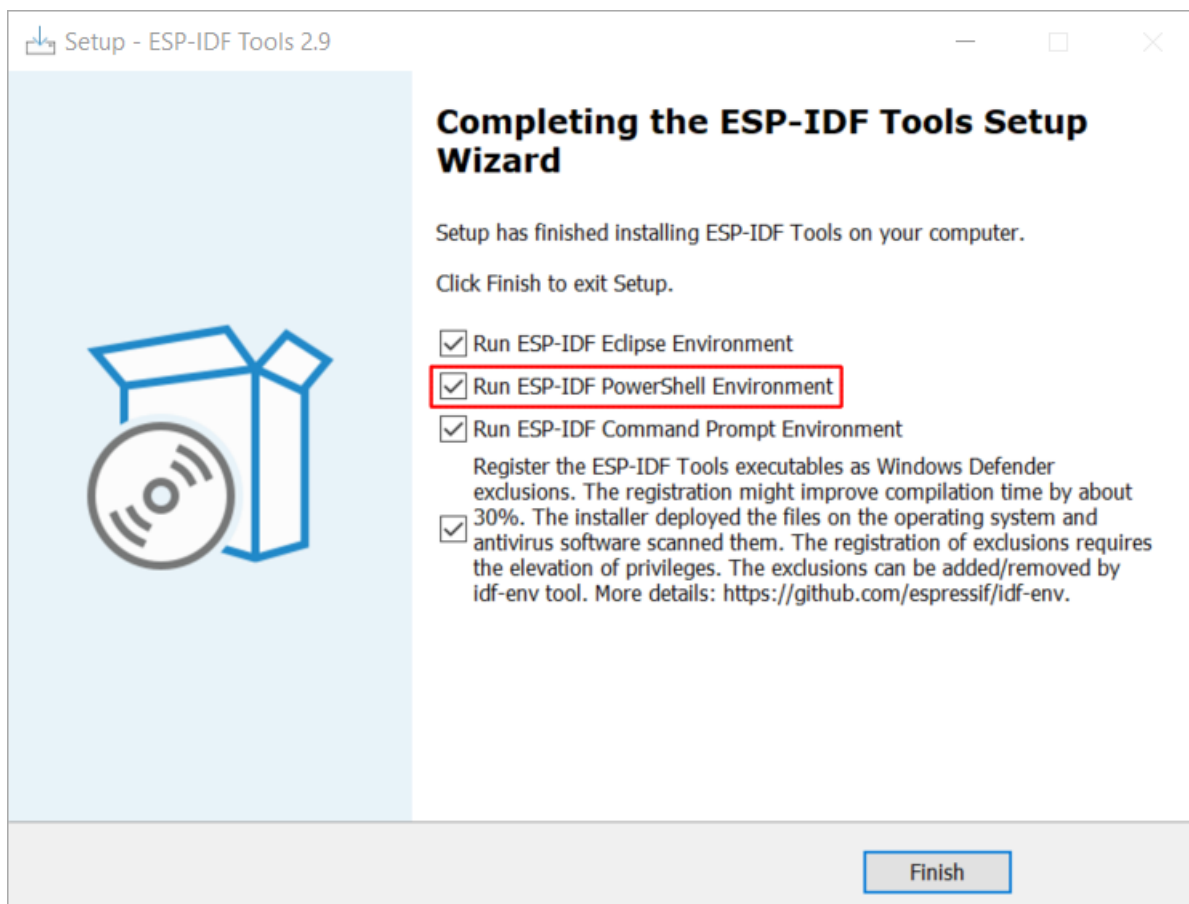

Fig. 5: Completing the ESP-IDF Tools Setup Wizard with Run ESP-IDF PowerShell Environment

```
ESP-IDF PowerShell
Using Python in C:\Users\developer\.espressif\python_env\idf4.1_py3.8_env\Scripts
Python 3.8.7
Using Git in C:\Program Files\Git\cmd/
git version 2.29.2.windows.1
Setting IDF_PATH: C:\Users\developer\Desktop\esp-idf
Adding ESP-IDF tools to PATH...
C:\Users\developer\.espressif\tools\xtensa-esp32-elf\esp-2020r3-8.4.0\xtensa-esp32-elf\bin
C:\Users\developer\.espressif\tools\xtensa-esp32s2-elf\esp-2020r3-8.4.0\xtensa-esp32s2-elf\bin
C:\Users\developer\.espressif\tools\esp32ulp-elf\2.28.51-esp-20191205\esp32ulp-elf-binutils\bin
C:\Users\developer\.espressif\tools\esp32ulp-elf\2.28.51-esp-20191205\esp32ulp-elf-binutils\bin
C:\Users\developer\.espressif\tools\cmake\3.13.4\bin
C:\Users\developer\.espressif\tools\openocd-esp32\v0.10.0-esp32-20200709\openocd-esp32\bin
C:\Users\developer\.espressif\tools\ninja\1.9.0\
C:\Users\developer\.espressif\tools\idf-exe\1.0.1\
C:\Users\developer\.espressif\tools\ccache\3.7\
C:\Users\developer\Desktop\esp-idf\tools
Checking if Python packages are up to date...
Python requirements from C:\Users\developer\Desktop\esp-idf\requirements.txt are satisfied.

Done! You can now compile ESP-IDF projects.
Go to the project directory and run:
  idf.py build

PS C:\Users\developer\Desktop\esp-idf>
```

Fig. 6: ESP-IDF PowerShell

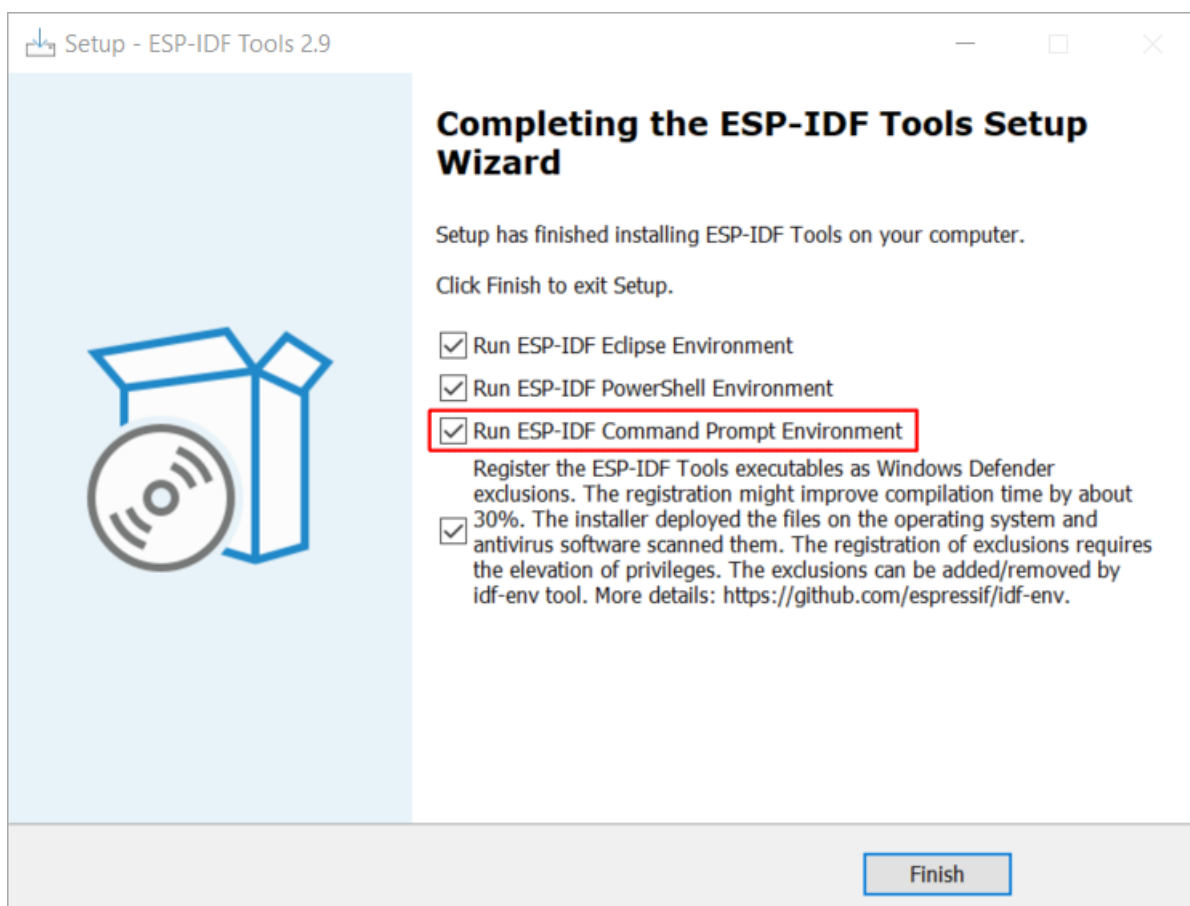

Fig. 7: Completing the ESP-IDF Tools Setup Wizard with Run ESP-IDF Command Prompt (cmd.exe)



```
ESP-IDF Command Prompt (cmd.exe)
Using Python in C:\Users\test\AppData\Local\Programs\Python\Python37\
Python 3.7.8
Using Git in C:\Users\test\Git\cmd\
git version 2.30.0.windows.1
Setting IDF_PATH: C:\Users\test\esp\esp-idf

Adding ESP-IDF tools to PATH...
  C:\Users\test\.espressif\tools\xtensa-esp32-elf\esp-2020r3-8.4.0\xtensa-esp32-elf\bin
  C:\Users\test\.espressif\tools\xtensa-esp32s2-elf\esp-2020r3-8.4.0\xtensa-esp32s2-elf\bin
  C:\Users\test\.espressif\tools\xtensa-esp32s3-elf\esp-2020r3-8.4.0\xtensa-esp32s3-elf\bin
  C:\Users\test\.espressif\tools\riscv32-esp-elf\1.24.0.123_64eb9ff-8.4.0\riscv32-esp-elf\bin
  C:\Users\test\.espressif\tools\esp32ulp-elf\2.28.51-esp-20191205\esp32ulp-elf-binutils\bin
  C:\Users\test\.espressif\tools\esp32s2ulp-elf\2.28.51-esp-20191205\esp32s2ulp-elf-binutils\bin
  C:\Users\test\.espressif\tools\cmake\3.16.4\bin
  C:\Users\test\.espressif\tools\openocd-esp32\v0.10.0-esp32-20200709\openocd-esp32\bin
  C:\Users\test\.espressif\tools\ninja\1.10.0\
  C:\Users\test\.espressif\tools\idf-exe\1.0.1\
  C:\Users\test\.espressif\tools\ccache\3.7\
  C:\Users\test\.espressif\tools\dfu-util\0.9\dfu-util-0.9-win64
  C:\Users\test\.espressif\python_env\idf4.3_py3.7_env\Scripts
  C:\Users\test\esp\esp-idf\tools

Checking if Python packages are up to date...
Python requirements from C:\Users\test\esp\esp-idf\requirements.txt are satisfied.

Done! You can now compile ESP-IDF projects.
Go to the project directory and run:

idf.py build

C:\Users\test\esp\esp-idf>
```

Fig. 8: ESP-IDF Command Prompt

Note that this shortcut is specific to the ESP-IDF directory selected in the ESP-IDF Tools Installer. If you have multiple ESP-IDF directories on the computer (for example, to work with different versions of ESP-IDF), you have two options to use them:

1. Create a copy of the shortcut created by the ESP-IDF Tools Installer, and change the working directory of the new shortcut to the ESP-IDF directory you wish to use.
2. Alternatively, run `cmd.exe`, then change to the ESP-IDF directory you wish to use, and run `export.bat`. Note that unlike the previous option, this way requires Python and Git to be present in `PATH`. If you get errors related to Python or Git not being found, use the first option.

**First Steps on ESP-IDF** Now since all requirements are met, the next topic will guide you on how to start your first project.

This guide will help you on the first steps using ESP-IDF. Follow this guide to start a new project on the ESP32-S2 and build, flash, and monitor the device output.

---

**Note:** If you have not yet installed ESP-IDF, please go to [Installation](#) and follow the instruction in order to get all the software needed to use this guide.

---

**Start a Project** Now you are ready to prepare your application for ESP32-S2. You can start with [get-started/hello\\_world](#) project from [examples](#) directory in ESP-IDF.

---

**Important:** The ESP-IDF build system does not support spaces in the paths to either ESP-IDF or to projects.

---

Copy the project [get-started/hello\\_world](#) to `~/esp` directory:

```
cd %userprofile%\esp
xcopy /e /i %IDF_PATH%\examples\get-started\hello_world hello_world
```

---

**Note:** There is a range of example projects in the [examples](#) directory in ESP-IDF. You can copy any project in the same way as presented above and run it. It is also possible to build examples in-place without copying them first.

---

**Connect Your Device** Now connect your ESP32-S2 board to the computer and check under which serial port the board is visible.

Serial port names start with COM in Windows.

If you are not sure how to check the serial port name, please refer to [Establish Serial Connection with ESP32-S2](#) for full details.

---

**Note:** Keep the port name handy as you will need it in the next steps.

---

**Configure Your Project** Navigate to your `hello_world` directory, set ESP32-S2 as the target, and run the project configuration utility `menuconfig`.

## Windows

```
cd %userprofile%\esp\hello_world
idf.py set-target esp32s2
idf.py menuconfig
```

After opening a new project, you should first set the target with `idf.py set-target esp32s2`. Note that existing builds and configurations in the project, if any, will be cleared and initialized in this process. The target may be saved in the environment variable to skip this step at all. See [Select the Target Chip: set-target](#) for additional information.

If the previous steps have been done correctly, the following menu appears:

```
(Top)
      Espressif IoT Development Framework Configuration
SDK tool configuration --->
Build type --->
Application manager --->
Bootloader config --->
Security features --->
Serial flasher config --->
Partition Table --->
Compiler options --->
Component config --->
Compatibility options --->

[Space/Enter] Toggle/enter  [ESC] Leave menu          [S] Save
[O] Load                   [?] Symbol info          [/] Jump to symbol
[F] Toggle show-help mode  [C] Toggle show-name mode [A] Toggle show-all mode
[Q] Quit (prompts for save) [D] Save minimal config (advanced)
```

Fig. 9: Project configuration - Home window

You are using this menu to set up project specific variables, e.g., Wi-Fi network name and password, the processor speed, etc. Setting up the project with `menuconfig` may be skipped for “hello\_word”, since this example runs with default configuration.

**Note:** The colors of the menu could be different in your terminal. You can change the appearance with the option `--style`. Please run `idf.py menuconfig --help` for further information.

If you are using one of the supported development boards, you can speed up your development by using Board Support Package. See [Additional Tips](#) for more information.

**Build the Project** Build the project by running:

```
idf.py build
```

This command will compile the application and all ESP-IDF components, then it will generate the bootloader, partition table, and application binaries.

```
$ idf.py build
Running cmake in directory /path/to/hello_world/build
Executing "cmake -G Ninja --warn-uninitialized /path/to/hello_world"...
Warn about uninitialized values.
-- Found Git: /usr/bin/git (found version "2.17.0")
-- Building empty aws_iot component due to configuration
-- Component names: ...
-- Component paths: ...

... (more lines of build system output)

[527/527] Generating hello_world.bin
```

(continues on next page)

(continued from previous page)

```
esptool.py v2.3.1

Project build complete. To flash, run this command:
../../components/esptool_py/esptool/esptool.py -p (PORT) -b 921600 write_flash -
↳-flash_mode dio --flash_size detect --flash_freq 40m 0x10000 build/hello_world.
↳bin build 0x1000 build/bootloader/bootloader.bin 0x8000 build/partition_table/
↳partition-table.bin
or run 'idf.py -p PORT flash'
```

If there are no errors, the build will finish by generating the firmware binary `.bin` files.

**Flash onto the Device** Flash the binaries that you just built (`bootloader.bin`, `partition-table.bin` and `hello_world.bin`) onto your ESP32-S2 board by running:

```
idf.py -p PORT [-b BAUD] flash
```

Replace `PORT` with your ESP32-S2 board's serial port name.

You can also change the flasher baud rate by replacing `BAUD` with the baud rate you need. The default baud rate is 460800.

For more information on `idf.py` arguments, see [idf.py](#).

---

**Note:** The option `flash` automatically builds and flashes the project, so running `idf.py build` is not necessary.

---

**Encountered Issues While Flashing?** If you run the given command and see errors such as “Failed to connect”, there might be several reasons for this. One of the reasons might be issues encountered by `esptool.py`, the utility that is called by the build system to reset the chip, interact with the ROM bootloader, and flash firmware. One simple solution to try is manual reset described below, and if it does not help you can find more details about possible issues in [Troubleshooting](#).

`esptool.py` resets ESP32-S2 automatically by asserting DTR and RTS control lines of the USB to serial converter chip, i.e., FTDI or CP210x (for more information, see [Establish Serial Connection with ESP32-S2](#)). The DTR and RTS control lines are in turn connected to `GPIO0` and `CHIP_PU (EN)` pins of ESP32-S2, thus changes in the voltage levels of DTR and RTS will boot ESP32-S2 into Firmware Download mode. As an example, check the [schematic](#) for the ESP32 DevKitC development board.

In general, you should have no problems with the [official esp-idf development boards](#). However, `esptool.py` is not able to reset your hardware automatically in the following cases:

- Your hardware does not have the DTR and RTS lines connected to `GPIO0` and `CHIP_PU`
- The DTR and RTS lines are configured differently
- There are no such serial control lines at all

Depending on the kind of hardware you have, it may also be possible to manually put your ESP32-S2 board into Firmware Download mode (reset).

- For development boards produced by Espressif, this information can be found in the respective getting started guides or user guides. For example, to manually reset an ESP-IDF development board, hold down the **Boot** button (`GPIO0`) and press the **EN** button (`CHIP_PU`).
- For other types of hardware, try pulling `GPIO0` down.

**Normal Operation** When flashing, you will see the output log similar to the following:

```
...
esptool.py --chip esp32s2 -p /dev/ttyUSB0 -b 460800 --before=default_reset --
↳after=hard_reset write_flash --flash_mode dio --flash_freq 40m --flash_size 2MB_
↳0x8000 partition_table/partition-table.bin 0x1000 bootloader/bootloader.bin_
↳0x10000 hello_world.bin
```

(continues on next page)

(continued from previous page)

```

esptool.py v3.0-dev
Serial port /dev/ttyUSB0
Connecting....
Chip is ESP32-S2
Features: WiFi
Crystal is 40MHz
MAC: 18:fe:34:72:50:e3
Uploading stub...
Running stub...
Stub running...
Changing baud rate to 460800
Changed.
Configuring flash size...
Compressed 3072 bytes to 103...
Writing at 0x00008000... (100 %)
Wrote 3072 bytes (103 compressed) at 0x00008000 in 0.0 seconds (effective 3851.6
↪kbit/s)...
Hash of data verified.
Compressed 22592 bytes to 13483...
Writing at 0x00001000... (100 %)
Wrote 22592 bytes (13483 compressed) at 0x00001000 in 0.3 seconds (effective 595.1
↪kbit/s)...
Hash of data verified.
Compressed 140048 bytes to 70298...
Writing at 0x00010000... (20 %)
Writing at 0x00014000... (40 %)
Writing at 0x00018000... (60 %)
Writing at 0x0001c000... (80 %)
Writing at 0x00020000... (100 %)
Wrote 140048 bytes (70298 compressed) at 0x00010000 in 1.7 seconds (effective 662.
↪5 kbit/s)...
Hash of data verified.

Leaving...
Hard resetting via RTS pin...
Done

```

If there are no issues by the end of the flash process, the board will reboot and start up the “hello\_world” application.

If you’d like to use the Eclipse or VS Code IDE instead of running `idf.py`, check out [Eclipse Plugin](#), [VSCode Extension](#).

**Monitor the Output** To check if “hello\_world” is indeed running, type `idf.py -p PORT monitor` (Do not forget to replace PORT with your serial port name).

This command launches the *IDF Monitor* application:

```

$ idf.py -p <PORT> monitor
Running idf_monitor in directory [...]esp/hello_world/build
Executing "python [...]esp-idf/tools/idf_monitor.py -b 115200 [...]esp/hello_
↪world/build/hello_world.elf"...
--- idf_monitor on <PORT> 115200 ---
--- Quit: Ctrl+] | Menu: Ctrl+T | Help: Ctrl+T followed by Ctrl+H ---
ets Jun  8 2016 00:22:57

rst:0x1 (POWERON_RESET),boot:0x13 (SPI_FAST_FLASH_BOOT)
ets Jun  8 2016 00:22:57
...

```

After startup and diagnostic logs scroll up, you should see “Hello world!” printed out by the application.



```
...
Hello world!
Restarting in 10 seconds...
  This is esp32s2 chip with 1 CPU core(s), WiFi, silicon revision 0, 2MB
↪external flash
Minimum free heap size: 253900 bytes
  Restarting in 9 seconds...
  Restarting in 8 seconds...
  Restarting in 7 seconds...
```

To exit IDF monitor use the shortcut `Ctrl+]`.

---

**Note:** You can combine building, flashing and monitoring into one step by running:

```
idf.py -p PORT flash monitor
```

See also:

- [IDF Monitor](#) for handy shortcuts and more details on using IDF monitor.
- [idf.py](#) for a full reference of `idf.py` commands and options.

### That's all that you need to get started with ESP32-S2!

Now you are ready to try some other [examples](#), or go straight to developing your own applications.

---

**Important:** Some of examples do not support ESP32-S2 because required hardware is not included in ESP32-S2 so it cannot be supported.

If building an example, please check the README file for the Supported Targets table. If this is present including ESP32-S2 target, or the table does not exist at all, the example will work on ESP32-S2.

---

### Additional Tips

**Permission issues /dev/ttyUSB0** With some Linux distributions, you may get the Failed to open port `/dev/ttyUSB0` error message when flashing the ESP32-S2. *This can be solved by adding the current user to the dialout group.*

**Python compatibility** ESP-IDF supports Python 3.7 or newer. It is recommended to upgrade your operating system to a recent version satisfying this requirement. Other options include the installation of Python from [sources](#) or the use of a Python version management system such as [pyenv](#).

**Start with Board Support Package** To speed up prototyping on some development boards, you can use [Board Support Packages \(BSPs\)](#), which makes initialization of a particular board as easy as few function calls.

A BSP typically supports all of the hardware components provided on development board. Apart from the pinout definition and initialization functions, a BSP ships with drivers for the external components such as sensors, displays, audio codecs etc.

The BSPs are distributed via [IDF Component Manager](#), so they can be found in [IDF Component Registry](#).

**Here's an example of how to add ESP32-S2-Kaluga-Kit BSP to your project:**

```
idf.py add-dependency esp32_s2_kaluga_kit
```

More examples of BSP usage can be found in [BSP examples folder](#).

**Related Documents** For advanced users who want to customize the install process:

- [Updating ESP-IDF tools on Windows](#)
- [Establish Serial Connection with ESP32-S2](#)
- [Eclipse Plugin](#)
- [VSCode Extension](#)
- [IDF Monitor](#)

### Updating ESP-IDF tools on Windows

**Install ESP-IDF tools using a script** From the Windows Command Prompt, change to the directory where ESP-IDF is installed. Then run:

```
install.bat
```

For Powershell, change to the directory where ESP-IDF is installed. Then run:

```
install.ps1
```

This will download and install the tools necessary to use ESP-IDF. If the specific version of the tool is already installed, no action will be taken. The tools are downloaded and installed into a directory specified during ESP-IDF Tools Installer process. By default, this is `C:\Users\username\.espressif`.

**Add ESP-IDF tools to PATH using an export script** ESP-IDF tools installer creates a Start menu shortcut for “ESP-IDF Command Prompt” . This shortcut opens a Command Prompt window where all the tools are already available.

In some cases, you may want to work with ESP-IDF in a Command Prompt window which wasn't started using that shortcut. If this is the case, follow the instructions below to add ESP-IDF tools to PATH.

In the command prompt where you need to use ESP-IDF, change to the directory where ESP-IDF is installed, then execute `export.bat`:

```
cd %userprofile%\esp\esp-idf
export.bat
```

Alternatively in the Powershell where you need to use ESP-IDF, change to the directory where ESP-IDF is installed, then execute `export.ps1`:

```
cd ~/esp/esp-idf
export.ps1
```

When this is done, the tools will be available in this command prompt.

### Establish Serial Connection with ESP32-S2

This section provides guidance how to establish serial connection between ESP32-S2 and PC.

**Connect ESP32-S2 to PC** Connect the ESP32-S2 board to the PC using the USB cable. If device driver does not install automatically, identify USB to serial converter chip on your ESP32-S2 board (or external converter dongle), search for drivers in internet and install them.

Below is the list of USB to serial converter chips installed on most of the ESP32-S2 boards produced by Espressif together with links to the drivers:

- CP210x: [CP210x USB to UART Bridge VCP Drivers](#)
- FTDI: [FTDI Virtual COM Port Drivers](#)

Please check the board user guide for specific USB to serial converter chip used. The drivers above are primarily for reference. Under normal circumstances, the drivers should be bundled with an operating system and automatically installed upon connecting the board to the PC.

**Check port on Windows** Check the list of identified COM ports in the Windows Device Manager. Disconnect ESP32-S2 and connect it back, to verify which port disappears from the list and then shows back again.

Figures below show serial port for ESP32 DevKitC and ESP32 WROVER KIT

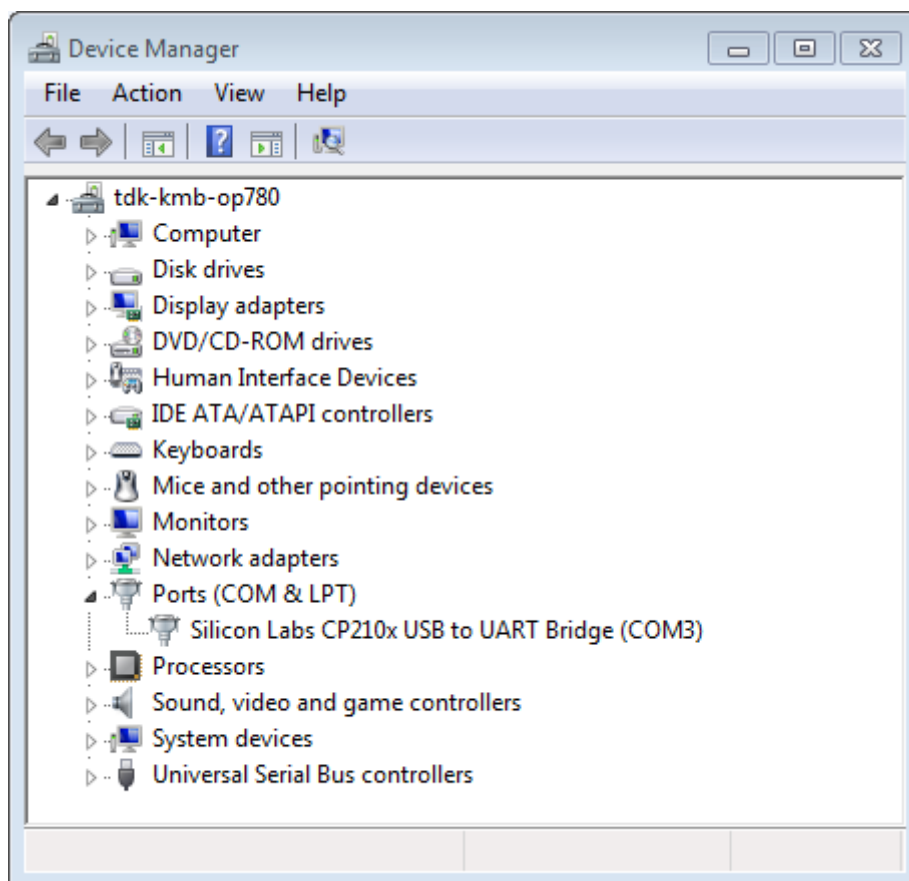

Fig. 10: USB to UART bridge of ESP32-DevKitC in Windows Device Manager

**Check port on Linux and macOS** To check the device name for the serial port of your ESP32-S2 board (or external converter dongle), run this command two times, first with the board / dongle unplugged, then with plugged in. The port which appears the second time is the one you need:

Linux

```
ls /dev/tty*
```

macOS

```
ls /dev/cu.*
```

**Note:** macOS users: if you don't see the serial port then check you have the USB/serial drivers installed. See Section [Connect ESP32-S2 to PC](#) for links to drivers. For macOS High Sierra (10.13), you may also have to explicitly allow the drivers to load. Open System Preferences -> Security & Privacy -> General and check if there is a message shown here about "System Software from developer ..." where the developer name is Silicon Labs or FTDI.

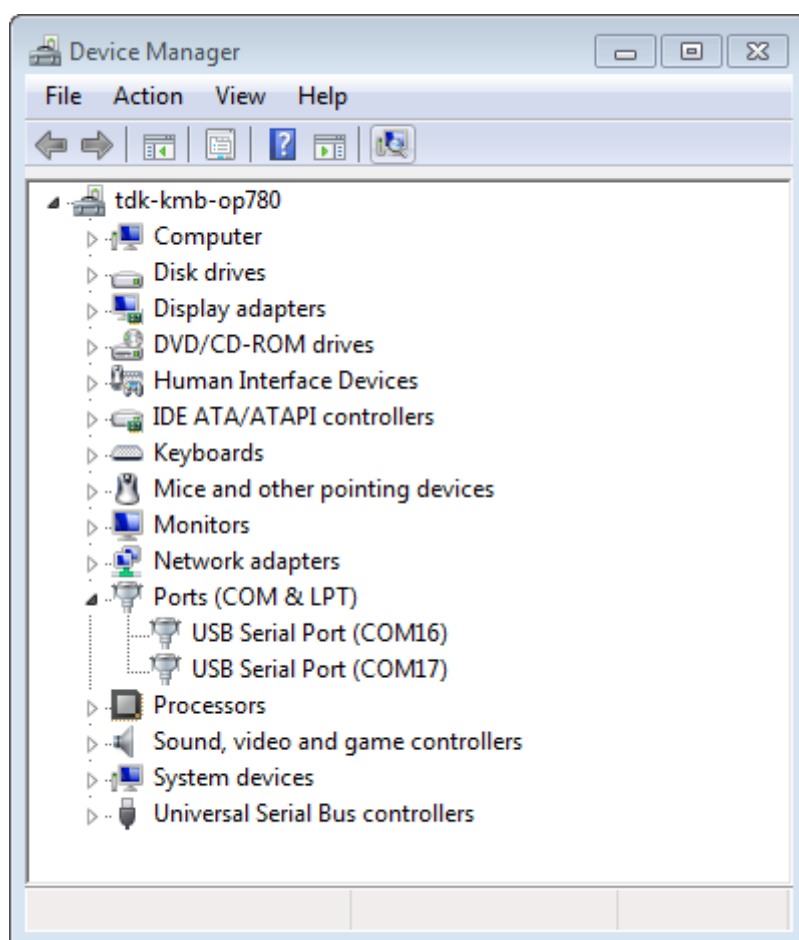

Fig. 11: Two USB Serial Ports of ESP-WROVER-KIT in Windows Device Manager

**Adding user to dialout on Linux** The currently logged user should have read and write access the serial port over USB. On most Linux distributions, this is done by adding the user to `dialout` group with the following command:

```
sudo usermod -a -G dialout $USER
```

on Arch Linux this is done by adding the user to `uucp` group with the following command:

```
sudo usermod -a -G uucp $USER
```

Make sure you re-login to enable read and write permissions for the serial port.

**Verify serial connection** Now verify that the serial connection is operational. You can do this using a serial terminal program by checking if you get any output on the terminal after resetting ESP32-S2.

The default console baud rate on ESP32-S2 is 115200.

**Windows and Linux** In this example we will use [PuTTY SSH Client](#) that is available for both Windows and Linux. You can use other serial programs and set communication parameters like below.

Run terminal and set identified serial port. Baud rate = 115200 (if needed, change this to the default baud rate of the chip in use), data bits = 8, stop bits = 1, and parity = N. Below are example screenshots of setting the port and such transmission parameters (in short described as 115200-8-1-N) on Windows and Linux. Remember to select exactly the same serial port you have identified in steps above.

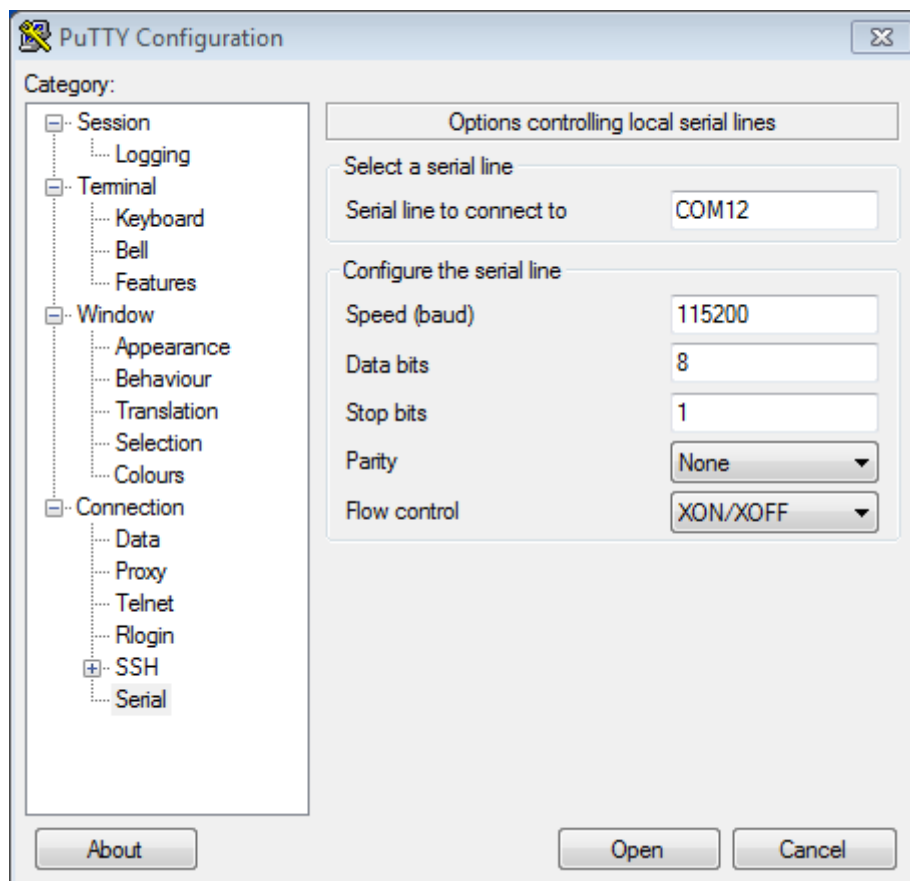

Fig. 12: Setting Serial Communication in PuTTY on Windows

Then open serial port in terminal and check, if you see any log printed out by ESP32-S2. The log contents will depend on application loaded to ESP32-S2, see [Example Output](#).



Fig. 13: Setting Serial Communication in PuTTY on Linux

**Note:** Close the serial terminal after verification that communication is working. If you keep the terminal session open, the serial port will be inaccessible for uploading firmware later.

---

**macOS** To spare you the trouble of installing a serial terminal program, macOS offers the **screen** command.

- As discussed in *Check port on Linux and macOS*, run:

```
ls /dev/cu.*
```

- You should see similar output:

```
/dev/cu.Bluetooth-Incoming-Port /dev/cu.SLAB_USBtoUART /dev/cu.SLAB_
↳USBtoUART7
```

- The output will vary depending on the type and the number of boards connected to your PC. Then pick the device name of your board and run (if needed, change “115200” to the default baud rate of the chip in use):

```
screen /dev/cu.device_name 115200
```

Replace `device_name` with the name found running `ls /dev/cu.*`.

- What you are looking for is some log displayed by the **screen**. The log contents will depend on application loaded to ESP32-S2, see *Example Output*. To exit the **screen** session type `Ctrl-A + \`.

---

**Note:** Do not forget to **exit the screen session** after verifying that the communication is working. If you fail to do it and just close the terminal window, the serial port will be inaccessible for uploading firmware later.

---

**Example Output** An example log is shown below. Reset the board if you do not see anything.

```
ets Jun  8 2016 00:22:57

rst:0x5 (DEEPSLEEP_RESET),boot:0x13 (SPI_FAST_FLASH_BOOT)
ets Jun  8 2016 00:22:57

rst:0x7 (TG0WDT_SYS_RESET),boot:0x13 (SPI_FAST_FLASH_BOOT)
configsip: 0, SPIWP:0x00
clk_drv:0x00,q_drv:0x00,d_drv:0x00,cs0_drv:0x00,hd_drv:0x00,wp_drv:0x00
mode:DIO, clock div:2
load:0x3fff0008,len:8
load:0x3fff0010,len:3464
load:0x40078000,len:7828
load:0x40080000,len:252
entry 0x40080034
I (44) boot: ESP-IDF v2.0-rc1-401-gf9fba35 2nd stage bootloader
I (45) boot: compile time 18:48:10

...
```

If you can see readable log output, it means serial connection is working and you are ready to proceed with installation and finally upload of application to ESP32-S2.

---

**Note:** For some serial port wiring configurations, the serial RTS & DTR pins need to be disabled in the terminal program before the ESP32-S2 will boot and produce serial output. This depends on the hardware itself, most development boards (including all Espressif boards) *do not* have this issue. The issue is present if RTS & DTR are wired directly to the EN & GPIO0 pins. See the [esptool documentation](#) for more details.

---

If you got here from *Step 5. First Steps on ESP-IDF* when installing s/w for ESP32-S2 development, then you can continue with *Step 5. First Steps on ESP-IDF*.

## IDF Monitor

IDF Monitor is mainly a serial terminal program which relays serial data to and from the target device's serial port. It also provides some IDF-specific features.

IDF Monitor can be launched from an IDF project by running `idf.py monitor`.

**Keyboard Shortcuts** For easy interaction with IDF Monitor, use the keyboard shortcuts given in the table.

Keyboard Shortcut	Action	Description
Ctrl+] ]	Exit the program	
Ctrl+T	Menu escape key	Press and follow it by one of the keys given below.
• Ctrl+T	Send the menu character itself to remote	
• Ctrl+] ]	Send the exit character itself to remote	
• Ctrl+P	Reset target into bootloader to pause app via RTS line	Resets the target, into bootloader via the RTS line (if connected), so that the board runs nothing. Useful when you need to wait for another device to startup.
• Ctrl+R	Reset target board via RTS	Resets the target board and re-starts the application via the RTS line (if connected).
• Ctrl+F	Build and flash the project	Pauses <code>idf_monitor</code> to run the <code>project flash</code> target, then resumes <code>idf_monitor</code> . Any changed source files are recompiled and then re-flashed. Target <code>encrypted-flash</code> is run if <code>idf_monitor</code> was started with argument <code>-E</code> .
• Ctrl+A (or A)	Build and flash the app only	Pauses <code>idf_monitor</code> to run the <code>app-flash</code> target, then resumes <code>idf_monitor</code> . Similar to the <code>flash</code> target, but only the main app is built and re-flashed. Target <code>encrypted-app-flash</code> is run if <code>idf_monitor</code> was started with argument <code>-E</code> .
• Ctrl+Y	Stop/resume log output printing on screen	Discards all incoming serial data while activated. Allows to quickly pause and examine log output without quitting the monitor.
• Ctrl+L	Stop/resume log output saved to file	Creates a file in the project directory and the output is written to that file until this is disabled with the same keyboard shortcut (or IDF Monitor exits).
• Ctrl+I (or I)	Stop/resume printing timestamps	IDF Monitor can print a timestamp in the beginning of each line. The timestamp format can be changed by the <code>--timestamp-format</code> command line argument.
• Ctrl+H (or H)	Display all keyboard shortcuts	
• Ctrl+X (or X)	Exit the program	
Ctrl+C	Interrupt running application	Pauses IDF Monitor and run <a href="#">GDB</a> project debugger to debug the application at runtime. This requires <code>:ref:CONFIG_ESP_SYSTEM_GDBSTUB_RUNTIME</code> option to be enabled.

Any keys pressed, other than `Ctrl-]` and `Ctrl-T`, will be sent through the serial port.

## IDF-specific features



**Automatic Address Decoding** Whenever ESP-IDF outputs a hexadecimal code address of the form 0x4\_\_\_\_\_, IDF Monitor uses `addr2line_` to look up the location in the source code and find the function name.

If an ESP-IDF app crashes and panics, a register dump and backtrace is produced, such as the following:

```
Guru Meditation Error of type StoreProhibited occurred on core 0. Exception was
↳unhandled.
Register dump:
PC      : 0x400f360d  PS      : 0x00060330  A0      : 0x800dbf56  A1      :
↳0x3ffb7e00
A2      : 0x3ffb136c  A3      : 0x00000005  A4      : 0x00000000  A5      :
↳0x00000000
A6      : 0x00000000  A7      : 0x00000080  A8      : 0x00000000  A9      :
↳0x3ffb7dd0
A10     : 0x00000003  A11     : 0x00060f23  A12     : 0x00060f20  A13     :
↳0x3ffba6d0
A14     : 0x00000047  A15     : 0x0000000f  SAR     : 0x00000019  EXCCAUSE:
↳0x0000001d
EXCVADDR: 0x00000000  LBEG    : 0x4000c46c  LEND    : 0x4000c477  LCOUNT  :
↳0x00000000

Backtrace: 0x400f360d:0x3ffb7e00 0x400dbf56:0x3ffb7e20 0x400dbf5e:0x3ffb7e40
↳0x400dbf82:0x3ffb7e60 0x400d071d:0x3ffb7e90
```

IDF Monitor adds more details to the dump:

```
Guru Meditation Error of type StoreProhibited occurred on core 0. Exception was
↳unhandled.
Register dump:
PC      : 0x400f360d  PS      : 0x00060330  A0      : 0x800dbf56  A1      :
↳0x3ffb7e00
0x400f360d: do_something_to_crash at /home/gus/esp/32/idf/examples/get-started/
↳hello_world/main/./hello_world_main.c:57
(inlined by) inner_dont_crash at /home/gus/esp/32/idf/examples/get-started/hello_
↳world/main/./hello_world_main.c:52
A2      : 0x3ffb136c  A3      : 0x00000005  A4      : 0x00000000  A5      :
↳0x00000000
A6      : 0x00000000  A7      : 0x00000080  A8      : 0x00000000  A9      :
↳0x3ffb7dd0
A10     : 0x00000003  A11     : 0x00060f23  A12     : 0x00060f20  A13     :
↳0x3ffba6d0
A14     : 0x00000047  A15     : 0x0000000f  SAR     : 0x00000019  EXCCAUSE:
↳0x0000001d
EXCVADDR: 0x00000000  LBEG    : 0x4000c46c  LEND    : 0x4000c477  LCOUNT  :
↳0x00000000

Backtrace: 0x400f360d:0x3ffb7e00 0x400dbf56:0x3ffb7e20 0x400dbf5e:0x3ffb7e40
↳0x400dbf82:0x3ffb7e60 0x400d071d:0x3ffb7e90
0x400f360d: do_something_to_crash at /home/gus/esp/32/idf/examples/get-started/
↳hello_world/main/./hello_world_main.c:57
(inlined by) inner_dont_crash at /home/gus/esp/32/idf/examples/get-started/hello_
↳world/main/./hello_world_main.c:52
0x400dbf56: still_dont_crash at /home/gus/esp/32/idf/examples/get-started/hello_
↳world/main/./hello_world_main.c:47
0x400dbf5e: dont_crash at /home/gus/esp/32/idf/examples/get-started/hello_world/
↳main/./hello_world_main.c:42
0x400dbf82: app_main at /home/gus/esp/32/idf/examples/get-started/hello_world/main/
↳./hello_world_main.c:33
0x400d071d: main_task at /home/gus/esp/32/idf/components/esp32s2/./cpu_start.c:254
```

To decode each address, IDF Monitor runs the following command in the background:

```
xtensa-esp32s2-elf-addr2line -pfiaC -e build/PROJECT.elf ADDRESS
```

---

**Note:** Set environment variable `ESP_MONITOR_DECODE` to 0 or call `idf_monitor.py` with specific command line option: `idf_monitor.py --disable-address-decoding` to disable address decoding.

---

**Target Reset on Connection** By default, IDF Monitor will reset the target when connecting to it. The reset of the target chip is performed using the DTR and RTS serial lines. To prevent IDF Monitor from automatically resetting the target on connection, call IDF Monitor with the `--no-reset` option (e.g., `idf_monitor.py --no-reset`).

---

**Note:** The `--no-reset` option applies the same behavior even when connecting IDF Monitor to a particular port (e.g., `idf.py monitor --no-reset -p [PORT]`).

---

**Launching GDB with GDBStub** GDBStub is a useful runtime debugging feature that runs on the target and connects to the host over the serial port to receive debugging commands. GDBStub supports commands such as reading memory and variables, examining call stack frames etc. Although GDBStub is less versatile than JTAG debugging, it does not require any special hardware (such as a JTAG to USB bridge) as communication is done entirely over the serial port.

A target can be configured to run GDBStub in the background by setting the `CONFIG_ESP_SYSTEM_PANIC` to `GDBStub` on `runtime`. GDBStub will run in the background until a `Ctrl+C` message is sent over the serial port and causes the GDBStub to break (i.e., stop the execution of) the program, thus allowing GDBStub to handle debugging commands.

Furthermore, the panic handler can be configured to run GDBStub on a crash by setting the `CONFIG_ESP_SYSTEM_PANIC` to `GDBStub` on `panic`. When a crash occurs, GDBStub will output a special string pattern over the serial port to indicate that it is running.

In both cases (i.e., sending the `Ctrl+C` message, or receiving the special string pattern), IDF Monitor will automatically launch GDB in order to allow the user to send debugging commands. After GDB exits, the target is reset via the RTS serial line. If this line is not connected, users can reset their target (by pressing the board's Reset button).

---

**Note:** In the background, IDF Monitor runs the following command to launch GDB:

```
xtensa-esp32s2-elf-gdb -ex "set serial baud BAUD" -ex "target remote PORT" -ex_
↳interrupt build/PROJECT.elf :idf_target:`Hello NAME chip`
```

---

**Output Filtering** IDF monitor can be invoked as `idf.py monitor --print-filter="xyz"`, where `--print-filter` is the parameter for output filtering. The default value is an empty string, which means that everything is printed.

Restrictions on what to print can be specified as a series of `<tag>:<log_level>` items where `<tag>` is the tag string and `<log_level>` is a character from the set {N, E, W, I, D, V, \*} referring to a level for *logging*.

For example, `PRINT_FILTER="tag1:W"` matches and prints only the outputs written with `ESP_LOGW("tag1", ...)` or at lower verbosity level, i.e. `ESP_LOGE("tag1", ...)`. Not specifying a `<log_level>` or using `*` defaults to Verbose level.

---

**Note:** Use primary logging to disable at compilation the outputs you do not need through the *logging library*. Output filtering with IDF monitor is a secondary solution which can be useful for adjusting the filtering options without recompiling the application.

---

Your app tags must not contain spaces, asterisks `*`, or colons `:` to be compatible with the output filtering feature.

If the last line of the output in your app is not followed by a carriage return, the output filtering might get confused, i.e., the monitor starts to print the line and later finds out that the line should not have been written. This is a known issue and can be avoided by always adding a carriage return (especially when no output follows immediately afterwards).

### Examples of Filtering Rules:

- `*` can be used to match any tags. However, the string `PRINT_FILTER="*:I tag1:E"` with regards to `tag1` prints errors only, because the rule for `tag1` has a higher priority over the rule for `*`.
- The default (empty) rule is equivalent to `*:V` because matching every tag at the Verbose level or lower means matching everything.
- `"*:N"` suppresses not only the outputs from logging functions, but also the prints made by `printf`, etc. To avoid this, use `*:E` or a higher verbosity level.
- Rules `"tag1:V"`, `"tag1:v"`, `"tag1:"`, `"tag1:*"`, and `"tag1"` are equivalent.
- Rule `"tag1:W tag1:E"` is equivalent to `"tag1:E"` because any consequent occurrence of the same tag name overwrites the previous one.
- Rule `"tag1:I tag2:W"` only prints `tag1` at the Info verbosity level or lower and `tag2` at the Warning verbosity level or lower.
- Rule `"tag1:I tag2:W tag3:N"` is essentially equivalent to the previous one because `tag3:N` specifies that `tag3` should not be printed.
- `tag3:N` in the rule `"tag1:I tag2:W tag3:N *:V"` is more meaningful because without `tag3:N` the `tag3` messages could have been printed; the errors for `tag1` and `tag2` will be printed at the specified (or lower) verbosity level and everything else will be printed by default.

**A More Complex Filtering Example** The following log snippet was acquired without any filtering options:

```
load:0x40078000,len:13564
entry 0x40078d4c
E (31) esp_image: image at 0x30000 has invalid magic byte
W (31) esp_image: image at 0x30000 has invalid SPI mode 255
E (39) boot: Factory app partition is not bootable
I (568) cpu_start: Pro cpu up.
I (569) heap_init: Initializing. RAM available for dynamic allocation:
I (603) cpu_start: Pro cpu start user code
D (309) light_driver: [light_init, 74]:status: 1, mode: 2
D (318) vfs: esp_vfs_register_fd_range is successful for range <54; 64) and VFS ID_
↪1
I (328) wifi: wifi driver task: 3ffdbf84, prio:23, stack:4096, core=0
```

The captured output for the filtering options `PRINT_FILTER="wifi esp_image:E light_driver:I"` is given below:

```
E (31) esp_image: image at 0x30000 has invalid magic byte
I (328) wifi: wifi driver task: 3ffdbf84, prio:23, stack:4096, core=0
```

The options `PRINT_FILTER="light_driver:D esp_image:N boot:N cpu_start:N vfs:N wifi:N *:V"` show the following output:

```
load:0x40078000,len:13564
entry 0x40078d4c
I (569) heap_init: Initializing. RAM available for dynamic allocation:
D (309) light_driver: [light_init, 74]:status: 1, mode: 2
```

### Known Issues with IDF Monitor

#### Issues Observed on Windows

- Arrow keys, as well as some other keys, do not work in GDB due to Windows Console limitations.
- Occasionally, when “idf.py” exits, it might stall for up to 30 seconds before IDF Monitor resumes.

- When “gdb” is run, it might stall for a short time before it begins communicating with the GDBStub.

## Standard Toolchain Setup for Linux and macOS

**Installation Step by Step** This is a detailed roadmap to walk you through the installation process.

**Setting up Development Environment** These are the steps for setting up the ESP-IDF for your ESP32-S2.

- [Step 1. Install Prerequisites](#)
- [Step 2. Get ESP-IDF](#)
- [Step 3. Set up the tools](#)
- [Step 4. Set up the environment variables](#)
- [Step 5. First Steps on ESP-IDF](#)

**Step 1. Install Prerequisites** In order to use ESP-IDF with the ESP32-S2, you need to install some software packages based on your Operating System. This setup guide will help you on getting everything installed on Linux and macOS based systems.

**For Linux Users** To compile using ESP-IDF you will need to get the following packages. The command to run depends on which distribution of Linux you are using:

- Ubuntu and Debian:

```
sudo apt-get install git wget flex bison gperf python3 python3-pip python3-venv cmake ninja-build ccache libffi-dev libssl-dev dfu-util libusb-1.0-0
```

- CentOS 7 & 8:

```
sudo yum -y update && sudo yum install git wget flex bison gperf python3 cmake ninja-build ccache dfu-util libusb
```

CentOS 7 is still supported but CentOS version 8 is recommended for a better user experience.

- Arch:

```
sudo pacman -S --needed gcc git make flex bison gperf python cmake ninja ccache dfu-util libusb
```

---

### Note:

- CMake version 3.16 or newer is required for use with ESP-IDF. Run “tools/idf\_tools.py install cmake” to install a suitable version if your OS versions doesn’ t have one.
  - If you do not see your Linux distribution in the above list then please check its documentation to find out which command to use for package installation.
- 

**For macOS Users** ESP-IDF will use the version of Python installed by default on macOS.

- Install CMake & Ninja build:
  - If you have [HomeBrew](#), you can run:

```
brew install cmake ninja dfu-util
```

- If you have [MacPorts](#), you can run:

```
sudo port install cmake ninja dfu-util
```

- Otherwise, consult the [CMake](#) and [Ninja](#) home pages for macOS installation downloads.
- It is strongly recommended to also install [ccache](#) for faster builds. If you have [HomeBrew](#), this can be done via `brew install ccache` or `sudo port install ccache` on [MacPorts](#).

---

**Note:** If an error like this is shown during any step:

```
xcrun: error: invalid active developer path (/Library/Developer/CommandLineTools),  
↳missing xcrun at: /Library/Developer/CommandLineTools/usr/bin/xcrun
```

Then you will need to install the XCode command line tools to continue. You can install these by running `xcode-select --install`.

---

**Apple M1 Users** If you use Apple M1 platform and see an error like this:

```
WARNING: directory for tool xtensa-esp32-elf version esp-2021r2-patch3-8.4.0 is  
↳present, but tool was not found  
ERROR: tool xtensa-esp32-elf has no installed versions. Please run 'install.sh' to  
↳install it.
```

or:

```
zsh: bad CPU type in executable: ~/.espressif/tools/xtensa-esp32-elf/esp-2021r2-  
↳patch3-8.4.0/xtensa-esp32-elf/bin/xtensa-esp32-elf-gcc
```

Then you will need to install Apple Rosetta 2 by running

```
/usr/sbin/softwareupdate --install-rosetta --agree-to-license
```

**Installing Python 3** Based on macOS [Catalina 10.15 release notes](#), use of Python 2.7 is not recommended and Python 2.7 will not be included by default in future versions of macOS. Check what Python you currently have:

```
python --version
```

If the output is like `Python 2.7.17`, your default interpreter is Python 2.7. If so, also check if Python 3 isn't already installed on your computer:

```
python3 --version
```

If the above command returns an error, it means Python 3 is not installed.

Below is an overview of the steps to install Python 3.

- Installing with [HomeBrew](#) can be done as follows:

```
brew install python3
```

- If you have [MacPorts](#), you can run:

```
sudo port install python38
```

**Step 2. Get ESP-IDF** To build applications for the ESP32-S2, you need the software libraries provided by Espressif in [ESP-IDF repository](#).

To get ESP-IDF, navigate to your installation directory and clone the repository with `git clone`, following instructions below specific to your operating system.

Open Terminal, and run the following commands:

```
mkdir -p ~/esp
cd ~/esp
git clone -b release/v5.0 --recursive https://github.com/espressif/esp-idf.git
```

ESP-IDF will be downloaded into `~/esp/esp-idf`.

Consult [ESP-IDF Versions](#) for information about which ESP-IDF version to use in a given situation.

**Step 3. Set up the tools** Aside from the ESP-IDF, you also need to install the tools used by ESP-IDF, such as the compiler, debugger, Python packages, etc, for projects supporting ESP32-S2.

```
cd ~/esp/esp-idf
./install.sh esp32s2
```

or with Fish shell

```
cd ~/esp/esp-idf
./install.fish esp32s2
```

The above commands install tools for ESP32-S2 only. If you intend to develop projects for more chip targets then you should list all of them and run for example:

```
cd ~/esp/esp-idf
./install.sh esp32,esp32s2
```

or with Fish shell

```
cd ~/esp/esp-idf
./install.fish esp32,esp32s2
```

In order to install tools for all supported targets please run the following command:

```
cd ~/esp/esp-idf
./install.sh all
```

or with Fish shell

```
cd ~/esp/esp-idf
./install.fish all
```

---

**Note:** For macOS users, if an error like this is shown during any step:

```
<urlopen error [SSL: CERTIFICATE_VERIFY_FAILED] certificate verify failed: unable
↳to get local issuer certificate (_ssl.c:xxx)
```

You may run `Install Certificates.command` in the Python folder of your computer to install certificates. For details, see [Download Error While Installing ESP-IDF Tools](#).

---

**Alternative File Downloads** The tools installer downloads a number of files attached to GitHub Releases. If accessing GitHub is slow then it is possible to set an environment variable to prefer Espressif's download server for GitHub asset downloads.

---

**Note:** This setting only controls individual tools downloaded from GitHub releases, it doesn't change the URLs used to access any Git repositories.

---

To prefer the Espressif download server when installing tools, use the following sequence of commands when running `install.sh`:

```
cd ~/esp/esp-idf
export IDF_GITHUB_ASSETS="dl.espressif.com/github_assets"
./install.sh
```

**Customizing the tools installation path** The scripts introduced in this step install compilation tools required by ESP-IDF inside the user home directory: `$HOME/.espressif` on Linux. If you wish to install the tools into a different directory, set the environment variable `IDF_TOOLS_PATH` before running the installation scripts. Make sure that your user account has sufficient permissions to read and write this path.

If changing the `IDF_TOOLS_PATH`, make sure it is set to the same value every time the Install script (`install.bat`, `install.ps1` or `install.sh`) and an Export script (`export.bat`, `export.ps1` or `export.sh`) are executed.

**Step 4. Set up the environment variables** The installed tools are not yet added to the `PATH` environment variable. To make the tools usable from the command line, some environment variables must be set. ESP-IDF provides another script which does that.

In the terminal where you are going to use ESP-IDF, run:

```
. $HOME/esp/esp-idf/export.sh
```

or for fish (supported only since fish version 3.0.0):

```
. $HOME/esp/esp-idf/export.fish
```

Note the space between the leading dot and the path!

If you plan to use `esp-idf` frequently, you can create an alias for executing `export.sh`:

1. Copy and paste the following command to your shell's profile (`.profile`, `.bashrc`, `.zprofile`, etc.)

```
alias get_idf='. $HOME/esp/esp-idf/export.sh'
```

2. Refresh the configuration by restarting the terminal session or by running `source [path to profile]`, for example, `source ~/.bashrc`.

Now you can run `get_idf` to set up or refresh the `esp-idf` environment in any terminal session.

Technically, you can add `export.sh` to your shell's profile directly; however, it is not recommended. Doing so activates IDF virtual environment in every terminal session (including those where IDF is not needed), defeating the purpose of the virtual environment and likely affecting other software.

**Step 5. First Steps on ESP-IDF** Now since all requirements are met, the next topic will guide you on how to start your first project.

This guide will help you on the first steps using ESP-IDF. Follow this guide to start a new project on the ESP32-S2 and build, flash, and monitor the device output.

---

**Note:** If you have not yet installed ESP-IDF, please go to [Installation](#) and follow the instruction in order to get all the software needed to use this guide.

---

**Start a Project** Now you are ready to prepare your application for ESP32-S2. You can start with [get-started/hello\\_world](#) project from `examples` directory in ESP-IDF.

---

**Important:** The ESP-IDF build system does not support spaces in the paths to either ESP-IDF or to projects.

---

Copy the project [get-started/hello\\_world](#) to `~/esp` directory:

```
cd ~/esp
cp -r $IDF_PATH/examples/get-started/hello_world .
```

**Note:** There is a range of example projects in the [examples](#) directory in ESP-IDF. You can copy any project in the same way as presented above and run it. It is also possible to build examples in-place without copying them first.

**Connect Your Device** Now connect your ESP32-S2 board to the computer and check under which serial port the board is visible.

Serial ports have the following naming patterns:

- **Linux:** starting with `/dev/tty`
- **macOS:** starting with `/dev/cu.`

If you are not sure how to check the serial port name, please refer to [Establish Serial Connection with ESP32-S2](#) for full details.

**Note:** Keep the port name handy as you will need it in the next steps.

**Configure Your Project** Navigate to your `hello_world` directory, set ESP32-S2 as the target, and run the project configuration utility `menuconfig`.

```
cd ~/esp/hello_world
idf.py set-target esp32s2
idf.py menuconfig
```

After opening a new project, you should first set the target with `idf.py set-target esp32s2`. Note that existing builds and configurations in the project, if any, will be cleared and initialized in this process. The target may be saved in the environment variable to skip this step at all. See [Select the Target Chip: set-target](#) for additional information.

If the previous steps have been done correctly, the following menu appears:

```
(Top)
Espressif IoT Development Framework Configuration
SDK tool configuration --->
Build type --->
Application manager --->
Bootloader config --->
Security features --->
Serial flasher config --->
Partition Table --->
Compiler options --->
Component config --->
Compatibility options --->

[Space/Enter] Toggle/enter  [ESC] Leave menu          [S] Save
[O] Load                    [?] Symbol info          [/] Jump to symbol
[F] Toggle show-help mode  [C] Toggle show-name mode [A] Toggle show-all mode
[Q] Quit (prompts for save) [D] Save minimal config (advanced)
```

Fig. 14: Project configuration - Home window



You are using this menu to set up project specific variables, e.g., Wi-Fi network name and password, the processor speed, etc. Setting up the project with `menuconfig` may be skipped for “hello\_world”, since this example runs with default configuration.

---

**Note:** The colors of the menu could be different in your terminal. You can change the appearance with the option `--style`. Please run `idf.py menuconfig --help` for further information.

---

If you are using one of the supported development boards, you can speed up your development by using Board Support Package. See [Additional Tips](#) for more information.

**Build the Project** Build the project by running:

```
idf.py build
```

This command will compile the application and all ESP-IDF components, then it will generate the bootloader, partition table, and application binaries.

```
$ idf.py build
Running cmake in directory /path/to/hello_world/build
Executing "cmake -G Ninja --warn-uninitialized /path/to/hello_world"...
Warn about uninitialized values.
-- Found Git: /usr/bin/git (found version "2.17.0")
-- Building empty aws_iot component due to configuration
-- Component names: ...
-- Component paths: ...

... (more lines of build system output)

[527/527] Generating hello_world.bin
esptool.py v2.3.1

Project build complete. To flash, run this command:
../../components/esptool_py/esptool/esptool.py -p (PORT) -b 921600 write_flash -
↪-flash_mode dio --flash_size detect --flash_freq 40m 0x10000 build/hello_world.
↪bin build 0x1000 build/bootloader/bootloader.bin 0x8000 build/partition-table/
↪partition-table.bin
or run 'idf.py -p PORT flash'
```

If there are no errors, the build will finish by generating the firmware binary `.bin` files.

**Flash onto the Device** Flash the binaries that you just built (`bootloader.bin`, `partition-table.bin` and `hello_world.bin`) onto your ESP32-S2 board by running:

```
idf.py -p PORT [-b BAUD] flash
```

Replace `PORT` with your ESP32-S2 board’s serial port name.

You can also change the flasher baud rate by replacing `BAUD` with the baud rate you need. The default baud rate is 460800.

For more information on `idf.py` arguments, see [idf.py](#).

---

**Note:** The option `flash` automatically builds and flashes the project, so running `idf.py build` is not necessary.

---

**Encountered Issues While Flashing?** If you run the given command and see errors such as “Failed to connect”, there might be several reasons for this. One of the reasons might be issues encountered by `esptool.py`, the utility that is called by the build system to reset the chip, interact with the ROM bootloader, and flash firmware. One simple

solution to try is manual reset described below, and if it does not help you can find more details about possible issues in [Troubleshooting](#).

`esptool.py` resets ESP32-S2 automatically by asserting DTR and RTS control lines of the USB to serial converter chip, i.e., FTDI or CP210x (for more information, see [Establish Serial Connection with ESP32-S2](#)). The DTR and RTS control lines are in turn connected to GPIO0 and CHIP\_PU (EN) pins of ESP32-S2, thus changes in the voltage levels of DTR and RTS will boot ESP32-S2 into Firmware Download mode. As an example, check the [schematic](#) for the ESP32 DevKitC development board.

In general, you should have no problems with the [official esp-idf development boards](#). However, `esptool.py` is not able to reset your hardware automatically in the following cases:

- Your hardware does not have the DTR and RTS lines connected to GPIO0 and CHIP\_PU
- The DTR and RTS lines are configured differently
- There are no such serial control lines at all

Depending on the kind of hardware you have, it may also be possible to manually put your ESP32-S2 board into Firmware Download mode (reset).

- For development boards produced by Espressif, this information can be found in the respective getting started guides or user guides. For example, to manually reset an ESP-IDF development board, hold down the **Boot** button (GPIO0) and press the **EN** button (CHIP\_PU).
- For other types of hardware, try pulling GPIO0 down.

**Normal Operation** When flashing, you will see the output log similar to the following:

```
...
esptool.py --chip esp32s2 -p /dev/ttyUSB0 -b 460800 --before=default_reset --
↳after=hard_reset write_flash --flash_mode dio --flash_freq 40m --flash_size 2MB
↳0x8000 partition_table/partition-table.bin 0x1000 bootloader/bootloader.bin
↳0x10000 hello_world.bin
esptool.py v3.0-dev
Serial port /dev/ttyUSB0
Connecting....
Chip is ESP32-S2
Features: WiFi
Crystal is 40MHz
MAC: 18:fe:34:72:50:e3
Uploading stub...
Running stub...
Stub running...
Changing baud rate to 460800
Changed.
Configuring flash size...
Compressed 3072 bytes to 103...
Writing at 0x00008000... (100 %)
Wrote 3072 bytes (103 compressed) at 0x00008000 in 0.0 seconds (effective 3851.6
↳kbit/s)...
Hash of data verified.
Compressed 22592 bytes to 13483...
Writing at 0x00001000... (100 %)
Wrote 22592 bytes (13483 compressed) at 0x00001000 in 0.3 seconds (effective 595.1
↳kbit/s)...
Hash of data verified.
Compressed 140048 bytes to 70298...
Writing at 0x00010000... (20 %)
Writing at 0x00014000... (40 %)
Writing at 0x00018000... (60 %)
Writing at 0x0001c000... (80 %)
Writing at 0x00020000... (100 %)
Wrote 140048 bytes (70298 compressed) at 0x00010000 in 1.7 seconds (effective 662.
↳5 kbit/s)...
```

(continues on next page)

(continued from previous page)

```
Hash of data verified.

Leaving...
Hard resetting via RTS pin...
Done
```

If there are no issues by the end of the flash process, the board will reboot and start up the “hello\_world” application. If you’d like to use the Eclipse or VS Code IDE instead of running `idf.py`, check out [Eclipse Plugin](#), [VSCode Extension](#).

**Monitor the Output** To check if “hello\_world” is indeed running, type `idf.py -p PORT monitor` (Do not forget to replace `PORT` with your serial port name).

This command launches the *IDF Monitor* application:

```
$ idf.py -p <PORT> monitor
Running idf_monitor in directory [...]/esp/hello_world/build
Executing "python [...]/esp-idf/tools/idf_monitor.py -b 115200 [...]/esp/hello_
↪world/build/hello_world.elf"...
--- idf_monitor on <PORT> 115200 ---
--- Quit: Ctrl+] | Menu: Ctrl+T | Help: Ctrl+T followed by Ctrl+H ---
ets Jun  8 2016 00:22:57

rst:0x1 (POWERON_RESET),boot:0x13 (SPI_FAST_FLASH_BOOT)
ets Jun  8 2016 00:22:57
...
```

After startup and diagnostic logs scroll up, you should see “Hello world!” printed out by the application.

```
...
Hello world!
Restarting in 10 seconds...
This is esp32s2 chip with 1 CPU core(s), WiFi, silicon revision 0, 2MBL
↪external flash
Minimum free heap size: 253900 bytes
Restarting in 9 seconds...
Restarting in 8 seconds...
Restarting in 7 seconds...
```

To exit IDF monitor use the shortcut `Ctrl+]`.

**Note:** You can combine building, flashing and monitoring into one step by running:

```
idf.py -p PORT flash monitor
```

See also:

- *IDF Monitor* for handy shortcuts and more details on using IDF monitor.
- *idf.py* for a full reference of `idf.py` commands and options.

**That’s all that you need to get started with ESP32-S2!**

Now you are ready to try some other [examples](#), or go straight to developing your own applications.

**Important:** Some of examples do not support ESP32-S2 because required hardware is not included in ESP32-S2 so it cannot be supported.

If building an example, please check the README file for the `Supported Targets` table. If this is present including ESP32-S2 target, or the table does not exist at all, the example will work on ESP32-S2.

---

### Additional Tips

**Permission issues /dev/ttyUSB0** With some Linux distributions, you may get the `Failed to open port /dev/ttyUSB0` error message when flashing the ESP32-S2. *This can be solved by adding the current user to the dialout group.*

**Python compatibility** ESP-IDF supports Python 3.7 or newer. It is recommended to upgrade your operating system to a recent version satisfying this requirement. Other options include the installation of Python from [sources](#) or the use of a Python version management system such as [pyenv](#).

**Start with Board Support Package** To speed up prototyping on some development boards, you can use [Board Support Packages \(BSPs\)](#), which makes initialization of a particular board as easy as few function calls.

A BSP typically supports all of the hardware components provided on development board. Apart from the pinout definition and initialization functions, a BSP ships with drivers for the external components such as sensors, displays, audio codecs etc.

The BSPs are distributed via [IDF Component Manager](#), so they can be found in [IDF Component Registry](#).

**Here's an example of how to add ESP32-S2-Kaluga-Kit BSP to your project:**

```
idf.py add-dependency esp32_s2_kaluga_kit
```

More examples of BSP usage can be found in [BSP examples folder](#).

**Tip: Updating ESP-IDF** It is recommended to update ESP-IDF from time to time, as newer versions fix bugs and/or provide new features. Please note that each ESP-IDF major and minor release version has an associated support period, and when one release branch is approaching end of life (EOL), all users are encouraged to upgrade their projects to more recent ESP-IDF releases, to find out more about support periods, see [ESP-IDF Versions](#).

The simplest way to do the update is to delete the existing `esp-idf` folder and clone it again, as if performing the initial installation described in [Step 2. Get ESP-IDF](#).

Another solution is to update only what has changed. *The update procedure depends on the version of ESP-IDF you are using.*

After updating ESP-IDF, execute the Install script again, in case the new ESP-IDF version requires different versions of tools. See instructions at [Step 3. Set up the tools](#).

Once the new tools are installed, update the environment using the Export script. See instructions at [Step 4. Set up the environment variables](#).

### Related Documents

- [Establish Serial Connection with ESP32-S2](#)
- [Eclipse Plugin](#)
- [VSCode Extension](#)
- [IDF Monitor](#)

## 1.4 Build Your First Project

If you already have the ESP-IDF installed and not using IDE, you can build your first project from the command line following the [Start a Project on Windows](#) or [Start a Project on Linux and macOS](#).

## 1.5 Uninstall ESP-IDF

If you want to remove ESP-IDF, please follow [Uninstall ESP-IDF](#).

# Chapter 2

## API Reference

### 2.1 API Conventions

This document describes conventions and assumptions common to ESP-IDF Application Programming Interfaces (APIs).

ESP-IDF provides several kinds of programming interfaces:

- C functions, structures, enums, type definitions and preprocessor macros declared in public header files of ESP-IDF components. Various pages in the API Reference section of the programming guide contain descriptions of these functions, structures and types.
- Build system functions, predefined variables and options. These are documented in the *build system guide*.
- *Kconfig* options can be used in code and in the build system (CMakeLists.txt) files.
- *Host tools* and their command line parameters are also part of ESP-IDF interface.

ESP-IDF consists of components written specifically for ESP-IDF as well as third-party libraries. In some cases, an ESP-IDF-specific wrapper is added to the third-party library, providing an interface that is either simpler or better integrated with the rest of ESP-IDF facilities. In other cases, the original API of the third-party library is presented to the application developers.

Following sections explain some of the aspects of ESP-IDF APIs and their usage.

#### 2.1.1 Error handling

Most ESP-IDF APIs return error codes defined with `esp_err_t` type. See *Error Handling* section for more information about error handling approaches. *Error Code Reference* contains the list of error codes returned by ESP-IDF components.

#### 2.1.2 Configuration structures

---

**Important:** Correct initialization of configuration structures is an important part in making the application compatible with future versions of ESP-IDF.

---

Most initialization or configuration functions in ESP-IDF take as an argument a pointer to a configuration structure. For example:

```

const esp_timer_create_args_t my_timer_args = {
    .callback = &my_timer_callback,
    .arg = callback_arg,
    .name = "my_timer"
};
esp_timer_handle_t my_timer;
esp_err_t err = esp_timer_create(&my_timer_args, &my_timer);

```

Initialization functions never store the pointer to the configuration structure, so it is safe to allocate the structure on the stack.

The application must initialize all fields of the structure. The following is incorrect:

```

esp_timer_create_args_t my_timer_args;
my_timer_args.callback = &my_timer_callback;
/* Incorrect! Fields .arg and .name are not initialized */
esp_timer_create(&my_timer_args, &my_timer);

```

Most ESP-IDF examples use C99 [designated initializers](#) for structure initialization, since they provide a concise way of setting a subset of fields, and zero-initializing the remaining fields:

```

const esp_timer_create_args_t my_timer_args = {
    .callback = &my_timer_callback,
    /* Correct, fields .arg and .name are zero-initialized */
};

```

C++ language doesn't support the designated initializers syntax until C++20, however GCC compiler partially supports it as an extension. When using ESP-IDF APIs in C++ code, you may consider using the following pattern:

```

esp_timer_create_args_t my_timer_args = {};
/* All the fields are zero-initialized */
my_timer_args.callback = &my_timer_callback;

```

## Default initializers

For some configuration structures, ESP-IDF provides macros for setting default values of fields:

```

httpd_config_t config = HTTPD_DEFAULT_CONFIG();
/* HTTPD_DEFAULT_CONFIG expands to a designated initializer.
   Now all fields are set to the default values.
   Any field can still be modified: */
config.server_port = 8081;
httpd_handle_t server;
esp_err_t err = httpd_start(&server, &config);

```

It is recommended to use default initializer macros whenever they are provided for a particular configuration structure.

## 2.1.3 Private APIs

Certain header files in ESP-IDF contain APIs intended to be used only in ESP-IDF source code, and not by the applications. Such header files often contain `private` or `esp_private` in their name or path. Certain components, such as `hal` only contain private APIs.

Private APIs may be removed or changed in an incompatible way between minor or patch releases.

## 2.1.4 Components in example projects

ESP-IDF examples contain a variety of projects demonstrating usage of ESP-IDF APIs. In order to reduce code duplication in the examples, a few common helpers are defined inside components that are used by multiple examples.

This includes components located in `common_components` directory, as well as some of the components located in the examples themselves. These components are not considered to be part of the ESP-IDF API.

It is not recommended to reference these components directly in custom projects (via `EXTRA_COMPONENT_DIRS` build system variable), as they may change significantly between ESP-IDF versions. When starting a new project based on an ESP-IDF example, copy both the project and the common components it depends on out of ESP-IDF, and treat the common components as part of the project. Note that the common components are written with examples in mind, and might not include all the error handling required for production applications. Take time to read the code and understand if it applicable to your use case.

### 2.1.5 API Stability

ESP-IDF uses [Semantic Versioning](#) as explained in the [versions page](#).

Minor and bugfix releases of ESP-IDF guarantee compatibility with previous releases. The sections below explain different aspects and limitations to compatibility.

#### Source level compatibility

ESP-IDF guarantees source level compatibility of C functions, structures, enums, type definitions and preprocessor macros declared in public header files of ESP-IDF components. Source level compatibility implies that the application can be recompiled with the newer version of ESP-IDF without changes.

The following changes are allowed between minor versions and do not break source level compatibility:

- Deprecating functions (using the `deprecated` attribute) and header files (using a preprocessor `#warning`). Deprecations are listed in ESP-IDF release notes. It is recommended to update the source code to use the newer functions or files that replace the deprecated ones, however this is not mandatory. Deprecated functions and files can be removed in major versions of ESP-IDF.
- Renaming components, moving source and header files between components — provided that the build system ensures that correct files are still found.
- Renaming Kconfig options. Kconfig system [renaming mechanism](#) ensures that the original Kconfig option names can still be used by the application in `sdkconfig` file, CMake files and source code.

#### Lack of binary compatibility

ESP-IDF does not guarantee binary compatibility between releases. This means that if a precompiled library is built with one ESP-IDF version, it is not guaranteed to work the same way with the next minor or bugfix release. The following are the possible changes that keep source level compatibility but not binary compatibility:

- Changing numerical values for C enum members.
- Adding new structure members or changing the order of members. See [Configuration structures](#) for tips that help ensure compatibility.
- Replacing an `extern` function with a `static inline` one with the same signature, or vice versa.
- Replacing a function-like macro with a compatible C function.

#### Other exceptions from compatibility

While we try to make upgrading to a new ESP-IDF version easy, there are parts of ESP-IDF that may change between minor versions in an incompatible way. We appreciate issue reports about any unintended breaking changes that don't fall into the categories below.

- [Private APIs](#).
- [Components in example projects](#).
- Features clearly marked as “beta”, “preview”, or “experimental”.
- Changes made to mitigate security issues or to replace insecure default behaviors with a secure ones.



- Features which were never functional. For example, if it was never possible to use a certain function or an enumeration value, it may get renamed (as part of fixing it) or removed. This includes software features which depend on non-functional chip hardware features.
- Unexpected or undefined behavior (for example, due to missing validation of argument ranges) that is not documented explicitly may be fixed/changed.
- Location of *Kconfig* options in menuconfig.
- Location and names of example projects.

## 2.2 Application Protocols

### 2.2.1 ASIO port

Asio is a cross-platform C++ library, see <https://think-async.com/Asio/>. It provides a consistent asynchronous model using a modern C++ approach.

The ESP-IDF component *ASIO* has been moved from ESP-IDF since version v5.0 to a separate repository:

- [ASIO component on GitHub](#)

To add ASIO component in your project, please run `idf.py add-dependency espressif/asio`

#### Hosted Documentation

The documentation can be found on the link below:

- [ASIO documentation \(English\)](#)

### 2.2.2 ESP-Modbus

The Espressif ESP-Modbus Library (*esp-modbus*) supports Modbus communication in the networks based on RS485, Wi-Fi, Ethernet interfaces. The ESP-IDF component *freemodbus* has been moved from ESP-IDF since version v5.0 to a separate repository:

- [ESP-Modbus component on GitHub](#)

#### Hosted Documentation

The documentation can be found on the link below:

- [ESP-Modbus documentation \(English\)](#)

#### Application Example

The examples below demonstrate the ESP-Modbus library of serial, TCP ports for slave and master implementations accordingly.

- [protocols/modbus/serial/mb\\_slave](#)
- [protocols/modbus/serial/mb\\_master](#)
- [protocols/modbus/tcp/mb\\_tcp\\_slave](#)
- [protocols/modbus/tcp/mb\\_tcp\\_master](#)

Please refer to the specific example README.md for details.

## Protocol References

- <https://modbus.org/specs.php>: Modbus Organization with protocol specifications.

### 2.2.3 ESP-MQTT

#### Overview

ESP-MQTT is an implementation of [MQTT](mqtt.org) protocol client (MQTT is a lightweight publish/subscribe messaging protocol).

#### Features

- Supports MQTT over TCP, SSL with mbedtls, MQTT over Websocket, MQTT over Websocket Secure.
- Easy to setup with URI
- Multiple instances (Multiple clients in one application)
- Support subscribing, publishing, authentication, last will messages, keep alive pings and all 3 QoS levels (it should be a fully functional client).

#### Application Example

- [protocols/mqtt/tcp](#): MQTT over tcp, default port 1883
- [protocols/mqtt/ssl](#): MQTT over tls, default port 8883
- [protocols/mqtt/ssl\\_ds](#): MQTT over tls using digital signature peripheral for authentication, default port 8883.
- [protocols/mqtt/ssl\\_mutual\\_auth](#): MQTT over tls using certificates for authentication, default port 8883
- [protocols/mqtt/ssl\\_psk](#): MQTT over tls using pre-shared keys for authentication, default port 8883.
- [protocols/mqtt/ws](#): MQTT over Websocket, default port 80
- [protocols/mqtt/wss](#): MQTT over Websocket Secure, default port 443

#### Configuration

The configuration is made by setting fields in `esp_mqtt_client_config_t` struct. The configuration struct has the following sub structs to configure different aspects of the client operation.

- `broker` - Allow to set address and security verification.
- `credentials` - Client credentials for authentication.
- `session` - Configuration for MQTT session aspects.
- `network` - Networking related configuration.
- `task` - Allow to configure FreeRTOS task.
- `buffer` - Buffer size for input and output.

In the following session the most common aspects are detailed.

#### Broker

**Address** Broker address can be set by usage of `broker.address` struct. The configuration can be made by usage of `uri` field or the combination of `hostname`, `transport` and `port`. Optionally, `path` could be set, this field is useful in websocket connections.

The `uri` field is used in the following format `scheme://hostname:port/path`. - Curently support `mqtt`, `mqttps`, `ws`, `wss` schemes - MQTT over TCP samples:

- `mqtt://mqtt.eclipseprojects.io`: MQTT over TCP, default port 1883:
- `mqtt://mqtt.eclipseprojects.io:1884` MQTT over TCP, port 1884:

- `mqtt://username:password@mqtt.eclipseprojects.io:1884` MQTT over TCP, port 1884, with username and password
- MQTT over SSL samples:
  - `mqttps://mqtt.eclipseprojects.io:MQTT over SSL, port 8883`
  - `mqttps://mqtt.eclipseprojects.io:8884:MQTT over SSL, port 8884`
- MQTT over Websocket samples:
  - `ws://mqtt.eclipseprojects.io:80/mqtt`
- MQTT over Websocket Secure samples:
  - `wss://mqtt.eclipseprojects.io:443/mqtt`
- Minimal configurations:

```
const esp_mqtt_client_config_t mqtt_cfg = {
    .broker.address.uri = "mqtt://mqtt.eclipseprojects.io",
};
esp_mqtt_client_handle_t client = esp_mqtt_client_init(&mqtt_cfg);
esp_mqtt_client_register_event(client, ESP_EVENT_ANY_ID, mqtt_event_handler,
    ↪client);
esp_mqtt_client_start(client);
```

- Note: By default mqtt client uses event loop library to post related mqtt events (connected, subscribed, published, etc.)

**Verification** For secure connections TLS is used, and to guarantee Broker's identity the `broker_verification` struct must be set. The broker certificate may be set in PEM or DER format. To select DER the equivalent `_len` field must be set, otherwise a NULL terminated string in PEM format should be provided to certificate field.

- Get certificate from server, example: `mqtt.eclipseprojects.io openssl s_client -showcerts -connect mqtt.eclipseprojects.io:8883 </dev/null 2>/dev/null|openssl x509 -outform PEM >mqtt_eclipse_org.pem`
- Check the sample application: `examples/mqtt_ssl`
- Configuration:

```
const esp_mqtt_client_config_t mqtt_cfg = {
    .broker = {
        .address.uri = "mqttps://mqtt.eclipseprojects.io:8883",
        .verification.certificate = (const char *)mqtt_eclipse_org_pem_start,
    },
};
```

To details on other fields check the Reference API and [TLS Server verification](#).

**Client Credentials** All client related credentials are under the `credentials` field.

- `username`: pointer to the username used for connecting to the broker, can also be set by URI.
- `client_id`: pointer to the client id, defaults to `ESP32_%CHIPID%` where `%CHIPID%` are the last 3 bytes of MAC address in hex format

**Authentication** It's possible to set authentication parameters through the `authentication` field. The client supports the following authentication methods:

- Using a password by setting `authentication.password`.
- Mutual authentication with TLS by setting `authentication.certificate` and `authentication.key`, both can be provided in PEM or DER format.
- Using secure element available in ESP32-WROOM-32SE, setting `authentication.use_secure_element`.
- Using Digital Signature Peripheral available in some Espressif devices, setting `authentication.ds_data`.

**Session** For MQTT session related configurations `session` fields should be used.

**Last Will and Testament** MQTT allows for a last will and testament (LWT) message to notify other clients when a client ungracefully disconnects. This is configured by the following fields in the `esp_mqtt_client_config_t.session.last_will`-struct.

- `topic`: pointer to the LWT message topic
- `msg`: pointer to the LWT message
- `msg_len`: length of the LWT message, required if `msg` is not null-terminated
- `qos`: quality of service for the LWT message
- `retain`: specifies the retain flag of the LWT message

**Change settings in Project Configuration Menu** The settings for MQTT can be found using `idf.py menuconfig`, under Component config -> ESP-MQTT Configuration

The following settings are available:

- `CONFIG_MQTT_PROTOCOL_311`: Enables 3.1.1 version of MQTT protocol
- `CONFIG_MQTT_TRANSPORT_SSL`, `CONFIG_MQTT_TRANSPORT_WEBSOCKET`: Enables specific MQTT transport layer, such as SSL, WEBSOCKET, WEBSOCKET\_SECURE
- `CONFIG_MQTT_CUSTOM_OUTBOX`: Disables default implementation of `mqtt_outbox`, so a specific implementation can be supplied

## Events

The following events may be posted by the MQTT client:

- `MQTT_EVENT_BEFORE_CONNECT`: The client is initialized and about to start connecting to the broker.
- `MQTT_EVENT_CONNECTED`: The client has successfully established a connection to the broker. The client is now ready to send and receive data.
- `MQTT_EVENT_DISCONNECTED`: The client has aborted the connection due to being unable to read or write data, e.g. because the server is unavailable.
- `MQTT_EVENT_SUBSCRIBED`: The broker has acknowledged the client's subscribe request. The event data will contain the message ID of the subscribe message.
- `MQTT_EVENT_UNSUBSCRIBED`: The broker has acknowledged the client's unsubscribe request. The event data will contain the message ID of the unsubscribe message.
- `MQTT_EVENT_PUBLISHED`: The broker has acknowledged the client's publish message. This will only be posted for Quality of Service level 1 and 2, as level 0 does not use acknowledgements. The event data will contain the message ID of the publish message.
- `MQTT_EVENT_DATA`: The client has received a publish message. The event data contains: message ID, name of the topic it was published to, received data and its length. For data that exceeds the internal buffer multiple `MQTT_EVENT_DATA` will be posted and `current_data_offset` and `total_data_len` from event data updated to keep track of the fragmented message.
- `MQTT_EVENT_ERROR`: The client has encountered an error. `esp_mqtt_error_type_t` from `error_handle` in the event data can be used to further determine the type of the error. The type of error will determine which parts of the `error_handle` struct is filled.

## API Reference

### Header File

- `components/mqtt/esp-mqtt/include/mqtt_client.h`

### Functions

`esp_mqtt_client_handle_t esp_mqtt_client_init` (const `esp_mqtt_client_config_t` \*config)

Creates *MQTT* client handle based on the configuration.

**Parameters** **config** –MQTT configuration structure

**Returns** mqtt\_client\_handle if successfully created, NULL on error

*esp\_err\_t* **esp\_mqtt\_client\_set\_uri** (*esp\_mqtt\_client\_handle\_t* client, const char \*uri)

Sets MQTT connection URI. This API is usually used to overrides the URI configured in esp\_mqtt\_client\_init.

**Parameters**

- **client** –MQTT client handle
- **uri** –

**Returns** ESP\_FAIL if URI parse error, ESP\_OK on success

*esp\_err\_t* **esp\_mqtt\_client\_start** (*esp\_mqtt\_client\_handle\_t* client)

Starts MQTT client with already created client handle.

**Parameters** **client** –MQTT client handle

**Returns** ESP\_OK on success ESP\_ERR\_INVALID\_ARG on wrong initialization ESP\_FAIL on other error

*esp\_err\_t* **esp\_mqtt\_client\_reconnect** (*esp\_mqtt\_client\_handle\_t* client)

This api is typically used to force reconnection upon a specific event.

**Parameters** **client** –MQTT client handle

**Returns** ESP\_OK on success ESP\_ERR\_INVALID\_ARG on wrong initialization ESP\_FAIL if client is in invalid state

*esp\_err\_t* **esp\_mqtt\_client\_disconnect** (*esp\_mqtt\_client\_handle\_t* client)

This api is typically used to force disconnection from the broker.

**Parameters** **client** –MQTT client handle

**Returns** ESP\_OK on success ESP\_ERR\_INVALID\_ARG on wrong initialization

*esp\_err\_t* **esp\_mqtt\_client\_stop** (*esp\_mqtt\_client\_handle\_t* client)

Stops MQTT client tasks.

- Notes:
- Cannot be called from the MQTT event handler

**Parameters** **client** –MQTT client handle

**Returns** ESP\_OK on success ESP\_ERR\_INVALID\_ARG on wrong initialization ESP\_FAIL if client is in invalid state

int **esp\_mqtt\_client\_subscribe** (*esp\_mqtt\_client\_handle\_t* client, const char \*topic, int qos)

Subscribe the client to defined topic with defined qos.

Notes:

- Client must be connected to send subscribe message
- This API is could be executed from a user task or from a MQTT event callback i.e. internal MQTT task (API is protected by internal mutex, so it might block if a longer data receive operation is in progress.

**Parameters**

- **client** –MQTT client handle
- **topic** –
- **qos** –// TODO describe parameters

**Returns** message\_id of the subscribe message on success -1 on failure

int **esp\_mqtt\_client\_unsubscribe** (*esp\_mqtt\_client\_handle\_t* client, const char \*topic)

Unsubscribe the client from defined topic.

Notes:

- Client must be connected to send unsubscribe message

- It is thread safe, please refer to `esp_mqtt_client_subscribe` for details

**Parameters**

- **client** –MQTT client handle
- **topic** –

**Returns** message\_id of the subscribe message on success -1 on failure

int `esp_mqtt_client_publish` (*esp\_mqtt\_client\_handle\_t* client, const char \*topic, const char \*data, int len, int qos, int retain)

Client to send a publish message to the broker.

Notes:

- This API might block for several seconds, either due to network timeout (10s) or if publishing payloads longer than internal buffer (due to message fragmentation)
- Client doesn't have to be connected for this API to work, enqueueing the messages with qos>1 (returning -1 for all the qos=0 messages if disconnected). If MQTT\_SKIP\_PUBLISH\_IF\_DISCONNECTED is enabled, this API will not attempt to publish when the client is not connected and will always return -1.
- It is thread safe, please refer to `esp_mqtt_client_subscribe` for details

**Parameters**

- **client** –MQTT client handle
- **topic** –topic string
- **data** –payload string (set to NULL, sending empty payload message)
- **len** –data length, if set to 0, length is calculated from payload string
- **qos** –QoS of publish message
- **retain** –retain flag

**Returns** message\_id of the publish message (for QoS 0 message\_id will always be zero) on success. -1 on failure.

int `esp_mqtt_client_enqueue` (*esp\_mqtt\_client\_handle\_t* client, const char \*topic, const char \*data, int len, int qos, int retain, bool store)

Enqueue a message to the outbox, to be sent later. Typically used for messages with qos>0, but could be also used for qos=0 messages if store=true.

This API generates and stores the publish message into the internal outbox and the actual sending to the network is performed in the mqtt-task context (in contrast to the `esp_mqtt_client_publish()` which sends the publish message immediately in the user task's context). Thus, it could be used as a non blocking version of `esp_mqtt_client_publish()`.

**Parameters**

- **client** –MQTT client handle
- **topic** –topic string
- **data** –payload string (set to NULL, sending empty payload message)
- **len** –data length, if set to 0, length is calculated from payload string
- **qos** –QoS of publish message
- **retain** –retain flag
- **store** –if true, all messages are enqueued; otherwise only QoS 1 and QoS 2 are enqueued

**Returns** message\_id if queued successfully, -1 otherwise

*esp\_err\_t* `esp_mqtt_client_destroy` (*esp\_mqtt\_client\_handle\_t* client)

Destroys the client handle.

Notes:

- Cannot be called from the MQTT event handler

**Parameters** **client** –MQTT client handle

**Returns** ESP\_OK ESP\_ERR\_INVALID\_ARG on wrong initialization

*esp\_err\_t* **esp\_mqtt\_set\_config** (*esp\_mqtt\_client\_handle\_t* client, const *esp\_mqtt\_client\_config\_t* \*config)

Set configuration structure, typically used when updating the config (i.e. on “before\_connect” event.

#### Parameters

- **client** –MQTT client handle
- **config** –MQTT configuration structure

**Returns** ESP\_ERR\_NO\_MEM if failed to allocate ESP\_ERR\_INVALID\_ARG if conflicts on transport configuration. ESP\_OK on success

*esp\_err\_t* **esp\_mqtt\_client\_register\_event** (*esp\_mqtt\_client\_handle\_t* client, *esp\_mqtt\_event\_id\_t* event, *esp\_event\_handler\_t* event\_handler, void \*event\_handler\_arg)

Registers MQTT event.

#### Parameters

- **client** –MQTT client handle
- **event** –event type
- **event\_handler** –handler callback
- **event\_handler\_arg** –handlers context

**Returns** ESP\_ERR\_NO\_MEM if failed to allocate ESP\_ERR\_INVALID\_ARG on wrong initialization ESP\_OK on success

int **esp\_mqtt\_client\_get\_outbox\_size** (*esp\_mqtt\_client\_handle\_t* client)

Get outbox size.

**Parameters** **client** –MQTT client handle

**Returns** outbox size 0 on wrong initialization

## Structures

struct **esp\_mqtt\_error\_codes**

MQTT error code structure to be passed as a contextual information into ERROR event

Important: This structure extends *esp\_tls\_last\_error* error structure and is backward compatible with it (so might be down-casted and treated as *esp\_tls\_last\_error* error, but recommended to update applications if used this way previously)

Use this structure directly checking error\_type first and then appropriate error code depending on the source of the error:

error_type	related member variables	note
MQTT_ERROR_TYPE_TCP_TRANSPORT	esp_tls_last_esp_err, esp_tls_stack_err, esp_tls_cert_verify_flags, sock_errno	Error reported from tcp_transport/esp-tls
MQTT_ERROR_TYPE_CONNECTION_REFUSED	connect_return_code	Internal error reported from MQTT broker on connection

## Public Members

*esp\_err\_t* **esp\_tls\_last\_esp\_err**

last esp\_err code reported from esp-tls component

int **esp\_tls\_stack\_err**

tls specific error code reported from underlying tls stack

int **esp\_tls\_cert\_verify\_flags**

tls flags reported from underlying tls stack during certificate verification

*esp\_mqtt\_error\_type\_t* **error\_type**

error type referring to the source of the error

*esp\_mqtt\_connect\_return\_code\_t* **connect\_return\_code**

connection refused error code reported from MQTT\* broker on connection

int **esp\_transport\_sock\_errno**

errno from the underlying socket

struct **esp\_mqtt\_event\_t**

*MQTT* event configuration structure

### Public Members

*esp\_mqtt\_event\_id\_t* **event\_id**

*MQTT* event type

*esp\_mqtt\_client\_handle\_t* **client**

*MQTT* client handle for this event

char \***data**

Data associated with this event

int **data\_len**

Length of the data for this event

int **total\_data\_len**

Total length of the data (longer data are supplied with multiple events)

int **current\_data\_offset**

Actual offset for the data associated with this event

char \***topic**

Topic associated with this event

int **topic\_len**

Length of the topic for this event associated with this event

int **msg\_id**

*MQTT* messaged id of message

int **session\_present**

*MQTT* session\_present flag for connection event

*esp\_mqtt\_error\_codes\_t* \***error\_handle**

esp-mqtt error handle including esp-tls errors as well as internal *MQTT* errors



bool **retain**

Retained flag of the message associated with this event

int **qos**

QoS of the messages associated with this event

bool **dup**

dup flag of the message associated with this event

*esp\_mqtt\_protocol\_ver\_t* **protocol\_ver**

MQTT protocol version used for connection, defaults to value from menuconfig

struct **esp\_mqtt\_client\_config\_t**

*MQTT* client configuration structure

- Default values can be set via menuconfig
- All certificates and key data could be passed in PEM or DER format. PEM format must have a terminating NULL character and the related len field set to 0. DER format requires a related len field set to the correct length.

### Public Members

struct *esp\_mqtt\_client\_config\_t::broker\_t* **broker**

Broker address and security verification

struct *esp\_mqtt\_client\_config\_t::credentials\_t* **credentials**

User credentials for broker

struct *esp\_mqtt\_client\_config\_t::session\_t* **session**

*MQTT* session configuration.

struct *esp\_mqtt\_client\_config\_t::network\_t* **network**

Network configuration

struct *esp\_mqtt\_client\_config\_t::task\_t* **task**

FreeRTOS task configuration.

struct *esp\_mqtt\_client\_config\_t::buffer\_t* **buffer**

Buffer size configuration.

struct **broker\_t**

Broker related configuration

### Public Members

struct *esp\_mqtt\_client\_config\_t::broker\_t::address\_t* **address**

Broker address configuration

```
struct esp_mqtt_client_config_t::broker_t::verification_t verification
```

Security verification of the broker

```
struct address_t
```

Broker address

- uri have precedence over other fields
- If uri isn't set at least hostname, transport and port should.

### Public Members

```
const char *uri
```

Complete *MQTT* broker URI

```
const char *hostname
```

Hostname, to set ipv4 pass it as string)

```
esp_mqtt_transport_t transport
```

Selects transport

```
const char *path
```

Path in the URI

```
uint32_t port
```

*MQTT* server port

```
struct verification_t
```

Broker identity verification

If fields are not set broker's identity isn't verified. it's recommended to set the options in this struct for security reasons.

### Public Members

```
bool use_global_ca_store
```

Use a global ca\_store, look esp-tls documentation for details.

```
esp_err_t (*crt_bundle_attach)(void *conf)
```

Pointer to ESP x509 Certificate Bundle attach function for the usage of certificate bundles.

```
const char *certificate
```

Certificate data, default is NULL, not required to verify the server.

```
size_t certificate_len
```

Length of the buffer pointed to by certificate.

const struct *psk\_key\_hint* \***psk\_hint\_key**

Pointer to PSK struct defined in esp\_tls.h to enable PSK authentication (as alternative to certificate verification). PSK is enabled only if there are no other ways to verify broker.

bool **skip\_cert\_common\_name\_check**

Skip any validation of server certificate CN field, this reduces the security of TLS and makes the *MQTT* client susceptible to MITM attacks

const char \*\***alpn\_protos**

NULL-terminated list of supported application protocols to be used for ALPN

struct **buffer\_t**

Client buffer size configuration

Client have two buffers for input and output respectively.

### Public Members

int **size**

size of *MQTT* send/receive buffer

int **out\_size**

size of *MQTT* output buffer. If not defined, defaults to the size defined by *buffer\_size*

struct **credentials\_t**

Client related credentials for authentication.

### Public Members

const char \***username**

*MQTT* username

const char \***client\_id**

Set *MQTT* client identifier. Ignored if *set\_null\_client\_id* == true If NULL set the default client id. Default client id is ESP32\_CHIPID% where CHIPID% are last 3 bytes of MAC address in hex format

bool **set\_null\_client\_id**

Selects a NULL client id

struct *esp\_mqtt\_client\_config\_t::credentials\_t::authentication\_t* **authentication**

Client authentication

struct **authentication\_t**

Client authentication

Fields related to client authentication by broker

For mutual authentication using TLS, user could select certificate and key, secure element or digital signature peripheral if available.

### Public Members

const char \***password**

*MQTT* password

const char \***certificate**

Certificate for ssl mutual authentication, not required if mutual authentication is not needed. Must be provided with *key*.

size\_t **certificate\_len**

Length of the buffer pointed to by *certificate*.

const char \***key**

Private key for SSL mutual authentication, not required if mutual authentication is not needed. If it is not NULL, also *certificate* has to be provided.

size\_t **key\_len**

Length of the buffer pointed to by *key*.

const char \***key\_password**

Client key decryption password, not PEM nor DER, if provided *key\_password\_len* must be correctly set.

int **key\_password\_len**

Length of the password pointed to by *key\_password*

bool **use\_secure\_element**

Enable secure element, available in ESP32-ROOM-32SE, for SSL connection

void \***ds\_data**

Carrier of handle for digital signature parameters, digital signature peripheral is available in some Espressif devices.

struct **network\_t**

Network related configuration

### Public Members

int **reconnect\_timeout\_ms**

Reconnect to the broker after this value in milliseconds if auto reconnect is not disabled (defaults to 10s)

int **timeout\_ms**

Abort network operation if it is not completed after this value, in milliseconds (defaults to 10s).

int **refresh\_connection\_after\_ms**

Refresh connection after this value (in milliseconds)

bool **disable\_auto\_reconnect**

Client will reconnect to server (when errors/disconnect). Set `disable_auto_reconnect=true` to disable

struct **session\_t**

*MQTT* Session related configuration

### Public Members

struct *esp\_mqtt\_client\_config\_t::session\_t::last\_will\_t* **last\_will**

Last will configuration

bool **disable\_clean\_session**

*MQTT* clean session, default `clean_session` is true

int **keepalive**

*MQTT* keepalive, default is 120 seconds

bool **disable\_keepalive**

Set `disable_keepalive=true` to turn off keep-alive mechanism, keepalive is active by default. Note: setting the config value `keepalive` to 0 doesn't disable keepalive feature, but uses a default keepalive period

*esp\_mqtt\_protocol\_ver\_t* **protocol\_ver**

*MQTT* protocol version used for connection.

int **message\_retransmit\_timeout**

timeout for retransmitting of failed packet

struct **last\_will\_t**

Last Will and Testament message configuration.

### Public Members

const char **\*topic**

LWT (Last Will and Testament) message topic

const char **\*msg**

LWT message, may be NULL terminated

int **msg\_len**

LWT message length, if `msg` isn't NULL terminated must have the correct length

int **qos**

LWT message QoS

int **retain**

LWT retained message flag

struct **task\_t**  
Client task configuration

### Public Members

int **priority**  
*MQTT* task priority

int **stack\_size**  
*MQTT* task stack size

### Macros

#### **MQTT\_ERROR\_TYPE\_ESP\_TLS**

**MQTT\_ERROR\_TYPE\_TCP\_TRANSPORT** error type hold all sorts of transport layer errors, including ESP-TLS error, but in the past only the errors from **MQTT\_ERROR\_TYPE\_ESP\_TLS** layer were reported, so the ESP-TLS error type is re-defined here for backward compatibility

### Type Definitions

typedef struct esp\_mqtt\_client \***esp\_mqtt\_client\_handle\_t**

typedef enum *esp\_mqtt\_event\_id\_t* **esp\_mqtt\_event\_id\_t**

*MQTT* event types.

User event handler receives context data in *esp\_mqtt\_event\_t* structure with

- *client* - *MQTT* client handle
- various other data depending on event type

typedef enum *esp\_mqtt\_connect\_return\_code\_t* **esp\_mqtt\_connect\_return\_code\_t**

*MQTT* connection error codes propagated via ERROR event

typedef enum *esp\_mqtt\_error\_type\_t* **esp\_mqtt\_error\_type\_t**

*MQTT* connection error codes propagated via ERROR event

typedef enum *esp\_mqtt\_transport\_t* **esp\_mqtt\_transport\_t**

typedef enum *esp\_mqtt\_protocol\_ver\_t* **esp\_mqtt\_protocol\_ver\_t**

*MQTT* protocol version used for connection

typedef struct *esp\_mqtt\_error\_codes* **esp\_mqtt\_error\_codes\_t**

*MQTT* error code structure to be passed as a contextual information into ERROR event

Important: This structure extends *esp\_tls\_last\_error* error structure and is backward compatible with it (so might be down-casted and treated as *esp\_tls\_last\_error* error, but recommended to update applications if used this way previously)

Use this structure directly checking *error\_type* first and then appropriate error code depending on the source of the error:

| *error\_type* | related member variables | note | | **MQTT\_ERROR\_TYPE\_TCP\_TRANSPORT** |  
*esp\_tls\_last\_esp\_err*, *esp\_tls\_stack\_err*, *esp\_tls\_cert\_verify\_flags*, *sock\_errno* | Error reported from

tcp\_transport/esp-tls || MQTT\_ERROR\_TYPE\_CONNECTION\_REFUSED | connect\_return\_code | Internal error reported from *MQTT* broker on connection |

typedef struct *esp\_mqtt\_event\_t* **esp\_mqtt\_event\_t**

*MQTT* event configuration structure

typedef *esp\_mqtt\_event\_t* \***esp\_mqtt\_event\_handle\_t**

typedef *esp\_err\_t* (\***mqtt\_event\_callback\_t**)(*esp\_mqtt\_event\_handle\_t* event)

typedef struct *esp\_mqtt\_client\_config\_t* **esp\_mqtt\_client\_config\_t**

*MQTT* client configuration structure

- Default values can be set via menuconfig
- All certificates and key data could be passed in PEM or DER format. PEM format must have a terminating NULL character and the related len field set to 0. DER format requires a related len field set to the correct length.

## Enumerations

enum **esp\_mqtt\_event\_id\_t**

*MQTT* event types.

User event handler receives context data in *esp\_mqtt\_event\_t* structure with

- *client* - *MQTT* client handle
- various other data depending on event type

*Values:*

enumerator **MQTT\_EVENT\_ANY**

enumerator **MQTT\_EVENT\_ERROR**

on error event, additional context: connection return code, error handle from *esp\_tls* (if supported)

enumerator **MQTT\_EVENT\_CONNECTED**

connected event, additional context: *session\_present* flag

enumerator **MQTT\_EVENT\_DISCONNECTED**

disconnected event

enumerator **MQTT\_EVENT\_SUBSCRIBED**

subscribed event, additional context:

- *msg\_id* message id
- data pointer to the received data
- *data\_len* length of the data for this event

enumerator **MQTT\_EVENT\_UNSUBSCRIBED**

unsubscribed event

enumerator **MQTT\_EVENT\_PUBLISHED**

published event, additional context: `msg_id`

enumerator **MQTT\_EVENT\_DATA**

data event, additional context:

- `msg_id` message id
- topic pointer to the received topic
- `topic_len` length of the topic
- data pointer to the received data
- `data_len` length of the data for this event
- `current_data_offset` offset of the current data for this event
- `total_data_len` total length of the data received
- `retain` retain flag of the message
- `qos` QoS level of the message
- `dup` dup flag of the message Note: Multiple **MQTT\_EVENT\_DATA** could be fired for one message, if it is longer than internal buffer. In that case only first event contains topic pointer and length, other contain data only with current data length and current data offset updating.

enumerator **MQTT\_EVENT\_BEFORE\_CONNECT**

The event occurs before connecting

enumerator **MQTT\_EVENT\_DELETED**

Notification on delete of one message from the internal outbox, if the message couldn't have been sent and acknowledged before expiring defined in `OUTBOX_EXPIRED_TIMEOUT_MS`. (events are not posted upon deletion of successfully acknowledged messages)

- This event id is posted only if `MQTT_REPORT_DELETED_MESSAGES==1`
- Additional context: `msg_id` (id of the deleted message).

enum **esp\_mqtt\_connect\_return\_code\_t**

*MQTT* connection error codes propagated via ERROR event

*Values:*

enumerator **MQTT\_CONNECTION\_ACCEPTED**

Connection accepted

enumerator **MQTT\_CONNECTION\_REFUSE\_PROTOCOL**

*MQTT* connection refused reason: Wrong protocol

enumerator **MQTT\_CONNECTION\_REFUSE\_ID\_REJECTED**

*MQTT* connection refused reason: ID rejected

enumerator **MQTT\_CONNECTION\_REFUSE\_SERVER\_UNAVAILABLE**

*MQTT* connection refused reason: Server unavailable

enumerator **MQTT\_CONNECTION\_REFUSE\_BAD\_USERNAME**

*MQTT* connection refused reason: Wrong user

enumerator **MQTT\_CONNECTION\_REFUSE\_NOT\_AUTHORIZED**

*MQTT* connection refused reason: Wrong username or password



enum **esp\_mqtt\_error\_type\_t**

*MQTT* connection error codes propagated via ERROR event

*Values:*

enumerator **MQTT\_ERROR\_TYPE\_NONE**

enumerator **MQTT\_ERROR\_TYPE\_TCP\_TRANSPORT**

enumerator **MQTT\_ERROR\_TYPE\_CONNECTION\_REFUSED**

enum **esp\_mqtt\_transport\_t**

*Values:*

enumerator **MQTT\_TRANSPORT\_UNKNOWN**

enumerator **MQTT\_TRANSPORT\_OVER\_TCP**

*MQTT* over TCP, using scheme: **MQTT**

enumerator **MQTT\_TRANSPORT\_OVER\_SSL**

*MQTT* over SSL, using scheme: **MQTTS**

enumerator **MQTT\_TRANSPORT\_OVER\_WS**

*MQTT* over Websocket, using scheme: **ws**

enumerator **MQTT\_TRANSPORT\_OVER\_WSS**

*MQTT* over Websocket Secure, using scheme: **wss**

enum **esp\_mqtt\_protocol\_ver\_t**

*MQTT* protocol version used for connection

*Values:*

enumerator **MQTT\_PROTOCOL\_UNDEFINED**

enumerator **MQTT\_PROTOCOL\_V\_3\_1**

enumerator **MQTT\_PROTOCOL\_V\_3\_1\_1**

enumerator **MQTT\_PROTOCOL\_V\_5**

## 2.2.4 ESP-TLS

### Overview

The ESP-TLS component provides a simplified API interface for accessing the commonly used TLS functionality. It supports common scenarios like CA certification validation, SNI, ALPN negotiation, non-blocking connection among others. All the configuration can be specified in the `esp_tls_cfg_t` data structure. Once done, TLS communication can be conducted using the following APIs:

- `esp_tls_init()`: for initializing the TLS connection handle.
- `esp_tls_conn_new_sync()`: for opening a new blocking TLS connection.
- `esp_tls_conn_new_async()`: for opening a new non-blocking TLS connection.
- `esp_tls_conn_read()`: for reading from the connection.
- `esp_tls_conn_write()`: for writing into the connection.
- `esp_tls_conn_destroy()`: for freeing up the connection.

Any application layer protocol like HTTP1, HTTP2 etc can be executed on top of this layer.

### Application Example

Simple HTTPS example that uses ESP-TLS to establish a secure socket connection: [protocols/https\\_request](#).

### Tree structure for ESP-TLS component

```

├── esp_tls.c
├── esp_tls.h
├── esp_tls_mbedtls.c
├── esp_tls_wolfssl.c
├── private_include
│   ├── esp_tls_mbedtls.h
│   └── esp_tls_wolfssl.h

```

The ESP-TLS component has a file `esp-tls/esp_tls.h` which contain the public API headers for the component. Internally ESP-TLS component uses one of the two SSL/TLS Libraries between `mbedtls` and `wolfssl` for its operation. API specific to `mbedtls` are present in `esp-tls/private_include/esp_tls_mbedtls.h` and API specific to `wolfssl` are present in `esp-tls/private_include/esp_tls_wolfssl.h`.

### TLS Server verification

The ESP-TLS provides multiple options for TLS server verification on the client side. The ESP-TLS client can verify the server by validating the peer's server certificate or with the help of pre-shared keys. The user should select only one of the following options in the `esp_tls_cfg_t` structure for TLS server verification. If no option is selected then client will return a fatal error by default at the time of the TLS connection setup.

- **cacert\_buf** and **cacert\_bytes**: The CA certificate can be provided in a buffer to the `esp_tls_cfg_t` structure. The ESP-TLS will use the CA certificate present in the buffer to verify the server. The following variables in `esp_tls_cfg_t` structure must be set.
  - `cacert_buf` - pointer to the buffer which contains the CA cert.
  - `cacert_bytes` - size of the CA certificate in bytes.
- **use\_global\_ca\_store**: The `global_ca_store` can be initialized and set at once. Then it can be used to verify the server for all the ESP-TLS connections which have set `use_global_ca_store = true` in their respective `esp_tls_cfg_t` structure. See API Reference section below on information regarding different API used for initializing and setting up the `global_ca_store`.
- **crt\_bundle\_attach**: The ESP x509 Certificate Bundle API provides an easy way to include a bundle of custom x509 root certificates for TLS server verification. More details can be found at [ESP x509 Certificate Bundle](#)
- **psk\_hint\_key**: To use pre-shared keys for server verification, `CONFIG_ESP_TLS_PSK_VERIFICATION` should be enabled in the ESP-TLS menuconfig. Then the pointer to PSK hint and key should be provided to the `esp_tls_cfg_t` structure. The ESP-TLS will use the PSK for server verification only when no other option regarding the server verification is selected.
- **skip server verification**: This is an insecure option provided in the ESP-TLS for testing purpose. The option can be set by enabling `CONFIG_ESP_TLS_INSECURE` and `CONFIG_ESP_TLS_SKIP_SERVER_CERT_VERIFY` in the ESP-TLS menuconfig. When this option is enabled the ESP-TLS will skip server verification by default when no other options for server verification are selected in the `esp_tls_cfg_t` structure. *WARNING:Enabling this option comes with a potential risk of establishing a TLS connection with a server which has a fake identity, provided that the server certificate is not provided either through API or other mechanism like ca\_store etc.*

### ESP-TLS Server cert selection hook

The ESP-TLS component provides an option to set the server cert selection hook when using the mbedTLS stack. This provides an ability to configure and use a certificate selection callback during server handshake, to select a certificate to present to the client based on the TLS extensions supplied in the client hello (alpn, sni, etc). To enable this feature, please enable `CONFIG_ESP_TLS_SERVER_CERT_SELECT_HOOK` in the ESP-TLS menuconfig. The certificate selection callback can be configured in the `esp_tls_cfg_t` structure as follows:

```
int cert_selection_callback(mbedtls_ssl_context *ssl)
{
    /* Code that the callback should execute */
    return 0;
}

esp_tls_cfg_t cfg = {
    cert_select_cb = cert_section_callback,
};
```

### Underlying SSL/TLS Library Options

The ESP-TLS component has an option to use mbedtls or wolfssl as their underlying SSL/TLS library. By default only mbedtls is available and is used, wolfssl SSL/TLS library is available publicly at <https://github.com/espressif/esp-wolfssl>. The repository provides wolfssl component in binary format, it also provides few examples which are useful for understanding the API. Please refer the repository README.md for information on licensing and other options. Please see below option for using wolfssl in your project.

---

**Note:** *As the library options are internal to ESP-TLS, switching the libraries will not change ESP-TLS specific code for a project.*

---

### How to use wolfssl with ESP-IDF

There are two ways to use wolfssl in your project

- 1) Directly add wolfssl as a component in your project with following three commands.:

```
(First change directory (cd) to your project directory)
mkdir components
cd components
git clone https://github.com/espressif/esp-wolfssl.git
```

- 2) Add wolfssl as an extra component in your project.

- Download wolfssl with:

```
git clone https://github.com/espressif/esp-wolfssl.git
```

- Include esp-wolfssl in ESP-IDF with setting `EXTRA_COMPONENT_DIRS` in CMakeLists.txt of your project as done in [wolfssl/examples](#). For reference see Optional Project variables in [build-system](#).

After above steps, you will have option to choose wolfssl as underlying SSL/TLS library in configuration menu of your project as follows:

```
idf.py menuconfig -> ESP-TLS -> choose SSL/TLS Library -> mbedtls/wolfssl
```

### Comparison between mbedtls and wolfssl

The following table shows a typical comparison between wolfssl and mbedtls when [protocols/https\\_request](#) example (which has server authentication) was run with both SSL/TLS libraries and with all respective configurations

set to default. (*mbedtls IN\_CONTENT length and OUT\_CONTENT length were set to 16384 bytes and 4096 bytes respectively*)

Property	Wolfssl	Mbedtls
Total Heap Consumed	~19 Kb	~37 Kb
Task Stack Used	~2.2 Kb	~3.6 Kb
Bin size	~858 Kb	~736 Kb

**Note:** *These values are subject to change with change in configuration options and version of respective libraries.*

## Digital Signature with ESP-TLS

ESP-TLS provides support for using the Digital Signature (DS) with ESP32-S2. Use of the DS for TLS is supported only when ESP-TLS is used with mbedTLS (default stack) as its underlying SSL/TLS stack. For more details on Digital Signature, please refer to the [Digital Signature Documentation](#). The technical details of Digital Signature such as how to calculate private key parameters can be found in *ESP32-S2 Technical Reference Manual > Digital Signature (DS)* [PDF]. The DS peripheral must be configured before it can be used to perform Digital Signature, see *Configure the DS Peripheral* in [Digital Signature](#).

The DS peripheral must be initialized with the required encrypted private key parameters (obtained when the DS peripheral is configured). ESP-TLS internally initializes the DS peripheral when provided with the required DS context (DS parameters). Please see the below code snippet for passing the DS context to esp-tls context. The DS context passed to the esp-tls context should not be freed till the TLS connection is deleted.

```
#include "esp_tls.h"
esp_ds_data_ctx_t *ds_ctx;
/* initialize ds_ctx with encrypted private key parameters, which can be read from
↳the nvs or
provided through the application code */
esp_tls_cfg_t cfg = {
    .clientcert_buf = /* the client cert */,
    .clientcert_bytes = /* length of the client cert */,
    /* other configurations options */
    .ds_data = (void *)ds_ctx,
};
```

**Note:** When using Digital Signature for the TLS connection, along with the other required params, only the client cert (*clientcert\_buf*) and the DS params (*ds\_data*) are required and the client key (*clientkey\_buf*) can be set to NULL.

- An example of mutual authentication with the DS peripheral can be found at [ssl mutual auth](#) which internally uses (ESP-TLS) for the TLS connection.

## API Reference

### Header File

- `components/esp-tls/esp_tls.h`

### Functions

`esp_tls_t *esp_tls_init` (void)

Create TLS connection.

This function allocates and initializes esp-tls structure handle.

**Returns** tls Pointer to esp-tls as esp-tls handle if successfully initialized, NULL if allocation error

*esp\_tls\_t* \***esp\_tls\_conn\_http\_new** (const char \*url, const *esp\_tls\_cfg\_t* \*cfg)

Create a new blocking TLS/SSL connection with a given “HTTP” url.

Note: This API is present for backward compatibility reasons. Alternative function with the same functionality is *esp\_tls\_conn\_http\_new\_sync* (and its asynchronous version *esp\_tls\_conn\_http\_new\_async*)

#### Parameters

- **url** –[in] url of host.
- **cfg** –[in] TLS configuration as *esp\_tls\_cfg\_t*. If you wish to open non-TLS connection, keep this NULL. For TLS connection, a pass pointer to ‘*esp\_tls\_cfg\_t*’. At a minimum, this structure should be zero-initialized.

**Returns** pointer to *esp\_tls\_t*, or NULL if connection couldn’t be opened.

int **esp\_tls\_conn\_new\_sync** (const char \*hostname, int hostlen, int port, const *esp\_tls\_cfg\_t* \*cfg, *esp\_tls\_t* \*tls)

Create a new blocking TLS/SSL connection.

This function establishes a TLS/SSL connection with the specified host in blocking manner.

#### Parameters

- **hostname** –[in] Hostname of the host.
- **hostlen** –[in] Length of hostname.
- **port** –[in] Port number of the host.
- **cfg** –[in] TLS configuration as *esp\_tls\_cfg\_t*. If you wish to open non-TLS connection, keep this NULL. For TLS connection, a pass pointer to *esp\_tls\_cfg\_t*. At a minimum, this structure should be zero-initialized.
- **tls** –[in] Pointer to esp-tls as esp-tls handle.

#### Returns

- -1 If connection establishment fails.
- 1 If connection establishment is successful.
- 0 If connection state is in progress.

int **esp\_tls\_conn\_http\_new\_sync** (const char \*url, const *esp\_tls\_cfg\_t* \*cfg, *esp\_tls\_t* \*tls)

Create a new blocking TLS/SSL connection with a given “HTTP” url.

The behaviour is same as *esp\_tls\_conn\_new\_sync*() API. However this API accepts host’s url.

#### Parameters

- **url** –[in] url of host.
- **cfg** –[in] TLS configuration as *esp\_tls\_cfg\_t*. If you wish to open non-TLS connection, keep this NULL. For TLS connection, a pass pointer to ‘*esp\_tls\_cfg\_t*’. At a minimum, this structure should be zero-initialized.
- **tls** –[in] Pointer to esp-tls as esp-tls handle.

#### Returns

- -1 If connection establishment fails.
- 1 If connection establishment is successful.
- 0 If connection state is in progress.

int **esp\_tls\_conn\_new\_async** (const char \*hostname, int hostlen, int port, const *esp\_tls\_cfg\_t* \*cfg, *esp\_tls\_t* \*tls)

Create a new non-blocking TLS/SSL connection.

This function initiates a non-blocking TLS/SSL connection with the specified host, but due to its non-blocking nature, it doesn’t wait for the connection to get established.

#### Parameters

- **hostname** –[in] Hostname of the host.
- **hostlen** –[in] Length of hostname.
- **port** –[in] Port number of the host.
- **cfg** –[in] TLS configuration as *esp\_tls\_cfg\_t*. *non\_block* member of this structure should be set to be true.
- **tls** –[in] pointer to esp-tls as esp-tls handle.

**Returns**

- -1 If connection establishment fails.
- 0 If connection establishment is in progress.
- 1 If connection establishment is successful.

int **esp\_tls\_conn\_http\_new\_async** (const char \*url, const *esp\_tls\_cfg\_t* \*cfg, *esp\_tls\_t* \*tls)

Create a new non-blocking TLS/SSL connection with a given “HTTP” url.

The behaviour is same as esp\_tls\_conn\_new\_async() API. However this API accepts host’s url.

**Parameters**

- **url** –[in] url of host.
- **cfg** –[in] TLS configuration as esp\_tls\_cfg\_t.
- **tls** –[in] pointer to esp-tls as esp-tls handle.

**Returns**

- -1 If connection establishment fails.
- 0 If connection establishment is in progress.
- 1 If connection establishment is successful.

ssize\_t **esp\_tls\_conn\_write** (*esp\_tls\_t* \*tls, const void \*data, size\_t datalen)

Write from buffer ‘data’ into specified tls connection.

**Parameters**

- **tls** –[in] pointer to esp-tls as esp-tls handle.
- **data** –[in] Buffer from which data will be written.
- **datalen** –[in] Length of data buffer.

**Returns**

- >=0 if write operation was successful, the return value is the number of bytes actually written to the TLS/SSL connection.
- <0 if write operation was not successful, because either an error occurred or an action must be taken by the calling process.
- ESP\_TLS\_ERR\_SSL\_WANT\_READ/ ESP\_TLS\_ERR\_SSL\_WANT\_WRITE. if the handshake is incomplete and waiting for data to be available for reading. In this case this functions needs to be called again when the underlying transport is ready for operation.

ssize\_t **esp\_tls\_conn\_read** (*esp\_tls\_t* \*tls, void \*data, size\_t datalen)

Read from specified tls connection into the buffer ‘data’ .

**Parameters**

- **tls** –[in] pointer to esp-tls as esp-tls handle.
- **data** –[in] Buffer to hold read data.
- **datalen** –[in] Length of data buffer.

**Returns**

- >0 if read operation was successful, the return value is the number of bytes actually read from the TLS/SSL connection.
- 0 if read operation was not successful. The underlying connection was closed.
- <0 if read operation was not successful, because either an error occurred or an action must be taken by the calling process.

int **esp\_tls\_conn\_destroy** (*esp\_tls\_t* \*tls)

Close the TLS/SSL connection and free any allocated resources.

This function should be called to close each tls connection opened with esp\_tls\_conn\_new\_sync() (or esp\_tls\_conn\_http\_new\_sync()) and esp\_tls\_conn\_new\_async() (or esp\_tls\_conn\_http\_new\_async()) APIs.

**Parameters** **tls** –[in] pointer to esp-tls as esp-tls handle.

**Returns** - 0 on success

- -1 if socket error or an invalid argument

ssize\_t **esp\_tls\_get\_bytes\_avail** (*esp\_tls\_t* \*tls)

Return the number of application data bytes remaining to be read from the current record.

This API is a wrapper over mbedtls’s mbedtls\_ssl\_get\_bytes\_avail() API.

**Parameters** **tls** **–[in]** pointer to esp-tls as esp-tls handle.

**Returns**

- -1 in case of invalid arg
- bytes available in the application data record read buffer

*esp\_err\_t* **esp\_tls\_get\_conn\_sockfd** (*esp\_tls\_t* \*tls, int \*sockfd)

Returns the connection socket file descriptor from esp\_tls session.

**Parameters**

- **tls** **–[in]** handle to esp\_tls context
- **sockfd** **–[out]** int pointer to sockfd value.

**Returns** - ESP\_OK on success and value of sockfd will be updated with socket file descriptor for connection

- ESP\_ERR\_INVALID\_ARG if (tls == NULL || sockfd == NULL)

void \***esp\_tls\_get\_ssl\_context** (*esp\_tls\_t* \*tls)

Returns the ssl context.

**Parameters** **tls** **–[in]** handle to esp\_tls context

**Returns** - ssl\_ctx pointer to ssl context of underlying TLS layer on success

- NULL in case of error

*esp\_err\_t* **esp\_tls\_init\_global\_ca\_store** (void)

Create a global CA store, initially empty.

This function should be called if the application wants to use the same CA store for multiple connections. This function initialises the global CA store which can be then set by calling `esp_tls_set_global_ca_store()`. To be effective, this function must be called before any call to `esp_tls_set_global_ca_store()`.

**Returns**

- ESP\_OK if creating global CA store was successful.
- ESP\_ERR\_NO\_MEM if an error occurred when allocating the mbedTLS resources.

*esp\_err\_t* **esp\_tls\_set\_global\_ca\_store** (const unsigned char \*cacert\_pem\_buf, const unsigned int cacert\_pem\_bytes)

Set the global CA store with the buffer provided in pem format.

This function should be called if the application wants to set the global CA store for multiple connections i.e. to add the certificates in the provided buffer to the certificate chain. This function implicitly calls `esp_tls_init_global_ca_store()` if it has not already been called. The application must call this function before calling `esp_tls_conn_new()`.

**Parameters**

- **cacert\_pem\_buf** **–[in]** Buffer which has certificates in pem format. This buffer is used for creating a global CA store, which can be used by other tls connections.
- **cacert\_pem\_bytes** **–[in]** Length of the buffer.

**Returns**

- ESP\_OK if adding certificates was successful.
- Other if an error occurred or an action must be taken by the calling process.

void **esp\_tls\_free\_global\_ca\_store** (void)

Free the global CA store currently being used.

The memory being used by the global CA store to store all the parsed certificates is freed up. The application can call this API if it no longer needs the global CA store.

*esp\_err\_t* **esp\_tls\_get\_and\_clear\_last\_error** (*esp\_tls\_error\_handle\_t* h, int \*esp\_tls\_code, int \*esp\_tls\_flags)

Returns last error in esp\_tls with detailed mbedtls related error codes. The error information is cleared internally upon return.

**Parameters**

- **h** **–[in]** esp-tls error handle.

- **esp\_tls\_code** –[out] last error code returned from mbedtls api (set to zero if none)  
This pointer could be NULL if caller does not care about esp\_tls\_code
- **esp\_tls\_flags** –[out] last certification verification flags (set to zero if none) This pointer could be NULL if caller does not care about esp\_tls\_code

**Returns**

- ESP\_ERR\_INVALID\_STATE if invalid parameters
- ESP\_OK (0) if no error occurred
- specific error code (based on ESP\_ERR\_ESP\_TLS\_BASE) otherwise

*esp\_err\_t* **esp\_tls\_get\_and\_clear\_error\_type** (*esp\_tls\_error\_handle\_t* h, *esp\_tls\_error\_type\_t* err\_type, int \*error\_code)

Returns the last error captured in esp\_tls of a specific type The error information is cleared internally upon return.

**Parameters**

- **h** –[in] esp-tls error handle.
- **err\_type** –[in] specific error type
- **error\_code** –[out] last error code returned from mbedtls api (set to zero if none) This pointer could be NULL if caller does not care about esp\_tls\_code

**Returns**

- ESP\_ERR\_INVALID\_STATE if invalid parameters
- ESP\_OK if a valid error returned and was cleared

*esp\_err\_t* **esp\_tls\_get\_error\_handle** (*esp\_tls\_t* \*tls, *esp\_tls\_error\_handle\_t* \*error\_handle)

Returns the ESP-TLS error\_handle.

**Parameters**

- **tls** –[in] handle to esp\_tls context
- **error\_handle** –[out] pointer to the error handle.

**Returns**

- ESP\_OK on success and error\_handle will be updated with the ESP-TLS error handle.
- ESP\_ERR\_INVALID\_ARG if (tls == NULL || error\_handle == NULL)

*mbedtls\_x509\_crt* \***esp\_tls\_get\_global\_ca\_store** (void)

Get the pointer to the global CA store currently being used.

The application must first call esp\_tls\_set\_global\_ca\_store(). Then the same CA store could be used by the application for APIs other than esp\_tls.

---

**Note:** Modifying the pointer might cause a failure in verifying the certificates.

---

**Returns**

- Pointer to the global CA store currently being used if successful.
- NULL if there is no global CA store set.

*esp\_err\_t* **esp\_tls\_plain\_tcp\_connect** (const char \*host, int hostlen, int port, const *esp\_tls\_cfg\_t* \*cfg, *esp\_tls\_error\_handle\_t* error\_handle, int \*sockfd)

Creates a plain TCP connection, returning a valid socket fd on success or an error handle.

**Parameters**

- **host** –[in] Hostname of the host.
- **hostlen** –[in] Length of hostname.
- **port** –[in] Port number of the host.
- **cfg** –[in] ESP-TLS configuration as esp\_tls\_cfg\_t.
- **error\_handle** –[out] ESP-TLS error handle holding potential errors occurred during connection
- **sockfd** –[out] Socket descriptor if successfully connected on TCP layer

**Returns** ESP\_OK on success ESP\_ERR\_INVALID\_ARG if invalid output parameters ESP-TLS based error codes on failure



## Structures

struct **psk\_key\_hint**

ESP-TLS preshared key and hint structure.

### Public Members

const uint8\_t \***key**

key in PSK authentication mode in binary format

const size\_t **key\_size**

length of the key

const char \***hint**

hint in PSK authentication mode in string format

struct **tls\_keep\_alive\_cfg**

esp-tls client session ticket ctx

Keep alive parameters structure

### Public Members

bool **keep\_alive\_enable**

Enable keep-alive timeout

int **keep\_alive\_idle**

Keep-alive idle time (second)

int **keep\_alive\_interval**

Keep-alive interval time (second)

int **keep\_alive\_count**

Keep-alive packet retry send count

struct **esp\_tls\_cfg**

ESP-TLS configuration parameters.

---

**Note:** Note about format of certificates:

- This structure includes certificates of a Certificate Authority, of client or server as well as private keys, which may be of PEM or DER format. In case of PEM format, the buffer must be NULL terminated (with NULL character included in certificate size).
  - Certificate Authority's certificate may be a chain of certificates in case of PEM format, but could be only one certificate in case of DER format
  - Variables names of certificates and private key buffers and sizes are defined as unions providing backward compatibility for legacy \*\_pem\_buf and \*\_pem\_bytes names which suggested only PEM format was supported. It is encouraged to use generic names such as cacert\_buf and cacert\_bytes.
-

## Public Members

const char **\*\*alpn\_protos**

Application protocols required for HTTP2. If HTTP2/ALPN support is required, a list of protocols that should be negotiated. The format is length followed by protocol name. For the most common cases the following is ok: const char **\*\*alpn\_protos** = { "h2", NULL };

- where 'h2' is the protocol name

const unsigned char **\*cacert\_buf**

Certificate Authority's certificate in a buffer. Format may be PEM or DER, depending on mbedtls-support This buffer should be NULL terminated in case of PEM

const unsigned char **\*cacert\_pem\_buf**

CA certificate buffer legacy name

unsigned int **cacert\_bytes**

Size of Certificate Authority certificate pointed to by cacert\_buf (including NULL-terminator in case of PEM format)

unsigned int **cacert\_pem\_bytes**

Size of Certificate Authority certificate legacy name

const unsigned char **\*clientcert\_buf**

Client certificate in a buffer Format may be PEM or DER, depending on mbedtls-support This buffer should be NULL terminated in case of PEM

const unsigned char **\*clientcert\_pem\_buf**

Client certificate legacy name

unsigned int **clientcert\_bytes**

Size of client certificate pointed to by clientcert\_pem\_buf (including NULL-terminator in case of PEM format)

unsigned int **clientcert\_pem\_bytes**

Size of client certificate legacy name

const unsigned char **\*clientkey\_buf**

Client key in a buffer Format may be PEM or DER, depending on mbedtls-support This buffer should be NULL terminated in case of PEM

const unsigned char **\*clientkey\_pem\_buf**

Client key legacy name

unsigned int **clientkey\_bytes**

Size of client key pointed to by clientkey\_pem\_buf (including NULL-terminator in case of PEM format)

unsigned int **clientkey\_pem\_bytes**

Size of client key legacy name

const unsigned char **\*clientkey\_password**

Client key decryption password string

unsigned int **clientkey\_password\_len**

String length of the password pointed to by clientkey\_password

bool **non\_block**

Configure non-blocking mode. If set to true the underneath socket will be configured in non blocking mode after tls session is established

bool **use\_secure\_element**

Enable this option to use secure element or atec608a chip ( Integrated with ESP32-WROOM-32SE )

int **timeout\_ms**

Network timeout in milliseconds. Note: If this value is not set, by default the timeout is set to 10 seconds. If you wish that the session should wait indefinitely then please use a larger value e.g., INT32\_MAX

bool **use\_global\_ca\_store**

Use a global ca\_store for all the connections in which this bool is set.

const char **\*common\_name**

If non-NULL, server certificate CN must match this name. If NULL, server certificate CN must match hostname.

bool **skip\_common\_name**

Skip any validation of server certificate CN field

*tls\_keep\_alive\_cfg\_t* **\*keep\_alive\_cfg**

Enable TCP keep-alive timeout for SSL connection

const *psk\_hint\_key\_t* **\*psk\_hint\_key**

Pointer to PSK hint and key. if not NULL (and certificates are NULL) then PSK authentication is enabled with configured setup. Important note: the pointer must be valid for connection

*esp\_err\_t* (**\*crt\_bundle\_attach**)(void \*conf)

Function pointer to esp\_cert\_bundle\_attach. Enables the use of certification bundle for server verification, must be enabled in menuconfig

void **\*ds\_data**

Pointer for digital signature peripheral context

bool **is\_plain\_tcp**

Use non-TLS connection: When set to true, the esp-tls uses plain TCP transport rather than TLS/SSL connection. Note, that it is possible to connect using a plain tcp transport directly with esp\_tls\_plain\_tcp\_connect() API

struct ifreq **\*if\_name**

The name of interface for data to go through. Use the default interface without setting

*esp\_tls\_addr\_family\_t* **addr\_family**

The address family to use when connecting to a host.

*esp\_tls\_proto\_ver\_t* **tls\_version**

TLS protocol version of the connection, e.g., TLS 1.2, TLS 1.3 (default - no preference)

### Type Definitions

typedef enum *esp\_tls\_conn\_state* **esp\_tls\_conn\_state\_t**

ESP-TLS Connection State.

typedef enum *esp\_tls\_role* **esp\_tls\_role\_t**

typedef struct *psk\_key\_hint* **psk\_hint\_key\_t**

ESP-TLS preshared key and hint structure.

typedef struct *tls\_keep\_alive\_cfg* **tls\_keep\_alive\_cfg\_t**

esp-tls client session ticket ctx

Keep alive parameters structure

typedef enum *esp\_tls\_addr\_family* **esp\_tls\_addr\_family\_t**

typedef struct *esp\_tls\_cfg* **esp\_tls\_cfg\_t**

ESP-TLS configuration parameters.

---

**Note:** Note about format of certificates:

- This structure includes certificates of a Certificate Authority, of client or server as well as private keys, which may be of PEM or DER format. In case of PEM format, the buffer must be NULL terminated (with NULL character included in certificate size).
  - Certificate Authority's certificate may be a chain of certificates in case of PEM format, but could be only one certificate in case of DER format
  - Variables names of certificates and private key buffers and sizes are defined as unions providing backward compatibility for legacy \*\_pem\_buf and \*\_pem\_bytes names which suggested only PEM format was supported. It is encouraged to use generic names such as cacert\_buf and cacert\_bytes.
- 

typedef struct esp\_tls **esp\_tls\_t**

### Enumerations

enum **esp\_tls\_conn\_state**

ESP-TLS Connection State.

*Values:*

enumerator **ESP\_TLS\_INIT**

enumerator **ESP\_TLS\_CONNECTING**

enumerator **ESP\_TLS\_HANDSHAKE**

enumerator **ESP\_TLS\_FAIL**

enumerator **ESP\_TLS\_DONE**

enum **esp\_tls\_role**

*Values:*

enumerator **ESP\_TLS\_CLIENT**

enumerator **ESP\_TLS\_SERVER**

enum **esp\_tls\_addr\_family**

*Values:*

enumerator **ESP\_TLS\_AF\_UNSPEC**

Unspecified address family.

enumerator **ESP\_TLS\_AF\_INET**

IPv4 address family.

enumerator **ESP\_TLS\_AF\_INET6**

IPv6 address family.

enum **esp\_tls\_proto\_ver\_t**

*Values:*

enumerator **ESP\_TLS\_VER\_ANY**

enumerator **ESP\_TLS\_VER\_TLS\_1\_2**

enumerator **ESP\_TLS\_VER\_TLS\_1\_3**

enumerator **ESP\_TLS\_VER\_TLS\_MAX**

### Header File

- [components/esp-tls/esp\\_tls\\_errors.h](#)

### Structures

struct **esp\_tls\_last\_error**

Error structure containing relevant errors in case tls error occurred.

## Public Members

### *esp\_err\_t* last\_error

error code (based on ESP\_ERR\_ESP\_TLS\_BASE) of the last occurred error

### int esp\_tls\_error\_code

esp\_tls error code from last esp\_tls failed api

### int esp\_tls\_flags

last certification verification flags

## Macros

### ESP\_ERR\_ESP\_TLS\_BASE

Starting number of ESP-TLS error codes

### ESP\_ERR\_ESP\_TLS\_CANNOT\_RESOLVE\_HOSTNAME

Error if hostname couldn't be resolved upon tls connection

### ESP\_ERR\_ESP\_TLS\_CANNOT\_CREATE\_SOCKET

Failed to create socket

### ESP\_ERR\_ESP\_TLS\_UNSUPPORTED\_PROTOCOL\_FAMILY

Unsupported protocol family

### ESP\_ERR\_ESP\_TLS\_FAILED\_CONNECT\_TO\_HOST

Failed to connect to host

### ESP\_ERR\_ESP\_TLS\_SOCKET\_SETOPT\_FAILED

failed to set/get socket option

### ESP\_ERR\_ESP\_TLS\_CONNECTION\_TIMEOUT

new connection in esp\_tls\_low\_level\_conn connection timeouted

### ESP\_ERR\_ESP\_TLS\_SE\_FAILED

### ESP\_ERR\_ESP\_TLS\_TCP\_CLOSED\_FIN

### ESP\_ERR\_MBEDTLS\_CERT\_PARTLY\_OK

mbedtls parse certificates was partly successful

### ESP\_ERR\_MBEDTLS\_CTR\_DRBG\_SEED\_FAILED

mbedtls api returned error

### ESP\_ERR\_MBEDTLS\_SSL\_SET\_HOSTNAME\_FAILED

mbedtls api returned error

### ESP\_ERR\_MBEDTLS\_SSL\_CONFIG\_DEFAULTS\_FAILED

mbedtls api returned error

**ESP\_ERR\_MBEDTLS\_SSL\_CONF\_ALPN\_PROTOCOLS\_FAILED**

mbedtls api returned error

**ESP\_ERR\_MBEDTLS\_X509\_CERT\_PARSE\_FAILED**

mbedtls api returned error

**ESP\_ERR\_MBEDTLS\_SSL\_CONF\_OWN\_CERT\_FAILED**

mbedtls api returned error

**ESP\_ERR\_MBEDTLS\_SSL\_SETUP\_FAILED**

mbedtls api returned error

**ESP\_ERR\_MBEDTLS\_SSL\_WRITE\_FAILED**

mbedtls api returned error

**ESP\_ERR\_MBEDTLS\_PK\_PARSE\_KEY\_FAILED**

mbedtls api returned failed

**ESP\_ERR\_MBEDTLS\_SSL\_HANDSHAKE\_FAILED**

mbedtls api returned failed

**ESP\_ERR\_MBEDTLS\_SSL\_CONF\_PSK\_FAILED**

mbedtls api returned failed

**ESP\_ERR\_MBEDTLS\_SSL\_TICKET\_SETUP\_FAILED**

mbedtls api returned failed

**ESP\_ERR\_WOLFSSL\_SSL\_SET\_HOSTNAME\_FAILED**

wolfSSL api returned error

**ESP\_ERR\_WOLFSSL\_SSL\_CONF\_ALPN\_PROTOCOLS\_FAILED**

wolfSSL api returned error

**ESP\_ERR\_WOLFSSL\_CERT\_VERIFY\_SETUP\_FAILED**

wolfSSL api returned error

**ESP\_ERR\_WOLFSSL\_KEY\_VERIFY\_SETUP\_FAILED**

wolfSSL api returned error

**ESP\_ERR\_WOLFSSL\_SSL\_HANDSHAKE\_FAILED**

wolfSSL api returned failed

**ESP\_ERR\_WOLFSSL\_CTX\_SETUP\_FAILED**

wolfSSL api returned failed

**ESP\_ERR\_WOLFSSL\_SSL\_SETUP\_FAILED**

wolfSSL api returned failed

**ESP\_ERR\_WOLFSSL\_SSL\_WRITE\_FAILED**

wolfSSL api returned failed

**ESP\_TLS\_ERR\_SSL\_WANT\_READ**

Definition of errors reported from IO API (potentially non-blocking) in case of error:

- esp\_tls\_conn\_read()
- esp\_tls\_conn\_write()

**ESP\_TLS\_ERR\_SSL\_WANT\_WRITE****ESP\_TLS\_ERR\_SSL\_TIMEOUT****Type Definitions**

```
typedef struct esp_tls_last_error *esp_tls_error_handle_t
```

```
typedef struct esp_tls_last_error esp_tls_last_error_t
```

Error structure containing relevant errors in case tls error occurred.

**Enumerations**

```
enum esp_tls_error_type_t
```

Definition of different types/sources of error codes reported from different components

*Values:*

enumerator **ESP\_TLS\_ERR\_TYPE\_UNKNOWN**

enumerator **ESP\_TLS\_ERR\_TYPE\_SYSTEM**

System error &#8212; errno

enumerator **ESP\_TLS\_ERR\_TYPE\_MBEDTLS**

Error code from mbedTLS library

enumerator **ESP\_TLS\_ERR\_TYPE\_MBEDTLS\_CERT\_FLAGS**

Certificate flags defined in mbedTLS

enumerator **ESP\_TLS\_ERR\_TYPE\_ESP**

ESP-IDF error type &#8212; esp\_err\_t

enumerator **ESP\_TLS\_ERR\_TYPE\_WOLFSSL**

Error code from wolfSSL library

enumerator **ESP\_TLS\_ERR\_TYPE\_WOLFSSL\_CERT\_FLAGS**

Certificate flags defined in wolfSSL

enumerator **ESP\_TLS\_ERR\_TYPE\_MAX**

Last err type &#8212; invalid entry



## 2.2.5 ESP HTTP Client

### Overview

`esp_http_client` provides an API for making HTTP/S requests from ESP-IDF applications. The steps to use this API are as follows:

- `esp_http_client_init()`: Creates an `esp_http_client_config_t` instance i.e. a HTTP client handle based on the given `esp_http_client_config_t` configuration. This function must be the first to be called; default values will be assumed for the configuration values that are not explicitly defined by the user.
- `esp_http_client_perform()`: Performs all operations of the `esp_http_client` - opening the connection, exchanging data and closing the connection (as required), while blocking the current task until its completion. All related events will be invoked through the event handler (as specified in `esp_http_client_config_t`).
- `esp_http_client_cleanup()`: Closes the connection (if any) and frees up all the memory allocated to the HTTP client instance. This must be the last function to be called after the completion of operations.

### Application Example

Simple example that uses ESP HTTP Client to make HTTP/S requests at [protocols/esp\\_http\\_client](#).

### Basic HTTP request

Check out the example functions `http_rest_with_url` and `http_rest_with_hostname_path` in the application example for implementation details.

### Persistent Connections

Persistent connection means that the HTTP client can re-use the same connection for several exchanges. If the server does not request to close the connection with the `Connection: close` header, the connection is not dropped but is instead kept open and used for further requests.

To allow ESP HTTP client to take full advantage of persistent connections, one should make as many requests as possible using the same handle instance.

Check out the example functions `http_rest_with_url` and `http_rest_with_hostname_path` in the application example. Here, once the connection is created, multiple requests (GET, POST, PUT, etc.) are made before the connection is closed.

### HTTPS Request

ESP HTTP client supports SSL connections using **mbedTLS**, with the `url` configuration starting with `https` scheme or `transport_type` set to `HTTP_TRANSPORT_OVER_SSL`. HTTPS support can be configured via `CONFIG_ESP_HTTP_CLIENT_ENABLE_HTTPS` (enabled by default).

---

**Note:** While making HTTPS requests, if server verification is needed, additional root certificate (in PEM format) needs to be provided to the `cert_pem` member in `esp_http_client_config_t` configuration. Users can also use the ESP x509 Certificate Bundle for server verification using the `crt_bundle_attach` member of the `esp_http_client_config_t` configuration.

---

Check out the example functions `https_with_url` and `https_with_hostname_path` in the application example. (Implementation details of the above note are found [here](#))

## HTTP Stream

Some applications need to open the connection and control the exchange of data actively (data streaming). In such cases, the application flow is different from regular requests. Example flow is given below:

- `esp_http_client_init()`: Create a HTTP client handle
- `esp_http_client_set_*` or `esp_http_client_delete_*`: Modify the HTTP connection parameters (optional)
- `esp_http_client_open()`: Open the HTTP connection with `write_len` parameter (content length that needs to be written to server), set `write_len=0` for read-only connection
- `esp_http_client_write()`: Write data to server with a maximum length equal to `write_len` of `esp_http_client_open()` function; no need to call this function for `write_len=0`
- `esp_http_client_fetch_headers()`: Read the HTTP Server response headers, after sending the request headers and server data (if any). Returns the `content-length` from the server and can be succeeded by `esp_http_client_get_status_code()` for getting the HTTP status of the connection.
- `esp_http_client_read()`: Read the HTTP stream
- `esp_http_client_close()`: Close the connection
- `esp_http_client_cleanup()`: Release allocated resources

Check out the example function `http_perform_as_stream_reader` in the application example for implementation details.

## HTTP Authentication

### ESP HTTP client supports both Basic and Digest Authentication.

- Users can provide the username and password in the `url` or the `username` and `password` members of the `esp_http_client_config_t` configuration. For `auth_type = HTTP_AUTH_TYPE_BASIC`, the HTTP client takes only 1 perform operation to pass the authentication process.
- If `auth_type = HTTP_AUTH_TYPE_NONE`, but the `username` and `password` fields are present in the configuration, the HTTP client takes 2 perform operations. The client will receive the 401 Unauthorized header in its first attempt to connect to the server. Based on this information, it decides which authentication method to choose and performs it in the second operation.
- Check out the example functions `http_auth_basic`, `http_auth_basic_redirect` (for Basic authentication) and `http_auth_digest` (for Digest authentication) in the application example for implementation details.

### Examples of Authentication Configuration

- Authentication with URI

```
esp_http_client_config_t config = {
    .url = "http://user:passwd@httpbin.org/basic-auth/user/passwd",
    .auth_type = HTTP_AUTH_TYPE_BASIC,
};
```

- Authentication with username and password entry

```
esp_http_client_config_t config = {
    .url = "http://httpbin.org/basic-auth/user/passwd",
    .username = "user",
    .password = "passwd",
    .auth_type = HTTP_AUTH_TYPE_BASIC,
};
```

## API Reference

### Header File

- [components/esp\\_http\\_client/include/esp\\_http\\_client.h](#)

## Functions

*esp\_http\_client\_handle\_t* **esp\_http\_client\_init** (const *esp\_http\_client\_config\_t* \*config)

Start a HTTP session This function must be the first function to call, and it returns a *esp\_http\_client\_handle\_t* that you must use as input to other functions in the interface. This call MUST have a corresponding call to *esp\_http\_client\_cleanup* when the operation is complete.

**Parameters** **config** –[in] The configurations, see *http\_client\_config\_t*

### Returns

- *esp\_http\_client\_handle\_t*
- NULL if any errors

*esp\_err\_t* **esp\_http\_client\_perform** (*esp\_http\_client\_handle\_t* client)

Invoke this function after *esp\_http\_client\_init* and all the options calls are made, and will perform the transfer as described in the options. It must be called with the same *esp\_http\_client\_handle\_t* as input as the *esp\_http\_client\_init* call returned. *esp\_http\_client\_perform* performs the entire request in either blocking or non-blocking manner. By default, the API performs request in a blocking manner and returns when done, or if it failed, and in non-blocking manner, it returns if EAGAIN/EWOULDBLOCK or EINPROGRESS is encountered, or if it failed. And in case of non-blocking request, the user may call this API multiple times unless request & response is complete or there is a failure. To enable non-blocking *esp\_http\_client\_perform*(), *is\_async* member of *esp\_http\_client\_config\_t* must be set while making a call to *esp\_http\_client\_init*() API. You can do any amount of calls to *esp\_http\_client\_perform* while using the same *esp\_http\_client\_handle\_t*. The underlying connection may be kept open if the server allows it. If you intend to transfer more than one file, you are even encouraged to do so. *esp\_http\_client* will then attempt to reuse the same connection for the following transfers, thus making the operations faster, less CPU intense and using less network resources. Just note that you will have to use *esp\_http\_client\_set\_\** between the invokes to set options for the following *esp\_http\_client\_perform*.

---

**Note:** You must never call this function simultaneously from two places using the same client handle. Let the function return first before invoking it another time. If you want parallel transfers, you must use several *esp\_http\_client\_handle\_t*. This function include *esp\_http\_client\_open* -> *esp\_http\_client\_write* -> *esp\_http\_client\_fetch\_headers* -> *esp\_http\_client\_read* (and option) *esp\_http\_client\_close*.

---

**Parameters** **client** –The *esp\_http\_client* handle

### Returns

- ESP\_OK on successful
- ESP\_FAIL on error

*esp\_err\_t* **esp\_http\_client\_set\_url** (*esp\_http\_client\_handle\_t* client, const char \*url)

Set URL for client, when performing this behavior, the options in the URL will replace the old ones.

### Parameters

- **client** –[in] The *esp\_http\_client* handle
- **url** –[in] The url

### Returns

- ESP\_OK
- ESP\_FAIL

*esp\_err\_t* **esp\_http\_client\_set\_post\_field** (*esp\_http\_client\_handle\_t* client, const char \*data, int len)

Set post data, this function must be called before *esp\_http\_client\_perform*. Note: The data parameter passed to this function is a pointer and this function will not copy the data.

### Parameters

- **client** –[in] The *esp\_http\_client* handle
- **data** –[in] post data pointer
- **len** –[in] post length

**Returns**

- ESP\_OK
- ESP\_FAIL

int **esp\_http\_client\_get\_post\_field** (*esp\_http\_client\_handle\_t* client, char \*\*data)

Get current post field information.

**Parameters**

- **client** –[in] The client
- **data** –[out] Point to post data pointer

**Returns** Size of post data

*esp\_err\_t* **esp\_http\_client\_set\_header** (*esp\_http\_client\_handle\_t* client, const char \*key, const char \*value)

Set http request header, this function must be called after `esp_http_client_init` and before any perform function.

**Parameters**

- **client** –[in] The `esp_http_client` handle
- **key** –[in] The header key
- **value** –[in] The header value

**Returns**

- ESP\_OK
- ESP\_FAIL

*esp\_err\_t* **esp\_http\_client\_get\_header** (*esp\_http\_client\_handle\_t* client, const char \*key, char \*\*value)

Get http request header. The value parameter will be set to NULL if there is no header which is same as the key specified, otherwise the address of header value will be assigned to value parameter. This function must be called after `esp_http_client_init`.

**Parameters**

- **client** –[in] The `esp_http_client` handle
- **key** –[in] The header key
- **value** –[out] The header value

**Returns**

- ESP\_OK
- ESP\_FAIL

*esp\_err\_t* **esp\_http\_client\_get\_username** (*esp\_http\_client\_handle\_t* client, char \*\*value)

Get http request username. The address of username buffer will be assigned to value parameter. This function must be called after `esp_http_client_init`.

**Parameters**

- **client** –[in] The `esp_http_client` handle
- **value** –[out] The username value

**Returns**

- ESP\_OK
- ESP\_ERR\_INVALID\_ARG

*esp\_err\_t* **esp\_http\_client\_set\_username** (*esp\_http\_client\_handle\_t* client, const char \*username)

Set http request username. The value of username parameter will be assigned to username buffer. If the username parameter is NULL then username buffer will be freed.

**Parameters**

- **client** –[in] The `esp_http_client` handle
- **username** –[in] The username value

**Returns**

- ESP\_OK
- ESP\_ERR\_INVALID\_ARG

*esp\_err\_t* **esp\_http\_client\_get\_password** (*esp\_http\_client\_handle\_t* client, char \*\*value)

Get http request password. The address of password buffer will be assigned to value parameter. This function must be called after `esp_http_client_init`.

**Parameters**

- **client** –[in] The esp\_http\_client handle
- **value** –[out] The password value

**Returns**

- ESP\_OK
- ESP\_ERR\_INVALID\_ARG

*esp\_err\_t* **esp\_http\_client\_set\_password** (*esp\_http\_client\_handle\_t* client, const char \*password)

Set http request password. The value of password parameter will be assigned to password buffer. If the password parameter is NULL then password buffer will be freed.

**Parameters**

- **client** –[in] The esp\_http\_client handle
- **password** –[in] The password value

**Returns**

- ESP\_OK
- ESP\_ERR\_INVALID\_ARG

*esp\_err\_t* **esp\_http\_client\_set\_auth\_type** (*esp\_http\_client\_handle\_t* client, *esp\_http\_client\_auth\_type\_t* auth\_type)

Set http request auth\_type.

**Parameters**

- **client** –[in] The esp\_http\_client handle
- **auth\_type** –[in] The esp\_http\_client auth type

**Returns**

- ESP\_OK
- ESP\_ERR\_INVALID\_ARG

int **esp\_http\_client\_get\_errno** (*esp\_http\_client\_handle\_t* client)

Get HTTP client session errno.

**Parameters** **client** –[in] The esp\_http\_client handle

**Returns**

- (-1) if invalid argument
- errno

*esp\_err\_t* **esp\_http\_client\_set\_method** (*esp\_http\_client\_handle\_t* client, *esp\_http\_client\_method\_t* method)

Set http request method.

**Parameters**

- **client** –[in] The esp\_http\_client handle
- **method** –[in] The method

**Returns**

- ESP\_OK
- ESP\_ERR\_INVALID\_ARG

*esp\_err\_t* **esp\_http\_client\_set\_timeout\_ms** (*esp\_http\_client\_handle\_t* client, int timeout\_ms)

Set http request timeout.

**Parameters**

- **client** –[in] The esp\_http\_client handle
- **timeout\_ms** –[in] The timeout value

**Returns**

- ESP\_OK
- ESP\_ERR\_INVALID\_ARG

*esp\_err\_t* **esp\_http\_client\_delete\_header** (*esp\_http\_client\_handle\_t* client, const char \*key)

Delete http request header.

**Parameters**

- **client** –[in] The esp\_http\_client handle

- **key** –[in] The key

**Returns**

- ESP\_OK
- ESP\_FAIL

*esp\_err\_t* **esp\_http\_client\_open** (*esp\_http\_client\_handle\_t* client, int write\_len)

This function will be open the connection, write all header strings and return.

**Parameters**

- **client** –[in] The esp\_http\_client handle
- **write\_len** –[in] HTTP Content length need to write to the server

**Returns**

- ESP\_OK
- ESP\_FAIL

int **esp\_http\_client\_write** (*esp\_http\_client\_handle\_t* client, const char \*buffer, int len)

This function will write data to the HTTP connection previously opened by esp\_http\_client\_open()

**Parameters**

- **client** –[in] The esp\_http\_client handle
- **buffer** –The buffer
- **len** –[in] This value must not be larger than the write\_len parameter provided to esp\_http\_client\_open()

**Returns**

- (-1) if any errors
- Length of data written

int64\_t **esp\_http\_client\_fetch\_headers** (*esp\_http\_client\_handle\_t* client)

This function need to call after esp\_http\_client\_open, it will read from http stream, process all receive headers.

**Parameters** **client** –[in] The esp\_http\_client handle

**Returns**

- (0) if stream doesn't contain content-length header, or chunked encoding (checked by esp\_http\_client\_is\_chunked response)
- (-1: ESP\_FAIL) if any errors
- (-ESP\_ERR\_HTTP\_EAGAIN = -0x7007) if call is timed-out before any data was ready
- Download data length defined by content-length header

bool **esp\_http\_client\_is\_chunked\_response** (*esp\_http\_client\_handle\_t* client)

Check response data is chunked.

**Parameters** **client** –[in] The esp\_http\_client handle

**Returns** true or false

int **esp\_http\_client\_read** (*esp\_http\_client\_handle\_t* client, char \*buffer, int len)

Read data from http stream.

---

**Note:** (-ESP\_ERR\_HTTP\_EAGAIN = -0x7007) is returned when call is timed-out before any data was ready

---

**Parameters**

- **client** –[in] The esp\_http\_client handle
- **buffer** –The buffer
- **len** –[in] The length

**Returns**

- (-1) if any errors
- Length of data was read

int **esp\_http\_client\_get\_status\_code** (*esp\_http\_client\_handle\_t* client)

Get http response status code, the valid value if this function invoke after esp\_http\_client\_perform

**Parameters** `client` –[in] The `esp_http_client` handle

**Returns** Status code

`int64_t esp_http_client_get_content_length` (*esp\_http\_client\_handle\_t* client)

Get http response content length (from header Content-Length) the valid value if this function invoke after `esp_http_client_perform`

**Parameters** `client` –[in] The `esp_http_client` handle

**Returns**

- (-1) Chunked transfer
- Content-Length value as bytes

*esp\_err\_t* `esp_http_client_close` (*esp\_http\_client\_handle\_t* client)

Close http connection, still kept all http request resources.

**Parameters** `client` –[in] The `esp_http_client` handle

**Returns**

- ESP\_OK
- ESP\_FAIL

*esp\_err\_t* `esp_http_client_cleanup` (*esp\_http\_client\_handle\_t* client)

This function must be the last function to call for an session. It is the opposite of the `esp_http_client_init` function and must be called with the same handle as input that a `esp_http_client_init` call returned. This might close all connections this handle has used and possibly has kept open until now. Don't call this function if you intend to transfer more files, re-using handles is a key to good performance with `esp_http_client`.

**Parameters** `client` –[in] The `esp_http_client` handle

**Returns**

- ESP\_OK
- ESP\_FAIL

*esp\_http\_client\_transport\_t* `esp_http_client_get_transport_type` (*esp\_http\_client\_handle\_t* client)

Get transport type.

**Parameters** `client` –[in] The `esp_http_client` handle

**Returns**

- HTTP\_TRANSPORT\_UNKNOWN
- HTTP\_TRANSPORT\_OVER\_TCP
- HTTP\_TRANSPORT\_OVER\_SSL

*esp\_err\_t* `esp_http_client_set_redirection` (*esp\_http\_client\_handle\_t* client)

Set redirection URL. When received the 30x code from the server, the client stores the redirect URL provided by the server. This function will set the current URL to redirect to enable client to execute the redirection request. When `disable_auto_redirect` is set, the client will not call this function but the event `HTTP_EVENT_REDIRECT` will be dispatched giving the user control over the redirection event.

**Parameters** `client` –[in] The `esp_http_client` handle

**Returns**

- ESP\_OK
- ESP\_FAIL

*esp\_err\_t* `esp_http_client_reset_redirect_counter` (*esp\_http\_client\_handle\_t* client)

Reset the redirection counter. This is useful to reset redirect counter in cases where the same handle is used for multiple requests.

**Parameters** `client` –[in] The `esp_http_client` handle

**Returns**

- ESP\_OK
- ESP\_ERR\_INVALID\_ARG

void `esp_http_client_add_auth` (*esp\_http\_client\_handle\_t* client)

On receiving HTTP Status code 401, this API can be invoked to add authorization information.

**Note:** There is a possibility of receiving body message with redirection status codes, thus make sure to flush off body data after calling this API.

---

**Parameters** **client** –[in] The esp\_http\_client handle

bool **esp\_http\_client\_is\_complete\_data\_received** (*esp\_http\_client\_handle\_t* client)

Checks if entire data in the response has been read without any error.

**Parameters** **client** –[in] The esp\_http\_client handle

**Returns**

- true
- false

int **esp\_http\_client\_read\_response** (*esp\_http\_client\_handle\_t* client, char \*buffer, int len)

Helper API to read larger data chunks This is a helper API which internally calls `esp_http_client_read` multiple times till the end of data is reached or till the buffer gets full.

**Parameters**

- **client** –[in] The esp\_http\_client handle
- **buffer** –The buffer
- **len** –[in] The buffer length

**Returns**

- Length of data was read

*esp\_err\_t* **esp\_http\_client\_flush\_response** (*esp\_http\_client\_handle\_t* client, int \*len)

Process all remaining response data This uses an internal buffer to repeatedly receive, parse, and discard response data until complete data is processed. As no additional user-supplied buffer is required, this may be preferable to `esp_http_client_read_response` in situations where the content of the response may be ignored.

**Parameters**

- **client** –[in] The esp\_http\_client handle
- **len** –Length of data discarded

**Returns**

- ESP\_OK If successful, len will have discarded length
- ESP\_FAIL If failed to read response
- ESP\_ERR\_INVALID\_ARG If the client is NULL

*esp\_err\_t* **esp\_http\_client\_get\_url** (*esp\_http\_client\_handle\_t* client, char \*url, const int len)

Get URL from client.

**Parameters**

- **client** –[in] The esp\_http\_client handle
- **url** –[inout] The buffer to store URL
- **len** –[in] The buffer length

**Returns**

- ESP\_OK
- ESP\_FAIL

*esp\_err\_t* **esp\_http\_client\_get\_chunk\_length** (*esp\_http\_client\_handle\_t* client, int \*len)

Get Chunk-Length from client.

**Parameters**

- **client** –[in] The esp\_http\_client handle
- **len** –[out] Variable to store length

**Returns**

- ESP\_OK If successful, len will have length of current chunk
- ESP\_FAIL If the server is not a chunked server
- ESP\_ERR\_INVALID\_ARG If the client or len are NULL



## Structures

struct **esp\_http\_client\_event**

HTTP Client events data.

### Public Members

*esp\_http\_client\_event\_id\_t* **event\_id**

event\_id, to know the cause of the event

*esp\_http\_client\_handle\_t* **client**

esp\_http\_client\_handle\_t context

void \***data**

data of the event

int **data\_len**

data length of data

void \***user\_data**

user\_data context, from *esp\_http\_client\_config\_t* user\_data

char \***header\_key**

For HTTP\_EVENT\_ON\_HEADER event\_id, it' s store current http header key

char \***header\_value**

For HTTP\_EVENT\_ON\_HEADER event\_id, it' s store current http header value

struct **esp\_http\_client\_config\_t**

HTTP configuration.

### Public Members

const char \***url**

HTTP URL, the information on the URL is most important, it overrides the other fields below, if any

const char \***host**

Domain or IP as string

int **port**

Port to connect, default depend on esp\_http\_client\_transport\_t (80 or 443)

const char \***username**

Using for Http authentication

const char \***password**

Using for Http authentication

***esp\_http\_client\_auth\_type\_t* auth\_type**

Http authentication type, see `esp_http_client_auth_type_t`

**const char \*path**

HTTP Path, if not set, default is /

**const char \*query**

HTTP query

**const char \*cert\_pem**

SSL server certification, PEM format as string, if the client requires to verify server

**size\_t cert\_len**

Length of the buffer pointed to by `cert_pem`. May be 0 for null-terminated pem

**const char \*client\_cert\_pem**

SSL client certification, PEM format as string, if the server requires to verify client

**size\_t client\_cert\_len**

Length of the buffer pointed to by `client_cert_pem`. May be 0 for null-terminated pem

**const char \*client\_key\_pem**

SSL client key, PEM format as string, if the server requires to verify client

**size\_t client\_key\_len**

Length of the buffer pointed to by `client_key_pem`. May be 0 for null-terminated pem

**const char \*client\_key\_password**

Client key decryption password string

**size\_t client\_key\_password\_len**

String length of the password pointed to by `client_key_password`

***esp\_http\_client\_proto\_ver\_t* tls\_version**

TLS protocol version of the connection, e.g., TLS 1.2, TLS 1.3 (default - no preference)

**const char \*user\_agent**

The User Agent string to send with HTTP requests

***esp\_http\_client\_method\_t* method**

HTTP Method

**int timeout\_ms**

Network timeout in milliseconds

**bool disable\_auto\_redirect**

Disable HTTP automatic redirects

int **max\_redirection\_count**

Max number of redirections on receiving HTTP redirect status code, using default value if zero

int **max\_authorization\_retries**

Max connection retries on receiving HTTP unauthorized status code, using default value if zero. Disables authorization retry if -1

*http\_event\_handle\_cb* **event\_handler**

HTTP Event Handle

*esp\_http\_client\_transport\_t* **transport\_type**

HTTP transport type, see *esp\_http\_client\_transport\_t*

int **buffer\_size**

HTTP receive buffer size

int **buffer\_size\_tx**

HTTP transmit buffer size

void **\*user\_data**

HTTP user\_data context

bool **is\_async**

Set asynchronous mode, only supported with HTTPS for now

bool **use\_global\_ca\_store**

Use a global ca\_store for all the connections in which this bool is set.

bool **skip\_cert\_common\_name\_check**

Skip any validation of server certificate CN field

*esp\_err\_t* (**\*crt\_bundle\_attach**)(void \*conf)

Function pointer to *esp\_cert\_bundle\_attach*. Enables the use of certification bundle for server verification, must be enabled in menuconfig

bool **keep\_alive\_enable**

Enable keep-alive timeout

int **keep\_alive\_idle**

Keep-alive idle time. Default is 5 (second)

int **keep\_alive\_interval**

Keep-alive interval time. Default is 5 (second)

int **keep\_alive\_count**

Keep-alive packet retry send count. Default is 3 counts

struct ifreq **\*if\_name**

The name of interface for data to go through. Use the default interface without setting

void **\*ds\_data**

Pointer for digital signature peripheral context, see ESP-TLS Documentation for more details

### Macros

**DEFAULT\_HTTP\_BUF\_SIZE**

**ESP\_ERR\_HTTP\_BASE**

Starting number of HTTP error codes

**ESP\_ERR\_HTTP\_MAX\_REDIRECT**

The error exceeds the number of HTTP redirects

**ESP\_ERR\_HTTP\_CONNECT**

Error open the HTTP connection

**ESP\_ERR\_HTTP\_WRITE\_DATA**

Error write HTTP data

**ESP\_ERR\_HTTP\_FETCH\_HEADER**

Error read HTTP header from server

**ESP\_ERR\_HTTP\_INVALID\_TRANSPORT**

There are no transport support for the input scheme

**ESP\_ERR\_HTTP\_CONNECTING**

HTTP connection hasn't been established yet

**ESP\_ERR\_HTTP\_EAGAIN**

Mapping of errno EAGAIN to esp\_err\_t

**ESP\_ERR\_HTTP\_CONNECTION\_CLOSED**

Read FIN from peer and the connection closed

### Type Definitions

typedef struct esp\_http\_client **\*esp\_http\_client\_handle\_t**

typedef struct *esp\_http\_client\_event* **\*esp\_http\_client\_event\_handle\_t**

typedef struct *esp\_http\_client\_event* **esp\_http\_client\_event\_t**

HTTP Client events data.

typedef *esp\_err\_t* (**\*http\_event\_handle\_cb**)(*esp\_http\_client\_event\_t* \*evt)

### Enumerations

enum **esp\_http\_client\_event\_id\_t**

HTTP Client events id.

*Values:*

enumerator **HTTP\_EVENT\_ERROR**

This event occurs when there are any errors during execution

enumerator **HTTP\_EVENT\_ON\_CONNECTED**

Once the HTTP has been connected to the server, no data exchange has been performed

enumerator **HTTP\_EVENT\_HEADERS\_SENT**

After sending all the headers to the server

enumerator **HTTP\_EVENT\_HEADER\_SENT**

This header has been kept for backward compatibility and will be deprecated in future versions esp-idf

enumerator **HTTP\_EVENT\_ON\_HEADER**

Occurs when receiving each header sent from the server

enumerator **HTTP\_EVENT\_ON\_DATA**

Occurs when receiving data from the server, possibly multiple portions of the packet

enumerator **HTTP\_EVENT\_ON\_FINISH**

Occurs when finish a HTTP session

enumerator **HTTP\_EVENT\_DISCONNECTED**

The connection has been disconnected

enumerator **HTTP\_EVENT\_REDIRECT**

Intercepting HTTP redirects to handle them manually

enum **esp\_http\_client\_transport\_t**

HTTP Client transport.

*Values:*

enumerator **HTTP\_TRANSPORT\_UNKNOWN**

Unknown

enumerator **HTTP\_TRANSPORT\_OVER\_TCP**

Transport over tcp

enumerator **HTTP\_TRANSPORT\_OVER\_SSL**

Transport over ssl

enum **esp\_http\_client\_proto\_ver\_t**

*Values:*

enumerator **ESP\_HTTP\_CLIENT\_TLS\_VER\_ANY**

enumerator **ESP\_HTTP\_CLIENT\_TLS\_VER\_TLS\_1\_2**

enumerator **ESP\_HTTP\_CLIENT\_TLS\_VER\_TLS\_1\_3**

enumerator **ESP\_HTTP\_CLIENT\_TLS\_VER\_MAX**

enum **esp\_http\_client\_method\_t**

HTTP method.

*Values:*

enumerator **HTTP\_METHOD\_GET**

HTTP GET Method

enumerator **HTTP\_METHOD\_POST**

HTTP POST Method

enumerator **HTTP\_METHOD\_PUT**

HTTP PUT Method

enumerator **HTTP\_METHOD\_PATCH**

HTTP PATCH Method

enumerator **HTTP\_METHOD\_DELETE**

HTTP DELETE Method

enumerator **HTTP\_METHOD\_HEAD**

HTTP HEAD Method

enumerator **HTTP\_METHOD\_NOTIFY**

HTTP NOTIFY Method

enumerator **HTTP\_METHOD\_SUBSCRIBE**

HTTP SUBSCRIBE Method

enumerator **HTTP\_METHOD\_UNSUBSCRIBE**

HTTP UNSUBSCRIBE Method

enumerator **HTTP\_METHOD\_OPTIONS**

HTTP OPTIONS Method

enumerator **HTTP\_METHOD\_COPY**

HTTP COPY Method

enumerator **HTTP\_METHOD\_MOVE**

HTTP MOVE Method

enumerator **HTTP\_METHOD\_LOCK**

HTTP LOCK Method

enumerator **HTTP\_METHOD\_UNLOCK**

HTTP UNLOCK Method

enumerator **HTTP\_METHOD\_PROPFIND**

HTTP PROPFIND Method

enumerator **HTTP\_METHOD\_PROPPATCH**

HTTP PROPPATCH Method

enumerator **HTTP\_METHOD\_MKCOL**

HTTP MKCOL Method

enumerator **HTTP\_METHOD\_MAX**

enum **esp\_http\_client\_auth\_type\_t**

HTTP Authentication type.

*Values:*

enumerator **HTTP\_AUTH\_TYPE\_NONE**

No authentication

enumerator **HTTP\_AUTH\_TYPE\_BASIC**

HTTP Basic authentication

enumerator **HTTP\_AUTH\_TYPE\_DIGEST**

HTTP Digest authentication

enum **HttpStatus\_Code**

Enum for the HTTP status codes.

*Values:*

enumerator **HttpStatus\_Ok**

enumerator **HttpStatus\_MultipleChoices**

enumerator **HttpStatus\_MovedPermanently**

enumerator **HttpStatus\_Found**

enumerator **HttpStatus\_SeeOther**

enumerator **HttpStatus\_TemporaryRedirect**

enumerator **HttpStatus\_PermanentRedirect**

enumerator **HttpStatus\_BadRequest**

enumerator **HttpStatus\_Unauthorized**

enumerator `HttpStatus_Forbidden`

enumerator `HttpStatus_NotFound`

enumerator `HttpStatus_InternalError`

## 2.2.6 ESP Local Control

### Overview

ESP Local Control (`esp_local_ctrl`) component in ESP-IDF provides capability to control an ESP device over Wi-Fi + HTTPS or BLE. It provides access to application defined **properties** that are available for reading / writing via a set of configurable handlers.

Initialization of the `esp_local_ctrl` service over BLE transport is performed as follows:

```
esp_local_ctrl_config_t config = {
    .transport = ESP_LOCAL_CTRL_TRANSPORT_BLE,
    .transport_config = {
        .ble = &(protocomm_ble_config_t) {
            .device_name = SERVICE_NAME,
            .service_uuid = {
                /* LSB <----->
                * -----> MSB */
                0x21, 0xd5, 0x3b, 0x8d, 0xbd, 0x75, 0x68, 0x8a,
                0xb4, 0x42, 0xeb, 0x31, 0x4a, 0x1e, 0x98, 0x3d
            }
        }
    },
    .proto_sec = {
        .version = PROTOCOM_SEC0,
        .custom_handle = NULL,
        .pop = NULL,
    },
    .handlers = {
        /* User defined handler functions */
        .get_prop_values = get_property_values,
        .set_prop_values = set_property_values,
        .usr_ctx = NULL,
        .usr_ctx_free_fn = NULL
    },
    /* Maximum number of properties that may be set */
    .max_properties = 10
};

/* Start esp_local_ctrl service */
ESP_ERROR_CHECK(esp_local_ctrl_start(&config));
```

Similarly for HTTPS transport:

```
/* Set the configuration */
httpd_ssl_config_t https_conf = HTTPD_SSL_CONFIG_DEFAULT();

/* Load server certificate */
extern const unsigned char servercert_start[] asm("_binary_servercert_pem_
↪start");
extern const unsigned char servercert_end[] asm("_binary_servercert_pem_
↪end");
https_conf.servercert = servercert_start;
```

(continues on next page)



(continued from previous page)

```

https_conf.servercert_len = servercert_end - servercert_start;

/* Load server private key */
extern const unsigned char prvtkey_pem_start[] asm("_binary_prvtkey_pem_
↪start");
extern const unsigned char prvtkey_pem_end[] asm("_binary_prvtkey_pem_
↪end");
https_conf.prvtkey_pem = prvtkey_pem_start;
https_conf.prvtkey_len = prvtkey_pem_end - prvtkey_pem_start;

esp_local_ctrl_config_t config = {
    .transport = ESP_LOCAL_CTRL_TRANSPORT_HTTPD,
    .transport_config = {
        .httpd = &https_conf
    },
    .proto_sec = {
        .version = PROTOCOM_SEC0,
        .custom_handle = NULL,
        .pop = NULL,
    },
    .handlers = {
        /* User defined handler functions */
        .get_prop_values = get_property_values,
        .set_prop_values = set_property_values,
        .usr_ctx = NULL,
        .usr_ctx_free_fn = NULL
    },
    /* Maximum number of properties that may be set */
    .max_properties = 10
};

/* Start esp_local_ctrl service */
ESP_ERROR_CHECK(esp_local_ctrl_start(&config));

```

You may set security for transport in ESP local control using following options:

1. *PROTOCOM\_SEC2*: specifies that SRP6a based key exchange and end to end encryption based on AES-GCM is used. This is the most preferred option as it adds a robust security with Augmented PAKE protocol i.e. SRP6a.
2. *PROTOCOM\_SEC1*: specifies that Curve25519 based key exchange and end to end encryption based on AES-CTR is used.
3. *PROTOCOM\_SEC0*: specifies that data will be exchanged as a plain text (no security).
4. *PROTOCOM\_SEC\_CUSTOM*: you can define your own security requirement. Please note that you will also have to provide *custom\_handle* of type *protocomm\_security\_t* \* in this context.

---

**Note:** The respective security schemes need to be enabled through the project configuration menu. Please refer to the Enabling protocom security version section in [Protocol Communication](#) for more details.

---

### Creating a property

Now that we know how to start the **esp\_local\_ctrl** service, let's add a property to it. Each property must have a unique *name* (string), a *type* (e.g. enum), *flags* (bit fields) and *size*.

The *size* is to be kept 0, if we want our property value to be of variable length (e.g. if its a string or bytestream). For fixed length property value data-types, like int, float, etc., setting the *size* field to the right value, helps **esp\_local\_ctrl** to perform internal checks on arguments received with write requests.

The interpretation of *type* and *flags* fields is totally upto the application, hence they may be used as enumerations, bit-fields, or even simple integers. One way is to use *type* values to classify properties, while *flags* to specify characteristics

of a property.

Here is an example property which is to function as a timestamp. It is assumed that the application defines `TYPE_TIMESTAMP` and `READONLY`, which are used for setting the `type` and `flags` fields here.

```
/* Create a timestamp property */
esp_local_ctrl_prop_t timestamp = {
    .name      = "timestamp",
    .type      = TYPE_TIMESTAMP,
    .size      = sizeof(int32_t),
    .flags     = READONLY,
    .ctx       = func_get_time,
    .ctx_free_fn = NULL
};

/* Now register the property */
esp_local_ctrl_add_property(&timestamp);
```

Also notice that there is a `ctx` field, which is set to point to some custom `func_get_time()`. This can be used inside the property get / set handlers to retrieve timestamp.

Here is an example of `get_prop_values()` handler, which is used for retrieving the timestamp.

```
static esp_err_t get_property_values(size_t props_count,
                                    const esp_local_ctrl_prop_t *props,
                                    esp_local_ctrl_prop_val_t *prop_
→values,
                                    void *usr_ctx)
{
    for (uint32_t i = 0; i < props_count; i++) {
        ESP_LOGI(TAG, "Reading %s", props[i].name);
        if (props[i].type == TYPE_TIMESTAMP) {
            /* Obtain the timer function from ctx */
            int32_t (*func_get_time)(void) = props[i].ctx;

            /* Use static variable for saving the value.
             * This is essential because the value has to be
             * valid even after this function returns.
             * Alternative is to use dynamic allocation
             * and set the free_fn field */
            static int32_t ts = func_get_time();
            prop_values[i].data = &ts;
        }
    }
    return ESP_OK;
}
```

Here is an example of `set_prop_values()` handler. Notice how we restrict from writing to read-only properties.

```
static esp_err_t set_property_values(size_t props_count,
                                    const esp_local_ctrl_prop_t *props,
                                    const esp_local_ctrl_prop_val_t
→*prop_values,
                                    void *usr_ctx)
{
    for (uint32_t i = 0; i < props_count; i++) {
        if (props[i].flags & READONLY) {
            ESP_LOGE(TAG, "Cannot write to read-only property %s",
→props[i].name);
            return ESP_ERR_INVALID_ARG;
        } else {
            ESP_LOGI(TAG, "Setting %s", props[i].name);
        }
    }
}
```

(continues on next page)

(continued from previous page)

```

        /* For keeping it simple, lets only log the incoming data */
        ESP_LOG_BUFFER_HEX_LEVEL(TAG, prop_values[i].data,
                                prop_values[i].size, ESP_LOG_INFO);
    }
}
return ESP_OK;
}

```

For complete example see [protocols/esp\\_local\\_ctrl](#)

## Client Side Implementation

The client side implementation will have establish a protocomm session with the device first, over the supported mode of transport, and then send and receive protobuf messages understood by the **esp\_local\_ctrl** service. The service will translate these messages into requests and then call the appropriate handlers (*set / get*). Then, the generated response for each handler is again packed into a protobuf message and transmitted back to the client.

See below the various protobuf messages understood by the **esp\_local\_ctrl** service:

1. *get\_prop\_count* : This should simply return the total number of properties supported by the service
2. *get\_prop\_values* : This accepts an array of indices and should return the information (name, type, flags) and values of the properties corresponding to those indices
3. *set\_prop\_values* : This accepts an array of indices and an array of new values, which are used for setting the values of the properties corresponding to the indices

Note that indices may or may not be the same for a property, across multiple sessions. Therefore, the client must only use the names of the properties to uniquely identify them. So, every time a new session is established, the client should first call *get\_prop\_count* and then *get\_prop\_values*, hence form an index to name mapping for all properties. Now when calling *set\_prop\_values* for a set of properties, it must first convert the names to indexes, using the created mapping. As emphasized earlier, the client must refresh the index to name mapping every time a new session is established with the same device.

The various protocomm endpoints provided by **esp\_local\_ctrl** are listed below:

Table 1: Endpoints provided by ESP Local Control

Endpoint Name (BLE + GATT Server)	URI (HTTPS Server + mDNS)	Description
esp_local_ctrl	<a href="https://&lt;mdns-hostname&gt;.local/esp_local_ctrl/version">https://&lt;mdns-hostname&gt;.local/esp_local_ctrl/version</a>	Endpoint used for retrieving version string
esp_local_ctrl	<a href="https://&lt;mdns-hostname&gt;.local/esp_local_ctrl/control">https://&lt;mdns-hostname&gt;.local/esp_local_ctrl/control</a>	Endpoint used for sending / receiving control messages

## API Reference

### Header File

- [components/esp\\_local\\_ctrl/include/esp\\_local\\_ctrl.h](#)

### Functions

const [esp\\_local\\_ctrl\\_transport\\_t](#) \***esp\_local\_ctrl\_get\_transport\_ble** (void)

Function for obtaining BLE transport mode.

const [esp\\_local\\_ctrl\\_transport\\_t](#) \***esp\_local\_ctrl\_get\_transport\_httpd** (void)

Function for obtaining HTTPD transport mode.

*esp\_err\_t* **esp\_local\_ctrl\_start** (const *esp\_local\_ctrl\_config\_t* \*config)

Start local control service.

**Parameters** **config** –[in] Pointer to configuration structure

**Returns**

- ESP\_OK : Success
- ESP\_FAIL : Failure

*esp\_err\_t* **esp\_local\_ctrl\_stop** (void)

Stop local control service.

*esp\_err\_t* **esp\_local\_ctrl\_add\_property** (const *esp\_local\_ctrl\_prop\_t* \*prop)

Add a new property.

This adds a new property and allocates internal resources for it. The total number of properties that could be added is limited by configuration option `max_properties`

**Parameters** **prop** –[in] Property description structure

**Returns**

- ESP\_OK : Success
- ESP\_FAIL : Failure

*esp\_err\_t* **esp\_local\_ctrl\_remove\_property** (const char \*name)

Remove a property.

This finds a property by name, and releases the internal resources which are associated with it.

**Parameters** **name** –[in] Name of the property to remove

**Returns**

- ESP\_OK : Success
- ESP\_ERR\_NOT\_FOUND : Failure

const *esp\_local\_ctrl\_prop\_t* \***esp\_local\_ctrl\_get\_property** (const char \*name)

Get property description structure by name.

This API may be used to get a property's context structure `esp_local_ctrl_prop_t` when its name is known

**Parameters** **name** –[in] Name of the property to find

**Returns**

- Pointer to property
- NULL if not found

*esp\_err\_t* **esp\_local\_ctrl\_set\_handler** (const char \*ep\_name, *protocomm\_req\_handler\_t* handler, void \*user\_ctx)

Register `protocomm` handler for a custom endpoint.

This API can be called by the application to register a `protocomm` handler for an endpoint after the local control service has started.

---

**Note:** In case of BLE transport the names and uuids of all custom endpoints must be provided beforehand as a part of the `protocomm_ble_config_t` structure set in `esp_local_ctrl_config_t`, and passed to `esp_local_ctrl_start()`.

---

**Parameters**

- **ep\_name** –[in] Name of the endpoint
- **handler** –[in] Endpoint handler function
- **user\_ctx** –[in] User data

**Returns**

- ESP\_OK : Success
- ESP\_FAIL : Failure

## Unions

union **esp\_local\_ctrl\_transport\_config\_t**

*#include <esp\_local\_ctrl.h>* Transport mode (BLE / HTTPD) configuration.

### Public Members

*esp\_local\_ctrl\_transport\_config\_ble\_t* \*ble

This is same as `protocomm_ble_config_t`. See `protocomm_ble.h` for available configuration parameters.

*esp\_local\_ctrl\_transport\_config\_httpd\_t* \*httpd

This is same as `httpd_ssl_config_t`. See `esp_https_server.h` for available configuration parameters.

## Structures

struct **esp\_local\_ctrl\_prop**

Property description data structure, which is to be populated and passed to the `esp_local_ctrl_add_property()` function.

Once a property is added, its structure is available for read-only access inside `get_prop_values()` and `set_prop_values()` handlers.

### Public Members

char \***name**

Unique name of property

uint32\_t **type**

Type of property. This may be set to application defined enums

size\_t **size**

Size of the property value, which:

- if zero, the property can have values of variable size
- if non-zero, the property can have values of fixed size only, therefore, checks are performed internally by `esp_local_ctrl` when setting the value of such a property

uint32\_t **flags**

Flags set for this property. This could be a bit field. A flag may indicate property behavior, e.g. read-only / constant

void \***ctx**

Pointer to some context data relevant for this property. This will be available for use inside the `get_prop_values` and `set_prop_values` handlers as a part of this property structure. When set, this is valid throughout the lifetime of a property, till either the property is removed or the `esp_local_ctrl` service is stopped.

void (\***ctx\_free\_fn**)(void \*ctx)

Function used by `esp_local_ctrl` to internally free the property context when `esp_local_ctrl_remove_property()` or `esp_local_ctrl_stop()` is called.

struct **esp\_local\_ctrl\_prop\_val**

Property value data structure. This gets passed to the `get_prop_values()` and `set_prop_values()` handlers for the purpose of retrieving or setting the present value of a property.

### Public Members

void **\*data**

Pointer to memory holding property value

size\_t **size**

Size of property value

void (**\*free\_fn**)(void \*data)

This may be set by the application in `get_prop_values()` handler to tell `esp_local_ctrl` to call this function on the data pointer above, for freeing its resources after sending the `get_prop_values` response.

struct **esp\_local\_ctrl\_handlers**

Handlers for receiving and responding to local control commands for getting and setting properties.

### Public Members

*esp\_err\_t* (**\*get\_prop\_values**)(size\_t props\_count, const *esp\_local\_ctrl\_prop\_t* props[],  
*esp\_local\_ctrl\_prop\_val\_t* prop\_values[], void \*usr\_ctx)

Handler function to be implemented for retrieving current values of properties.

---

**Note:** If any of the properties have fixed sizes, the size field of corresponding element in `prop_values` need to be set

---

**Param props\_count [in]** Total elements in the props array

**Param props [in]** Array of properties, the current values for which have been requested by the client

**Param prop\_values [out]** Array of empty property values, the elements of which need to be populated with the current values of those properties specified by props argument

**Param usr\_ctx [in]** This provides value of the `usr_ctx` field of `esp_local_ctrl_handlers_t` structure

**Return** Returning different error codes will convey the corresponding protocol level errors to the client :

- ESP\_OK : Success
- ESP\_ERR\_INVALID\_ARG : InvalidArgument
- ESP\_ERR\_INVALID\_STATE : InvalidProto
- All other error codes : InternalError

*esp\_err\_t* (**\*set\_prop\_values**)(size\_t props\_count, const *esp\_local\_ctrl\_prop\_t* props[], const  
*esp\_local\_ctrl\_prop\_val\_t* prop\_values[], void \*usr\_ctx)

Handler function to be implemented for changing values of properties.

---

**Note:** If any of the properties have variable sizes, the size field of the corresponding element in `prop_values` must be checked explicitly before making any assumptions on the size.

---

**Param props\_count [in]** Total elements in the props array

**Param props [in]** Array of properties, the values for which the client requests to change

**Param prop\_values [in]** Array of property values, the elements of which need to be used for updating those properties specified by props argument

**Param usr\_ctx [in]** This provides value of the `usr_ctx` field of `esp_local_ctrl_handlers_t` structure

**Return** Returning different error codes will convey the corresponding protocol level errors to the client :

- `ESP_OK` : Success
- `ESP_ERR_INVALID_ARG` : InvalidArgument
- `ESP_ERR_INVALID_STATE` : InvalidProto
- All other error codes : InternalError

void **\*usr\_ctx**

Context pointer to be passed to above handler functions upon invocation. This is different from the property level context, as this is valid throughout the lifetime of the `esp_local_ctrl` service, and freed only when the service is stopped.

void (**\*usr\_ctx\_free\_fn**)(void \*usr\_ctx)

Pointer to function which will be internally invoked on `usr_ctx` for freeing the context resources when `esp_local_ctrl_stop()` is called.

struct **esp\_local\_ctrl\_proto\_sec\_cfg**

Protocom security configs

### Public Members

*esp\_local\_ctrl\_proto\_sec\_t* **version**

This sets protocom security version, `sec0/sec1` or `custom`. If `custom`, user must provide handle via `proto_sec_custom_handle` below

void **\*custom\_handle**

Custom security handle if security is set `custom` via `proto_sec` above. This handle must follow `protocomm_security_t` signature

const void **\*pop**

Proof of possession to be used for local control. Could be `NULL`.

const void **\*sec\_params**

Pointer to security params (`NULL` if not needed). This is not needed for `protocomm` security 0. This pointer should hold the struct of type `esp_local_ctrl_security1_params_t` for `protocomm` security 1 and `esp_local_ctrl_security2_params_t` for `protocomm` security 2 respectively. Could be `NULL`.

struct **esp\_local\_ctrl\_config**

Configuration structure to pass to `esp_local_ctrl_start()`

### Public Members

const *esp\_local\_ctrl\_transport\_t* **\*transport**

Transport layer over which service will be provided

*esp\_local\_ctrl\_transport\_cfg\_t* **transport\_config**

Transport layer over which service will be provided

*esp\_local\_ctrl\_proto\_sec\_cfg\_t* **proto\_sec**

Security version and POP

*esp\_local\_ctrl\_handlers\_t* **handlers**

Register handlers for responding to get/set requests on properties

size\_t **max\_properties**

This limits the number of properties that are available at a time

## Macros

**ESP\_LOCAL\_CTRL\_TRANSPORT\_BLE**

**ESP\_LOCAL\_CTRL\_TRANSPORT\_HTTPD**

## Type Definitions

typedef struct *esp\_local\_ctrl\_prop* **esp\_local\_ctrl\_prop\_t**

Property description data structure, which is to be populated and passed to the `esp_local_ctrl_add_property()` function.

Once a property is added, its structure is available for read-only access inside `get_prop_values()` and `set_prop_values()` handlers.

typedef struct *esp\_local\_ctrl\_prop\_val* **esp\_local\_ctrl\_prop\_val\_t**

Property value data structure. This gets passed to the `get_prop_values()` and `set_prop_values()` handlers for the purpose of retrieving or setting the present value of a property.

typedef struct *esp\_local\_ctrl\_handlers* **esp\_local\_ctrl\_handlers\_t**

Handlers for receiving and responding to local control commands for getting and setting properties.

typedef struct *esp\_local\_ctrl\_transport* **esp\_local\_ctrl\_transport\_t**

Transport mode (BLE / HTTPD) over which the service will be provided.

This is forward declaration of a private structure, implemented internally by `esp_local_ctrl`.

typedef struct *protocomm\_ble\_config* **esp\_local\_ctrl\_transport\_config\_ble\_t**

Configuration for transport mode BLE.

This is a forward declaration for `protocomm_ble_config_t`. To use this, application must set `CONFIG_BT_BLUEDROID_ENABLED` and include `protocomm_ble.h`.

typedef struct *httpd\_config* **esp\_local\_ctrl\_transport\_config\_httpd\_t**

Configuration for transport mode HTTPD.

This is a forward declaration for `httpd_ssl_config_t` (for HTTPS) or `httpd_config_t` (for HTTP)

typedef enum *esp\_local\_ctrl\_proto\_sec* **esp\_local\_ctrl\_proto\_sec\_t**

Security types for `esp_local_control`.



```
typedef protocomm_security1_params_t esp_local_ctrl_security1_params_t
```

```
typedef protocomm_security2_params_t esp_local_ctrl_security2_params_t
```

```
typedef struct esp_local_ctrl_proto_sec_cfg esp_local_ctrl_proto_sec_cfg_t
```

Protocom security configs

```
typedef struct esp_local_ctrl_config esp_local_ctrl_config_t
```

Configuration structure to pass to `esp_local_ctrl_start()`

## Enumerations

```
enum esp_local_ctrl_proto_sec
```

Security types for `esp_local_control`.

*Values:*

enumerator **PROTOCOLCOM\_SEC0**

enumerator **PROTOCOLCOM\_SEC1**

enumerator **PROTOCOLCOM\_SEC2**

enumerator **PROTOCOLCOM\_SEC\_CUSTOM**

## 2.2.7 ESP Serial Slave Link

### Overview

Espressif provides several chips that can work as slaves. These slave devices rely on some common buses, and have their own communication protocols over those buses. The `esp_serial_slave_link` component is designed for the master to communicate with ESP slave devices through those protocols over the bus drivers.

After an `esp_serial_slave_link` device is initialized properly, the application can use it to communicate with the ESP slave devices conveniently.

### Espressif Device protocols

For more details about Espressif device protocols, see the following documents.

### ESP SPI Slave HD (Half Duplex) Mode Protocol

#### SPI Slave Capabilities of Espressif chips

	ESP32	ESP32-S2	ESP32-C3
SPI Slave HD	N	Y (v2)	Y (v2)
Tohost intr		N	N
Frhost intr		2 *	2 *
TX DMA		Y	Y
RX DMA		Y	Y
Shared registers		72	64

**Introduction** In the half duplex mode, the master has to use the protocol defined by the slave to communicate with the slave. Each transaction may consist of the following phases (list by the order they should exist):

- **Command:** 8-bit, master to slave  
This phase determines the rest phases of the transactions. See *Supported Commands*.
- **Address:** 8-bit, master to slave, optional  
For some commands (WRBUF, RDBUF), this phase specifies the address of the shared buffer to write to/read from. For other commands with this phase, they are meaningless but still have to exist in the transaction.
- **Dummy:** 8-bit (for 1-bit mode) or 4-bit (for 2/4-bit mode), floating, optional  
This phase is the turnaround time between the master and the slave on the bus, and also provides enough time for the slave to prepare the data to send to the master.
- **Data:** variable length, the direction is also determined by the command.  
This may be a data OUT phase, in which the direction is slave to master, or a data IN phase, in which the direction is master to slave.

The *direction* means which side (master or slave) controls the MOSI, MISO, WP, and HD pins.

**Data IO Modes** In some IO modes, more data wires can be used to send the data. As a result, the SPI clock cycles required for the same amount of data will be less than in the 1-bit mode. For example, in QIO mode, address and data (IN and OUT) should be sent on all 4 data wires (MOSI, MISO, WP, and HD). Here are the modes supported by the ESP32-S2 SPI slave and the wire number used in corresponding modes.

Mode	command WN	address WN	dummy cycles	data WN
1-bit	1	1	1	1
DOUT	1	1	4	2
DIO	1	2	4	2
QOUT	1	1	4	4
QIO	1	4	4	4
QPI	4	4	4	4

Normally, which mode is used is determined by the command sent by the master (See *Supported Commands*), except the QPI mode.

**QPI Mode** The QPI mode is a special state of the SPI Slave. The master can send the ENQPI command to put the slave into the QPI mode state. In the QPI mode, the command is also sent in 4-bit, thus it's not compatible with the normal modes. The master should only send QPI commands when the slave is in QPI mode. To exit from the QPI mode, master can send the EXQPI command.

### Supported Commands

**Note:** The command name is in a master-oriented direction. For example, WRBUF means master writes the buffer of slave.

Name	Description	Command	Address	Data
WRBUF	Write buffer	0x01	Buf addr	master to slave, no longer than buffer size
RDBUF	Read buffer	0x02	Buf addr	slave to master, no longer than buffer size
WRDMA	Write DMA	0x03	8 bits	master to slave, no longer than length provided by slave
RDDMA	Read DMA	0x04	8 bits	slave to master, no longer than length provided by slave
SEG_DONE	Segments done	0x05	.	.
ENQPI	Enter QPI mode	0x06	.	.
WR_DONE	Write segments done	0x07	.	.
CMD8	Interrupt	0x08	.	.
CMD9	Interrupt	0x09	.	.
CMDA	Interrupt	0x0A	.	.
EXQPI	Exit QPI mode	0xDD	.	.

Moreover, WRBUF, RDBUF, WRDMA, RDDMA commands have their 2-bit and 4-bit version. To do transactions in 2-bit or 4-bit mode, send the original command ORed by the corresponding command mask below. For example, command 0xA1 means WRBUF in QIO mode.

Mode	Mask
1-bit	0x00
DOUT	0x10
DIO	0x50
QOUT	0x20
QIO	0xA0
QPI	0xA0

**Segment Transaction Mode** Segment transaction mode is the only mode supported by the SPI Slave HD driver for now. In this mode, for a transaction the slave load onto the DMA, the master is allowed to read or write in segments. This way the master doesn't have to prepare a large buffer as the size of data provided by the slave. After the master finishes reading/writing a buffer, it has to send the corresponding termination command to the slave as a synchronization signal. The slave driver will update new data (if exist) onto the DMA upon seeing the termination command.

The termination command is WR\_DONE (0x07) for the WRDMA and CMD8 (0x08) for the RDDMA.

Here's an example for the flow the master read data from the slave DMA:

1. The slave loads 4092 bytes of data onto the RDDMA
2. The master do seven RDDMA transactions, each of them is 512 bytes long, and reads the first 3584 bytes from the slave

3. The master do the last RDDMA transaction of 512 bytes (equal, longer, or shorter than the total length loaded by the slave are all allowed). The first 508 bytes are valid data from the slave, while the last 4 bytes are meaningless bytes.
4. The master sends CMD8 to the slave
5. The slave loads another 4092 bytes of data onto the RDDMA
6. The master can start new reading transactions after it sends the CMD8

### Terminology

- ESSL: Abbreviation for ESP Serial Slave Link, the component described by this document.
- Master: The device running the *esp\_serial\_slave\_link* component.
- ESSL device: a virtual device on the master associated with an ESP slave device. The device context has the knowledge of the slave protocol above the bus, relying on some bus drivers to communicate with the slave.
- ESSL device handle: a handle to ESSL device context containing the configuration, status and data required by the ESSL component. The context stores the driver configurations, communication state, data shared by master and slave, etc.  
The context should be initialized before it is used, and get deinitialized if not used any more. The master application operates on the ESSL device through this handle.
- ESP slave: the slave device connected to the bus, which ESSL component is designed to communicate with.
- Bus: The bus over which the master and the slave communicate with each other.
- Slave protocol: The special communication protocol specified by Espressif HW/SW over the bus.
- TX buffer num: a counter, which is on the slave and can be read by the master, indicates the accumulated buffer numbers that the slave has loaded to the hardware to receive data from the master.
- RX data size: a counter, which is on the slave and can be read by the master, indicates the accumulated data size that the slave has loaded to the hardware to send to the master.

### Services provided by ESP slave

There are some common services provided by the Espressif slaves:

1. Tohost Interrupts: The slave can inform the master about certain events by the interrupt line. (optional)
2. Frhost Interrupts: The master can inform the slave about certain events.
3. Tx FIFO (master to slave): the slave can send data in stream to the master. The SDIO slave can also indicate it has new data to send to master by the interrupt line.  
The slave updates the TX buffer num to inform the master how much data it can receive, and the master then read the TX buffer num, and take off the used buffer number to know how many buffers are remaining.
4. Rx FIFO (slave to master): the slave can receive data from the master in units of receiving buffers.  
The slave updates the RX data size to inform the master how much data it has prepared to send, and then the master read the data size, and take off the data length it has already received to know how many data is remaining.
5. Shared registers: the master can read some part of the registers on the slave, and also write these registers to let the slave read.

The services provided by the slave depends on the slave's model. See *SPI Slave Capabilities of Espressif chips* for more details.

### Initialization of ESP Serial Slave Link

**ESP SDIO Slave** The ESP SDIO slave link (ESSL SDIO) devices relies on the sdmmc component. It includes the usage of communicating with ESP SDIO Slave device via SDSPI feature. The ESSL device should be initialized as below:

1. Initialize a sdmmc card (see `:doc:` Document of SDMMC driver </api-reference/storage/sdmmc>``) structure.
2. Call `sdmmc_card_init()` to initialize the card.
3. Initialize the ESSL device with `essl_sdio_config_t`. The `card` member should be the `sdmmc_card_t` got in step 2, and the `recv_buffer_size` member should be filled correctly according to pre-negotiated value.

4. Call `essl_init()` to do initialization of the SDIO part.
5. Call `essl_wait_for_ready()` to wait for the slave to be ready.

### ESP SPI Slave

**Note:** If you are communicating with the ESP SDIO Slave device through SPI interface, you should use the *SDIO interface* instead.

---

Hasn't been supported yet.

### APIs

After the initialization process above is performed, you can call the APIs below to make use of the services provided by the slave:

#### Tohost Interrupts (optional)

1. Call `essl_get_intr_ena()` to know which events will trigger the interrupts to the master.
2. Call `essl_set_intr_ena()` to set the events that will trigger interrupts to the master.
3. Call `essl_wait_int()` to wait until interrupt from the slave, or timeout.
4. When interrupt is triggered, call `essl_get_intr()` to know which events are active, and call `essl_clear_intr()` to clear them.

#### Frhost Interrupts

1. Call `essl_send_slave_intr()` to trigger general purpose interrupt of the slave.

#### TX FIFO

1. Call `essl_get_tx_buffer_num()` to know how many buffers the slave has prepared to receive data from the master. This is optional. The master will poll `tx_buffer_num` when it try to send packets to the slave, until the slave has enough buffer or timeout.
2. Call `essl_send_packet()` to send data to the slave.

#### RX FIFO

1. Call `essl_get_rx_data_size()` to know how many data the slave has prepared to send to the master. This is optional. When the master tries to receive data from the slave, it will update the `rx_data_size` for once, if the current `rx_data_size` is shorter than the buffer size the master prepared to receive. And it may poll the `rx_data_size` if the `rx_data_size` keeps 0, until timeout.
2. Call `essl_get_packet()` to receive data from the slave.

**Reset counters (Optional)** Call `essl_reset_cnt()` to reset the internal counter if you find the slave has reset its counter.

### Application Example

The example below shows how ESP32-S2 SDIO host and slave communicate with each other. The host use the ESSL SDIO.

[peripherals/sdio](#).

Please refer to the specific example README.md for details.

## API Reference

### Header File

- `components/driver/test/esp_serial_slave_link/include/esp_serial_slave_link/essl.h`

### Functions

`esp_err_t` **essl\_init** (*essl\_handle\_t* handle, uint32\_t wait\_ms)

Initialize the slave.

#### Parameters

- **handle** –Handle of an ESSL device.
- **wait\_ms** –Millisecond to wait before timeout, will not wait at all if set to 0-9.

#### Returns

- ESP\_OK: If success
- ESP\_ERR\_NOT\_SUPPORTED: Current device does not support this function.
- Other value returned from lower layer `init`.

`esp_err_t` **essl\_wait\_for\_ready** (*essl\_handle\_t* handle, uint32\_t wait\_ms)

Wait for interrupt of an ESSL slave device.

#### Parameters

- **handle** –Handle of an ESSL device.
- **wait\_ms** –Millisecond to wait before timeout, will not wait at all if set to 0-9.

#### Returns

- ESP\_OK: If success
- ESP\_ERR\_NOT\_SUPPORTED: Current device does not support this function.
- One of the error codes from SDMMC host controller

`esp_err_t` **essl\_get\_tx\_buffer\_num** (*essl\_handle\_t* handle, uint32\_t \*out\_tx\_num, uint32\_t wait\_ms)

Get buffer num for the host to send data to the slave. The buffers are size of `buffer_size`.

#### Parameters

- **handle** –Handle of a ESSL device.
- **out\_tx\_num** –Output of buffer num that host can send data to ESSL slave.
- **wait\_ms** –Millisecond to wait before timeout, will not wait at all if set to 0-9.

#### Returns

- ESP\_OK: Success
- ESP\_ERR\_NOT\_SUPPORTED: This API is not supported in this mode
- One of the error codes from SDMMC/SPI host controller

`esp_err_t` **essl\_get\_rx\_data\_size** (*essl\_handle\_t* handle, uint32\_t \*out\_rx\_size, uint32\_t wait\_ms)

Get the size, in bytes, of the data that the ESSL slave is ready to send

#### Parameters

- **handle** –Handle of an ESSL device.
- **out\_rx\_size** –Output of data size to read from slave, in bytes
- **wait\_ms** –Millisecond to wait before timeout, will not wait at all if set to 0-9.

#### Returns

- ESP\_OK: Success
- ESP\_ERR\_NOT\_SUPPORTED: This API is not supported in this mode
- One of the error codes from SDMMC/SPI host controller

`esp_err_t` **essl\_reset\_cnt** (*essl\_handle\_t* handle)

Reset the counters of this component. Usually you don't need to do this unless you know the slave is reset.

**Parameters** **handle** –Handle of an ESSL device.

#### Returns

- ESP\_OK: Success
- ESP\_ERR\_NOT\_SUPPORTED: This API is not supported in this mode
- ESP\_ERR\_INVALID\_ARG: Invalid argument, handle is not init.

*esp\_err\_t* **essl\_send\_packet** (*essl\_handle\_t* handle, const void \*start, size\_t length, uint32\_t wait\_ms)

Send a packet to the ESSL Slave. The Slave receives the packet into buffers whose size is `buffer_size` (configured during initialization).

#### Parameters

- **handle** –Handle of an ESSL device.
- **start** –Start address of the packet to send
- **length** –Length of data to send, if the packet is over-size, the it will be divided into blocks and hold into different buffers automatically.
- **wait\_ms** –Millisecond to wait before timeout, will not wait at all if set to 0-9.

#### Returns

- ESP\_OK Success
- ESP\_ERR\_INVALID\_ARG: Invalid argument, handle is not init or other argument is not valid.
- ESP\_ERR\_TIMEOUT: No buffer to use, or error from SDMMC host controller.
- ESP\_ERR\_NOT\_FOUND: Slave is not ready for receiving.
- ESP\_ERR\_NOT\_SUPPORTED: This API is not supported in this mode
- One of the error codes from SDMMC/SPI host controller.

*esp\_err\_t* **essl\_get\_packet** (*essl\_handle\_t* handle, void \*out\_data, size\_t size, size\_t \*out\_length, uint32\_t wait\_ms)

Get a packet from ESSL slave.

#### Parameters

- **handle** –Handle of an ESSL device.
- **out\_data** –[out] Data output address
- **size** –The size of the output buffer, if the buffer is smaller than the size of data to receive from slave, the driver returns `ESP_ERR_NOT_FINISHED`
- **out\_length** –[out] Output of length the data actually received from slave.
- **wait\_ms** –Millisecond to wait before timeout, will not wait at all if set to 0-9.

#### Returns

- ESP\_OK Success: All the data has been read from the slave.
- ESP\_ERR\_INVALID\_ARG: Invalid argument, The handle is not initialized or the other arguments are invalid.
- ESP\_ERR\_NOT\_FINISHED: Read was successful, but there is still data remaining.
- ESP\_ERR\_NOT\_FOUND: Slave is not ready to send data.
- ESP\_ERR\_NOT\_SUPPORTED: This API is not supported in this mode
- One of the error codes from SDMMC/SPI host controller.

*esp\_err\_t* **essl\_write\_reg** (*essl\_handle\_t* handle, uint8\_t addr, uint8\_t value, uint8\_t \*value\_o, uint32\_t wait\_ms)

Write general purpose R/W registers (8-bit) of ESSL slave.

---

**Note:** sdio 28-31 are reserved, the lower API helps to skip.

---

#### Parameters

- **handle** –Handle of an ESSL device.
- **addr** –Address of register to write. For SDIO, valid address: 0-59. For SPI, see `essl_spi.h`
- **value** –Value to write to the register.
- **value\_o** –Output of the returned written value.
- **wait\_ms** –Millisecond to wait before timeout, will not wait at all if set to 0-9.

#### Returns

- ESP\_OK Success
- One of the error codes from SDMMC/SPI host controller

*esp\_err\_t* **essl\_read\_reg** (*essl\_handle\_t* handle, uint8\_t add, uint8\_t \*value\_o, uint32\_t wait\_ms)

Read general purpose R/W registers (8-bit) of ESSL slave.

**Parameters**

- **handle** –Handle of a `essl` device.
- **add** –Address of register to read. For SDIO, Valid address: 0-27, 32-63 (28-31 reserved, return interrupt bits on read). For SPI, see `essl_spi.h`
- **value\_o** –Output value read from the register.
- **wait\_ms** –Millisecond to wait before timeout, will not wait at all if set to 0-9.

**Returns**

- ESP\_OK Success
- One of the error codes from SDMMC/SPI host controller

`esp_err_t` **essl\_wait\_int** (`essl_handle_t` handle, `uint32_t` wait\_ms)

wait for an interrupt of the slave

**Parameters**

- **handle** –Handle of an ESSL device.
- **wait\_ms** –Millisecond to wait before timeout, will not wait at all if set to 0-9.

**Returns**

- ESP\_OK: If interrupt is triggered.
- ESP\_ERR\_NOT\_SUPPORTED: Current device does not support this function.
- ESP\_ERR\_TIMEOUT: No interrupts before timeout.

`esp_err_t` **essl\_clear\_intr** (`essl_handle_t` handle, `uint32_t` intr\_mask, `uint32_t` wait\_ms)

Clear interrupt bits of ESSL slave. All the bits set in the mask will be cleared, while other bits will stay the same.

**Parameters**

- **handle** –Handle of an ESSL device.
- **intr\_mask** –Mask of interrupt bits to clear.
- **wait\_ms** –Millisecond to wait before timeout, will not wait at all if set to 0-9.

**Returns**

- ESP\_OK: Success
- ESP\_ERR\_NOT\_SUPPORTED: Current device does not support this function.
- One of the error codes from SDMMC host controller

`esp_err_t` **essl\_get\_intr** (`essl_handle_t` handle, `uint32_t` \*intr\_raw, `uint32_t` \*intr\_st, `uint32_t` wait\_ms)

Get interrupt bits of ESSL slave.

**Parameters**

- **handle** –Handle of an ESSL device.
- **intr\_raw** –Output of the raw interrupt bits. Set to NULL if only masked bits are read.
- **intr\_st** –Output of the masked interrupt bits. set to NULL if only raw bits are read.
- **wait\_ms** –Millisecond to wait before timeout, will not wait at all if set to 0-9.

**Returns**

- ESP\_OK: Success
- ESP\_INVALID\_ARG: If both `intr_raw` and `intr_st` are NULL.
- ESP\_ERR\_NOT\_SUPPORTED: Current device does not support this function.
- One of the error codes from SDMMC host controller

`esp_err_t` **essl\_set\_intr\_ena** (`essl_handle_t` handle, `uint32_t` ena\_mask, `uint32_t` wait\_ms)

Set interrupt enable bits of ESSL slave. The slave only sends interrupt on the line when there is a bit both the raw status and the enable are set.

**Parameters**

- **handle** –Handle of an ESSL device.
- **ena\_mask** –Mask of the interrupt bits to enable.
- **wait\_ms** –Millisecond to wait before timeout, will not wait at all if set to 0-9.

**Returns**

- ESP\_OK: Success
- ESP\_ERR\_NOT\_SUPPORTED: Current device does not support this function.
- One of the error codes from SDMMC host controller



*esp\_err\_t* **essl\_get\_intr\_ena** (*essl\_handle\_t* handle, uint32\_t \*ena\_mask\_o, uint32\_t wait\_ms)

Get interrupt enable bits of ESSL slave.

#### Parameters

- **handle** –Handle of an ESSL device.
- **ena\_mask\_o** –Output of interrupt bit enable mask.
- **wait\_ms** –Millisecond to wait before timeout, will not wait at all if set to 0-9.

#### Returns

- ESP\_OK Success
- One of the error codes from SDMMC host controller

*esp\_err\_t* **essl\_send\_slave\_intr** (*essl\_handle\_t* handle, uint32\_t intr\_mask, uint32\_t wait\_ms)

Send interrupts to slave. Each bit of the interrupt will be triggered.

#### Parameters

- **handle** –Handle of an ESSL device.
- **intr\_mask** –Mask of interrupt bits to send to slave.
- **wait\_ms** –Millisecond to wait before timeout, will not wait at all if set to 0-9.

#### Returns

- ESP\_OK: Success
- ESP\_ERR\_NOT\_SUPPORTED: Current device does not support this function.
- One of the error codes from SDMMC host controller

## Type Definitions

```
typedef struct essl_dev_t *essl_handle_t
```

Handle of an ESSL device.

## Header File

- [components/driver/test/esp\\_serial\\_slave\\_link/include/esp\\_serial\\_slave\\_link/essl\\_sdio.h](#)

## Functions

*esp\_err\_t* **essl\_sdio\_init\_dev** (*essl\_handle\_t* \*out\_handle, const *essl\_sdio\_config\_t* \*config)

Initialize the ESSL SDIO device and get its handle.

#### Parameters

- **out\_handle** –Output of the handle.
- **config** –Configuration for the ESSL SDIO device.

#### Returns

- ESP\_OK: on success
- ESP\_ERR\_NO\_MEM: memory exhausted.

*esp\_err\_t* **essl\_sdio\_deinit\_dev** (*essl\_handle\_t* handle)

Deinitialize and free the space used by the ESSL SDIO device.

**Parameters** **handle** –Handle of the ESSL SDIO device to deinit.

#### Returns

- ESP\_OK: on success
- ESP\_ERR\_INVALID\_ARG: wrong handle passed

## Structures

```
struct essl_sdio_config_t
```

Configuration for the ESSL SDIO device.

## Public Members

*sdmmc\_card\_t* \***card**

The initialized sdmmc card pointer of the slave.

int **recv\_buffer\_size**

The pre-negotiated recv buffer size used by both the host and the slave.

## Header File

- `components/driver/test/esp_serial_slave_link/include/esp_serial_slave_link/essl_spi.h`

## Functions

*esp\_err\_t* **essl\_spi\_init\_dev** (*essl\_handle\_t* \*out\_handle, const *essl\_spi\_config\_t* \*init\_config)

Initialize the ESSL SPI device function list and get its handle.

### Parameters

- **out\_handle** –[out] Output of the handle
- **init\_config** –Configuration for the ESSL SPI device

### Returns

- ESP\_OK: On success
- ESP\_ERR\_NO\_MEM: Memory exhausted
- ESP\_ERR\_INVALID\_STATE: SPI driver is not initialized
- ESP\_ERR\_INVALID\_ARG: Wrong register ID

*esp\_err\_t* **essl\_spi\_deinit\_dev** (*essl\_handle\_t* handle)

Deinitialize the ESSL SPI device and free the memory used by the device.

**Parameters** **handle** –Handle of the ESSL SPI device

### Returns

- ESP\_OK: On success
- ESP\_ERR\_INVALID\_STATE: ESSL SPI is not in use

*esp\_err\_t* **essl\_spi\_read\_reg** (void \*arg, uint8\_t addr, uint8\_t \*out\_value, uint32\_t wait\_ms)

Read from the shared registers.

---

**Note:** The registers for Master/Slave synchronization are reserved. Do not use them. (see `rx_sync_reg` in `essl_spi_config_t`)

---

### Parameters

- **arg** –Context of the component. (Member `arg` from `essl_handle_t`)
- **addr** –Address of the shared registers. (Valid: 0 ~ SOC\_SPI\_MAXIMUM\_BUFFER\_SIZE, registers for M/S sync are reserved, see note1).
- **out\_value** –[out] Read buffer for the shared registers.
- **wait\_ms** –Time to wait before timeout (reserved for future use, user should set this to 0).

### Returns

- ESP\_OK: success
- ESP\_ERR\_INVALID\_STATE: ESSL SPI has not been initialized.
- ESP\_ERR\_INVALID\_ARG: The address argument is not valid. See note 1.
- or other return value from `:cpp:func:spi_device_transmit`.

*esp\_err\_t* **essl\_spi\_get\_packet** (void \*arg, void \*out\_data, size\_t size, uint32\_t wait\_ms)

Get a packet from Slave.

**Parameters**

- **arg** –Context of the component. (Member `arg` from `essl_handle_t`)
- **out\_data** –[out] Output data address
- **size** –The size of the output data.
- **wait\_ms** –Time to wait before timeout (reserved for future use, user should set this to 0).

**Returns**

- `ESP_OK`: On Success
- `ESP_ERR_INVALID_STATE`: ESSL SPI has not been initialized.
- `ESP_ERR_INVALID_ARG`: The output data address is neither DMA capable nor 4 byte-aligned
- `ESP_ERR_INVALID_SIZE`: Master requires `size` bytes of data but Slave did not load enough bytes.

`esp_err_t` **essl\_spi\_write\_reg** (void \*arg, uint8\_t addr, uint8\_t value, uint8\_t \*out\_value, uint32\_t wait\_ms)

Write to the shared registers.

---

**Note:** The registers for Master/Slave synchronization are reserved. Do not use them. (see `tx_sync_reg` in `essl_spi_config_t`)

---

---

**Note:** Feature of checking the actual written value (`out_value`) is not supported.

---

**Parameters**

- **arg** –Context of the component. (Member `arg` from `essl_handle_t`)
- **addr** –Address of the shared registers. (Valid: 0 ~ `SOC_SPI_MAXIMUM_BUFFER_SIZE`, registers for M/S sync are reserved, see note1)
- **value** –Buffer for data to send, should be align to 4.
- **out\_value** –[out] Not supported, should be set to `NULL`.
- **wait\_ms** –Time to wait before timeout (reserved for future use, user should set this to 0).

**Returns**

- `ESP_OK`: success
- `ESP_ERR_INVALID_STATE`: ESSL SPI has not been initialized.
- `ESP_ERR_INVALID_ARG`: The address argument is not valid. See note 1.
- `ESP_ERR_NOT_SUPPORTED`: Should set `out_value` to `NULL`. See note 2.
- or other return value from `:cpp:func:spi_device_transmit`.

`esp_err_t` **essl\_spi\_send\_packet** (void \*arg, const void \*data, size\_t size, uint32\_t wait\_ms)

Send a packet to Slave.

**Parameters**

- **arg** –Context of the component. (Member `arg` from `essl_handle_t`)
- **data** –Address of the data to send
- **size** –Size of the data to send.
- **wait\_ms** –Time to wait before timeout (reserved for future use, user should set this to 0).

**Returns**

- `ESP_OK`: On success
- `ESP_ERR_INVALID_STATE`: ESSL SPI has not been initialized.
- `ESP_ERR_INVALID_ARG`: The data address is not DMA capable
- `ESP_ERR_INVALID_SIZE`: Master will send `size` bytes of data but Slave did not load enough RX buffer

void **essl\_spi\_reset\_cnt** (void \*arg)

Reset the counter in Master context.

---

**Note:** Shall only be called if the slave has reset its counter. Else, Slave and Master would be desynchronized

---

**Parameters** **arg** –Context of the component. (Member **arg** from **essl\_handle\_t**)

*esp\_err\_t* **essl\_spi\_rdbuf** (*spi\_device\_handle\_t* spi, uint8\_t \*out\_data, int addr, int len, uint32\_t flags)

Read the shared buffer from the slave in ISR way.

---

**Note:** The slave's HW doesn't guarantee the data in one SPI transaction is consistent. It sends data in unit of byte. In other words, if the slave SW attempts to update the shared register when a rdbuf SPI transaction is in-flight, the data got by the master will be the combination of bytes of different writes of slave SW.

---

---

**Note:** **out\_data** should be prepared in words and in the DRAM. The buffer may be written in words by the DMA. When a byte is written, the remaining bytes in the same word will also be overwritten, even the **len** is shorter than a word.

---

**Parameters**

- **spi** –SPI device handle representing the slave
- **out\_data** –[out] Buffer for read data, strongly suggested to be in the DRAM and aligned to 4
- **addr** –Address of the slave shared buffer
- **len** –Length to read
- **flags** –SPI\_TRANS\_\* flags to control the transaction mode of the transaction to send.

**Returns**

- ESP\_OK: on success
- or other return value from :cpp:func:spi\_device\_transmit.

*esp\_err\_t* **essl\_spi\_rdbuf\_polling** (*spi\_device\_handle\_t* spi, uint8\_t \*out\_data, int addr, int len, uint32\_t flags)

Read the shared buffer from the slave in polling way.

---

**Note:** **out\_data** should be prepared in words and in the DRAM. The buffer may be written in words by the DMA. When a byte is written, the remaining bytes in the same word will also be overwritten, even the **len** is shorter than a word.

---

**Parameters**

- **spi** –SPI device handle representing the slave
- **out\_data** –[out] Buffer for read data, strongly suggested to be in the DRAM and aligned to 4
- **addr** –Address of the slave shared buffer
- **len** –Length to read
- **flags** –SPI\_TRANS\_\* flags to control the transaction mode of the transaction to send.

**Returns**

- ESP\_OK: on success
- or other return value from :cpp:func:spi\_device\_transmit.

*esp\_err\_t* **essl\_spi\_wrbuf** (*spi\_device\_handle\_t* spi, const uint8\_t \*data, int addr, int len, uint32\_t flags)

Write the shared buffer of the slave in ISR way.

---

**Note:** `out_data` should be prepared in words and in the DRAM. The buffer may be written in words by the DMA. When a byte is written, the remaining bytes in the same word will also be overwritten, even the `len` is shorter than a word.

---

**Parameters**

- **spi** –SPI device handle representing the slave
- **data** –Buffer for data to send, strongly suggested to be in the DRAM
- **addr** –Address of the slave shared buffer,
- **len** –Length to write
- **flags** –SPI\_TRANS\_\* flags to control the transaction mode of the transaction to send.

**Returns**

- ESP\_OK: success
- or other return value from `:cpp:func:spi_device_transmit`.

*esp\_err\_t* `essl_spi_wrbuf_polling` (*spi\_device\_handle\_t* spi, const uint8\_t \*data, int addr, int len, uint32\_t flags)

Write the shared buffer of the slave in polling way.

---

**Note:** `out_data` should be prepared in words and in the DRAM. The buffer may be written in words by the DMA. When a byte is written, the remaining bytes in the same word will also be overwritten, even the `len` is shorter than a word.

---

**Parameters**

- **spi** –SPI device handle representing the slave
- **data** –Buffer for data to send, strongly suggested to be in the DRAM
- **addr** –Address of the slave shared buffer,
- **len** –Length to write
- **flags** –SPI\_TRANS\_\* flags to control the transaction mode of the transaction to send.

**Returns**

- ESP\_OK: success
- or other return value from `:cpp:func:spi_device_polling_transmit`.

*esp\_err\_t* `essl_spi_rddma` (*spi\_device\_handle\_t* spi, uint8\_t \*out\_data, int len, int seg\_len, uint32\_t flags)

Receive long buffer in segments from the slave through its DMA.

---

**Note:** This function combines several `:cpp:func:essl_spi_rddma_seg` and one `:cpp:func:essl_spi_rddma_done` at the end. Used when the slave is working in segment mode.

---

**Parameters**

- **spi** –SPI device handle representing the slave
- **out\_data** –[out] Buffer to hold the received data, strongly suggested to be in the DRAM and aligned to 4
- **len** –Total length of data to receive.
- **seg\_len** –Length of each segment, which is not larger than the maximum transaction length allowed for the spi device. Suggested to be multiples of 4. When set < 0, means send all data in one segment (the `rddma_done` will still be sent.)
- **flags** –SPI\_TRANS\_\* flags to control the transaction mode of the transaction to send.

**Returns**

- ESP\_OK: success
- or other return value from `:cpp:func:spi_device_transmit`.

*esp\_err\_t* **essl\_spi\_rddma\_seg** (*spi\_device\_handle\_t* spi, uint8\_t \*out\_data, int seg\_len, uint32\_t flags)

Read one data segment from the slave through its DMA.

---

**Note:** To read long buffer, call `:cpp:func:essl_spi_rddma` instead.

---

#### Parameters

- **spi** –SPI device handle representing the slave
- **out\_data** –[out] Buffer to hold the received data. strongly suggested to be in the DRAM and aligned to 4
- **seg\_len** –Length of this segment
- **flags** –SPI\_TRANS\_\* flags to control the transaction mode of the transaction to send.

#### Returns

- ESP\_OK: success
- or other return value from `:cpp:func:spi_device_transmit`.

*esp\_err\_t* **essl\_spi\_rddma\_done** (*spi\_device\_handle\_t* spi, uint32\_t flags)

Send the `rddma_done` command to the slave. Upon receiving this command, the slave will stop sending the current buffer even there are data unsent, and maybe prepare the next buffer to send.

---

**Note:** This is required only when the slave is working in segment mode.

---

#### Parameters

- **spi** –SPI device handle representing the slave
- **flags** –SPI\_TRANS\_\* flags to control the transaction mode of the transaction to send.

#### Returns

- ESP\_OK: success
- or other return value from `:cpp:func:spi_device_transmit`.

*esp\_err\_t* **essl\_spi\_wrdma** (*spi\_device\_handle\_t* spi, const uint8\_t \*data, int len, int seg\_len, uint32\_t flags)

Send long buffer in segments to the slave through its DMA.

---

**Note:** This function combines several `:cpp:func:essl_spi_wrdma_seg` and one `:cpp:func:essl_spi_wrdma_done` at the end. Used when the slave is working in segment mode.

---

#### Parameters

- **spi** –SPI device handle representing the slave
- **data** –Buffer for data to send, strongly suggested to be in the DRAM
- **len** –Total length of data to send.
- **seg\_len** –Length of each segment, which is not larger than the maximum transaction length allowed for the spi device. Suggested to be multiples of 4. When set < 0, means send all data in one segment (the `wrdma_done` will still be sent.)
- **flags** –SPI\_TRANS\_\* flags to control the transaction mode of the transaction to send.

#### Returns

- ESP\_OK: success
- or other return value from `:cpp:func:spi_device_transmit`.

*esp\_err\_t* **essl\_spi\_wrdma\_seg** (*spi\_device\_handle\_t* spi, const uint8\_t \*data, int seg\_len, uint32\_t flags)

Send one data segment to the slave through its DMA.

---

**Note:** To send long buffer, call `:cpp:func:essl_spi_wrdma` instead.

---

**Parameters**

- **spi** –SPI device handle representing the slave
- **data** –Buffer for data to send, strongly suggested to be in the DRAM
- **seg\_len** –Length of this segment
- **flags** –SPI\_TRANS\_\* flags to control the transaction mode of the transaction to send.

**Returns**

- ESP\_OK: success
- or other return value from :cpp:func:spi\_device\_transmit.

*esp\_err\_t* **essl\_spi\_wrdma\_done** (*spi\_device\_handle\_t* spi, uint32\_t flags)

Send the wrdma\_done command to the slave. Upon receiving this command, the slave will stop receiving, process the received data, and maybe prepare the next buffer to receive.

---

**Note:** This is required only when the slave is working in segment mode.

---

**Parameters**

- **spi** –SPI device handle representing the slave
- **flags** –SPI\_TRANS\_\* flags to control the transaction mode of the transaction to send.

**Returns**

- ESP\_OK: success
- or other return value from :cpp:func:spi\_device\_transmit.

**Structures**

struct **essl\_spi\_config\_t**

Configuration of ESSL SPI device.

**Public Members**

*spi\_device\_handle\_t* \***spi**

Pointer to SPI device handle.

uint32\_t **tx\_buf\_size**

The pre-negotiated Master TX buffer size used by both the host and the slave.

uint8\_t **tx\_sync\_reg**

The pre-negotiated register ID for Master-TX-SLAVE-RX synchronization. 1 word (4 Bytes) will be reserved for the synchronization.

uint8\_t **rx\_sync\_reg**

The pre-negotiated register ID for Master-RX-Slave-TX synchronization. 1 word (4 Bytes) will be reserved for the synchronization.

## 2.2.8 ESP x509 Certificate Bundle

**Overview**

The ESP x509 Certificate Bundle API provides an easy way to include a bundle of custom x509 root certificates for TLS server verification.

**Note:** The bundle is currently not available when using WolfSSL.

---

The bundle comes with the complete list of root certificates from Mozilla's NSS root certificate store. Using the `gen_cert_bundle.py` python utility the certificates' subject name and public key are stored in a file and embedded in the ESP32-S2 binary.

When generating the bundle you may choose between:

- The full root certificate bundle from Mozilla, containing more than 130 certificates. The current bundle was updated Tue Jul 19 03:12:06 2022 GMT.
- A pre-selected filter list of the name of the most commonly used root certificates, reducing the amount of certificates to around 35 while still having around 90 % coverage according to market share statistics.

In addition it is possible to specify a path to a certificate file or a directory containing certificates which then will be added to the generated bundle.

**Note:** Trusting all root certificates means the list will have to be updated if any of the certificates are retracted. This includes removing them from `ca.crt_all.pem`.

---

### Configuration

Most configuration is done through `menuconfig`. CMake will generate the bundle according to the configuration and embed it.

- `CONFIG_MBEDTLS_CERTIFICATE_BUNDLE`: automatically build and attach the bundle.
- `CONFIG_MBEDTLS_DEFAULT_CERTIFICATE_BUNDLE`: decide which certificates to include from the complete root list.
- `CONFIG_MBEDTLS_CUSTOM_CERTIFICATE_BUNDLE_PATH`: specify the path of any additional certificates to embed in the bundle.

To enable the bundle when using ESP-TLS simply pass the function pointer to the bundle attach function:

```
esp_tls_cfg_t cfg = {
    .cert_bundle_attach = esp_cert_bundle_attach,
};
```

This is done to avoid embedding the certificate bundle unless activated by the user.

If using mbedTLS directly then the bundle may be activated by directly calling the attach function during the setup process:

```
mbedtls_ssl_config conf;
mbedtls_ssl_config_init(&conf);

esp_cert_bundle_attach(&conf);
```

### Generating the List of Root Certificates

The list of root certificates comes from Mozilla's NSS root certificate store, which can be found [here](#). The list can be downloaded and created by running the script `mk-ca-bundle.pl` that is distributed as a part of `curl`. Another alternative would be to download the finished list directly from the curl website: [CA certificates extracted from Mozilla](#)

The common certificates bundle were made by selecting the authorities with a market share of more than 1 % from w3tech's [SSL Survey](#). These authorities were then used to pick the names of the certificates for the filter list, `cmn_cert_authorities.csv`, from [this list](#) provided by Mozilla.



## Updating the Certificate Bundle

The bundle is embedded into the app and can be updated along with the app by an OTA update. If you want to include a more up-to-date bundle than the bundle currently included in ESP-IDF, then the certificate list can be downloaded from Mozilla as described in [Generating the List of Root Certificates](#).

## Application Example

Simple HTTPS example that uses ESP-TLS to establish a secure socket connection using the certificate bundle with two custom certificates added for verification: [protocols/https\\_x509\\_bundle](#).

HTTPS example that uses ESP-TLS and the default bundle: [protocols/https\\_request](#).

HTTPS example that uses mbedTLS and the default bundle: [protocols/https\\_mbedtls](#).

## API Reference

### Header File

- [components/mbedtls/esp\\_cert\\_bundle/include/esp\\_cert\\_bundle.h](#)

### Functions

*esp\_err\_t* **esp\_cert\_bundle\_attach** (void \*conf)

Attach and enable use of a bundle for certificate verification.

Attach and enable use of a bundle for certificate verification through a verification callback. If no specific bundle has been set through `esp_cert_bundle_set()` it will default to the bundle defined in menuconfig and embedded in the binary.

**Parameters** **conf** –[in] The config struct for the SSL connection.

**Returns**

- ESP\_OK if adding certificates was successful.
- Other if an error occurred or an action must be taken by the calling process.

void **esp\_cert\_bundle\_detach** (mbedtls\_ssl\_config \*conf)

Disable and deallocate the certification bundle.

Removes the certificate verification callback and deallocates used resources

**Parameters** **conf** –[in] The config struct for the SSL connection.

*esp\_err\_t* **esp\_cert\_bundle\_set** (const uint8\_t \*x509\_bundle, size\_t bundle\_size)

Set the default certificate bundle used for verification.

Overrides the default certificate bundle only in case of successful initialization. In most use cases the bundle should be set through menuconfig. The bundle needs to be sorted by subject name since binary search is used to find certificates.

**Parameters**

- **x509\_bundle** –[in] A pointer to the certificate bundle.
- **bundle\_size** –[in] Size of the certificate bundle in bytes.

**Returns**

- ESP\_OK if adding certificates was successful.
- Other if an error occurred or an action must be taken by the calling process.

## 2.2.9 HTTP Server

## Overview

The HTTP Server component provides an ability for running a lightweight web server on ESP32-S2. Following are detailed steps to use the API exposed by HTTP Server:

- `httpd_start()`: Creates an instance of HTTP server, allocate memory/resources for it depending upon the specified configuration and outputs a handle to the server instance. The server has both, a listening socket (TCP) for HTTP traffic, and a control socket (UDP) for control signals, which are selected in a round robin fashion in the server task loop. The task priority and stack size are configurable during server instance creation by passing `httpd_config_t` structure to `httpd_start()`. TCP traffic is parsed as HTTP requests and, depending on the requested URI, user registered handlers are invoked which are supposed to send back HTTP response packets.
- `httpd_stop()`: This stops the server with the provided handle and frees up any associated memory/resources. This is a blocking function that first signals a halt to the server task and then waits for the task to terminate. While stopping, the task will close all open connections, remove registered URI handlers and reset all session context data to empty.
- `httpd_register_uri_handler()`: A URI handler is registered by passing object of type `httpd_uri_t` structure which has members including `uri name`, `method type` (eg. `HTTPD_GET/HTTPD_POST/HTTPD_PUT` etc.), `function pointer of type esp_err_t *handler (httpd_req_t *req)` and `user_ctx` pointer to user context data.

## Application Example

```

/* Our URI handler function to be called during GET /uri request */
esp_err_t get_handler(httpd_req_t *req)
{
    /* Send a simple response */
    const char resp[] = "URI GET Response";
    httpd_resp_send(req, resp, HTTPD_RESP_USE_STRLEN);
    return ESP_OK;
}

/* Our URI handler function to be called during POST /uri request */
esp_err_t post_handler(httpd_req_t *req)
{
    /* Destination buffer for content of HTTP POST request.
     * httpd_req_recv() accepts char* only, but content could
     * as well be any binary data (needs type casting).
     * In case of string data, null termination will be absent, and
     * content length would give length of string */
    char content[100];

    /* Truncate if content length larger than the buffer */
    size_t recv_size = MIN(req->content_len, sizeof(content));

    int ret = httpd_req_recv(req, content, recv_size);
    if (ret <= 0) { /* 0 return value indicates connection closed */
        /* Check if timeout occurred */
        if (ret == HTTPD SOCK_ERR_TIMEOUT) {
            /* In case of timeout one can choose to retry calling
             * httpd_req_recv(), but to keep it simple, here we
             * respond with an HTTP 408 (Request Timeout) error */
            httpd_resp_send_408(req);
        }
        /* In case of error, returning ESP_FAIL will
         * ensure that the underlying socket is closed */
        return ESP_FAIL;
    }

    /* Send a simple response */

```

(continues on next page)

(continued from previous page)

```
const char resp[] = "URI POST Response";
httpd_resp_send(req, resp, HTTPD_RESP_USE_STRLEN);
return ESP_OK;
}

/* URI handler structure for GET /uri */
httpd_uri_t uri_get = {
    .uri      = "/uri",
    .method   = HTTP_GET,
    .handler  = get_handler,
    .user_ctx = NULL
};

/* URI handler structure for POST /uri */
httpd_uri_t uri_post = {
    .uri      = "/uri",
    .method   = HTTP_POST,
    .handler  = post_handler,
    .user_ctx = NULL
};

/* Function for starting the webserver */
httpd_handle_t start_webserver(void)
{
    /* Generate default configuration */
    httpd_config_t config = HTTPD_DEFAULT_CONFIG();

    /* Empty handle to esp_http_server */
    httpd_handle_t server = NULL;

    /* Start the httpd server */
    if (httpd_start(&server, &config) == ESP_OK) {
        /* Register URI handlers */
        httpd_register_uri_handler(server, &uri_get);
        httpd_register_uri_handler(server, &uri_post);
    }
    /* If server failed to start, handle will be NULL */
    return server;
}

/* Function for stopping the webserver */
void stop_webserver(httpd_handle_t server)
{
    if (server) {
        /* Stop the httpd server */
        httpd_stop(server);
    }
}
```

**Simple HTTP Server Example** Check HTTP server example under [protocols/http\\_server/simple](#) where handling of arbitrary content lengths, reading request headers and URL query parameters, and setting response headers is demonstrated.

### Persistent Connections

HTTP server features persistent connections, allowing for the re-use of the same connection (session) for several transfers, all the while maintaining context specific data for the session. Context data may be allocated dynamically by the handler in which case a custom function may need to be specified for freeing this data when the connection/session is closed.

### Persistent Connections Example

```

/* Custom function to free context */
void free_ctx_func(void *ctx)
{
    /* Could be something other than free */
    free(ctx);
}

esp_err_t adder_post_handler(httpd_req_t *req)
{
    /* Create session's context if not already available */
    if (! req->sess_ctx) {
        req->sess_ctx = malloc(sizeof(ANY_DATA_TYPE)); /*!< Pointer to context_
↳data */
        req->free_ctx = free_ctx_func; /*!< Function to free_
↳context data */
    }

    /* Access context data */
    ANY_DATA_TYPE *ctx_data = (ANY_DATA_TYPE *) req->sess_ctx;

    /* Respond */
    .....
    .....
    .....

    return ESP_OK;
}

```

Check the example under [protocols/http\\_server/persistent\\_sockets](#).

### Websocket Server

The HTTP server component provides websocket support. The websocket feature can be enabled in menuconfig using the `CONFIG_HTTPD_WS_SUPPORT` option. Please refer to the [protocols/http\\_server/ws\\_echo\\_server](#) example which demonstrates usage of the websocket feature.

### Event Handling

ESP HTTP Server has various events for which a handler can be triggered by *the Event Loop library* when the particular event occurs. The handler has to be registered using `esp_event_handler_register()`. This helps in event handling for ESP HTTP Server. `esp_http_server_event_id_t` has all the events which can happen for ESP HTTP Server.

#### Expected data type for different ESP HTTP Server events in event loop:

- HTTP\_SERVER\_EVENT\_ERROR: httpd\_err\_code\_t
- HTTP\_SERVER\_EVENT\_START: NULL
- HTTP\_SERVER\_EVENT\_ON\_CONNECTED: int
- HTTP\_SERVER\_EVENT\_ON\_HEADER: int
- HTTP\_SERVER\_EVENT\_HEADERS\_SENT: int
- HTTP\_SERVER\_EVENT\_ON\_DATA: esp\_http\_server\_event\_data
- HTTP\_SERVER\_EVENT\_SENT\_DATA: esp\_http\_server\_event\_data
- HTTP\_SERVER\_EVENT\_DISCONNECTED: int
- HTTP\_SERVER\_EVENT\_STOP: NULL

### API Reference

#### Header File

- [components/esp\\_http\\_server/include/esp\\_http\\_server.h](#)

## Functions

*esp\_err\_t* **httpd\_register\_uri\_handler** (*httpd\_handle\_t* handle, const *httpd\_uri\_t* \*uri\_handler)

Registers a URI handler.

Example usage:

```
esp_err_t my_uri_handler(httpd_req_t* req)
{
    // Recv , Process and Send
    ....
    ....
    ....

    // Fail condition
    if (....) {
        // Return fail to close session //
        return ESP_FAIL;
    }

    // On success
    return ESP_OK;
}

// URI handler structure
httpd_uri_t my_uri {
    .uri      = "/my_uri/path/xyz",
    .method   = HTTPD_GET,
    .handler  = my_uri_handler,
    .user_ctx = NULL
};

// Register handler
if (httpd_register_uri_handler(server_handle, &my_uri) != ESP_OK) {
    // If failed to register handler
    ....
}
```

---

**Note:** URI handlers can be registered in real time as long as the server handle is valid.

---

### Parameters

- **handle** *–[in]* handle to HTTPD server instance
- **uri\_handler** *–[in]* pointer to handler that needs to be registered

### Returns

- ESP\_OK : On successfully registering the handler
- ESP\_ERR\_INVALID\_ARG : Null arguments
- ESP\_ERR\_HTTPD\_HANDLERS\_FULL : If no slots left for new handler
- ESP\_ERR\_HTTPD\_HANDLER\_EXISTS : If handler with same URI and method is already registered

*esp\_err\_t* **httpd\_unregister\_uri\_handler** (*httpd\_handle\_t* handle, const char \*uri, *httpd\_method\_t* method)

Unregister a URI handler.

### Parameters

- **handle** *–[in]* handle to HTTPD server instance
- **uri** *–[in]* URI string

- **method** –[in] HTTP method

**Returns**

- ESP\_OK : On successfully deregistering the handler
- ESP\_ERR\_INVALID\_ARG : Null arguments
- ESP\_ERR\_NOT\_FOUND : Handler with specified URI and method not found

*esp\_err\_t* **httpd\_unregister\_uri** (*httpd\_handle\_t* handle, const char \*uri)

Unregister all URI handlers with the specified uri string.

**Parameters**

- **handle** –[in] handle to HTTPD server instance
- **uri** –[in] uri string specifying all handlers that need to be deregistered

**Returns**

- ESP\_OK : On successfully deregistering all such handlers
- ESP\_ERR\_INVALID\_ARG : Null arguments
- ESP\_ERR\_NOT\_FOUND : No handler registered with specified uri string

*esp\_err\_t* **httpd\_sess\_set\_recv\_override** (*httpd\_handle\_t* hd, int sockfd, *httpd\_recv\_func\_t* recv\_func)

Override web server's receive function (by session FD)

This function overrides the web server's receive function. This same function is used to read HTTP request packets.

---

**Note:** This API is supposed to be called either from the context of

- an http session APIs where sockfd is a valid parameter
  - a URI handler where sockfd is obtained using `httpd_req_to_sockfd()`
- 

**Parameters**

- **hd** –[in] HTTPD instance handle
- **sockfd** –[in] Session socket FD
- **recv\_func** –[in] The receive function to be set for this session

**Returns**

- ESP\_OK : On successfully registering override
- ESP\_ERR\_INVALID\_ARG : Null arguments

*esp\_err\_t* **httpd\_sess\_set\_send\_override** (*httpd\_handle\_t* hd, int sockfd, *httpd\_send\_func\_t* send\_func)

Override web server's send function (by session FD)

This function overrides the web server's send function. This same function is used to send out any response to any HTTP request.

---

**Note:** This API is supposed to be called either from the context of

- an http session APIs where sockfd is a valid parameter
  - a URI handler where sockfd is obtained using `httpd_req_to_sockfd()`
- 

**Parameters**

- **hd** –[in] HTTPD instance handle
- **sockfd** –[in] Session socket FD
- **send\_func** –[in] The send function to be set for this session

**Returns**

- ESP\_OK : On successfully registering override
- ESP\_ERR\_INVALID\_ARG : Null arguments

*esp\_err\_t* **httpd\_sess\_set\_pending\_override** (*httpd\_handle\_t* hd, int sockfd, *httpd\_pending\_func\_t* pending\_func)

Override web server's pending function (by session FD)

This function overrides the web server's pending function. This function is used to test for pending bytes in a socket.

---

**Note:** This API is supposed to be called either from the context of

- an http session APIs where sockfd is a valid parameter
  - a URI handler where sockfd is obtained using `httpd_req_to_sockfd()`
- 

#### Parameters

- **hd** –[in] HTTPD instance handle
- **sockfd** –[in] Session socket FD
- **pending\_func** –[in] The receive function to be set for this session

#### Returns

- ESP\_OK : On successfully registering override
- ESP\_ERR\_INVALID\_ARG : Null arguments

int **httpd\_req\_to\_sockfd** (*httpd\_req\_t* \*r)

Get the Socket Descriptor from the HTTP request.

This API will return the socket descriptor of the session for which URI handler was executed on reception of HTTP request. This is useful when user wants to call functions that require session socket fd, from within a URI handler, ie. : `httpd_sess_get_ctx()`, `httpd_sess_trigger_close()`, `httpd_sess_update_lru_counter()`.

---

**Note:** This API is supposed to be called only from the context of a URI handler where `httpd_req_t*` request pointer is valid.

---

**Parameters** **r** –[in] The request whose socket descriptor should be found

#### Returns

- Socket descriptor : The socket descriptor for this request
- -1 : Invalid/NULL request pointer

int **httpd\_req\_recv** (*httpd\_req\_t* \*r, char \*buf, size\_t buf\_len)

API to read content data from the HTTP request.

This API will read HTTP content data from the HTTP request into provided buffer. Use `content_len` provided in `httpd_req_t` structure to know the length of data to be fetched. If `content_len` is too large for the buffer then user may have to make multiple calls to this function, each time fetching 'buf\_len' number of bytes, while the pointer to content data is incremented internally by the same number.

---

#### Note:

- This API is supposed to be called only from the context of a URI handler where `httpd_req_t*` request pointer is valid.
  - If an error is returned, the URI handler must further return an error. This will ensure that the erroneous socket is closed and cleaned up by the web server.
  - Presently Chunked Encoding is not supported
- 

#### Parameters

- **r** –[in] The request being responded to
- **buf** –[in] Pointer to a buffer that the data will be read into
- **buf\_len** –[in] Length of the buffer

#### Returns

- Bytes : Number of bytes read into the buffer successfully

- 0 : Buffer length parameter is zero / connection closed by peer
- HTTPD\_SOCK\_ERR\_INVALID : Invalid arguments
- HTTPD\_SOCK\_ERR\_TIMEOUT : Timeout/interrupted while calling socket recv()
- HTTPD\_SOCK\_ERR\_FAIL : Unrecoverable error while calling socket recv()

size\_t **httpd\_req\_get\_hdr\_value\_len** (*httpd\_req\_t* \*r, const char \*field)

Search for a field in request headers and return the string length of it' s value.

---

**Note:**

- This API is supposed to be called only from the context of a URI handler where httpd\_req\_t\* request pointer is valid.
  - Once httpd\_resp\_send() API is called all request headers are purged, so request headers need be copied into separate buffers if they are required later.
- 

**Parameters**

- **r** –[in] The request being responded to
- **field** –[in] The header field to be searched in the request

**Returns**

- Length : If field is found in the request URL
- Zero : Field not found / Invalid request / Null arguments

*esp\_err\_t* **httpd\_req\_get\_hdr\_value\_str** (*httpd\_req\_t* \*r, const char \*field, char \*val, size\_t val\_size)

Get the value string of a field from the request headers.

---

**Note:**

- This API is supposed to be called only from the context of a URI handler where httpd\_req\_t\* request pointer is valid.
  - Once httpd\_resp\_send() API is called all request headers are purged, so request headers need be copied into separate buffers if they are required later.
  - If output size is greater than input, then the value is truncated, accompanied by truncation error as return value.
  - Use httpd\_req\_get\_hdr\_value\_len() to know the right buffer length
- 

**Parameters**

- **r** –[in] The request being responded to
- **field** –[in] The field to be searched in the header
- **val** –[out] Pointer to the buffer into which the value will be copied if the field is found
- **val\_size** –[in] Size of the user buffer “val”

**Returns**

- ESP\_OK : Field found in the request header and value string copied
- ESP\_ERR\_NOT\_FOUND : Key not found
- ESP\_ERR\_INVALID\_ARG : Null arguments
- ESP\_ERR\_HTTPD\_INVALID\_REQ : Invalid HTTP request pointer
- ESP\_ERR\_HTTPD\_RESULT\_TRUNC : Value string truncated

size\_t **httpd\_req\_get\_url\_query\_len** (*httpd\_req\_t* \*r)

Get Query string length from the request URL.

---

**Note:** This API is supposed to be called only from the context of a URI handler where httpd\_req\_t\* request pointer is valid

---

**Parameters** **r** –[in] The request being responded to



**Returns**

- Length : Query is found in the request URL
- Zero : Query not found / Null arguments / Invalid request

*esp\_err\_t* **httpd\_req\_get\_url\_query\_str** (*httpd\_req\_t* \*r, char \*buf, size\_t buf\_len)

Get Query string from the request URL.

---

**Note:**

- Presently, the user can fetch the full URL query string, but decoding will have to be performed by the user. Request headers can be read using `httpd_req_get_hdr_value_str()` to know the ‘Content-Type’ (eg. Content-Type: application/x-www-form-urlencoded) and then the appropriate decoding algorithm needs to be applied.
- This API is supposed to be called only from the context of a URI handler where `httpd_req_t*` request pointer is valid
- If output size is greater than input, then the value is truncated, accompanied by truncation error as return value
- Prior to calling this function, one can use `httpd_req_get_url_query_len()` to know the query string length beforehand and hence allocate the buffer of right size (usually query string length + 1 for null termination) for storing the query string

---

**Parameters**

- **r** –[in] The request being responded to
- **buf** –[out] Pointer to the buffer into which the query string will be copied (if found)
- **buf\_len** –[in] Length of output buffer

**Returns**

- `ESP_OK` : Query is found in the request URL and copied to buffer
- `ESP_ERR_NOT_FOUND` : Query not found
- `ESP_ERR_INVALID_ARG` : Null arguments
- `ESP_ERR_HTTPD_INVALID_REQ` : Invalid HTTP request pointer
- `ESP_ERR_HTTPD_RESULT_TRUNC` : Query string truncated

*esp\_err\_t* **httpd\_query\_key\_value** (const char \*qry, const char \*key, char \*val, size\_t val\_size)

Helper function to get a URL query tag from a query string of the type param1=val1&param2=val2.

---

**Note:**

- The components of URL query string (keys and values) are not URLdecoded. The user must check for ‘Content-Type’ field in the request headers and then depending upon the specified encoding (URLencoded or otherwise) apply the appropriate decoding algorithm.
- If actual value size is greater than `val_size`, then the value is truncated, accompanied by truncation error as return value.

---

**Parameters**

- **qry** –[in] Pointer to query string
- **key** –[in] The key to be searched in the query string
- **val** –[out] Pointer to the buffer into which the value will be copied if the key is found
- **val\_size** –[in] Size of the user buffer “val”

**Returns**

- `ESP_OK` : Key is found in the URL query string and copied to buffer
- `ESP_ERR_NOT_FOUND` : Key not found
- `ESP_ERR_INVALID_ARG` : Null arguments
- `ESP_ERR_HTTPD_RESULT_TRUNC` : Value string truncated

*esp\_err\_t* **httpd\_req\_get\_cookie\_val** (*httpd\_req\_t* \*req, const char \*cookie\_name, char \*val, size\_t \*val\_size)

Get the value string of a cookie value from the “Cookie” request headers by cookie name.

#### Parameters

- **req** –[in] Pointer to the HTTP request
- **cookie\_name** –[in] The cookie name to be searched in the request
- **val** –[out] Pointer to the buffer into which the value of cookie will be copied if the cookie is found
- **val\_size** –[inout] Pointer to size of the user buffer “val” . This variable will contain cookie length if ESP\_OK is returned and required buffer length incase ESP\_ERR\_HTTPD\_RESULT\_TRUNC is returned.

#### Returns

- ESP\_OK : Key is found in the cookie string and copied to buffer
- ESP\_ERR\_NOT\_FOUND : Key not found
- ESP\_ERR\_INVALID\_ARG : Null arguments
- ESP\_ERR\_HTTPD\_RESULT\_TRUNC : Value string truncated
- ESP\_ERR\_NO\_MEM : Memory allocation failure

bool **httpd\_uri\_match\_wildcard** (const char \*uri\_template, const char \*uri\_to\_match, size\_t match\_upto)

Test if a URI matches the given wildcard template.

Template may end with “?” to make the previous character optional (typically a slash), “\*” for a wildcard match, and “?\*” to make the previous character optional, and if present, allow anything to follow.

Example:

- \* matches everything
- /foo/? matches /foo and /foo/
- /foo/\* (sans the backslash) matches /foo/ and /foo/bar, but not /foo or /fo
- /foo/?\* or /foo/\*? (sans the backslash) matches /foo/, /foo/bar, and also /foo, but not /foox or /fo

The special characters “?” and “\*” anywhere else in the template will be taken literally.

#### Parameters

- **uri\_template** –[in] URI template (pattern)
- **uri\_to\_match** –[in] URI to be matched
- **match\_upto** –[in] how many characters of the URI buffer to test (there may be trailing query string etc.)

**Returns** true if a match was found

*esp\_err\_t* **httpd\_resp\_send** (*httpd\_req\_t* \*r, const char \*buf, ssize\_t buf\_len)

API to send a complete HTTP response.

This API will send the data as an HTTP response to the request. This assumes that you have the entire response ready in a single buffer. If you wish to send response in incremental chunks use `httpd_resp_send_chunk()` instead.

If no status code and content-type were set, by default this will send 200 OK status code and content type as text/html. You may call the following functions before this API to configure the response headers : `httpd_resp_set_status()` - for setting the HTTP status string, `httpd_resp_set_type()` - for setting the Content Type, `httpd_resp_set_hdr()` - for appending any additional field value entries in the response header

---

#### Note:

- This API is supposed to be called only from the context of a URI handler where `httpd_req_t*` request pointer is valid.
- Once this API is called, the request has been responded to.
- No additional data can then be sent for the request.
- Once this API is called, all request headers are purged, so request headers need be copied into separate buffers if they are required later.

**Parameters**

- **r** –[in] The request being responded to
- **buf** –[in] Buffer from where the content is to be fetched
- **buf\_len** –[in] Length of the buffer, HTTPD\_RESP\_USE\_STRLEN to use strlen()

**Returns**

- ESP\_OK : On successfully sending the response packet
- ESP\_ERR\_INVALID\_ARG : Null request pointer
- ESP\_ERR\_HTTPD\_RESP\_HDR : Essential headers are too large for internal buffer
- ESP\_ERR\_HTTPD\_RESP\_SEND : Error in raw send
- ESP\_ERR\_HTTPD\_INVALID\_REQ : Invalid request

*esp\_err\_t* **httpd\_resp\_send\_chunk** (*httpd\_req\_t* \*r, const char \*buf, ssize\_t buf\_len)

API to send one HTTP chunk.

This API will send the data as an HTTP response to the request. This API will use chunked-encoding and send the response in the form of chunks. If you have the entire response contained in a single buffer, please use `httpd_resp_send()` instead.

If no status code and content-type were set, by default this will send 200 OK status code and content type as text/html. You may call the following functions before this API to configure the response headers `httpd_resp_set_status()` - for setting the HTTP status string, `httpd_resp_set_type()` - for setting the Content Type, `httpd_resp_set_hdr()` - for appending any additional field value entries in the response header

---

**Note:**

- This API is supposed to be called only from the context of a URI handler where `httpd_req_t*` request pointer is valid.
  - When you are finished sending all your chunks, you must call this function with `buf_len` as 0.
  - Once this API is called, all request headers are purged, so request headers need be copied into separate buffers if they are required later.
- 

**Parameters**

- **r** –[in] The request being responded to
- **buf** –[in] Pointer to a buffer that stores the data
- **buf\_len** –[in] Length of the buffer, HTTPD\_RESP\_USE\_STRLEN to use strlen()

**Returns**

- ESP\_OK : On successfully sending the response packet chunk
- ESP\_ERR\_INVALID\_ARG : Null request pointer
- ESP\_ERR\_HTTPD\_RESP\_HDR : Essential headers are too large for internal buffer
- ESP\_ERR\_HTTPD\_RESP\_SEND : Error in raw send
- ESP\_ERR\_HTTPD\_INVALID\_REQ : Invalid request pointer

static inline *esp\_err\_t* **httpd\_resp\_sendstr** (*httpd\_req\_t* \*r, const char \*str)

API to send a complete string as HTTP response.

This API simply calls `httpd_resp_send` with buffer length set to string length assuming the buffer contains a null terminated string

**Parameters**

- **r** –[in] The request being responded to
- **str** –[in] String to be sent as response body

**Returns**

- ESP\_OK : On successfully sending the response packet
- ESP\_ERR\_INVALID\_ARG : Null request pointer
- ESP\_ERR\_HTTPD\_RESP\_HDR : Essential headers are too large for internal buffer
- ESP\_ERR\_HTTPD\_RESP\_SEND : Error in raw send
- ESP\_ERR\_HTTPD\_INVALID\_REQ : Invalid request

static inline *esp\_err\_t* **httpd\_resp\_sendstr\_chunk** (*httpd\_req\_t* \*r, const char \*str)

API to send a string as an HTTP response chunk.

This API simply calls `http_resp_send_chunk` with buffer length set to string length assuming the buffer contains a null terminated string

#### Parameters

- **r** –[in] The request being responded to
- **str** –[in] String to be sent as response body (NULL to finish response packet)

#### Returns

- `ESP_OK` : On successfully sending the response packet
- `ESP_ERR_INVALID_ARG` : Null request pointer
- `ESP_ERR_HTTPD_RESP_HDR` : Essential headers are too large for internal buffer
- `ESP_ERR_HTTPD_RESP_SEND` : Error in raw send
- `ESP_ERR_HTTPD_INVALID_REQ` : Invalid request

*esp\_err\_t* **httpd\_resp\_set\_status** (*httpd\_req\_t* \*r, const char \*status)

API to set the HTTP status code.

This API sets the status of the HTTP response to the value specified. By default, the ‘200 OK’ response is sent as the response.

---

#### Note:

- This API is supposed to be called only from the context of a URI handler where `httpd_req_t*` request pointer is valid.
  - This API only sets the status to this value. The status isn’t sent out until any of the send APIs is executed.
  - Make sure that the lifetime of the status string is valid till send function is called.
- 

#### Parameters

- **r** –[in] The request being responded to
- **status** –[in] The HTTP status code of this response

#### Returns

- `ESP_OK` : On success
- `ESP_ERR_INVALID_ARG` : Null arguments
- `ESP_ERR_HTTPD_INVALID_REQ` : Invalid request pointer

*esp\_err\_t* **httpd\_resp\_set\_type** (*httpd\_req\_t* \*r, const char \*type)

API to set the HTTP content type.

This API sets the ‘Content Type’ field of the response. The default content type is ‘text/html’ .

---

#### Note:

- This API is supposed to be called only from the context of a URI handler where `httpd_req_t*` request pointer is valid.
  - This API only sets the content type to this value. The type isn’t sent out until any of the send APIs is executed.
  - Make sure that the lifetime of the type string is valid till send function is called.
- 

#### Parameters

- **r** –[in] The request being responded to
- **type** –[in] The Content Type of the response

#### Returns

- `ESP_OK` : On success
- `ESP_ERR_INVALID_ARG` : Null arguments
- `ESP_ERR_HTTPD_INVALID_REQ` : Invalid request pointer

*esp\_err\_t* **httpd\_resp\_set\_hdr** (*httpd\_req\_t* \*r, const char \*field, const char \*value)

API to append any additional headers.

This API sets any additional header fields that need to be sent in the response.

---

**Note:**

- This API is supposed to be called only from the context of a URI handler where *httpd\_req\_t*\* request pointer is valid.
  - The header isn't sent out until any of the send APIs is executed.
  - The maximum allowed number of additional headers is limited to value of *max\_resp\_headers* in config structure.
  - Make sure that the lifetime of the field value strings are valid till send function is called.
- 

**Parameters**

- **r** –[in] The request being responded to
- **field** –[in] The field name of the HTTP header
- **value** –[in] The value of this HTTP header

**Returns**

- *ESP\_OK* : On successfully appending new header
- *ESP\_ERR\_INVALID\_ARG* : Null arguments
- *ESP\_ERR\_HTTPD\_RESP\_HDR* : Total additional headers exceed max allowed
- *ESP\_ERR\_HTTPD\_INVALID\_REQ* : Invalid request pointer

*esp\_err\_t* **httpd\_resp\_send\_err** (*httpd\_req\_t* \*req, *httpd\_err\_code\_t* error, const char \*msg)

For sending out error code in response to HTTP request.

---

**Note:**

- This API is supposed to be called only from the context of a URI handler where *httpd\_req\_t*\* request pointer is valid.
  - Once this API is called, all request headers are purged, so request headers need be copied into separate buffers if they are required later.
  - If you wish to send additional data in the body of the response, please use the lower-level functions directly.
- 

**Parameters**

- **req** –[in] Pointer to the HTTP request for which the response needs to be sent
- **error** –[in] Error type to send
- **msg** –[in] Error message string (pass NULL for default message)

**Returns**

- *ESP\_OK* : On successfully sending the response packet
- *ESP\_ERR\_INVALID\_ARG* : Null arguments
- *ESP\_ERR\_HTTPD\_RESP\_SEND* : Error in raw send
- *ESP\_ERR\_HTTPD\_INVALID\_REQ* : Invalid request pointer

static inline *esp\_err\_t* **httpd\_resp\_send\_404** (*httpd\_req\_t* \*r)

Helper function for HTTP 404.

Send HTTP 404 message. If you wish to send additional data in the body of the response, please use the lower-level functions directly.

---

**Note:**

- This API is supposed to be called only from the context of a URI handler where *httpd\_req\_t*\* request pointer is valid.

- Once this API is called, all request headers are purged, so request headers need be copied into separate buffers if they are required later.
- 

**Parameters** `r` –[in] The request being responded to

**Returns**

- `ESP_OK` : On successfully sending the response packet
- `ESP_ERR_INVALID_ARG` : Null arguments
- `ESP_ERR_HTTPD_RESP_SEND` : Error in raw send
- `ESP_ERR_HTTPD_INVALID_REQ` : Invalid request pointer

static inline `esp_err_t httpd_resp_send_408` (`httpd_req_t` \*r)

Helper function for HTTP 408.

Send HTTP 408 message. If you wish to send additional data in the body of the response, please use the lower-level functions directly.

---

**Note:**

- This API is supposed to be called only from the context of a URI handler where `httpd_req_t*` request pointer is valid.
  - Once this API is called, all request headers are purged, so request headers need be copied into separate buffers if they are required later.
- 

**Parameters** `r` –[in] The request being responded to

**Returns**

- `ESP_OK` : On successfully sending the response packet
- `ESP_ERR_INVALID_ARG` : Null arguments
- `ESP_ERR_HTTPD_RESP_SEND` : Error in raw send
- `ESP_ERR_HTTPD_INVALID_REQ` : Invalid request pointer

static inline `esp_err_t httpd_resp_send_500` (`httpd_req_t` \*r)

Helper function for HTTP 500.

Send HTTP 500 message. If you wish to send additional data in the body of the response, please use the lower-level functions directly.

---

**Note:**

- This API is supposed to be called only from the context of a URI handler where `httpd_req_t*` request pointer is valid.
  - Once this API is called, all request headers are purged, so request headers need be copied into separate buffers if they are required later.
- 

**Parameters** `r` –[in] The request being responded to

**Returns**

- `ESP_OK` : On successfully sending the response packet
- `ESP_ERR_INVALID_ARG` : Null arguments
- `ESP_ERR_HTTPD_RESP_SEND` : Error in raw send
- `ESP_ERR_HTTPD_INVALID_REQ` : Invalid request pointer

int `httpd_send` (`httpd_req_t` \*r, const char \*buf, size\_t buf\_len)

Raw HTTP send.

Call this API if you wish to construct your custom response packet. When using this, all essential header, eg. HTTP version, Status Code, Content Type and Length, Encoding, etc. will have to be constructed manually,

and HTTP delimiters (CRLF) will need to be placed correctly for separating sub-sections of the HTTP response packet.

If the send override function is set, this API will end up calling that function eventually to send data out.

---

**Note:**

- This API is supposed to be called only from the context of a URI handler where `httpd_req_t*` request pointer is valid.
  - Unless the response has the correct HTTP structure (which the user must now ensure) it is not guaranteed that it will be recognized by the client. For most cases, you wouldn't have to call this API, but you would rather use either of : `httpd_resp_send()`, `httpd_resp_send_chunk()`
- 

**Parameters**

- **r** `–[in]` The request being responded to
- **buf** `–[in]` Buffer from where the fully constructed packet is to be read
- **buf\_len** `–[in]` Length of the buffer

**Returns**

- Bytes : Number of bytes that were sent successfully
- `HTTPD SOCK_ERR_INVALID` : Invalid arguments
- `HTTPD SOCK_ERR_TIMEOUT` : Timeout/interrupted while calling socket send()
- `HTTPD SOCK_ERR_FAIL` : Unrecoverable error while calling socket send()

int `httpd_socket_send` (`httpd_handle_t` hd, int sockfd, const char \*buf, size\_t buf\_len, int flags)

A low level API to send data on a given socket

This internally calls the default send function, or the function registered by `httpd_sess_set_send_override()`.

---

**Note:** This API is not recommended to be used in any request handler. Use this only for advanced use cases, wherein some asynchronous data is to be sent over a socket.

---

**Parameters**

- **hd** `–[in]` server instance
- **sockfd** `–[in]` session socket file descriptor
- **buf** `–[in]` buffer with bytes to send
- **buf\_len** `–[in]` data size
- **flags** `–[in]` flags for the send() function

**Returns**

- Bytes : The number of bytes sent successfully
- `HTTPD SOCK_ERR_INVALID` : Invalid arguments
- `HTTPD SOCK_ERR_TIMEOUT` : Timeout/interrupted while calling socket send()
- `HTTPD SOCK_ERR_FAIL` : Unrecoverable error while calling socket send()

int `httpd_socket_recv` (`httpd_handle_t` hd, int sockfd, char \*buf, size\_t buf\_len, int flags)

A low level API to receive data from a given socket

This internally calls the default recv function, or the function registered by `httpd_sess_set_recv_override()`.

---

**Note:** This API is not recommended to be used in any request handler. Use this only for advanced use cases, wherein some asynchronous communication is required.

---

**Parameters**

- **hd** –[in] server instance
- **sockfd** –[in] session socket file descriptor
- **buf** –[in] buffer with bytes to send
- **buf\_len** –[in] data size
- **flags** –[in] flags for the send() function

**Returns**

- Bytes : The number of bytes received successfully
- 0 : Buffer length parameter is zero / connection closed by peer
- HTTPD\_SOCK\_ERR\_INVALID : Invalid arguments
- HTTPD\_SOCK\_ERR\_TIMEOUT : Timeout/interrupted while calling socket recv()
- HTTPD\_SOCK\_ERR\_FAIL : Unrecoverable error while calling socket recv()

*esp\_err\_t* **httpd\_register\_err\_handler** (*httpd\_handle\_t* handle, *httpd\_err\_code\_t* error, *httpd\_err\_handler\_func\_t* handler\_fn)

Function for registering HTTP error handlers.

This function maps a handler function to any supported error code given by *httpd\_err\_code\_t*. See prototype *httpd\_err\_handler\_func\_t* above for details.

**Parameters**

- **handle** –[in] HTTP server handle
- **error** –[in] Error type
- **handler\_fn** –[in] User implemented handler function (Pass NULL to unset any previously set handler)

**Returns**

- ESP\_OK : handler registered successfully
- ESP\_ERR\_INVALID\_ARG : invalid error code or server handle

*esp\_err\_t* **httpd\_start** (*httpd\_handle\_t* \*handle, const *httpd\_config\_t* \*config)

Starts the web server.

Create an instance of HTTP server and allocate memory/resources for it depending upon the specified configuration.

Example usage:

```
//Function for starting the webserver
httpd_handle_t start_webserver(void)
{
    // Generate default configuration
    httpd_config_t config = HTTPD_DEFAULT_CONFIG();

    // Empty handle to http_server
    httpd_handle_t server = NULL;

    // Start the httpd server
    if (httpd_start(&server, &config) == ESP_OK) {
        // Register URI handlers
        httpd_register_uri_handler(server, &uri_get);
        httpd_register_uri_handler(server, &uri_post);
    }
    // If server failed to start, handle will be NULL
    return server;
}
```

**Parameters**

- **config** –[in] Configuration for new instance of the server
- **handle** –[out] Handle to newly created instance of the server. NULL on error

**Returns**

- ESP\_OK : Instance created successfully
- ESP\_ERR\_INVALID\_ARG : Null argument(s)



- `ESP_ERR_HTTPD_ALLOC_MEM` : Failed to allocate memory for instance
- `ESP_ERR_HTTPD_TASK` : Failed to launch server task

`esp_err_t httpd_stop` (*httpd\_handle\_t* handle)

Stops the web server.

Deallocates memory/resources used by an HTTP server instance and deletes it. Once deleted the handle can no longer be used for accessing the instance.

Example usage:

```
// Function for stopping the webserver
void stop_webserver(httpd_handle_t server)
{
    // Ensure handle is non NULL
    if (server != NULL) {
        // Stop the httpd server
        httpd_stop(server);
    }
}
```

**Parameters** `handle` –[in] Handle to server returned by `httpd_start`

**Returns**

- `ESP_OK` : Server stopped successfully
- `ESP_ERR_INVALID_ARG` : Handle argument is Null

`esp_err_t httpd_queue_work` (*httpd\_handle\_t* handle, *httpd\_work\_fn\_t* work, void \*arg)

Queue execution of a function in HTTPD' s context.

This API queues a work function for asynchronous execution

---

**Note:** Some protocols require that the web server generate some asynchronous data and send it to the persistently opened connection. This facility is for use by such protocols.

---

**Parameters**

- `handle` –[in] Handle to server returned by `httpd_start`
- `work` –[in] Pointer to the function to be executed in the HTTPD' s context
- `arg` –[in] Pointer to the arguments that should be passed to this function

**Returns**

- `ESP_OK` : On successfully queueing the work
- `ESP_FAIL` : Failure in ctrl socket
- `ESP_ERR_INVALID_ARG` : Null arguments

void \*`httpd_sess_get_ctx` (*httpd\_handle\_t* handle, int sockfd)

Get session context from socket descriptor.

Typically if a session context is created, it is available to URI handlers through the `httpd_req_t` structure. But, there are cases where the web server' s send/receive functions may require the context (for example, for accessing keying information etc). Since the send/receive function only have the socket descriptor at their disposal, this API provides them with a way to retrieve the session context.

**Parameters**

- `handle` –[in] Handle to server returned by `httpd_start`
- `sockfd` –[in] The socket descriptor for which the context should be extracted.

**Returns**

- void\* : Pointer to the context associated with this session
- NULL : Empty context / Invalid handle / Invalid socket fd

void **httpd\_sess\_set\_ctx** (*httpd\_handle\_t* handle, int sockfd, void \*ctx, *httpd\_free\_ctx\_fn\_t* free\_fn)

Set session context by socket descriptor.

**Parameters**

- **handle** –[in] Handle to server returned by httpd\_start
- **sockfd** –[in] The socket descriptor for which the context should be extracted.
- **ctx** –[in] Context object to assign to the session
- **free\_fn** –[in] Function that should be called to free the context

void \***httpd\_sess\_get\_transport\_ctx** (*httpd\_handle\_t* handle, int sockfd)

Get session ‘transport’ context by socket descriptor.

This context is used by the send/receive functions, for example to manage SSL context.

**See also:**

httpd\_sess\_get\_ctx()

**Parameters**

- **handle** –[in] Handle to server returned by httpd\_start
- **sockfd** –[in] The socket descriptor for which the context should be extracted.

**Returns**

- void\* : Pointer to the transport context associated with this session
- NULL : Empty context / Invalid handle / Invalid socket fd

void **httpd\_sess\_set\_transport\_ctx** (*httpd\_handle\_t* handle, int sockfd, void \*ctx, *httpd\_free\_ctx\_fn\_t* free\_fn)

Set session ‘transport’ context by socket descriptor.

**See also:**

httpd\_sess\_set\_ctx()

**Parameters**

- **handle** –[in] Handle to server returned by httpd\_start
- **sockfd** –[in] The socket descriptor for which the context should be extracted.
- **ctx** –[in] Transport context object to assign to the session
- **free\_fn** –[in] Function that should be called to free the transport context

void \***httpd\_get\_global\_user\_ctx** (*httpd\_handle\_t* handle)

Get HTTPD global user context (it was set in the server config struct)

**Parameters** **handle** –[in] Handle to server returned by httpd\_start

**Returns** global user context

void \***httpd\_get\_global\_transport\_ctx** (*httpd\_handle\_t* handle)

Get HTTPD global transport context (it was set in the server config struct)

**Parameters** **handle** –[in] Handle to server returned by httpd\_start

**Returns** global transport context

*esp\_err\_t* **httpd\_sess\_trigger\_close** (*httpd\_handle\_t* handle, int sockfd)

Trigger an httpd session close externally.

---

**Note:** Calling this API is only required in special circumstances wherein some application requires to close an httpd client session asynchronously.

---

**Parameters**

- **handle** –[in] Handle to server returned by `httpd_start`
- **sockfd** –[in] The socket descriptor of the session to be closed

**Returns**

- `ESP_OK` : On successfully initiating closure
- `ESP_FAIL` : Failure to queue work
- `ESP_ERR_NOT_FOUND` : Socket fd not found
- `ESP_ERR_INVALID_ARG` : Null arguments

*esp\_err\_t* **httpd\_sess\_update\_lru\_counter** (*httpd\_handle\_t* handle, int sockfd)

Update LRU counter for a given socket.

LRU Counters are internally associated with each session to monitor how recently a session exchanged traffic. When LRU purge is enabled, if a client is requesting for connection but maximum number of sockets/sessions is reached, then the session having the earliest LRU counter is closed automatically.

Updating the LRU counter manually prevents the socket from being purged due to the Least Recently Used (LRU) logic, even though it might not have received traffic for some time. This is useful when all open sockets/session are frequently exchanging traffic but the user specifically wants one of the sessions to be kept open, irrespective of when it last exchanged a packet.

---

**Note:** Calling this API is only necessary if the LRU Purge Enable option is enabled.

---

**Parameters**

- **handle** –[in] Handle to server returned by `httpd_start`
- **sockfd** –[in] The socket descriptor of the session for which LRU counter is to be updated

**Returns**

- `ESP_OK` : Socket found and LRU counter updated
- `ESP_ERR_NOT_FOUND` : Socket not found
- `ESP_ERR_INVALID_ARG` : Null arguments

*esp\_err\_t* **httpd\_get\_client\_list** (*httpd\_handle\_t* handle, size\_t \*fds, int \*client\_fds)

Returns list of current socket descriptors of active sessions.

---

**Note:** Size of provided array has to be equal or greater than maximum number of opened sockets, configured upon initialization with `max_open_sockets` field in `httpd_config_t` structure.

---

**Parameters**

- **handle** –[in] Handle to server returned by `httpd_start`
- **fds** –[inout] In: Size of provided `client_fds` array Out: Number of valid client fds returned in `client_fds`,
- **client\_fds** –[out] Array of client fds

**Returns**

- `ESP_OK` : Successfully retrieved session list
- `ESP_ERR_INVALID_ARG` : Wrong arguments or list is longer than provided array

**Structures**

struct **esp\_http\_server\_event\_data**

Argument structure for `HTTP_SERVER_EVENT_ON_DATA` and `HTTP_SERVER_EVENT_SENT_DATA` event

**Public Members**

int **fd**

Session socket file descriptor

int **data\_len**

Data length

struct **httpd\_config**

HTTP Server Configuration Structure.

---

**Note:** Use HTTPD\_DEFAULT\_CONFIG() to initialize the configuration to a default value and then modify only those fields that are specifically determined by the use case.

---

### Public Members

unsigned **task\_priority**

Priority of FreeRTOS task which runs the server

size\_t **stack\_size**

The maximum stack size allowed for the server task

BaseType\_t **core\_id**

The core the HTTP server task will run on

uint16\_t **server\_port**

TCP Port number for receiving and transmitting HTTP traffic

uint16\_t **ctrl\_port**

UDP Port number for asynchronously exchanging control signals between various components of the server

uint16\_t **max\_open\_sockets**

Max number of sockets/clients connected at any time

uint16\_t **max\_uri\_handlers**

Maximum allowed uri handlers

uint16\_t **max\_resp\_headers**

Maximum allowed additional headers in HTTP response

uint16\_t **backlog\_conn**

Number of backlog connections

bool **lru\_purge\_enable**

Purge “Least Recently Used” connection

uint16\_t **recv\_wait\_timeout**

Timeout for recv function (in seconds)

`uint16_t send_wait_timeout`

Timeout for send function (in seconds)

`void *global_user_ctx`

Global user context.

This field can be used to store arbitrary user data within the server context. The value can be retrieved using the server handle, available e.g. in the `httpd_req_t` struct.

When shutting down, the server frees up the user context by calling `free()` on the `global_user_ctx` field. If you wish to use a custom function for freeing the global user context, please specify that here.

[\*httpd\\_free\\_ctx\\_fn\\_t\*](#) `global_user_ctx_free_fn`

Free function for global user context

`void *global_transport_ctx`

Global transport context.

Similar to `global_user_ctx`, but used for session encoding or encryption (e.g. to hold the SSL context). It will be freed using `free()`, unless `global_transport_ctx_free_fn` is specified.

[\*httpd\\_free\\_ctx\\_fn\\_t\*](#) `global_transport_ctx_free_fn`

Free function for global transport context

`bool enable_so_linger`

bool to enable/disable linger

`int linger_timeout`

linger timeout (in seconds)

`bool keep_alive_enable`

Enable keep-alive timeout

`int keep_alive_idle`

Keep-alive idle time. Default is 5 (second)

`int keep_alive_interval`

Keep-alive interval time. Default is 5 (second)

`int keep_alive_count`

Keep-alive packet retry send count. Default is 3 counts

[\*httpd\\_open\\_func\\_t\*](#) `open_fn`

Custom session opening callback.

Called on a new session socket just after `accept()`, but before reading any data.

This is an opportunity to set up e.g. SSL encryption using `global_transport_ctx` and the `send/recv/pending` session overrides.

If a context needs to be maintained between these functions, store it in the session using `httpd_sess_set_transport_ctx()` and retrieve it later with `httpd_sess_get_transport_ctx()`

Returning a value other than `ESP_OK` will immediately close the new socket.

***httpd\_close\_func\_t* close\_fn**

Custom session closing callback.

Called when a session is deleted, before freeing user and transport contexts and before closing the socket. This is a place for custom de-init code common to all sockets.

The server will only close the socket if no custom session closing callback is set. If a custom callback is used, `close(sockfd)` should be called in here for most cases.

Set the user or transport context to NULL if it was freed here, so the server does not try to free it again.

This function is run for all terminated sessions, including sessions where the socket was closed by the network stack - that is, the file descriptor may not be valid anymore.

***httpd\_uri\_match\_func\_t* uri\_match\_fn**

URI matcher function.

Called when searching for a matching URI: 1) whose request handler is to be executed right after an HTTP request is successfully parsed 2) in order to prevent duplication while registering a new URI handler using `httpd_register_uri_handler()`

Available options are: 1) NULL : Internally do basic matching using `strcmp()` 2) `httpd_uri_match_wildcard()` : URI wildcard matcher

Users can implement their own matching functions (See description of the `httpd_uri_match_func_t` function prototype)

**struct `httpd_req`**

HTTP Request Data Structure.

**Public Members*****httpd\_handle\_t* handle**

Handle to server instance

**int `method`**

The type of HTTP request, -1 if unsupported method

**const char `uri`[HTTPD\_MAX\_URI\_LEN + 1]**

The URI of this request (1 byte extra for null termination)

**size\_t `content_len`**

Length of the request body

**void \*`aux`**

Internally used members

**void \*`user_ctx`**

User context pointer passed during URI registration.

**void \*`sess_ctx`**

Session Context Pointer

A session context. Contexts are maintained across 'sessions' for a given open TCP connection. One session could have multiple request responses. The web server will ensure that the context persists across all these request and responses.

By default, this is NULL. URI Handlers can set this to any meaningful value.

If the underlying socket gets closed, and this pointer is non-NULL, the web server will free up the context by calling `free()`, unless `free_ctx` function is set.

#### *httpd\_free\_ctx\_fn\_t* **free\_ctx**

Pointer to free context hook

Function to free session context

If the web server's socket closes, it frees up the session context by calling `free()` on the `sess_ctx` member. If you wish to use a custom function for freeing the session context, please specify that here.

#### bool **ignore\_sess\_ctx\_changes**

Flag indicating if Session Context changes should be ignored

By default, if you change the `sess_ctx` in some URI handler, the http server will internally free the earlier context (if non NULL), after the URI handler returns. If you want to manage the allocation/reallocation/freeing of `sess_ctx` yourself, set this flag to true, so that the server will not perform any checks on it. The context will be cleared by the server (by calling `free_ctx` or `free()`) only if the socket gets closed.

#### struct **httpd\_uri**

Structure for URI handler.

#### **Public Members**

##### const char \***uri**

The URI to handle

##### *httpd\_method\_t* **method**

Method supported by the URI

##### *esp\_err\_t* (\***handler**)(*httpd\_req\_t* \*r)

Handler to call for supported request method. This must return `ESP_OK`, or else the underlying socket will be closed.

##### void \***user\_ctx**

Pointer to user context data which will be available to handler

#### **Macros**

**HTTPD\_MAX\_REQ\_HDR\_LEN**

**HTTPD\_MAX\_URI\_LEN**

**HTTPD SOCK\_ERR\_FAIL**

**HTTPD SOCK\_ERR\_INVALID**

**HTTPD SOCK\_ERR\_TIMEOUT**

**HTTPD\_200**

HTTP Response 200

**HTTPD\_204**

HTTP Response 204

**HTTPD\_207**

HTTP Response 207

**HTTPD\_400**

HTTP Response 400

**HTTPD\_404**

HTTP Response 404

**HTTPD\_408**

HTTP Response 408

**HTTPD\_500**

HTTP Response 500

**HTTPD\_TYPE\_JSON**

HTTP Content type JSON

**HTTPD\_TYPE\_TEXT**

HTTP Content type text/HTML

**HTTPD\_TYPE\_OCTET**

HTTP Content type octext-stream

**ESP\_HTTPD\_DEF\_CTRL\_PORT**

HTTP Server control socket port

**HTTPD\_DEFAULT\_CONFIG ()**

**ESP\_ERR\_HTTPD\_BASE**

Starting number of HTTPD error codes

**ESP\_ERR\_HTTPD\_HANDLERS\_FULL**

All slots for registering URI handlers have been consumed

**ESP\_ERR\_HTTPD\_HANDLER\_EXISTS**

URI handler with same method and target URI already registered

**ESP\_ERR\_HTTPD\_INVALID\_REQ**

Invalid request pointer

**ESP\_ERR\_HTTPD\_RESULT\_TRUNC**

Result string truncated



**ESP\_ERR\_HTTPD\_RESP\_HDR**

Response header field larger than supported

**ESP\_ERR\_HTTPD\_RESP\_SEND**

Error occurred while sending response packet

**ESP\_ERR\_HTTPD\_ALLOC\_MEM**

Failed to dynamically allocate memory for resource

**ESP\_ERR\_HTTPD\_TASK**

Failed to launch server task/thread

**HTTPD\_RESP\_USE\_STRLEN****Type Definitions**

```
typedef struct httpd_req httpd_req_t
```

HTTP Request Data Structure.

```
typedef struct httpd_uri httpd_uri_t
```

Structure for URI handler.

```
typedef int (*httpd_send_func_t)(httpd_handle_t hd, int sockfd, const char *buf, size_t buf_len, int flags)
```

Prototype for HTTPDs low-level send function.

---

**Note:** User specified send function must handle errors internally, depending upon the set value of `errno`, and return specific `HTTPD_SOCK_ERR_` codes, which will eventually be conveyed as return value of `httpd_send()` function

---

**Param `hd` [in]** server instance

**Param `sockfd` [in]** session socket file descriptor

**Param `buf` [in]** buffer with bytes to send

**Param `buf_len` [in]** data size

**Param `flags` [in]** flags for the `send()` function

**Return**

- Bytes : The number of bytes sent successfully
- `HTTPD_SOCK_ERR_INVALID` : Invalid arguments
- `HTTPD_SOCK_ERR_TIMEOUT` : Timeout/interrupted while calling socket `send()`
- `HTTPD_SOCK_ERR_FAIL` : Unrecoverable error while calling socket `send()`

```
typedef int (*httpd_recv_func_t)(httpd_handle_t hd, int sockfd, char *buf, size_t buf_len, int flags)
```

Prototype for HTTPDs low-level recv function.

---

**Note:** User specified recv function must handle errors internally, depending upon the set value of `errno`, and return specific `HTTPD_SOCK_ERR_` codes, which will eventually be conveyed as return value of `httpd_req_recv()` function

---

**Param `hd` [in]** server instance

**Param `sockfd` [in]** session socket file descriptor

**Param `buf` [in]** buffer with bytes to send

**Param buf\_len [in]** data size

**Param flags [in]** flags for the send() function

**Return**

- Bytes : The number of bytes received successfully
- 0 : Buffer length parameter is zero / connection closed by peer
- HTTPD\_SOCK\_ERR\_INVALID : Invalid arguments
- HTTPD\_SOCK\_ERR\_TIMEOUT : Timeout/interrupted while calling socket recv()
- HTTPD\_SOCK\_ERR\_FAIL : Unrecoverable error while calling socket recv()

```
typedef int (*httpd_pending_func_t)(httpd_handle_t hd, int sockfd)
```

Prototype for HTTPDs low-level “get pending bytes” function.

---

**Note:** User specified pending function must handle errors internally, depending upon the set value of errno, and return specific HTTPD\_SOCK\_ERR\_ codes, which will be handled accordingly in the server task.

---

**Param hd [in]** server instance

**Param sockfd [in]** session socket file descriptor

**Return**

- Bytes : The number of bytes waiting to be received
- HTTPD\_SOCK\_ERR\_INVALID : Invalid arguments
- HTTPD\_SOCK\_ERR\_TIMEOUT : Timeout/interrupted while calling socket pending()
- HTTPD\_SOCK\_ERR\_FAIL : Unrecoverable error while calling socket pending()

```
typedef esp_err_t (*httpd_err_handler_func_t)(httpd_req_t *req, httpd_err_code_t error)
```

Function prototype for HTTP error handling.

This function is executed upon HTTP errors generated during internal processing of an HTTP request. This is used to override the default behavior on error, which is to send HTTP error response and close the underlying socket.

---

**Note:**

- If implemented, the server will not automatically send out HTTP error response codes, therefore, httpd\_resp\_send\_err() must be invoked inside this function if user wishes to generate HTTP error responses.
  - When invoked, the validity of uri, method, content\_len and user\_ctx fields of the httpd\_req\_t parameter is not guaranteed as the HTTP request may be partially received/parsed.
  - The function must return ESP\_OK if underlying socket needs to be kept open. Any other value will ensure that the socket is closed. The return value is ignored when error is of type HTTPD\_500\_INTERNAL\_SERVER\_ERROR and the socket closed anyway.
- 

**Param req [in]** HTTP request for which the error needs to be handled

**Param error [in]** Error type

**Return**

- ESP\_OK : error handled successful
- ESP\_FAIL : failure indicates that the underlying socket needs to be closed

```
typedef void *httpd_handle_t
```

HTTP Server Instance Handle.

Every instance of the server will have a unique handle.

---

typedef enum http\_method **httpd\_method\_t**

HTTP Method Type wrapper over “enum http\_method” available in “http\_parser” library.

typedef void (\***httpd\_free\_ctx\_fn\_t**)(void \*ctx)

Prototype for freeing context data (if any)

**Param ctx [in]** object to free

typedef *esp\_err\_t* (\***httpd\_open\_func\_t**)(*httpd\_handle\_t* hd, int sockfd)

Function prototype for opening a session.

Called immediately after the socket was opened to set up the send/recv functions and other parameters of the socket.

**Param hd [in]** server instance

**Param sockfd [in]** session socket file descriptor

**Return**

- ESP\_OK : On success
- Any value other than ESP\_OK will signal the server to close the socket immediately

typedef void (\***httpd\_close\_func\_t**)(*httpd\_handle\_t* hd, int sockfd)

Function prototype for closing a session.

---

**Note:** It’s possible that the socket descriptor is invalid at this point, the function is called for all terminated sessions. Ensure proper handling of return codes.

---

**Param hd [in]** server instance

**Param sockfd [in]** session socket file descriptor

typedef bool (\***httpd\_uri\_match\_func\_t**)(const char \*reference\_uri, const char \*uri\_to\_match, size\_t match\_upto)

Function prototype for URI matching.

**Param reference\_uri [in]** URI/template with respect to which the other URI is matched

**Param uri\_to\_match [in]** URI/template being matched to the reference URI/template

**Param match\_upto [in]** For specifying the actual length of uri\_to\_match up to which the matching algorithm is to be applied (The maximum value is strlen(uri\_to\_match), independent of the length of reference\_uri)

**Return** true on match

typedef struct *httpd\_config* **httpd\_config\_t**

HTTP Server Configuration Structure.

---

**Note:** Use HTTPD\_DEFAULT\_CONFIG() to initialize the configuration to a default value and then modify only those fields that are specifically determined by the use case.

---

typedef void (\***httpd\_work\_fn\_t**)(void \*arg)

Prototype of the HTTPD work function Please refer to httpd\_queue\_work() for more details.

**Param arg [in]** The arguments for this work function

## Enumerations

enum **httpd\_err\_code\_t**

Error codes sent as HTTP response in case of errors encountered during processing of an HTTP request.

*Values:*

enumerator **HTTPD\_500\_INTERNAL\_SERVER\_ERROR**

enumerator **HTTPD\_501\_METHOD\_NOT\_IMPLEMENTED**

enumerator **HTTPD\_505\_VERSION\_NOT\_SUPPORTED**

enumerator **HTTPD\_400\_BAD\_REQUEST**

enumerator **HTTPD\_401\_UNAUTHORIZED**

enumerator **HTTPD\_403\_FORBIDDEN**

enumerator **HTTPD\_404\_NOT\_FOUND**

enumerator **HTTPD\_405\_METHOD\_NOT\_ALLOWED**

enumerator **HTTPD\_408\_REQ\_TIMEOUT**

enumerator **HTTPD\_411\_LENGTH\_REQUIRED**

enumerator **HTTPD\_414\_URI\_TOO\_LONG**

enumerator **HTTPD\_431\_REQ\_HDR\_FIELDS\_TOO\_LARGE**

enumerator **HTTPD\_ERR\_CODE\_MAX**

enum **esp\_http\_server\_event\_id\_t**

HTTP Server events id.

*Values:*

enumerator **HTTP\_SERVER\_EVENT\_ERROR**

This event occurs when there are any errors during execution

enumerator **HTTP\_SERVER\_EVENT\_START**

This event occurs when HTTP Server is started

enumerator **HTTP\_SERVER\_EVENT\_ON\_CONNECTED**

Once the HTTP Server has been connected to the client, no data exchange has been performed

enumerator **HTTP\_SERVER\_EVENT\_ON\_HEADER**

Occurs when receiving each header sent from the client

enumerator **HTTP\_SERVER\_EVENT\_HEADERS\_SENT**

After sending all the headers to the client

enumerator **HTTP\_SERVER\_EVENT\_ON\_DATA**

Occurs when receiving data from the client

enumerator **HTTP\_SERVER\_EVENT\_SENT\_DATA**

Occurs when an ESP HTTP server session is finished

enumerator **HTTP\_SERVER\_EVENT\_DISCONNECTED**

The connection has been disconnected

enumerator **HTTP\_SERVER\_EVENT\_STOP**

This event occurs when HTTP Server is stopped

## 2.2.10 HTTPS Server

### Overview

This component is built on top of *HTTP Server*. The HTTPS server takes advantage of hook registration functions in the regular HTTP server to provide callback function for SSL session.

All documentation for *HTTP Server* applies also to a server you create this way.

### Used APIs

The following APIs of *HTTP Server* should not be used with *HTTPS Server*, as they are used internally to handle secure sessions and to maintain internal state:

- “send” , “receive” and “pending” callback registration functions - secure socket handling
  - `httpd_sess_set_send_override()`
  - `httpd_sess_set_recv_override()`
  - `httpd_sess_set_pending_override()`
- “transport context” - both global and session
  - `httpd_sess_get_transport_ctx()` - returns SSL used for the session
  - `httpd_sess_set_transport_ctx()`
  - `httpd_get_global_transport_ctx()` - returns the shared SSL context
  - `httpd_config::global_transport_ctx`
  - `httpd_config::global_transport_ctx_free_fn`
  - `httpd_config::open_fn` - used to set up secure sockets

Everything else can be used without limitations.

### Usage

Please see the example [protocols/https\\_server](#) to learn how to set up a secure server.

Basically, all you need is to generate a certificate, embed it into the firmware, and pass the init struct into the start function after the certificate address and lengths are correctly configured in the init struct.

The server can be started with or without SSL by changing a flag in the init struct - `httpd_ssl_config::transport_mode`. This could be used, e.g., for testing or in trusted environments where you prefer speed over security.

## Performance

The initial session setup can take about two seconds, or more with slower clock speed or more verbose logging. Subsequent requests through the open secure socket are much faster (down to under 100 ms).

## API Reference

### Header File

- `components/esp_https_server/include/esp_https_server.h`

### Functions

`esp_err_t httpd_ssl_start` (`httpd_handle_t *handle`, `httpd_ssl_config_t *config`)

Create a SSL capable HTTP server (secure mode may be disabled in config)

#### Parameters

- **config** –[inout] - server config, must not be const. Does not have to stay valid after calling this function.
- **handle** –[out] - storage for the server handle, must be a valid pointer

**Returns** success

`esp_err_t httpd_ssl_stop` (`httpd_handle_t handle`)

Stop the server. Blocks until the server is shut down.

**Parameters** **handle** –[in]

#### Returns

- ESP\_OK: Server stopped successfully
- ESP\_ERR\_INVALID\_ARG: Invalid argument
- ESP\_FAIL: Failure to shut down server

### Structures

struct `esp_https_server_user_cb_arg`

Callback data struct, contains the ESP-TLS connection handle and the connection state at which the callback is executed.

### Public Members

`httpd_ssl_user_cb_state_t user_cb_state`

State of user callback

`esp_tls_t *tls`

ESP-TLS connection handle

struct `httpd_ssl_config`

HTTPS server config struct

Please use `HTTPD_SSL_CONFIG_DEFAULT()` to initialize it.

### Public Members

`httpd_config_t httpd`

Underlying HTTPD server config

Parameters like task stack size and priority can be adjusted here.

const uint8\_t \***servercert**

Server certificate

size\_t **servercert\_len**

Server certificate byte length

const uint8\_t \***cacert\_pem**

CA certificate ((CA used to sign clients, or client cert itself)

size\_t **cacert\_len**

CA certificate byte length

const uint8\_t \***prvtkey\_pem**

Private key

size\_t **prvtkey\_len**

Private key byte length

*httpd\_ssl\_transport\_mode\_t* **transport\_mode**

Transport Mode (default secure)

uint16\_t **port\_secure**

Port used when transport mode is secure (default 443)

uint16\_t **port\_insecure**

Port used when transport mode is insecure (default 80)

bool **session\_tickets**

Enable tls session tickets

bool **use\_secure\_element**

Enable secure element for server session

*esp\_https\_server\_user\_cb* \***user\_cb**

User callback for esp\_https\_server

void \***ssl\_userdata**

user data to add to the ssl context

esp\_tls\_handshake\_callback **cert\_select\_cb**

Certificate selection callback to use

### Macros

**HTTPD\_SSL\_CONFIG\_DEFAULT** ()

Default config struct init

(http\_server default config had to be copied for customization)

Notes:

- port is set when starting the server, according to 'transport\_mode'

- one socket uses ~ 40kB RAM with SSL, we reduce the default socket count to 4
- SSL sockets are usually long-lived, closing LRU prevents pool exhaustion DOS
- Stack size may need adjustments depending on the user application

### Type Definitions

typedef struct *esp\_https\_server\_user\_cb\_arg* **esp\_https\_server\_user\_cb\_arg\_t**

Callback data struct, contains the ESP-TLS connection handle and the connection state at which the callback is executed.

typedef void **esp\_https\_server\_user\_cb** (*esp\_https\_server\_user\_cb\_arg\_t* \*user\_cb)

Callback function prototype Can be used to get connection or client information (SSL context) E.g. Client certificate, Socket FD, Connection state, etc.

**Param user\_cb** Callback data struct

typedef struct *httpd\_ssl\_config* **httpd\_ssl\_config\_t**

### Enumerations

enum **httpd\_ssl\_transport\_mode\_t**

*Values:*

enumerator **HTTPD\_SSL\_TRANSPORT\_SECURE**

enumerator **HTTPD\_SSL\_TRANSPORT\_INSECURE**

enum **httpd\_ssl\_user\_cb\_state\_t**

Indicates the state at which the user callback is executed, i.e at session creation or session close.

*Values:*

enumerator **HTTPD\_SSL\_USER\_CB\_SESS\_CREATE**

enumerator **HTTPD\_SSL\_USER\_CB\_SESS\_CLOSE**

## 2.2.11 ICMP Echo

### Overview

ICMP (Internet Control Message Protocol) is used for diagnostic or control purposes or generated in response to errors in IP operations. The common network util `ping` is implemented based on the ICMP packets with the type field value of 0, also called `Echo Reply`.

During a ping session, the source host firstly sends out an ICMP echo request packet and wait for an ICMP echo reply with specific times. In this way, it also measures the round-trip time for the messages. After receiving a valid ICMP echo reply, the source host will generate statistics about the IP link layer (e.g. packet loss, elapsed time, etc).

It is common that IoT device needs to check whether a remote server is alive or not. The device should show the warnings to users when it got offline. It can be achieved by creating a ping session and sending/parsing ICMP echo packets periodically.

To make this internal procedure much easier for users, ESP-IDF provides some out-of-box APIs.



**Create a new ping session** To create a ping session, you need to fill in the `esp_ping_config_t` configuration structure firstly, specifying target IP address, interval times, and etc. Optionally, you can also register some callback functions with the `esp_ping_callbacks_t` structure.

Example method to create a new ping session and register callbacks:

```
static void test_on_ping_success(esp_ping_handle_t hdl, void *args)
{
    // optionally, get callback arguments
    // const char* str = (const char*) args;
    // printf("%s\r\n", str); // "foo"
    uint8_t ttl;
    uint16_t seqno;
    uint32_t elapsed_time, recv_len;
    ip_addr_t target_addr;
    esp_ping_get_profile(hdl, ESP_PING_PROF_SEQNO, &seqno, sizeof(seqno));
    esp_ping_get_profile(hdl, ESP_PING_PROF_TTL, &ttl, sizeof(ttl));
    esp_ping_get_profile(hdl, ESP_PING_PROF_IPADDR, &target_addr, sizeof(target_
    ↪addr));
    esp_ping_get_profile(hdl, ESP_PING_PROF_SIZE, &recv_len, sizeof(recv_len));
    esp_ping_get_profile(hdl, ESP_PING_PROF_TIMEGAP, &elapsed_time, sizeof(elapsed_
    ↪time));
    printf("%d bytes from %s icmp_seq=%d ttl=%d time=%d ms\n",
           recv_len, inet_ntoa(target_addr.u_addr.ip4), seqno, ttl, elapsed_time);
}

static void test_on_ping_timeout(esp_ping_handle_t hdl, void *args)
{
    uint16_t seqno;
    ip_addr_t target_addr;
    esp_ping_get_profile(hdl, ESP_PING_PROF_SEQNO, &seqno, sizeof(seqno));
    esp_ping_get_profile(hdl, ESP_PING_PROF_IPADDR, &target_addr, sizeof(target_
    ↪addr));
    printf("From %s icmp_seq=%d timeout\n", inet_ntoa(target_addr.u_addr.ip4),
    ↪seqno);
}

static void test_on_ping_end(esp_ping_handle_t hdl, void *args)
{
    uint32_t transmitted;
    uint32_t received;
    uint32_t total_time_ms;

    esp_ping_get_profile(hdl, ESP_PING_PROF_REQUEST, &transmitted,
    ↪sizeof(transmitted));
    esp_ping_get_profile(hdl, ESP_PING_PROF_REPLY, &received, sizeof(received));
    esp_ping_get_profile(hdl, ESP_PING_PROF_DURATION, &total_time_ms, sizeof(total_
    ↪time_ms));
    printf("%d packets transmitted, %d received, time %dms\n", transmitted,
    ↪received, total_time_ms);
}

void initialize_ping()
{
    /* convert URL to IP address */
    ip_addr_t target_addr;
    struct addrinfo hint;
    struct addrinfo *res = NULL;
    memset(&hint, 0, sizeof(hint));
    memset(&target_addr, 0, sizeof(target_addr));
    getaddrinfo("www.espressif.com", NULL, &hint, &res);
    struct in_addr addr4 = ((struct sockaddr_in *) (res->ai_addr))->sin_addr;
    inet_addr_to_ip4addr(ip_2_ip4(&target_addr), &addr4);
}
```

(continues on next page)

(continued from previous page)

```

freeaddrinfo(res);

esp_ping_config_t ping_config = ESP_PING_DEFAULT_CONFIG();
ping_config.target_addr = target_addr;           // target IP address
ping_config.count = ESP_PING_COUNT_INFINITE;    // ping in infinite mode, esp_
↳ping_stop can stop it

/* set callback functions */
esp_ping_callbacks_t cbs;
cbs.on_ping_success = test_on_ping_success;
cbs.on_ping_timeout = test_on_ping_timeout;
cbs.on_ping_end = test_on_ping_end;
cbs.cb_args = "foo"; // arguments that will feed to all callback functions,
↳can be NULL
cbs.cb_args = eth_event_group;

esp_ping_handle_t ping;
esp_ping_new_session(&ping_config, &cbs, &ping);
}

```

**Start and Stop ping session** You can start and stop ping session with the handle returned by `esp_ping_new_session`. Note that, the ping session won't start automatically after creation. If the ping session is stopped, and restart again, the sequence number in ICMP packets will recount from zero again.

**Delete a ping session** If a ping session won't be used any more, you can delete it with `esp_ping_delete_session`. Please make sure the ping session is in stop state (i.e. you have called `esp_ping_stop` before or the ping session has finished all the procedures) when you call this function.

**Get runtime statistics** As the example code above, you can call `esp_ping_get_profile` to get different runtime statistics of ping session in the callback function.

## Application Example

ICMP echo example: [protocols/icmp\\_echo](#)

## API Reference

### Header File

- `components/lwip/include/apps/ping/ping_sock.h`

### Functions

`esp_err_t esp_ping_new_session` (const `esp_ping_config_t` \*config, const `esp_ping_callbacks_t` \*cbs, `esp_ping_handle_t` \*hdl\_out)

Create a ping session.

#### Parameters

- **config** –ping configuration
- **cbs** –a bunch of callback functions invoked by internal ping task
- **hdl\_out** –handle of ping session

#### Returns

- `ESP_ERR_INVALID_ARG`: invalid parameters (e.g. configuration is null, etc)
- `ESP_ERR_NO_MEM`: out of memory
- `ESP_FAIL`: other internal error (e.g. socket error)

- ESP\_OK: create ping session successfully, user can take the ping handle to do follow-on jobs

*esp\_err\_t* **esp\_ping\_delete\_session** (*esp\_ping\_handle\_t* hdl)

Delete a ping session.

**Parameters** **hdl** –handle of ping session

**Returns**

- ESP\_ERR\_INVALID\_ARG: invalid parameters (e.g. ping handle is null, etc)
- ESP\_OK: delete ping session successfully

*esp\_err\_t* **esp\_ping\_start** (*esp\_ping\_handle\_t* hdl)

Start the ping session.

**Parameters** **hdl** –handle of ping session

**Returns**

- ESP\_ERR\_INVALID\_ARG: invalid parameters (e.g. ping handle is null, etc)
- ESP\_OK: start ping session successfully

*esp\_err\_t* **esp\_ping\_stop** (*esp\_ping\_handle\_t* hdl)

Stop the ping session.

**Parameters** **hdl** –handle of ping session

**Returns**

- ESP\_ERR\_INVALID\_ARG: invalid parameters (e.g. ping handle is null, etc)
- ESP\_OK: stop ping session successfully

*esp\_err\_t* **esp\_ping\_get\_profile** (*esp\_ping\_handle\_t* hdl, *esp\_ping\_profile\_t* profile, void \*data, uint32\_t size)

Get runtime profile of ping session.

**Parameters**

- **hdl** –handle of ping session
- **profile** –type of profile
- **data** –profile data
- **size** –profile data size

**Returns**

- ESP\_ERR\_INVALID\_ARG: invalid parameters (e.g. ping handle is null, etc)
- ESP\_ERR\_INVALID\_SIZE: the actual profile data size doesn't match the "size" parameter
- ESP\_OK: get profile successfully

## Structures

struct **esp\_ping\_callbacks\_t**

Type of "ping" callback functions.

## Public Members

void \***cb\_args**

arguments for callback functions

void (**\*on\_ping\_success**)(*esp\_ping\_handle\_t* hdl, void \*args)

Invoked by internal ping thread when received ICMP echo reply packet.

void (**\*on\_ping\_timeout**)(*esp\_ping\_handle\_t* hdl, void \*args)

Invoked by internal ping thread when receive ICMP echo reply packet timeout.

void (\***on\_ping\_end**)(*esp\_ping\_handle\_t* hdl, void \*args)

Invoked by internal ping thread when a ping session is finished.

struct **esp\_ping\_config\_t**

Type of “ping” configuration.

### Public Members

uint32\_t **count**

A “ping” session contains count procedures

uint32\_t **interval\_ms**

Milliseconds between each ping procedure

uint32\_t **timeout\_ms**

Timeout value (in milliseconds) of each ping procedure

uint32\_t **data\_size**

Size of the data next to ICMP packet header

int **tos**

Type of Service, a field specified in the IP header

int **ttl**

Time to Live, a field specified in the IP header

ip\_addr\_t **target\_addr**

Target IP address, either IPv4 or IPv6

uint32\_t **task\_stack\_size**

Stack size of internal ping task

uint32\_t **task\_prio**

Priority of internal ping task

uint32\_t **interface**

Netif index, interface=0 means NETIF\_NO\_INDEX

### Macros

**ESP\_PING\_DEFAULT\_CONFIG** ()

Default ping configuration.

**ESP\_PING\_COUNT\_INFINITE**

Set ping count to zero will ping target infinitely

### Type Definitions

typedef void \***esp\_ping\_handle\_t**

Type of “ping” session handle.

## Enumerations

enum **esp\_ping\_profile\_t**

Profile of ping session.

*Values:*

enumerator **ESP\_PING\_PROF\_SEQNO**

Sequence number of a ping procedure

enumerator **ESP\_PING\_PROF\_TOS**

Type of service of a ping procedure

enumerator **ESP\_PING\_PROF\_TTL**

Time to live of a ping procedure

enumerator **ESP\_PING\_PROF\_REQUEST**

Number of request packets sent out

enumerator **ESP\_PING\_PROF\_REPLY**

Number of reply packets received

enumerator **ESP\_PING\_PROF\_IPADDR**

IP address of replied target

enumerator **ESP\_PING\_PROF\_SIZE**

Size of received packet

enumerator **ESP\_PING\_PROF\_TIMEGAP**

Elapsed time between request and reply packet

enumerator **ESP\_PING\_PROF\_DURATION**

Elapsed time of the whole ping session

### 2.2.12 mDNS Service

mDNS is a multicast UDP service that is used to provide local network service and host discovery.

The ESP-IDF component *mDNS* has been moved from ESP-IDF since version v5.0 to a separate repository:

- [mDNS component on GitHub](#)

To add mDNS component in your project, please run *idf.py add-dependency espressif/mdns*.

#### Hosted Documentation

The documentation can be found on the link below:

- [mDNS documentation](#)

### 2.2.13 Mbed TLS

**Mbed TLS** is a C library that implements cryptographic primitives, X.509 certificate manipulation and the SSL/TLS and DTLS protocols. Its small code footprint makes it suitable for embedded systems.

---

**Note:** ESP-IDF uses a [fork](#) of Mbed TLS which includes a few patches (related to hardware routines of certain modules like `bignum` (MPI) and ECC) over vanilla Mbed TLS.

---

Mbed TLS supports SSL 3.0 up to TLS 1.3 and DTLS 1.0 to 1.2 communication by providing the following:

- TCP/IP communication functions: listen, connect, accept, read/write.
- SSL/TLS communication functions: init, handshake, read/write.
- X.509 functions: CRT, CRL and key handling
- Random number generation
- Hashing
- Encryption/decryption

---

**Note:** Mbed TLS is in the process of migrating all the documentation to a single place. In the meantime, users can find the documentation at the [old Mbed TLS site](#).

---

#### Mbed TLS Support in ESP-IDF

Please find the information about the Mbed TLS versions present in different branches of ESP-IDF [here](#).

---

**Note:** Please refer the [ESP-IDF Migration Guide](#) to migrate from Mbed TLS version 2.x to version 3.0 or greater.

---

#### Application Examples

Examples in ESP-IDF use [ESP-TLS](#) which provides a simplified API interface for accessing the commonly used TLS functionality.

Refer to the examples [protocols/https\\_server/simple](#) (Simple HTTPS server) and [protocols/https\\_request](#) (Make HTTPS requests) for more information.

If the Mbed TLS API is to be used directly, refer to the example [protocols/https\\_mbedtls](#).

#### Alternatives

[ESP-TLS](#) acts as an abstraction layer over the underlying SSL/TLS library and thus has an option to use Mbed TLS or wolfSSL as the underlying library. By default, only Mbed TLS is available and used in ESP-IDF whereas wolfSSL is available publicly at <https://github.com/espressif/esp-wolfSSL> with the upstream submodule pointer.

Please refer to [ESP-TLS: Underlying SSL/TLS Library Options](#) docs for more information on this and comparison of Mbed TLS and wolfSSL.

#### Important Config Options

Following is a brief list of important config options accessible at `Component Config -> mbedtls`. The full list of config options can be found [here](#).

- `CONFIG_MBEDTLS_SSL_PROTO_TLS1_2`: Support for TLS 1.2
- `CONFIG_MBEDTLS_SSL_PROTO_TLS1_3`: Support for TLS 1.3

- [\*CONFIG\\_MBEDTLS\\_CERTIFICATE\\_BUNDLE\*](#): Support for trusted root certificate bundle (more about this: [ESP x509 Certificate Bundle](#))
- [\*CONFIG\\_MBEDTLS\\_CLIENT\\_SSL\\_SESSION\\_TICKETS\*](#): Support for TLS Session Resumption: Client session tickets
- [\*CONFIG\\_MBEDTLS\\_SERVER\\_SSL\\_SESSION\\_TICKETS\*](#): Support for TLS Session Resumption: Server session tickets
- [\*CONFIG\\_MBEDTLS\\_HARDWARE\\_SHA\*](#): Support for hardware SHA acceleration
- [\*CONFIG\\_MBEDTLS\\_HARDWARE\\_AES\*](#): Support for hardware AES acceleration
- [\*CONFIG\\_MBEDTLS\\_HARDWARE\\_MPI\*](#): Support for hardware MPI (bignum) acceleration

**Note:** Mbed TLS v3.0.0 and later support only TLS 1.2 and TLS 1.3 (SSL 3.0, TLS 1.0, TLS 1.1 and DTLS 1.0 are not supported). The support for TLS 1.3 is experimental and only supports the client-side. More information about this can be found out [here](#).

## Performance and Memory Tweaks

**Reducing Heap Usage** The following table shows typical memory usage with different configs when the [protocols/https\\_request](#) example (with Server Validation enabled) was run with Mbed TLS as the SSL/TLS library.

Mbed TLS Test	Related Configs	Heap Usage (approx.)
Default	NA	42196 B
Enable SSL Variable Length	<a href="#"><i>CONFIG_MBEDTLS_SSL_VARIABLE_BUFFER_LENGTH</i></a>	42120 B
Disable Keep Peer Certificate	<a href="#"><i>CONFIG_MBEDTLS_SSL_KEEP_PEER_CERTIFICATE</i></a>	38533 B
Enable Dynamic TX/RX Buffer	<a href="#"><i>CONFIG_MBEDTLS_DYNAMIC_BUFFER</i></a> <a href="#"><i>FIG_MBEDTLS_DYNAMIC_FREE_CONFIG_DATA</i></a> <a href="#"><i>FIG_MBEDTLS_DYNAMIC_FREE_CA_CERT</i></a>	<a href="#">CON-</a> <a href="#">CON-</a> 22013 B

**Note:** These values are subject to change with change in configuration options and versions of Mbed TLS.

**Reducing Binary Size** Under Component Config -> mbedTLS, there are multiple Mbed TLS features which are enabled by default but can be disabled if not needed to save code size. More information can be about this can be found in [Minimizing Binary Size](#) docs.

Code examples for this API section are provided in the [protocols](#) directory of ESP-IDF examples.

### 2.2.14 IP Network Layer

Documentation for IP Network Layer protocols (below the Application Protocol layer) are provided in [Networking APIs](#).

## 2.3 Error Codes Reference

This section lists various error code constants defined in ESP-IDF.

For general information about error codes in ESP-IDF, see [Error Handling](#).

[\*ESP\\_FAIL\*](#) (-1): Generic esp\_err\_t code indicating failure

*ESP\_OK* (0): *esp\_err\_t* value indicating success (no error)

*ESP\_ERR\_NO\_MEM* (0x101): Out of memory

*ESP\_ERR\_INVALID\_ARG* (0x102): Invalid argument

*ESP\_ERR\_INVALID\_STATE* (0x103): Invalid state

*ESP\_ERR\_INVALID\_SIZE* (0x104): Invalid size

*ESP\_ERR\_NOT\_FOUND* (0x105): Requested resource not found

*ESP\_ERR\_NOT\_SUPPORTED* (0x106): Operation or feature not supported

*ESP\_ERR\_TIMEOUT* (0x107): Operation timed out

*ESP\_ERR\_INVALID\_RESPONSE* (0x108): Received response was invalid

*ESP\_ERR\_INVALID\_CRC* (0x109): CRC or checksum was invalid

*ESP\_ERR\_INVALID\_VERSION* (0x10a): Version was invalid

*ESP\_ERR\_INVALID\_MAC* (0x10b): MAC address was invalid

*ESP\_ERR\_NOT\_FINISHED* (0x10c): There are items remained to retrieve

*ESP\_ERR\_NVS\_BASE* (0x1100): Starting number of error codes

*ESP\_ERR\_NVS\_NOT\_INITIALIZED* (0x1101): The storage driver is not initialized

*ESP\_ERR\_NVS\_NOT\_FOUND* (0x1102): A requested entry couldn't be found or namespace doesn't exist yet and mode is NVS\_READONLY

*ESP\_ERR\_NVS\_TYPE\_MISMATCH* (0x1103): The type of set or get operation doesn't match the type of value stored in NVS

*ESP\_ERR\_NVS\_READ\_ONLY* (0x1104): Storage handle was opened as read only

*ESP\_ERR\_NVS\_NOT\_ENOUGH\_SPACE* (0x1105): There is not enough space in the underlying storage to save the value

*ESP\_ERR\_NVS\_INVALID\_NAME* (0x1106): Namespace name doesn't satisfy constraints

*ESP\_ERR\_NVS\_INVALID\_HANDLE* (0x1107): Handle has been closed or is NULL

*ESP\_ERR\_NVS\_REMOVE\_FAILED* (0x1108): The value wasn't updated because flash write operation has failed. The value was written however, and update will be finished after re-initialization of nvs, provided that flash operation doesn't fail again.

*ESP\_ERR\_NVS\_KEY\_TOO\_LONG* (0x1109): Key name is too long

*ESP\_ERR\_NVS\_PAGE\_FULL* (0x110a): Internal error; never returned by nvs API functions

*ESP\_ERR\_NVS\_INVALID\_STATE* (0x110b): NVS is in an inconsistent state due to a previous error. Call *nvs\_flash\_init* and *nvs\_open* again, then retry.

*ESP\_ERR\_NVS\_INVALID\_LENGTH* (0x110c): String or blob length is not sufficient to store data

*ESP\_ERR\_NVS\_NO\_FREE\_PAGES* (0x110d): NVS partition doesn't contain any empty pages. This may happen if NVS partition was truncated. Erase the whole partition and call *nvs\_flash\_init* again.

*ESP\_ERR\_NVS\_VALUE\_TOO\_LONG* (0x110e): Value doesn't fit into the entry or string or blob length is longer than supported by the implementation

*ESP\_ERR\_NVS\_PART\_NOT\_FOUND* (0x110f): Partition with specified name is not found in the partition table

*ESP\_ERR\_NVS\_NEW\_VERSION\_FOUND* (0x1110): NVS partition contains data in new format and cannot be recognized by this version of code

*ESP\_ERR\_NVS\_XTS\_ENCR\_FAILED* (0x1111): XTS encryption failed while writing NVS entry

*ESP\_ERR\_NVS\_XTS\_DECR\_FAILED* (0x1112): XTS decryption failed while reading NVS entry

*ESP\_ERR\_NVS\_XTS\_CFG\_FAILED* (0x1113): XTS configuration setting failed



*ESP\_ERR\_NVS\_XTS\_CFG\_NOT\_FOUND* (**0x1114**): XTS configuration not found

*ESP\_ERR\_NVS\_ENCR\_NOT\_SUPPORTED* (**0x1115**): NVS encryption is not supported in this version

*ESP\_ERR\_NVS\_KEYS\_NOT\_INITIALIZED* (**0x1116**): NVS key partition is uninitialized

*ESP\_ERR\_NVS\_CORRUPT\_KEY\_PART* (**0x1117**): NVS key partition is corrupt

*ESP\_ERR\_NVS\_CONTENT\_DIFFERS* (**0x1118**): Internal error; never returned by nvs API functions. NVS key is different in comparison

*ESP\_ERR\_NVS\_WRONG\_ENCRYPTION* (**0x1119**): NVS partition is marked as encrypted with generic flash encryption. This is forbidden since the NVS encryption works differently.

*ESP\_ERR\_ULP\_BASE* (**0x1200**): Offset for ULP-related error codes

*ESP\_ERR\_ULP\_SIZE\_TOO\_BIG* (**0x1201**): Program doesn't fit into RTC memory reserved for the ULP

*ESP\_ERR\_ULP\_INVALID\_LOAD\_ADDR* (**0x1202**): Load address is outside of RTC memory reserved for the ULP

*ESP\_ERR\_ULP\_DUPLICATE\_LABEL* (**0x1203**): More than one label with the same number was defined

*ESP\_ERR\_ULP\_UNDEFINED\_LABEL* (**0x1204**): Branch instructions references an undefined label

*ESP\_ERR\_ULP\_BRANCH\_OUT\_OF\_RANGE* (**0x1205**): Branch target is out of range of B instruction (try replacing with BX)

*ESP\_ERR\_OTA\_BASE* (**0x1500**): Base error code for ota\_ops api

*ESP\_ERR\_OTA\_PARTITION\_CONFLICT* (**0x1501**): Error if request was to write or erase the current running partition

*ESP\_ERR\_OTA\_SELECT\_INFO\_INVALID* (**0x1502**): Error if OTA data partition contains invalid content

*ESP\_ERR\_OTA\_VALIDATE\_FAILED* (**0x1503**): Error if OTA app image is invalid

*ESP\_ERR\_OTA\_SMALL\_SEC\_VER* (**0x1504**): Error if the firmware has a secure version less than the running firmware.

*ESP\_ERR\_OTA\_ROLLBACK\_FAILED* (**0x1505**): Error if flash does not have valid firmware in passive partition and hence rollback is not possible

*ESP\_ERR\_OTA\_ROLLBACK\_INVALID\_STATE* (**0x1506**): Error if current active firmware is still marked in pending validation state (*ESP\_OTA\_IMG\_PENDING\_VERIFY*), essentially first boot of firmware image post upgrade and hence firmware upgrade is not possible

*ESP\_ERR\_EFUSE* (**0x1600**): Base error code for efuse api.

*ESP\_OK\_EFUSE\_CNT* (**0x1601**): OK the required number of bits is set.

*ESP\_ERR\_EFUSE\_CNT\_IS\_FULL* (**0x1602**): Error field is full.

*ESP\_ERR\_EFUSE\_REPEATED\_PROG* (**0x1603**): Error repeated programming of programmed bits is strictly forbidden.

*ESP\_ERR\_CODING* (**0x1604**): Error while a encoding operation.

*ESP\_ERR\_NOT\_ENOUGH\_UNUSED\_KEY\_BLOCKS* (**0x1605**): Error not enough unused key blocks available

*ESP\_ERR\_DAMAGED\_READING* (**0x1606**): Error. Burn or reset was done during a reading operation leads to damage read data. This error is internal to the efuse component and not returned by any public API.

*ESP\_ERR\_IMAGE\_BASE* (**0x2000**)

*ESP\_ERR\_IMAGE\_FLASH\_FAIL* (**0x2001**)

*ESP\_ERR\_IMAGE\_INVALID* (**0x2002**)

*ESP\_ERR\_WIFI\_BASE* (**0x3000**): Starting number of WiFi error codes

*ESP\_ERR\_WIFI\_NOT\_INIT* (**0x3001**): WiFi driver was not installed by *esp\_wifi\_init*

*ESP\_ERR\_WIFI\_NOT\_STARTED* (**0x3002**): WiFi driver was not started by *esp\_wifi\_start*

*ESP\_ERR\_WIFI\_NOT\_STOPPED* (**0x3003**): WiFi driver was not stopped by `esp_wifi_stop`

*ESP\_ERR\_WIFI\_IF* (**0x3004**): WiFi interface error

*ESP\_ERR\_WIFI\_MODE* (**0x3005**): WiFi mode error

*ESP\_ERR\_WIFI\_STATE* (**0x3006**): WiFi internal state error

*ESP\_ERR\_WIFI\_CONN* (**0x3007**): WiFi internal control block of station or soft-AP error

*ESP\_ERR\_WIFI\_NVS* (**0x3008**): WiFi internal NVS module error

*ESP\_ERR\_WIFI\_MAC* (**0x3009**): MAC address is invalid

*ESP\_ERR\_WIFI\_SSID* (**0x300a**): SSID is invalid

*ESP\_ERR\_WIFI\_PASSWORD* (**0x300b**): Password is invalid

*ESP\_ERR\_WIFI\_TIMEOUT* (**0x300c**): Timeout error

*ESP\_ERR\_WIFI\_WAKE\_FAIL* (**0x300d**): WiFi is in sleep state(RF closed) and wakeup fail

*ESP\_ERR\_WIFI\_WOULD\_BLOCK* (**0x300e**): The caller would block

*ESP\_ERR\_WIFI\_NOT\_CONNECT* (**0x300f**): Station still in disconnect status

*ESP\_ERR\_WIFI\_POST* (**0x3012**): Failed to post the event to WiFi task

*ESP\_ERR\_WIFI\_INIT\_STATE* (**0x3013**): Invalid WiFi state when init/deinit is called

*ESP\_ERR\_WIFI\_STOP\_STATE* (**0x3014**): Returned when WiFi is stopping

*ESP\_ERR\_WIFI\_NOT\_ASSOC* (**0x3015**): The WiFi connection is not associated

*ESP\_ERR\_WIFI\_TX\_DISALLOW* (**0x3016**): The WiFi TX is disallowed

*ESP\_ERR\_WIFI\_DISCARD* (**0x3017**): Discard frame

*ESP\_ERR\_WIFI\_ROC\_IN\_PROGRESS* (**0x3018**): ROC op is in progress

*ESP\_ERR\_WIFI\_REGISTRAR* (**0x3033**): WPS registrar is not supported

*ESP\_ERR\_WIFI\_WPS\_TYPE* (**0x3034**): WPS type error

*ESP\_ERR\_WIFI\_WPS\_SM* (**0x3035**): WPS state machine is not initialized

*ESP\_ERR\_ESPNOW\_BASE* (**0x3064**): ESPNOW error number base.

*ESP\_ERR\_ESPNOW\_NOT\_INIT* (**0x3065**): ESPNOW is not initialized.

*ESP\_ERR\_ESPNOW\_ARG* (**0x3066**): Invalid argument

*ESP\_ERR\_ESPNOW\_NO\_MEM* (**0x3067**): Out of memory

*ESP\_ERR\_ESPNOW\_FULL* (**0x3068**): ESPNOW peer list is full

*ESP\_ERR\_ESPNOW\_NOT\_FOUND* (**0x3069**): ESPNOW peer is not found

*ESP\_ERR\_ESPNOW\_INTERNAL* (**0x306a**): Internal error

*ESP\_ERR\_ESPNOW\_EXIST* (**0x306b**): ESPNOW peer has existed

*ESP\_ERR\_ESPNOW\_IF* (**0x306c**): Interface error

*ESP\_ERR\_DPP\_FAILURE* (**0x3097**): Generic failure during DPP Operation

*ESP\_ERR\_DPP\_TX\_FAILURE* (**0x3098**): DPP Frame Tx failed OR not Acked

*ESP\_ERR\_DPP\_INVALID\_ATTR* (**0x3099**): Encountered invalid DPP Attribute

*ESP\_ERR\_DPP\_AUTH\_TIMEOUT* (**0x309a**): DPP Auth response was not recieved in time

*ESP\_ERR\_MESH\_BASE* (**0x4000**): Starting number of MESH error codes

*ESP\_ERR\_MESH\_WIFI\_NOT\_START* (**0x4001**)

*ESP\_ERR\_MESH\_NOT\_INIT* (**0x4002**)

*ESP\_ERR\_MESH\_NOT\_CONFIG* (0x4003)  
*ESP\_ERR\_MESH\_NOT\_START* (0x4004)  
*ESP\_ERR\_MESH\_NOT\_SUPPORT* (0x4005)  
*ESP\_ERR\_MESH\_NOT\_ALLOWED* (0x4006)  
*ESP\_ERR\_MESH\_NO\_MEMORY* (0x4007)  
*ESP\_ERR\_MESH\_ARGUMENT* (0x4008)  
*ESP\_ERR\_MESH\_EXCEED\_MTU* (0x4009)  
*ESP\_ERR\_MESH\_TIMEOUT* (0x400a)  
*ESP\_ERR\_MESH\_DISCONNECTED* (0x400b)  
*ESP\_ERR\_MESH\_QUEUE\_FAIL* (0x400c)  
*ESP\_ERR\_MESH\_QUEUE\_FULL* (0x400d)  
*ESP\_ERR\_MESH\_NO\_PARENT\_FOUND* (0x400e)  
*ESP\_ERR\_MESH\_NO\_ROUTE\_FOUND* (0x400f)  
*ESP\_ERR\_MESH\_OPTION\_NULL* (0x4010)  
*ESP\_ERR\_MESH\_OPTION\_UNKNOWN* (0x4011)  
*ESP\_ERR\_MESH\_XON\_NO\_WINDOW* (0x4012)  
*ESP\_ERR\_MESH\_INTERFACE* (0x4013)  
*ESP\_ERR\_MESH\_DISCARD\_DUPLICATE* (0x4014)  
*ESP\_ERR\_MESH\_DISCARD* (0x4015)  
*ESP\_ERR\_MESH\_VOTING* (0x4016)  
*ESP\_ERR\_MESH\_XMIT* (0x4017)  
*ESP\_ERR\_MESH\_QUEUE\_READ* (0x4018)  
*ESP\_ERR\_MESH\_PS* (0x4019)  
*ESP\_ERR\_MESH\_RECV\_RELEASE* (0x401a)  
*ESP\_ERR\_ESP\_NETIF\_BASE* (0x5000)  
*ESP\_ERR\_ESP\_NETIF\_INVALID\_PARAMS* (0x5001)  
*ESP\_ERR\_ESP\_NETIF\_IF\_NOT\_READY* (0x5002)  
*ESP\_ERR\_ESP\_NETIF\_DHCP\_START\_FAILED* (0x5003)  
*ESP\_ERR\_ESP\_NETIF\_DHCP\_ALREADY\_STARTED* (0x5004)  
*ESP\_ERR\_ESP\_NETIF\_DHCP\_ALREADY\_STOPPED* (0x5005)  
*ESP\_ERR\_ESP\_NETIF\_NO\_MEM* (0x5006)  
*ESP\_ERR\_ESP\_NETIF\_DHCP\_NOT\_STOPPED* (0x5007)  
*ESP\_ERR\_ESP\_NETIF\_DRIVER\_ATTACH\_FAILED* (0x5008)  
*ESP\_ERR\_ESP\_NETIF\_INIT\_FAILED* (0x5009)  
*ESP\_ERR\_ESP\_NETIF\_DNS\_NOT\_CONFIGURED* (0x500a)  
*ESP\_ERR\_ESP\_NETIF\_MLD6\_FAILED* (0x500b)  
*ESP\_ERR\_ESP\_NETIF\_IP6\_ADDR\_FAILED* (0x500c)  
*ESP\_ERR\_ESP\_NETIF\_DHCP\_START\_FAILED* (0x500d)  
*ESP\_ERR\_FLASH\_BASE* (0x6000): Starting number of flash error codes

*ESP\_ERR\_FLASH\_OP\_FAIL* (**0x6001**)

*ESP\_ERR\_FLASH\_OP\_TIMEOUT* (**0x6002**)

*ESP\_ERR\_FLASH\_NOT\_INITIALISED* (**0x6003**)

*ESP\_ERR\_FLASH\_UNSUPPORTED\_HOST* (**0x6004**)

*ESP\_ERR\_FLASH\_UNSUPPORTED\_CHIP* (**0x6005**)

*ESP\_ERR\_FLASH\_PROTECTED* (**0x6006**)

*ESP\_ERR\_HTTP\_BASE* (**0x7000**): Starting number of HTTP error codes

*ESP\_ERR\_HTTP\_MAX\_REDIRECT* (**0x7001**): The error exceeds the number of HTTP redirects

*ESP\_ERR\_HTTP\_CONNECT* (**0x7002**): Error open the HTTP connection

*ESP\_ERR\_HTTP\_WRITE\_DATA* (**0x7003**): Error write HTTP data

*ESP\_ERR\_HTTP\_FETCH\_HEADER* (**0x7004**): Error read HTTP header from server

*ESP\_ERR\_HTTP\_INVALID\_TRANSPORT* (**0x7005**): There are no transport support for the input scheme

*ESP\_ERR\_HTTP\_CONNECTING* (**0x7006**): HTTP connection hasn't been established yet

*ESP\_ERR\_HTTP\_EAGAIN* (**0x7007**): Mapping of errno EAGAIN to esp\_err\_t

*ESP\_ERR\_HTTP\_CONNECTION\_CLOSED* (**0x7008**): Read FIN from peer and the connection closed

*ESP\_ERR\_ESP\_TLS\_BASE* (**0x8000**): Starting number of ESP-TLS error codes

*ESP\_ERR\_ESP\_TLS\_CANNOT\_RESOLVE\_HOSTNAME* (**0x8001**): Error if hostname couldn't be resolved upon tls connection

*ESP\_ERR\_ESP\_TLS\_CANNOT\_CREATE\_SOCKET* (**0x8002**): Failed to create socket

*ESP\_ERR\_ESP\_TLS\_UNSUPPORTED\_PROTOCOL\_FAMILY* (**0x8003**): Unsupported protocol family

*ESP\_ERR\_ESP\_TLS\_FAILED\_CONNECT\_TO\_HOST* (**0x8004**): Failed to connect to host

*ESP\_ERR\_ESP\_TLS\_SOCKET\_SETOPT\_FAILED* (**0x8005**): failed to set/get socket option

*ESP\_ERR\_ESP\_TLS\_CONNECTION\_TIMEOUT* (**0x8006**): new connection in esp\_tls\_low\_level\_conn connection timed out

*ESP\_ERR\_ESP\_TLS\_SE\_FAILED* (**0x8007**)

*ESP\_ERR\_ESP\_TLS\_TCP\_CLOSED\_FIN* (**0x8008**)

*ESP\_ERR\_MBEDTLS\_CERT\_PARTLY\_OK* (**0x8010**): mbedtls parse certificates was partly successful

*ESP\_ERR\_MBEDTLS\_CTR\_DRBG\_SEED\_FAILED* (**0x8011**): mbedtls api returned error

*ESP\_ERR\_MBEDTLS\_SSL\_SET\_HOSTNAME\_FAILED* (**0x8012**): mbedtls api returned error

*ESP\_ERR\_MBEDTLS\_SSL\_CONFIG\_DEFAULTS\_FAILED* (**0x8013**): mbedtls api returned error

*ESP\_ERR\_MBEDTLS\_SSL\_CONF\_ALPN\_PROTOCOLS\_FAILED* (**0x8014**): mbedtls api returned error

*ESP\_ERR\_MBEDTLS\_X509\_CERT\_PARSE\_FAILED* (**0x8015**): mbedtls api returned error

*ESP\_ERR\_MBEDTLS\_SSL\_CONF\_OWN\_CERT\_FAILED* (**0x8016**): mbedtls api returned error

*ESP\_ERR\_MBEDTLS\_SSL\_SETUP\_FAILED* (**0x8017**): mbedtls api returned error

*ESP\_ERR\_MBEDTLS\_SSL\_WRITE\_FAILED* (**0x8018**): mbedtls api returned error

*ESP\_ERR\_MBEDTLS\_PK\_PARSE\_KEY\_FAILED* (**0x8019**): mbedtls api returned failed

*ESP\_ERR\_MBEDTLS\_SSL\_HANDSHAKE\_FAILED* (**0x801a**): mbedtls api returned failed

*ESP\_ERR\_MBEDTLS\_SSL\_CONF\_PSK\_FAILED* (**0x801b**): mbedtls api returned failed

*ESP\_ERR\_MBEDTLS\_SSL\_TICKET\_SETUP\_FAILED* (**0x801c**): mbedtls api returned failed

*ESP\_ERR\_WOLFSSL\_SSL\_SET\_HOSTNAME\_FAILED* (**0x8031**): wolfSSL api returned error

*ESP\_ERR\_WOLFSSL\_SSL\_CONF\_ALPN\_PROTOCOLS\_FAILED* (**0x8032**): wolfSSL api returned error

*ESP\_ERR\_WOLFSSL\_CERT\_VERIFY\_SETUP\_FAILED* (**0x8033**): wolfSSL api returned error

*ESP\_ERR\_WOLFSSL\_KEY\_VERIFY\_SETUP\_FAILED* (**0x8034**): wolfSSL api returned error

*ESP\_ERR\_WOLFSSL\_SSL\_HANDSHAKE\_FAILED* (**0x8035**): wolfSSL api returned failed

*ESP\_ERR\_WOLFSSL\_CTX\_SETUP\_FAILED* (**0x8036**): wolfSSL api returned failed

*ESP\_ERR\_WOLFSSL\_SSL\_SETUP\_FAILED* (**0x8037**): wolfSSL api returned failed

*ESP\_ERR\_WOLFSSL\_SSL\_WRITE\_FAILED* (**0x8038**): wolfSSL api returned failed

*ESP\_ERR\_HTTPS\_OTA\_BASE* (**0x9000**)

*ESP\_ERR\_HTTPS\_OTA\_IN\_PROGRESS* (**0x9001**)

*ESP\_ERR\_PING\_BASE* (**0xa000**)

*ESP\_ERR\_PING\_INVALID\_PARAMS* (**0xa001**)

*ESP\_ERR\_PING\_NO\_MEM* (**0xa002**)

*ESP\_ERR\_HTTPD\_BASE* (**0xb000**): Starting number of HTTPD error codes

*ESP\_ERR\_HTTPD\_HANDLERS\_FULL* (**0xb001**): All slots for registering URI handlers have been consumed

*ESP\_ERR\_HTTPD\_HANDLER\_EXISTS* (**0xb002**): URI handler with same method and target URI already registered

*ESP\_ERR\_HTTPD\_INVALID\_REQ* (**0xb003**): Invalid request pointer

*ESP\_ERR\_HTTPD\_RESULT\_TRUNC* (**0xb004**): Result string truncated

*ESP\_ERR\_HTTPD\_RESP\_HDR* (**0xb005**): Response header field larger than supported

*ESP\_ERR\_HTTPD\_RESP\_SEND* (**0xb006**): Error occurred while sending response packet

*ESP\_ERR\_HTTPD\_ALLOC\_MEM* (**0xb007**): Failed to dynamically allocate memory for resource

*ESP\_ERR\_HTTPD\_TASK* (**0xb008**): Failed to launch server task/thread

*ESP\_ERR\_HW\_CRYPTO\_BASE* (**0xc000**): Starting number of HW cryptography module error codes

*ESP\_ERR\_HW\_CRYPTO\_DS\_HMAC\_FAIL* (**0xc001**): HMAC peripheral problem

*ESP\_ERR\_HW\_CRYPTO\_DS\_INVALID\_KEY* (**0xc002**)

*ESP\_ERR\_HW\_CRYPTO\_DS\_INVALID\_DIGEST* (**0xc004**)

*ESP\_ERR\_HW\_CRYPTO\_DS\_INVALID\_PADDING* (**0xc005**)

*ESP\_ERR\_MEMPROT\_BASE* (**0xd000**): Starting number of Memory Protection API error codes

*ESP\_ERR\_MEMPROT\_MEMORY\_TYPE\_INVALID* (**0xd001**)

*ESP\_ERR\_MEMPROT\_SPLIT\_ADDR\_INVALID* (**0xd002**)

*ESP\_ERR\_MEMPROT\_SPLIT\_ADDR\_OUT\_OF\_RANGE* (**0xd003**)

*ESP\_ERR\_MEMPROT\_SPLIT\_ADDR\_UNALIGNED* (**0xd004**)

*ESP\_ERR\_MEMPROT\_UNIMGMT\_BLOCK\_INVALID* (**0xd005**)

*ESP\_ERR\_MEMPROT\_WORLD\_INVALID* (**0xd006**)

*ESP\_ERR\_MEMPROT\_AREA\_INVALID* (**0xd007**)

*ESP\_ERR\_MEMPROT\_CPUID\_INVALID* (**0xd008**)

*ESP\_ERR\_TCP\_TRANSPORT\_BASE* (**0xe000**): Starting number of TCP Transport error codes

*ESP\_ERR\_TCP\_TRANSPORT\_CONNECTION\_TIMEOUT* (**0xe001**): Connection has timed out

*ESP\_ERR\_TCP\_TRANSPORT\_CONNECTION\_CLOSED\_BY\_FIN* (**0xe002**): Read FIN from peer and the connection has closed (in a clean way)

ESP\_ERR\_TCP\_TRANSPORT\_CONNECTION\_FAILED (**0xe003**): Failed to connect to the peer

ESP\_ERR\_TCP\_TRANSPORT\_NO\_MEM (**0xe004**): Memory allocation failed

## 2.4 Networking APIs

### 2.4.1 Wi-Fi

#### ESP-NOW

**Overview** ESP-NOW is a kind of connectionless Wi-Fi communication protocol that is defined by Espressif. In ESP-NOW, application data is encapsulated in a vendor-specific action frame and then transmitted from one Wi-Fi device to another without connection. CTR with CBC-MAC Protocol(CCMP) is used to protect the action frame for security. ESP-NOW is widely used in smart light, remote controlling, sensor, etc.

**Frame Format** ESP-NOW uses a vendor-specific action frame to transmit ESP-NOW data. The default ESP-NOW bit rate is 1 Mbps. The format of the vendor-specific action frame is as follows:

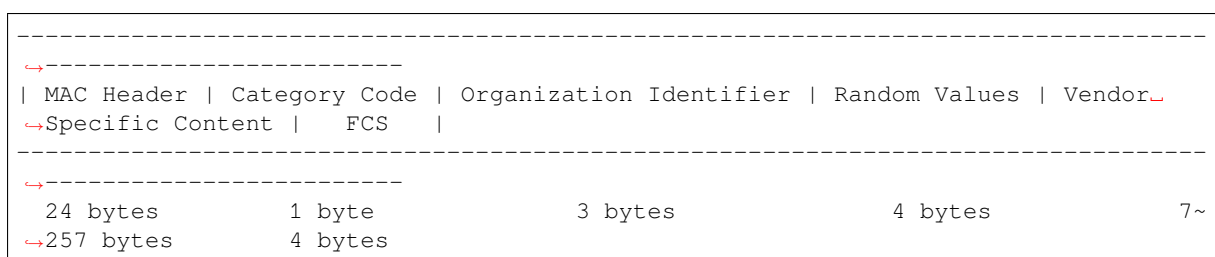

- **Category Code:** The Category Code field is set to the value(127) indicating the vendor-specific category.
- **Organization Identifier:** The Organization Identifier contains a unique identifier (0x18fe34), which is the first three bytes of MAC address applied by Espressif.
- **Random Value:** The Random Value filed is used to prevents relay attacks.
- **Vendor Specific Content:** The Vendor Specific Content contains vendor-specific fields as follows:

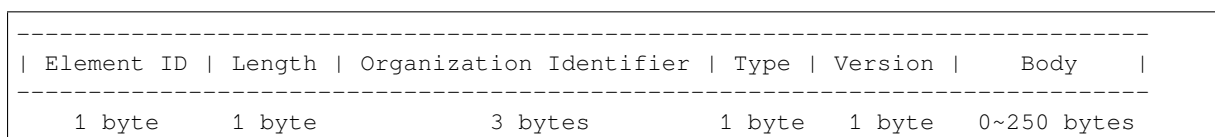

- **Element ID:** The Element ID field is set to the value (221), indicating the vendor-specific element.
- **Length:** The length is the total length of Organization Identifier, Type, Version and Body.
- **Organization Identifier:** The Organization Identifier contains a unique identifier(0x18fe34), which is the first three bytes of MAC address applied by Espressif.
- **Type:** The Type field is set to the value (4) indicating ESP-NOW.
- **Version:** The Version field is set to the version of ESP-NOW.
- **Body:** The Body contains the ESP-NOW data.

As ESP-NOW is connectionless, the MAC header is a little different from that of standard frames. The FromDS and ToDS bits of FrameControl field are both 0. The first address field is set to the destination address. The second address field is set to the source address. The third address field is set to broadcast address (0xff:0xff:0xff:0xff:0xff:0xff).



## Security

ESP-NOW uses the CCMP method, which is described in IEEE Std. 802.11-2012, to protect the vendor-specific action frame

- PMK is used to encrypt LMK with the AES-128 algorithm. Call `esp_now_set_pmk()` to set PMK. If PMK is not set, a default PMK will be used.
- LMK of the paired device is used to encrypt the vendor-specific action frame with the CCMP method. If the LMK of the paired device is not set, the vendor-specific action frame will not be encrypted.

Encrypting multicast vendor-specific action frame is not supported.

**Initialization and De-initialization** Call `esp_now_init()` to initialize ESP-NOW and `esp_now_deinit()` to de-initialize ESP-NOW. ESP-NOW data must be transmitted after Wi-Fi is started, so it is recommended to start Wi-Fi before initializing ESP-NOW and stop Wi-Fi after de-initializing ESP-NOW. When `esp_now_deinit()` is called, all of the information of paired devices will be deleted.

**Add Paired Device** Call `esp_now_add_peer()` to add the device to the paired device list before you send data to this device. If security is enabled, the LMK must be set. You can send ESP-NOW data via both the Station and the SoftAP interface. Make sure that the interface is enabled before sending ESP-NOW data.

The maximum number of paired devices is 20, and the paired encryption devices are no more than 17, the default is 7. If you want to change the number of paired encryption devices, set `CONFIG_ESP_WIFI_ESPNOW_MAX_ENCRYPT_NUM` in the Wi-Fi component configuration menu.

A device with a broadcast MAC address must be added before sending broadcast data. The range of the channel of paired devices is from 0 to 14. If the channel is set to 0, data will be sent on the current channel. Otherwise, the channel must be set as the channel that the local device is on.

**Send ESP-NOW Data** Call `esp_now_send()` to send ESP-NOW data and `esp_now_register_send_cb()` to register sending callback function. It will return `ESP_NOW_SEND_SUCCESS` in sending callback function if the data is received successfully on the MAC layer. Otherwise, it will return `ESP_NOW_SEND_FAIL`. Several reasons can lead to ESP-NOW fails to send data. For example, the destination device doesn't exist; the channels of the devices are not the same; the action frame is lost when transmitting on the air, etc. It is not guaranteed that application layer can receive the data. If necessary, send back ack data when receiving ESP-NOW data. If receiving ack data timeouts, retransmit the ESP-NOW data. A sequence number can also be assigned to ESP-NOW data to drop the duplicate data.

If there is a lot of ESP-NOW data to send, call `esp_now_send()` to send less than or equal to 250 bytes of data once a time. Note that too short interval between sending two ESP-NOW data may lead to disorder of sending callback function. So, it is recommended that sending the next ESP-NOW data after the sending callback function of the previous sending has returned. The sending callback function runs from a high-priority Wi-Fi task. So, do not do lengthy operations in the callback function. Instead, post the necessary data to a queue and handle it from a lower priority task.

**Receiving ESP-NOW Data** Call `esp_now_register_rcv_cb()` to register receiving callback function. Call the receiving callback function when receiving ESP-NOW. The receiving callback function also runs from the Wi-Fi task. So, do not do lengthy operations in the callback function. Instead, post the necessary data to a queue and handle it from a lower priority task.

**Config ESP-NOW Rate** Call `esp_wifi_config_espnw_rate()` to config ESPNOW rate of specified interface. Make sure that the interface is enabled before config rate. This API should be called after `esp_wifi_start()`.

**Config ESP-NOW Power-saving Parameter** Sleep is supported only when ESP32-S2 is configured as station.

Call `esp_now_set_wake_window()` to configure Window for ESP-NOW RX at sleep. The default value is the maximum, which allowing RX all the time.

If Power-saving is needed for ESP-NOW, call `esp_wifi_connectionless_module_set_wake_interval()` to configure Interval as well.

Please refer to [connectionless module power save](#) to get more detail.

## Application Examples

- Example of sending and receiving ESP-NOW data between two devices: [wifi/espnow](#).
- For more application examples of how to use ESP-NOW, please visit [ESP-NOW](#) repository.

## API Reference

### Header File

- `components/esp_wifi/include/esp_now.h`

### Functions

`esp_err_t esp_now_init` (void)

Initialize ESPNOW function.

#### Returns

- `ESP_OK` : succeed
- `ESP_ERR_ESPNOW_INTERNAL` : Internal error

`esp_err_t esp_now_deinit` (void)

De-initialize ESPNOW function.

#### Returns

- `ESP_OK` : succeed

`esp_err_t esp_now_get_version` (uint32\_t \*version)

Get the version of ESPNOW.

**Parameters** `version` –ESPNOW version

#### Returns

- `ESP_OK` : succeed
- `ESP_ERR_ESPNOW_ARG` : invalid argument

`esp_err_t esp_now_register_recv_cb` (`esp_now_recv_cb_t` cb)

Register callback function of receiving ESPNOW data.

**Parameters** `cb` –callback function of receiving ESPNOW data

#### Returns

- `ESP_OK` : succeed
- `ESP_ERR_ESPNOW_NOT_INIT` : ESPNOW is not initialized
- `ESP_ERR_ESPNOW_INTERNAL` : internal error

`esp_err_t esp_now_unregister_recv_cb` (void)

Unregister callback function of receiving ESPNOW data.

#### Returns

- `ESP_OK` : succeed
- `ESP_ERR_ESPNOW_NOT_INIT` : ESPNOW is not initialized

`esp_err_t esp_now_register_send_cb` (`esp_now_send_cb_t` cb)

Register callback function of sending ESPNOW data.

**Parameters** `cb` –callback function of sending ESPNOW data

#### Returns

- `ESP_OK` : succeed
- `ESP_ERR_ESPNOW_NOT_INIT` : ESPNOW is not initialized



- `ESP_ERR_ESPNOW_INTERNAL` : internal error

*esp\_err\_t* `esp_now_unregister_send_cb` (void)

Unregister callback function of sending ESPNOW data.

**Returns**

- `ESP_OK` : succeed
- `ESP_ERR_ESPNOW_NOT_INIT` : ESPNOW is not initialized

*esp\_err\_t* `esp_now_send` (const uint8\_t \*peer\_addr, const uint8\_t \*data, size\_t len)

Send ESPNOW data.

**Attention** 1. If peer\_addr is not NULL, send data to the peer whose MAC address matches peer\_addr

**Attention** 2. If peer\_addr is NULL, send data to all of the peers that are added to the peer list

**Attention** 3. The maximum length of data must be less than `ESP_NOW_MAX_DATA_LEN`

**Attention** 4. The buffer pointed to by data argument does not need to be valid after esp\_now\_send returns

**Parameters**

- **peer\_addr** –peer MAC address
- **data** –data to send
- **len** –length of data

**Returns**

- `ESP_OK` : succeed
- `ESP_ERR_ESPNOW_NOT_INIT` : ESPNOW is not initialized
- `ESP_ERR_ESPNOW_ARG` : invalid argument
- `ESP_ERR_ESPNOW_INTERNAL` : internal error
- `ESP_ERR_ESPNOW_NO_MEM` : out of memory, when this happens, you can delay a while before sending the next data
- `ESP_ERR_ESPNOW_NOT_FOUND` : peer is not found
- `ESP_ERR_ESPNOW_IF` : current WiFi interface doesn't match that of peer

*esp\_err\_t* `esp_now_add_peer` (const *esp\_now\_peer\_info\_t* \*peer)

Add a peer to peer list.

**Parameters** **peer** –peer information

**Returns**

- `ESP_OK` : succeed
- `ESP_ERR_ESPNOW_NOT_INIT` : ESPNOW is not initialized
- `ESP_ERR_ESPNOW_ARG` : invalid argument
- `ESP_ERR_ESPNOW_FULL` : peer list is full
- `ESP_ERR_ESPNOW_NO_MEM` : out of memory
- `ESP_ERR_ESPNOW_EXIST` : peer has existed

*esp\_err\_t* `esp_now_del_peer` (const uint8\_t \*peer\_addr)

Delete a peer from peer list.

**Parameters** **peer\_addr** –peer MAC address

**Returns**

- `ESP_OK` : succeed
- `ESP_ERR_ESPNOW_NOT_INIT` : ESPNOW is not initialized
- `ESP_ERR_ESPNOW_ARG` : invalid argument
- `ESP_ERR_ESPNOW_NOT_FOUND` : peer is not found

*esp\_err\_t* `esp_now_mod_peer` (const *esp\_now\_peer\_info\_t* \*peer)

Modify a peer.

**Parameters** **peer** –peer information

**Returns**

- `ESP_OK` : succeed
- `ESP_ERR_ESPNOW_NOT_INIT` : ESPNOW is not initialized

- `ESP_ERR_ESPNOW_ARG` : invalid argument
- `ESP_ERR_ESPNOW_FULL` : peer list is full

*esp\_err\_t* **esp\_wifi\_config\_espnow\_rate** (*wifi\_interface\_t* ifx, *wifi\_phy\_rate\_t* rate)

Config ESPNOW rate of specified interface.

**Attention** 1. This API should be called after `esp_wifi_start()`.

#### Parameters

- **ifx** –Interface to be configured.
- **rate** –Phy rate to be configured.

#### Returns

- `ESP_OK`: succeed
- others: failed

*esp\_err\_t* **esp\_now\_get\_peer** (const uint8\_t \*peer\_addr, *esp\_now\_peer\_info\_t* \*peer)

Get a peer whose MAC address matches peer\_addr from peer list.

#### Parameters

- **peer\_addr** –peer MAC address
- **peer** –peer information

#### Returns

- `ESP_OK` : succeed
- `ESP_ERR_ESPNOW_NOT_INIT` : ESPNOW is not initialized
- `ESP_ERR_ESPNOW_ARG` : invalid argument
- `ESP_ERR_ESPNOW_NOT_FOUND` : peer is not found

*esp\_err\_t* **esp\_now\_fetch\_peer** (bool from\_head, *esp\_now\_peer\_info\_t* \*peer)

Fetch a peer from peer list. Only return the peer which address is unicast, for the multicast/broadcast address, the function will ignore and try to find the next in the peer list.

#### Parameters

- **from\_head** –fetch from head of list or not
- **peer** –peer information

#### Returns

- `ESP_OK` : succeed
- `ESP_ERR_ESPNOW_NOT_INIT` : ESPNOW is not initialized
- `ESP_ERR_ESPNOW_ARG` : invalid argument
- `ESP_ERR_ESPNOW_NOT_FOUND` : peer is not found

bool **esp\_now\_is\_peer\_exist** (const uint8\_t \*peer\_addr)

Peer exists or not.

**Parameters** **peer\_addr** –peer MAC address

#### Returns

- true : peer exists
- false : peer not exists

*esp\_err\_t* **esp\_now\_get\_peer\_num** (*esp\_now\_peer\_num\_t* \*num)

Get the number of peers.

**Parameters** **num** –number of peers

#### Returns

- `ESP_OK` : succeed
- `ESP_ERR_ESPNOW_NOT_INIT` : ESPNOW is not initialized
- `ESP_ERR_ESPNOW_ARG` : invalid argument

*esp\_err\_t* **esp\_now\_set\_pmk** (const uint8\_t \*pmk)

Set the primary master key.

**Attention** 1. primary master key is used to encrypt local master key

**Parameters** **pmk** –primary master key

**Returns**

- ESP\_OK : succeed
- ESP\_ERR\_ESPNOW\_NOT\_INIT : ESPNOW is not initialized
- ESP\_ERR\_ESPNOW\_ARG : invalid argument

*esp\_err\_t* **esp\_now\_set\_wake\_window** (uint16\_t window)

Set wake window for esp\_now to wake up in interval unit.

**Attention** 1. This configuration could work at connected status. When ESP\_WIFI\_STA\_DISCONNECTED\_PM\_ENABLE is enabled, this configuration could work at disconnected status.

**Attention** 2. Default value is the maximum.

**Parameters** **window** –Milliseconds would the chip keep waked each interval, from 0 to 65535.

**Returns**

- ESP\_OK : succeed
- ESP\_ERR\_ESPNOW\_NOT\_INIT : ESPNOW is not initialized

## Structures

struct **esp\_now\_peer\_info**

ESPNOW peer information parameters.

### Public Members

uint8\_t **peer\_addr**[ESP\_NOW\_ETH\_ALEN]

ESPNOW peer MAC address that is also the MAC address of station or softap

uint8\_t **lmk**[ESP\_NOW\_KEY\_LEN]

ESPNOW peer local master key that is used to encrypt data

uint8\_t **channel**

Wi-Fi channel that peer uses to send/receive ESPNOW data. If the value is 0, use the current channel which station or softap is on. Otherwise, it must be set as the channel that station or softap is on.

*wifi\_interface\_t* **ifidx**

Wi-Fi interface that peer uses to send/receive ESPNOW data

bool **encrypt**

ESPNOW data that this peer sends/receives is encrypted or not

void \***priv**

ESPNOW peer private data

struct **esp\_now\_peer\_num**

Number of ESPNOW peers which exist currently.

### Public Members

int **total\_num**

Total number of ESPNOW peers, maximum value is ESP\_NOW\_MAX\_TOTAL\_PEER\_NUM

int **encrypt\_num**

Number of encrypted ESPNOW peers, maximum value is ESP\_NOW\_MAX\_ENCRYPT\_PEER\_NUM

struct **esp\_now\_recv\_info**

ESPNOW packet information.

### Public Members

uint8\_t \***src\_addr**

Source address of ESPNOW packet

uint8\_t \***des\_addr**

Destination address of ESPNOW packet

*wifi\_pkt\_rx\_ctrl\_t* \***rx\_ctrl**

Rx control info of ESPNOW packet

### Macros

**ESP\_ERR\_ESPNOW\_BASE**

ESPNOW error number base.

**ESP\_ERR\_ESPNOW\_NOT\_INIT**

ESPNOW is not initialized.

**ESP\_ERR\_ESPNOW\_ARG**

Invalid argument

**ESP\_ERR\_ESPNOW\_NO\_MEM**

Out of memory

**ESP\_ERR\_ESPNOW\_FULL**

ESPNOW peer list is full

**ESP\_ERR\_ESPNOW\_NOT\_FOUND**

ESPNOW peer is not found

**ESP\_ERR\_ESPNOW\_INTERNAL**

Internal error

**ESP\_ERR\_ESPNOW\_EXIST**

ESPNOW peer has existed

**ESP\_ERR\_ESPNOW\_IF**

Interface error

**ESP\_NOW\_ETH\_ALEN**

Length of ESPNOW peer MAC address

**ESP\_NOW\_KEY\_LEN**

Length of ESPNOW peer local master key

**ESP\_NOW\_MAX\_TOTAL\_PEER\_NUM**

Maximum number of ESPNOW total peers

**ESP\_NOW\_MAX\_ENCRYPT\_PEER\_NUM**

Maximum number of ESPNOW encrypted peers

**ESP\_NOW\_MAX\_DATA\_LEN**

Maximum length of ESPNOW data which is sent very time

**Type Definitions**typedef struct *esp\_now\_peer\_info* **esp\_now\_peer\_info\_t**

ESPNOW peer information parameters.

typedef struct *esp\_now\_peer\_num* **esp\_now\_peer\_num\_t**

Number of ESPNOW peers which exist currently.

typedef struct *esp\_now\_recv\_info* **esp\_now\_recv\_info\_t**

ESPNOW packet information.

typedef void (\***esp\_now\_recv\_cb\_t**)(const *esp\_now\_recv\_info\_t* \*esp\_now\_info, const uint8\_t \*data, int data\_len)

Callback function of receiving ESPNOW data.

**Attention** `esp_now_info` is a local variable , it can only be used in the callback.**Param `esp_now_info`** received ESPNOW packet information**Param `data`** received data**Param `data_len`** length of received datatypedef void (\***esp\_now\_send\_cb\_t**)(const uint8\_t \*mac\_addr, *esp\_now\_send\_status\_t* status)

Callback function of sending ESPNOW data.

**Param `mac_addr`** peer MAC address**Param `status`** status of sending ESPNOW data (succeed or fail)**Enumerations**enum **esp\_now\_send\_status\_t**

Status of sending ESPNOW data .

*Values:*

enumerator **ESP\_NOW\_SEND\_SUCCESS**

Send ESPNOW data successfully

enumerator **ESP\_NOW\_SEND\_FAIL**

Send ESPNOW data fail

## ESP-WIFI-MESH Programming Guide

This is a programming guide for ESP-WIFI-MESH, including the API reference and coding examples. This guide is split into the following parts:

1. *ESP-WIFI-MESH Programming Model*
2. *Writing an ESP-WIFI-MESH Application*
3. *Self Organized Networking*
4. *Application Examples*
5. *API Reference*

For documentation regarding the ESP-WIFI-MESH protocol, please see the [ESP-WIFI-MESH API Guide](#). For more information about ESP-WIFI-MESH Development Framework, please see [ESP-WIFI-MESH Development Framework](#).

## ESP-WIFI-MESH Programming Model

**Software Stack** The ESP-WIFI-MESH software stack is built atop the Wi-Fi Driver/FreeRTOS and may use the LwIP Stack in some instances (i.e. the root node). The following diagram illustrates the ESP-WIFI-MESH software stack.

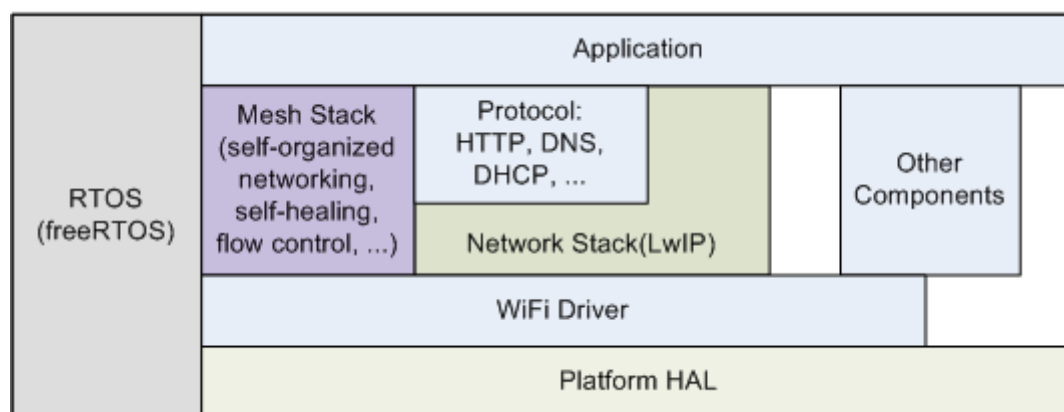

Fig. 1: ESP-WIFI-MESH Software Stack

**System Events** An application interfaces with ESP-WIFI-MESH via **ESP-WIFI-MESH Events**. Since ESP-WIFI-MESH is built atop the Wi-Fi stack, it is also possible for the application to interface with the Wi-Fi driver via the **Wi-Fi Event Task**. The following diagram illustrates the interfaces for the various System Events in an ESP-WIFI-MESH application.

The `mesh_event_id_t` defines all possible ESP-WIFI-MESH events and can indicate events such as the connection/disconnection of parent/child. Before ESP-WIFI-MESH events can be used, the application must register a **Mesh Events handler** via `esp_event_handler_register()` to the default event task. The Mesh Events handler that is registered contain handlers for each ESP-WIFI-MESH event relevant to the application.

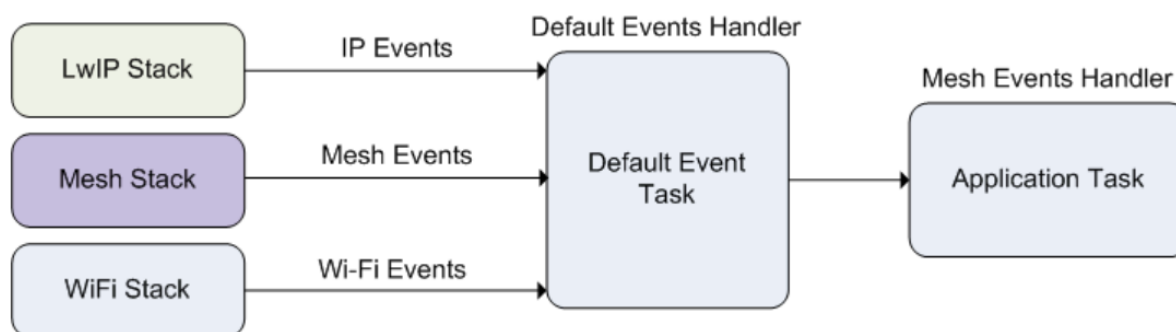

Fig. 2: ESP-WIFI-MESH System Events Delivery

Typical use cases of mesh events include using events such as `MESH_EVENT_PARENT_CONNECTED` and `MESH_EVENT_CHILD_CONNECTED` to indicate when a node can begin transmitting data upstream and downstream respectively. Likewise, `IP_EVENT_STA_GOT_IP` and `IP_EVENT_STA_LOST_IP` can be used to indicate when the root node can and cannot transmit data to the external IP network.

**Warning:** When using ESP-WIFI-MESH under self-organized mode, users must ensure that no calls to Wi-Fi API are made. This is due to the fact that the self-organizing mode will internally make Wi-Fi API calls to connect/disconnect/scan etc. **Any Wi-Fi calls from the application (including calls from callbacks and handlers of Wi-Fi events) may interfere with ESP-WIFI-MESH's self-organizing behavior.** Therefore, users should not call Wi-Fi APIs after `esp_mesh_start()` is called, and before `esp_mesh_stop()` is called.

**LwIP & ESP-WIFI-MESH** The application can access the ESP-WIFI-MESH stack directly without having to go through the LwIP stack. The LwIP stack is only required by the root node to transmit/receive data to/from an external IP network. However, since every node can potentially become the root node (due to automatic root node selection), each node must still initialize the LwIP stack.

**Each node that could become root is required to initialize LwIP by calling `esp_netif_init()`.** In order to prevent non-root node access to LwIP, the application should not create or register any network interfaces using `esp_netif` APIs.

ESP-WIFI-MESH requires a root node to be connected with a router. Therefore, in the event that a node becomes the root, **the corresponding handler must start the DHCP client service and immediately obtain an IP address.** Doing so will allow other nodes to begin transmitting/receiving packets to/from the external IP network. However, this step is unnecessary if static IP settings are used.

**Writing an ESP-WIFI-MESH Application** The prerequisites for starting ESP-WIFI-MESH is to initialize LwIP and Wi-Fi. The following code snippet demonstrates the necessary prerequisite steps before ESP-WIFI-MESH itself can be initialized.

```

ESP_ERROR_CHECK(esp_netif_init());

/* event initialization */
ESP_ERROR_CHECK(esp_event_loop_create_default());

/* Wi-Fi initialization */
wifi_init_config_t config = WIFI_INIT_CONFIG_DEFAULT();
ESP_ERROR_CHECK(esp_wifi_init(&config));
/* register IP events handler */
ESP_ERROR_CHECK(esp_event_handler_register(IP_EVENT, IP_EVENT_STA_GOT_IP, &ip_
↪event_handler, NULL));
ESP_ERROR_CHECK(esp_wifi_set_storage(WIFI_STORAGE_FLASH));
ESP_ERROR_CHECK(esp_wifi_start());
  
```

After initializing LwIP and Wi-Fi, the process of getting an ESP-WIFI-MESH network up and running can be summarized into the following three steps:

1. *Initialize Mesh*
2. *Configuring an ESP-WIFI-MESH Network*
3. *Start Mesh*

**Initialize Mesh** The following code snippet demonstrates how to initialize ESP-WIFI-MESH

```
/* mesh initialization */
ESP_ERROR_CHECK(esp_mesh_init());
/* register mesh events handler */
ESP_ERROR_CHECK(esp_event_handler_register(MESH_EVENT, ESP_EVENT_ANY_ID, &mesh_
↪event_handler, NULL));
```

**Configuring an ESP-WIFI-MESH Network** ESP-WIFI-MESH is configured via `esp_mesh_set_config()` which receives its arguments using the `mesh_cfg_t` structure. The structure contains the following parameters used to configure ESP-WIFI-MESH:

Parameter	Description
Channel	Range from 1 to 14
Mesh ID	ID of ESP-WIFI-MESH Network, see <a href="#">mesh_addr_t</a>
Router	Router Configuration, see <a href="#">mesh_router_t</a>
Mesh AP	Mesh AP Configuration, see <a href="#">mesh_ap_cfg_t</a>
Crypto Functions	Crypto Functions for Mesh IE, see <a href="#">mesh_crypto_funcs_t</a>

The following code snippet demonstrates how to configure ESP-WIFI-MESH.

```
/* Enable the Mesh IE encryption by default */
mesh_cfg_t cfg = MESH_INIT_CONFIG_DEFAULT();
/* mesh ID */
memcpy((uint8_t *) &cfg.mesh_id, MESH_ID, 6);
/* channel (must match the router's channel) */
cfg.channel = CONFIG_MESH_CHANNEL;
/* router */
cfg.router.ssid_len = strlen(CONFIG_MESH_ROUTER_SSID);
memcpy((uint8_t *) &cfg.router.ssid, CONFIG_MESH_ROUTER_SSID, cfg.router.ssid_len);
memcpy((uint8_t *) &cfg.router.password, CONFIG_MESH_ROUTER_PASSWD,
      strlen(CONFIG_MESH_ROUTER_PASSWD));
/* mesh softAP */
cfg.mesh_ap.max_connection = CONFIG_MESH_AP_CONNECTIONS;
memcpy((uint8_t *) &cfg.mesh_ap.password, CONFIG_MESH_AP_PASSWD,
      strlen(CONFIG_MESH_AP_PASSWD));
ESP_ERROR_CHECK(esp_mesh_set_config(&cfg));
```

**Start Mesh** The following code snippet demonstrates how to start ESP-WIFI-MESH.

```
/* mesh start */
ESP_ERROR_CHECK(esp_mesh_start());
```

After starting ESP-WIFI-MESH, the application should check for ESP-WIFI-MESH events to determine when it has connected to the network. After connecting, the application can start transmitting and receiving packets over the ESP-WIFI-MESH network using `esp_mesh_send()` and `esp_mesh_recv()`.

**Self Organized Networking** Self organized networking is a feature of ESP-WIFI-MESH where nodes can autonomously scan/select/connect/reconnect to other nodes and routers. This feature allows an ESP-WIFI-MESH network to operate with high degree of autonomy by making the network robust to dynamic network topologies and



conditions. With self organized networking enabled, nodes in an ESP-WIFI-MESH network are able to carry out the following actions without autonomously:

- Selection or election of the root node (see **Automatic Root Node Selection** in *Building a Network*)
- Selection of a preferred parent node (see **Parent Node Selection** in *Building a Network*)
- Automatic reconnection upon detecting a disconnection (see **Intermediate Parent Node Failure** in *Managing a Network*)

When self organized networking is enabled, the ESP-WIFI-MESH stack will internally make calls to Wi-Fi APIs. Therefore, **the application layer should not make any calls to Wi-Fi APIs whilst self organized networking is enabled as doing so would risk interfering with ESP-WIFI-MESH.**

**Toggling Self Organized Networking** Self organized networking can be enabled or disabled by the application at runtime by calling the `esp_mesh_set_self_organized()` function. The function has the two following parameters:

- `bool enable` specifies whether to enable or disable self organized networking.
- `bool select_parent` specifies whether a new parent node should be selected when enabling self organized networking. Selecting a new parent has different effects depending the node type and the node's current state. This parameter is unused when disabling self organized networking.

**Disabling Self Organized Networking** The following code snippet demonstrates how to disable self organized networking.

```
//Disable self organized networking  
esp_mesh_set_self_organized(false, false);
```

ESP-WIFI-MESH will attempt to maintain the node's current Wi-Fi state when disabling self organized networking.

- If the node was previously connected to other nodes, it will remain connected.
- If the node was previously disconnected and was scanning for a parent node or router, it will stop scanning.
- If the node was previously attempting to reconnect to a parent node or router, it will stop reconnecting.

**Enabling Self Organized Networking** ESP-WIFI-MESH will attempt to maintain the node's current Wi-Fi state when enabling self organized networking. However, depending on the node type and whether a new parent is selected, the Wi-Fi state of the node can change. The following table shows effects of enabling self organized networking.

Select Parent	Is Root Node	Effects
N	N	<ul style="list-style-type: none"> <li>Nodes already connected to a parent node will remain connected.</li> <li>Nodes previously scanning for a parent nodes will stop scanning. Call <code>esp_mesh_connect()</code> to restart.</li> </ul>
	Y	<ul style="list-style-type: none"> <li>A root node already connected to router will stay connected.</li> <li>A root node disconnected from router will need to call <code>esp_mesh_connect()</code> to reconnect.</li> </ul>
Y	N	<ul style="list-style-type: none"> <li>Nodes without a parent node will automatically select a preferred parent and connect.</li> <li>Nodes already connected to a parent node will disconnect, reselect a preferred parent node, and connect.</li> </ul>
	Y	<ul style="list-style-type: none"> <li>For a root node to connect to a parent node, it must give up it's role as root. Therefore, a root node will disconnect from the router and all child nodes, select a preferred parent node, and connect.</li> </ul>

The following code snippet demonstrates how to enable self organized networking.

```
//Enable self organized networking and select a new parent
esp_mesh_set_self_organized(true, true);

...

//Enable self organized networking and manually reconnect
esp_mesh_set_self_organized(true, false);
esp_mesh_connect();
```

**Calling Wi-Fi API** There can be instances in which an application may want to directly call Wi-Fi API whilst using ESP-WIFI-MESH. For example, an application may want to manually scan for neighboring APs. However, **self organized networking must be disabled before the application calls any Wi-Fi APIs**. This will prevent the ESP-WIFI-MESH stack from attempting to call any Wi-Fi APIs and potentially interfering with the application's calls.

Therefore, application calls to Wi-Fi APIs should be placed in between calls of `esp_mesh_set_self_organized()` which disable and enable self organized networking. The following code snippet demonstrates how an application can safely call `esp_wifi_scan_start()` whilst using

**ESP-WIFI-MESH.**

```
//Disable self organized networking
esp_mesh_set_self_organized(0, 0);

//Stop any scans already in progress
esp_wifi_scan_stop();
//Manually start scan. Will automatically stop when run to completion
esp_wifi_scan_start();

//Process scan results

...

//Re-enable self organized networking if still connected
esp_mesh_set_self_organized(1, 0);

...

//Re-enable self organized networking if non-root and disconnected
esp_mesh_set_self_organized(1, 1);

...

//Re-enable self organized networking if root and disconnected
esp_mesh_set_self_organized(1, 0); //Don't select new parent
esp_mesh_connect(); //Manually reconnect to router
```

**Application Examples** ESP-IDF contains these ESP-WIFI-MESH example projects:

[The Internal Communication Example](#) demonstrates how to set up a ESP-WIFI-MESH network and have the root node send a data packet to every node within the network.

[The Manual Networking Example](#) demonstrates how to use ESP-WIFI-MESH without the self-organizing features. This example shows how to program a node to manually scan for a list of potential parent nodes and select a parent node based on custom criteria.

**API Reference****Header File**

- [components/esp\\_wifi/include/esp\\_mesh.h](#)

**Functions**

*esp\_err\_t* **esp\_mesh\_init** (void)

Mesh initialization.

- Check whether Wi-Fi is started.
- Initialize mesh global variables with default values.

**Attention** This API shall be called after Wi-Fi is started.

**Returns**

- ESP\_OK
- ESP\_FAIL

*esp\_err\_t* **esp\_mesh\_deinit** (void)

Mesh de-initialization.

- Release resources **and** stop the mesh

**Returns**

- ESP\_OK
- ESP\_FAIL

*esp\_err\_t* **esp\_mesh\_start** (void)

Start mesh.

- Initialize mesh IE.
- Start mesh network management service.
- Create TX and RX queues according to the configuration.
- Register mesh packets receive callback.

**Attention** This API shall be called after mesh initialization and configuration.

**Returns**

- ESP\_OK
- ESP\_FAIL
- ESP\_ERR\_MESH\_NOT\_INIT
- ESP\_ERR\_MESH\_NOT\_CONFIG
- ESP\_ERR\_MESH\_NO\_MEMORY

*esp\_err\_t* **esp\_mesh\_stop** (void)

Stop mesh.

- Deinitialize mesh IE.
- Disconnect with current parent.
- Disassociate all currently associated children.
- Stop mesh network management service.
- Unregister mesh packets receive callback.
- Delete TX and RX queues.
- Release resources.
- Restore Wi-Fi softAP to default settings if Wi-Fi dual mode is enabled.
- Set Wi-Fi Power Save type to WIFI\_PS\_NONE.

**Returns**

- ESP\_OK
- ESP\_FAIL

*esp\_err\_t* **esp\_mesh\_send** (const *mesh\_addr\_t* \*to, const *mesh\_data\_t* \*data, int flag, const *mesh\_opt\_t* opt[], int opt\_count)

Send a packet over the mesh network.

- Send a packet to any device in the mesh network.
- Send a packet to external IP network.

**Attention** This API is not reentrant.

### Parameters

- **to** –[in] the address of the final destination of the packet
  - If the packet is to the root, set this parameter to NULL.
  - If the packet is to an external IP network, set this parameter to the IPv4:PORT combination. This packet will be delivered to the root firstly, then the root will forward this packet to the final IP server address.
- **data** –[in] pointer to a sending mesh packet
  - Field size should not exceed MESH\_MPS. Note that the size of one mesh packet should not exceed MESH\_MTU.
  - Field proto should be set to data protocol in use (default is MESH\_PROTO\_BIN for binary).
  - Field tos should be set to transmission tos (type of service) in use (default is MESH\_TOS\_P2P for point-to-point reliable).
    - \* If the packet is to the root, MESH\_TOS\_P2P must be set to ensure reliable transmission.
    - \* As long as the MESH\_TOS\_P2P is set, the API is blocking, even if the flag is set with MESH\_DATA\_NONBLOCK.
    - \* As long as the MESH\_TOS\_DEF is set, the API is non-blocking.
- **flag** –[in] bitmap for data sent
  - Flag is at least one of the three MESH\_DATA\_P2P/MESH\_DATA\_FROMDS/MESH\_DATA\_TODS, which represents the direction of packet sending.
  - Speed up the route search
    - \* If the packet is to an internal device, MESH\_DATA\_P2P should be set.
    - \* If the packet is to the root ( “to” parameter isn’ t NULL) or to external IP network, MESH\_DATA\_TODS should be set.
    - \* If the packet is from the root to an internal device, MESH\_DATA\_FROMDS should be set.
  - Specify whether this API is blocking or non-blocking, blocking by default.
  - In the situation of the root change, MESH\_DATA\_DROP identifies this packet can be dropped by the new root for upstream data to external IP network, we try our best to avoid data loss caused by the root change, but there is a risk that the new root is running out of memory because most of memory is occupied by the pending data which isn’ t read out in time by esp\_mesh\_rcv\_toDS().  
Generally, we suggest esp\_mesh\_rcv\_toDS() is called after a connection with IP network is created. Thus data outgoing to external IP network via socket is just from reading esp\_mesh\_rcv\_toDS() which avoids unnecessary memory copy.
- **opt** –[in] options
  - In case of sending a packet to a certain group, MESH\_OPT\_SEND\_GROUP is a good choice. In this option, the value field should be set to the target receiver addresses in this group.
  - Root sends a packet to an internal device, this packet is from external IP network in case the receiver device responds this packet, MESH\_OPT\_RECV\_DS\_ADDR is required to attach the target DS address.
- **opt\_count** –[in] option count
  - Currently, this API only takes one option, so opt\_count is only supported to be 1.

### Returns

- ESP\_OK
- ESP\_FAIL
- ESP\_ERR\_MESH\_ARGUMENT
- ESP\_ERR\_MESH\_NOT\_START
- ESP\_ERR\_MESH\_DISCONNECTED
- ESP\_ERR\_MESH\_OPT\_UNKNOWN
- ESP\_ERR\_MESH\_EXCEED\_MTU
- ESP\_ERR\_MESH\_NO\_MEMORY
- ESP\_ERR\_MESH\_TIMEOUT
- ESP\_ERR\_MESH\_QUEUE\_FULL

- ESP\_ERR\_MESH\_NO\_ROUTE\_FOUND
- ESP\_ERR\_MESH\_DISCARD

*esp\_err\_t* **esp\_mesh\_send\_block\_time** (uint32\_t time\_ms)

Set blocking time of esp\_mesh\_send()

- Suggest to set the blocking time to at least 5s when the environment is poor. Otherwise, esp\_mesh\_send() may timeout frequently.

**Attention** This API shall be called before mesh is started.

**Parameters** *time\_ms* –[in] blocking time of esp\_mesh\_send(), unit:ms

**Returns**

- ESP\_OK

*esp\_err\_t* **esp\_mesh\_recv** (*mesh\_addr\_t* \*from, *mesh\_data\_t* \*data, int timeout\_ms, int \*flag, *mesh\_opt\_t* opt[], int opt\_count)

Receive a packet targeted to self over the mesh network.

flag could be MESH\_DATA\_FROMDS or MESH\_DATA\_TODS.

**Attention** Mesh RX queue should be checked regularly to avoid running out of memory.

- Use esp\_mesh\_get\_rx\_pending() to check the number of packets available in the queue waiting to be received by applications.

**Parameters**

- **from** –[out] the address of the original source of the packet
- **data** –[out] pointer to the received mesh packet
  - Field proto is the data protocol in use. Should follow it to parse the received data.
  - Field tos is the transmission tos (type of service) in use.
- **timeout\_ms** –[in] wait time if a packet isn't immediately available (0:no wait, port-MAX\_DELAY:wait forever)
- **flag** –[out] bitmap for data received
  - MESH\_DATA\_FROMDS represents data from external IP network
  - MESH\_DATA\_TODS represents data directed upward within the mesh network
- **opt** –[out] options desired to receive
  - MESH\_OPT\_RECV\_DS\_ADDR attaches the DS address
- **opt\_count** –[in] option count desired to receive
  - Currently, this API only takes one option, so opt\_count is only supported to be 1.

**Returns**

- ESP\_OK
- ESP\_ERR\_MESH\_ARGUMENT
- ESP\_ERR\_MESH\_NOT\_START
- ESP\_ERR\_MESH\_TIMEOUT
- ESP\_ERR\_MESH\_DISCARD

*esp\_err\_t* **esp\_mesh\_recv\_toDS** (*mesh\_addr\_t* \*from, *mesh\_addr\_t* \*to, *mesh\_data\_t* \*data, int timeout\_ms, int \*flag, *mesh\_opt\_t* opt[], int opt\_count)

Receive a packet targeted to external IP network.

- Root uses this API to receive packets destined to external IP network
- Root forwards the received packets to the final destination via socket.
- If no socket connection is ready to send out the received packets and this esp\_mesh\_recv\_toDS() hasn't been called by applications, packets from the whole mesh network will be pending in toDS queue.

Use `esp_mesh_get_rx_pending()` to check the number of packets available in the queue waiting to be received by applications in case of running out of memory in the root.

Using `esp_mesh_set_xon_qsize()` users may configure the RX queue size, default:32. If this size is too large, and `esp_mesh_recv_toDS()` isn't called in time, there is a risk that a great deal of memory is occupied by the pending packets. If this size is too small, it will impact the efficiency on upstream. How to decide this value depends on the specific application scenarios.

flag could be `MESH_DATA_TODS`.

**Attention** This API is only called by the root.

#### Parameters

- **from** –[**out**] the address of the original source of the packet
- **to** –[**out**] the address contains remote IP address and port (IPv4:PORT)
- **data** –[**out**] pointer to the received packet
  - Contain the protocol and applications should follow it to parse the data.
- **timeout\_ms** –[**in**] wait time if a packet isn't immediately available (0:no wait, port-MAX\_DELAY:wait forever)
- **flag** –[**out**] bitmap for data received
  - `MESH_DATA_TODS` represents the received data target to external IP network. Root shall forward this data to external IP network via the association with router.
- **opt** –[**out**] options desired to receive
- **opt\_count** –[**in**] option count desired to receive

#### Returns

- `ESP_OK`
- `ESP_ERR_MESH_ARGUMENT`
- `ESP_ERR_MESH_NOT_START`
- `ESP_ERR_MESH_TIMEOUT`
- `ESP_ERR_MESH_DISCARD`
- `ESP_ERR_MESH_RECV_RELEASE`

*esp\_err\_t* `esp_mesh_set_config` (const *mesh\_cfg\_t* \*config)

Set mesh stack configuration.

- Use `MESH_INIT_CONFIG_DEFAULT()` to initialize the default values, mesh IE is encrypted by default.
- Mesh network is established on a fixed channel (1-14).
- Mesh event callback is mandatory.
- Mesh ID is an identifier of an MBSS. Nodes with the same mesh ID can communicate with each other.
- Regarding to the router configuration, if the router is hidden, BSSID field is mandatory.

If BSSID field isn't set and there exists more than one router with same SSID, there is a risk that more roots than one connected with different BSSID will appear. It means more than one mesh network is established with the same mesh ID.

Root conflict function could eliminate redundant roots connected with the same BSSID, but couldn't handle roots connected with different BSSID. Because users might have such requirements of setting up routers with same SSID for the future replacement. But in that case, if the above situations happen, please make sure applications implement forward functions on the root to guarantee devices in different mesh networks can communicate with each other. `max_connection` of mesh softAP is limited by the max number of Wi-Fi softAP supported (max:10).

**Attention** This API shall be called before mesh is started after mesh is initialized.

**Parameters** `config` –[**in**] pointer to mesh stack configuration

**Returns**

- ESP\_OK
- ESP\_ERR\_MESH\_ARGUMENT
- ESP\_ERR\_MESH\_NOT\_ALLOWED

*esp\_err\_t* **esp\_mesh\_get\_config** (*mesh\_cfg\_t* \*config)

Get mesh stack configuration.

**Parameters** **config** –[out] pointer to mesh stack configuration

**Returns**

- ESP\_OK
- ESP\_ERR\_MESH\_ARGUMENT

*esp\_err\_t* **esp\_mesh\_set\_router** (const *mesh\_router\_t* \*router)

Get router configuration.

**Attention** This API is used to dynamically modify the router configuration after mesh is configured.

**Parameters** **router** –[in] pointer to router configuration

**Returns**

- ESP\_OK
- ESP\_ERR\_MESH\_ARGUMENT

*esp\_err\_t* **esp\_mesh\_get\_router** (*mesh\_router\_t* \*router)

Get router configuration.

**Parameters** **router** –[out] pointer to router configuration

**Returns**

- ESP\_OK
- ESP\_ERR\_MESH\_ARGUMENT

*esp\_err\_t* **esp\_mesh\_set\_id** (const *mesh\_addr\_t* \*id)

Set mesh network ID.

**Attention** This API is used to dynamically modify the mesh network ID.

**Parameters** **id** –[in] pointer to mesh network ID

**Returns**

- ESP\_OK
- ESP\_ERR\_MESH\_ARGUMENT: invalid argument

*esp\_err\_t* **esp\_mesh\_get\_id** (*mesh\_addr\_t* \*id)

Get mesh network ID.

**Parameters** **id** –[out] pointer to mesh network ID

**Returns**

- ESP\_OK
- ESP\_ERR\_MESH\_ARGUMENT

*esp\_err\_t* **esp\_mesh\_set\_type** (*mesh\_type\_t* type)

Designate device type over the mesh network.

- MESH\_IDLE: designates a device as a self-organized node for a mesh network
- MESH\_ROOT: designates the root node for a mesh network
- MESH\_LEAF: designates a device as a standalone Wi-Fi station that connects to a parent
- MESH\_STA: designates a device as a standalone Wi-Fi station that connects to a router

**Parameters** **type** –[in] device type



**Returns**

- ESP\_OK
- ESP\_ERR\_MESH\_NOT\_ALLOWED

*mesh\_type\_t* **esp\_mesh\_get\_type** (void)

Get device type over mesh network.

**Attention** This API shall be called after having received the event MESH\_EVENT\_PARENT\_CONNECTED.

**Returns** mesh type

*esp\_err\_t* **esp\_mesh\_set\_max\_layer** (int max\_layer)

Set network max layer value.

- for tree topology, the max is 25.
- for chain topology, the max is 1000.
- Network max layer limits the max hop count.

**Attention** This API shall be called before mesh is started.

**Parameters** **max\_layer** –[in] max layer value

**Returns**

- ESP\_OK
- ESP\_ERR\_MESH\_ARGUMENT
- ESP\_ERR\_MESH\_NOT\_ALLOWED

int **esp\_mesh\_get\_max\_layer** (void)

Get max layer value.

**Returns** max layer value

*esp\_err\_t* **esp\_mesh\_set\_ap\_password** (const uint8\_t \*pwd, int len)

Set mesh softAP password.

**Attention** This API shall be called before mesh is started.

**Parameters**

- **pwd** –[in] pointer to the password
- **len** –[in] password length

**Returns**

- ESP\_OK
- ESP\_ERR\_MESH\_ARGUMENT
- ESP\_ERR\_MESH\_NOT\_ALLOWED

*esp\_err\_t* **esp\_mesh\_set\_ap\_authmode** (*wifi\_auth\_mode\_t* authmode)

Set mesh softAP authentication mode.

**Attention** This API shall be called before mesh is started.

**Parameters** **authmode** –[in] authentication mode

**Returns**

- ESP\_OK

- ESP\_ERR\_MESH\_ARGUMENT
- ESP\_ERR\_MESH\_NOT\_ALLOWED

*wifi\_auth\_mode\_t* **esp\_mesh\_get\_ap\_authmode** (void)

Get mesh softAP authentication mode.

**Returns** authentication mode

*esp\_err\_t* **esp\_mesh\_set\_ap\_connections** (int connections)

Set mesh max connection value.

- Set mesh softAP max connection = mesh max connection + non-mesh max connection

**Attention** This API shall be called before mesh is started.

**Parameters** **connections** –[in] the number of max connections

**Returns**

- ESP\_OK
- ESP\_ERR\_MESH\_ARGUMENT

int **esp\_mesh\_get\_ap\_connections** (void)

Get mesh max connection configuration.

**Returns** the number of mesh max connections

int **esp\_mesh\_get\_non\_mesh\_connections** (void)

Get non-mesh max connection configuration.

**Returns** the number of non-mesh max connections

int **esp\_mesh\_get\_layer** (void)

Get current layer value over the mesh network.

**Attention** This API shall be called after having received the event MESH\_EVENT\_PARENT\_CONNECTED.

**Returns** layer value

*esp\_err\_t* **esp\_mesh\_get\_parent\_bssid** (*mesh\_addr\_t* \*bssid)

Get the parent BSSID.

**Attention** This API shall be called after having received the event MESH\_EVENT\_PARENT\_CONNECTED.

**Parameters** **bssid** –[out] pointer to parent BSSID

**Returns**

- ESP\_OK
- ESP\_FAIL

bool **esp\_mesh\_is\_root** (void)

Return whether the device is the root node of the network.

**Returns** true/false

*esp\_err\_t* **esp\_mesh\_set\_self\_organized** (bool enable, bool select\_parent)

Enable/disable self-organized networking.

- Self-organized networking has three main functions: select the root node; find a preferred parent; initiate reconnection if a disconnection is detected.
- Self-organized networking is enabled by default.
- If self-organized is disabled, users should set a parent for the device via `esp_mesh_set_parent()`.

**Attention** This API is used to dynamically modify whether to enable the self organizing.

#### Parameters

- **enable** –[in] enable or disable self-organized networking
- **select\_parent** –[in] Only valid when self-organized networking is enabled.
  - if `select_parent` is set to true, the root will give up its mesh root status and search for a new parent like other non-root devices.

#### Returns

- ESP\_OK
- ESP\_FAIL

bool **esp\_mesh\_get\_self\_organized** (void)

Return whether enable self-organized networking or not.

**Returns** true/false

*esp\_err\_t* **esp\_mesh\_waive\_root** (const *mesh\_vote\_t* \*vote, int reason)

Cause the root device to give up (waive) its mesh root status.

- A device is elected root primarily based on RSSI from the external router.
- If external router conditions change, users can call this API to perform a root switch.
- In this API, users could specify a desired root address to replace itself or specify an attempts value to ask current root to initiate a new round of voting. During the voting, a better root candidate would be expected to find to replace the current one.
- If no desired root candidate, the vote will try a specified number of attempts (at least 15). If no better root candidate is found, keep the current one. If a better candidate is found, the new better one will send a root switch request to the current root, current root will respond with a root switch acknowledgment.
- After that, the new candidate will connect to the router to be a new root, the previous root will disconnect with the router and choose another parent instead.

Root switch is completed with minimal disruption to the whole mesh network.

**Attention** This API is only called by the root.

#### Parameters

- **vote** –[in] vote configuration
  - If this parameter is set NULL, the vote will perform the default 15 times.
  - Field percentage threshold is 0.9 by default.
  - Field `is_rc_specified` shall be false.
  - Field `attempts` shall be at least 15 times.
- **reason** –[in] only accept MESH\_VOTE\_REASON\_ROOT\_INITIATED for now

#### Returns

- ESP\_OK
- ESP\_ERR\_MESH\_QUEUE\_FULL
- ESP\_ERR\_MESH\_DISCARD
- ESP\_FAIL

*esp\_err\_t* **esp\_mesh\_set\_vote\_percentage** (float percentage)

Set vote percentage threshold for approval of being a root (default:0.9)

- During the networking, only obtaining vote percentage reaches this threshold, the device could be a root.

**Attention** This API shall be called before mesh is started.

**Parameters** **percentage** –[in] vote percentage threshold

**Returns**

- ESP\_OK
- ESP\_FAIL

float **esp\_mesh\_get\_vote\_percentage** (void)

Get vote percentage threshold for approval of being a root.

**Returns** percentage threshold

*esp\_err\_t* **esp\_mesh\_set\_ap\_assoc\_expire** (int seconds)

Set mesh softAP associate expired time (default:10 seconds)

- If mesh softAP hasn't received any data from an associated child within this time, mesh softAP will take this child inactive and disassociate it.
- If mesh softAP is encrypted, this value should be set a greater value, such as 30 seconds.

**Parameters** **seconds** –[in] the expired time

**Returns**

- ESP\_OK
- ESP\_FAIL

int **esp\_mesh\_get\_ap\_assoc\_expire** (void)

Get mesh softAP associate expired time.

**Returns** seconds

int **esp\_mesh\_get\_total\_node\_num** (void)

Get total number of devices in current network (including the root)

**Attention** The returned value might be incorrect when the network is changing.

**Returns** total number of devices (including the root)

int **esp\_mesh\_get\_routing\_table\_size** (void)

Get the number of devices in this device's sub-network (including self)

**Returns** the number of devices over this device's sub-network (including self)

*esp\_err\_t* **esp\_mesh\_get\_routing\_table** (*mesh\_addr\_t* \*mac, int len, int \*size)

Get routing table of this device's sub-network (including itself)

**Parameters**

- **mac** –[out] pointer to routing table
- **len** –[in] routing table size(in bytes)
- **size** –[out] pointer to the number of devices in routing table (including itself)

**Returns**

- ESP\_OK
- ESP\_ERR\_MESH\_ARGUMENT

*esp\_err\_t* **esp\_mesh\_post\_toDS\_state** (bool reachable)

Post the toDS state to the mesh stack.

**Attention** This API is only for the root.

**Parameters** **reachable** –[in] this state represents whether the root is able to access external IP network

**Returns**

- ESP\_OK
- ESP\_FAIL

*esp\_err\_t* **esp\_mesh\_get\_tx\_pending** (*mesh\_tx\_pending\_t* \*pending)

Return the number of packets pending in the queue waiting to be sent by the mesh stack.

**Parameters** **pending** –[out] pointer to the TX pending

**Returns**

- ESP\_OK
- ESP\_FAIL

*esp\_err\_t* **esp\_mesh\_get\_rx\_pending** (*mesh\_rx\_pending\_t* \*pending)

Return the number of packets available in the queue waiting to be received by applications.

**Parameters** **pending** –[out] pointer to the RX pending

**Returns**

- ESP\_OK
- ESP\_FAIL

int **esp\_mesh\_available\_txupQ\_num** (const *mesh\_addr\_t* \*addr, uint32\_t \*xseqno\_in)

Return the number of packets could be accepted from the specified address.

**Parameters**

- **addr** –[in] self address or an associate children address
- **xseqno\_in** –[out] sequence number of the last received packet from the specified address

**Returns** the number of upQ for a certain address

*esp\_err\_t* **esp\_mesh\_set\_xon\_qsize** (int qsize)

Set the number of RX queue for the node, the average number of window allocated to one of its child node is:  $wnd = xon\_qsize / (2 * max\_connection + 1)$ . However, the window of each child node is not strictly equal to the average value, it is affected by the traffic also.

**Attention** This API shall be called before mesh is started.

**Parameters** **qsize** –[in] default:32 (min:16)

**Returns**

- ESP\_OK
- ESP\_FAIL

int **esp\_mesh\_get\_xon\_qsize** (void)

Get queue size.

**Returns** the number of queue

*esp\_err\_t* **esp\_mesh\_allow\_root\_conflicts** (bool allowed)

Set whether allow more than one root existing in one network.

- The default value is true, that is, multiple roots are allowed.

**Parameters** **allowed** –[in] allow or not

**Returns**

- ESP\_OK
- ESP\_WIFI\_ERR\_NOT\_INIT
- ESP\_WIFI\_ERR\_NOT\_START

bool **esp\_mesh\_is\_root\_conflicts\_allowed** (void)

Check whether allow more than one root to exist in one network.

**Returns** true/false

*esp\_err\_t* **esp\_mesh\_set\_group\_id** (const *mesh\_addr\_t* \*addr, int num)

Set group ID addresses.

**Parameters**

- **addr** –[in] pointer to new group ID addresses
- **num** –[in] the number of group ID addresses

**Returns**

- ESP\_OK
- ESP\_MESH\_ERR\_ARGUMENT

*esp\_err\_t* **esp\_mesh\_delete\_group\_id** (const *mesh\_addr\_t* \*addr, int num)

Delete group ID addresses.

**Parameters**

- **addr** –[in] pointer to deleted group ID address
- **num** –[in] the number of group ID addresses

**Returns**

- ESP\_OK
- ESP\_MESH\_ERR\_ARGUMENT

int **esp\_mesh\_get\_group\_num** (void)

Get the number of group ID addresses.

**Returns** the number of group ID addresses

*esp\_err\_t* **esp\_mesh\_get\_group\_list** (*mesh\_addr\_t* \*addr, int num)

Get group ID addresses.

**Parameters**

- **addr** –[out] pointer to group ID addresses
- **num** –[in] the number of group ID addresses

**Returns**

- ESP\_OK
- ESP\_MESH\_ERR\_ARGUMENT

bool **esp\_mesh\_is\_my\_group** (const *mesh\_addr\_t* \*addr)

Check whether the specified group address is my group.

**Returns** true/false

*esp\_err\_t* **esp\_mesh\_set\_capacity\_num** (int num)

Set mesh network capacity (max:1000, default:300)

**Attention** This API shall be called before mesh is started.

**Parameters** **num** –[in] mesh network capacity

**Returns**

- ESP\_OK
- ESP\_ERR\_MESH\_NOT\_ALLOWED
- ESP\_MESH\_ERR\_ARGUMENT

int **esp\_mesh\_get\_capacity\_num** (void)

Get mesh network capacity.

**Returns** mesh network capacity

*esp\_err\_t* **esp\_mesh\_set\_ie\_crypto\_funcs** (const mesh\_crypto\_funcs\_t \*crypto\_funcs)

Set mesh IE crypto functions.

**Attention** This API can be called at any time after mesh is initialized.

**Parameters** **crypto\_funcs** –[in] crypto functions for mesh IE

- If **crypto\_funcs** is set to NULL, mesh IE is no longer encrypted.

**Returns**

- ESP\_OK

*esp\_err\_t* **esp\_mesh\_set\_ie\_crypto\_key** (const char \*key, int len)

Set mesh IE crypto key.

**Attention** This API can be called at any time after mesh is initialized.

**Parameters**

- **key** –[in] ASCII crypto key
- **len** –[in] length in bytes, range:8~64

**Returns**

- ESP\_OK
- ESP\_MESH\_ERR\_ARGUMENT

*esp\_err\_t* **esp\_mesh\_get\_ie\_crypto\_key** (char \*key, int len)

Get mesh IE crypto key.

**Parameters**

- **key** –[out] ASCII crypto key
- **len** –[in] length in bytes, range:8~64

**Returns**

- ESP\_OK
- ESP\_MESH\_ERR\_ARGUMENT

*esp\_err\_t* **esp\_mesh\_set\_root\_healing\_delay** (int delay\_ms)

Set delay time before starting root healing.

**Parameters** **delay\_ms** –[in] delay time in milliseconds

**Returns**

- ESP\_OK

int **esp\_mesh\_get\_root\_healing\_delay** (void)

Get delay time before network starts root healing.

**Returns** delay time in milliseconds

*esp\_err\_t* **esp\_mesh\_fix\_root** (bool enable)

Enable network Fixed Root Setting.

- Enabling fixed root disables automatic election of the root node via voting.
- All devices in the network shall use the same Fixed Root Setting (enabled or disabled).
- If Fixed Root is enabled, users should make sure a root node is designated for the network.

**Parameters** **enable** –[in] enable or not

**Returns**

- ESP\_OK

bool **esp\_mesh\_is\_root\_fixed** (void)

Check whether network Fixed Root Setting is enabled.

- Enable/disable network Fixed Root Setting by API `esp_mesh_fix_root()`.
- Network Fixed Root Setting also changes with the “flag” value in parent networking IE.

**Returns** true/false

*esp\_err\_t* **esp\_mesh\_set\_parent** (const *wifi\_config\_t* \*parent, const *mesh\_addr\_t* \*parent\_mesh\_id, *mesh\_type\_t* my\_type, int my\_layer)

Set a specified parent for the device.

**Attention** This API can be called at any time after mesh is configured.

**Parameters**

- **parent** –[in] parent configuration, the SSID and the channel of the parent are mandatory.
  - If the BSSID is set, make sure that the SSID and BSSID represent the same parent, otherwise the device will never find this specified parent.
- **parent\_mesh\_id** –[in] parent mesh ID,
  - If this value is not set, the original mesh ID is used.
- **my\_type** –[in] mesh type
  - MESH\_STA is not supported.
  - If the parent set for the device is the same as the router in the network configuration, then my\_type shall set MESH\_ROOT and my\_layer shall set MESH\_ROOT\_LAYER.
- **my\_layer** –[in] mesh layer
  - my\_layer of the device may change after joining the network.
  - If my\_type is set MESH\_NODE, my\_layer shall be greater than MESH\_ROOT\_LAYER.
  - If my\_type is set MESH\_LEAF, the device becomes a standalone Wi-Fi station and no longer has the ability to extend the network.

**Returns**

- ESP\_OK
- ESP\_ERR\_ARGUMENT
- ESP\_ERR\_MESH\_NOT\_CONFIG

*esp\_err\_t* **esp\_mesh\_scan\_get\_ap\_ie\_len** (int \*len)

Get mesh networking IE length of one AP.

**Parameters** len –[out] mesh networking IE length

**Returns**

- ESP\_OK
- ESP\_ERR\_WIFI\_NOT\_INIT
- ESP\_ERR\_INVALID\_ARG
- ESP\_ERR\_WIFI\_FAIL

*esp\_err\_t* **esp\_mesh\_scan\_get\_ap\_record** (*wifi\_ap\_record\_t* \*ap\_record, void \*buffer)

Get AP record.

**Attention** Different from `esp_wifi_scan_get_ap_records()`, this API only gets one of APs scanned each time. See “manual\_networking” example.

**Parameters**



- **ap\_record** –[out] pointer to one AP record
- **buffer** –[out] pointer to the mesh networking IE of this AP

**Returns**

- ESP\_OK
- ESP\_ERR\_WIFI\_NOT\_INIT
- ESP\_ERR\_INVALID\_ARG
- ESP\_ERR\_WIFI\_FAIL

*esp\_err\_t* **esp\_mesh\_flush\_upstream\_packets** (void)

Flush upstream packets pending in to\_parent queue and to\_parent\_p2p queue.

**Returns**

- ESP\_OK

*esp\_err\_t* **esp\_mesh\_get\_subnet\_nodes\_num** (const *mesh\_addr\_t* \*child\_mac, int \*nodes\_num)

Get the number of nodes in the subnet of a specific child.

**Parameters**

- **child\_mac** –[in] an associated child address of this device
- **nodes\_num** –[out] pointer to the number of nodes in the subnet of a specific child

**Returns**

- ESP\_OK
- ESP\_ERR\_MESH\_NOT\_START
- ESP\_ERR\_MESH\_ARGUMENT

*esp\_err\_t* **esp\_mesh\_get\_subnet\_nodes\_list** (const *mesh\_addr\_t* \*child\_mac, *mesh\_addr\_t* \*nodes, int nodes\_num)

Get nodes in the subnet of a specific child.

**Parameters**

- **child\_mac** –[in] an associated child address of this device
- **nodes** –[out] pointer to nodes in the subnet of a specific child
- **nodes\_num** –[in] the number of nodes in the subnet of a specific child

**Returns**

- ESP\_OK
- ESP\_ERR\_MESH\_NOT\_START
- ESP\_ERR\_MESH\_ARGUMENT

*esp\_err\_t* **esp\_mesh\_disconnect** (void)

Disconnect from current parent.

**Returns**

- ESP\_OK

*esp\_err\_t* **esp\_mesh\_connect** (void)

Connect to current parent.

**Returns**

- ESP\_OK

*esp\_err\_t* **esp\_mesh\_flush\_scan\_result** (void)

Flush scan result.

**Returns**

- ESP\_OK

*esp\_err\_t* **esp\_mesh\_switch\_channel** (const uint8\_t \*new\_bssid, int csa\_newchan, int csa\_count)

Cause the root device to add Channel Switch Announcement Element (CSA IE) to beacon.

- Set the new channel
- Set how many beacons with CSA IE will be sent before changing a new channel

- Enable the channel switch function

**Attention** This API is only called by the root.

**Parameters**

- **new\_bssid** –[in] the new router BSSID if the router changes
- **csa\_newchan** –[in] the new channel number to which the whole network is moving
- **csa\_count** –[in] channel switch period (beacon count), unit is based on beacon interval of its softAP, the default value is 15.

**Returns**

- ESP\_OK

*esp\_err\_t* **esp\_mesh\_get\_router\_bssid** (uint8\_t \*router\_bssid)

Get the router BSSID.

**Parameters** **router\_bssid** –[out] pointer to the router BSSID

**Returns**

- ESP\_OK
- ESP\_ERR\_WIFI\_NOT\_INIT
- ESP\_ERR\_INVALID\_ARG

int64\_t **esp\_mesh\_get\_tsf\_time** (void)

Get the TSF time.

**Returns** the TSF time

*esp\_err\_t* **esp\_mesh\_set\_topology** (*esp\_mesh\_topology\_t* topo)

Set mesh topology. The default value is MESH\_TOPO\_TREE.

- MESH\_TOPO\_CHAIN supports up to 1000 layers

**Attention** This API shall be called before mesh is started.

**Parameters** **topo** –[in] MESH\_TOPO\_TREE or MESH\_TOPO\_CHAIN

**Returns**

- ESP\_OK
- ESP\_MESH\_ERR\_ARGUMENT
- ESP\_ERR\_MESH\_NOT\_ALLOWED

*esp\_mesh\_topology\_t* **esp\_mesh\_get\_topology** (void)

Get mesh topology.

**Returns** MESH\_TOPO\_TREE or MESH\_TOPO\_CHAIN

*esp\_err\_t* **esp\_mesh\_enable\_ps** (void)

Enable mesh Power Save function.

**Attention** This API shall be called before mesh is started.

**Returns**

- ESP\_OK
- ESP\_ERR\_WIFI\_NOT\_INIT
- ESP\_ERR\_MESH\_NOT\_ALLOWED

*esp\_err\_t* **esp\_mesh\_disable\_ps** (void)

Disable mesh Power Save function.

**Attention** This API shall be called before mesh is started.

**Returns**

- ESP\_OK
- ESP\_ERR\_WIFI\_NOT\_INIT
- ESP\_ERR\_MESH\_NOT\_ALLOWED

bool **esp\_mesh\_is\_ps\_enabled** (void)

Check whether the mesh Power Save function is enabled.

**Returns** true/false

bool **esp\_mesh\_is\_device\_active** (void)

Check whether the device is in active state.

- If the device is not in active state, it will neither transmit nor receive frames.

**Returns** true/false

*esp\_err\_t* **esp\_mesh\_set\_active\_duty\_cycle** (int dev\_duty, int dev\_duty\_type)

Set the device duty cycle and type.

- The range of dev\_duty values is 1 to 100. The default value is 10.
- dev\_duty = 100, the PS will be stopped.
- dev\_duty is better to not less than 5.
- dev\_duty\_type could be MESH\_PS\_DEVICE\_DUTY\_REQUEST or MESH\_PS\_DEVICE\_DUTY\_DEMAND.
- If dev\_duty\_type is set to MESH\_PS\_DEVICE\_DUTY\_REQUEST, the device will use a nwk\_duty provided by the network.
- If dev\_duty\_type is set to MESH\_PS\_DEVICE\_DUTY\_DEMAND, the device will use the specified dev\_duty.

**Attention** This API can be called at any time after mesh is started.

**Parameters**

- **dev\_duty** –[in] device duty cycle
- **dev\_duty\_type** –[in] device PS duty cycle type, not accept MESH\_PS\_NETWORK\_DUTY\_MASTER

**Returns**

- ESP\_OK
- ESP\_FAIL

*esp\_err\_t* **esp\_mesh\_get\_active\_duty\_cycle** (int \*dev\_duty, int \*dev\_duty\_type)

Get device duty cycle and type.

**Parameters**

- **dev\_duty** –[out] device duty cycle
- **dev\_duty\_type** –[out] device PS duty cycle type

**Returns**

- ESP\_OK

*esp\_err\_t* **esp\_mesh\_set\_network\_duty\_cycle** (int nwk\_duty, int duration\_mins, int applied\_rule)

Set the network duty cycle, duration and rule.

- The range of nwk\_duty values is 1 to 100. The default value is 10.
- nwk\_duty is the network duty cycle the entire network or the up-link path will use. A device that successfully sets the nwk\_duty is known as a NWK-DUTY-MASTER.
- duration\_mins specifies how long the specified nwk\_duty will be used. Once duration\_mins expires, the root will take over as the NWK-DUTY-MASTER. If an existing NWK-DUTY-MASTER leaves the network, the root will take over as the NWK-DUTY-MASTER again.
- duration\_mins = (-1) represents nwk\_duty will be used until a new NWK-DUTY-MASTER with a different nwk\_duty appears.
- Only the root can set duration\_mins to (-1).
- If applied\_rule is set to MESH\_PS\_NETWORK\_DUTY\_APPLIED\_ENTIRE, the nwk\_duty will be used by the entire network.
- If applied\_rule is set to MESH\_PS\_NETWORK\_DUTY\_APPLIED\_UPLINK, the nwk\_duty will only be used by the up-link path nodes.
- The root does not accept MESH\_PS\_NETWORK\_DUTY\_APPLIED\_UPLINK.
- A nwk\_duty with duration\_mins(-1) set by the root is the default network duty cycle used by the entire network.

**Attention** This API can be called at any time after mesh is started.

- In self-organized network, if this API is called before mesh is started in all devices, (1)nwk\_duty shall be set to the same value for all devices; (2)duration\_mins shall be set to (-1); (3)applied\_rule shall be set to MESH\_PS\_NETWORK\_DUTY\_APPLIED\_ENTIRE; after the voted root appears, the root will become the NWK-DUTY-MASTER and broadcast the nwk\_duty and its identity of NWK-DUTY-MASTER.
- If the root is specified (FIXED-ROOT), call this API in the root to provide a default nwk\_duty for the entire network.
- After joins the network, any device can call this API to change the nwk\_duty, duration\_mins or applied\_rule.

#### Parameters

- **nwk\_duty** –[in] network duty cycle
- **duration\_mins** –[in] duration (unit: minutes)
- **applied\_rule** –[in] only support MESH\_PS\_NETWORK\_DUTY\_APPLIED\_ENTIRE

#### Returns

- ESP\_OK
- ESP\_FAIL

*esp\_err\_t* **esp\_mesh\_get\_network\_duty\_cycle** (int \*nwk\_duty, int \*duration\_mins, int \*dev\_duty\_type, int \*applied\_rule)

Get the network duty cycle, duration, type and rule.

#### Parameters

- **nwk\_duty** –[out] current network duty cycle
- **duration\_mins** –[out] the duration of current nwk\_duty
- **dev\_duty\_type** –[out] if it includes MESH\_PS\_DEVICE\_DUTY\_MASTER, this device is the current NWK-DUTY-MASTER.
- **applied\_rule** –[out] MESH\_PS\_NETWORK\_DUTY\_APPLIED\_ENTIRE

#### Returns

- ESP\_OK

int **esp\_mesh\_get\_running\_active\_duty\_cycle** (void)

Get the running active duty cycle.

- The running active duty cycle of the root is 100.
- If duty type is set to `MESH_PS_DEVICE_DUTY_REQUEST`, the running active duty cycle is `nwk_duty` provided by the network.
- If duty type is set to `MESH_PS_DEVICE_DUTY_DEMAND`, the running active duty cycle is `dev_duty` specified by the users.
- In a mesh network, devices are typically working with a certain duty-cycle (transmitting, receiving and sleep) to reduce the power consumption. The running active duty cycle decides the amount of awake time within a beacon interval. At each start of beacon interval, all devices wake up, broadcast beacons, and transmit packets if they do have pending packets for their parents or for their children. Note that Low-duty-cycle means devices may not be active in most of the time, the latency of data transmission might be greater.

**Returns** the running active duty cycle

*esp\_err\_t* **esp\_mesh\_ps\_duty\_signaling** (int fwd\_times)

Duty signaling.

**Parameters** `fwd_times` –[in] the times of forwarding duty signaling packets

**Returns**

- `ESP_OK`

## Unions

union **mesh\_addr\_t**

*#include <esp\_mesh.h>* Mesh address.

### Public Members

`uint8_t` **addr**[6]

mac address

*mip\_t* **mip**

mip address

union **mesh\_event\_info\_t**

*#include <esp\_mesh.h>* Mesh event information.

### Public Members

*mesh\_event\_channel\_switch\_t* **channel\_switch**

channel switch

*mesh\_event\_child\_connected\_t* **child\_connected**

child connected

*mesh\_event\_child\_disconnected\_t* **child\_disconnected**

child disconnected

*mesh\_event\_routing\_table\_change\_t* **routing\_table**

routing table change

*mesh\_event\_connected\_t* **connected**

parent connected

*mesh\_event\_disconnected\_t* **disconnected**

parent disconnected

*mesh\_event\_no\_parent\_found\_t* **no\_parent**

no parent found

*mesh\_event\_layer\_change\_t* **layer\_change**

layer change

*mesh\_event\_toDS\_state\_t* **toDS\_state**

toDS state, devices shall check this state firstly before trying to send packets to external IP network. This state indicates right now whether the root is capable of sending packets out. If not, devices had better to wait until this state changes to be MESH\_TODS\_REACHABLE.

*mesh\_event\_vote\_started\_t* **vote\_started**

vote started

*mesh\_event\_root\_address\_t* **root\_addr**

root address

*mesh\_event\_root\_switch\_req\_t* **switch\_req**

root switch request

*mesh\_event\_root\_conflict\_t* **root\_conflict**

other powerful root

*mesh\_event\_root\_fixed\_t* **root\_fixed**

fixed root

*mesh\_event\_scan\_done\_t* **scan\_done**

scan done

*mesh\_event\_network\_state\_t* **network\_state**

network state, such as whether current mesh network has a root.

*mesh\_event\_find\_network\_t* **find\_network**

network found that can join

*mesh\_event\_router\_switch\_t* **router\_switch**

new router information

*mesh\_event\_ps\_duty\_t* **ps\_duty**

PS duty information

union **mesh\_rc\_config\_t**

*#include <esp\_mesh.h>* Vote address configuration.

### Public Members

int **attempts**

max vote attempts before a new root is elected automatically by mesh network. (min:15, 15 by default)

*mesh\_addr\_t* **rc\_addr**

a new root address specified by users for API esp\_mesh\_waive\_root()

### Structures

struct **mip\_t**

IP address and port.

### Public Members

ip4\_addr\_t **ip4**

IP address

uint16\_t **port**

port

struct **mesh\_event\_channel\_switch\_t**

Channel switch information.

### Public Members

uint8\_t **channel**

new channel

struct **mesh\_event\_connected\_t**

Parent connected information.

### Public Members

*wifi\_event\_sta\_connected\_t* **connected**

parent information, same as Wi-Fi event SYSTEM\_EVENT\_STA\_CONNECTED does

uint16\_t **self\_layer**

layer

uint8\_t **duty**

parent duty

struct **mesh\_event\_no\_parent\_found\_t**

No parent found information.

**Public Members**

int **scan\_times**  
scan times being through

struct **mesh\_event\_layer\_change\_t**  
Layer change information.

**Public Members**

uint16\_t **new\_layer**  
new layer

struct **mesh\_event\_vote\_started\_t**  
vote started information

**Public Members**

int **reason**  
vote reason, vote could be initiated by children or by the root itself

int **attempts**  
max vote attempts before stopped

*mesh\_addr\_t* **rc\_addr**  
root address specified by users via API `esp_mesh_waive_root()`

struct **mesh\_event\_find\_network\_t**  
find a mesh network that this device can join

**Public Members**

uint8\_t **channel**  
channel number of the new found network

uint8\_t **router\_bssid**[6]  
router BSSID

struct **mesh\_event\_root\_switch\_req\_t**  
Root switch request information.

**Public Members**

int **reason**  
root switch reason, generally root switch is initialized by users via API `esp_mesh_waive_root()`



*mesh\_addr\_t* **rc\_addr**

the address of root switch requester

struct **mesh\_event\_root\_conflict\_t**

Other powerful root address.

### **Public Members**

int8\_t **rss\_i**

rss\_i with router

uint16\_t **capacity**

the number of devices in current network

uint8\_t **addr**[6]

other powerful root address

struct **mesh\_event\_routing\_table\_change\_t**

Routing table change.

### **Public Members**

uint16\_t **rt\_size\_new**

the new value

uint16\_t **rt\_size\_change**

the changed value

struct **mesh\_event\_root\_fixed\_t**

Root fixed.

### **Public Members**

bool **is\_fixed**

status

struct **mesh\_event\_scan\_done\_t**

Scan done event information.

### **Public Members**

uint8\_t **number**

the number of APs scanned

struct **mesh\_event\_network\_state\_t**

Network state information.

### Public Members

bool **is\_rootless**

whether current mesh network has a root

struct **mesh\_event\_ps\_duty\_t**

PS duty information.

### Public Members

uint8\_t **duty**

parent or child duty

*mesh\_event\_child\_connected\_t* **child\_connected**

child info

struct **mesh\_opt\_t**

Mesh option.

### Public Members

uint8\_t **type**

option type

uint16\_t **len**

option length

uint8\_t \***val**

option value

struct **mesh\_data\_t**

Mesh data for esp\_mesh\_send() and esp\_mesh\_rcv()

### Public Members

uint8\_t \***data**

data

uint16\_t **size**

data size

*mesh\_proto\_t* **proto**

data protocol

*mesh\_tos\_t* **tos**

data type of service

struct **mesh\_router\_t**  
Router configuration.

### Public Members

uint8\_t **ssid**[32]  
SSID

uint8\_t **ssid\_len**  
length of SSID

uint8\_t **bssid**[6]  
BSSID, if this value is specified, users should also specify “allow\_router\_switch” .

uint8\_t **password**[64]  
password

bool **allow\_router\_switch**  
if the BSSID is specified and this value is also set, when the router of this specified BSSID fails to be found after “fail” (mesh\_attempts\_t) times, the whole network is allowed to switch to another router with the same SSID. The new router might also be on a different channel. The default value is false. There is a risk that if the password is different between the new switched router and the previous one, the mesh network could be established but the root will never connect to the new switched router.

struct **mesh\_ap\_cfg\_t**  
Mesh softAP configuration.

### Public Members

uint8\_t **password**[64]  
mesh softAP password

uint8\_t **max\_connection**  
max number of stations allowed to connect in, default 6, max 10 = max\_connection + non-mesh\_max\_connection max mesh connections

uint8\_t **nonmesh\_max\_connection**  
max non-mesh connections

struct **mesh\_cfg\_t**  
Mesh initialization configuration.

### Public Members

uint8\_t **channel**  
channel, the mesh network on

bool **allow\_channel\_switch**

if this value is set, when “fail” (`mesh_attempts_t`) times is reached, device will change to a full channel scan for a network that could join. The default value is false.

*mesh\_addr\_t* **mesh\_id**

mesh network identification

*mesh\_router\_t* **router**

router configuration

*mesh\_ap\_cfg\_t* **mesh\_ap**

mesh softAP configuration

const *mesh\_crypto\_funcs\_t* \***crypto\_funcs**

crypto functions

struct **mesh\_vote\_t**

Vote.

### Public Members

float **percentage**

vote percentage threshold for approval of being a root

bool **is\_rc\_specified**

if true, `rc_addr` shall be specified (Unimplemented). if false, `attempts` value shall be specified to make network start root election.

*mesh\_rc\_config\_t* **config**

vote address configuration

struct **mesh\_tx\_pending\_t**

The number of packets pending in the queue waiting to be sent by the mesh stack.

### Public Members

int **to\_parent**

to parent queue

int **to\_parent\_p2p**

to parent (P2P) queue

int **to\_child**

to child queue

int **to\_child\_p2p**

to child (P2P) queue

int **mgmt**  
management queue

int **broadcast**  
broadcast and multicast queue

struct **mesh\_rx\_pending\_t**  
The number of packets available in the queue waiting to be received by applications.

### Public Members

int **toDS**  
to external DS

int **toSelf**  
to self

### Macros

**MESH\_ROOT\_LAYER**  
root layer value

**MESH\_MTU**  
max transmit unit(in bytes)

**MESH\_MPS**  
max payload size(in bytes)

**ESP\_ERR\_MESH\_WIFI\_NOT\_START**  
Mesh error code definition.  
Wi-Fi isn't started

**ESP\_ERR\_MESH\_NOT\_INIT**  
mesh isn't initialized

**ESP\_ERR\_MESH\_NOT\_CONFIG**  
mesh isn't configured

**ESP\_ERR\_MESH\_NOT\_START**  
mesh isn't started

**ESP\_ERR\_MESH\_NOT\_SUPPORT**  
not supported yet

**ESP\_ERR\_MESH\_NOT\_ALLOWED**  
operation is not allowed

**ESP\_ERR\_MESH\_NO\_MEMORY**

out of memory

**ESP\_ERR\_MESH\_ARGUMENT**

illegal argument

**ESP\_ERR\_MESH\_EXCEED\_MTU**

packet size exceeds MTU

**ESP\_ERR\_MESH\_TIMEOUT**

timeout

**ESP\_ERR\_MESH\_DISCONNECTED**

disconnected with parent on station interface

**ESP\_ERR\_MESH\_QUEUE\_FAIL**

queue fail

**ESP\_ERR\_MESH\_QUEUE\_FULL**

queue full

**ESP\_ERR\_MESH\_NO\_PARENT\_FOUND**

no parent found to join the mesh network

**ESP\_ERR\_MESH\_NO\_ROUTE\_FOUND**

no route found to forward the packet

**ESP\_ERR\_MESH\_OPTION\_NULL**

no option found

**ESP\_ERR\_MESH\_OPTION\_UNKNOWN**

unknown option

**ESP\_ERR\_MESH\_XON\_NO\_WINDOW**

no window for software flow control on upstream

**ESP\_ERR\_MESH\_INTERFACE**

low-level Wi-Fi interface error

**ESP\_ERR\_MESH\_DISCARD\_DUPLICATE**

discard the packet due to the duplicate sequence number

**ESP\_ERR\_MESH\_DISCARD**

discard the packet

**ESP\_ERR\_MESH\_VOTING**

vote in progress

**ESP\_ERR\_MESH\_XMIT**

XMIT

**ESP\_ERR\_MESH\_QUEUE\_READ**

error in reading queue

**ESP\_ERR\_MESH\_PS**

mesh PS is not specified as enable or disable

**ESP\_ERR\_MESH\_RECV\_RELEASE**

release esp\_mesh\_rcv\_toDS

**MESH\_DATA\_ENC**

Flags bitmap for esp\_mesh\_send() and esp\_mesh\_rcv()

data encrypted (Unimplemented)

**MESH\_DATA\_P2P**

point-to-point delivery over the mesh network

**MESH\_DATA\_FROMDS**

receive from external IP network

**MESH\_DATA\_TODS**

identify this packet is target to external IP network

**MESH\_DATA\_NONBLOCK**

esp\_mesh\_send() non-block

**MESH\_DATA\_DROP**

in the situation of the root having been changed, identify this packet can be dropped by new root

**MESH\_DATA\_GROUP**

identify this packet is target to a group address

**MESH\_OPT\_SEND\_GROUP**

Option definitions for esp\_mesh\_send() and esp\_mesh\_rcv()

data transmission by group; used with esp\_mesh\_send() and shall have payload

**MESH\_OPT\_RECV\_DS\_ADDR**

return a remote IP address; used with esp\_mesh\_send() and esp\_mesh\_rcv()

**MESH\_ASSOC\_FLAG\_VOTE\_IN\_PROGRESS**

Flag of mesh networking IE.

vote in progress

**MESH\_ASSOC\_FLAG\_NETWORK\_FREE**

no root in current network

**MESH\_ASSOC\_FLAG\_STA\_VOTE\_EXPIRE**

the voted address is expired, means the voted device lose the chance to be root

**MESH\_ASSOC\_FLAG\_ROOTS\_FOUND**

roots conflict is found, means that there are at least two roots in the mesh network

**MESH\_ASSOC\_FLAG\_ROOT\_FIXED**

the root is fixed in the mesh network

**MESH\_PS\_DEVICE\_DUTY\_REQUEST**

Mesh PS (Power Save) duty cycle type.

requests to join a network PS without specifying a device duty cycle. After the device joins the network, a network duty cycle will be provided by the network

**MESH\_PS\_DEVICE\_DUTY\_DEMAND**

requests to join a network PS and specifies a demanded device duty cycle

**MESH\_PS\_NETWORK\_DUTY\_MASTER**

indicates the device is the NWK-DUTY-MASTER (network duty cycle master)

**MESH\_PS\_NETWORK\_DUTY\_APPLIED\_ENTIRE**

Mesh PS (Power Save) duty cycle applied rule.

**MESH\_PS\_NETWORK\_DUTY\_APPLIED\_UPLINK****MESH\_INIT\_CONFIG\_DEFAULT ()****Type Definitions**

```
typedef mesh_addr_t mesh_event_root_address_t
```

Root address.

```
typedef wifi_event_sta_disconnected_t mesh_event_disconnected_t
```

Parent disconnected information.

```
typedef wifi_event_ap_staconnected_t mesh_event_child_connected_t
```

Child connected information.

```
typedef wifi_event_ap_stadisconnected_t mesh_event_child_disconnected_t
```

Child disconnected information.

```
typedef wifi_event_sta_connected_t mesh_event_router_switch_t
```

New router information.

**Enumerations**

```
enum mesh_event_id_t
```

Enumerated list of mesh event id.

*Values:*



enumerator **MESH\_EVENT\_STARTED**

mesh is started

enumerator **MESH\_EVENT\_STOPPED**

mesh is stopped

enumerator **MESH\_EVENT\_CHANNEL\_SWITCH**

channel switch

enumerator **MESH\_EVENT\_CHILD\_CONNECTED**

a child is connected on softAP interface

enumerator **MESH\_EVENT\_CHILD\_DISCONNECTED**

a child is disconnected on softAP interface

enumerator **MESH\_EVENT\_ROUTING\_TABLE\_ADD**

routing table is changed by adding newly joined children

enumerator **MESH\_EVENT\_ROUTING\_TABLE\_REMOVE**

routing table is changed by removing leave children

enumerator **MESH\_EVENT\_PARENT\_CONNECTED**

parent is connected on station interface

enumerator **MESH\_EVENT\_PARENT\_DISCONNECTED**

parent is disconnected on station interface

enumerator **MESH\_EVENT\_NO\_PARENT\_FOUND**

no parent found

enumerator **MESH\_EVENT\_LAYER\_CHANGE**

layer changes over the mesh network

enumerator **MESH\_EVENT\_TODS\_STATE**

state represents whether the root is able to access external IP network. This state is a manual event that needs to be triggered with `esp_mesh_post_toDS_state()`.

enumerator **MESH\_EVENT\_VOTE\_STARTED**

the process of voting a new root is started either by children or by the root

enumerator **MESH\_EVENT\_VOTE\_STOPPED**

the process of voting a new root is stopped

enumerator **MESH\_EVENT\_ROOT\_ADDRESS**

the root address is obtained. It is posted by mesh stack automatically.

enumerator **MESH\_EVENT\_ROOT\_SWITCH\_REQ**

root switch request sent from a new voted root candidate

enumerator **MESH\_EVENT\_ROOT\_SWITCH\_ACK**

root switch acknowledgment responds the above request sent from current root

enumerator **MESH\_EVENT\_ROOT\_ASKED\_YIELD**

the root is asked yield by a more powerful existing root. If self organized is disabled and this device is specified to be a root by users, users should set a new parent for this device. if self organized is enabled, this device will find a new parent by itself, users could ignore this event.

enumerator **MESH\_EVENT\_ROOT\_FIXED**

when devices join a network, if the setting of Fixed Root for one device is different from that of its parent, the device will update the setting the same as its parent's. Fixed Root Setting of each device is variable as that setting changes of the root.

enumerator **MESH\_EVENT\_SCAN\_DONE**

if self-organized networking is disabled, user can call `esp_wifi_scan_start()` to trigger this event, and add the corresponding scan done handler in this event.

enumerator **MESH\_EVENT\_NETWORK\_STATE**

network state, such as whether current mesh network has a root.

enumerator **MESH\_EVENT\_STOP\_RECONNECTION**

the root stops reconnecting to the router and non-root devices stop reconnecting to their parents.

enumerator **MESH\_EVENT\_FIND\_NETWORK**

when the channel field in mesh configuration is set to zero, mesh stack will perform a full channel scan to find a mesh network that can join, and return the channel value after finding it.

enumerator **MESH\_EVENT\_ROUTER\_SWITCH**

if users specify BSSID of the router in mesh configuration, when the root connects to another router with the same SSID, this event will be posted and the new router information is attached.

enumerator **MESH\_EVENT\_PS\_PARENT\_DUTY**

parent duty

enumerator **MESH\_EVENT\_PS\_CHILD\_DUTY**

child duty

enumerator **MESH\_EVENT\_PS\_DEVICE\_DUTY**

device duty

enumerator **MESH\_EVENT\_MAX**

enum **mesh\_type\_t**

Device type.

*Values:*

enumerator **MESH\_IDLE**

hasn't joined the mesh network yet

enumerator **MESH\_ROOT**

the only sink of the mesh network. Has the ability to access external IP network

enumerator **MESH\_NODE**

intermediate device. Has the ability to forward packets over the mesh network

enumerator **MESH\_LEAF**

has no forwarding ability

enumerator **MESH\_STA**

connect to router with a standalone Wi-Fi station mode, no network expansion capability

enum **mesh\_proto\_t**

Protocol of transmitted application data.

*Values:*

enumerator **MESH\_PROTO\_BIN**

binary

enumerator **MESH\_PROTO\_HTTP**

HTTP protocol

enumerator **MESH\_PROTO\_JSON**

JSON format

enumerator **MESH\_PROTO\_MQTT**

MQTT protocol

enumerator **MESH\_PROTO\_AP**

IP network mesh communication of node's AP interface

enumerator **MESH\_PROTO\_STA**

IP network mesh communication of node's STA interface

enum **mesh\_tos\_t**

For reliable transmission, mesh stack provides three type of services.

*Values:*

enumerator **MESH\_TOS\_P2P**

provide P2P (point-to-point) retransmission on mesh stack by default

enumerator **MESH\_TOS\_E2E**

provide E2E (end-to-end) retransmission on mesh stack (Unimplemented)

enumerator **MESH\_TOS\_DEF**

no retransmission on mesh stack

enum **mesh\_vote\_reason\_t**

Vote reason.

*Values:*

enumerator **MESH\_VOTE\_REASON\_ROOT\_INITIATED**

vote is initiated by the root

enumerator **MESH\_VOTE\_REASON\_CHILD\_INITIATED**

vote is initiated by children

enum **mesh\_disconnect\_reason\_t**

Mesh disconnect reason code.

*Values:*

enumerator **MESH\_REASON\_CYCLIC**

cyclic is detected

enumerator **MESH\_REASON\_PARENT\_IDLE**

parent is idle

enumerator **MESH\_REASON\_LEAF**

the connected device is changed to a leaf

enumerator **MESH\_REASON\_DIFF\_ID**

in different mesh ID

enumerator **MESH\_REASON\_ROOTS**

root conflict is detected

enumerator **MESH\_REASON\_PARENT\_STOPPED**

parent has stopped the mesh

enumerator **MESH\_REASON\_SCAN\_FAIL**

scan fail

enumerator **MESH\_REASON\_IE\_UNKNOWN**

unknown IE

enumerator **MESH\_REASON\_WAIVE\_ROOT**

waive root

enumerator **MESH\_REASON\_PARENT\_WORSE**

parent with very poor RSSI

enumerator **MESH\_REASON\_EMPTY\_PASSWORD**

use an empty password to connect to an encrypted parent

enumerator **MESH\_REASON\_PARENT\_UNENCRYPTED**

connect to an unencrypted parent/router

enum **esp\_mesh\_topology\_t**

Mesh topology.

*Values:*

enumerator **MESH\_TOPO\_TREE**

tree topology

enumerator **MESH\_TOPO\_CHAIN**

chain topology

enum **mesh\_event\_toDS\_state\_t**

The reachability of the root to a DS (distribute system)

*Values:*

enumerator **MESH\_TODS\_UNREACHABLE**

the root isn't able to access external IP network

enumerator **MESH\_TODS\_REACHABLE**

the root is able to access external IP network

## SmartConfig

The SmartConfig™ is a provisioning technology developed by TI to connect a new Wi-Fi device to a Wi-Fi network. It uses a mobile app to broadcast the network credentials from a smartphone, or a tablet, to an un-provisioned Wi-Fi device.

The advantage of this technology is that the device does not need to directly know SSID or password of an Access Point (AP). This information is provided using the smartphone. This is particularly important to headless device and systems, due to their lack of a user interface.

If you are looking for other options to provision your ESP32-S2 devices, check [Provisioning API](#).

**Application Example** Connect ESP32-S2 to target AP using SmartConfig: [wifi/smart\\_config](#).

## API Reference

### Header File

- [components/esp\\_wifi/include/esp\\_smartconfig.h](#)

### Functions

const char \***esp\_smartconfig\_get\_version** (void)

Get the version of SmartConfig.

#### Returns

- SmartConfig version const char.

*esp\_err\_t* **esp\_smartconfig\_start** (const *smartconfig\_start\_config\_t* \*config)

Start SmartConfig, config ESP device to connect AP. You need to broadcast information by phone APP. Device sniffer special packets from the air that containing SSID and password of target AP.

**Attention** 1. This API can be called in station or softAP-station mode.

**Attention** 2. Can not call `esp_smartconfig_start` twice before it finish, please call `esp_smartconfig_stop` first.

**Parameters** `config` –pointer to smartconfig start configure structure

**Returns**

- ESP\_OK: succeed
- others: fail

*esp\_err\_t* **esp\_smartconfig\_stop** (void)

Stop SmartConfig, free the buffer taken by `esp_smartconfig_start`.

**Attention** Whether connect to AP succeed or not, this API should be called to free memory taken by `smartconfig_start`.

**Returns**

- ESP\_OK: succeed
- others: fail

*esp\_err\_t* **esp\_esptouch\_set\_timeout** (uint8\_t time\_s)

Set timeout of SmartConfig process.

**Attention** Timing starts from SC\_STATUS\_FIND\_CHANNEL status. SmartConfig will restart if timeout.

**Parameters** `time_s` –range 15s~255s, offset:45s.

**Returns**

- ESP\_OK: succeed
- others: fail

*esp\_err\_t* **esp\_smartconfig\_set\_type** (*smartconfig\_type\_t* type)

Set protocol type of SmartConfig.

**Attention** If users need to set the SmartConfig type, please set it before calling `esp_smartconfig_start`.

**Parameters** `type` –Choose from the `smartconfig_type_t`.

**Returns**

- ESP\_OK: succeed
- others: fail

*esp\_err\_t* **esp\_smartconfig\_fast\_mode** (bool enable)

Set mode of SmartConfig. default normal mode.

**Attention** 1. Please call it before API `esp_smartconfig_start`.

**Attention** 2. Fast mode have corresponding APP(phone).

**Attention** 3. Two mode is compatible.

**Parameters** `enable` –false-disable(default); true-enable;

**Returns**

- ESP\_OK: succeed

- others: fail

*esp\_err\_t* **esp\_smartconfig\_get\_rvd\_data** (uint8\_t \*rvd\_data, uint8\_t len)

Get reserved data of ESPTouch v2.

#### Parameters

- **rvd\_data** –reserved data
- **len** –length of reserved data

#### Returns

- ESP\_OK: succeed
- others: fail

## Structures

struct **smartconfig\_event\_got\_ssid\_pswd\_t**

Argument structure for SC\_EVENT\_GOT\_SSID\_PSWD event

### Public Members

uint8\_t **ssid**[32]

SSID of the AP. Null terminated string.

uint8\_t **password**[64]

Password of the AP. Null terminated string.

bool **bssid\_set**

whether set MAC address of target AP or not.

uint8\_t **bssid**[6]

MAC address of target AP.

*smartconfig\_type\_t* **type**

Type of smartconfig(ESPTouch or AirKiss).

uint8\_t **token**

Token from cellphone which is used to send ACK to cellphone.

uint8\_t **cellphone\_ip**[4]

IP address of cellphone.

struct **smartconfig\_start\_config\_t**

Configure structure for esp\_smartconfig\_start

### Public Members

bool **enable\_log**

Enable smartconfig logs.

bool **esp\_touch\_v2\_enable\_crypt**

Enable ESPTouch v2 crypt.

char **\*esp\_touch\_v2\_key**  
ESPTouch v2 crypt key, len should be 16.

### Macros

**SMARTCONFIG\_START\_CONFIG\_DEFAULT** ()

### Enumerations

enum **smartconfig\_type\_t**

*Values:*

enumerator **SC\_TYPE\_ESPTOUCH**  
protocol: ESPTouch

enumerator **SC\_TYPE\_AIRKISS**  
protocol: AirKiss

enumerator **SC\_TYPE\_ESPTOUCH\_AIRKISS**  
protocol: ESPTouch and AirKiss

enumerator **SC\_TYPE\_ESPTOUCH\_V2**  
protocol: ESPTouch v2

enum **smartconfig\_event\_t**

Smartconfig event declarations

*Values:*

enumerator **SC\_EVENT\_SCAN\_DONE**  
ESP32 station smartconfig has finished to scan for APs

enumerator **SC\_EVENT\_FOUND\_CHANNEL**  
ESP32 station smartconfig has found the channel of the target AP

enumerator **SC\_EVENT\_GOT\_SSID\_PSWD**  
ESP32 station smartconfig got the SSID and password

enumerator **SC\_EVENT\_SEND\_ACK\_DONE**  
ESP32 station smartconfig has sent ACK to cellphone

### Wi-Fi

**Introduction** The Wi-Fi libraries provide support for configuring and monitoring the ESP32-S2 Wi-Fi networking functionality. This includes configuration for:

- Station mode (aka STA mode or Wi-Fi client mode). ESP32-S2 connects to an access point.
- AP mode (aka Soft-AP mode or Access Point mode). Stations connect to the ESP32-S2.
- Station/AP-coexistence mode (ESP32-S2 is concurrently an access point and a station connected to another access point).



- Various security modes for the above (WPA, WPA2, WPA3, etc.)
- Scanning for access points (active & passive scanning).
- Promiscuous mode for monitoring of IEEE802.11 Wi-Fi packets.

**Application Examples** The `wifi` directory of ESP-IDF examples contains the following applications:

- Code examples for Wi-Fi.
- A simple `esp-idf-template` application to demonstrate a minimal IDF project structure.

## API Reference

### Header File

- `components/esp_wifi/include/esp_wifi.h`

### Functions

`esp_err_t esp_wifi_init` (const `wifi_init_config_t` \*config)

Initialize WiFi Allocate resource for WiFi driver, such as WiFi control structure, RX/TX buffer, WiFi NVS structure etc. This WiFi also starts WiFi task.

**Attention** 1. This API must be called before all other WiFi API can be called

**Attention** 2. Always use `WIFI_INIT_CONFIG_DEFAULT` macro to initialize the configuration to default values, this can guarantee all the fields get correct value when more fields are added into `wifi_init_config_t` in future release. If you want to set your own initial values, overwrite the default values which are set by `WIFI_INIT_CONFIG_DEFAULT`. Please be notified that the field ‘magic’ of `wifi_init_config_t` should always be `WIFI_INIT_CONFIG_MAGIC`!

**Parameters** `config` –pointer to WiFi initialized configuration structure; can point to a temporary variable.

#### Returns

- `ESP_OK`: succeed
- `ESP_ERR_NO_MEM`: out of memory
- others: refer to error code `esp_err.h`

`esp_err_t esp_wifi_deinit` (void)

Deinit WiFi Free all resource allocated in `esp_wifi_init` and stop WiFi task.

**Attention** 1. This API should be called if you want to remove WiFi driver from the system

#### Returns

- `ESP_OK`: succeed
- `ESP_ERR_WIFI_NOT_INIT`: WiFi is not initialized by `esp_wifi_init`

`esp_err_t esp_wifi_set_mode` (`wifi_mode_t` mode)

Set the WiFi operating mode.

Set the WiFi operating mode **as** station, soft-AP **or** station+soft-AP,  
The default mode **is** station mode.

**Parameters** `mode` –WiFi operating mode

#### Returns

- `ESP_OK`: succeed

- ESP\_ERR\_WIFI\_NOT\_INIT: WiFi is not initialized by esp\_wifi\_init
- ESP\_ERR\_INVALID\_ARG: invalid argument
- others: refer to error code in esp\_err.h

*esp\_err\_t* **esp\_wifi\_get\_mode** (*wifi\_mode\_t* \*mode)

Get current operating mode of WiFi.

**Parameters** mode –[out] store current WiFi mode

**Returns**

- ESP\_OK: succeed
- ESP\_ERR\_WIFI\_NOT\_INIT: WiFi is not initialized by esp\_wifi\_init
- ESP\_ERR\_INVALID\_ARG: invalid argument

*esp\_err\_t* **esp\_wifi\_start** (void)

Start WiFi according to current configuration. If mode is WIFI\_MODE\_STA, it creates station control block and starts station. If mode is WIFI\_MODE\_AP, it creates soft-AP control block and starts soft-AP. If mode is WIFI\_MODE\_APSTA, it creates soft-AP and station control block and starts soft-AP and station.

**Returns**

- ESP\_OK: succeed
- ESP\_ERR\_WIFI\_NOT\_INIT: WiFi is not initialized by esp\_wifi\_init
- ESP\_ERR\_INVALID\_ARG: invalid argument
- ESP\_ERR\_NO\_MEM: out of memory
- ESP\_ERR\_WIFI\_CONN: WiFi internal error, station or soft-AP control block wrong
- ESP\_FAIL: other WiFi internal errors

*esp\_err\_t* **esp\_wifi\_stop** (void)

Stop WiFi. If mode is WIFI\_MODE\_STA, it stops station and frees station control block. If mode is WIFI\_MODE\_AP, it stops soft-AP and frees soft-AP control block. If mode is WIFI\_MODE\_APSTA, it stops station/soft-AP and frees station/soft-AP control block.

**Returns**

- ESP\_OK: succeed
- ESP\_ERR\_WIFI\_NOT\_INIT: WiFi is not initialized by esp\_wifi\_init

*esp\_err\_t* **esp\_wifi\_restore** (void)

Restore WiFi stack persistent settings to default values.

This function will reset settings made using the following APIs:

- esp\_wifi\_set\_bandwidth,
- esp\_wifi\_set\_protocol,
- esp\_wifi\_set\_config related
- esp\_wifi\_set\_mode

**Returns**

- ESP\_OK: succeed
- ESP\_ERR\_WIFI\_NOT\_INIT: WiFi is not initialized by esp\_wifi\_init

*esp\_err\_t* **esp\_wifi\_connect** (void)

Connect the ESP32 WiFi station to the AP.

**Attention** 1. This API only impacts WIFI\_MODE\_STA or WIFI\_MODE\_APSTA mode.

**Attention** 2. If the ESP32 is connected to an AP, call esp\_wifi\_disconnect to disconnect.

**Attention** 3. The scanning triggered by esp\_wifi\_scan\_start() will not be effective until connection between ESP32 and the AP is established. If ESP32 is scanning and connecting at the same time, ESP32 will abort scanning and return a warning message and error number ESP\_ERR\_WIFI\_STATE.

**Attention** 4. This API attempts to connect to an Access Point (AP) only once. To enable reconnection in case of a connection failure, please use the 'failure\_retry\_cnt' feature in the '*wifi\_sta\_config\_t*'. Users

are suggested to implement reconnection logic in their application for scenarios where the specified AP does not exist, or reconnection is desired after the device has received a disconnect event.

**Returns**

- ESP\_OK: succeed
- ESP\_ERR\_WIFI\_NOT\_INIT: WiFi is not initialized by esp\_wifi\_init
- ESP\_ERR\_WIFI\_NOT\_STARTED: WiFi is not started by esp\_wifi\_start
- ESP\_ERR\_WIFI\_MODE: WiFi mode error
- ESP\_ERR\_WIFI\_CONN: WiFi internal error, station or soft-AP control block wrong
- ESP\_ERR\_WIFI\_SSID: SSID of AP which station connects is invalid

*esp\_err\_t* esp\_wifi\_disconnect (void)

Disconnect the ESP32 WiFi station from the AP.

**Returns**

- ESP\_OK: succeed
- ESP\_ERR\_WIFI\_NOT\_INIT: WiFi was not initialized by esp\_wifi\_init
- ESP\_ERR\_WIFI\_NOT\_STARTED: WiFi was not started by esp\_wifi\_start
- ESP\_FAIL: other WiFi internal errors

*esp\_err\_t* esp\_wifi\_clear\_fast\_connect (void)

Currently this API is just an stub API.

**Returns**

- ESP\_OK: succeed
- others: fail

*esp\_err\_t* esp\_wifi\_deauth\_sta (uint16\_t aid)

deauthenticate all stations or associated id equals to aid

**Parameters** **aid** –when aid is 0, deauthenticate all stations, otherwise deauthenticate station whose associated id is aid

**Returns**

- ESP\_OK: succeed
- ESP\_ERR\_WIFI\_NOT\_INIT: WiFi is not initialized by esp\_wifi\_init
- ESP\_ERR\_WIFI\_NOT\_STARTED: WiFi was not started by esp\_wifi\_start
- ESP\_ERR\_INVALID\_ARG: invalid argument
- ESP\_ERR\_WIFI\_MODE: WiFi mode is wrong

*esp\_err\_t* esp\_wifi\_scan\_start (const *wifi\_scan\_config\_t* \*config, bool block)

Scan all available APs.

**Attention** If this API is called, the found APs are stored in WiFi driver dynamic allocated memory. And then can be freed in esp\_wifi\_scan\_get\_ap\_records(), esp\_wifi\_scan\_get\_ap\_record() or esp\_wifi\_clear\_ap\_list(), so call any one to free the memory once the scan is done.

**Attention** The values of maximum active scan time and passive scan time per channel are limited to 1500 milliseconds. Values above 1500ms may cause station to disconnect from AP and are not recommended.

**Parameters**

- **config** –configuration settings for scanning, if set to NULL default settings will be used of which default values are show\_hidden:false, scan\_type:active, scan\_time.active.min:0, scan\_time.active.max:120 miliseconds, scan\_time.passive:360 miliseconds
- **block** –if block is true, this API will block the caller until the scan is done, otherwise it will return immediately

**Returns**

- ESP\_OK: succeed
- ESP\_ERR\_WIFI\_NOT\_INIT: WiFi is not initialized by esp\_wifi\_init
- ESP\_ERR\_WIFI\_NOT\_STARTED: WiFi was not started by esp\_wifi\_start
- ESP\_ERR\_WIFI\_TIMEOUT: blocking scan is timeout

- ESP\_ERR\_WIFI\_STATE: wifi still connecting when invoke esp\_wifi\_scan\_start
- others: refer to error code in esp\_err.h

*esp\_err\_t* **esp\_wifi\_scan\_stop** (void)

Stop the scan in process.

**Returns**

- ESP\_OK: succeed
- ESP\_ERR\_WIFI\_NOT\_INIT: WiFi is not initialized by esp\_wifi\_init
- ESP\_ERR\_WIFI\_NOT\_STARTED: WiFi is not started by esp\_wifi\_start

*esp\_err\_t* **esp\_wifi\_scan\_get\_ap\_num** (uint16\_t \*number)

Get number of APs found in last scan.

**Attention** This API can only be called when the scan is completed, otherwise it may get wrong value.

**Parameters** **number** –[out] store number of APs found in last scan

**Returns**

- ESP\_OK: succeed
- ESP\_ERR\_WIFI\_NOT\_INIT: WiFi is not initialized by esp\_wifi\_init
- ESP\_ERR\_WIFI\_NOT\_STARTED: WiFi is not started by esp\_wifi\_start
- ESP\_ERR\_INVALID\_ARG: invalid argument

*esp\_err\_t* **esp\_wifi\_scan\_get\_ap\_records** (uint16\_t \*number, *wifi\_ap\_record\_t* \*ap\_records)

Get AP list found in last scan.

**Attention** This API will free all memory occupied by scanned AP list.

**Parameters**

- **number** –[inout] As input param, it stores max AP number ap\_records can hold. As output param, it receives the actual AP number this API returns.
- **ap\_records** –*wifi\_ap\_record\_t* array to hold the found APs

**Returns**

- ESP\_OK: succeed
- ESP\_ERR\_WIFI\_NOT\_INIT: WiFi is not initialized by esp\_wifi\_init
- ESP\_ERR\_WIFI\_NOT\_STARTED: WiFi is not started by esp\_wifi\_start
- ESP\_ERR\_INVALID\_ARG: invalid argument
- ESP\_ERR\_NO\_MEM: out of memory

*esp\_err\_t* **esp\_wifi\_scan\_get\_ap\_record** (*wifi\_ap\_record\_t* \*ap\_record)

Get one AP record from the scanned AP list.

**Attention** Different from esp\_wifi\_scan\_get\_ap\_records(), this API only gets one AP record from the scanned AP list each time. This API will free the memory of one AP record, if the user doesn't get all records in the scanned AP list, then needs to call esp\_wifi\_clear\_ap\_list() to free the remaining memory.

**Parameters** **ap\_record** –[out] pointer to one AP record

**Returns**

- ESP\_OK: succeed
- ESP\_ERR\_WIFI\_NOT\_INIT: WiFi is not initialized by esp\_wifi\_init
- ESP\_ERR\_WIFI\_NOT\_STARTED: WiFi is not started by esp\_wifi\_start
- ESP\_ERR\_INVALID\_ARG: invalid argument
- ESP\_FAIL: scan APs is NULL, means all AP records fetched or no AP found

*esp\_err\_t* **esp\_wifi\_clear\_ap\_list** (void)

Clear AP list found in last scan.

**Attention** This API will free all memory occupied by scanned AP list. When the obtained AP list fails, AP records must be cleared, otherwise it may cause memory leakage.

**Returns**

- ESP\_OK: succeed
- ESP\_ERR\_WIFI\_NOT\_INIT: WiFi is not initialized by esp\_wifi\_init
- ESP\_ERR\_WIFI\_NOT\_STARTED: WiFi is not started by esp\_wifi\_start
- ESP\_ERR\_WIFI\_MODE: WiFi mode is wrong
- ESP\_ERR\_INVALID\_ARG: invalid argument

*esp\_err\_t* **esp\_wifi\_sta\_get\_ap\_info** (*wifi\_ap\_record\_t* \*ap\_info)

Get information of AP which the ESP32 station is associated with.

**Attention** When the obtained country information is empty, it means that the AP does not carry country information

**Parameters** **ap\_info** –the *wifi\_ap\_record\_t* to hold AP information sta can get the connected ap's phy mode info through the struct member phy\_11b, phy\_11g, phy\_11n, phy\_lr in the *wifi\_ap\_record\_t* struct. For example, phy\_11b = 1 imply that ap support 802.11b mode

**Returns**

- ESP\_OK: succeed
- ESP\_ERR\_WIFI\_CONN: The station interface don't initialized
- ESP\_ERR\_WIFI\_NOT\_CONNECT: The station is in disconnect status

*esp\_err\_t* **esp\_wifi\_set\_ps** (*wifi\_ps\_type\_t* type)

Set current WiFi power save type.

**Attention** Default power save type is WIFI\_PS\_MIN\_MODEM.

**Parameters** **type** –power save type

**Returns** ESP\_OK: succeed

*esp\_err\_t* **esp\_wifi\_get\_ps** (*wifi\_ps\_type\_t* \*type)

Get current WiFi power save type.

**Attention** Default power save type is WIFI\_PS\_MIN\_MODEM.

**Parameters** **type** –[out] store current power save type

**Returns** ESP\_OK: succeed

*esp\_err\_t* **esp\_wifi\_set\_protocol** (*wifi\_interface\_t* ifx, uint8\_t protocol\_bitmap)

Set protocol type of specified interface The default protocol is (WIFI\_PROTOCOL\_11B|WIFI\_PROTOCOL\_11G|WIFI\_PROTOCOL\_11N|WIFI\_PROTOCOL\_LR)

**Attention** Support 802.11b or 802.11bg or 802.11bgn or LR mode

**Parameters**

- **ifx** –interfaces
- **protocol\_bitmap** –WiFi protocol bitmap

**Returns**

- ESP\_OK: succeed
- ESP\_ERR\_WIFI\_NOT\_INIT: WiFi is not initialized by esp\_wifi\_init
- ESP\_ERR\_WIFI\_IF: invalid interface
- others: refer to error codes in esp\_err.h

*esp\_err\_t* **esp\_wifi\_get\_protocol** (*wifi\_interface\_t* ifx, uint8\_t \*protocol\_bitmap)

Get the current protocol bitmap of the specified interface.

**Parameters**

- **ifx** –interface
- **protocol\_bitmap** –[out] store current WiFi protocol bitmap of interface ifx

**Returns**

- ESP\_OK: succeed
- ESP\_ERR\_WIFI\_NOT\_INIT: WiFi is not initialized by esp\_wifi\_init
- ESP\_ERR\_WIFI\_IF: invalid interface
- ESP\_ERR\_INVALID\_ARG: invalid argument
- others: refer to error codes in esp\_err.h

*esp\_err\_t* **esp\_wifi\_set\_bandwidth** (*wifi\_interface\_t* ifx, *wifi\_bandwidth\_t* bw)

Set the bandwidth of ESP32 specified interface.

**Attention** 1. API return false if try to configure an interface that is not enabled

**Attention** 2. WIFI\_BW\_HT40 is supported only when the interface support 11N

**Parameters**

- **ifx** –interface to be configured
- **bw** –bandwidth

**Returns**

- ESP\_OK: succeed
- ESP\_ERR\_WIFI\_NOT\_INIT: WiFi is not initialized by esp\_wifi\_init
- ESP\_ERR\_WIFI\_IF: invalid interface
- ESP\_ERR\_INVALID\_ARG: invalid argument
- others: refer to error codes in esp\_err.h

*esp\_err\_t* **esp\_wifi\_get\_bandwidth** (*wifi\_interface\_t* ifx, *wifi\_bandwidth\_t* \*bw)

Get the bandwidth of ESP32 specified interface.

**Attention** 1. API return false if try to get a interface that is not enable

**Parameters**

- **ifx** –interface to be configured
- **bw** –[out] store bandwidth of interface ifx

**Returns**

- ESP\_OK: succeed
- ESP\_ERR\_WIFI\_NOT\_INIT: WiFi is not initialized by esp\_wifi\_init
- ESP\_ERR\_WIFI\_IF: invalid interface
- ESP\_ERR\_INVALID\_ARG: invalid argument

*esp\_err\_t* **esp\_wifi\_set\_channel** (uint8\_t primary, *wifi\_second\_chan\_t* second)

Set primary/secondary channel of ESP32.

**Attention** 1. This API should be called after esp\_wifi\_start() and before esp\_wifi\_stop()

**Attention** 2. When ESP32 is in STA mode, this API should not be called when STA is scanning or connecting to an external AP

**Attention** 3. When ESP32 is in softAP mode, this API should not be called when softAP has connected to external STAs

**Attention** 4. When ESP32 is in STA+softAP mode, this API should not be called when in the scenarios described above

**Attention** 5. The channel info set by this API will not be stored in NVS. So If you want to remember the channel used before wifi stop, you need to call this API again after wifi start, or you can call `esp_wifi_set_config()` to store the channel info in NVS.

#### Parameters

- **primary** –for HT20, primary is the channel number, for HT40, primary is the primary channel
- **second** –for HT20, second is ignored, for HT40, second is the second channel

#### Returns

- ESP\_OK: succeed
- ESP\_ERR\_WIFI\_NOT\_INIT: WiFi is not initialized by `esp_wifi_init`
- ESP\_ERR\_WIFI\_IF: invalid interface
- ESP\_ERR\_INVALID\_ARG: invalid argument
- ESP\_ERR\_WIFI\_NOT\_STARTED: WiFi is not started by `esp_wifi_start`

`esp_err_t esp_wifi_get_channel` (uint8\_t \*primary, *wifi\_second\_chan\_t* \*second)

Get the primary/secondary channel of ESP32.

**Attention** 1. API return false if try to get a interface that is not enable

#### Parameters

- **primary** –store current primary channel
- **second** –[out] store current second channel

#### Returns

- ESP\_OK: succeed
- ESP\_ERR\_WIFI\_NOT\_INIT: WiFi is not initialized by `esp_wifi_init`
- ESP\_ERR\_INVALID\_ARG: invalid argument

`esp_err_t esp_wifi_set_country` (const *wifi\_country\_t* \*country)

configure country info

**Attention** 1. It is discouraged to call this API since this doesn't validate the per-country rules, it's up to the user to fill in all fields according to local regulations. Please use `esp_wifi_set_country_code` instead.

**Attention** 2. The default country is "01" (world safe mode) {.cc="01", .schan=1, .nchan=11, .policy=WIFI\_COUNTRY\_POLICY\_AUTO}.

**Attention** 3. The third octet of country code string is one of the following: ' ', 'O', 'I', 'X', otherwise it is considered as ' '.

**Attention** 4. When the country policy is WIFI\_COUNTRY\_POLICY\_AUTO, the country info of the AP to which the station is connected is used. E.g. if the configured country info is {.cc="US", .schan=1, .nchan=11} and the country info of the AP to which the station is connected is {.cc="JP", .schan=1, .nchan=14} then the country info that will be used is {.cc="JP", .schan=1, .nchan=14}. If the station disconnected from the AP the country info is set back to the country info of the station automatically, {.cc="US", .schan=1, .nchan=11} in the example.

**Attention** 5. When the country policy is WIFI\_COUNTRY\_POLICY\_MANUAL, then the configured country info is used always.

**Attention** 6. When the country info is changed because of configuration or because the station connects to a different external AP, the country IE in probe response/beacon of the soft-AP is also changed.

**Attention** 7. The country configuration is stored into flash.

**Attention** 8. When this API is called, the PHY init data will switch to the PHY init data type corresponding to the country info.

**Parameters** **country** –the configured country info

**Returns**

- ESP\_OK: succeed
- ESP\_ERR\_WIFI\_NOT\_INIT: WiFi is not initialized by esp\_wifi\_init
- ESP\_ERR\_INVALID\_ARG: invalid argument

*esp\_err\_t* **esp\_wifi\_get\_country** (*wifi\_country\_t* \*country)

get the current country info

**Parameters** **country** –country info

**Returns**

- ESP\_OK: succeed
- ESP\_ERR\_WIFI\_NOT\_INIT: WiFi is not initialized by esp\_wifi\_init
- ESP\_ERR\_INVALID\_ARG: invalid argument

*esp\_err\_t* **esp\_wifi\_set\_mac** (*wifi\_interface\_t* ifx, const uint8\_t mac[6])

Set MAC address of the ESP32 WiFi station or the soft-AP interface.

**Attention** 1. This API can only be called when the interface is disabled

**Attention** 2. ESP32 soft-AP and station have different MAC addresses, do not set them to be the same.

**Attention** 3. The bit 0 of the first byte of ESP32 MAC address can not be 1. For example, the MAC address can set to be “1a:XX:XX:XX:XX:XX” , but can not be “15:XX:XX:XX:XX:XX” .

**Parameters**

- **ifx** –interface
- **mac** –the MAC address

**Returns**

- ESP\_OK: succeed
- ESP\_ERR\_WIFI\_NOT\_INIT: WiFi is not initialized by esp\_wifi\_init
- ESP\_ERR\_INVALID\_ARG: invalid argument
- ESP\_ERR\_WIFI\_IF: invalid interface
- ESP\_ERR\_WIFI\_MAC: invalid mac address
- ESP\_ERR\_WIFI\_MODE: WiFi mode is wrong
- others: refer to error codes in esp\_err.h

*esp\_err\_t* **esp\_wifi\_get\_mac** (*wifi\_interface\_t* ifx, uint8\_t mac[6])

Get mac of specified interface.

**Parameters**

- **ifx** –interface
- **mac** –[out] store mac of the interface ifx

**Returns**

- ESP\_OK: succeed
- ESP\_ERR\_WIFI\_NOT\_INIT: WiFi is not initialized by esp\_wifi\_init
- ESP\_ERR\_INVALID\_ARG: invalid argument
- ESP\_ERR\_WIFI\_IF: invalid interface

*esp\_err\_t* **esp\_wifi\_set\_promiscuous\_rx\_cb** (*wifi\_promiscuous\_cb\_t* cb)

Register the RX callback function in the promiscuous mode.

Each time a packet is received, the registered callback function will be called.

**Parameters** **cb** –callback

**Returns**

- ESP\_OK: succeed
- ESP\_ERR\_WIFI\_NOT\_INIT: WiFi is not initialized by esp\_wifi\_init

*esp\_err\_t* **esp\_wifi\_set\_promiscuous** (bool en)

Enable the promiscuous mode.

**Parameters** **en** –false - disable, true - enable



**Returns**

- ESP\_OK: succeed
- ESP\_ERR\_WIFI\_NOT\_INIT: WiFi is not initialized by esp\_wifi\_init

*esp\_err\_t* **esp\_wifi\_get\_promiscuous** (bool \*en)

Get the promiscuous mode.

**Parameters** en –[out] store the current status of promiscuous mode

**Returns**

- ESP\_OK: succeed
- ESP\_ERR\_WIFI\_NOT\_INIT: WiFi is not initialized by esp\_wifi\_init
- ESP\_ERR\_INVALID\_ARG: invalid argument

*esp\_err\_t* **esp\_wifi\_set\_promiscuous\_filter** (const *wifi\_promiscuous\_filter\_t* \*filter)

Enable the promiscuous mode packet type filter.

---

**Note:** The default filter is to filter all packets except WIFI\_PKT\_MISC

---

**Parameters** filter –the packet type filtered in promiscuous mode.

**Returns**

- ESP\_OK: succeed
- ESP\_ERR\_WIFI\_NOT\_INIT: WiFi is not initialized by esp\_wifi\_init

*esp\_err\_t* **esp\_wifi\_get\_promiscuous\_filter** (*wifi\_promiscuous\_filter\_t* \*filter)

Get the promiscuous filter.

**Parameters** filter –[out] store the current status of promiscuous filter

**Returns**

- ESP\_OK: succeed
- ESP\_ERR\_WIFI\_NOT\_INIT: WiFi is not initialized by esp\_wifi\_init
- ESP\_ERR\_INVALID\_ARG: invalid argument

*esp\_err\_t* **esp\_wifi\_set\_promiscuous\_ctrl\_filter** (const *wifi\_promiscuous\_filter\_t* \*filter)

Enable subtype filter of the control packet in promiscuous mode.

---

**Note:** The default filter is to filter none control packet.

---

**Parameters** filter –the subtype of the control packet filtered in promiscuous mode.

**Returns**

- ESP\_OK: succeed
- ESP\_ERR\_WIFI\_NOT\_INIT: WiFi is not initialized by esp\_wifi\_init

*esp\_err\_t* **esp\_wifi\_get\_promiscuous\_ctrl\_filter** (*wifi\_promiscuous\_filter\_t* \*filter)

Get the subtype filter of the control packet in promiscuous mode.

**Parameters** filter –[out] store the current status of subtype filter of the control packet in promiscuous mode

**Returns**

- ESP\_OK: succeed
- ESP\_ERR\_WIFI\_NOT\_INIT: WiFi is not initialized by esp\_wifi\_init
- ESP\_ERR\_INVALID\_ARG: invalid argument

*esp\_err\_t* **esp\_wifi\_set\_config** (*wifi\_interface\_t* interface, *wifi\_config\_t* \*conf)

Set the configuration of the ESP32 STA or AP.

**Attention** 1. This API can be called only when specified interface is enabled, otherwise, API fail

**Attention** 2. For station configuration, `ssid_set` needs to be 0; and it needs to be 1 only when users need to check the MAC address of the AP.

**Attention** 3. ESP32 is limited to only one channel, so when in the soft-AP+station mode, the soft-AP will adjust its channel automatically to be the same as the channel of the ESP32 station.

**Attention** 4. The configuration will be stored in NVS

#### Parameters

- **interface** –interface
- **conf** –station or soft-AP configuration

#### Returns

- ESP\_OK: succeed
- ESP\_ERR\_WIFI\_NOT\_INIT: WiFi is not initialized by `esp_wifi_init`
- ESP\_ERR\_INVALID\_ARG: invalid argument
- ESP\_ERR\_WIFI\_IF: invalid interface
- ESP\_ERR\_WIFI\_MODE: invalid mode
- ESP\_ERR\_WIFI\_PASSWORD: invalid password
- ESP\_ERR\_WIFI\_NVS: WiFi internal NVS error
- others: refer to the error code in `esp_err.h`

`esp_err_t esp_wifi_get_config (wifi_interface_t interface, wifi_config_t *conf)`

Get configuration of specified interface.

#### Parameters

- **interface** –interface
- **conf** –[out] station or soft-AP configuration

#### Returns

- ESP\_OK: succeed
- ESP\_ERR\_WIFI\_NOT\_INIT: WiFi is not initialized by `esp_wifi_init`
- ESP\_ERR\_INVALID\_ARG: invalid argument
- ESP\_ERR\_WIFI\_IF: invalid interface

`esp_err_t esp_wifi_ap_get_sta_list (wifi_sta_list_t *sta)`

Get STAs associated with soft-AP.

**Attention** SSC only API

**Parameters** **sta** –[out] station list ap can get the connected sta's phy mode info through the struct member `phy_11b`, `phy_11g`, `phy_11n`, `phy_lr` in the `wifi_sta_info_t` struct. For example, `phy_11b = 1` imply that sta support 802.11b mode

#### Returns

- ESP\_OK: succeed
- ESP\_ERR\_WIFI\_NOT\_INIT: WiFi is not initialized by `esp_wifi_init`
- ESP\_ERR\_INVALID\_ARG: invalid argument
- ESP\_ERR\_WIFI\_MODE: WiFi mode is wrong
- ESP\_ERR\_WIFI\_CONN: WiFi internal error, the station/soft-AP control block is invalid

`esp_err_t esp_wifi_ap_get_sta_aid (const uint8_t mac[6], uint16_t *aid)`

Get AID of STA connected with soft-AP.

#### Parameters

- **mac** –STA's mac address
- **aid** –[out] Store the AID corresponding to STA mac

#### Returns

- ESP\_OK: succeed
- ESP\_ERR\_WIFI\_NOT\_INIT: WiFi is not initialized by `esp_wifi_init`
- ESP\_ERR\_INVALID\_ARG: invalid argument
- ESP\_ERR\_NOT\_FOUND: Requested resource not found
- ESP\_ERR\_WIFI\_MODE: WiFi mode is wrong

- `ESP_ERR_WIFI_CONN`: WiFi internal error, the station/soft-AP control block is invalid

`esp_err_t esp_wifi_set_storage` (*wifi\_storage\_t* storage)

Set the WiFi API configuration storage type.

**Attention** 1. The default value is `WIFI_STORAGE_FLASH`

**Parameters** `storage` –: storage type

**Returns**

- `ESP_OK`: succeed
- `ESP_ERR_WIFI_NOT_INIT`: WiFi is not initialized by `esp_wifi_init`
- `ESP_ERR_INVALID_ARG`: invalid argument

`esp_err_t esp_wifi_set_vendor_ie` (bool enable, *wifi\_vendor\_ie\_type\_t* type, *wifi\_vendor\_ie\_id\_t* idx, const void \*vnd\_ie)

Set 802.11 Vendor-Specific Information Element.

**Parameters**

- **enable** –If true, specified IE is enabled. If false, specified IE is removed.
- **type** –Information Element type. Determines the frame type to associate with the IE.
- **idx** –Index to set or clear. Each IE type can be associated with up to two elements (indices 0 & 1).
- **vnd\_ie** –Pointer to vendor specific element data. First 6 bytes should be a header with fields matching *vendor\_ie\_data\_t*. If enable is false, this argument is ignored and can be NULL. Data does not need to remain valid after the function returns.

**Returns**

- `ESP_OK`: succeed
- `ESP_ERR_WIFI_NOT_INIT`: WiFi is not initialized by `esp_wifi_init()`
- `ESP_ERR_INVALID_ARG`: Invalid argument, including if first byte of `vnd_ie` is not `WIFI_VENDOR_IE_ELEMENT_ID` (0xDD) or second byte is an invalid length.
- `ESP_ERR_NO_MEM`: Out of memory

`esp_err_t esp_wifi_set_vendor_ie_cb` (*esp\_vendor\_ie\_cb\_t* cb, void \*ctx)

Register Vendor-Specific Information Element monitoring callback.

**Parameters**

- **cb** –Callback function
- **ctx** –Context argument, passed to callback function.

**Returns**

- `ESP_OK`: succeed
- `ESP_ERR_WIFI_NOT_INIT`: WiFi is not initialized by `esp_wifi_init`

`esp_err_t esp_wifi_set_max_tx_power` (int8\_t power)

Set maximum transmitting power after WiFi start.

**Attention** 1. Maximum power before wifi startup is limited by PHY init data bin.

**Attention** 2. The value set by this API will be mapped to the `max_tx_power` of the structure *wifi\_country\_t* variable.

**Attention** 3. Mapping Table {Power, max\_tx\_power} = {{8, 2}, {20, 5}, {28, 7}, {34, 8}, {44, 11}, {52, 13}, {56, 14}, {60, 15}, {66, 16}, {72, 18}, {80, 20}}.

**Attention** 4. Param power unit is 0.25dBm, range is [8, 84] corresponding to 2dBm - 20dBm.

**Attention** 5. Relationship between set value and actual value. As follows: {set value range, actual value} = {{[8, 19],8}, {[20, 27],20}, {[28, 33],28}, {[34, 43],34}, {[44, 51],44}, {[52, 55],52}, {[56, 59],56}, {[60, 65],60}, {[66, 71],66}, {[72, 79],72}, {[80, 84],80}}.

**Parameters** `power` –Maximum WiFi transmitting power.

**Returns**

- `ESP_OK`: succeed

- `ESP_ERR_WIFI_NOT_INIT`: WiFi is not initialized by `esp_wifi_init`
- `ESP_ERR_WIFI_NOT_STARTED`: WiFi is not started by `esp_wifi_start`
- `ESP_ERR_INVALID_ARG`: invalid argument, e.g. parameter is out of range

*esp\_err\_t* `esp_wifi_get_max_tx_power` (`int8_t *power`)

Get maximum transmitting power after WiFi start.

**Parameters** `power` –Maximum WiFi transmitting power, unit is 0.25dBm.

**Returns**

- `ESP_OK`: succeed
- `ESP_ERR_WIFI_NOT_INIT`: WiFi is not initialized by `esp_wifi_init`
- `ESP_ERR_WIFI_NOT_STARTED`: WiFi is not started by `esp_wifi_start`
- `ESP_ERR_INVALID_ARG`: invalid argument

*esp\_err\_t* `esp_wifi_set_event_mask` (`uint32_t mask`)

Set mask to enable or disable some WiFi events.

**Attention** 1. Mask can be created by logical OR of various `WIFI_EVENT_MASK_` constants. Events which have corresponding bit set in the mask will not be delivered to the system event handler.

**Attention** 2. Default WiFi event mask is `WIFI_EVENT_MASK_AP_PROBEREQRCVD`.

**Attention** 3. There may be lots of stations sending probe request data around. Don't unmask this event unless you need to receive probe request data.

**Parameters** `mask` –WiFi event mask.

**Returns**

- `ESP_OK`: succeed
- `ESP_ERR_WIFI_NOT_INIT`: WiFi is not initialized by `esp_wifi_init`

*esp\_err\_t* `esp_wifi_get_event_mask` (`uint32_t *mask`)

Get mask of WiFi events.

**Parameters** `mask` –WiFi event mask.

**Returns**

- `ESP_OK`: succeed
- `ESP_ERR_WIFI_NOT_INIT`: WiFi is not initialized by `esp_wifi_init`
- `ESP_ERR_INVALID_ARG`: invalid argument

*esp\_err\_t* `esp_wifi_80211_tx` (`wifi_interface_t ifx`, `const void *buffer`, `int len`, `bool en_sys_seq`)

Send raw ieee80211 data.

**Attention** Currently only support for sending beacon/probe request/probe response/action and non-QoS data frame

**Parameters**

- `ifx` –interface if the Wi-Fi mode is Station, the `ifx` should be `WIFI_IF_STA`. If the Wi-Fi mode is SoftAP, the `ifx` should be `WIFI_IF_AP`. If the Wi-Fi mode is Station+SoftAP, the `ifx` should be `WIFI_IF_STA` or `WIFI_IF_AP`. If the `ifx` is wrong, the API returns `ESP_ERR_WIFI_IF`.
- `buffer` –raw ieee80211 buffer
- `len` –the length of raw buffer, the `len` must be `<= 1500` Bytes and `>= 24` Bytes
- `en_sys_seq` –indicate whether use the internal sequence number. If `en_sys_seq` is false, the sequence in raw buffer is unchanged, otherwise it will be overwritten by WiFi driver with the system sequence number. Generally, if `esp_wifi_80211_tx` is called before the Wi-Fi connection has been set up, both `en_sys_seq==true` and `en_sys_seq==false` are fine. However, if the API is called after the Wi-Fi connection has been set up, `en_sys_seq` must be true, otherwise `ESP_ERR_INVALID_ARG` is returned.

**Returns**

- ESP\_OK: success
- ESP\_ERR\_WIFI\_IF: Invalid interface
- ESP\_ERR\_INVALID\_ARG: Invalid parameter
- ESP\_ERR\_WIFI\_NO\_MEM: out of memory

*esp\_err\_t* **esp\_wifi\_set\_csi\_rx\_cb** (*wifi\_csi\_cb\_t* cb, void \*ctx)

Register the RX callback function of CSI data.

Each time a CSI data **is** received, the callback function will be called.

#### Parameters

- **cb** –callback
- **ctx** –context argument, passed to callback function

#### Returns

- ESP\_OK: succeed
- ESP\_ERR\_WIFI\_NOT\_INIT: WiFi is not initialized by esp\_wifi\_init

*esp\_err\_t* **esp\_wifi\_set\_csi\_config** (const *wifi\_csi\_config\_t* \*config)

Set CSI data configuration.

return

- ESP\_OK: succeed
- ESP\_ERR\_WIFI\_NOT\_INIT: WiFi is not initialized by esp\_wifi\_init
- ESP\_ERR\_WIFI\_NOT\_STARTED: WiFi is not started by esp\_wifi\_start or promiscuous mode is not enabled
- ESP\_ERR\_INVALID\_ARG: invalid argument

**Parameters** **config** –configuration

*esp\_err\_t* **esp\_wifi\_set\_csi** (bool en)

Enable or disable CSI.

return

- ESP\_OK: succeed
- ESP\_ERR\_WIFI\_NOT\_INIT: WiFi is not initialized by esp\_wifi\_init
- ESP\_ERR\_WIFI\_NOT\_STARTED: WiFi is not started by esp\_wifi\_start or promiscuous mode is not enabled
- ESP\_ERR\_INVALID\_ARG: invalid argument

**Parameters** **en** –true - enable, false - disable

*esp\_err\_t* **esp\_wifi\_set\_ant\_gpio** (const *wifi\_ant\_gpio\_config\_t* \*config)

Set antenna GPIO configuration.

**Parameters** **config** –Antenna GPIO configuration.

#### Returns

- ESP\_OK: succeed
- ESP\_ERR\_WIFI\_NOT\_INIT: WiFi is not initialized by esp\_wifi\_init
- ESP\_ERR\_INVALID\_ARG: Invalid argument, e.g. parameter is NULL, invalid GPIO number etc

*esp\_err\_t* **esp\_wifi\_get\_ant\_gpio** (*wifi\_ant\_gpio\_config\_t* \*config)

Get current antenna GPIO configuration.

**Parameters** **config** –Antenna GPIO configuration.

**Returns**

- **ESP\_OK**: succeed
- **ESP\_ERR\_WIFI\_NOT\_INIT**: WiFi is not initialized by `esp_wifi_init`
- **ESP\_ERR\_INVALID\_ARG**: invalid argument, e.g. parameter is NULL

*esp\_err\_t* **esp\_wifi\_set\_ant** (const *wifi\_ant\_config\_t* \*config)

Set antenna configuration.

**Parameters** **config** –Antenna configuration.

**Returns**

- **ESP\_OK**: succeed
- **ESP\_ERR\_WIFI\_NOT\_INIT**: WiFi is not initialized by `esp_wifi_init`
- **ESP\_ERR\_INVALID\_ARG**: Invalid argument, e.g. parameter is NULL, invalid antenna mode or invalid GPIO number

*esp\_err\_t* **esp\_wifi\_get\_ant** (*wifi\_ant\_config\_t* \*config)

Get current antenna configuration.

**Parameters** **config** –Antenna configuration.

**Returns**

- **ESP\_OK**: succeed
- **ESP\_ERR\_WIFI\_NOT\_INIT**: WiFi is not initialized by `esp_wifi_init`
- **ESP\_ERR\_INVALID\_ARG**: invalid argument, e.g. parameter is NULL

*int64\_t* **esp\_wifi\_get\_tsf\_time** (*wifi\_interface\_t* interface)

Get the TSF time In Station mode or SoftAP+Station mode if station is not connected or station doesn't receive at least one beacon after connected, will return 0.

**Attention** Enabling power save may cause the return value inaccurate, except WiFi modem sleep

**Parameters** **interface** –The interface whose `tsf_time` is to be retrieved.

**Returns** 0 or the TSF time

*esp\_err\_t* **esp\_wifi\_set\_inactive\_time** (*wifi\_interface\_t* ifx, *uint16\_t* sec)

Set the inactive time of the ESP32 STA or AP.

**Attention** 1. For Station, If the station does not receive a beacon frame from the connected SoftAP during the inactive time, disconnect from SoftAP. Default 6s.

**Attention** 2. For SoftAP, If the softAP doesn't receive any data from the connected STA during inactive time, the softAP will force deauth the STA. Default is 300s.

**Attention** 3. The inactive time configuration is not stored into flash

**Parameters**

- **ifx** –interface to be configured.
- **sec** –Inactive time. Unit seconds.

**Returns**

- **ESP\_OK**: succeed
- **ESP\_ERR\_WIFI\_NOT\_INIT**: WiFi is not initialized by `esp_wifi_init`
- **ESP\_ERR\_WIFI\_NOT\_STARTED**: WiFi is not started by `esp_wifi_start`
- **ESP\_ERR\_INVALID\_ARG**: invalid argument, For Station, if `sec` is less than 3. For SoftAP, if `sec` is less than 10.

*esp\_err\_t* **esp\_wifi\_get\_inactive\_time** (*wifi\_interface\_t* ifx, uint16\_t \*sec)

Get inactive time of specified interface.

**Parameters**

- **ifx** –Interface to be configured.
- **sec** –Inactive time. Unit seconds.

**Returns**

- ESP\_OK: succeed
- ESP\_ERR\_WIFI\_NOT\_INIT: WiFi is not initialized by esp\_wifi\_init
- ESP\_ERR\_WIFI\_NOT\_STARTED: WiFi is not started by esp\_wifi\_start
- ESP\_ERR\_INVALID\_ARG: invalid argument

*esp\_err\_t* **esp\_wifi\_stats\_dump** (uint32\_t modules)

Dump WiFi statistics.

**Parameters** **modules** –statistic modules to be dumped

**Returns**

- ESP\_OK: succeed
- others: failed

*esp\_err\_t* **esp\_wifi\_set\_rssi\_threshold** (int32\_t rssi)

Set RSSI threshold, if average rssi gets lower than threshold, WiFi task will post event WIFI\_EVENT\_STA\_BSS\_RSSI\_LOW.

**Attention** If the user wants to receive another WIFI\_EVENT\_STA\_BSS\_RSSI\_LOW event after receiving one, this API needs to be called again with an updated/same RSSI threshold.

**Parameters** **rssi** –threshold value in dbm between -100 to 10 Note that in some rare cases where signal strength is very strong, rssi values can be slightly positive.

**Returns**

- ESP\_OK: succeed
- ESP\_ERR\_WIFI\_NOT\_INIT: WiFi is not initialized by esp\_wifi\_init
- ESP\_ERR\_INVALID\_ARG: invalid argument

*esp\_err\_t* **esp\_wifi\_ftm\_initiate\_session** (*wifi\_ftm\_initiator\_cfg\_t* \*cfg)

Start an FTM Initiator session by sending FTM request If successful, event WIFI\_EVENT\_FTM\_REPORT is generated with the result of the FTM procedure.

**Attention** 1. Use this API only in Station mode.

**Attention** 2. If FTM is initiated on a different channel than Station is connected in or internal SoftAP is started in, FTM defaults to a single burst in ASAP mode.

**Parameters** **cfg** –FTM Initiator session configuration

**Returns**

- ESP\_OK: succeed
- others: failed

*esp\_err\_t* **esp\_wifi\_ftm\_end\_session** (void)

End the ongoing FTM Initiator session.

**Attention** This API works only on FTM Initiator

**Returns**

- ESP\_OK: succeed
- others: failed

*esp\_err\_t* **esp\_wifi\_ftm\_resp\_set\_offset** (int16\_t offset\_cm)

Set offset in cm for FTM Responder. An equivalent offset is calculated in picoseconds and added in TOD of FTM Measurement frame (T1).

**Attention** Use this API only in AP mode before performing FTM as responder

**Parameters** **offset\_cm** –T1 Offset to be added in centimeters

**Returns**

- ESP\_OK: succeed
- others: failed

*esp\_err\_t* **esp\_wifi\_ftm\_get\_report** (*wifi\_ftm\_report\_entry\_t* \*report, uint8\_t num\_entries)

Get FTM measurements report copied into a user provided buffer.

**Attention 1.** To get the FTM report, user first needs to allocate a buffer of size (sizeof(wifi\_ftm\_report\_entry\_t) \* num\_entries) where the API will fill up to num\_entries valid FTM measurements in the buffer. Total number of entries can be found in the event WIFI\_EVENT\_FTM\_REPORT as ftm\_report\_num\_entries

**Attention 2.** The internal FTM report is freed upon use of this API which means the API can only be used once after every FTM session initiated

**Attention 3.** Passing the buffer as NULL merely frees the FTM report

**Parameters**

- **report** –Pointer to the buffer for receiving the FTM report
- **num\_entries** –Number of FTM report entries to be filled in the report

**Returns**

- ESP\_OK: succeed
- others: failed

*esp\_err\_t* **esp\_wifi\_config\_11b\_rate** (*wifi\_interface\_t* ifx, bool disable)

Enable or disable 11b rate of specified interface.

**Attention 1.** This API should be called after esp\_wifi\_init() and before esp\_wifi\_start().

**Attention 2.** Only when really need to disable 11b rate call this API otherwise don't call this.

**Parameters**

- **ifx** –Interface to be configured.
- **disable** –true means disable 11b rate while false means enable 11b rate.

**Returns**

- ESP\_OK: succeed
- others: failed

*esp\_err\_t* **esp\_wifi\_connectionless\_module\_set\_wake\_interval** (uint16\_t wake\_interval)

Set wake interval for connectionless modules to wake up periodically.

**Attention 1.** Only one wake interval for all connectionless modules.

**Attention 2.** This configuration could work at connected status. When ESP\_WIFI\_STA\_DISCONNECTED\_PM\_ENABLE is enabled, this configuration could work at disconnected status.

**Attention 3.** Event WIFI\_EVENT\_CONNECTIONLESS\_MODULE\_WAKE\_INTERVAL\_START would be posted each time wake interval starts.

**Attention 4.** Recommend to configure interval in multiples of hundred. (e.g. 100ms)



**Attention** 5. Recommend to configure interval to `ESP_WIFI_CONNECTIONLESS_INTERVAL_DEFAULT_MODE` to get stable performance at coexistence mode.

**Parameters** `wake_interval` –Milliseconds after would the chip wake up, from 1 to 65535.

*esp\_err\_t* `esp_wifi_force_wakeup_acquire` (void)

Request extra reference of Wi-Fi radio. Wi-Fi keep active state(RF opened) to be able to receive packets.

**Attention** Please pair the use of `esp_wifi_force_wakeup_acquire` with `esp_wifi_force_wakeup_release`.

#### Returns

- `ESP_OK`: succeed
- `ESP_ERR_WIFI_NOT_INIT`: WiFi is not initialized by `esp_wifi_init`
- `ESP_ERR_WIFI_NOT_STARTED`: WiFi is not started by `esp_wifi_start`

*esp\_err\_t* `esp_wifi_force_wakeup_release` (void)

Release extra reference of Wi-Fi radio. Wi-Fi go to sleep state(RF closed) if no more use of radio.

**Attention** Please pair the use of `esp_wifi_force_wakeup_acquire` with `esp_wifi_force_wakeup_release`.

#### Returns

- `ESP_OK`: succeed
- `ESP_ERR_WIFI_NOT_INIT`: WiFi is not initialized by `esp_wifi_init`
- `ESP_ERR_WIFI_NOT_STARTED`: WiFi is not started by `esp_wifi_start`

*esp\_err\_t* `esp_wifi_set_country_code` (const char \*country, bool ieee80211d\_enabled)

configure country

**Attention** 1. When `ieee80211d_enabled`, the country info of the AP to which the station is connected is used. E.g. if the configured country is US and the country info of the AP to which the station is connected is JP then the country info that will be used is JP. If the station disconnected from the AP the country info is set back to the country info of the station automatically, US in the example.

**Attention** 2. When `ieee80211d_enabled` is disabled, then the configured country info is used always.

**Attention** 3. When the country info is changed because of configuration or because the station connects to a different external AP, the country IE in probe response/beacon of the soft-AP is also changed.

**Attention** 4. The country configuration is stored into flash.

**Attention** 5. When this API is called, the PHY init data will switch to the PHY init data type corresponding to the country info.

**Attention** 6. Supported country codes are “01” (world safe mode) “AT” ,” AU” ,” BE” ,” BG” ,” BR” ,” CA” ,” CH” ,” CN” ,” CY” ,” CZ” ,” DE” ,” DK” ,” EE” ,” ES” ,” FI” ,” FR” ,” GB” ,” GR” ,” HK” ,” HR” ,” HU” ,” IE” ,” IN” ,” IS” ,” IT” ,” JP” ,” KR” ,” LI” ,” LT” ,” LU” ,” LV” ,” MT” ,” MX” ,” NL” ,” NO” ,” NZ” ,” PL” ,” PT” ,” RO” ,” SE” ,” SI” ,” SK” ,” TW” ,” US”

**Attention** 7. When country code “01” (world safe mode) is set, SoftAP mode won't contain country IE.

**Attention** 8. The default country is “01” (world safe mode) and `ieee80211d_enabled` is TRUE.

**Attention** 9. The third octet of country code string is one of the following: ‘ ‘, ‘O’, ‘I’, ‘X’, otherwise it is considered as ‘ ‘.

#### Parameters

- `country` –the configured country ISO code
- `ieee80211d_enabled` –802.11d is enabled or not

#### Returns

- ESP\_OK: succeed
- ESP\_ERR\_WIFI\_NOT\_INIT: WiFi is not initialized by esp\_wifi\_init
- ESP\_ERR\_INVALID\_ARG: invalid argument

*esp\_err\_t* **esp\_wifi\_get\_country\_code** (char \*country)

get the current country code

**Parameters** **country** –country code

**Returns**

- ESP\_OK: succeed
- ESP\_ERR\_WIFI\_NOT\_INIT: WiFi is not initialized by esp\_wifi\_init
- ESP\_ERR\_INVALID\_ARG: invalid argument

*esp\_err\_t* **esp\_wifi\_config\_80211\_tx\_rate** (*wifi\_interface\_t* ifx, *wifi\_phy\_rate\_t* rate)

Config 80211 tx rate of specified interface.

**Attention** 1. This API should be called after esp\_wifi\_init() and before esp\_wifi\_start().

**Parameters**

- **ifx** –Interface to be configured.
- **rate** –Phy rate to be configured.

**Returns**

- ESP\_OK: succeed
- others: failed

*esp\_err\_t* **esp\_wifi\_disable\_pmf\_config** (*wifi\_interface\_t* ifx)

Disable PMF configuration for specified interface.

**Attention** This API should be called after esp\_wifi\_set\_config() and before esp\_wifi\_start().

**Parameters** **ifx** –Interface to be configured.

**Returns**

- ESP\_OK: succeed
- others: failed

*esp\_err\_t* **esp\_wifi\_sta\_get\_aid** (uint16\_t \*aid)

Get the Association id assigned to STA by AP.

**Attention** aid = 0 if station is not connected to AP.

**Parameters** **aid** –[out] store the aid

**Returns**

- ESP\_OK: succeed

*esp\_err\_t* **esp\_wifi\_sta\_get\_negotiated\_phymode** (*wifi\_phy\_mode\_t* \*phymode)

Get the negotiated phymode after connection.

**Parameters** **phymode** –[out] store the negotiated phymode.

**Returns**

- ESP\_OK: succeed

*esp\_err\_t* **esp\_wifi\_sta\_get\_rssi** (int \*rssi)

Get the rssi information of AP to which the device is associated with.

**Attention** 1. This API should be called after station connected to AP.

**Attention** 2. Use this API only in WIFI\_MODE\_STA or WIFI\_MODE\_APSTA mode.

**Parameters** `rss` –store the rssi info received from last beacon.

**Returns**

- ESP\_OK: succeed
- ESP\_ERR\_INVALID\_ARG: invalid argument
- ESP\_FAIL: failed

## Structures

struct **wifi\_init\_config\_t**

WiFi stack configuration parameters passed to esp\_wifi\_init call.

### Public Members

wifi\_osi\_funcs\_t \***osi\_funcs**

WiFi OS functions

wpa\_crypto\_funcs\_t **wpa\_crypto\_funcs**

WiFi station crypto functions when connect

int **static\_rx\_buf\_num**

WiFi static RX buffer number

int **dynamic\_rx\_buf\_num**

WiFi dynamic RX buffer number

int **tx\_buf\_type**

WiFi TX buffer type

int **static\_tx\_buf\_num**

WiFi static TX buffer number

int **dynamic\_tx\_buf\_num**

WiFi dynamic TX buffer number

int **rx\_mgmt\_buf\_type**

WiFi RX MGMT buffer type

int **rx\_mgmt\_buf\_num**

WiFi RX MGMT buffer number

int **cache\_tx\_buf\_num**

WiFi TX cache buffer number

int **csi\_enable**

WiFi channel state information enable flag

int **ampdu\_rx\_enable**

WiFi AMPDU RX feature enable flag

int **ampdu\_tx\_enable**

WiFi AMPDU TX feature enable flag

int **amsdu\_tx\_enable**

WiFi AMSDU TX feature enable flag

int **nvs\_enable**

WiFi NVS flash enable flag

int **nano\_enable**

Nano option for printf/scan family enable flag

int **rx\_ba\_win**

WiFi Block Ack RX window size

int **wifi\_task\_core\_id**

WiFi Task Core ID

int **beacon\_max\_len**

WiFi softAP maximum length of the beacon

int **mgmt\_sbuf\_num**

WiFi management short buffer number, the minimum value is 6, the maximum value is 32

uint64\_t **feature\_caps**

Enables additional WiFi features and capabilities

bool **sta\_disconnected\_pm**

WiFi Power Management for station at disconnected status

int **espnow\_max\_encrypt\_num**

Maximum encrypt number of peers supported by espnow

int **magic**

WiFi init magic number, it should be the last field

## Macros

**ESP\_ERR\_WIFI\_NOT\_INIT**

WiFi driver was not installed by esp\_wifi\_init

**ESP\_ERR\_WIFI\_NOT\_STARTED**

WiFi driver was not started by esp\_wifi\_start

**ESP\_ERR\_WIFI\_NOT\_STOPPED**

WiFi driver was not stopped by esp\_wifi\_stop

**ESP\_ERR\_WIFI\_IF**

WiFi interface error

**ESP\_ERR\_WIFI\_MODE**

WiFi mode error

**ESP\_ERR\_WIFI\_STATE**

WiFi internal state error

**ESP\_ERR\_WIFI\_CONN**

WiFi internal control block of station or soft-AP error

**ESP\_ERR\_WIFI\_NVS**

WiFi internal NVS module error

**ESP\_ERR\_WIFI\_MAC**

MAC address is invalid

**ESP\_ERR\_WIFI\_SSID**

SSID is invalid

**ESP\_ERR\_WIFI\_PASSWORD**

Password is invalid

**ESP\_ERR\_WIFI\_TIMEOUT**

Timeout error

**ESP\_ERR\_WIFI\_WAKE\_FAIL**

WiFi is in sleep state(RF closed) and wakeup fail

**ESP\_ERR\_WIFI\_WOULD\_BLOCK**

The caller would block

**ESP\_ERR\_WIFI\_NOT\_CONNECT**

Station still in disconnect status

**ESP\_ERR\_WIFI\_POST**

Failed to post the event to WiFi task

**ESP\_ERR\_WIFI\_INIT\_STATE**

Invalid WiFi state when init/deinit is called

**ESP\_ERR\_WIFI\_STOP\_STATE**

Returned when WiFi is stopping

**ESP\_ERR\_WIFI\_NOT\_ASSOC**

The WiFi connection is not associated

**ESP\_ERR\_WIFI\_TX\_DISALLOW**

The WiFi TX is disallowed

**ESP\_ERR\_WIFI\_DISCARD**

Discard frame

**ESP\_ERR\_WIFI\_ROC\_IN\_PROGRESS**

ROC op is in progress

**WIFI\_STATIC\_TX\_BUFFER\_NUM**

**WIFI\_CACHE\_TX\_BUFFER\_NUM**

**WIFI\_DYNAMIC\_TX\_BUFFER\_NUM**

**WIFI\_RX\_MGMT\_BUF\_NUM\_DEF**

**WIFI\_CSI\_ENABLED**

**WIFI\_AMPDU\_RX\_ENABLED**

**WIFI\_AMPDU\_TX\_ENABLED**

**WIFI\_AMSDU\_TX\_ENABLED**

**WIFI\_NVS\_ENABLED**

**WIFI\_NANO\_FORMAT\_ENABLED**

**WIFI\_INIT\_CONFIG\_MAGIC**

**WIFI\_DEFAULT\_RX\_BA\_WIN**

**WIFI\_TASK\_CORE\_ID**

**WIFI\_SOFTAP\_BEACON\_MAX\_LEN**

**WIFI\_MGMT\_SBUF\_NUM**

**WIFI\_STA\_DISCONNECTED\_PM\_ENABLED**

**WIFI\_ENABLE\_WPA3\_SAE**

**WIFI\_ENABLE\_SPIRAM**

**WIFI\_FTM\_INITIATOR**

**WIFI\_FTM\_RESPONDER**

WIFI\_ENABLE\_GCMP

WIFI\_ENABLE\_GMAC

WIFI\_ENABLE\_11R

WIFI\_ENABLE\_ENTERPRISE

CONFIG\_FEATURE\_WPA3\_SAE\_BIT

CONFIG\_FEATURE\_CACHE\_TX\_BUF\_BIT

CONFIG\_FEATURE\_FTM\_INITIATOR\_BIT

CONFIG\_FEATURE\_FTM\_RESPONDER\_BIT

CONFIG\_FEATURE\_GCMP\_BIT

CONFIG\_FEATURE\_GMAC\_BIT

CONFIG\_FEATURE\_11R\_BIT

CONFIG\_FEATURE\_WIFI\_ENT\_BIT

WIFI\_FEATURE\_CAPS

WIFI\_INIT\_CONFIG\_DEFAULT()

ESP\_WIFI\_CONNECTIONLESS\_INTERVAL\_DEFAULT\_MODE

### Type Definitions

typedef void (\***wifi\_promiscuous\_cb\_t**)(void \*buf, *wifi\_promiscuous\_pkt\_type\_t* type)

The RX callback function in the promiscuous mode. Each time a packet is received, the callback function will be called.

**Param buf** Data received. Type of data in buffer (*wifi\_promiscuous\_pkt\_t* or *wifi\_pkt\_rx\_ctrl\_t*) indicated by 'type' parameter.

**Param type** promiscuous packet type.

typedef void (\***esp\_vendor\_ie\_cb\_t**)(void \*ctx, *wifi\_vendor\_ie\_type\_t* type, const uint8\_t sa[6], const *vendor\_ie\_data\_t* \*vnd\_ie, int rssi)

Function signature for received Vendor-Specific Information Element callback.

**Param ctx** Context argument, as passed to `esp_wifi_set_vendor_ie_cb()` when registering callback.

**Param type** Information element type, based on frame type received.

**Param sa** Source 802.11 address.

**Param vnd\_ie** Pointer to the vendor specific element data received.

**Param rssi** Received signal strength indication.

```
typedef void (*wifi_csi_cb_t)(void *ctx, wifi_csi_info_t *data)
```

The RX callback function of Channel State Information(CSI) data.

Each time a CSI data **is** received, the callback function will be called.

**Param ctx** context argument, passed to `esp_wifi_set_csi_rx_cb()` when registering callback function.

**Param data** CSI data received. The memory that it points to will be deallocated after callback function returns.

### Header File

- `components/esp_wifi/include/esp_wifi_types.h`

### Unions

```
union wifi_config_t
```

`#include <esp_wifi_types.h>` Configuration data for ESP32 AP or STA.

The usage of this union (for ap or sta configuration) is determined by the accompanying interface argument passed to `esp_wifi_set_config()` or `esp_wifi_get_config()`

### Public Members

*wifi\_ap\_config\_t* **ap**

configuration of AP

*wifi\_sta\_config\_t* **sta**

configuration of STA

### Structures

```
struct wifi_country_t
```

Structure describing WiFi country-based regional restrictions.

### Public Members

char **cc**[3]

country code string

uint8\_t **schan**

start channel

uint8\_t **nchan**

total channel number



`int8_t max_tx_power`

This field is used for getting WiFi maximum transmitting power, call `esp_wifi_set_max_tx_power` to set the maximum transmitting power.

`wifi_country_policy_t policy`

country policy

struct `wifi_active_scan_time_t`

Range of active scan times per channel.

### Public Members

`uint32_t min`

minimum active scan time per channel, units: millisecond

`uint32_t max`

maximum active scan time per channel, units: millisecond, values above 1500ms may cause station to disconnect from AP and are not recommended.

struct `wifi_scan_time_t`

Aggregate of active & passive scan time per channel.

### Public Members

`wifi_active_scan_time_t active`

active scan time per channel, units: millisecond.

`uint32_t passive`

passive scan time per channel, units: millisecond, values above 1500ms may cause station to disconnect from AP and are not recommended.

struct `wifi_scan_config_t`

Parameters for an SSID scan.

### Public Members

`uint8_t *ssid`

SSID of AP

`uint8_t *bssid`

MAC address of AP

`uint8_t channel`

channel, scan the specific channel

`bool show_hidden`

enable to scan AP whose SSID is hidden

*wifi\_scan\_type\_t* **scan\_type**  
scan type, active or passive

*wifi\_scan\_time\_t* **scan\_time**  
scan time per channel

**uint8\_t home\_chan\_dwell\_time**  
time spent at home channel between scanning consecutive channels.

struct **wifi\_ap\_record\_t**  
Description of a WiFi AP.

### Public Members

**uint8\_t bssid[6]**  
MAC address of AP

**uint8\_t ssid[33]**  
SSID of AP

**uint8\_t primary**  
channel of AP

*wifi\_second\_chan\_t* **second**  
secondary channel of AP

**int8\_t rssi**  
signal strength of AP. Note that in some rare cases where signal strength is very strong, rssi values can be slightly positive

*wifi\_auth\_mode\_t* **authmode**  
authmode of AP

*wifi\_cipher\_type\_t* **pairwise\_cipher**  
pairwise cipher of AP

*wifi\_cipher\_type\_t* **group\_cipher**  
group cipher of AP

*wifi\_ant\_t* **ant**  
antenna used to receive beacon from AP

**uint32\_t phy\_11b**  
bit: 0 flag to identify if 11b mode is enabled or not

**uint32\_t phy\_11g**  
bit: 1 flag to identify if 11g mode is enabled or not

uint32\_t **phy\_11n**

bit: 2 flag to identify if 11n mode is enabled or not

uint32\_t **phy\_1r**

bit: 3 flag to identify if low rate is enabled or not

uint32\_t **wps**

bit: 4 flag to identify if WPS is supported or not

uint32\_t **ftm\_responder**

bit: 5 flag to identify if FTM is supported in responder mode

uint32\_t **ftm\_initiator**

bit: 6 flag to identify if FTM is supported in initiator mode

uint32\_t **reserved**

bit: 7..31 reserved

*wifi\_country\_t* **country**

country information of AP

struct **wifi\_scan\_threshold\_t**

Structure describing parameters for a WiFi fast scan.

### Public Members

int8\_t **rss**

The minimum rssi to accept in the fast scan mode

*wifi\_auth\_mode\_t* **authmode**

The weakest authmode to accept in the fast scan mode Note: In case this value is not set and password is set as per WPA2 standards(password len >= 8), it will be defaulted to WPA2 and device won't connect to deprecated WEP/WPA networks. Please set authmode threshold as WIFI\_AUTH\_WEP/WIFI\_AUTH\_WPA\_PSK to connect to WEP/WPA networks

struct **wifi\_pmf\_config\_t**

Configuration structure for Protected Management Frame

### Public Members

bool **capable**

Deprecated variable. Device will always connect in PMF mode if other device also advertizes PMF capability.

bool **required**

Advertizes that Protected Management Frame is required. Device will not associate to non-PMF capable devices.

struct **wifi\_ap\_config\_t**

Soft-AP configuration settings for the ESP32.

### Public Members

uint8\_t **ssid**[32]

SSID of ESP32 soft-AP. If `ssid_len` field is 0, this must be a Null terminated string. Otherwise, length is set according to `ssid_len`.

uint8\_t **password**[64]

Password of ESP32 soft-AP.

uint8\_t **ssid\_len**

Optional length of SSID field.

uint8\_t **channel**

Channel of soft-AP

*wifi\_auth\_mode\_t* **authmode**

Auth mode of soft-AP. Do not support AUTH\_WEP, AUTH\_WAPI\_PSK and AUTH\_OWE in soft-AP mode. When the auth mode is set to WPA2\_PSK, WPA2\_WPA3\_PSK or WPA3\_PSK, the pairwise cipher will be overwritten with WIFI\_CIPHER\_TYPE\_CCMP.

uint8\_t **ssid\_hidden**

Broadcast SSID or not, default 0, broadcast the SSID

uint8\_t **max\_connection**

Max number of stations allowed to connect in

uint16\_t **beacon\_interval**

Beacon interval which should be multiples of 100. Unit: TU(time unit, 1 TU = 1024 us). Range: 100 ~ 60000. Default value: 100

*wifi\_cipher\_type\_t* **pairwise\_cipher**

Pairwise cipher of SoftAP, group cipher will be derived using this. Cipher values are valid starting from WIFI\_CIPHER\_TYPE\_TKIP, enum values before that will be considered as invalid and default cipher suites(TKIP+CCMP) will be used. Valid cipher suites in softAP mode are WIFI\_CIPHER\_TYPE\_TKIP, WIFI\_CIPHER\_TYPE\_CCMP and WIFI\_CIPHER\_TYPE\_TKIP\_CCMP.

bool **ftm\_responder**

Enable FTM Responder mode

*wifi\_pmf\_config\_t* **pmf\_cfg**

Configuration for Protected Management Frame

struct **wifi\_sta\_config\_t**

STA configuration settings for the ESP32.

## Public Members

uint8\_t **ssid**[32]

SSID of target AP.

uint8\_t **password**[64]

Password of target AP.

*wifi\_scan\_method\_t* **scan\_method**

do all channel scan or fast scan

bool **bssid\_set**

whether set MAC address of target AP or not. Generally, station\_config.bssid\_set needs to be 0; and it needs to be 1 only when users need to check the MAC address of the AP.

uint8\_t **bssid**[6]

MAC address of target AP

uint8\_t **channel**

channel of target AP. Set to 1~13 to scan starting from the specified channel before connecting to AP. If the channel of AP is unknown, set it to 0.

uint16\_t **listen\_interval**

Listen interval for ESP32 station to receive beacon when WIFI\_PS\_MAX\_MODEM is set. Units: AP beacon intervals. Defaults to 3 if set to 0.

*wifi\_sort\_method\_t* **sort\_method**

sort the connect AP in the list by rssi or security mode

*wifi\_scan\_threshold\_t* **threshold**

When scan\_threshold is set, only APs which have an auth mode that is more secure than the selected auth mode and a signal stronger than the minimum RSSI will be used.

*wifi\_pmf\_config\_t* **pmf\_cfg**

Configuration for Protected Management Frame. Will be advertised in RSN Capabilities in RSN IE.

uint32\_t **rm\_enabled**

Whether Radio Measurements are enabled for the connection

uint32\_t **btm\_enabled**

Whether BSS Transition Management is enabled for the connection

uint32\_t **mbo\_enabled**

Whether MBO is enabled for the connection

uint32\_t **ft\_enabled**

Whether FT is enabled for the connection

uint32\_t **owe\_enabled**

Whether OWE is enabled for the connection

uint32\_t **transition\_disable**

Whether to enable transition disable feature

uint32\_t **reserved**

Reserved for future feature set

*wifi\_sae\_pwe\_method\_t* **sae\_pwe\_h2e**

Configuration for SAE PWE derivation method

uint8\_t **failure\_retry\_cnt**

Number of connection retries station will do before moving to next AP. scan\_method should be set as WIFI\_ALL\_CHANNEL\_SCAN to use this config. Note: Enabling this may cause connection time to increase incase best AP doesn't behave properly.

struct **wifi\_sta\_info\_t**

Description of STA associated with AP.

### Public Members

uint8\_t **mac**[6]

mac address

int8\_t **rss**

current average rssi of sta connected

uint32\_t **phy\_11b**

bit: 0 flag to identify if 11b mode is enabled or not

uint32\_t **phy\_11g**

bit: 1 flag to identify if 11g mode is enabled or not

uint32\_t **phy\_11n**

bit: 2 flag to identify if 11n mode is enabled or not

uint32\_t **phy\_1r**

bit: 3 flag to identify if low rate is enabled or not

uint32\_t **is\_mesh\_child**

bit: 4 flag to identify mesh child

uint32\_t **reserved**

bit: 5..31 reserved

struct **wifi\_sta\_list\_t**

List of stations associated with the ESP32 Soft-AP.

### Public Members

`wifi_sta_info_t sta`[ESP\_WIFI\_MAX\_CONN\_NUM]  
station list

`int num`  
number of stations in the list (other entries are invalid)

struct `vendor_ie_data_t`

Vendor Information Element header.

The first bytes of the Information Element will match this header. Payload follows.

### Public Members

`uint8_t element_id`  
Should be set to `WIFI_VENDOR_IE_ELEMENT_ID` (0xDD)

`uint8_t length`  
Length of all bytes in the element data following this field. Minimum 4.

`uint8_t vendor_oui`[3]  
Vendor identifier (OUI).

`uint8_t vendor_oui_type`  
Vendor-specific OUI type.

`uint8_t payload`[0]  
Payload. Length is equal to value in 'length' field, minus 4.

struct `wifi_pkt_rx_ctrl_t`

Received packet radio metadata header, this is the common header at the beginning of all promiscuous mode RX callback buffers.

### Public Members

signed `rss_i`  
Received Signal Strength Indicator(RSSI) of packet. unit: dBm

unsigned `rate`  
PHY rate encoding of the packet. Only valid for non HT(11bg) packet

unsigned `__pad0__`  
reserved

unsigned `sig_mode`  
0: non HT(11bg) packet; 1: HT(11n) packet; 3: VHT(11ac) packet

unsigned **\_\_pad1\_\_**  
reserved

unsigned **mcs**  
Modulation Coding Scheme. If is HT(11n) packet, shows the modulation, range from 0 to 76(MSC0 ~ MCS76)

unsigned **cwb**  
Channel Bandwidth of the packet. 0: 20MHz; 1: 40MHz

unsigned **\_\_pad2\_\_**  
reserved

unsigned **smoothing**  
reserved

unsigned **not\_sounding**  
reserved

unsigned **\_\_pad3\_\_**  
reserved

unsigned **aggregation**  
Aggregation. 0: MPDU packet; 1: AMPDU packet

unsigned **stbc**  
Space Time Block Code(STBC). 0: non STBC packet; 1: STBC packet

unsigned **fec\_coding**  
Flag is set for 11n packets which are LDPC

unsigned **sgi**  
Short Guide Interval(SGI). 0: Long GI; 1: Short GI

unsigned **\_\_pad4\_\_**  
reserved

unsigned **ampdu\_cnt**  
ampdu cnt

unsigned **channel**  
primary channel on which this packet is received

unsigned **secondary\_channel**  
secondary channel on which this packet is received. 0: none; 1: above; 2: below

unsigned **\_\_pad5\_\_**  
reserved



unsigned **timestamp**

timestamp. The local time when this packet is received. It is precise only if modem sleep or light sleep is not enabled. unit: microsecond

unsigned **\_\_pad6\_\_**

reserved

unsigned **\_\_pad7\_\_**

reserved

unsigned **\_\_pad8\_\_**

reserved

unsigned **ant**

antenna number from which this packet is received. 0: WiFi antenna 0; 1: WiFi antenna 1

signed **noise\_floor**

noise floor of Radio Frequency Module(RF). unit: dBm

unsigned **\_\_pad9\_\_**

reserved

unsigned **sig\_len**

length of packet including Frame Check Sequence(FCS)

unsigned **\_\_pad10\_\_**

reserved

unsigned **rx\_state**

state of the packet. 0: no error; others: error numbers which are not public

struct **wifi\_promiscuous\_pkt\_t**

Payload passed to ‘buf’ parameter of promiscuous mode RX callback.

### Public Members

*wifi\_pkt\_rx\_ctrl\_t* **rx\_ctrl**

metadata header

uint8\_t **payload**[0]

Data or management payload. Length of payload is described by rx\_ctrl.sig\_len. Type of content determined by packet type argument of callback.

struct **wifi\_promiscuous\_filter\_t**

Mask for filtering different packet types in promiscuous mode.

### Public Members

uint32\_t **filter\_mask**

OR of one or more filter values WIFI\_PROMIS\_FILTER\_\*

struct **wifi\_csi\_config\_t**

Channel state information(CSI) configuration type.

### Public Members

bool **lltf\_en**

enable to receive legacy long training field(lltf) data. Default enabled

bool **htltf\_en**

enable to receive HT long training field(htltf) data. Default enabled

bool **stbc\_htltf2\_en**

enable to receive space time block code HT long training field(stbc-hlftf2) data. Default enabled

bool **ltf\_merge\_en**

enable to generate hlftf data by averaging lltf and ht\_ltf data when receiving HT packet. Otherwise, use ht\_ltf data directly. Default enabled

bool **channel\_filter\_en**

enable to turn on channel filter to smooth adjacent sub-carrier. Disable it to keep independence of adjacent sub-carrier. Default enabled

bool **manu\_scale**

manually scale the CSI data by left shifting or automatically scale the CSI data. If set true, please set the shift bits. false: automatically. true: manually. Default false

uint8\_t **shift**

manually left shift bits of the scale of the CSI data. The range of the left shift bits is 0~15

bool **dump\_ack\_en**

enable to dump 802.11 ACK frame, default disabled

struct **wifi\_csi\_info\_t**

CSI data type.

### Public Members

*wifi\_pkt\_rx\_ctrl\_t* **rx\_ctrl**

received packet radio metadata header of the CSI data

uint8\_t **mac**[6]

source MAC address of the CSI data

uint8\_t **dmac**[6]  
destination MAC address of the CSI data

bool **first\_word\_invalid**  
first four bytes of the CSI data is invalid or not

int8\_t \***buf**  
buffer of CSI data

uint16\_t **len**  
length of CSI data

struct **wifi\_ant\_gpio\_t**  
WiFi GPIO configuration for antenna selection.

### Public Members

uint8\_t **gpio\_select**  
Whether this GPIO is connected to external antenna switch

uint8\_t **gpio\_num**  
The GPIO number that connects to external antenna switch

struct **wifi\_ant\_gpio\_config\_t**  
WiFi GPIOs configuration for antenna selection.

### Public Members

*wifi\_ant\_gpio\_t* **gpio\_cfg**[4]  
The configurations of GPIOs that connect to external antenna switch

struct **wifi\_ant\_config\_t**  
WiFi antenna configuration.

### Public Members

*wifi\_ant\_mode\_t* **rx\_ant\_mode**  
WiFi antenna mode for receiving

*wifi\_ant\_t* **rx\_ant\_default**  
Default antenna mode for receiving, it's ignored if rx\_ant\_mode is not WIFI\_ANT\_MODE\_AUTO

*wifi\_ant\_mode\_t* **tx\_ant\_mode**  
WiFi antenna mode for transmission, it can be set to WIFI\_ANT\_MODE\_AUTO only if rx\_ant\_mode is set to WIFI\_ANT\_MODE\_AUTO

uint8\_t **enabled\_ant0**

Index (in antenna GPIO configuration) of enabled WIFI\_ANT\_MODE\_ANT0

uint8\_t **enabled\_ant1**

Index (in antenna GPIO configuration) of enabled WIFI\_ANT\_MODE\_ANT1

struct **wifi\_action\_tx\_req\_t**

Action Frame Tx Request.

### Public Members

*wifi\_interface\_t* **ifx**

WiFi interface to send request to

uint8\_t **dest\_mac**[6]

Destination MAC address

bool **no\_ack**

Indicates no ack required

*wifi\_action\_rx\_cb\_t* **rx\_cb**

Rx Callback to receive any response

uint32\_t **data\_len**

Length of the appended Data

uint8\_t **data**[0]

Appended Data payload

struct **wifi\_ftm\_initiator\_cfg\_t**

FTM Initiator configuration.

### Public Members

uint8\_t **resp\_mac**[6]

MAC address of the FTM Responder

uint8\_t **channel**

Primary channel of the FTM Responder

uint8\_t **frm\_count**

No. of FTM frames requested in terms of 4 or 8 bursts (allowed values - 0(No pref), 16, 24, 32, 64)

uint16\_t **burst\_period**

Requested period between FTM bursts in 100<sup>'</sup> s of milliseconds (allowed values 0(No pref) - 100)

bool **use\_get\_report\_api**

True - Using `esp_wifi_ftm_get_report` to get FTM report, False - Using `ftm_report_data` from `WIFI_EVENT_FTM_REPORT` to get FTM report

struct **wifi\_event\_sta\_scan\_done\_t**

Argument structure for `WIFI_EVENT_SCAN_DONE` event

### Public Members

uint32\_t **status**

status of scanning APs: 0 —success, 1 - failure

uint8\_t **number**

number of scan results

uint8\_t **scan\_id**

scan sequence number, used for block scan

struct **wifi\_event\_sta\_connected\_t**

Argument structure for `WIFI_EVENT_STA_CONNECTED` event

### Public Members

uint8\_t **ssid**[32]

SSID of connected AP

uint8\_t **ssid\_len**

SSID length of connected AP

uint8\_t **bssid**[6]

BSSID of connected AP

uint8\_t **channel**

channel of connected AP

*wifi\_auth\_mode\_t* **authmode**

authentication mode used by AP

struct **wifi\_event\_sta\_disconnected\_t**

Argument structure for `WIFI_EVENT_STA_DISCONNECTED` event

### Public Members

uint8\_t **ssid**[32]

SSID of disconnected AP

uint8\_t **ssid\_len**

SSID length of disconnected AP

uint8\_t **bssid**[6]

BSSID of disconnected AP

uint8\_t **reason**

reason of disconnection

int8\_t **rssi**

rssi of disconnection

struct **wifi\_event\_sta\_authmode\_change\_t**

Argument structure for WIFI\_EVENT\_STA\_AUTHMODE\_CHANGE event

### Public Members

*wifi\_auth\_mode\_t* **old\_mode**

the old auth mode of AP

*wifi\_auth\_mode\_t* **new\_mode**

the new auth mode of AP

struct **wifi\_event\_sta\_wps\_er\_pin\_t**

Argument structure for WIFI\_EVENT\_STA\_WPS\_ER\_PIN event

### Public Members

uint8\_t **pin\_code**[8]

PIN code of station in enrollee mode

struct **wifi\_event\_sta\_wps\_er\_success\_t**

Argument structure for WIFI\_EVENT\_STA\_WPS\_ER\_SUCCESS event

### Public Members

uint8\_t **ap\_cred\_cnt**

Number of AP credentials received

uint8\_t **ssid**[MAX\_SSID\_LEN]

SSID of AP

uint8\_t **passphrase**[MAX\_PASSPHRASE\_LEN]

Passphrase for the AP

```
struct wifi_event_sta_wps_er_success_t::[anonymous] ap_cred[MAX_WPS_AP_CRED]
```

All AP credentials received from WPS handshake

```
struct wifi_event_ap_staconnected_t
```

Argument structure for WIFI\_EVENT\_AP\_STACONNECTED event

### Public Members

```
uint8_t mac[6]
```

MAC address of the station connected to ESP32 soft-AP

```
uint8_t aid
```

the aid that ESP32 soft-AP gives to the station connected to

```
bool is_mesh_child
```

flag to identify mesh child

```
struct wifi_event_ap_stadisconnected_t
```

Argument structure for WIFI\_EVENT\_AP\_STADISCONNECTED event

### Public Members

```
uint8_t mac[6]
```

MAC address of the station disconnects to ESP32 soft-AP

```
uint8_t aid
```

the aid that ESP32 soft-AP gave to the station disconnects to

```
bool is_mesh_child
```

flag to identify mesh child

```
struct wifi_event_ap_probe_req_rx_t
```

Argument structure for WIFI\_EVENT\_AP\_PROBEREQRECVED event

### Public Members

```
int rss_i
```

Received probe request signal strength

```
uint8_t mac[6]
```

MAC address of the station which send probe request

```
struct wifi_event_bss_rssi_low_t
```

Argument structure for WIFI\_EVENT\_STA\_BSS\_RSSI\_LOW event

**Public Members****int32\_t rssi**

RSSI value of bss

struct **wifi\_ftm\_report\_entry\_t**

Argument structure for

**Public Members****uint8\_t dlog\_token**

Dialog Token of the FTM frame

**int8\_t rssi**

RSSI of the FTM frame received

**uint32\_t rtt**

Round Trip Time in pSec with a peer

**uint64\_t t1**

Time of departure of FTM frame from FTM Responder in pSec

**uint64\_t t2**

Time of arrival of FTM frame at FTM Initiator in pSec

**uint64\_t t3**

Time of departure of ACK from FTM Initiator in pSec

**uint64\_t t4**

Time of arrival of ACK at FTM Responder in pSec

struct **wifi\_event\_ftm\_report\_t**

Argument structure for WIFI\_EVENT\_FTM\_REPORT event

**Public Members****uint8\_t peer\_mac[6]**

MAC address of the FTM Peer

*wifi\_ftm\_status\_t* **status**

Status of the FTM operation

**uint32\_t rtt\_raw**

Raw average Round-Trip-Time with peer in Nano-Seconds

**uint32\_t rtt\_est**

Estimated Round-Trip-Time with peer in Nano-Seconds



uint32\_t **dist\_est**

Estimated one-way distance in Centi-Meters

*wifi\_ftm\_report\_entry\_t* \***ftm\_report\_data**

Pointer to FTM Report, should be freed after use. Note: Highly recommended to use API `esp_wifi_ftm_get_report` to get the report instead of using this

uint8\_t **ftm\_report\_num\_entries**

Number of entries in the FTM Report data

struct **wifi\_event\_action\_tx\_status\_t**

Argument structure for WIFI\_EVENT\_ACTION\_TX\_STATUS event

### Public Members

*wifi\_interface\_t* **ifx**

WiFi interface to send request to

uint32\_t **context**

Context to identify the request

uint8\_t **da**[6]

Destination MAC address

uint8\_t **status**

Status of the operation

struct **wifi\_event\_roc\_done\_t**

Argument structure for WIFI\_EVENT\_ROC\_DONE event

### Public Members

uint32\_t **context**

Context to identify the request

struct **wifi\_event\_ap\_wps\_rg\_pin\_t**

Argument structure for WIFI\_EVENT\_AP\_WPS\_RG\_PIN event

### Public Members

uint8\_t **pin\_code**[8]

PIN code of station in enrollee mode

struct **wifi\_event\_ap\_wps\_rg\_fail\_reason\_t**

Argument structure for WIFI\_EVENT\_AP\_WPS\_RG\_FAILED event

### Public Members

*wps\_fail\_reason\_t* **reason**

WPS failure reason *wps\_fail\_reason\_t*

uint8\_t **peer\_macaddr**[6]

Enrollee mac address

struct **wifi\_event\_ap\_wps\_rg\_success\_t**

Argument structure for WIFI\_EVENT\_AP\_WPS\_RG\_SUCCESS event

### Public Members

uint8\_t **peer\_macaddr**[6]

Enrollee mac address

### Macros

**WIFI\_OFFCHAN\_TX\_REQ**

**WIFI\_OFFCHAN\_TX\_CANCEL**

**WIFI\_ROC\_REQ**

**WIFI\_ROC\_CANCEL**

**WIFI\_PROTOCOL\_11B**

**WIFI\_PROTOCOL\_11G**

**WIFI\_PROTOCOL\_11N**

**WIFI\_PROTOCOL\_LR**

**ESP\_WIFI\_MAX\_CONN\_NUM**

max number of stations which can connect to ESP32/ESP32S3/ESP32S2 soft-AP

**WIFI\_VENDOR\_IE\_ELEMENT\_ID**

**WIFI\_PROMIS\_FILTER\_MASK\_ALL**

filter all packets

**WIFI\_PROMIS\_FILTER\_MASK\_MGMT**

filter the packets with type of WIFI\_PKT\_MGMT

**WIFI\_PROMIS\_FILTER\_MASK\_CTRL**

filter the packets with type of WIFI\_PKT\_CTRL

**WIFI\_PROMIS\_FILTER\_MASK\_DATA**

filter the packets with type of WIFI\_PKT\_DATA

**WIFI\_PROMIS\_FILTER\_MASK\_MISC**

filter the packets with type of WIFI\_PKT\_MISC

**WIFI\_PROMIS\_FILTER\_MASK\_DATA\_MPDU**

filter the MPDU which is a kind of WIFI\_PKT\_DATA

**WIFI\_PROMIS\_FILTER\_MASK\_DATA\_AMPDU**

filter the AMPDU which is a kind of WIFI\_PKT\_DATA

**WIFI\_PROMIS\_FILTER\_MASK\_FCSFAIL**

filter the FCS failed packets, do not open it in general

**WIFI\_PROMIS\_CTRL\_FILTER\_MASK\_ALL**

filter all control packets

**WIFI\_PROMIS\_CTRL\_FILTER\_MASK\_WRAPPER**

filter the control packets with subtype of Control Wrapper

**WIFI\_PROMIS\_CTRL\_FILTER\_MASK\_BAR**

filter the control packets with subtype of Block Ack Request

**WIFI\_PROMIS\_CTRL\_FILTER\_MASK\_BA**

filter the control packets with subtype of Block Ack

**WIFI\_PROMIS\_CTRL\_FILTER\_MASK\_PSPOLL**

filter the control packets with subtype of PS-Poll

**WIFI\_PROMIS\_CTRL\_FILTER\_MASK\_RTS**

filter the control packets with subtype of RTS

**WIFI\_PROMIS\_CTRL\_FILTER\_MASK\_CTS**

filter the control packets with subtype of CTS

**WIFI\_PROMIS\_CTRL\_FILTER\_MASK\_ACK**

filter the control packets with subtype of ACK

**WIFI\_PROMIS\_CTRL\_FILTER\_MASK\_CFEND**

filter the control packets with subtype of CF-END

**WIFI\_PROMIS\_CTRL\_FILTER\_MASK\_CFENDACK**

filter the control packets with subtype of CF-END+CF-ACK

**WIFI\_EVENT\_MASK\_ALL**

mask all WiFi events

**WIFI\_EVENT\_MASK\_NONE**

mask none of the WiFi events

**WIFI\_EVENT\_MASK\_AP\_PROBEREQRECVED**

mask SYSTEM\_EVENT\_AP\_PROBEREQRECVED event

**MAX\_SSID\_LEN****MAX\_PASSPHRASE\_LEN****MAX\_WPS\_AP\_CRED****WIFI\_STATIS\_BUFFER****WIFI\_STATIS\_RXTX****WIFI\_STATIS\_HW****WIFI\_STATIS\_DIAG****WIFI\_STATIS\_PS****WIFI\_STATIS\_ALL**

### Type Definitions

```
typedef int (*wifi_action_rx_cb_t)(uint8_t *hdr, uint8_t *payload, size_t len, uint8_t channel)
```

The Rx callback function of Action Tx operations.

**Param hdr** pointer to the IEEE 802.11 Header structure**Param payload** pointer to the Payload following 802.11 Header**Param len** length of the Payload**Param channel** channel number the frame is received on

### Enumerations

enum **wifi\_mode\_t***Values:*enumerator **WIFI\_MODE\_NULL**

null mode

enumerator **WIFI\_MODE\_STA**

WiFi station mode

enumerator **WIFI\_MODE\_AP**

WiFi soft-AP mode

enumerator **WIFI\_MODE\_APSTA**

WiFi station + soft-AP mode

enumerator **WIFI\_MODE\_MAX**

enum **wifi\_interface\_t**

*Values:*

enumerator **WIFI\_IF\_STA**

enumerator **WIFI\_IF\_AP**

enum **wifi\_country\_policy\_t**

*Values:*

enumerator **WIFI\_COUNTRY\_POLICY\_AUTO**

Country policy is auto, use the country info of AP to which the station is connected

enumerator **WIFI\_COUNTRY\_POLICY\_MANUAL**

Country policy is manual, always use the configured country info

enum **wifi\_auth\_mode\_t**

*Values:*

enumerator **WIFI\_AUTH\_OPEN**

authenticate mode : open

enumerator **WIFI\_AUTH\_WEP**

authenticate mode : WEP

enumerator **WIFI\_AUTH\_WPA\_PSK**

authenticate mode : WPA\_PSK

enumerator **WIFI\_AUTH\_WPA2\_PSK**

authenticate mode : WPA2\_PSK

enumerator **WIFI\_AUTH\_WPA\_WPA2\_PSK**

authenticate mode : WPA\_WPA2\_PSK

enumerator **WIFI\_AUTH\_ENTERPRISE**

authenticate mode : WiFi EAP security

enumerator **WIFI\_AUTH\_WPA2\_ENTERPRISE**

authenticate mode : WiFi EAP security

enumerator **WIFI\_AUTH\_WPA3\_PSK**

authenticate mode : WPA3\_PSK

enumerator **WIFI\_AUTH\_WPA2\_WPA3\_PSK**

authenticate mode : WPA2\_WPA3\_PSK

enumerator **WIFI\_AUTH\_WAPI\_PSK**

authenticate mode : WAPI\_PSK

enumerator **WIFI\_AUTH\_OWE**

authenticate mode : OWE

enumerator **WIFI\_AUTH\_WPA3\_ENT\_192**

authenticate mode : WPA3\_ENT\_SUITE\_B\_192\_BIT

enumerator **WIFI\_AUTH\_MAX**

enum **wifi\_err\_reason\_t**

*Values:*

enumerator **WIFI\_REASON\_UNSPECIFIED**

enumerator **WIFI\_REASON\_AUTH\_EXPIRE**

enumerator **WIFI\_REASON\_AUTH\_LEAVE**

enumerator **WIFI\_REASON\_ASSOC\_EXPIRE**

enumerator **WIFI\_REASON\_ASSOC\_TOOMANY**

enumerator **WIFI\_REASON\_NOT\_AUTHED**

enumerator **WIFI\_REASON\_NOT\_ASSOCED**

enumerator **WIFI\_REASON\_ASSOC\_LEAVE**

enumerator **WIFI\_REASON\_ASSOC\_NOT\_AUTHED**

enumerator **WIFI\_REASON\_DISASSOC\_PWRCAP\_BAD**

enumerator **WIFI\_REASON\_DISASSOC\_SUPCHAN\_BAD**

enumerator **WIFI\_REASON\_BSS\_TRANSITION\_DISASSOC**

enumerator **WIFI\_REASON\_IE\_INVALID**

enumerator **WIFI\_REASON\_MIC\_FAILURE**

enumerator **WIFI\_REASON\_4WAY\_HANDSHAKE\_TIMEOUT**

enumerator **WIFI\_REASON\_GROUP\_KEY\_UPDATE\_TIMEOUT**

enumerator **WIFI\_REASON\_IE\_IN\_4WAY\_DIFFERS**

enumerator **WIFI\_REASON\_GROUP\_CIPHER\_INVALID**

enumerator **WIFI\_REASON\_PAIRWISE\_CIPHER\_INVALID**

enumerator **WIFI\_REASON\_AKMP\_INVALID**

enumerator **WIFI\_REASON\_UNSUPP\_RSN\_IE\_VERSION**

enumerator **WIFI\_REASON\_INVALID\_RSN\_IE\_CAP**

enumerator **WIFI\_REASON\_802\_1X\_AUTH\_FAILED**

enumerator **WIFI\_REASON\_CIPHER\_SUITE\_REJECTED**

enumerator **WIFI\_REASON\_TDLS\_PEER\_UNREACHABLE**

enumerator **WIFI\_REASON\_TDLS\_UNSPECIFIED**

enumerator **WIFI\_REASON\_SSP\_REQUESTED\_DISASSOC**

enumerator **WIFI\_REASON\_NO\_SSP\_ROAMING\_AGREEMENT**

enumerator **WIFI\_REASON\_BAD\_CIPHER\_OR\_AKM**

enumerator **WIFI\_REASON\_NOT\_AUTHORIZED\_THIS\_LOCATION**

enumerator **WIFI\_REASON\_SERVICE\_CHANGE\_PERCLUDES\_TS**

enumerator **WIFI\_REASON\_UNSPECIFIED\_QOS**

enumerator **WIFI\_REASON\_NOT\_ENOUGH\_BANDWIDTH**

enumerator **WIFI\_REASON\_MISSING\_ACKS**

enumerator **WIFI\_REASON\_EXCEEDED\_TXOP**

enumerator **WIFI\_REASON\_STA\_LEAVING**

enumerator **WIFI\_REASON\_END\_BA**

enumerator **WIFI\_REASON\_UNKNOWN\_BA**

enumerator **WIFI\_REASON\_TIMEOUT**

enumerator **WIFI\_REASON\_PEER\_INITIATED**

enumerator **WIFI\_REASON\_AP\_INITIATED**

enumerator **WIFI\_REASON\_INVALID\_FT\_ACTION\_FRAME\_COUNT**

enumerator **WIFI\_REASON\_INVALID\_PMKID**

enumerator **WIFI\_REASON\_INVALID\_MDE**

enumerator **WIFI\_REASON\_INVALID\_FTE**

enumerator **WIFI\_REASON\_TRANSMISSION\_LINK\_ESTABLISH\_FAILED**

enumerator **WIFI\_REASON\_ALTERATIVE\_CHANNEL\_OCCUPIED**

enumerator **WIFI\_REASON\_BEACON\_TIMEOUT**

enumerator **WIFI\_REASON\_NO\_AP\_FOUND**

enumerator **WIFI\_REASON\_AUTH\_FAIL**

enumerator **WIFI\_REASON\_ASSOC\_FAIL**

enumerator **WIFI\_REASON\_HANDSHAKE\_TIMEOUT**

enumerator **WIFI\_REASON\_CONNECTION\_FAIL**

enumerator **WIFI\_REASON\_AP\_TSF\_RESET**

enumerator **WIFI\_REASON\_ROAMING**

enumerator **WIFI\_REASON\_ASSOC\_COMEBACK\_TIME\_TOO\_LONG**

enumerator **WIFI\_REASON\_SA\_QUERY\_TIMEOUT**

enum **wifi\_second\_chan\_t**

*Values:*

enumerator **WIFI\_SECOND\_CHAN\_NONE**

the channel width is HT20

enumerator **WIFI\_SECOND\_CHAN\_ABOVE**

the channel width is HT40 and the secondary channel is above the primary channel



enumerator **WIFI\_SECOND\_CHAN\_BELOW**

the channel width is HT40 and the secondary channel is below the primary channel

enum **wifi\_scan\_type\_t**

*Values:*

enumerator **WIFI\_SCAN\_TYPE\_ACTIVE**

active scan

enumerator **WIFI\_SCAN\_TYPE\_PASSIVE**

passive scan

enum **wifi\_cipher\_type\_t**

*Values:*

enumerator **WIFI\_CIPHER\_TYPE\_NONE**

the cipher type is none

enumerator **WIFI\_CIPHER\_TYPE\_WEP40**

the cipher type is WEP40

enumerator **WIFI\_CIPHER\_TYPE\_WEP104**

the cipher type is WEP104

enumerator **WIFI\_CIPHER\_TYPE\_TKIP**

the cipher type is TKIP

enumerator **WIFI\_CIPHER\_TYPE\_CCMP**

the cipher type is CCMP

enumerator **WIFI\_CIPHER\_TYPE\_TKIP\_CCMP**

the cipher type is TKIP and CCMP

enumerator **WIFI\_CIPHER\_TYPE\_AES\_CMAC128**

the cipher type is AES-CMAC-128

enumerator **WIFI\_CIPHER\_TYPE\_SMS4**

the cipher type is SMS4

enumerator **WIFI\_CIPHER\_TYPE\_GCMP**

the cipher type is GCMP

enumerator **WIFI\_CIPHER\_TYPE\_GCMP256**

the cipher type is GCMP-256

enumerator **WIFI\_CIPHER\_TYPE\_AES\_GMAC128**

the cipher type is AES-GMAC-128

enumerator **WIFI\_CIPHER\_TYPE\_AES\_GMAC256**

the cipher type is AES-GMAC-256

enumerator **WIFI\_CIPHER\_TYPE\_UNKNOWN**

the cipher type is unknown

enum **wifi\_ant\_t**

WiFi antenna.

*Values:*

enumerator **WIFI\_ANT\_ANT0**

WiFi antenna 0

enumerator **WIFI\_ANT\_ANT1**

WiFi antenna 1

enumerator **WIFI\_ANT\_MAX**

Invalid WiFi antenna

enum **wifi\_scan\_method\_t**

*Values:*

enumerator **WIFI\_FAST\_SCAN**

Do fast scan, scan will end after find SSID match AP

enumerator **WIFI\_ALL\_CHANNEL\_SCAN**

All channel scan, scan will end after scan all the channel

enum **wifi\_sort\_method\_t**

*Values:*

enumerator **WIFI\_CONNECT\_AP\_BY\_SIGNAL**

Sort match AP in scan list by RSSI

enumerator **WIFI\_CONNECT\_AP\_BY\_SECURITY**

Sort match AP in scan list by security mode

enum **wifi\_ps\_type\_t**

*Values:*

enumerator **WIFI\_PS\_NONE**

No power save

enumerator **WIFI\_PS\_MIN\_MODEM**

Minimum modem power saving. In this mode, station wakes up to receive beacon every DTIM period

enumerator **WIFI\_PS\_MAX\_MODEM**

Maximum modem power saving. In this mode, interval to receive beacons is determined by the `listen_interval` parameter in [wifi\\_sta\\_config\\_t](#)

enum **wifi\_bandwidth\_t**

*Values:*

enumerator **WIFI\_BW\_HT20**

enumerator **WIFI\_BW\_HT40**

enum **wifi\_sae\_pwe\_method\_t**

Configuration for SAE PWE derivation

*Values:*

enumerator **WPA3\_SAE\_PWE\_UNSPECIFIED**

enumerator **WPA3\_SAE\_PWE\_HUNT\_AND\_PECK**

enumerator **WPA3\_SAE\_PWE\_HASH\_TO\_ELEMENT**

enumerator **WPA3\_SAE\_PWE\_BOTH**

enum **wifi\_storage\_t**

*Values:*

enumerator **WIFI\_STORAGE\_FLASH**

all configuration will store in both memory and flash

enumerator **WIFI\_STORAGE\_RAM**

all configuration will only store in the memory

enum **wifi\_vendor\_ie\_type\_t**

Vendor Information Element type.

Determines the frame type that the IE will be associated with.

*Values:*

enumerator **WIFI\_VND\_IE\_TYPE\_BEACON**

enumerator **WIFI\_VND\_IE\_TYPE\_PROBE\_REQ**

enumerator **WIFI\_VND\_IE\_TYPE\_PROBE\_RESP**

enumerator **WIFI\_VND\_IE\_TYPE\_ASSOC\_REQ**

enumerator **WIFI\_VND\_IE\_TYPE\_ASSOC\_RESP**

enum **wifi\_vendor\_ie\_id\_t**

Vendor Information Element index.

Each IE type can have up to two associated vendor ID elements.

*Values:*

enumerator **WIFI\_VND\_IE\_ID\_0**

enumerator **WIFI\_VND\_IE\_ID\_1**

enum **wifi\_phy\_mode\_t**

Operation Phymode.

*Values:*

enumerator **WIFI\_PHY\_MODE\_LR**

PHY mode for Low Rate

enumerator **WIFI\_PHY\_MODE\_11B**

PHY mode for 11b

enumerator **WIFI\_PHY\_MODE\_11G**

PHY mode for 11g

enumerator **WIFI\_PHY\_MODE\_HT20**

PHY mode for Bandwidth HT20

enumerator **WIFI\_PHY\_MODE\_HT40**

PHY mode for Bandwidth HT40

enumerator **WIFI\_PHY\_MODE\_HE20**

PHY mode for Bandwidth HE20

enum **wifi\_promiscuous\_pkt\_type\_t**

Promiscuous frame type.

Passed to promiscuous mode RX callback to indicate the type of parameter in the buffer.

*Values:*

enumerator **WIFI\_PKT\_MGMT**

Management frame, indicates ‘buf’ argument is *wifi\_promiscuous\_pkt\_t*

enumerator **WIFI\_PKT\_CTRL**

Control frame, indicates ‘buf’ argument is *wifi\_promiscuous\_pkt\_t*

enumerator **WIFI\_PKT\_DATA**

Data frame, indicates ‘buf’ argument is *wifi\_promiscuous\_pkt\_t*

enumerator **WIFI\_PKT\_MISC**

Other type, such as MIMO etc. ‘buf’ argument is *wifi\_promiscuous\_pkt\_t* but the payload is zero length.

enum **wifi\_ant\_mode\_t**

WiFi antenna mode.

*Values:*

enumerator **WIFI\_ANT\_MODE\_ANT0**

Enable WiFi antenna 0 only

enumerator **WIFI\_ANT\_MODE\_ANT1**

Enable WiFi antenna 1 only

enumerator **WIFI\_ANT\_MODE\_AUTO**

Enable WiFi antenna 0 and 1, automatically select an antenna

enumerator **WIFI\_ANT\_MODE\_MAX**

Invalid WiFi enabled antenna

enum **wifi\_phy\_rate\_t**

WiFi PHY rate encodings.

*Values:*

enumerator **WIFI\_PHY\_RATE\_1M\_L**

1 Mbps with long preamble

enumerator **WIFI\_PHY\_RATE\_2M\_L**

2 Mbps with long preamble

enumerator **WIFI\_PHY\_RATE\_5M\_L**

5.5 Mbps with long preamble

enumerator **WIFI\_PHY\_RATE\_11M\_L**

11 Mbps with long preamble

enumerator **WIFI\_PHY\_RATE\_2M\_S**

2 Mbps with short preamble

enumerator **WIFI\_PHY\_RATE\_5M\_S**

5.5 Mbps with short preamble

enumerator **WIFI\_PHY\_RATE\_11M\_S**

11 Mbps with short preamble

enumerator **WIFI\_PHY\_RATE\_48M**

48 Mbps

enumerator **WIFI\_PHY\_RATE\_24M**

24 Mbps

enumerator **WIFI\_PHY\_RATE\_12M**

12 Mbps

enumerator **WIFI\_PHY\_RATE\_6M**

6 Mbps

enumerator **WIFI\_PHY\_RATE\_54M**

54 Mbps

enumerator **WIFI\_PHY\_RATE\_36M**

36 Mbps

enumerator **WIFI\_PHY\_RATE\_18M**

18 Mbps

enumerator **WIFI\_PHY\_RATE\_9M**

9 Mbps

enumerator **WIFI\_PHY\_RATE\_MCS0\_LGI**

MCS0 with long GI, 6.5 Mbps for 20MHz, 13.5 Mbps for 40MHz

enumerator **WIFI\_PHY\_RATE\_MCS1\_LGI**

MCS1 with long GI, 13 Mbps for 20MHz, 27 Mbps for 40MHz

enumerator **WIFI\_PHY\_RATE\_MCS2\_LGI**

MCS2 with long GI, 19.5 Mbps for 20MHz, 40.5 Mbps for 40MHz

enumerator **WIFI\_PHY\_RATE\_MCS3\_LGI**

MCS3 with long GI, 26 Mbps for 20MHz, 54 Mbps for 40MHz

enumerator **WIFI\_PHY\_RATE\_MCS4\_LGI**

MCS4 with long GI, 39 Mbps for 20MHz, 81 Mbps for 40MHz

enumerator **WIFI\_PHY\_RATE\_MCS5\_LGI**

MCS5 with long GI, 52 Mbps for 20MHz, 108 Mbps for 40MHz

enumerator **WIFI\_PHY\_RATE\_MCS6\_LGI**

MCS6 with long GI, 58.5 Mbps for 20MHz, 121.5 Mbps for 40MHz

enumerator **WIFI\_PHY\_RATE\_MCS7\_LGI**

MCS7 with long GI, 65 Mbps for 20MHz, 135 Mbps for 40MHz

enumerator **WIFI\_PHY\_RATE\_MCS0\_SGI**

MCS0 with short GI, 7.2 Mbps for 20MHz, 15 Mbps for 40MHz

enumerator **WIFI\_PHY\_RATE\_MCS1\_SGI**

MCS1 with short GI, 14.4 Mbps for 20MHz, 30 Mbps for 40MHz

enumerator **WIFI\_PHY\_RATE\_MCS2\_SGI**

MCS2 with short GI, 21.7 Mbps for 20MHz, 45 Mbps for 40MHz

enumerator **WIFI\_PHY\_RATE\_MCS3\_SGI**

MCS3 with short GI, 28.9 Mbps for 20MHz, 60 Mbps for 40MHz

enumerator **WIFI\_PHY\_RATE\_MCS4\_SGI**

MCS4 with short GI, 43.3 Mbps for 20MHz, 90 Mbps for 40MHz

enumerator **WIFI\_PHY\_RATE\_MCS5\_SGI**

MCS5 with short GI, 57.8 Mbps for 20MHz, 120 Mbps for 40MHz

enumerator **WIFI\_PHY\_RATE\_MCS6\_SGI**

MCS6 with short GI, 65 Mbps for 20MHz, 135 Mbps for 40MHz

enumerator **WIFI\_PHY\_RATE\_MCS7\_SGI**

MCS7 with short GI, 72.2 Mbps for 20MHz, 150 Mbps for 40MHz

enumerator **WIFI\_PHY\_RATE\_LORA\_250K**

250 Kbps

enumerator **WIFI\_PHY\_RATE\_LORA\_500K**

500 Kbps

enumerator **WIFI\_PHY\_RATE\_MAX**

enum **wifi\_event\_t**

WiFi event declarations

*Values:*

enumerator **WIFI\_EVENT\_WIFI\_READY**

ESP32 WiFi ready

enumerator **WIFI\_EVENT\_SCAN\_DONE**

ESP32 finish scanning AP

enumerator **WIFI\_EVENT\_STA\_START**

ESP32 station start

enumerator **WIFI\_EVENT\_STA\_STOP**

ESP32 station stop

enumerator **WIFI\_EVENT\_STA\_CONNECTED**

ESP32 station connected to AP

enumerator **WIFI\_EVENT\_STA\_DISCONNECTED**

ESP32 station disconnected from AP

enumerator **WIFI\_EVENT\_STA\_AUTHMODE\_CHANGE**

the auth mode of AP connected by ESP32 station changed

enumerator **WIFI\_EVENT\_STA\_WPS\_ER\_SUCCESS**

ESP32 station wps succeeds in enrollee mode

- enumerator **WIFI\_EVENT\_STA\_WPS\_ER\_FAILED**  
ESP32 station wps fails in enrollee mode
- enumerator **WIFI\_EVENT\_STA\_WPS\_ER\_TIMEOUT**  
ESP32 station wps timeout in enrollee mode
- enumerator **WIFI\_EVENT\_STA\_WPS\_ER\_PIN**  
ESP32 station wps pin code in enrollee mode
- enumerator **WIFI\_EVENT\_STA\_WPS\_ER\_PBC\_OVERLAP**  
ESP32 station wps overlap in enrollee mode
- enumerator **WIFI\_EVENT\_AP\_START**  
ESP32 soft-AP start
- enumerator **WIFI\_EVENT\_AP\_STOP**  
ESP32 soft-AP stop
- enumerator **WIFI\_EVENT\_AP\_STACONNECTED**  
a station connected to ESP32 soft-AP
- enumerator **WIFI\_EVENT\_AP\_STADISCONNECTED**  
a station disconnected from ESP32 soft-AP
- enumerator **WIFI\_EVENT\_AP\_PROBEREQRCVD**  
Receive probe request packet in soft-AP interface
- enumerator **WIFI\_EVENT\_FTM\_REPORT**  
Receive report of FTM procedure
- enumerator **WIFI\_EVENT\_STA\_BSS\_RSSI\_LOW**  
AP' s RSSI crossed configured threshold
- enumerator **WIFI\_EVENT\_ACTION\_TX\_STATUS**  
Status indication of Action Tx operation
- enumerator **WIFI\_EVENT\_ROC\_DONE**  
Remain-on-Channel operation complete
- enumerator **WIFI\_EVENT\_STA\_BEACON\_TIMEOUT**  
ESP32 station beacon timeout
- enumerator **WIFI\_EVENT\_CONNECTIONLESS\_MODULE\_WAKE\_INTERVAL\_START**  
ESP32 connectionless module wake interval start
- enumerator **WIFI\_EVENT\_AP\_WPS\_RG\_SUCCESS**  
Soft-AP wps succeeds in registrar mode



enumerator **WIFI\_EVENT\_AP\_WPS\_RG\_FAILED**

Soft-AP wps fails in registrar mode

enumerator **WIFI\_EVENT\_AP\_WPS\_RG\_TIMEOUT**

Soft-AP wps timeout in registrar mode

enumerator **WIFI\_EVENT\_AP\_WPS\_RG\_PIN**

Soft-AP wps pin code in registrar mode

enumerator **WIFI\_EVENT\_AP\_WPS\_RG\_PBC\_OVERLAP**

Soft-AP wps overlap in registrar mode

enumerator **WIFI\_EVENT\_MAX**

Invalid WiFi event ID

enum **wifi\_event\_sta\_wps\_fail\_reason\_t**

Argument structure for WIFI\_EVENT\_STA\_WPS\_ER\_FAILED event

*Values:*

enumerator **WPS\_FAIL\_REASON\_NORMAL**

ESP32 WPS normal fail reason

enumerator **WPS\_FAIL\_REASON\_RECV\_M2D**

ESP32 WPS receive M2D frame

enumerator **WPS\_FAIL\_REASON\_RECV\_DEAUTH**

Recv deauth from AP while wps handshake

enumerator **WPS\_FAIL\_REASON\_MAX**

enum **wifi\_ftm\_status\_t**

FTM operation status types.

*Values:*

enumerator **FTM\_STATUS\_SUCCESS**

FTM exchange is successful

enumerator **FTM\_STATUS\_UNSUPPORTED**

Peer does not support FTM

enumerator **FTM\_STATUS\_CONF\_REJECTED**

Peer rejected FTM configuration in FTM Request

enumerator **FTM\_STATUS\_NO\_RESPONSE**

Peer did not respond to FTM Requests

enumerator **FTM\_STATUS\_FAIL**

Unknown error during FTM exchange

enumerator **FTM\_STATUS\_NO\_VALID\_MSMT**  
FTM session did not result in any valid measurements

enumerator **FTM\_STATUS\_USER\_TERM**  
User triggered termination

enum **wps\_fail\_reason\_t**

*Values:*

enumerator **WPS\_AP\_FAIL\_REASON\_NORMAL**  
WPS normal fail reason

enumerator **WPS\_AP\_FAIL\_REASON\_CONFIG**  
WPS failed due to incorrect config

enumerator **WPS\_AP\_FAIL\_REASON\_AUTH**  
WPS failed during auth

enumerator **WPS\_AP\_FAIL\_REASON\_MAX**

### Header File

- [components/wpa\\_supplicant/esp\\_supplicant/include/esp\\_eap\\_client.h](#)

### Functions

*esp\_err\_t* **esp\_wifi\_sta\_enterprise\_enable** (void)

Enable EAP authentication(WiFi Enterprise) for the station mode.

This function enables Extensible Authentication Protocol (EAP) authentication for the Wi-Fi station mode. When EAP authentication is enabled, the ESP device will attempt to authenticate with the configured EAP credentials when connecting to a secure Wi-Fi network.

---

**Note:** Before calling this function, ensure that the Wi-Fi configuration and EAP credentials (such as username and password) have been properly set using the appropriate configuration APIs.

---

#### Returns

- **ESP\_OK**: EAP authentication enabled successfully.
- **ESP\_ERR\_NO\_MEM**: Failed to enable EAP authentication due to memory allocation failure.

*esp\_err\_t* **esp\_wifi\_sta\_enterprise\_disable** (void)

Disable EAP authentication(WiFi Enterprise) for the station mode.

This function disables Extensible Authentication Protocol (EAP) authentication for the Wi-Fi station mode. When EAP authentication is disabled, the ESP device will not attempt to authenticate using EAP credentials when connecting to a secure Wi-Fi network.

---

**Note:** Disabling EAP authentication may cause the device to connect to the Wi-Fi network using other available authentication methods, if configured using `esp_wifi_set_config()`.

---

#### Returns

- ESP\_OK: EAP authentication disabled successfully.
- ESP\_ERR\_INVALID\_STATE: EAP client is in an invalid state for disabling.

*esp\_err\_t* **esp\_eap\_client\_set\_identity** (const unsigned char \*identity, int len)

Set identity for PEAP/TTLS authentication method.

This function sets the identity to be used during PEAP/TTLS authentication.

#### Parameters

- **identity** –[in] Pointer to the identity data.
- **len** –[in] Length of the identity data (limited to 1~127 bytes).

#### Returns

- ESP\_OK: The identity was set successfully.
- ESP\_ERR\_INVALID\_ARG: Invalid argument (len <= 0 or len >= 128).
- ESP\_ERR\_NO\_MEM: Memory allocation failure.

void **esp\_eap\_client\_clear\_identity** (void)

Clear the previously set identity for PEAP/TTLS authentication.

This function clears the identity that was previously set for the EAP client. After calling this function, the EAP client will no longer use the previously configured identity during the authentication process.

*esp\_err\_t* **esp\_eap\_client\_set\_username** (const unsigned char \*username, int len)

Set username for PEAP/TTLS authentication method.

This function sets the username to be used during PEAP/TTLS authentication.

#### Parameters

- **username** –[in] Pointer to the username data.
- **len** –[in] Length of the username data (limited to 1~127 bytes).

#### Returns

- ESP\_OK: The username was set successfully.
- ESP\_ERR\_INVALID\_ARG: Failed due to an invalid argument (len <= 0 or len >= 128).
- ESP\_ERR\_NO\_MEM: Failed due to memory allocation failure.

void **esp\_eap\_client\_clear\_username** (void)

Clear username for PEAP/TTLS method.

This function clears the previously set username for the EAP client.

*esp\_err\_t* **esp\_eap\_client\_set\_password** (const unsigned char \*password, int len)

Set password for PEAP/TTLS authentication method.

This function sets the password to be used during PEAP/TTLS authentication.

#### Parameters

- **password** –[in] Pointer to the password data.
- **len** –[in] Length of the password data (len > 0).

#### Returns

- ESP\_OK: The password was set successfully.
- ESP\_ERR\_INVALID\_ARG: Failed due to an invalid argument (len <= 0).
- ESP\_ERR\_NO\_MEM: Failed due to memory allocation failure.

void **esp\_eap\_client\_clear\_password** (void)

Clear password for PEAP/TTLS method.

This function clears the previously set password for the EAP client.

*esp\_err\_t* **esp\_eap\_client\_set\_new\_password** (const unsigned char \*new\_password, int len)

Set a new password for MSCHAPv2 authentication method.

This function sets the new password to be used during MSCHAPv2 authentication. The new password is used to substitute the old password when an eap-mschapv2 failure request message with error code ERROR\_PASSWD\_EXPIRED is received.

**Parameters**

- **new\_password** –[in] Pointer to the new password data.
- **len** –[in] Length of the new password data.

**Returns**

- ESP\_OK: The new password was set successfully.
- ESP\_ERR\_INVALID\_ARG: Failed due to an invalid argument (len <= 0).
- ESP\_ERR\_NO\_MEM: Failed due to memory allocation failure.

void **esp\_eap\_client\_clear\_new\_password** (void)

Clear new password for MSCHAPv2 method.

This function clears the previously set new password for the EAP client.

*esp\_err\_t* **esp\_eap\_client\_set\_ca\_cert** (const unsigned char \*ca\_cert, int ca\_cert\_len)

Set CA certificate for EAP authentication.

This function sets the Certificate Authority (CA) certificate to be used during EAP authentication. The CA certificate is passed to the EAP client module through a global pointer.

**Parameters**

- **ca\_cert** –[in] Pointer to the CA certificate data.
- **ca\_cert\_len** –[in] Length of the CA certificate data.

**Returns**

- ESP\_OK: The CA certificate was set successfully.

void **esp\_eap\_client\_clear\_ca\_cert** (void)

Clear the previously set Certificate Authority (CA) certificate for EAP authentication.

This function clears the CA certificate that was previously set for the EAP client. After calling this function, the EAP client will no longer use the previously configured CA certificate during the authentication process.

*esp\_err\_t* **esp\_eap\_client\_set\_certificate\_and\_key** (const unsigned char \*client\_cert, int client\_cert\_len, const unsigned char \*private\_key, int private\_key\_len, const unsigned char \*private\_key\_password, int private\_key\_passwd\_len)

Set client certificate and private key for EAP authentication.

This function sets the client certificate and private key to be used during authentication. Optionally, a private key password can be provided for encrypted private keys.

**Attention** 1. The client certificate, private key, and private key password are provided as pointers to the respective data arrays.

**Attention** 2. The client\_cert, private\_key, and private\_key\_password should be zero-terminated.

**Parameters**

- **client\_cert** –[in] Pointer to the client certificate data.
- **client\_cert\_len** –[in] Length of the client certificate data.
- **private\_key** –[in] Pointer to the private key data.
- **private\_key\_len** –[in] Length of the private key data (limited to 1~4096 bytes).
- **private\_key\_password** –[in] Pointer to the private key password data (optional).
- **private\_key\_passwd\_len** –[in] Length of the private key password data (can be 0 for no password).

**Returns**

- ESP\_OK: The certificate, private key, and password (if provided) were set successfully.

void **esp\_eap\_client\_clear\_certificate\_and\_key** (void)

Clear the previously set client certificate and private key for EAP authentication.

This function clears the client certificate and private key that were previously set for the EAP client. After calling this function, the EAP client will no longer use the previously configured certificate and private key during the authentication process.

*esp\_err\_t* **esp\_eap\_client\_set\_disable\_time\_check** (bool disable)

Set EAP client certificates time check (disable or not).

This function enables or disables the time check for EAP client certificates. When disabled, the certificates' expiration time will not be checked during the authentication process.

**Parameters** **disable** –[in] True to disable EAP client certificates time check, false to enable it.

**Returns**

- ESP\_OK: The EAP client certificates time check setting was updated successfully.

*esp\_err\_t* **esp\_eap\_client\_get\_disable\_time\_check** (bool \*disable)

Get EAP client certificates time check status.

This function retrieves the current status of the EAP client certificates time check.

**Parameters** **disable** –[out] Pointer to a boolean variable to store the disable status.

**Returns**

- ESP\_OK: The status of EAP client certificates time check was retrieved successfully.

*esp\_err\_t* **esp\_eap\_client\_set\_ttls\_phase2\_method** (*esp\_eap\_ttls\_phase2\_types* type)

Set EAP-TTLS phase 2 method.

This function sets the phase 2 method to be used during EAP-TTLS authentication.

**Parameters** **type** –[in] The type of phase 2 method to be used (e.g., EAP, MSCHAPv2, MSCHAP, PAP, CHAP).

**Returns**

- ESP\_OK: The EAP-TTLS phase 2 method was set successfully.

*esp\_err\_t* **esp\_eap\_client\_set\_suiteb\_192bit\_certification** (bool enable)

Enable or disable Suite-B 192-bit certification checks.

This function enables or disables the 192-bit Suite-B certification checks during EAP-TLS authentication. Suite-B is a set of cryptographic algorithms which generally are considered more secure.

**Parameters** **enable** –[in] True to enable 192-bit Suite-B certification checks, false to disable it.

**Returns**

- ESP\_OK: The 192-bit Suite-B certification checks were set successfully.

*esp\_err\_t* **esp\_eap\_client\_set\_pac\_file** (const unsigned char \*pac\_file, int pac\_file\_len)

Set the PAC (Protected Access Credential) file for EAP-FAST authentication.

EAP-FAST requires a PAC file that contains the client's credentials.

**Attention** 1. For files read from the file system, length has to be decremented by 1 byte.

**Attention** 2. Disabling the WPA\_MBEDTLS\_TLS\_CLIENT config is required to use EAP-FAST.

**Parameters**

- **pac\_file** –[in] Pointer to the PAC file buffer.
- **pac\_file\_len** –[in] Length of the PAC file buffer.

**Returns**

- ESP\_OK: The PAC file for EAP-FAST authentication was set successfully.

*esp\_err\_t* **esp\_eap\_client\_set\_fast\_params** (*esp\_eap\_fast\_config* config)

Set the parameters for EAP-FAST Phase 1 authentication.

EAP-FAST supports Fast Provisioning, where clients can be authenticated faster using precomputed keys (PAC). This function allows configuring parameters for Fast Provisioning.

**Attention** 1. Disabling the `WPA_MBEDTLS_TLS_CLIENT` config is required to use EAP-FAST.

**Parameters** `config` **–[in]** Configuration structure with Fast Provisioning parameters.

**Returns**

- `ESP_OK`: The parameters for EAP-FAST Phase 1 authentication were set successfully.

*esp\_err\_t* `esp_eap_client_use_default_cert_bundle` (bool use\_default\_bundle)

Use the default certificate bundle for EAP authentication.

By default, the EAP client uses a built-in certificate bundle for server verification. Enabling this option allows the use of the default certificate bundle.

**Parameters** `use_default_bundle` **–[in]** True to use the default certificate bundle, false to use a custom bundle.

**Returns**

- `ESP_OK`: The option to use the default certificate bundle was set successfully.

## Structures

struct `esp_eap_fast_config`

Configuration settings for EAP-FAST (Extensible Authentication Protocol - Flexible Authentication via Secure Tunneling).

This structure defines the configuration options that can be used to customize the behavior of the EAP-FAST authentication protocol, specifically for Fast Provisioning and PAC (Protected Access Credential) handling.

## Public Members

int `fast_provisioning`

Enable or disable Fast Provisioning in EAP-FAST (0 = disabled, 1 = enabled)

int `fast_max_pac_list_len`

Maximum length of the PAC (Protected Access Credential) list

bool `fast_pac_format_binary`

Set to true for binary format PAC, false for ASCII format PAC

## Enumerations

enum `esp_eap_ttls_phase2_types`

Enumeration of phase 2 authentication types for EAP-TTLS.

This enumeration defines the supported phase 2 authentication methods that can be used in the EAP-TTLS (Extensible Authentication Protocol - Tunneled Transport Layer Security) protocol for the second authentication phase.

*Values:*

enumerator `ESP_EAP_TTLS_PHASE2_EAP`

EAP (Extensible Authentication Protocol)

enumerator `ESP_EAP_TTLS_PHASE2_MSCHAPV2`

MS-CHAPv2 (Microsoft Challenge Handshake Authentication Protocol - Version 2)

enumerator **ESP\_EAP\_TTLS\_PHASE2\_MSCHAP**

MS-CHAP (Microsoft Challenge Handshake Authentication Protocol)

enumerator **ESP\_EAP\_TTLS\_PHASE2\_PAP**

PAP (Password Authentication Protocol)

enumerator **ESP\_EAP\_TTLS\_PHASE2\_CHAP**

CHAP (Challenge Handshake Authentication Protocol)

## Header File

- [components/wpa\\_supplicant/esp\\_supplicant/include/esp\\_wps.h](#)

## Functions

*esp\_err\_t* **esp\_wifi\_wps\_enable** (const *esp\_wps\_config\_t* \*config)

Enable Wi-Fi WPS function.

**Parameters** *config* –: WPS config to be used in connection

### Returns

- **ESP\_OK** : succeed
- **ESP\_ERR\_WIFI\_WPS\_TYPE** : wps type is invalid
- **ESP\_ERR\_WIFI\_WPS\_MODE** : wifi is not in station mode or sniffer mode is on
- **ESP\_FAIL** : wps initialization fails

*esp\_err\_t* **esp\_wifi\_wps\_disable** (void)

Disable Wi-Fi WPS function and release resource it taken.

### Returns

- **ESP\_OK** : succeed
- **ESP\_ERR\_WIFI\_WPS\_MODE** : wifi is not in station mode or sniffer mode is on

*esp\_err\_t* **esp\_wifi\_wps\_start** (int timeout\_ms)

Start WPS session.

**Attention** WPS can only be used when station is enabled. WPS needs to be enabled first for using this API.

**Parameters** *timeout\_ms* –: deprecated: This argument' s value will have not effect in functionality of API. The argument will be removed in future. The app should start WPS and register for WIFI events to get the status. WPS status is updated through WPS events. See *wifi\_event\_t* enum for more info.

### Returns

- **ESP\_OK** : succeed
- **ESP\_ERR\_WIFI\_WPS\_TYPE** : wps type is invalid
- **ESP\_ERR\_WIFI\_WPS\_MODE** : wifi is not in station mode or sniffer mode is on
- **ESP\_ERR\_WIFI\_WPS\_SM** : wps state machine is not initialized
- **ESP\_FAIL** : wps initialization fails

*esp\_err\_t* **esp\_wifi\_ap\_wps\_enable** (const *esp\_wps\_config\_t* \*config)

Enable Wi-Fi AP WPS function.

**Attention** WPS can only be used when softAP is enabled.

**Parameters** *config* –wps configuration to be used.

### Returns

- **ESP\_OK** : succeed

- `ESP_ERR_WIFI_WPS_TYPE` : wps type is invalid
- `ESP_ERR_WIFI_WPS_MODE` : wifi is not in station mode or sniffer mode is on
- `ESP_FAIL` : wps initialization fails

*esp\_err\_t* **esp\_wifi\_ap\_wps\_disable** (void)

Disable Wi-Fi SoftAP WPS function and release resource it taken.

#### Returns

- `ESP_OK` : succeed
- `ESP_ERR_WIFI_WPS_MODE` : wifi is not in station mode or sniffer mode is on

*esp\_err\_t* **esp\_wifi\_ap\_wps\_start** (const unsigned char \*pin)

WPS starts to work.

**Attention** WPS can only be used when softAP is enabled.

**Parameters** `pin` –: Pin to be used in case of WPS mode is pin. If Pin is not provided, device will use the pin generated/provided during *esp\_wifi\_ap\_wps\_enable()* and reported in `WIFI_EVENT_AP_WPS_RG_PIN`

#### Returns

- `ESP_OK` : succeed
- `ESP_ERR_WIFI_WPS_TYPE` : wps type is invalid
- `ESP_ERR_WIFI_WPS_MODE` : wifi is not in station mode or sniffer mode is on
- `ESP_ERR_WIFI_WPS_SM` : wps state machine is not initialized
- `ESP_FAIL` : wps initialization fails

## Structures

struct **wps\_factory\_information\_t**

Structure representing WPS factory information for ESP device.

This structure holds various strings representing factory information for a device, such as the manufacturer, model number, model name, and device name. Each string is a null-terminated character array. If any of the strings are empty, the default values are used.

### Public Members

char **manufacturer**[WPS\_MAX\_MANUFACTURER\_LEN]

Manufacturer of the device. If empty, the default manufacturer is used.

char **model\_number**[WPS\_MAX\_MODEL\_NUMBER\_LEN]

Model number of the device. If empty, the default model number is used.

char **model\_name**[WPS\_MAX\_MODEL\_NAME\_LEN]

Model name of the device. If empty, the default model name is used.

char **device\_name**[WPS\_MAX\_DEVICE\_NAME\_LEN]

Device name. If empty, the default device name is used.

struct **esp\_wps\_config\_t**

Structure representing configuration settings for WPS (Wi-Fi Protected Setup).

This structure encapsulates various configuration settings for WPS, including the WPS type (PBC or PIN), factory information that will be shown in the WPS Information Element (IE), and a PIN if the WPS type is set to PIN.



## Public Members

### *wps\_type\_t* **wps\_type**

The type of WPS to be used (PBC or PIN).

### *wps\_factory\_information\_t* **factory\_info**

Factory information to be shown in the WPS Information Element (IE). Vendor can choose to display their own information.

char **pin**[PIN\_LEN]

WPS PIN (Personal Identification Number) used when *wps\_type* is set to WPS\_TYPE\_PIN.

## Macros

### **ESP\_ERR\_WIFI\_REGISTRAR**

WPS registrar is not supported

### **ESP\_ERR\_WIFI\_WPS\_TYPE**

WPS type error

### **ESP\_ERR\_WIFI\_WPS\_SM**

WPS state machine is not initialized

### **WPS\_MAX\_MANUFACTURER\_LEN**

Maximum length of the manufacturer name in WPS information

### **WPS\_MAX\_MODEL\_NUMBER\_LEN**

Maximum length of the model number in WPS information

### **WPS\_MAX\_MODEL\_NAME\_LEN**

Maximum length of the model name in WPS information

### **WPS\_MAX\_DEVICE\_NAME\_LEN**

Maximum length of the device name in WPS information

### **PIN\_LEN**

The length of the WPS PIN (Personal Identification Number).

### **WPS\_CONFIG\_INIT\_DEFAULT** (type)

Initialize a default WPS configuration structure with specified WPS type.

This macro initializes a *esp\_wps\_config\_t* structure with default values for the specified WPS type. It sets the WPS type, factory information (including default manufacturer, model number, model name, and device name), and a default PIN value if applicable.

#### Parameters

- **type** –The WPS type to be used (PBC or PIN).

**Returns** An initialized *esp\_wps\_config\_t* structure with the specified WPS type and default values.

## Type Definitions

typedef enum *wps\_type* **wps\_type\_t**

Enumeration of WPS (Wi-Fi Protected Setup) types.

## Enumerations

enum **wps\_type**

Enumeration of WPS (Wi-Fi Protected Setup) types.

*Values:*

enumerator **WPS\_TYPE\_DISABLE**

WPS is disabled

enumerator **WPS\_TYPE\_PBC**

WPS Push Button Configuration method

enumerator **WPS\_TYPE\_PIN**

WPS PIN (Personal Identification Number) method

enumerator **WPS\_TYPE\_MAX**

Maximum value for WPS type enumeration

## Header File

- [components/wpa\\_supplicant/esp\\_supplicant/include/esp\\_rrm.h](#)

## Functions

int **esp\_rrm\_send\_neighbor\_rep\_request** (*neighbor\_rep\_request\_cb* cb, void \*cb\_ctx)

Send Radio measurement neighbor report request to connected AP.

### Parameters

- **cb** –callback function for neighbor report
- **cb\_ctx** –callback context

### Returns

- 0: success
- -1: AP does not support RRM
- -2: station not connected to AP

bool **esp\_rrm\_is\_rrm\_supported\_connection** (void)

Check RRM capability of connected AP.

### Returns

- true: AP supports RRM
- false: AP does not support RRM or station not connected to AP

## Type Definitions

typedef void (\***neighbor\_rep\_request\_cb**)(void \*ctx, const uint8\_t \*report, size\_t report\_len)

Callback function type to get neighbor report.

**Param ctx** neighbor report context

**Param report** neighbor report

**Param report\_len** neighbor report length

**Return**

- void

## Header File

- [components/wpa\\_supplicant/esp\\_supplicant/include/esp\\_wnm.h](#)

## Functions

int **esp\_wmm\_send\_bss\_transition\_mgmt\_query** (enum *btm\_query\_reason* query\_reason, const char \*btm\_candidates, int cand\_list)

Send bss transition query to connected AP.

### Parameters

- **query\_reason** –reason for sending query
- **btm\_candidates** –btm candidates list if available
- **cand\_list** –whether candidate list to be included from scan results available in supplicant's cache.

### Returns

- 0: success
- -1: AP does not support BTM
- -2: station not connected to AP

bool **esp\_wmm\_is\_btm\_supported\_connection** (void)

Check bss transition capability of connected AP.

### Returns

- true: AP supports BTM
- false: AP does not support BTM or station not connected to AP

## Enumerations

enum **btm\_query\_reason**

enum btm\_query\_reason: Reason code for sending btm query

*Values:*

enumerator **REASON\_UNSPECIFIED**

enumerator **REASON\_FRAME\_LOSS**

enumerator **REASON\_DELAY**

enumerator **REASON\_BANDWIDTH**

enumerator **REASON\_LOAD\_BALANCE**

enumerator **REASON\_RSSI**

enumerator **REASON\_RETRANSMISSIONS**

enumerator **REASON\_INTERFERENCE**

enumerator **REASON\_GRAY\_ZONE**

enumerator **REASON\_PREMIUM\_AP**

## Header File

- [components/wpa\\_supplicant/esp\\_supplicant/include/esp\\_mbo.h](#)

## Functions

int **esp\_mbo\_update\_non\_pref\_chan** (struct *non\_pref\_chan\_s* \*non\_pref\_chan)

Update channel preference for MBO IE.

**Parameters** *non\_pref\_chan* –Non preference channel list

**Returns**

- 0: success else failure

## Structures

struct **non\_pref\_chan**

Structure representing a non-preferred channel in a wireless network.

This structure encapsulates information about a non-preferred channel including the reason for its non-preference, the operating class, channel number, and preference level.

## Public Members

enum *non\_pref\_chan\_reason* **reason**

Reason for the channel being non-preferred

uint8\_t **oper\_class**

Operating class of the channel

uint8\_t **chan**

Channel number

uint8\_t **preference**

Preference level of the channel

struct **non\_pref\_chan\_s**

Structure representing a list of non-preferred channels in a wireless network.

This structure encapsulates information about a list of non-preferred channels including the number of non-preferred channels and an array of structures representing individual non-preferred channels.

## Public Members

size\_t **non\_pref\_chan\_num**

Number of non-preferred channels in the list

struct *non\_pref\_chan* **chan** []

Array of structures representing individual non-preferred channels

## Enumerations

enum **non\_pref\_chan\_reason**

Enumeration of reasons for a channel being non-preferred in a wireless network.

This enumeration defines various reasons why a specific channel might be considered non-preferred in a wireless network configuration.

*Values:*

enumerator **NON\_PREF\_CHAN\_REASON\_UNSPECIFIED**

Unspecified reason for non-preference

enumerator **NON\_PREF\_CHAN\_REASON\_RSSI**

Non-preferred due to low RSSI (Received Signal Strength Indication)

enumerator **NON\_PREF\_CHAN\_REASON\_EXT\_INTERFERENCE**

Non-preferred due to external interference

enumerator **NON\_PREF\_CHAN\_REASON\_INT\_INTERFERENCE**

Non-preferred due to internal interference

### Wi-Fi Easy Connect™ (DPP)

Wi-Fi Easy Connect™, also known as Device Provisioning Protocol (DPP) or Easy Connect, is a provisioning protocol certified by Wi-Fi Alliance. It is a secure and standardized provisioning protocol for configuration of Wi-Fi Devices. With Easy Connect adding a new device to a network is as simple as scanning a QR Code. This reduces complexity and enhances user experience while onboarding devices without UI like Smart Home and IoT products. Unlike old protocols like WiFi Protected Setup (WPS), Wi-Fi Easy Connect incorporates strong encryption through public key cryptography to ensure networks remain secure as new devices are added. Easy Connect brings many benefits in the User Experience:

- Simple and intuitive to use; no lengthy instructions to follow for new device setup
- No need to remember and enter passwords into the device being provisioned
- Works with electronic or printed QR codes, or human-readable strings
- Supports both WPA2 and WPA3 networks

Please refer to Wi-Fi Alliance's official page on [Easy Connect](#) for more information.

ESP32-S2 supports Enrollee mode of Easy Connect with QR Code as the provisioning method. A display is required to display this QR Code. Users can scan this QR Code using their capable device and provision the ESP32-S2 to their Wi-Fi network. The provisioning device needs to be connected to the AP which need not support Wi-Fi Easy Connect™. Easy Connect is still an evolving protocol. Of known platforms that support the QR Code method are some Android smartphones with Android 10 or higher. To use Easy Connect no additional App needs to be installed on the supported smartphone.

**Application Example** Example on how to provision ESP32-S2 using a supported smartphone: [wifi/wifi\\_easy\\_connect/dpp-enrollee](#).

### API Reference

#### Header File

- [components/wpa\\_supplicant/esp\\_supplicant/include/esp\\_dpp.h](#)

#### Functions

`esp_err_t esp_supp_dpp_init (esp_supp_dpp_event_cb_t evt_cb)`

Initialize DPP Supplicant.

Starts DPP Supplicant <b>and</b> initializes related Data Structures.
---

return

- ESP\_OK: Success
- ESP\_FAIL: Failure

**Parameters** `evt_cb` –Callback function to receive DPP related events

void `esp_supp_dpp_deinit` (void)

De-initialize DPP Supplicant.

Frees memory **from** DPP Supplicant Data Structures.

*esp\_err\_t* `esp_supp_dpp_bootstrap_gen` (const char \*chan\_list, *esp\_supp\_dpp\_bootstrap\_t* type, const char \*key, const char \*info)

Generates Bootstrap Information as an Enrollee.

Generates Out Of Band Bootstrap information **as** an Enrollee which can be used by a DPP Configurator to provision the Enrollee.

**Parameters**

- **chan\_list** –List of channels device will be available on for listening
- **type** –Bootstrap method type, only QR Code method is supported for now.
- **key** –(Optional) 32 byte Raw Private Key for generating a Bootstrapping Public Key
- **info** –(Optional) Ancilliary Device Information like Serial Number

**Returns**

- ESP\_OK: Success
- ESP\_FAIL: Failure

*esp\_err\_t* `esp_supp_dpp_start_listen` (void)

Start listening on Channels provided during `esp_supp_dpp_bootstrap_gen`.

Listens on every Channel **from** Channel List **for** a pre-defined wait time.

**Returns**

- ESP\_OK: Success
- ESP\_FAIL: Generic Failure
- ESP\_ERR\_INVALID\_STATE: ROC attempted before WiFi is started
- ESP\_ERR\_NO\_MEM: Memory allocation failed while posting ROC request

void `esp_supp_dpp_stop_listen` (void)

Stop listening on Channels.

Stops listening on Channels **and** cancels ongoing listen operation.

**Macros**

**ESP\_DPP\_AUTH\_TIMEOUT\_SECS**

**ESP\_ERR\_DPP\_FAILURE**

Generic failure during DPP Operation

**ESP\_ERR\_DPP\_TX\_FAILURE**

DPP Frame Tx failed OR not Acked

**ESP\_ERR\_DPP\_INVALID\_ATTR**

Encountered invalid DPP Attribute

**ESP\_ERR\_DPP\_AUTH\_TIMEOUT**

DPP Auth response was not recieved in time

**Type Definitions**typedef enum *dpp\_bootstrap\_type* **esp\_supp\_dpp\_bootstrap\_t**

Types of Bootstrap Methods for DPP.

typedef void (\***esp\_supp\_dpp\_event\_cb\_t**)(*esp\_supp\_dpp\_event\_t* evt, void \*data)

Callback function for receiving DPP Events from Supplicant.

Callback function will be called **with** DPP related information.

**Param evt** DPP event ID**Param data** Event data payload**Enumerations**enum **dpp\_bootstrap\_type**

Types of Bootstrap Methods for DPP.

*Values:*enumerator **DPP\_BOOTSTRAP\_QR\_CODE**

QR Code Method

enumerator **DPP\_BOOTSTRAP\_PKEX**

Proof of Knowledge Method

enumerator **DPP\_BOOTSTRAP\_NFC\_URI**

NFC URI record Method

enum **esp\_supp\_dpp\_event\_t**

Types of Callback Events received from DPP Supplicant.

*Values:*enumerator **ESP\_SUPP\_DPP\_URI\_READY**

URI is ready through Bootstrapping

enumerator **ESP\_SUPP\_DPP\_CFG\_RECVD**

Config received via DPP Authentication

enumerator **ESP\_SUPP\_DPP\_FAIL**

DPP Authentication failure

Code examples for the Wi-Fi API are provided in the [wifi](#) directory of ESP-IDF examples.

Code examples for ESP-WIFI-MESH are provided in the [mesh](#) directory of ESP-IDF examples.

## 2.4.2 Ethernet

### Ethernet

**Overview** ESP-IDF provides a set of consistent and flexible APIs to support both internal Ethernet MAC (EMAC) controller and external SPI-Ethernet modules.

This programming guide is split into the following sections:

1. [Basic Ethernet Concepts](#)
2. [Configure MAC and PHY](#)
3. [Connect Driver to TCP/IP Stack](#)
4. [Misc control of Ethernet driver](#)

**Basic Ethernet Concepts** Ethernet is an asynchronous Carrier Sense Multiple Access with Collision Detect (CSMA/CD) protocol/interface. It is generally not well suited for low power applications. However, with ubiquitous deployment, internet connectivity, high data rates and limitless range expandability, Ethernet can accommodate nearly all wired communications.

Normal IEEE 802.3 compliant Ethernet frames are between 64 and 1518 bytes in length. They are made up of five or six different fields: a destination MAC address (DA), a source MAC address (SA), a type/length field, data payload, an optional padding field and a Cyclic Redundancy Check (CRC). Additionally, when transmitted on the Ethernet medium, a 7-byte preamble field and Start-of-Frame (SOF) delimiter byte are appended to the beginning of the Ethernet packet.

Thus the traffic on the twist-pair cabling will appear as shown below:

**Preamble and Start-of-Frame Delimiter** The preamble contains seven bytes of 55H, it allows the receiver to lock onto the stream of data before the actual frame arrives. The Start-of-Frame Delimiter (SFD) is a binary sequence 10101011 (as seen on the physical medium). It is sometimes considered to be part of the preamble.

When transmitting and receiving data, the preamble and SFD bytes will automatically be generated or stripped from the packets.

**Destination Address** The destination address field contains a 6-byte length MAC address of the device that the packet is directed to. If the Least Significant bit in the first byte of the MAC address is set, the address is a multi-cast destination. For example, 01-00-00-00-F0-00 and 33-45-67-89-AB-CD are multi-cast addresses, while 00-00-00-00-F0-00 and 32-45-67-89-AB-CD are not. Packets with multi-cast destination addresses are designed to arrive and be important to a selected group of Ethernet nodes. If the destination address field is the reserved multi-cast address, i.e. FF-FF-FF-FF-FF-FF, the packet is a broadcast packet and it will be directed to everyone sharing the network. If the Least Significant bit in the first byte of the MAC address is clear, the address is a uni-cast address and will be designed for usage by only the addressed node.

Normally the EMAC controller incorporates receive filters which can be used to discard or accept packets with multi-cast, broadcast and/or uni-cast destination addresses. When transmitting packets, the host controller is responsible for writing the desired destination address into the transmit buffer.



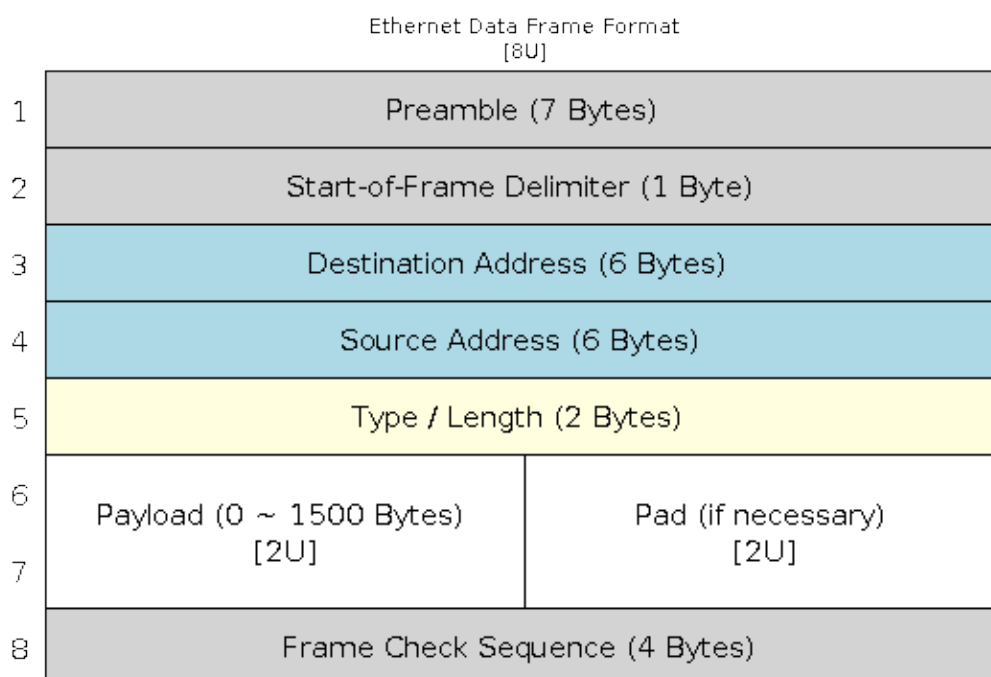

Fig. 3: Ethernet Data Frame Format

**Source Address** The source address field contains a 6-byte length MAC address of the node which created the Ethernet packet. Users of Ethernet must generate a unique MAC address for each controller used. MAC addresses consist of two portions. The first three bytes are known as the Organizationally Unique Identifier (OUI). OUIs are distributed by the IEEE. The last three bytes are address bytes at the discretion of the company that purchased the OUI. More information about MAC Address used in ESP-IDF, please see [MAC Address Allocation](#).

When transmitting packets, the assigned source MAC address must be written into the transmit buffer by the host controller.

**Type / Length** The type/length field is a 2-byte field, if the value in this field is  $\leq 1500$  (decimal), it is considered a length field and it specifies the amount of non-padding data which follows in the data field. If the value is  $\geq 1536$ , it represents the protocol the following packet data belongs to. The following are the most common type values:

- IPv4 = 0800H
- IPv6 = 86DDH
- ARP = 0806H

Users implementing proprietary networks may choose to treat this field as a length field, while applications implementing protocols such as the Internet Protocol (IP) or Address Resolution Protocol (ARP), should program this field with the appropriate type defined by the protocol's specification when transmitting packets.

**Payload** The payload field is a variable length field, anywhere from 0 to 1500 bytes. Larger data packets will violate Ethernet standards and will be dropped by most Ethernet nodes. This field contains the client data, such as an IP datagram.

**Padding and FCS** The padding field is a variable length field added to meet IEEE 802.3 specification requirements when small data payloads are used. The DA, SA, type, payload and padding of an Ethernet packet must be no smaller

than 60 bytes. Adding the required 4-byte FCS field, packets must be no smaller than 64 bytes. If the data field is less than 46 bytes long, a padding field is required.

The FCS field is a 4-byte field which contains an industry standard 32-bit CRC calculated with the data from the DA, SA, type, payload and padding fields. Given the complexity of calculating a CRC, the hardware normally will automatically generate a valid CRC and transmit it. Otherwise, the host controller must generate the CRC and place it in the transmit buffer.

Normally, the host controller does not need to concern itself with padding and the CRC which the hardware EMAC will also be able to automatically generate when transmitting and verify when receiving. However, the padding and CRC fields will be written into the receive buffer when packets arrive, so they may be evaluated by the host controller if needed.

---

**Note:** Besides the basic data frame described above, there're two other common frame types in 10/100 Mbps Ethernet: control frames and VLAN tagged frames. They're not supported in ESP-IDF.

---

**Configure MAC and PHY** Ethernet driver is composed of two parts: MAC and PHY.

We need to setup necessary parameters for MAC and PHY respectively based on your Ethernet board design and then combine the two together, completing the driver installation.

Configuration for MAC is described in `eth_mac_config_t`, including:

- `eth_mac_config_t::sw_reset_timeout_ms`: software reset timeout value, in milliseconds, typically MAC reset should be finished within 100ms.
- `eth_mac_config_t::rx_task_stack_size` and `eth_mac_config_t::rx_task_prio`: the MAC driver creates a dedicated task to process incoming packets, these two parameters are used to set the stack size and priority of the task.
- `eth_mac_config_t::flags`: specifying extra features that the MAC driver should have, it could be useful in some special situations. The value of this field can be OR'd with macros prefixed with `ETH_MAC_FLAG_`. For example, if the MAC driver should work when cache is disabled, then you should configure this field with `ETH_MAC_FLAG_WORK_WITH_CACHE_DISABLE`.

Configuration for PHY is described in `eth_phy_config_t`, including:

- `eth_phy_config_t::phy_addr`: multiple PHY device can share the same SMI bus, so each PHY needs a unique address. Usually this address is configured during hardware design by pulling up/down some PHY strapping pins. You can set the value from 0 to 15 based on your Ethernet board. Especially, if the SMI bus is shared by only one PHY device, setting this value to -1 can enable the driver to detect the PHY address automatically.
- `eth_phy_config_t::reset_timeout_ms`: reset timeout value, in milliseconds, typically PHY reset should be finished within 100ms.
- `eth_phy_config_t::autonego_timeout_ms`: auto-negotiation timeout value, in milliseconds. Ethernet driver will start negotiation with the peer Ethernet node automatically, to determine to duplex and speed mode. This value usually depends on the ability of the PHY device on your board.
- `eth_phy_config_t::reset_gpio_num`: if your board also connect the PHY reset pin to one of the GPIO, then set it here. Otherwise, set this field to -1.

ESP-IDF provides a default configuration for MAC and PHY in macro `ETH_MAC_DEFAULT_CONFIG` and `ETH_PHY_DEFAULT_CONFIG`.

**Create MAC and PHY Instance** Ethernet driver is implemented in an Object-Oriented style. Any operation on MAC and PHY should be based on the instance of them two.

**SPI-Ethernet Module**

```

eth_mac_config_t mac_config = ETH_MAC_DEFAULT_CONFIG();           // apply default
↳common MAC configuration
eth_phy_config_t phy_config = ETH_PHY_DEFAULT_CONFIG();           // apply default PHY
↳configuration
phy_config.phy_addr = CONFIG_EXAMPLE_ETH_PHY_ADDR;                // alter the PHY
↳address according to your board design
phy_config.reset_gpio_num = CONFIG_EXAMPLE_ETH_PHY_RST_GPIO;     // alter the GPIO
↳used for PHY reset
// Install GPIO interrupt service (as the SPI-Ethernet module is interrupt driven)
gpio_install_isr_service(0);
// SPI bus configuration
spi_device_handle_t spi_handle = NULL;
spi_bus_config_t buscfg = {
    .miso_io_num = CONFIG_EXAMPLE_ETH_SPI_MISO_GPIO,
    .mosi_io_num = CONFIG_EXAMPLE_ETH_SPI_MOSI_GPIO,
    .sclk_io_num = CONFIG_EXAMPLE_ETH_SPI_SCLK_GPIO,
    .quadwp_io_num = -1,
    .quadhd_io_num = -1,
};
ESP_ERROR_CHECK(spi_bus_initialize(CONFIG_EXAMPLE_ETH_SPI_HOST, &buscfg, 1));
// Configure SPI device
spi_device_interface_config_t spi_devcfg = {
    .mode = 0,
    .clock_speed_hz = CONFIG_EXAMPLE_ETH_SPI_CLOCK_MHZ * 1000 * 1000,
    .spics_io_num = CONFIG_EXAMPLE_ETH_SPI_CS_GPIO,
    .queue_size = 20
};
/* dm9051 ethernet driver is based on spi driver */
eth_dm9051_config_t dm9051_config = ETH_DM9051_DEFAULT_CONFIG(CONFIG_EXAMPLE_ETH_
↳SPI_HOST, &spi_devcfg);
dm9051_config.int_gpio_num = CONFIG_EXAMPLE_ETH_SPI_INT_GPIO;
esp_eth_mac_t *mac = esp_eth_mac_new_dm9051(&dm9051_config, &mac_config);
esp_eth_phy_t *phy = esp_eth_phy_new_dm9051(&phy_config);

```

**Note:**

- When creating MAC and PHY instance for SPI-Ethernet modules (e.g. DM9051), the constructor function must have the same suffix (e.g. `esp_eth_mac_new_dm9051` and `esp_eth_phy_new_dm9051`). This is because we don't have other choices but the integrated PHY.
- The SPI device configuration (i.e. `spi_device_interface_config_t`) may slightly differ for other Ethernet modules or to meet SPI timing on specific PCB. Please check out your module's spec and the examples in `esp-idf`.

**Install Driver** To install the Ethernet driver, we need to combine the instance of MAC and PHY and set some additional high-level configurations (i.e. not specific to either MAC or PHY) in `esp_eth_config_t`:

- `esp_eth_config_t::mac`: instance that created from MAC generator (e.g. `esp_eth_mac_new_esp32()`).
- `esp_eth_config_t::phy`: instance that created from PHY generator (e.g. `esp_eth_phy_new_ip101()`).
- `esp_eth_config_t::check_link_period_ms`: Ethernet driver starts an OS timer to check the link status periodically, this field is used to set the interval, in milliseconds.
- `esp_eth_config_t::stack_input`: In most of Ethernet IoT applications, any Ethernet frame that received by driver should be passed to upper layer (e.g. TCP/IP stack). This field is set to a function which is responsible to deal with the incoming frames. You can even update this field at runtime via function `esp_eth_update_input_path()` after driver installation.
- `esp_eth_config_t::on_lowlevel_init_done` and `esp_eth_config_t::on_lowlevel_deinit_done`: These two fields are used to specify the hooks which get invoked when low level hardware has been initialized or de-initialized.

ESP-IDF provides a default configuration for driver installation in macro `ETH_DEFAULT_CONFIG`.

```
esp_eth_config_t config = ETH_DEFAULT_CONFIG(mac, phy); // apply default driver_
↳configuration
esp_eth_handle_t eth_handle = NULL; // after driver installed, we will get the_
↳handle of the driver
esp_eth_driver_install(&config, &eth_handle); // install driver
```

Ethernet driver also includes event-driven model, which will send useful and important event to user space. We need to initialize the event loop before installing the Ethernet driver. For more information about event-driven programming, please refer to [ESP Event](#).

```
/** Event handler for Ethernet events */
static void eth_event_handler(void *arg, esp_event_base_t event_base,
                             int32_t event_id, void *event_data)
{
    uint8_t mac_addr[6] = {0};
    /* we can get the ethernet driver handle from event data */
    esp_eth_handle_t eth_handle = *(esp_eth_handle_t *)event_data;

    switch (event_id) {
        case ETHERNET_EVENT_CONNECTED:
            esp_eth_ioctl(eth_handle, ETH_CMD_G_MAC_ADDR, mac_addr);
            ESP_LOGI(TAG, "Ethernet Link Up");
            ESP_LOGI(TAG, "Ethernet HW Addr %02x:%02x:%02x:%02x:%02x:%02x",
                    mac_addr[0], mac_addr[1], mac_addr[2], mac_addr[3], mac_
↳addr[4], mac_addr[5]);
            break;
        case ETHERNET_EVENT_DISCONNECTED:
            ESP_LOGI(TAG, "Ethernet Link Down");
            break;
        case ETHERNET_EVENT_START:
            ESP_LOGI(TAG, "Ethernet Started");
            break;
        case ETHERNET_EVENT_STOP:
            ESP_LOGI(TAG, "Ethernet Stopped");
            break;
        default:
            break;
    }
}

esp_event_loop_create_default(); // create a default event loop that running in_
↳background
esp_event_handler_register(ETH_EVENT, ESP_EVENT_ANY_ID, &eth_event_handler, NULL);_
↳// register Ethernet event handler (to deal with user specific stuffs when event_
↳like link up/down happened)
```

**Start Ethernet Driver** After driver installation, we can start Ethernet immediately.

```
esp_eth_start(eth_handle); // start Ethernet driver state machine
```

**Connect Driver to TCP/IP Stack** Up until now, we have installed the Ethernet driver. From the view of OSI (Open System Interconnection), we're still on level 2 (i.e. Data Link Layer). We can detect link up and down event, we can gain MAC address in user space, but we can't obtain IP address, let alone send HTTP request. The TCP/IP stack used in ESP-IDF is called LwIP, for more information about it, please refer to [LwIP](#).

To connect Ethernet driver to TCP/IP stack, these three steps need to follow:

1. Create network interface for Ethernet driver
2. Attach the network interface to Ethernet driver

### 3. Register IP event handlers

More information about network interface, please refer to [Network Interface](#).

```

/** Event handler for IP_EVENT_ETH_GOT_IP */
static void got_ip_event_handler(void *arg, esp_event_base_t event_base,
                                int32_t event_id, void *event_data)
{
    ip_event_got_ip_t *event = (ip_event_got_ip_t *) event_data;
    const esp_netif_ip_info_t *ip_info = &event->ip_info;

    ESP_LOGI(TAG, "Ethernet Got IP Address");
    ESP_LOGI(TAG, "~~~~~");
    ESP_LOGI(TAG, "ETHIP:" IPSTR, IP2STR(&ip_info->ip));
    ESP_LOGI(TAG, "ETHMASK:" IPSTR, IP2STR(&ip_info->netmask));
    ESP_LOGI(TAG, "ETHGW:" IPSTR, IP2STR(&ip_info->gw));
    ESP_LOGI(TAG, "~~~~~");
}

esp_netif_init(); // Initialize TCP/IP network interface (should be called only
↳once in application)
esp_netif_config_t cfg = ESP_NETIF_DEFAULT_ETH(); // apply default network
↳interface configuration for Ethernet
esp_netif_t *eth_netif = esp_netif_new(&cfg); // create network interface for
↳Ethernet driver

esp_netif_attach(eth_netif, esp_eth_new_netif_glue(eth_handle)); // attach
↳Ethernet driver to TCP/IP stack
esp_event_handler_register(IP_EVENT, IP_EVENT_ETH_GOT_IP, &got_ip_event_handler,
↳NULL); // register user defined IP event handlers
esp_eth_start(eth_handle); // start Ethernet driver state machine

```

**Warning:** It is recommended to fully initialize the Ethernet driver and network interface prior registering user's Ethernet/IP event handlers, i.e. register the event handlers as the last thing prior starting the Ethernet driver. Such approach ensures that Ethernet/IP events get executed first by the Ethernet driver or network interface and so the system is in expected state when executing user's handlers.

**Misc control of Ethernet driver** The following functions should only be invoked after the Ethernet driver has been installed.

- Stop Ethernet driver: `esp_eth_stop()`
- Update Ethernet data input path: `esp_eth_update_input_path()`
- Misc get/set of Ethernet driver attributes: `esp_eth_ioctl()`

```

/* get MAC address */
uint8_t mac_addr[6];
memset(mac_addr, 0, sizeof(mac_addr));
esp_eth_ioctl(eth_handle, ETH_CMD_G_MAC_ADDR, mac_addr);
ESP_LOGI(TAG, "Ethernet MAC Address: %02x:%02x:%02x:%02x:%02x:%02x",
         mac_addr[0], mac_addr[1], mac_addr[2], mac_addr[3], mac_addr[4], mac_
↳addr[5]);

/* get PHY address */
int phy_addr = -1;
esp_eth_ioctl(eth_handle, ETH_CMD_G_PHY_ADDR, &phy_addr);
ESP_LOGI(TAG, "Ethernet PHY Address: %d", phy_addr);

```

**Flow control** Ethernet on MCU usually has a limitation in the number of frames it can handle during network congestion, because of the limitation in RAM size. A sending station might be transmitting data faster than the

peer end can accept it. Ethernet flow control mechanism allows the receiving node to signal the sender requesting suspension of transmissions until the receiver catches up. The magic behind that is the pause frame, which was defined in IEEE 802.3x.

Pause frame is a special Ethernet frame used to carry the pause command, whose EtherType field is 0x8808, with the Control opcode set to 0x0001. Only stations configured for full-duplex operation may send pause frames. When a station wishes to pause the other end of a link, it sends a pause frame to the 48-bit reserved multicast address of 01-80-C2-00-00-01. The pause frame also includes the period of pause time being requested, in the form of a two-byte integer, ranging from 0 to 65535.

After Ethernet driver installation, the flow control feature is disabled by default. You can enable it by:

```
bool flow_ctrl_enable = true;
esp_eth_ioctl(eth_handle, ETH_CMD_S_FLOW_CTRL, &flow_ctrl_enable);
```

One thing should be kept in mind, is that the pause frame ability will be advertised to peer end by PHY during auto negotiation. Ethernet driver sends pause frame only when both sides of the link support it.

### Application Examples

- Ethernet basic example: [ethernet/basic](#).
- Ethernet iperf example: [ethernet/iperf](#).
- Ethernet to Wi-Fi AP “router” : [ethernet/eth2ap](#).
- Most of protocol examples should also work for Ethernet: [protocols](#).

### Advanced Topics

**Custom PHY Driver** There are multiple PHY manufactures with their wide portfolios of chips available. The ESP-IDF already supports several PHY chips however one can easily get to a point where none of them satisfies user’s actual needs due to either price, features, stock availability etc.

Luckily, a management interface between EMAC and PHY is standardized by IEEE 802.3 in 22.2.4 Management functions section. It defines provisions of so called “MII Management Interface” for the purposes of controlling the PHY and gathering status from the PHY. A set of management registers is defined to control chip behavior, link properties, auto-negotiation configuration etc. This basic management functionality is addressed by [esp\\_eth/src/esp\\_eth\\_phy\\_802\\_3.c](#) in ESP-IDF and so it makes a creation of new custom PHY chip driver quite a simple task.

---

**Note:** Always consult with PHY datasheet since some PHY chips may not comply with IEEE 802.3, Section 22.2.4. It does not mean you are not able to create a custom PHY driver, it will just require more effort. You will have to define all PHY management functions.

---

Majority of PHY management functionality required by the ESP-IDF Ethernet driver is covered by the [esp\\_eth/src/esp\\_eth\\_phy\\_802\\_3.c](#) however, the following may require developing chip specific management functions:

- link status which is almost always chip specific,
- chip initialization, even though it is not strictly required, should be customized to at least ensure that expected chip is used and
- chip specific features configuration.

#### Steps to create custom PHY driver:

1. Define vendor specific registry layout based on PHY datasheet. See [esp\\_eth/src/esp\\_eth\\_phy\\_ip101.c](#) as an example.
2. Prepare derived PHY management object infostructure which
  - must contain at least parent IEEE 802.3 [phy\\_802\\_3\\_t](#) object and
  - optionally contain additional variables needed to support non-IEEE 802.3 or customized functionality. See [esp\\_eth/src/esp\\_eth\\_phy\\_ksz80xx.c](#) as an example.

3. Define chip specific management call-back functions.
4. Initialize parent IEEE 802.3 object and re-assign chip specific management call-back functions.

Once you finish the new custom PHY driver implementation, consider sharing it among with other users via [IDF Component Registry](#).

## API Reference

### Header File

- [components/esp\\_eth/include/esp\\_eth.h](#)

### Header File

- [components/esp\\_eth/include/esp\\_eth\\_driver.h](#)

### Functions

*esp\_err\_t* **esp\_eth\_driver\_install** (const *esp\_eth\_config\_t* \*config, *esp\_eth\_handle\_t* \*out\_hdl)

Install Ethernet driver.

#### Parameters

- **config** –[in] configuration of the Ethernet driver
- **out\_hdl** –[out] handle of Ethernet driver

#### Returns

- ESP\_OK: install esp\_eth driver successfully
- ESP\_ERR\_INVALID\_ARG: install esp\_eth driver failed because of some invalid argument
- ESP\_ERR\_NO\_MEM: install esp\_eth driver failed because there's no memory for driver
- ESP\_FAIL: install esp\_eth driver failed because some other error occurred

*esp\_err\_t* **esp\_eth\_driver\_uninstall** (*esp\_eth\_handle\_t* hdl)

Uninstall Ethernet driver.

---

**Note:** It's not recommended to uninstall Ethernet driver unless it won't get used any more in application code. To uninstall Ethernet driver, you have to make sure, all references to the driver are released. Ethernet driver can only be uninstalled successfully when reference counter equals to one.

---

**Parameters** **hdl** –[in] handle of Ethernet driver

#### Returns

- ESP\_OK: uninstall esp\_eth driver successfully
- ESP\_ERR\_INVALID\_ARG: uninstall esp\_eth driver failed because of some invalid argument
- ESP\_ERR\_INVALID\_STATE: uninstall esp\_eth driver failed because it has more than one reference
- ESP\_FAIL: uninstall esp\_eth driver failed because some other error occurred

*esp\_err\_t* **esp\_eth\_start** (*esp\_eth\_handle\_t* hdl)

Start Ethernet driver **ONLY** in standalone mode (i.e. without TCP/IP stack)

---

**Note:** This API will start driver state machine and internal software timer (for checking link status).

---

**Parameters** **hdl** –[in] handle of Ethernet driver

#### Returns

- ESP\_OK: start esp\_eth driver successfully
- ESP\_ERR\_INVALID\_ARG: start esp\_eth driver failed because of some invalid argument



- `ESP_ERR_INVALID_STATE`: start `esp_eth` driver failed because driver has started already
- `ESP_FAIL`: start `esp_eth` driver failed because some other error occurred

`esp_err_t esp_eth_stop(esp_eth_handle_t hdl)`

Stop Ethernet driver.

---

**Note:** This function does the oppsite operation of `esp_eth_start`.

---

**Parameters** `hdl` –[in] handle of Ethernet driver

**Returns**

- `ESP_OK`: stop `esp_eth` driver successfully
- `ESP_ERR_INVALID_ARG`: stop `esp_eth` driver failed because of some invalid argument
- `ESP_ERR_INVALID_STATE`: stop `esp_eth` driver failed because driver has not started yet
- `ESP_FAIL`: stop `esp_eth` driver failed because some other error occurred

`esp_err_t esp_eth_update_input_path(esp_eth_handle_t hdl, esp_err_t (*stack_input)(esp_eth_handle_t hdl, uint8_t *buffer, uint32_t length, void *priv), void *priv)`

Update Ethernet data input path (i.e. specify where to pass the input buffer)

---

**Note:** After install driver, Ethernet still don't know where to deliver the input buffer. In fact, this API registers a callback function which get invoked when Ethernet received new packets.

---

**Parameters**

- `hdl` –[in] handle of Ethernet driver
- `stack_input` –[in] function pointer, which does the actual process on incoming packets
- `priv` –[in] private resource, which gets passed to `stack_input` callback without any modification

**Returns**

- `ESP_OK`: update input path successfully
- `ESP_ERR_INVALID_ARG`: update input path failed because of some invalid argument
- `ESP_FAIL`: update input path failed because some other error occurred

`esp_err_t esp_eth_transmit(esp_eth_handle_t hdl, void *buf, size_t length)`

General Transmit.

**Parameters**

- `hdl` –[in] handle of Ethernet driver
- `buf` –[in] buffer of the packet to transfer
- `length` –[in] length of the buffer to transfer

**Returns**

- `ESP_OK`: transmit frame buffer successfully
- `ESP_ERR_INVALID_ARG`: transmit frame buffer failed because of some invalid argument
- `ESP_ERR_INVALID_STATE`: invalid driver state (e.i. driver is not started)
- `ESP_ERR_TIMEOUT`: transmit frame buffer failed because HW was not get available in predefined period
- `ESP_FAIL`: transmit frame buffer failed because some other error occurred

`esp_err_t esp_eth_transmit_vargs(esp_eth_handle_t hdl, uint32_t argc, ...)`

Special Transmit with variable number of arguments.

**Parameters**

- `hdl` –[in] handle of Ethernet driver



- **argc** –[in] number variable arguments
- . . . –variable arguments

**Returns**

- ESP\_OK: transmit successful
- ESP\_ERR\_INVALID\_STATE: invalid driver state (e.i. driver is not started)
- ESP\_ERR\_TIMEOUT: transmit frame buffer failed because HW was not get available in predefined period
- ESP\_FAIL: transmit frame buffer failed because some other error occurred

*esp\_err\_t* **esp\_eth\_ioctl** (*esp\_eth\_handle\_t* hdl, *esp\_eth\_io\_cmd\_t* cmd, void \*data)

Misc IO function of Ethernet driver.

The following common IO control commands are supported:

- ETH\_CMD\_S\_MAC\_ADDR sets Ethernet interface MAC address. *data* argument is pointer to MAC address buffer with expected size of 6 bytes.
- ETH\_CMD\_G\_MAC\_ADDR gets Ethernet interface MAC address. *data* argument is pointer to a buffer to which MAC address is to be copied. The buffer size must be at least 6 bytes.
- ETH\_CMD\_S\_PHY\_ADDR sets PHY address in range of <0-31>. *data* argument is pointer to memory of *uint32\_t* datatype from where the configuration option is read.
- ETH\_CMD\_G\_PHY\_ADDR gets PHY address. *data* argument is pointer to memory of *uint32\_t* datatype to which the PHY address is to be stored.
- ETH\_CMD\_S\_AUTONEGO enables or disables Ethernet link speed and duplex mode autonegotiation. *data* argument is pointer to memory of *bool* datatype from which the configuration option is read. Preconditions: Ethernet driver needs to be stopped.
- ETH\_CMD\_G\_AUTONEGO gets current configuration of the Ethernet link speed and duplex mode autonegotiation. *data* argument is pointer to memory of *bool* datatype to which the current configuration is to be stored.
- ETH\_CMD\_S\_SPEED sets the Ethernet link speed. *data* argument is pointer to memory of *eth\_speed\_t* datatype from which the configuration option is read. Preconditions: Ethernet driver needs to be stopped and auto-negotiation disabled.
- ETH\_CMD\_G\_SPEED gets current Ethernet link speed. *data* argument is pointer to memory of *eth\_speed\_t* datatype to which the speed is to be stored.
- ETH\_CMD\_S\_PROMISCUOUS sets/resets Ethernet interface promiscuous mode. *data* argument is pointer to memory of *bool* datatype from which the configuration option is read.
- ETH\_CMD\_S\_FLOW\_CTRL sets/resets Ethernet interface flow control. *data* argument is pointer to memory of *bool* datatype from which the configuration option is read.
- ETH\_CMD\_S\_DUPLEX\_MODE sets the Ethernet duplex mode. *data* argument is pointer to memory of *eth\_duplex\_t* datatype from which the configuration option is read. Preconditions: Ethernet driver needs to be stopped and auto-negotiation disabled.
- ETH\_CMD\_G\_DUPLEX\_MODE gets current Ethernet link duplex mode. *data* argument is pointer to memory of *eth\_duplex\_t* datatype to which the duplex mode is to be stored.
- ETH\_CMD\_S\_PHY\_LOOPBACK sets/resets PHY to/from loopback mode. *data* argument is pointer to memory of *bool* datatype from which the configuration option is read.
- Note that additional control commands may be available for specific MAC or PHY chips. Please consult specific MAC or PHY documentation or driver code.

**Parameters**

- **hdl** –[in] handle of Ethernet driver
- **cmd** –[in] IO control command
- **data** –[inout] address of data for *set* command or address where to store the data when used with *get* command

**Returns**

- ESP\_OK: process io command successfully
- ESP\_ERR\_INVALID\_ARG: process io command failed because of some invalid argument
- ESP\_FAIL: process io command failed because some other error occurred

- `ESP_ERR_NOT_SUPPORTED`: requested feature is not supported

*esp\_err\_t* **esp\_eth\_increase\_reference** (*esp\_eth\_handle\_t* hdl)

Increase Ethernet driver reference.

---

**Note:** Ethernet driver handle can be obtained by `os_timer`, `netif`, etc. It's dangerous when thread A is using Ethernet but thread B uninstalls the driver. Using reference counter can prevent such risk, but care should be taken, when you obtain Ethernet driver, this API must be invoked so that the driver won't be uninstalled during your using time.

---

**Parameters** `hdl` –[in] handle of Ethernet driver

**Returns**

- `ESP_OK`: increase reference successfully
- `ESP_ERR_INVALID_ARG`: increase reference failed because of some invalid argument

*esp\_err\_t* **esp\_eth\_decrease\_reference** (*esp\_eth\_handle\_t* hdl)

Decrease Ethernet driver reference.

**Parameters** `hdl` –[in] handle of Ethernet driver

**Returns**

- `ESP_OK`: increase reference successfully
- `ESP_ERR_INVALID_ARG`: increase reference failed because of some invalid argument

## Structures

struct **esp\_eth\_config\_t**

Configuration of Ethernet driver.

## Public Members

*esp\_eth\_mac\_t* \***mac**

Ethernet MAC object.

*esp\_eth\_phy\_t* \***phy**

Ethernet PHY object.

uint32\_t **check\_link\_period\_ms**

Period time of checking Ethernet link status.

*esp\_err\_t* (**\*stack\_input**)(*esp\_eth\_handle\_t* eth\_handle, uint8\_t \*buffer, uint32\_t length, void \*priv)

Input frame buffer to user's stack.

**Param eth\_handle** [in] handle of Ethernet driver

**Param buffer** [in] frame buffer that will get input to upper stack

**Param length** [in] length of the frame buffer

**Return**

- `ESP_OK`: input frame buffer to upper stack successfully
- `ESP_FAIL`: error occurred when inputting buffer to upper stack

*esp\_err\_t* (**\*on\_lowlevel\_init\_done**)(*esp\_eth\_handle\_t* eth\_handle)

Callback function invoked when lowlevel initialization is finished.

**Param eth\_handle** [in] handle of Ethernet driver

**Return**

- ESP\_OK: process extra lowlevel initialization successfully
- ESP\_FAIL: error occurred when processing extra lowlevel initialization

*esp\_err\_t* (\***on\_lowlevel\_deinit\_done**)(*esp\_eth\_handle\_t* eth\_handle)

Callback function invoked when lowlevel deinitialization is finished.

**Param eth\_handle [in]** handle of Ethernet driver

**Return**

- ESP\_OK: process extra lowlevel deinitialization successfully
- ESP\_FAIL: error occurred when processing extra lowlevel deinitialization

*esp\_err\_t* (\***read\_phy\_reg**)(*esp\_eth\_handle\_t* eth\_handle, uint32\_t phy\_addr, uint32\_t phy\_reg, uint32\_t \*reg\_value)

Read PHY register.

---

**Note:** Usually the PHY register read/write function is provided by MAC (SMI interface), but if the PHY device is managed by other interface (e.g. I2C), then user needs to implement the corresponding read/write. Setting this to NULL means your PHY device is managed by MAC's SMI interface.

---

**Param eth\_handle [in]** handle of Ethernet driver

**Param phy\_addr [in]** PHY chip address (0~31)

**Param phy\_reg [in]** PHY register index code

**Param reg\_value [out]** PHY register value

**Return**

- ESP\_OK: read PHY register successfully
- ESP\_ERR\_INVALID\_ARG: read PHY register failed because of invalid argument
- ESP\_ERR\_TIMEOUT: read PHY register failed because of timeout
- ESP\_FAIL: read PHY register failed because some other error occurred

*esp\_err\_t* (\***write\_phy\_reg**)(*esp\_eth\_handle\_t* eth\_handle, uint32\_t phy\_addr, uint32\_t phy\_reg, uint32\_t reg\_value)

Write PHY register.

---

**Note:** Usually the PHY register read/write function is provided by MAC (SMI interface), but if the PHY device is managed by other interface (e.g. I2C), then user needs to implement the corresponding read/write. Setting this to NULL means your PHY device is managed by MAC's SMI interface.

---

**Param eth\_handle [in]** handle of Ethernet driver

**Param phy\_addr [in]** PHY chip address (0~31)

**Param phy\_reg [in]** PHY register index code

**Param reg\_value [in]** PHY register value

**Return**

- ESP\_OK: write PHY register successfully
- ESP\_ERR\_INVALID\_ARG: read PHY register failed because of invalid argument
- ESP\_ERR\_TIMEOUT: write PHY register failed because of timeout
- ESP\_FAIL: write PHY register failed because some other error occurred

struct **esp\_eth\_phy\_reg\_rw\_data\_t**

Data structure to Read/Write PHY register via ioctl API.

**Public Members**

uint32\_t **reg\_addr**

PHY register address

uint32\_t \***reg\_value\_p**

Pointer to a memory where the register value is read/written

### Macros

**ETH\_DEFAULT\_CONFIG** (emac, ephy)

Default configuration for Ethernet driver.

### Type Definitions

typedef void \***esp\_eth\_handle\_t**

Handle of Ethernet driver.

### Enumerations

enum **esp\_eth\_io\_cmd\_t**

Command list for ioctl API.

*Values:*

enumerator **ETH\_CMD\_G\_MAC\_ADDR**

Get MAC address

enumerator **ETH\_CMD\_S\_MAC\_ADDR**

Set MAC address

enumerator **ETH\_CMD\_G\_PHY\_ADDR**

Get PHY address

enumerator **ETH\_CMD\_S\_PHY\_ADDR**

Set PHY address

enumerator **ETH\_CMD\_G\_AUTONEGO**

Get PHY Auto Negotiation

enumerator **ETH\_CMD\_S\_AUTONEGO**

Set PHY Auto Negotiation

enumerator **ETH\_CMD\_G\_SPEED**

Get Speed

enumerator **ETH\_CMD\_S\_SPEED**

Set Speed

enumerator **ETH\_CMD\_S\_PROMISCUOUS**

Set promiscuous mode

- enumerator **ETH\_CMD\_S\_FLOW\_CTRL**  
Set flow control
- enumerator **ETH\_CMD\_G\_DUPLEX\_MODE**  
Get Duplex mode
- enumerator **ETH\_CMD\_S\_DUPLEX\_MODE**  
Set Duplex mode
- enumerator **ETH\_CMD\_S\_PHY\_LOOPBACK**  
Set PHY loopback
- enumerator **ETH\_CMD\_READ\_PHY\_REG**  
Read PHY register
- enumerator **ETH\_CMD\_WRITE\_PHY\_REG**  
Write PHY register
- enumerator **ETH\_CMD\_CUSTOM\_MAC\_CMDS**
- enumerator **ETH\_CMD\_CUSTOM\_PHY\_CMDS**

### Header File

- [components/esp\\_eth/include/esp\\_eth\\_com.h](#)

### Structures

struct **esp\_eth\_mediator\_s**  
Ethernet mediator.

### Public Members

*esp\_err\_t* (**\*phy\_reg\_read**)(*esp\_eth\_mediator\_t* \*eth, uint32\_t phy\_addr, uint32\_t phy\_reg, uint32\_t \*reg\_value)

Read PHY register.

**Param eth [in]** mediator of Ethernet driver  
**Param phy\_addr [in]** PHY Chip address (0~31)  
**Param phy\_reg [in]** PHY register index code  
**Param reg\_value [out]** PHY register value

**Return**

- ESP\_OK: read PHY register successfully
- ESP\_FAIL: read PHY register failed because some error occurred

*esp\_err\_t* (**\*phy\_reg\_write**)(*esp\_eth\_mediator\_t* \*eth, uint32\_t phy\_addr, uint32\_t phy\_reg, uint32\_t reg\_value)

Write PHY register.

**Param eth [in]** mediator of Ethernet driver  
**Param phy\_addr [in]** PHY Chip address (0~31)

**Param phy\_reg [in]** PHY register index code

**Param reg\_value [in]** PHY register value

**Return**

- ESP\_OK: write PHY register successfully
- ESP\_FAIL: write PHY register failed because some error occurred

*esp\_err\_t* (\***stack\_input**)(*esp\_eth\_mediator\_t* \*eth, uint8\_t \*buffer, uint32\_t length)

Deliver packet to upper stack.

**Param eth [in]** mediator of Ethernet driver

**Param buffer [in]** packet buffer

**Param length [in]** length of the packet

**Return**

- ESP\_OK: deliver packet to upper stack successfully
- ESP\_FAIL: deliver packet failed because some error occurred

*esp\_err\_t* (\***on\_state\_changed**)(*esp\_eth\_mediator\_t* \*eth, *esp\_eth\_state\_t* state, void \*args)

Callback on Ethernet state changed.

**Param eth [in]** mediator of Ethernet driver

**Param state [in]** new state

**Param args [in]** optional argument for the new state

**Return**

- ESP\_OK: process the new state successfully
- ESP\_FAIL: process the new state failed because some error occurred

## Type Definitions

typedef struct *esp\_eth\_mediator\_s* **esp\_eth\_mediator\_t**

Ethernet mediator.

## Enumerations

enum **esp\_eth\_state\_t**

Ethernet driver state.

*Values:*

enumerator **ETH\_STATE\_LLINIT**

Lowlevel init done

enumerator **ETH\_STATE\_DEINIT**

Deinit done

enumerator **ETH\_STATE\_LINK**

Link status changed

enumerator **ETH\_STATE\_SPEED**

Speed updated

enumerator **ETH\_STATE\_DUPLEX**

Duplex updated

enumerator **ETH\_STATE\_PAUSE**

Pause ability updated

enum **eth\_event\_t**

Ethernet event declarations.

*Values:*

enumerator **ETHERNET\_EVENT\_START**

Ethernet driver start

enumerator **ETHERNET\_EVENT\_STOP**

Ethernet driver stop

enumerator **ETHERNET\_EVENT\_CONNECTED**

Ethernet got a valid link

enumerator **ETHERNET\_EVENT\_DISCONNECTED**

Ethernet lost a valid link

### Header File

- [components/esp\\_eth/include/esp\\_eth\\_mac.h](#)

### Unions

union **eth\_mac\_clock\_config\_t**

*#include* <esp\_eth\_mac.h> Ethernet MAC Clock Configuration.

### Public Members

struct *eth\_mac\_clock\_config\_t*::[anonymous] **mi**

EMAC MII Clock Configuration

*emac\_rmii\_clock\_mode\_t* **clock\_mode**

RMII Clock Mode Configuration

*emac\_rmii\_clock\_gpio\_t* **clock\_gpio**

RMII Clock GPIO Configuration

struct *eth\_mac\_clock\_config\_t*::[anonymous] **rmii**

EMAC RMII Clock Configuration

### Structures

struct **esp\_eth\_mac\_s**

Ethernet MAC.

**Public Members**

*esp\_err\_t* (\***set\_mediator**)(*esp\_eth\_mac\_t* \*mac, *esp\_eth\_mediator\_t* \*eth)

Set mediator for Ethernet MAC.

**Param mac [in]** Ethernet MAC instance

**Param eth [in]** Ethernet mediator

**Return**

- ESP\_OK: set mediator for Ethernet MAC successfully
- ESP\_ERR\_INVALID\_ARG: set mediator for Ethernet MAC failed because of invalid argument

*esp\_err\_t* (\***init**)(*esp\_eth\_mac\_t* \*mac)

Initialize Ethernet MAC.

**Param mac [in]** Ethernet MAC instance

**Return**

- ESP\_OK: initialize Ethernet MAC successfully
- ESP\_ERR\_TIMEOUT: initialize Ethernet MAC failed because of timeout
- ESP\_FAIL: initialize Ethernet MAC failed because some other error occurred

*esp\_err\_t* (\***deinit**)(*esp\_eth\_mac\_t* \*mac)

Deinitialize Ethernet MAC.

**Param mac [in]** Ethernet MAC instance

**Return**

- ESP\_OK: deinitialize Ethernet MAC successfully
- ESP\_FAIL: deinitialize Ethernet MAC failed because some error occurred

*esp\_err\_t* (\***start**)(*esp\_eth\_mac\_t* \*mac)

Start Ethernet MAC.

**Param mac [in]** Ethernet MAC instance

**Return**

- ESP\_OK: start Ethernet MAC successfully
- ESP\_FAIL: start Ethernet MAC failed because some other error occurred

*esp\_err\_t* (\***stop**)(*esp\_eth\_mac\_t* \*mac)

Stop Ethernet MAC.

**Param mac [in]** Ethernet MAC instance

**Return**

- ESP\_OK: stop Ethernet MAC successfully
- ESP\_FAIL: stop Ethernet MAC failed because some error occurred

*esp\_err\_t* (\***transmit**)(*esp\_eth\_mac\_t* \*mac, *uint8\_t* \*buf, *uint32\_t* length)

Transmit packet from Ethernet MAC.

---

**Note:** Returned error codes may differ for each specific MAC chip.

---

**Param mac [in]** Ethernet MAC instance

**Param buf [in]** packet buffer to transmit

**Param length [in]** length of packet

**Return**

- ESP\_OK: transmit packet successfully



- ESP\_ERR\_INVALID\_SIZE: number of actually sent bytes differs to expected
- ESP\_FAIL: transmit packet failed because some other error occurred

*esp\_err\_t* (\***transmit\_vargs**)(*esp\_eth\_mac\_t* \*mac, uint32\_t argc, va\_list args)

Transmit packet from Ethernet MAC constructed with special parameters at Layer2.

---

**Note:** Typical intended use case is to make possible to construct a frame from multiple higher layer buffers without a need of buffer reallocations. However, other use cases are not limited.

---

---

**Note:** Returned error codes may differ for each specific MAC chip.

---

**Param mac [in]** Ethernet MAC instance

**Param argc [in]** number variable arguments

**Param args [in]** variable arguments

**Return**

- ESP\_OK: transmit packet successfully
- ESP\_ERR\_INVALID\_SIZE: number of actually sent bytes differs to expected
- ESP\_FAIL: transmit packet failed because some other error occurred

*esp\_err\_t* (\***receive**)(*esp\_eth\_mac\_t* \*mac, uint8\_t \*buf, uint32\_t \*length)

Receive packet from Ethernet MAC.

---

**Note:** Memory of buf is allocated in the Layer2, make sure it get free after process.

---

---

**Note:** Before this function got invoked, the value of “length” should set by user, equals the size of buffer. After the function returned, the value of “length” means the real length of received data.

---

**Param mac [in]** Ethernet MAC instance

**Param buf [out]** packet buffer which will preserve the received frame

**Param length [out]** length of the received packet

**Return**

- ESP\_OK: receive packet successfully
- ESP\_ERR\_INVALID\_ARG: receive packet failed because of invalid argument
- ESP\_ERR\_INVALID\_SIZE: input buffer size is not enough to hold the incoming data. in this case, value of returned “length” indicates the real size of incoming data.
- ESP\_FAIL: receive packet failed because some other error occurred

*esp\_err\_t* (\***read\_phy\_reg**)(*esp\_eth\_mac\_t* \*mac, uint32\_t phy\_addr, uint32\_t phy\_reg, uint32\_t \*reg\_value)

Read PHY register.

**Param mac [in]** Ethernet MAC instance

**Param phy\_addr [in]** PHY chip address (0~31)

**Param phy\_reg [in]** PHY register index code

**Param reg\_value [out]** PHY register value

**Return**

- ESP\_OK: read PHY register successfully
- ESP\_ERR\_INVALID\_ARG: read PHY register failed because of invalid argument
- ESP\_ERR\_INVALID\_STATE: read PHY register failed because of wrong state of MAC

- ESP\_ERR\_TIMEOUT: read PHY register failed because of timeout
- ESP\_FAIL: read PHY register failed because some other error occurred

*esp\_err\_t* (\***write\_phy\_reg**)(*esp\_eth\_mac\_t* \*mac, uint32\_t phy\_addr, uint32\_t phy\_reg, uint32\_t reg\_value)

Write PHY register.

**Param mac [in]** Ethernet MAC instance

**Param phy\_addr [in]** PHY chip address (0~31)

**Param phy\_reg [in]** PHY register index code

**Param reg\_value [in]** PHY register value

**Return**

- ESP\_OK: write PHY register successfully
- ESP\_ERR\_INVALID\_STATE: write PHY register failed because of wrong state of MAC
- ESP\_ERR\_TIMEOUT: write PHY register failed because of timeout
- ESP\_FAIL: write PHY register failed because some other error occurred

*esp\_err\_t* (\***set\_addr**)(*esp\_eth\_mac\_t* \*mac, uint8\_t \*addr)

Set MAC address.

**Param mac [in]** Ethernet MAC instance

**Param addr [in]** MAC address

**Return**

- ESP\_OK: set MAC address successfully
- ESP\_ERR\_INVALID\_ARG: set MAC address failed because of invalid argument
- ESP\_FAIL: set MAC address failed because some other error occurred

*esp\_err\_t* (\***get\_addr**)(*esp\_eth\_mac\_t* \*mac, uint8\_t \*addr)

Get MAC address.

**Param mac [in]** Ethernet MAC instance

**Param addr [out]** MAC address

**Return**

- ESP\_OK: get MAC address successfully
- ESP\_ERR\_INVALID\_ARG: get MAC address failed because of invalid argument
- ESP\_FAIL: get MAC address failed because some other error occurred

*esp\_err\_t* (\***set\_speed**)(*esp\_eth\_mac\_t* \*mac, eth\_speed\_t speed)

Set speed of MAC.

**Param mac [in]** Ethernet MAC instance

**Param speed [in]** MAC speed

**Return**

- ESP\_OK: set MAC speed successfully
- ESP\_ERR\_INVALID\_ARG: set MAC speed failed because of invalid argument
- ESP\_FAIL: set MAC speed failed because some other error occurred

*esp\_err\_t* (\***set\_duplex**)(*esp\_eth\_mac\_t* \*mac, eth\_duplex\_t duplex)

Set duplex mode of MAC.

**Param mac [in]** Ethernet MAC instance

**Param duplex [in]** MAC duplex

**Return**

- ESP\_OK: set MAC duplex mode successfully
- ESP\_ERR\_INVALID\_ARG: set MAC duplex failed because of invalid argument
- ESP\_FAIL: set MAC duplex failed because some other error occurred

*esp\_err\_t* (\***set\_link**)(*esp\_eth\_mac\_t* \*mac, eth\_link\_t link)

Set link status of MAC.

**Param mac [in]** Ethernet MAC instance

**Param link [in]** Link status

**Return**

- ESP\_OK: set link status successfully
- ESP\_ERR\_INVALID\_ARG: set link status failed because of invalid argument
- ESP\_FAIL: set link status failed because some other error occurred

*esp\_err\_t* (\***set\_promiscuous**)(*esp\_eth\_mac\_t* \*mac, bool enable)

Set promiscuous of MAC.

**Param mac [in]** Ethernet MAC instance

**Param enable [in]** set true to enable promiscuous mode; set false to disable promiscuous mode

**Return**

- ESP\_OK: set promiscuous mode successfully
- ESP\_FAIL: set promiscuous mode failed because some error occurred

*esp\_err\_t* (\***enable\_flow\_ctrl**)(*esp\_eth\_mac\_t* \*mac, bool enable)

Enable flow control on MAC layer or not.

**Param mac [in]** Ethernet MAC instance

**Param enable [in]** set true to enable flow control; set false to disable flow control

**Return**

- ESP\_OK: set flow control successfully
- ESP\_FAIL: set flow control failed because some error occurred

*esp\_err\_t* (\***set\_peer\_pause\_ability**)(*esp\_eth\_mac\_t* \*mac, uint32\_t ability)

Set the PAUSE ability of peer node.

**Param mac [in]** Ethernet MAC instance

**Param ability [in]** zero indicates that pause function is supported by link partner; non-zero indicates that pause function is not supported by link partner

**Return**

- ESP\_OK: set peer pause ability successfully
- ESP\_FAIL: set peer pause ability failed because some error occurred

*esp\_err\_t* (\***custom\_ioctl**)(*esp\_eth\_mac\_t* \*mac, uint32\_t cmd, void \*data)

Custom IO function of MAC driver. This function is intended to extend common options of *esp\_eth\_ioctl* to cover specifics of MAC chip.

---

**Note:** This function may not be assigned when the MAC chip supports only most common set of configuration options.

---

**Param mac [in]** Ethernet MAC instance

**Param cmd [in]** IO control command

**Param data [inout]** address of data for *set* command or address where to store the data when used with *get* command

**Return**

- ESP\_OK: process io command successfully
- ESP\_ERR\_INVALID\_ARG: process io command failed because of some invalid argument
- ESP\_FAIL: process io command failed because some other error occurred
- ESP\_ERR\_NOT\_SUPPORTED: requested feature is not supported

`esp_err_t (*del)(esp_eth_mac_t *mac)`

Free memory of Ethernet MAC.

**Param mac [in]** Ethernet MAC instance

**Return**

- ESP\_OK: free Ethernet MAC instance successfully
- ESP\_FAIL: free Ethernet MAC instance failed because some error occurred

struct **eth\_mac\_config\_t**

Configuration of Ethernet MAC object.

### Public Members

uint32\_t **sw\_reset\_timeout\_ms**

Software reset timeout value (Unit: ms)

uint32\_t **rx\_task\_stack\_size**

Stack size of the receive task

uint32\_t **rx\_task\_prio**

Priority of the receive task

uint32\_t **flags**

Flags that specify extra capability for mac driver

### Macros

**ETH\_MAC\_FLAG\_WORK\_WITH\_CACHE\_DISABLE**

MAC driver can work when cache is disabled

**ETH\_MAC\_FLAG\_PIN\_TO\_CORE**

Pin MAC task to the CPU core where driver installation happened

**ETH\_MAC\_DEFAULT\_CONFIG ()**

Default configuration for Ethernet MAC object.

### Type Definitions

typedef struct *esp\_eth\_mac\_s* **esp\_eth\_mac\_t**

Ethernet MAC.

### Enumerations

enum **emac\_rmii\_clock\_mode\_t**

RMII Clock Mode Options.

*Values:*

enumerator **EMAC\_CLK\_DEFAULT**

Default values configured using Kconfig are going to be used when “Default” selected.

enumerator **EMAC\_CLK\_EXT\_IN**

Input RMIIClock from external. EMAC Clock GPIO number needs to be configured when this option is selected.

---

**Note:** MAC will get RMIIClock from outside. Note that ESP32 only supports GPIO0 to input the RMIIClock.

---

enumerator **EMAC\_CLK\_OUT**

Output RMIIClock from internal APLL Clock. EMAC Clock GPIO number needs to be configured when this option is selected.

enum **emac\_rmii\_clock\_gpio\_t**

RMIIClock GPIO number Options.

**Warning:** If you want the Ethernet to work with WiFi, don't select ESP32 as RMIICLK output as it would result in clock instability.

*Values:*

enumerator **EMAC\_CLK\_IN\_GPIO**

MAC will get RMIIClock from outside at this GPIO.

---

**Note:** ESP32 only supports GPIO0 to input the RMIIClock.

---

enumerator **EMAC\_APPL\_CLK\_OUT\_GPIO**

Output RMIIClock from internal APLL Clock available at GPIO0.

---

**Note:** GPIO0 can be set to output a pre-divided PLL clock. Enabling this option will configure GPIO0 to output a 50MHz clock. In fact this clock doesn't have directly relationship with EMAC peripheral. Sometimes this clock may not work well with your PHY chip.

---

enumerator **EMAC\_CLK\_OUT\_GPIO**

Output RMIIClock from internal APLL Clock available at GPIO16.

enumerator **EMAC\_CLK\_OUT\_180\_GPIO**

Inverted Output RMIIClock from internal APLL Clock available at GPIO17.

## Header File

- [components/esp\\_eth/include/esp\\_eth\\_phy.h](#)

## Functions

*esp\_eth\_phy\_t* \***esp\_eth\_phy\_new\_ip101** (const *eth\_phy\_config\_t* \*config)

Create a PHY instance of IP101.

**Parameters** **config** –[in] configuration of PHY

**Returns**

- instance: create PHY instance successfully

- NULL: create PHY instance failed because some error occurred

*esp\_eth\_phy\_t* \***esp\_eth\_phy\_new\_rtl8201** (const *eth\_phy\_config\_t* \*config)

Create a PHY instance of RTL8201.

**Parameters** **config** –[in] configuration of PHY

**Returns**

- instance: create PHY instance successfully
- NULL: create PHY instance failed because some error occurred

*esp\_eth\_phy\_t* \***esp\_eth\_phy\_new\_lan87xx** (const *eth\_phy\_config\_t* \*config)

Create a PHY instance of LAN87xx.

**Parameters** **config** –[in] configuration of PHY

**Returns**

- instance: create PHY instance successfully
- NULL: create PHY instance failed because some error occurred

*esp\_eth\_phy\_t* \***esp\_eth\_phy\_new\_dp83848** (const *eth\_phy\_config\_t* \*config)

Create a PHY instance of DP83848.

**Parameters** **config** –[in] configuration of PHY

**Returns**

- instance: create PHY instance successfully
- NULL: create PHY instance failed because some error occurred

*esp\_eth\_phy\_t* \***esp\_eth\_phy\_new\_ksz80xx** (const *eth\_phy\_config\_t* \*config)

Create a PHY instance of KSZ80xx.

The phy model from the KSZ80xx series is detected automatically. If the driver is unable to detect a supported model, NULL is returned.

Currently, the following models are supported: KSZ8001, KSZ8021, KSZ8031, KSZ8041, KSZ8051, KSZ8061, KSZ8081, KSZ8091

**Parameters** **config** –[in] configuration of PHY

**Returns**

- instance: create PHY instance successfully
- NULL: create PHY instance failed because some error occurred

## Structures

struct **esp\_eth\_phy\_s**

Ethernet PHY.

## Public Members

*esp\_err\_t* (\***set\_mediator**)(*esp\_eth\_phy\_t* \*phy, *esp\_eth\_mediator\_t* \*mediator)

Set mediator for PHY.

**Param** **phy** [in] Ethernet PHY instance

**Param** **mediator** [in] mediator of Ethernet driver

**Return**

- ESP\_OK: set mediator for Ethernet PHY instance successfully
- ESP\_ERR\_INVALID\_ARG: set mediator for Ethernet PHY instance failed because of some invalid arguments

*esp\_err\_t* (\***reset**)(*esp\_eth\_phy\_t* \*phy)

Software Reset Ethernet PHY.

**Param** **phy** [in] Ethernet PHY instance

**Return**

- ESP\_OK: reset Ethernet PHY successfully
- ESP\_FAIL: reset Ethernet PHY failed because some error occurred

*esp\_err\_t* (\***reset\_hw**)(*esp\_eth\_phy\_t* \*phy)

Hardware Reset Ethernet PHY.

---

**Note:** Hardware reset is mostly done by pull down and up PHY's nRST pin

---

**Param phy [in]** Ethernet PHY instance

**Return**

- ESP\_OK: reset Ethernet PHY successfully
- ESP\_FAIL: reset Ethernet PHY failed because some error occurred

*esp\_err\_t* (\***init**)(*esp\_eth\_phy\_t* \*phy)

Initialize Ethernet PHY.

**Param phy [in]** Ethernet PHY instance

**Return**

- ESP\_OK: initialize Ethernet PHY successfully
- ESP\_FAIL: initialize Ethernet PHY failed because some error occurred

*esp\_err\_t* (\***deinit**)(*esp\_eth\_phy\_t* \*phy)

Deinitialize Ethernet PHY.

**Param phy [in]** Ethernet PHY instance

**Return**

- ESP\_OK: deinitialize Ethernet PHY successfully
- ESP\_FAIL: deinitialize Ethernet PHY failed because some error occurred

*esp\_err\_t* (\***autonego\_ctrl**)(*esp\_eth\_phy\_t* \*phy, *eth\_phy\_autoneg\_cmd\_t* cmd, bool \*autonego\_en\_stat)

Configure auto negotiation.

**Param phy [in]** Ethernet PHY instance

**Param cmd [in]** Configuration command, it is possible to Enable (restart), Disable or get current status of PHY auto negotiation

**Param autonego\_en\_stat [out]** Address where to store current status of auto negotiation configuration

**Return**

- ESP\_OK: restart auto negotiation successfully
- ESP\_FAIL: restart auto negotiation failed because some error occurred
- ESP\_ERR\_INVALID\_ARG: invalid command

*esp\_err\_t* (\***get\_link**)(*esp\_eth\_phy\_t* \*phy)

Get Ethernet PHY link status.

**Param phy [in]** Ethernet PHY instance

**Return**

- ESP\_OK: get Ethernet PHY link status successfully
- ESP\_FAIL: get Ethernet PHY link status failed because some error occurred

*esp\_err\_t* (\***set\_link**)(*esp\_eth\_phy\_t* \*phy, *eth\_link\_t* link)

Set Ethernet PHY link status.

**Param phy [in]** Ethernet PHY instance

**Param link [in]** new link status

**Return**

- ESP\_OK: set Ethernet PHY link status successfully
- ESP\_FAIL: set Ethernet PHY link status failed because some error occurred

*esp\_err\_t* (\***pwrcctl**)(*esp\_eth\_phy\_t* \*phy, bool enable)

Power control of Ethernet PHY.

**Param phy [in]** Ethernet PHY instance

**Param enable [in]** set true to power on Ethernet PHY; ser false to power off Ethernet PHY

**Return**

- ESP\_OK: control Ethernet PHY power successfully
- ESP\_FAIL: control Ethernet PHY power failed because some error occurred

*esp\_err\_t* (\***set\_addr**)(*esp\_eth\_phy\_t* \*phy, uint32\_t addr)

Set PHY chip address.

**Param phy [in]** Ethernet PHY instance

**Param addr [in]** PHY chip address

**Return**

- ESP\_OK: set Ethernet PHY address successfully
- ESP\_FAIL: set Ethernet PHY address failed because some error occurred

*esp\_err\_t* (\***get\_addr**)(*esp\_eth\_phy\_t* \*phy, uint32\_t \*addr)

Get PHY chip address.

**Param phy [in]** Ethernet PHY instance

**Param addr [out]** PHY chip address

**Return**

- ESP\_OK: get Ethernet PHY address successfully
- ESP\_ERR\_INVALID\_ARG: get Ethernet PHY address failed because of invalid argument

*esp\_err\_t* (\***advertise\_pause\_ability**)(*esp\_eth\_phy\_t* \*phy, uint32\_t ability)

Advertise pause function supported by MAC layer.

**Param phy [in]** Ethernet PHY instance

**Param addr [out]** Pause ability

**Return**

- ESP\_OK: Advertise pause ability successfully
- ESP\_ERR\_INVALID\_ARG: Advertise pause ability failed because of invalid argument

*esp\_err\_t* (\***loopback**)(*esp\_eth\_phy\_t* \*phy, bool enable)

Sets the PHY to loopback mode.

**Param phy [in]** Ethernet PHY instance

**Param enable [in]** enables or disables PHY loopback

**Return**

- ESP\_OK: PHY instance loopback mode has been configured successfully
- ESP\_FAIL: PHY instance loopback configuration failed because some error occurred

*esp\_err\_t* (\***set\_speed**)(*esp\_eth\_phy\_t* \*phy, eth\_speed\_t speed)

Sets PHY speed mode.

---

**Note:** Autonegotiation feature needs to be disabled prior to calling this function for the new setting to be applied

---



**Param phy [in]** Ethernet PHY instance

**Param speed [in]** Speed mode to be set

**Return**

- ESP\_OK: PHY instance speed mode has been configured successfully
- ESP\_FAIL: PHY instance speed mode configuration failed because some error occurred

*esp\_err\_t* (\***set\_duplex**)(*esp\_eth\_phy\_t* \*phy, eth\_duplex\_t duplex)

Sets PHY duplex mode.

---

**Note:** Autonegotiation feature needs to be disabled prior to calling this function for the new setting to be applied

---

**Param phy [in]** Ethernet PHY instance

**Param duplex [in]** Duplex mode to be set

**Return**

- ESP\_OK: PHY instance duplex mode has been configured successfully
- ESP\_FAIL: PHY instance duplex mode configuration failed because some error occurred

*esp\_err\_t* (\***custom\_ioctl**)(*esp\_eth\_phy\_t* \*phy, uint32\_t cmd, void \*data)

Custom IO function of PHY driver. This function is intended to extend common options of *esp\_eth\_ioctl* to cover specifics of PHY chip.

---

**Note:** This function may not be assigned when the PHY chip supports only most common set of configuration options.

---

**Param phy [in]** Ethernet PHY instance

**Param cmd [in]** IO control command

**Param data [inout]** address of data for *set* command or address where to store the data when used with *get* command

**Return**

- ESP\_OK: process io command successfully
- ESP\_ERR\_INVALID\_ARG: process io command failed because of some invalid argument
- ESP\_FAIL: process io command failed because some other error occurred
- ESP\_ERR\_NOT\_SUPPORTED: requested feature is not supported

*esp\_err\_t* (\***del**)(*esp\_eth\_phy\_t* \*phy)

Free memory of Ethernet PHY instance.

**Param phy [in]** Ethernet PHY instance

**Return**

- ESP\_OK: free PHY instance successfully
- ESP\_FAIL: free PHY instance failed because some error occurred

struct **eth\_phy\_config\_t**

Ethernet PHY configuration.

### Public Members

int32\_t **phy\_addr**

PHY address, set -1 to enable PHY address detection at initialization stage

uint32\_t **reset\_timeout\_ms**

Reset timeout value (Unit: ms)

uint32\_t **autonego\_timeout\_ms**

Auto-negotiation timeout value (Unit: ms)

int **reset\_gpio\_num**

Reset GPIO number, -1 means no hardware reset

### Macros

**ESP\_ETH\_PHY\_ADDR\_AUTO**

**ETH\_PHY\_DEFAULT\_CONFIG** ()

Default configuration for Ethernet PHY object.

### Type Definitions

typedef struct *esp\_eth\_phy\_s* **esp\_eth\_phy\_t**

Ethernet PHY.

### Enumerations

enum **eth\_phy\_autoneg\_cmd\_t**

Auto-negotiation controll commands.

*Values:*

enumerator **ESP\_ETH\_PHY\_AUTONEGO\_RESTART**

enumerator **ESP\_ETH\_PHY\_AUTONEGO\_EN**

enumerator **ESP\_ETH\_PHY\_AUTONEGO\_DIS**

enumerator **ESP\_ETH\_PHY\_AUTONEGO\_G\_STAT**

### Header File

- [components/esp\\_eth/include/esp\\_eth\\_phy\\_802\\_3.h](#)

### Functions

*esp\_err\_t* **esp\_eth\_phy\_802\_3\_set\_mediator** (*phy\_802\_3\_t* \*phy\_802\_3, *esp\_eth\_mediator\_t* \*eth)

Set Ethernet mediator.

#### Parameters

- **phy\_802\_3** –IEEE 802.3 PHY object infostructure
- **eth** –Ethernet mediator pointer

#### Returns

- **ESP\_OK**: Ethermet mediator set successfully
- **ESP\_ERR\_INVALID\_ARG**: if *eth* is **NULL**

*esp\_err\_t* **esp\_eth\_phy\_802\_3\_reset** (*phy\_802\_3\_t* \*phy\_802\_3)

Reset PHY.

**Parameters** **phy\_802\_3** –IEEE 802.3 PHY object infostructure

**Returns**

- **ESP\_OK**: Ethernet PHY reset successfully
- **ESP\_FAIL**: reset Ethernet PHY failed because some error occurred

*esp\_err\_t* **esp\_eth\_phy\_802\_3\_autonego\_ctrl** (*phy\_802\_3\_t* \*phy\_802\_3, *eth\_phy\_autoneg\_cmd\_t* cmd, bool \*autonego\_en\_stat)

Control autonegotiation mode of Ethernet PHY.

**Parameters**

- **phy\_802\_3** –IEEE 802.3 PHY object infostructure
- **cmd** –autonegotiation command enumeration
- **autonego\_en\_stat** –[out] autonegotiation enabled flag

**Returns**

- **ESP\_OK**: Ethernet PHY autonegotiation configured successfully
- **ESP\_FAIL**: Ethernet PHY autonegotiation configuration fail because some error occurred
- **ESP\_ERR\_INVALID\_ARG**: invalid value of **cmd**

*esp\_err\_t* **esp\_eth\_phy\_802\_3\_pwrctl** (*phy\_802\_3\_t* \*phy\_802\_3, bool enable)

Power control of Ethernet PHY.

**Parameters**

- **phy\_802\_3** –IEEE 802.3 PHY object infostructure
- **enable** –set true to power ON Ethernet PHY; set false to power OFF Ethernet PHY

**Returns**

- **ESP\_OK**: Ethernet PHY power down mode set successfully
- **ESP\_FAIL**: Ethernet PHY power up or power down failed because some error occurred

*esp\_err\_t* **esp\_eth\_phy\_802\_3\_set\_addr** (*phy\_802\_3\_t* \*phy\_802\_3, uint32\_t addr)

Set Ethernet PHY address.

**Parameters**

- **phy\_802\_3** –IEEE 802.3 PHY object infostructure
- **addr** –new PHY address

**Returns**

- **ESP\_OK**: Ethernet PHY address set

*esp\_err\_t* **esp\_eth\_phy\_802\_3\_get\_addr** (*phy\_802\_3\_t* \*phy\_802\_3, uint32\_t \*addr)

Get Ethernet PHY address.

**Parameters**

- **phy\_802\_3** –IEEE 802.3 PHY object infostructure
- **addr** –[out] Ethernet PHY address

**Returns**

- **ESP\_OK**: Ethernet PHY address read successfully
- **ESP\_ERR\_INVALID\_ARG**: **addr** pointer is NULL

*esp\_err\_t* **esp\_eth\_phy\_802\_3\_advertise\_pause\_ability** (*phy\_802\_3\_t* \*phy\_802\_3, uint32\_t ability)

Advertise pause function ability.

**Parameters**

- **phy\_802\_3** –IEEE 802.3 PHY object infostructure
- **ability** –enable or disable pause ability

**Returns**

- **ESP\_OK**: pause ability set successfully
- **ESP\_FAIL**: Advertise pause function ability failed because some error occurred

*esp\_err\_t* **esp\_eth\_phy\_802\_3\_loopback** (*phy\_802\_3\_t* \*phy\_802\_3, bool enable)

Set Ethernet PHY loopback mode.

**Parameters**

- **phy\_802\_3** –IEEE 802.3 PHY object infostructure
- **enable** –set true to enable loopback; set false to disable loopback

**Returns**

- ESP\_OK: Ethernet PHY loopback mode set successfully
- ESP\_FAIL: Ethernet PHY loopback configuration failed because some error occurred

*esp\_err\_t* **esp\_eth\_phy\_802\_3\_set\_speed** (*phy\_802\_3\_t* \*phy\_802\_3, eth\_speed\_t speed)

Set Ethernet PHY speed.

**Parameters**

- **phy\_802\_3** –IEEE 802.3 PHY object infostructure
- **speed** –new speed of Ethernet PHY link

**Returns**

- ESP\_OK: Ethernet PHY speed set successfully
- ESP\_FAIL: Set Ethernet PHY speed failed because some error occurred

*esp\_err\_t* **esp\_eth\_phy\_802\_3\_set\_duplex** (*phy\_802\_3\_t* \*phy\_802\_3, eth\_duplex\_t duplex)

Set Ethernet PHY duplex mode.

**Parameters**

- **phy\_802\_3** –IEEE 802.3 PHY object infostructure
- **duplex** –new duplex mode for Ethernet PHY link

**Returns**

- ESP\_OK: Ethernet PHY duplex mode set successfully
- ESP\_ERR\_INVALID\_STATE: unable to set duplex mode to Half if loopback is enabled
- ESP\_FAIL: Set Ethernet PHY duplex mode failed because some error occurred

*esp\_err\_t* **esp\_eth\_phy\_802\_3\_set\_link** (*phy\_802\_3\_t* \*phy\_802\_3, eth\_link\_t link)

Set Ethernet PHY link status.

**Parameters**

- **phy\_802\_3** –IEEE 802.3 PHY object infostructure
- **link** –new link status

**Returns**

- ESP\_OK: Ethernet PHY link set successfully

*esp\_err\_t* **esp\_eth\_phy\_802\_3\_init** (*phy\_802\_3\_t* \*phy\_802\_3)

Initialize Ethernet PHY.

**Parameters** **phy\_802\_3** –IEEE 802.3 PHY object infostructure

**Returns**

- ESP\_OK: Ethernet PHY initialized successfully

*esp\_err\_t* **esp\_eth\_phy\_802\_3\_deinit** (*phy\_802\_3\_t* \*phy\_802\_3)

Power off Ethernet PHY.

**Parameters** **phy\_802\_3** –IEEE 802.3 PHY object infostructure

**Returns**

- ESP\_OK: Ethernet PHY powered off successfully

*esp\_err\_t* **esp\_eth\_phy\_802\_3\_del** (*phy\_802\_3\_t* \*phy\_802\_3)

Delete Ethernet PHY infostructure.

**Parameters** **phy\_802\_3** –IEEE 802.3 PHY object infostructure

**Returns**

- ESP\_OK: Ethernet PHY infostructure deleted

*esp\_err\_t* **esp\_eth\_phy\_802\_3\_reset\_hw** (*phy\_802\_3\_t* \*phy\_802\_3, uint32\_t reset\_assert\_us)

Performs hardware reset with specific reset pin assertion time.

**Parameters**

- **phy\_802\_3** –IEEE 802.3 PHY object infostructure
- **reset\_assert\_us** –Hardware reset pin assertion time

**Returns**

- ESP\_OK: reset Ethernet PHY successfully

*esp\_err\_t* **esp\_eth\_phy\_802\_3\_detect\_phy\_addr** (*esp\_eth\_mediator\_t* \*eth, int \*detected\_addr)

Detect PHY address.

**Parameters**

- **eth** –Mediator of Ethernet driver
- **detected\_addr** –[out] a valid address after detection

**Returns**

- ESP\_OK: detect phy address successfully
- ESP\_ERR\_INVALID\_ARG: invalid parameter
- ESP\_ERR\_NOT\_FOUND: can't detect any PHY device
- ESP\_FAIL: detect phy address failed because some error occurred

*esp\_err\_t* **esp\_eth\_phy\_802\_3\_basic\_phy\_init** (*phy\_802\_3\_t* \*phy\_802\_3)

Performs basic PHY chip initialization.

---

**Note:** It should be called as the first function in PHY specific driver instance

---

**Parameters** **phy\_802\_3** –IEEE 802.3 PHY object infostructure

**Returns**

- ESP\_OK: initialized Ethernet PHY successfully
- ESP\_FAIL: initialization of Ethernet PHY failed because some error occurred
- ESP\_ERR\_INVALID\_ARG: invalid argument
- ESP\_ERR\_NOT\_FOUND: PHY device not detected
- ESP\_ERR\_TIMEOUT: MII Management read/write operation timeout
- ESP\_ERR\_INVALID\_STATE: PHY is in invalid state to perform requested operation

*esp\_err\_t* **esp\_eth\_phy\_802\_3\_basic\_phy\_deinit** (*phy\_802\_3\_t* \*phy\_802\_3)

Performs basic PHY chip de-initialization.

---

**Note:** It should be called as the last function in PHY specific driver instance

---

**Parameters** **phy\_802\_3** –IEEE 802.3 PHY object infostructure

**Returns**

- ESP\_OK: de-initialized Ethernet PHY successfully
- ESP\_FAIL: de-initialization of Ethernet PHY failed because some error occurred
- ESP\_ERR\_TIMEOUT: MII Management read/write operation timeout
- ESP\_ERR\_INVALID\_STATE: PHY is in invalid state to perform requested operation

*esp\_err\_t* **esp\_eth\_phy\_802\_3\_read\_oui** (*phy\_802\_3\_t* \*phy\_802\_3, uint32\_t \*oui)

Reads raw content of OUI field.

**Parameters**

- **phy\_802\_3** –IEEE 802.3 PHY object infostructure
- **oui** –[out] OUI value

**Returns**

- ESP\_OK: OUI field read successfully
- ESP\_FAIL: OUI field read failed because some error occurred
- ESP\_ERR\_INVALID\_ARG: invalid oui argument
- ESP\_ERR\_TIMEOUT: MII Management read/write operation timeout
- ESP\_ERR\_INVALID\_STATE: PHY is in invalid state to perform requested operation

*esp\_err\_t* **esp\_eth\_phy\_802\_3\_read\_manufac\_info** (*phy\_802\_3\_t* \*phy\_802\_3, uint8\_t \*model, uint8\_t \*rev)

Reads manufacturer's model and revision number.

#### Parameters

- **phy\_802\_3** –IEEE 802.3 PHY object infostructure
- **model** –[out] Manufacturer's model number (can be NULL when not required)
- **rev** –[out] Manufacturer's revision number (can be NULL when not required)

#### Returns

- ESP\_OK: Manufacturer's info read successfully
- ESP\_FAIL: Manufacturer's info read failed because some error occurred
- ESP\_ERR\_TIMEOUT: MII Management read/write operation timeout
- ESP\_ERR\_INVALID\_STATE: PHY is in invalid state to perform requested operation

*esp\_err\_t* **esp\_eth\_phy\_802\_3\_get\_mmd\_addr** (*phy\_802\_3\_t* \*phy\_802\_3, uint8\_t devaddr, uint16\_t \*mmd\_addr)

Reads MDIO device's internal address register.

#### Parameters

- **phy\_802\_3** –IEEE 802.3 PHY object infostructure
- **devaddr** –Address of MDIO device
- **mmd\_addr** –[out] Current address stored in device's register

#### Returns

- ESP\_OK: Address register read successfully
- ESP\_FAIL: Address register read failed because of some error occurred
- ESP\_ERR\_INVALID\_ARG: Device address provided is out of range (hardware limits device address to 5 bits)

*esp\_err\_t* **esp\_eth\_phy\_802\_3\_set\_mmd\_addr** (*phy\_802\_3\_t* \*phy\_802\_3, uint8\_t devaddr, uint16\_t mmd\_addr)

Write to DIO device's internal address register.

#### Parameters

- **phy\_802\_3** –IEEE 802.3 PHY object infostructure
- **devaddr** –Address of MDIO device
- **mmd\_addr** –[out] New value of MDIO device's address register value

#### Returns

- ESP\_OK: Address register written to successfully
- ESP\_FAIL: Address register write failed because of some error occurred
- ESP\_ERR\_INVALID\_ARG: Device address provided is out of range (hardware limits device address to 5 bits)

*esp\_err\_t* **esp\_eth\_phy\_802\_3\_read\_mmd\_data** (*phy\_802\_3\_t* \*phy\_802\_3, uint8\_t devaddr, *esp\_eth\_phy\_802\_3\_mmd\_func\_t* function, uint32\_t \*data)

Read data of MDIO device's memory at address register.

#### Parameters

- **phy\_802\_3** –IEEE 802.3 PHY object infostructure
- **devaddr** –Address of MDIO device
- **function** –MMD function
- **data** –[out] Data read from the device's memory

#### Returns

- ESP\_OK: Memory read successfully
- ESP\_FAIL: Memory read failed because of some error occurred
- ESP\_ERR\_INVALID\_ARG: Device address provided is out of range (hardware limits device address to 5 bits) or MMD access function is invalid

*esp\_err\_t* **esp\_eth\_phy\_802\_3\_write\_mmd\_data** (*phy\_802\_3\_t* \*phy\_802\_3, uint8\_t devaddr, *esp\_eth\_phy\_802\_3\_mmd\_func\_t* function, uint32\_t data)

Write data to MDIO device's memory at address register.

#### Parameters

- **phy\_802\_3** –IEEE 802.3 PHY object infostructure
- **devaddr** –Address of MDIO device
- **function** –MMD function
- **data** –[out] Data to write to the device's memory

#### Returns

- ESP\_OK: Memory written successfully
- ESP\_FAIL: Memory write failed because of some error occurred
- ESP\_ERR\_INVALID\_ARG: Device address provided is out of range (hardware limits device address to 5 bits) or MMD access function is invalid

```
esp_err_t esp_eth_phy_802_3_read_mmd_register(phy_802_3_t *phy_802_3, uint8_t devaddr,
                                             uint16_t mmd_addr, uint32_t *data)
```

Set MMD address to mmd\_addr with function MMD\_FUNC\_NOINCR and read contents to \*data.

#### Parameters

- **phy\_802\_3** –IEEE 802.3 PHY object infostructure
- **devaddr** –Address of MDIO device
- **mmd\_addr** –Address of MDIO device register
- **data** –[out] Data read from the device's memory

#### Returns

- ESP\_OK: Memory read successfully
- ESP\_FAIL: Memory read failed because of some error occurred
- ESP\_ERR\_INVALID\_ARG: Device address provided is out of range (hardware limits device address to 5 bits)

```
esp_err_t esp_eth_phy_802_3_write_mmd_register(phy_802_3_t *phy_802_3, uint8_t devaddr,
                                               uint16_t mmd_addr, uint32_t data)
```

Set MMD address to mmd\_addr with function MMD\_FUNC\_NOINCR and write data.

#### Parameters

- **phy\_802\_3** –IEEE 802.3 PHY object infostructure
- **devaddr** –Address of MDIO device
- **mmd\_addr** –Address of MDIO device register
- **data** –[out] Data to write to the device's memory

#### Returns

- ESP\_OK: Memory written to successfully
- ESP\_FAIL: Memory write failed because of some error occurred
- ESP\_ERR\_INVALID\_ARG: Device address provided is out of range (hardware limits device address to 5 bits)

```
inline phy_802_3_t *esp_eth_phy_into_phy_802_3(esp_eth_phy_t *phy)
```

Returns address to parent IEEE 802.3 PHY object infostructure.

**Parameters** **phy** –Ethernet PHY instance

**Returns** *phy\_802\_3\_t*\*

- address to parent IEEE 802.3 PHY object infostructure

```
esp_err_t esp_eth_phy_802_3_obj_config_init(phy_802_3_t *phy_802_3, const eth_phy_config_t
                                             *config)
```

Initializes configuration of parent IEEE 802.3 PHY object infostructure.

#### Parameters

- **phy\_802\_3** –Address to IEEE 802.3 PHY object infostructure
- **config** –Configuration of the IEEE 802.3 PHY object

#### Returns

- ESP\_OK: configuration initialized successfully
- ESP\_ERR\_INVALID\_ARG: invalid `config` argument

## Structures

struct **phy\_802\_3\_t**

IEEE 802.3 PHY object infostructure.

## Public Members

*esp\_eth\_phy\_t* **parent**

Parent Ethernet PHY instance

*esp\_eth\_mediator\_t* \***eth**

Mediator of Ethernet driver

int **addr**

PHY address

uint32\_t **reset\_timeout\_ms**

Reset timeout value (Unit: ms)

uint32\_t **autonego\_timeout\_ms**

Auto-negotiation timeout value (Unit: ms)

eth\_link\_t **link\_status**

Current Link status

int **reset\_gpio\_num**

Reset GPIO number, -1 means no hardware reset

## Enumerations

enum **esp\_eth\_phy\_802\_3\_mmd\_func\_t**

IEEE 802.3 MMD modes enumeration.

*Values:*

enumerator **MMD\_FUNC\_ADDRESS**

enumerator **MMD\_FUNC\_DATA\_NOINCR**

enumerator **MMD\_FUNC\_DATA\_RWINCR**

enumerator **MMD\_FUNC\_DATA\_WINCR**

## Header File

- [components/esp\\_eth/include/esp\\_eth\\_netif\\_glue.h](#)



### Functions

*esp\_eth\_netif\_glue\_handle\_t* **esp\_eth\_new\_netif\_glue** (*esp\_eth\_handle\_t* eth\_hdl)

Create a netif glue for Ethernet driver.

---

**Note:** netif glue is used to attach io driver to TCP/IP netif

---

**Parameters** **eth\_hdl** –Ethernet driver handle

**Returns** glue object, which inherits esp\_netif\_driver\_base\_t

*esp\_err\_t* **esp\_eth\_del\_netif\_glue** (*esp\_eth\_netif\_glue\_handle\_t* eth\_netif\_glue)

Delete netif glue of Ethernet driver.

**Parameters** **eth\_netif\_glue** –netif glue

**Returns** -ESP\_OK: delete netif glue successfully

### Type Definitions

```
typedef struct esp_eth_netif_glue_t *esp_eth_netif_glue_handle_t
```

Handle of netif glue - an intermediate layer between netif and Ethernet driver.

Code examples for the Ethernet API are provided in the [ethernet](#) directory of ESP-IDF examples.

## 2.4.3 Thread

### Thread

**Introduction** [Thread](#) is a IP-based mesh networking protocol. It' s based on the 802.15.4 physical and MAC layer.

**Application Examples** The [openthread](#) directory of ESP-IDF examples contains the following applications:

- The OpenThread interactive shell [openthread/ot\\_cli](#).
- The Thread border router [openthread/ot\\_br](#).
- The Thread radio co-processor [openthread/ot\\_rcp](#).

**API Reference** For manipulating the Thread network, the OpenThread api shall be used. The OpenThread api docs can be found at the [OpenThread official website](#).

ESP-IDF provides extra apis for launching and managing the OpenThread stack, binding to network interfaces and border routing features.

### Header File

- [components/openthread/include/esp\\_openthread.h](#)

### Functions

*esp\_err\_t* **esp\_openthread\_init** (const *esp\_openthread\_platform\_config\_t* \*init\_config)

Initializes the full OpenThread stack.

---

**Note:** The OpenThread instance will also be initialized in this function.

---

**Parameters** **init\_config** –[in] The initialization configuration.

**Returns**

- ESP\_OK on success
- ESP\_ERR\_NO\_MEM if allocation has failed
- ESP\_ERR\_INVALID\_ARG if radio or host connection mode not supported
- ESP\_ERR\_INVALID\_STATE if already initialized

*esp\_err\_t* **esp\_openthread\_launch\_mainloop** (void)

Launches the OpenThread main loop.

---

**Note:** This function will not return unless error happens when running the OpenThread stack.

---

#### Returns

- ESP\_OK on success
- ESP\_ERR\_NO\_MEM if allocation has failed
- ESP\_FAIL on other failures

*esp\_err\_t* **esp\_openthread\_deinit** (void)

This function performs OpenThread stack and platform driver deinitialization.

#### Returns

- ESP\_OK on success
- ESP\_ERR\_INVALID\_STATE if not initialized

otInstance \***esp\_openthread\_get\_instance** (void)

This function acquires the underlying OpenThread instance.

---

**Note:** This function can be called on other tasks without lock.

---

**Returns** The OpenThread instance pointer

### Header File

- [components/openthread/include/esp\\_openthread\\_types.h](#)

### Structures

struct **esp\_openthread\_mainloop\_context\_t**

This structure represents a context for a select() based mainloop.

#### Public Members

fd\_set **read\_fds**

The read file descriptors

fd\_set **write\_fds**

The write file descriptors

fd\_set **error\_fds**

The error file descriptors

int **max\_fd**

The max file descriptor

struct timeval **timeout**

The timeout

struct **esp\_openthread\_uart\_config\_t**

The uart port config for OpenThread.

### Public Members

*uart\_port\_t* **port**

UART port number

*uart\_config\_t* **uart\_config**

UART configuration, see *uart\_config\_t* docs

int **rx\_pin**

UART RX pin

int **tx\_pin**

UART TX pin

struct **esp\_openthread\_radio\_config\_t**

The OpenThread radio configuration.

### Public Members

*esp\_openthread\_radio\_mode\_t* **radio\_mode**

The radio mode

*esp\_openthread\_uart\_config\_t* **radio\_uart\_config**

The uart configuration to RCP

struct **esp\_openthread\_host\_connection\_config\_t**

The OpenThread host connection configuration.

### Public Members

*esp\_openthread\_host\_connection\_mode\_t* **host\_connection\_mode**

The host connection mode

*esp\_openthread\_uart\_config\_t* **host\_uart\_config**

The uart configuration to host

struct **esp\_openthread\_port\_config\_t**

The OpenThread port specific configuration.

### Public Members

const char \***storage\_partition\_name**

The partition for storing OpenThread dataset

uint8\_t **netif\_queue\_size**

The packet queue size for the network interface

uint8\_t **task\_queue\_size**

The task queue size

struct **esp\_openthread\_platform\_config\_t**

The OpenThread platform configuration.

### Public Members

*esp\_openthread\_radio\_config\_t* **radio\_config**

The radio configuration

*esp\_openthread\_host\_connection\_config\_t* **host\_config**

The host connection configuration

*esp\_openthread\_port\_config\_t* **port\_config**

The port configuration

### Type Definitions

typedef void (\***esp\_openthread\_rcp\_failure\_handler**)(void)

### Enumerations

enum **esp\_openthread\_event\_t**

OpenThread event declarations.

*Values:*

enumerator **OPENTHREAD\_EVENT\_START**

OpenThread stack start

enumerator **OPENTHREAD\_EVENT\_STOP**

OpenThread stack stop

enumerator **OPENTHREAD\_EVENT\_IF\_UP**

OpenThread network interface up

enumerator **OPENTHREAD\_EVENT\_IF\_DOWN**

OpenThread network interface down

enumerator **OPENTHREAD\_EVENT\_GOT\_IP6**

OpenThread stack added IPv6 address

enumerator **OPENTHREAD\_EVENT\_LOST\_IP6**

OpenThread stack removed IPv6 address

enumerator **OPENTHREAD\_EVENT\_MULTICAST\_GROUP\_JOIN**

OpenThread stack joined IPv6 multicast group

enumerator **OPENTHREAD\_EVENT\_MULTICAST\_GROUP\_LEAVE**

OpenThread stack left IPv6 multicast group

enumerator **OPENTHREAD\_EVENT\_TREL\_ADD\_IP6**

OpenThread stack added TREL IPv6 address

enumerator **OPENTHREAD\_EVENT\_TREL\_REMOVE\_IP6**

OpenThread stack removed TREL IPv6 address

enumerator **OPENTHREAD\_EVENT\_TREL\_MULTICAST\_GROUP\_JOIN**

OpenThread stack joined TREL IPv6 multicast group

enum **esp\_openthread\_radio\_mode\_t**

The radio mode of OpenThread.

*Values:*

enumerator **RADIO\_MODE\_NATIVE**

Use the native 15.4 radio

enumerator **RADIO\_MODE\_UART\_RCP**

UART connection to a 15.4 capable radio co-processor (RCP)

enumerator **RADIO\_MODE\_SPI\_RCP**

SPI connection to a 15.4 capable radio co-processor (RCP)

enum **esp\_openthread\_host\_connection\_mode\_t**

How OpenThread connects to the host.

*Values:*

enumerator **HOST\_CONNECTION\_MODE\_NONE**

Disable host connection

enumerator **HOST\_CONNECTION\_MODE\_CLI\_UART**

CLI UART connection to the host

enumerator **HOST\_CONNECTION\_MODE\_RCP\_UART**

RCP UART connection to the host

### Header File

- [components/openthread/include/esp\\_openthread\\_lock.h](#)

## Functions

*esp\_err\_t* **esp\_openthread\_lock\_init** (void)

This function initializes the OpenThread API lock.

### Returns

- ESP\_OK on success
- ESP\_ERR\_NO\_MEM if allocation has failed
- ESP\_ERR\_INVALID\_STATE if already initialized

void **esp\_openthread\_lock\_deinit** (void)

This function deinitializes the OpenThread API lock.

bool **esp\_openthread\_lock\_acquire** (TickType\_t block\_ticks)

This functions acquires the OpenThread API lock.

---

**Note:** Every OT APIs that takes an otInstance argument MUST be protected with this API lock except that the call site is in OT callbacks.

---

**Parameters** **block\_ticks** –[in] The maximum number of RTOS ticks to wait for the lock.

### Returns

- True on lock acquired
- False on failing to acquire the lock with the timeout.

void **esp\_openthread\_lock\_release** (void)

This function releases the OpenThread API lock.

## Header File

- [components/openthread/include/esp\\_openthread\\_netif\\_glue.h](#)

## Functions

void **\*esp\_openthread\_netif\_glue\_init** (const *esp\_openthread\_platform\_config\_t* \*config)

This function initializes the OpenThread network interface glue.

**Parameters** **config** –[in] The platform configuration.

### Returns

- glue pointer on success
- NULL on failure

void **esp\_openthread\_netif\_glue\_deinit** (void)

This function deinitializes the OpenThread network interface glue.

*esp\_netif\_t* **\*esp\_openthread\_get\_netif** (void)

This function acquires the OpenThread netif.

**Returns** The OpenThread netif or NULL if not initialized.

## Macros

**ESP\_NETIF\_INHERENT\_DEFAULT\_OPENTHREAD** ()

Default configuration reference of OT esp-netif.

**ESP\_NETIF\_DEFAULT\_OPENTHREAD** ()

## Header File

- [components/openthread/include/esp\\_openthread\\_border\\_router.h](#)

## Functions

void **esp\_openthread\_set\_backbone\_netif** (*esp\_netif\_t* \*backbone\_netif)

Sets the backbone interface used for border routing.

---

**Note:** This function must be called before `esp_openthread_init`

---

**Parameters** `backbone_netif` –[in] The backbone network interface (WiFi or ethernet)

*esp\_err\_t* **esp\_openthread\_border\_router\_init** (void)

Initializes the border router features of OpenThread.

---

**Note:** Calling this function will make the device behave as an OpenThread border router. Kconfig option `CONFIG_OPENTHREAD_BORDER_ROUTER` is required.

---

### Returns

- `ESP_OK` on success
- `ESP_ERR_NOT_SUPPORTED` if feature not supported
- `ESP_ERR_INVALID_STATE` if already initialized
- `ESP_FIAL` on other failures

*esp\_err\_t* **esp\_openthread\_border\_router\_deinit** (void)

Deinitializes the border router features of OpenThread.

### Returns

- `ESP_OK` on success
- `ESP_ERR_INVALID_STATE` if not initialized
- `ESP_FIAL` on other failures

*esp\_netif\_t* \***esp\_openthread\_get\_backbone\_netif** (void)

Gets the backbone interface of OpenThread border router.

**Returns** The backbone interface or `NULL` if border router not initialized.

void **esp\_openthread\_register\_rcp\_failure\_handler** (*esp\_openthread\_rcp\_failure\_handler* handler)

Registers the callback for RCP failure.

void **esp\_openthread\_rcp\_deinit** (void)

Deinitializes the connecton to RCP.

Thread is an IPv6-based mesh networking technology for IoT. Code examples for the Thread API are provided in the [openthread](#) directory of ESP-IDF examples.

## 2.4.4 ESP-NETIF

### ESP-NETIF

The purpose of ESP-NETIF library is twofold:

- It provides an abstraction layer for the application on top of the TCP/IP stack. This will allow applications to choose between IP stacks in the future.
- The APIs it provides are thread safe, even if the underlying TCP/IP stack APIs are not.

ESP-IDF currently implements ESP-NETIF for the lwIP TCP/IP stack only. However, the adapter itself is TCP/IP implementation agnostic and different implementations are possible.

Some ESP-NETIF API functions are intended to be called by application code, for example to get/set interface IP addresses, configure DHCP. Other functions are intended for internal ESP-IDF use by the network driver layer.

In many cases, applications do not need to call ESP-NETIF APIs directly as they are called from the default network event handlers.

**ESP-NETIF architecture**

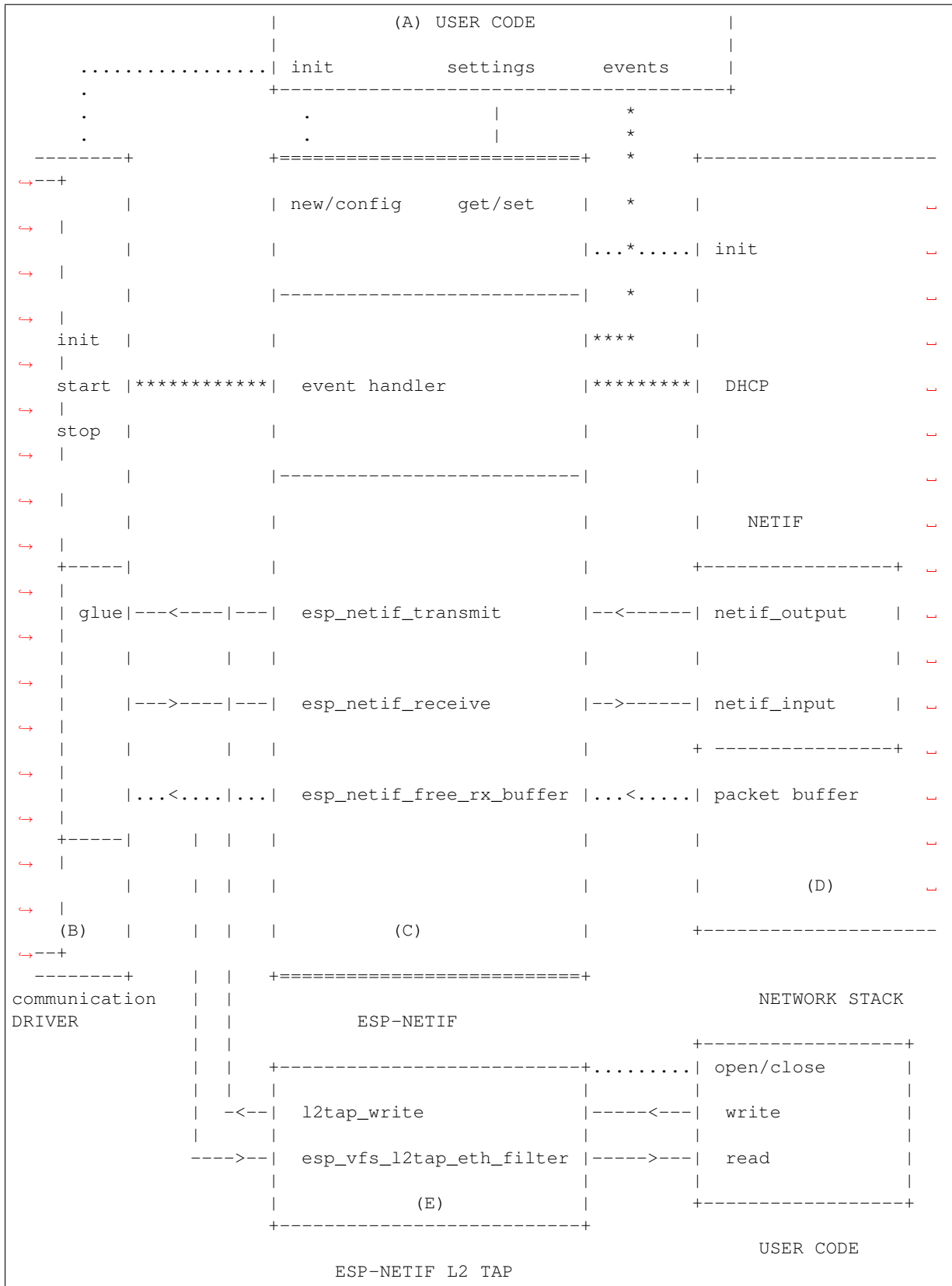



### Data and event flow in the diagram

- . . . . . Initialization line from user code to ESP-NETIF and communication driver
- --<---->-- Data packets going from communication media to TCP/IP stack and back
- \*\*\*\*\* Events aggregated in ESP-NETIF propagates to driver, user code and network stack
- | User settings and runtime configuration

### ESP-NETIF interaction

**A) User code, boiler plate** Overall application interaction with a specific IO driver for communication media and configured TCP/IP network stack is abstracted using ESP-NETIF APIs and outlined as below:

#### A) Initialization code

- 1) Initializes IO driver
- 2) Creates a new instance of ESP-NETIF and configure with
  - ESP-NETIF specific options (flags, behaviour, name)
  - Network stack options (netif init and input functions, not publicly available)
  - IO driver specific options (transmit, free rx buffer functions, IO driver handle)
- 3) Attaches the IO driver handle to the ESP-NETIF instance created in the above steps
- 4) Configures event handlers
  - use default handlers for common interfaces defined in IO drivers; or define a specific handlers for customised behaviour/new interfaces
  - register handlers for app related events (such as IP lost/acquired)

#### B) Interaction with network interfaces using ESP-NETIF API

- Getting and setting TCP/IP related parameters (DHCP, IP, etc)
- Receiving IP events (connect/disconnect)
- Controlling application lifecycle (set interface up/down)

**B) Communication driver, IO driver, media driver** Communication driver plays these two important roles in relation with ESP-NETIF:

- 1) Event handlers: Define behaviour patterns of interaction with ESP-NETIF (for example: ethernet link-up -> turn netif on)
- 2) Glue IO layer: Adapts the input/output functions to use ESP-NETIF transmit, receive and free receive buffer
  - Installs driver\_transmit to appropriate ESP-NETIF object, so that outgoing packets from network stack are passed to the IO driver
  - Calls `esp_netif_receive()` to pass incoming data to network stack

**C) ESP-NETIF** ESP-NETIF is an intermediary between an IO driver and a network stack, connecting packet data path between these two. As that it provides a set of interfaces for attaching a driver to ESP-NETIF object (runtime) and configuring a network stack (compile time). In addition to that a set of API is provided to control network interface lifecycle and its TCP/IP properties. As an overview, the ESP-NETIF public interface could be divided into these 6 groups:

- 1) Initialization APIs (to create and configure ESP-NETIF instance)
- 2) Input/Output API (for passing data between IO driver and network stack)
- 3) Event or Action API
  - Used for network interface lifecycle management
  - ESP-NETIF provides building blocks for designing event handlers
- 4) Setters and Getters for basic network interface properties
- 5) Network stack abstraction: enabling user interaction with TCP/IP stack
  - Set interface up or down

- DHCP server and client API
- DNS API

6) Driver conversion utilities

**D) Network stack** Network stack has no public interaction with application code with regard to public interfaces and shall be fully abstracted by ESP-NETIF API.

**E) ESP-NETIF L2 TAP Interface** The ESP-NETIF L2 TAP interface is ESP-IDF mechanism utilized to access Data Link Layer (L2 per OSI/ISO) for frame reception and transmission from user application. Its typical usage in embedded world might be implementation of non-IP related protocols such as PTP, Wake on LAN and others. Note that only Ethernet (IEEE 802.3) is currently supported.

From user perspective, the ESP-NETIF L2 TAP interface is accessed using file descriptors of VFS which provides a file-like interfacing (using functions like `open()`, `read()`, `write()`, etc). Refer to [Virtual filesystem component](#) to learn more.

There is only one ESP-NETIF L2 TAP interface device (path name) available. However multiple file descriptors with different configuration can be opened at a time since the ESP-NETIF L2 TAP interface can be understood as generic entry point to Layer 2 infrastructure. Important is then specific configuration of particular file descriptor. It can be configured to give an access to specific Network Interface identified by `if_key` (e.g. `ETH_DEF`) and to filter only specific frames based on their type (e.g. Ethernet type in case of IEEE 802.3). Filtering only specific frames is crucial since the ESP-NETIF L2 TAP needs to exist along with IP stack and so the IP related traffic (IP, ARP, etc.) should not be passed directly to the user application. Even though such option is still configurable, it is not recommended in standard use cases. Filtering is also advantageous from a perspective the user's application gets access only to frame types it is interested in and the remaining traffic is either passed to other L2 TAP file descriptors or to IP stack.

### ESP-NETIF L2 TAP Interface Usage Manual

**Initialization** To be able to use the ESP-NETIF L2 TAP interface, it needs to be enabled in Kconfig by [CONFIG\\_ESP\\_NETIF\\_L2\\_TAP](#) first and then registered by `esp_vfs_l2tap_intf_register()` prior usage of any VFS function.

**open()** Once the ESP-NETIF L2 TAP is registered, it can be opened at path name `"/dev/net/tap"`. The same path name can be opened multiple times up to [CONFIG\\_ESP\\_NETIF\\_L2\\_TAP\\_MAX\\_FDS](#) and multiple file descriptors with with different configuration may access the Data Link Layer frames.

The ESP-NETIF L2 TAP can be opened with `O_NONBLOCK` file status flag to the `read()` does not block. Note that the `write()` may block in current implementation when accessing a Network interface since it is a shared resource among multiple ESP-NETIF L2 TAP file descriptors and IP stack, and there is currently no queuing mechanism deployed. The file status flag can be retrieved and modified using `fcntl()`.

On success, `open()` returns the new file descriptor (a nonnegative integer). On error, -1 is returned and `errno` is set to indicate the error.

**ioctl()** The newly opened ESP-NETIF L2 TAP file descriptor needs to be configured prior its usage since it is not bounded to any specific Network Interface and no frame type filter is configured. The following configuration options are available to do so:

- `L2TAP_S_INTF_DEVICE` - bounds the file descriptor to specific Network Interface which is identified by its `if_key`. ESP-NETIF Network Interface `if_key` is passed to `ioctl()` as the third parameter. Note that default Network Interfaces `if_key`'s used in ESP-IDF can be found in [esp\\_netif/include/esp\\_netif\\_defaults.h](#).
- `L2TAP_S_DEVICE_DRV_HNDL` - is other way how to bound the file descriptor to specific Network Interface. In this case the Network interface is identified directly by IO Driver handle (e.g. `esp_eth_handle_t` in case of Ethernet). The IO Driver handle is passed to `ioctl()` as the third parameter.

- `L2TAP_S_RCV_FILTER` - sets the filter to frames with this type to be passed to the file descriptor. In case of Ethernet frames, the frames are to be filtered based on Length/Ethernet type field. In case the filter value is set less than or equal to `0x05DC`, the Ethernet type field is considered to represent IEEE802.3 Length Field and all frames with values in interval `<0, 0x05DC>` at that field are to be passed to the file descriptor. The IEEE802.2 logical link control (LLC) resolution is then expected to be performed by user's application. In case the filter value is set greater than `0x05DC`, the Ethernet type field is considered to represent protocol identification and only frames which are equal to the set value are to be passed to the file descriptor.

All above set configuration options have getter counterpart option to read the current settings.

**Warning:** The file descriptor needs to be firstly bounded to specific Network Interface by `L2TAP_S_INTF_DEVICE` or `L2TAP_S_DEVICE_DRV_HNDL` to be `L2TAP_S_RCV_FILTER` option available.

---

**Note:** VLAN tagged frames are currently not recognized. If user needs to process VLAN tagged frames, they need set filter to be equal to VLAN tag (i.e. `0x8100` or `0x88A8`) and process the VLAN tagged frames in user application.

---

---

**Note:** `L2TAP_S_DEVICE_DRV_HNDL` is particularly useful when user's application does not require usage of IP stack and so ESP-NETIF is not required to be initialized too. As a result, Network Interface cannot be identified by its `if_key` and hence it needs to be identified directly by its IO Driver handle.

---

On success, `ioctl()` returns 0. On error, -1 is returned, and `errno` is set to indicate the error.

**EBADF** - not a valid file descriptor.

**EACCES** - option change is denied in this state (e.g. file descriptor has not be bounded to Network interface yet).

**EINVAL** - invalid configuration argument. Ethernet type filter is already used by other file descriptor on that same Network interface.

**ENODEV** - no such Network Interface which is tried to be assigned to the file descriptor exists.

**ENOSYS** - unsupported operation, passed configuration option does not exists.

**fcntl()** `fcntl()` is used to manipulate with properties of opened ESP-NETIF L2 TAP file descriptor.

The following commands manipulate the status flags associated with file descriptor:

- `F_GETFD` - the function returns the file descriptor flags, the third argument is ignored.
- `F_SETFD` - sets the file descriptor flags to the value specified by the third argument. Zero is returned.

On error, -1 is returned, and `errno` is set to indicate the error.

**EBADF** - not a valid file descriptor.

**ENOSYS** - unsupported command.

**read()** Opened and configured ESP-NETIF L2 TAP file descriptor can be accessed by `read()` to get inbound frames. The read operation can be either blocking or non-blocking based on actual state of `O_NONBLOCK` file status flag. When the file status flag is set blocking, the read operation waits until a frame is received and context is switched to other task. When the file status flag is set non-blocking, the read operation returns immediately. In such case, either a frame is returned if it was already queued or the function indicates the queue is empty. The number of queued frames associated with one file descriptor is limited by `CONFIG_ESP_NETIF_L2_TAP_RX_QUEUE_SIZE` Kconfig option. Once the number of queued frames reach configured threshold, the newly arriving frames are dropped until the queue has enough room to accept incoming traffic (Tail Drop queue management).

On success, `read()` returns the number of bytes read. Zero is returned when size of the destination buffer is 0. On error, -1 is returned, and `errno` is set to indicate the error.

**EBADF** - not a valid file descriptor.

**EAGAIN** - the file descriptor has been marked non-blocking (`O_NONBLOCK`), and the read would block.

**write()** A raw Data Link Layer frame can be sent to Network Interface via opened and configured ESP-NETIF L2 TAP file descriptor. User's application is responsible to construct the whole frame except for fields which are added automatically by the physical interface device. The following fields need to be constructed by the user's application in case of Ethernet link: source/destination MAC addresses, Ethernet type, actual protocol header and user data. See below for more information about Ethernet frame structure.

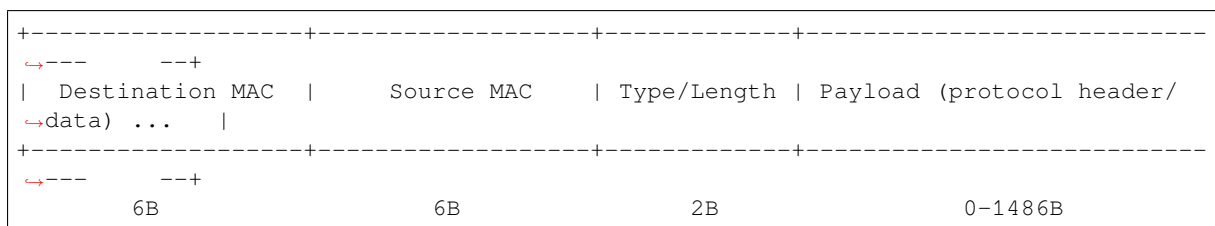

In other words, there is no additional frame processing performed by the ESP-NETIF L2 TAP interface. It only checks the Ethernet type of the frame is the same as the filter configured in the file descriptor. If the Ethernet type is different, an error is returned and the frame is not sent. Note that the `write()` may block in current implementation when accessing a Network interface since it is a shared resource among multiple ESP-NETIF L2 TAP file descriptors and IP stack, and there is currently no queuing mechanism deployed.

On success, `write()` returns the number of bytes written. Zero is returned when size of the input buffer is 0. On error, -1 is returned, and `errno` is set to indicate the error.

**EBADF** - not a valid file descriptor.

**EBADMSG** - Ethernet type of the frame is different then file descriptor configured filter.

**EIO** - Network interface not available or busy.

**close()** Opened ESP-NETIF L2 TAP file descriptor can be closed by the `close()` to free its allocated resources. The ESP-NETIF L2 TAP implementation of `close()` may block. On the other hand, it is thread safe and can be called from different task than the file descriptor is actually used. If such situation occurs and one task is blocked in I/O operation and another task tries to close the file descriptor, the first task is unblocked. The first's task read operation then ends with error.

On success, `close()` returns zero. On error, -1 is returned, and `errno` is set to indicate the error.

**EBADF** - not a valid file descriptor.

**select()** Select is used in a standard way, just `CONFIG_VFS_SUPPORT_SELECT` needs to be enabled to be the `select()` function available.

**ESP-NETIF programmer's manual** Please refer to the example section for basic initialization of default interfaces:

- WiFi Station: [wifi/getting\\_started/station/main/station\\_example\\_main.c](#)
- Ethernet: [ethernet/basic/main/ethernet\\_example\\_main.c](#)
- L2 TAP: [protocols/l2tap/main/l2tap\\_main.c](#)
- WiFi Access Point: [wifi/getting\\_started/softAP/main/softap\\_example\\_main.c](#)

For more specific cases please consult this guide: [ESP-NETIF Custom I/O Driver](#).

**WiFi default initialization** The initialization code as well as registering event handlers for default interfaces, such as softAP and station, are provided in separate APIs to facilitate simple startup code for most applications:

- `esp_netif_create_default_wifi_sta()`
- `esp_netif_create_default_wifi_ap()`

Please note that these functions return the `esp_netif` handle, i.e. a pointer to a network interface object allocated and configured with default settings, which as a consequence, means that:

- The created object has to be destroyed if a network de-initialization is provided by an application using `esp_netif_destroy_default_wifi()`.
- These *default* interfaces must not be created multiple times, unless the created handle is deleted using `esp_netif_destroy()`.
- When using Wifi in AP+STA mode, both these interfaces has to be created.

## API Reference

### Header File

- `components/esp_netif/include/esp_netif.h`

### Functions

`esp_err_t esp_netif_init` (void)

Initialize the underlying TCP/IP stack.

---

**Note:** This function should be called exactly once from application code, when the application starts up.

---

#### Returns

- ESP\_OK on success
- ESP\_FAIL if initializing failed

`esp_err_t esp_netif_deinit` (void)

Deinitialize the esp-netif component (and the underlying TCP/IP stack)

Note: Deinitialization **is not** supported yet

#### Returns

- ESP\_ERR\_INVALID\_STATE if esp\_netif not initialized
- ESP\_ERR\_NOT\_SUPPORTED otherwise

`esp_netif_t *esp_netif_new` (const `esp_netif_config_t` \*esp\_netif\_config)

Creates an instance of new esp-netif object based on provided config.

**Parameters** `esp_netif_config` –pointer esp-netif configuration

#### Returns

- pointer to esp-netif object on success
- NULL otherwise

void `esp_netif_destroy` (`esp_netif_t` \*esp\_netif)

Destroys the esp\_netif object.

**Parameters** `esp_netif` –[in] pointer to the object to be deleted

*esp\_err\_t* **esp\_netif\_set\_driver\_config** (*esp\_netif\_t* \*esp\_netif, const *esp\_netif\_driver\_ifconfig\_t* \*driver\_config)

Configures driver related options of esp\_netif object.

**Parameters**

- **esp\_netif** –[inout] pointer to the object to be configured
- **driver\_config** –[in] pointer esp-netif io driver related configuration

**Returns**

- ESP\_OK on success
- ESP\_ERR\_ESP\_NETIF\_INVALID\_PARAMS if invalid parameters provided

*esp\_err\_t* **esp\_netif\_attach** (*esp\_netif\_t* \*esp\_netif, *esp\_netif\_io\_driver\_handle\_t* driver\_handle)

Attaches esp\_netif instance to the io driver handle.

Calling this function enables connecting specific esp\_netif object with already initialized io driver to update esp\_netif object with driver specific configuration (i.e. calls post\_attach callback, which typically sets io driver callbacks to esp\_netif instance and starts the driver)

**Parameters**

- **esp\_netif** –[inout] pointer to esp\_netif object to be attached
- **driver\_handle** –[in] pointer to the driver handle

**Returns**

- ESP\_OK on success
- ESP\_ERR\_ESP\_NETIF\_DRIVER\_ATTACH\_FAILED if driver's post\_attach callback failed

*esp\_err\_t* **esp\_netif\_receive** (*esp\_netif\_t* \*esp\_netif, void \*buffer, size\_t len, void \*eb)

Passes the raw packets from communication media to the appropriate TCP/IP stack.

This function is called from the configured (peripheral) driver layer. The data are then forwarded as frames to the TCP/IP stack.

**Parameters**

- **esp\_netif** –[in] Handle to esp-netif instance
- **buffer** –[in] Received data
- **len** –[in] Length of the data frame
- **eb** –[in] Pointer to internal buffer (used in Wi-Fi driver)

**Returns**

- ESP\_OK

void **esp\_netif\_action\_start** (void \*esp\_netif, esp\_event\_base\_t base, int32\_t event\_id, void \*data)

Default building block for network interface action upon IO driver start event Creates network interface, if AUTOUP enabled turns the interface on, if DHCP enabled starts dhcp server.

---

**Note:** This API can be directly used as event handler

---

**Parameters**

- **esp\_netif** –[in] Handle to esp-netif instance
- **base** –
- **event\_id** –
- **data** –

void **esp\_netif\_action\_stop** (void \*esp\_netif, esp\_event\_base\_t base, int32\_t event\_id, void \*data)

Default building block for network interface action upon IO driver stop event.

---

**Note:** This API can be directly used as event handler

---

**Parameters**

- **esp\_netif** –[in] Handle to esp-netif instance
- **base** –
- **event\_id** –
- **data** –

void **esp\_netif\_action\_connected** (void \*esp\_netif, esp\_event\_base\_t base, int32\_t event\_id, void \*data)

Default building block for network interface action upon IO driver connected event.

---

**Note:** This API can be directly used as event handler

---

#### Parameters

- **esp\_netif** –[in] Handle to esp-netif instance
- **base** –
- **event\_id** –
- **data** –

void **esp\_netif\_action\_disconnected** (void \*esp\_netif, esp\_event\_base\_t base, int32\_t event\_id, void \*data)

Default building block for network interface action upon IO driver disconnected event.

---

**Note:** This API can be directly used as event handler

---

#### Parameters

- **esp\_netif** –[in] Handle to esp-netif instance
- **base** –
- **event\_id** –
- **data** –

void **esp\_netif\_action\_got\_ip** (void \*esp\_netif, esp\_event\_base\_t base, int32\_t event\_id, void \*data)

Default building block for network interface action upon network got IP event.

---

**Note:** This API can be directly used as event handler

---

#### Parameters

- **esp\_netif** –[in] Handle to esp-netif instance
- **base** –
- **event\_id** –
- **data** –

void **esp\_netif\_action\_join\_ip6\_multicast\_group** (void \*esp\_netif, esp\_event\_base\_t base, int32\_t event\_id, void \*data)

Default building block for network interface action upon IPv6 multicast group join.

---

**Note:** This API can be directly used as event handler

---

#### Parameters

- **esp\_netif** –[in] Handle to esp-netif instance
- **base** –
- **event\_id** –
- **data** –

void **esp\_netif\_action\_leave\_ip6\_multicast\_group** (void \*esp\_netif, esp\_event\_base\_t base, int32\_t event\_id, void \*data)

Default building block for network interface action upon IPv6 multicast group leave.

---

**Note:** This API can be directly used as event handler

---

#### Parameters

- **esp\_netif** –[in] Handle to esp-netif instance
- **base** –
- **event\_id** –
- **data** –

void **esp\_netif\_action\_add\_ip6\_address** (void \*esp\_netif, esp\_event\_base\_t base, int32\_t event\_id, void \*data)

Default building block for network interface action upon IPv6 address added by the underlying stack.

---

**Note:** This API can be directly used as event handler

---

#### Parameters

- **esp\_netif** –[in] Handle to esp-netif instance
- **base** –
- **event\_id** –
- **data** –

void **esp\_netif\_action\_remove\_ip6\_address** (void \*esp\_netif, esp\_event\_base\_t base, int32\_t event\_id, void \*data)

Default building block for network interface action upon IPv6 address removed by the underlying stack.

---

**Note:** This API can be directly used as event handler

---

#### Parameters

- **esp\_netif** –[in] Handle to esp-netif instance
- **base** –
- **event\_id** –
- **data** –

*esp\_err\_t* **esp\_netif\_set\_default\_netif** (*esp\_netif\_t* \*esp\_netif)

Manual configuration of the default netif.

This API overrides the automatic configuration of the default interface based on the route\_prio. If the selected netif is set default using this API, no other interface could be set-default disregarding its route\_prio number (unless the selected netif gets destroyed)

**Parameters** **esp\_netif** –[in] Handle to esp-netif instance

**Returns** ESP\_OK on success

*esp\_err\_t* **esp\_netif\_join\_ip6\_multicast\_group** (*esp\_netif\_t* \*esp\_netif, const *esp\_ip6\_addr\_t* \*addr)

Cause the TCP/IP stack to join a IPv6 multicast group.

#### Parameters

- **esp\_netif** –[in] Handle to esp-netif instance
- **addr** –[in] The multicast group to join

**Returns**



- ESP\_OK
- ESP\_ERR\_ESP\_NETIF\_INVALID\_PARAMS
- ESP\_ERR\_ESP\_NETIF\_MLD6\_FAILED
- ESP\_ERR\_NO\_MEM

*esp\_err\_t* **esp\_netif\_leave\_ip6\_multicast\_group** (*esp\_netif\_t* \*esp\_netif, const *esp\_ip6\_addr\_t* \*addr)

Cause the TCP/IP stack to leave a IPv6 multicast group.

#### Parameters

- **esp\_netif** –[in] Handle to esp-netif instance
- **addr** –[in] The multicast group to leave

#### Returns

- ESP\_OK
- ESP\_ERR\_ESP\_NETIF\_INVALID\_PARAMS
- ESP\_ERR\_ESP\_NETIF\_MLD6\_FAILED
- ESP\_ERR\_NO\_MEM

*esp\_err\_t* **esp\_netif\_set\_mac** (*esp\_netif\_t* \*esp\_netif, uint8\_t mac[])

Set the mac address for the interface instance.

#### Parameters

- **esp\_netif** –[in] Handle to esp-netif instance
- **mac** –[in] Desired mac address for the related network interface

#### Returns

- ESP\_OK - success
- ESP\_ERR\_ESP\_NETIF\_IF\_NOT\_READY - interface status error
- ESP\_ERR\_NOT\_SUPPORTED - mac not supported on this interface

*esp\_err\_t* **esp\_netif\_get\_mac** (*esp\_netif\_t* \*esp\_netif, uint8\_t mac[])

Get the mac address for the interface instance.

#### Parameters

- **esp\_netif** –[in] Handle to esp-netif instance
- **mac** –[out] Resultant mac address for the related network interface

#### Returns

- ESP\_OK - success
- ESP\_ERR\_ESP\_NETIF\_IF\_NOT\_READY - interface status error
- ESP\_ERR\_NOT\_SUPPORTED - mac not supported on this interface

*esp\_err\_t* **esp\_netif\_set\_hostname** (*esp\_netif\_t* \*esp\_netif, const char \*hostname)

Set the hostname of an interface.

The configured hostname overrides the default configuration value CONFIG\_LWIP\_LOCAL\_HOSTNAME. Please note that when the hostname is altered after interface started/connected the changes would only be reflected once the interface restarts/reconnects

#### Parameters

- **esp\_netif** –[in] Handle to esp-netif instance
- **hostname** –[in] New hostname for the interface. Maximum length 32 bytes.

#### Returns

- ESP\_OK - success
- ESP\_ERR\_ESP\_NETIF\_IF\_NOT\_READY - interface status error
- ESP\_ERR\_ESP\_NETIF\_INVALID\_PARAMS - parameter error

*esp\_err\_t* **esp\_netif\_get\_hostname** (*esp\_netif\_t* \*esp\_netif, const char \*\*hostname)

Get interface hostname.

#### Parameters

- **esp\_netif** –[in] Handle to esp-netif instance
- **hostname** –[out] Returns a pointer to the hostname. May be NULL if no hostname is set. If set non-NULL, pointer remains valid (and string may change if the hostname changes).

**Returns**

- ESP\_OK - success
- ESP\_ERR\_ESP\_NETIF\_IF\_NOT\_READY - interface status error
- ESP\_ERR\_ESP\_NETIF\_INVALID\_PARAMS - parameter error

bool **esp\_netif\_is\_netif\_up** (*esp\_netif\_t* \*esp\_netif)

Test if supplied interface is up or down.

**Parameters** *esp\_netif* –[in] Handle to esp-netif instance

**Returns**

- true - Interface is up
- false - Interface is down

*esp\_err\_t* **esp\_netif\_get\_ip\_info** (*esp\_netif\_t* \*esp\_netif, *esp\_netif\_ip\_info\_t* \*ip\_info)

Get interface's IP address information.

If the interface is up, IP information is read directly from the TCP/IP stack. If the interface is down, IP information is read from a copy kept in the ESP-NETIF instance

**Parameters**

- *esp\_netif* –[in] Handle to esp-netif instance
- *ip\_info* –[out] If successful, IP information will be returned in this argument.

**Returns**

- ESP\_OK
- ESP\_ERR\_ESP\_NETIF\_INVALID\_PARAMS

*esp\_err\_t* **esp\_netif\_get\_old\_ip\_info** (*esp\_netif\_t* \*esp\_netif, *esp\_netif\_ip\_info\_t* \*ip\_info)

Get interface's old IP information.

Returns an "old" IP address previously stored for the interface when the valid IP changed.

If the IP lost timer has expired (meaning the interface was down for longer than the configured interval) then the old IP information will be zero.

**Parameters**

- *esp\_netif* –[in] Handle to esp-netif instance
- *ip\_info* –[out] If successful, IP information will be returned in this argument.

**Returns**

- ESP\_OK
- ESP\_ERR\_ESP\_NETIF\_INVALID\_PARAMS

*esp\_err\_t* **esp\_netif\_set\_ip\_info** (*esp\_netif\_t* \*esp\_netif, const *esp\_netif\_ip\_info\_t* \*ip\_info)

Set interface's IP address information.

This function is mainly used to set a static IP on an interface.

If the interface is up, the new IP information is set directly in the TCP/IP stack.

The copy of IP information kept in the ESP-NETIF instance is also updated (this copy is returned if the IP is queried while the interface is still down.)

---

**Note:** DHCP client/server must be stopped (if enabled for this interface) before setting new IP information.

---

---

**Note:** Calling this interface for may generate a SYSTEM\_EVENT\_STA\_GOT\_IP or SYSTEM\_EVENT\_ETH\_GOT\_IP event.

---

**Parameters**

- *esp\_netif* –[in] Handle to esp-netif instance
- *ip\_info* –[in] IP information to set on the specified interface

**Returns**

- ESP\_OK

- `ESP_ERR_ESP_NETIF_INVALID_PARAMS`
- `ESP_ERR_ESP_NETIF_DHCP_NOT_STOPPED` If DHCP server or client is still running

*esp\_err\_t* `esp_netif_set_old_ip_info` (*esp\_netif\_t* \*esp\_netif, const *esp\_netif\_ip\_info\_t* \*ip\_info)

Set interface old IP information.

This function is called from the DHCP client (if enabled), before a new IP is set. It is also called from the default handlers for the `SYSTEM_EVENT_STA_CONNECTED` and `SYSTEM_EVENT_ETH_CONNECTED` events.

Calling this function stores the previously configured IP, which can be used to determine if the IP changes in the future.

If the interface is disconnected or down for too long, the “IP lost timer” will expire (after the configured interval) and set the old IP information to zero.

#### Parameters

- `esp_netif` –[in] Handle to esp-netif instance
- `ip_info` –[in] Store the old IP information for the specified interface

#### Returns

- `ESP_OK`
- `ESP_ERR_ESP_NETIF_INVALID_PARAMS`

int `esp_netif_get_netif_impl_index` (*esp\_netif\_t* \*esp\_netif)

Get net interface index from network stack implementation.

---

**Note:** This index could be used in `setsockopt()` to bind socket with multicast interface

---

**Parameters** `esp_netif` –[in] Handle to esp-netif instance

**Returns** implementation specific index of interface represented with supplied `esp_netif`

*esp\_err\_t* `esp_netif_get_netif_impl_name` (*esp\_netif\_t* \*esp\_netif, char \*name)

Get net interface name from network stack implementation.

---

**Note:** This name could be used in `setsockopt()` to bind socket with appropriate interface

---

#### Parameters

- `esp_netif` –[in] Handle to esp-netif instance
- `name` –[out] Interface name as specified in underlying TCP/IP stack. Note that the actual name will be copied to the specified buffer, which must be allocated to hold maximum interface name size (6 characters for lwIP)

#### Returns

- `ESP_OK`
- `ESP_ERR_ESP_NETIF_INVALID_PARAMS`

*esp\_err\_t* `esp_netif_dhcps_option` (*esp\_netif\_t* \*esp\_netif, *esp\_netif\_dhcp\_option\_mode\_t* opt\_op, *esp\_netif\_dhcp\_option\_id\_t* opt\_id, void \*opt\_val, uint32\_t opt\_len)

Set or Get DHCP server option.

#### Parameters

- `esp_netif` –[in] Handle to esp-netif instance
- `opt_op` –[in] `ESP_NETIF_OP_SET` to set an option, `ESP_NETIF_OP_GET` to get an option.
- `opt_id` –[in] Option index to get or set, must be one of the supported enum values.
- `opt_val` –[inout] Pointer to the option parameter.
- `opt_len` –[in] Length of the option parameter.

**Returns**

- ESP\_OK
- ESP\_ERR\_ESP\_NETIF\_INVALID\_PARAMS
- ESP\_ERR\_ESP\_NETIF\_DHCP\_ALREADY\_STOPPED
- ESP\_ERR\_ESP\_NETIF\_DHCP\_ALREADY\_STARTED

*esp\_err\_t* **esp\_netif\_dhcpc\_option** (*esp\_netif\_t* \*esp\_netif, *esp\_netif\_dhcp\_option\_mode\_t* opt\_op, *esp\_netif\_dhcp\_option\_id\_t* opt\_id, void \*opt\_val, uint32\_t opt\_len)

Set or Get DHCP client option.

**Parameters**

- **esp\_netif** –[in] Handle to esp-netif instance
- **opt\_op** –[in] ESP\_NETIF\_OP\_SET to set an option, ESP\_NETIF\_OP\_GET to get an option.
- **opt\_id** –[in] Option index to get or set, must be one of the supported enum values.
- **opt\_val** –[inout] Pointer to the option parameter.
- **opt\_len** –[in] Length of the option parameter.

**Returns**

- ESP\_OK
- ESP\_ERR\_ESP\_NETIF\_INVALID\_PARAMS
- ESP\_ERR\_ESP\_NETIF\_DHCP\_ALREADY\_STOPPED
- ESP\_ERR\_ESP\_NETIF\_DHCP\_ALREADY\_STARTED

*esp\_err\_t* **esp\_netif\_dhcpc\_start** (*esp\_netif\_t* \*esp\_netif)

Start DHCP client (only if enabled in interface object)

---

**Note:** The default event handlers for the SYSTEM\_EVENT\_STA\_CONNECTED and SYSTEM\_EVENT\_ETH\_CONNECTED events call this function.

---

**Parameters** **esp\_netif** –[in] Handle to esp-netif instance

**Returns**

- ESP\_OK
- ESP\_ERR\_ESP\_NETIF\_INVALID\_PARAMS
- ESP\_ERR\_ESP\_NETIF\_DHCP\_ALREADY\_STARTED
- ESP\_ERR\_ESP\_NETIF\_DHCPC\_START\_FAILED

*esp\_err\_t* **esp\_netif\_dhcpc\_stop** (*esp\_netif\_t* \*esp\_netif)

Stop DHCP client (only if enabled in interface object)

---

**Note:** Calling action\_netif\_stop() will also stop the DHCP Client if it is running.

---

**Parameters** **esp\_netif** –[in] Handle to esp-netif instance

**Returns**

- ESP\_OK
- ESP\_ERR\_ESP\_NETIF\_INVALID\_PARAMS
- ESP\_ERR\_ESP\_NETIF\_DHCP\_ALREADY\_STOPPED
- ESP\_ERR\_ESP\_NETIF\_IF\_NOT\_READY

*esp\_err\_t* **esp\_netif\_dhcpc\_get\_status** (*esp\_netif\_t* \*esp\_netif, *esp\_netif\_dhcp\_status\_t* \*status)

Get DHCP client status.

**Parameters**

- **esp\_netif** –[in] Handle to esp-netif instance
- **status** –[out] If successful, the status of DHCP client will be returned in this argument.

**Returns**

- ESP\_OK

*esp\_err\_t* **esp\_netif\_dhcps\_get\_status** (*esp\_netif\_t* \*esp\_netif, *esp\_netif\_dhcp\_status\_t* \*status)

Get DHCP Server status.

**Parameters**

- **esp\_netif** –[in] Handle to esp-netif instance
- **status** –[out] If successful, the status of the DHCP server will be returned in this argument.

**Returns**

- ESP\_OK

*esp\_err\_t* **esp\_netif\_dhcps\_start** (*esp\_netif\_t* \*esp\_netif)

Start DHCP server (only if enabled in interface object)

**Parameters** **esp\_netif** –[in] Handle to esp-netif instance

**Returns**

- ESP\_OK
- ESP\_ERR\_ESP\_NETIF\_INVALID\_PARAMS
- ESP\_ERR\_ESP\_NETIF\_DHCP\_ALREADY\_STARTED

*esp\_err\_t* **esp\_netif\_dhcps\_stop** (*esp\_netif\_t* \*esp\_netif)

Stop DHCP server (only if enabled in interface object)

**Parameters** **esp\_netif** –[in] Handle to esp-netif instance

**Returns**

- ESP\_OK
- ESP\_ERR\_ESP\_NETIF\_INVALID\_PARAMS
- ESP\_ERR\_ESP\_NETIF\_DHCP\_ALREADY\_STOPPED
- ESP\_ERR\_ESP\_NETIF\_IF\_NOT\_READY

*esp\_err\_t* **esp\_netif\_dhcps\_get\_clients\_by\_mac** (*esp\_netif\_t* \*esp\_netif, int num, *esp\_netif\_pair\_mac\_ip\_t* \*mac\_ip\_pair)

Populate IP addresses of clients connected to DHCP server listed by their MAC addresses.

**Parameters**

- **esp\_netif** –[in] Handle to esp-netif instance
- **num** –[in] Number of clients with specified MAC addresses in the array of pairs
- **mac\_ip\_pair** –[inout] Array of pairs of MAC and IP addresses (MAC are inputs, IP outputs)

**Returns**

- ESP\_OK on success
- ESP\_ERR\_ESP\_NETIF\_INVALID\_PARAMS on invalid params
- ESP\_ERR\_NOT\_SUPPORTED if DHCP server not enabled

*esp\_err\_t* **esp\_netif\_set\_dns\_info** (*esp\_netif\_t* \*esp\_netif, *esp\_netif\_dns\_type\_t* type, *esp\_netif\_dns\_info\_t* \*dns)

Set DNS Server information.

This function behaves differently if DHCP server or client is enabled

If DHCP client is enabled, main and backup DNS servers will be updated automatically from the DHCP lease if the relevant DHCP options are set. Fallback DNS Server is never updated from the DHCP lease and is designed to be set via this API. If DHCP client is disabled, all DNS server types can be set via this API only.

If DHCP server is enabled, the Main DNS Server setting is used by the DHCP server to provide a DNS Server option to DHCP clients (Wi-Fi stations).

- The default Main DNS server is typically the IP of the DHCP server itself.
- This function can override it by setting server type ESP\_NETIF\_DNS\_MAIN.
- Other DNS Server types are not supported for the DHCP server.
- To propagate the DNS info to client, please stop the DHCP server before using this API.

**Parameters**

- **esp\_netif** –[in] Handle to esp-netif instance

- **type** *–[in]* Type of DNS Server to set: ESP\_NETIF\_DNS\_MAIN, ESP\_NETIF\_DNS\_BACKUP, ESP\_NETIF\_DNS\_FALLBACK
- **dns** *–[in]* DNS Server address to set

**Returns**

- ESP\_OK on success
- ESP\_ERR\_ESP\_NETIF\_INVALID\_PARAMS invalid params

*esp\_err\_t* **esp\_netif\_get\_dns\_info** (*esp\_netif\_t* \*esp\_netif, *esp\_netif\_dns\_type\_t* type, *esp\_netif\_dns\_info\_t* \*dns)

Get DNS Server information.

Return the currently configured DNS Server address for the specified interface and Server type.

This may be result of a previous call to *esp\_netif\_set\_dns\_info()*. If the interface's DHCP client is enabled, the Main or Backup DNS Server may be set by the current DHCP lease.

**Parameters**

- **esp\_netif** *–[in]* Handle to esp-netif instance
- **type** *–[in]* Type of DNS Server to get: ESP\_NETIF\_DNS\_MAIN, ESP\_NETIF\_DNS\_BACKUP, ESP\_NETIF\_DNS\_FALLBACK
- **dns** *–[out]* DNS Server result is written here on success

**Returns**

- ESP\_OK on success
- ESP\_ERR\_ESP\_NETIF\_INVALID\_PARAMS invalid params

*esp\_err\_t* **esp\_netif\_create\_ip6\_linklocal** (*esp\_netif\_t* \*esp\_netif)

Create interface link-local IPv6 address.

Cause the TCP/IP stack to create a link-local IPv6 address for the specified interface.

This function also registers a callback for the specified interface, so that if the link-local address becomes verified as the preferred address then a SYSTEM\_EVENT\_GOT\_IP6 event will be sent.

**Parameters** **esp\_netif** *–[in]* Handle to esp-netif instance

**Returns**

- ESP\_OK
- ESP\_ERR\_ESP\_NETIF\_INVALID\_PARAMS

*esp\_err\_t* **esp\_netif\_get\_ip6\_linklocal** (*esp\_netif\_t* \*esp\_netif, *esp\_ip6\_addr\_t* \*if\_ip6)

Get interface link-local IPv6 address.

If the specified interface is up and a preferred link-local IPv6 address has been created for the interface, return a copy of it.

**Parameters**

- **esp\_netif** *–[in]* Handle to esp-netif instance
- **if\_ip6** *–[out]* IPv6 information will be returned in this argument if successful.

**Returns**

- ESP\_OK
- ESP\_FAIL If interface is down, does not have a link-local IPv6 address, or the link-local IPv6 address is not a preferred address.

*esp\_err\_t* **esp\_netif\_get\_ip6\_global** (*esp\_netif\_t* \*esp\_netif, *esp\_ip6\_addr\_t* \*if\_ip6)

Get interface global IPv6 address.

If the specified interface is up and a preferred global IPv6 address has been created for the interface, return a copy of it.

**Parameters**

- **esp\_netif** *–[in]* Handle to esp-netif instance
- **if\_ip6** *–[out]* IPv6 information will be returned in this argument if successful.

**Returns**

- ESP\_OK

- `ESP_FAIL` If interface is down, does not have a global IPv6 address, or the global IPv6 address is not a preferred address.

int `esp_netif_get_all_ip6` (*esp\_netif\_t* \*esp\_netif, *esp\_ip6\_addr\_t* if\_ip6[])

Get all IPv6 addresses of the specified interface.

**Parameters**

- `esp_netif` **–[in]** Handle to esp-netif instance
- `if_ip6` **–[out]** Array of IPv6 addresses will be copied to the argument

**Returns** number of returned IPv6 addresses

void `esp_netif_set_ip4_addr` (*esp\_ip4\_addr\_t* \*addr, uint8\_t a, uint8\_t b, uint8\_t c, uint8\_t d)

Sets IPv4 address to the specified octets.

**Parameters**

- `addr` **–[out]** IP address to be set
- `a` **–**the first octet (127 for IP 127.0.0.1)
- `b` **–**
- `c` **–**
- `d` **–**

char \*`esp_ip4addr_ntoa` (const *esp\_ip4\_addr\_t* \*addr, char \*buf, int buflen)

Converts numeric IP address into decimal dotted ASCII representation.

**Parameters**

- `addr` **–**ip address in network order to convert
- `buf` **–**target buffer where the string is stored
- `buflen` **–**length of buf

**Returns** either pointer to buf which now holds the ASCII representation of addr or NULL if buf was too small

uint32\_t `esp_ip4addr_aton` (const char \*addr)

Ascii internet address interpretation routine The value returned is in network order.

**Parameters** `addr` **–**IP address in ascii representation (e.g. “127.0.0.1” )

**Returns** ip address in network order

*esp\_err\_t* `esp_netif_str_to_ip4` (const char \*src, *esp\_ip4\_addr\_t* \*dst)

Converts Ascii internet IPv4 address into `esp_ip4_addr_t`.

**Parameters**

- `src` **–[in]** IPv4 address in ascii representation (e.g. “127.0.0.1” )
- `dst` **–[out]** Address of the target `esp_ip4_addr_t` structure to receive converted address

**Returns**

- `ESP_OK` on success
- `ESP_FAIL` if conversion failed
- `ESP_ERR_INVALID_ARG` if invalid parameter is passed into

*esp\_err\_t* `esp_netif_str_to_ip6` (const char \*src, *esp\_ip6\_addr\_t* \*dst)

Converts Ascii internet IPv6 address into `esp_ip4_addr_t` Zeros in the IP address can be stripped or completely omitted: “2001:db8:85a3:0:0:0:2:1” or “2001:db8::2:1” )

**Parameters**

- `src` **–[in]** IPv6 address in ascii representation (e.g. “2001:0db8:85a3:0000:0000:0000:0002:0001” )
- `dst` **–[out]** Address of the target `esp_ip6_addr_t` structure to receive converted address

**Returns**

- `ESP_OK` on success
- `ESP_FAIL` if conversion failed
- `ESP_ERR_INVALID_ARG` if invalid parameter is passed into

*esp\_netif\_io\_driver\_handle* `esp_netif_get_io_driver` (*esp\_netif\_t* \*esp\_netif)

Gets media driver handle for this esp-netif instance.

**Parameters** `esp_netif` –[in] Handle to esp-netif instance

**Returns** opaque pointer of related IO driver

`esp_netif_t *esp_netif_get_handle_from_ifkey` (const char \*if\_key)

Searches over a list of created objects to find an instance with supplied if key.

**Parameters** `if_key` –Textual description of network interface

**Returns** Handle to esp-netif instance

`esp_netif_flags_t esp_netif_get_flags` (`esp_netif_t *esp_netif`)

Returns configured flags for this interface.

**Parameters** `esp_netif` –[in] Handle to esp-netif instance

**Returns** Configuration flags

const char \*`esp_netif_get_ifkey` (`esp_netif_t *esp_netif`)

Returns configured interface key for this esp-netif instance.

**Parameters** `esp_netif` –[in] Handle to esp-netif instance

**Returns** Textual description of related interface

const char \*`esp_netif_get_desc` (`esp_netif_t *esp_netif`)

Returns configured interface type for this esp-netif instance.

**Parameters** `esp_netif` –[in] Handle to esp-netif instance

**Returns** Enumerated type of this interface, such as station, AP, ethernet

int `esp_netif_get_route_prio` (`esp_netif_t *esp_netif`)

Returns configured routing priority number.

**Parameters** `esp_netif` –[in] Handle to esp-netif instance

**Returns** Integer representing the instance's route-prio, or -1 if invalid parameters

int32\_t `esp_netif_get_event_id` (`esp_netif_t *esp_netif`, `esp_netif_ip_event_type_t event_type`)

Returns configured event for this esp-netif instance and supplied event type.

**Parameters**

- `esp_netif` –[in] Handle to esp-netif instance
- `event_type` –(either get or lost IP)

**Returns** specific event id which is configured to be raised if the interface lost or acquired IP address  
-1 if supplied event\_type is not known

`esp_netif_t *esp_netif_next` (`esp_netif_t *esp_netif`)

Iterates over list of interfaces. Returns first netif if NULL given as parameter.

You can use `esp_netif_next_unsafe()` directly if all the system interfaces are under your control and you can safely iterate over them. Otherwise, iterate over interfaces using `esp_netif_tcpip_exec()`, or use `esp_netif_find_if()` to search in the list of netifs with defined predicate.

---

**Note:** This API doesn't lock the list, nor the TCPIP context, as this it's usually required to get atomic access between iteration steps rather than within a single iteration. Therefore it is recommended to iterate over the interfaces inside `esp_netif_tcpip_exec()`

---

**Parameters** `esp_netif` –[in] Handle to esp-netif instance

**Returns** First netif from the list if supplied parameter is NULL, next one otherwise

`esp_netif_t *esp_netif_next_unsafe` (`esp_netif_t *esp_netif`)

Iterates over list of interfaces without list locking. Returns first netif if NULL given as parameter.

Used for bulk search loops within TCPIP context, e.g. using `esp_netif_tcpip_exec()`, or if we're sure that the iteration is safe from our application perspective (e.g. no interface is removed between iterations)



**Parameters** `esp_netif` –[in] Handle to esp-netif instance

**Returns** First netif from the list if supplied parameter is NULL, next one otherwise

`esp_netif_t *esp_netif_find_if(esp_netif_find_predicate_t fn, void *ctx)`

Return a netif pointer for the first interface that meets criteria defined by the callback.

**Parameters**

- **fn** –Predicate function returning true for the desired interface
- **ctx** –Context pointer passed to the predicate, typically a descriptor to compare with

**Returns** valid netif pointer if found, NULL if not

`size_t esp_netif_get_nr_of_ifs(void)`

Returns number of registered esp\_netif objects.

**Returns** Number of esp\_netifs

`void esp_netif_netstack_buf_ref(void *netstack_buf)`

increase the reference counter of net stack buffer

**Parameters** `netstack_buf` –[in] the net stack buffer

`void esp_netif_netstack_buf_free(void *netstack_buf)`

free the netstack buffer

**Parameters** `netstack_buf` –[in] the net stack buffer

`esp_err_t esp_netif_tcpip_exec(esp_netif_callback_fn fn, void *ctx)`

Utility to execute the supplied callback in TCP/IP context.

**Parameters**

- **fn** –Pointer to the callback
- **ctx** –Parameter to the callback

**Returns** The error code (`esp_err_t`) returned by the callback

## Type Definitions

`typedef bool (*esp_netif_find_predicate_t)(esp_netif_t *netif, void *ctx)`

Predicate callback for `esp_netif_find_if()` used to find interface which meets defined criteria.

`typedef esp_err_t (*esp_netif_callback_fn)(void *ctx)`

TCP/IP thread safe callback used with `esp_netif_tcpip_exec()`

## Header File

- `components/esp_netif/include/esp_netif_types.h`

## Structures

`struct esp_netif_dns_info_t`

DNS server info.

## Public Members

`esp_ip_addr_t ip`

IPV4 address of DNS server

`struct esp_netif_ip_info_t`

Event structure for `IP_EVENT_STA_GOT_IP`, `IP_EVENT_ETH_GOT_IP` events

**Public Members***esp\_ip4\_addr\_t* **ip**

Interface IPV4 address

*esp\_ip4\_addr\_t* **netmask**

Interface IPV4 netmask

*esp\_ip4\_addr\_t* **gw**

Interface IPV4 gateway address

struct **esp\_netif\_ip6\_info\_t**

IPV6 IP address information.

**Public Members***esp\_ip6\_addr\_t* **ip**

Interface IPV6 address

struct **ip\_event\_got\_ip\_t**

Event structure for IP\_EVENT\_GOT\_IP event.

**Public Members***esp\_netif\_t* \***esp\_netif**

Pointer to corresponding esp-netif object

*esp\_netif\_ip\_info\_t* **ip\_info**

IP address, netmask, gateway IP address

bool **ip\_changed**

Whether the assigned IP has changed or not

struct **ip\_event\_got\_ip6\_t**

Event structure for IP\_EVENT\_GOT\_IP6 event

**Public Members***esp\_netif\_t* \***esp\_netif**

Pointer to corresponding esp-netif object

*esp\_netif\_ip6\_info\_t* **ip6\_info**

IPv6 address of the interface

int **ip\_index**

IPv6 address index

struct **ip\_event\_add\_ip6\_t**

Event structure for ADD\_IP6 event

### Public Members

*esp\_ip6\_addr\_t* **addr**

The address to be added to the interface

bool **preferred**

The default preference of the address

struct **ip\_event\_ap\_staipassigned\_t**

Event structure for IP\_EVENT\_AP\_STAIPASSIGNED event

### Public Members

*esp\_netif\_t* \***esp\_netif**

Pointer to the associated netif handle

*esp\_ip4\_addr\_t* **ip**

IP address which was assigned to the station

uint8\_t **mac**[6]

MAC address of the connected client

struct **bridgeif\_config**

LwIP bridge configuration

### Public Members

uint16\_t **max\_fdb\_dyn\_entries**

maximum number of entries in dynamic forwarding database

uint16\_t **max\_fdb\_sta\_entries**

maximum number of entries in static forwarding database

uint8\_t **max\_ports**

maximum number of ports the bridge can consist of

struct **esp\_netif\_inherent\_config**

ESP-netif inherent config parameters.

### Public Members

*esp\_netif\_flags\_t* **flags**

flags that define esp-netif behavior

uint8\_t **mac**[6]

initial mac address for this interface

const *esp\_netif\_ip\_info\_t* \***ip\_info**

initial ip address for this interface

uint32\_t **get\_ip\_event**

event id to be raised when interface gets an IP

uint32\_t **lost\_ip\_event**

event id to be raised when interface loses its IP

const char \***if\_key**

string identifier of the interface

const char \***if\_desc**

textual description of the interface

int **route\_prio**

numeric priority of this interface to become a default routing if (if other netifs are up). A higher value of route\_prio indicates a higher priority

*bridgeif\_config\_t* \***bridge\_info**

LwIP bridge configuration

struct **esp\_netif\_driver\_base\_s**

ESP-netif driver base handle.

### Public Members

*esp\_err\_t* (\***post\_attach**)(*esp\_netif\_t* \*netif, *esp\_netif\_io\_driver\_handle* h)

post attach function pointer

*esp\_netif\_t* \***netif**

netif handle

struct **esp\_netif\_driver\_ifconfig**

Specific IO driver configuration.

### Public Members

*esp\_netif\_io\_driver\_handle* **handle**

io-driver handle

*esp\_err\_t* (\***transmit**)(void \*h, void \*buffer, size\_t len)

transmit function pointer

*esp\_err\_t* (\***transmit\_wrap**)(void \*h, void \*buffer, size\_t len, void \*netstack\_buffer)

transmit wrap function pointer

void (\***driver\_free\_rx\_buffer**)(void \*h, void \*buffer)

free rx buffer function pointer

struct **esp\_netif\_config**

Generic esp\_netif configuration.

### Public Members

const *esp\_netif\_inherent\_config\_t* \***base**

base config

const *esp\_netif\_driver\_ifconfig\_t* \***driver**

driver config

const *esp\_netif\_netstack\_config\_t* \***stack**

stack config

struct **esp\_netif\_pair\_mac\_ip\_t**

DHCP client's addr info (pair of MAC and IP address)

### Public Members

uint8\_t **mac**[6]

Clients MAC address

*esp\_ip4\_addr\_t* **ip**

Clients IP address

### Macros

**ESP\_ERR\_ESP\_NETIF\_BASE**

Definition of ESP-NETIF based errors.

**ESP\_ERR\_ESP\_NETIF\_INVALID\_PARAMS**

**ESP\_ERR\_ESP\_NETIF\_IF\_NOT\_READY**

**ESP\_ERR\_ESP\_NETIF\_DHCP\_START\_FAILED**

**ESP\_ERR\_ESP\_NETIF\_DHCP\_ALREADY\_STARTED**

**ESP\_ERR\_ESP\_NETIF\_DHCP\_ALREADY\_STOPPED**

**ESP\_ERR\_ESP\_NETIF\_NO\_MEM**

**ESP\_ERR\_ESP\_NETIF\_DHCP\_NOT\_STOPPED**

**ESP\_ERR\_ESP\_NETIF\_DRIVER\_ATTACH\_FAILED**

**ESP\_ERR\_ESP\_NETIF\_INIT\_FAILED**

**ESP\_ERR\_ESP\_NETIF\_DNS\_NOT\_CONFIGURED**

**ESP\_ERR\_ESP\_NETIF\_MLD6\_FAILED**

**ESP\_ERR\_ESP\_NETIF\_IP6\_ADDR\_FAILED**

**ESP\_ERR\_ESP\_NETIF\_DHCP\_START\_FAILED**

**ESP\_NETIF\_BR\_FLOOD**

Definition of ESP-NETIF bridge controll.

**ESP\_NETIF\_BR\_DROP**

**ESP\_NETIF\_BR\_FDW\_CPU**

### Type Definitions

typedef struct esp\_netif\_obj **esp\_netif\_t**

typedef enum *esp\_netif\_flags* **esp\_netif\_flags\_t**

typedef enum *esp\_netif\_ip\_event\_type* **esp\_netif\_ip\_event\_type\_t**

typedef struct *bridgeif\_config* **bridgeif\_config\_t**

LwIP bridge configuration

typedef struct *esp\_netif\_inherent\_config* **esp\_netif\_inherent\_config\_t**

ESP-netif inherent config parameters.

typedef struct *esp\_netif\_config* **esp\_netif\_config\_t**

typedef void \***esp\_netif\_iodriver\_handle**

IO driver handle type.

typedef struct *esp\_netif\_driver\_base\_s* **esp\_netif\_driver\_base\_t**

ESP-netif driver base handle.

typedef struct *esp\_netif\_driver\_ifconfig* **esp\_netif\_driver\_ifconfig\_t**

typedef struct esp\_netif\_netstack\_config **esp\_netif\_netstack\_config\_t**

Specific L3 network stack configuration.

typedef *esp\_err\_t* (**\*esp\_netif\_receive\_t**)(*esp\_netif\_t* \*esp\_netif, void \*buffer, size\_t len, void \*eb)  
ESP-NETIF Receive function type.

### Enumerations

enum **esp\_netif\_dns\_type\_t**

Type of DNS server.

*Values:*

enumerator **ESP\_NETIF\_DNS\_MAIN**

DNS main server address

enumerator **ESP\_NETIF\_DNS\_BACKUP**

DNS backup server address (Wi-Fi STA and Ethernet only)

enumerator **ESP\_NETIF\_DNS\_FALLBACK**

DNS fallback server address (Wi-Fi STA and Ethernet only)

enumerator **ESP\_NETIF\_DNS\_MAX**

enum **esp\_netif\_dhcp\_status\_t**

Status of DHCP client or DHCP server.

*Values:*

enumerator **ESP\_NETIF\_DHCP\_INIT**

DHCP client/server is in initial state (not yet started)

enumerator **ESP\_NETIF\_DHCP\_STARTED**

DHCP client/server has been started

enumerator **ESP\_NETIF\_DHCP\_STOPPED**

DHCP client/server has been stopped

enumerator **ESP\_NETIF\_DHCP\_STATUS\_MAX**

enum **esp\_netif\_dhcp\_option\_mode\_t**

Mode for DHCP client or DHCP server option functions.

*Values:*

enumerator **ESP\_NETIF\_OP\_START**

enumerator **ESP\_NETIF\_OP\_SET**

Set option

enumerator **ESP\_NETIF\_OP\_GET**

Get option

enumerator **ESP\_NETIF\_OP\_MAX**

enum **esp\_netif\_dhcp\_option\_id\_t**

Supported options for DHCP client or DHCP server.

*Values:*

enumerator **ESP\_NETIF\_SUBNET\_MASK**

Network mask

enumerator **ESP\_NETIF\_DOMAIN\_NAME\_SERVER**

Domain name server

enumerator **ESP\_NETIF\_ROUTER\_SOLICITATION\_ADDRESS**

Solicitation router address

enumerator **ESP\_NETIF\_REQUESTED\_IP\_ADDRESS**

Request specific IP address

enumerator **ESP\_NETIF\_IP\_ADDRESS\_LEASE\_TIME**

Request IP address lease time

enumerator **ESP\_NETIF\_IP\_REQUEST\_RETRY\_TIME**

Request IP address retry counter

enumerator **ESP\_NETIF\_VENDOR\_CLASS\_IDENTIFIER**

Vendor Class Identifier of a DHCP client

enumerator **ESP\_NETIF\_VENDOR\_SPECIFIC\_INFO**

Vendor Specific Information of a DHCP server

enum **ip\_event\_t**

IP event declarations

*Values:*

enumerator **IP\_EVENT\_STA\_GOT\_IP**

station got IP from connected AP

enumerator **IP\_EVENT\_STA\_LOST\_IP**

station lost IP and the IP is reset to 0

enumerator **IP\_EVENT\_AP\_STAIPASSIGNED**

soft-AP assign an IP to a connected station

enumerator **IP\_EVENT\_GOT\_IP6**

station or ap or ethernet interface v6IP addr is preferred

enumerator **IP\_EVENT\_ETH\_GOT\_IP**

ethernet got IP from connected AP



enumerator **IP\_EVENT\_ETH\_LOST\_IP**  
ethernet lost IP and the IP is reset to 0

enumerator **IP\_EVENT\_PPP\_GOT\_IP**  
PPP interface got IP

enumerator **IP\_EVENT\_PPP\_LOST\_IP**  
PPP interface lost IP

enum **esp\_netif\_flags**

*Values:*

enumerator **ESP\_NETIF\_DHCP\_CLIENT**

enumerator **ESP\_NETIF\_DHCP\_SERVER**

enumerator **ESP\_NETIF\_FLAG\_AUTOUP**

enumerator **ESP\_NETIF\_FLAG\_GARP**

enumerator **ESP\_NETIF\_FLAG\_EVENT\_IP\_MODIFIED**

enumerator **ESP\_NETIF\_FLAG\_IS\_PPP**

enumerator **ESP\_NETIF\_FLAG\_IS\_BRIDGE**

enumerator **ESP\_NETIF\_FLAG\_MLDV6\_REPORT**

enum **esp\_netif\_ip\_event\_type**

*Values:*

enumerator **ESP\_NETIF\_IP\_EVENT\_GOT\_IP**

enumerator **ESP\_NETIF\_IP\_EVENT\_LOST\_IP**

## Header File

- [components/esp\\_netif/include/esp\\_netif\\_ip\\_addr.h](#)

## Functions

*esp\_ip6\_addr\_type\_t* **esp\_netif\_ip6\_get\_addr\_type** (*esp\_ip6\_addr\_t* \*ip6\_addr)

Get the IPv6 address type.

**Parameters** **ip6\_addr** –[in] IPv6 type

**Returns** IPv6 type in form of enum *esp\_ip6\_addr\_type\_t*

static inline void **esp\_netif\_ip\_addr\_copy** (*esp\_ip\_addr\_t* \*dest, const *esp\_ip\_addr\_t* \*src)

Copy IP addresses.

**Parameters**

- **dest** –[out] destination IP
- **src** –[in] source IP

## Structures

struct **esp\_ip6\_addr**

IPv6 address.

### Public Members

uint32\_t **addr**[4]

IPv6 address

uint8\_t **zone**

zone ID

struct **esp\_ip4\_addr**

IPv4 address.

### Public Members

uint32\_t **addr**

IPv4 address

struct **\_ip\_addr**

IP address.

### Public Members

*esp\_ip6\_addr\_t* **ip6**

IPv6 address type

*esp\_ip4\_addr\_t* **ip4**

IPv4 address type

union *\_ip\_addr::*[anonymous] **u\_addr**

IP address union

uint8\_t **type**

ipaddress type

## Macros

**esp\_netif\_htonl** (x)

**esp\_netif\_ip4\_makeu32** (a, b, c, d)

**ESP\_IP6\_ADDR\_BLOCK1** (ip6addr)

**ESP\_IP6\_ADDR\_BLOCK2** (ip6addr)

**ESP\_IP6\_ADDR\_BLOCK3** (ip6addr)

**ESP\_IP6\_ADDR\_BLOCK4** (ip6addr)

**ESP\_IP6\_ADDR\_BLOCK5** (ip6addr)

**ESP\_IP6\_ADDR\_BLOCK6** (ip6addr)

**ESP\_IP6\_ADDR\_BLOCK7** (ip6addr)

**ESP\_IP6\_ADDR\_BLOCK8** (ip6addr)

#### **IPSTR**

**esp\_ip4\_addr\_get\_byte** (ipaddr, idx)

**esp\_ip4\_addr1** (ipaddr)

**esp\_ip4\_addr2** (ipaddr)

**esp\_ip4\_addr3** (ipaddr)

**esp\_ip4\_addr4** (ipaddr)

**esp\_ip4\_addr1\_16** (ipaddr)

**esp\_ip4\_addr2\_16** (ipaddr)

**esp\_ip4\_addr3\_16** (ipaddr)

**esp\_ip4\_addr4\_16** (ipaddr)

**IP2STR** (ipaddr)

#### **IPV6STR**

**IPV62STR** (ipaddr)

**ESP\_IPADDR\_TYPE\_V4**

**ESP\_IPADDR\_TYPE\_V6**

**ESP\_IPADDR\_TYPE\_ANY**

**ESP\_IP4TOUINT32** (a, b, c, d)

**ESP\_IP4TOADDR** (a, b, c, d)

**ESP\_IP4ADDR\_INIT** (a, b, c, d)

**ESP\_IP6ADDR\_INIT** (a, b, c, d)

#### **Type Definitions**

typedef struct *esp\_ip4\_addr* **esp\_ip4\_addr\_t**

typedef struct *esp\_ip6\_addr* **esp\_ip6\_addr\_t**

typedef struct *\_ip\_addr* **esp\_ip\_addr\_t**

IP address.

## Enumerations

enum **esp\_ip6\_addr\_type\_t**

Values:

enumerator **ESP\_IP6\_ADDR\_IS\_UNKNOWN**

enumerator **ESP\_IP6\_ADDR\_IS\_GLOBAL**

enumerator **ESP\_IP6\_ADDR\_IS\_LINK\_LOCAL**

enumerator **ESP\_IP6\_ADDR\_IS\_SITE\_LOCAL**

enumerator **ESP\_IP6\_ADDR\_IS\_UNIQUE\_LOCAL**

enumerator **ESP\_IP6\_ADDR\_IS\_IPV4\_MAPPED\_IPV6**

## Header File

- [components/esp\\_netif/include/esp\\_vfs\\_l2tap.h](#)

## Functions

*esp\_err\_t* **esp\_vfs\_l2tap\_intf\_register** (*l2tap\_vfs\_config\_t* \*config)

Add L2 TAP virtual filesystem driver.

This function must be called prior usage of ESP-NETIF L2 TAP Interface

**Parameters** **config** –L2 TAP virtual filesystem driver configuration. Default base path /dev/net/tap is used when this parameter is NULL.

**Returns** *esp\_err\_t*

- **ESP\_OK** on success

*esp\_err\_t* **esp\_vfs\_l2tap\_intf\_unregister** (const char \*base\_path)

Removes L2 TAP virtual filesystem driver.

**Parameters** **base\_path** –Base path to the L2 TAP virtual filesystem driver. Default path /dev/net/tap is used when this parameter is NULL.

**Returns** *esp\_err\_t*

- **ESP\_OK** on success

*esp\_err\_t* **esp\_vfs\_l2tap\_eth\_filter** (*l2tap\_iodriver\_handle* driver\_handle, void \*buff, *size\_t* \*size)

Filters received Ethernet L2 frames into L2 TAP infrastructure.

**Parameters**

- **driver\_handle** –handle of driver at which the frame was received
- **buff** –received L2 frame
- **size** –input length of the L2 frame which is set to 0 when frame is filtered into L2 TAP

**Returns** *esp\_err\_t*

- **ESP\_OK** is always returned

## Structures

struct **l2tap\_vfs\_config\_t**

L2Tap VFS config parameters.

## Public Members

const char **\*base\_path**  
vfs base path

## Macros

**L2TAP\_VFS\_DEFAULT\_PATH**  
**L2TAP\_VFS\_CONFIG\_DEFAULT()**

## Type Definitions

typedef void **\*l2tap\_iodriver\_handle**

## Enumerations

enum **l2tap\_ioctl\_opt\_t**

*Values:*

enumerator **L2TAP\_S\_RCV\_FILTER**

enumerator **L2TAP\_G\_RCV\_FILTER**

enumerator **L2TAP\_S\_INTF\_DEVICE**

enumerator **L2TAP\_G\_INTF\_DEVICE**

enumerator **L2TAP\_S\_DEVICE\_DRV\_HNDL**

enumerator **L2TAP\_G\_DEVICE\_DRV\_HNDL**

## WiFi default API reference

### Header File

- [components/esp\\_wifi/include/esp\\_wifi\\_default.h](#)

### Functions

*esp\_err\_t* **esp\_netif\_attach\_wifi\_station** (*esp\_netif\_t* \*esp\_netif)

Attaches wifi station interface to supplied netif.

**Parameters** **esp\_netif** –instance to attach the wifi station to

**Returns**

- ESP\_OK on success
- ESP\_FAIL if attach failed

*esp\_err\_t* **esp\_netif\_attach\_wifi\_ap** (*esp\_netif\_t* \*esp\_netif)

Attaches wifi soft AP interface to supplied netif.

**Parameters** **esp\_netif** –instance to attach the wifi AP to

**Returns**

- ESP\_OK on success
- ESP\_FAIL if attach failed

*esp\_err\_t* **esp\_wifi\_set\_default\_wifi\_sta\_handlers** (void)

Sets default wifi event handlers for STA interface.

**Returns**

- ESP\_OK on success, error returned from esp\_event\_handler\_register if failed

*esp\_err\_t* **esp\_wifi\_set\_default\_wifi\_ap\_handlers** (void)

Sets default wifi event handlers for AP interface.

**Returns**

- ESP\_OK on success, error returned from esp\_event\_handler\_register if failed

*esp\_err\_t* **esp\_wifi\_clear\_default\_wifi\_driver\_and\_handlers** (void \*esp\_netif)

Clears default wifi event handlers for supplied network interface.

**Parameters** *esp\_netif* –instance of corresponding if object

**Returns**

- ESP\_OK on success, error returned from esp\_event\_handler\_register if failed

*esp\_netif\_t* \***esp\_netif\_create\_default\_wifi\_ap** (void)

Creates default WIFI AP. In case of any init error this API aborts.

---

**Note:** The API creates esp\_netif object with default WiFi access point config, attaches the netif to wifi and registers wifi handlers to the default event loop. This API uses assert() to check for potential errors, so it could abort the program. (Note that the default event loop needs to be created prior to calling this API)

---

**Returns** pointer to esp-netif instance

*esp\_netif\_t* \***esp\_netif\_create\_default\_wifi\_sta** (void)

Creates default WIFI STA. In case of any init error this API aborts.

---

**Note:** The API creates esp\_netif object with default WiFi station config, attaches the netif to wifi and registers wifi handlers to the default event loop. This API uses assert() to check for potential errors, so it could abort the program. (Note that the default event loop needs to be created prior to calling this API)

---

**Returns** pointer to esp-netif instance

void **esp\_netif\_destroy\_default\_wifi** (void \*esp\_netif)

Destroys default WIFI netif created with esp\_netif\_create\_default\_wifi\_...() API.

---

**Note:** This API unregisters wifi handlers and detaches the created object from the wifi. (this function is a no-operation if esp\_netif is NULL)

---

**Parameters** *esp\_netif* –[in] object to detach from WiFi and destroy

*esp\_netif\_t* \***esp\_netif\_create\_wifi** (*wifi\_interface\_t* wifi\_if, *esp\_netif\_inherent\_config\_t* \*esp\_netif\_config)

Creates esp\_netif WiFi object based on the custom configuration.

**Attention** This API DOES NOT register default handlers!

**Parameters**

- **wifi\_if** –[in] type of wifi interface
- **esp\_netif\_config** –inherent esp-netif configuration pointer

**Returns** pointer to esp-netif instance

```
esp_err_t esp_netif_create_default_wifi_mesh_netifs (esp_netif_t **p_netif_sta, esp_netif_t
                                                    **p_netif_ap)
```

Creates default STA and AP network interfaces for esp-mesh.

Both netifs are almost identical to the default station and softAP, but with DHCP client and server disabled. Please note that the DHCP client is typically enabled only if the device is promoted to a root node.

Returns created interfaces which could be ignored setting parameters to NULL if an application code does not need to save the interface instances for further processing.

**Parameters**

- **p\_netif\_sta** –[out] pointer where the resultant STA interface is saved (if non NULL)
- **p\_netif\_ap** –[out] pointer where the resultant AP interface is saved (if non NULL)

**Returns** ESP\_OK on success

## 2.4.5 IP Network Layer

### ESP-NETIF Custom I/O Driver

This section outlines implementing a new I/O driver with esp-netif connection capabilities. By convention the I/O driver has to register itself as an esp-netif driver and thus holds a dependency on esp-netif component and is responsible for providing data path functions, post-attach callback and in most cases also default event handlers to define network interface actions based on driver' s lifecycle transitions.

**Packet input/output** As shown in the diagram, the following three API functions for the packet data path must be defined for connecting with esp-netif:

- `esp_netif_transmit()`
- `esp_netif_free_rx_buffer()`
- `esp_netif_receive()`

The first two functions for transmitting and freeing the rx buffer are provided as callbacks, i.e. they get called from esp-netif (and its underlying TCP/IP stack) and I/O driver provides their implementation.

The receiving function on the other hand gets called from the I/O driver, so that the driver' s code simply calls `esp_netif_receive()` on a new data received event.

**Post attach callback** A final part of the network interface initialization consists of attaching the esp-netif instance to the I/O driver, by means of calling the following API:

```
esp_err_t esp_netif_attach(esp_netif_t *esp_netif, esp_netif_iodriver_handle_t
↳ driver_handle);
```

It is assumed that the `esp_netif_iodriver_handle` is a pointer to driver' s object, a struct derived from `struct esp_netif_driver_base_s`, so that the first member of I/O driver structure must be this base structure with pointers to

- post-attach function callback
- related esp-netif instance

As a consequence the I/O driver has to create an instance of the struct per below:

```

typedef struct my_netif_driver_s {
    esp_netif_driver_base_t base;           /*!< base structure reserved as...
↪esp-netif driver */
    driver_impl          *h;               /*!< handle of driver...
↪implementation */
} my_netif_driver_t;

```

with actual values of `my_netif_driver_t::base.post_attach` and the actual drivers handle `my_netif_driver_t::h`. So when the `esp_netif_attach()` gets called from the initialization code, the post-attach callback from I/O driver's code gets executed to mutually register callbacks between esp-netif and I/O driver instances. Typically the driver is started as well in the post-attach callback. An example of a simple post-attach callback is outlined below:

```

static esp_err_t my_post_attach_start(esp_netif_t * esp_netif, void * args)
{
    my_netif_driver_t *driver = args;
    const esp_netif_driver_ifconfig_t driver_ifconfig = {
        .driver_free_rx_buffer = my_free_rx_buf,
        .transmit = my_transmit,
        .handle = driver->driver_impl
    };
    driver->base.netif = esp_netif;
    ESP_ERROR_CHECK(esp_netif_set_driver_config(esp_netif, &driver_ifconfig));
    my_driver_start(driver->driver_impl);
    return ESP_OK;
}

```

**Default handlers** I/O drivers also typically provide default definitions of lifecycle behaviour of related network interfaces based on state transitions of I/O drivers. For example *driver start* → *network start*, etc. An example of such a default handler is provided below:

```

esp_err_t my_driver_netif_set_default_handlers(my_netif_driver_t *driver, esp_
↪netif_t * esp_netif)
{
    driver_set_event_handler(driver->driver_impl, esp_netif_action_start, MY_DRV_
↪EVENT_START, esp_netif);
    driver_set_event_handler(driver->driver_impl, esp_netif_action_stop, MY_DRV_
↪EVENT_STOP, esp_netif);
    return ESP_OK;
}

```

**Network stack connection** The packet data path functions for transmitting and freeing the rx buffer (defined in the I/O driver) are called from the esp-netif, specifically from its TCP/IP stack connecting layer.

Note, that IDF provides several network stack configurations for the most common network interfaces, such as for the WiFi station or Ethernet. These configurations are defined in `esp_netif/include/esp_netif_defaults.h` and should be sufficient for most network drivers. (In rare cases, expert users might want to define custom lwIP based interface layers; it is possible, but an explicit dependency to lwIP needs to be set)

The following API reference outlines these network stack interaction with the esp-netif:

## Header File

- `components/esp_netif/include/esp_netif_net_stack.h`

## Functions



`esp_netif_t *esp_netif_get_handle_from_netif_impl (void *dev)`

Returns esp-netif handle.

**Parameters** `dev` –[in] opaque ptr to network interface of specific TCP/IP stack

**Returns** handle to related esp-netif instance

`void *esp_netif_get_netif_impl (esp_netif_t *esp_netif)`

Returns network stack specific implementation handle (if supported)

Note that it is not supported to acquire PPP netif impl pointer and this function will return NULL for esp\_netif instances configured to PPP mode

**Parameters** `esp_netif` –[in] Handle to esp-netif instance

**Returns** handle to related network stack netif handle

`esp_err_t esp_netif_set_link_speed (esp_netif_t *esp_netif, uint32_t speed)`

Set link-speed for the specified network interface.

**Parameters**

- `esp_netif` –[in] Handle to esp-netif instance
- `speed` –[in] Link speed in bit/s

**Returns** ESP\_OK on success

`esp_err_t esp_netif_transmit (esp_netif_t *esp_netif, void *data, size_t len)`

Outputs packets from the TCP/IP stack to the media to be transmitted.

This function gets called from network stack to output packets to IO driver.

**Parameters**

- `esp_netif` –[in] Handle to esp-netif instance
- `data` –[in] Data to be transmitted
- `len` –[in] Length of the data frame

**Returns** ESP\_OK on success, an error passed from the I/O driver otherwise

`esp_err_t esp_netif_transmit_wrap (esp_netif_t *esp_netif, void *data, size_t len, void *netstack_buf)`

Outputs packets from the TCP/IP stack to the media to be transmitted.

This function gets called from network stack to output packets to IO driver.

**Parameters**

- `esp_netif` –[in] Handle to esp-netif instance
- `data` –[in] Data to be transmitted
- `len` –[in] Length of the data frame
- `netstack_buf` –[in] net stack buffer

**Returns** ESP\_OK on success, an error passed from the I/O driver otherwise

`void esp_netif_free_rx_buffer (void *esp_netif, void *buffer)`

Free the rx buffer allocated by the media driver.

This function gets called from network stack when the rx buffer to be freed in IO driver context, i.e. to deallocate a buffer owned by io driver (when data packets were passed to higher levels to avoid copying)

**Parameters**

- `esp_netif` –[in] Handle to esp-netif instance
- `buffer` –[in] Rx buffer pointer

Code examples for TCP/IP socket APIs are provided in the [protocols/sockets](#) directory of ESP-IDF examples.

## 2.4.6 Application Layer

Documentation for Application layer network protocols (above the IP Network layer) are provided in [Application Protocols](#).

## 2.5 Peripherals API

### 2.5.1 Analog to Digital Converter (ADC) Oneshot Mode Driver

#### Introduction

The Analog to Digital Converter is an on-chip sensor which is able to measure analog signals from dedicated analog IO pads.

The ADC on ESP32-S2 can be used in scenario(s) like:

- Generate one-shot ADC conversion result
- Generate continuous ADC conversion results

This guide will introduce ADC oneshot mode conversion.

#### Functional Overview

The following sections of this document cover the typical steps to install and operate an ADC:

- [Resource Allocation](#) - covers which parameters should be set up to get an ADC handle and how to recycle the resources when ADC finishes working.
- [Unit Configuration](#) - covers the parameters that should be set up to configure the ADC unit, so as to get ADC conversion raw result.
- [Read Conversion Result](#) - covers how to get ADC conversion raw result.
- [Hardware Limitations](#) - describes the ADC related hardware limitations.
- [Power Management](#) - covers power management related.
- [IRAM Safe](#) - describes tips on how to read ADC conversion raw result when cache is disabled.
- [Thread Safety](#) - lists which APIs are guaranteed to be thread safe by the driver.
- [Kconfig Options](#) - lists the supported Kconfig options that can be used to make a different effect on driver behavior.

**Resource Allocation** The ADC oneshot mode driver is implemented based on ESP32-S2 SAR ADC module. Different ESP chips might have different number of independent ADCs. From oneshot mode driver's point of view, an ADC instance is represented by `adc_oneshot_unit_handle_t`.

To install an ADC instance, set up the required initial configuration structure `adc_oneshot_unit_init_cfg_t`:

- `adc_oneshot_unit_init_cfg_t::unit_id` selects the ADC. Please refer to the [datasheet](#) to know dedicated analog IOs for this ADC.
- `adc_oneshot_unit_init_cfg_t::ulp_mode` sets if the ADC will be working under super low power mode.

After setting up the initial configurations for the ADC, call `adc_oneshot_new_unit()` with the prepared `adc_oneshot_unit_init_cfg_t`. This function will return an ADC unit handle, if the allocation is successful.

This function may fail due to various errors such as invalid arguments, insufficient memory, etc. Specifically, when the to-be-allocated ADC instance is registered already, this function will return `ESP_ERR_NOT_FOUND` error. Number of available ADC(s) is recorded by `SOC_ADC_PERIPH_NUM`.

If a previously created ADC instance is no longer required, you should recycle the ADC instance by calling `adc_oneshot_del_unit()`, related hardware and software resources will be recycled as well.

### Create an ADC Unit Handle under Normal Oneshot Mode

```
adc_oneshot_unit_handle_t adc1_handle;
adc_oneshot_unit_init_cfg_t init_config1 = {
    .unit_id = ADC_UNIT_1,
    .ulp_mode = ADC_ULP_MODE_DISABLE,
};
ESP_ERROR_CHECK(adc_oneshot_new_unit(&init_config1, &adc1_handle));
```

### Recycle the ADC Unit

```
ESP_ERROR_CHECK(adc_oneshot_del_unit(adc1_handle));
```

**Unit Configuration** After an ADC instance is created, set up the `adc_oneshot_chan_cfg_t` to configure ADC IO to measure analog signal:

- `adc_oneshot_chan_cfg_t::atten`, ADC attenuation. Refer to the On-Chip Sensor chapter in [TRM](#).
- `adc_oneshot_chan_cfg_t::channel`, the IO corresponding ADC channel number. See below note.
- `adc_oneshot_chan_cfg_t::bitwidth`, the bitwidth of the raw conversion result.

**Note:** For the IO corresponding ADC channel number. Check [datasheet](#) to know the ADC IOs. On the other hand, `adc_continuous_io_to_channel()` and `adc_continuous_channel_to_io()` can be used to know the ADC channels and ADC IOs.

To make these settings take effect, call `adc_oneshot_config_channel()` with above configuration structure. Especially, this `adc_oneshot_config_channel()` can be called multiple times to configure different ADC channels. Driver will save these per channel configurations internally.

### Configure Two ADC Channels

```
adc_oneshot_chan_cfg_t config = {
    .channel = EXAMPLE_ADC1_CHAN0,
    .bitwidth = ADC_BITWIDTH_DEFAULT,
    .atten = ADC_ATTEN_DB_12,
};
ESP_ERROR_CHECK(adc_oneshot_config_channel(adc1_handle, &config));

config.channel = EXAMPLE_ADC1_CHAN1;
ESP_ERROR_CHECK(adc_oneshot_config_channel(adc1_handle, &config));
```

**Read Conversion Result** After above configurations, the ADC is ready to measure the analog signal(s) from the configured ADC channel(s). Call `adc_oneshot_read()` to get the conversion raw result of an ADC channel.

- `adc_oneshot_read()` is safer. ADC(s) are shared by some other drivers / peripherals, see [Hardware Limitations](#). This function takes some mutexes, to avoid concurrent hardware usage. Therefore, this function should not be used in an ISR context. This function may fail when the ADC is in use by other drivers / peripherals, and return `ESP_ERR_TIMEOUT`. Under this condition, the ADC raw result is invalid.

These two functions will both fail due to invalid arguments.

The ADC conversion results read from these two functions are raw data. To calculate the voltage based on the ADC raw results, this formula can be used:

$$V_{out} = D_{out} * V_{max} / D_{max} \quad (1)$$

where:

Vout	Digital output result, standing for the voltage.
Dout	ADC raw digital reading result.
Vmax	Maximum measurable input analog voltage, this is related to the ADC attenuation, please refer to the On-Chip Sensor chapter in <a href="#">TRM</a> .
Dmax	Maximum of the output ADC raw digital reading result, which is $2^{\text{bitwidth}}$ , where bitwidth is the <code>adc_oneshot_chan_cfg_t::bitwidth</code> configured before.

To do further calibration to convert the ADC raw result to voltage in mV, please refer to calibration doc [Analog to Digital Converter \(ADC\) Calibration Driver](#).

### Read Raw Result

```
ESP_ERROR_CHECK(adc_oneshot_read(adc1_handle, EXAMPLE_ADC1_CHAN0, &adc_raw[0][0]));
ESP_LOGI(TAG, "ADC%d Channel[%d] Raw Data: %d", ADC_UNIT_1 + 1, EXAMPLE_ADC1_CHAN0,
↪ adc_raw[0][0]);

ESP_ERROR_CHECK(adc_oneshot_read(adc1_handle, EXAMPLE_ADC1_CHAN1, &adc_raw[0][1]));
ESP_LOGI(TAG, "ADC%d Channel[%d] Raw Data: %d", ADC_UNIT_1 + 1, EXAMPLE_ADC1_CHAN1,
↪ adc_raw[0][1]);
```

### Hardware Limitations

- Random Number Generator uses ADC as a input source. When ADC `adc_oneshot_read()` works, the random number generated from RNG will be less random.
- A specific ADC unit can only work under one operating mode at any one time, either continuous mode or oneshot mode. `adc_oneshot_read()` has provided the protection.
- ADC2 is also used by the Wi-Fi. `adc_oneshot_read()` has provided the protection between Wi-Fi driver and ADC oneshot mode driver.

**Power Management** When power management is enabled (i.e. `CONFIG_PM_ENABLE` is on), the system clock frequency may be adjusted when the system is in an idle state. However, the ADC oneshot mode driver works in a polling routine, the `adc_oneshot_read()` will poll the CPU until the function returns. During this period of time, the task in which ADC oneshot mode driver resides won't be blocked. Therefore the clock frequency is stable when reading.

**IRAM Safe** By default, all the ADC oneshot mode driver APIs are not supposed to be run when the Cache is disabled (Cache may be disabled due to many reasons, such as Flash writing/erasing, OTA, etc.). If these APIs executes when the Cache is disabled, you will probably see errors like Illegal Instruction or Load/Store Prohibited.

### Thread Safety

- `adc_oneshot_new_unit()`
- `adc_oneshot_config_channel()`
- `adc_oneshot_read()`

Above functions are guaranteed to be thread safe. Therefore, you can call them from different RTOS tasks without protection by extra locks.

- `adc_oneshot_del_unit()` is not thread safe. Besides, concurrently calling this function may result in thread-safe APIs fail.

### Kconfig Options

- `CONFIG_ADC_ONESHOT_CTRL_FUNC_IN_IRAM` controls where to place the ADC fast read function (IRAM or Flash), see [IRAM Safe](#) for more details.

## Application Examples

- ADC oneshot mode example: [peripherals/adc/oneshot\\_read](#).

## API Reference

### Header File

- [components/hal/include/hal/adc\\_types.h](#)

### Structures

struct **adc\_digi\_pattern\_config\_t**  
ADC digital controller pattern configuration.

#### Public Members

uint8\_t **atten**  
Attenuation of this ADC channel.

uint8\_t **channel**  
ADC channel.

uint8\_t **unit**  
ADC unit.

uint8\_t **bit\_width**  
ADC output bit width.

struct **adc\_digi\_output\_data\_t**  
ADC digital controller (DMA mode) output data format. Used to analyze the acquired ADC (DMA) data.

---

**Note:** ESP32: Only `type1` is valid. ADC2 does not support DMA mode.

---

---

**Note:** ESP32-S2: Member `channel` can be used to judge the validity of the ADC data, because the role of the arbiter may get invalid ADC data.

---

#### Public Members

uint16\_t **data**  
ADC real output data info. Resolution: 12 bit.  
ADC real output data info. Resolution: 11 bit.

uint16\_t **channel**  
ADC channel index info.  
ADC channel index info. For ESP32-S2: If (`channel < ADC_CHANNEL_MAX`), The data is valid. If (`channel > ADC_CHANNEL_MAX`), The data is invalid.

struct *adc\_digi\_output\_data\_t*::[anonymous]::[anonymous] **type1**  
ADC type1

uint16\_t **unit**  
ADC unit index info. 0: ADC1; 1: ADC2.

struct *adc\_digi\_output\_data\_t*::[anonymous]::[anonymous] **type2**  
When the configured output format is 11bit.

uint16\_t **val**  
Raw data value

struct **adc\_digi\_clk\_t**  
ADC digital controller (DMA mode) clock system setting. Calculation formula:  $\text{controller\_clk} = (\text{APLL or APB}) / (\text{div\_num} + \text{div\_a} / \text{div\_b} + 1)$ .

---

**Note:** : The clocks of the DAC digital controller use the ADC digital controller clock divider.

---

### Public Members

bool **use\_apll**  
true: use APLL clock; false: use APB clock.

uint32\_t **div\_num**  
Division factor. Range: 0 ~ 255. Note: When a higher frequency clock is used (the division factor is less than 9), the ADC reading value will be slightly offset.

uint32\_t **div\_b**  
Division factor. Range: 1 ~ 63.

uint32\_t **div\_a**  
Division factor. Range: 0 ~ 63.

### Enumerations

enum **adc\_unit\_t**  
ADC unit.

*Values:*

enumerator **ADC\_UNIT\_1**  
SAR ADC 1.

enumerator **ADC\_UNIT\_2**  
SAR ADC 2.

enum **adc\_channel\_t**  
ADC channels.

*Values:*

enumerator **ADC\_CHANNEL\_0**

ADC channel.

enumerator **ADC\_CHANNEL\_1**

ADC channel.

enumerator **ADC\_CHANNEL\_2**

ADC channel.

enumerator **ADC\_CHANNEL\_3**

ADC channel.

enumerator **ADC\_CHANNEL\_4**

ADC channel.

enumerator **ADC\_CHANNEL\_5**

ADC channel.

enumerator **ADC\_CHANNEL\_6**

ADC channel.

enumerator **ADC\_CHANNEL\_7**

ADC channel.

enumerator **ADC\_CHANNEL\_8**

ADC channel.

enumerator **ADC\_CHANNEL\_9**

ADC channel.

enum **adc\_atten\_t**

ADC attenuation parameter. Different parameters determine the range of the ADC.

*Values:*

enumerator **ADC\_ATTEN\_DB\_0**

No input attenuation, ADC can measure up to approx.

enumerator **ADC\_ATTEN\_DB\_2\_5**

The input voltage of ADC will be attenuated extending the range of measurement by about 2.5 dB.

enumerator **ADC\_ATTEN\_DB\_6**

The input voltage of ADC will be attenuated extending the range of measurement by about 6 dB.

enumerator **ADC\_ATTEN\_DB\_12**

The input voltage of ADC will be attenuated extending the range of measurement by about 12 dB.

enumerator **ADC\_ATTEN\_DB\_11**

This is deprecated, it behaves the same as **ADC\_ATTEN\_DB\_12**

enum **adc\_bitwidth\_t**

*Values:*

enumerator **ADC\_BITWIDTH\_DEFAULT**

Default ADC output bits, max supported width will be selected.

enumerator **ADC\_BITWIDTH\_9**

ADC output width is 9Bit.

enumerator **ADC\_BITWIDTH\_10**

ADC output width is 10Bit.

enumerator **ADC\_BITWIDTH\_11**

ADC output width is 11Bit.

enumerator **ADC\_BITWIDTH\_12**

ADC output width is 12Bit.

enumerator **ADC\_BITWIDTH\_13**

ADC output width is 13Bit.

enum **adc\_ulp\_mode\_t**

*Values:*

enumerator **ADC\_ULP\_MODE\_DISABLE**

ADC ULP mode is disabled.

enumerator **ADC\_ULP\_MODE\_FSM**

ADC is controlled by ULP FSM.

enumerator **ADC\_ULP\_MODE\_RISCV**

ADC is controlled by ULP RISCV.

enum **adc\_digi\_convert\_mode\_t**

ADC digital controller (DMA mode) work mode.

*Values:*

enumerator **ADC\_CONV\_SINGLE\_UNIT\_1**

Only use ADC1 for conversion.

enumerator **ADC\_CONV\_SINGLE\_UNIT\_2**

Only use ADC2 for conversion.

enumerator **ADC\_CONV\_BOTH\_UNIT**

Use Both ADC1 and ADC2 for conversion simultaneously.

enumerator **ADC\_CONV\_ALTER\_UNIT**

Use both ADC1 and ADC2 for conversion by turn. e.g. ADC1 -> ADC2 -> ADC1 -> ADC2 ...



enum **adc\_digi\_output\_format\_t**

ADC digital controller (DMA mode) output data format option.

Values:

enumerator **ADC\_DIGI\_OUTPUT\_FORMAT\_TYPE1**

See [adc\\_digi\\_output\\_data\\_t.type1](#)

enumerator **ADC\_DIGI\_OUTPUT\_FORMAT\_TYPE2**

See [adc\\_digi\\_output\\_data\\_t.type2](#)

### Header File

- [components/esp\\_adc/include/esp\\_adc/adc\\_oneshot.h](#)

### Functions

*esp\_err\_t* **adc\_oneshot\_new\_unit** (const *adc\_oneshot\_unit\_init\_cfg\_t* \*init\_config,  
*adc\_oneshot\_unit\_handle\_t* \*ret\_unit)

Create a handle to a specific ADC unit.

---

**Note:** This API is thread-safe. For more details, see ADC programming guide

---

#### Parameters

- **init\_config** –[in] Driver initial configurations
- **ret\_unit** –[out] ADC unit handle

#### Returns

- ESP\_OK: On success
- ESP\_ERR\_INVALID\_ARG: Invalid arguments
- ESP\_ERR\_NO\_MEM: No memory
- ESP\_ERR\_NOT\_FOUND: The ADC peripheral to be claimed is already in use

*esp\_err\_t* **adc\_oneshot\_config\_channel** (*adc\_oneshot\_unit\_handle\_t* handle, *adc\_channel\_t* channel,  
const *adc\_oneshot\_chan\_cfg\_t* \*config)

Set ADC oneshot mode required configurations.

---

**Note:** This API is thread-safe. For more details, see ADC programming guide

---

#### Parameters

- **handle** –[in] ADC handle
- **channel** –[in] ADC channel to be configured
- **config** –[in] ADC configurations

#### Returns

- ESP\_OK: On success
- ESP\_ERR\_INVALID\_ARG: Invalid arguments

*esp\_err\_t* **adc\_oneshot\_read** (*adc\_oneshot\_unit\_handle\_t* handle, *adc\_channel\_t* chan, int \*out\_raw)

Get one ADC conversion raw result.

---

**Note:** This API is thread-safe. For more details, see ADC programming guide

---

---

**Note:** This API should NOT be called in an ISR context

---

#### Parameters

- **handle** –[in] ADC handle
- **chan** –[in] ADC channel
- **out\_raw** –[out] ADC conversion raw result

#### Returns

- ESP\_OK: On success
- ESP\_ERR\_INVALID\_ARG: Invalid arguments
- ESP\_ERR\_TIMEOUT: Timeout, the ADC result is invalid

*esp\_err\_t* **adc\_oneshot\_del\_unit** (*adc\_oneshot\_unit\_handle\_t* handle)

Delete the ADC unit handle.

---

**Note:** This API is thread-safe. For more details, see ADC programming guide

---

**Parameters** **handle** –[in] ADC handle

#### Returns

- ESP\_OK: On success
- ESP\_ERR\_INVALID\_ARG: Invalid arguments
- ESP\_ERR\_NOT\_FOUND: The ADC peripheral to be disclaimed isn't in use

*esp\_err\_t* **adc\_oneshot\_io\_to\_channel** (int io\_num, *adc\_unit\_t* \*unit\_id, *adc\_channel\_t* \*channel)

Get ADC channel from the given GPIO number.

#### Parameters

- **io\_num** –[in] GPIO number
- **unit\_id** –[out] ADC unit
- **channel** –[out] ADC channel

#### Returns

- ESP\_OK: On success
- ESP\_ERR\_INVALID\_ARG: Invalid argument
- ESP\_ERR\_NOT\_FOUND: The IO is not a valid ADC pad

*esp\_err\_t* **adc\_oneshot\_channel\_to\_io** (*adc\_unit\_t* unit\_id, *adc\_channel\_t* channel, int \*io\_num)

Get GPIO number from the given ADC channel.

#### Parameters

- **unit\_id** –[in] ADC unit
- **channel** –[in] ADC channel
- **io\_num** –[out] GPIO number
- – ESP\_OK: On success
- ESP\_ERR\_INVALID\_ARG: Invalid argument

### Structures

struct **adc\_oneshot\_unit\_init\_cfg\_t**

ADC oneshot driver initial configurations.

### Public Members

*adc\_unit\_t* **unit\_id**

ADC unit.

***adc\_ulp\_mode\_t* ulp\_mode**ADC controlled by ULP, see `adc_ulp_mode_t`struct **adc\_oneshot\_chan\_cfg\_t**

ADC channel configurations.

**Public Members*****adc\_atten\_t* atten**

ADC attenuation.

***adc\_bitwidth\_t* bitwidth**

ADC conversion result bits.

**Type Definitions**typedef struct `adc_oneshot_unit_ctx_t` \***adc\_oneshot\_unit\_handle\_t**

Type of ADC unit handle for oneshot mode.

**2.5.2 Analog to Digital Converter (ADC) Continuous Mode Driver****Introduction**

The Analog to Digital Converter is an on-chip sensor which is able to measure analog signals from specific analog IO pads.

The ADC on ESP32-S2 can be used in scenario(s) like:

- Generate one-shot ADC conversion result
- Generate continuous ADC conversion results

This guide will introduce ADC continuous mode conversion.

**Driver Concepts** ADC continuous mode conversion is made up with multiple Conversion Frames. - Conversion Frame: One Conversion Frame contains multiple Conversion Results. Conversion Frame size is configured in `adc_continuous_new_handle()`, in bytes. - Conversion Result: One Conversion Result contains multiple bytes (see `SOC_ADC_DIGI_RESULT_BYTES`). Its structure is `adc_digi_output_data_t`, including ADC unit, ADC channel and raw data.

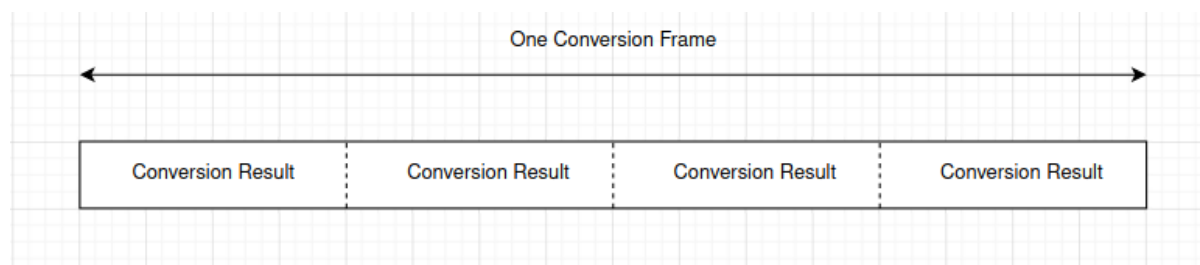
**Functional Overview**

The following sections of this document cover the typical steps to install the ADC continuous mode driver, and read ADC conversion results from group of ADC channels continuously:

- [Resource Allocation](#) - covers which parameters should be set up to initialize the ADC continuous mode driver and how to deinitialize it.
- [ADC Configurations](#) - describes how to configure the ADC(s) to make it work under continuous mode.
- [ADC Control](#) - describes ADC control functions.
- [Register Event Callbacks](#) - describes how to hook user specific code to an ADC continuous mode event callback function.
- [Read Conversion Result](#) - covers how to get ADC conversion result.
- [Hardware Limitations](#) - describes the ADC related hardware limitations.
- [Power Management](#) - covers power management related.
- [IRAM Safe](#) - covers the IRAM safe functions.
- [Thread Safety](#) - lists which APIs are guaranteed to be thread safe by the driver.

**Resource Allocation** The ADC continuous mode driver is implemented based on ESP32-S2 SAR ADC module. Different ESP targets might have different number of independent ADCs.

To create an ADC continuous mode driver handle, set up the required configuration structure `adc_continuous_handle_cfg_t`:

- `adc_continuous_handle_cfg_t::max_store_buf_size` set the maximum size (in bytes) of the pool that the driver saves ADC conversion result into. If this pool is full, new conversion results will be lost.
- `adc_continuous_handle_cfg_t::conv_frame_size` set the size of the ADC conversion frame, in bytes.

After setting up above configurations for the ADC, call `adc_continuous_new_handle()` with the prepared `adc_continuous_handle_cfg_t`. This function may fail due to various errors such as invalid arguments, insufficient memory, etc.

Especially, when this function returns `ESP_ERR_NOT_FOUND`, this means the SPI3 peripheral is in use. See [Hardware Limitations](#) for more information.

If the ADC continuous mode driver is no longer used, you should deinitialize the driver by calling `adc_continuous_deinit()`.

### Initialize the ADC Continuous Mode Driver

```
adc_continuous_handle_cfg_t adc_config = {
    .max_store_buf_size = 1024,
    .conv_frame_size = 100,
};
ESP_ERROR_CHECK(adc_continuous_new_handle(&adc_config));
```

### Recycle the ADC Unit

```
ESP_ERROR_CHECK(adc_continuous_deinit());
```

**ADC Configurations** After the ADC continuous mode driver is initialized, set up the `adc_continuous_config_t` to configure ADC IOs to measure analog signal:

- `adc_continuous_config_t::pattern_num`, number of ADC channels that will be used.
- `adc_continuous_config_t::adc_pattern`, list of configs for each ADC channel that will be used, see below description.
- `adc_continuous_config_t::sample_freq_hz`, expected ADC sampling frequency in Hz.
- `adc_continuous_config_t::conv_mode`, continuous conversion mode.
- `adc_continuous_config_t::format`, conversion output format.

For `adc_digi_pattern_config_t`:

- `adc_digi_pattern_config_t::atten`, ADC attenuation. Refer to the On-Chip Sensor chapter in TRM.

- `adc_digi_pattern_config_t::channel`, the IO corresponding ADC channel number. See below note.
- `adc_digi_pattern_config_t::unit`, the ADC that the IO is subordinate to.
- `adc_digi_pattern_config_t::bit_width`, the bitwidth of the raw conversion result.

---

**Note:** For the IO corresponding ADC channel number. Check [datasheet](#) to acquire the ADC IOs. On the other hand, `adc_continuous_io_to_channel()` and `adc_continuous_channel_to_io()` can be used to acquire the ADC channels and ADC IOs.

---

To make these settings take effect, call `adc_continuous_config()` with the configuration structure above. This API may fail due to reasons like `ESP_ERR_INVALID_ARG`. When it returns `ESP_ERR_INVALID_STATE`, this means the ADC continuous mode driver is started, you shouldn't call this API at this moment.

See ADC continuous mode example [peripherals/adc/continuous\\_read](#) to see configuration codes.

## ADC Control

**Start and Stop** Calling `adc_continuous_start()` will make the ADC start to measure analog signals from the configured ADC channels, and generate the conversion results. On the contrary, calling `adc_continuous_stop()` will stop the ADC conversion.

```
ESP_ERROR_CHECK(adc_continuous_stop());
```

**Register Event Callbacks** By calling `adc_continuous_register_event_callbacks()`, you can hook your own function to the driver ISR. Supported event callbacks are listed in `adc_continuous_evt_cbs_t` - `adc_continuous_evt_cbs_t::on_conv_done`, this is invoked when one conversion frame finishes. - `adc_continuous_evt_cbs_t::on_pool_ovf`, this is invoked when internal pool is full. Newer conversion results will be discarded.

As above callbacks are called in an ISR context, you should always ensure the callback function is suitable for an ISR context. Blocking logics should not appear in these callbacks. Callback function prototype is declared in `adc_continuous_callback_t`.

You can also register your own context when calling `adc_continuous_register_event_callbacks()`, by the parameter `user_data`. This user data will be passed to the callback functions directly.

This function may fail due to reasons like `ESP_ERR_INVALID_ARG`. Specially, when `CONFIG_ADC_CONTINUOUS_ISR_IRAM_SAFE` is enabled, this error may indicate that the callback functions aren't in internal RAM. Check error log to know this. Besides, when it fails due to `ESP_ERR_INVALID_STATE`, this means the ADC continuous mode driver is started, you shouldn't add callback at this moment.

**Conversion Done Event** The driver will fill in the event data of a `adc_continuous_evt_cbs_t::on_conv_done` event. Event data contains a buffer pointer to a conversion frame buffer, together with the size. Refer to `adc_continuous_evt_data_t` to know the event data structure.

---

**Note:** It is worth noting that, the data buffer `adc_continuous_evt_data_t::conv_frame_buffer` is maintained by the driver itself. Therefore, never free this piece of memory.

---

**Note:** When the Kconfig option `CONFIG_ADC_CONTINUOUS_ISR_IRAM_SAFE` is enabled, the registered callbacks and the functions called by the callbacks should be placed in IRAM. The involved variables should be placed in internal RAM as well.

---

**Pool Overflow Event** The ADC continuous mode driver has an internal pool to save the conversion results. When the pool is full, a pool overflow event will emerge. Under this condition, the driver won't fill in the event data. This usually happens the speed to read data from the pool (by calling `adc_continuous_read()`) is much slower than the ADC conversion speed.

**Read Conversion Result** After calling `adc_continuous_start()`, the ADC continuous conversion starts. Call `adc_continuous_read()` to get the conversion results of the ADC channels. You need to provide a buffer to get the raw results.

This function will try to read the expected length of conversion results each time.

- If the requested length isn't reached, the function will still move the data from the internal pool to the buffer you prepared. Therefore, check the `out_length` to know the actual size of conversion results.
- If there is no conversion result generated in the internal pool, the function will block for `timeout_ms` until the conversion results are generated. If there is still no generated results, the function will return `ESP_ERR_TIMEOUT`.
- If the generated results fill up the internal pool, new generated results will be lost. Next time when the `adc_continuous_read()` is called, this function will return `ESP_ERR_INVALID_STATE` indicating this situation.

This API aims to give you a chance to read all the ADC continuous conversion results.

The ADC conversion results read from above function are raw data. To calculate the voltage based on the ADC raw results, this formula can be used:

$$V_{out} = D_{out} * V_{max} / D_{max} \quad (1)$$

where:

Vout	Digital output result, standing for the voltage.
Dout	ADC raw digital reading result.
Vmax	Maximum measurable input analog voltage, this is related to the ADC attenuation, please refer to the On-Chip Sensor chapter in <a href="#">TRM</a> .
Dmax	Maximum of the output ADC raw digital reading result, which is $2^{\text{bitwidth}}$ , where bitwidth is the <code>adc_digi_pattern_config_1.bit_width</code> configured before.

To do further calibration to convert the ADC raw result to voltage in mV, please refer to calibration doc [Analog to Digital Converter \(ADC\) Calibration Driver](#).

### Hardware Limitations

- A specific ADC unit can only work under one operating mode at any one time, either continuous mode or oneshot mode. `adc_continuous_start()` has provided the protection.
- Random Number Generator uses ADC as an input source. When ADC continuous mode driver works, the random number generated from RNG will be less random.
- ADC2 is also used by the Wi-Fi. `adc_continuous_start()` has provided the protection between Wi-Fi driver and ADC continuous mode driver.
- ADC continuous mode driver uses SPI3 peripheral as hardware DMA fifo. Therefore, if SPI3 is in use already, the `adc_continuous_new_handle()` will return `ESP_ERR_NOT_FOUND`.

**Power Management** When power management is enabled (i.e. `CONFIG_PM_ENABLE` is on), the APB clock frequency may be adjusted when the system is in an idle state, thus potentially changing the behavior of ADC continuous conversion.

However, the continuous mode driver can prevent this change by acquiring a power management lock of type `ESP_PM_APB_FREQ_MAX`. The lock is acquired after the continuous conversion is started by

`adc_continuous_start()`. Similarly, the lock will be released after `adc_continuous_stop()`. Therefore, `adc_continuous_start()` and `adc_continuous_stop()` should appear in pairs, otherwise the power management will be out of action.

**IRAM Safe** All the ADC continuous mode driver APIs are not IRAM-safe. They are not supposed to be run when the Cache is disabled. By enabling the Kconfig option `CONFIG_ADC_CONTINUOUS_ISR_IRAM_SAFE`, driver internal ISR handler is IRAM-safe, which means even when the Cache is disabled, the driver will still save the conversion results into its internal pool.

**Thread Safety** ADC continuous mode driver APIs are not guaranteed to be thread safe. However, the share hardware mutual exclusion is provided by the driver. See *Hardware Limitations* for more details.

### Application Examples

- ADC continuous mode example: [peripherals/adc/continuous\\_read](#).

### API Reference

#### Header File

- [components/esp\\_adc/include/esp\\_adc/adc\\_continuous.h](#)

#### Functions

`esp_err_t adc_continuous_new_handle` (const `adc_continuous_handle_cfg_t` \*hdl\_config, `adc_continuous_handle_t` \*ret\_handle)

Initialize ADC continuous driver and get a handle to it.

##### Parameters

- **hdl\_config** `-[in]` Pointer to ADC initialization config. Refer to `adc_continuous_handle_cfg_t`.
- **ret\_handle** `-[out]` ADC continuous mode driver handle

##### Returns

- `ESP_ERR_INVALID_ARG` If the combination of arguments is invalid.
- `ESP_ERR_NOT_FOUND` No free interrupt found with the specified flags
- `ESP_ERR_NO_MEM` If out of memory
- `ESP_OK` On success

`esp_err_t adc_continuous_config` (`adc_continuous_handle_t` handle, const `adc_continuous_config_t` \*config)

Set ADC continuous mode required configurations.

##### Parameters

- **handle** `-[in]` ADC continuous mode driver handle
- **config** `-[in]` Refer to `adc_digi_config_t`.

##### Returns

- `ESP_ERR_INVALID_STATE`: Driver state is invalid, you shouldn't call this API at this moment
- `ESP_ERR_INVALID_ARG`: If the combination of arguments is invalid.
- `ESP_OK`: On success

`esp_err_t adc_continuous_register_event_callbacks` (`adc_continuous_handle_t` handle, const `adc_continuous_evt_cbs_t` \*cbs, void \*user\_data)

Register callbacks.

---

**Note:** User can deregister a previously registered callback by calling this function and setting the to-be-deregistered callback member in the `cbs` structure to `NULL`.

---

---

**Note:** When `CONFIG_ADC_CONTINUOUS_ISR_IRAM_SAFE` is enabled, the callback itself and functions called by it should be placed in `IRAM`. Involved variables (including `user_data`) should be in internal `RAM` as well.

---

---

**Note:** You should only call this API when the ADC continuous mode driver isn't started. Check return value to know this.

---

#### Parameters

- **handle** –[in] ADC continuous mode driver handle
- **cbs** –[in] Group of callback functions
- **user\_data** –[in] User data, which will be delivered to the callback functions directly

#### Returns

- `ESP_OK`: On success
- `ESP_ERR_INVALID_ARG`: Invalid arguments
- `ESP_ERR_INVALID_STATE`: Driver state is invalid, you shouldn't call this API at this moment

*esp\_err\_t* **adc\_continuous\_start** (*adc\_continuous\_handle\_t* handle)

Start the ADC under continuous mode. After this, the hardware starts working.

**Parameters** **handle** –[in] ADC continuous mode driver handle

#### Returns

- `ESP_ERR_INVALID_STATE` Driver state is invalid.
- `ESP_OK` On success

*esp\_err\_t* **adc\_continuous\_read** (*adc\_continuous\_handle\_t* handle, `uint8_t *buf`, `uint32_t length_max`, `uint32_t *out_length`, `uint32_t timeout_ms`)

Read bytes from ADC under continuous mode.

#### Parameters

- **handle** –[in] ADC continuous mode driver handle
- **buf** –[out] Conversion result buffer to read from ADC. Suggest convert to *adc\_digi\_output\_data\_t* for ADC Conversion Results. See @brief Driver Backgrounds to know this concept.
- **length\_max** –[in] Expected length of the Conversion Results read from the ADC, in bytes.
- **out\_length** –[out] Real length of the Conversion Results read from the ADC via this API, in bytes.
- **timeout\_ms** –[in] Time to wait for data via this API, in millisecond.

#### Returns

- `ESP_ERR_INVALID_STATE` Driver state is invalid. Usually it means the ADC sampling rate is faster than the task processing rate.
- `ESP_ERR_TIMEOUT` Operation timed out
- `ESP_OK` On success

*esp\_err\_t* **adc\_continuous\_stop** (*adc\_continuous\_handle\_t* handle)

Stop the ADC. After this, the hardware stops working.

**Parameters** **handle** –[in] ADC continuous mode driver handle

#### Returns

- `ESP_ERR_INVALID_STATE` Driver state is invalid.
- `ESP_OK` On success



*esp\_err\_t* **adc\_continuous\_deinit** (*adc\_continuous\_handle\_t* handle)

Deinitialize the ADC continuous driver.

**Parameters** handle –[in] ADC continuous mode driver handle

**Returns**

- ESP\_ERR\_INVALID\_STATE Driver state is invalid.
- ESP\_OK On success

*esp\_err\_t* **adc\_continuous\_io\_to\_channel** (int io\_num, *adc\_unit\_t* \*unit\_id, *adc\_channel\_t* \*channel)

Get ADC channel from the given GPIO number.

**Parameters**

- io\_num –[in] GPIO number
- unit\_id –[out] ADC unit
- channel –[out] ADC channel

**Returns**

- ESP\_OK: On success
- ESP\_ERR\_INVALID\_ARG: Invalid argument
- ESP\_ERR\_NOT\_FOUND: The IO is not a valid ADC pad

*esp\_err\_t* **adc\_continuous\_channel\_to\_io** (*adc\_unit\_t* unit\_id, *adc\_channel\_t* channel, int \*io\_num)

Get GPIO number from the given ADC channel.

**Parameters**

- unit\_id –[in] ADC unit
- channel –[in] ADC channel
- io\_num –[out] GPIO number
- –ESP\_OK: On success
- ESP\_ERR\_INVALID\_ARG: Invalid argument

## Structures

struct **adc\_continuous\_handle\_cfg\_t**

ADC continuous mode driver initial configurations.

### Public Members

uint32\_t **max\_store\_buf\_size**

Max length of the conversion Results that driver can store, in bytes.

uint32\_t **conv\_frame\_size**

Conversion frame size, in bytes. This should be in multiples of SOC\_ADC\_DIGI\_DATA\_BYTES\_PER\_CONV.

struct **adc\_continuous\_config\_t**

ADC continuous mode driver configurations.

### Public Members

uint32\_t **pattern\_num**

Number of ADC channels that will be used.

*adc\_digi\_pattern\_config\_t* \***adc\_pattern**

List of configs for each ADC channel that will be used.

uint32\_t **sample\_freq\_hz**

The expected ADC sampling frequency in Hz. Please refer to `soc/soc_caps.h` to know available sampling frequency range

*adc\_digi\_convert\_mode\_t* **conv\_mode**

ADC DMA conversion mode, see `adc_digi_convert_mode_t`.

*adc\_digi\_output\_format\_t* **format**

ADC DMA conversion output format, see `adc_digi_output_format_t`.

struct **adc\_continuous\_evt\_data\_t**

Event data structure.

---

**Note:** The `conv_frame_buffer` is maintained by the driver itself, so never free this piece of memory.

---

### Public Members

uint8\_t \***conv\_frame\_buffer**

Pointer to conversion result buffer for one conversion frame.

uint32\_t **size**

Conversion frame size.

struct **adc\_continuous\_evt\_cbs\_t**

Group of ADC continuous mode callbacks.

---

**Note:** These callbacks are all running in an ISR environment.

---

---

**Note:** When `CONFIG_ADC_CONTINUOUS_ISR_IRAM_SAFE` is enabled, the callback itself and functions called by it should be placed in IRAM. Involved variables should be in internal RAM as well.

---

### Public Members

*adc\_continuous\_callback\_t* **on\_conv\_done**

Event callback, invoked when one conversion frame is done. See @brief Driver Backgrounds to know conversion frame concept.

*adc\_continuous\_callback\_t* **on\_pool\_ovf**

Event callback, invoked when the internal pool is full.

### Macros

**ADC\_MAX\_DELAY**

Driver Backgrounds.

## Type Definitions

```
typedef struct adc_continuous_ctx_t *adc_continuous_handle_t
```

Type of adc continuous mode driver handle.

```
typedef bool (*adc_continuous_callback_t)(adc_continuous_handle_t handle, const
adc_continuous_evt_data_t *edata, void *user_data)
```

Prototype of ADC continuous mode event callback.

**Param handle [in]** ADC continuous mode driver handle

**Param edata [in]** Pointer to ADC continuous mode event data

**Param user\_data [in]** User registered context, registered when in  
`adc_continuous_register_event_callbacks()`

**Return** Whether a high priority task is woken up by this function

## 2.5.3 Analog to Digital Converter (ADC) Calibration Driver

### Introduction

Based on series of comparisons with the reference voltage, ESP32-S2 ADC determines each bit of the output digital result. Per design the ESP32-S2 ADC reference voltage is 1100 mV, however the true reference voltage can range from 1000 mV to 1200 mV among different chips. This guide will introduce an ADC calibration driver to minimize this difference.

### Functional Overview

The following sections of this document cover the typical steps to install and use the ADC calibration driver:

- *Calibration Scheme Creation* - covers how to create a calibration scheme handle and delete the calibration scheme handle.
- *Calibration Configuration* - covers how to configure the calibration driver to calculate necessary characteristics used for calibration.
- *Result Conversion* - covers how to convert ADC raw result to calibrated result.
- *Thread Safety* - lists which APIs are guaranteed to be thread safe by the driver.
- *Minimize Noise* - describes a general way to minimize the noise.

**Calibration Scheme Creation** The ADC calibration driver provides ADC calibration scheme(s). From calibration driver's point of view, an ADC calibration scheme is created to an ADC calibration handle `adc_cali_handle_t`.

`adc_cali_check_scheme()` can be used to know which calibration scheme is supported on the chip. For those users who are already aware of the supported scheme, this step can be skipped. Just call the corresponding function to create the scheme handle.

For those users who use their custom ADC calibration schemes, you could either modify this function `adc_cali_check_scheme()`, or just skip this step and call your custom creation function.

**ADC Calibration Line Fitting Scheme** ESP32-S2 supports `ADC_CALI_SCHEME_VER_LINE_FITTING` scheme. To create this scheme, set up `adc_cali_line_fitting_config_t` first.

- `adc_cali_line_fitting_config_t::unit_id`, the ADC that your ADC raw results are from.
- `adc_cali_line_fitting_config_t::atten`, ADC attenuation that your ADC raw results use.
- `adc_cali_line_fitting_config_t::bitwidth`, the ADC raw result bitwidth.

After setting up the configuration structure, call `adc_cali_create_scheme_line_fitting()` to create a Line Fitting calibration scheme handle.

This function may fail due to reasons such as `ESP_ERR_INVALID_ARG` or `ESP_ERR_NO_MEM`. Especially, when the function return `ESP_ERR_NOT_SUPPORTED`, this means the calibration scheme required eFuse bits are not burnt on your board.

```
ESP_LOGI(TAG, "calibration scheme version is %s", "Line Fitting");
adc_cali_line_fitting_config_t cali_config = {
    .unit_id = unit,
    .atten = atten,
    .bitwidth = ADC_BITWIDTH_DEFAULT,
};
ESP_ERROR_CHECK(adc_cali_create_scheme_line_fitting(&cali_config, &handle));
```

When the ADC calibration is no longer used, please delete the calibration scheme handle by calling `adc_cali_delete_scheme_line_fitting()`.

### Delete Line Fitting Scheme

```
ESP_LOGI(TAG, "delete %s calibration scheme", "Line Fitting");
ESP_ERROR_CHECK(adc_cali_delete_scheme_line_fitting(handle));
```

**Note:** For users who want to use their custom calibration schemes, you could provide a creation function to create your calibration scheme handle. Check the function table `adc_cali_scheme_t` in `components/esp_adc/interface/adc_cali_interface.h` to know the ESP ADC calibration interface.

**Result Conversion** After setting up the calibration characteristics, you can call `adc_cali_raw_to_voltage()` to convert the ADC raw result into calibrated result. The calibrated result is in the unit of mV. This function may fail due to invalid argument. Especially, if this function returns `ESP_ERR_INVALID_STATE`, this means the calibration scheme isn't created. You need to create a calibration scheme handle, use `adc_cali_check_scheme()` to know the supported calibration scheme. On the other hand, you could also provide a custom calibration scheme and create the handle.

### Get Voltage

```
ESP_ERROR_CHECK(adc_cali_raw_to_voltage(adc_cali_handle, adc_raw[0][0], &
↪voltage[0][0]));
ESP_LOGI(TAG, "ADC%d Channel[%d] Cali Voltage: %d mV", ADC_UNIT_1 + 1, EXAMPLE_
↪ADC1_CHAN0, voltage[0][0]);
```

**Thread Safety** The factory function `esp_adc_cali_new_scheme()` is guaranteed to be thread safe by the driver. Therefore, you can call them from different RTOS tasks without protection by extra locks.

Other functions that take the `adc_cali_handle_t` as the first positional parameter are not thread safe, you should avoid calling them from multiple tasks.

**Minimize Noise** The ESP32-S2 ADC can be sensitive to noise leading to large discrepancies in ADC readings. Depending on the usage scenario, you may need to connect a bypass capacitor (e.g. a 100 nF ceramic capacitor) to the ADC input pad in use, to minimize noise. Besides, multisampling may also be used to further mitigate the effects of noise.

## API Reference

### Header File

- `components/esp_adc/include/esp_adc/adc_cali.h`

## Functions

`esp_err_t adc_cali_check_scheme (adc_cali_scheme_ver_t *scheme_mask)`

Check the supported ADC calibration scheme.

**Parameters** `scheme_mask` –[out] Supported ADC calibration scheme(s)

### Returns

- `ESP_OK`: On success
- `ESP_ERR_INVALID_ARG`: Invalid argument
- `ESP_ERR_NOT_SUPPORTED`: No supported calibration scheme

`esp_err_t adc_cali_raw_to_voltage (adc_cali_handle_t handle, int raw, int *voltage)`

Convert ADC raw data to calibrated voltage.

### Parameters

- `handle` –[in] ADC calibration handle
- `raw` –[in] ADC raw data
- `voltage` –[out] Calibrated ADC voltage (in mV)

### Returns

- `ESP_OK`: On success
- `ESP_ERR_INVALID_ARG`: Invalid argument
- `ESP_ERR_INVALID_STATE`: Invalid state, scheme didn't registered

## Type Definitions

```
typedef struct adc_cali_scheme_t *adc_cali_handle_t
```

ADC calibration handle.

## Enumerations

```
enum adc_cali_scheme_ver_t
```

ADC calibration scheme.

*Values:*

enumerator `ADC_CALI_SCHEME_VER_LINE_FITTING`

Line fitting scheme.

enumerator `ADC_CALI_SCHEME_VER_CURVE_FITTING`

Curve fitting scheme.

## Header File

- `components/esp_adc/include/esp_adc/adc_cali_scheme.h`

## 2.5.4 Clock Tree

This section lists definitions of the ESP32-S2's supported root clocks and module clocks. These definitions are commonly used in the driver configuration, to help user select a proper source clock for the peripheral.

### Root Clocks

Root clocks generate reliable clock signals. These clock signals then pass through various gates, muxes, dividers, or multipliers to become the clock sources for every functional module: the CPU core(s), WIFI, BT, the RTC, and the peripherals.

ESP32-S2's root clocks are listed in `soc_root_clk_t`:

- Internal 8MHz RC Oscillator (RC\_FAST)  
This RC oscillator generates a ~8.5MHz clock signal output as the RC\_FAST\_CLK. The ~8.5MHz signal output is also passed into a configurable divider, which by default divides the input clock frequency by 256, to generate a RC\_FAST\_D256\_CLK. The exact frequency of RC\_FAST\_CLK can be computed in runtime through calibration on the RC\_FAST\_D256\_CLK.
- External 40MHz Crystal (XTAL)
- Internal 90kHz RC Oscillator (RC\_SLOW)  
This RC oscillator generates a ~90kHz clock signal output as the RC\_SLOW\_CLK. The exact frequency of this clock can be computed in runtime through calibration.
- External 32kHz Crystal - optional (XTAL32K)  
The clock source for this XTAL32K\_CLK can be either a 32kHz crystal connecting to the XTAL\_32K\_P and XTAL\_32K\_N pins or a 32kHz clock signal generated by an external circuit. The external signal must be connected to the XTAL\_32K\_P pin. XTAL32K\_CLK can also be calibrated to get its exact frequency.

Typically, the frequency of the signal generated from a RC oscillator circuit is less accurate and more sensitive to environment comparing to the signal generated from a crystal. ESP32-S2 provides several clock source options for the RTC\_SLOW\_CLK, and users can make the choice based on the requirements for system time accuracy and power consumption (refer to *RTC Timer Clock Sources* for more details).

## Module Clocks

ESP32-S2's available module clocks are listed in `soc_module_clk_t`. Each module clock has a unique ID. You can get more information on each clock by checking the documented enum value.

## API Reference

### Header File

- `components/soc/esp32s2/include/soc/clk_tree_defs.h`

### Macros

#### **SOC\_CLK\_RC\_FAST\_FREQ\_APPROX**

Approximate RC\_FAST\_CLK frequency in Hz

#### **SOC\_CLK\_RC\_SLOW\_FREQ\_APPROX**

Approximate RC\_SLOW\_CLK frequency in Hz

#### **SOC\_CLK\_RC\_FAST\_D256\_FREQ\_APPROX**

Approximate RC\_FAST\_D256\_CLK frequency in Hz

#### **SOC\_CLK\_XTAL32K\_FREQ\_APPROX**

Approximate XTAL32K\_CLK frequency in Hz

#### **SOC\_GPTIMER\_CLKS**

Array initializer for all supported clock sources of GPTimer.

The following code can be used to iterate all possible clocks:

```
soc_periph_gptimer_clk_src_t gptimer_clks[] = (soc_periph_gptimer_clk_src_
↪t)SOC_GPTIMER_CLKS;
for (size_t i = 0; i < sizeof(gptimer_clks) / sizeof(gptimer_clks[0]); i++) {
    soc_periph_gptimer_clk_src_t clk = gptimer_clks[i];
    // Test GPTimer with the clock `clk`
}
```

**SOC\_LCD\_CLKS**

Array initializer for all supported clock sources of LCD.

**SOC\_RMT\_CLKS**

Array initializer for all supported clock sources of RMT.

**SOC\_TEMP\_SENSOR\_CLKS**

Array initializer for all supported clock sources of Temperature Sensor.

**SOC\_I2S\_CLKS**

Array initializer for all supported clock sources of I2S.

**SOC\_I2C\_CLKS**

Array initializer for all supported clock sources of I2C.

**SOC\_SDM\_CLKS**

Array initializer for all supported clock sources of SDM.

**Enumerations**enum **soc\_root\_clk\_t**

Root clock.

*Values:*

enumerator **SOC\_ROOT\_CLK\_INT\_RC\_FAST**

Internal 8MHz RC oscillator

enumerator **SOC\_ROOT\_CLK\_INT\_RC\_SLOW**

Internal 90kHz RC oscillator

enumerator **SOC\_ROOT\_CLK\_EXT\_XTAL**

External 40MHz crystal

enumerator **SOC\_ROOT\_CLK\_EXT\_XTAL32K**

External 32kHz crystal/clock signal

enum **soc\_cpu\_clk\_src\_t**

CPU\_CLK mux inputs, which are the supported clock sources for the CPU\_CLK.

---

**Note:** Enum values are matched with the register field values on purpose

---

*Values:*

enumerator **SOC\_CPU\_CLK\_SRC\_XTAL**

Select XTAL\_CLK as CPU\_CLK source

enumerator **SOC\_CPU\_CLK\_SRC\_PLL**

Select PLL\_CLK as CPU\_CLK source (PLL\_CLK is the output of 40MHz crystal oscillator frequency multiplier, can be 480MHz or 320MHz)

enumerator **SOC\_CPU\_CLK\_SRC\_RC\_FAST**

Select RC\_FAST\_CLK as CPU\_CLK source

enumerator **SOC\_CPU\_CLK\_SRC\_APLL**

Select APLL\_CLK as CPU\_CLK source

enumerator **SOC\_CPU\_CLK\_SRC\_INVALID**

Invalid CPU\_CLK source

enum **soc\_rtc\_slow\_clk\_src\_t**

RTC\_SLOW\_CLK mux inputs, which are the supported clock sources for the RTC\_SLOW\_CLK.

---

**Note:** Enum values are matched with the register field values on purpose

---

*Values:*

enumerator **SOC\_RTC\_SLOW\_CLK\_SRC\_RC\_SLOW**

Select RC\_SLOW\_CLK as RTC\_SLOW\_CLK source

enumerator **SOC\_RTC\_SLOW\_CLK\_SRC\_XTAL32K**

Select XTAL32K\_CLK as RTC\_SLOW\_CLK source

enumerator **SOC\_RTC\_SLOW\_CLK\_SRC\_RC\_FAST\_D256**

Select RC\_FAST\_D256\_CLK (referred as FOSC\_DIV or 8m\_d256/8md256 in TRM and reg. description) as RTC\_SLOW\_CLK source

enumerator **SOC\_RTC\_SLOW\_CLK\_SRC\_INVALID**

Invalid RTC\_SLOW\_CLK source

enum **soc\_rtc\_fast\_clk\_src\_t**

RTC\_FAST\_CLK mux inputs, which are the supported clock sources for the RTC\_FAST\_CLK.

---

**Note:** Enum values are matched with the register field values on purpose

---

*Values:*

enumerator **SOC\_RTC\_FAST\_CLK\_SRC\_XTAL\_D4**

Select XTAL\_D4\_CLK (may referred as XTAL\_CLK\_DIV\_4) as RTC\_FAST\_CLK source

enumerator **SOC\_RTC\_FAST\_CLK\_SRC\_XTAL\_DIV**

Alias name for SOC\_RTC\_FAST\_CLK\_SRC\_XTAL\_D4



enumerator **SOC\_RTC\_FAST\_CLK\_SRC\_RC\_FAST**

Select RC\_FAST\_CLK as RTC\_FAST\_CLK source

enumerator **SOC\_RTC\_FAST\_CLK\_SRC\_INVALID**

Invalid RTC\_FAST\_CLK source

enum **soc\_module\_clk\_t**

Supported clock sources for modules (CPU, peripherals, RTC, etc.)

---

**Note:** enum starts from 1, to save 0 for special purpose

---

*Values:*

enumerator **SOC\_MOD\_CLK\_CPU**

CPU\_CLK can be sourced from XTAL, PLL, RC\_FAST, or APLL by configuring soc\_cpu\_clk\_src\_t

enumerator **SOC\_MOD\_CLK\_RTC\_FAST**

RTC\_FAST\_CLK can be sourced from XTAL\_D4 or RC\_FAST by configuring soc\_rtc\_fast\_clk\_src\_t

enumerator **SOC\_MOD\_CLK\_RTC\_SLOW**

RTC\_SLOW\_CLK can be sourced from RC\_SLOW, XTAL32K, or RC\_FAST\_D256 by configuring soc\_rtc\_slow\_clk\_src\_t

enumerator **SOC\_MOD\_CLK\_APB**

APB\_CLK is highly dependent on the CPU\_CLK source

enumerator **SOC\_MOD\_CLK\_PLL\_F160M**

PLL\_F160M\_CLK is derived from PLL, and has a fixed frequency of 160MHz

enumerator **SOC\_MOD\_CLK\_XTAL32K**

XTAL32K\_CLK comes from the external 32kHz crystal, passing a clock gating to the peripherals

enumerator **SOC\_MOD\_CLK\_RC\_FAST**

RC\_FAST\_CLK comes from the internal 8MHz rc oscillator, passing a clock gating to the peripherals

enumerator **SOC\_MOD\_CLK\_RC\_FAST\_D256**

RC\_FAST\_D256\_CLK is derived from the internal 8MHz rc oscillator, divided by 256, and passing a clock gating to the peripherals

enumerator **SOC\_MOD\_CLK\_XTAL**

XTAL\_CLK comes from the external 40MHz crystal

enumerator **SOC\_MOD\_CLK\_REF\_TICK**

REF\_TICK is derived from XTAL or RC\_FAST via a divider, it has a fixed frequency of 1MHz by default

enumerator **SOC\_MOD\_CLK\_APLL**

APLL is sourced from PLL, and its frequency is configurable through APLL configuration registers

enumerator **SOC\_MOD\_CLK\_TEMP\_SENSOR**

TEMP\_SENSOR\_CLK comes directly from the internal 8MHz rc oscillator

enum **soc\_periph\_gptimer\_clk\_src\_t**

Type of GPTimer clock source.

*Values:*

enumerator **GPTIMER\_CLK\_SRC\_APB**

Select APB as the source clock

enumerator **GPTIMER\_CLK\_SRC\_XTAL**

Select XTAL as the source clock

enumerator **GPTIMER\_CLK\_SRC\_DEFAULT**

Select APB as the default choice

enum **soc\_periph\_tg\_clk\_src\_legacy\_t**

Type of Timer Group clock source, reserved for the legacy timer group driver.

*Values:*

enumerator **TIMER\_SRC\_CLK\_APB**

Timer group source clock is APB

enumerator **TIMER\_SRC\_CLK\_XTAL**

Timer group source clock is XTAL

enumerator **TIMER\_SRC\_CLK\_DEFAULT**

Timer group source clock default choice is APB

enum **soc\_periph\_lcd\_clk\_src\_t**

Type of LCD clock source.

*Values:*

enumerator **LCD\_CLK\_SRC\_PLL160M**

Select PLL\_F160M as the source clock

enumerator **LCD\_CLK\_SRC\_DEFAULT**

Select PLL\_F160M as the default choice

enum **soc\_periph\_rmt\_clk\_src\_t**

Type of RMT clock source.

*Values:*

enumerator **RMT\_CLK\_SRC\_APB**

Select APB as the source clock

enumerator **RMT\_CLK\_SRC\_REF\_TICK**

Select REF\_TICK as the source clock

enumerator **RMT\_CLK\_SRC\_DEFAULT**

Select APB as the default choice

enum **soc\_periph\_rmt\_clk\_src\_legacy\_t**

Type of RMT clock source, reserved for the legacy RMT driver.

*Values:*

enumerator **RMT\_BASECLK\_APB**

RMT source clock is APB CLK

enumerator **RMT\_BASECLK\_REF**

RMT source clock is REF\_TICK

enumerator **RMT\_BASECLK\_DEFAULT**

RMT source clock default choice is APB

enum **soc\_periph\_temperature\_sensor\_clk\_src\_t**

Type of Temp Sensor clock source.

*Values:*

enumerator **TEMPERATURE\_SENSOR\_CLK\_SRC\_RC\_FAST**

Select RC\_FAST as the source clock

enumerator **TEMPERATURE\_SENSOR\_CLK\_SRC\_DEFAULT**

Select RC\_FAST as the default choice

enum **soc\_periph\_uart\_clk\_src\_legacy\_t**

Type of UART clock source, reserved for the legacy UART driver.

*Values:*

enumerator **UART\_SCLK\_APB**

UART source clock is APB CLK

enumerator **UART\_SCLK\_REF\_TICK**

UART source clock is REF\_TICK

enumerator **UART\_SCLK\_DEFAULT**

UART source clock default choice is APB

enum **soc\_periph\_i2s\_clk\_src\_t**

I2S clock source enum.

*Values:*

enumerator **I2S\_CLK\_SRC\_DEFAULT**

Select PLL\_F160M as the default source clock

enumerator **I2S\_CLK\_SRC\_PLL\_160M**

Select PLL\_F160M as the source clock

enumerator **I2S\_CLK\_SRC\_APLL**  
Select APLL as the source clock

enum **soc\_periph\_i2c\_clk\_src\_t**  
Type of I2C clock source.

*Values:*

enumerator **I2C\_CLK\_SRC\_APB**

enumerator **I2C\_CLK\_SRC\_REF\_TICK**

enumerator **I2C\_CLK\_SRC\_DEFAULT**

enum **soc\_periph\_sdm\_clk\_src\_t**  
Sigma Delta Modulator clock source.

*Values:*

enumerator **SDM\_CLK\_SRC\_APB**  
Select APB as the source clock

enumerator **SDM\_CLK\_SRC\_DEFAULT**  
Select APB as the default clock choice

## 2.5.5 Digital To Analog Converter (DAC)

### Overview

ESP32-S2 has two 8-bit DAC (digital to analog converter) channels, connected to GPIO17 (Channel 1) and GPIO18 (Channel 2).

The DAC driver allows these channels to be set to arbitrary voltages.

The DAC channels can also be driven with DMA-style written sample data by the digital controller, however the driver does not supported this yet.

For other analog output options, see the *Sigma-delta Modulation module* and the *LED Control module*. Both these modules produce high frequency PDM/PWM output, which can be hardware low-pass filtered in order to generate a lower frequency analog output.

### Application Example

Setting DAC channel 1 (GPIO17) voltage to approx 0.78 of VDD\_A voltage ( $VDD * 200 / 255$ ). For VDD\_A 3.3V, this is 2.59V.

```
#include <driver/dac.h>

...

dac_output_enable (DAC_CHANNEL_1);
dac_output_voltage (DAC_CHANNEL_1, 200);
```

## API Reference

### Header File

- [components/driver/esp32s2/include/driver/dac.h](#)

### Functions

*esp\_err\_t* **dac\_digi\_init** (void)

DAC digital controller initialization.

#### Returns

- ESP\_OK success

*esp\_err\_t* **dac\_digi\_deinit** (void)

DAC digital controller deinitialization.

#### Returns

- ESP\_OK success

*esp\_err\_t* **dac\_digi\_controller\_config** (const *dac\_digi\_config\_t* \*cfg)

Setting the DAC digital controller.

**Parameters** *cfg* –Pointer to digital controller paramter. See [dac\\_digi\\_config\\_t](#).

#### Returns

- ESP\_OK success
- ESP\_ERR\_INVALID\_ARG Parameter error

*esp\_err\_t* **dac\_digi\_start** (void)

DAC digital controller start output voltage.

#### Returns

- ESP\_OK success

*esp\_err\_t* **dac\_digi\_stop** (void)

DAC digital controller stop output voltage.

#### Returns

- ESP\_OK success

*esp\_err\_t* **dac\_digi\_fifo\_reset** (void)

Reset DAC digital controller FIFO.

#### Returns

- ESP\_OK success

*esp\_err\_t* **dac\_digi\_reset** (void)

Reset DAC digital controller.

#### Returns

- ESP\_OK success

### Header File

- [components/driver/include/driver/dac\\_common.h](#)

### Functions

*esp\_err\_t* **dac\_pad\_get\_io\_num** (*dac\_channel\_t* channel, *gpio\_num\_t* \*gpio\_num)

Get the GPIO number of a specific DAC channel.

#### Parameters

- **channel** –Channel to get the gpio number
- **gpio\_num** –output buffer to hold the gpio number

**Returns**

- ESP\_OK if success

*esp\_err\_t* **dac\_output\_voltage** (*dac\_channel\_t* channel, uint8\_t dac\_value)

Set DAC output voltage. DAC output is 8-bit. Maximum (255) corresponds to VDD3P3\_RTC.

---

**Note:** Need to configure DAC pad before calling this function. DAC channel 1 is attached to GPIO25, DAC channel 2 is attached to GPIO26

---

**Parameters**

- **channel** –DAC channel
- **dac\_value** –DAC output value

**Returns**

- ESP\_OK success

*esp\_err\_t* **dac\_output\_enable** (*dac\_channel\_t* channel)

DAC pad output enable.

---

**Note:** DAC channel 1 is attached to GPIO25, DAC channel 2 is attached to GPIO26 I2S left channel will be mapped to DAC channel 2 I2S right channel will be mapped to DAC channel 1

---

**Parameters** **channel** –DAC channel

*esp\_err\_t* **dac\_output\_disable** (*dac\_channel\_t* channel)

DAC pad output disable.

---

**Note:** DAC channel 1 is attached to GPIO25, DAC channel 2 is attached to GPIO26

---

**Parameters** **channel** –DAC channel

**Returns**

- ESP\_OK success

*esp\_err\_t* **dac\_cw\_generator\_enable** (void)

Enable cosine wave generator output.

**Returns**

- ESP\_OK success

*esp\_err\_t* **dac\_cw\_generator\_disable** (void)

Disable cosine wave generator output.

**Returns**

- ESP\_OK success

*esp\_err\_t* **dac\_cw\_generator\_config** (*dac\_cw\_config\_t* \*cw)

Config the cosine wave generator function in DAC module.

**Parameters** **cw** –Configuration.

**Returns**

- ESP\_OK success
- ESP\_ERR\_INVALID\_ARG The parameter is NULL.

**GPIO Lookup Macros** Some useful macros can be used to specified the GPIO number of a DAC channel, or vice versa. e.g.

1. `DAC_CHANNEL_1_GPIO_NUM` is the GPIO number of channel 1 (GPIO17);
2. `DAC_GPIO18_CHANNEL` is the channel number of GPIO 26 (channel 2).

### Header File

- [components/soc/esp32s2/include/soc/dac\\_channel.h](#)

### Macros

`DAC_GPIO17_CHANNEL`

`DAC_CHANNEL_1_GPIO_NUM`

`DAC_GPIO18_CHANNEL`

`DAC_CHANNEL_2_GPIO_NUM`

### Header File

- [components/hal/include/hal/dac\\_types.h](#)

### Structures

struct `dac_cw_config_t`

Config the cosine wave generator function in DAC module.

#### Public Members

`dac_channel_t` **en\_ch**

Enable the cosine wave generator of DAC channel.

`dac_cw_scale_t` **scale**

Set the amplitude of the cosine wave generator output.

`dac_cw_phase_t` **phase**

Set the phase of the cosine wave generator output.

`uint32_t` **freq**

Set frequency of cosine wave generator output. Range: 130(130Hz) ~ 55000(100KHz).

`int8_t` **offset**

Set the voltage value of the DC component of the cosine wave generator output. Note: Unreasonable settings can cause waveform to be oversaturated. Range: -128 ~ 127.

struct `dac_digi_config_t`

DAC digital controller (DMA mode) configuration parameters.

## Public Members

### `dac_digi_convert_mode_t` mode

DAC digital controller (DMA mode) work mode. See `dac_digi_convert_mode_t`.

### `uint32_t` interval

The number of interval clock cycles for the DAC digital controller to output voltage. The unit is the divided clock. Range: 1 ~ 4095. Expression: `dac_output_freq = controller_clk / interval`. Refer to `adc_digi_clk_t`. Note: The sampling rate of each channel is also related to the conversion mode (See `dac_digi_convert_mode_t`) and pattern table settings.

### `adc_digi_clk_t` dig\_clk

DAC digital controller clock divider settings. Refer to `adc_digi_clk_t`. Note: The clocks of the DAC digital controller use the ADC digital controller clock divider.

## Enumerations

### enum `dac_channel_t`

*Values:*

#### enumerator `DAC_CHANNEL_1`

DAC channel 1 is GPIO25(ESP32) / GPIO17(ESP32S2)

#### enumerator `DAC_CHANNEL_2`

DAC channel 2 is GPIO26(ESP32) / GPIO18(ESP32S2)

#### enumerator `DAC_CHANNEL_MAX`

### enum `dac_cw_scale_t`

The multiple of the amplitude of the cosine wave generator. The max amplitude is VDD3P3\_RTC.

*Values:*

#### enumerator `DAC_CW_SCALE_1`

1/1. Default.

#### enumerator `DAC_CW_SCALE_2`

1/2.

#### enumerator `DAC_CW_SCALE_4`

1/4.

#### enumerator `DAC_CW_SCALE_8`

1/8.

### enum `dac_cw_phase_t`

Set the phase of the cosine wave generator output.

*Values:*

#### enumerator `DAC_CW_PHASE_0`

Phase shift +0°



enumerator **DAC\_CW\_PHASE\_180**

Phase shift +180°

enum **dac\_digi\_convert\_mode\_t**

DAC digital controller (DMA mode) work mode.

*Values:*

enumerator **DAC\_CONV\_NORMAL**

The data in the DMA buffer is simultaneously output to the enable channel of the DAC.

enumerator **DAC\_CONV\_ALTER**

The data in the DMA buffer is alternately output to the enable channel of the DAC.

enumerator **DAC\_CONV\_MAX**

## 2.5.6 GPIO & RTC GPIO

### Overview

The ESP32-S2 chip features 43 physical GPIO pins (GPIO0 ~ GPIO21 and GPIO26 ~ GPIO46). Each pin can be used as a general-purpose I/O, or be connected to an internal peripheral signal. Through IO MUX, RTC IO MUX and the GPIO matrix, peripheral input signals can be from any IO pins, and peripheral output signals can be routed to any IO pins. Together these modules provide highly configurable I/O. For more details, see *ESP32-S2 Technical Reference Manual > IO MUX and GPIO Matrix (GPIO, IO\_MUX)* [PDF].

The table below provides more information on pin usage, and please note the comments in the table for GPIOs with restrictions.

GPIO	Analog Function	RTC GPIO	Comment
GPIO0		RTC_GPIO0	Strapping pin
GPIO1	ADC1_CH0	RTC_GPIO1	
GPIO2	ADC1_CH1	RTC_GPIO2	
GPIO3	ADC1_CH2	RTC_GPIO3	
GPIO4	ADC1_CH3	RTC_GPIO4	
GPIO5	ADC1_CH4	RTC_GPIO5	
GPIO6	ADC1_CH5	RTC_GPIO6	
GPIO7	ADC1_CH6	RTC_GPIO7	
GPIO8	ADC1_CH7	RTC_GPIO8	
GPIO9	ADC1_CH8	RTC_GPIO9	
GPIO10	ADC1_CH9	RTC_GPIO10	
GPIO11	ADC2_CH0	RTC_GPIO11	
GPIO12	ADC2_CH1	RTC_GPIO12	
GPIO13	ADC2_CH2	RTC_GPIO13	
GPIO14	ADC2_CH3	RTC_GPIO14	
GPIO15	ADC2_CH4	RTC_GPIO15	
GPIO16	ADC2_CH5	RTC_GPIO16	
GPIO17	ADC2_CH6	RTC_GPIO17	
GPIO18	ADC2_CH7	RTC_GPIO18	
GPIO19	ADC2_CH8	RTC_GPIO19	

continues on next page

Table 2 – continued from previous page

GPIO	Analog Function	RTC GPIO	Comment
GPIO20	ADC2_CH9	RTC_GPIO20	
GPIO21		RTC_GPIO21	
GPIO26			SPI0/1
GPIO27			SPI0/1
GPIO28			SPI0/1
GPIO29			SPI0/1
GPIO30			SPI0/1
GPIO31			SPI0/1
GPIO32			SPI0/1
GPIO33			
GPIO34			
GPIO35			
GPIO36			
GPIO37			
GPIO38			
GPIO39			JTAG
GPIO40			JTAG
GPIO41			JTAG
GPIO42			JTAG
GPIO43			
GPIO44			
GPIO45			Strapping pin
GPIO46			GPI; Strapping pin

**Note:**

- Strapping pin: GPIO0, GPIO45 and GPIO46 are strapping pins. For more information, please refer to [ESP32-S2 datasheet](#)
- SPI0/1: GPIO26-32 are usually used for SPI flash and PSRAM and not recommended for other uses.
- JTAG: GPIO39-42 are usually used for inline debug.
- GPI: GPIO46 is fixed to pull-down and is input only.

There is also separate “RTC GPIO” support, which functions when GPIOs are routed to the “RTC” low-power and analog subsystem. These pin functions can be used when:

- In Deep-sleep mode
- The *Ultra Low Power co-processor* is running
- Analog functions such as ADC/DAC/etc are in use.

**Application Example**

GPIO output and input interrupt example: [peripherals/gpio/generic\\_gpio](#).

**API Reference - Normal GPIO****Header File**

- [components/driver/include/driver/gpio.h](#)

**Functions**

*esp\_err\_t* **gpio\_config** (const *gpio\_config\_t* \*pGPIOConfig)

GPIO common configuration.

Configure GPIO's Mode, pull-up, PullDown, IntrType

**Parameters** *pGPIOConfig* –Pointer to GPIO configure struct

**Returns**

- ESP\_OK success
- ESP\_ERR\_INVALID\_ARG Parameter error

*esp\_err\_t* **gpio\_reset\_pin** (*gpio\_num\_t* gpio\_num)

Reset an gpio to default state (select gpio function, enable pullup and disable input and output).

---

**Note:** This function also configures the IOMUX for this pin to the GPIO function, and disconnects any other peripheral output configured via GPIO Matrix.

---

**Parameters** *gpio\_num* –GPIO number.

**Returns** Always return ESP\_OK.

*esp\_err\_t* **gpio\_set\_intr\_type** (*gpio\_num\_t* gpio\_num, *gpio\_int\_type\_t* intr\_type)

GPIO set interrupt trigger type.

**Parameters**

- *gpio\_num* –GPIO number. If you want to set the trigger type of e.g. of GPIO16, *gpio\_num* should be GPIO\_NUM\_16 (16);
- *intr\_type* –Interrupt type, select from *gpio\_int\_type\_t*

**Returns**

- ESP\_OK Success
- ESP\_ERR\_INVALID\_ARG Parameter error

*esp\_err\_t* **gpio\_intr\_enable** (*gpio\_num\_t* gpio\_num)

Enable GPIO module interrupt signal.

---

**Note:** ESP32: Please do not use the interrupt of GPIO36 and GPIO39 when using ADC or Wi-Fi and Bluetooth with sleep mode enabled. Please refer to the comments of `adc1_get_raw`. Please refer to Section 3.11 of [ESP32 ECO and Workarounds for Bugs](#) for the description of this issue. As a workaround, call `adc_power_acquire()` in the app. This will result in higher power consumption (by ~1mA), but will remove the glitches on GPIO36 and GPIO39.

---

**Parameters** *gpio\_num* –GPIO number. If you want to enable an interrupt on e.g. GPIO16, *gpio\_num* should be GPIO\_NUM\_16 (16);

**Returns**

- ESP\_OK Success
- ESP\_ERR\_INVALID\_ARG Parameter error

*esp\_err\_t* **gpio\_intr\_disable** (*gpio\_num\_t* gpio\_num)

Disable GPIO module interrupt signal.

---

**Note:** This function is allowed to be executed when Cache is disabled within ISR context, by enabling `CONFIG_GPIO_CTRL_FUNC_IN_IRAM`

---

**Parameters** `gpio_num` –GPIO number. If you want to disable the interrupt of e.g. GPIO16, `gpio_num` should be `GPIO_NUM_16` (16);

**Returns**

- `ESP_OK` success
- `ESP_ERR_INVALID_ARG` Parameter error

*esp\_err\_t* `gpio_set_level` (*gpio\_num\_t* `gpio_num`, *uint32\_t* `level`)

GPIO set output level.

---

**Note:** This function is allowed to be executed when Cache is disabled within ISR context, by enabling `CONFIG_GPIO_CTRL_FUNC_IN_IRAM`

---

**Parameters**

- `gpio_num` –GPIO number. If you want to set the output level of e.g. GPIO16, `gpio_num` should be `GPIO_NUM_16` (16);
- `level` –Output level. 0: low ; 1: high

**Returns**

- `ESP_OK` Success
- `ESP_ERR_INVALID_ARG` GPIO number error

*int* `gpio_get_level` (*gpio\_num\_t* `gpio_num`)

GPIO get input level.

**Warning:** If the pad is not configured for input (or input and output) the returned value is always 0.

**Parameters** `gpio_num` –GPIO number. If you want to get the logic level of e.g. pin GPIO16, `gpio_num` should be `GPIO_NUM_16` (16);

**Returns**

- 0 the GPIO input level is 0
- 1 the GPIO input level is 1

*esp\_err\_t* `gpio_set_direction` (*gpio\_num\_t* `gpio_num`, *gpio\_mode\_t* `mode`)

GPIO set direction.

Configure GPIO direction,such as `output_only`,`input_only`,`output_and_input`

**Parameters**

- `gpio_num` –Configure GPIO pins number, it should be GPIO number. If you want to set direction of e.g. GPIO16, `gpio_num` should be `GPIO_NUM_16` (16);
- `mode` –GPIO direction

**Returns**

- `ESP_OK` Success
- `ESP_ERR_INVALID_ARG` GPIO error

*esp\_err\_t* `gpio_set_pull_mode` (*gpio\_num\_t* `gpio_num`, *gpio\_pull\_mode\_t* `pull`)

Configure GPIO pull-up/pull-down resistors.

---

**Note:** ESP32: Only pins that support both input & output have integrated pull-up and pull-down resistors. Input-only GPIOs 34-39 do not.

---

**Parameters**

- `gpio_num` –GPIO number. If you want to set pull up or down mode for e.g. GPIO16, `gpio_num` should be `GPIO_NUM_16` (16);
- `pull` –GPIO pull up/down mode.

**Returns**

- ESP\_OK Success
- ESP\_ERR\_INVALID\_ARG : Parameter error

*esp\_err\_t* **gpio\_wakeup\_enable** (*gpio\_num\_t* gpio\_num, *gpio\_int\_type\_t* intr\_type)

Enable GPIO wake-up function.

**Parameters**

- **gpio\_num** –GPIO number.
- **intr\_type** –GPIO wake-up type. Only GPIO\_INTR\_LOW\_LEVEL or GPIO\_INTR\_HIGH\_LEVEL can be used.

**Returns**

- ESP\_OK Success
- ESP\_ERR\_INVALID\_ARG Parameter error

*esp\_err\_t* **gpio\_wakeup\_disable** (*gpio\_num\_t* gpio\_num)

Disable GPIO wake-up function.

**Parameters** **gpio\_num** –GPIO number

**Returns**

- ESP\_OK Success
- ESP\_ERR\_INVALID\_ARG Parameter error

*esp\_err\_t* **gpio\_isr\_register** (void (\*fn)(void\*), void \*arg, int intr\_alloc\_flags, *gpio\_isr\_handle\_t* \*handle)

Register GPIO interrupt handler, the handler is an ISR. The handler will be attached to the same CPU core that this function is running on.

This ISR function is called whenever any GPIO interrupt occurs. See the alternative `gpio_install_isr_service()` and `gpio_isr_handler_add()` API in order to have the driver support per-GPIO ISRs.

To disable or remove the ISR, pass the returned handle to the *interrupt allocation functions*.

**Parameters**

- **fn** –Interrupt handler function.
- **arg** –Parameter for handler function
- **intr\_alloc\_flags** –Flags used to allocate the interrupt. One or multiple (ORred) ESP\_INTR\_FLAG\_\* values. See `esp_intr_alloc.h` for more info.
- **handle** –Pointer to return handle. If non-NULL, a handle for the interrupt will be returned here.

**Returns**

- ESP\_OK Success ;
- ESP\_ERR\_INVALID\_ARG GPIO error
- ESP\_ERR\_NOT\_FOUND No free interrupt found with the specified flags

*esp\_err\_t* **gpio\_pullup\_en** (*gpio\_num\_t* gpio\_num)

Enable pull-up on GPIO.

**Parameters** **gpio\_num** –GPIO number

**Returns**

- ESP\_OK Success
- ESP\_ERR\_INVALID\_ARG Parameter error

*esp\_err\_t* **gpio\_pullup\_dis** (*gpio\_num\_t* gpio\_num)

Disable pull-up on GPIO.

**Parameters** **gpio\_num** –GPIO number

**Returns**

- ESP\_OK Success
- ESP\_ERR\_INVALID\_ARG Parameter error

*esp\_err\_t* **gpiopulldown\_en** (*gpio\_num\_t* gpio\_num)

Enable pull-down on GPIO.

**Parameters** `gpio_num` –GPIO number

**Returns**

- ESP\_OK Success
- ESP\_ERR\_INVALID\_ARG Parameter error

*esp\_err\_t* **gpio\_pullup\_dis** (*gpio\_num\_t* gpio\_num)

Disable pull-up on GPIO.

**Parameters** `gpio_num` –GPIO number

**Returns**

- ESP\_OK Success
- ESP\_ERR\_INVALID\_ARG Parameter error

*esp\_err\_t* **gpio\_install\_isr\_service** (int intr\_alloc\_flags)

Install the GPIO driver's `ETS_GPIO_INTR_SOURCE` ISR handler service, which allows per-pin GPIO interrupt handlers.

This function is incompatible with `gpio_isr_register()` - if that function is used, a single global ISR is registered for all GPIO interrupts. If this function is used, the ISR service provides a global GPIO ISR and individual pin handlers are registered via the `gpio_isr_handler_add()` function.

**Parameters** `intr_alloc_flags` –Flags used to allocate the interrupt. One or multiple (ORred) `ESP_INTR_FLAG_*` values. See `esp_intr_alloc.h` for more info.

**Returns**

- ESP\_OK Success
- ESP\_ERR\_NO\_MEM No memory to install this service
- ESP\_ERR\_INVALID\_STATE ISR service already installed.
- ESP\_ERR\_NOT\_FOUND No free interrupt found with the specified flags
- ESP\_ERR\_INVALID\_ARG GPIO error

void **gpio\_uninstall\_isr\_service** (void)

Uninstall the driver's GPIO ISR service, freeing related resources.

*esp\_err\_t* **gpio\_isr\_handler\_add** (*gpio\_num\_t* gpio\_num, *gpio\_isr\_t* isr\_handler, void \*args)

Add ISR handler for the corresponding GPIO pin.

Call this function after using `gpio_install_isr_service()` to install the driver's GPIO ISR handler service.

The pin ISR handlers no longer need to be declared with `IRAM_ATTR`, unless you pass the `ESP_INTR_FLAG_IRAM` flag when allocating the ISR in `gpio_install_isr_service()`.

This ISR handler will be called from an ISR. So there is a stack size limit (configurable as “ISR stack size” in menuconfig). This limit is smaller compared to a global GPIO interrupt handler due to the additional level of indirection.

**Parameters**

- `gpio_num` –GPIO number
- `isr_handler` –ISR handler function for the corresponding GPIO number.
- `args` –parameter for ISR handler.

**Returns**

- ESP\_OK Success
- ESP\_ERR\_INVALID\_STATE Wrong state, the ISR service has not been initialized.
- ESP\_ERR\_INVALID\_ARG Parameter error

*esp\_err\_t* **gpio\_isr\_handler\_remove** (*gpio\_num\_t* gpio\_num)

Remove ISR handler for the corresponding GPIO pin.

**Parameters** `gpio_num` –GPIO number

**Returns**

- ESP\_OK Success
- ESP\_ERR\_INVALID\_STATE Wrong state, the ISR service has not been initialized.
- ESP\_ERR\_INVALID\_ARG Parameter error

*esp\_err\_t* **gpio\_set\_drive\_capability** (*gpio\_num\_t* gpio\_num, *gpio\_drive\_cap\_t* strength)

Set GPIO pad drive capability.

**Parameters**

- **gpio\_num** –GPIO number, only support output GPIOs
- **strength** –Drive capability of the pad

**Returns**

- ESP\_OK Success
- ESP\_ERR\_INVALID\_ARG Parameter error

*esp\_err\_t* **gpio\_get\_drive\_capability** (*gpio\_num\_t* gpio\_num, *gpio\_drive\_cap\_t* \*strength)

Get GPIO pad drive capability.

**Parameters**

- **gpio\_num** –GPIO number, only support output GPIOs
- **strength** –Pointer to accept drive capability of the pad

**Returns**

- ESP\_OK Success
- ESP\_ERR\_INVALID\_ARG Parameter error

*esp\_err\_t* **gpio\_hold\_en** (*gpio\_num\_t* gpio\_num)

Enable gpio pad hold function.

When the pin is set to hold, the state is latched at that moment and will not change no matter how the internal signals change or how the IO MUX/GPIO configuration is modified (including input enable, output enable, output value, function, and drive strength values). It can be used to retain the pin state through a core reset and system reset triggered by watchdog time-out or Deep-sleep events.

The gpio pad hold function works in both input and output modes, but must be output-capable gpios. If pad hold enabled: in output mode: the output level of the pad will be force locked and can not be changed. in input mode: input read value can still reflect the changes of the input signal.

The state of the digital gpio cannot be held during Deep-sleep, and it will resume to hold at its default pin state when the chip wakes up from Deep-sleep. If the digital gpio also needs to be held during Deep-sleep, `gpio_deep_sleep_hold_en` should also be called.

Power down or call `gpio_hold_dis` will disable this function.

**Parameters** **gpio\_num** –GPIO number, only support output-capable GPIOs

**Returns**

- ESP\_OK Success
- ESP\_ERR\_NOT\_SUPPORTED Not support pad hold function

*esp\_err\_t* **gpio\_hold\_dis** (*gpio\_num\_t* gpio\_num)

Disable gpio pad hold function.

When the chip is woken up from Deep-sleep, the gpio will be set to the default mode, so, the gpio will output the default level if this function is called. If you don't want the level changes, the gpio should be configured to a known state before this function is called. e.g. If you hold gpio18 high during Deep-sleep, after the chip is woken up and `gpio_hold_dis` is called, gpio18 will output low level(because gpio18 is input mode by default). If you don't want this behavior, you should configure gpio18 as output mode and set it to high level before calling `gpio_hold_dis`.

**Parameters** **gpio\_num** –GPIO number, only support output-capable GPIOs

**Returns**

- ESP\_OK Success
- ESP\_ERR\_NOT\_SUPPORTED Not support pad hold function

void **gpio\_deep\_sleep\_hold\_en** (void)

Enable all digital gpio pads hold function during Deep-sleep.

Enabling this feature makes all digital gpio pads be at the holding state during Deep-sleep. The state of each pad holds is its active configuration (not pad's sleep configuration!).

Note that this pad hold feature only works when the chip is in Deep-sleep mode. When the chip is in active mode, the digital gpio state can be changed freely even you have called this function.

After this API is being called, the digital gpio Deep-sleep hold feature will work during every sleep process. You should call `gpio_deep_sleep_hold_dis` to disable this feature.

void **gpio\_deep\_sleep\_hold\_dis** (void)

Disable all digital gpio pads hold function during Deep-sleep.

void **gpio\_iomux\_in** (uint32\_t gpio\_num, uint32\_t signal\_idx)

Set pad input to a peripheral signal through the IOMUX.

#### Parameters

- **gpio\_num** –GPIO number of the pad.
- **signal\_idx** –Peripheral signal id to input. One of the \*\_IN\_IDX signals in `soc/gpio_sig_map.h`.

void **gpio\_iomux\_out** (uint8\_t gpio\_num, int func, bool oen\_inv)

Set peripheral output to an GPIO pad through the IOMUX.

#### Parameters

- **gpio\_num** –gpio\_num GPIO number of the pad.
- **func** –The function number of the peripheral pin to output pin. One of the FUNC\_X\_\* of specified pin (X) in `soc/io_mux_reg.h`.
- **oen\_inv** –True if the output enable needs to be inverted, otherwise False.

*esp\_err\_t* **gpio\_force\_hold\_all** (void)

Force hold all digital and rtc gpio pads.

GPIO force hold, no matter the chip in active mode or sleep modes.

This function will immediately cause all pads to latch the current values of input enable, output enable, output value, function, and drive strength values.

**Warning:** This function will hold flash and UART pins as well. Therefore, this function, and all code run afterwards (till calling `gpio_force_unhold_all` to disable this feature), MUST be placed in internal RAM as holding the flash pins will halt SPI flash operation, and holding the UART pins will halt any UART logging.

*esp\_err\_t* **gpio\_force\_unhold\_all** (void)

Force unhold all digital and rtc gpio pads.

*esp\_err\_t* **gpio\_sleep\_sel\_en** (*gpio\_num\_t* gpio\_num)

Enable SLP\_SEL to change GPIO status automatically in lightsleep.

**Parameters** **gpio\_num** –GPIO number of the pad.

#### Returns

- ESP\_OK Success

*esp\_err\_t* **gpio\_sleep\_sel\_dis** (*gpio\_num\_t* gpio\_num)

Disable SLP\_SEL to change GPIO status automatically in lightsleep.

**Parameters** **gpio\_num** –GPIO number of the pad.

#### Returns

- ESP\_OK Success

*esp\_err\_t* **gpio\_sleep\_set\_direction** (*gpio\_num\_t* gpio\_num, *gpio\_mode\_t* mode)

GPIO set direction at sleep.

Configure GPIO direction,such as output\_only,input\_only,output\_and\_input

#### Parameters



- **gpio\_num** –Configure GPIO pins number, it should be GPIO number. If you want to set direction of e.g. GPIO16, gpio\_num should be GPIO\_NUM\_16 (16);
- **mode** –GPIO direction

**Returns**

- ESP\_OK Success
- ESP\_ERR\_INVALID\_ARG GPIO error

*esp\_err\_t* **gpio\_sleep\_set\_pull\_mode** (*gpio\_num\_t* gpio\_num, *gpio\_pull\_mode\_t* pull)

Configure GPIO pull-up/pull-down resistors at sleep.

---

**Note:** ESP32: Only pins that support both input & output have integrated pull-up and pull-down resistors. Input-only GPIOs 34-39 do not.

---

**Parameters**

- **gpio\_num** –GPIO number. If you want to set pull up or down mode for e.g. GPIO16, gpio\_num should be GPIO\_NUM\_16 (16);
- **pull** –GPIO pull up/down mode.

**Returns**

- ESP\_OK Success
- ESP\_ERR\_INVALID\_ARG : Parameter error

**Structures**

struct **gpio\_config\_t**

Configuration parameters of GPIO pad for gpio\_config function.

**Public Members**

uint64\_t **pin\_bit\_mask**

GPIO pin: set with bit mask, each bit maps to a GPIO

*gpio\_mode\_t* **mode**

GPIO mode: set input/output mode

*gpio\_pullup\_t* **pull\_up\_en**

GPIO pull-up

*gpio\_pulldown\_t* **pull\_down\_en**

GPIO pull-down

*gpio\_int\_type\_t* **intr\_type**

GPIO interrupt type

**Macros**

**GPIO\_PIN\_COUNT**

**GPIO\_IS\_VALID\_GPIO** (gpio\_num)

Check whether it is a valid GPIO number.

**GPIO\_IS\_VALID\_OUTPUT\_GPIO** (gpio\_num)

Check whether it can be a valid GPIO number of output mode.

**GPIO\_IS\_VALID\_DIGITAL\_IO\_PAD** (gpio\_num)

Check whether it can be a valid digital I/O pad.

### Type Definitions

typedef *intr\_handle\_t* **gpio\_isr\_handle\_t**

typedef void (\***gpio\_isr\_t**)(void \*arg)

GPIO interrupt handler.

**Param arg** User registered data

### Header File

- [components/hal/include/hal/gpio\\_types.h](#)

### Macros

**GPIO\_PIN\_REG\_0**

**GPIO\_PIN\_REG\_1**

**GPIO\_PIN\_REG\_2**

**GPIO\_PIN\_REG\_3**

**GPIO\_PIN\_REG\_4**

**GPIO\_PIN\_REG\_5**

**GPIO\_PIN\_REG\_6**

**GPIO\_PIN\_REG\_7**

**GPIO\_PIN\_REG\_8**

**GPIO\_PIN\_REG\_9**

**GPIO\_PIN\_REG\_10**

**GPIO\_PIN\_REG\_11**

**GPIO\_PIN\_REG\_12**

**GPIO\_PIN\_REG\_13**

**GPIO\_PIN\_REG\_14**

**GPIO\_PIN\_REG\_15**

GPIO\_PIN\_REG\_16

GPIO\_PIN\_REG\_17

GPIO\_PIN\_REG\_18

GPIO\_PIN\_REG\_19

GPIO\_PIN\_REG\_20

GPIO\_PIN\_REG\_21

GPIO\_PIN\_REG\_22

GPIO\_PIN\_REG\_23

GPIO\_PIN\_REG\_24

GPIO\_PIN\_REG\_25

GPIO\_PIN\_REG\_26

GPIO\_PIN\_REG\_27

GPIO\_PIN\_REG\_28

GPIO\_PIN\_REG\_29

GPIO\_PIN\_REG\_30

GPIO\_PIN\_REG\_31

GPIO\_PIN\_REG\_32

GPIO\_PIN\_REG\_33

GPIO\_PIN\_REG\_34

GPIO\_PIN\_REG\_35

GPIO\_PIN\_REG\_36

GPIO\_PIN\_REG\_37

GPIO\_PIN\_REG\_38

GPIO\_PIN\_REG\_39

GPIO\_PIN\_REG\_40

GPIO\_PIN\_REG\_41

GPIO\_PIN\_REG\_42

GPIO\_PIN\_REG\_43

GPIO\_PIN\_REG\_44

GPIO\_PIN\_REG\_45

GPIO\_PIN\_REG\_46

GPIO\_PIN\_REG\_47

GPIO\_PIN\_REG\_48

### Enumerations

enum `gpio_port_t`

*Values:*

enumerator `GPIO_PORT_0`

enumerator `GPIO_PORT_MAX`

enum `gpio_num_t`

*Values:*

enumerator `GPIO_NUM_NC`

Use to signal not connected to S/W

enumerator `GPIO_NUM_0`

GPIO0, input and output

enumerator `GPIO_NUM_1`

GPIO1, input and output

enumerator `GPIO_NUM_2`

GPIO2, input and output

enumerator `GPIO_NUM_3`

GPIO3, input and output

- enumerator **GPIO\_NUM\_4**  
GPIO4, input and output
- enumerator **GPIO\_NUM\_5**  
GPIO5, input and output
- enumerator **GPIO\_NUM\_6**  
GPIO6, input and output
- enumerator **GPIO\_NUM\_7**  
GPIO7, input and output
- enumerator **GPIO\_NUM\_8**  
GPIO8, input and output
- enumerator **GPIO\_NUM\_9**  
GPIO9, input and output
- enumerator **GPIO\_NUM\_10**  
GPIO10, input and output
- enumerator **GPIO\_NUM\_11**  
GPIO11, input and output
- enumerator **GPIO\_NUM\_12**  
GPIO12, input and output
- enumerator **GPIO\_NUM\_13**  
GPIO13, input and output
- enumerator **GPIO\_NUM\_14**  
GPIO14, input and output
- enumerator **GPIO\_NUM\_15**  
GPIO15, input and output
- enumerator **GPIO\_NUM\_16**  
GPIO16, input and output
- enumerator **GPIO\_NUM\_17**  
GPIO17, input and output
- enumerator **GPIO\_NUM\_18**  
GPIO18, input and output
- enumerator **GPIO\_NUM\_19**  
GPIO19, input and output

- enumerator **GPIO\_NUM\_20**  
GPIO20, input and output
- enumerator **GPIO\_NUM\_21**  
GPIO21, input and output
- enumerator **GPIO\_NUM\_26**  
GPIO26, input and output
- enumerator **GPIO\_NUM\_27**  
GPIO27, input and output
- enumerator **GPIO\_NUM\_28**  
GPIO28, input and output
- enumerator **GPIO\_NUM\_29**  
GPIO29, input and output
- enumerator **GPIO\_NUM\_30**  
GPIO30, input and output
- enumerator **GPIO\_NUM\_31**  
GPIO31, input and output
- enumerator **GPIO\_NUM\_32**  
GPIO32, input and output
- enumerator **GPIO\_NUM\_33**  
GPIO33, input and output
- enumerator **GPIO\_NUM\_34**  
GPIO34, input and output
- enumerator **GPIO\_NUM\_35**  
GPIO35, input and output
- enumerator **GPIO\_NUM\_36**  
GPIO36, input and output
- enumerator **GPIO\_NUM\_37**  
GPIO37, input and output
- enumerator **GPIO\_NUM\_38**  
GPIO38, input and output
- enumerator **GPIO\_NUM\_39**  
GPIO39, input and output

enumerator **GPIO\_NUM\_40**  
GPIO40, input and output

enumerator **GPIO\_NUM\_41**  
GPIO41, input and output

enumerator **GPIO\_NUM\_42**  
GPIO42, input and output

enumerator **GPIO\_NUM\_43**  
GPIO43, input and output

enumerator **GPIO\_NUM\_44**  
GPIO44, input and output

enumerator **GPIO\_NUM\_45**  
GPIO45, input and output

enumerator **GPIO\_NUM\_46**  
GPIO46, input mode only

enumerator **GPIO\_NUM\_MAX**

enum **gpio\_int\_type\_t**

*Values:*

enumerator **GPIO\_INTR\_DISABLE**  
Disable GPIO interrupt

enumerator **GPIO\_INTR\_POSEDGE**  
GPIO interrupt type : rising edge

enumerator **GPIO\_INTR\_NEGEDGE**  
GPIO interrupt type : falling edge

enumerator **GPIO\_INTR\_ANYEDGE**  
GPIO interrupt type : both rising and falling edge

enumerator **GPIO\_INTR\_LOW\_LEVEL**  
GPIO interrupt type : input low level trigger

enumerator **GPIO\_INTR\_HIGH\_LEVEL**  
GPIO interrupt type : input high level trigger

enumerator **GPIO\_INTR\_MAX**

enum **gpio\_mode\_t**

*Values:*

enumerator **GPIO\_MODE\_DISABLE**

GPIO mode : disable input and output

enumerator **GPIO\_MODE\_INPUT**

GPIO mode : input only

enumerator **GPIO\_MODE\_OUTPUT**

GPIO mode : output only mode

enumerator **GPIO\_MODE\_OUTPUT\_OD**

GPIO mode : output only with open-drain mode

enumerator **GPIO\_MODE\_INPUT\_OUTPUT\_OD**

GPIO mode : output and input with open-drain mode

enumerator **GPIO\_MODE\_INPUT\_OUTPUT**

GPIO mode : output and input mode

enum **gpio\_pullup\_t**

*Values:*

enumerator **GPIO\_PULLUP\_DISABLE**

Disable GPIO pull-up resistor

enumerator **GPIO\_PULLUP\_ENABLE**

Enable GPIO pull-up resistor

enum **gpio\_pulldown\_t**

*Values:*

enumerator **GPIO\_PULLDOWN\_DISABLE**

Disable GPIO pull-down resistor

enumerator **GPIO\_PULLDOWN\_ENABLE**

Enable GPIO pull-down resistor

enum **gpio\_pull\_mode\_t**

*Values:*

enumerator **GPIO\_PULLUP\_ONLY**

Pad pull up

enumerator **GPIO\_PULLDOWN\_ONLY**

Pad pull down

enumerator **GPIO\_PULLUP\_PULLDOWN**

Pad pull up + pull down



enumerator **GPIO\_FLOATING**

Pad floating

enum **gpio\_drive\_cap\_t**

*Values:*

enumerator **GPIO\_DRIVE\_CAP\_0**

Pad drive capability: weak

enumerator **GPIO\_DRIVE\_CAP\_1**

Pad drive capability: stronger

enumerator **GPIO\_DRIVE\_CAP\_2**

Pad drive capability: medium

enumerator **GPIO\_DRIVE\_CAP\_DEFAULT**

Pad drive capability: medium

enumerator **GPIO\_DRIVE\_CAP\_3**

Pad drive capability: strongest

enumerator **GPIO\_DRIVE\_CAP\_MAX**

## API Reference - RTC GPIO

### Header File

- [components/driver/include/driver/rtc\\_io.h](#)

### Functions

bool **rtc\_gpio\_is\_valid\_gpio** (*gpio\_num\_t* gpio\_num)

Determine if the specified GPIO is a valid RTC GPIO.

**Parameters** **gpio\_num** –GPIO number

**Returns** true if GPIO is valid for RTC GPIO use. false otherwise.

int **rtc\_io\_number\_get** (*gpio\_num\_t* gpio\_num)

Get RTC IO index number by gpio number.

**Parameters** **gpio\_num** –GPIO number

**Returns** >=0: Index of rtcio. -1 : The gpio is not rtcio.

*esp\_err\_t* **rtc\_gpio\_init** (*gpio\_num\_t* gpio\_num)

Init a GPIO as RTC GPIO.

This function must be called when initializing a pad for an analog function.

**Parameters** **gpio\_num** –GPIO number (e.g. GPIO\_NUM\_12)

**Returns**

- ESP\_OK success
- ESP\_ERR\_INVALID\_ARG GPIO is not an RTC IO

*esp\_err\_t* **rtc\_gpio\_deinit** (*gpio\_num\_t* gpio\_num)

Init a GPIO as digital GPIO.

**Parameters** **gpio\_num** –GPIO number (e.g. GPIO\_NUM\_12)

**Returns**

- ESP\_OK success
- ESP\_ERR\_INVALID\_ARG GPIO is not an RTC IO

`uint32_t rtc_gpio_get_level (gpio_num_t gpio_num)`

Get the RTC IO input level.

**Parameters** `gpio_num` –GPIO number (e.g. GPIO\_NUM\_12)

**Returns**

- 1 High level
- 0 Low level
- ESP\_ERR\_INVALID\_ARG GPIO is not an RTC IO

`esp_err_t rtc_gpio_set_level (gpio_num_t gpio_num, uint32_t level)`

Set the RTC IO output level.

**Parameters**

- `gpio_num` –GPIO number (e.g. GPIO\_NUM\_12)
- `level` –output level

**Returns**

- ESP\_OK Success
- ESP\_ERR\_INVALID\_ARG GPIO is not an RTC IO

`esp_err_t rtc_gpio_set_direction (gpio_num_t gpio_num, rtc_gpio_mode_t mode)`

RTC GPIO set direction.

Configure RTC GPIO direction, such as output only, input only, output and input.

**Parameters**

- `gpio_num` –GPIO number (e.g. GPIO\_NUM\_12)
- `mode` –GPIO direction

**Returns**

- ESP\_OK Success
- ESP\_ERR\_INVALID\_ARG GPIO is not an RTC IO

`esp_err_t rtc_gpio_set_direction_in_sleep (gpio_num_t gpio_num, rtc_gpio_mode_t mode)`

RTC GPIO set direction in deep sleep mode or disable sleep status (default). In some application scenarios, IO needs to have another states during deep sleep.

NOTE: ESP32 support INPUT\_ONLY mode. ESP32S2 support INPUT\_ONLY, OUTPUT\_ONLY, INPUT\_OUTPUT mode.

**Parameters**

- `gpio_num` –GPIO number (e.g. GPIO\_NUM\_12)
- `mode` –GPIO direction

**Returns**

- ESP\_OK Success
- ESP\_ERR\_INVALID\_ARG GPIO is not an RTC IO

`esp_err_t rtc_gpio_pullup_en (gpio_num_t gpio_num)`

RTC GPIO pullup enable.

This function only works for RTC IOs. In general, call `gpio_pullup_en`, which will work both for normal GPIOs and RTC IOs.

**Parameters** `gpio_num` –GPIO number (e.g. GPIO\_NUM\_12)

**Returns**

- ESP\_OK Success
- ESP\_ERR\_INVALID\_ARG GPIO is not an RTC IO

`esp_err_t rtc_gpio_pulldown_en (gpio_num_t gpio_num)`

RTC GPIO pulldown enable.

This function only works for RTC IOs. In general, call `gpio_pulldown_en`, which will work both for normal GPIOs and RTC IOs.

**Parameters** `gpio_num` –GPIO number (e.g. GPIO\_NUM\_12)

**Returns**

- ESP\_OK Success
- ESP\_ERR\_INVALID\_ARG GPIO is not an RTC IO

*esp\_err\_t* `rtc_gpio_pullup_dis` (*gpio\_num\_t* gpio\_num)

RTC GPIO pullup disable.

This function only works for RTC IOs. In general, call `gpio_pullup_dis`, which will work both for normal GPIOs and RTC IOs.

**Parameters** `gpio_num` –GPIO number (e.g. GPIO\_NUM\_12)

**Returns**

- ESP\_OK Success
- ESP\_ERR\_INVALID\_ARG GPIO is not an RTC IO

*esp\_err\_t* `rtc_gpio_pulldown_dis` (*gpio\_num\_t* gpio\_num)

RTC GPIO pulldown disable.

This function only works for RTC IOs. In general, call `gpio_pulldown_dis`, which will work both for normal GPIOs and RTC IOs.

**Parameters** `gpio_num` –GPIO number (e.g. GPIO\_NUM\_12)

**Returns**

- ESP\_OK Success
- ESP\_ERR\_INVALID\_ARG GPIO is not an RTC IO

*esp\_err\_t* `rtc_gpio_set_drive_capability` (*gpio\_num\_t* gpio\_num, *gpio\_drive\_cap\_t* strength)

Set RTC GPIO pad drive capability.

**Parameters**

- `gpio_num` –GPIO number, only support output GPIOs
- `strength` –Drive capability of the pad

**Returns**

- ESP\_OK Success
- ESP\_ERR\_INVALID\_ARG Parameter error

*esp\_err\_t* `rtc_gpio_get_drive_capability` (*gpio\_num\_t* gpio\_num, *gpio\_drive\_cap\_t* \*strength)

Get RTC GPIO pad drive capability.

**Parameters**

- `gpio_num` –GPIO number, only support output GPIOs
- `strength` –Pointer to accept drive capability of the pad

**Returns**

- ESP\_OK Success
- ESP\_ERR\_INVALID\_ARG Parameter error

*esp\_err\_t* `rtc_gpio_hold_en` (*gpio\_num\_t* gpio\_num)

Enable hold function on an RTC IO pad.

Enabling HOLD function will cause the pad to latch current values of input enable, output enable, output value, function, drive strength values. This function is useful when going into light or deep sleep mode to prevent the pin configuration from changing.

**Parameters** `gpio_num` –GPIO number (e.g. GPIO\_NUM\_12)

**Returns**

- ESP\_OK Success
- ESP\_ERR\_INVALID\_ARG GPIO is not an RTC IO

*esp\_err\_t* `rtc_gpio_hold_dis` (*gpio\_num\_t* gpio\_num)

Disable hold function on an RTC IO pad.

Disabling hold function will allow the pad receive the values of input enable, output enable, output value, function, drive strength from RTC\_IO peripheral.

**Parameters** `gpio_num` –GPIO number (e.g. GPIO\_NUM\_12)

**Returns**

- ESP\_OK Success
- ESP\_ERR\_INVALID\_ARG GPIO is not an RTC IO

*esp\_err\_t* `rtc_gpio_isolate` (*gpio\_num\_t* gpio\_num)

Helper function to disconnect internal circuits from an RTC IO This function disables input, output, pullup, pulldown, and enables hold feature for an RTC IO. Use this function if an RTC IO needs to be disconnected from internal circuits in deep sleep, to minimize leakage current.

In particular, for ESP32-WROVER module, call `rtc_gpio_isolate(GPIO_NUM_12)` before entering deep sleep, to reduce deep sleep current.

**Parameters** `gpio_num` –GPIO number (e.g. GPIO\_NUM\_12).

**Returns**

- ESP\_OK on success
- ESP\_ERR\_INVALID\_ARG if GPIO is not an RTC IO

*esp\_err\_t* `rtc_gpio_force_hold_en_all` (void)

Enable force hold signal for all RTC IOs.

Each RTC pad has a “force hold” input signal from the RTC controller. If this signal is set, pad latches current values of input enable, function, output enable, and other signals which come from the RTC mux. Force hold signal is enabled before going into deep sleep for pins which are used for EXT1 wakeup.

*esp\_err\_t* `rtc_gpio_force_hold_dis_all` (void)

Disable force hold signal for all RTC IOs.

*esp\_err\_t* `rtc_gpio_wakeup_enable` (*gpio\_num\_t* gpio\_num, *gpio\_intr\_type\_t* intr\_type)

Enable wakeup from sleep mode using specific GPIO.

**Parameters**

- `gpio_num` –GPIO number
- `intr_type` –Wakeup on high level (GPIO\_INTR\_HIGH\_LEVEL) or low level (GPIO\_INTR\_LOW\_LEVEL)

**Returns**

- ESP\_OK on success
- ESP\_ERR\_INVALID\_ARG if `gpio_num` is not an RTC IO, or `intr_type` is not one of GPIO\_INTR\_HIGH\_LEVEL, GPIO\_INTR\_LOW\_LEVEL.

*esp\_err\_t* `rtc_gpio_wakeup_disable` (*gpio\_num\_t* gpio\_num)

Disable wakeup from sleep mode using specific GPIO.

**Parameters** `gpio_num` –GPIO number

**Returns**

- ESP\_OK on success
- ESP\_ERR\_INVALID\_ARG if `gpio_num` is not an RTC IO

## Macros

`RTC_GPIO_IS_VALID_GPIO` (gpio\_num)

## Header File

- `components/hal/include/hal/rtc_io_types.h`

## Enumerations

enum `rtc_gpio_mode_t`

RTCIO output/input mode type.

Values:

enumerator `RTC_GPIO_MODE_INPUT_ONLY`

Pad input

enumerator `RTC_GPIO_MODE_OUTPUT_ONLY`

Pad output

enumerator `RTC_GPIO_MODE_INPUT_OUTPUT`

Pad input + output

enumerator `RTC_GPIO_MODE_DISABLED`

Pad (output + input) disable

enumerator `RTC_GPIO_MODE_OUTPUT_OD`

Pad open-drain output

enumerator `RTC_GPIO_MODE_INPUT_OUTPUT_OD`

Pad input + open-drain output

## 2.5.7 General Purpose Timer (GPTimer)

### Introduction

GPTimer (General Purpose Timer) is the driver of ESP32-S2 Timer Group peripheral. The hardware timer features high resolution and flexible alarm action. The behavior when the internal counter of a timer reaches a specific target value is called a timer alarm. When a timer alarms, a user registered per-timer callback would be called.

Typically, a general purpose timer can be used in scenarios like:

- Free running as a wall clock, fetching a high-resolution timestamp at any time and any places
- Generate period alarms, trigger events periodically
- Generate one-shot alarm, respond in target time

### Functional Overview

The following sections of this document cover the typical steps to install and operate a timer:

- *Resource Allocation* - covers which parameters should be set up to get a timer handle and how to recycle the resources when GPTimer finishes working.
- *Set and Get Count Value* - covers how to force the timer counting from a start point and how to get the count value at anytime.
- *Set up Alarm Action* - covers the parameters that should be set up to enable the alarm event.
- *Register Event Callbacks* - covers how to hook user specific code to the alarm event callback function.
- *Enable and Disable Timer* - covers how to enable and disable the timer.
- *Start and Stop Timer* - shows some typical use cases that start the timer with different alarm behavior.
- *Power Management* - describes how different source clock selections can affect power consumption.
- *IRAM Safe* - describes tips on how to make the timer interrupt and IO control functions work better along with a disabled cache.
- *Thread Safety* - lists which APIs are guaranteed to be thread safe by the driver.
- *Kconfig Options* - lists the supported Kconfig options that can be used to make a different effect on driver behavior.

**Resource Allocation** Different ESP chips might have different numbers of independent timer groups, and within each group, there could also be several independent timers.<sup>1</sup>

A GPTimer instance is represented by `gptimer_handle_t`. The driver behind will manage all available hardware resources in a pool, so that you do not need to care about which timer and which group it belongs to.

To install a timer instance, there is a configuration structure that needs to be given in advance: `gptimer_config_t`:

- `gptimer_config_t::clk_src` selects the source clock for the timer. The available clocks are listed in `gptimer_clock_source_t`, you can only pick one of them. For the effect on power consumption of different clock source, please refer to Section *Power Management*.
- `gptimer_config_t::direction` sets the counting direction of the timer, supported directions are listed in `gptimer_count_direction_t`, you can only pick one of them.
- `gptimer_config_t::resolution_hz` sets the resolution of the internal counter. Each count step is equivalent to  $1 / \text{resolution\_hz}$  seconds.
- `gptimer_config::intr_priority` sets the priority of the timer interrupt. If it is set to 0, the driver will allocate an interrupt with a default priority. Otherwise, the driver will use the given priority.
- Optional `gptimer_config_t::intr_shared` sets whether or not mark the timer interrupt source as a shared one. For the pros/cons of a shared interrupt, you can refer to *Interrupt Handling*.

With all the above configurations set in the structure, the structure can be passed to `gptimer_new_timer()` which will instantiate the timer instance and return a handle of the timer.

The function can fail due to various errors such as insufficient memory, invalid arguments, etc. Specifically, when there are no more free timers (i.e. all hardware resources have been used up), then `ESP_ERR_NOT_FOUND` will be returned. The total number of available timers is represented by the `SOC_TIMER_GROUP_TOTAL_TIMERS` and its value will depend on the ESP chip.

If a previously created GPTimer instance is no longer required, you should recycle the timer by calling `gptimer_del_timer()`. This will allow the underlying HW timer to be used for other purposes. Before deleting a GPTimer handle, please disable it by `gptimer_disable()` in advance or make sure it has not enabled yet by `gptimer_enable()`.

### Creating a GPTimer Handle with Resolution of 1 MHz

```
gptimer_handle_t gptimer = NULL;
gptimer_config_t timer_config = {
    .clk_src = GPTIMER_CLK_SRC_DEFAULT,
    .direction = GPTIMER_COUNT_UP,
    .resolution_hz = 1 * 1000 * 1000, // 1MHz, 1 tick = 1us
};
ESP_ERROR_CHECK(gptimer_new_timer(&timer_config, &gptimer));
```

**Set and Get Count Value** When the GPTimer is created, the internal counter will be reset to zero by default. The counter value can be updated asynchronously by `gptimer_set_raw_count()`. The maximum count value is dependent on the bit width of the hardware timer, which is also reflected by the SOC macro `SOC_TIMER_GROUP_COUNTER_BIT_WIDTH`. When updating the raw count of an active timer, the timer will immediately start counting from the new value.

Count value can be retrieved by `gptimer_get_raw_count()`, at any time.

**Set up Alarm Action** For most of the use cases of GPTimer, you should set up the alarm action before starting the timer, except for the simple wall-clock scenario, where a free running timer is enough. To set up the alarm action, you should configure several members of `gptimer_alarm_config_t` based on how you make use of the alarm event:

<sup>1</sup> Different ESP chip series might have different numbers of GPTimer instances. For more details, please refer to *ESP32-S2 Technical Reference Manual* > Chapter *Timer Group (TIMG)* [PDF]. The driver will not forbid you from applying for more timers, but it will return error when all available hardware resources are used up. Please always check the return value when doing resource allocation (e.g. `gptimer_new_timer()`).

- `gptimer_alarm_config_t::alarm_count` sets the target count value that will trigger the alarm event. You should also take the counting direction into consideration when setting the alarm value. Specially, `gptimer_alarm_config_t::alarm_count` and `gptimer_alarm_config_t::reload_count` cannot be set to the same value when `gptimer_alarm_config_t::auto_reload_on_alarm` is true, as keeping reload with a target alarm count is meaningless.
- `gptimer_alarm_config_t::reload_count` sets the count value to be reloaded when the alarm event happens. This configuration only takes effect when `gptimer_alarm_config_t::auto_reload_on_alarm` is set to true.
- `gptimer_alarm_config_t::auto_reload_on_alarm` flag sets whether to enable the auto-reload feature. If enabled, the hardware timer will reload the value of `gptimer_alarm_config_t::reload_count` into counter immediately when an alarm event happens.

To make the alarm configurations take effect, you should call `gptimer_set_alarm_action()`. Especially, if `gptimer_alarm_config_t` is set to NULL, the alarm function will be disabled.

---

**Note:** If an alarm value is set and the timer has already exceeded this value, the alarm will be triggered immediately.

---

**Register Event Callbacks** After the timer starts up, it can generate a specific event (e.g. the “Alarm Event” ) dynamically. If you have some functions that should be called when the event happens, please hook your function to the interrupt service routine by calling `gptimer_register_event_callbacks()`. All supported event callbacks are listed in `gptimer_event_callbacks_t`:

- `gptimer_event_callbacks_t::on_alarm` sets a callback function for alarm events. As this function is called within the ISR context, you must ensure that the function does not attempt to block (e.g., by making sure that only FreeRTOS APIs with ISR suffix are called from within the function). The function prototype is declared in `gptimer_alarm_cb_t`.

You can save your own context to `gptimer_register_event_callbacks()` as well, via the parameter `user_data`. The user data will be directly passed to the callback function.

This function will lazy install the interrupt service for the timer but not enable it. So please call this function before `gptimer_enable()`, otherwise the `ESP_ERR_INVALID_STATE` error will be returned. See Section [Enable and Disable Timer](#) for more information.

**Enable and Disable Timer** Before doing IO control to the timer, you needs to enable the timer first, by calling `gptimer_enable()`. This function will:

- Switch the timer driver state from **init** to **enable**.
- Enable the interrupt service if it has been lazy installed by `gptimer_register_event_callbacks()`.
- Acquire a proper power management lock if a specific clock source (e.g. APB clock) is selected. See Section [Power Management](#) for more information.

Calling `gptimer_disable()` will do the opposite, that is, put the timer driver back to the **init** state, disable the interrupts service and release the power management lock.

**Start and Stop Timer** The basic IO operation of a timer is to start and stop. Calling `gptimer_start()` can make the internal counter work, while calling `gptimer_stop()` can make the counter stop working. The following illustrates how to start a timer with or without an alarm event. Calling `gptimer_start()` will transit the driver state from **enable** to **run**, and vice versa. You need to make sure the start and stop functions are used in pairs, otherwise, the functions may return `ESP_ERR_INVALID_STATE`. Most of the time, this error means that the timer is already stopped or in the “start protection” state (i.e. `gptimer_start()` is called but not finished).

### Start Timer as a Wall Clock

```

ESP_ERROR_CHECK(gptimer_enable(gptimer));
ESP_ERROR_CHECK(gptimer_start(gptimer));
// Retrieve the timestamp at any time
uint64_t count;
ESP_ERROR_CHECK(gptimer_get_raw_count(gptimer, &count));

```

### Trigger Period Events

```

typedef struct {
    uint64_t event_count;
} example_queue_element_t;

static bool example_timer_on_alarm_cb(gptimer_handle_t timer, const gptimer_alarm_
↳event_data_t *edata, void *user_ctx)
{
    BaseType_t high_task_awoken = pdFALSE;
    QueueHandle_t queue = (QueueHandle_t)user_ctx;
    // Retrieve the count value from event data
    example_queue_element_t ele = {
        .event_count = edata->count_value
    };
    // Optional: send the event data to other task by OS queue
    // Do not introduce complex logics in callbacks
    // Suggest dealing with event data in the main loop, instead of in this.
↳callback
    xQueueSendFromISR(queue, &ele, &high_task_awoken);
    // return whether we need to yield at the end of ISR
    return high_task_awoken == pdTRUE;
}

gptimer_alarm_config_t alarm_config = {
    .reload_count = 0, // counter will reload with 0 on alarm event
    .alarm_count = 1000000, // period = 1s @resolution 1MHz
    .flags.auto_reload_on_alarm = true, // enable auto-reload
};
ESP_ERROR_CHECK(gptimer_set_alarm_action(gptimer, &alarm_config));

gptimer_event_callbacks_t cbs = {
    .on_alarm = example_timer_on_alarm_cb, // register user callback
};
ESP_ERROR_CHECK(gptimer_register_event_callbacks(gptimer, &cbs, queue));
ESP_ERROR_CHECK(gptimer_enable(gptimer));
ESP_ERROR_CHECK(gptimer_start(gptimer));

```

### Trigger One-Shot Event

```

typedef struct {
    uint64_t event_count;
} example_queue_element_t;

static bool example_timer_on_alarm_cb(gptimer_handle_t timer, const gptimer_alarm_
↳event_data_t *edata, void *user_ctx)
{
    BaseType_t high_task_awoken = pdFALSE;
    QueueHandle_t queue = (QueueHandle_t)user_ctx;
    // Stop timer the sooner the better
    gptimer_stop(timer);
    // Retrieve the count value from event data
    example_queue_element_t ele = {
        .event_count = edata->count_value
    };

```

(continues on next page)



(continued from previous page)

```

};
// Optional: send the event data to other task by OS queue
xQueueSendFromISR(queue, &ele, &high_task_awoken);
// return whether we need to yield at the end of ISR
return high_task_awoken == pdTRUE;
}

gptimer_alarm_config_t alarm_config = {
    .alarm_count = 1 * 1000 * 1000, // alarm target = 1s @resolution 1MHz
};
ESP_ERROR_CHECK(gptimer_set_alarm_action(gptimer, &alarm_config));

gptimer_event_callbacks_t cbs = {
    .on_alarm = example_timer_on_alarm_cb, // register user callback
};
ESP_ERROR_CHECK(gptimer_register_event_callbacks(gptimer, &cbs, queue));
ESP_ERROR_CHECK(gptimer_enable(gptimer));
ESP_ERROR_CHECK(gptimer_start(gptimer));

```

**Dynamic Alarm Update** Alarm value can be updated dynamically inside the ISR handler callback, by changing `gptimer_alarm_event_data_t::alarm_value`. Then the alarm value will be updated after the callback function returns.

```

typedef struct {
    uint64_t event_count;
} example_queue_element_t;

static bool example_timer_on_alarm_cb(gptimer_handle_t timer, const gptimer_alarm_
↪event_data_t *edata, void *user_ctx)
{
    BaseType_t high_task_awoken = pdFALSE;
    QueueHandle_t queue = (QueueHandle_t)user_data;
    // Retrieve the count value from event data
    example_queue_element_t ele = {
        .event_count = edata->count_value
    };
    // Optional: send the event data to other task by OS queue
    xQueueSendFromISR(queue, &ele, &high_task_awoken);
    // reconfigure alarm value
    gptimer_alarm_config_t alarm_config = {
        .alarm_count = edata->alarm_value + 1000000, // alarm in next 1s
    };
    gptimer_set_alarm_action(timer, &alarm_config);
    // return whether we need to yield at the end of ISR
    return high_task_awoken == pdTRUE;
}

gptimer_alarm_config_t alarm_config = {
    .alarm_count = 1000000, // initial alarm target = 1s @resolution 1MHz
};
ESP_ERROR_CHECK(gptimer_set_alarm_action(gptimer, &alarm_config));

gptimer_event_callbacks_t cbs = {
    .on_alarm = example_timer_on_alarm_cb, // register user callback
};
ESP_ERROR_CHECK(gptimer_register_event_callbacks(gptimer, &cbs, queue));
ESP_ERROR_CHECK(gptimer_enable(gptimer));
ESP_ERROR_CHECK(gptimer_start(gptimer));

```

**Power Management** There're some power management strategies, which might turn off or change the frequency of GPTimer's source clock to save power consumption. For example, during DFS, APB clock will be scaled down. If light-sleep is also enabled, PLL and XTAL clocks will be powered off. Both of them can result in an inaccurate time keeping.

The driver can prevent the above situation from happening by creating different power management lock according to different clock source. The driver will increase the reference count of that power management lock in the `gptimer_enable()` and decrease it in the `gptimer_disable()`. So we can ensure the clock source is stable between `gptimer_enable()` and `gptimer_disable()`.

**IRAM Safe** By default, the GPTimer interrupt will be deferred when the cache is disabled because of writing or erasing the flash. Thus the alarm interrupt will not get executed in time, which is not expected in a real-time application.

There is a Kconfig option `CONFIG_GPTIMER_ISR_IRAM_SAFE` that will:

- Enable the interrupt being serviced even when the cache is disabled
- Place all functions that used by the ISR into IRAM<sup>2</sup>
- Place driver object into DRAM (in case it is mapped to PSRAM by accident)

This will allow the interrupt to run while the cache is disabled, but will come at the cost of increased IRAM consumption.

There is another Kconfig option `CONFIG_GPTIMER_CTRL_FUNC_IN_IRAM` that can put commonly used IO control functions into IRAM as well. So, these functions can also be executable when the cache is disabled. These IO control functions are as follows:

- `gptimer_start()`
- `gptimer_stop()`
- `gptimer_get_raw_count()`
- `gptimer_set_raw_count()`
- `gptimer_set_alarm_action()`

**Thread Safety** All the APIs provided by the driver are guaranteed to be thread safe, which means you can call them from different RTOS tasks without protection by extra locks. The following functions are allowed to run under ISR context.

- `gptimer_start()`
- `gptimer_stop()`
- `gptimer_get_raw_count()`
- `gptimer_set_raw_count()`
- `gptimer_set_alarm_action()`

### Kconfig Options

- `CONFIG_GPTIMER_CTRL_FUNC_IN_IRAM` controls where to place the GPTimer control functions (IRAM or flash), see Section *IRAM Safe* for more information.
- `CONFIG_GPTIMER_ISR_IRAM_SAFE` controls whether the default ISR handler can work when the cache is disabled, see Section *IRAM Safe* for more information.
- `CONFIG_GPTIMER_ENABLE_DEBUG_LOG` is used to enable the debug log output. Enable this option will increase the firmware binary size.

### Application Examples

- Typical use cases of GPTimer are listed in the example `peripherals/timer_group/gptimer`.

---

<sup>2</sup> `gptimer_event_callbacks_t::on_alarm` callback and the functions invoked by the callback should also be placed in IRAM, please take care of them by yourself.

## API Reference

### Header File

- `components/driver/include/driver/gptimer.h`

### Functions

*esp\_err\_t* **gptimer\_new\_timer** (const *gptimer\_config\_t* \*config, *gptimer\_handle\_t* \*ret\_timer)

Create a new General Purpose Timer, and return the handle.

---

**Note:** The newly created timer is put in the “init” state.

---

#### Parameters

- **config** –[in] GPTimer configuration
- **ret\_timer** –[out] Returned timer handle

#### Returns

- ESP\_OK: Create GPTimer successfully
- ESP\_ERR\_INVALID\_ARG: Create GPTimer failed because of invalid argument
- ESP\_ERR\_NO\_MEM: Create GPTimer failed because out of memory
- ESP\_ERR\_NOT\_FOUND: Create GPTimer failed because all hardware timers are used up and no more free one
- ESP\_FAIL: Create GPTimer failed because of other error

*esp\_err\_t* **gptimer\_del\_timer** (*gptimer\_handle\_t* timer)

Delete the GPTimer handle.

---

**Note:** A timer must be in the “init” state before it can be deleted.

---

**Parameters** **timer** –[in] Timer handle created by `gptimer_new_timer()`

#### Returns

- ESP\_OK: Delete GPTimer successfully
- ESP\_ERR\_INVALID\_ARG: Delete GPTimer failed because of invalid argument
- ESP\_ERR\_INVALID\_STATE: Delete GPTimer failed because the timer is not in init state
- ESP\_FAIL: Delete GPTimer failed because of other error

*esp\_err\_t* **gptimer\_set\_raw\_count** (*gptimer\_handle\_t* timer, *uint64\_t* value)

Set GPTimer raw count value.

---

**Note:** When updating the raw count of an active timer, the timer will immediately start counting from the new value.

---

**Note:** This function is allowed to run within ISR context

---

**Note:** If `CONFIG_GPTIMER_CTRL_FUNC_IN_IRAM` is enabled, this function will be placed in the IRAM by linker, makes it possible to execute even when the Flash Cache is disabled.

---

#### Parameters

- **timer** –[in] Timer handle created by `gptimer_new_timer()`
- **value** –[in] Count value to be set

**Returns**

- ESP\_OK: Set GPTimer raw count value successfully
- ESP\_ERR\_INVALID\_ARG: Set GPTimer raw count value failed because of invalid argument
- ESP\_FAIL: Set GPTimer raw count value failed because of other error

*esp\_err\_t* **gptimer\_get\_raw\_count** (*gptimer\_handle\_t* timer, uint64\_t \*value)

Get GPTimer raw count value.

---

**Note:** With the raw count value and the resolution set in the *gptimer\_config\_t*, you can convert the count value into seconds.

---

---

**Note:** This function is allowed to run within ISR context

---

---

**Note:** If CONFIG\_GPTIMER\_CTRL\_FUNC\_IN\_IRAM is enabled, this function will be placed in the IRAM by linker, makes it possible to execute even when the Flash Cache is disabled.

---

**Parameters**

- **timer** –[in] Timer handle created by *gptimer\_new\_timer()*
- **value** –[out] Returned GPTimer count value

**Returns**

- ESP\_OK: Get GPTimer raw count value successfully
- ESP\_ERR\_INVALID\_ARG: Get GPTimer raw count value failed because of invalid argument
- ESP\_FAIL: Get GPTimer raw count value failed because of other error

*esp\_err\_t* **gptimer\_register\_event\_callbacks** (*gptimer\_handle\_t* timer, const *gptimer\_event\_callbacks\_t* \*cbs, void \*user\_data)

Set callbacks for GPTimer.

---

**Note:** User registered callbacks are expected to be runnable within ISR context

---

---

**Note:** The first call to this function needs to be before the call to *gptimer\_enable*

---

---

**Note:** User can deregister a previously registered callback by calling this function and setting the callback member in the *cbs* structure to NULL.

---

**Parameters**

- **timer** –[in] Timer handle created by *gptimer\_new\_timer()*
- **cbs** –[in] Group of callback functions
- **user\_data** –[in] User data, which will be passed to callback functions directly

**Returns**

- ESP\_OK: Set event callbacks successfully
- ESP\_ERR\_INVALID\_ARG: Set event callbacks failed because of invalid argument
- ESP\_ERR\_INVALID\_STATE: Set event callbacks failed because the timer is not in init state
- ESP\_FAIL: Set event callbacks failed because of other error

*esp\_err\_t* **gptimer\_set\_alarm\_action** (*gptimer\_handle\_t* timer, const *gptimer\_alarm\_config\_t* \*config)

Set alarm event actions for GPTimer.

---

**Note:** This function is allowed to run within ISR context, so that user can set new alarm action immediately in the ISR callback.

---

---

**Note:** If `CONFIG_GPTIMER_CTRL_FUNC_IN_IRAM` is enabled, this function will be placed in the IRAM by linker, makes it possible to execute even when the Flash Cache is disabled.

---

#### Parameters

- **timer** –[in] Timer handle created by `gptimer_new_timer()`
- **config** –[in] Alarm configuration, especially, set config to NULL means disabling the alarm function

#### Returns

- `ESP_OK`: Set alarm action for GPTimer successfully
- `ESP_ERR_INVALID_ARG`: Set alarm action for GPTimer failed because of invalid argument
- `ESP_FAIL`: Set alarm action for GPTimer failed because of other error

*esp\_err\_t* **gptimer\_enable** (*gptimer\_handle\_t* timer)

Enable GPTimer.

---

**Note:** This function will transit the timer state from “init” to “enable” .

---

---

**Note:** This function will enable the interrupt service, if it's lazy installed in `gptimer_register_event_callbacks`.

---

---

**Note:** This function will acquire a PM lock, if a specific source clock (e.g. APB) is selected in the `gptimer_config_t`, while `CONFIG_PM_ENABLE` is enabled.

---

---

**Note:** Enable a timer doesn't mean to start it. See also `gptimer_start()` for how to make the timer start counting.

---

**Parameters** **timer** –[in] Timer handle created by `gptimer_new_timer()`

#### Returns

- `ESP_OK`: Enable GPTimer successfully
- `ESP_ERR_INVALID_ARG`: Enable GPTimer failed because of invalid argument
- `ESP_ERR_INVALID_STATE`: Enable GPTimer failed because the timer is already enabled
- `ESP_FAIL`: Enable GPTimer failed because of other error

*esp\_err\_t* **gptimer\_disable** (*gptimer\_handle\_t* timer)

Disable GPTimer.

---

**Note:** This function will transit the timer state from “enable” to “init” .

---

---

**Note:** This function will disable the interrupt service if it's installed.

---

---

**Note:** This function will release the PM lock if it's acquired in the `gptimer_enable`.

---

---

**Note:** Disable a timer doesn't mean to stop it. See also `gptimer_stop` for how to make the timer stop counting.

---

**Parameters** `timer` –[in] Timer handle created by `gptimer_new_timer()`

**Returns**

- `ESP_OK`: Disable GPTimer successfully
- `ESP_ERR_INVALID_ARG`: Disable GPTimer failed because of invalid argument
- `ESP_ERR_INVALID_STATE`: Disable GPTimer failed because the timer is not enabled yet
- `ESP_FAIL`: Disable GPTimer failed because of other error

*esp\_err\_t* `gptimer_start` (*gptimer\_handle\_t* timer)

Start GPTimer (internal counter starts counting)

---

**Note:** This function will transit the timer state from “enable” to “run” .

---

---

**Note:** This function is allowed to run within ISR context

---

---

**Note:** If `CONFIG_GPTIMER_CTRL_FUNC_IN_IRAM` is enabled, this function will be placed in the IRAM by linker, makes it possible to execute even when the Flash Cache is disabled.

---

**Parameters** `timer` –[in] Timer handle created by `gptimer_new_timer()`

**Returns**

- `ESP_OK`: Start GPTimer successfully
- `ESP_ERR_INVALID_ARG`: Start GPTimer failed because of invalid argument
- `ESP_ERR_INVALID_STATE`: Start GPTimer failed because the timer is not enabled or is already in running
- `ESP_FAIL`: Start GPTimer failed because of other error

*esp\_err\_t* `gptimer_stop` (*gptimer\_handle\_t* timer)

Stop GPTimer (internal counter stops counting)

---

**Note:** This function will transit the timer state from “run” to “enable” .

---

---

**Note:** This function is allowed to run within ISR context

---

---

**Note:** If `CONFIG_GPTIMER_CTRL_FUNC_IN_IRAM` is enabled, this function will be placed in the IRAM by linker, makes it possible to execute even when the Flash Cache is disabled.

---

**Parameters** `timer` –[in] Timer handle created by `gptimer_new_timer()`

**Returns**

- ESP\_OK: Stop GPTimer successfully
- ESP\_ERR\_INVALID\_ARG: Stop GPTimer failed because of invalid argument
- ESP\_ERR\_INVALID\_STATE: Stop GPTimer failed because the timer is not in running.
- ESP\_FAIL: Stop GPTimer failed because of other error

**Structures**

struct **gptimer\_alarm\_event\_data\_t**

GPTimer alarm event data.

**Public Members**

uint64\_t **count\_value**

Current count value

uint64\_t **alarm\_value**

Current alarm value

struct **gptimer\_event\_callbacks\_t**

Group of supported GPTimer callbacks.

---

**Note:** The callbacks are all running under ISR environment

---

---

**Note:** When CONFIG\_GPTIMER\_ISR\_IRAM\_SAFE is enabled, the callback itself and functions called by it should be placed in IRAM.

---

**Public Members**

*gptimer\_alarm\_cb\_t* **on\_alarm**

Timer alarm callback

struct **gptimer\_config\_t**

General Purpose Timer configuration.

**Public Members**

*gptimer\_clock\_source\_t* **clk\_src**

GPTimer clock source

*gptimer\_count\_direction\_t* **direction**

Count direction

uint32\_t **resolution\_hz**

Counter resolution (working frequency) in Hz, hence, the step size of each count tick equals to (1 / resolution\_hz) seconds

int **intr\_priority**

GPTimer interrupt priority, if set to 0, the driver will try to allocate an interrupt with a relative low priority (1,2,3)

uint32\_t **intr\_shared**

Set true, the timer interrupt number can be shared with other peripherals

struct *gptimer\_config\_t*::[anonymous] **flags**

GPTimer config flags

struct **gptimer\_alarm\_config\_t**

General Purpose Timer alarm configuration.

### Public Members

uint64\_t **alarm\_count**

Alarm target count value

uint64\_t **reload\_count**

Alarm reload count value, effect only when `auto_reload_on_alarm` is set to true

uint32\_t **auto\_reload\_on\_alarm**

Reload the count value by hardware, immediately at the alarm event

struct *gptimer\_alarm\_config\_t*::[anonymous] **flags**

Alarm config flags

### Type Definitions

typedef struct gptimer\_t \***gptimer\_handle\_t**

Type of General Purpose Timer handle.

typedef bool (\***gptimer\_alarm\_cb\_t**)(*gptimer\_handle\_t* timer, const *gptimer\_alarm\_event\_data\_t* \*edata, void \*user\_ctx)

Timer alarm callback prototype.

**Param timer [in]** Timer handle created by `gptimer_new_timer()`

**Param edata [in]** Alarm event data, fed by driver

**Param user\_ctx [in]** User data, passed from `gptimer_register_event_callbacks()`

**Return** Whether a high priority task has been waken up by this function

### Header File

- [components/hal/include/hal/timer\\_types.h](#)

### Type Definitions

typedef *soc\_periph\_gptimer\_clk\_src\_t* **gptimer\_clock\_source\_t**

GPTimer clock source.

---

**Note:** User should select the clock source based on the power and resolution requirement

---



## Enumerations

enum `gptimer_count_direction_t`

GPTimer count direction.

*Values:*

enumerator `GPTIMER_COUNT_DOWN`

Decrease count value

enumerator `GPTIMER_COUNT_UP`

Increase count value

## 2.5.8 Dedicated GPIO

### Overview

The dedicated GPIO is designed for CPU interaction with GPIO matrix and IO MUX. Any GPIO that is configured as “dedicated” can be access by CPU instructions directly, which makes it easy to achieve a high GPIO flip speed, and simulate serial/parallel interface in a bit-banging way. As toggling a GPIO in this “CPU Dedicated” way costs few overhead, it would be great for cases like performance measurement using an oscilloscope.

### Create/Destroy GPIO Bundle

A GPIO bundle is a group of GPIOs, which can be manipulated at the same time in one CPU cycle. The maximal number of GPIOs that a bundle can contain is limited by each CPU. What’ s more, the GPIO bundle has a strong relevance to the CPU which it derives from. **Any operations on the GPIO bundle should be put inside a task which is running on the same CPU core to the GPIO bundle belongs to.** Likewise, only those ISRs who are installed on the same CPU core are allowed to do operations on that GPIO bundle.

---

**Note:** Dedicated GPIO is more of a CPU peripheral, so it has a strong relationship with CPU core. It’ s highly recommended to install and operate GPIO bundle in a pin-to-core task. For example, if GPIOA is connected to CPU0, and the dedicated GPIO instruction is issued from CPU1, then it’ s impossible to control GPIOA.

---

To install a GPIO bundle, one needs to call `dedic_gpio_new_bundle()` to allocate the software resources and connect the dedicated channels to user selected GPIOs. Configurations for a GPIO bundle are covered in `dedic_gpio_bundle_config_t` structure:

- `gpio_array`: An array that contains GPIO number.
- `array_size`: Element number of `gpio_array`.
- `flags`: Extra flags to control the behavior of GPIO Bundle.
  - `in_en` and `out_en` are used to select whether to enable the input and output function (note, they can be enabled together).
  - `in_invert` and `out_invert` are used to select whether to invert the GPIO signal.

The following code shows how to install a output only GPIO bundle:

```
// configure GPIO
const int bundleA_gpios[] = {0, 1};
gpio_config_t io_conf = {
    .mode = GPIO_MODE_OUTPUT,
};
for (int i = 0; i < sizeof(bundleA_gpios) / sizeof(bundleA_gpios[0]); i++) {
```

(continues on next page)

(continued from previous page)

```

    io_conf.pin_bit_mask = 1ULL << bundleA_gpios[i];
    gpio_config(&io_conf);
}
// Create bundleA, output only
dedic_gpio_bundle_handle_t bundleA = NULL;
dedic_gpio_bundle_config_t bundleA_config = {
    .gpio_array = bundleA_gpios,
    .array_size = sizeof(bundleA_gpios) / sizeof(bundleA_gpios[0]),
    .flags = {
        .out_en = 1,
    },
};
ESP_ERROR_CHECK(dedic_gpio_new_bundle(&bundleA_config, &bundleA));

```

To uninstall the GPIO bundle, one needs to call `dedic_gpio_del_bundle()`.

**Note:** `dedic_gpio_new_bundle()` doesn't cover any GPIO pad configuration (e.g. pull up/down, drive ability, output/input enable), so before installing a dedicated GPIO bundle, you have to configure the GPIO separately using GPIO driver API (e.g. `gpio_config()`). For more information about GPIO driver, please refer to [GPIO API Reference](#).

## GPIO Bundle Operations

Operations	Functions
Write to GPIOs in the bundle by mask	<code>dedic_gpio_bundle_write()</code>
Read the value that output from the given GPIO bundle	<code>dedic_gpio_bundle_read_out()</code>
Read the value that input to the given GPIO bundle	<code>dedic_gpio_bundle_read_in()</code>

**Note:** Using the above functions might not get a high GPIO flip speed because of the overhead of function calls and the bit operations involved inside. Users can try [Manipulate GPIOs by Writing Assembly Code](#) instead to reduce the overhead but should take care of the thread safety by themselves.

## Manipulate GPIOs by Writing Assembly Code

For advanced users, they can always manipulate the GPIOs by writing assembly code or invoking CPU Low Level APIs. The usual procedure could be:

1. Allocate a GPIO bundle: `dedic_gpio_new_bundle()`
2. Query the mask occupied by that bundle: `dedic_gpio_get_out_mask()` or/and `dedic_gpio_get_in_mask()`
3. Call CPU LL apis (e.g. `dedic_gpio_cpu_ll_write_mask`) or write assembly code with that mask
4. The fastest way of toggling IO is to use the dedicated “set/clear” instructions:
  - Set bits of GPIO: `set_bit_gpio_out imm[7:0]`
  - Clear bits of GPIO: `clr_bit_gpio_out imm[7:0]`
  - Note: Immediate value width depends on the number of dedicated GPIO channels

For details of supported dedicated GPIO instructions, please refer to [ESP32-S2 Technical Reference Manual > IO MUX and GPIO Matrix \(GPIO, IO\\_MUX\)](#) [PDF].

Some of the dedicated CPU instructions are also wrapped inside `hal/dedic_gpio_cpu_ll.h` as helper inline functions.

---

**Note:** Writing assembly code in application could make your code hard to port between targets, because those customized instructions are not guaranteed to remain the same format on different targets.

---

## Interrupt Handling

Dedicated GPIO can also trigger interrupt on specific input event. All supported events are defined in `dedic_gpio_intr_type_t`.

One can enable and register interrupt callback by calling `dedic_gpio_bundle_set_interrupt_and_callback()`. The prototype of the callback function is defined in `dedic_gpio_isr_callback_t`. Keep in mind, the callback should return true if there's some high priority task woken up.

```
// user defined ISR callback
IRAM_ATTR bool dedic_gpio_isr_callback(dedic_gpio_bundle_handle_t bundle, uint32_t
↳index, void *args)
{
    SemaphoreHandle_t sem = (SemaphoreHandle_t)args;
    BaseType_t high_task_wakeup = pdFALSE;
    xSemaphoreGiveFromISR(sem, &high_task_wakeup);
    return high_task_wakeup == pdTRUE;
}

// enable positive edge interrupt on the second GPIO in the bundle (i.e. index 1)
ESP_ERROR_CHECK(dedic_gpio_bundle_set_interrupt_and_callback(bundle, BIT(1), DEDIC_
↳GPIO_INTR_POS_EDGE, dedic_gpio_isr_callback, sem));

// wait for done semaphore
xSemaphoreTake(sem, portMAX_DELAY);
```

## Application Example

Matrix keyboard example based on dedicated GPIO: [peripherals/gpio/matrix\\_keyboard](#).

## API Reference

### Header File

- `components/driver/include/driver/dedic_gpio.h`

### Functions

`esp_err_t dedic_gpio_get_out_mask(dedic_gpio_bundle_handle_t bundle, uint32_t *mask)`

Get allocated channel mask.

---

**Note:** Each bundle should have at least one mask (in or/and out), based on bundle configuration.

---



---

**Note:** With the returned mask, user can directly invoke LL function like “`dedic_gpio_cpu_ll_write_mask`” or write assembly code with dedicated GPIO instructions, to get better performance on GPIO manipulation.

---

### Parameters

- **bundle** –[in] Handle of GPIO bundle that returned from “`dedic_gpio_new_bundle`”
- **mask** –[out] Returned mask value for on specific direction (in or out)

### Returns

- `ESP_OK`: Get channel mask successfully
- `ESP_ERR_INVALID_ARG`: Get channel mask failed because of invalid argument
- `ESP_FAIL`: Get channel mask failed because of other error

`esp_err_t` **dedic\_gpio\_get\_in\_mask** (*dedic\_gpio\_bundle\_handle\_t* bundle, `uint32_t` \*mask)

`esp_err_t` **dedic\_gpio\_new\_bundle** (const *dedic\_gpio\_bundle\_config\_t* \*config, *dedic\_gpio\_bundle\_handle\_t* \*ret\_bundle)

Create GPIO bundle and return the handle.

---

**Note:** One has to enable at least input or output mode in “config” parameter.

---

#### Parameters

- **config** –[in] Configuration of GPIO bundle
- **ret\_bundle** –[out] Returned handle of the new created GPIO bundle

#### Returns

- `ESP_OK`: Create GPIO bundle successfully
- `ESP_ERR_INVALID_ARG`: Create GPIO bundle failed because of invalid argument
- `ESP_ERR_NO_MEM`: Create GPIO bundle failed because of no capable memory
- `ESP_ERR_NOT_FOUND`: Create GPIO bundle failed because of no enough continuous dedicated channels
- `ESP_FAIL`: Create GPIO bundle failed because of other error

`esp_err_t` **dedic\_gpio\_del\_bundle** (*dedic\_gpio\_bundle\_handle\_t* bundle)

Destory GPIO bundle.

**Parameters** **bundle** –[in] Handle of GPIO bundle that returned from “dedic\_gpio\_new\_bundle”

#### Returns

- `ESP_OK`: Destory GPIO bundle successfully
- `ESP_ERR_INVALID_ARG`: Destory GPIO bundle failed because of invalid argument
- `ESP_FAIL`: Destory GPIO bundle failed because of other error

void **dedic\_gpio\_bundle\_write** (*dedic\_gpio\_bundle\_handle\_t* bundle, `uint32_t` mask, `uint32_t` value)

Write value to GPIO bundle.

---

**Note:** The mask is seen from the view of GPIO bundle. For example, bundleA contains [GPIO10, GPIO12, GPIO17], to set GPIO17 individually, the mask should be 0x04.

---

---

**Note:** For performance reasons, this function doesn’ t check the validity of any parameters, and is placed in IRAM.

---

#### Parameters

- **bundle** –[in] Handle of GPIO bundle that returned from “dedic\_gpio\_new\_bundle”
- **mask** –[in] Mask of the GPIOs to be written in the given bundle
- **value** –[in] Value to write to given GPIO bundle, low bit represents low member in the bundle

`uint32_t` **dedic\_gpio\_bundle\_read\_out** (*dedic\_gpio\_bundle\_handle\_t* bundle)

Read the value that output from the given GPIO bundle.

---

**Note:** For performance reasons, this function doesn’ t check the validity of any parameters, and is placed in IRAM.

---

**Parameters** **bundle** –[in] Handle of GPIO bundle that returned from “dedic\_gpio\_new\_bundle”

**Returns** Value that output from the GPIO bundle, low bit represents low member in the bundle

uint32\_t **dedic\_gpio\_bundle\_read\_in** (*dedic\_gpio\_bundle\_handle\_t* bundle)

Read the value that input to the given GPIO bundle.

---

**Note:** For performance reasons, this function doesn't check the validity of any parameters, and is placed in IRAM.

---

**Parameters** **bundle** –[in] Handle of GPIO bundle that returned from “dedic\_gpio\_new\_bundle”

**Returns** Value that input to the GPIO bundle, low bit represents low member in the bundle

*esp\_err\_t* **dedic\_gpio\_bundle\_set\_interrupt\_and\_callback** (*dedic\_gpio\_bundle\_handle\_t* bundle,  
uint32\_t mask,  
*dedic\_gpio\_intr\_type\_t* intr\_type,  
*dedic\_gpio\_isr\_callback\_t* cb\_isr,  
void \*cb\_args)

Set interrupt and callback function for GPIO bundle.

---

**Note:** This function is only valid for bundle with input mode enabled. See “dedic\_gpio\_bundle\_config\_t”

---

---

**Note:** The mask is seen from the view of GPIO Bundle. For example, bundleA contains [GPIO10, GPIO12, GPIO17], to set GPIO17 individually, the mask should be 0x04.

---

#### Parameters

- **bundle** –[in] Handle of GPIO bundle that returned from “dedic\_gpio\_new\_bundle”
- **mask** –[in] Mask of the GPIOs in the given bundle
- **intr\_type** –[in] Interrupt type, set to DEDIC\_GPIO\_INTR\_NONE can disable interrupt
- **cb\_isr** –[in] Callback function, which got invoked in ISR context. A NULL pointer here will bypass the callback
- **cb\_args** –[in] User defined argument to be passed to the callback function

#### Returns

- ESP\_OK: Set GPIO interrupt and callback function successfully
- ESP\_ERR\_INVALID\_ARG: Set GPIO interrupt and callback function failed because of invalid argument
- ESP\_FAIL: Set GPIO interrupt and callback function failed because of other error

### Structures

struct **dedic\_gpio\_bundle\_config\_t**

Type of Dedicated GPIO bundle configuration.

### Public Members

const int \***gpio\_array**

Array of GPIO numbers, gpio\_array[0] ~ gpio\_array[size-1] <=> low\_dedic\_channel\_num ~ high\_dedic\_channel\_num

size\_t **array\_size**  
Number of GPIOs in `gpio_array`

unsigned int **in\_en**  
Enable input

unsigned int **in\_invert**  
Invert input signal

unsigned int **out\_en**  
Enable output

unsigned int **out\_invert**  
Invert output signal

struct *dedic\_gpio\_bundle\_config\_t*::[anonymous] **flags**  
Flags to control specific behaviour of GPIO bundle

### Type Definitions

typedef struct *dedic\_gpio\_bundle\_t* \***dedic\_gpio\_bundle\_handle\_t**

Type of Dedicated GPIO bundle.

typedef bool (\***dedic\_gpio\_isr\_callback\_t**)(*dedic\_gpio\_bundle\_handle\_t* bundle, uint32\_t index, void \*args)

Type of dedicated GPIO ISR callback function.

**Param bundle** Handle of GPIO bundle that returned from “`dedic_gpio_new_bundle`”

**Param index** Index of the GPIO in its corresponding bundle (count from 0)

**Param args** User defined arguments for the callback function. It's passed through `dedic_gpio_bundle_set_interrupt_and_callback`

**Return** If a high priority task is woken up by the callback function

### Enumerations

enum **dedic\_gpio\_intr\_type\_t**

Supported type of dedicated GPIO interrupt.

*Values:*

enumerator **DEDIC\_GPIO\_INTR\_NONE**

No interrupt

enumerator **DEDIC\_GPIO\_INTR\_LOW\_LEVEL**

Interrupt on low level

enumerator **DEDIC\_GPIO\_INTR\_HIGH\_LEVEL**

Interrupt on high level

enumerator **DEDIC\_GPIO\_INTR\_NEG\_EDGE**

Interrupt on negedge

enumerator `DEDIC_GPIO_INTR_POS_EDGE`

Interrupt on posedge

enumerator `DEDIC_GPIO_INTR_BOTH_EDGE`

Interrupt on both negedge and posedge

## 2.5.9 Hash-based Message Authentication Code (HMAC)

The HMAC (Hash-based Message Authentication Code) module provides hardware acceleration for SHA256-HMAC generation using a key burned into an eFuse block. HMACs work with pre-shared secret keys and provide authenticity and integrity to a message.

For more detailed information on the application workflow and the HMAC calculation process, see *ESP32-S2 Technical Reference Manual > HMAC Accelerator (HMAC)* [PDF].

### Generalized Application Scheme

Let there be two parties, A and B. They want to verify the authenticity and integrity of messages sent between each other. Before they can start sending messages, they need to exchange the secret key via a secure channel. To verify A's messages, B can do the following:

- A calculates the HMAC of the message it wants to send.
- A sends the message and the HMAC to B.
- B calculates HMAC of the received message itself.
- B checks whether the received and calculated HMACs match. If they do match, the message is authentic.

However, the HMAC itself isn't bound to this use case. It can also be used for challenge-response protocols supporting HMAC or as a key input for further security modules (see below), etc.

### HMAC on the ESP32-S2

On the ESP32-S2, the HMAC module works with a secret key burnt into the eFuses. This eFuse key can be made completely inaccessible for any resources outside the cryptographic modules, thus avoiding key leakage.

Furthermore, the ESP32-S2 has three different application scenarios for its HMAC module:

1. HMAC is generated for software use
2. HMAC is used as a key for the Digital Signature (DS) module
3. HMAC is used for enabling the soft-disabled JTAG interface

The first mode is called *Upstream* mode, while the last two modes are called *Downstream* modes.

**eFuse Keys for HMAC** Six physical eFuse blocks can be used as keys for the HMAC module: block 4 up to block 9. The enum `hmac_key_id_t` in the API maps them to `HMAC_KEY0` ... `HMAC_KEY5`. Each key has a corresponding eFuse parameter `key_purpose` determining for which of the three HMAC application scenarios (see below) the key may be used:

Key Purpose	Application Scenario
8	HMAC generated for software use
7	HMAC used as a key for the Digital Signature (DS) module
6	HMAC used for enabling the soft-disabled JTAG interface
5	HMAC both as a key for the DS module and for enabling JTAG

This is to prevent the usage of a key for a different function than originally intended.

To calculate an HMAC, the software has to provide the ID of the key block containing the secret key as well as the *key purpose* (see *ESP32-S2 Technical Reference Manual > eFuse Controller (eFuse)* [PDF]). Before the HMAC key calculation, the HMAC module looks up the purpose of the provided key block. The calculation only proceeds if the purpose of the provided key block matches the purpose stored in the eFuses of the key block provided by the ID.

### **HMAC Generation for Software** Key Purpose value: 8

In this case, the HMAC is given out to the software (e.g. to authenticate a message).

The API to calculate the HMAC is `esp_hmac_calculate()`. The input arguments for the function are the message, message length and the eFuse key block ID which contains the secret and has eFuse key purpose set to Upstream mode.

### **HMAC for Digital Signature** Key Purpose values: 7, 5

The HMAC can be used as a key derivation function to decrypt private key parameters which are used by the Digital Signature module. A standard message is used by the hardware in that case. The user only needs to provide the eFuse key block and purpose on the HMAC side (additional parameters are required for the Digital Signature component in that case). Neither the key nor the actual HMAC are ever exposed to outside the HMAC module and DS component. The calculation of the HMAC and its hand-over to the DS component happen internally.

For more details, see *ESP32-S2 Technical Reference Manual > Digital Signature (DS)* [PDF].

### **HMAC for Enabling JTAG** Key Purpose values: 6, 5

The third application is using the HMAC as a key to enable JTAG if it was soft-disabled before. Following is the procedure to re-enable the JTAG

#### Setup

1. Generate a 256-bit HMAC secret key to use for JTAG re-enable.
2. Write the key to an eFuse block with key purpose HMAC\_DOWN\_ALL (5) or HMAC\_DOWN\_JTAG (6). This can be done using the `ets_efuse_write_key()` function in the firmware or using `espefuse.py` from the host.
3. Configure the eFuse key block to be read protected using the `esp_efuse_set_read_protect()`, so that software cannot read back the value.
4. Burn the “soft JTAG disable” bit/bits on ESP32-S2. This will permanently disable JTAG unless the correct key value is provided by software.

---

**Note:** The API `esp_efuse_write_field_bit(ESP_EFUSE_SOFT_DIS_JTAG)` can be used to burn “soft JTAG disable” bit on ESP32-S2.

---

---

**Note:** If `HARD_DIS_JTAG` eFuse is set, then `SOFT_DIS_JTAG` functionality does not work because JTAG is permanently disabled.

---

#### JTAG enable

1. The key to re-enable JTAG is the output of the HMAC-SHA256 function using the secret key in eFuse and 32 0x00 bytes as the message.
2. Pass this key value when calling the `esp_hmac_jtag_enable()` function from the firmware.
3. To re-disable JTAG in the firmware, reset the system or call `esp_hmac_jtag_disable()`.

For more details, see *ESP32-S2 Technical Reference Manual > HMAC Accelerator (HMAC)* [PDF].

### **Application Outline**

Following code is an outline of how to set an eFuse key and then use it to calculate an HMAC for software usage. We use `ets_efuse_write_key` to set physical key block 4 in the eFuse for the HMAC module together with its purpose.



`ETS_EFUSE_KEY_PURPOSE_HMAC_UP` (8) means that this key can only be used for HMAC generation for software usage:

```
#include "esp32s2/rom/efuse.h"

const uint8_t key_data[32] = { ... };

int ets_status = ets_efuse_write_key(ETS_EFUSE_BLOCK_KEY4,
    ETS_EFUSE_KEY_PURPOSE_HMAC_UP,
    key_data, sizeof(key_data));

if (ets_status == ESP_OK) {
    // written key
} else {
    // writing key failed, maybe written already
}
```

Now we can use the saved key to calculate an HMAC for software usage.

```
#include "esp_hmac.h"

uint8_t hmac[32];

const char *message = "Hello, HMAC!";
const size_t msg_len = 12;

esp_err_t result = esp_hmac_calculate(HMAC_KEY4, message, msg_len, hmac);

if (result == ESP_OK) {
    // HMAC written to hmac now
} else {
    // failure calculating HMAC
}
```

## API Reference

### Header File

- [components/esp\\_hw\\_support/include/soc/esp32s2/esp\\_hmac.h](#)

### Functions

`esp_err_t esp_hmac_calculate` (*hmac\_key\_id\_t* key\_id, const void \*message, size\_t message\_len, uint8\_t \*hmac)

Calculate the HMAC of a given message.

Calculate the HMAC `hmac` of a given message `message` with length `message_len`. SHA256 is used for the calculation (fixed on ESP32S2).

---

**Note:** Uses the HMAC peripheral in “upstream” mode.

---

### Parameters

- **key\_id** –Determines which of the 6 key blocks in the efuses should be used for the HMAC calculation. The corresponding purpose field of the key block in the efuse must be set to the HMAC upstream purpose value.
- **message** –the message for which to calculate the HMAC
- **message\_len** –message length return `ESP_ERR_INVALID_STATE` if unsuccessful
- **hmac** –[out] the hmac result; the buffer behind the provided pointer must be a writeable buffer of 32 bytes

**Returns**

- ESP\_OK, if the calculation was successful,
- ESP\_ERR\_INVALID\_ARG if message or hmac is a nullptr or if key\_id out of range
- ESP\_FAIL, if the hmac calculation failed

*esp\_err\_t* **esp\_hmac\_jtag\_enable** (*hmac\_key\_id\_t* key\_id, const uint8\_t \*token)

Use HMAC peripheral in Downstream mode to re-enable the JTAG, if it is not permanently disabled by HW. In downstream mode HMAC calculations performed by peripheral used internally and not provided back to user.

---

**Note:** Return value of the API does not indicate the JTAG status.

---

**Parameters**

- **key\_id** –Determines which of the 6 key blocks in the efuses should be used for the HMAC calculation. The corresponding purpose field of the key block in the efuse must be set to HMAC downstream purpose.
- **token** –Pre calculated HMAC value of the 32-byte 0x00 using SHA-256 and the known private HMAC key. The key is already programmed to a eFuse key block. The key block number is provided as the first parameter to this function.

**Returns**

- ESP\_OK, if the key\_purpose of the key\_id matches to HMAC downstream mode, The API returns success even if calculated HMAC does not match with the provided token. However, The JTAG will be re-enabled only if the calculated HMAC value matches with provided token, otherwise JTAG will remain disabled.
- ESP\_FAIL, if the key\_purpose of the key\_id is not set to HMAC downstream purpose or JTAG is permanently disabled by EFUSE\_HARD\_DIS\_JTAG eFuse parameter.
- ESP\_ERR\_INVALID\_ARG, invalid input arguments

*esp\_err\_t* **esp\_hmac\_jtag\_disable** (void)

Disable the JTAG which might be enable using the HMAC downstream mode. This function just clear the result generated by JTAG key by calling esp\_hmac\_jtag\_enable() API.

**Returns**

- ESP\_OK return ESP\_OK after writing the HMAC\_SET\_INVALIDATE\_JTAG\_REG with value 1.

**Enumerations**

enum **hmac\_key\_id\_t**

The possible efuse keys for the HMAC peripheral

*Values:*

enumerator **HMAC\_KEY0**

enumerator **HMAC\_KEY1**

enumerator **HMAC\_KEY2**

enumerator **HMAC\_KEY3**

enumerator **HMAC\_KEY4**

enumerator `HMAC_KEY5`

enumerator `HMAC_KEY_MAX`

### 2.5.10 Digital Signature (DS)

The Digital Signature (DS) module provides hardware acceleration of signing messages based on RSA. It uses pre-encrypted parameters to calculate a signature. The parameters are encrypted using HMAC as a key-derivation function. In turn, the HMAC uses eFuses as input key. The whole process happens in hardware so that neither the decryption key for the RSA parameters nor the input key for the HMAC key derivation function can be seen by the software while calculating the signature.

For more detailed information on the hardware involved in signature calculation and the registers used, see *ESP32-S2 Technical Reference Manual > Digital Signature (DS)* [PDF].

#### Private Key Parameters

The private key parameters for the RSA signature are stored in flash. To prevent unauthorized access, they are AES-encrypted. The HMAC module is used as a key-derivation function to calculate the AES encryption key for the private key parameters. In turn, the HMAC module uses a key from the eFuses key block which can be read-protected to prevent unauthorized access as well.

Upon signature calculation invocation, the software only specifies which eFuse key to use, the corresponding eFuse key purpose, the location of the encrypted RSA parameters and the message.

#### Key Generation

Both the HMAC key and the RSA private key have to be created and stored before the DS peripheral can be used. This needs to be done in software on the ESP32-S2 or alternatively on a host. For this context, the IDF provides `esp_efuse_write_block()` to set the HMAC key and `esp_hmac_calculate()` to encrypt the private RSA key parameters.

You can find instructions on how to calculate and assemble the private key parameters in *ESP32-S2 Technical Reference Manual > Digital Signature (DS)* [PDF].

#### Signature Calculation with IDF

For more detailed information on the workflow and the registers used, see *ESP32-S2 Technical Reference Manual > Digital Signature (DS)* [PDF].

Three parameters need to be prepared to calculate the digital signature:

1. the eFuse key block ID which is used as key for the HMAC,
2. the location of the encrypted private key parameters,
3. and the message to be signed.

Since the signature calculation takes some time, there are two possible API versions to use in IDF. The first one is `esp_ds_sign()` and simply blocks until the calculation is finished. If software needs to do something else during the calculation, `esp_ds_start_sign()` can be called, followed by periodic calls to `esp_ds_is_busy()` to check when the calculation has finished. Once the calculation has finished, `esp_ds_finish_sign()` can be called to get the resulting signature.

The APIs `esp_ds_sign()` and `esp_ds_start_sign()` calculate a plain RSA signature with help of the DS peripheral. This signature needs to be converted to appropriate format for further use. For example, MbedTLS SSL stack supports PKCS#1 format. The API `esp_ds_rsa_sign()` can be used to obtain the signature directly in the PKCS#1 v1.5 format. It internally uses `esp_ds_start_sign()` and converts the signature into PKCS#1 v1.5 format.

---

**Note:** Note that this is only the basic DS building block, the message length is fixed. To create signatures of arbitrary messages, the input is normally a hash of the actual message, padded up to the required length. An API to do this is planned in the future.

---

### Configure the DS peripheral for a TLS connection

The DS peripheral on ESP32-S2 chip must be configured before it can be used for a TLS connection. The configuration involves the following steps -

- 1) Randomly generate a 256 bit value called the *Initialization Vector (IV)*.
- 2) Randomly generate a 256 bit value called the *HMAC\_KEY*.
- 3) Calculate the encrypted private key parameters from the client private key (RSA) and the parameters generated in the above steps.
- 4) Then burn the 256 bit *HMAC\_KEY* on the efuse, which can only be read by the DS peripheral.

For more details, see *ESP32-S2 Technical Reference Manual > Digital Signature (DS)* [PDF].

To configure the DS peripheral for development purposes, you can use the [esp-secure-cert-tool](#).

The encrypted private key parameters obtained after the DS peripheral configuration are then to be kept in flash. Furthermore, they are to be passed to the DS peripheral which makes use of those parameters for the Digital Signature operation. The application then needs to read the ds data from the flash which has been done through the API's provided by the [esp\\_secure\\_cert\\_mgr](#) component. Please refer the [component/README](#). for more details.

The process of initializing the DS peripheral and then performing the Digital Signature operation is done internally with help of *ESP-TLS*. Please refer to *Digital Signature with ESP-TLS* in *ESP-TLS* for more details. As mentioned in the *ESP-TLS* documentation, the application only needs to provide the encrypted private key parameters to the `esp_tls` context (as `ds_data`), which internally performs all necessary operations for initializing the DS peripheral and then performing the DS operation.

### Example for SSL Mutual Authentication using DS

The example `ssl_ds` shows how to use the DS peripheral for mutual authentication. The example uses `mqtt_client` (Implemented through *ESP-MQTT*) to connect to broker `test.mosquitto.org` using `ssl` transport with mutual authentication. The `ssl` part is internally performed with *ESP-TLS*. See [example README](#) for more details.

## API Reference

### Header File

- [components/esp\\_hw\\_support/include/soc/esp32s2/esp\\_ds.h](#)

### Functions

`esp_err_t esp_ds_sign` (const void \*message, const `esp_ds_data_t` \*data, `hmac_key_id_t` key\_id, void \*signature)

Sign the message.

This function is a wrapper around `esp_ds_finish_sign()` and `esp_ds_start_sign()`, so do not use them in parallel. It blocks until the signing is finished and then returns the signature.

The function calculates a plain RSA signature with help of the DS peripheral. The RSA encryption operation is as follows:  $Z = XY \text{ mod } M$  where,  $Z$  is the signature,  $X$  is the input message,  $Y$  and  $M$  are the RSA private key parameters.

---

**Note:** This function locks the HMAC, SHA, AES and RSA components during its entire execution time.

---

**Parameters**

- **message** –the message to be signed; its length should be  $(data->rsa\_length + 1)*4$  bytes
- **data** –the encrypted signing key data (AES encrypted RSA key + IV)
- **key\_id** –the HMAC key ID determining the HMAC key of the HMAC which will be used to decrypt the signing key data
- **signature** –the destination of the signature, should be  $(data->rsa\_length + 1)*4$  bytes long

**Returns**

- ESP\_OK if successful, the signature was written to the parameter `signature`.
- ESP\_ERR\_INVALID\_ARG if one of the parameters is NULL or `data->rsa_length` is too long or 0
- ESP\_ERR\_HW\_CRYPTODS\_HMAC\_FAIL if there was an HMAC failure during retrieval of the decryption key
- ESP\_ERR\_NO\_MEM if there hasn't been enough memory to allocate the context object
- ESP\_ERR\_HW\_CRYPTODS\_INVALID\_KEY if there's a problem with passing the HMAC key to the DS component
- ESP\_ERR\_HW\_CRYPTODS\_INVALID\_DIGEST if the message digest didn't match; the signature is invalid.
- ESP\_ERR\_HW\_CRYPTODS\_INVALID\_PADDING if the message padding is incorrect, the signature can be read though since the message digest matches.

`esp_err_t esp_ds_start_sign` (const void \*message, const `esp_ds_data_t` \*data, `hmac_key_id_t` key\_id, `esp_ds_context_t` \*\*esp\_ds\_ctx)

Start the signing process.

This function yields a context object which needs to be passed to `esp_ds_finish_sign()` to finish the signing process.

The function calculates a plain RSA signature with help of the DS peripheral. The RSA encryption operation is as follows:  $Z = XY \text{ mod } M$  where, Z is the signature, X is the input message, Y and M are the RSA private key parameters.

---

**Note:** This function locks the HMAC, SHA, AES and RSA components, so the user has to ensure to call `esp_ds_finish_sign()` in a timely manner.

---

**Parameters**

- **message** –the message to be signed; its length should be  $(data->rsa\_length + 1)*4$  bytes
- **data** –the encrypted signing key data (AES encrypted RSA key + IV)
- **key\_id** –the HMAC key ID determining the HMAC key of the HMAC which will be used to decrypt the signing key data
- **esp\_ds\_ctx** –the context object which is needed for finishing the signing process later

**Returns**

- ESP\_OK if successful, the ds operation was started now and has to be finished with `esp_ds_finish_sign()`
- ESP\_ERR\_INVALID\_ARG if one of the parameters is NULL or `data->rsa_length` is too long or 0
- ESP\_ERR\_HW\_CRYPTODS\_HMAC\_FAIL if there was an HMAC failure during retrieval of the decryption key
- ESP\_ERR\_NO\_MEM if there hasn't been enough memory to allocate the context object
- ESP\_ERR\_HW\_CRYPTODS\_INVALID\_KEY if there's a problem with passing the HMAC key to the DS component

bool `esp_ds_is_busy` (void)

Return true if the DS peripheral is busy, otherwise false.

---

**Note:** Only valid if `esp_ds_start_sign()` was called before.

---

*esp\_err\_t* **esp\_ds\_finish\_sign** (void \*signature, *esp\_ds\_context\_t* \*esp\_ds\_ctx)

Finish the signing process.

#### Parameters

- **signature** –the destination of the signature, should be (data->rsa\_length + 1)\*4 bytes long
- **esp\_ds\_ctx** –the context object retrieved by `esp_ds_start_sign()`

#### Returns

- ESP\_OK if successful, the ds operation has been finished and the result is written to signature.
- ESP\_ERR\_INVALID\_ARG if one of the parameters is NULL
- ESP\_ERR\_HW\_CRYPTODS\_INVALID\_DIGEST if the message digest didn't match; the signature is invalid.
- ESP\_ERR\_HW\_CRYPTODS\_INVALID\_PADDING if the message padding is incorrect, the signature can be read though since the message digest matches.

*esp\_err\_t* **esp\_ds\_encrypt\_params** (*esp\_ds\_data\_t* \*data, const void \*iv, const *esp\_ds\_p\_data\_t* \*p\_data, const void \*key)

Encrypt the private key parameters.

#### Parameters

- **data** –Output buffer to store encrypted data, suitable for later use generating signatures. The allocated memory must be in internal memory and word aligned since it's filled by DMA. Both is asserted at run time.
- **iv** –Pointer to 16 byte IV buffer, will be copied into 'data'. Should be randomly generated bytes each time.
- **p\_data** –Pointer to input plaintext key data. The expectation is this data will be deleted after this process is done and 'data' is stored.
- **key** –Pointer to 32 bytes of key data. Type determined by `key_type` parameter. The expectation is the corresponding HMAC key will be stored to efuse and then permanently erased.

#### Returns

- ESP\_OK if successful, the ds operation has been finished and the result is written to signature.
- ESP\_ERR\_INVALID\_ARG if one of the parameters is NULL or `p_data->rsa_length` is too long

## Structures

struct **esp\_digital\_signature\_data**

Encrypted private key data. Recommended to store in flash in this format.

---

**Note:** This struct has to match to one from the ROM code! This documentation is mostly taken from there.

---

## Public Members

*esp\_digital\_signature\_length\_t* **rsa\_length**

RSA LENGTH register parameters (number of words in RSA key & operands, minus one).

Max value 127 (for RSA 4096).

This value must match the length field encrypted and stored in 'c', or invalid results will be returned. (The DS peripheral will always use the value in 'c', not this value, so an attacker can't alter the DS peripheral results this way, it will just truncate or extend the message and the resulting signature in software.)

---

**Note:** In IDF, the enum type length is the same as of type unsigned, so they can be used interchangeably. See the ROM code for the original declaration of struct `ets_ds_data_t`.

---

uint8\_t **iv**[ESP\_DS\_IV\_LEN]  
IV value used to encrypt 'c'

uint8\_t **c**[ESP\_DS\_C\_LEN]  
Encrypted Digital Signature parameters. Result of AES-CBC encryption of plaintext values. Includes an encrypted message digest.

struct **esp\_ds\_p\_data\_t**  
Plaintext parameters used by Digital Signature.  
Not used for signing with DS peripheral, but can be encrypted in-device by calling `esp_ds_encrypt_params()`

---

**Note:** This documentation is mostly taken from the ROM code.

---

### Public Members

uint32\_t **Y**[4096 / 32]  
RSA exponent.

uint32\_t **M**[4096 / 32]  
RSA modulus.

uint32\_t **Rb**[4096 / 32]  
RSA r inverse operand.

uint32\_t **M\_prime**  
RSA M prime operand.

*esp\_digital\_signature\_length\_t* **length**  
RSA length.

### Macros

**ESP\_ERR\_HW\_CRYPTODS\_HMAC\_FAIL**  
HMAC peripheral problem

**ESP\_ERR\_HW\_CRYPTODS\_INVALID\_KEY**  
given HMAC key isn't correct, HMAC peripheral problem

**ESP\_ERR\_HW\_CRYPTODS\_INVALID\_DIGEST**  
message digest check failed, result is invalid

**ESP\_ERR\_HW\_CRYPTODS\_INVALID\_PADDING**  
padding check failed, but result is produced anyway and can be read

**ESP\_DS\_IV\_LEN**

**ESP\_DS\_C\_LEN**

### Type Definitions

typedef struct esp\_ds\_context **esp\_ds\_context\_t**

typedef struct *esp\_digital\_signature\_data* **esp\_ds\_data\_t**

Encrypted private key data. Recommended to store in flash in this format.

---

**Note:** This struct has to match to one from the ROM code! This documentation is mostly taken from there.

---

### Enumerations

enum **esp\_digital\_signature\_length\_t**

*Values:*

enumerator **ESP\_DS\_RSA\_1024**

enumerator **ESP\_DS\_RSA\_2048**

enumerator **ESP\_DS\_RSA\_3072**

enumerator **ESP\_DS\_RSA\_4096**

## 2.5.11 Inter-Integrated Circuit (I2C)

### Overview

I2C is a serial, synchronous, half-duplex communication protocol that allows co-existence of multiple masters and slaves on the same bus. The I2C bus consists of two lines: serial data line (SDA) and serial clock (SCL). Both lines require pull-up resistors.

With such advantages as simplicity and low manufacturing cost, I2C is mostly used for communication of low-speed peripheral devices over short distances (within one foot).

ESP32-S2 has 2 I2C controller (also referred to as port), responsible for handling communications on the I2C bus. A single I2C controller can operate as master or slave.

### Driver Features

I2C driver governs communications of devices over the I2C bus. The driver supports the following features:

- Reading and writing bytes in Master mode
- Slave mode
- Reading and writing to registers which are in turn read/written by the master



## Driver Usage

The following sections describe typical steps of configuring and operating the I2C driver:

1. *Configuration* - set the initialization parameters (master or slave mode, GPIO pins for SDA and SCL, clock speed, etc.)
2. *Install Driver*- activate the driver on one of the two I2C controllers as a master or slave
3. Depending on whether you configure the driver for a master or slave, choose the appropriate item
  - a) *Communication as Master* - handle communications (master)
  - b) *Communication as Slave* - respond to messages from the master (slave)
4. *Interrupt Handling* - configure and service I2C interrupts
5. *Customized Configuration* - adjust default I2C communication parameters (timings, bit order, etc.)
6. *Error Handling* - how to recognize and handle driver configuration and communication errors
7. *Delete Driver*- release resources used by the I2C driver when communication ends

**Configuration** To establish I2C communication, start by configuring the driver. This is done by setting the parameters of the structure `i2c_config_t`:

- Set **I2C mode of operation** - master or slave from `i2c_mode_t`
- Configure **communication pins**
  - Assign GPIO pins for SDA and SCL signals
  - Set whether to enable ESP32-S2' s internal pull-ups
- (Master only) Set **I2C clock speed**
- (Slave only) Configure the following
  - Whether to enable **10 bit address mode**
  - Define **slave address**

After that, initialize the configuration for a given I2C port. For this, call the function `i2c_param_config()` and pass to it the port number and the structure `i2c_config_t`.

Configuration example (master):

```
int i2c_master_port = 0;
i2c_config_t conf = {
    .mode = I2C_MODE_MASTER,
    .sda_io_num = I2C_MASTER_SDA_IO,           // select GPIO specific to your
    ↪project
    .sda_pullup_en = GPIO_PULLUP_ENABLE,
    .scl_io_num = I2C_MASTER_SCL_IO,           // select GPIO specific to your
    ↪project
    .scl_pullup_en = GPIO_PULLUP_ENABLE,
    .master.clk_speed = I2C_MASTER_FREQ_HZ,    // select frequency specific to your
    ↪project
    .clk_flags = 0,                            // you can use I2C_SCLK_SRC_FLAG_*
    ↪flags to choose i2c source clock here
};
```

Configuration example (slave):

```
int i2c_slave_port = I2C_SLAVE_NUM;
i2c_config_t conf_slave = {
    .sda_io_num = I2C_SLAVE_SDA_IO,           // select GPIO specific to your
    ↪project
    .sda_pullup_en = GPIO_PULLUP_ENABLE,
    .scl_io_num = I2C_SLAVE_SCL_IO,           // select GPIO specific to your
    ↪project
    .scl_pullup_en = GPIO_PULLUP_ENABLE,
    .mode = I2C_MODE_SLAVE,
    .slave.addr_10bit_en = 0,
    .slave.slave_addr = ESP_SLAVE_ADDR,       // address of your project
};
```

(continues on next page)

(continued from previous page)

```
.clk_flags = 0,
};
```

At this stage, `i2c_param_config()` also sets a few other I2C configuration parameters to default values that are defined by the I2C specification. For more details on the values and how to modify them, see [Customized Configuration](#).

**Source Clock Configuration** **Clock sources allocator** is added for supporting different clock sources. The clock allocator will choose one clock source that meets all the requirements of frequency and capability (as requested in `i2c_config_t::clk_flags`).

When `i2c_config_t::clk_flags` is 0, the clock allocator will select only according to the desired frequency. If no special capabilities are needed, such as APB, you can configure the clock allocator to select the source clock only according to the desired frequency. For this, set `i2c_config_t::clk_flags` to 0. For clock characteristics, see the table below.

**Note:** A clock is not a valid option, if it doesn't meet the requested capabilities, i.e. any bit of requested capabilities (`clk_flags`) is 0 in the clock's capabilities.

Table 3: Characteristics of ESP32-S2 clock sources

Clock name	MAX freq for SCL frequency	Clock capabilities
APB0 clock	4 MHz	/
REF_TICK	100 kHz	<code>I2C_SCLK_SRC_FLAG_AWARE_DFS</code> , <code>I2C_SCLK_SRC_FLAG_LIGHT_SLEEP</code>

Explanations for `i2c_config_t::clk_flags` are as follows: 1. `I2C_SCLK_SRC_FLAG_AWARE_DFS`: Clock's baud rate will not change while APB clock is changing. 2. `I2C_SCLK_SRC_FLAG_LIGHT_SLEEP`: It supports Light-sleep mode, which APB clock cannot do.

Explanations for `i2c_config_t::clk_flags` are as follows:

1. `I2C_SCLK_SRC_FLAG_AWARE_DFS`: Clock's baud rate will not change while APB clock is changing.
2. `I2C_SCLK_SRC_FLAG_LIGHT_SLEEP`: It supports Light-sleep mode, which APB clock cannot do.
3. Some flags may not be supported on ESP32-S2, reading technical reference manual before using it.

**Note:** The clock frequency of SCL in master mode should not be larger than max frequency for SCL mentioned in the table above.

**Note:** The clock frequency of SCL will be influenced by the pull-up resistors and wire capacitance (or might slave capacitance) together. Therefore, users need to choose correct pull-up resistors by themselves to make the frequency accurate. It is recommended by I2C protocol that the pull-up resistors commonly range from 1KOhms to 10KOhms, but different frequencies need different resistors.

Generally speaking, the higher frequency is selected, the smaller resistor should be used (but not less than 1KOhms). This is because high resistor will decline the current, which will lengthen the rising time and reduce the frequency. Usually, range 2KOhms to 5KOhms is what we recommend, but users also might need to make some adjustment depends on their reality.

**Install Driver** After the I2C driver is configured, install it by calling the function `i2c_driver_install()` with the following parameters:

- Port number, one of the two port numbers from `i2c_port_t`
- master or slave, selected from `i2c_mode_t`
- (Slave only) Size of buffers to allocate for sending and receiving data. As I2C is a master-centric bus, data can only go from the slave to the master at the master's request. Therefore, the slave will usually have a send buffer where the slave application writes data. The data remains in the send buffer to be read by the master at the master's own discretion.
- Flags for allocating the interrupt (see `ESP_INTR_FLAG_*` values in `esp_hw_support/include/esp_intr_alloc.h`)

**Communication as Master** After installing the I2C driver, ESP32-S2 is ready to communicate with other I2C devices.

ESP32-S2's I2C controller operating as master is responsible for establishing communication with I2C slave devices and sending commands to trigger a slave to action, for example, to take a measurement and send the readings back to the master.

For better process organization, the driver provides a container, called a “command link”, that should be populated with a sequence of commands and then passed to the I2C controller for execution.

**Master Write** The example below shows how to build a command link for an I2C master to send  $n$  bytes to a slave.

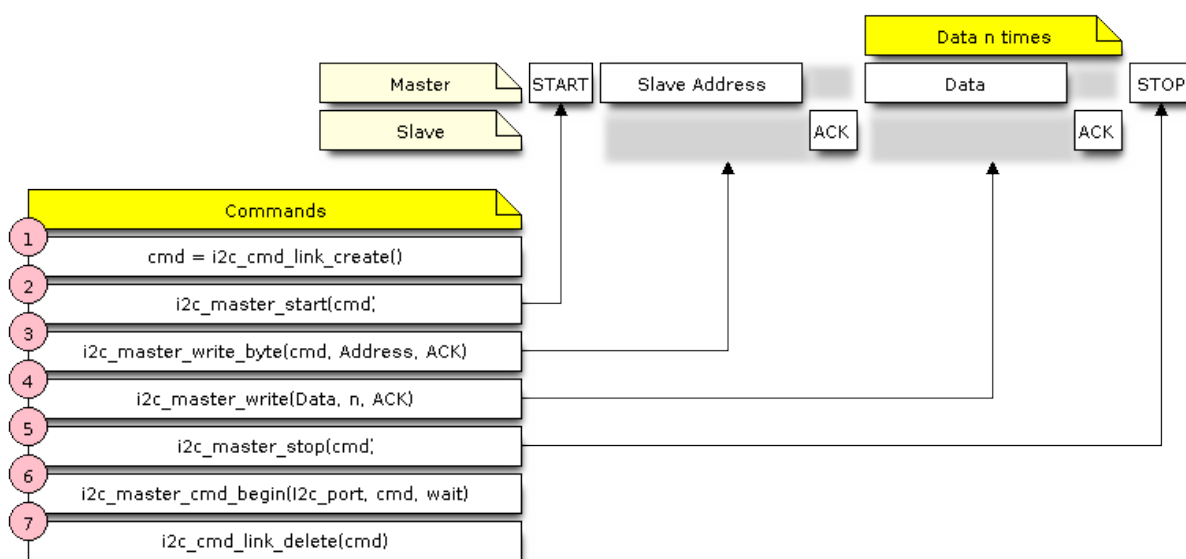

Fig. 4: I2C command link - master write example

The following describes how a command link for a “master write” is set up and what comes inside:

1. Create a command link with `i2c_cmd_link_create()`.  
Then, populate it with the series of data to be sent to the slave:
  - a) **Start bit** - `i2c_master_start()`
  - b) **Slave address** - `i2c_master_write_byte()`. The single byte address is provided as an argument of this function call.
  - c) **Data** - One or more bytes as an argument of `i2c_master_write()`
  - d) **Stop bit** - `i2c_master_stop()`
Both functions `i2c_master_write_byte()` and `i2c_master_write()` have an additional argument specifying whether the master should ensure that it has received the ACK bit.
2. Trigger the execution of the command link by I2C controller by calling `i2c_master_cmd_begin()`. Once the execution is triggered, the command link cannot be modified.

- After the commands are transmitted, release the resources used by the command link by calling `i2c_cmd_link_delete()`.

**Master Read** The example below shows how to build a command link for an I2C master to read  $n$  bytes from a slave.

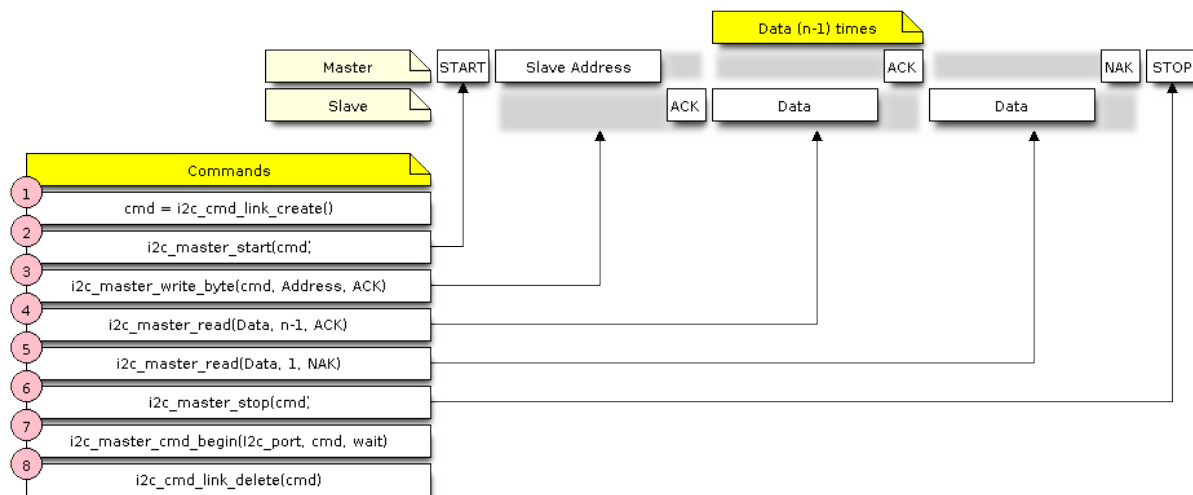

Fig. 5: I2C command link - master read example

Compared to writing data, the command link is populated in Step 4 not with `i2c_master_write...` functions but with `i2c_master_read_byte()` and / or `i2c_master_read()`. Also, the last read in Step 5 is configured so that the master does not provide the ACK bit.

**Indicating Write or Read** After sending a slave address (see Step 3 on both diagrams above), the master either writes or reads from the slave.

The information on what the master will actually do is hidden in the least significant bit of the slave's address.

For this reason, the command link sent by the master to write data to the slave contains the address  $(ESP\_SLAVE\_ADDR \ll 1) | I2C\_MASTER\_WRITE$  and looks as follows:

```
i2c_master_write_byte(cmd, (ESP_SLAVE_ADDR << 1) | I2C_MASTER_WRITE, ACK_EN);
```

Likewise, the command link to read from the slave looks as follows:

```
i2c_master_write_byte(cmd, (ESP_SLAVE_ADDR << 1) | I2C_MASTER_READ, ACK_EN);
```

**Communication as Slave** After installing the I2C driver, ESP32-S2 is ready to communicate with other I2C devices.

The API provides the following functions for slaves

- `i2c_slave_read_buffer()`  
Whenever the master writes data to the slave, the slave will automatically store it in the receive buffer. This allows the slave application to call the function `i2c_slave_read_buffer()` at its own discretion. This function also has a parameter to specify block time if no data is in the receive buffer. This will allow the slave application to wait with a specified timeout for data to arrive to the buffer.
- `i2c_slave_write_buffer()`  
The send buffer is used to store all the data that the slave wants to send to the master in FIFO order. The data stays there until the master requests for it. The function `i2c_slave_write_buffer()` has a parameter to specify block time if the send buffer is

full. This will allow the slave application to wait with a specified timeout for the adequate amount of space to become available in the send buffer.

A code example showing how to use these functions can be found in [peripherals/i2c](#).

**Interrupt Handling** During driver installation, an interrupt handler is installed by default.

**Customized Configuration** As mentioned at the end of Section [Configuration](#), when the function `i2c_param_config()` initializes the driver configuration for an I2C port, it also sets several I2C communication parameters to default values defined in the I2C specification. Some other related parameters are pre-configured in registers of the I2C controller.

All these parameters can be changed to user-defined values by calling dedicated functions given in the table below. Please note that the timing values are defined in APB clock cycles. The frequency of APB is specified in `I2C_APB_CLK_FREQ`.

Table 4: Other Configurable I2C Communication Parameters

Parameters to Change	Function
High time and low time for SCL pulses	<code>i2c_set_period()</code>
SCL and SDA signal timing used during generation of <b>start</b> signals	<code>i2c_set_start_timing()</code>
SCL and SDA signal timing used during generation of <b>stop</b> signals	<code>i2c_set_stop_timing()</code>
Timing relationship between SCL and SDA signals when slave samples, as well as when master toggles	<code>i2c_set_data_timing()</code>
I2C timeout	<code>i2c_set_timeout()</code>
Choice between transmitting / receiving the LSB or MSB first, choose one of the modes defined in <code>i2c_trans_mode_t</code>	<code>i2c_set_data_mode()</code>

Each of the above functions has a `_get_` counterpart to check the currently set value. For example, to check the I2C timeout value, call `i2c_get_timeout()`.

To check the default parameter values which are set during the driver configuration process, please refer to the file [driver/i2c.c](#) and look for defines with the suffix `_DEFAULT`.

You can also select different pins for SDA and SCL signals and alter the configuration of pull-ups with the function `i2c_set_pin()`. If you want to modify already entered values, use the function `i2c_param_config()`.

---

**Note:** ESP32-S2's internal pull-ups are in the range of tens of kOhm, which is, in most cases, insufficient for use as I2C pull-ups. Users are advised to use external pull-ups with values described in the I2C specification. For help with calculating the resistor values see [TI Application Note](#)

---

**Error Handling** The majority of I2C driver functions either return `ESP_OK` on successful completion or a specific error code on failure. It is a good practice to always check the returned values and implement error handling. The driver also prints out log messages that contain error details, e.g., when checking the validity of entered configuration. For details please refer to the file [driver/i2c.c](#) and look for defines with the suffix `_ERR_STR`.

Use dedicated interrupts to capture communication failures. For instance, if a slave stretches the clock for too long while preparing the data to send back to master, the interrupt `I2C_TIME_OUT_INT` will be triggered. For detailed information, see [Interrupt Handling](#).

In case of a communication failure, you can reset the internal hardware buffers by calling the functions `i2c_reset_tx_fifo()` and `i2c_reset_rx_fifo()` for the send and receive buffers respectively.

**Delete Driver** When the I2C communication is established with the function `i2c_driver_install()` and is not required for some substantial amount of time, the driver may be deinitialized to release allocated resources by calling `i2c_driver_delete()`.

Before calling `i2c_driver_delete()` to remove i2c driver, please make sure that all threads have stopped using the driver in any way, because this function does not guarantee thread safety.

### Application Example

I2C examples: [peripherals/i2c](#).

### API Reference

#### Header File

- [components/driver/include/driver/i2c.h](#)

#### Functions

`esp_err_t i2c_driver_install(i2c_port_t i2c_num, i2c_mode_t mode, size_t slv_rx_buf_len, size_t slv_tx_buf_len, int intr_alloc_flags)`

Install an I2C driver.

---

**Note:** Not all Espressif chips can support slave mode (e.g. ESP32C2)

---

---

**Note:** In master mode, if the cache is likely to be disabled (such as write flash) and the slave is time-sensitive, `ESP_INTR_FLAG_IRAM` is suggested to be used. In this case, please use the memory allocated from internal RAM in i2c read and write function, because we can not access the psram (if psram is enabled) in interrupt handle function when cache is disabled.

---

#### Parameters

- **i2c\_num** – I2C port number
- **mode** – I2C mode (either master or slave).
- **slv\_rx\_buf\_len** – Receiving buffer size. Only slave mode will use this value, it is ignored in master mode.
- **slv\_tx\_buf\_len** – Sending buffer size. Only slave mode will use this value, it is ignored in master mode.
- **intr\_alloc\_flags** – Flags used to allocate the interrupt. One or multiple (ORred) `ESP_INTR_FLAG_*` values. See `esp_intr_alloc.h` for more info.

#### Returns

- `ESP_OK` Success
- `ESP_ERR_INVALID_ARG` Parameter error
- `ESP_FAIL` Driver installation error

`esp_err_t i2c_driver_delete(i2c_port_t i2c_num)`

Delete I2C driver.

---

**Note:** This function does not guarantee thread safety. Please make sure that no thread will continuously hold semaphores before calling the delete function.

---

**Parameters** **i2c\_num** – I2C port to delete

#### Returns

- `ESP_OK` Success
- `ESP_ERR_INVALID_ARG` Parameter error

*esp\_err\_t* **i2c\_param\_config** (*i2c\_port\_t* i2c\_num, const *i2c\_config\_t* \*i2c\_conf)

Configure an I2C bus with the given configuration.

**Parameters**

- **i2c\_num** –I2C port to configure
- **i2c\_conf** –Pointer to the I2C configuration

**Returns**

- ESP\_OK Success
- ESP\_ERR\_INVALID\_ARG Parameter error

*esp\_err\_t* **i2c\_reset\_tx\_fifo** (*i2c\_port\_t* i2c\_num)

reset I2C tx hardware fifo

**Parameters** **i2c\_num** –I2C port number

**Returns**

- ESP\_OK Success
- ESP\_ERR\_INVALID\_ARG Parameter error

*esp\_err\_t* **i2c\_reset\_rx\_fifo** (*i2c\_port\_t* i2c\_num)

reset I2C rx fifo

**Parameters** **i2c\_num** –I2C port number

**Returns**

- ESP\_OK Success
- ESP\_ERR\_INVALID\_ARG Parameter error

*esp\_err\_t* **i2c\_set\_pin** (*i2c\_port\_t* i2c\_num, int sda\_io\_num, int scl\_io\_num, bool sda\_pullup\_en, bool scl\_pullup\_en, *i2c\_mode\_t* mode)

Configure GPIO pins for I2C SCK and SDA signals.

**Parameters**

- **i2c\_num** –I2C port number
- **sda\_io\_num** –GPIO number for I2C SDA signal
- **scl\_io\_num** –GPIO number for I2C SCL signal
- **sda\_pullup\_en** –Enable the internal pullup for SDA pin
- **scl\_pullup\_en** –Enable the internal pullup for SCL pin
- **mode** –I2C mode

**Returns**

- ESP\_OK Success
- ESP\_ERR\_INVALID\_ARG Parameter error

*esp\_err\_t* **i2c\_master\_write\_to\_device** (*i2c\_port\_t* i2c\_num, uint8\_t device\_address, const uint8\_t \*write\_buffer, size\_t write\_size, TickType\_t ticks\_to\_wait)

Perform a write to a device connected to a particular I2C port. This function is a wrapper to `i2c_master_start()`, `i2c_master_write()`, `i2c_master_read()`, etc...It shall only be called in I2C master mode.

**Parameters**

- **i2c\_num** –I2C port number to perform the transfer on
- **device\_address** –I2C device's 7-bit address
- **write\_buffer** –Bytes to send on the bus
- **write\_size** –Size, in bytes, of the write buffer
- **ticks\_to\_wait** –Maximum ticks to wait before issuing a timeout.

**Returns**

- ESP\_OK Success
- ESP\_ERR\_INVALID\_ARG Parameter error
- ESP\_FAIL Sending command error, slave hasn't ACK the transfer.
- ESP\_ERR\_INVALID\_STATE I2C driver not installed or not in master mode.
- ESP\_ERR\_TIMEOUT Operation timeout because the bus is busy.

*esp\_err\_t* **i2c\_master\_read\_from\_device** (*i2c\_port\_t* i2c\_num, uint8\_t device\_address, uint8\_t \*read\_buffer, size\_t read\_size, TickType\_t ticks\_to\_wait)



Perform a read to a device connected to a particular I2C port. This function is a wrapper to `i2c_master_start()`, `i2c_master_write()`, `i2c_master_read()`, etc...It shall only be called in I2C master mode.

**Parameters**

- **i2c\_num** –I2C port number to perform the transfer on
- **device\_address** –I2C device's 7-bit address
- **read\_buffer** –Buffer to store the bytes received on the bus
- **read\_size** –Size, in bytes, of the read buffer
- **ticks\_to\_wait** –Maximum ticks to wait before issuing a timeout.

**Returns**

- `ESP_OK` Success
- `ESP_ERR_INVALID_ARG` Parameter error
- `ESP_FAIL` Sending command error, slave hasn't ACK the transfer.
- `ESP_ERR_INVALID_STATE` I2C driver not installed or not in master mode.
- `ESP_ERR_TIMEOUT` Operation timeout because the bus is busy.

`esp_err_t i2c_master_write_read_device(i2c_port_t i2c_num, uint8_t device_address, const uint8_t *write_buffer, size_t write_size, uint8_t *read_buffer, size_t read_size, TickType_t ticks_to_wait)`

Perform a write followed by a read to a device on the I2C bus. A repeated start signal is used between the write and read, thus, the bus is not released until the two transactions are finished. This function is a wrapper to `i2c_master_start()`, `i2c_master_write()`, `i2c_master_read()`, etc...It shall only be called in I2C master mode.

**Parameters**

- **i2c\_num** –I2C port number to perform the transfer on
- **device\_address** –I2C device's 7-bit address
- **write\_buffer** –Bytes to send on the bus
- **write\_size** –Size, in bytes, of the write buffer
- **read\_buffer** –Buffer to store the bytes received on the bus
- **read\_size** –Size, in bytes, of the read buffer
- **ticks\_to\_wait** –Maximum ticks to wait before issuing a timeout.

**Returns**

- `ESP_OK` Success
- `ESP_ERR_INVALID_ARG` Parameter error
- `ESP_FAIL` Sending command error, slave hasn't ACK the transfer.
- `ESP_ERR_INVALID_STATE` I2C driver not installed or not in master mode.
- `ESP_ERR_TIMEOUT` Operation timeout because the bus is busy.

`i2c_cmd_handle_t i2c_cmd_link_create_static(uint8_t *buffer, uint32_t size)`

Create and initialize an I2C commands list with a given buffer. All the allocations for data or signals (START, STOP, ACK, ...) will be performed within this buffer. This buffer must be valid during the whole transaction. After finishing the I2C transactions, it is required to call `i2c_cmd_link_delete_static()`.

---

**Note:** It is **highly** advised to not allocate this buffer on the stack. The size of the data used underneath may increase in the future, resulting in a possible stack overflow as the macro `I2C_LINK_RECOMMENDED_SIZE` would also return a bigger value. A better option is to use a buffer allocated statically or dynamically (with `malloc`).

---

**Parameters**

- **buffer** –Buffer to use for commands allocations
- **size** –Size in bytes of the buffer

**Returns** Handle to the I2C command link or NULL if the buffer provided is too small, please use `I2C_LINK_RECOMMENDED_SIZE` macro to get the recommended size for the buffer.



***i2c\_cmd\_handle\_t* i2c\_cmd\_link\_create**(void)

Create and initialize an I2C commands list with a given buffer. After finishing the I2C transactions, it is required to call `i2c_cmd_link_delete()` to release and return the resources. The required bytes will be dynamically allocated.

**Returns** Handle to the I2C command link or NULL in case of insufficient dynamic memory.

**void i2c\_cmd\_link\_delete\_static**(*i2c\_cmd\_handle\_t* cmd\_handle)

Free the I2C commands list allocated statically with `i2c_cmd_link_create_static`.

**Parameters** **cmd\_handle** –I2C commands list allocated statically. This handle should be created thanks to `i2c_cmd_link_create_static()` function

**void i2c\_cmd\_link\_delete**(*i2c\_cmd\_handle\_t* cmd\_handle)

Free the I2C commands list.

**Parameters** **cmd\_handle** –I2C commands list. This handle should be created thanks to `i2c_cmd_link_create()` function

***esp\_err\_t* i2c\_master\_start**(*i2c\_cmd\_handle\_t* cmd\_handle)

Queue a “START signal” to the given commands list. This function shall only be called in I2C master mode. Call `i2c_master_cmd_begin()` to send all the queued commands.

**Parameters** **cmd\_handle** –I2C commands list

**Returns**

- ESP\_OK Success
- ESP\_ERR\_INVALID\_ARG Parameter error
- ESP\_ERR\_NO\_MEM The static buffer used to create `cmd_handler` is too small
- ESP\_FAIL No more memory left on the heap

***esp\_err\_t* i2c\_master\_write\_byte**(*i2c\_cmd\_handle\_t* cmd\_handle, uint8\_t data, bool ack\_en)

Queue a “write byte” command to the commands list. A single byte will be sent on the I2C port. This function shall only be called in I2C master mode. Call `i2c_master_cmd_begin()` to send all queued commands.

**Parameters**

- **cmd\_handle** –I2C commands list
- **data** –Byte to send on the port
- **ack\_en** –Enable ACK signal

**Returns**

- ESP\_OK Success
- ESP\_ERR\_INVALID\_ARG Parameter error
- ESP\_ERR\_NO\_MEM The static buffer used to create `cmd_handler` is too small
- ESP\_FAIL No more memory left on the heap

***esp\_err\_t* i2c\_master\_write**(*i2c\_cmd\_handle\_t* cmd\_handle, const uint8\_t \*data, size\_t data\_len, bool ack\_en)

Queue a “write (multiple) bytes” command to the commands list. This function shall only be called in I2C master mode. Call `i2c_master_cmd_begin()` to send all queued commands.

**Parameters**

- **cmd\_handle** –I2C commands list
- **data** –Bytes to send. This buffer shall remain **valid** until the transaction is finished. If the PSRAM is enabled and `intr_flag` is set to `ESP_INTR_FLAG_IRAM`, `data` should be allocated from internal RAM.
- **data\_len** –Length, in bytes, of the data buffer
- **ack\_en** –Enable ACK signal

**Returns**

- ESP\_OK Success
- ESP\_ERR\_INVALID\_ARG Parameter error
- ESP\_ERR\_NO\_MEM The static buffer used to create `cmd_handler` is too small
- ESP\_FAIL No more memory left on the heap

*esp\_err\_t* **i2c\_master\_read\_byte** (*i2c\_cmd\_handle\_t* cmd\_handle, uint8\_t \*data, *i2c\_ack\_type\_t* ack)

Queue a “read byte” command to the commands list. A single byte will be read on the I2C bus. This function shall only be called in I2C master mode. Call `i2c_master_cmd_begin()` to send all queued commands.

#### Parameters

- **cmd\_handle** –I2C commands list
- **data** –Pointer where the received byte will be stored. This buffer shall remain **valid** until the transaction is finished.
- **ack** –ACK signal

#### Returns

- ESP\_OK Success
- ESP\_ERR\_INVALID\_ARG Parameter error
- ESP\_ERR\_NO\_MEM The static buffer used to create `cmd_handler` is too small
- ESP\_FAIL No more memory left on the heap

*esp\_err\_t* **i2c\_master\_read** (*i2c\_cmd\_handle\_t* cmd\_handle, uint8\_t \*data, size\_t data\_len, *i2c\_ack\_type\_t* ack)

Queue a “read (multiple) bytes” command to the commands list. Multiple bytes will be read on the I2C bus. This function shall only be called in I2C master mode. Call `i2c_master_cmd_begin()` to send all queued commands.

#### Parameters

- **cmd\_handle** –I2C commands list
- **data** –Pointer where the received bytes will be stored. This buffer shall remain **valid** until the transaction is finished.
- **data\_len** –Size, in bytes, of the `data` buffer
- **ack** –ACK signal

#### Returns

- ESP\_OK Success
- ESP\_ERR\_INVALID\_ARG Parameter error
- ESP\_ERR\_NO\_MEM The static buffer used to create `cmd_handler` is too small
- ESP\_FAIL No more memory left on the heap

*esp\_err\_t* **i2c\_master\_stop** (*i2c\_cmd\_handle\_t* cmd\_handle)

Queue a “STOP signal” to the given commands list. This function shall only be called in I2C master mode. Call `i2c_master_cmd_begin()` to send all the queued commands.

**Parameters** **cmd\_handle** –I2C commands list

#### Returns

- ESP\_OK Success
- ESP\_ERR\_INVALID\_ARG Parameter error
- ESP\_ERR\_NO\_MEM The static buffer used to create `cmd_handler` is too small
- ESP\_FAIL No more memory left on the heap

*esp\_err\_t* **i2c\_master\_cmd\_begin** (*i2c\_port\_t* i2c\_num, *i2c\_cmd\_handle\_t* cmd\_handle, TickType\_t ticks\_to\_wait)

Send all the queued commands on the I2C bus, in master mode. The task will be blocked until all the commands have been sent out. The I2C port is protected by mutex, so this function is thread-safe. This function shall only be called in I2C master mode.

#### Parameters

- **i2c\_num** –I2C port number
- **cmd\_handle** –I2C commands list
- **ticks\_to\_wait** –Maximum ticks to wait before issuing a timeout.

#### Returns

- ESP\_OK Success
- ESP\_ERR\_INVALID\_ARG Parameter error
- ESP\_FAIL Sending command error, slave hasn't ACK the transfer.
- ESP\_ERR\_INVALID\_STATE I2C driver not installed or not in master mode.
- ESP\_ERR\_TIMEOUT Operation timeout because the bus is busy.

int **i2c\_slave\_write\_buffer** (*i2c\_port\_t* i2c\_num, const uint8\_t \*data, int size, TickType\_t ticks\_to\_wait)

Write bytes to internal ringbuffer of the I2C slave data. When the TX fifo empty, the ISR will fill the hardware FIFO with the internal ringbuffer's data.

---

**Note:** This function shall only be called in I2C slave mode.

---

#### Parameters

- **i2c\_num** –I2C port number
- **data** –Bytes to write into internal buffer
- **size** –Size, in bytes, of data buffer
- **ticks\_to\_wait** –Maximum ticks to wait.

#### Returns

- ESP\_FAIL (-1) Parameter error
- Other (>=0) The number of data bytes pushed to the I2C slave buffer.

int **i2c\_slave\_read\_buffer** (*i2c\_port\_t* i2c\_num, uint8\_t \*data, size\_t max\_size, TickType\_t ticks\_to\_wait)

Read bytes from I2C internal buffer. When the I2C bus receives data, the ISR will copy them from the hardware RX FIFO to the internal ringbuffer. Calling this function will then copy bytes from the internal ringbuffer to the data user buffer.

---

**Note:** This function shall only be called in I2C slave mode.

---

#### Parameters

- **i2c\_num** –I2C port number
- **data** –Buffer to fill with ringbuffer's bytes
- **max\_size** –Maximum bytes to read
- **ticks\_to\_wait** –Maximum waiting ticks

#### Returns

- ESP\_FAIL(-1) Parameter error
- Others(>=0) The number of data bytes read from I2C slave buffer.

*esp\_err\_t* **i2c\_set\_period** (*i2c\_port\_t* i2c\_num, int high\_period, int low\_period)

Set I2C master clock period.

#### Parameters

- **i2c\_num** –I2C port number
- **high\_period** –Clock cycle number during SCL is high level, high\_period is a 14 bit value
- **low\_period** –Clock cycle number during SCL is low level, low\_period is a 14 bit value

#### Returns

- ESP\_OK Success
- ESP\_ERR\_INVALID\_ARG Parameter error

*esp\_err\_t* **i2c\_get\_period** (*i2c\_port\_t* i2c\_num, int \*high\_period, int \*low\_period)

Get I2C master clock period.

#### Parameters

- **i2c\_num** –I2C port number
- **high\_period** –pointer to get clock cycle number during SCL is high level, will get a 14 bit value
- **low\_period** –pointer to get clock cycle number during SCL is low level, will get a 14 bit value

#### Returns

- ESP\_OK Success
- ESP\_ERR\_INVALID\_ARG Parameter error

*esp\_err\_t* **i2c\_filter\_enable** (*i2c\_port\_t* i2c\_num, uint8\_t cyc\_num)

Enable hardware filter on I2C bus Sometimes the I2C bus is disturbed by high frequency noise(about 20ns), or the rising edge of the SCL clock is very slow, these may cause the master state machine to break. Enable hardware filter can filter out high frequency interference and make the master more stable.

---

**Note:** Enable filter will slow down the SCL clock.

---

**Parameters**

- **i2c\_num** –I2C port number to filter
- **cyc\_num** –the APB cycles need to be filtered (0<= cyc\_num <=7). When the period of a pulse is less than cyc\_num \* APB\_cycle, the I2C controller will ignore this pulse.

**Returns**

- ESP\_OK Success
- ESP\_ERR\_INVALID\_ARG Parameter error

*esp\_err\_t* **i2c\_filter\_disable** (*i2c\_port\_t* i2c\_num)

Disable filter on I2C bus.

**Parameters** **i2c\_num** –I2C port number

**Returns**

- ESP\_OK Success
- ESP\_ERR\_INVALID\_ARG Parameter error

*esp\_err\_t* **i2c\_set\_start\_timing** (*i2c\_port\_t* i2c\_num, int setup\_time, int hold\_time)

set I2C master start signal timing

**Parameters**

- **i2c\_num** –I2C port number
- **setup\_time** –clock number between the falling-edge of SDA and rising-edge of SCL for start mark, it' s a 10-bit value.
- **hold\_time** –clock num between the falling-edge of SDA and falling-edge of SCL for start mark, it' s a 10-bit value.

**Returns**

- ESP\_OK Success
- ESP\_ERR\_INVALID\_ARG Parameter error

*esp\_err\_t* **i2c\_get\_start\_timing** (*i2c\_port\_t* i2c\_num, int \*setup\_time, int \*hold\_time)

get I2C master start signal timing

**Parameters**

- **i2c\_num** –I2C port number
- **setup\_time** –pointer to get setup time
- **hold\_time** –pointer to get hold time

**Returns**

- ESP\_OK Success
- ESP\_ERR\_INVALID\_ARG Parameter error

*esp\_err\_t* **i2c\_set\_stop\_timing** (*i2c\_port\_t* i2c\_num, int setup\_time, int hold\_time)

set I2C master stop signal timing

**Parameters**

- **i2c\_num** –I2C port number
- **setup\_time** –clock num between the rising-edge of SCL and the rising-edge of SDA, it' s a 10-bit value.
- **hold\_time** –clock number after the STOP bit' s rising-edge, it' s a 14-bit value.

**Returns**

- ESP\_OK Success
- ESP\_ERR\_INVALID\_ARG Parameter error

*esp\_err\_t* **i2c\_get\_stop\_timing** (*i2c\_port\_t* i2c\_num, int \*setup\_time, int \*hold\_time)

get I2C master stop signal timing

**Parameters**

- **i2c\_num** –I2C port number
- **setup\_time** –pointer to get setup time.
- **hold\_time** –pointer to get hold time.

**Returns**

- ESP\_OK Success
- ESP\_ERR\_INVALID\_ARG Parameter error

*esp\_err\_t* **i2c\_set\_data\_timing** (*i2c\_port\_t* i2c\_num, int sample\_time, int hold\_time)

set I2C data signal timing

**Parameters**

- **i2c\_num** –I2C port number
- **sample\_time** –clock number I2C used to sample data on SDA after the rising-edge of SCL, it's a 10-bit value
- **hold\_time** –clock number I2C used to hold the data after the falling-edge of SCL, it's a 10-bit value

**Returns**

- ESP\_OK Success
- ESP\_ERR\_INVALID\_ARG Parameter error

*esp\_err\_t* **i2c\_get\_data\_timing** (*i2c\_port\_t* i2c\_num, int \*sample\_time, int \*hold\_time)

get I2C data signal timing

**Parameters**

- **i2c\_num** –I2C port number
- **sample\_time** –pointer to get sample time
- **hold\_time** –pointer to get hold time

**Returns**

- ESP\_OK Success
- ESP\_ERR\_INVALID\_ARG Parameter error

*esp\_err\_t* **i2c\_set\_timeout** (*i2c\_port\_t* i2c\_num, int timeout)

set I2C timeout value

**Parameters**

- **i2c\_num** –I2C port number
- **timeout** –timeout value for I2C bus (unit: APB 80Mhz clock cycle)

**Returns**

- ESP\_OK Success
- ESP\_ERR\_INVALID\_ARG Parameter error

*esp\_err\_t* **i2c\_get\_timeout** (*i2c\_port\_t* i2c\_num, int \*timeout)

get I2C timeout value

**Parameters**

- **i2c\_num** –I2C port number
- **timeout** –pointer to get timeout value

**Returns**

- ESP\_OK Success
- ESP\_ERR\_INVALID\_ARG Parameter error

*esp\_err\_t* **i2c\_set\_data\_mode** (*i2c\_port\_t* i2c\_num, *i2c\_trans\_mode\_t* tx\_trans\_mode, *i2c\_trans\_mode\_t* rx\_trans\_mode)

set I2C data transfer mode

**Parameters**

- **i2c\_num** –I2C port number
- **tx\_trans\_mode** –I2C sending data mode

- **rx\_trans\_mode** –I2C receiving data mode

**Returns**

- ESP\_OK Success
- ESP\_ERR\_INVALID\_ARG Parameter error

*esp\_err\_t* **i2c\_get\_data\_mode** (*i2c\_port\_t* i2c\_num, *i2c\_trans\_mode\_t* \*tx\_trans\_mode, *i2c\_trans\_mode\_t* \*rx\_trans\_mode)

get I2C data transfer mode

**Parameters**

- **i2c\_num** –I2C port number
- **tx\_trans\_mode** –pointer to get I2C sending data mode
- **rx\_trans\_mode** –pointer to get I2C receiving data mode

**Returns**

- ESP\_OK Success
- ESP\_ERR\_INVALID\_ARG Parameter error

**Structures**

struct **i2c\_config\_t**

I2C initialization parameters.

**Public Members**

*i2c\_mode\_t* **mode**

I2C mode

int **sda\_io\_num**

GPIO number for I2C sda signal

int **scl\_io\_num**

GPIO number for I2C scl signal

bool **sda\_pullup\_en**

Internal GPIO pull mode for I2C sda signal

bool **scl\_pullup\_en**

Internal GPIO pull mode for I2C scl signal

uint32\_t **clk\_speed**

I2C clock frequency for master mode, (no higher than 1MHz for now)

struct *i2c\_config\_t*::[anonymous]::[anonymous] **master**

I2C master config

uint8\_t **addr\_10bit\_en**

I2C 10bit address mode enable for slave mode

uint16\_t **slave\_addr**

I2C address for slave mode

uint32\_t **maximum\_speed**

I2C expected clock speed from SCL.

struct *i2c\_config\_t*::[anonymous]::[anonymous] **slave**

I2C slave config

uint32\_t **clk\_flags**

Bitwise of I2C\_SCLK\_SRC\_FLAG\_\*\*FOR\_DFS\*\* for clk source choice

## Macros

**I2C\_APB\_CLK\_FREQ**

I2C source clock is APB clock, 80MHz

**I2C\_NUM\_MAX**

I2C port max

**I2C\_NUM\_0**

I2C port 0

**I2C\_NUM\_1**

I2C port 1

**I2C\_SCLK\_SRC\_FLAG\_FOR\_NOMAL**

Any one clock source that is available for the specified frequency may be chosen

**I2C\_SCLK\_SRC\_FLAG\_AWARE\_DFS**

For REF tick clock, it won't change with APB.

**I2C\_SCLK\_SRC\_FLAG\_LIGHT\_SLEEP**

For light sleep mode.

**I2C\_INTERNAL\_STRUCT\_SIZE**

Minimum size, in bytes, of the internal private structure used to describe I2C commands link.

**I2C\_LINK\_RECOMMENDED\_SIZE** (TRANSACTIONS)

The following macro is used to determine the recommended size of the buffer to pass to `i2c_cmd_link_create_static()` function. It requires one parameter, `TRANSACTIONS`, describing the number of transactions intended to be performed on the I2C port. For example, if one wants to perform a read on an I2C device register, `TRANSACTIONS` must be at least 2, because the commands required are the following:

- write device register
- read register content

Signals such as “(repeated) start”, “stop”, “nack”, “ack” shall not be counted.

## Type Definitions

typedef void \***i2c\_cmd\_handle\_t**

I2C command handle

## Header File

- [components/hal/include/hal/i2c\\_types.h](#)

## Type Definitions

typedef int **i2c\_port\_t**

I2C port number, can be I2C\_NUM\_0 ~ (I2C\_NUM\_MAX-1).

typedef *soc\_periph\_i2c\_clk\_src\_t* **i2c\_clock\_source\_t**

I2C group clock source.

## Enumerations

enum **i2c\_mode\_t**

*Values:*

enumerator **I2C\_MODE\_SLAVE**

I2C slave mode

enumerator **I2C\_MODE\_MASTER**

I2C master mode

enumerator **I2C\_MODE\_MAX**

enum **i2c\_rw\_t**

*Values:*

enumerator **I2C\_MASTER\_WRITE**

I2C write data

enumerator **I2C\_MASTER\_READ**

I2C read data

enum **i2c\_trans\_mode\_t**

*Values:*

enumerator **I2C\_DATA\_MODE\_MSB\_FIRST**

I2C data msb first

enumerator **I2C\_DATA\_MODE\_LSB\_FIRST**

I2C data lsb first

enumerator **I2C\_DATA\_MODE\_MAX**

enum **i2c\_addr\_mode\_t**

*Values:*

enumerator **I2C\_ADDR\_BIT\_7**

I2C 7bit address for slave mode



enumerator **I2C\_ADDR\_BIT\_10**  
I2C 10bit address for slave mode

enumerator **I2C\_ADDR\_BIT\_MAX**

enum **i2c\_ack\_type\_t**

*Values:*

enumerator **I2C\_MASTER\_ACK**  
I2C ack for each byte read

enumerator **I2C\_MASTER\_NACK**  
I2C nack for each byte read

enumerator **I2C\_MASTER\_LAST\_NACK**  
I2C nack for the last byte

enumerator **I2C\_MASTER\_ACK\_MAX**

## 2.5.12 Inter-IC Sound (I2S)

### Introduction

I2S (Inter-IC Sound) is a synchronous serial communication protocol usually used for transmitting audio data between two digital audio devices.

ESP32-S2 contains one I2S peripheral(s). These peripherals can be configured to input and output sample data via the I2S driver.

An I2S bus that communicates in standard or TDM mode consists of the following lines:

- **MCLK:** Master clock line. It is an optional signal depending on the slave side, mainly used for offering a reference clock to the I2S slave device.
- **BCLK:** Bit clock line. The bit clock for data line.
- **WS:** Word (Slot) select line. It is usually used to identify the vocal tract except PDM mode.
- **DIN/DOUT:** Serial data input/output line. Data will loopback internally if DIN and DOUT are set to a same GPIO.

Each I2S controller has the following features that can be configured by the I2S driver:

- Operation as system master or slave
- Capable of acting as transmitter or receiver
- DMA controller that allows stream sampling of data without requiring the CPU to copy each data sample

Each controller supports single RX or TX simplex communication. As RX and TX channels share a clock, they can only be combined with the same configuration to establish a full-duplex communication.

### I2S File Structure

**Public headers that need to be included in the I2S application are as follows:**

- `i2s.h`: The header file that provides legacy I2S APIs (for apps using legacy driver).

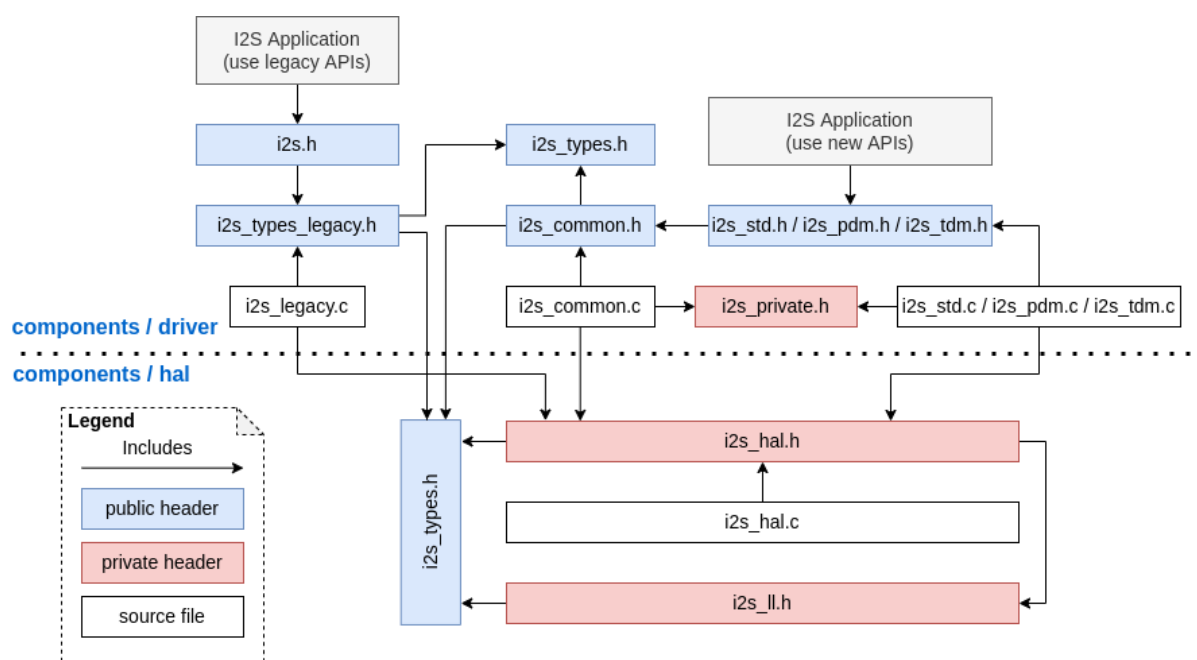

Fig. 6: I2S File Structure

- `i2s_std.h`: The header file that provides standard communication mode specific APIs (for apps using new driver with standard mode).
- `i2s_pdm.h`: The header file that provides PDM communication mode specific APIs (for apps using new driver with PDM mode).
- `i2s_tdm.h`: The header file that provides TDM communication mode specific APIs (for apps using new driver with TDM mode).

**Note:** The legacy driver cannot coexist with the new driver. Include `i2s.h` to use the legacy driver, or include the other three headers to use the new driver. The legacy driver might be removed in future.

#### Public headers that have been included in the headers above are as follows:

- `i2s_types_legacy.h`: The header file that provides legacy public types that are only used in the legacy driver.
- `i2s_types.h`: The header file that provides public types.
- `i2s_common.h`: The header file that provides common APIs for all communication modes.

### I2S Clock

#### Clock Source

- `i2s_clock_src_t::I2S_CLK_SRC_DEFAULT`: Default PLL clock.
- `i2s_clock_src_t::I2S_CLK_SRC_PLL_160M`: 160 MHz PLL clock.
- `i2s_clock_src_t::I2S_CLK_SRC_APLL`: Audio PLL clock, which is more precise than `I2S_CLK_SRC_PLL_160M` in high sample rate applications. Its frequency is configurable according to the sample rate. However, if APLL has been occupied by EMAC or other channels, the APLL frequency cannot be changed, and the driver will try to work under this APLL frequency. If this frequency cannot meet the requirements of I2S, the clock configuration will fail.

#### Clock Terminology

- **Sample rate**: The number of sampled data in one second per slot.

- **SCLK**: Source clock frequency. It is the frequency of the clock source.
- **MCLK**: Master clock frequency. BCLK is generated from this clock. The MCLK signal usually serves as a reference clock and is mostly needed to synchronize BCLK and WS between I2S master and slave roles.
- **BCLK**: Bit clock frequency. Every tick of this clock stands for one data bit on data pin. The slot bit width configured in `i2s_std_slot_config_t::slot_bit_width` is equal to the number of BCLK ticks, which means there will be 8/16/24/32 BCLK ticks in one slot.
- **LRCK / WS**: Left/right clock or word select clock. For non-PDM mode, its frequency is equal to the sample rate.

**Note:** Normally, MCLK should be the multiple of sample rate and BCLK at the same time. The field `i2s_std_clk_config_t::mclk_multiple` indicates the multiple of MCLK to the sample rate. In most cases, I2S\_MCLK\_MULTIPLE\_256 should be enough. However, if `slot_bit_width` is set to I2S\_SLOT\_BIT\_WIDTH\_24BIT, to keep MCLK a multiple to the BCLK, `i2s_std_clk_config_t::mclk_multiple` should be set to multiples that are divisible by 3 such as I2S\_MCLK\_MULTIPLE\_384. Otherwise, WS will be inaccurate.

## I2S Communication Mode

### Overview of All Modes

Target	Standard	PDM TX	PDM RX	TDM	ADC/DAC	LCD/Camera
ESP-32	I2S 0/1	I2S 0	I2S 0	none	I2S 0	I2S 0
ESP32-S2	I2S 0	none	none	none	none	I2S 0
ESP32-C3	I2S 0	I2S 0	none	I2S0	none	none
ESP32-S3	I2S 0/1	I2S 0	I2S 0	I2S 0/1	none	none

**Standard Mode** In standard mode, there are always two sound channels, i.e., the left and right channels, which are called “slots”. These slots support 8/16/24/32-bit width sample data. The communication format for the slots mainly includes the followings:

- **Philips Format**: Data signal has one-bit shift comparing to the WS signal, and the duty of WS signal is 50%.

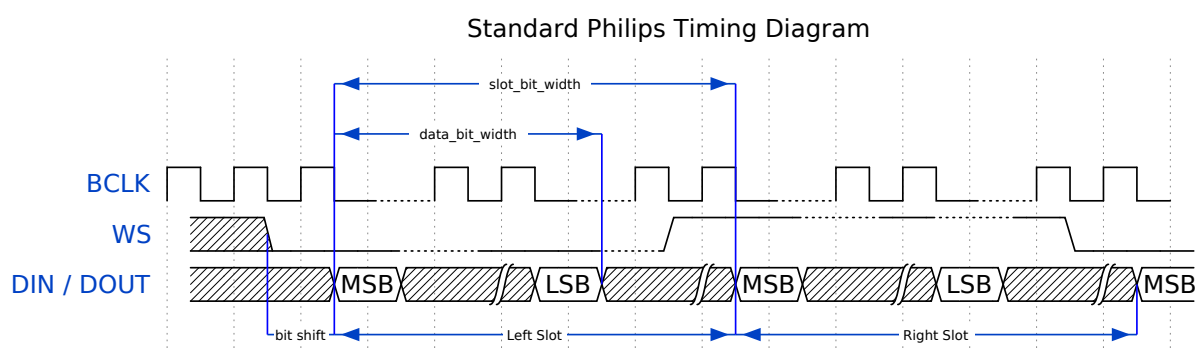

- **MSB Format**: Basically the same as Philips format, but without data shift.

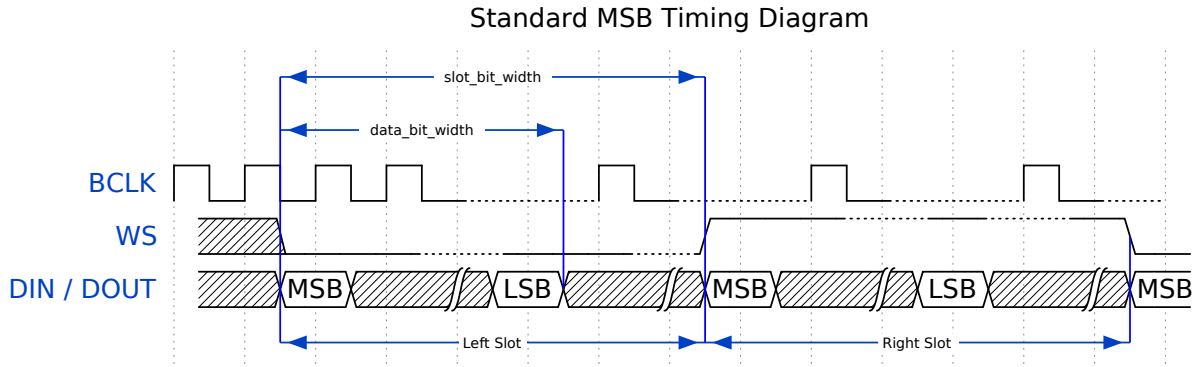

- **PCM Short Format:** Data has one-bit shift and meanwhile the WS signal becomes a pulse lasting for one BCLK cycle.

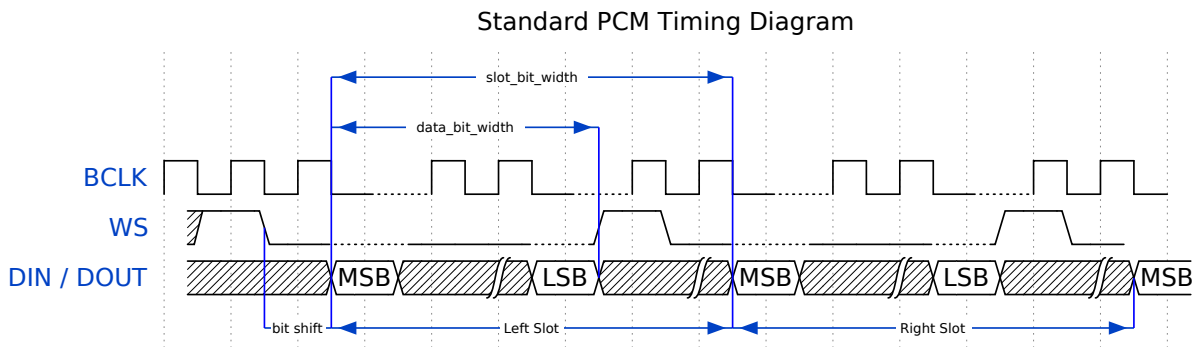

## Functional Overview

The I2S driver offers the following services:

**Resource Management** There are three levels of resources in the I2S driver:

- platform level: Resources of all I2S controllers in the current target.
- controller level: Resources in one I2S controller.
- channel level: Resources of TX or RX channel in one I2S controller.

The public APIs are all channel-level APIs. The channel handle `i2s_chan_handle_t` can help users to manage the resources under a specific channel without considering the other two levels. The other two upper levels' resources are private and are managed by the driver automatically. Users can call `i2s_new_channel()` to allocate a channel handle and call `i2s_del_channel()` to delete it.

**Power Management** When the power management is enabled (i.e., `CONFIG_PM_ENABLE` is on), the system will adjust or stop the source clock of I2S before entering Light-sleep, thus potentially changing the I2S signals and leading to transmitting or receiving invalid data.

The I2S driver can prevent the system from changing or stopping the source clock by acquiring a power management lock. When the source clock is generated from APB, the lock type will be set to `esp_pm_lock_type_t::ESP_PM_APB_FREQ_MAX` and when the source clock is APLL (if supported), it will be set to `esp_pm_lock_type_t::ESP_PM_NO_LIGHT_SLEEP`. Whenever the user is reading or writing via I2S (i.e., calling `i2s_channel_read()` or `i2s_channel_write()`), the driver will guarantee that the power management lock is acquired. Likewise, the driver releases the lock after the reading or writing finishes.

**Finite State Machine** There are three states for an I2S channel, namely, `registered`, `ready`, and `running`. Their relationship is shown in the following diagram:

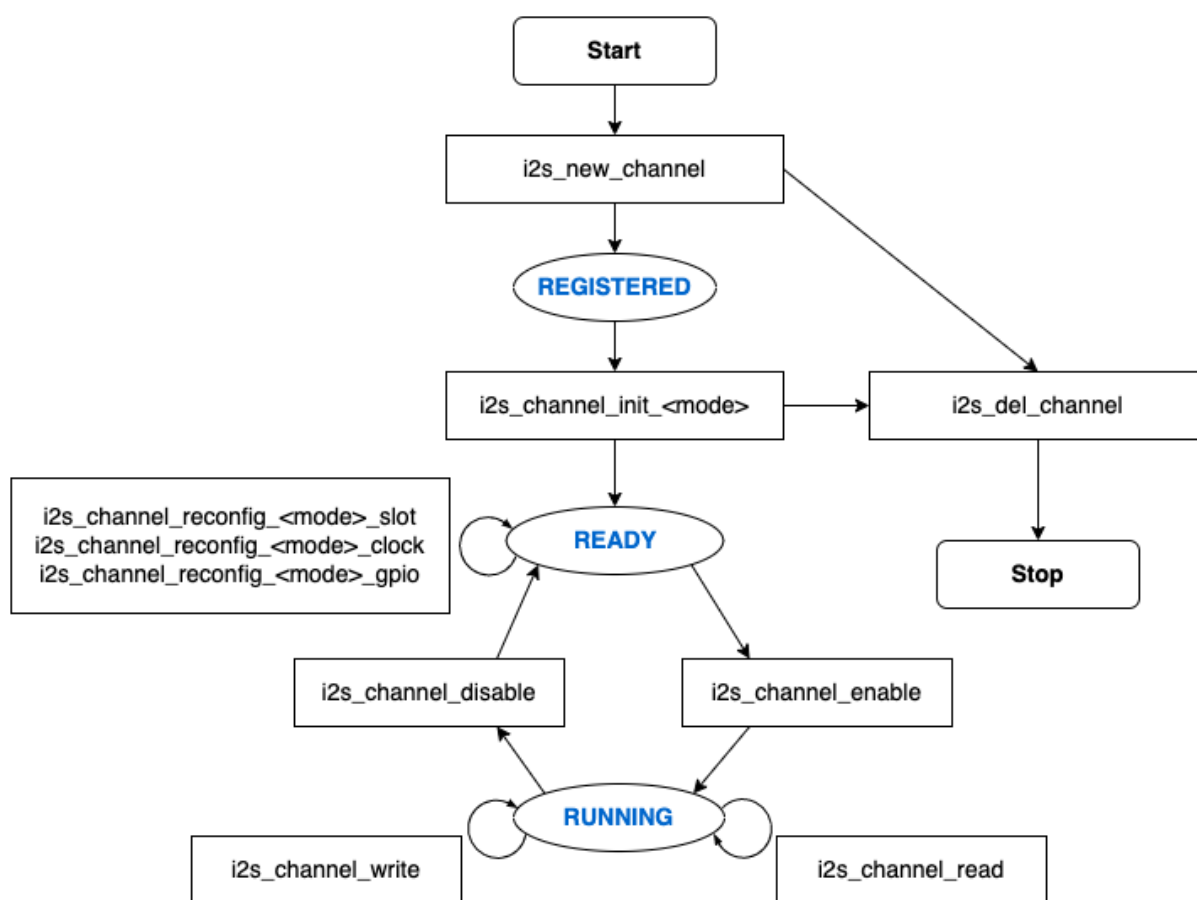

Fig. 7: I2S Finite State Machine

The `<mode>` in the diagram can be replaced by corresponding I2S communication modes, e.g., `std` for standard two-slot mode. For more information about communication modes, please refer to the *I2S Communication Mode* section.

**Data Transport** The data transport of the I2S peripheral, including sending and receiving, is realized by DMA. Before transporting data, please call `i2s_channel_enable()` to enable the specific channel. When the sent or received data reaches the size of one DMA buffer, the `I2S_OUT_EOF` or `I2S_IN_SUC_EOF` interrupt will be triggered. Note that the DMA buffer size is not equal to `i2s_chan_config_t::dma_frame_num`. One frame here refers to all the sampled data in one WS circle. Therefore, `dma_buffer_size = dma_frame_num * slot_num * slot_bit_width / 8`. For the data transmitting, users can input the data by calling `i2s_channel_write()`. This function helps users to copy the data from the source buffer to the DMA TX buffer and wait for the transmission to finish. Then it will repeat until the sent bytes reach the given size. For the data receiving, the function `i2s_channel_read()` waits to receive the message queue which contains the DMA buffer address. It helps users copy the data from the DMA RX buffer to the destination buffer.

Both `i2s_channel_write()` and `i2s_channel_read()` are blocking functions. They keep waiting until the whole source buffer is sent or the whole destination buffer is loaded, unless they exceed the max blocking time, where the error code `ESP_ERR_TIMEOUT` returns. To send or receive data asynchronously, callbacks can be registered by `i2s_channel_register_event_callback()`. Users are able to access the DMA buffer directly in the callback function instead of transmitting or receiving by the two blocking functions. However, please be aware that it is an interrupt callback, so do not add complex logic, run floating operation, or call non-reentrant functions in the callback.

**Configuration** Users can initialize a channel by calling corresponding functions (i.e., `i2s_channel_init_std_mode()`, `i2s_channel_init_pdm_rx_mode()`, `i2s_channel_init_pdm_tx_mode()`, or `i2s_channel_init_tdm_mode()`) to a specific mode. If the configurations need to be updated after initialization, users have to first call `i2s_channel_disable()` to ensure that the channel has stopped, and then call corresponding ‘reconfig’ functions, like `i2s_channel_reconfig_std_slot()`, `i2s_channel_reconfig_std_clock()`, and `i2s_channel_reconfig_std_gpio()`.

**IRAM Safe** By default, the I2S interrupt will be deferred when the cache is disabled for reasons like writing/erasing flash. Thus the EOF interrupt will not get executed in time.

To avoid such case in real-time applications, you can enable the Kconfig option `CONFIG_I2S_ISR_IRAM_SAFE` that will:

1. Keep the interrupt being serviced even when the cache is disabled.
2. Place driver object into DRAM (in case it is linked to PSRAM by accident).

This will allow the interrupt to run while the cache is disabled, but will come at the cost of increased IRAM consumption.

**Thread Safety** All the public I2S APIs are guaranteed to be thread safe by the driver, which means users can call them from different RTOS tasks without protection by extra locks. Notice that the I2S driver uses mutex lock to ensure the thread safety, thus these APIs are not allowed to be used in ISR.

### Kconfig Options

- `CONFIG_I2S_ISR_IRAM_SAFE` controls whether the default ISR handler can work when the cache is disabled. See *IRAM Safe* for more information.
- `CONFIG_I2S_SUPPRESS_DEPRECATED_WARN` controls whether to suppress the compiling warning message while using the legacy I2S driver.
- `CONFIG_I2S_ENABLE_DEBUG_LOG` is used to enable the debug log output. Enable this option will increase the firmware binary size.

## Application Example

The examples of the I2S driver can be found in the directory [peripherals/i2s](#). Here are some simple usages of each mode:

**Standard TX/RX Usage** Different slot communication formats can be generated by the following helper macros for standard mode. As described above, there are three formats in standard mode, and their helper macros are:

- `I2S_STD_PHILIPS_SLOT_DEFAULT_CONFIG`
- `I2S_STD_PCM_SLOT_DEFAULT_CONFIG`
- `I2S_STD_MSB_SLOT_DEFAULT_CONFIG`

The clock config helper macro is:

- `I2S_STD_CLK_DEFAULT_CONFIG`

Please refer to *Standard Mode* for information about STD API. And for more details, please refer to [driver/include/driver/i2s\\_std.h](#).

**STD TX Mode** Take 16-bit data width for example. When the data in a `uint16_t` writing buffer are:

data 0	data 1	data 2	data 3	data 4	data 5	data 6	data 7	...
0x0001	0x0002	0x0003	0x0004	0x0005	0x0006	0x0007	0x0008	...

Here is the table of the real data on the line with different `i2s_std_slot_config_t::slot_mode` and `i2s_std_slot_config_t::slot_mask`.

data bit width	slot mode	slot mask	WS low	WS high	WS low	WS high	WS low	WS high	WS low	WS high
16 bit	mono	left	0x0001	0x0000	0x0002	0x0000	0x0003	0x0000	0x0004	0x0000
		right	0x0000	0x0001	0x0000	0x0002	0x0000	0x0003	0x0000	0x0004
		both	0x0001	0x0001	0x0002	0x0002	0x0003	0x0003	0x0004	0x0004
	stereo	left	0x0001	0x0001	0x0003	0x0003	0x0005	0x0005	0x0007	0x0007
		right	0x0002	0x0002	0x0004	0x0004	0x0006	0x0006	0x0008	0x0008
		both	0x0001	0x0002	0x0003	0x0004	0x0005	0x0006	0x0007	0x0008

**Note:** Similar for 8-bit and 32-bit data widths, the type of the buffer is better to be `uint8_t` and `uint32_t`. But specially, when the data width is 24-bit, the data buffer should be aligned with 3-byte (i.e., every 3 bytes stands for a 24-bit data in one slot). Additionally, `i2s_chan_config_t::dma_frame_num`, `i2s_std_clk_config_t::mclk_multiple`, and the writing buffer size should be the multiple of 3, otherwise the data on the line or the sample rate will be incorrect.

```
#include "driver/i2s_std.h"
#include "driver/gpio.h"

i2s_chan_handle_t tx_handle;
/* Get the default channel configuration by the helper macro.
 * This helper macro is defined in 'i2s_common.h' and shared by all the I2S_
↳communication modes.
 * It can help to specify the I2S role and port ID */
i2s_chan_config_t chan_cfg = I2S_CHANNEL_DEFAULT_CONFIG(I2S_NUM_AUTO, I2S_ROLE_
↳MASTER);
/* Allocate a new TX channel and get the handle of this channel */
i2s_new_channel(&chan_cfg, &tx_handle, NULL);

/* Setting the configurations, the slot configuration and clock configuration can_
↳be generated by the macros
```

(continues on next page)

(continued from previous page)

```

* These two helper macros are defined in 'i2s_std.h' which can only be used in
↳STD mode.
* They can help to specify the slot and clock configurations for initialization
↳or updating */
i2s_std_config_t std_cfg = {
    .clk_cfg = I2S_STD_CLK_DEFAULT_CONFIG(48000),
    .slot_cfg = I2S_STD_MSB_SLOT_DEFAULT_CONFIG(I2S_DATA_BIT_WIDTH_32BIT, I2S_SLOT_
↳MODE_STEREO),
    .gpio_cfg = {
        .mclk = I2S_GPIO_UNUSED,
        .bclk = GPIO_NUM_4,
        .ws = GPIO_NUM_5,
        .dout = GPIO_NUM_18,
        .din = I2S_GPIO_UNUSED,
        .invert_flags = {
            .mclk_inv = false,
            .bclk_inv = false,
            .ws_inv = false,
        },
    },
};
/* Initialize the channel */
i2s_channel_init_std_mode(tx_handle, &std_cfg);

/* Before writing data, start the TX channel first */
i2s_channel_enable(tx_handle);
i2s_channel_write(tx_handle, src_buf, bytes_to_write, bytes_written, ticks_to_
↳wait);

/* If the configurations of slot or clock need to be updated,
* stop the channel first and then update it */
// i2s_channel_disable(tx_handle);
// std_cfg.slot_cfg.slot_mode = I2S_SLOT_MODE_MONO; // Default is stereo
// i2s_channel_reconfig_std_slot(tx_handle, &std_cfg.slot_cfg);
// std_cfg.clk_cfg.sample_rate_hz = 96000;
// i2s_channel_reconfig_std_clock(tx_handle, &std_cfg.clk_cfg);

/* Have to stop the channel before deleting it */
i2s_channel_disable(tx_handle);
/* If the handle is not needed any more, delete it to release the channel
↳resources */
i2s_del_channel(tx_handle);

```

**STD RX Mode** Taking 16-bit data width for example, when the data on the line are:

WS low	WS high	WS low	WS high	WS low	WS high	WS low	WS high	...
0x0001	0x0002	0x0003	0x0004	0x0005	0x0006	0x0007	0x0008	...

Here is the table of the data received in the buffer with different `i2s_std_slot_config_t::slot_mode` and `i2s_std_slot_config_t::slot_mask`.

data width	bit	slot mode	slot mask	data 0	data 1	data 2	data 3	data 4	data 5	data 6	data 7
16 bit		mono	left	0x0001	0x0003	0x0005	0x0007	0x0009	0x000b	0x000d	0x000f
			right	0x0002	0x0004	0x0006	0x0008	0x000a	0x000c	0x000e	0x0010
		stereo	any	0x0001	0x0002	0x0003	0x0004	0x0005	0x0006	0x0007	0x0008



**Note:** 8-bit, 24-bit, and 32-bit are similar as 16-bit, where the data bit-width in the receiving buffer is equal to the data bit-width on the line. Additionally, when using 24-bit data width, `i2s_chan_config_t::dma_frame_num`, `i2s_std_clk_config_t::mclk_multiple`, and the receiving buffer size should be the multiple of 3, otherwise the data on the line or the sample rate will be incorrect.

```
#include "driver/i2s_std.h"
#include "driver/gpio.h"

i2s_chan_handle_t rx_handle;
/* Get the default channel configuration by helper macro.
 * This helper macro is defined in 'i2s_common.h' and shared by all the I2S_
↳communication modes.
 * It can help to specify the I2S role and port ID */
i2s_chan_config_t chan_cfg = I2S_CHANNEL_DEFAULT_CONFIG(I2S_NUM_AUTO, I2S_ROLE_
↳MASTER);
/* Allocate a new RX channel and get the handle of this channel */
i2s_new_channel(&chan_cfg, NULL, &rx_handle);

/* Setting the configurations, the slot configuration and clock configuration can_
↳be generated by the macros
 * These two helper macros are defined in 'i2s_std.h' which can only be used in_
↳STD mode.
 * They can help to specify the slot and clock configurations for initialization_
↳or updating */
i2s_std_config_t std_cfg = {
    .clk_cfg = I2S_STD_CLK_DEFAULT_CONFIG(48000),
    .slot_cfg = I2S_STD_MSB_SLOT_DEFAULT_CONFIG(I2S_DATA_BIT_WIDTH_32BIT, I2S_SLOT_
↳MODE_STEREO),
    .gpio_cfg = {
        .mclk = I2S_GPIO_UNUSED,
        .bclk = GPIO_NUM_4,
        .ws = GPIO_NUM_5,
        .dout = I2S_GPIO_UNUSED,
        .din = GPIO_NUM_19,
        .invert_flags = {
            .mclk_inv = false,
            .bclk_inv = false,
            .ws_inv = false,
        },
    },
};
/* Initialize the channel */
i2s_channel_init_std_mode(rx_handle, &std_cfg);

/* Before reading data, start the RX channel first */
i2s_channel_enable(rx_handle);
i2s_channel_read(rx_handle, desc_buf, bytes_to_read, bytes_read, ticks_to_wait);

/* Have to stop the channel before deleting it */
i2s_channel_disable(rx_handle);
/* If the handle is not needed any more, delete it to release the channel_
↳resources */
i2s_del_channel(rx_handle);
```

**Full-duplex** Full-duplex mode registers TX and RX channel in an I2S port at the same time, and the channels share the BCLK and WS signals. Currently, STD and TDM communication modes supports full-duplex mode in the following way, but PDM full-duplex is not supported because due to different PDM TX and RX clocks.

Note that one handle can only stand for one channel. Therefore, it is still necessary to configure the slot and clock for both TX and RX channels one by one.

Here is an example of how to allocate a pair of full-duplex channels:

```
#include "driver/i2s_std.h"
#include "driver/gpio.h"

i2s_chan_handle_t tx_handle;
i2s_chan_handle_t rx_handle;

/* Allocate a pair of I2S channel */
i2s_chan_config_t chan_cfg = I2S_CHANNEL_DEFAULT_CONFIG(I2S_NUM_AUTO, I2S_ROLE_
↪MASTER);
/* Allocate for TX and RX channel at the same time, then they will work in full-
↪duplex mode */
i2s_new_channel(&chan_cfg, &tx_handle, &rx_handle);

/* Set the configurations for BOTH TWO channels, since TX and RX channel have to
↪be same in full-duplex mode */
i2s_std_config_t std_cfg = {
    .clk_cfg = I2S_STD_CLK_DEFAULT_CONFIG(32000),
    .slot_cfg = I2S_STD_PHILIPS_SLOT_DEFAULT_CONFIG(I2S_DATA_BIT_WIDTH_16BIT, I2S_
↪SLOT_MODE_STEREO),
    .gpio_cfg = {
        .mclk = I2S_GPIO_UNUSED,
        .bclk = GPIO_NUM_4,
        .ws = GPIO_NUM_5,
        .dout = GPIO_NUM_18,
        .din = GPIO_NUM_19,
        .invert_flags = {
            .mclk_inv = false,
            .bclk_inv = false,
            .ws_inv = false,
        },
    },
};
i2s_channel_init_std_mode(tx_handle, &std_cfg);
i2s_channel_init_std_mode(rx_handle, &std_cfg);

i2s_channel_enable(tx_handle);
i2s_channel_enable(rx_handle);

...
```

**Simplex Mode** To allocate a channel handle in simplex mode, `i2s_new_channel()` should be called for each channel. The clock and GPIO pins of TX/RX channel on ESP32-S2 are not independent, so the TX and RX channel cannot coexist on the same I2S port in simplex mode.

```
#include "driver/i2s_std.h"
#include "driver/gpio.h"

i2s_chan_handle_t tx_handle;
i2s_chan_handle_t rx_handle;

i2s_chan_config_t chan_cfg = I2S_CHANNEL_DEFAULT_CONFIG(I2S_NUM_AUTO, I2S_ROLE_
↪MASTER);
i2s_new_channel(&chan_cfg, &tx_handle, NULL);
i2s_std_config_t std_tx_cfg = {
    .clk_cfg = I2S_STD_CLK_DEFAULT_CONFIG(48000),
    .slot_cfg = I2S_STD_PHILIPS_SLOT_DEFAULT_CONFIG(I2S_DATA_BIT_WIDTH_16BIT, I2S_
↪SLOT_MODE_STEREO),
    .gpio_cfg = {
        .mclk = GPIO_NUM_0,
```

(continues on next page)

```

        .bclk = GPIO_NUM_4,
        .ws = GPIO_NUM_5,
        .dout = GPIO_NUM_18,
        .din = I2S_GPIO_UNUSED,
        .invert_flags = {
            .mclk_inv = false,
            .bclk_inv = false,
            .ws_inv = false,
        },
    },
};
/* Initialize the channel */
i2s_channel_init_std_mode(tx_handle, &std_tx_cfg);
i2s_channel_enable(tx_handle);

/* RX channel will be registered on another I2S, if no other available I2S unit_
↳found
 * it will return ESP_ERR_NOT_FOUND */
i2s_new_channel(&chan_cfg, NULL, &rx_handle);
i2s_std_config_t std_rx_cfg = {
    .clk_cfg = I2S_STD_CLK_DEFAULT_CONFIG(16000),
    .slot_cfg = I2S_STD_MSB_SLOT_DEFAULT_CONFIG(I2S_DATA_BIT_WIDTH_32BIT, I2S_SLOT_
↳MODE_STEREO),
    .gpio_cfg = {
        .mclk = I2S_GPIO_UNUSED,
        .bclk = GPIO_NUM_6,
        .ws = GPIO_NUM_7,
        .dout = I2S_GPIO_UNUSED,
        .din = GPIO_NUM_19,
        .invert_flags = {
            .mclk_inv = false,
            .bclk_inv = false,
            .ws_inv = false,
        },
    },
};
i2s_channel_init_std_mode(rx_handle, &std_rx_cfg);
i2s_channel_enable(rx_handle);

```

## Application Notes

**How to Prevent Data Lost** For applications that need a high frequency sample rate, the massive data throughput may cause data lost. Users can receive data lost event by registering the ISR callback function to receive the event queue:

```

static IRAM_ATTR bool i2s_rx_queue_overflow_callback(i2s_chan_handle_t_
↳handle, i2s_event_data_t *event, void *user_ctx)
{
    // handle RX queue overflow event ...
    return false;
}

i2s_event_callbacks_t cbs = {
    .on_recv = NULL,
    .on_recv_q_ovf = i2s_rx_queue_overflow_callback,
    .on_sent = NULL,
    .on_send_q_ovf = NULL,
};
TEST_ESP_OK(i2s_channel_register_event_callback(rx_handle, &cbs, NULL));

```

Please follow these steps to prevent data lost:

1. Determine the interrupt interval. Generally, when data lost happens, the bigger the interval, the better, which helps to reduce the interrupt times. This means `dma_frame_num` should be as big as possible while the DMA buffer size is below the maximum value of 4092. The relationships are:

```
interrupt_interval(unit: sec) = dma_frame_num / sample_rate
dma_buffer_size = dma_frame_num * slot_num * data_bit_width / 8 <= 4092
```

2. Determine `dma_desc_num`. `dma_desc_num` is decided by the maximum time of `i2s_channel_read` polling cycle. All the received data is supposed to be stored between two `i2s_channel_read`. This cycle can be measured by a timer or an outputting GPIO signal. The relationship is:

```
dma_desc_num > polling_cycle / interrupt_interval
```

3. Determine the receiving buffer size. The receiving buffer offered by users in `i2s_channel_read` should be able to take all the data in all DMA buffers, which means that it should be larger than the total size of all the DMA buffers:

```
recv_buffer_size > dma_desc_num * dma_buffer_size
```

For example, if there is an I2S application, and the known values are:

```
sample_rate = 144000 Hz
data_bit_width = 32 bits
slot_num = 2
polling_cycle = 10 ms
```

Then the parameters `dma_frame_num`, `dma_desc_num`, and `recv_buf_size` can be calculated as follows:

```
dma_frame_num * slot_num * data_bit_width / 8 = dma_buffer_size <= 4092
dma_frame_num <= 511
interrupt_interval = dma_frame_num / sample_rate = 511 / 144000 = 0.003549 s = 3.
↪ 549 ms
dma_desc_num > polling_cycle / interrupt_interval = cell(10 / 3.549) = cell(2.818)
↪ = 3
recv_buffer_size > dma_desc_num * dma_buffer_size = 3 * 4092 = 12276 bytes
```

## API Reference

### Standard Mode

#### Header File

- `components/driver/include/driver/i2s_std.h`

#### Functions

`esp_err_t i2s_channel_init_std_mode` (`i2s_chan_handle_t` handle, const `i2s_std_config_t` \*std\_cfg)

Initialize i2s channel to standard mode.

---

**Note:** Only allowed to be called when the channel state is REGISTERED, (i.e., channel has been allocated, but not initialized) and the state will be updated to READY if initialization success, otherwise the state will return to REGISTERED.

---

#### Parameters

- **handle** –[in] I2S channel handler

- **std\_cfg** **–[in]** Configurations for standard mode, including clock, slot and gpio. The clock configuration can be generated by the helper macro `I2S_STD_CLK_DEFAULT_CONFIG`. The slot configuration can be generated by the helper macro `I2S_STD_PHILIPS_SLOT_DEFAULT_CONFIG`, `I2S_STD_PCM_SLOT_DEFAULT_CONFIG` or `I2S_STD_MSB_SLOT_DEFAULT_CONFIG`.

**Returns**

- `ESP_OK` Initialize successfully
- `ESP_ERR_NO_MEM` No memory for storing the channel information
- `ESP_ERR_INVALID_ARG` NULL pointer or invalid configuration
- `ESP_ERR_INVALID_STATE` This channel is not registered

*esp\_err\_t* **i2s\_channel\_reconfig\_std\_clock** (*i2s\_chan\_handle\_t* handle, const *i2s\_std\_clk\_config\_t* \*clk\_cfg)

Reconfigure the I2S clock for standard mode.

---

**Note:** Only allowed to be called when the channel state is `READY`, i.e., channel has been initialized, but not started. This function won't change the state. `i2s_channel_disable` should be called before calling this function if i2s has started.

---

---

**Note:** The input channel handle has to be initialized to standard mode, i.e., `i2s_channel_init_std_mode` has been called before reconfiguring.

---

**Parameters**

- **handle** **–[in]** I2S channel handler
- **clk\_cfg** **–[in]** Standard mode clock configuration, can be generated by `I2S_STD_CLK_DEFAULT_CONFIG`

**Returns**

- `ESP_OK` Set clock successfully
- `ESP_ERR_INVALID_ARG` NULL pointer, invalid configuration or not standard mode
- `ESP_ERR_INVALID_STATE` This channel is not initialized or not stopped

*esp\_err\_t* **i2s\_channel\_reconfig\_std\_slot** (*i2s\_chan\_handle\_t* handle, const *i2s\_std\_slot\_config\_t* \*slot\_cfg)

Reconfigure the I2S slot for standard mode.

---

**Note:** Only allowed to be called when the channel state is `READY`, i.e., channel has been initialized, but not started. This function won't change the state. `i2s_channel_disable` should be called before calling this function if i2s has started.

---

---

**Note:** The input channel handle has to be initialized to standard mode, i.e., `i2s_channel_init_std_mode` has been called before reconfiguring.

---

**Parameters**

- **handle** **–[in]** I2S channel handler
- **slot\_cfg** **–[in]** Standard mode slot configuration, can be generated by `I2S_STD_PHILIPS_SLOT_DEFAULT_CONFIG`, `I2S_STD_PCM_SLOT_DEFAULT_CONFIG` and `I2S_STD_MSB_SLOT_DEFAULT_CONFIG`.

**Returns**

- `ESP_OK` Set clock successfully
- `ESP_ERR_NO_MEM` No memory for DMA buffer
- `ESP_ERR_INVALID_ARG` NULL pointer, invalid configuration or not standard mode
- `ESP_ERR_INVALID_STATE` This channel is not initialized or not stopped

*esp\_err\_t* **i2s\_channel\_reconfig\_std\_gpio** (*i2s\_chan\_handle\_t* handle, const *i2s\_std\_gpio\_config\_t* \*gpio\_cfg)

Reconfigure the I2S gpio for standard mode.

---

**Note:** Only allowed to be called when the channel state is `READY`, i.e., channel has been initialized, but not started this function won't change the state. `i2s_channel_disable` should be called before calling this function if i2s has started.

---

---

**Note:** The input channel handle has to be initialized to standard mode, i.e., `i2s_channel_init_std_mode` has been called before reconfiguring

---

#### Parameters

- **handle** –[in] I2S channel handler
- **gpio\_cfg** –[in] Standard mode gpio configuration, specified by user

#### Returns

- `ESP_OK` Set clock successfully
- `ESP_ERR_INVALID_ARG` NULL pointer, invalid configuration or not standard mode
- `ESP_ERR_INVALID_STATE` This channel is not initialized or not stopped

### Structures

struct **i2s\_std\_slot\_config\_t**

I2S slot configuration for standard mode.

#### Public Members

*i2s\_data\_bit\_width\_t* **data\_bit\_width**

I2S sample data bit width (valid data bits per sample)

*i2s\_slot\_bit\_width\_t* **slot\_bit\_width**

I2S slot bit width (total bits per slot)

*i2s\_slot\_mode\_t* **slot\_mode**

Set mono or stereo mode with `I2S_SLOT_MODE_MONO` or `I2S_SLOT_MODE_STEREO` In TX direction, mono means the written buffer contains only one slot data and stereo means the written buffer contains both left and right data

*i2s\_std\_slot\_mask\_t* **slot\_mask**

Select the left, right or both slot

uint32\_t **ws\_width**

WS signal width (i.e. the number of bclk ticks that ws signal is high)

bool **ws\_pol**

WS signal polarity, set true to enable high lever first

bool **bit\_shift**

Set to enable bit shift in Philips mode

bool **msb\_right**

Set to place right channel data at the MSB in the FIFO

struct **i2s\_std\_clk\_config\_t**

I2S clock configuration for standard mode.

### Public Members

uint32\_t **sample\_rate\_hz**

I2S sample rate

*i2s\_clock\_src\_t* **clk\_src**

Choose clock source

*i2s\_mclk\_multiple\_t* **mclk\_multiple**

The multiple of mclk to the sample rate Default is 256 in the helper macro, it can satisfy most of cases, but please set this field a multiple of '3' (like 384) when using 24-bit data width, otherwise the sample rate might be inaccurate

struct **i2s\_std\_gpio\_config\_t**

I2S standard mode GPIO pins configuration.

### Public Members

*gpio\_num\_t* **mclk**

MCK pin, output

*gpio\_num\_t* **bclk**

BCK pin, input in slave role, output in master role

*gpio\_num\_t* **ws**

WS pin, input in slave role, output in master role

*gpio\_num\_t* **dout**

DATA pin, output

*gpio\_num\_t* **din**

DATA pin, input

uint32\_t **mclk\_inv**

Set 1 to invert the mclk output

uint32\_t **bclk\_inv**

Set 1 to invert the bclk input/output

uint32\_t **ws\_inv**

Set 1 to invert the ws input/output

struct *i2s\_std\_gpio\_config\_t*::[anonymous] **invert\_flags**  
GPIO pin invert flags

struct **i2s\_std\_config\_t**  
I2S standard mode major configuration that including clock/slot/gpio configuration.

### Public Members

*i2s\_std\_clk\_config\_t* **clk\_cfg**  
Standard mode clock configuration, can be generated by macro I2S\_STD\_CLK\_DEFAULT\_CONFIG

*i2s\_std\_slot\_config\_t* **slot\_cfg**  
Standard mode slot configuration, can be generated by macros I2S\_STD\_[mode]\_SLOT\_DEFAULT\_CONFIG, [mode] can be replaced with PHILIPS/MSB/PCM

*i2s\_std\_gpio\_config\_t* **gpio\_cfg**  
Standard mode gpio configuration, specified by user

### Macros

**I2S\_STD\_PHILIPS\_SLOT\_DEFAULT\_CONFIG** (bits\_per\_sample, mono\_or\_stereo)  
Philips format in 2 slots.

This file is specified for I2S standard communication mode Features:

- Philips/MSB/PCM are supported in standard mode
- Fixed to 2 slots

#### Parameters

- **bits\_per\_sample** –i2s data bit width
- **mono\_or\_stereo** –I2S\_SLOT\_MODE\_MONO or I2S\_SLOT\_MODE\_STEREO

**I2S\_STD\_PCM\_SLOT\_DEFAULT\_CONFIG** (bits\_per\_sample, mono\_or\_stereo)  
PCM(short) format in 2 slots.

---

**Note:** PCM(long) is same as philips in 2 slots

---

#### Parameters

- **bits\_per\_sample** –i2s data bit width
- **mono\_or\_stereo** –I2S\_SLOT\_MODE\_MONO or I2S\_SLOT\_MODE\_STEREO

**I2S\_STD\_MSB\_SLOT\_DEFAULT\_CONFIG** (bits\_per\_sample, mono\_or\_stereo)  
MSB format in 2 slots.

#### Parameters

- **bits\_per\_sample** –i2s data bit width
- **mono\_or\_stereo** –I2S\_SLOT\_MODE\_MONO or I2S\_SLOT\_MODE\_STEREO

**I2S\_STD\_CLK\_DEFAULT\_CONFIG** (rate)  
i2s default standard clock configuration

---

**Note:** Please set the mclk\_multiple to I2S\_MCLK\_MULTIPLE\_384 while using 24 bits data width Otherwise the sample rate might be imprecise since the bclk division is not a integer

---



**Parameters**

- **rate** –sample rate

**I2S Driver****Header File**

- [components/driver/include/driver/i2s\\_common.h](#)

**Functions**

*esp\_err\_t* **i2s\_new\_channel** (const *i2s\_chan\_config\_t* \*chan\_cfg, *i2s\_chan\_handle\_t* \*ret\_tx\_handle, *i2s\_chan\_handle\_t* \*ret\_rx\_handle)

Allocate new I2S channel(s)

---

**Note:** The new created I2S channel handle will be REGISTERED state after it is allocated successfully.

---

---

**Note:** When the port id in channel configuration is I2S\_NUM\_AUTO, driver will allocate I2S port automatically on one of the i2s controller, otherwise driver will try to allocate the new channel on the selected port.

---

---

**Note:** If both tx\_handle and rx\_handle are not NULL, it means this I2S controller will work at full-duplex mode, the rx and tx channels will be allocated on a same I2S port in this case. Note that some configurations of tx/rx channel are shared on ESP32 and ESP32S2, so please make sure they are working at same condition and under same status(start/stop). Currently, full-duplex mode can't guarantee tx/rx channels write/read synchronously, they can only share the clock signals for now.

---

---

**Note:** If tx\_handle OR rx\_handle is NULL, it means this I2S controller will work at simplex mode. For ESP32 and ESP32S2, the whole I2S controller (i.e. both rx and tx channel) will be occupied, even if only one of rx or tx channel is registered. For the other targets, another channel on this controller will still available.

---

**Parameters**

- **chan\_cfg** –[in] I2S controller channel configurations
- **ret\_tx\_handle** –[out] I2S channel handler used for managing the sending channel(optional)
- **ret\_rx\_handle** –[out] I2S channel handler used for managing the receiving channel(optional)

**Returns**

- ESP\_OK Allocate new channel(s) success
- ESP\_ERR\_NOT\_SUPPORTED The communication mode is not supported on the current chip
- ESP\_ERR\_INVALID\_ARG NULL pointer or illegal parameter in *i2s\_chan\_config\_t*
- ESP\_ERR\_NOT\_FOUND No available I2S channel found

*esp\_err\_t* **i2s\_del\_channel** (*i2s\_chan\_handle\_t* handle)

Delete the i2s channel.

---

**Note:** Only allowed to be called when the i2s channel is at REGISTERED or READY state (i.e., it should stop before deleting it).

---

---

**Note:** Resource will be free automatically if all channels in one port are deleted

---

**Parameters** **handle** –[in] I2S channel handler

- ESP\_OK Delete successfully
- ESP\_ERR\_INVALID\_ARG NULL pointer

*esp\_err\_t* **i2s\_channel\_get\_info** (*i2s\_chan\_handle\_t* handle, *i2s\_chan\_info\_t* \*chan\_info)

Get I2S channel information.

**Parameters**

- **handle** –[in] I2S channel handler
- **chan\_info** –[out] I2S channel basic information

**Returns**

- ESP\_OK Get i2s channel information success
- ESP\_ERR\_NOT\_FOUND The input handle doesn't match any registered I2S channels, it may not an i2s channel handle or not available any more
- ESP\_ERR\_INVALID\_ARG The input handle or chan\_info pointer is NULL

*esp\_err\_t* **i2s\_channel\_enable** (*i2s\_chan\_handle\_t* handle)

Enable the i2s channel.

---

**Note:** Only allowed to be called when the channel state is READY, (i.e., channel has been initialized, but not started) the channel will enter RUNNING state once it is enabled successfully.

---

---

**Note:** Enable the channel can start the I2S communication on hardware. It will start outputting bclk and ws signal. For mclk signal, it will start to output when initialization is finished

---

**Parameters** **handle** –[in] I2S channel handler

- ESP\_OK Start successfully
- ESP\_ERR\_INVALID\_ARG NULL pointer
- ESP\_ERR\_INVALID\_STATE This channel has not initialized or already started

*esp\_err\_t* **i2s\_channel\_disable** (*i2s\_chan\_handle\_t* handle)

Disable the i2s channel.

---

**Note:** Only allowed to be called when the channel state is READY / RUNNING, (i.e., channel has been initialized) the channel will enter READY state once it is disabled successfully.

---

---

**Note:** Disable the channel can stop the I2S communication on hardware. It will stop bclk and ws signal but not mclk signal

---

**Parameters** **handle** –[in] I2S channel handler

**Returns**

- ESP\_OK Stop successfully
- ESP\_ERR\_INVALID\_ARG NULL pointer
- ESP\_ERR\_INVALID\_STATE This channel has not stated

*esp\_err\_t* **i2s\_channel\_write** (*i2s\_chan\_handle\_t* handle, const void \*src, size\_t size, size\_t \*bytes\_written, uint32\_t timeout\_ms)

I2S write data.

---

**Note:** Only allowed to be called when the channel state is RUNNING, (i.e., tx channel has been started and is not writing now) but the RUNNING only stands for the software state, it doesn't mean there is no the signal transporting on line.

---

#### Parameters

- **handle** –[in] I2S channel handler
- **src** –[in] The pointer of sent data buffer
- **size** –[in] Max data buffer length
- **bytes\_written** –[out] Byte number that actually be sent
- **timeout\_ms** –[in] Max block time

#### Returns

- ESP\_OK Write successfully
- ESP\_ERR\_INVALID\_ARG NULL pointer or this handle is not tx handle
- ESP\_ERR\_TIMEOUT Writing timeout, no writing event received from ISR within ticks\_to\_wait
- ESP\_ERR\_INVALID\_STATE I2S is not ready to write

*esp\_err\_t* **i2s\_channel\_read** (*i2s\_chan\_handle\_t* handle, void \*dest, size\_t size, size\_t \*bytes\_read, uint32\_t timeout\_ms)

I2S read data.

---

**Note:** Only allowed to be called when the channel state is RUNNING but the RUNNING only stands for the software state, it doesn't mean there is no the signal transporting on line.

---

#### Parameters

- **handle** –[in] I2S channel handler
- **dest** –[in] The pointer of receiving data buffer
- **size** –[in] Max data buffer length
- **bytes\_read** –[out] Byte number that actually be read
- **timeout\_ms** –[in] Max block time

#### Returns

- ESP\_OK Read successfully
- ESP\_ERR\_INVALID\_ARG NULL pointer or this handle is not rx handle
- ESP\_ERR\_TIMEOUT Reading timeout, no reading event received from ISR within ticks\_to\_wait
- ESP\_ERR\_INVALID\_STATE I2S is not ready to read

*esp\_err\_t* **i2s\_channel\_register\_event\_callback** (*i2s\_chan\_handle\_t* handle, const *i2s\_event\_callbacks\_t* \*callbacks, void \*user\_data)

Set event callbacks for I2S channel.

---

**Note:** Only allowed to be called when the channel state is REGISTERED / READY, (i.e., before channel starts)

---

---

**Note:** User can deregister a previously registered callback by calling this function and setting the callback member in the `callbacks` structure to NULL.

---

---

**Note:** When CONFIG\_I2S\_ISR\_IRAM\_SAFE is enabled, the callback itself and functions called by it should be placed in IRAM. The variables used in the function should be in the SRAM as well. The `user_data` should also reside in SRAM or internal RAM as well.

---

#### Parameters

- **handle** –[in] I2S channel handler
- **callbacks** –[in] Group of callback functions
- **user\_data** –[in] User data, which will be passed to callback functions directly

#### Returns

- ESP\_OK Set event callbacks successfully
- ESP\_ERR\_INVALID\_ARG Set event callbacks failed because of invalid argument
- ESP\_ERR\_INVALID\_STATE Set event callbacks failed because the current channel state is not REGISTERED or READY

### Structures

struct **i2s\_event\_callbacks\_t**

Group of I2S callbacks.

---

**Note:** The callbacks are all running under ISR environment

---

---

**Note:** When CONFIG\_I2S\_ISR\_IRAM\_SAFE is enabled, the callback itself and functions called by it should be placed in IRAM. The variables used in the function should be in the SRAM as well.

---

### Public Members

*i2s\_isr\_callback\_t* **on\_recv**

Callback of data received event, only for rx channel The event data includes DMA buffer address and size that just finished receiving data

*i2s\_isr\_callback\_t* **on\_recv\_q\_ovf**

Callback of receiving queue overflowed event, only for rx channel The event data includes buffer size that has been overwritten

*i2s\_isr\_callback\_t* **on\_sent**

Callback of data sent event, only for tx channel The event data includes DMA buffer address and size that just finished sending data

*i2s\_isr\_callback\_t* **on\_send\_q\_ovf**

Callback of sending queue overflowed event, only for tx channel The event data includes buffer size that has been overwritten

struct **i2s\_chan\_config\_t**

I2S controller channel configuration.

### Public Members

*i2s\_port\_t* **id**

I2S port id

*i2s\_role\_t* **role**

I2S role, I2S\_ROLE\_MASTER or I2S\_ROLE\_SLAVE

uint32\_t **dma\_desc\_num**

I2S DMA buffer number, it is also the number of DMA descriptor

uint32\_t **dma\_frame\_num**

I2S frame number in one DMA buffer. One frame means one-time sample data in all slots, it should be the multiple of '3' when the data bit width is 24.

bool **auto\_clear**

Set to auto clear DMA TX buffer, i2s will always send zero automatically if no data to send

struct **i2s\_chan\_info\_t**

I2S channel information.

### Public Members

*i2s\_port\_t* **id**

I2S port id

*i2s\_role\_t* **role**

I2S role, I2S\_ROLE\_MASTER or I2S\_ROLE\_SLAVE

*i2s\_dir\_t* **dir**

I2S channel direction

*i2s\_comm\_mode\_t* **mode**

I2S channel communication mode

*i2s\_chan\_handle\_t* **pair\_chan**

I2S pair channel handle in duplex mode, always NULL in simplex mode

### Macros

**I2S\_CHANNEL\_DEFAULT\_CONFIG** (i2s\_num, i2s\_role)

get default I2S property

**I2S\_GPIO\_UNUSED**

Used in i2s\_gpio\_config\_t for signals which are not used

### I2S Types

#### Header File

- [components/driver/include/driver/i2s\\_types.h](#)

## Structures

struct **i2s\_event\_data\_t**

Event structure used in I2S event queue.

## Public Members

void \***data**

The pointer of DMA buffer that just finished sending or receiving for `on_recv` and `on_sent` callback  
NULL for `on_recv_q_ovf` and `on_send_q_ovf` callback

size\_t **size**

The buffer size of DMA buffer when success to send or receive, also the buffer size that dropped when queue overflow. It is related to the `dma_frame_num` and `data_bit_width`, typically it is fixed when `data_bit_width` is not changed.

## Type Definitions

typedef struct i2s\_channel\_obj\_t \***i2s\_chan\_handle\_t**

I2S channel object handle, the control unit of the i2s driver

typedef bool (**i2s\_isr\_callback\_t**)(*i2s\_chan\_handle\_t* handle, *i2s\_event\_data\_t* \*event, void \*user\_ctx)

I2S event callback.

**Param handle [in]** I2S channel handle, created from `i2s_new_channel()`

**Param event [in]** I2S event data

**Param user\_ctx [in]** User registered context, passed from  
`i2s_channel_register_event_callback()`

**Return** Whether a high priority task has been waken up by this callback function

## Enumerations

enum **i2s\_port\_t**

I2S controller port number, the max port number is (SOC\_I2S\_NUM -1).

*Values:*

enumerator **I2S\_NUM\_0**

I2S controller port 0

enumerator **I2S\_NUM\_AUTO**

Select whichever port is available

enum **i2s\_comm\_mode\_t**

I2S controller communication mode.

*Values:*

enumerator **I2S\_COMM\_MODE\_STD**

I2S controller using standard communication mode, support philips/MSB/PCM format

enumerator **I2S\_COMM\_MODE\_NONE**

Unspecified I2S controller mode

enum **i2s\_mclk\_multiple\_t**

The multiple of mclk to sample rate.

*Values:*

enumerator **I2S\_MCLK\_MULTIPLE\_128**

mclk = sample\_rate \* 128

enumerator **I2S\_MCLK\_MULTIPLE\_256**

mclk = sample\_rate \* 256

enumerator **I2S\_MCLK\_MULTIPLE\_384**

mclk = sample\_rate \* 384

enumerator **I2S\_MCLK\_MULTIPLE\_512**

mclk = sample\_rate \* 512

### Header File

- [components/hal/include/hal/i2s\\_types.h](#)

### Type Definitions

typedef *soc\_periph\_i2s\_clk\_src\_t* **i2s\_clock\_src\_t**

I2S clock source

### Enumerations

enum **i2s\_slot\_mode\_t**

I2S channel slot mode.

*Values:*

enumerator **I2S\_SLOT\_MODE\_MONO**

I2S channel slot format mono, transmit same data in all slots for tx mode, only receive the data in the first slots for rx mode.

enumerator **I2S\_SLOT\_MODE\_STEREO**

I2S channel slot format stereo, transmit different data in different slots for tx mode, receive the data in all slots for rx mode.

enum **i2s\_dir\_t**

I2S channel direction.

*Values:*

enumerator **I2S\_DIR\_RX**

I2S channel direction RX

enumerator **I2S\_DIR\_TX**

I2S channel direction TX

enum **i2s\_role\_t**

I2S controller role.

*Values:*

enumerator **I2S\_ROLE\_MASTER**

I2S controller master role, bclk and ws signal will be set to output

enumerator **I2S\_ROLE\_SLAVE**

I2S controller slave role, bclk and ws signal will be set to input

enum **i2s\_data\_bit\_width\_t**

Available data bit width in one slot.

*Values:*

enumerator **I2S\_DATA\_BIT\_WIDTH\_8BIT**

I2S channel data bit-width: 8

enumerator **I2S\_DATA\_BIT\_WIDTH\_16BIT**

I2S channel data bit-width: 16

enumerator **I2S\_DATA\_BIT\_WIDTH\_24BIT**

I2S channel data bit-width: 24

enumerator **I2S\_DATA\_BIT\_WIDTH\_32BIT**

I2S channel data bit-width: 32

enum **i2s\_slot\_bit\_width\_t**

Total slot bit width in one slot.

*Values:*

enumerator **I2S\_SLOT\_BIT\_WIDTH\_AUTO**

I2S channel slot bit-width equals to data bit-width

enumerator **I2S\_SLOT\_BIT\_WIDTH\_8BIT**

I2S channel slot bit-width: 8

enumerator **I2S\_SLOT\_BIT\_WIDTH\_16BIT**

I2S channel slot bit-width: 16

enumerator **I2S\_SLOT\_BIT\_WIDTH\_24BIT**

I2S channel slot bit-width: 24

enumerator **I2S\_SLOT\_BIT\_WIDTH\_32BIT**

I2S channel slot bit-width: 32

enum **i2s\_std\_slot\_mask\_t**

I2S slot select in standard mode.



---

**Note:** It has different meanings in tx/rx/mono/stereo mode, and it may have different behaviors on different targets. For the details, please refer to the I2S API reference.

---

*Values:*

enumerator **I2S\_STD\_SLOT\_LEFT**

I2S transmits or receives left slot

enumerator **I2S\_STD\_SLOT\_RIGHT**

I2S transmits or receives right slot

enumerator **I2S\_STD\_SLOT\_BOTH**

I2S transmits or receives both left and right slot

enum **i2s\_pdm\_slot\_mask\_t**

I2S slot select in PDM mode.

*Values:*

enumerator **I2S\_PDM\_SLOT\_RIGHT**

I2S PDM only transmits or receives the PDM device whose 'select' pin is pulled up

enumerator **I2S\_PDM\_SLOT\_LEFT**

I2S PDM only transmits or receives the PDM device whose 'select' pin is pulled down

enumerator **I2S\_PDM\_SLOT\_BOTH**

I2S PDM transmits or receives both two slots

## 2.5.13 LCD

### Introduction

ESP chips can generate various kinds of timings that needed by common LCDs on the market, like SPI LCD, I80 LCD (a.k.a Intel 8080 parallel LCD), RGB/SRGB LCD, I2C LCD, etc. The `esp_lcd` component is officially to support those LCDs with a group of universal APIs across chips.

### Functional Overview

In `esp_lcd`, an LCD panel is represented by `esp_lcd_panel_handle_t`, which plays the role of an **abstract frame buffer**, regardless of the frame memory is allocated inside ESP chip or in external LCD controller. Based on the location of the frame buffer and the hardware connection interface, the LCD panel drivers are mainly grouped into the following categories:

- Controller based LCD driver involves multiple steps to get a panel handle, like bus allocation, IO device registration and controller driver install. The frame buffer is located in the controller's internal GRAM (Graphical RAM). ESP-IDF provides only a limited number of LCD controller drivers out of the box (e.g., ST7789, SSD1306), *More Controller Based LCD Drivers* are maintained in the [Espressif Component Registry](#).
- *SPI Interfaced LCD* describes the steps to install the SPI LCD IO driver and then get the panel handle.
- *I2C Interfaced LCD* describes the steps to install the I2C LCD IO driver and then get the panel handle.
- *I80 Interfaced LCD* describes the steps to install the I80 LCD IO driver and then get the panel handle.

- *LCD Panel IO Operations* - provides a set of APIs to operate the LCD panel, like turning on/off the display, setting the orientation, etc. These operations are common for either controller-based LCD panel driver or RGB LCD panel driver.

## SPI Interfaced LCD

1. Create an SPI bus. Please refer to *SPI Master API doc* for more details.

```
spi_bus_config_t buscfg = {
    .sclk_io_num = EXAMPLE_PIN_NUM_SCLK,
    .mosi_io_num = EXAMPLE_PIN_NUM_MOSI,
    .miso_io_num = EXAMPLE_PIN_NUM_MISO,
    .quadwp_io_num = -1, // Quad SPI LCD driver is not yet supported
    .quadhd_io_num = -1, // Quad SPI LCD driver is not yet supported
    .max_transfer_sz = EXAMPLE_LCD_H_RES * 80 * sizeof(uint16_t), //
    ↪transfer 80 lines of pixels (assume pixel is RGB565) at most in one
    ↪SPI transaction
};
ESP_ERROR_CHECK(spi_bus_initialize(LCD_HOST, &buscfg, SPI_DMA_CH_
    ↪AUTO)); // Enable the DMA feature
```

2. Allocate an LCD IO device handle from the SPI bus. In this step, you need to provide the following information:

- *esp\_lcd\_panel\_io\_spi\_config\_t::dc\_gpio\_num*: Sets the gpio number for the DC signal line (some LCD calls this RS line). The LCD driver will use this GPIO to switch between sending command and sending data.
- *esp\_lcd\_panel\_io\_spi\_config\_t::cs\_gpio\_num*: Sets the gpio number for the CS signal line. The LCD driver will use this GPIO to select the LCD chip. If the SPI bus only has one device attached (i.e. this LCD), you can set the gpio number to -1 to occupy the bus exclusively.
- *esp\_lcd\_panel\_io\_spi\_config\_t::pclk\_hz* sets the frequency of the pixel clock, in Hz. The value should not exceed the range recommended in the LCD spec.
- *esp\_lcd\_panel\_io\_spi\_config\_t::spi\_mode* sets the SPI mode. The LCD driver will use this mode to communicate with the LCD. For the meaning of the SPI mode, please refer to the *SPI Master API doc*.
- *esp\_lcd\_panel\_io\_spi\_config\_t::lcd\_cmd\_bits* and *esp\_lcd\_panel\_io\_spi\_config\_t::lcd\_param\_bits* set the bit width of the command and parameter that recognized by the LCD controller chip. This is chip specific, you should refer to your LCD spec in advance.
- *esp\_lcd\_panel\_io\_spi\_config\_t::trans\_queue\_depth* sets the depth of the SPI transaction queue. A bigger value means more transactions can be queued up, but it also consumes more memory.

```
esp_lcd_panel_io_handle_t io_handle = NULL;
esp_lcd_panel_io_spi_config_t io_config = {
    .dc_gpio_num = EXAMPLE_PIN_NUM_LCD_DC,
    .cs_gpio_num = EXAMPLE_PIN_NUM_LCD_CS,
    .pclk_hz = EXAMPLE_LCD_PIXEL_CLOCK_HZ,
    .lcd_cmd_bits = EXAMPLE_LCD_CMD_BITS,
    .lcd_param_bits = EXAMPLE_LCD_PARAM_BITS,
    .spi_mode = 0,
    .trans_queue_depth = 10,
};
// Attach the LCD to the SPI bus
ESP_ERROR_CHECK(esp_lcd_new_panel_io_spi((esp_lcd_spi_bus_handle_t)LCD_
    ↪HOST, &io_config, &io_handle));
```

3. Install the LCD controller driver. The LCD controller driver is responsible for sending the commands and parameters to the LCD controller chip. In this step, you need to specify the SPI IO device handle that allocated in the last step, and some panel specific configurations:

- *esp\_lcd\_panel\_dev\_config\_t::reset\_gpio\_num* sets the LCD's hardware reset GPIO number. If the LCD does not have a hardware reset pin, set this to -1.

- `esp_lcd_panel_dev_config_t::rgb_ele_order` sets the R-G-B element order of each color data.
- `esp_lcd_panel_dev_config_t::bits_per_pixel` sets the bit width of the pixel color data. The LCD driver uses this value to calculate the number of bytes to send to the LCD controller chip.
- `esp_lcd_panel_dev_config_t::data_endian` specifies the data endian to be transmitted to the screen. No need to specify for color data within 1 byte, like RGB232. For drivers that do not support specifying data endian, this field would be ignored.

```
esp_lcd_panel_handle_t panel_handle = NULL;
esp_lcd_panel_dev_config_t panel_config = {
    .reset_gpio_num = EXAMPLE_PIN_NUM_RST,
    .rgb_ele_order = LCD_RGB_ELEMENT_ORDER_BGR,
    .bits_per_pixel = 16,
};
// Create LCD panel handle for ST7789, with the SPI IO device handle
ESP_ERROR_CHECK(esp_lcd_new_panel_st7789(io_handle, &panel_config, &
↪panel_handle));
```

## I2C Interfaced LCD

1. Create I2C bus. Please refer to *I2C API doc* for more details.

```
i2c_config_t i2c_conf = {
    .mode = I2C_MODE_MASTER, // I2C LCD is a master node
    .sda_io_num = EXAMPLE_PIN_NUM_SDA,
    .scl_io_num = EXAMPLE_PIN_NUM_SCL,
    .sda_pullup_en = GPIO_PULLUP_ENABLE,
    .scl_pullup_en = GPIO_PULLUP_ENABLE,
    .master.clk_speed = EXAMPLE_LCD_PIXEL_CLOCK_HZ,
};
ESP_ERROR_CHECK(i2c_param_config(I2C_HOST, &i2c_conf));
ESP_ERROR_CHECK(i2c_driver_install(I2C_HOST, I2C_MODE_MASTER, 0, 0, ↪
↪0));
```

2. Allocate an LCD IO device handle from the I2C bus. In this step, you need to provide the following information:
  - `esp_lcd_panel_io_i2c_config_t::dev_addr` sets the I2C device address of the LCD controller chip. The LCD driver will use this address to communicate with the LCD controller chip.
  - `esp_lcd_panel_io_i2c_config_t::lcd_cmd_bits` and `esp_lcd_panel_io_i2c_config_t::lcd_param_bits` set the bit width of the command and parameter that recognized by the LCD controller chip. This is chip specific, you should refer to your LCD spec in advance.

```
esp_lcd_panel_io_handle_t io_handle = NULL;
esp_lcd_panel_io_i2c_config_t io_config = {
    .dev_addr = EXAMPLE_I2C_HW_ADDR,
    .control_phase_bytes = 1, // refer to LCD spec
    .dc_bit_offset = 6, // refer to LCD spec
    .lcd_cmd_bits = EXAMPLE_LCD_CMD_BITS,
    .lcd_param_bits = EXAMPLE_LCD_CMD_BITS,
};
ESP_ERROR_CHECK(esp_lcd_new_panel_io_i2c((esp_lcd_i2c_bus_handle_t)I2C_
↪HOST, &io_config, &io_handle));
```

3. Install the LCD controller driver. The LCD controller driver is responsible for sending the commands and parameters to the LCD controller chip. In this step, you need to specify the I2C IO device handle that allocated in the last step, and some panel specific configurations:
  - `esp_lcd_panel_dev_config_t::reset_gpio_num` sets the LCD's hardware reset GPIO number. If the LCD does not have a hardware reset pin, set this to -1.

- `esp_lcd_panel_dev_config_t::bits_per_pixel` sets the bit width of the pixel color data. The LCD driver will use this value to calculate the number of bytes to send to the LCD controller chip.

```
esp_lcd_panel_handle_t panel_handle = NULL;
esp_lcd_panel_dev_config_t panel_config = {
    .bits_per_pixel = 1,
    .reset_gpio_num = EXAMPLE_PIN_NUM_RST,
};
ESP_ERROR_CHECK(esp_lcd_new_panel_ssd1306(io_handle, &panel_config, &
↪panel_handle));
```

## I80 Interfaced LCD

1. Create I80 bus by `esp_lcd_new_i80_bus()`. You need to set up the following parameters for an Intel 8080 parallel bus:

- `esp_lcd_i80_bus_config_t::clk_src` sets the clock source of the I80 bus. Note, the default clock source may be different between ESP targets.
- `esp_lcd_i80_bus_config_t::wr_gpio_num` sets the GPIO number of the pixel clock (also referred as WR in some LCD spec)
- `esp_lcd_i80_bus_config_t::dc_gpio_num` sets the GPIO number of the data/command select pin (also referred as RS in some LCD spec)
- `esp_lcd_i80_bus_config_t::bus_width` sets the bit width of the data bus (only support 8 or 16)
- `esp_lcd_i80_bus_config_t::data_gpio_nums` is the array of the GPIO number of the data bus. The number of GPIOs should be equal to the `esp_lcd_i80_bus_config_t::bus_width` value.
- `esp_lcd_i80_bus_config_t::max_transfer_bytes` sets the maximum number of bytes that can be transferred in one transaction.

```
esp_lcd_i80_bus_handle_t i80_bus = NULL;
esp_lcd_i80_bus_config_t bus_config = {
    .clk_src = LCD_CLK_SRC_DEFAULT,
    .dc_gpio_num = EXAMPLE_PIN_NUM_DC,
    .wr_gpio_num = EXAMPLE_PIN_NUM_PCLK,
    .data_gpio_nums = {
        EXAMPLE_PIN_NUM_DATA0,
        EXAMPLE_PIN_NUM_DATA1,
        EXAMPLE_PIN_NUM_DATA2,
        EXAMPLE_PIN_NUM_DATA3,
        EXAMPLE_PIN_NUM_DATA4,
        EXAMPLE_PIN_NUM_DATA5,
        EXAMPLE_PIN_NUM_DATA6,
        EXAMPLE_PIN_NUM_DATA7,
    },
    .bus_width = 8,
    .max_transfer_bytes = EXAMPLE_LCD_H_RES * 100 * sizeof(uint16_t), /
↪/ transfer 100 lines of pixels (assume pixel is RGB565) at most in
↪one transaction
    .psram_trans_align = EXAMPLE_PSRAM_DATA_ALIGNMENT,
    .sram_trans_align = 4,
};
ESP_ERROR_CHECK(esp_lcd_new_i80_bus(&bus_config, &i80_bus));
```

2. Allocate an LCD IO device handle from the I80 bus. In this step, you need to provide the following information:
  - `esp_lcd_panel_io_i80_config_t::cs_gpio_num` sets the GPIO number of the chip select pin.
  - `esp_lcd_panel_io_i80_config_t::pclk_hz` sets the pixel clock frequency in Hz. Higher pixel clock frequency will result in higher refresh rate, but may cause flickering if the DMA bandwidth is not sufficient or the LCD controller chip does not support high

pixel clock frequency.

- `esp_lcd_panel_io_i80_config_t::lcd_cmd_bits` and `esp_lcd_panel_io_i80_config_t::lcd_param_bits` set the bit width of the command and parameter that recognized by the LCD controller chip. This is chip specific, you should refer to your LCD spec in advance.
- `esp_lcd_panel_io_i80_config_t::trans_queue_depth` sets the maximum number of transactions that can be queued in the LCD IO device. A bigger value means more transactions can be queued up, but it also consumes more memory.

```
esp_lcd_panel_io_handle_t io_handle = NULL;
esp_lcd_panel_io_i80_config_t io_config = {
    .cs_gpio_num = EXAMPLE_PIN_NUM_CS,
    .pclk_hz = EXAMPLE_LCD_PIXEL_CLOCK_HZ,
    .trans_queue_depth = 10,
    .dc_levels = {
        .dc_idle_level = 0,
        .dc_cmd_level = 0,
        .dc_dummy_level = 0,
        .dc_data_level = 1,
    },
    .lcd_cmd_bits = EXAMPLE_LCD_CMD_BITS,
    .lcd_param_bits = EXAMPLE_LCD_PARAM_BITS,
};
ESP_ERROR_CHECK(esp_lcd_new_panel_io_i80(i80_bus, &io_config, &io_
↪handle));
```

3. Install the LCD controller driver. The LCD controller driver is responsible for sending the commands and parameters to the LCD controller chip. In this step, you need to specify the I80 IO device handle that allocated in the last step, and some panel specific configurations:

- `esp_lcd_panel_dev_config_t::bits_per_pixel` sets the bit width of the pixel color data. The LCD driver will use this value to calculate the number of bytes to send to the LCD controller chip.
- `esp_lcd_panel_dev_config_t::reset_gpio_num` sets the GPIO number of the reset pin. If the LCD controller chip does not have a reset pin, you can set this value to -1.
- `esp_lcd_panel_dev_config_t::rgb_ele_order` sets the color order the pixel color data.

```
esp_lcd_panel_dev_config_t panel_config = {
    .reset_gpio_num = EXAMPLE_PIN_NUM_RST,
    .rgb_ele_order = LCD_RGB_ELEMENT_ORDER_RGB,
    .bits_per_pixel = 16,
};
ESP_ERROR_CHECK(esp_lcd_new_panel_st7789(io_handle, &panel_config, &
↪panel_handle));
```

### More Controller Based LCD Drivers

More LCD panel drivers and touch drivers are available in [IDF Component Registry](#). The list of available and planned drivers with links is in this [table](#).

### LCD Panel IO Operations

- `esp_lcd_panel_reset()` can reset the LCD panel.
- Use `esp_lcd_panel_swap_xy()` and `esp_lcd_panel_mirror()`, you can rotate the LCD screen.
- `esp_lcd_panel_disp_on_off()` can turn on or off the LCD screen (different from LCD backlight).
- `esp_lcd_panel_draw_bitmap()` is the most significant function, that will do the magic to draw the user provided color buffer to the LCD screen, where the draw window is also configurable.

## Application Example

LCD examples are located under: [peripherals/lcd](#):

- Universal SPI LCD example with SPI touch - [peripherals/lcd/spi\\_lcd\\_touch](#)
- Jpeg decoding and LCD display - [peripherals/lcd/tjpgd](#)
- i80 controller based LCD and LVGL animation UI - [peripherals/lcd/i80\\_controller](#)
- RGB panel example with scatter chart UI - [peripherals/lcd/rgb\\_panel](#)
- I2C interfaced OLED display scrolling text - [peripherals/lcd/i2c\\_oled](#)

## API Reference

### Header File

- [components/hal/include/hal/lcd\\_types.h](#)

### Type Definitions

typedef *soc\_periph\_lcd\_clk\_src\_t* **lcd\_clock\_source\_t**  
LCD clock source.

### Enumerations

enum **lcd\_rgb\_element\_order\_t**  
RGB color endian.

*Values:*

enumerator **LCD\_RGB\_ELEMENT\_ORDER\_RGB**  
RGB element order: RGB

enumerator **LCD\_RGB\_ELEMENT\_ORDER\_BGR**  
RGB element order: BGR

enum **lcd\_rgb\_data\_endian\_t**  
RGB data endian.

*Values:*

enumerator **LCD\_RGB\_DATA\_ENDIAN\_BIG**  
RGB data endian: MSB first

enumerator **LCD\_RGB\_DATA\_ENDIAN\_LITTLE**  
RGB data endian: LSB first

enum **lcd\_color\_space\_t**  
LCD color space.

*Values:*

enumerator **LCD\_COLOR\_SPACE\_RGB**  
Color space: RGB

enumerator **LCD\_COLOR\_SPACE\_YUV**

Color space: YUV

enum **lcd\_color\_range\_t**

LCD color range.

*Values:*

enumerator **LCD\_COLOR\_RANGE\_LIMIT**

Limited color range

enumerator **LCD\_COLOR\_RANGE\_FULL**

Full color range

enum **lcd\_yuv\_sample\_t**

YUV sampling method.

*Values:*

enumerator **LCD\_YUV\_SAMPLE\_422**

YUV 4:2:2 sampling

enumerator **LCD\_YUV\_SAMPLE\_420**

YUV 4:2:0 sampling

enumerator **LCD\_YUV\_SAMPLE\_411**

YUV 4:1:1 sampling

enum **lcd\_yuv\_conv\_std\_t**

The standard used for conversion between RGB and YUV.

*Values:*

enumerator **LCD\_YUV\_CONV\_STD\_BT601**

YUV<->RGB conversion standard: BT.601

enumerator **LCD\_YUV\_CONV\_STD\_BT709**

YUV<->RGB conversion standard: BT.709

### Header File

- [components/esp\\_lcd/include/esp\\_lcd\\_types.h](#)

### Type Definitions

typedef struct esp\_lcd\_panel\_io\_t \***esp\_lcd\_panel\_io\_handle\_t**

Type of LCD panel IO handle

typedef struct esp\_lcd\_panel\_t \***esp\_lcd\_panel\_handle\_t**

Type of LCD panel handle

## Header File

- `components/esp_lcd/include/esp_lcd_panel_io.h`

## Functions

`esp_err_t esp_lcd_panel_io_rx_param(esp_lcd_panel_io_handle_t io, int lcd_cmd, void *param, size_t param_size)`

Transmit LCD command and receive corresponding parameters.

---

**Note:** Commands sent by this function are short, so they are sent using polling transactions. The function does not return before the command transfer is completed. If any queued transactions sent by `esp_lcd_panel_io_tx_color()` are still pending when this function is called, this function will wait until they are finished and the queue is empty before sending the command(s).

---

### Parameters

- **io** `-[in]` LCD panel IO handle, which is created by other factory API like `esp_lcd_new_panel_io_spi()`
- **lcd\_cmd** `-[in]` The specific LCD command, set to -1 if no command needed
- **param** `-[out]` Buffer for the command data
- **param\_size** `-[in]` Size of `param` buffer

### Returns

- `ESP_ERR_INVALID_ARG` if parameter is invalid
- `ESP_ERR_NOT_SUPPORTED` if read is not supported by transport
- `ESP_OK` on success

`esp_err_t esp_lcd_panel_io_tx_param(esp_lcd_panel_io_handle_t io, int lcd_cmd, const void *param, size_t param_size)`

Transmit LCD command and corresponding parameters.

---

**Note:** Commands sent by this function are short, so they are sent using polling transactions. The function does not return before the command transfer is completed. If any queued transactions sent by `esp_lcd_panel_io_tx_color()` are still pending when this function is called, this function will wait until they are finished and the queue is empty before sending the command(s).

---

### Parameters

- **io** `-[in]` LCD panel IO handle, which is created by other factory API like `esp_lcd_new_panel_io_spi()`
- **lcd\_cmd** `-[in]` The specific LCD command, set to -1 if no command needed
- **param** `-[in]` Buffer that holds the command specific parameters, set to `NULL` if no parameter is needed for the command
- **param\_size** `-[in]` Size of `param` in memory, in bytes, set to zero if no parameter is needed for the command

### Returns

- `ESP_ERR_INVALID_ARG` if parameter is invalid
- `ESP_OK` on success

`esp_err_t esp_lcd_panel_io_tx_color(esp_lcd_panel_io_handle_t io, int lcd_cmd, const void *color, size_t color_size)`

Transmit LCD RGB data.

---

**Note:** This function will package the command and RGB data into a transaction, and push into a queue. The real transmission is performed in the background (DMA+interrupt). The caller should take care of the lifecycle of the `color` buffer. Recycling of color buffer should be done in the callback `on_color_trans_done()`.

---



**Parameters**

- **io** **-[in]** LCD panel IO handle, which is created by factory API like `esp_lcd_new_panel_io_spi()`
- **lcd\_cmd** **-[in]** The specific LCD command, set to -1 if no command needed
- **color** **-[in]** Buffer that holds the RGB color data
- **color\_size** **-[in]** Size of `color` in memory, in bytes

**Returns**

- `ESP_ERR_INVALID_ARG` if parameter is invalid
- `ESP_OK` on success

`esp_err_t esp_lcd_panel_io_del(esp_lcd_panel_io_handle_t io)`

Destroy LCD panel IO handle (deinitialize panel and free all corresponding resource)

**Parameters** **io** **-[in]** LCD panel IO handle, which is created by factory API like `esp_lcd_new_panel_io_spi()`

**Returns**

- `ESP_ERR_INVALID_ARG` if parameter is invalid
- `ESP_OK` on success

`esp_err_t esp_lcd_panel_io_register_event_callbacks(esp_lcd_panel_io_handle_t io, const esp_lcd_panel_io_callbacks_t *cbs, void *user_ctx)`

Register LCD panel IO callbacks.

**Parameters**

- **io** **-[in]** LCD panel IO handle, which is created by factory API like `esp_lcd_new_panel_io_spi()`
- **cbs** **-[in]** structure with all LCD panel IO callbacks
- **user\_ctx** **-[in]** User private data, passed directly to callback's `user_ctx`

**Returns**

- `ESP_ERR_INVALID_ARG` if parameter is invalid
- `ESP_OK` on success

`esp_err_t esp_lcd_new_panel_io_spi(esp_lcd_spi_bus_handle_t bus, const esp_lcd_panel_io_spi_config_t *io_config, esp_lcd_panel_io_handle_t *ret_io)`

Create LCD panel IO handle, for SPI interface.

**Parameters**

- **bus** **-[in]** SPI bus handle
- **io\_config** **-[in]** IO configuration, for SPI interface
- **ret\_io** **-[out]** Returned IO handle

**Returns**

- `ESP_ERR_INVALID_ARG` if parameter is invalid
- `ESP_ERR_NO_MEM` if out of memory
- `ESP_OK` on success

`esp_err_t esp_lcd_new_panel_io_i2c(esp_lcd_i2c_bus_handle_t bus, const esp_lcd_panel_io_i2c_config_t *io_config, esp_lcd_panel_io_handle_t *ret_io)`

Create LCD panel IO handle, for I2C interface.

**Parameters**

- **bus** **-[in]** I2C bus handle
- **io\_config** **-[in]** IO configuration, for I2C interface
- **ret\_io** **-[out]** Returned IO handle

**Returns**

- `ESP_ERR_INVALID_ARG` if parameter is invalid
- `ESP_ERR_NO_MEM` if out of memory
- `ESP_OK` on success

*esp\_err\_t* **esp\_lcd\_new\_i80\_bus** (const *esp\_lcd\_i80\_bus\_config\_t* \*bus\_config, *esp\_lcd\_i80\_bus\_handle\_t* \*ret\_bus)

Create Intel 8080 bus handle.

#### Parameters

- **bus\_config** –[in] Bus configuration
- **ret\_bus** –[out] Returned bus handle

#### Returns

- ESP\_ERR\_INVALID\_ARG if parameter is invalid
- ESP\_ERR\_NO\_MEM if out of memory
- ESP\_ERR\_NOT\_FOUND if no free bus is available
- ESP\_OK on success

*esp\_err\_t* **esp\_lcd\_del\_i80\_bus** (*esp\_lcd\_i80\_bus\_handle\_t* bus)

Destroy Intel 8080 bus handle.

**Parameters** **bus** –[in] Intel 8080 bus handle, created by `esp_lcd_new_i80_bus()`

#### Returns

- ESP\_ERR\_INVALID\_ARG if parameter is invalid
- ESP\_ERR\_INVALID\_STATE if there still be some device attached to the bus
- ESP\_OK on success

*esp\_err\_t* **esp\_lcd\_new\_panel\_io\_i80** (*esp\_lcd\_i80\_bus\_handle\_t* bus, const *esp\_lcd\_panel\_io\_i80\_config\_t* \*io\_config, *esp\_lcd\_panel\_io\_handle\_t* \*ret\_io)

Create LCD panel IO, for Intel 8080 interface.

#### Parameters

- **bus** –[in] Intel 8080 bus handle, created by `esp_lcd_new_i80_bus()`
- **io\_config** –[in] IO configuration, for i80 interface
- **ret\_io** –[out] Returned panel IO handle

#### Returns

- ESP\_ERR\_INVALID\_ARG if parameter is invalid
- ESP\_ERR\_NOT\_SUPPORTED if some configuration can't be satisfied, e.g. pixel clock out of the range
- ESP\_ERR\_NO\_MEM if out of memory
- ESP\_OK on success

## Structures

struct **esp\_lcd\_panel\_io\_event\_data\_t**

Type of LCD panel IO event data.

struct **esp\_lcd\_panel\_io\_callbacks\_t**

Type of LCD panel IO callbacks.

## Public Members

*esp\_lcd\_panel\_io\_color\_trans\_done\_cb\_t* **on\_color\_trans\_done**

Callback invoked when color data transfer has finished

struct **esp\_lcd\_panel\_io\_spi\_config\_t**

Panel IO configuration structure, for SPI interface.

## Public Members

int **cs\_gpio\_num**  
GPIO used for CS line

int **dc\_gpio\_num**  
GPIO used to select the D/C line, set this to -1 if the D/C line is not used

int **spi\_mode**  
Traditional SPI mode (0~3)

unsigned int **pclk\_hz**  
Frequency of pixel clock

size\_t **trans\_queue\_depth**  
Size of internal transaction queue

*esp\_lcd\_panel\_io\_color\_trans\_done\_cb\_t* **on\_color\_trans\_done**  
Callback invoked when color data transfer has finished

void \***user\_ctx**  
User private data, passed directly to `on_color_trans_done`'s `user_ctx`

int **lcd\_cmd\_bits**  
Bit-width of LCD command

int **lcd\_param\_bits**  
Bit-width of LCD parameter

unsigned int **dc\_high\_on\_cmd**  
If enabled, DC level = 1 indicates command transfer

unsigned int **dc\_low\_on\_data**  
If enabled, DC level = 0 indicates color data transfer

unsigned int **dc\_low\_on\_param**  
If enabled, DC level = 0 indicates parameter transfer

unsigned int **octal\_mode**  
transmit with octal mode (8 data lines), this mode is used to simulate Intel 8080 timing

unsigned int **quad\_mode**  
transmit with quad mode (4 data lines), this mode is useful when transmitting LCD parameters (Only use one line for command)

unsigned int **sio\_mode**  
Read and write through a single data line (MOSI)

unsigned int **lsb\_first**  
transmit LSB bit first

unsigned int **cs\_high\_active**

CS line is high active

struct *esp\_lcd\_panel\_io\_spi\_config\_t*::[anonymous] **flags**

Extra flags to fine-tune the SPI device

struct **esp\_lcd\_panel\_io\_i2c\_config\_t**

Panel IO configuration structure, for I2C interface.

### Public Members

uint32\_t **dev\_addr**

I2C device address

*esp\_lcd\_panel\_io\_color\_trans\_done\_cb\_t* **on\_color\_trans\_done**

Callback invoked when color data transfer has finished

void \***user\_ctx**

User private data, passed directly to *on\_color\_trans\_done*'s *user\_ctx*

size\_t **control\_phase\_bytes**

I2C LCD panel will encode control information (e.g. D/C selection) into control phase, in several bytes

unsigned int **dc\_bit\_offset**

Offset of the D/C selection bit in control phase

int **lcd\_cmd\_bits**

Bit-width of LCD command

int **lcd\_param\_bits**

Bit-width of LCD parameter

unsigned int **dc\_low\_on\_data**

If this flag is enabled, DC line = 0 means transfer data, DC line = 1 means transfer command; vice versa

unsigned int **disable\_control\_phase**

If this flag is enabled, the control phase isn't used

struct *esp\_lcd\_panel\_io\_i2c\_config\_t*::[anonymous] **flags**

Extra flags to fine-tune the I2C device

struct **esp\_lcd\_i80\_bus\_config\_t**

LCD Intel 8080 bus configuration structure.

### Public Members

int **dc\_gpio\_num**  
GPIO used for D/C line

int **wr\_gpio\_num**  
GPIO used for WR line

*lcd\_clock\_source\_t* **clk\_src**  
Clock source for the I80 LCD peripheral

int **data\_gpio\_nums**[(24)]  
GPIOs used for data lines

size\_t **bus\_width**  
Number of data lines, 8 or 16

size\_t **max\_transfer\_bytes**  
Maximum transfer size, this determines the length of internal DMA link

size\_t **psram\_trans\_align**  
DMA transfer alignment for data allocated from PSRAM

size\_t **sram\_trans\_align**  
DMA transfer alignment for data allocated from SRAM

struct **esp\_lcd\_panel\_io\_i80\_config\_t**  
Panel IO configuration structure, for intel 8080 interface.

### Public Members

int **cs\_gpio\_num**  
GPIO used for CS line, set to -1 will declaim exclusively use of I80 bus

uint32\_t **pclk\_hz**  
Frequency of pixel clock

size\_t **trans\_queue\_depth**  
Transaction queue size, larger queue, higher throughput

*esp\_lcd\_panel\_io\_color\_trans\_done\_cb\_t* **on\_color\_trans\_done**  
Callback invoked when color data was transferred done

void **\*user\_ctx**  
User private data, passed directly to `on_color_trans_done`'s `user_ctx`

int **lcd\_cmd\_bits**  
Bit-width of LCD command

int **lcd\_param\_bits**  
Bit-width of LCD parameter

unsigned int **dc\_idle\_level**  
Level of DC line in IDLE phase

unsigned int **dc\_cmd\_level**  
Level of DC line in CMD phase

unsigned int **dc\_dummy\_level**  
Level of DC line in DUMMY phase

unsigned int **dc\_data\_level**  
Level of DC line in DATA phase

struct *esp\_lcd\_panel\_io\_i80\_config\_t*::[anonymous] **dc\_levels**  
Each i80 device might have its own D/C control logic

unsigned int **cs\_active\_high**  
If set, a high level of CS line will select the device, otherwise, CS line is low level active

unsigned int **reverse\_color\_bits**  
Reverse the data bits, D[N:0] -> D[0:N]

unsigned int **swap\_color\_bytes**  
Swap adjacent two color bytes

unsigned int **pclk\_active\_neg**  
The display will write data lines when there's a falling edge on WR signal (a.k.a the PCLK)

unsigned int **pclk\_idle\_low**  
The WR signal (a.k.a the PCLK) stays at low level in IDLE phase

struct *esp\_lcd\_panel\_io\_i80\_config\_t*::[anonymous] **flags**  
Panel IO config flags

### Type Definitions

typedef void **\*esp\_lcd\_spi\_bus\_handle\_t**  
Type of LCD SPI bus handle

typedef void **\*esp\_lcd\_i2c\_bus\_handle\_t**  
Type of LCD I2C bus handle

typedef struct esp\_lcd\_i80\_bus\_t **\*esp\_lcd\_i80\_bus\_handle\_t**  
Type of LCD intel 8080 bus handle

typedef bool (**\*esp\_lcd\_panel\_io\_color\_trans\_done\_cb\_t**)(*esp\_lcd\_panel\_io\_handle\_t* panel\_io, *esp\_lcd\_panel\_io\_event\_data\_t* \*edata, void \*user\_ctx)  
Declare the prototype of the function that will be invoked when panel IO finishes transferring color data.

**Param panel\_io [in]** LCD panel IO handle, which is created by factory API like `esp_lcd_new_panel_io_spi()`  
**Param edata [in]** Panel IO event data, fed by driver  
**Param user\_ctx [in]** User data, passed from `esp_lcd_panel_io_XXX_config_t`  
**Return** Whether a high priority task has been waken up by this function

### Header File

- `components/esp_lcd/include/esp_lcd_panel_ops.h`

### Functions

*esp\_err\_t* **esp\_lcd\_panel\_reset** (*esp\_lcd\_panel\_handle\_t* panel)

Reset LCD panel.

---

**Note:** Panel reset must be called before attempting to initialize the panel using `esp_lcd_panel_init()`.

---

**Parameters panel** **[in]** LCD panel handle, which is created by other factory API like `esp_lcd_new_panel_st7789()`

#### Returns

- ESP\_OK on success

*esp\_err\_t* **esp\_lcd\_panel\_init** (*esp\_lcd\_panel\_handle\_t* panel)

Initialize LCD panel.

---

**Note:** Before calling this function, make sure the LCD panel has finished the reset stage by `esp_lcd_panel_reset()`.

---

**Parameters panel** **[in]** LCD panel handle, which is created by other factory API like `esp_lcd_new_panel_st7789()`

#### Returns

- ESP\_OK on success

*esp\_err\_t* **esp\_lcd\_panel\_del** (*esp\_lcd\_panel\_handle\_t* panel)

Deinitialize the LCD panel.

**Parameters panel** **[in]** LCD panel handle, which is created by other factory API like `esp_lcd_new_panel_st7789()`

#### Returns

- ESP\_OK on success

*esp\_err\_t* **esp\_lcd\_panel\_draw\_bitmap** (*esp\_lcd\_panel\_handle\_t* panel, int x\_start, int y\_start, int x\_end, int y\_end, const void \*color\_data)

Draw bitmap on LCD panel.

#### Parameters

- **panel** **[in]** LCD panel handle, which is created by other factory API like `esp_lcd_new_panel_st7789()`
- **x\_start** **[in]** Start index on x-axis (x\_start included)
- **y\_start** **[in]** Start index on y-axis (y\_start included)
- **x\_end** **[in]** End index on x-axis (x\_end not included)
- **y\_end** **[in]** End index on y-axis (y\_end not included)
- **color\_data** **[in]** RGB color data that will be dumped to the specific window range

#### Returns

- ESP\_OK on success

*esp\_err\_t* **esp\_lcd\_panel\_mirror** (*esp\_lcd\_panel\_handle\_t* panel, bool mirror\_x, bool mirror\_y)

Mirror the LCD panel on specific axis.

---

**Note:** Combined with `esp_lcd_panel_swap_xy()`, one can realize screen rotation

---

#### Parameters

- **panel** **–[in]** LCD panel handle, which is created by other factory API like `esp_lcd_new_panel_st7789()`
- **mirror\_x** **–[in]** Whether the panel will be mirrored about the x axis
- **mirror\_y** **–[in]** Whether the panel will be mirrored about the y axis

#### Returns

- ESP\_OK on success
- ESP\_ERR\_NOT\_SUPPORTED if this function is not supported by the panel

*esp\_err\_t* **esp\_lcd\_panel\_swap\_xy** (*esp\_lcd\_panel\_handle\_t* panel, bool swap\_axes)

Swap/Exchange x and y axis.

---

**Note:** Combined with `esp_lcd_panel_mirror()`, one can realize screen rotation

---

#### Parameters

- **panel** **–[in]** LCD panel handle, which is created by other factory API like `esp_lcd_new_panel_st7789()`
- **swap\_axes** **–[in]** Whether to swap the x and y axis

#### Returns

- ESP\_OK on success
- ESP\_ERR\_NOT\_SUPPORTED if this function is not supported by the panel

*esp\_err\_t* **esp\_lcd\_panel\_set\_gap** (*esp\_lcd\_panel\_handle\_t* panel, int x\_gap, int y\_gap)

Set extra gap in x and y axis.

The gap is the space (in pixels) between the left/top sides of the LCD panel and the first row/column respectively of the actual contents displayed.

---

**Note:** Setting a gap is useful when positioning or centering a frame that is smaller than the LCD.

---

#### Parameters

- **panel** **–[in]** LCD panel handle, which is created by other factory API like `esp_lcd_new_panel_st7789()`
- **x\_gap** **–[in]** Extra gap on x axis, in pixels
- **y\_gap** **–[in]** Extra gap on y axis, in pixels

#### Returns

- ESP\_OK on success

*esp\_err\_t* **esp\_lcd\_panel\_invert\_color** (*esp\_lcd\_panel\_handle\_t* panel, bool invert\_color\_data)

Invert the color (bit-wise invert the color data line)

#### Parameters

- **panel** **–[in]** LCD panel handle, which is created by other factory API like `esp_lcd_new_panel_st7789()`
- **invert\_color\_data** **–[in]** Whether to invert the color data

#### Returns

- ESP\_OK on success



*esp\_err\_t* **esp\_lcd\_panel\_disp\_on\_off** (*esp\_lcd\_panel\_handle\_t* panel, bool on\_off)

Turn on or off the display.

#### Parameters

- **panel** **–[in]** LCD panel handle, which is created by other factory API like `esp_lcd_new_panel_st7789()`
- **on\_off** **–[in]** True to turns on display, False to turns off display

#### Returns

- ESP\_OK on success
- ESP\_ERR\_NOT\_SUPPORTED if this function is not supported by the panel

*esp\_err\_t* **esp\_lcd\_panel\_disp\_off** (*esp\_lcd\_panel\_handle\_t* panel, bool off)

Turn off the display.

#### Parameters

- **panel** **–[in]** LCD panel handle, which is created by other factory API like `esp_lcd_new_panel_st7789()`
- **off** **–[in]** Whether to turn off the screen

#### Returns

- ESP\_OK on success
- ESP\_ERR\_NOT\_SUPPORTED if this function is not supported by the panel

### Header File

- `components/esp_lcd/include/esp_lcd_panel_rgb.h`

### Header File

- `components/esp_lcd/include/esp_lcd_panel_vendor.h`

### Functions

*esp\_err\_t* **esp\_lcd\_new\_panel\_st7789** (const *esp\_lcd\_panel\_io\_handle\_t* io, const *esp\_lcd\_panel\_dev\_config\_t* \*panel\_dev\_config, *esp\_lcd\_panel\_handle\_t* \*ret\_panel)

Create LCD panel for model ST7789.

#### Parameters

- **io** **–[in]** LCD panel IO handle
- **panel\_dev\_config** **–[in]** general panel device configuration
- **ret\_panel** **–[out]** Returned LCD panel handle

#### Returns

- ESP\_ERR\_INVALID\_ARG if parameter is invalid
- ESP\_ERR\_NO\_MEM if out of memory
- ESP\_OK on success

*esp\_err\_t* **esp\_lcd\_new\_panel\_nt35510** (const *esp\_lcd\_panel\_io\_handle\_t* io, const *esp\_lcd\_panel\_dev\_config\_t* \*panel\_dev\_config, *esp\_lcd\_panel\_handle\_t* \*ret\_panel)

Create LCD panel for model NT35510.

#### Parameters

- **io** **–[in]** LCD panel IO handle
- **panel\_dev\_config** **–[in]** general panel device configuration
- **ret\_panel** **–[out]** Returned LCD panel handle

#### Returns

- ESP\_ERR\_INVALID\_ARG if parameter is invalid
- ESP\_ERR\_NO\_MEM if out of memory
- ESP\_OK on success

```
esp_err_t esp_lcd_new_panel_ssd1306 (const esp_lcd_panel_io_handle_t io, const  
                                     esp_lcd_panel_dev_config_t *panel_dev_config,  
                                     esp_lcd_panel_handle_t *ret_panel)
```

Create LCD panel for model SSD1306.

#### Parameters

- **io** –[in] LCD panel IO handle
- **panel\_dev\_config** –[in] general panel device configuration
- **ret\_panel** –[out] Returned LCD panel handle

#### Returns

- ESP\_ERR\_INVALID\_ARG if parameter is invalid
- ESP\_ERR\_NO\_MEM if out of memory
- ESP\_OK on success

## Structures

```
struct esp_lcd_panel_dev_config_t
```

Configuration structure for panel device.

### Public Members

```
int reset_gpio_num
```

GPIO used to reset the LCD panel, set to -1 if it's not used

```
esp_lcd_color_space_t color_space
```

*Deprecated:*

Set RGB color space, please use `rgb_ele_order` instead

```
lcd_color_rgb_endian_t rgb_endian
```

*Deprecated:*

Set RGB data endian, please use `rgb_ele_order` instead

```
lcd_rgb_element_order_t rgb_ele_order
```

Set RGB element order, RGB or BGR

```
lcd_rgb_data_endian_t data_endian
```

Set the data endian for color data larger than 1 byte

```
unsigned int bits_per_pixel
```

Color depth, in bpp

```
unsigned int reset_active_high
```

Setting this if the panel reset is high level active

```
struct esp_lcd_panel_dev_config_t::[anonymous] flags
```

LCD panel config flags

```
void *vendor_config
```

vendor specific configuration, optional, left as NULL if not used

## 2.5.14 LED Control (LEDC)

### Introduction

The LED control (LEDC) peripheral is primarily designed to control the intensity of LEDs, although it can also be used to generate PWM signals for other purposes. It has 8 channels which can generate independent waveforms that can be used, for example, to drive RGB LED devices.

The PWM controller can automatically increase or decrease the duty cycle gradually, allowing for fades without any processor interference.

### Functionality Overview

Setting up a channel of the LEDC is done in three steps. Note that unlike ESP32, ESP32-S2 only supports configuring channels in “low speed” mode.

1. *Timer Configuration* by specifying the PWM signal’s frequency and duty cycle resolution.
2. *Channel Configuration* by associating it with the timer and GPIO to output the PWM signal.
3. *Change PWM Signal* that drives the output in order to change LED’s intensity. This can be done under the full control of software or with hardware fading functions.

As an optional step, it is also possible to set up an interrupt on fade end.

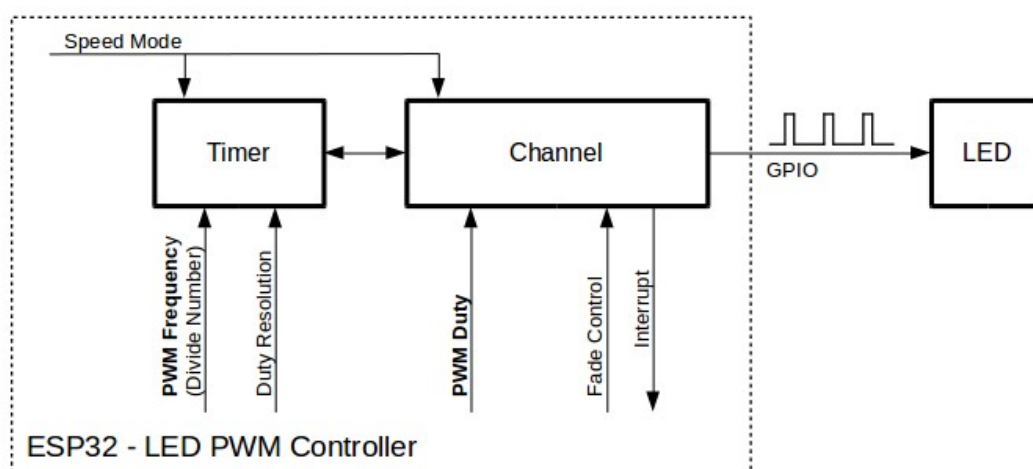

Fig. 8: Key Settings of LED PWM Controller’s API

**Timer Configuration** Setting the timer is done by calling the function `ledc_timer_config()` and passing the data structure `ledc_timer_config_t` that contains the following configuration settings:

- Speed mode (value must be `LEDC_LOW_SPEED_MODE`)
- Timer number `ledc_timer_t`
- PWM signal frequency
- Resolution of PWM duty
- Source clock `ledc_clk_cfg_t`

The frequency and the duty resolution are interdependent. The higher the PWM frequency, the lower the duty resolution which is available, and vice versa. This relationship might be important if you are planning to use this API for purposes other than changing the intensity of LEDs. For more details, see Section [Supported Range of Frequency and Duty Resolutions](#).

The source clock can also limit the PWM frequency. The higher the source clock frequency, the higher the maximum PWM frequency can be configured.

Table 5: Characteristics of ESP32-S2 LEDC source clocks

Clock name	Clock freq	Clock capabilities
APB_CLK	80 MHz	/
REF_TICK	1 MHz	Dynamic Frequency Scaling compatible
RTC8M_CLK	~8 MHz	Dynamic Frequency Scaling compatible, Light sleep compatible
XTAL_CLK	40 MHz	Dynamic Frequency Scaling compatible

**Note:**

1. On ESP32-S2, if RTCxM\_CLK is chosen as the LEDC clock source, an internal calibration will be performed to get the exact frequency of the clock. This ensures the accuracy of output PWM signal frequency.

**Channel Configuration** When the timer is set up, configure the desired channel (one out of `ledc_channel_t`). This is done by calling the function `ledc_channel_config()`.

Similar to the timer configuration, the channel setup function should be passed a structure `ledc_channel_config_t` that contains the channel's configuration parameters.

At this point, the channel should start operating and generating the PWM signal on the selected GPIO, as configured in `ledc_channel_config_t`, with the frequency specified in the timer settings and the given duty cycle. The channel operation (signal generation) can be suspended at any time by calling the function `ledc_stop()`.

**Change PWM Signal** Once the channel starts operating and generating the PWM signal with the constant duty cycle and frequency, there are a couple of ways to change this signal. When driving LEDs, primarily the duty cycle is changed to vary the light intensity.

The following two sections describe how to change the duty cycle using software and hardware fading. If required, the signal's frequency can also be changed; it is covered in Section [Change PWM Frequency](#).

**Note:** All the timers and channels in the ESP32-S2's LED PWM Controller only support low speed mode. Any change of PWM settings must be explicitly triggered by software (see below).

**Change PWM Duty Cycle Using Software** To set the duty cycle, use the dedicated function `ledc_set_duty()`. After that, call `ledc_update_duty()` to activate the changes. To check the currently set value, use the corresponding `_get_` function `ledc_get_duty()`.

Another way to set the duty cycle, as well as some other channel parameters, is by calling `ledc_channel_config()` covered in Section [Channel Configuration](#).

The range of the duty cycle values passed to functions depends on selected `duty_resolution` and should be from 0 to  $(2^{**} \text{duty\_resolution})$ . For example, if the selected duty resolution is 10, then the duty cycle values can range from 0 to 1024. This provides the resolution of ~ 0.1%.

**Warning:** On ESP32-S2, when channel's bind timer selects its maximum duty resolution, the duty cycle value cannot be set to  $(2^{**} \text{duty\_resolution})$ . Otherwise, the internal duty counter in the hardware will overflow and be messed up.

**Change PWM Duty Cycle using Hardware** The LEDC hardware provides the means to gradually transition from one duty cycle value to another. To use this functionality, enable fading with `ledc_fade_func_install()` and then configure it by calling one of the available fading functions:

- `ledc_set_fade_with_time()`
- `ledc_set_fade_with_step()`
- `ledc_set_fade()`

Start fading with `ledc_fade_start()`. A fade can be operated in blocking or non-blocking mode, please check `ledc_fade_mode_t` for the difference between the two available fade modes. Note that with either fade mode, the next fade or fixed-duty update will not take effect until the last fade finishes or is stopped. `ledc_fade_stop()` has to be called to stop a fade that is in progress.

To get a notification about the completion of a fade operation, a fade end callback function can be registered for each channel by calling `ledc_cb_register()` after the fade service being installed. The fade end callback prototype is defined in `ledc_cb_t`, where you should return a boolean value from the callback function, indicating whether a high priority task is woken up by this callback function. It is worth mentioning, the callback and the function invoked by itself should be placed in IRAM, as the interrupt service routine is in IRAM. `ledc_cb_register()` will print a warning message if it finds the addresses of callback and user context are incorrect.

If not required anymore, fading and an associated interrupt can be disabled with `ledc_fade_func_uninstall()`.

**Change PWM Frequency** The LEDC API provides several ways to change the PWM frequency “on the fly” :

- Set the frequency by calling `ledc_set_freq()`. There is a corresponding function `ledc_get_freq()` to check the current frequency.
- Change the frequency and the duty resolution by calling `ledc_bind_channel_timer()` to bind some other timer to the channel.
- Change the channel's timer by calling `ledc_channel_config()`.

**More Control Over PWM** There are several lower level timer-specific functions that can be used to change PWM settings:

- `ledc_timer_set()`
- `ledc_timer_rst()`
- `ledc_timer_pause()`
- `ledc_timer_resume()`

The first two functions are called “behind the scenes” by `ledc_channel_config()` to provide a startup of a timer after it is configured.

**Use Interrupts** When configuring an LEDC channel, one of the parameters selected within `ledc_channel_config_t` is `ledc_intr_type_t` which triggers an interrupt on fade completion.

For registration of a handler to address this interrupt, call `ledc_isr_register()`.

### Supported Range of Frequency and Duty Resolutions

The LED PWM Controller is designed primarily to drive LEDs. It provides a large flexibility of PWM duty cycle settings. For instance, the PWM frequency of 5 kHz can have the maximum duty resolution of 13 bits. This means that the duty can be set anywhere from 0 to 100% with a resolution of ~0.012% ( $2^{**} 13 = 8192$  discrete levels of the LED intensity). Note, however, that these parameters depend on the clock signal clocking the LED PWM Controller

timer which in turn clocks the channel (see [timer configuration](#) and the *ESP32-S2 Technical Reference Manual > LED PWM Controller (LEDC)* [PDF]).

The LEDC can be used for generating signals at much higher frequencies that are sufficient enough to clock other devices, e.g., a digital camera module. In this case, the maximum available frequency is 40 MHz with duty resolution of 1 bit. This means that the duty cycle is fixed at 50% and cannot be adjusted.

The LEDC API is designed to report an error when trying to set a frequency and a duty resolution that exceed the range of LEDC's hardware. For example, an attempt to set the frequency to 20 MHz and the duty resolution to 3 bits will result in the following error reported on a serial monitor:

```
E (196) ledc: requested frequency and duty resolution cannot be achieved, try_
↪reducing freq_hz or duty_resolution. div_param=128
```

In such a situation, either the duty resolution or the frequency must be reduced. For example, setting the duty resolution to 2 will resolve this issue and will make it possible to set the duty cycle at 25% steps, i.e., at 25%, 50% or 75%.

The LEDC driver will also capture and report attempts to configure frequency / duty resolution combinations that are below the supported minimum, e.g.:

```
E (196) ledc: requested frequency and duty resolution cannot be achieved, try_
↪increasing freq_hz or duty_resolution. div_param=128000000
```

The duty resolution is normally set using `ledc_timer_bit_t`. This enumeration covers the range from 10 to 15 bits. If a smaller duty resolution is required (from 10 down to 1), enter the equivalent numeric values directly.

### Application Example

The LEDC change duty cycle and fading control example: [peripherals/ledc/ledc\\_fade](#).

The LEDC basic example: [peripherals/ledc/ledc\\_basic](#).

### API Reference

#### Header File

- `components/driver/include/driver/ledc.h`

#### Functions

`esp_err_t ledc_channel_config` (const `ledc_channel_config_t` \*ledc\_conf)

LEDC channel configuration Configure LEDC channel with the given channel/output gpio\_num/interrupt/source timer/frequency(Hz)/LEDC duty resolution.

**Parameters** `ledc_conf` –Pointer of LEDC channel configure struct

#### Returns

- ESP\_OK Success
- ESP\_ERR\_INVALID\_ARG Parameter error

`esp_err_t ledc_timer_config` (const `ledc_timer_config_t` \*timer\_conf)

LEDC timer configuration Configure LEDC timer with the given source timer/frequency(Hz)/duty\_resolution.

**Parameters** `timer_conf` –Pointer of LEDC timer configure struct

#### Returns

- ESP\_OK Success
- ESP\_ERR\_INVALID\_ARG Parameter error
- ESP\_FAIL Can not find a proper pre-divider number base on the given frequency and the current duty\_resolution.

*esp\_err\_t* **ledc\_update\_duty** (*ledc\_mode\_t* speed\_mode, *ledc\_channel\_t* channel)

LEDC update channel parameters.

---

**Note:** Call this function to activate the LEDC updated parameters. After `ledc_set_duty`, we need to call this function to update the settings. And the new LEDC parameters don't take effect until the next PWM cycle.

---

---

**Note:** `ledc_set_duty`, `ledc_set_duty_with_hpoint` and `ledc_update_duty` are not thread-safe, do not call these functions to control one LEDC channel in different tasks at the same time. A thread-safe version of API is `ledc_set_duty_and_update`

---

#### Parameters

- **speed\_mode** –Select the LEDC channel group with specified speed mode. Note that not all targets support high speed mode.
- **channel** –LEDC channel (0 - LEDC\_CHANNEL\_MAX-1), select from `ledc_channel_t`

#### Returns

- ESP\_OK Success
- ESP\_ERR\_INVALID\_ARG Parameter error

*esp\_err\_t* **ledc\_set\_pin** (int gpio\_num, *ledc\_mode\_t* speed\_mode, *ledc\_channel\_t* ledc\_channel)

Set LEDC output gpio.

---

**Note:** This function only routes the LEDC signal to GPIO through matrix, other LEDC resources initialization are not involved. Please use `ledc_channel_config()` instead to fully configure a LEDC channel.

---

#### Parameters

- **gpio\_num** –The LEDC output gpio
- **speed\_mode** –Select the LEDC channel group with specified speed mode. Note that not all targets support high speed mode.
- **ledc\_channel** –LEDC channel (0 - LEDC\_CHANNEL\_MAX-1), select from `ledc_channel_t`

#### Returns

- ESP\_OK Success
- ESP\_ERR\_INVALID\_ARG Parameter error

*esp\_err\_t* **ledc\_stop** (*ledc\_mode\_t* speed\_mode, *ledc\_channel\_t* channel, uint32\_t idle\_level)

LEDC stop. Disable LEDC output, and set idle level.

#### Parameters

- **speed\_mode** –Select the LEDC channel group with specified speed mode. Note that not all targets support high speed mode.
- **channel** –LEDC channel (0 - LEDC\_CHANNEL\_MAX-1), select from `ledc_channel_t`
- **idle\_level** –Set output idle level after LEDC stops.

#### Returns

- ESP\_OK Success
- ESP\_ERR\_INVALID\_ARG Parameter error

*esp\_err\_t* **ledc\_set\_freq** (*ledc\_mode\_t* speed\_mode, *ledc\_timer\_t* timer\_num, uint32\_t freq\_hz)

LEDC set channel frequency (Hz)

#### Parameters

- **speed\_mode** –Select the LEDC channel group with specified speed mode. Note that not all targets support high speed mode.

- **timer\_num** –LEDC timer index (0-3), select from `ledc_timer_t`
- **freq\_hz** –Set the LEDC frequency

**Returns**

- `ESP_OK` Success
- `ESP_ERR_INVALID_ARG` Parameter error
- `ESP_FAIL` Can not find a proper pre-divider number base on the given frequency and the current `duty_resolution`.

`uint32_t ledc_get_freq` (*ledc\_mode\_t* speed\_mode, *ledc\_timer\_t* timer\_num)

LEDC get channel frequency (Hz)

**Parameters**

- **speed\_mode** –Select the LEDC channel group with specified speed mode. Note that not all targets support high speed mode.
- **timer\_num** –LEDC timer index (0-3), select from `ledc_timer_t`

**Returns**

- 0 error
- Others Current LEDC frequency

*esp\_err\_t ledc\_set\_duty\_with\_hpoint* (*ledc\_mode\_t* speed\_mode, *ledc\_channel\_t* channel, `uint32_t` duty, `uint32_t` hpoint)

LEDC set duty and hpoint value Only after calling `ledc_update_duty` will the duty update.

---

**Note:** `ledc_set_duty`, `ledc_set_duty_with_hpoint` and `ledc_update_duty` are not thread-safe, do not call these functions to control one LEDC channel in different tasks at the same time. A thread-safe version of API is `ledc_set_duty_and_update`

---

---

**Note:** For ESP32, hardware does not support any duty change while a fade operation is running in progress on that channel. Other duty operations will have to wait until the fade operation has finished.

---

**Parameters**

- **speed\_mode** –Select the LEDC channel group with specified speed mode. Note that not all targets support high speed mode.
- **channel** –LEDC channel (0 - `LEDC_CHANNEL_MAX-1`), select from `ledc_channel_t`
- **duty** –Set the LEDC duty, the range of duty setting is  $[0, (2^{**}duty\_resolution)]$
- **hpoint** –Set the LEDC hpoint value, the range is  $[0, (2^{**}duty\_resolution)-1]$

**Returns**

- `ESP_OK` Success
- `ESP_ERR_INVALID_ARG` Parameter error

`int ledc_get_hpoint` (*ledc\_mode\_t* speed\_mode, *ledc\_channel\_t* channel)

LEDC get hpoint value, the counter value when the output is set high level.

**Parameters**

- **speed\_mode** –Select the LEDC channel group with specified speed mode. Note that not all targets support high speed mode.
- **channel** –LEDC channel (0 - `LEDC_CHANNEL_MAX-1`), select from `ledc_channel_t`

**Returns**

- `LEDC_ERR_VAL` if parameter error
- Others Current hpoint value of LEDC channel

*esp\_err\_t ledc\_set\_duty* (*ledc\_mode\_t* speed\_mode, *ledc\_channel\_t* channel, `uint32_t` duty)

LEDC set duty This function do not change the hpoint value of this channel. if needed, please call `ledc_set_duty_with_hpoint`. only after calling `ledc_update_duty` will the duty update.



**Note:** `ledc_set_duty`, `ledc_set_duty_with_hpoint` and `ledc_update_duty` are not thread-safe, do not call these functions to control one LEDC channel in different tasks at the same time. A thread-safe version of API is `ledc_set_duty_and_update`.

---

**Note:** For ESP32, hardware does not support any duty change while a fade operation is running in progress on that channel. Other duty operations will have to wait until the fade operation has finished.

---

#### Parameters

- **speed\_mode** –Select the LEDC channel group with specified speed mode. Note that not all targets support high speed mode.
- **channel** –LEDC channel (0 - LEDC\_CHANNEL\_MAX-1), select from `ledc_channel_t`
- **duty** –Set the LEDC duty, the range of duty setting is [0, (2\*\*duty\_resolution)]

#### Returns

- ESP\_OK Success
- ESP\_ERR\_INVALID\_ARG Parameter error

`uint32_t ledc_get_duty` (*ledc\_mode\_t* speed\_mode, *ledc\_channel\_t* channel)

LEDC get duty This function returns the duty at the present PWM cycle. You shouldn't expect the function to return the new duty in the same cycle of calling `ledc_update_duty`, because duty update doesn't take effect until the next cycle.

#### Parameters

- **speed\_mode** –Select the LEDC channel group with specified speed mode. Note that not all targets support high speed mode.
- **channel** –LEDC channel (0 - LEDC\_CHANNEL\_MAX-1), select from `ledc_channel_t`

#### Returns

- LEDC\_ERR\_DUTY if parameter error
- Others Current LEDC duty

*esp\_err\_t ledc\_set\_fade* (*ledc\_mode\_t* speed\_mode, *ledc\_channel\_t* channel, `uint32_t` duty, *ledc\_duty\_direction\_t* fade\_direction, `uint32_t` step\_num, `uint32_t` duty\_cycle\_num, `uint32_t` duty\_scale)

LEDC set gradient Set LEDC gradient, After the function calls the `ledc_update_duty` function, the function can take effect.

**Note:** For ESP32, hardware does not support any duty change while a fade operation is running in progress on that channel. Other duty operations will have to wait until the fade operation has finished.

---

#### Parameters

- **speed\_mode** –Select the LEDC channel group with specified speed mode. Note that not all targets support high speed mode.
- **channel** –LEDC channel (0 - LEDC\_CHANNEL\_MAX-1), select from `ledc_channel_t`
- **duty** –Set the start of the gradient duty, the range of duty setting is [0, (2\*\*duty\_resolution)]
- **fade\_direction** –Set the direction of the gradient
- **step\_num** –Set the number of the gradient
- **duty\_cycle\_num** –Set how many LEDC tick each time the gradient lasts
- **duty\_scale** –Set gradient change amplitude

#### Returns

- ESP\_OK Success
- ESP\_ERR\_INVALID\_ARG Parameter error

*esp\_err\_t* **ledc\_isr\_register** (void (\*fn)(void\*), void \*arg, int intr\_alloc\_flags, *ledc\_isr\_handle\_t* \*handle)

Register LEDC interrupt handler, the handler is an ISR. The handler will be attached to the same CPU core that this function is running on.

**Parameters**

- **fn** –Interrupt handler function.
- **arg** –User-supplied argument passed to the handler function.
- **intr\_alloc\_flags** –Flags used to allocate the interrupt. One or multiple (ORred) ESP\_INTR\_FLAG\_\* values. See esp\_intr\_alloc.h for more info.
- **handle** –Pointer to return handle. If non-NULL, a handle for the interrupt will be returned here.

**Returns**

- ESP\_OK Success
- ESP\_ERR\_INVALID\_ARG Parameter error
- ESP\_ERR\_NOT\_FOUND Failed to find available interrupt source

*esp\_err\_t* **ledc\_timer\_set** (*ledc\_mode\_t* speed\_mode, *ledc\_timer\_t* timer\_sel, uint32\_t clock\_divider, uint32\_t duty\_resolution, *ledc\_clk\_src\_t* clk\_src)

Configure LEDC settings.

**Parameters**

- **speed\_mode** –Select the LEDC channel group with specified speed mode. Note that not all targets support high speed mode.
- **timer\_sel** –Timer index (0-3), there are 4 timers in LEDC module
- **clock\_divider** –Timer clock divide value, the timer clock is divided from the selected clock source
- **duty\_resolution** –Resolution of duty setting in number of bits. The range is [1, SOC\_LEDC\_TIMER\_BIT\_WIDTH]
- **clk\_src** –Select LEDC source clock.

**Returns**

- (-1) Parameter error
- Other Current LEDC duty

*esp\_err\_t* **ledc\_timer\_rst** (*ledc\_mode\_t* speed\_mode, *ledc\_timer\_t* timer\_sel)

Reset LEDC timer.

**Parameters**

- **speed\_mode** –Select the LEDC channel group with specified speed mode. Note that not all targets support high speed mode.
- **timer\_sel** –LEDC timer index (0-3), select from ledc\_timer\_t

**Returns**

- ESP\_ERR\_INVALID\_ARG Parameter error
- ESP\_OK Success

*esp\_err\_t* **ledc\_timer\_pause** (*ledc\_mode\_t* speed\_mode, *ledc\_timer\_t* timer\_sel)

Pause LEDC timer counter.

**Parameters**

- **speed\_mode** –Select the LEDC channel group with specified speed mode. Note that not all targets support high speed mode.
- **timer\_sel** –LEDC timer index (0-3), select from ledc\_timer\_t

**Returns**

- ESP\_ERR\_INVALID\_ARG Parameter error
- ESP\_OK Success

*esp\_err\_t* **ledc\_timer\_resume** (*ledc\_mode\_t* speed\_mode, *ledc\_timer\_t* timer\_sel)

Resume LEDC timer.

**Parameters**

- **speed\_mode** –Select the LEDC channel group with specified speed mode. Note that not all targets support high speed mode.

- **timer\_sel** –LEDC timer index (0-3), select from `ledc_timer_t`

**Returns**

- `ESP_ERR_INVALID_ARG` Parameter error
- `ESP_OK` Success

*esp\_err\_t* **ledc\_bind\_channel\_timer** (*ledc\_mode\_t* speed\_mode, *ledc\_channel\_t* channel, *ledc\_timer\_t* timer\_sel)

Bind LEDC channel with the selected timer.

**Parameters**

- **speed\_mode** –Select the LEDC channel group with specified speed mode. Note that not all targets support high speed mode.
- **channel** –LEDC channel index (0 - `LEDC_CHANNEL_MAX-1`), select from `ledc_channel_t`
- **timer\_sel** –LEDC timer index (0-3), select from `ledc_timer_t`

**Returns**

- `ESP_ERR_INVALID_ARG` Parameter error
- `ESP_OK` Success

*esp\_err\_t* **ledc\_set\_fade\_with\_step** (*ledc\_mode\_t* speed\_mode, *ledc\_channel\_t* channel, `uint32_t` target\_duty, `uint32_t` scale, `uint32_t` cycle\_num)

Set LEDC fade function.

---

**Note:** Call `ledc_fade_func_install()` once before calling this function. Call `ledc_fade_start()` after this to start fading.

---

---

**Note:** `ledc_set_fade_with_step`, `ledc_set_fade_with_time` and `ledc_fade_start` are not thread-safe, do not call these functions to control one LEDC channel in different tasks at the same time. A thread-safe version of API is `ledc_set_fade_step_and_start`

---

---

**Note:** For ESP32, hardware does not support any duty change while a fade operation is running in progress on that channel. Other duty operations will have to wait until the fade operation has finished.

---

**Parameters**

- **speed\_mode** –Select the LEDC channel group with specified speed mode. Note that not all targets support high speed mode.
- **channel** –LEDC channel index (0 - `LEDC_CHANNEL_MAX-1`), select from `ledc_channel_t`
- **target\_duty** –Target duty of fading [0, (2\*\*duty\_resolution)]
- **scale** –Controls the increase or decrease step scale.
- **cycle\_num** –increase or decrease the duty every `cycle_num` cycles

**Returns**

- `ESP_OK` Success
- `ESP_ERR_INVALID_ARG` Parameter error
- `ESP_ERR_INVALID_STATE` Channel not initialized
- `ESP_FAIL` Fade function init error

*esp\_err\_t* **ledc\_set\_fade\_with\_time** (*ledc\_mode\_t* speed\_mode, *ledc\_channel\_t* channel, `uint32_t` target\_duty, `int` max\_fade\_time\_ms)

Set LEDC fade function, with a limited time.

---

**Note:** Call `ledc_fade_func_install()` once before calling this function. Call `ledc_fade_start()` after this to start fading.

---

---

**Note:** `ledc_set_fade_with_step`, `ledc_set_fade_with_time` and `ledc_fade_start` are not thread-safe, do not call these functions to control one LEDC channel in different tasks at the same time. A thread-safe version of API is `ledc_set_fade_step_and_start`

---

---

**Note:** For ESP32, hardware does not support any duty change while a fade operation is running in progress on that channel. Other duty operations will have to wait until the fade operation has finished.

---

#### Parameters

- **speed\_mode** –Select the LEDC channel group with specified speed mode. Note that not all targets support high speed mode.
- **channel** –LEDC channel index (0 - LEDC\_CHANNEL\_MAX-1), select from `ledc_channel_t`
- **target\_duty** –Target duty of fading [0, (2\*\*duty\_resolution)]
- **max\_fade\_time\_ms** –The maximum time of the fading ( ms ).

#### Returns

- ESP\_OK Success
- ESP\_ERR\_INVALID\_ARG Parameter error
- ESP\_ERR\_INVALID\_STATE Channel not initialized
- ESP\_FAIL Fade function init error

*esp\_err\_t* `ledc_fade_func_install` (int intr\_alloc\_flags)

Install LEDC fade function. This function will occupy interrupt of LEDC module.

**Parameters** `intr_alloc_flags` –Flags used to allocate the interrupt. One or multiple (ORred) ESP\_INTR\_FLAG\_\* values. See `esp_intr_alloc.h` for more info.

#### Returns

- ESP\_OK Success
- ESP\_ERR\_INVALID\_ARG Intr flag error
- ESP\_ERR\_NOT\_FOUND Failed to find available interrupt source
- ESP\_ERR\_INVALID\_STATE Fade function already installed

void `ledc_fade_func_uninstall` (void)

Uninstall LEDC fade function.

*esp\_err\_t* `ledc_fade_start` (*ledc\_mode\_t* speed\_mode, *ledc\_channel\_t* channel, *ledc\_fade\_mode\_t* fade\_mode)

Start LEDC fading.

---

**Note:** Call `ledc_fade_func_install()` once before calling this function. Call this API right after `ledc_set_fade_with_time` or `ledc_set_fade_with_step` before to start fading.

---

---

**Note:** Starting fade operation with this API is not thread-safe, use with care.

---

---

**Note:** For ESP32, hardware does not support any duty change while a fade operation is running in progress on that channel. Other duty operations will have to wait until the fade operation has finished.

---

#### Parameters

- **speed\_mode** –Select the LEDC channel group with specified speed mode. Note that not all targets support high speed mode.
- **channel** –LEDC channel number

- **fade\_mode** –Whether to block until fading done. See `ledc_types.h` `ledc_fade_mode_t` for more info. Note that this function will not return until fading to the target duty if `LEDC_FADE_WAIT_DONE` mode is selected.

**Returns**

- `ESP_OK` Success
- `ESP_ERR_INVALID_STATE` Channel not initialized or fade function not installed.
- `ESP_ERR_INVALID_ARG` Parameter error.

*esp\_err\_t* **ledc\_fade\_stop** (*ledc\_mode\_t* speed\_mode, *ledc\_channel\_t* channel)

Stop LEDC fading. Duty of the channel will stay at its present vlaue.

---

**Note:** This API can be called if a new fixed duty or a new fade want to be set while the last fade operation is still running in progress.

---

---

**Note:** Call this API will abort the fading operation only if it was started by calling `ledc_fade_start` with `LEDC_FADE_NO_WAIT` mode.

---

---

**Note:** If a fade was started with `LEDC_FADE_WAIT_DONE` mode, calling this API afterwards is no use in stopping the fade. Fade will continue until it reaches the target duty.

---

**Parameters**

- **speed\_mode** –Select the LEDC channel group with specified speed mode. Note that not all targets support high speed mode.
- **channel** –LEDC channel number

**Returns**

- `ESP_OK` Success
- `ESP_ERR_INVALID_STATE` Channel not initialized
- `ESP_ERR_INVALID_ARG` Parameter error
- `ESP_FAIL` Fade function init error

*esp\_err\_t* **ledc\_set\_duty\_and\_update** (*ledc\_mode\_t* speed\_mode, *ledc\_channel\_t* channel, *uint32\_t* duty, *uint32\_t* hpoint)

A thread-safe API to set duty for LEDC channel and return when duty updated.

---

**Note:** For ESP32, hardware does not support any duty change while a fade operation is running in progress on that channel. Other duty operations will have to wait until the fade operation has finished.

---

**Parameters**

- **speed\_mode** –Select the LEDC channel group with specified speed mode. Note that not all targets support high speed mode.
- **channel** –LEDC channel (0 - `LEDC_CHANNEL_MAX-1`), select from `ledc_channel_t`
- **duty** –Set the LEDC duty, the range of duty setting is `[0, (2**duty_resolution)]`
- **hpoint** –Set the LEDC hpoint value, the range is `[0, (2**duty_resolution)-1]`

**Returns**

- `ESP_OK` Success
- `ESP_ERR_INVALID_STATE` Channel not initialized
- `ESP_ERR_INVALID_ARG` Parameter error
- `ESP_FAIL` Fade function init error

*esp\_err\_t* **ledc\_set\_fade\_time\_and\_start** (*ledc\_mode\_t* speed\_mode, *ledc\_channel\_t* channel, uint32\_t target\_duty, uint32\_t max\_fade\_time\_ms, *ledc\_fade\_mode\_t* fade\_mode)

A thread-safe API to set and start LEDC fade function, with a limited time.

---

**Note:** Call `ledc_fade_func_install()` once, before calling this function.

---

---

**Note:** For ESP32, hardware does not support any duty change while a fade operation is running in progress on that channel. Other duty operations will have to wait until the fade operation has finished.

---

#### Parameters

- **speed\_mode** –Select the LEDC channel group with specified speed mode. Note that not all targets support high speed mode.
- **channel** –LEDC channel index (0 - LEDC\_CHANNEL\_MAX-1), select from `ledc_channel_t`
- **target\_duty** –Target duty of fading [0, (2\*\*duty\_resolution)]
- **max\_fade\_time\_ms** –The maximum time of the fading ( ms ).
- **fade\_mode** –choose blocking or non-blocking mode

#### Returns

- ESP\_OK Success
- ESP\_ERR\_INVALID\_ARG Parameter error
- ESP\_ERR\_INVALID\_STATE Channel not initialized
- ESP\_FAIL Fade function init error

*esp\_err\_t* **ledc\_set\_fade\_step\_and\_start** (*ledc\_mode\_t* speed\_mode, *ledc\_channel\_t* channel, uint32\_t target\_duty, uint32\_t scale, uint32\_t cycle\_num, *ledc\_fade\_mode\_t* fade\_mode)

A thread-safe API to set and start LEDC fade function.

---

**Note:** Call `ledc_fade_func_install()` once before calling this function.

---

---

**Note:** For ESP32, hardware does not support any duty change while a fade operation is running in progress on that channel. Other duty operations will have to wait until the fade operation has finished.

---

#### Parameters

- **speed\_mode** –Select the LEDC channel group with specified speed mode. Note that not all targets support high speed mode.
- **channel** –LEDC channel index (0 - LEDC\_CHANNEL\_MAX-1), select from `ledc_channel_t`
- **target\_duty** –Target duty of fading [0, (2\*\*duty\_resolution)]
- **scale** –Controls the increase or decrease step scale.
- **cycle\_num** –increase or decrease the duty every cycle\_num cycles
- **fade\_mode** –choose blocking or non-blocking mode

#### Returns

- ESP\_OK Success
- ESP\_ERR\_INVALID\_ARG Parameter error
- ESP\_ERR\_INVALID\_STATE Channel not initialized
- ESP\_FAIL Fade function init error

*esp\_err\_t* **ledc\_cb\_register** (*ledc\_mode\_t* speed\_mode, *ledc\_channel\_t* channel, *ledc\_cbs\_t* \*cbs, void \*user\_arg)

LEDC callback registration function.

---

**Note:** The callback is called from an ISR, it must never attempt to block, and any FreeRTOS API called must be ISR capable.

---

#### Parameters

- **speed\_mode** –Select the LEDC channel group with specified speed mode. Note that not all targets support high speed mode.
- **channel** –LEDC channel index (0 - LEDC\_CHANNEL\_MAX-1), select from `ledc_channel_t`
- **cbs** –Group of LEDC callback functions
- **user\_arg** –user registered data for the callback function

#### Returns

- `ESP_OK` Success
- `ESP_ERR_INVALID_ARG` Parameter error
- `ESP_ERR_INVALID_STATE` Channel not initialized
- `ESP_FAIL` Fade function init error

### Structures

struct `ledc_channel_config_t`

Configuration parameters of LEDC channel for `ledc_channel_config` function.

### Public Members

int `gpio_num`

the LEDC output `gpio_num`, if you want to use `gpio16`, `gpio_num = 16`

`ledc_mode_t` `speed_mode`

LEDC speed `speed_mode`, high-speed mode (only exists on `esp32`) or low-speed mode

`ledc_channel_t` `channel`

LEDC channel (0 - 7)

`ledc_intr_type_t` `intr_type`

configure interrupt, Fade interrupt enable or Fade interrupt disable

`ledc_timer_t` `timer_sel`

Select the timer source of channel (0 - 3)

uint32\_t `duty`

LEDC channel duty, the range of duty setting is  $[0, (2^{**}duty\_resolution)]$

int `hpoint`

LEDC channel `hpoint` value, the range is  $[0, (2^{**}duty\_resolution)-1]$

unsigned int `output_invert`

Enable (1) or disable (0) `gpio` output invert

struct *ledc\_channel\_config\_t*::[anonymous] **flags**

LEDC flags

struct **ledc\_timer\_config\_t**

Configuration parameters of LEDC Timer timer for `ledc_timer_config` function.

### Public Members

*ledc\_mode\_t* **speed\_mode**

LEDC speed `speed_mode`, high-speed mode (only exists on esp32) or low-speed mode

*ledc\_timer\_bit\_t* **duty\_resolution**

LEDC channel duty resolution

*ledc\_timer\_t* **timer\_num**

The timer source of channel (0 - 3)

uint32\_t **freq\_hz**

LEDC timer frequency (Hz)

*ledc\_clk\_cfg\_t* **clk\_cfg**

Configure LEDC source clock from `ledc_clk_cfg_t`. Note that `LEDC_USE_RTC8M_CLK` and `LEDC_USE_XTAL_CLK` are non-timer-specific clock sources. You can not have one LEDC timer uses `RTC8M_CLK` as the clock source and have another LEDC timer uses `XTAL_CLK` as its clock source. All chips except esp32 and esp32s2 do not have timer-specific clock sources, which means clock source for all timers must be the same one.

struct **ledc\_cb\_param\_t**

LEDC callback parameter.

### Public Members

*ledc\_cb\_event\_t* **event**

Event name

uint32\_t **speed\_mode**

Speed mode of the LEDC channel group

uint32\_t **channel**

LEDC channel (0 - `LEDC_CHANNEL_MAX-1`)

uint32\_t **duty**

LEDC current duty of the channel, the range of duty is  $[0, (2^{**}duty\_resolution)]$

struct **ledc\_cbs\_t**

Group of supported LEDC callbacks.

---

**Note:** The callbacks are all running under ISR environment

---



## Public Members

### `ledc_cb_t fade_cb`

LEDC fade\_end callback function

## Macros

### `LEDC_APB_CLK_HZ`

Frequency of one of the LEDC peripheral clock sources, APB\_CLK.

---

**Note:** This macro should have no use in your application, we keep it here only for backward compatible

---

### `LEDC_REF_CLK_HZ`

Frequency of one of the LEDC peripheral clock sources, REF\_TICK.

---

**Note:** This macro should have no use in your application, we keep it here only for backward compatible

---

### `LEDC_ERR_DUTY`

### `LEDC_ERR_VAL`

## Type Definitions

typedef `intr_handle_t ledc_isr_handle_t`

typedef bool (`*ledc_cb_t`)(const `ledc_cb_param_t` \*param, void \*user\_arg)

Type of LEDC event callback.

**Param param** LEDC callback parameter

**Param user\_arg** User registered data

**Return** Whether a high priority task has been waken up by this function

## Enumerations

enum `ledc_cb_event_t`

LEDC callback event type.

*Values:*

enumerator `LEDC_FADE_END_EVT`

LEDC fade end event

## Header File

- `components/hal/include/hal/ledc_types.h`

## Enumerations

enum `ledc_mode_t`

*Values:*

enumerator **LEDC\_LOW\_SPEED\_MODE**

LEDC low speed speed\_mode

enumerator **LEDC\_SPEED\_MODE\_MAX**

LEDC speed limit

enum **ledc\_intr\_type\_t**

*Values:*

enumerator **LEDC\_INTR\_DISABLE**

Disable LEDC interrupt

enumerator **LEDC\_INTR\_FADE\_END**

Enable LEDC interrupt

enumerator **LEDC\_INTR\_MAX**

enum **ledc\_duty\_direction\_t**

*Values:*

enumerator **LEDC\_DUTY\_DIR\_DECREASE**

LEDC duty decrease direction

enumerator **LEDC\_DUTY\_DIR\_INCREASE**

LEDC duty increase direction

enumerator **LEDC\_DUTY\_DIR\_MAX**

enum **ledc\_slow\_clk\_sel\_t**

*Values:*

enumerator **LEDC\_SLOW\_CLK\_RTC8M**

LEDC low speed timer clock source is 8MHz RTC clock

enumerator **LEDC\_SLOW\_CLK\_APB**

LEDC low speed timer clock source is 80MHz APB clock

enumerator **LEDC\_SLOW\_CLK\_XTAL**

LEDC low speed timer clock source XTAL clock

enum **ledc\_clk\_cfg\_t**

In theory, the following enumeration shall be placed in LEDC driver's header. However, as the next enumeration, `ledc_clk_src_t`, makes the use of some of these values and to avoid mutual inclusion of the headers, we must define it here.

*Values:*

enumerator **LEDC\_AUTO\_CLK**

The driver will automatically select the source clock based on the giving resolution and duty parameter when init the timer

enumerator **LEDC\_USE\_APB\_CLK**

LEDC timer select APB clock as source clock

enumerator **LEDC\_USE\_RTC8M\_CLK**

LEDC timer select RTC8M\_CLK as source clock. Only for low speed channels and this parameter must be the same for all low speed channels

enumerator **LEDC\_USE\_REF\_TICK**

LEDC timer select REF\_TICK clock as source clock

enumerator **LEDC\_USE\_XTAL\_CLK**

LEDC timer select XTAL clock as source clock

enum **ledc\_clk\_src\_t**

*Values:*

enumerator **LEDC\_REF\_TICK**

LEDC timer clock divided from reference tick (1Mhz)

enumerator **LEDC\_APB\_CLK**

LEDC timer clock divided from APB clock (80Mhz)

enumerator **LEDC\_SCLK**

Selecting this value for LEDC\_TICK\_SEL\_TIMER let the hardware take its source clock from LEDC\_APB\_CLK\_SEL

enum **ledc\_timer\_t**

*Values:*

enumerator **LEDC\_TIMER\_0**

LEDC timer 0

enumerator **LEDC\_TIMER\_1**

LEDC timer 1

enumerator **LEDC\_TIMER\_2**

LEDC timer 2

enumerator **LEDC\_TIMER\_3**

LEDC timer 3

enumerator **LEDC\_TIMER\_MAX**

enum **ledc\_channel\_t**

*Values:*

enumerator **LEDC\_CHANNEL\_0**

LEDC channel 0

enumerator **LEDC\_CHANNEL\_1**

LEDC channel 1

enumerator **LEDC\_CHANNEL\_2**

LEDC channel 2

enumerator **LEDC\_CHANNEL\_3**

LEDC channel 3

enumerator **LEDC\_CHANNEL\_4**

LEDC channel 4

enumerator **LEDC\_CHANNEL\_5**

LEDC channel 5

enumerator **LEDC\_CHANNEL\_6**

LEDC channel 6

enumerator **LEDC\_CHANNEL\_7**

LEDC channel 7

enumerator **LEDC\_CHANNEL\_MAX**

enum **ledc\_timer\_bit\_t**

*Values:*

enumerator **LEDC\_TIMER\_1\_BIT**

LEDC PWM duty resolution of 1 bits

enumerator **LEDC\_TIMER\_2\_BIT**

LEDC PWM duty resolution of 2 bits

enumerator **LEDC\_TIMER\_3\_BIT**

LEDC PWM duty resolution of 3 bits

enumerator **LEDC\_TIMER\_4\_BIT**

LEDC PWM duty resolution of 4 bits

enumerator **LEDC\_TIMER\_5\_BIT**

LEDC PWM duty resolution of 5 bits

enumerator **LEDC\_TIMER\_6\_BIT**

LEDC PWM duty resolution of 6 bits

enumerator **LEDC\_TIMER\_7\_BIT**

LEDC PWM duty resolution of 7 bits

enumerator **LEDC\_TIMER\_8\_BIT**

LEDC PWM duty resolution of 8 bits

enumerator **LEDC\_TIMER\_9\_BIT**

LEDC PWM duty resolution of 9 bits

enumerator **LEDC\_TIMER\_10\_BIT**

LEDC PWM duty resolution of 10 bits

enumerator **LEDC\_TIMER\_11\_BIT**

LEDC PWM duty resolution of 11 bits

enumerator **LEDC\_TIMER\_12\_BIT**

LEDC PWM duty resolution of 12 bits

enumerator **LEDC\_TIMER\_13\_BIT**

LEDC PWM duty resolution of 13 bits

enumerator **LEDC\_TIMER\_14\_BIT**

LEDC PWM duty resolution of 14 bits

enumerator **LEDC\_TIMER\_BIT\_MAX**

enum **ledc\_fade\_mode\_t**

*Values:*

enumerator **LEDC\_FADE\_NO\_WAIT**

LEDC fade function will return immediately

enumerator **LEDC\_FADE\_WAIT\_DONE**

LEDC fade function will block until fading to the target duty

enumerator **LEDC\_FADE\_MAX**

## 2.5.15 Pulse Counter (PCNT)

### Introduction

The PCNT (Pulse Counter) module is designed to count the number of rising and/or falling edges of input signals. The ESP32-S2 contains multiple pulse counter units in the module.<sup>1</sup> Each unit is in effect an independent counter with multiple channels, where each channel can increment/decrement the counter on a rising/falling edge. Furthermore, each channel can be configured separately.

PCNT channels can react to signals of **edge** type and **level** type, however for simple applications, detecting the edge signal is usually sufficient. PCNT channels can be configured react to both pulse edges (i.e., rising and falling edge), and can be configured to increase, decrease or do nothing to the unit's counter on each edge. The level signal is the so-called **control signal**, which is used to control the counting mode of the edge signals that are attached to the same channel. By combining the usage of both edge and level signals, a PCNT unit can act as a **quadrature decoder**.

Besides that, PCNT unit is equipped with a separate glitch filter, which is helpful to remove noise from the signal.

Typically, a PCNT module can be used in scenarios like:

---

<sup>1</sup> Different ESP chip series might have different number of PCNT units and channels. Please refer to the [TRM] for details. The driver won't forbid you from applying for more PCNT units and channels, but it will return error when all available hardware resources are used up. Please always check the return value when doing resource allocation (e.g. `pcnt_new_unit()`).

- Calculate periodic signal's frequency by counting the pulse numbers within a time slice
- Decode quadrature signals into speed and direction

### Functional Overview

Description of the PCNT functionality is divided into the following sections:

- *Resource Allocation* - covers how to allocate PCNT units and channels with properly set of configurations. It also covers how to recycle the resources when they finished working.
- *Set Up Channel Actions* - covers how to configure the PCNT channel to behave on different signal edges and levels.
- *Watch Points* - describes how to configure PCNT watch points (i.e., tell PCNT unit to trigger an event when the count reaches a certain value).
- *Register Event Callbacks* - describes how to hook your specific code to the watch point event callback function.
- *Set Glitch Filter* - describes how to enable and set the timing parameters for the internal glitch filter.
- *Enable and Disable Unit* - describes how to enable and disable the PCNT unit.
- *Unit IO Control* - describes IO control functions of PCNT unit, like enable glitch filter, start and stop unit, get and clear count value.
- *Power Management* - describes what functionality will prevent the chip from going into low power mode.
- *IRAM Safe* - describes tips on how to make the PCNT interrupt and IO control functions work better along with a disabled cache.
- *Thread Safety* - lists which APIs are guaranteed to be thread safe by the driver.
- *Kconfig Options* - lists the supported Kconfig options that can be used to make a different effect on driver behavior.

**Resource Allocation** The PCNT unit and channel are represented by `pcnt_unit_handle_t` and `pcnt_channel_handle_t` respectively. All available units and channels are maintained by the driver in a resource pool, so you do not need to know the exact underlying instance ID.

**Install PCNT Unit** To install a PCNT unit, there's a configuration structure that needs to be given in advance: `pcnt_unit_config_t`:

- `pcnt_unit_config_t::low_limit` and `pcnt_unit_config_t::high_limit` specify the range for the internal hardware counter. The counter will reset to zero automatically when it crosses either the high or low limit.
- `pcnt_unit_config_t::accum_count` sets whether to create an internal accumulator for the counter. This is helpful when you want to extend the counter's width, which by default is 16bit at most, defined in the hardware. See also *Compensate Overflow Loss* for how to use this feature to compensate the overflow loss.
- `pcnt_unit_config_t::intr_priority` sets the priority of the timer interrupt. If it is set to 0, the driver will allocate an interrupt with a default priority. Otherwise, the driver will use the given priority.

---

**Note:** Since all PCNT units share the same interrupt source, when installing multiple PCNT units make sure that the interrupt priority `pcnt_unit_config_t::intr_priority` is the same for each unit.

---

Unit allocation and initialization is done by calling a function `pcnt_new_unit()` with `pcnt_unit_config_t` as an input parameter. The function will return a PCNT unit handle only when it runs correctly. Specifically, when there are no more free PCNT units in the pool (i.e. unit resources have been used up), then this function will return `ESP_ERR_NOT_FOUND` error. The total number of available PCNT units is recorded by `SOC_PCNT_UNITS_PER_GROUP` for reference.

If a previously created PCNT unit is no longer needed, it's recommended to recycle the resource by calling `pcnt_del_unit()`. Which in return allows the underlying unit hardware to be used for other purposes. Before deleting a PCNT unit, one should ensure the following prerequisites:

- The unit is in the init state, in other words, the unit is either disabled by `pcnt_unit_disable()` or not enabled yet.
- The attached PCNT channels are all removed by `pcnt_del_channel()`.

```

#define EXAMPLE_PCNT_HIGH_LIMIT 100
#define EXAMPLE_PCNT_LOW_LIMIT -100

pcnt_unit_config_t unit_config = {
    .high_limit = EXAMPLE_PCNT_HIGH_LIMIT,
    .low_limit = EXAMPLE_PCNT_LOW_LIMIT,
};
pcnt_unit_handle_t pcnt_unit = NULL;
ESP_ERROR_CHECK(pcnt_new_unit(&unit_config, &pcnt_unit));

```

**Install PCNT Channel** To install a PCNT channel, you must initialize a `pcnt_chan_config_t` structure in advance, and then call `pcnt_new_channel()`. The configuration fields of the `pcnt_chan_config_t` structure are described below:

- `pcnt_chan_config_t::edge_gpio_num` and `pcnt_chan_config_t::level_gpio_num` specify the GPIO numbers used by **edge** type signal and **level** type signal. Please note, either of them can be assigned to `-1` if it's not actually used, and thus it will become a **virtual IO**. For some simple pulse counting applications where one of the level/edge signals is fixed (i.e., never changes), you can reclaim a GPIO by setting the signal as a virtual IO on channel allocation. Setting the level/edge signal as a virtual IO will cause that signal to be internally routed to a fixed High/Low logic level, thus allowing you to save a GPIO for other purposes.
- `pcnt_chan_config_t::virt_edge_io_level` and `pcnt_chan_config_t::virt_level_io_level` specify the virtual IO level for **edge** and **level** input signal, to ensure a deterministic state for such control signal. Please note, they are only valid when either `pcnt_chan_config_t::edge_gpio_num` or `pcnt_chan_config_t::level_gpio_num` is assigned to `-1`.
- `pcnt_chan_config_t::invert_edge_input` and `pcnt_chan_config_t::invert_level_input` are used to decide whether to invert the input signals before they going into PCNT hardware. The invert is done by GPIO matrix instead of PCNT hardware.
- `pcnt_chan_config_t::io_loop_back` is for debug only, which enables both the GPIO's input and output paths. This can help to simulate the pulse signals by function `gpio_set_level()` on the same GPIO.

Channel allocating and initialization is done by calling a function `pcnt_new_channel()` with the above `pcnt_chan_config_t` as an input parameter plus a PCNT unit handle returned from `pcnt_new_unit()`. This function will return a PCNT channel handle if it runs correctly. Specifically, when there are no more free PCNT channel within the unit (i.e. channel resources have been used up), then this function will return `ESP_ERR_NOT_FOUND` error. The total number of available PCNT channels within the unit is recorded by `SOC_PCNT_CHANNELS_PER_UNIT` for reference. Note that, when install a PCNT channel for a specific unit, one should ensure the unit is in the init state, otherwise this function will return `ESP_ERR_INVALID_STATE` error.

If a previously created PCNT channel is no longer needed, it's recommended to recycle the resources by calling `pcnt_del_channel()`. Which in return allows the underlying channel hardware to be used for other purposes.

```

#define EXAMPLE_CHAN_GPIO_A 0
#define EXAMPLE_CHAN_GPIO_B 2

pcnt_chan_config_t chan_config = {
    .edge_gpio_num = EXAMPLE_CHAN_GPIO_A,
    .level_gpio_num = EXAMPLE_CHAN_GPIO_B,
};
pcnt_channel_handle_t pcnt_chan = NULL;
ESP_ERROR_CHECK(pcnt_new_channel(pcnt_unit, &chan_config, &pcnt_chan));

```

**Set Up Channel Actions** The PCNT will increase/decrease/hold its internal count value when the input pulse signal toggles. You can set different actions for edge signal and/or level signal.

- `pcnt_channel_set_edge_action()` function is to set specific actions for rising and falling edge of the signal attached to the `pcnt_chan_config_t::edge_gpio_num`. Supported actions are listed in

`pcnt_channel_edge_action_t`.

- `pcnt_channel_set_level_action()` function is to set specific actions for high and low level of the signal attached to the `pcnt_chan_config_t::level_gpio_num`. Supported actions are listed in `pcnt_channel_level_action_t`. This function is not mandatory if the `pcnt_chan_config_t::level_gpio_num` is set to `-1` when allocating PCNT channel by `pcnt_new_channel()`.

```
// decrease the counter on rising edge, increase the counter on falling edge
ESP_ERROR_CHECK(pcnt_channel_set_edge_action(pcnt_chan, PCNT_CHANNEL_EDGE_ACTION_
↳DECREASE, PCNT_CHANNEL_EDGE_ACTION_INCREASE));
// keep the counting mode when the control signal is high level, and reverse the_
↳counting mode when the control signal is low level
ESP_ERROR_CHECK(pcnt_channel_set_level_action(pcnt_chan, PCNT_CHANNEL_LEVEL_ACTION_
↳KEEP, PCNT_CHANNEL_LEVEL_ACTION_INVERSE));
```

**Watch Points** Each PCNT unit can be configured to watch several different values that you're interested in. The value to be watched is also called **Watch Point**. The watch point itself can't exceed the range set in `pcnt_unit_config_t` by `pcnt_unit_config_t::low_limit` and `pcnt_unit_config_t::high_limit`. When the counter reaches either watch point, a watch event will be triggered and notify you by interrupt if any watch event callback has ever registered in `pcnt_unit_register_event_callbacks()`. See [Register Event Callbacks](#) for how to register event callbacks.

The watch point can be added and removed by `pcnt_unit_add_watch_point()` and `pcnt_unit_remove_watch_point()`. The commonly used watch points are: **zero cross**, **maximum / minimum count** and other threshold values. The number of available watch point is limited, `pcnt_unit_add_watch_point()` will return error `ESP_ERR_NOT_FOUND` if it can't find any free hardware resource to save the watch point. You can't add the same watch point for multiple times, otherwise it will return error `ESP_ERR_INVALID_STATE`.

It is recommended to remove the unused watch point by `pcnt_unit_remove_watch_point()` to recycle the watch point resources.

```
// add zero across watch point
ESP_ERROR_CHECK(pcnt_unit_add_watch_point(pcnt_unit, 0));
// add high limit watch point
ESP_ERROR_CHECK(pcnt_unit_add_watch_point(pcnt_unit, EXAMPLE_PCNT_HIGH_LIMIT));
```

**Register Event Callbacks** When PCNT unit reaches any enabled watch point, specific event will be generated and notify the CPU by interrupt. If you have some function that want to get executed when event happens, you should hook your function to the interrupt service routine by calling `pcnt_unit_register_event_callbacks()`. All supported event callbacks are listed in the `pcnt_event_callbacks_t`:

- `pcnt_event_callbacks_t::on_reach` sets a callback function for watch point event. As this function is called within the ISR context, you must ensure that the function doesn't attempt to block (e.g., by making sure that only FreeRTOS APIs with `ISR` suffix are called from within the function). The function prototype is declared in `pcnt_watch_cb_t`.

You can save their own context to `pcnt_unit_register_event_callbacks()` as well, via the parameter `user_ctx`. This user data will be directly passed to the callback functions.

In the callback function, the driver will fill in the event data of specific event. For example, the watch point event data is declared as `pcnt_watch_event_data_t`:

- `pcnt_watch_event_data_t::watch_point_value` saves the watch point value that triggers the event.
- `pcnt_watch_event_data_t::zero_cross_mode` saves how the PCNT unit crosses the zero point in the latest time. The possible zero cross modes are listed in the `pcnt_unit_zero_cross_mode_t`. Usually different zero cross mode means different **counting direction** and **counting step size**.



Registering callback function will result in lazy installation of interrupt service, thus this function should only be called before the unit is enabled by `pcnt_unit_enable()`. Otherwise, it can return `ESP_ERR_INVALID_STATE` error.

```
static bool example_pcnt_on_reach(pcnt_unit_handle_t unit, const pcnt_watch_event_
↳data_t *edata, void *user_ctx)
{
    BaseType_t high_task_wakeup;
    QueueHandle_t queue = (QueueHandle_t)user_ctx;
    // send watch point to queue, from this interrupt callback
    xQueueSendFromISR(queue, &(edata->watch_point_value), &high_task_wakeup);
    // return whether a high priority task has been waken up by this function
    return (high_task_wakeup == pdTRUE);
}

pcnt_event_callbacks_t cbs = {
    .on_reach = example_pcnt_on_reach,
};
QueueHandle_t queue = xQueueCreate(10, sizeof(int));
ESP_ERROR_CHECK(pcnt_unit_register_event_callbacks(pcnt_unit, &cbs, queue));
```

**Set Glitch Filter** The PCNT unit features filters to ignore possible short glitches in the signals. The parameters that can be configured for the glitch filter are listed in `pcnt_glitch_filter_config_t`:

- `pcnt_glitch_filter_config_t::max_glitch_ns` sets the maximum glitch width, in nano seconds. If a signal pulse's width is smaller than this value, then it will be treated as noise and won't increase/decrease the internal counter.

You can enable the glitch filter for PCNT unit by calling `pcnt_unit_set_glitch_filter()` with the filter configuration provided above. Particularly, you can disable the glitch filter later by calling `pcnt_unit_set_glitch_filter()` with a `NULL` filter configuration.

This function should be called when the the unit is in the init state. Otherwise, it will return `ESP_ERR_INVALID_STATE` error.

**Note:** The glitch filter is clocked from APB. For the counter not to miss any pulses, the maximum glitch width should be longer than one APB\_CLK cycle (usually 12.5 ns if APB equals 80MHz). As the APB frequency would be changed after DFS (Dynamic Frequency Scaling) enabled, which means the filter won't work as expect in that case. So the driver will install a PM lock for PCNT unit during the first time you enable the glitch filter. For more information related to power management strategy used in PCNT driver, please see [Power Management](#).

```
pcnt_glitch_filter_config_t filter_config = {
    .max_glitch_ns = 1000,
};
ESP_ERROR_CHECK(pcnt_unit_set_glitch_filter(pcnt_unit, &filter_config));
```

**Enable and Disable Unit** Before doing IO control to the PCNT unit, you need to enable it first, by calling `pcnt_unit_enable()`. Internally, this function will:

- switch the PCNT driver state from **init** to **enable**.
- enable the interrupt service if it has been lazy installed in `pcnt_unit_register_event_callbacks()`.
- acquire a proper power management lock if it has been lazy installed in `pcnt_unit_set_glitch_filter()`. See also [Power Management](#) for more information.

On the contrary, calling `pcnt_unit_disable()` will do the opposite, that is, put the PCNT driver back to the **init** state, disable the interrupts service and release the power management lock.

## Unit IO Control

**Start/Stop and Clear** Calling `pcnt_unit_start()` will make the PCNT unit start to work, increase or decrease counter according to pulse signals. On the contrary, calling `pcnt_unit_stop()` will stop the PCNT unit but retain current count value. Instead, clearing counter can only be done by calling `pcnt_unit_clear_count()`.

Note, `pcnt_unit_start()` and `pcnt_unit_stop()` should be called when the unit has been enabled by `pcnt_unit_enable()`. Otherwise, it will return `ESP_ERR_INVALID_STATE` error.

**Get Count Value** You can read current count value at any time by calling `pcnt_unit_get_count()`. The returned count value is a **signed** integer, where the sign can be used to reflect the direction.

```
int pulse_count = 0;
ESP_ERROR_CHECK(pcnt_unit_get_count(pcnt_unit, &pulse_count));
```

**Compensate Overflow Loss** The internal hardware counter will be cleared to zero automatically when it reaches high or low limit. If you want to compensate for that count loss and extend the counter's bit-width, you can:

1. Enable `pcnt_unit_config_t::accum_count` when installing the PCNT unit.
2. Add the high/low limit as the *Watch Points*.
3. Now, the returned count value from the `pcnt_unit_get_count()` function not only reflects the hardware's count value, but also accumulates the high/low overflow loss to it.

---

**Note:** `pcnt_unit_clear_count()` will reset the accumulated count value as well.

---

**Power Management** When power management is enabled (i.e. `CONFIG_PM_ENABLE` is on), the system will adjust the APB frequency before going into light sleep, thus potentially changing the behavior of PCNT glitch filter and leading to valid signal being treated as noise.

However, the driver can prevent the system from changing APB frequency by acquiring a power management lock of type `ESP_PM_APB_FREQ_MAX`. Whenever you enable the glitch filter by `pcnt_unit_set_glitch_filter()`, the driver will guarantee that the power management lock is acquired after the PCNT unit is enabled by `pcnt_unit_enable()`. Likewise, the driver releases the lock after `pcnt_unit_disable()` is called.

**IRAM Safe** By default, the PCNT interrupt will be deferred when the Cache is disabled for reasons like writing/erasing Flash. Thus the alarm interrupt will not get executed in time, which is not expected in a real-time application.

There's a Kconfig option `CONFIG_PCNT_ISR_IRAM_SAFE` that will:

1. Enable the interrupt being serviced even when cache is disabled
2. Place all functions that used by the ISR into IRAM<sup>2</sup>
3. Place driver object into DRAM (in case it's mapped to PSRAM by accident)

This will allow the interrupt to run while the cache is disabled but will come at the cost of increased IRAM consumption.

There's another Kconfig option `CONFIG_PCNT_CTRL_FUNC_IN_IRAM` that can put commonly used IO control functions into IRAM as well. So that these functions can also be executable when the cache is disabled. These IO control functions are as follows:

- `pcnt_unit_start()`
- `pcnt_unit_stop()`
- `pcnt_unit_clear_count()`
- `pcnt_unit_get_count()`

---

<sup>2</sup> `pcnt_event_callbacks_t::on_reach` callback and the functions invoked by itself should also be placed in IRAM, you need to take care of them by themselves.

**Thread Safety** The factory functions `pcnt_new_unit()` and `pcnt_new_channel()` are guaranteed to be thread safe by the driver, which means, you can call them from different RTOS tasks without protection by extra locks. The following functions are allowed to run under ISR context, the driver uses a critical section to prevent them being called concurrently in both task and ISR.

- `pcnt_unit_start()`
- `pcnt_unit_stop()`
- `pcnt_unit_clear_count()`
- `pcnt_unit_get_count()`

Other functions that take the `pcnt_unit_handle_t` and `pcnt_channel_handle_t` as the first positional parameter, are not treated as thread safe. This means you should avoid calling them from multiple tasks.

### Kconfig Options

- `CONFIG_PCNT_CTRL_FUNC_IN_IRAM` controls where to place the PCNT control functions (IRAM or Flash), see *IRAM Safe* for more information.
- `CONFIG_PCNT_ISR_IRAM_SAFE` controls whether the default ISR handler can work when cache is disabled, see *IRAM Safe* for more information.
- `CONFIG_PCNT_ENABLE_DEBUG_LOG` is used to enable the debug log output. Enable this option will increase the firmware binary size.

### Application Examples

- Decode the quadrature signals from rotary encoder: [peripherals/pcnt/rotary\\_encoder](#).

### API Reference

#### Header File

- `components/driver/include/driver/pulse_cnt.h`

#### Functions

`esp_err_t pcnt_new_unit` (const `pcnt_unit_config_t` \*config, `pcnt_unit_handle_t` \*ret\_unit)

Create a new PCNT unit, and return the handle.

---

**Note:** The newly created PCNT unit is put in the init state.

---

#### Parameters

- **config** –[in] PCNT unit configuration
- **ret\_unit** –[out] Returned PCNT unit handle

#### Returns

- `ESP_OK`: Create PCNT unit successfully
- `ESP_ERR_INVALID_ARG`: Create PCNT unit failed because of invalid argument (e.g. high/low limit value out of the range)
- `ESP_ERR_NO_MEM`: Create PCNT unit failed because out of memory
- `ESP_ERR_NOT_FOUND`: Create PCNT unit failed because all PCNT units are used up and no more free one
- `ESP_FAIL`: Create PCNT unit failed because of other error

`esp_err_t pcnt_del_unit` (`pcnt_unit_handle_t` unit)

Delete the PCNT unit handle.

---

**Note:** A PCNT unit can't be in the enable state when this function is invoked. See also `pcnt_unit_disable()` for how to disable a unit.

---

**Parameters** `unit` –[in] PCNT unit handle created by `pcnt_new_unit()`

**Returns**

- `ESP_OK`: Delete the PCNT unit successfully
- `ESP_ERR_INVALID_ARG`: Delete the PCNT unit failed because of invalid argument
- `ESP_ERR_INVALID_STATE`: Delete the PCNT unit failed because the unit is not in init state or some PCNT channel is still in working
- `ESP_FAIL`: Delete the PCNT unit failed because of other error

*esp\_err\_t* `pcnt_unit_set_glitch_filter` (*pcnt\_unit\_handle\_t* unit, const *pcnt\_glitch\_filter\_config\_t* \*config)

Set glitch filter for PCNT unit.

---

**Note:** The glitch filter module is clocked from APB, and APB frequency can be changed during DFS, which in return make the filter out of action. So this function will lazy-install a PM lock internally when the power management is enabled. With this lock, the APB frequency won't be changed. The PM lock can be uninstalled in `pcnt_del_unit()`.

---

---

**Note:** This function should be called when the PCNT unit is in the init state (i.e. before calling `pcnt_unit_enable()`)

---

**Parameters**

- `unit` –[in] PCNT unit handle created by `pcnt_new_unit()`
- `config` –[in] PCNT filter configuration, set config to NULL means disabling the filter function

**Returns**

- `ESP_OK`: Set glitch filter successfully
- `ESP_ERR_INVALID_ARG`: Set glitch filter failed because of invalid argument (e.g. glitch width is too big)
- `ESP_ERR_INVALID_STATE`: Set glitch filter failed because the unit is not in the init state
- `ESP_FAIL`: Set glitch filter failed because of other error

*esp\_err\_t* `pcnt_unit_enable` (*pcnt\_unit\_handle\_t* unit)

Enable the PCNT unit.

---

**Note:** This function will transit the unit state from init to enable.

---

---

**Note:** This function will enable the interrupt service, if it's lazy installed in `pcnt_unit_register_event_callbacks()`.

---

---

**Note:** This function will acquire the PM lock if it's lazy installed in `pcnt_unit_set_glitch_filter()`.

---

---

**Note:** Enable a PCNT unit doesn't mean to start it. See also `pcnt_unit_start()` for how to start the PCNT counter.

---

**Parameters** `unit` –[in] PCNT unit handle created by `pcnt_new_unit()`

**Returns**

- `ESP_OK`: Enable PCNT unit successfully

- ESP\_ERR\_INVALID\_ARG: Enable PCNT unit failed because of invalid argument
- ESP\_ERR\_INVALID\_STATE: Enable PCNT unit failed because the unit is already enabled
- ESP\_FAIL: Enable PCNT unit failed because of other error

*esp\_err\_t* **pcnt\_unit\_disable** (*pcnt\_unit\_handle\_t* unit)

Disable the PCNT unit.

---

**Note:** This function will do the opposite work to the `pcnt_unit_enable()`

---

---

**Note:** Disable a PCNT unit doesn't mean to stop it. See also `pcnt_unit_stop()` for how to stop the PCNT counter.

---

**Parameters** **unit** –[in] PCNT unit handle created by `pcnt_new_unit()`

**Returns**

- ESP\_OK: Disable PCNT unit successfully
- ESP\_ERR\_INVALID\_ARG: Disable PCNT unit failed because of invalid argument
- ESP\_ERR\_INVALID\_STATE: Disable PCNT unit failed because the unit is not enabled yet
- ESP\_FAIL: Disable PCNT unit failed because of other error

*esp\_err\_t* **pcnt\_unit\_start** (*pcnt\_unit\_handle\_t* unit)

Start the PCNT unit, the counter will start to count according to the edge and/or level input signals.

---

**Note:** This function should be called when the unit is in the enable state (i.e. after calling `pcnt_unit_enable()`)

---

---

**Note:** This function is allowed to run within ISR context

---

---

**Note:** This function will be placed into IRAM if `CONFIG_PCNT_CTRL_FUNC_IN_IRAM` is on, so that it's allowed to be executed when Cache is disabled

---

**Parameters** **unit** –[in] PCNT unit handle created by `pcnt_new_unit()`

**Returns**

- ESP\_OK: Start PCNT unit successfully
- ESP\_ERR\_INVALID\_ARG: Start PCNT unit failed because of invalid argument
- ESP\_ERR\_INVALID\_STATE: Start PCNT unit failed because the unit is not enabled yet
- ESP\_FAIL: Start PCNT unit failed because of other error

*esp\_err\_t* **pcnt\_unit\_stop** (*pcnt\_unit\_handle\_t* unit)

Stop PCNT from counting.

---

**Note:** This function should be called when the unit is in the enable state (i.e. after calling `pcnt_unit_enable()`)

---

---

**Note:** The stop operation won't clear the counter. Also see `pcnt_unit_clear_count()` for how to clear pulse count value.

---

---

**Note:** This function is allowed to run within ISR context

---

---

**Note:** This function will be placed into IRAM if `CONFIG_PCNT_CTRL_FUNC_IN_IRAM`, so that it is allowed to be executed when Cache is disabled

---

**Parameters** `unit` –[in] PCNT unit handle created by `pcnt_new_unit()`

**Returns**

- `ESP_OK`: Stop PCNT unit successfully
- `ESP_ERR_INVALID_ARG`: Stop PCNT unit failed because of invalid argument
- `ESP_ERR_INVALID_STATE`: Stop PCNT unit failed because the unit is not enabled yet
- `ESP_FAIL`: Stop PCNT unit failed because of other error

*esp\_err\_t* `pcnt_unit_clear_count` (*pcnt\_unit\_handle\_t* unit)

Clear PCNT pulse count value to zero.

---

**Note:** It's recommended to call this function after adding a watch point by `pcnt_unit_add_watch_point()`, so that the newly added watch point is effective immediately.

---

---

**Note:** This function is allowed to run within ISR context

---

---

**Note:** This function will be placed into IRAM if `CONFIG_PCNT_CTRL_FUNC_IN_IRAM`, so that it's allowed to be executed when Cache is disabled

---

**Parameters** `unit` –[in] PCNT unit handle created by `pcnt_new_unit()`

**Returns**

- `ESP_OK`: Clear PCNT pulse count successfully
- `ESP_ERR_INVALID_ARG`: Clear PCNT pulse count failed because of invalid argument
- `ESP_FAIL`: Clear PCNT pulse count failed because of other error

*esp\_err\_t* `pcnt_unit_get_count` (*pcnt\_unit\_handle\_t* unit, int \*value)

Get PCNT count value.

---

**Note:** This function is allowed to run within ISR context

---

---

**Note:** This function will be placed into IRAM if `CONFIG_PCNT_CTRL_FUNC_IN_IRAM`, so that it's allowed to be executed when Cache is disabled

---

**Parameters**

- `unit` –[in] PCNT unit handle created by `pcnt_new_unit()`
- `value` –[out] Returned count value

**Returns**

- `ESP_OK`: Get PCNT pulse count successfully
- `ESP_ERR_INVALID_ARG`: Get PCNT pulse count failed because of invalid argument
- `ESP_FAIL`: Get PCNT pulse count failed because of other error

*esp\_err\_t* **pcnt\_unit\_register\_event\_callbacks** (*pcnt\_unit\_handle\_t* unit, const *pcnt\_event\_callbacks\_t* \*cbs, void \*user\_data)

Set event callbacks for PCNT unit.

---

**Note:** User registered callbacks are expected to be runnable within ISR context

---



---

**Note:** The first call to this function needs to be before the call to `pcnt_unit_enable`

---



---

**Note:** User can deregister a previously registered callback by calling this function and setting the callback member in the `cbs` structure to NULL.

---

#### Parameters

- **unit** –[in] PCNT unit handle created by `pcnt_new_unit()`
- **cbs** –[in] Group of callback functions
- **user\_data** –[in] User data, which will be passed to callback functions directly

#### Returns

- **ESP\_OK:** Set event callbacks successfully
- **ESP\_ERR\_INVALID\_ARG:** Set event callbacks failed because of invalid argument
- **ESP\_ERR\_INVALID\_STATE:** Set event callbacks failed because the unit is not in init state
- **ESP\_FAIL:** Set event callbacks failed because of other error

*esp\_err\_t* **pcnt\_unit\_add\_watch\_point** (*pcnt\_unit\_handle\_t* unit, int watch\_point)

Add a watch point for PCNT unit, PCNT will generate an event when the counter value reaches the watch point value.

#### Parameters

- **unit** –[in] PCNT unit handle created by `pcnt_new_unit()`
- **watch\_point** –[in] Value to be watched

#### Returns

- **ESP\_OK:** Add watch point successfully
- **ESP\_ERR\_INVALID\_ARG:** Add watch point failed because of invalid argument (e.g. the value to be watched is out of the limitation set in `pcnt_unit_config_t`)
- **ESP\_ERR\_INVALID\_STATE:** Add watch point failed because the same watch point has already been added
- **ESP\_ERR\_NOT\_FOUND:** Add watch point failed because no more hardware watch point can be configured
- **ESP\_FAIL:** Add watch point failed because of other error

*esp\_err\_t* **pcnt\_unit\_remove\_watch\_point** (*pcnt\_unit\_handle\_t* unit, int watch\_point)

Remove a watch point for PCNT unit.

#### Parameters

- **unit** –[in] PCNT unit handle created by `pcnt_new_unit()`
- **watch\_point** –[in] Watch point value

#### Returns

- **ESP\_OK:** Remove watch point successfully
- **ESP\_ERR\_INVALID\_ARG:** Remove watch point failed because of invalid argument
- **ESP\_ERR\_INVALID\_STATE:** Remove watch point failed because the watch point was not added by `pcnt_unit_add_watch_point()` yet
- **ESP\_FAIL:** Remove watch point failed because of other error

*esp\_err\_t* **pcnt\_new\_channel** (*pcnt\_unit\_handle\_t* unit, const *pcnt\_chan\_config\_t* \*config, *pcnt\_channel\_handle\_t* \*ret\_chan)

Create PCNT channel for specific unit, each PCNT has several channels associated with it.

---

**Note:** This function should be called when the unit is in init state (i.e. before calling `pcnt_unit_enable()`)

---

#### Parameters

- **unit** –[in] PCNT unit handle created by `pcnt_new_unit()`
- **config** –[in] PCNT channel configuration
- **ret\_chan** –[out] Returned channel handle

#### Returns

- `ESP_OK`: Create PCNT channel successfully
- `ESP_ERR_INVALID_ARG`: Create PCNT channel failed because of invalid argument
- `ESP_ERR_NO_MEM`: Create PCNT channel failed because of insufficient memory
- `ESP_ERR_NOT_FOUND`: Create PCNT channel failed because all PCNT channels are used up and no more free one
- `ESP_ERR_INVALID_STATE`: Create PCNT channel failed because the unit is not in the init state
- `ESP_FAIL`: Create PCNT channel failed because of other error

*esp\_err\_t* `pcnt_del_channel` (*pcnt\_channel\_handle\_t* chan)

Delete the PCNT channel.

**Parameters** **chan** –[in] PCNT channel handle created by `pcnt_new_channel()`

#### Returns

- `ESP_OK`: Delete the PCNT channel successfully
- `ESP_ERR_INVALID_ARG`: Delete the PCNT channel failed because of invalid argument
- `ESP_FAIL`: Delete the PCNT channel failed because of other error

*esp\_err\_t* `pcnt_channel_set_edge_action` (*pcnt\_channel\_handle\_t* chan, *pcnt\_channel\_edge\_action\_t* pos\_act, *pcnt\_channel\_edge\_action\_t* neg\_act)

Set channel actions when edge signal changes (e.g. falling or rising edge occurred). The edge signal is input from the `edge_gpio_num` configured in `pcnt_chan_config_t`. We use these actions to control when and how to change the counter value.

#### Parameters

- **chan** –[in] PCNT channel handle created by `pcnt_new_channel()`
- **pos\_act** –[in] Action on posedge signal
- **neg\_act** –[in] Action on negedge signal

#### Returns

- `ESP_OK`: Set edge action for PCNT channel successfully
- `ESP_ERR_INVALID_ARG`: Set edge action for PCNT channel failed because of invalid argument
- `ESP_FAIL`: Set edge action for PCNT channel failed because of other error

*esp\_err\_t* `pcnt_channel_set_level_action` (*pcnt\_channel\_handle\_t* chan, *pcnt\_channel\_level\_action\_t* high\_act, *pcnt\_channel\_level\_action\_t* low\_act)

Set channel actions when level signal changes (e.g. signal level goes from high to low). The level signal is input from the `level_gpio_num` configured in `pcnt_chan_config_t`. We use these actions to control when and how to change the counting mode.

#### Parameters

- **chan** –[in] PCNT channel handle created by `pcnt_new_channel()`
- **high\_act** –[in] Action on high level signal
- **low\_act** –[in] Action on low level signal

#### Returns

- `ESP_OK`: Set level action for PCNT channel successfully
- `ESP_ERR_INVALID_ARG`: Set level action for PCNT channel failed because of invalid argument
- `ESP_FAIL`: Set level action for PCNT channel failed because of other error



## Structures

struct **pcnt\_watch\_event\_data\_t**

PCNT watch event data.

### Public Members

int **watch\_point\_value**

Watch point value that triggered the event

*pcnt\_unit\_zero\_cross\_mode\_t* **zero\_cross\_mode**

Zero cross mode

struct **pcnt\_event\_callbacks\_t**

Group of supported PCNT callbacks.

---

**Note:** The callbacks are all running under ISR environment

---

---

**Note:** When CONFIG\_PCNT\_ISR\_IRAM\_SAFE is enabled, the callback itself and functions called by it should be placed in IRAM.

---

### Public Members

*pcnt\_watch\_cb\_t* **on\_reach**

Called when PCNT unit counter reaches any watch point

struct **pcnt\_unit\_config\_t**

PCNT unit configuration.

### Public Members

int **low\_limit**

Low limitation of the count unit, should be lower than 0

int **high\_limit**

High limitation of the count unit, should be higher than 0

int **intr\_priority**

PCNT interrupt priority, if set to 0, the driver will try to allocate an interrupt with a relative low priority (1,2,3)

uint32\_t **accum\_count**

Whether to accumulate the count value when overflows at the high/low limit

struct *pcnt\_unit\_config\_t*::[anonymous] **flags**

Extra flags

struct **pcnt\_chan\_config\_t**  
PCNT channel configuration.

### Public Members

int **edge\_gpio\_num**  
GPIO number used by the edge signal, input mode with pull up enabled. Set to -1 if unused

int **level\_gpio\_num**  
GPIO number used by the level signal, input mode with pull up enabled. Set to -1 if unused

uint32\_t **invert\_edge\_input**  
Invert the input edge signal

uint32\_t **invert\_level\_input**  
Invert the input level signal

uint32\_t **virt\_edge\_io\_level**  
Virtual edge IO level, 0: low, 1: high. Only valid when edge\_gpio\_num is set to -1

uint32\_t **virt\_level\_io\_level**  
Virtual level IO level, 0: low, 1: high. Only valid when level\_gpio\_num is set to -1

uint32\_t **io\_loop\_back**  
For debug/test, the signal output from the GPIO will be fed to the input path as well

struct *pcnt\_chan\_config\_t*::[anonymous] **flags**  
Channel config flags

struct **pcnt\_glitch\_filter\_config\_t**  
PCNT glitch filter configuration.

### Public Members

uint32\_t **max\_glitch\_ns**  
Pulse width smaller than this threshold will be treated as glitch and ignored, in the unit of ns

### Type Definitions

typedef struct pcnt\_unit\_t **\*pcnt\_unit\_handle\_t**  
Type of PCNT unit handle.

typedef struct pcnt\_chan\_t **\*pcnt\_channel\_handle\_t**  
Type of PCNT channel handle.

typedef bool (**\*pcnt\_watch\_cb\_t**)(*pcnt\_unit\_handle\_t* unit, const *pcnt\_watch\_event\_data\_t* \*edata, void \*user\_ctx)

PCNT watch event callback prototype.

---

**Note:** The callback function is invoked from an ISR context, so it should meet the restrictions of not calling any blocking APIs when implementing the callback. e.g. must use ISR version of FreeRTOS APIs.

---

**Param unit [in]** PCNT unit handle

**Param edata [in]** PCNT event data, fed by the driver

**Param user\_ctx [in]** User data, passed from `pcnt_unit_register_event_callbacks()`

**Return** Whether a high priority task has been woken up by this function

### Header File

- [components/hal/include/hal/pcnt\\_types.h](#)

### Enumerations

enum `pcnt_channel_level_action_t`

PCNT channel action on control level.

*Values:*

enumerator `PCNT_CHANNEL_LEVEL_ACTION_KEEP`

Keep current count mode

enumerator `PCNT_CHANNEL_LEVEL_ACTION_INVERSE`

Invert current count mode (increase -> decrease, decrease -> increase)

enumerator `PCNT_CHANNEL_LEVEL_ACTION_HOLD`

Hold current count value

enum `pcnt_channel_edge_action_t`

PCNT channel action on signal edge.

*Values:*

enumerator `PCNT_CHANNEL_EDGE_ACTION_HOLD`

Hold current count value

enumerator `PCNT_CHANNEL_EDGE_ACTION_INCREASE`

Increase count value

enumerator `PCNT_CHANNEL_EDGE_ACTION_DECREASE`

Decrease count value

enum `pcnt_unit_zero_cross_mode_t`

PCNT unit zero cross mode.

*Values:*

enumerator `PCNT_UNIT_ZERO_CROSS_POS_ZERO`

start from positive value, end to zero, i.e. +N->0

enumerator `PCNT_UNIT_ZERO_CROSS_NEG_ZERO`

start from negative value, end to zero, i.e.  $-N \rightarrow 0$

enumerator `PCNT_UNIT_ZERO_CROSS_NEG_POS`

start from negative value, end to positive value, i.e.  $-N \rightarrow +M$

enumerator `PCNT_UNIT_ZERO_CROSS_POS_NEG`

start from positive value, end to negative value, i.e.  $+N \rightarrow -M$

## 2.5.16 Remote Control Transceiver (RMT)

### Introduction

The RMT (Remote Control Transceiver) peripheral was designed to act as an infrared transceiver. However, due to the flexibility of its data format, RMT can be extended to a versatile and general-purpose transceiver, transmitting or receiving many other types of signals. From the perspective of network layering, the RMT hardware contains both physical and data link layers. The physical layer defines the communication media and bit signal representation. The data link layer defines the format of an RMT frame. The minimal data unit in the frame is called the **RMT symbol**, which is represented by `rmt_symbol_word_t` in the driver.

ESP32-S2 contains multiple channels in the RMT peripheral<sup>1</sup>. Each channel can be independently configured as either transmitter or receiver.

Typically, the RMT peripheral can be used in the following scenarios:

- Transmit or receive infrared signals, with any IR protocols, e.g., NEC
- General-purpose sequence generator
- Transmit signals in a hardware-controlled loop, with a finite or infinite number of times
- Multi-channel simultaneous transmission
- Modulate the carrier to the output signal or demodulate the carrier from the input signal

**Layout of RMT Symbols** The RMT hardware defines data in its own pattern –the **RMT symbol**. The diagram below illustrates the bit fields of an RMT symbol. Each symbol consists of two pairs of two values. The first value in the pair is a 15-bit value representing the signal's duration in units of RMT ticks. The second in the pair is a 1-bit value representing the signal's logic level, i.e., high or low.

**RMT Transmitter Overview** The data path and control path of an RMT TX channel is illustrated in the figure below:

The driver encodes the user's data into RMT data format, then the RMT transmitter can generate the waveforms according to the encoding artifacts. It is also possible to modulate a high-frequency carrier signal before being routed to a GPIO pad.

**RMT Receiver Overview** The data path and control path of an RMT RX channel is illustrated in the figure below:

The RMT receiver can sample incoming signals into RMT data format, and store the data in memory. It is also possible to tell the receiver the basic characteristics of the incoming signal, so that the signal's stop condition can be recognized, and signal glitches and noise can be filtered out. The RMT peripheral also supports demodulating the high-frequency carrier from the base signal.

---

<sup>1</sup> Different ESP chip series might have different numbers of RMT channels. Please refer to [TRM] for details. The driver does not forbid you from applying for more RMT channels, but it returns an error when there are no hardware resources available. Please always check the return value when doing *Resource Allocation*.

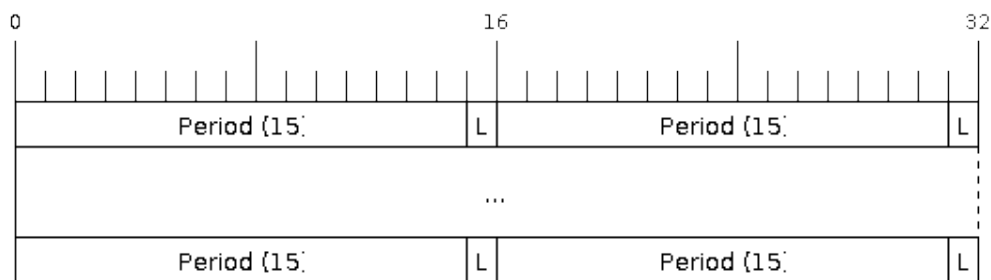

Fig. 9: Structure of RMT symbols (L - signal level)

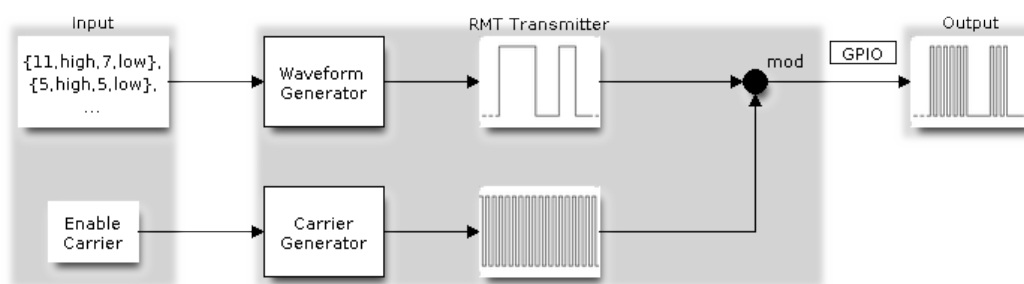

Fig. 10: RMT Transmitter Overview

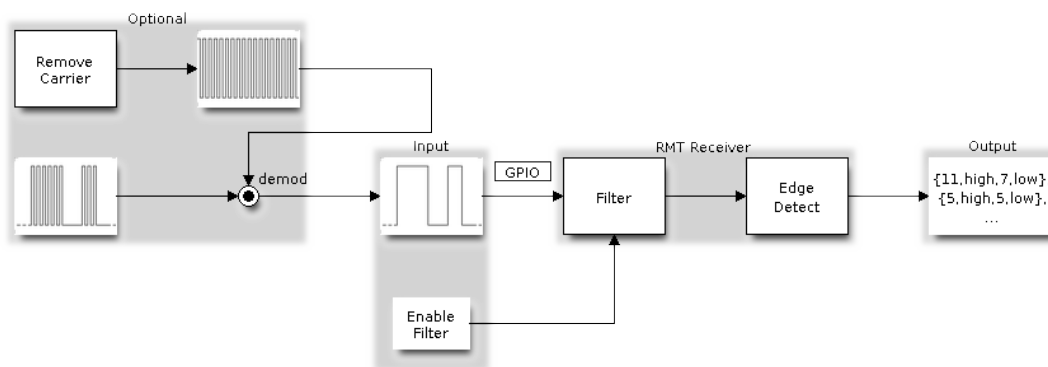

Fig. 11: RMT Receiver Overview

## Functional Overview

The description of the RMT functionality is divided into the following sections:

- *Resource Allocation* - covers how to allocate and properly configure RMT channels. It also covers how to recycle channels and other resources when they are no longer used.
- *Carrier Modulation and Demodulation* - describes how to modulate and demodulate the carrier signals for TX and RX channels respectively.
- *Register Event Callbacks* - covers how to register user-provided event callbacks to receive RMT channel events.
- *Enable and Disable Channel* - shows how to enable and disable the RMT channel.
- *Initiate TX Transaction* - describes the steps to initiate a transaction for a TX channel.
- *Initiate RX Transaction* - describes the steps to initiate a transaction for an RX channel.
- *Multiple Channels Simultaneous Transmission* - describes how to collect multiple channels into a sync group so that their transmissions can be started simultaneously.
- *RMT Encoder* - focuses on how to write a customized encoder by combining multiple primitive encoders that are provided by the driver.
- *Power Management* - describes how different clock sources affects power consumption.
- *IRAM Safe* - describes how disabling the cache affects the RMT driver, and tips to mitigate it.
- *Thread Safety* - lists which APIs are guaranteed to be thread-safe by the driver.
- *Kconfig Options* - describes the various Kconfig options supported by the RMT driver.

**Resource Allocation** Both RMT TX and RX channels are represented by `rmt_channel_handle_t` in the driver. The driver internally manages which channels are available and hands out a free channel on request.

**Install RMT TX Channel** To install an RMT TX channel, there is a configuration structure that needs to be given in advance `rmt_tx_channel_config_t`. The following list describes each member of the configuration structure.

- `rmt_tx_channel_config_t::gpio_num` sets the GPIO number used by the transmitter.
- `rmt_tx_channel_config_t::clk_src` selects the source clock for the RMT channel. The available clocks are listed in `rmt_clock_source_t`. Note that, the selected clock is also used by other channels, which means the user should ensure this configuration is the same when allocating other channels, regardless of TX or RX. For the effect on the power consumption of different clock sources, please refer to the *Power Management* section.
- `rmt_tx_channel_config_t::resolution_hz` sets the resolution of the internal tick counter. The timing parameter of the RMT signal is calculated based on this **tick**.
- `rmt_tx_channel_config_t::mem_block_symbols` has a slightly different meaning based on if the DMA backend is enabled or not.
  - If the DMA is enabled via `rmt_tx_channel_config_t::with_dma`, then this field controls the size of the internal DMA buffer. To achieve a better throughput and smaller CPU overhead, you can set a larger value, e.g., 1024.
  - If DMA is not used, this field controls the size of the dedicated memory block owned by the channel, which should be at least 64.
- `rmt_tx_channel_config_t::trans_queue_depth` sets the depth of the internal transaction queue, the deeper the queue, the more transactions can be prepared in the backlog.
- `rmt_tx_channel_config_t::invert_out` is used to decide whether to invert the RMT signal before sending it to the GPIO pad.
- `rmt_tx_channel_config_t::with_dma` enables the DMA backend for the channel. Using the DMA allows a significant amount of the channel's workload to be offloaded from the CPU. However, the DMA backend is not available on all ESP chips, please refer to [TRM] before you enable this option. Or you might encounter a `ESP_ERR_NOT_SUPPORTED` error.
- `rmt_tx_channel_config_t::io_loop_back` enables both input and output capabilities on the channel's assigned GPIO. Thus, by binding a TX and RX channel to the same GPIO, loopback can be achieved.
- `rmt_tx_channel_config_t::io_od_mode` configures the channel's assigned GPIO as open-drain. When combined with `rmt_tx_channel_config_t::io_loop_back`, a bi-directional bus (e.g., 1-wire) can be achieved.

- `rmt_tx_channel_config_t::intr_priority` Set the priority of the interrupt. If set to 0, then the driver will use an interrupt with low or medium priority (priority level may be one of 1,2 or 3), otherwise use the priority indicated by `rmt_tx_channel_config_t::intr_priority`. Please use the number form (1,2,3), not the bitmask form ((1<<1),(1<<2),(1<<3)). Please pay attention that once the interrupt priority is set, it cannot be changed until `rmt_del_channel()` is called.

Once the `rmt_tx_channel_config_t` structure is populated with mandatory parameters, users can call `rmt_new_tx_channel()` to allocate and initialize a TX channel. This function returns an RMT channel handle if it runs correctly. Specifically, when there are no more free channels in the RMT resource pool, this function returns `ESP_ERR_NOT_FOUND` error. If some feature (e.g., DMA backend) is not supported by the hardware, it returns `ESP_ERR_NOT_SUPPORTED` error.

```
rmt_channel_handle_t tx_chan = NULL;
rmt_tx_channel_config_t tx_chan_config = {
    .clk_src = RMT_CLK_SRC_DEFAULT,    // select source clock
    .gpio_num = 0,                    // GPIO number
    .mem_block_symbols = 64,           // memory block size, 64 * 4 = 256 Bytes
    .resolution_hz = 1 * 1000 * 1000, // 1 MHz tick resolution, i.e., 1 tick = 1 μs
    .trans_queue_depth = 4,           // set the number of transactions that can
    ↪pend in the background
    .flags.invert_out = false,         // do not invert output signal
    .flags.with_dma = false,          // do not need DMA backend
};
ESP_ERROR_CHECK(rmt_new_tx_channel(&tx_chan_config, &tx_chan));
```

**Install RMT RX Channel** To install an RMT RX channel, there is a configuration structure that needs to be given in advance `rmt_rx_channel_config_t`. The following list describes each member of the configuration structure.

- `rmt_rx_channel_config_t::gpio_num` sets the GPIO number used by the receiver.
- `rmt_rx_channel_config_t::clk_src` selects the source clock for the RMT channel. The available clocks are listed in `rmt_clock_source_t`. Note that, the selected clock is also used by other channels, which means the user should ensure this configuration is the same when allocating other channels, regardless of TX or RX. For the effect on the power consumption of different clock sources, please refer to the [Power Management](#) section.
- `rmt_rx_channel_config_t::resolution_hz` sets the resolution of the internal tick counter. The timing parameter of the RMT signal is calculated based on this **tick**.
- `rmt_rx_channel_config_t::mem_block_symbols` has a slightly different meaning based on whether the DMA backend is enabled.
  - If the DMA is enabled via `rmt_rx_channel_config_t::with_dma`, this field controls the maximum size of the DMA buffer.
  - If DMA is not used, this field controls the size of the dedicated memory block owned by the channel, which should be at least 64.
- `rmt_rx_channel_config_t::invert_in` is used to invert the input signals before it is passed to the RMT receiver. The inversion is done by the GPIO matrix instead of by the RMT peripheral.
- `rmt_rx_channel_config_t::with_dma` enables the DMA backend for the channel. Using the DMA allows a significant amount of the channel's workload to be offloaded from the CPU. However, the DMA backend is not available on all ESP chips, please refer to [TRM] before you enable this option. Or you might encounter a `ESP_ERR_NOT_SUPPORTED` error.
- `rmt_rx_channel_config_t::io_loop_back` enables both input and output capabilities on the channel's assigned GPIO. Thus, by binding a TX and RX channel to the same GPIO, loopback can be achieved.
- `rmt_rx_channel_config_t::intr_priority` Set the priority of the interrupt. If set to 0, then the driver will use an interrupt with low or medium priority (priority level may be one of 1,2 or 3), otherwise use the priority indicated by `rmt_rx_channel_config_t::intr_priority`. Please use the number form (1,2,3), not the bitmask form ((1<<1),(1<<2),(1<<3)). Please pay attention that once the interrupt priority is set, it cannot be changed until `rmt_del_channel()` is called.

Once the `rmt_rx_channel_config_t` structure is populated with mandatory parameters, users can call `rmt_new_rx_channel()` to allocate and initialize an RX channel. This function returns an RMT channel han-

dle if it runs correctly. Specifically, when there are no more free channels in the RMT resource pool, this function returns `ESP_ERR_NOT_FOUND` error. If some feature (e.g., DMA backend) is not supported by the hardware, it returns `ESP_ERR_NOT_SUPPORTED` error.

```
rmt_channel_handle_t rx_chan = NULL;
rmt_rx_channel_config_t rx_chan_config = {
    .clk_src = RMT_CLK_SRC_DEFAULT, // select source clock
    .resolution_hz = 1 * 1000 * 1000, // 1 MHz tick resolution, i.e., 1 tick = 1 μs
    .mem_block_symbols = 64, // memory block size, 64 * 4 = 256 Bytes
    .gpio_num = 2, // GPIO number
    .flags.invert_in = false, // do not invert input signal
    .flags.with_dma = false, // do not need DMA backend
};
ESP_ERROR_CHECK(rmt_new_rx_channel(&rx_chan_config, &rx_chan));
```

**Note:** Due to a software limitation in the GPIO driver, when both TX and RX channels are bound to the same GPIO, ensure the RX Channel is initialized before the TX Channel. If the TX Channel was set up first, then during the RX Channel setup, the previous RMT TX Channel signal will be overridden by the GPIO control signal.

**Uninstall RMT Channel** If a previously installed RMT channel is no longer needed, it is recommended to recycle the resources by calling `rmt_del_channel()`, which in return allows the underlying software and hardware resources to be reused for other purposes.

**Carrier Modulation and Demodulation** The RMT transmitter can generate a carrier wave and modulate it onto the message signal. Compared to the message signal, the carrier signal's frequency is significantly higher. In addition, the user can only set the frequency and duty cycle for the carrier signal. The RMT receiver can demodulate the carrier signal from the incoming signal. Note that, carrier modulation and demodulation are not supported on all ESP chips, please refer to [TRM] before configuring the carrier, or you might encounter a `ESP_ERR_NOT_SUPPORTED` error.

Carrier-related configurations lie in `rmt_carrier_config_t`:

- `rmt_carrier_config_t::frequency_hz` sets the carrier frequency, in Hz.
- `rmt_carrier_config_t::duty_cycle` sets the carrier duty cycle.
- `rmt_carrier_config_t::polarity_active_low` sets the carrier polarity, i.e., on which level the carrier is applied.
- `rmt_carrier_config_t::always_on` sets whether to output the carrier even when the data transmission has finished. This configuration is only valid for the TX channel.

**Note:** For the RX channel, we should not set the carrier frequency exactly to the theoretical value. It is recommended to leave a tolerance for the carrier frequency. For example, in the snippet below, we set the frequency to 25 KHz, instead of the 38 KHz configured on the TX side. The reason is that reflection and refraction occur when a signal travels through the air, leading to distortion on the receiver side.

```
rmt_carrier_config_t tx_carrier_cfg = {
    .duty_cycle = 0.33, // duty cycle 33%
    .frequency_hz = 38000, // 38 KHz
    .flags.polarity_active_low = false, // carrier should be modulated to high_
    ↪level
};
// modulate carrier to TX channel
ESP_ERROR_CHECK(rmt_apply_carrier(tx_chan, &tx_carrier_cfg));

rmt_carrier_config_t rx_carrier_cfg = {
    .duty_cycle = 0.33, // duty cycle 33%
    .frequency_hz = 25000, // 25 KHz carrier, should be smaller than_
    ↪the transmitter's carrier frequency
```

(continues on next page)



(continued from previous page)

```

        .flags.polarity_active_low = false, // the carrier is modulated to high level
    };
    // demodulate carrier from RX channel
    ESP_ERROR_CHECK(rmt_apply_carrier(rx_chan, &rx_carrier_cfg));

```

**Register Event Callbacks** When an event occurs on an RMT channel (e.g., transmission or receiving is completed), the CPU is notified of this event via an interrupt. If you have some function that needs to be called when a particular events occur, you can register a callback for that event to the RMT driver's ISR (Interrupt Service Routine) by calling `rmt_tx_register_event_callbacks()` and `rmt_rx_register_event_callbacks()` for TX and RX channel respectively. Since the registered callback functions are called in the interrupt context, the user should ensure the callback function does not block, e.g., by making sure that only FreeRTOS APIs with the `FromISR` suffix are called from within the function. The callback function has a boolean return value used to indicate whether a higher priority task has been unblocked by the callback.

The TX channel-supported event callbacks are listed in the `rmt_tx_event_callbacks_t`:

- `rmt_tx_event_callbacks_t::on_trans_done` sets a callback function for the “trans-done” event. The function prototype is declared in `rmt_tx_done_callback_t`.

The RX channel-supported event callbacks are listed in the `rmt_rx_event_callbacks_t`:

- `rmt_rx_event_callbacks_t::on_recv_done` sets a callback function for “receive-done” event. The function prototype is declared in `rmt_rx_done_callback_t`.

Users can save their own context in `rmt_tx_register_event_callbacks()` and `rmt_rx_register_event_callbacks()` as well, via the parameter `user_data`. The user data is directly passed to each callback function.

In the callback function, users can fetch the event-specific data that is filled by the driver in the `edata`. Note that the `edata` pointer is only valid during the callback.

The TX-done event data is defined in `rmt_tx_done_event_data_t`:

- `rmt_tx_done_event_data_t::num_symbols` indicates the number of transmitted RMT symbols. This also reflects the size of the encoding artifacts. Please note, this value accounts for the EOF symbol as well, which is appended by the driver to mark the end of one transaction.

The RX-complete event data is defined in `rmt_rx_done_event_data_t`:

- `rmt_rx_done_event_data_t::received_symbols` points to the received RMT symbols. These symbols are saved in the `buffer` parameter of the `rmt_receive()` function. Users should not free this receive buffer before the callback returns.
- `rmt_rx_done_event_data_t::num_symbols` indicates the number of received RMT symbols. This value is not larger than the `buffer_size` parameter of `rmt_receive()` function. If the `buffer_size` is not sufficient to accommodate all the received RMT symbols, the driver only keeps the maximum number of symbols that the buffer can hold, and excess symbols are discarded or ignored.

**Enable and Disable Channel** `rmt_enable()` must be called in advance before transmitting or receiving RMT symbols. For TX channels, enabling a channel enables a specific interrupt and prepares the hardware to dispatch transactions. For RX channels, enabling a channel enables an interrupt, but the receiver is not started during this time, as the characteristics of the incoming signal have yet to be specified. The receiver is started in `rmt_receive()`.

`rmt_disable()` does the opposite by disabling the interrupt and clearing any pending interrupts. The transmitter and receiver are disabled as well.

```

ESP_ERROR_CHECK(rmt_enable(tx_chan));
ESP_ERROR_CHECK(rmt_enable(rx_chan));

```

**Initiate TX Transaction** RMT is a special communication peripheral, as it is unable to transmit raw byte streams like SPI and I2C. RMT can only send data in its own format `rmt_symbol_word_t`. However, the hardware does not help to convert the user data into RMT symbols, this can only be done in software by the so-called **RMT Encoder**. The encoder is responsible for encoding user data into RMT symbols and then writing to the RMT memory block or the DMA buffer. For how to create an RMT encoder, please refer to *RMT Encoder*.

Once you created an encoder, you can initiate a TX transaction by calling `rmt_transmit()`. This function takes several positional parameters like channel handle, encoder handle, and payload buffer. Besides, you also need to provide a transmission-specific configuration in `rmt_transmit_config_t`:

- `rmt_transmit_config_t::loop_count` sets the number of transmission loops. After the transmitter has finished one round of transmission, it can restart the same transmission again if this value is not set to zero. As the loop is controlled by hardware, the RMT channel can be used to generate many periodic sequences with minimal CPU intervention.
  - Setting `rmt_transmit_config_t::loop_count` to `-1` means an infinite loop transmission. In this case, the channel does not stop until `rmt_disable()` is called. The “trans-done” event is not generated as well.
  - Setting `rmt_transmit_config_t::loop_count` to a positive number means finite number of iterations. In this case, the “trans-done” event is when the specified number of iterations have completed.

---

**Note:** The **loop transmit** feature is not supported on all ESP chips, please refer to [TRM] before you configure this option, or you might encounter `ESP_ERR_NOT_SUPPORTED` error.

---

- `rmt_transmit_config_t::eot_level` sets the output level when the transmitter finishes working or stops working by calling `rmt_disable()`.
- `rmt_transmit_config_t::queue_nonblocking` sets whether to wait for a free slot in the transaction queue when it is full. If this value is set to `true`, then the function will return with an error code `ESP_ERR_INVALID_STATE` when the queue is full. Otherwise, the function will block until a free slot is available in the queue.

---

**Note:** There is a limitation in the transmission size if the `rmt_transmit_config_t::loop_count` is set to non-zero, i.e., to enable the loop feature. The encoded RMT symbols should not exceed the capacity of the RMT hardware memory block size, or you might see an error message like `encoding artifacts can't exceed hw memory block for loop transmission`. If you have to start a large transaction by loop, you can try either of the following methods.

- Increase the `rmt_tx_channel_config_t::mem_block_symbols`. This approach does not work if the DMA backend is also enabled.
  - Customize an encoder and construct an infinite loop in the encoding function. See also *RMT Encoder*.
- 

Internally, `rmt_transmit()` constructs a transaction descriptor and sends it to a job queue, which is dispatched in the ISR. So it is possible that the transaction is not started yet when `rmt_transmit()` returns. To ensure all pending transactions to complete, the user can use `rmt_tx_wait_all_done()`.

**Multiple Channels Simultaneous Transmission** In some real-time control applications (e.g., to make two robotic arms move simultaneously), you do not want any time drift between different channels. The RMT driver can help to manage this by creating a so-called **Sync Manager**. The sync manager is represented by `rmt_sync_manager_handle_t` in the driver. The procedure of RMT sync transmission is shown as follows:

**Install RMT Sync Manager** To create a sync manager, the user needs to tell which channels are going to be managed in the `rmt_sync_manager_config_t`:

- `rmt_sync_manager_config_t::tx_channel_array` points to the array of TX channels to be managed.
- `rmt_sync_manager_config_t::array_size` sets the number of channels to be managed.

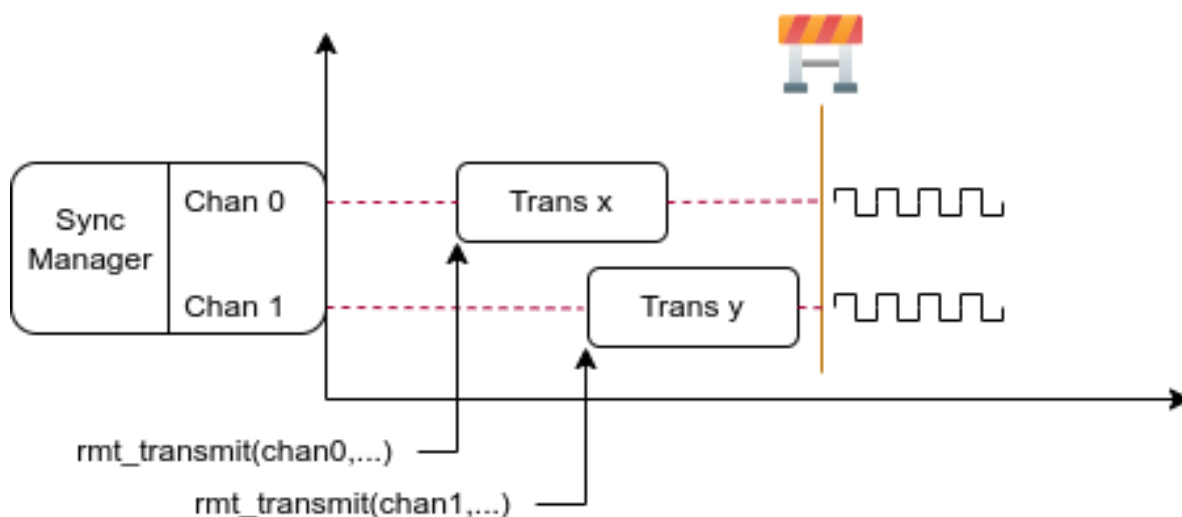

Fig. 12: RMT TX Sync

`rmt_new_sync_manager()` can return a manager handle on success. This function could also fail due to various errors such as invalid arguments, etc. Especially, when the sync manager has been installed before, and there are no hardware resources to create another manager, this function reports `ESP_ERR_NOT_FOUND` error. In addition, if the sync manager is not supported by the hardware, it reports a `ESP_ERR_NOT_SUPPORTED` error. Please refer to [TRM] before using the sync manager feature.

**Start Transmission Simultaneously** For any managed TX channel, it does not start the machine until `rmt_transmit()` has been called on all channels in `rmt_sync_manager_config_t::tx_channel_array`. Before that, the channel is just put in a waiting state. TX channels will usually complete their transactions at different times due to differing transactions, thus resulting in a loss of sync. So before restarting a simultaneous transmission, the user needs to call `rmt_sync_reset()` to synchronize all channels again.

Calling `rmt_del_sync_manager()` can recycle the sync manager and enable the channels to initiate transactions independently afterward.

```

rmt_channel_handle_t tx_channels[2] = {NULL}; // declare two channels
int tx_gpio_number[2] = {0, 2};
// install channels one by one
for (int i = 0; i < 2; i++) {
    rmt_tx_channel_config_t tx_chan_config = {
        .clk_src = RMT_CLK_SRC_DEFAULT, // select source clock
        .gpio_num = tx_gpio_number[i], // GPIO number
        .mem_block_symbols = 64, // memory block size, 64 * 4 = 256 Bytes
        .resolution_hz = 1 * 1000 * 1000, // 1 MHz resolution
        .trans_queue_depth = 1, // set the number of transactions that
        ↪ can pend in the background
    };
    ESP_ERROR_CHECK(rmt_new_tx_channel(&tx_chan_config, &tx_channels[i]));
}
// install sync manager
rmt_sync_manager_handle_t synchro = NULL;
rmt_sync_manager_config_t synchro_config = {
    .tx_channel_array = tx_channels,
    .array_size = sizeof(tx_channels) / sizeof(tx_channels[0]),
};
ESP_ERROR_CHECK(rmt_new_sync_manager(&synchro_config, &synchro));

ESP_ERROR_CHECK(rmt_transmit(tx_channels[0], led_strip_encoders[0], led_data, led_
↪ num * 3, &transmit_config));

```

(continues on next page)

(continued from previous page)

```
// tx_channels[0] does not start transmission until call of `rmt_transmit()` for_
↳tx_channels[1] returns
ESP_ERROR_CHECK(rmt_transmit(tx_channels[1], led_strip_encoders[1], led_data, led_
↳num * 3, &transmit_config));
```

**Initiate RX Transaction** As also discussed in the *Enable and Disable Channel*, calling `rmt_enable()` does not prepare an RX to receive RMT symbols. The user needs to specify the basic characteristics of the incoming signals in `rmt_receive_config_t`:

- `rmt_receive_config_t::signal_range_min_ns` specifies the minimal valid pulse duration in either high or low logic levels. A pulse width that is smaller than this value is treated as a glitch, and ignored by the hardware.
- `rmt_receive_config_t::signal_range_max_ns` specifies the maximum valid pulse duration in either high or low logic levels. A pulse width that is bigger than this value is treated as **Stop Signal**, and the receiver generates receive-complete event immediately.

The RMT receiver starts the RX machine after the user calls `rmt_receive()` with the provided configuration above. Note that, this configuration is transaction specific, which means, to start a new round of reception, the user needs to set the `rmt_receive_config_t` again. The receiver saves the incoming signals into its internal memory block or DMA buffer, in the format of `rmt_symbol_word_t`.

Due to the limited size of the memory block, the RMT receiver can only save short frames whose length is not longer than the memory block capacity. Long frames are truncated by the hardware, and the driver reports an error message: `hw buffer too small, received symbols truncated`.

The copy destination should be provided in the `buffer` parameter of `rmt_receive()` function. If this buffer overflows due to an insufficient buffer size, the receiver can continue to work, but overflowed symbols are dropped and the following error message is reported: `user buffer too small, received symbols truncated`. Please take care of the lifecycle of the `buffer` parameter, ensuring that the buffer is not recycled before the receiver is finished or stopped.

The receiver is stopped by the driver when it finishes working, i.e., receive a signal whose duration is bigger than `rmt_receive_config_t::signal_range_max_ns`. The user needs to call `rmt_receive()` again to restart the receiver, if necessary. The user can get the received data in the `rmt_rx_event_callbacks_t::on_recv_done` callback. See also *Register Event Callbacks* for more information.

```
static bool example_rmt_rx_done_callback(rmt_channel_handle_t channel, const rmt_
↳rx_done_event_data_t *edata, void *user_data)
{
    BaseType_t high_task_wakeup = pdFALSE;
    QueueHandle_t receive_queue = (QueueHandle_t)user_data;
    // send the received RMT symbols to the parser task
    xQueueSendFromISR(receive_queue, edata, &high_task_wakeup);
    // return whether any task is woken up
    return high_task_wakeup == pdTRUE;
}

QueueHandle_t receive_queue = xQueueCreate(1, sizeof(rmt_rx_done_event_data_t));
rmt_rx_event_callbacks_t cbs = {
    .on_recv_done = example_rmt_rx_done_callback,
};
ESP_ERROR_CHECK(rmt_rx_register_event_callbacks(rx_channel, &cbs, receive_queue));

// the following timing requirement is based on NEC protocol
rmt_receive_config_t receive_config = {
    .signal_range_min_ns = 1250, // the shortest duration for NEC signal is_
↳560 µs, 1250 ns < 560 µs, valid signal is not treated as noise
    .signal_range_max_ns = 12000000, // the longest duration for NEC signal is_
↳9000 µs, 12000000 ns > 9000 µs, the receive does not stop early
```

(continues on next page)

```
};

rmt_symbol_word_t raw_symbols[64]; // 64 symbols should be sufficient for a
↳standard NEC frame
// ready to receive
ESP_ERROR_CHECK(rmt_receive(rx_channel, raw_symbols, sizeof(raw_symbols), &receive_
↳config));
// wait for the RX-done signal
rmt_rx_done_event_data_t rx_data;
xQueueReceive(receive_queue, &rx_data, portMAX_DELAY);
// parse the received symbols
example_parse_nec_frame(rx_data.received_symbols, rx_data.num_symbols);
```

**RMT Encoder** An RMT encoder is part of the RMT TX transaction, whose responsibility is to generate and write the correct RMT symbols into hardware memory or DMA buffer at a specific time. There are some special restrictions for an encoding function:

- During a single transaction, the encoding function may be called multiple times. This is necessary because the target RMT memory block cannot hold all the artifacts at once. To overcome this limitation, the driver utilizes a **ping-pong** approach, where the encoding session is divided into multiple parts. This means that the encoder needs to **keep track of its state** to continue encoding from where it left off in the previous part.
- The encoding function is running in the ISR context. To speed up the encoding session, it is highly recommended to put the encoding function into IRAM. This can also avoid the cache miss during encoding.

To help get started with the RMT driver faster, some commonly used encoders are provided out-of-the-box. They can either work alone or be chained together into a new encoder. See also [Composite Pattern](#) for the principle behind it. The driver has defined the encoder interface in `rmt_encoder_t`, it contains the following functions:

- `rmt_encoder_t::encode` is the fundamental function of an encoder. This is where the encoding session happens.
  - The function might be called multiple times within a single transaction. The encode function should return the state of the current encoding session.
  - The supported states are listed in the `rmt_encode_state_t`. If the result contains `RMT_ENCODING_COMPLETE`, it means the current encoder has finished work.
  - If the result contains `RMT_ENCODING_MEM_FULL`, the program needs to yield from the current session, as there is no space to save more encoding artifacts.
- `rmt_encoder_t::reset` should reset the encoder state back to the initial state (the RMT encoder is stateful).
  - If the RMT transmitter is manually stopped without resetting its corresponding encoder, subsequent encoding session can be erroneous.
  - This function is also called implicitly in `rmt_disable()`.
- `rmt_encoder_t::del` should free the resources allocated by the encoder.

**Copy Encoder** A copy encoder is created by calling `rmt_new_copy_encoder()`. A copy encoder's main functionality is to copy the RMT symbols from user space into the driver layer. It is usually used to encode `const` data, i.e., data does not change at runtime after initialization such as the leading code in the IR protocol.

A configuration structure `rmt_copy_encoder_config_t` should be provided in advance before calling `rmt_new_copy_encoder()`. Currently, this configuration is reserved for future expansion, and has no specific use or setting items for now.

**Bytes Encoder** A bytes encoder is created by calling `rmt_new_bytes_encoder()`. The bytes encoder's main functionality is to convert the user space byte stream into RMT symbols dynamically. It is usually used to encode dynamic data, e.g., the address and command fields in the IR protocol.

A configuration structure `rmt_bytes_encoder_config_t` should be provided in advance before calling `rmt_new_bytes_encoder()`:

- `rmt_bytes_encoder_config_t::bit0` and `rmt_bytes_encoder_config_t::bit1` are necessary to specify the encoder how to represent bit zero and bit one in the format of `rmt_symbol_word_t`.
- `rmt_bytes_encoder_config_t::msb_first` sets the bit endianness of each byte. If it is set to true, the encoder encodes the **Most Significant Bit** first. Otherwise, it encodes the **Least Significant Bit** first.

Besides the primitive encoders provided by the driver, the user can implement his own encoder by chaining the existing encoders together. A common encoder chain is shown as follows:

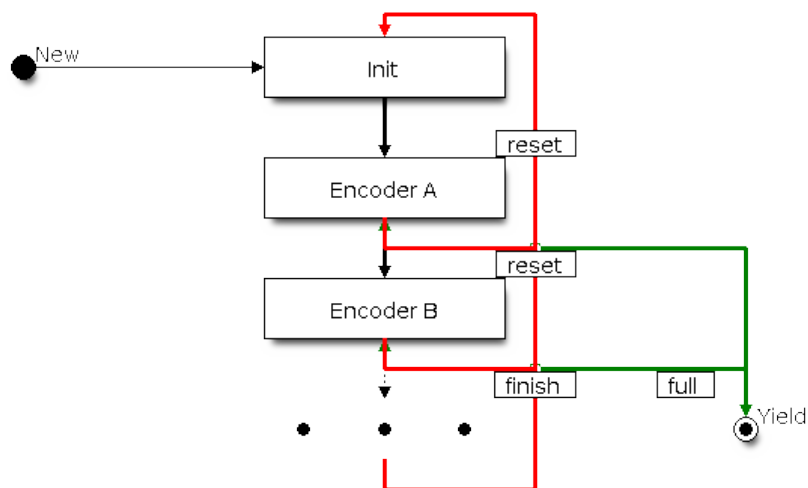

Fig. 13: RMT Encoder Chain

**Customize RMT Encoder for NEC Protocol** This section demonstrates how to write an NEC encoder. The NEC IR protocol uses pulse distance encoding of the message bits. Each pulse burst is  $562.5 \mu\text{s}$  in length, logical bits are transmitted as follows. It is worth mentioning that the least significant bit of each byte is sent first.

- Logical 0: a  $562.5 \mu\text{s}$  pulse burst followed by a  $562.5 \mu\text{s}$  space, with a total transmit time of  $1.125 \text{ ms}$
- Logical 1: a  $562.5 \mu\text{s}$  pulse burst followed by a  $1.6875 \text{ ms}$  space, with a total transmit time of  $2.25 \text{ ms}$

When a key is pressed on the remote controller, the transmitted message includes the following elements in the specified order:

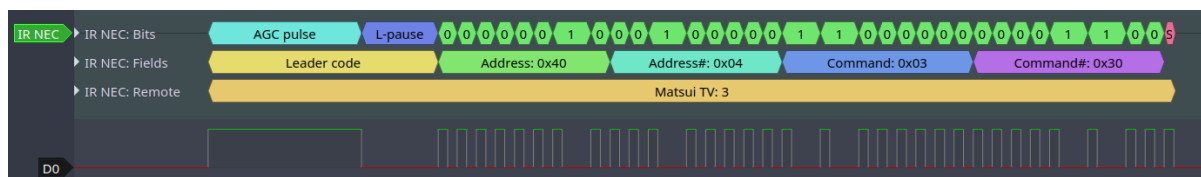

Fig. 14: IR NEC Frame

- $9 \text{ ms}$  leading pulse burst, also called the “AGC pulse”
- $4.5 \text{ ms}$  space
- 8-bit address for the receiving device
- 8-bit logical inverse of the address
- 8-bit command
- 8-bit logical inverse of the command
- a final  $562.5 \mu\text{s}$  pulse burst to signify the end of message transmission

Then you can construct the NEC `rmt_encoder_t::encode` function in the same order, for example:

```

// IR NEC scan code representation
typedef struct {
    uint16_t address;
    uint16_t command;
} ir_nec_scan_code_t;

// construct an encoder by combining primitive encoders
typedef struct {
    rmt_encoder_t base;           // the base "class" declares the standard_
    ↪encoder interface
    rmt_encoder_t *copy_encoder; // use the copy_encoder to encode the leading_
    ↪and ending pulse
    rmt_encoder_t *bytes_encoder; // use the bytes_encoder to encode the address_
    ↪and command data
    rmt_symbol_word_t nec_leading_symbol; // NEC leading code with RMT_
    ↪representation
    rmt_symbol_word_t nec_ending_symbol; // NEC ending code with RMT_
    ↪representation
    int state; // record the current encoding state, i.e., we are in which_
    ↪encoding phase
} rmt_ir_nec_encoder_t;

static size_t rmt_encode_ir_nec(rmt_encoder_t *encoder, rmt_channel_handle_t_
    ↪channel, const void *primary_data, size_t data_size, rmt_encode_state_t *ret_
    ↪state)
{
    rmt_ir_nec_encoder_t *nec_encoder = __containerof(encoder, rmt_ir_nec_encoder_
    ↪t, base);
    rmt_encode_state_t session_state = RMT_ENCODING_RESET;
    rmt_encode_state_t state = RMT_ENCODING_RESET;
    size_t encoded_symbols = 0;
    ir_nec_scan_code_t *scan_code = (ir_nec_scan_code_t *)primary_data;
    rmt_encoder_handle_t copy_encoder = nec_encoder->copy_encoder;
    rmt_encoder_handle_t bytes_encoder = nec_encoder->bytes_encoder;
    switch (nec_encoder->state) {
        case 0: // send leading code
            encoded_symbols += copy_encoder->encode(copy_encoder, channel, &nec_
            ↪encoder->nec_leading_symbol,
                                sizeof(rmt_symbol_word_t), &
            ↪session_state);
            if (session_state & RMT_ENCODING_COMPLETE) {
                nec_encoder->state = 1; // we can only switch to the next state when_
            ↪the current encoder finished
            }
            if (session_state & RMT_ENCODING_MEM_FULL) {
                state |= RMT_ENCODING_MEM_FULL;
                goto out; // yield if there is no free space to put other encoding_
            ↪artifacts
            }
            // fall-through
            case 1: // send address
                encoded_symbols += bytes_encoder->encode(bytes_encoder, channel, &scan_
            ↪code->address, sizeof(uint16_t), &session_state);
                if (session_state & RMT_ENCODING_COMPLETE) {
                    nec_encoder->state = 2; // we can only switch to the next state when_
            ↪the current encoder finished
                }
                if (session_state & RMT_ENCODING_MEM_FULL) {
                    state |= RMT_ENCODING_MEM_FULL;
                    goto out; // yield if there is no free space to put other encoding_
            ↪artifacts
                }
    }
}

```

(continues on next page)



(continued from previous page)

```

// fall-through
case 2: // send command
    encoded_symbols += bytes_encoder->encode(bytes_encoder, channel, &scan_
↪code->command, sizeof(uint16_t), &session_state);
    if (session_state & RMT_ENCODING_COMPLETE) {
        nec_encoder->state = 3; // we can only switch to the next state when
↪the current encoder finished
    }
    if (session_state & RMT_ENCODING_MEM_FULL) {
        state |= RMT_ENCODING_MEM_FULL;
        goto out; // yield if there is no free space to put other encoding
↪artifacts
    }
// fall-through
case 3: // send ending code
    encoded_symbols += copy_encoder->encode(copy_encoder, channel, &nec_
↪encoder->nec_ending_symbol,
                                sizeof(rmt_symbol_word_t), &
↪session_state);
    if (session_state & RMT_ENCODING_COMPLETE) {
        nec_encoder->state = RMT_ENCODING_RESET; // back to the initial
↪encoding session
        state |= RMT_ENCODING_COMPLETE; // telling the caller the NEC encoding
↪has finished
    }
    if (session_state & RMT_ENCODING_MEM_FULL) {
        state |= RMT_ENCODING_MEM_FULL;
        goto out; // yield if there is no free space to put other encoding
↪artifacts
    }
}
out:
*ret_state = state;
return encoded_symbols;
}

```

A full sample code can be found in [peripherals/rmt/ir\\_nec\\_transceiver](#). In the above snippet, we use a switch-case and several goto statements to implement a [Finite-state machine](#). With this pattern, users can construct much more complex IR protocols.

**Power Management** When power management is enabled, i.e., [CONFIG\\_PM\\_ENABLE](#) is on, the system adjusts the APB frequency before going into Light-sleep, thus potentially changing the resolution of the RMT internal counter.

However, the driver can prevent the system from changing APB frequency by acquiring a power management lock of type [ESP\\_PM\\_APB\\_FREQ\\_MAX](#). Whenever the user creates an RMT channel that has selected [RMT\\_CLK\\_SRC\\_APB](#) as the clock source, the driver guarantees that the power management lock is acquired after the channel enabled by [rmt\\_enable\(\)](#). Likewise, the driver releases the lock after [rmt\\_disable\(\)](#) is called for the same channel. This also reveals that the [rmt\\_enable\(\)](#) and [rmt\\_disable\(\)](#) should appear in pairs.

If the channel clock source is selected to others like [RMT\\_CLK\\_SRC\\_XTAL](#), then the driver does not install a power management lock for it, which is more suitable for a low-power application as long as the source clock can still provide sufficient resolution.

**IRAM Safe** By default, the RMT interrupt is deferred when the Cache is disabled for reasons like writing or erasing the main Flash. Thus the transaction-done interrupt does not get handled in time, which is not acceptable in a real-time application. What is worse, when the RMT transaction relies on **ping-pong** interrupt to successively encode or copy RMT symbols, a delayed interrupt can lead to an unpredictable result.

There is a Kconfig option [CONFIG\\_RMT\\_ISR\\_IRAM\\_SAFE](#) that has the following features:



1. Enable the interrupt being serviced even when the cache is disabled
2. Place all functions used by the ISR into IRAM<sup>2</sup>
3. Place the driver object into DRAM in case it is mapped to PSRAM by accident

This Kconfig option allows the interrupt handler to run while the cache is disabled but comes at the cost of increased IRAM consumption.

Another Kconfig option `CONFIG_RMT_RECV_FUNC_IN_IRAM` can place `rmt_receive()` into the IRAM as well. So that the receive function can be used even when the flash cache is disabled.

**Thread Safety** The factory function `rmt_new_tx_channel()`, `rmt_new_rx_channel()` and `rmt_new_sync_manager()` are guaranteed to be thread-safe by the driver, which means, user can call them from different RTOS tasks without protection by extra locks. Other functions that take the `rmt_channel_handle_t` and `rmt_sync_manager_handle_t` as the first positional parameter, are not thread-safe. which means the user should avoid calling them from multiple tasks.

The following functions are allowed to use under ISR context as well.

- `rmt_receive()`

### Kconfig Options

- `CONFIG_RMT_ISR_IRAM_SAFE` controls whether the default ISR handler can work when cache is disabled, see also *IRAM Safe* for more information.
- `CONFIG_RMT_ENABLE_DEBUG_LOG` is used to enable the debug log at the cost of increased firmware binary size.
- `CONFIG_RMT_RECV_FUNC_IN_IRAM` controls where to place the RMT receive function (IRAM or Flash), see *IRAM Safe* for more information.

### Application Examples

- RMT-based RGB LED strip customized encoder: [peripherals/rmt/led\\_strip](#)
- RMT IR NEC protocol encoding and decoding: [peripherals/rmt/ir\\_nec\\_transceiver](#)
- RMT transactions in queue: [peripherals/rmt/musical\\_buzzer](#)
- RMT-based stepper motor with S-curve algorithm: [peripherals/rmt/stepper\\_motor](#)
- RMT infinite loop for driving DShot ESC: [peripherals/rmt/dshot\\_esc](#)
- RMT simulate 1-wire protocol (take DS18B20 as example): [peripherals/rmt/onewire](#)

### FAQ

- Why the RMT encoder results in more data than expected?

The RMT encoding takes place in the ISR context. If your RMT encoding session takes a long time (e.g., by logging debug information) or the encoding session is deferred somehow because of interrupt latency, then it is possible the transmitting becomes **faster** than the encoding. As a result, the encoder can not prepare the next data in time, leading to the transmitter sending the previous data again. There is no way to ask the transmitter to stop and wait. You can mitigate the issue by combining the following ways:

- Increase the `rmt_tx_channel_config_t::mem_block_symbols`, in steps of 64.
- Place the encoding function in the IRAM.
- Enables the `rmt_tx_channel_config_t::with_dma` if it is available for your chip.

---

<sup>2</sup> The callback function, e.g., `rmt_tx_event_callbacks_t::on_trans_done`, and the functions invoked by itself should also reside in IRAM, users need to take care of this by themselves.

## API Reference

### Header File

- `components/driver/include/driver/rmt_tx.h`

### Functions

`esp_err_t rmt_new_tx_channel` (const `rmt_tx_channel_config_t` \*config, `rmt_channel_handle_t` \*ret\_chan)

Create a RMT TX channel.

#### Parameters

- **config** –[in] TX channel configurations
- **ret\_chan** –[out] Returned generic RMT channel handle

#### Returns

- `ESP_OK`: Create RMT TX channel successfully
- `ESP_ERR_INVALID_ARG`: Create RMT TX channel failed because of invalid argument
- `ESP_ERR_NO_MEM`: Create RMT TX channel failed because out of memory
- `ESP_ERR_NOT_FOUND`: Create RMT TX channel failed because all RMT channels are used up and no more free one
- `ESP_ERR_NOT_SUPPORTED`: Create RMT TX channel failed because some feature is not supported by hardware, e.g. DMA feature is not supported by hardware
- `ESP_FAIL`: Create RMT TX channel failed because of other error

`esp_err_t rmt_transmit` (`rmt_channel_handle_t` tx\_channel, `rmt_encoder_handle_t` encoder, const void \*payload, `size_t` payload\_bytes, const `rmt_transmit_config_t` \*config)

Transmit data by RMT TX channel.

---

**Note:** This function constructs a transaction descriptor then pushes to a queue. The transaction will not start immediately if there's another one under processing. Based on the setting of `rmt_transmit_config_t::queue_nonblocking`, if there're too many transactions pending in the queue, this function can block until it has free slot, otherwise just return quickly.

---



---

**Note:** The data to be transmitted will be encoded into RMT symbols by the specific `encoder`.

---

#### Parameters

- **tx\_channel** –[in] RMT TX channel that created by `rmt_new_tx_channel()`
- **encoder** –[in] RMT encoder that created by various factory APIs like `rmt_new_bytes_encoder()`
- **payload** –[in] The raw data to be encoded into RMT symbols
- **payload\_bytes** –[in] Size of the payload in bytes
- **config** –[in] Transmission specific configuration

#### Returns

- `ESP_OK`: Transmit data successfully
- `ESP_ERR_INVALID_ARG`: Transmit data failed because of invalid argument
- `ESP_ERR_INVALID_STATE`: Transmit data failed because channel is not enabled
- `ESP_ERR_NOT_SUPPORTED`: Transmit data failed because some feature is not supported by hardware, e.g. unsupported loop count
- `ESP_FAIL`: Transmit data failed because of other error

`esp_err_t rmt_tx_wait_all_done` (`rmt_channel_handle_t` tx\_channel, int timeout\_ms)

Wait for all pending TX transactions done.

---

**Note:** This function will block forever if the pending transaction can't be finished within a limited time (e.g. an infinite loop transaction). See also `rmt_disable()` for how to terminate a working channel.

---

**Parameters**

- **tx\_channel** –[in] RMT TX channel that created by `rmt_new_tx_channel()`
- **timeout\_ms** –[in] Wait timeout, in ms. Specially, -1 means to wait forever.

**Returns**

- `ESP_OK`: Flush transactions successfully
- `ESP_ERR_INVALID_ARG`: Flush transactions failed because of invalid argument
- `ESP_ERR_TIMEOUT`: Flush transactions failed because of timeout
- `ESP_FAIL`: Flush transactions failed because of other error

```
esp_err_t rmt_tx_register_event_callbacks(rmt_channel_handle_t tx_channel, const  
                                         rmt_tx_event_callbacks_t *cbs, void *user_data)
```

Set event callbacks for RMT TX channel.

---

**Note:** User can deregister a previously registered callback by calling this function and setting the callback member in the `cbs` structure to `NULL`.

---

---

**Note:** When `CONFIG_RMT_ISR_IRAM_SAFE` is enabled, the callback itself and functions called by it should be placed in IRAM. The variables used in the function should be in the SRAM as well. The `user_data` should also reside in SRAM.

---

**Parameters**

- **tx\_channel** –[in] RMT generic channel that created by `rmt_new_tx_channel()`
- **cbs** –[in] Group of callback functions
- **user\_data** –[in] User data, which will be passed to callback functions directly

**Returns**

- `ESP_OK`: Set event callbacks successfully
- `ESP_ERR_INVALID_ARG`: Set event callbacks failed because of invalid argument
- `ESP_FAIL`: Set event callbacks failed because of other error

```
esp_err_t rmt_new_sync_manager(const rmt_sync_manager_config_t *config, rmt_sync_manager_handle_t  
                              *ret_synchro)
```

Create a synchronization manager for multiple TX channels, so that the managed channel can start transmitting at the same time.

---

**Note:** All the channels to be managed should be enabled by `rmt_enable()` before put them into sync manager.

---

**Parameters**

- **config** –[in] Synchronization manager configuration
- **ret\_synchro** –[out] Returned synchronization manager handle

**Returns**

- `ESP_OK`: Create sync manager successfully
- `ESP_ERR_INVALID_ARG`: Create sync manager failed because of invalid argument
- `ESP_ERR_NOT_SUPPORTED`: Create sync manager failed because it is not supported by hardware
- `ESP_ERR_INVALID_STATE`: Create sync manager failed because not all channels are enabled
- `ESP_ERR_NO_MEM`: Create sync manager failed because out of memory
- `ESP_ERR_NOT_FOUND`: Create sync manager failed because all sync controllers are used up and no more free one
- `ESP_FAIL`: Create sync manager failed because of other error

*esp\_err\_t* **rmt\_del\_sync\_manager** (*rmt\_sync\_manager\_handle\_t* *synchro*)

Delete synchronization manager.

**Parameters** *synchro* **–[in]** Synchronization manager handle returned from `rmt_new_sync_manager()`

**Returns**

- `ESP_OK`: Delete the synchronization manager successfully
- `ESP_ERR_INVALID_ARG`: Delete the synchronization manager failed because of invalid argument
- `ESP_FAIL`: Delete the synchronization manager failed because of other error

*esp\_err\_t* **rmt\_sync\_reset** (*rmt\_sync\_manager\_handle\_t* *synchro*)

Reset synchronization manager.

**Parameters** *synchro* **–[in]** Synchronization manager handle returned from `rmt_new_sync_manager()`

**Returns**

- `ESP_OK`: Reset the synchronization manager successfully
- `ESP_ERR_INVALID_ARG`: Reset the synchronization manager failed because of invalid argument
- `ESP_FAIL`: Reset the synchronization manager failed because of other error

## Structures

struct **rmt\_tx\_event\_callbacks\_t**

Group of RMT TX callbacks.

---

**Note:** The callbacks are all running under ISR environment

---

---

**Note:** When `CONFIG_RMT_ISR_IRAM_SAFE` is enabled, the callback itself and functions called by it should be placed in IRAM. The variables used in the function should be in the SRAM as well.

---

## Public Members

*rmt\_tx\_done\_callback\_t* **on\_trans\_done**

Event callback, invoked when transmission is finished

struct **rmt\_tx\_channel\_config\_t**

RMT TX channel specific configuration.

## Public Members

*gpio\_num\_t* **gpio\_num**

GPIO number used by RMT TX channel. Set to -1 if unused

*rmt\_clock\_source\_t* **clk\_src**

Clock source of RMT TX channel, channels in the same group must use the same clock source

*uint32\_t* **resolution\_hz**

Channel clock resolution, in Hz

**size\_t mem\_block\_symbols**

Size of memory block, in number of *rmt\_symbol\_word\_t*, must be an even. In the DMA mode, this field controls the DMA buffer size, it can be set to a large value; In the normal mode, this field controls the number of RMT memory block that will be used by the channel.

**size\_t trans\_queue\_depth**

Depth of internal transfer queue, increase this value can support more transfers pending in the background

**int intr\_priority**

RMT interrupt priority, if set to 0, the driver will try to allocate an interrupt with a relative low priority (1,2,3)

**uint32\_t invert\_out**

Whether to invert the RMT channel signal before output to GPIO pad

**uint32\_t with\_dma**

If set, the driver will allocate an RMT channel with DMA capability

**uint32\_t io\_loop\_back**

The signal output from the GPIO will be fed to the input path as well

**uint32\_t io\_od\_mode**

Configure the GPIO as open-drain mode

**struct *rmt\_tx\_channel\_config\_t*::[anonymous] flags**

TX channel config flags

**struct *rmt\_transmit\_config\_t***

RMT transmit specific configuration.

**Public Members****int loop\_count**

Specify the times of transmission in a loop, -1 means transmitting in an infinite loop

**uint32\_t eot\_level**

Set the output level for the “End Of Transmission”

**uint32\_t queue\_nonblocking**

If set, when the transaction queue is full, driver will not block the thread but return directly

**struct *rmt\_transmit\_config\_t*::[anonymous] flags**

Transmit specific config flags

**struct *rmt\_sync\_manager\_config\_t***

Synchronous manager configuration.

## Public Members

const *rmt\_channel\_handle\_t* \***tx\_channel\_array**

Array of TX channels that are about to be managed by a synchronous controller

size\_t **array\_size**

Size of the *tx\_channel\_array*

## Header File

- [components/driver/include/driver/rmt\\_rx.h](#)

## Functions

*esp\_err\_t* **rmt\_new\_rx\_channel** (const *rmt\_rx\_channel\_config\_t* \*config, *rmt\_channel\_handle\_t* \*ret\_chan)

Create a RMT RX channel.

### Parameters

- **config** –[in] RX channel configurations
- **ret\_chan** –[out] Returned generic RMT channel handle

### Returns

- ESP\_OK: Create RMT RX channel successfully
- ESP\_ERR\_INVALID\_ARG: Create RMT RX channel failed because of invalid argument
- ESP\_ERR\_NO\_MEM: Create RMT RX channel failed because out of memory
- ESP\_ERR\_NOT\_FOUND: Create RMT RX channel failed because all RMT channels are used up and no more free one
- ESP\_ERR\_NOT\_SUPPORTED: Create RMT RX channel failed because some feature is not supported by hardware, e.g. DMA feature is not supported by hardware
- ESP\_FAIL: Create RMT RX channel failed because of other error

*esp\_err\_t* **rmt\_receive** (*rmt\_channel\_handle\_t* rx\_channel, void \*buffer, size\_t buffer\_size, const *rmt\_receive\_config\_t* \*config)

Initiate a receive job for RMT RX channel.

---

**Note:** This function is non-blocking, it initiates a new receive job and then returns. User should check the received data from the *on\_recv\_done* callback that registered by *rmt\_rx\_register\_event\_callbacks()*.

---

---

**Note:** This function can also be called in ISR context.

---

---

**Note:** If you want this function to work even when the flash cache is disabled, please enable the *CONFIG\_RMT\_RECV\_FUNC\_IN\_IRAM* option.

---

### Parameters

- **rx\_channel** –[in] RMT RX channel that created by *rmt\_new\_rx\_channel()*
- **buffer** –[in] The buffer to store the received RMT symbols
- **buffer\_size** –[in] size of the *buffer*, in bytes
- **config** –[in] Receive specific configurations

### Returns

- ESP\_OK: Initiate receive job successfully
- ESP\_ERR\_INVALID\_ARG: Initiate receive job failed because of invalid argument
- ESP\_ERR\_INVALID\_STATE: Initiate receive job failed because channel is not enabled
- ESP\_FAIL: Initiate receive job failed because of other error

*esp\_err\_t* **rmt\_rx\_register\_event\_callbacks** (*rmt\_channel\_handle\_t* rx\_channel, const *rmt\_rx\_event\_callbacks\_t* \*cbs, void \*user\_data)

Set callbacks for RMT RX channel.

---

**Note:** User can deregister a previously registered callback by calling this function and setting the callback member in the `cbs` structure to NULL.

---

---

**Note:** When `CONFIG_RMT_ISR_IRAM_SAFE` is enabled, the callback itself and functions called by it should be placed in IRAM. The variables used in the function should be in the SRAM as well. The `user_data` should also reside in SRAM.

---

#### Parameters

- **rx\_channel** –[in] RMT generic channel that created by `rmt_new_rx_channel()`
- **cbs** –[in] Group of callback functions
- **user\_data** –[in] User data, which will be passed to callback functions directly

#### Returns

- `ESP_OK`: Set event callbacks successfully
- `ESP_ERR_INVALID_ARG`: Set event callbacks failed because of invalid argument
- `ESP_FAIL`: Set event callbacks failed because of other error

### Structures

struct **rmt\_rx\_event\_callbacks\_t**

Group of RMT RX callbacks.

---

**Note:** The callbacks are all running under ISR environment

---

---

**Note:** When `CONFIG_RMT_ISR_IRAM_SAFE` is enabled, the callback itself and functions called by it should be placed in IRAM. The variables used in the function should be in the SRAM as well.

---

### Public Members

*rmt\_rx\_done\_callback\_t* **on\_recv\_done**

Event callback, invoked when one RMT channel receiving transaction completes

struct **rmt\_rx\_channel\_config\_t**

RMT RX channel specific configuration.

### Public Members

*gpio\_num\_t* **gpio\_num**

GPIO number used by RMT RX channel. Set to -1 if unused

*rmt\_clock\_source\_t* **clk\_src**

Clock source of RMT RX channel, channels in the same group must use the same clock source

uint32\_t **resolution\_hz**

Channel clock resolution, in Hz

size\_t **mem\_block\_symbols**

Size of memory block, in number of *rmt\_symbol\_word\_t*, must be an even. In the DMA mode, this field controls the DMA buffer size, it can be set to a large value (e.g. 1024); In the normal mode, this field controls the number of RMT memory block that will be used by the channel.

uint32\_t **invert\_in**

Whether to invert the incoming RMT channel signal

uint32\_t **with\_dma**

If set, the driver will allocate an RMT channel with DMA capability

uint32\_t **io\_loop\_back**

For debug/test, the signal output from the GPIO will be fed to the input path as well

struct *rmt\_rx\_channel\_config\_t*::[anonymous] **flags**

RX channel config flags

int **intr\_priority**

RMT interrupt priority, if set to 0, the driver will try to allocate an interrupt with a relative low priority (1,2,3)

struct **rmt\_receive\_config\_t**

RMT receive specific configuration.

## Public Members

uint32\_t **signal\_range\_min\_ns**

A pulse whose width is smaller than this threshold will be treated as glitch and ignored

uint32\_t **signal\_range\_max\_ns**

RMT will stop receiving if one symbol level has kept more than *signal\_range\_max\_ns*

## Header File

- [components/driver/include/driver/rmt\\_common.h](#)

## Functions

*esp\_err\_t* **rmt\_del\_channel** (*rmt\_channel\_handle\_t* channel)

Delete an RMT channel.

**Parameters** **channel** –[in] RMT generic channel that created by *rmt\_new\_tx\_channel()* or *rmt\_new\_rx\_channel()*

### Returns

- **ESP\_OK**: Delete RMT channel successfully
- **ESP\_ERR\_INVALID\_ARG**: Delete RMT channel failed because of invalid argument
- **ESP\_ERR\_INVALID\_STATE**: Delete RMT channel failed because it is still in working
- **ESP\_FAIL**: Delete RMT channel failed because of other error



*esp\_err\_t* **rmt\_apply\_carrier** (*rmt\_channel\_handle\_t* channel, const *rmt\_carrier\_config\_t* \*config)

Apply modulation feature for TX channel or demodulation feature for RX channel.

**Parameters**

- **channel** –[in] RMT generic channel that created by `rmt_new_tx_channel()` or `rmt_new_rx_channel()`
- **config** –[in] Carrier configuration. Specially, a NULL config means to disable the carrier modulation or demodulation feature

**Returns**

- ESP\_OK: Apply carrier configuration successfully
- ESP\_ERR\_INVALID\_ARG: Apply carrier configuration failed because of invalid argument
- ESP\_FAIL: Apply carrier configuration failed because of other error

*esp\_err\_t* **rmt\_enable** (*rmt\_channel\_handle\_t* channel)

Enable the RMT channel.

---

**Note:** This function will acquire a PM lock that might be installed during channel allocation

---

**Parameters** **channel** –[in] RMT generic channel that created by `rmt_new_tx_channel()` or `rmt_new_rx_channel()`

**Returns**

- ESP\_OK: Enable RMT channel successfully
- ESP\_ERR\_INVALID\_ARG: Enable RMT channel failed because of invalid argument
- ESP\_ERR\_INVALID\_STATE: Enable RMT channel failed because it's enabled already
- ESP\_FAIL: Enable RMT channel failed because of other error

*esp\_err\_t* **rmt\_disable** (*rmt\_channel\_handle\_t* channel)

Disable the RMT channel.

---

**Note:** This function will release a PM lock that might be installed during channel allocation

---

**Parameters** **channel** –[in] RMT generic channel that created by `rmt_new_tx_channel()` or `rmt_new_rx_channel()`

**Returns**

- ESP\_OK: Disable RMT channel successfully
- ESP\_ERR\_INVALID\_ARG: Disable RMT channel failed because of invalid argument
- ESP\_ERR\_INVALID\_STATE: Disable RMT channel failed because it's not enabled yet
- ESP\_FAIL: Disable RMT channel failed because of other error

## Structures

struct **rmt\_carrier\_config\_t**

RMT carrier wave configuration (for either modulation or demodulation)

### Public Members

uint32\_t **frequency\_hz**

Carrier wave frequency, in Hz, 0 means disabling the carrier

float **duty\_cycle**

Carrier wave duty cycle (0~100%)

uint32\_t **polarity\_active\_low**

Specify the polarity of carrier, by default it's modulated to base signal's high level

uint32\_t **always\_on**

If set, the carrier can always exist even there's not transfer undergoing

struct *rmt\_carrier\_config\_t*::[anonymous] **flags**

Carrier config flags

## Header File

- [components/driver/include/driver/rmt\\_encoder.h](#)

## Functions

*esp\_err\_t* **rmt\_new\_bytes\_encoder** (const *rmt\_bytes\_encoder\_config\_t* \*config, *rmt\_encoder\_handle\_t* \*ret\_encoder)

Create RMT bytes encoder, which can encode byte stream into RMT symbols.

### Parameters

- **config** –[in] Bytes encoder configuration
- **ret\_encoder** –[out] Returned encoder handle

### Returns

- ESP\_OK: Create RMT bytes encoder successfully
- ESP\_ERR\_INVALID\_ARG: Create RMT bytes encoder failed because of invalid argument
- ESP\_ERR\_NO\_MEM: Create RMT bytes encoder failed because out of memory
- ESP\_FAIL: Create RMT bytes encoder failed because of other error

*esp\_err\_t* **rmt\_bytes\_encoder\_update\_config** (*rmt\_encoder\_handle\_t* bytes\_encoder, const *rmt\_bytes\_encoder\_config\_t* \*config)

Update the configuration of the bytes encoder.

---

**Note:** The configurations of the bytes encoder is also set up by `rmt_new_bytes_encoder()`. This function is used to update the configuration of the bytes encoder at runtime.

---

### Parameters

- **bytes\_encoder** –[in] Bytes encoder handle, created by e.g `rmt_new_bytes_encoder()`
- **config** –[in] Bytes encoder configuration

### Returns

- ESP\_OK: Update RMT bytes encoder successfully
- ESP\_ERR\_INVALID\_ARG: Update RMT bytes encoder failed because of invalid argument
- ESP\_FAIL: Update RMT bytes encoder failed because of other error

*esp\_err\_t* **rmt\_new\_copy\_encoder** (const *rmt\_copy\_encoder\_config\_t* \*config, *rmt\_encoder\_handle\_t* \*ret\_encoder)

Create RMT copy encoder, which copies the given RMT symbols into RMT memory.

### Parameters

- **config** –[in] Copy encoder configuration
- **ret\_encoder** –[out] Returned encoder handle

### Returns

- ESP\_OK: Create RMT copy encoder successfully

- `ESP_ERR_INVALID_ARG`: Create RMT copy encoder failed because of invalid argument
- `ESP_ERR_NO_MEM`: Create RMT copy encoder failed because out of memory
- `ESP_FAIL`: Create RMT copy encoder failed because of other error

`esp_err_t rmt_del_encoder (rmt_encoder_handle_t encoder)`

Delete RMT encoder.

**Parameters** `encoder` `–[in]` RMT encoder handle, created by e.g. `rmt_new_bytes_encoder()`

**Returns**

- `ESP_OK`: Delete RMT encoder successfully
- `ESP_ERR_INVALID_ARG`: Delete RMT encoder failed because of invalid argument
- `ESP_FAIL`: Delete RMT encoder failed because of other error

`esp_err_t rmt_encoder_reset (rmt_encoder_handle_t encoder)`

Reset RMT encoder.

**Parameters** `encoder` `–[in]` RMT encoder handle, created by e.g. `rmt_new_bytes_encoder()`

**Returns**

- `ESP_OK`: Reset RMT encoder successfully
- `ESP_ERR_INVALID_ARG`: Reset RMT encoder failed because of invalid argument
- `ESP_FAIL`: Reset RMT encoder failed because of other error

`void *rmt_alloc_encoder_mem (size_t size)`

A helper function to allocate a proper memory for RMT encoder.

**Parameters** `size` –Size of memory to be allocated

**Returns** Pointer to the allocated memory if the allocation is successful, NULL otherwise

## Structures

struct `rmt_encoder_t`

Interface of RMT encoder.

## Public Members

`size_t (*encode)(rmt_encoder_t *encoder, rmt_channel_handle_t tx_channel, const void *primary_data, size_t data_size, rmt_encode_state_t *ret_state)`

Encode the user data into RMT symbols and write into RMT memory.

---

**Note:** The encoding function will also be called from an ISR context, thus the function must not call any blocking API.

---



---

**Note:** It's recommended to put this function implementation in the IRAM, to achieve a high performance and less interrupt latency.

---

**Param** `encoder` `[in]` Encoder handle

**Param** `tx_channel` `[in]` RMT TX channel handle, returned from `rmt_new_tx_channel()`

**Param** `primary_data` `[in]` App data to be encoded into RMT symbols

**Param** `data_size` `[in]` Size of `primary_data`, in bytes

**Param** `ret_state` `[out]` Returned current encoder's state

**Return** Number of RMT symbols that the primary data has been encoded into

*esp\_err\_t* (\***reset**)(*rmt\_encoder\_t* \*encoder)

Reset encoding state.

**Param encoder [in]** Encoder handle

**Return**

- ESP\_OK: reset encoder successfully
- ESP\_FAIL: reset encoder failed

*esp\_err\_t* (\***del**)(*rmt\_encoder\_t* \*encoder)

Delete encoder object.

**Param encoder [in]** Encoder handle

**Return**

- ESP\_OK: delete encoder successfully
- ESP\_FAIL: delete encoder failed

struct **rmt\_bytes\_encoder\_config\_t**

Bytes encoder configuration.

### Public Members

*rmt\_symbol\_word\_t* **bit0**

How to represent BIT0 in RMT symbol

*rmt\_symbol\_word\_t* **bit1**

How to represent BIT1 in RMT symbol

uint32\_t **msb\_first**

Whether to encode MSB bit first

struct *rmt\_bytes\_encoder\_config\_t*::[anonymous] **flags**

Encoder config flag

struct **rmt\_copy\_encoder\_config\_t**

Copy encoder configuration.

### Type Definitions

typedef struct *rmt\_encoder\_t* **rmt\_encoder\_t**

Type of RMT encoder.

### Enumerations

enum **rmt\_encode\_state\_t**

RMT encoding state.

*Values:*

enumerator **RMT\_ENCODING\_RESET**

The encoding session is in reset state

enumerator **RMT\_ENCODING\_COMPLETE**

The encoding session is finished, the caller can continue with subsequent encoding

enumerator **RMT\_ENCODING\_MEM\_FULL**

The encoding artifact memory is full, the caller should return from current encoding session

### Header File

- [components/driver/include/driver/rmt\\_types.h](#)

### Structures

struct **rmt\_tx\_done\_event\_data\_t**

Type of RMT TX done event data.

#### Public Members

size\_t **num\_symbols**

The number of transmitted RMT symbols (only one round is counted if it's a loop transmission)

struct **rmt\_rx\_done\_event\_data\_t**

Type of RMT RX done event data.

#### Public Members

*rmt\_symbol\_word\_t* \***received\_symbols**

Point to the received RMT symbols

size\_t **num\_symbols**

The number of received RMT symbols

### Type Definitions

typedef struct *rmt\_channel\_t* \***rmt\_channel\_handle\_t**

Type of RMT channel handle.

typedef struct *rmt\_sync\_manager\_t* \***rmt\_sync\_manager\_handle\_t**

Type of RMT synchronization manager handle.

typedef struct *rmt\_encoder\_t* \***rmt\_encoder\_handle\_t**

Type of RMT encoder handle.

typedef bool (\***rmt\_tx\_done\_callback\_t**)(*rmt\_channel\_handle\_t* tx\_chan, const *rmt\_tx\_done\_event\_data\_t* \*edata, void \*user\_ctx)

Prototype of RMT event callback.

**Param tx\_chan [in]** RMT channel handle, created from `rmt_new_tx_channel()`

**Param edata [in]** Point to RMT event data. The lifecycle of this pointer memory is inside this function, user should copy it into static memory if used outside this function.

**Param user\_ctx [in]** User registered context, passed from `rmt_tx_register_event_callbacks()`

**Return** Whether a high priority task has been waken up by this callback function

```
typedef bool (*rmt_rx_done_callback_t)(rmt_channel_handle_t rx_chan, const  
rmt_rx_done_event_data_t *edata, void *user_ctx)
```

Prototype of RMT event callback.

**Param rx\_chan [in]** RMT channel handle, created from `rmt_new_rx_channel()`

**Param edata [in]** Point to RMT event data. The lifecycle of this pointer memory is inside this function, user should copy it into static memory if used outside this function.

**Param user\_ctx [in]** User registered context, passed from `rmt_rx_register_event_callbacks()`

**Return** Whether a high priority task has been waken up by this function

## Header File

- [components/hal/include/hal/rmt\\_types.h](#)

## Unions

```
union rmt_symbol_word_t
```

*#include <rmt\_types.h>* The layout of RMT symbol stored in memory, which is decided by the hardware design.

## Public Members

```
uint16_t duration0
```

Duration of level0

```
uint16_t level0
```

Level of the first part

```
uint16_t duration1
```

Duration of level1

```
uint16_t level1
```

Level of the second part

```
struct rmt_symbol_word_t::[anonymous] [anonymous]
```

```
uint32_t val
```

Equivalent unsigned value for the RMT symbol

## Type Definitions

```
typedef soc_periph_rmt_clk_src_t rmt_clock_source_t
```

RMT group clock source.

---

**Note:** User should select the clock source based on the power and resolution requirement

---

## 2.5.17 SD SPI Host Driver

### Overview

The SD SPI host driver allows communicating with one or more SD cards by the SPI Master driver which makes use of the SPI host. Each card is accessed through an SD SPI device represented by an `sdspi_dev_handle_t spi_handle` returned when attaching the device to an SPI bus by calling `sdspi_host_init_device`. The bus should be already initialized before (by `spi_bus_initialize`).

With the help of *SPI Master driver* based on, the SPI bus can be shared among SD cards and other SPI devices. The SPI Master driver will handle exclusive access from different tasks.

The SD SPI driver uses software-controlled CS signal.

### How to Use

Firstly, use the macro `SDSPI_DEVICE_CONFIG_DEFAULT` to initialize a structure `sdmmc_slot_config_t`, which is used to initialize an SD SPI device. This macro will also fill in the default pin mappings, which is same as the pin mappings of SDMMC host driver. Modify the host and pins of the structure to desired value. Then call `sdspi_host_init_device` to initialize the SD SPI device and attach to its bus.

Then use `SDSPI_HOST_DEFAULT` macro to initialize a `sdmmc_host_t` structure, which is used to store the state and configurations of upper layer (SD/SDIO/MMC driver). Modify the `slot` parameter of the structure to the SD SPI device `spi_handle` just returned from `sdspi_host_init_device`. Call `sdmmc_card_init` with the `sdmmc_host_t` to probe and initialize the SD card.

Now you can use SD/SDIO/MMC driver functions to access your card!

### Other Details

Only the following driver's API functions are normally used by most applications:

- `sdspi_host_init()`
- `sdspi_host_init_device()`
- `sdspi_host_remove_device()`
- `sdspi_host_deinit()`

Other functions are mostly used by the protocol level SD/SDIO/MMC driver via function pointers in the `sdmmc_host_t` structure. For more details, see *the SD/SDIO/MMC Driver*.

---

**Note:** SD over SPI does not support speeds above `SDMMC_FREQ_DEFAULT` due to the limitations of the SPI driver.

---

**Warning:** If you want to share the SPI bus among SD card and other SPI devices, there are some restrictions, see *Sharing the SPI bus among SD card and other SPI devices*.

### Related Docs

**Sharing the SPI bus among SD card and other SPI devices** The SD card has a SPI mode, which allows it to be communicated to as a SPI device. But there are some restrictions that we need to pay attention to.

**Pin loading of other devices** When adding more devices onto the same bus, the overall pin loading increases. The loading consists of AC loading (pin capacitor) and DC loading (pull-ups).

**AC loading** SD cards, which are designed for high-speed communications, have small pin capacitors (AC loading) to work until 50MHz. However, the other attached devices will increase the pin's AC loading.

Heavy AC loading of a pin may prevent the pin from being toggled quickly. By using an oscilloscope, you will see the edges of the pin become smoother and not ideal any more (the gradient of the edge is smaller). The setup timing requirements of an SD card may be violated when the card is connected to such bus. Even worse, the clock from the host may not be recognized by the SD card and other SPI devices on the same bus.

This issue may be more obvious if other attached devices are not designed to work at the same frequency as the SD card, because they may have larger pin capacitors.

To see if your pin AC loading is too heavy, you can try the following tests:

(Terminology: **launch edge**: at which clock edge the data start to toggle; **latch edge**: at which clock edge the data is supposed to be sampled by the receiver, for SD card, it's the rising edge.)

1. Use an oscilloscope to see the clock and compare the data line to the clock. - If you see the clock is not fast enough (for example, the rising/falling edge is longer than 1/4 of the clock cycle), it means the clock is skewed too much. - If you see the data line unstable before the latch edge of the clock, it means the load of the data line is too large.  
You may also observed the corresponding phenomenon (data delayed largely from launching edge of clock) with logic analyzers. But it's not as obvious as with an oscilloscope.
2. Try to use slower clock frequency.  
If the lower frequency can work while the higher frequency can't, it's an indication of the AC loading on the pins is too large.

If the AC loading of the pins is too large, you can either use other faster devices (with lower pin load) or slow down the clock speed.

**DC loading** The pull-ups required by SD cards are usually around 10 kOhm to 50 kOhm, which may be too strong for some other SPI devices.

Check the specification of your device about its DC output current, it should be larger than 700uA, otherwise the device output may not be read correctly.

### Initialization sequence

---

**Note:** If you see any problem in the following steps, please make sure the timing is correct first. You can try to slow down the clock speed (`SDMMC_FREQ_PROBING = 400 KHz` for SD card) to avoid the influence of pin AC loading (see above section).

---

When using an SD card with other SPI devices on the same SPI bus, due to the restrictions of the SD card startup flow, the following initialization sequence should be followed: (See also [storage/sd\\_card](#))

1. Initialize the SPI bus properly by `spi_bus_initialize`.
2. Tie the CS lines of all other devices than the SD card to high. This is to avoid conflicts to the SD card in the following step.  
You can do this by either:
  1. Attach devices to the SPI bus by calling `spi_bus_add_device`. This function will initialize the GPIO that is used as CS to the idle level: high.
  2. Initialize GPIO on the CS pin that needs to be tied up before actually adding a new device.
  3. Rely on the internal/external pull-up (not recommended) to pull-up all the CS pins when the GPIOs of ESP are not initialized yet. You need to check carefully the pull-up is strong enough and there are no other pull-downs that will influence the pull-up (For example, internal pull-down should be enabled).
3. Mount the card to the filesystem by calling `esp_vfs_fat_sdspi_mount`.  
This step will put the SD card into the SPI mode, which SHOULD be done before all other SPI communications on the same bus. Otherwise the card will stay in the SD mode, in which mode it may randomly respond to any SPI communications on the bus, even when its CS line is not addressed.  
If you want to test this behavior, please also note that, once the card is put into SPI mode, it will not return to SD mode before next power cycle, i.e. powered down and powered up again.
4. Now you can talk to other SPI devices freely!



## API Reference

### Header File

- `components/driver/include/driver/sdspi_host.h`

### Functions

*esp\_err\_t* **sdspi\_host\_init** (void)

Initialize SD SPI driver.

---

**Note:** This function is not thread safe

---

#### Returns

- `ESP_OK` on success
- other error codes may be returned in future versions

*esp\_err\_t* **sdspi\_host\_init\_device** (const *sdspi\_device\_config\_t* \*dev\_config, *sdspi\_dev\_handle\_t* \*out\_handle)

Attach and initialize an SD SPI device on the specific SPI bus.

---

**Note:** This function is not thread safe

---

---

**Note:** Initialize the SPI bus by `spi_bus_initialize()` before calling this function.

---

---

**Note:** The SDIO over sdspi needs an extra interrupt line. Call `gpio_install_isr_service()` before this function.

---

#### Parameters

- **dev\_config** – pointer to device configuration structure
- **out\_handle** – Output of the handle to the sdspi device.

#### Returns

- `ESP_OK` on success
- `ESP_ERR_INVALID_ARG` if `sdspi_host_init_device` has invalid arguments
- `ESP_ERR_NO_MEM` if memory can not be allocated
- other errors from the underlying `spi_master` and `gpio` drivers

*esp\_err\_t* **sdspi\_host\_remove\_device** (*sdspi\_dev\_handle\_t* handle)

Remove an SD SPI device.

**Parameters** **handle** – Handle of the SD SPI device

**Returns** Always `ESP_OK`

*esp\_err\_t* **sdspi\_host\_do\_transaction** (*sdspi\_dev\_handle\_t* handle, *sdmmc\_command\_t* \*cmdinfo)

Send command to the card and get response.

This function returns when command is sent and response is received, or data is transferred, or timeout occurs.

---

**Note:** This function is not thread safe w.r.t. `init/deinit` functions, and bus width/clock speed configuration functions. Multiple tasks can call `sdspi_host_do_transaction` as long as other `sdspi_host_*` functions are not called.

---

**Parameters**

- **handle** –Handle of the sdspi device
- **cmdinfo** –pointer to structure describing command and data to transfer

**Returns**

- ESP\_OK on success
- ESP\_ERR\_TIMEOUT if response or data transfer has timed out
- ESP\_ERR\_INVALID\_CRC if response or data transfer CRC check has failed
- ESP\_ERR\_INVALID\_RESPONSE if the card has sent an invalid response

*esp\_err\_t* **sdspi\_host\_set\_card\_clk** (*sdspi\_dev\_handle\_t* host, uint32\_t freq\_khz)

Set card clock frequency.

Currently only integer fractions of 40MHz clock can be used. For High Speed cards, 40MHz can be used. For Default Speed cards, 20MHz can be used.

---

**Note:** This function is not thread safe

---

**Parameters**

- **host** –Handle of the sdspi device
- **freq\_khz** –card clock frequency, in kHz

**Returns**

- ESP\_OK on success
- other error codes may be returned in the future

*esp\_err\_t* **sdspi\_host\_deinit** (void)

Release resources allocated using sdspi\_host\_init.

---

**Note:** This function is not thread safe

---

**Returns**

- ESP\_OK on success
- ESP\_ERR\_INVALID\_STATE if sdspi\_host\_init function has not been called

*esp\_err\_t* **sdspi\_host\_io\_int\_enable** (*sdspi\_dev\_handle\_t* handle)

Enable SDIO interrupt.

**Parameters** **handle** –Handle of the sdspi device

**Returns**

- ESP\_OK on success

*esp\_err\_t* **sdspi\_host\_io\_int\_wait** (*sdspi\_dev\_handle\_t* handle, TickType\_t timeout\_ticks)

Wait for SDIO interrupt until timeout.

**Parameters**

- **handle** –Handle of the sdspi device
- **timeout\_ticks** –Ticks to wait before timeout.

**Returns**

- ESP\_OK on success

**Structures**

struct **sdspi\_device\_config\_t**

Extra configuration for SD SPI device.

## Public Members

*spi\_host\_device\_t* **host\_id**

SPI host to use, SPIx\_HOST (see spi\_types.h).

*gpio\_num\_t* **gpio\_cs**

GPIO number of CS signal.

*gpio\_num\_t* **gpio\_cd**

GPIO number of card detect signal.

*gpio\_num\_t* **gpio\_wp**

GPIO number of write protect signal.

*gpio\_num\_t* **gpio\_int**

GPIO number of interrupt line (input) for SDIO card.

## Macros

**SDSPI\_DEFAULT\_HOST**

**SDSPI\_DEFAULT\_DMA**

**SDSPI\_HOST\_DEFAULT ()**

Default *sdmmc\_host\_t* structure initializer for SD over SPI driver.

Uses SPI mode and max frequency set to 20MHz

‘slot’ should be set to an sdspi device initialized by *sdspi\_host\_init\_device ()*.

**SDSPI\_SLOT\_NO\_CS**

indicates that card select line is not used

**SDSPI\_SLOT\_NO\_CD**

indicates that card detect line is not used

**SDSPI\_SLOT\_NO\_WP**

indicates that write protect line is not used

**SDSPI\_SLOT\_NO\_INT**

indicates that interrupt line is not used

**SDSPI\_DEVICE\_CONFIG\_DEFAULT ()**

Macro defining default configuration of SD SPI device.

## Type Definitions

typedef int **sdspi\_dev\_handle\_t**

Handle representing an SD SPI device.

## 2.5.18 Sigma-Delta Modulation (SDM)

### Introduction

ESP32-S2 has a second-order sigma-delta modulator, which can generate independent PDM pulses to multiple channels. Please refer to the TRM to check how many hardware channels are available.<sup>1</sup>

Typically, a Sigma-Delta modulated channel can be used in scenarios like:

- LED dimming
- Simple DAC (8-bit), with the help of an active RC low-pass filter
- Class D amplifier, with the help of a half-bridge or full-bridge circuit plus an LC low-pass filter

### Functional Overview

The following sections of this document cover the typical steps to install and operate a SDM channel:

- *Resource Allocation* - covers which parameters should be set up to get a channel handle and how to recycle the resources when it finishes working.
- *Enable and Disable Channel* - covers how to enable and disable the channel.
- *Set Equivalent Duty Cycle* - describes how to set the equivalent duty cycle of the PDM pulses.
- *Power Management* - describes how different source clock selections can affect power consumption.
- *IRAM Safe* - lists which functions are supposed to work even when the cache is disabled.
- *Thread Safety* - lists which APIs are guaranteed to be thread safe by the driver.
- *Kconfig Options* - lists the supported Kconfig options that can be used to make a different effect on driver behavior.

**Resource Allocation** A SDM channel is represented by `sdm_channel_handle_t`. Each channel is capable to output the binary, hardware generated signal with the sigma-delta modulation. The driver manages all available channels in a pool, so that users don't need to manually assign a fixed channel to a GPIO.

To install a SDM channel, you should call `sdm_new_channel()` to get a channel handle. Channel specific configurations are passed in the `sdm_config_t` structure:

- `sdm_config_t::gpio_num` sets the GPIO that the PDM pulses will output from
- `sdm_config_t::clk_src` selects the source clock for the SDM module. Note that, all channels should select the same clock source.
- `sdm_config_t::sample_rate_hz` sets the sample rate of the SDM module.
- `sdm_config_t::invert_out` sets whether to invert the output signal.
- `sdm_config_t::io_loop_back` is for debugging purposes only. It enables both the GPIO's input and output ability through the GPIO matrix peripheral.

The function `sdm_new_channel()` can fail due to various errors such as insufficient memory, invalid arguments, etc. Specifically, when there are no more free channels (i.e. all hardware SDM channels have been used up), then `ESP_ERR_NOT_FOUND` will be returned.

If a previously created SDM channel is no longer required, you should recycle it by calling `sdm_del_channel()`. It allows the underlying HW channel to be used for other purposes. Before deleting a SDM channel handle, you should disable it by `sdm_channel_disable()` in advance or make sure it has not enabled yet by `sdm_channel_enable()`.

### Creating a SDM Channel with Sample Rate of 1MHz

```
sdm_channel_handle_t chan = NULL;
sdm_config_t config = {
    .clk_src = SDM_CLK_SRC_DEFAULT,
```

(continues on next page)

<sup>1</sup> Different ESP chip series might have different numbers of SDM channels. Please refer to Chapter [GPIO and IOMUX](#) in ESP32-S2 Technical Reference Manual for more details. The driver won't forbid you from applying for more channels, but it will return error when all available hardware resources are used up. Please always check the return value when doing resource allocation (e.g. `sdm_new_channel()`).

(continued from previous page)

```

        .sample_rate_hz = 1 * 1000 * 1000,
        .gpio_num = 0,
    };
    ESP_ERROR_CHECK(sdm_new_channel(&config, &chan));

```

**Enable and Disable Channel** Before doing further IO control to the SDM channel, you should enable it first, by calling `sdm_channel_enable()`. Internally, this function will:

- switch the channel state from **init** to **enable**
- acquire a proper power management lock if a specific clock source (e.g. APB clock) is selected. See also [Power management](#) for more information.

On the contrary, calling `sdm_channel_disable()` will do the opposite, that is, put the channel back to the **init** state and release the power management lock.

**Set Equivalent Duty Cycle** For the output PDM signals, the duty cycle refers to the percentage of high level cycles to the whole statistical period. The average output voltage from the channel is calculated by  $V_{out} = VDD_{IO} / 256 * duty + VDD_{IO} / 2$ . Thus the range of the `duty` input parameter of `sdm_channel_set_duty()` is from -128 to 127 (eight bit signed integer). For example, if zero value is set, then the output signal's duty will be about 50%.

**Power Management** When power management is enabled (i.e. `CONFIG_PM_ENABLE` is on), the system will adjust the APB frequency before going into light sleep, thus potentially changing the sample rate of the sigma-delta modulator.

However, the driver can prevent the system from changing APB frequency by acquiring a power management lock of type `ESP_PM_APB_FREQ_MAX`. Whenever the driver creates a SDM channel instance that has selected `SDM_CLK_SRC_APB` as its clock source, the driver will guarantee that the power management lock is acquired when enable the channel by `sdm_channel_enable()`. Likewise, the driver releases the lock when `sdm_channel_disable()` is called for that channel.

**IRAM Safe** There's a Kconfig option `CONFIG_SDM_CTRL_FUNC_IN_IRAM` that can put commonly used IO control functions into IROM as well. So that these functions can also be executable when the cache is disabled. These IO control functions are listed as follows:

- `sdm_channel_set_duty()`

**Thread Safety** The factory function `sdm_new_channel()` is guaranteed to be thread safe by the driver, which means, user can call it from different RTOS tasks without protection by extra locks. The following functions are allowed to run under ISR context, the driver uses a critical section to prevent them being called concurrently in both task and ISR.

- `sdm_channel_set_duty()`

Other functions that take the `sdm_channel_handle_t` as the first positional parameter, are not treated as thread safe. Which means the user should avoid calling them from multiple tasks.

### Kconfig Options

- `CONFIG_SDM_CTRL_FUNC_IN_IRAM` controls where to place the SDM channel control functions (IRAM or Flash), see [IRAM Safe](#) for more information.
- `CONFIG_SDM_ENABLE_DEBUG_LOG` is used to enable the debug log output. Enable this option will increase the firmware binary size.

### Convert to analog signal (Optional)

Typically, if the sigma-delta signal is connected to an LED, you don't have to add any filter between them (because our eyes are a low pass filter naturally). However, if you want to check the real voltage or watch the analog waveform, you need to design an analog low pass filter. Also, it is recommended to use an active filter instead of a passive filter to gain better isolation and not lose too much voltage.

For example, you can take the following [Sallen-Key topology Low Pass Filter](#) as a reference.

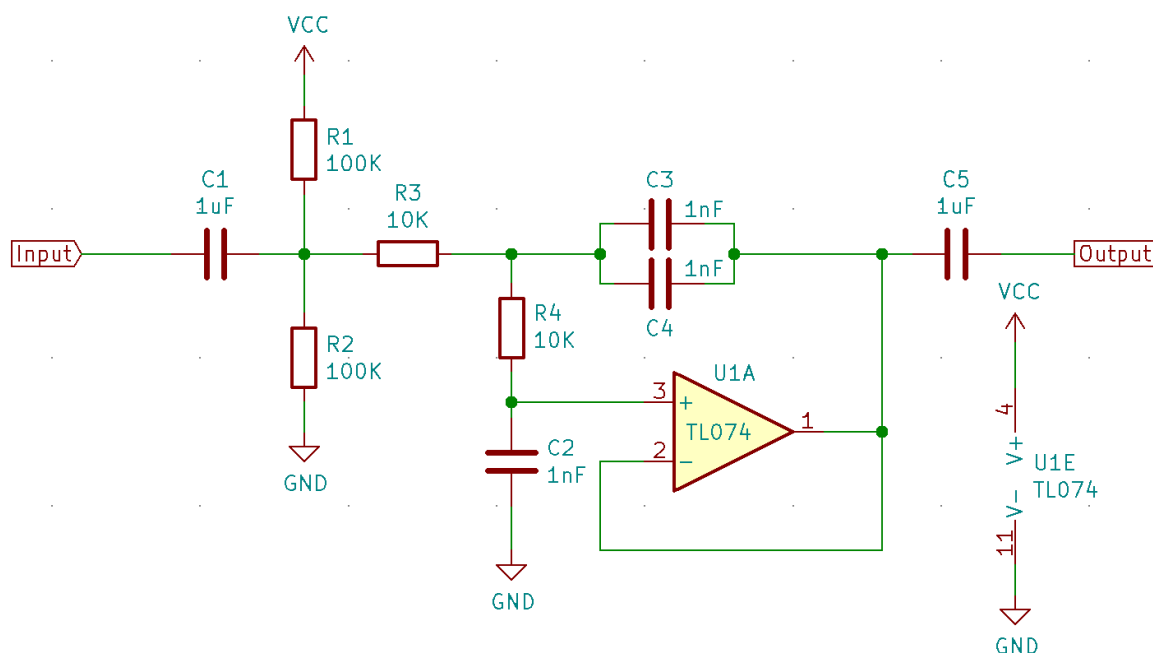

Fig. 15: Sallen-Key Low Pass Filter

### Application Example

- LED driven by a GPIO that is modulated with Sigma-Delta: [peripherals/sigma\\_delta](#).

### API Reference

#### Header File

- [components/driver/include/driver/sdm.h](#)

#### Functions

`esp_err_t sdm_new_channel` (const `sdm_config_t` \*config, `sdm_channel_handle_t` \*ret\_chan)

Create a new Sigma Delta channel.

#### Parameters

- **config** –[in] SDM configuration
- **ret\_chan** –[out] Returned SDM channel handle

#### Returns

- ESP\_OK: Create SDM channel successfully
- ESP\_ERR\_INVALID\_ARG: Create SDM channel failed because of invalid argument
- ESP\_ERR\_NO\_MEM: Create SDM channel failed because out of memory
- ESP\_ERR\_NOT\_FOUND: Create SDM channel failed because all channels are used up and no more free one

• ESP\_FAIL: Create SDM channel failed because of other error  
*esp\_err\_t* **sdm\_del\_channel** (*sdm\_channel\_handle\_t* chan)

Delete the Sigma Delta channel.

**Parameters** **chan** –[in] SDM channel created by `sdm_new_channel`

**Returns**

- ESP\_OK: Delete the SDM channel successfully
- ESP\_ERR\_INVALID\_ARG: Delete the SDM channel failed because of invalid argument
- ESP\_ERR\_INVALID\_STATE: Delete the SDM channel failed because the channel is not in init state
- ESP\_FAIL: Delete the SDM channel failed because of other error

*esp\_err\_t* **sdm\_channel\_enable** (*sdm\_channel\_handle\_t* chan)

Enable the Sigma Delta channel.

---

**Note:** This function will transit the channel state from init to enable.

---

---

**Note:** This function will acquire a PM lock, if a specific source clock (e.g. APB) is selected in the `sdm_config_t`, while `CONFIG_PM_ENABLE` is enabled.

---

**Parameters** **chan** –[in] SDM channel created by `sdm_new_channel`

**Returns**

- ESP\_OK: Enable SDM channel successfully
- ESP\_ERR\_INVALID\_ARG: Enable SDM channel failed because of invalid argument
- ESP\_ERR\_INVALID\_STATE: Enable SDM channel failed because the channel is already enabled
- ESP\_FAIL: Enable SDM channel failed because of other error

*esp\_err\_t* **sdm\_channel\_disable** (*sdm\_channel\_handle\_t* chan)

Disable the Sigma Delta channel.

---

**Note:** This function will do the opposite work to the `sdm_channel_enable()`

---

**Parameters** **chan** –[in] SDM channel created by `sdm_new_channel`

**Returns**

- ESP\_OK: Disable SDM channel successfully
- ESP\_ERR\_INVALID\_ARG: Disable SDM channel failed because of invalid argument
- ESP\_ERR\_INVALID\_STATE: Disable SDM channel failed because the channel is not enabled yet
- ESP\_FAIL: Disable SDM channel failed because of other error

*esp\_err\_t* **sdm\_channel\_set\_duty** (*sdm\_channel\_handle\_t* chan, *int8\_t* duty)

Set the duty cycle of the PDM output signal.

---

**Note:** For PDM signals, duty cycle refers to the percentage of high level cycles to the whole statistical period. The average output voltage could be  $V_{out} = VDD_{IO} / 256 * duty + VDD_{IO} / 2$

---

---

**Note:** If the duty is set to zero, the output signal is like a 50% duty cycle square wave, with a frequency around  $(sample\_rate\_hz / 4)$ .

---

---

**Note:** The duty is proportional to the equivalent output voltage after a low-pass-filter.

---

---

**Note:** This function is allowed to run within ISR context

---

---

**Note:** This function will be placed into IRAM if `CONFIG_SDM_CTRL_FUNC_IN_IRAM` is on, so that it's allowed to be executed when Cache is disabled

---

#### Parameters

- **chan** –[in] SDM channel created by `sdm_new_channel`
- **duty** –[in] Equivalent duty cycle of the PDM output signal, ranges from -128 to 127. But the range of [-90, 90] can provide a better randomness.

#### Returns

- `ESP_OK`: Set duty cycle successfully
- `ESP_ERR_INVALID_ARG`: Set duty cycle failed because of invalid argument
- `ESP_FAIL`: Set duty cycle failed because of other error

### Structures

struct **sdm\_config\_t**

Sigma Delta channel configuration.

#### Public Members

int **gpio\_num**

GPIO number

*sdm\_clock\_source\_t* **clk\_src**

Clock source

uint32\_t **sample\_rate\_hz**

Sample rate in Hz, it determines how frequent the modulator outputs a pulse

uint32\_t **invert\_out**

Whether to invert the output signal

uint32\_t **io\_loop\_back**

For debug/test, the signal output from the GPIO will be fed to the input path as well

struct *sdm\_config\_t*::[anonymous] **flags**

Extra flags

### Type Definitions

typedef struct *sdm\_channel\_t* \***sdm\_channel\_handle\_t**

Type of Sigma Delta channel handle.



### Header File

- [components/hal/include/hal/sdm\\_types.h](#)

### Type Definitions

typedef *soc\_periph\_sdm\_clk\_src\_t* **sdm\_clock\_source\_t**

## 2.5.19 SPI Master Driver

SPI Master driver is a program that controls ESP32-S2' s SPI peripherals while they function as masters.

### Overview of ESP32-S2' s SPI peripherals

ESP32-S2 integrates 4 SPI peripherals.

- SPI0 and SPI1 are used internally to access the ESP32-S2' s attached flash memory. Both controllers share the same SPI bus signals, and there is an arbiter to determine which can access the bus. Currently, SPI Master driver does not support SPI1 bus.
- SPI2 and SPI3 are general purpose SPI controllers. They are open to users. SPI2 and SPI3 have independent signal buses with the same respective names. SPI2 has 6 CS lines. SPI3 has 3 CS lines. Each CS line can be used to drive one SPI slave.

### Terminology

The terms used in relation to the SPI master driver are given in the table below.

Term	Definition
<b>Host</b>	The SPI controller peripheral inside ESP32-S2 that initiates SPI transmissions over the bus, and acts as an SPI Master.
<b>De-vice</b>	SPI slave device. An SPI bus may be connected to one or more Devices. Each Device shares the MOSI, MISO and SCLK signals but is only active on the bus when the Host asserts the Device' s individual CS line.
<b>Bus</b>	A signal bus, common to all Devices connected to one Host. In general, a bus includes the following lines: MISO, MOSI, SCLK, one or more CS lines, and, optionally, QUADWP and QUADHD. So Devices are connected to the same lines, with the exception that each Device has its own CS line. Several Devices can also share one CS line if connected in the daisy-chain manner.
<b>MOSI</b>	Master Out, Slave In, a.k.a. D. Data transmission from a Host to Device. Also data0 signal in Octal/OPI mode.
<b>MISO</b>	Master In, Slave Out, a.k.a. Q. Data transmission from a Device to Host. Also data1 signal in Octal/OPI mode.
<b>SCLK</b>	Serial Clock. Oscillating signal generated by a Host that keeps the transmission of data bits in sync.
<b>CS</b>	Chip Select. Allows a Host to select individual Device(s) connected to the bus in order to send or receive data.
<b>QUADWP</b>	Write Protect signal. Used for 4-bit (qio/qout) transactions. Also for data2 signal in Octal/OPI mode.
<b>QUADHD</b>	Hold signal. Used for 4-bit (qio/qout) transactions. Also for data3 signal in Octal/OPI mode.
<b>DATA4</b>	Data4 signal in Octal/OPI mode.
<b>DATA5</b>	Data5 signal in Octal/OPI mode.
<b>DATA6</b>	Data6 signal in Octal/OPI mode.
<b>DATA7</b>	Data7 signal in Octal/OPI mode.
<b>As- ser- tion</b>	The action of activating a line.
<b>De- asser- tion</b>	The action of returning the line back to inactive (back to idle) status.
<b>Trans- ac- tion</b>	One instance of a Host asserting a CS line, transferring data to and from a Device, and de-asserting the CS line. Transactions are atomic, which means they can never be interrupted by another transaction.
<b>Launch- edge</b>	Edge of the clock at which the source register <i>launches</i> the signal onto the line.
<b>Latch- edge</b>	Edge of the clock at which the destination register <i>latches in</i> the signal.

## Driver Features

The SPI master driver governs communications of Hosts with Devices. The driver supports the following features:

- Multi-threaded environments
- Transparent handling of DMA transfers while reading and writing data
- Automatic time-division multiplexing of data coming from different Devices on the same signal bus, see [SPI Bus Lock](#).

**Warning:** The SPI master driver has the concept of multiple Devices connected to a single bus (sharing a single ESP32-S2 SPI peripheral). As long as each Device is accessed by only one task, the driver is thread safe. However, if multiple tasks try to access the same SPI Device, the driver is **not thread-safe**. In this case, it is recommended to either:

- Refactor your application so that each SPI peripheral is only accessed by a single task at a time.
- Add a mutex lock around the shared Device using [xSemaphoreCreateMutex](#).

## SPI Features

## SPI Master

**SPI Bus Lock** To realize the multiplexing of different devices from different drivers, including SPI Master, SPI Flash, etc., an SPI bus lock is applied on each SPI bus. Drivers can attach their devices onto the bus with the arbitration of the lock.

Each bus lock is initialized with a BG (background) service registered. All devices that request transactions on the bus should wait until the BG is successfully disabled.

- For SPI1 bus, the BG is the cache. The bus lock will disable the cache before device operations start, and enable it again after device releases the lock. No devices on SPI1 is allowed to use ISR, since it is meaningless for the task to yield to other tasks when the cache is disabled.  
The SPI Master driver hasn't supported SPI1 bus. Only SPI Flash driver can attach to the bus.
- For other buses, the driver may register its ISR as the BG. When a device task requests for exclusive use of the bus, the bus lock will block the task and try to disable ISR. After ISR is successfully disabled, the bus lock will then unblock the device task and allow it to exclusively use the bus. When the task releases the lock, the lock will also try to resume ISR if there are pending transactions in ISR.

## SPI Transactions

An SPI bus transaction consists of five phases which can be found in the table below. Any of these phases can be skipped.

Phase	Description
<b>Command</b>	In this phase, a command (0-16 bit) is written to the bus by the Host.
<b>Address</b>	In this phase, an address (0-32 bit) is transmitted over the bus by the Host.
<b>Write</b>	Host sends data to a Device. This data follows the optional command and address phases and is indistinguishable from them at the electrical level.
<b>Dummy</b>	This phase is configurable and is used to meet the timing requirements.
<b>Read</b>	Device sends data to its Host.

The attributes of a transaction are determined by the bus configuration structure `spi_bus_config_t`, device configuration structure `spi_device_interface_config_t`, and transaction configuration structure `spi_transaction_t`.

An SPI Host can send full-duplex transactions, during which the read and write phases occur simultaneously. The total transaction length is determined by the sum of the following members:

- `spi_device_interface_config_t::command_bits`
- `spi_device_interface_config_t::address_bits`
- `spi_transaction_t::length`

While the member `spi_transaction_t::rxlength` only determines the length of data received into the buffer.

In half-duplex transactions, the read and write phases are not simultaneous (one direction at a time). The lengths of the write and read phases are determined by `spi_transaction_t::length` and `spi_transaction_t::rxlength` respectively.

The command and address phases are optional, as not every SPI device requires a command and/or address. This is reflected in the Device's configuration: if `spi_device_interface_config_t::command_bits` and/or `spi_device_interface_config_t::address_bits` are set to zero, no command or address phase will occur.

The read and write phases can also be optional, as not every transaction requires both writing and reading data. If `spi_transaction_t::rx_buffer` is NULL and `SPI_TRANS_USE_RXDATA` is not set, the read phase is skipped. If `spi_transaction_t::tx_buffer` is NULL and `SPI_TRANS_USE_TXDATA` is not set, the write phase is skipped.

The driver supports two types of transactions: the interrupt transactions and polling transactions. The programmer can choose to use a different transaction type per Device. If your Device requires both transaction types, see [Notes on Sending Mixed Transactions to the Same Device](#).

**Interrupt Transactions** Interrupt transactions will block the transaction routine until the transaction completes, thus allowing the CPU to run other tasks.

An application task can queue multiple transactions, and the driver will automatically handle them one-by-one in the interrupt service routine (ISR). It allows the task to switch to other procedures until all the transactions complete.

**Polling Transactions** Polling transactions do not use interrupts. The routine keeps polling the SPI Host's status bit until the transaction is finished.

All the tasks that use interrupt transactions can be blocked by the queue. At this point, they will need to wait for the ISR to run twice before the transaction is finished. Polling transactions save time otherwise spent on queue handling and context switching, which results in smaller transaction duration. The disadvantage is that the CPU is busy while these transactions are in progress.

The `spi_device_polling_end()` routine needs an overhead of at least 1 us to unblock other tasks when the transaction is finished. It is strongly recommended to wrap a series of polling transactions using the functions `spi_device_acquire_bus()` and `spi_device_release_bus()` to avoid the overhead. For more information, see [Bus Acquiring](#).

**Transaction Line Mode** Supported line modes for ESP32-S2 are listed as follows, to make use of these modes, set the member `flags` in the struct `spi_transaction_t` as shown in the *Transaction Flag* column. If you want to check if corresponding IO pins are set or not, set the member `flags` in the `spi_bus_config_t` as shown in the *Bus IO setting Flag* column.

Mode name	Command Line Width	Address Line Width	Data Line Width	Transaction Flag	Bus IO setting Flag
Normal SPI	1	1	1	0	0
Dual Output	1	1	2	SPI_TRANS_MODE_DIO	SPICOMMON_BUSFLAG_DUAL
Dual I/O	1	2	2	SPI_TRANS_MODE_DIO SPI_TRANS_MULTILINE_ADDR	
Quad Output	1	1	4	SPI_TRANS_MODE_QIO	SPICOMMON_BUSFLAG_QUAD
Quad I/O	1	4	4	SPI_TRANS_MODE_QIO SPI_TRANS_MULTILINE_ADDR	
Octal Output	1	1	8	SPI_TRANS_MODE_OCT	SPICOMMON_BUSFLAG_OCTAL
OPI	8	8	8	SPI_TRANS_MODE_OCT SPI_TRANS_MULTILINE_ADDR SPI_TRANS_MULTILINE_CMD	

**Command and Address Phases** During the command and address phases, the members `spi_transaction_t::cmd` and `spi_transaction_t::addr` are sent to the bus, nothing is read at this time. The default lengths of the command and address phases are set in `spi_device_interface_config_t` by calling `spi_bus_add_device()`. If the flags `SPI_TRANS_VARIABLE_CMD` and

`SPI_TRANS_VARIABLE_ADDR` in the member `spi_transaction_t::flags` are not set, the driver automatically sets the length of these phases to default values during Device initialization.

If the lengths of the command and address phases need to be variable, declare the struct `spi_transaction_ext_t`, set the flags `SPI_TRANS_VARIABLE_CMD` and/or `SPI_TRANS_VARIABLE_ADDR` in the member `spi_transaction_ext_t::base` and configure the rest of base as usual. Then the length of each phase will be equal to `spi_transaction_ext_t::command_bits` and `spi_transaction_ext_t::address_bits` set in the struct `spi_transaction_ext_t`.

If the command and address phase need to be as the same number of lines as data phase, you need to set `SPI_TRANS_MULTILINE_CMD` and/or `SPI_TRANS_MULTILINE_ADDR` to the `flags` member in the struct `spi_transaction_t`. Also see *Transaction Line Mode*.

**Write and Read Phases** Normally, the data that needs to be transferred to or from a Device will be read from or written to a chunk of memory indicated by the members `spi_transaction_t::rx_buffer` and `spi_transaction_t::tx_buffer`. If DMA is enabled for transfers, the buffers are required to be:

1. Allocated in DMA-capable internal memory. If *external PSRAM is enabled*, this means using `pvPortMallocCaps(size, MALLOC_CAP_DMA)`.
2. 32-bit aligned (starting from a 32-bit boundary and having a length of multiples of 4 bytes).

If these requirements are not satisfied, the transaction efficiency will be affected due to the allocation and copying of temporary buffers.

If using more than one data lines to transmit, please set `SPI_DEVICE_HALFDUPLEX` flag for the member `flags` in the struct `spi_device_interface_config_t`. And the member `flags` in the struct `spi_transaction_t` should be set as described in *Transaction Line Mode*.

**Bus Acquiring** Sometimes you might want to send SPI transactions exclusively and continuously so that it takes as little time as possible. For this, you can use bus acquiring, which helps to suspend transactions (both polling or interrupt) to other devices until the bus is released. To acquire and release a bus, use the functions `spi_device_acquire_bus()` and `spi_device_release_bus()`.

## Driver Usage

- Initialize an SPI bus by calling the function `spi_bus_initialize()`. Make sure to set the correct I/O pins in the struct `spi_bus_config_t`. Set the signals that are not needed to `-1`.
- Register a Device connected to the bus with the driver by calling the function `spi_bus_add_device()`. Make sure to configure any timing requirements the device might need with the parameter `dev_config`. You should now have obtained the Device's handle which will be used when sending a transaction to it.
- To interact with the Device, fill one or more `spi_transaction_t` structs with any transaction parameters required. Then send the structs either using a polling transaction or an interrupt transaction:
  - **Interrupt** Either queue all transactions by calling the function `spi_device_queue_trans()` and, at a later time, query the result using the function `spi_device_get_trans_result()`, or handle all requests synchronously by feeding them into `spi_device_transmit()`.
  - **Polling** Call the function `spi_device_polling_transmit()` to send polling transactions. Alternatively, if you want to insert something in between, send the transactions by using `spi_device_polling_start()` and `spi_device_polling_end()`.
- (Optional) To perform back-to-back transactions with a Device, call the function `spi_device_acquire_bus()` before sending transactions and `spi_device_release_bus()` after the transactions have been sent.
- (Optional) To unload the driver for a certain Device, call `spi_bus_remove_device()` with the Device handle as an argument.
- (Optional) To remove the driver for a bus, make sure no more drivers are attached and call `spi_bus_free()`.

The example code for the SPI master driver can be found in the `peripherals/spi_master` directory of ESP-IDF examples.

**Transactions with Data Not Exceeding 32 Bits** When the transaction data size is equal to or less than 32 bits, it will be sub-optimal to allocate a buffer for the data. The data can be directly stored in the transaction struct instead. For transmitted data, it can be achieved by using the `spi_transaction_t::tx_data` member and setting the `SPI_TRANS_USE_TXDATA` flag on the transmission. For received data, use `spi_transaction_t::rx_data` and set `SPI_TRANS_USE_RXDATA`. In both cases, do not touch the `spi_transaction_t::tx_buffer` or `spi_transaction_t::rx_buffer` members, because they use the same memory locations as `spi_transaction_t::tx_data` and `spi_transaction_t::rx_data`.

**Transactions with Integers Other Than `uint8_t`** An SPI Host reads and writes data into memory byte by byte. By default, data is sent with the most significant bit (MSB) first, as LSB first used in rare cases. If a value less than 8 bits needs to be sent, the bits should be written into memory in the MSB first manner.

For example, if `0b00010` needs to be sent, it should be written into a `uint8_t` variable, and the length for reading should be set to 5 bits. The Device will still receive 8 bits with 3 additional “random” bits, so the reading must be performed correctly.

On top of that, ESP32-S2 is a little-endian chip, which means that the least significant byte of `uint16_t` and `uint32_t` variables is stored at the smallest address. Hence, if `uint16_t` is stored in memory, bits [7:0] are sent first, followed by bits [15:8].

For cases when the data to be transmitted has the size differing from `uint8_t` arrays, the following macros can be used to transform data to the format that can be sent by the SPI driver directly:

- `SPI_SWAP_DATA_TX` for data to be transmitted
- `SPI_SWAP_DATA_RX` for data received

**Notes on Sending Mixed Transactions to the Same Device** To reduce coding complexity, send only one type of transactions (interrupt or polling) to one Device. However, you still can send both interrupt and polling transactions alternately. The notes below explain how to do this.

The polling transactions should be initiated only after all the polling and interrupt transactions are finished.

Since an unfinished polling transaction blocks other transactions, please do not forget to call the function `spi_device_polling_end()` after `spi_device_polling_start()` to allow other transactions or to allow other Devices to use the bus. Remember that if there is no need to switch to other tasks during your polling transaction, you can initiate a transaction with `spi_device_polling_transmit()` so that it will be ended automatically.

In-flight polling transactions are disturbed by the ISR operation to accommodate interrupt transactions. Always make sure that all the interrupt transactions sent to the ISR are finished before you call `spi_device_polling_start()`. To do that, you can keep calling `spi_device_get_trans_result()` until all the transactions are returned.

To have better control of the calling sequence of functions, send mixed transactions to the same Device only within a single task.

### Transfer Speed Considerations

There are three factors limiting the transfer speed:

- Transaction interval
- SPI clock frequency
- Cache miss of SPI functions, including callbacks

The main parameter that determines the transfer speed for large transactions is clock frequency. For multiple small transactions, the transfer speed is mostly determined by the length of transaction intervals.

**Transaction Duration** Transaction duration includes setting up SPI peripheral registers, copying data to FIFOs or setting up DMA links, and the time for SPI transaction.

Interrupt transactions allow appending extra overhead to accommodate the cost of FreeRTOS queues and the time needed for switching between tasks and the ISR.

For **interrupt transactions**, the CPU can switch to other tasks when a transaction is in progress. This saves the CPU time but increases the transaction duration. See *Interrupt Transactions*. For **polling transactions**, it does not block the task but allows to do polling when the transaction is in progress. For more information, see *Polling Transactions*.

If DMA is enabled, setting up the linked list requires about 2 us per transaction. When a master is transferring data, it automatically reads the data from the linked list. If DMA is not enabled, the CPU has to write and read each byte from the FIFO by itself. Usually, this is faster than 2 us, but the transaction length is limited to 64 bytes for both write and read.

Typical transaction duration for one byte of data are given below.

- Interrupt Transaction via DMA: 23 μs.
- Interrupt Transaction via CPU: 22 μs.
- Polling Transaction via DMA: 9 μs.
- Polling Transaction via CPU: 8 μs.

**SPI Clock Frequency** Transferring each byte takes eight times the clock period  $8/f_{spi}$ .

**Cache Miss** The default config puts only the ISR into the IRAM. Other SPI related functions, including the driver itself and the callback, might suffer from cache misses and will need to wait until the code is read from flash. Select `CONFIG_SPI_MASTER_IN_IRAM` to put the whole SPI driver into IRAM and put the entire callback(s) and its callee functions into IRAM to prevent cache misses.

For an interrupt transaction, the overall cost is  $20+8n/f_{spi}[MHz]$  [us] for n bytes transferred in one transaction. Hence, the transferring speed is:  $n/(20+8n/f_{spi})$ . An example of transferring speed at 8 MHz clock speed is given in the following table.

Frequency (MHz)	Transaction Interval (us)	Transaction Length (bytes)	Total Time (us)	Total Speed (KBps)
8	25	1	26	38.5
8	25	8	33	242.4
8	25	16	41	490.2
8	25	64	89	719.1
8	25	128	153	836.6

When a transaction length is short, the cost of transaction interval is high. If possible, try to squash several short transactions into one transaction to achieve a higher transfer speed.

Please note that the ISR is disabled during flash operation by default. To keep sending transactions during flash operations, enable `CONFIG_SPI_MASTER_ISR_IN_IRAM` and set `ESP_INTR_FLAG_IRAM` in the member `spi_bus_config_t::intr_flags`. In this case, all the transactions queued before starting flash operations will be handled by the ISR in parallel. Also note that the callback of each Device and their callee functions should be in IRAM, or your callback will crash due to cache miss. For more details, see *IRAM-Safe Interrupt Handlers*.

### Application Example

The code example for using the SPI master half duplex mode to read/write a AT93C46D EEPROM (8-bit mode) can be found in the `peripherals/spi_master/hd_eeprom` directory of ESP-IDF examples.

### API Reference - SPI Common

#### Header File



- [components/hal/include/hal/spi\\_types.h](#)

## Structures

struct **spi\_line\_mode\_t**

Line mode of SPI transaction phases: CMD, ADDR, DOUT/DIN.

### Public Members

uint8\_t **cmd\_lines**

The line width of command phase, e.g. 2-line-cmd-phase.

uint8\_t **addr\_lines**

The line width of address phase, e.g. 1-line-addr-phase.

uint8\_t **data\_lines**

The line width of data phase, e.g. 4-line-data-phase.

## Enumerations

enum **spi\_host\_device\_t**

Enum with the three SPI peripherals that are software-accessible in it.

*Values:*

enumerator **SPI1\_HOST**

SPI1.

enumerator **SPI2\_HOST**

SPI2.

enumerator **SPI3\_HOST**

SPI3.

enumerator **SPI\_HOST\_MAX**

invalid host value

enum **spi\_clock\_source\_t**

*Values:*

enumerator **SPI\_CLK\_APB**

Select APB as the source clock.

enumerator **SPI\_CLK\_XTAL**

Select XTAL as the source clock.

enum **spi\_event\_t**

SPI Events.

*Values:*



enumerator **SPI\_EV\_BUF\_TX**

The buffer has sent data to master.

enumerator **SPI\_EV\_BUF\_RX**

The buffer has received data from master.

enumerator **SPI\_EV\_SEND\_DMA\_READY**

Slave has loaded its TX data buffer to the hardware (DMA).

enumerator **SPI\_EV\_SEND**

Master has received certain number of the data, the number is determined by Master.

enumerator **SPI\_EV\_RECV\_DMA\_READY**

Slave has loaded its RX data buffer to the hardware (DMA).

enumerator **SPI\_EV\_RECV**

Slave has received certain number of data from master, the number is determined by Master.

enumerator **SPI\_EV\_CMD9**

Received CMD9 from master.

enumerator **SPI\_EV\_CMDA**

Received CMDA from master.

enumerator **SPI\_EV\_TRANS**

A transaction has done.

enum **spi\_command\_t**

SPI command.

*Values:*

enumerator **SPI\_CMD\_HD\_WRBUF**

enumerator **SPI\_CMD\_HD\_RDBUF**

enumerator **SPI\_CMD\_HD\_WRDMA**

enumerator **SPI\_CMD\_HD\_RDDMA**

enumerator **SPI\_CMD\_HD\_SEG\_END**

enumerator **SPI\_CMD\_HD\_EN\_QPI**

enumerator **SPI\_CMD\_HD\_WR\_END**

enumerator **SPI\_CMD\_HD\_INT0**

enumerator `SPI_CMD_HD_INT1`

enumerator `SPI_CMD_HD_INT2`

## Header File

- `components/driver/include/driver/spi_common.h`

## Functions

`esp_err_t spi_bus_initialize` (*spi\_host\_device\_t* host\_id, const *spi\_bus\_config\_t* \*bus\_config, *spi\_dma\_chan\_t* dma\_chan)

Initialize a SPI bus.

**Warning:** SPI0/1 is not supported

**Warning:** If a DMA channel is selected, any transmit and receive buffer used should be allocated in DMA-capable memory.

**Warning:** The ISR of SPI is always executed on the core which calls this function. Never starve the ISR on this core or the SPI transactions will not be handled.

### Parameters

- **host\_id** – SPI peripheral that controls this bus
- **bus\_config** – Pointer to a *spi\_bus\_config\_t* struct specifying how the host should be initialized
- **dma\_chan** – Selecting a DMA channel for an SPI bus allows transactions on the bus with size only limited by the amount of internal memory.
  - Selecting `SPI_DMA_DISABLED` limits the size of transactions.
  - Set to `SPI_DMA_DISABLED` if only the SPI flash uses this bus.
  - Set to `SPI_DMA_CH_AUTO` to let the driver to allocate the DMA channel.

### Returns

- `ESP_ERR_INVALID_ARG` if configuration is invalid
- `ESP_ERR_INVALID_STATE` if host already is in use
- `ESP_ERR_NOT_FOUND` if there is no available DMA channel
- `ESP_ERR_NO_MEM` if out of memory
- `ESP_OK` on success

`esp_err_t spi_bus_free` (*spi\_host\_device\_t* host\_id)

Free a SPI bus.

**Warning:** In order for this to succeed, all devices have to be removed first.

**Parameters** **host\_id** – SPI peripheral to free

### Returns

- `ESP_ERR_INVALID_ARG` if parameter is invalid
- `ESP_ERR_INVALID_STATE` if bus hasn't been initialized before, or not all devices on the bus are freed
- `ESP_OK` on success

## Structures

struct **spi\_bus\_config\_t**

This is a configuration structure for a SPI bus.

You can use this structure to specify the GPIO pins of the bus. Normally, the driver will use the GPIO matrix to route the signals. An exception is made when all signals either can be routed through the IO\_MUX or are -1. In that case, the IO\_MUX is used, allowing for >40MHz speeds.

---

**Note:** Be advised that the slave driver does not use the quadwp/quadhd lines and fields in *spi\_bus\_config\_t* referring to these lines will be ignored and can thus safely be left uninitialized.

---

## Public Members

int **mosi\_io\_num**

GPIO pin for Master Out Slave In (=spi\_d) signal, or -1 if not used.

int **data0\_io\_num**

GPIO pin for spi data0 signal in quad/octal mode, or -1 if not used.

int **miso\_io\_num**

GPIO pin for Master In Slave Out (=spi\_q) signal, or -1 if not used.

int **data1\_io\_num**

GPIO pin for spi data1 signal in quad/octal mode, or -1 if not used.

int **sclk\_io\_num**

GPIO pin for SPI Clock signal, or -1 if not used.

int **quadwp\_io\_num**

GPIO pin for WP (Write Protect) signal, or -1 if not used.

int **data2\_io\_num**

GPIO pin for spi data2 signal in quad/octal mode, or -1 if not used.

int **quadhd\_io\_num**

GPIO pin for HD (Hold) signal, or -1 if not used.

int **data3\_io\_num**

GPIO pin for spi data3 signal in quad/octal mode, or -1 if not used.

int **data4\_io\_num**

GPIO pin for spi data4 signal in octal mode, or -1 if not used.

int **data5\_io\_num**

GPIO pin for spi data5 signal in octal mode, or -1 if not used.

int **data6\_io\_num**

GPIO pin for spi data6 signal in octal mode, or -1 if not used.

int **data7\_io\_num**

GPIO pin for spi data7 signal in octal mode, or -1 if not used.

int **max\_transfer\_sz**

Maximum transfer size, in bytes. Defaults to 4092 if 0 when DMA enabled, or to `SOC_SPI_MAXIMUM_BUFFER_SIZE` if DMA is disabled.

uint32\_t **flags**

Abilities of bus to be checked by the driver. Or-ed value of `SPICOMMON_BUSFLAG_*` flags.

int **intr\_flags**

Interrupt flag for the bus to set the priority, and IRAM attribute, see `esp_intr_alloc.h`. Note that the `EDGE`, `INTRDISABLED` attribute are ignored by the driver. Note that if `ESP_INTR_FLAG_IRAM` is set, ALL the callbacks of the driver, and their callee functions, should be put in the IRAM.

## Macros

**SPI\_MAX\_DMA\_LEN**

**SPI\_SWAP\_DATA\_TX** (DATA, LEN)

Transform unsigned integer of length  $\leq 32$  bits to the format which can be sent by the SPI driver directly.

E.g. to send 9 bits of data, you can:

```
uint16_t data = SPI_SWAP_DATA_TX(0x145, 9);
```

Then points `tx_buffer` to `&data`.

### Parameters

- **DATA** –Data to be sent, can be `uint8_t`, `uint16_t` or `uint32_t`.
- **LEN** –Length of data to be sent, since the SPI peripheral sends from the MSB, this helps to shift the data to the MSB.

**SPI\_SWAP\_DATA\_RX** (DATA, LEN)

Transform received data of length  $\leq 32$  bits to the format of an unsigned integer.

E.g. to transform the data of 15 bits placed in a 4-byte array to integer:

```
uint16_t data = SPI_SWAP_DATA_RX(*(uint32_t*)t->rx_data, 15);
```

### Parameters

- **DATA** –Data to be rearranged, can be `uint8_t`, `uint16_t` or `uint32_t`.
- **LEN** –Length of data received, since the SPI peripheral writes from the MSB, this helps to shift the data to the LSB.

**SPICOMMON\_BUSFLAG\_SLAVE**

Initialize I/O in slave mode.

**SPICOMMON\_BUSFLAG\_MASTER**

Initialize I/O in master mode.

**SPICOMMON\_BUSFLAG\_IOMUX\_PINS**

Check using iomux pins. Or indicates the pins are configured through the IO mux rather than GPIO matrix.

**SPICOMMON\_BUSFLAG\_GPIO\_PINS**

Force the signals to be routed through GPIO matrix. Or indicates the pins are routed through the GPIO matrix.

**SPICOMMON\_BUSFLAG\_SCLK**

Check existing of SCLK pin. Or indicates CLK line initialized.

**SPICOMMON\_BUSFLAG\_MISO**

Check existing of MISO pin. Or indicates MISO line initialized.

**SPICOMMON\_BUSFLAG\_MOSI**

Check existing of MOSI pin. Or indicates MOSI line initialized.

**SPICOMMON\_BUSFLAG\_DUAL**

Check MOSI and MISO pins can output. Or indicates bus able to work under DIO mode.

**SPICOMMON\_BUSFLAG\_WPHD**

Check existing of WP and HD pins. Or indicates WP & HD pins initialized.

**SPICOMMON\_BUSFLAG\_QUAD**

Check existing of MOSI/MISO/WP/HD pins as output. Or indicates bus able to work under QIO mode.

**SPICOMMON\_BUSFLAG\_IO4\_IO7**

Check existing of IO4~IO7 pins. Or indicates IO4~IO7 pins initialized.

**SPICOMMON\_BUSFLAG\_OCTAL**

Check existing of MOSI/MISO/WP/HD/SPIIO4/SPIIO5/SPIIO6/SPIIO7 pins as output. Or indicates bus able to work under octal mode.

**SPICOMMON\_BUSFLAG\_NATIVE\_PINS****Type Definitions**

```
typedef spi_common_dma_t spi_dma_chan_t
```

**Enumerations**

```
enum spi_common_dma_t
```

SPI DMA channels.

*Values:*

```
enumerator SPI_DMA_DISABLED
```

Do not enable DMA for SPI.

```
enumerator SPI_DMA_CH_AUTO
```

Enable DMA, channel is automatically selected by driver.

## API Reference - SPI Master

### Header File

- `components/driver/include/driver/spi_master.h`

### Functions

`esp_err_t spi_bus_add_device` (`spi_host_device_t` host\_id, const `spi_device_interface_config_t` \*dev\_config, `spi_device_handle_t` \*handle)

Allocate a device on a SPI bus.

This initializes the internal structures for a device, plus allocates a CS pin on the indicated SPI master peripheral and routes it to the indicated GPIO. All SPI master devices have three CS pins and can thus control up to three devices.

---

**Note:** While in general, speeds up to 80MHz on the dedicated SPI pins and 40MHz on GPIO-matrix-routed pins are supported, full-duplex transfers routed over the GPIO matrix only support speeds up to 26MHz.

---

#### Parameters

- **host\_id** –SPI peripheral to allocate device on
- **dev\_config** –SPI interface protocol config for the device
- **handle** –Pointer to variable to hold the device handle

#### Returns

- `ESP_ERR_INVALID_ARG` if parameter is invalid
- `ESP_ERR_NOT_FOUND` if host doesn't have any free CS slots
- `ESP_ERR_NO_MEM` if out of memory
- `ESP_OK` on success

`esp_err_t spi_bus_remove_device` (`spi_device_handle_t` handle)

Remove a device from the SPI bus.

**Parameters** **handle** –Device handle to free

#### Returns

- `ESP_ERR_INVALID_ARG` if parameter is invalid
- `ESP_ERR_INVALID_STATE` if device already is freed
- `ESP_OK` on success

`esp_err_t spi_device_queue_trans` (`spi_device_handle_t` handle, `spi_transaction_t` \*trans\_desc, `TickType_t` ticks\_to\_wait)

Queue a SPI transaction for interrupt transaction execution. Get the result by `spi_device_get_trans_result`.

---

**Note:** Normally a device cannot start (queue) polling and interrupt transactions simultaneously.

---

#### Parameters

- **handle** –Device handle obtained using `spi_host_add_dev`
- **trans\_desc** –Description of transaction to execute
- **ticks\_to\_wait** –Ticks to wait until there's room in the queue; use `portMAX_DELAY` to never time out.

#### Returns

- `ESP_ERR_INVALID_ARG` if parameter is invalid. This can happen if `SPI_TRANS_CS_KEEP_ACTIVE` flag is specified while the bus was not acquired (`spi_device_acquire_bus()` should be called first)
- `ESP_ERR_TIMEOUT` if there was no room in the queue before `ticks_to_wait` expired
- `ESP_ERR_NO_MEM` if allocating DMA-capable temporary buffer failed
- `ESP_ERR_INVALID_STATE` if previous transactions are not finished

- ESP\_OK on success

*esp\_err\_t* **spi\_device\_get\_trans\_result** (*spi\_device\_handle\_t* handle, *spi\_transaction\_t* \*\*trans\_desc, TickType\_t ticks\_to\_wait)

Get the result of a SPI transaction queued earlier by `spi_device_queue_trans`.

This routine will wait until a transaction to the given device successfully completed. It will then return the description of the completed transaction so software can inspect the result and e.g. free the memory or re-use the buffers.

#### Parameters

- **handle** –Device handle obtained using `spi_host_add_dev`
- **trans\_desc** –Pointer to variable able to contain a pointer to the description of the transaction that is executed. The descriptor should not be modified until the descriptor is returned by `spi_device_get_trans_result`.
- **ticks\_to\_wait** –Ticks to wait until there's a returned item; use `portMAX_DELAY` to never time out.

#### Returns

- ESP\_ERR\_INVALID\_ARG if parameter is invalid
- ESP\_ERR\_TIMEOUT if there was no completed transaction before `ticks_to_wait` expired
- ESP\_OK on success

*esp\_err\_t* **spi\_device\_transmit** (*spi\_device\_handle\_t* handle, *spi\_transaction\_t* \*trans\_desc)

Send a SPI transaction, wait for it to complete, and return the result.

This function is the equivalent of calling `spi_device_queue_trans()` followed by `spi_device_get_trans_result()`. Do not use this when there is still a transaction separately queued (started) from `spi_device_queue_trans()` or `polling_start/transmit` that hasn't been finalized.

---

**Note:** This function is not thread safe when multiple tasks access the same SPI device. Normally a device cannot start (queue) polling and interrupt transactions simultaneously.

---

#### Parameters

- **handle** –Device handle obtained using `spi_host_add_dev`
- **trans\_desc** –Description of transaction to execute

#### Returns

- ESP\_ERR\_INVALID\_ARG if parameter is invalid
- ESP\_OK on success

*esp\_err\_t* **spi\_device\_polling\_start** (*spi\_device\_handle\_t* handle, *spi\_transaction\_t* \*trans\_desc, TickType\_t ticks\_to\_wait)

Immediately start a polling transaction.

---

**Note:** Normally a device cannot start (queue) polling and interrupt transactions simultaneously. Moreover, a device cannot start a new polling transaction if another polling transaction is not finished.

---

#### Parameters

- **handle** –Device handle obtained using `spi_host_add_dev`
- **trans\_desc** –Description of transaction to execute
- **ticks\_to\_wait** –Ticks to wait until there's a room in the queue; currently only `portMAX_DELAY` is supported.

#### Returns

- ESP\_ERR\_INVALID\_ARG if parameter is invalid. This can happen if `SPI_TRANS_CS_KEEP_ACTIVE` flag is specified while the bus was not acquired (`spi_device_acquire_bus()` should be called first)

- `ESP_ERR_TIMEOUT` if the device cannot get control of the bus before `ticks_to_wait` expired
- `ESP_ERR_NO_MEM` if allocating DMA-capable temporary buffer failed
- `ESP_ERR_INVALID_STATE` if previous transactions are not finished
- `ESP_OK` on success

*esp\_err\_t* **spi\_device\_polling\_end** (*spi\_device\_handle\_t* handle, TickType\_t ticks\_to\_wait)

Poll until the polling transaction ends.

This routine will not return until the transaction to the given device has successfully completed. The task is not blocked, but actively busy-spins for the transaction to be completed.

#### Parameters

- **handle** –Device handle obtained using `spi_host_add_dev`
- **ticks\_to\_wait** –Ticks to wait until there's a returned item; use `portMAX_DELAY` to never time out.

#### Returns

- `ESP_ERR_INVALID_ARG` if parameter is invalid
- `ESP_ERR_TIMEOUT` if the transaction cannot finish before `ticks_to_wait` expired
- `ESP_OK` on success

*esp\_err\_t* **spi\_device\_polling\_transmit** (*spi\_device\_handle\_t* handle, *spi\_transaction\_t* \*trans\_desc)

Send a polling transaction, wait for it to complete, and return the result.

This function is the equivalent of calling `spi_device_polling_start()` followed by `spi_device_polling_end()`. Do not use this when there is still a transaction that hasn't been finalized.

---

**Note:** This function is not thread safe when multiple tasks access the same SPI device. Normally a device cannot start (queue) polling and interrupt transactions simultaneously.

---

#### Parameters

- **handle** –Device handle obtained using `spi_host_add_dev`
- **trans\_desc** –Description of transaction to execute

#### Returns

- `ESP_ERR_INVALID_ARG` if parameter is invalid
- `ESP_ERR_TIMEOUT` if the device cannot get control of the bus
- `ESP_ERR_NO_MEM` if allocating DMA-capable temporary buffer failed
- `ESP_ERR_INVALID_STATE` if previous transactions of same device are not finished
- `ESP_OK` on success

*esp\_err\_t* **spi\_device\_acquire\_bus** (*spi\_device\_handle\_t* device, TickType\_t wait)

Occupy the SPI bus for a device to do continuous transactions.

Transactions to all other devices will be put off until `spi_device_release_bus` is called.

---

**Note:** The function will wait until all the existing transactions have been sent.

---

#### Parameters

- **device** –The device to occupy the bus.
- **wait** –Time to wait before the the bus is occupied by the device. Currently MUST set to `portMAX_DELAY`.

#### Returns

- `ESP_ERR_INVALID_ARG` : `wait` is not set to `portMAX_DELAY`.
- `ESP_OK` : Success.



void **spi\_device\_release\_bus** (*spi\_device\_handle\_t* dev)

Release the SPI bus occupied by the device. All other devices can start sending transactions.

**Parameters** **dev** –The device to release the bus.

int **spi\_get\_actual\_clock** (int fapb, int hz, int duty\_cycle)

Calculate the working frequency that is most close to desired frequency.

**Parameters**

- **fapb** –The frequency of apb clock, should be APB\_CLK\_FREQ.
- **hz** –Desired working frequency
- **duty\_cycle** –Duty cycle of the spi clock

**Returns** Actual working frequency that most fit.

void **spi\_get\_timing** (bool gpio\_is\_used, int input\_delay\_ns, int eff\_clk, int \*dummy\_o, int \*cycles\_remain\_o)

Calculate the timing settings of specified frequency and settings.

---

**Note:** If **\*\*dummy\_o\*** is not zero, it means dummy bits should be applied in half duplex mode, and full duplex mode may not work.

---

**Parameters**

- **gpio\_is\_used** –True if using GPIO matrix, or False if iomux pins are used.
- **input\_delay\_ns** –Input delay from SCLK launch edge to MISO data valid.
- **eff\_clk** –Effective clock frequency (in Hz) from `spi_get_actual_clock()`.
- **dummy\_o** –Address of dummy bits used output. Set to NULL if not needed.
- **cycles\_remain\_o** –Address of cycles remaining (after dummy bits are used) output.
  - -1 If too many cycles remaining, suggest to compensate half a clock.
  - 0 If no remaining cycles or dummy bits are not used.
  - positive value: cycles suggest to compensate.

int **spi\_get\_freq\_limit** (bool gpio\_is\_used, int input\_delay\_ns)

Get the frequency limit of current configurations. SPI master working at this limit is OK, while above the limit, full duplex mode and DMA will not work, and dummy bits will be applied in the half duplex mode.

**Parameters**

- **gpio\_is\_used** –True if using GPIO matrix, or False if native pins are used.
- **input\_delay\_ns** –Input delay from SCLK launch edge to MISO data valid.

**Returns** Frequency limit of current configurations.

*esp\_err\_t* **spi\_bus\_get\_max\_transaction\_len** (*spi\_host\_device\_t* host\_id, size\_t \*max\_bytes)

Get max length (in bytes) of one transaction.

**Parameters**

- **host\_id** –SPI peripheral
- **max\_bytes** –[out] Max length of one transaction, in bytes

**Returns**

- ESP\_OK: On success
- ESP\_ERR\_INVALID\_ARG: Invalid argument

## Structures

struct **spi\_device\_interface\_config\_t**

This is a configuration for a SPI slave device that is connected to one of the SPI buses.

## Public Members

**uint8\_t command\_bits**

Default amount of bits in command phase (0-16), used when `SPI_TRANS_VARIABLE_CMD` is not used, otherwise ignored.

**uint8\_t address\_bits**

Default amount of bits in address phase (0-64), used when `SPI_TRANS_VARIABLE_ADDR` is not used, otherwise ignored.

**uint8\_t dummy\_bits**

Amount of dummy bits to insert between address and data phase.

**uint8\_t mode**

SPI mode, representing a pair of (CPOL, CPHA) configuration:

- 0: (0, 0)
- 1: (0, 1)
- 2: (1, 0)
- 3: (1, 1)

**uint16\_t duty\_cycle\_pos**

Duty cycle of positive clock, in 1/256th increments (128 = 50%/50% duty). Setting this to 0 (=not setting it) is equivalent to setting this to 128.

**uint16\_t cs\_ena\_pretrans**

Amount of SPI bit-cycles the cs should be activated before the transmission (0-16). This only works on half-duplex transactions.

**uint8\_t cs\_ena\_posttrans**

Amount of SPI bit-cycles the cs should stay active after the transmission (0-16)

**int clock\_speed\_hz**

Clock speed, divisors of 80MHz, in Hz. See `SPI_MASTER_FREQ_*`.

**int input\_delay\_ns**

Maximum data valid time of slave. The time required between SCLK and MISO valid, including the possible clock delay from slave to master. The driver uses this value to give an extra delay before the MISO is ready on the line. Leave at 0 unless you know you need a delay. For better timing performance at high frequency (over 8MHz), it's suggest to have the right value.

**int spics\_io\_num**

CS GPIO pin for this device, or -1 if not used.

**uint32\_t flags**

Bitwise OR of `SPI_DEVICE_*` flags.

**int queue\_size**

Transaction queue size. This sets how many transactions can be 'in the air' (queued using `spi_device_queue_trans` but not yet finished using `spi_device_get_trans_result`) at the same time.

***transaction\_cb\_t* pre\_cb**

Callback to be called before a transmission is started.

This callback is called within interrupt context should be in IRAM for best performance, see “Transferring Speed” section in the SPI Master documentation for full details. If not, the callback may crash during flash operation when the driver is initialized with `ESP_INTR_FLAG_IRAM`.

#### *transaction\_cb\_t* **post\_cb**

Callback to be called after a transmission has completed.

This callback is called within interrupt context should be in IRAM for best performance, see “Transferring Speed” section in the SPI Master documentation for full details. If not, the callback may crash during flash operation when the driver is initialized with `ESP_INTR_FLAG_IRAM`.

#### struct **spi\_transaction\_t**

This structure describes one SPI transaction. The descriptor should not be modified until the transaction finishes.

### Public Members

#### uint32\_t **flags**

Bitwise OR of `SPI_TRANS_*` flags.

#### uint16\_t **cmd**

Command data, of which the length is set in the `command_bits` of *spi\_device\_interface\_config\_t*.

**NOTE: this field, used to be “command” in ESP-IDF 2.1 and before, is re-written to be used in a new way in ESP-IDF 3.0.**

Example: write 0x0123 and `command_bits=12` to send command 0x12, 0x3\_ (in previous version, you may have to write 0x3\_12).

#### uint64\_t **addr**

Address data, of which the length is set in the `address_bits` of *spi\_device\_interface\_config\_t*.

**NOTE: this field, used to be “address” in ESP-IDF 2.1 and before, is re-written to be used in a new way in ESP-IDF 3.0.**

Example: write 0x123400 and `address_bits=24` to send address of 0x12, 0x34, 0x00 (in previous version, you may have to write 0x12340000).

#### size\_t **length**

Total data length, in bits.

#### size\_t **rxlength**

Total data length received, should be not greater than `length` in full-duplex mode (0 defaults this to the value of `length`).

#### void \***user**

User-defined variable. Can be used to store eg transaction ID.

#### const void \***tx\_buffer**

Pointer to transmit buffer, or NULL for no MOSI phase.

#### uint8\_t **tx\_data**[4]

If `SPI_TRANS_USE_TXDATA` is set, data set here is sent directly from this variable.

void **\*rx\_buffer**

Pointer to receive buffer, or NULL for no MISO phase. Written by 4 bytes-unit if DMA is used.

uint8\_t **rx\_data**[4]

If SPI\_TRANS\_USE\_RXDATA is set, data is received directly to this variable.

struct **spi\_transaction\_ext\_t**

This struct is for SPI transactions which may change their address and command length. Please do set the flags in base to SPI\_TRANS\_VARIABLE\_CMD\_ADR to use the bit length here.

### Public Members

struct *spi\_transaction\_t* **base**

Transaction data, so that pointer to *spi\_transaction\_t* can be converted into *spi\_transaction\_ext\_t*.

uint8\_t **command\_bits**

The command length in this transaction, in bits.

uint8\_t **address\_bits**

The address length in this transaction, in bits.

uint8\_t **dummy\_bits**

The dummy length in this transaction, in bits.

### Macros

**SPI\_MASTER\_FREQ\_8M**

SPI master clock is divided by 80MHz apb clock. Below defines are example frequencies, and are accurate. Be free to specify a random frequency, it will be rounded to closest frequency (to macros below if above 8MHz).  
8MHz

**SPI\_MASTER\_FREQ\_9M**

8.89MHz

**SPI\_MASTER\_FREQ\_10M**

10MHz

**SPI\_MASTER\_FREQ\_11M**

11.43MHz

**SPI\_MASTER\_FREQ\_13M**

13.33MHz

**SPI\_MASTER\_FREQ\_16M**

16MHz

**SPI\_MASTER\_FREQ\_20M**

20MHz

**SPI\_MASTER\_FREQ\_26M**

26.67MHz

**SPI\_MASTER\_FREQ\_40M**

40MHz

**SPI\_MASTER\_FREQ\_80M**

80MHz

**SPI\_DEVICE\_TXBIT\_LSBFIRST**

Transmit command/address/data LSB first instead of the default MSB first.

**SPI\_DEVICE\_RXBIT\_LSBFIRST**

Receive data LSB first instead of the default MSB first.

**SPI\_DEVICE\_BIT\_LSBFIRST**

Transmit and receive LSB first.

**SPI\_DEVICE\_3WIRE**

Use MOSI (=spid) for both sending and receiving data.

**SPI\_DEVICE\_POSITIVE\_CS**

Make CS positive during a transaction instead of negative.

**SPI\_DEVICE\_HALFDUPLEX**

Transmit data before receiving it, instead of simultaneously.

**SPI\_DEVICE\_CLK\_AS\_CS**

Output clock on CS line if CS is active.

**SPI\_DEVICE\_NO\_DUMMY**

There are timing issue when reading at high frequency (the frequency is related to whether iomux pins are used, valid time after slave sees the clock).

- In half-duplex mode, the driver automatically inserts dummy bits before reading phase to fix the timing issue. Set this flag to disable this feature.
- In full-duplex mode, however, the hardware cannot use dummy bits, so there is no way to prevent data being read from getting corrupted. Set this flag to confirm that you're going to work with output only, or read without dummy bits at your own risk.

**SPI\_DEVICE\_DDRCLK**

**SPI\_TRANS\_MODE\_DIO**

Transmit/receive data in 2-bit mode.

**SPI\_TRANS\_MODE\_QIO**

Transmit/receive data in 4-bit mode.

**SPI\_TRANS\_USE\_RXDATA**

Receive into rx\_data member of *spi\_transaction\_t* instead into memory at rx\_buffer.

**SPI\_TRANS\_USE\_TXDATA**

Transmit tx\_data member of *spi\_transaction\_t* instead of data at tx\_buffer. Do not set tx\_buffer when using this.

**SPI\_TRANS\_MODE\_DIOQIO\_ADDR**

Also transmit address in mode selected by SPI\_MODE\_DIO/SPI\_MODE\_QIO.

**SPI\_TRANS\_VARIABLE\_CMD**

Use the command\_bits in *spi\_transaction\_ext\_t* rather than default value in *spi\_device\_interface\_config\_t*.

**SPI\_TRANS\_VARIABLE\_ADDR**

Use the address\_bits in *spi\_transaction\_ext\_t* rather than default value in *spi\_device\_interface\_config\_t*.

**SPI\_TRANS\_VARIABLE\_DUMMY**

Use the dummy\_bits in *spi\_transaction\_ext\_t* rather than default value in *spi\_device\_interface\_config\_t*.

**SPI\_TRANS\_CS\_KEEP\_ACTIVE**

Keep CS active after data transfer.

**SPI\_TRANS\_MULTILINE\_CMD**

The data lines used at command phase is the same as data phase (otherwise, only one data line is used at command phase)

**SPI\_TRANS\_MODE\_OCT**

Transmit/receive data in 8-bit mode.

**SPI\_TRANS\_MULTILINE\_ADDR**

The data lines used at address phase is the same as data phase (otherwise, only one data line is used at address phase)

**Type Definitions**

```
typedef struct spi_transaction_t spi_transaction_t
```

```
typedef void (*transaction_cb_t)(spi_transaction_t *trans)
```

```
typedef struct spi_device_t *spi_device_handle_t
```

Handle for a device on a SPI bus.

**2.5.20 SPI Slave Driver**

SPI Slave driver is a program that controls ESP32-S2's SPI peripherals while they function as slaves.

**Overview of ESP32-S2's SPI peripherals**

ESP32-S2 integrates two general purpose SPI controllers which can be used as slave nodes driven by an off-chip SPI master.

SPI2 and SPI3 have independent signal buses with the same respective names.

### Terminology

The terms used in relation to the SPI slave driver are given in the table below.

Term	Definition
Host	The SPI controller peripheral external to ESP32-S2 that initiates SPI transmissions over the bus, and acts as an SPI Master.
Device	SPI slave device (general purpose SPI controller). Each Device shares the MOSI, MISO and SCLK signals but is only active on the bus when the Host asserts the Device's individual CS line.
Bus	A signal bus, common to all Devices connected to one Host. In general, a bus includes the following lines: MISO, MOSI, SCLK, one or more CS lines, and, optionally, QUADWP and QUADHD. So Devices are connected to the same lines, with the exception that each Device has its own CS line. Several Devices can also share one CS line if connected in the daisy-chain manner.
MISO	Master In, Slave Out, a.k.a. Q. Data transmission from a Device to Host.
MOSI	Master Out, Slave In, a.k.a. D. Data transmission from a Host to Device.
SCLK	Serial Clock. Oscillating signal generated by a Host that keeps the transmission of data bits in sync.
CS	Chip Select. Allows a Host to select individual Device(s) connected to the bus in order to send or receive data.
QUADWP	Write Protect signal. Only used for 4-bit (qio/qout) transactions.
QUADHD	Hold signal. Only used for 4-bit (qio/qout) transactions.
Assertion	The action of activating a line. The opposite action of returning the line back to inactive (back to idle) is called <i>de-assertion</i> .
Transaction	One instance of a Host asserting a CS line, transferring data to and from a Device, and de-asserting the CS line. Transactions are atomic, which means they can never be interrupted by another transaction.
Launch Edge	Edge of the clock at which the source register <i>launches</i> the signal onto the line.
Latch Edge	Edge of the clock at which the destination register <i>latches in</i> the signal.

### Driver Features

The SPI slave driver allows using the SPI peripherals as full-duplex Devices. The driver can send/receive transactions up to 72 bytes in length, or utilize DMA to send/receive longer transactions. However, there are some *known issues* related to DMA.

### SPI Transactions

A full-duplex SPI transaction begins when the Host asserts the CS line and starts sending out clock pulses on the SCLK line. Every clock pulse, a data bit is shifted from the Host to the Device on the MOSI line and back on the MISO line at the same time. At the end of the transaction, the Host de-asserts the CS line.

The attributes of a transaction are determined by the configuration structure for an SPI peripheral acting as a slave device `spi_slave_interface_config_t`, and transaction configuration structure `spi_slave_transaction_t`.

As not every transaction requires both writing and reading data, you have a choice to configure the `spi_transaction_t` structure for TX only, RX only, or TX and RX transactions. If `spi_slave_transaction_t::rx_buffer` is set to NULL, the read phase will be skipped. If `spi_slave_transaction_t::tx_buffer` is set to NULL, the write phase will be skipped.

**Note:** A Host should not start a transaction before its Device is ready for receiving data. It is recommended to use another GPIO pin for a handshake signal to sync the Devices. For more details, see [Transaction Interval](#).

---

### Driver Usage

- Initialize an SPI peripheral as a Device by calling the function `cpp:func:spi_slave_initialize`. Make sure to set the correct I/O pins in the struct `bus_config`. Set the unused signals to `-1`.

If transactions will be longer than 32 bytes, allow a DMA channel by setting the parameter `dma_chan` to the host device. Otherwise, set `dma_chan` to 0.

- Before initiating transactions, fill one or more `spi_slave_transaction_t` structs with the transaction parameters required. Either queue all transactions by calling the function `spi_slave_queue_trans()` and, at a later time, query the result by using the function `spi_slave_get_trans_result()`, or handle all requests individually by feeding them into `spi_slave_transmit()`. The latter two functions will be blocked until the Host has initiated and finished a transaction, causing the queued data to be sent and received.
- (Optional) To unload the SPI slave driver, call `spi_slave_free()`.

### Transaction Data and Master/Slave Length Mismatches

Normally, the data that needs to be transferred to or from a Device is read or written to a chunk of memory indicated by the `spi_slave_transaction_t::rx_buffer` and `spi_slave_transaction_t::tx_buffer`. The SPI driver can be configured to use DMA for transfers, in which case these buffers must be allocated in DMA-capable memory using `pvPortMallocCaps(size, MALLOC_CAP_DMA)`.

The amount of data that the driver can read or write to the buffers is limited by `spi_slave_transaction_t::length`. However, this member does not define the actual length of an SPI transaction. A transaction's length is determined by the clock and CS lines driven by the Host. The actual length of the transmission can be read only after a transaction is finished from the member `spi_slave_transaction_t::trans_len`.

If the length of the transmission is greater than the buffer length, only the initial number of bits specified in the `spi_slave_transaction_t::length` member will be sent and received. In this case, `spi_slave_transaction_t::trans_len` is set to `spi_slave_transaction_t::length` instead of the actual transaction length. To meet the actual transaction length requirements, set `spi_slave_transaction_t::length` to a value greater than the maximum `spi_slave_transaction_t::trans_len` expected. If the transmission length is shorter than the buffer length, only the data equal to the length of the buffer will be transmitted.

### Speed and Timing Considerations

**Transaction Interval** The ESP32-S2 SPI slave peripherals are designed as general purpose Devices controlled by a CPU. As opposed to dedicated slaves, CPU-based SPI Devices have a limited number of pre-defined registers. All transactions must be handled by the CPU, which means that the transfers and responses are not real-time, and there might be noticeable latency.

As a solution, a Device's response rate can be doubled by using the functions `spi_slave_queue_trans()` and then `spi_slave_get_trans_result()` instead of using `spi_slave_transmit()`.

You can also configure a GPIO pin through which the Device will signal to the Host when it is ready for a new transaction. A code example of this can be found in [peripherals/spi\\_slave](#).

**SCLK Frequency Requirements** The SPI slaves are designed to operate at up to 40 MHz. The data cannot be recognized or received correctly if the clock is too fast or does not have a 50% duty cycle.



## Restrictions and Known Issues

1. If DMA is enabled, the rx buffer should be word-aligned (starting from a 32-bit boundary and having a length of multiples of 4 bytes). Otherwise, DMA may write incorrectly or not in a boundary aligned manner. The driver reports an error if this condition is not satisfied.  
Also, a Host should write lengths that are multiples of 4 bytes. The data with inappropriate lengths will be discarded.

## Application Example

The code example for Device/Host communication can be found in the [peripherals/spi\\_slave](#) directory of ESP-IDF examples.

## API Reference

### Header File

- [components/driver/include/driver/spi\\_slave.h](#)

### Functions

`esp_err_t spi_slave_initialize` ([spi\\_host\\_device\\_t](#) host, const [spi\\_bus\\_config\\_t](#) \*bus\_config, const [spi\\_slave\\_interface\\_config\\_t](#) \*slave\_config, [spi\\_dma\\_chan\\_t](#) dma\_chan)

Initialize a SPI bus as a slave interface.

**Warning:** SPI0/1 is not supported

**Warning:** If a DMA channel is selected, any transmit and receive buffer used should be allocated in DMA-capable memory.

**Warning:** The ISR of SPI is always executed on the core which calls this function. Never starve the ISR on this core or the SPI transactions will not be handled.

### Parameters

- **host** –SPI peripheral to use as a SPI slave interface
- **bus\_config** –Pointer to a [spi\\_bus\\_config\\_t](#) struct specifying how the host should be initialized
- **slave\_config** –Pointer to a [spi\\_slave\\_interface\\_config\\_t](#) struct specifying the details for the slave interface
- **dma\_chan** -- Selecting a DMA channel for an SPI bus allows transactions on the bus with size only limited by the amount of internal memory.
  - Selecting SPI\_DMA\_DISABLED limits the size of transactions.
  - Set to SPI\_DMA\_DISABLED if only the SPI flash uses this bus.
  - Set to SPI\_DMA\_CH\_AUTO to let the driver to allocate the DMA channel.

### Returns

- ESP\_ERR\_INVALID\_ARG if configuration is invalid
- ESP\_ERR\_INVALID\_STATE if host already is in use
- ESP\_ERR\_NOT\_FOUND if there is no available DMA channel
- ESP\_ERR\_NO\_MEM if out of memory
- ESP\_OK on success

*esp\_err\_t* **spi\_slave\_free** (*spi\_host\_device\_t* host)

Free a SPI bus claimed as a SPI slave interface.

**Parameters** **host** –SPI peripheral to free

**Returns**

- `ESP_ERR_INVALID_ARG` if parameter is invalid
- `ESP_ERR_INVALID_STATE` if not all devices on the bus are freed
- `ESP_OK` on success

*esp\_err\_t* **spi\_slave\_queue\_trans** (*spi\_host\_device\_t* host, const *spi\_slave\_transaction\_t* \*trans\_desc, TickType\_t ticks\_to\_wait)

Queue a SPI transaction for execution.

Queues a SPI transaction to be executed by this slave device. (The transaction queue size was specified when the slave device was initialised via `spi_slave_initialize`.) This function may block if the queue is full (depending on the `ticks_to_wait` parameter). No SPI operation is directly initiated by this function, the next queued transaction will happen when the master initiates a SPI transaction by pulling down CS and sending out clock signals.

This function hands over ownership of the buffers in `trans_desc` to the SPI slave driver; the application is not to access this memory until `spi_slave_queue_trans` is called to hand ownership back to the application.

**Parameters**

- **host** –SPI peripheral that is acting as a slave
- **trans\_desc** –Description of transaction to execute. Not const because we may want to write status back into the transaction description.
- **ticks\_to\_wait** –Ticks to wait until there's room in the queue; use `portMAX_DELAY` to never time out.

**Returns**

- `ESP_ERR_INVALID_ARG` if parameter is invalid
- `ESP_OK` on success

*esp\_err\_t* **spi\_slave\_get\_trans\_result** (*spi\_host\_device\_t* host, *spi\_slave\_transaction\_t* \*\*trans\_desc, TickType\_t ticks\_to\_wait)

Get the result of a SPI transaction queued earlier.

This routine will wait until a transaction to the given device (queued earlier with `spi_slave_queue_trans`) has successfully completed. It will then return the description of the completed transaction so software can inspect the result and e.g. free the memory or re-use the buffers.

It is mandatory to eventually use this function for any transaction queued by `spi_slave_queue_trans`.

**Parameters**

- **host** –SPI peripheral to that is acting as a slave
- **trans\_desc** –[out] Pointer to variable able to contain a pointer to the description of the transaction that is executed
- **ticks\_to\_wait** –Ticks to wait until there's a returned item; use `portMAX_DELAY` to never time out.

**Returns**

- `ESP_ERR_INVALID_ARG` if parameter is invalid
- `ESP_OK` on success

*esp\_err\_t* **spi\_slave\_transmit** (*spi\_host\_device\_t* host, *spi\_slave\_transaction\_t* \*trans\_desc, TickType\_t ticks\_to\_wait)

Do a SPI transaction.

Essentially does the same as `spi_slave_queue_trans` followed by `spi_slave_get_trans_result`. Do not use this when there is still a transaction queued that hasn't been finalized using `spi_slave_get_trans_result`.

**Parameters**

- **host** –SPI peripheral to that is acting as a slave

- **trans\_desc** –Pointer to variable able to contain a pointer to the description of the transaction that is executed. Not const because we may want to write status back into the transaction description.
- **ticks\_to\_wait** –Ticks to wait until there's a returned item; use portMAX\_DELAY to never time out.

**Returns**

- ESP\_ERR\_INVALID\_ARG if parameter is invalid
- ESP\_OK on success

**Structures**

struct **spi\_slave\_interface\_config\_t**

This is a configuration for a SPI host acting as a slave device.

**Public Members**

int **spics\_io\_num**

CS GPIO pin for this device.

uint32\_t **flags**

Bitwise OR of SPI\_SLAVE\_\* flags.

int **queue\_size**

Transaction queue size. This sets how many transactions can be 'in the air' (queued using spi\_slave\_queue\_trans but not yet finished using spi\_slave\_get\_trans\_result) at the same time.

uint8\_t **mode**

SPI mode, representing a pair of (CPOL, CPHA) configuration:

- 0: (0, 0)
- 1: (0, 1)
- 2: (1, 0)
- 3: (1, 1)

[\*slave\\_transaction\\_cb\\_t post\\_setup\\_cb\*](#)

Callback called after the SPI registers are loaded with new data.

This callback is called within interrupt context should be in IRAM for best performance, see “Transferring Speed” section in the SPI Master documentation for full details. If not, the callback may crash during flash operation when the driver is initialized with ESP\_INTR\_FLAG\_IRAM.

[\*slave\\_transaction\\_cb\\_t post\\_trans\\_cb\*](#)

Callback called after a transaction is done.

This callback is called within interrupt context should be in IRAM for best performance, see “Transferring Speed” section in the SPI Master documentation for full details. If not, the callback may crash during flash operation when the driver is initialized with ESP\_INTR\_FLAG\_IRAM.

struct **spi\_slave\_transaction\_t**

This structure describes one SPI transaction

**Public Members**

size\_t **length**

Total data length, in bits.

size\_t **trans\_len**

Transaction data length, in bits.

const void \***tx\_buffer**

Pointer to transmit buffer, or NULL for no MOSI phase.

void \***rx\_buffer**

Pointer to receive buffer, or NULL for no MISO phase. When the DMA is enabled, must start at WORD boundary (`rx_buffer%4==0`), and has length of a multiple of 4 bytes.

void \***user**

User-defined variable. Can be used to store eg transaction ID.

## Macros

**SPI\_SLAVE\_TXBIT\_LSBFIRST**

Transmit command/address/data LSB first instead of the default MSB first.

**SPI\_SLAVE\_RXBIT\_LSBFIRST**

Receive data LSB first instead of the default MSB first.

**SPI\_SLAVE\_BIT\_LSBFIRST**

Transmit and receive LSB first.

## Type Definitions

```
typedef struct spi_slave_transaction_t spi_slave_transaction_t
```

```
typedef void (*slave_transaction_cb_t)(spi_slave_transaction_t *trans)
```

### 2.5.21 SPI Slave Half Duplex

#### Introduction

The Half Duplex (HD) Mode is a special mode provided by ESP SPI Slave peripheral. Under this mode, the hardware provides more services than the Full Duplex (FD) Mode (the mode for general-purpose SPI transactions, see *SPI Slave Driver*). These services reduce the CPU load and the response time of SPI Slave. However, it is important to note that the communication format is determined by the hardware and is always in a half-duplex configuration, allowing only one-way data transfer at any given time. Hence, the mode is named Half Duplex Mode due to this characteristic.

When conducting an SPI transaction, transactions can be classified into several types based on the **command** phase of the transaction. Each transaction may consist of the following phases: command, address, dummy, and data. The command phase is mandatory, while the other phases may be determined by the command field. During the command, address, and dummy phases, the bus is always controlled by the master (usually the host), while the direction of the data phase depends on the command. The data phase can be either an input phase, where the master writes data to the slave (e.g., the host sends data to the slave), or an output phase, where the master reads data from the slave (e.g., the host receives data from the slave).

About the details of how master should communicate with the SPI Slave, see *ESP SPI Slave HD (Half Duplex) Mode Protocol*.

Through these different transactions, the slave provides these services to the master:

- A DMA channel for the master to write a great amount of data to the slave.
- A DMA channel for the master to read a great amount of data from the slave.
- Several general purpose registers, shared between the master and the slave.
- Several general purpose interrupts, for the master to interrupt the SW of the slave.

### Terminology

- Transaction
- Channel
- Sending
- Receiving
- Data Descriptor

### Driver Feature

- Transaction read/write by master in segments
- Queues for data to send and received

### Driver Usage

**Slave Initialization** Call `spi_slave_hd_init()` to initialize the SPI bus as well as the peripheral and the driver. The SPI Slave exclusively uses the SPI peripheral, pins of the bus before it is deinitialized, which means other devices are unable to use the above resources during initialization. Thus, to ensure SPI resources are correctly occupied and the connections work properly, most configurations of the slave should be done as soon as the slave is initialized.

The `spi_bus_config_t` specifies how the bus should be initialized, while `spi_slave_hd_slot_config_t` specifies how the SPI Slave driver should work.

**Deinitialization (Optional)** Call `spi_slave_hd_deinit()` to uninstall the driver. The resources, including the pins, SPI peripheral, internal memory used by the driver, and interrupt sources, are released by the `deinit()` function.

**Send/Receive Data by DMA Channels** To send data to the master through the sending DMA channel, the application should properly wrap the data in an `spi_slave_hd_data_t` descriptor structure before calling `spi_slave_hd_queue_trans()` with the data descriptor and the channel argument of `SPI_SLAVE_CHAN_TX`. The pointers to descriptors are stored in the queue, and the data is sent to the master in the same order they are enqueued using `spi_slave_hd_queue_trans()`, upon receiving the master's `Rd_DMA` command.

The application should check the result of data sending by calling `spi_slave_hd_get_trans_res()` with the channel set as `SPI_SLAVE_CHAN_TX`. This function blocks until the transaction with the command `Rd_DMA` from the master successfully completes (or timeout). The `out_trans` argument of the function outputs the pointer of the data descriptor which is just finished, providing information about the sending.

Receiving data from the master through the receiving DMA channel is quite similar. The application calls `spi_slave_hd_queue_trans()` with proper data descriptor and the channel argument of `SPI_SLAVE_CHAN_RX`. And the application calls the `spi_slave_hd_get_trans_res()` later to get the descriptor to the receiving buffer before it handles the data in the receiving buffer.

---

**Note:** This driver itself does not have an internal buffer for the data to send or just received. The application should provide data buffer for driver via data descriptors to send to the master, or to receive data from the master.

The application has to properly keep the data descriptor as well as the buffer it points, after the descriptor is successfully sent into the driver internal queue by `spi_slave_hd_queue_trans()`, and before returned by `spi_slave_hd_get_trans_res()`. During this period, the hardware as well as the driver may read or write to the buffer and the descriptor when required at any time.

---

Please note that, when using this driver for data transfer, the buffer does not have to be fully sent or filled before it is terminated. For example, in the segment transaction mode, the master has to send CMD7 to terminate a `Wr_DMA` transaction or send CMD8 to terminate an `Rd_DMA` transaction (in segments), no matter whether the send (receive) buffer is used up (full) or not.

**Using Data Descriptor with Customized User Arguments** Sometimes you may have initiator (sending data descriptor) and closure (handling returned descriptors) functions in different places. When you get the returned data descriptor in the closure, you may need some extra information when handling the finished data descriptor. For example, you may want to know which round it is for the returned descriptor when you send the same piece of data several times.

Set the `arg` member in the data descriptor to a variable indicating the transaction by force casting, or point it to a structure that wraps all the information you may need when handling the sending/receiving data. Then you can get what you need in your closure.

---

### Using Callbacks

**Note:** These callbacks are called in the ISR, so the required operations need to be processed quickly and returned as soon as possible to ensure that the system is functioning properly. You may need to be very careful to write the code in the ISR.

Since the interrupt handling is executed concurrently with the application, long delays or blocking may cause the system to respond slower or lead to unpredictable behavior. Therefore, when writing callback functions, avoid using operations that may cause delays or blocking, e.g., waiting, sleeping, resource locking, etc.

---

The `spi_slave_hd_callback_config_t` member in the `spi_slave_hd_slot_config_t` configuration structure passed when initializing the SPI Slave HD driver, allows you to have callbacks for each event you may concern.

The corresponding interrupt for each callback that is not `NULL` is enabled, so that the callbacks can be called immediately when the events happen. You do not need to provide callbacks for the unconcerned events.

The `arg` member in the configuration structure can help you pass some context to the callback or indicate the specific SPI Slave instance when using the same callbacks for multiple SPI Slave peripherals. You can set the `arg` member to a variable that indicates the SPI Slave instance by performing a forced type casting or point it to a context structure. All the callbacks are called with this `arg` argument you set when the callbacks are initialized.

There are two other arguments: the `event` and the `awoken`.

- The `event` passes the information of the current event to the callback. The `spi_slave_hd_event_t` type contains the information of the event, for example, event type, the data descriptor just finished (The `data argument` is very useful in this case!).
- The `awoken` argument serves as an output parameter. It informs the ISR that tasks have been awakened after the callback function, and the ISR should call `portYIELD_FROM_ISR()` to schedule these tasks. Simply pass the `awoken` argument to all FreeRTOS APIs that may unblock tasks, and the value of `awoken` will be returned to the ISR.

**Writing/Reading Shared Registers** Call `spi_slave_hd_write_buffer()` to write the shared buffer, and `spi_slave_hd_read_buffer()` to read the shared buffer.

---

**Note:** On ESP32-S2, the shared registers are read/written in words by the application but read/written in bytes by the master. There is no guarantee four continuous bytes read from the master are from the same word written by the slave's application. It is also possible that if the slave reads a word while the master is writing bytes of the word, the slave may get one word with half of them just written by the master, and the other half has not been written into.

The master can confirm that the word is not in transition by reading the word twice and comparing the values.

For the slave, it is more difficult to ensure the word is not in transition because the process of master writing four bytes can be very long (32 SPI clocks). You can put some CRC in the last (largest address) byte of a word so that when the byte is written, the word is sure to be all written.

Due to the conflicts that may be among read/write from SW (worse if there are multi-cores) and master, it is suggested that a word is only used in one direction (only written by the master or only written by the slave).

---

**Receiving General Purpose Interrupts from the Master** When the master sends CMD8, CMD9 or CMDA, the slave corresponding is triggered. Currently the CMD8 is permanently used to indicate the termination of Rd\_DMA segments. To receive general-purpose interrupts, register callbacks for CMD9 and CMDA when the slave is initialized, see [Using Callbacks](#).

### Application Example

The code example for Device/Host communication can be found in the [peripherals/spi\\_slave\\_hd](#) directory of ESP-IDF examples.

### API Reference

#### Header File

- [components/driver/include/driver/spi\\_slave\\_hd.h](#)

#### Functions

`esp_err_t spi_slave_hd_init` (*spi\_host\_device\_t* host\_id, const *spi\_bus\_config\_t* \*bus\_config, const *spi\_slave\_hd\_slot\_config\_t* \*config)

Initialize the SPI Slave HD driver.

##### Parameters

- **host\_id** –The host to use
- **bus\_config** –Bus configuration for the bus used
- **config** –Configuration for the SPI Slave HD driver

##### Returns

- ESP\_OK: on success
- ESP\_ERR\_INVALID\_ARG: invalid argument given
- ESP\_ERR\_INVALID\_STATE: function called in invalid state, may be some resources are already in use
- ESP\_ERR\_NOT\_FOUND if there is no available DMA channel
- ESP\_ERR\_NO\_MEM: memory allocation failed
- or other return value from `esp_intr_alloc`

`esp_err_t spi_slave_hd_deinit` (*spi\_host\_device\_t* host\_id)

Deinitialize the SPI Slave HD driver.

**Parameters** **host\_id** –The host to deinitialize the driver

##### Returns

- ESP\_OK: on success
- ESP\_ERR\_INVALID\_ARG: if the host\_id is not correct

`esp_err_t spi_slave_hd_queue_trans` (*spi\_host\_device\_t* host\_id, *spi\_slave\_chan\_t* chan, *spi\_slave\_hd\_data\_t* \*trans, TickType\_t timeout)

Queue transactions (segment mode)

##### Parameters

- **host\_id** –Host to queue the transaction
- **chan** –SPI\_SLAVE\_CHAN\_TX or SPI\_SLAVE\_CHAN\_RX

- **trans** –Transaction descriptors
- **timeout** –Timeout before the data is queued

**Returns**

- ESP\_OK: on success
- ESP\_ERR\_INVALID\_ARG: The input argument is invalid. Can be the following reason:
  - The buffer given is not DMA capable
  - The length of data is invalid (not larger than 0, or exceed the max transfer length)
  - The transaction direction is invalid
- ESP\_ERR\_TIMEOUT: Cannot queue the data before timeout. Master is still processing previous transaction.
- ESP\_ERR\_INVALID\_STATE: Function called in invalid state. This API should be called under segment mode.

*esp\_err\_t* **spi\_slave\_hd\_get\_trans\_res** (*spi\_host\_device\_t* host\_id, *spi\_slave\_chan\_t* chan, *spi\_slave\_hd\_data\_t* \*\*out\_trans, TickType\_t timeout)

Get the result of a data transaction (segment mode)

---

**Note:** This API should be called successfully the same times as the `spi_slave_hd_queue_trans`.

---

**Parameters**

- **host\_id** –Host to queue the transaction
- **chan** –Channel to get the result, SPI\_SLAVE\_CHAN\_TX or SPI\_SLAVE\_CHAN\_RX
- **out\_trans** –[out] Pointer to the transaction descriptor (*spi\_slave\_hd\_data\_t*) passed to the driver before. Hardware has finished this transaction. Member `trans_len` indicates the actual number of bytes of received data, it' s meaningless for TX.
- **timeout** –Timeout before the result is got

**Returns**

- ESP\_OK: on success
- ESP\_ERR\_INVALID\_ARG: Function is not valid
- ESP\_ERR\_TIMEOUT: There' s no transaction done before timeout
- ESP\_ERR\_INVALID\_STATE: Function called in invalid state. This API should be called under segment mode.

void **spi\_slave\_hd\_read\_buffer** (*spi\_host\_device\_t* host\_id, int addr, uint8\_t \*out\_data, size\_t len)

Read the shared registers.

**Parameters**

- **host\_id** –Host to read the shared registers
- **addr** –Address of register to read, 0 to SOC\_SPI\_MAXIMUM\_BUFFER\_SIZE-1
- **out\_data** –[out] Output buffer to store the read data
- **len** –Length to read, not larger than SOC\_SPI\_MAXIMUM\_BUFFER\_SIZE-addr

void **spi\_slave\_hd\_write\_buffer** (*spi\_host\_device\_t* host\_id, int addr, uint8\_t \*data, size\_t len)

Write the shared registers.

**Parameters**

- **host\_id** –Host to write the shared registers
- **addr** –Address of register to write, 0 to SOC\_SPI\_MAXIMUM\_BUFFER\_SIZE-1
- **data** –Buffer holding the data to write
- **len** –Length to write, SOC\_SPI\_MAXIMUM\_BUFFER\_SIZE-addr

*esp\_err\_t* **spi\_slave\_hd\_append\_trans** (*spi\_host\_device\_t* host\_id, *spi\_slave\_chan\_t* chan, *spi\_slave\_hd\_data\_t* \*trans, TickType\_t timeout)

Load transactions (append mode)

---

**Note:** In this mode, user transaction descriptors will be appended to the DMA and the DMA will keep processing the data without stopping

---



**Parameters**

- **host\_id** –Host to load transactions
- **chan** –SPI\_SLAVE\_CHAN\_TX or SPI\_SLAVE\_CHAN\_RX
- **trans** –Transaction descriptor
- **timeout** –Timeout before the transaction is loaded

**Returns**

- ESP\_OK: on success
- ESP\_ERR\_INVALID\_ARG: The input argument is invalid. Can be the following reason:
  - The buffer given is not DMA capable
  - The length of data is invalid (not larger than 0, or exceed the max transfer length)
  - The transaction direction is invalid
- ESP\_ERR\_TIMEOUT: Master is still processing previous transaction. There is no available transaction for slave to load
- ESP\_ERR\_INVALID\_STATE: Function called in invalid state. This API should be called under append mode.

*esp\_err\_t* **spi\_slave\_hd\_get\_append\_trans\_res** (*spi\_host\_device\_t* host\_id, *spi\_slave\_chan\_t* chan, *spi\_slave\_hd\_data\_t* \*\*out\_trans, TickType\_t timeout)

Get the result of a data transaction (append mode)

---

**Note:** This API should be called the same times as the `spi_slave_hd_append_trans`

---

**Parameters**

- **host\_id** –Host to load the transaction
- **chan** –SPI\_SLAVE\_CHAN\_TX or SPI\_SLAVE\_CHAN\_RX
- **out\_trans** –[out] Pointer to the transaction descriptor (*spi\_slave\_hd\_data\_t*) passed to the driver before. Hardware has finished this transaction. Member `trans_len` indicates the actual number of bytes of received data, it's meaningless for TX.
- **timeout** –Timeout before the result is got

**Returns**

- ESP\_OK: on success
- ESP\_ERR\_INVALID\_ARG: Function is not valid
- ESP\_ERR\_TIMEOUT: There's no transaction done before timeout
- ESP\_ERR\_INVALID\_STATE: Function called in invalid state. This API should be called under append mode.

**Structures**

struct **spi\_slave\_hd\_data\_t**

Descriptor of data to send/receive.

**Public Members**

uint8\_t \***data**

Buffer to send, must be DMA capable.

size\_t **len**

Len of data to send/receive. For receiving the buffer length should be multiples of 4 bytes, otherwise the extra part will be truncated.

size\_t **trans\_len**

For RX direction, it indicates the data actually received. For TX direction, it is meaningless.

void **\*arg**

Extra argument indicating this data.

struct **spi\_slave\_hd\_event\_t**

Information of SPI Slave HD event.

### Public Members

*spi\_event\_t* **event**

Event type.

*spi\_slave\_hd\_data\_t* **\*trans**

Corresponding transaction for SPI\_EV\_SEND and SPI\_EV\_RECV events.

struct **spi\_slave\_hd\_callback\_config\_t**

Callback configuration structure for SPI Slave HD.

### Public Members

*slave\_cb\_t* **cb\_buffer\_tx**

Callback when master reads from shared buffer.

*slave\_cb\_t* **cb\_buffer\_rx**

Callback when master writes to shared buffer.

*slave\_cb\_t* **cb\_send\_dma\_ready**

Callback when TX data buffer is loaded to the hardware (DMA)

*slave\_cb\_t* **cb\_sent**

Callback when data are sent.

*slave\_cb\_t* **cb\_recv\_dma\_ready**

Callback when RX data buffer is loaded to the hardware (DMA)

*slave\_cb\_t* **cb\_recv**

Callback when data are received.

*slave\_cb\_t* **cb\_cmd9**

Callback when CMD9 received.

*slave\_cb\_t* **cb\_cmdA**

Callback when CMDA received.

void **\*arg**

Argument indicating this SPI Slave HD peripheral instance.

struct **spi\_slave\_hd\_slot\_config\_t**

Configuration structure for the SPI Slave HD driver.

## Public Members

### `uint8_t mode`

SPI mode, representing a pair of (CPOL, CPHA) configuration:

- 0: (0, 0)
- 1: (0, 1)
- 2: (1, 0)
- 3: (1, 1)

### `uint32_t spics_io_num`

CS GPIO pin for this device.

### `uint32_t flags`

Bitwise OR of `SPI_SLAVE_HD_*` flags.

### `uint32_t command_bits`

command field bits, multiples of 8 and at least 8.

### `uint32_t address_bits`

address field bits, multiples of 8 and at least 8.

### `uint32_t dummy_bits`

dummy field bits, multiples of 8 and at least 8.

### `uint32_t queue_size`

Transaction queue size. This sets how many transactions can be ‘in the air’ (queued using `spi_slave_hd_queue_trans` but not yet finished using `spi_slave_hd_get_trans_result`) at the same time.

### `spi_dma_chan_t dma_chan`

DMA channel to used.

### `spi_slave_hd_callback_config_t cb_config`

Callback configuration.

## Macros

### `SPI_SLAVE_HD_TXBIT_LSBFIRST`

Transmit command/address/data LSB first instead of the default MSB first.

### `SPI_SLAVE_HD_RXBIT_LSBFIRST`

Receive data LSB first instead of the default MSB first.

### `SPI_SLAVE_HD_BIT_LSBFIRST`

Transmit and receive LSB first.

### `SPI_SLAVE_HD_APPEND_MODE`

Adopt DMA append mode for transactions. In this mode, users can load(append) DMA descriptors without stopping the DMA.

## Type Definitions

```
typedef bool (*slave_cb_t)(void *arg, spi_slave_hd_event_t *event, BaseType_t *awoken)
```

Callback for SPI Slave HD.

## Enumerations

```
enum spi_slave_chan_t
```

Channel of SPI Slave HD to do data transaction.

*Values:*

```
enumerator SPI_SLAVE_CHAN_TX
```

The output channel (RDDMA)

```
enumerator SPI_SLAVE_CHAN_RX
```

The input channel (WRDMA)

## 2.5.22 Temperature Sensor

### Introduction

The ESP32-S2 has a built-in sensor used to measure the chip's internal temperature. The temperature sensor module contains an 8-bit Sigma-Delta ADC and a DAC to compensate for the temperature offset.

Due to restrictions of hardware, the sensor has predefined measurement ranges with specific measurement errors. See the table below for details.

predefined range (°C)	error (°C)
50 ~ 125	< 3
20 ~ 100	< 2
-10 ~ 80	< 1
-30 ~ 50	< 2
-40 ~ 20	< 3

---

**Note:** The temperature sensor is designed primarily to measure the temperature changes inside the chip. The temperature value depends on factors like microcontroller clock frequency or I/O load. Generally, the chip's internal temperature might be higher than the ambient temperature.

---

### Functional Overview

- [Resource Allocation](#) - covers which parameters should be set up to get a temperature sensor handle and how to recycle the resources when temperature sensor finishes working.
- [Enable and Disable Temperature Sensor](#) - covers how to enable and disable the temperature sensor.
- [Get Temperature Value](#) - covers how to get the real-time temperature value.
- [Power Management](#) - covers how temperature sensor is affected when changing power mode (i.e. light sleep).
- [Thread Safety](#) - covers how to make the driver to be thread safe.

**Resource Allocation** The ESP32-S2 has just one built-in temperature sensor hardware. The temperature sensor instance is represented by `temperature_sensor_handle_t`, which is also the bond of the context. It would always be the parameter of the temperature APIs with the information of hardware and configurations, so user can just create a pointer of type `temperature_sensor_handle_t` and passing to APIs as needed.

In order to install a built-in temperature sensor instance, the first thing is to evaluate the temperature range in your detection environment (For example: if the testing environment is in a room, the range you evaluate might be 10 °C ~ 30 °C; if the testing in a lamp bulb, the range you evaluate might be 60 °C ~ 110 °C). Based on that, the following configuration structure should be defined in advance: `temperature_sensor_config_t`:

- `range_min`. The minimum value of testing range you have evaluated.
- `range_max`. The maximum value of testing range you have evaluated.

After the ranges are set, the structure could be passed to `temperature_sensor_install()`, which will instantiate the temperature sensor instance and return a handle.

As mentioned above, different measure ranges have different measurement errors. The user doesn't need to care about the measurement error because we have an internal mechanism to choose the minimum error according to the given range.

If the temperature sensor is no longer needed, you need to call `temperature_sensor_uninstall()` to free the temperature sensor resource.

### Creating a Temperature Sensor Handle

- Step1: Evaluate the testing range. In this example, the range is 20 °C ~ 50 °C.
- Step2: Configure the range and obtain a handle

```
temperature_sensor_handle_t temp_handle = NULL;
temperature_sensor_config_t temp_sensor = {
    .range_min = 20,
    .range_max = 50,
};
ESP_ERROR_CHECK(temperature_sensor_install(&temp_sensor, &temp_handle));
```

### Enable and Disable Temperature Sensor

1. Enable the temperature sensor by calling `temperature_sensor_enable()`. The internal temperature sensor circuit will start to work. The driver state will transit from init to enable.
2. To Disable the temperature sensor, please call `temperature_sensor_disable()`.

**Get Temperature Value** After the temperature sensor is enabled by `temperature_sensor_enable()`, user can get the current temperature by calling `temperature_sensor_get_celsius()`.

```
// Enable temperature sensor
ESP_ERROR_CHECK(temperature_sensor_enable(temp_handle));
// Get converted sensor data
float tsens_out;
ESP_ERROR_CHECK(temperature_sensor_get_celsius(temp_handle, &tsens_out));
printf("Temperature in %f °C\n", tsens_out);
// Disable the temperature sensor if it's not needed and save the power
ESP_ERROR_CHECK(temperature_sensor_disable(temp_handle));
```

**Power Management** When power management is enabled (i.e. `CONFIG_PM_ENABLE` is on), temperature sensor will still keep working because it uses XTAL clock (on ESP32-C3) or RTC clock (on ESP32-S2/S3).

**Thread Safety** In temperature sensor we don't add any protection to keep the thread safe. Because from the common usage, temperature sensor should only be called in one task. If you must use this driver in different tasks, please add extra locks to protect it.

## Unexpected Behaviors

1. The value user gets from the chip is usually different from the ambient temperature. It is because the temperature sensor is built inside the chip. To some extent, it measures the temperature of the chip.
2. When installing the temperature sensor, the driver gives a ‘the boundary you gave cannot meet the range of internal temperature sensor’ error feedback. It is because the built-in temperature sensor has testing limit. The error due to setting `temperature_sensor_config_t`:
  - (1) Totally out of range, like 200 °C ~ 300 °C.
  - (2) Cross the boundary of each predefined measurement. like 40 °C ~ 110 °C.

## Application Example

- Temperature sensor reading example: [peripherals/temp\\_sensor](#).

## API Reference

### Header File

- [components/driver/include/driver/temperature\\_sensor.h](#)

### Functions

`esp_err_t temperature_sensor_install` (const `temperature_sensor_config_t` \*tsens\_config, `temperature_sensor_handle_t` \*ret\_tsens)

Install temperature sensor driver.

#### Parameters

- `tsens_config` –Pointer to config structure.
- `ret_tsens` –Return the pointer of temperature sensor handle.

#### Returns

- ESP\_OK if succeed

`esp_err_t temperature_sensor_uninstall` (`temperature_sensor_handle_t` tsens)

Uninstall the temperature sensor driver.

**Parameters** `tsens` –The handle created by `temperature_sensor_install()`.

#### Returns

- ESP\_OK if succeed.

`esp_err_t temperature_sensor_enable` (`temperature_sensor_handle_t` tsens)

Enable the temperature sensor.

**Parameters** `tsens` –The handle created by `temperature_sensor_install()`.

#### Returns

- ESP\_OK Success
- ESP\_ERR\_INVALID\_STATE if temperature sensor is enabled already.

`esp_err_t temperature_sensor_disable` (`temperature_sensor_handle_t` tsens)

Disable temperature sensor.

**Parameters** `tsens` –The handle created by `temperature_sensor_install()`.

#### Returns

- ESP\_OK Success
- ESP\_ERR\_INVALID\_STATE if temperature sensor is not enabled yet.

`esp_err_t temperature_sensor_get_celsius` (`temperature_sensor_handle_t` tsens, float \*out\_celsius)

Read temperature sensor data that is converted to degrees Celsius.

---

**Note:** Should not be called from interrupt.

---

**Parameters**

- **tsens** –The handle created by `temperature_sensor_install()`.
- **out\_celsius** –The measure output value.

**Returns**

- ESP\_OK Success
- ESP\_ERR\_INVALID\_ARG invalid arguments
- ESP\_ERR\_INVALID\_STATE Temperature sensor is not enabled yet.
- ESP\_FAIL Parse the sensor data into ambient temperature failed (e.g. out of the range).

**Structures**

```
struct temperature_sensor_config_t
```

Configuration of measurement range for the temperature sensor.

---

**Note:** If you see the log the boundary you gave cannot meet the range of internal temperature sensor. You may need to refer to predefined range listed `doc/api-reference/peripherals/Temperature sensor`.

---

**Public Members**

```
int range_min
```

the minimum value of the temperature you want to test

```
int range_max
```

the maximum value of the temperature you want to test

```
temperature_sensor_clk_src_t clk_src
```

the clock source of the temperature sensor.

**Macros**

```
TEMPERATURE_SENSOR_CONFIG_DEFAULT (min, max)
```

*temperature\_sensor\_config\_t* default constructure

**Type Definitions**

```
typedef struct temperature_sensor_obj_t *temperature_sensor_handle_t
```

Type of temperature sensor driver handle.

## 2.5.23 Touch Sensor

**Introduction**

A touch sensor system is built on a substrate which carries electrodes and relevant connections under a protective flat surface. When a user touches the surface, the capacitance variation is used to evaluate if the touch was valid.

Touch sensor on ESP32-S2 can support up to 14 capacitive touch pads / GPIOs.

The sensing pads can be arranged in different combinations (e.g., matrix, slider), so that a larger area or more points can be detected. The touch pad sensing process is under the control of a hardware-implemented finite-state machine (FSM) which is initiated by software or a dedicated hardware timer.

For design, operation, and control registers of a touch sensor, see *ESP32-S2 Technical Reference Manual > On-Chip Sensors and Analog Signal Processing* [PDF].

In-depth design details of touch sensors and firmware development guidelines for ESP32-S2 are available in [Touch Sensor Application Note](#).

## Functionality Overview

Description of API is broken down into groups of functions to provide a quick overview of the following features:

- Initialization of touch pad driver
- Configuration of touch pad GPIO pins
- Taking measurements
- Adjusting parameters of measurements
- Filtering measurements
- Touch detection methods
- Setting up interrupts to report touch detection
- Waking up from Sleep mode on interrupt

For detailed description of a particular function, please go to Section [API Reference](#). Practical implementation of this API is covered in Section [Application Examples](#).

**Initialization** Before using a touch pad, you need to initialize the touch pad driver by calling the function `touch_pad_init()`. This function sets several `._DEFAULT` driver parameters listed in [API Reference](#) under *Macros*. It also removes the information about which pads have been touched before, if any, and disables interrupts.

If the driver is not required anymore, deinitialize it by calling `touch_pad_deinit()`.

**Configuration** Enabling the touch sensor functionality for a particular GPIO is done with `touch_pad_config()`.

Use the function `touch_pad_set_fsm_mode()` to select if touch pad measurement (operated by FSM) should be started automatically by a hardware timer, or by software. If software mode is selected, use `touch_pad_sw_start()` to start the FSM.

**Touch State Measurements** The following function come in handy to read raw measurements from the sensor:

- `touch_pad_read_raw_data()`

It can also be used, for example, to evaluate a particular touch pad design by checking the range of sensor readings when a pad is touched or released. This information can be then used to establish a touch threshold.

For the demonstration of how to read the touch pad data, check the application example [peripherals/touch\\_sensor/touch\\_sensor\\_v2/touch\\_pad\\_read](#).

**Method of Measurements** The touch sensor will record the period of time (i.e. the number of clock cycles) over a fixed charge/discharge cycles (specified by `touch_pad_set_charge_discharge_times()`). The count result is the raw data that read from `touch_pad_read_raw_data()`. After finishing one measurement, the touch sensor will sleep until the next measurement start, this interval between two measurements can be set by `touch_pad_set_measurement_interval()`.

---

**Note:** If the specified charge and discharge cycles for measurement is too small, the result may be inaccurate, but increasing charge and discharge cycles will increase the power consumption as well. Additionally, the response of the touch sensor will slow down if the total time of the interval and measurement is too long.

---



**Optimization of Measurements** A touch sensor has several configurable parameters to match the characteristics of a particular touch pad design. For instance, to sense smaller capacity changes, it is possible to narrow down the reference voltage range within which the touch pads are charged / discharged. The high and low reference voltages are set using the function `touch_pad_set_voltage()`.

Besides the ability to discern smaller capacity changes, a positive side effect is reduction of power consumption for low power applications. A likely negative effect is an increase in measurement noise. If the dynamic range of obtained readings is still satisfactory, then further reduction of power consumption might be done by reducing the measurement time with `touch_pad_set_charge_discharge_times()`.

The following list summarizes available measurement parameters and corresponding ‘set’ functions:

- Touch pad charge / discharge parameters:
  - voltage range: `touch_pad_set_voltage()`
  - speed (slope): `touch_pad_set_cnt_mode()`
- Charge and discharge times of one measurement: `touch_pad_set_charge_discharge_times()`

Relationship between the voltage range (high / low reference voltages), speed (slope), and measurement time is shown in the figure below.

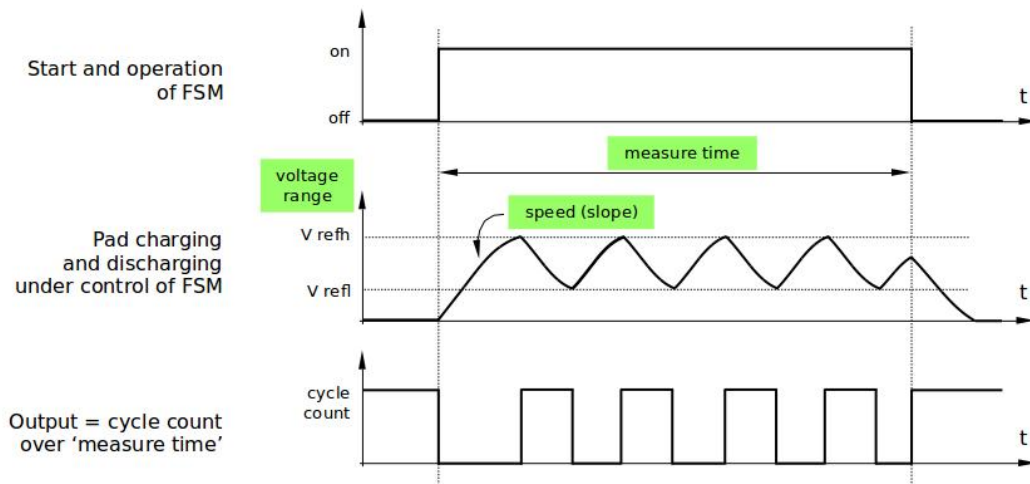

Fig. 16: Touch pad - relationship between measurement parameters

The last chart *Output* represents the touch sensor reading, i.e., the count of pulses collected within the measurement time.

All functions are provided in pairs to *set* a specific parameter and to *get* the current parameter's value, e.g., `touch_pad_set_voltage()` and `touch_pad_get_voltage()`.

**Filtering of Measurements** If measurements are noisy, you can filter them with provided API functions. The ESP32-S2's touch functionality provide two sets of APIs for doing this.

There is an internal touch channel that is not connected to any external GPIO. The measurements from this denoise pad can be used to filter out interference introduced on all channels, such as noise introduced by the power supply and external EMI. The denoise parameters are set with the function `touch_pad_denoise_set_config()` and started by with `touch_pad_denoise_enable()`

There is also a configurable hardware implemented IIR-filter (infinite impulse response). This IIR-filter is configured with the function `touch_pad_filter_set_config()` and enabled by calling `touch_pad_filter_enable()`

**Touch Detection** Touch detection is implemented in ESP32's hardware based on the user-configured threshold and raw measurements executed by FSM. Use the functions `touch_pad_get_status()` to check which pads have been touched and `touch_pad_clear_status()` to clear the touch status information.

Hardware touch detection can also be wired to interrupts. This is described in the next section.

If measurements are noisy and capacity changes are small, hardware touch detection might be unreliable. To resolve this issue, instead of using hardware detection / provided interrupts, implement measurement filtering and perform touch detection in your own application. For sample implementation of both methods of touch detection, see [peripherals/touch\\_sensor/touch\\_sensor\\_v2/touch\\_pad\\_interrupt](#).

**Touch Triggered Interrupts** Before enabling an interrupt on a touch detection, you should establish a touch detection threshold. Use the functions described in *Touch State Measurements* to read and display sensor measurements when a pad is touched and released. Apply a filter if measurements are noisy and relative capacity changes are small. Depending on your application and environment conditions, test the influence of temperature and power supply voltage changes on measured values.

Once a detection threshold is established, it can be set during initialization with `touch_pad_config()` or at the runtime with `touch_pad_set_thresh()`.

Finally, configure and manage interrupt calls using the following functions:

- `touch_pad_isr_register()` / `touch_pad_isr_deregister()`
- `touch_pad_intr_enable()` / `touch_pad_intr_disable()`

When interrupts are operational, you can obtain the information from which particular pad an interrupt came by invoking `touch_pad_get_status()` and clear the pad status with `touch_pad_clear_status()`.

## Application Examples

- Touch sensor read example: [peripherals/touch\\_sensor/touch\\_sensor\\_v2/touch\\_pad\\_read](#).
- Touch sensor interrupt example: [peripherals/touch\\_sensor/touch\\_sensor\\_v2/touch\\_pad\\_interrupt](#).

## API Reference

### Header File

- `components/driver/esp32s2/include/driver/touch_sensor.h`

### Functions

`esp_err_t touch_pad_fsm_start` (void)

Set touch sensor FSM start.

---

**Note:** Start FSM after the touch sensor FSM mode is set.

---

---

**Note:** Call this function will reset benchmark of all touch channels.

---

#### Returns

- ESP\_OK on success

`esp_err_t touch_pad_fsm_stop` (void)

Stop touch sensor FSM.

#### Returns

- ESP\_OK on success

*esp\_err\_t* **touch\_pad\_sw\_start** (void)

Trigger a touch sensor measurement, only support in SW mode of FSM.

**Returns**

- ESP\_OK on success

*esp\_err\_t* **touch\_pad\_set\_charge\_discharge\_times** (uint16\_t charge\_discharge\_times)

Set charge and discharge times of each measurement.

---

**Note:** This function will specify the charge and discharge times in each measurement period. The clock is sourced from SOC\_MOD\_CLK\_RTC\_FAST, and its default frequency is SOC\_CLK\_RC\_FAST\_FREQ\_APPROX. The touch sensor will record the total clock cycles of all the charge and discharge cycles as the final result (raw value).

---

---

**Note:** If the charge and discharge times is too small, it may lead to inaccurate results.

---

**Parameters** **charge\_discharge\_times** –Charge and discharge times, range: 0 ~ 0xffff. No exact typical value can be recommended because the capacity is influenced by the hardware design and how finger touches, but suggest adjusting this value to make the measurement time around 1 ms.

**Returns**

- ESP\_OK Set charge and discharge times success

*esp\_err\_t* **touch\_pad\_get\_charge\_discharge\_times** (uint16\_t \*charge\_discharge\_times)

Get charge and discharge times of each measurement.

**Parameters** **charge\_discharge\_times** –Charge and discharge times

**Returns**

- ESP\_OK Get charge\_discharge\_times success
- ESP\_ERR\_INVALID\_ARG The input parameter is NULL

*esp\_err\_t* **touch\_pad\_set\_measurement\_interval** (uint16\_t interval\_cycle)

Set the interval between two measurements.

---

**Note:** The touch sensor will sleep between two measurements. This function is to set the interval cycle. And the interval is clocked from SOC\_MOD\_CLK\_RTC\_SLOW, its default frequency is SOC\_CLK\_RC\_SLOW\_FREQ\_APPROX.

---

**Parameters** **interval\_cycle** –The interval between two measurements  $sleep\_time = interval\_cycle / SOC\_CLK\_RC\_SLOW\_FREQ\_APPROX$ . The approximate frequency value of RTC\_SLOW\_CLK can be obtained using `rtc_clk_slow_freq_get_hz` function.

**Returns**

- ESP\_OK Set interval cycle success

*esp\_err\_t* **touch\_pad\_get\_measurement\_interval** (uint16\_t \*interval\_cycle)

Get the interval between two measurements.

**Parameters** **interval\_cycle** –The interval between two measurements

**Returns**

- ESP\_OK Get interval cycle success
- ESP\_ERR\_INVALID\_ARG The input parameter is NULL

*esp\_err\_t* **touch\_pad\_set\_meas\_time** (uint16\_t sleep\_cycle, uint16\_t meas\_times)

Set touch sensor times of charge and discharge and sleep time. Excessive total time will slow down the touch response. Too small measurement time will not be sampled enough, resulting in inaccurate measurements.

---

**Note:** The touch sensor will measure time of a fixed number of charge/discharge cycles (specified as the second parameter). That means the time (raw value) will increase as the capacity of the touch pad is increasing. The time (raw value) here is the number of clock cycles which is sourced from SOC\_MOD\_CLK\_RTC\_FAST and at (SOC\_CLK\_RC\_FAST\_FREQ\_APPROX) Hz as default

---

---

**Note:** The greater the duty cycle of the measurement time, the more system power is consumed.

---

#### Parameters

- **sleep\_cycle** –The touch sensor will sleep after each measurement. `sleep_cycle` decide the interval between each measurement.  $t_{sleep} = sleep\_cycle / SOC\_CLK\_RC\_SLOW\_FREQ\_APPROX$ . The approximate frequency value of RTC\_SLOW\_CLK can be obtained using `rtc_clk_slow_freq_get_hz` function.
- **meas\_times** –The times of charge and discharge in each measurement of touch channels. Range: 0 ~ 0xffff. Recommended typical value: Modify this value to make the measurement time around 1 ms.

#### Returns

- ESP\_OK on success

*esp\_err\_t* **touch\_pad\_get\_meas\_time** (uint16\_t \*sleep\_cycle, uint16\_t \*meas\_times)

Get touch sensor times of charge and discharge and sleep time.

#### Parameters

- **sleep\_cycle** –Pointer to accept sleep cycle number
- **meas\_times** –Pointer to accept measurement times count.

#### Returns

- ESP\_OK on success

*esp\_err\_t* **touch\_pad\_set\_idle\_channel\_connect** (*touch\_pad\_conn\_type\_t* type)

Set the connection type of touch channels in idle status. When a channel is in measurement mode, other initialized channels are in idle mode. The touch channel is generally adjacent to the trace, so the connection state of the idle channel affects the stability and sensitivity of the test channel. The `CONN_HIGHZ`(high resistance) setting increases the sensitivity of touch channels. The `CONN_GND`(grounding) setting increases the stability of touch channels.

**Parameters** **type** –Select idle channel connect to high resistance state or ground.

#### Returns

- ESP\_OK on success

*esp\_err\_t* **touch\_pad\_get\_idle\_channel\_connect** (*touch\_pad\_conn\_type\_t* \*type)

Get the connection type of touch channels in idle status. When a channel is in measurement mode, other initialized channels are in idle mode. The touch channel is generally adjacent to the trace, so the connection state of the idle channel affects the stability and sensitivity of the test channel. The `CONN_HIGHZ`(high resistance) setting increases the sensitivity of touch channels. The `CONN_GND`(grounding) setting increases the stability of touch channels.

**Parameters** **type** –Pointer to connection type.

#### Returns

- ESP\_OK on success

*esp\_err\_t* **touch\_pad\_set\_thresh** (*touch\_pad\_t* touch\_num, uint32\_t threshold)

Set the trigger threshold of touch sensor. The threshold determines the sensitivity of the touch sensor. The threshold is the original value of the trigger state minus the benchmark value.

---

**Note:** If set “TOUCH\_PAD\_THRESHOLD\_MAX” , the touch is never be triggered.

---

**Parameters**

- **touch\_num** –touch pad index
- **threshold** –threshold of touch sensor. Should be less than the max change value of touch.

**Returns**

- ESP\_OK on success

*esp\_err\_t* **touch\_pad\_get\_thresh** (*touch\_pad\_t* touch\_num, uint32\_t \*threshold)

Get touch sensor trigger threshold.

**Parameters**

- **touch\_num** –touch pad index
- **threshold** –pointer to accept threshold

**Returns**

- ESP\_OK on success
- ESP\_ERR\_INVALID\_ARG if argument is wrong

*esp\_err\_t* **touch\_pad\_set\_channel\_mask** (uint16\_t enable\_mask)

Register touch channel into touch sensor scan group. The working mode of the touch sensor is cyclically scanned. This function will set the scan bits according to the given bitmask.

---

**Note:** If set this mask, the FSM timer should be stop firstly.

---

---

**Note:** The touch sensor that in scan map, should be deinit GPIO function firstly by `touch_pad_io_init`.

---

**Parameters** **enable\_mask** –bitmask of touch sensor scan group. e.g. TOUCH\_PAD\_NUM14  
-> BIT(14)

**Returns**

- ESP\_OK on success

*esp\_err\_t* **touch\_pad\_get\_channel\_mask** (uint16\_t \*enable\_mask)

Get the touch sensor scan group bit mask.

**Parameters** **enable\_mask** –Pointer to bitmask of touch sensor scan group. e.g.  
TOUCH\_PAD\_NUM14 -> BIT(14)

**Returns**

- ESP\_OK on success

*esp\_err\_t* **touch\_pad\_clear\_channel\_mask** (uint16\_t enable\_mask)

Clear touch channel from touch sensor scan group. The working mode of the touch sensor is cyclically scanned. This function will clear the scan bits according to the given bitmask.

---

**Note:** If clear all mask, the FSM timer should be stop firstly.

---

**Parameters** **enable\_mask** –bitmask of touch sensor scan group. e.g. TOUCH\_PAD\_NUM14  
-> BIT(14)

**Returns**

- ESP\_OK on success

*esp\_err\_t* **touch\_pad\_config** (*touch\_pad\_t* touch\_num)

Configure parameter for each touch channel.

---

**Note:** Touch num 0 is denoise channel, please use `touch_pad_denoise_enable` to set denoise function

---

**Parameters** `touch_num` –touch pad index

**Returns**

- ESP\_OK Success
- ESP\_ERR\_INVALID\_ARG if argument wrong
- ESP\_FAIL if touch pad not initialized

*esp\_err\_t* `touch_pad_reset` (void)

Reset the FSM of touch module.

---

**Note:** Call this function after `touch_pad_fsm_stop`.

---

**Returns**

- ESP\_OK Success

*touch\_pad\_t* `touch_pad_get_current_meas_channel` (void)

Get the current measure channel.

---

**Note:** Should be called when touch sensor measurement is in cyclic scan mode.

---

**Returns**

- touch channel number

*uint32\_t* `touch_pad_read_intr_status_mask` (void)

Get the touch sensor interrupt status mask.

**Returns**

- touch interrupt bit

*esp\_err\_t* `touch_pad_intr_enable` (*touch\_pad\_intr\_mask\_t* int\_mask)

Enable touch sensor interrupt by bitmask.

---

**Note:** This API can be called in ISR handler.

---

**Parameters** `int_mask` –Pad mask to enable interrupts

**Returns**

- ESP\_OK on success

*esp\_err\_t* `touch_pad_intr_disable` (*touch\_pad\_intr\_mask\_t* int\_mask)

Disable touch sensor interrupt by bitmask.

---

**Note:** This API can be called in ISR handler.

---

**Parameters** `int_mask` –Pad mask to disable interrupts

**Returns**

- ESP\_OK on success

*esp\_err\_t* `touch_pad_intr_clear` (*touch\_pad\_intr\_mask\_t* int\_mask)

Clear touch sensor interrupt by bitmask.

**Parameters** `int_mask` –Pad mask to clear interrupts

**Returns**

- ESP\_OK on success

*esp\_err\_t* **touch\_pad\_isr\_register** (*intr\_handler\_t* fn, void \*arg, *touch\_pad\_intr\_mask\_t* intr\_mask)

Register touch-pad ISR. The handler will be attached to the same CPU core that this function is running on.

**Parameters**

- **fn** –Pointer to ISR handler
- **arg** –Parameter for ISR
- **intr\_mask** –Enable touch sensor interrupt handler by bitmask.

**Returns**

- ESP\_OK Success
- ESP\_ERR\_INVALID\_ARG Arguments error
- ESP\_ERR\_NO\_MEM No memory

*esp\_err\_t* **touch\_pad\_timeout\_set** (bool enable, uint32\_t threshold)

Enable/disable the timeout check and set timeout threshold for all touch sensor channels measurements. If enable: When the touch reading of a touch channel exceeds the measurement threshold, a timeout interrupt will be generated. If disable: the FSM does not check if the channel under measurement times out.

---

**Note:** The threshold compared with touch readings.

---

---

**Note:** In order to avoid abnormal short circuit of some touch channels. This function should be turned on. Ensure the normal operation of other touch channels.

---

**Parameters**

- **enable** –true(default): Enable the timeout check; false: Disable the timeout check.
- **threshold** –For all channels, the maximum value that will not be exceeded during normal operation.

**Returns**

- ESP\_OK Success

*esp\_err\_t* **touch\_pad\_timeout\_resume** (void)

Call this interface after timeout to make the touch channel resume normal work. Point on the next channel to measure. If this API is not called, the touch FSM will stop the measurement after timeout interrupt.

---

**Note:** Call this API after finishes the exception handling by user.

---

**Returns**

- ESP\_OK Success

*esp\_err\_t* **touch\_pad\_read\_raw\_data** (*touch\_pad\_t* touch\_num, uint32\_t \*raw\_data)

get raw data of touch sensor.

---

**Note:** After the initialization is complete, the “raw\_data” is max value. You need to wait for a measurement cycle before you can read the correct touch value.

---

**Parameters**

- **touch\_num** –touch pad index
- **raw\_data** –pointer to accept touch sensor value

**Returns**

- ESP\_OK Success
- ESP\_FAIL Touch channel 0 haven't this parameter.

*esp\_err\_t* **touch\_pad\_read\_benchmark** (*touch\_pad\_t* touch\_num, uint32\_t \*benchmark)

get benchmark of touch sensor.

---

**Note:** After initialization, the benchmark value is the maximum during the first measurement period.

---

**Parameters**

- **touch\_num** –touch pad index
- **benchmark** –pointer to accept touch sensor benchmark value

**Returns**

- ESP\_OK Success
- ESP\_ERR\_INVALID\_ARG Touch channel 0 haven't this parameter.

*esp\_err\_t* **touch\_pad\_filter\_read\_smooth** (*touch\_pad\_t* touch\_num, uint32\_t \*smooth)

Get smoothed data that obtained by filtering the raw data.

**Parameters**

- **touch\_num** –touch pad index
- **smooth** –pointer to smoothed data

*esp\_err\_t* **touch\_pad\_reset\_benchmark** (*touch\_pad\_t* touch\_num)

Force reset benchmark to raw data of touch sensor.

**Parameters** **touch\_num** –touch pad index

- TOUCH\_PAD\_MAX Reset baseline of all channels

**Returns**

- ESP\_OK Success

*esp\_err\_t* **touch\_pad\_filter\_set\_config** (const *touch\_filter\_config\_t* \*filter\_info)

set parameter of touch sensor filter and detection algorithm. For more details on the detection algorithm, please refer to the application documentation.

**Parameters** **filter\_info** –select filter type and threshold of detection algorithm

**Returns**

- ESP\_OK Success

*esp\_err\_t* **touch\_pad\_filter\_get\_config** (*touch\_filter\_config\_t* \*filter\_info)

get parameter of touch sensor filter and detection algorithm. For more details on the detection algorithm, please refer to the application documentation.

**Parameters** **filter\_info** –select filter type and threshold of detection algorithm

**Returns**

- ESP\_OK Success

*esp\_err\_t* **touch\_pad\_filter\_enable** (void)

enable touch sensor filter for detection algorithm. For more details on the detection algorithm, please refer to the application documentation.

**Returns**

- ESP\_OK Success

*esp\_err\_t* **touch\_pad\_filter\_disable** (void)

disable touch sensor filter for detection algorithm. For more details on the detection algorithm, please refer to the application documentation.

**Returns**

- ESP\_OK Success

*esp\_err\_t* **touch\_pad\_denoise\_set\_config** (const *touch\_pad\_denoise\_t* \*denoise)

set parameter of denoise pad (TOUCH\_PAD\_NUM0). T0 is an internal channel that does not have a corresponding external GPIO. T0 will work simultaneously with the measured channel Tn. Finally, the actual measured value of Tn is the value after subtracting lower bits of T0. The noise reduction function filters out



interference introduced simultaneously on all channels, such as noise introduced by power supplies and external EMI.

**Parameters** **denoise** –parameter of denoise

**Returns**

- ESP\_OK Success

*esp\_err\_t* **touch\_pad\_denoise\_get\_config** (*touch\_pad\_denoise\_t* \*denoise)

get parameter of denoise pad (TOUCH\_PAD\_NUM0).

**Parameters** **denoise** –Pointer to parameter of denoise

**Returns**

- ESP\_OK Success

*esp\_err\_t* **touch\_pad\_denoise\_enable** (void)

enable denoise function. T0 is an internal channel that does not have a corresponding external GPIO. T0 will work simultaneously with the measured channel Tn. Finally, the actual measured value of Tn is the value after subtracting lower bits of T0. The noise reduction function filters out interference introduced simultaneously on all channels, such as noise introduced by power supplies and external EMI.

**Returns**

- ESP\_OK Success

*esp\_err\_t* **touch\_pad\_denoise\_disable** (void)

disable denoise function.

**Returns**

- ESP\_OK Success

*esp\_err\_t* **touch\_pad\_denoise\_read\_data** (uint32\_t \*data)

Get denoise measure value (TOUCH\_PAD\_NUM0).

**Parameters** **data** –Pointer to receive denoise value

**Returns**

- ESP\_OK Success

*esp\_err\_t* **touch\_pad\_waterproof\_set\_config** (const *touch\_pad\_waterproof\_t* \*waterproof)

set parameter of waterproof function.

The waterproof function includes a shielded channel (TOUCH\_PAD\_NUM14) **and** a **guard** channel.  
 Guard pad **is** used to detect the large area of water covering the touch **panel**.  
 Shield pad **is** used to shield the influence of water droplets covering the **touch panel**.  
 It **is** generally designed **as** a grid **and is** placed around the touch buttons.

**Parameters** **waterproof** –parameter of waterproof

**Returns**

- ESP\_OK Success

*esp\_err\_t* **touch\_pad\_waterproof\_get\_config** (*touch\_pad\_waterproof\_t* \*waterproof)

get parameter of waterproof function.

**Parameters** **waterproof** –parameter of waterproof

**Returns**

- ESP\_OK Success

*esp\_err\_t* **touch\_pad\_waterproof\_enable** (void)

Enable parameter of waterproof function. Should be called after function `touch_pad_waterproof_set_config`.

**Returns**

- ESP\_OK Success

*esp\_err\_t* **touch\_pad\_waterproof\_disable** (void)

Disable parameter of waterproof function.

**Returns**

- ESP\_OK Success

*esp\_err\_t* **touch\_pad\_proximity\_enable** (*touch\_pad\_t* touch\_num, bool enabled)

Enable/disable proximity function of touch channels. The proximity sensor measurement is the accumulation of touch channel measurements.

---

**Note:** Supports up to three touch channels configured as proximity sensors.

---

**Parameters**

- **touch\_num** –touch pad index
- **enabled** –true: enable the proximity function; false: disable the proximity function

**Returns**

- ESP\_OK: Configured correctly.
- ESP\_ERR\_INVALID\_ARG: Touch channel number error.
- ESP\_ERR\_NOT\_SUPPORTED: Don't support configured.

*esp\_err\_t* **touch\_pad\_proximity\_set\_count** (*touch\_pad\_t* touch\_num, uint32\_t count)

Set measure count of proximity channel. The proximity sensor measurement is the accumulation of touch channel measurements.

---

**Note:** All proximity channels use the same `count` value. So please pass the parameter `TOUCH_PAD_MAX`.

---

**Parameters**

- **touch\_num** –Touch pad index. In this version, pass the parameter `TOUCH_PAD_MAX`.
- **count** –The cumulative times of measurements for proximity pad. Range: 0 ~ 255.

**Returns**

- ESP\_OK: Configured correctly.
- ESP\_ERR\_INVALID\_ARG: Touch channel number error.

*esp\_err\_t* **touch\_pad\_proximity\_get\_count** (*touch\_pad\_t* touch\_num, uint32\_t \*count)

Get measure count of proximity channel. The proximity sensor measurement is the accumulation of touch channel measurements.

---

**Note:** All proximity channels use the same `count` value. So please pass the parameter `TOUCH_PAD_MAX`.

---

**Parameters**

- **touch\_num** –Touch pad index. In this version, pass the parameter `TOUCH_PAD_MAX`.
- **count** –The cumulative times of measurements for proximity pad. Range: 0 ~ 255.

**Returns**

- ESP\_OK: Configured correctly.
- ESP\_ERR\_INVALID\_ARG: Touch channel number error.

*esp\_err\_t* **touch\_pad\_proximity\_get\_data** (*touch\_pad\_t* touch\_num, uint32\_t \*measure\_out)

Get the accumulated measurement of the proximity sensor. The proximity sensor measurement is the accumulation of touch channel measurements.

**Parameters**

- **touch\_num** –touch pad index
- **measure\_out** –If the accumulation process does not end, the `measure_out` is the process value.

**Returns**

- ESP\_OK Success
- ESP\_ERR\_INVALID\_ARG Touch num is not proximity

*esp\_err\_t* **touch\_pad\_sleep\_channel\_get\_info** (*touch\_pad\_sleep\_channel\_t* \*slp\_config)

Get parameter of touch sensor sleep channel. The touch sensor can works in sleep mode to wake up sleep.

---

**Note:** After the sleep channel is configured, Please use special functions for sleep channel. e.g. The user should uses `touch_pad_sleep_channel_read_data` instead of `touch_pad_read_raw_data` to obtain the sleep channel reading.

---

**Parameters** **slp\_config** –touch sleep pad config.

**Returns**

- ESP\_OK Success

*esp\_err\_t* **touch\_pad\_sleep\_channel\_enable** (*touch\_pad\_t* pad\_num, bool enable)

Enable/Disable sleep channel function for touch sensor. The touch sensor can works in sleep mode to wake up sleep.

---

**Note:** ESP32S2 only support one sleep channel.

---

---

**Note:** After the sleep channel is configured, Please use special functions for sleep channel. e.g. The user should uses `touch_pad_sleep_channel_read_data` instead of `touch_pad_read_raw_data` to obtain the sleep channel reading.

---

**Parameters**

- **pad\_num** –Set touch channel number for sleep pad. Only one touch sensor channel is supported in deep sleep mode.
- **enable** –true: enable sleep pad for touch sensor; false: disable sleep pad for touch sensor;

**Returns**

- ESP\_OK Success

*esp\_err\_t* **touch\_pad\_sleep\_channel\_enable\_proximity** (*touch\_pad\_t* pad\_num, bool enable)

Enable/Disable proximity function for sleep channel. The touch sensor can works in sleep mode to wake up sleep.

---

**Note:** ESP32S2 only support one sleep channel.

---

**Parameters**

- **pad\_num** –Set touch channel number for sleep pad. Only one touch sensor channel is supported in deep sleep mode.
- **enable** –true: enable proximity for sleep channel; false: disable proximity for sleep channel;

**Returns**

- ESP\_OK Success

*esp\_err\_t* **touch\_pad\_sleep\_set\_threshold** (*touch\_pad\_t* pad\_num, uint32\_t touch\_thres)

Set the trigger threshold of touch sensor in deep sleep. The threshold determines the sensitivity of the touch sensor.

---

**Note:** In general, the touch threshold during sleep can use the threshold parameter parameters before sleep.

---

**Parameters**

- **pad\_num** –Set touch channel number for sleep pad. Only one touch sensor channel is supported in deep sleep mode.
- **touch\_thres** –touch sleep pad threshold

**Returns**

- ESP\_OK Success

*esp\_err\_t* **touch\_pad\_sleep\_get\_threshold** (*touch\_pad\_t* pad\_num, uint32\_t \*touch\_thres)

Get the trigger threshold of touch sensor in deep sleep. The threshold determines the sensitivity of the touch sensor.

---

**Note:** In general, the touch threshold during sleep can use the threshold parameter parameters before sleep.

---

**Parameters**

- **pad\_num** –Set touch channel number for sleep pad. Only one touch sensor channel is supported in deep sleep mode.
- **touch\_thres** –touch sleep pad threshold

**Returns**

- ESP\_OK Success

*esp\_err\_t* **touch\_pad\_sleep\_channel\_read\_benchmark** (*touch\_pad\_t* pad\_num, uint32\_t \*benchmark)

Read benchmark of touch sensor sleep channel.

**Parameters**

- **pad\_num** –Set touch channel number for sleep pad. Only one touch sensor channel is supported in deep sleep mode.
- **benchmark** –pointer to accept touch sensor benchmark value

**Returns**

- ESP\_OK Success
- ESP\_ERR\_INVALID\_ARG parameter is NULL

*esp\_err\_t* **touch\_pad\_sleep\_channel\_read\_smooth** (*touch\_pad\_t* pad\_num, uint32\_t \*smooth\_data)

Read smoothed data of touch sensor sleep channel. Smoothed data is filtered from the raw data.

**Parameters**

- **pad\_num** –Set touch channel number for sleep pad. Only one touch sensor channel is supported in deep sleep mode.
- **smooth\_data** –pointer to accept touch sensor smoothed data

**Returns**

- ESP\_OK Success
- ESP\_ERR\_INVALID\_ARG parameter is NULL

*esp\_err\_t* **touch\_pad\_sleep\_channel\_read\_data** (*touch\_pad\_t* pad\_num, uint32\_t \*raw\_data)

Read raw data of touch sensor sleep channel.

**Parameters**

- **pad\_num** –Set touch channel number for sleep pad. Only one touch sensor channel is supported in deep sleep mode.
- **raw\_data** –pointer to accept touch sensor raw data

**Returns**

- ESP\_OK Success
- ESP\_ERR\_INVALID\_ARG parameter is NULL

*esp\_err\_t* **touch\_pad\_sleep\_channel\_reset\_benchmark** (void)

Reset benchmark of touch sensor sleep channel.

**Returns**

- ESP\_OK Success

*esp\_err\_t* **touch\_pad\_sleep\_channel\_read\_proximity\_cnt** (*touch\_pad\_t* pad\_num, uint32\_t \*proximity\_cnt)

Read proximity count of touch sensor sleep channel.

**Parameters**

- **pad\_num** –Set touch channel number for sleep pad. Only one touch sensor channel is supported in deep sleep mode.
- **proximity\_cnt** –pointer to accept touch sensor proximity count value

**Returns**

- ESP\_OK Success
- ESP\_ERR\_INVALID\_ARG parameter is NULL

*esp\_err\_t* **touch\_pad\_sleep\_channel\_set\_work\_time** (uint16\_t sleep\_cycle, uint16\_t meas\_times)

Change the operating frequency of touch pad in deep sleep state. Reducing the operating frequency can effectively reduce power consumption. If this function is not called, the working frequency of touch in the deep sleep state is the same as that in the wake-up state.

**Parameters**

- **sleep\_cycle** –The touch sensor will sleep after each measurement. sleep\_cycle decide the interval between each measurement.  $t_{sleep} = sleep\_cycle / (RTC\_SLOW\_CLK \text{ frequency})$ . The approximate frequency value of RTC\_SLOW\_CLK can be obtained using rtc\_clk\_slow\_freq\_get\_hz function.
- **meas\_times** –The times of charge and discharge in each measure process of touch channels. The timer frequency is 8Mhz. Range: 0 ~ 0xffff. Recommended typical value: Modify this value to make the measurement time around 1ms.

**Returns**

- ESP\_OK Success

## Header File

- [components/driver/include/driver/touch\\_sensor\\_common.h](#)

## Functions

*esp\_err\_t* **touch\_pad\_init** (void)

Initialize touch module.

---

**Note:** If default parameter don't match the usage scenario, it can be changed after this function.

---

**Returns**

- ESP\_OK Success
- ESP\_ERR\_NO\_MEM Touch pad init error
- ESP\_ERR\_NOT\_SUPPORTED Touch pad is providing current to external XTAL

*esp\_err\_t* **touch\_pad\_deinit** (void)

Un-install touch pad driver.

---

**Note:** After this function is called, other touch functions are prohibited from being called.

---

**Returns**

- ESP\_OK Success

- ESP\_FAIL Touch pad driver not initialized

*esp\_err\_t touch\_pad\_io\_init* (*touch\_pad\_t* touch\_num)

Initialize touch pad GPIO.

**Parameters** *touch\_num* –touch pad index

**Returns**

- ESP\_OK on success
- ESP\_ERR\_INVALID\_ARG if argument is wrong

*esp\_err\_t touch\_pad\_set\_voltage* (*touch\_high\_volt\_t* refh, *touch\_low\_volt\_t* refl, *touch\_volt\_atten\_t* atten)

Set touch sensor high voltage threshold of charge. The touch sensor measures the channel capacitance value by charging and discharging the channel. So the high threshold should be less than the supply voltage.

**Parameters**

- **refh** –the value of DREFH
- **refl** –the value of DREFL
- **atten** –the attenuation on DREFH

**Returns**

- ESP\_OK on success
- ESP\_ERR\_INVALID\_ARG if argument is wrong

*esp\_err\_t touch\_pad\_get\_voltage* (*touch\_high\_volt\_t* \*refh, *touch\_low\_volt\_t* \*refl, *touch\_volt\_atten\_t* \*atten)

Get touch sensor reference voltage,.

**Parameters**

- **refh** –pointer to accept DREFH value
- **refl** –pointer to accept DREFL value
- **atten** –pointer to accept the attenuation on DREFH

**Returns**

- ESP\_OK on success

*esp\_err\_t touch\_pad\_set\_cnt\_mode* (*touch\_pad\_t* touch\_num, *touch\_cnt\_slope\_t* slope, *touch\_tie\_opt\_t* opt)

Set touch sensor charge/discharge speed for each pad. If the slope is 0, the counter would always be zero. If the slope is 1, the charging and discharging would be slow, accordingly. If the slope is set 7, which is the maximum value, the charging and discharging would be fast.

---

**Note:** The higher the charge and discharge current, the greater the immunity of the touch channel, but it will increase the system power consumption.

---

**Parameters**

- **touch\_num** –touch pad index
- **slope** –touch pad charge/discharge speed
- **opt** –the initial voltage

**Returns**

- ESP\_OK on success
- ESP\_ERR\_INVALID\_ARG if argument is wrong

*esp\_err\_t touch\_pad\_get\_cnt\_mode* (*touch\_pad\_t* touch\_num, *touch\_cnt\_slope\_t* \*slope, *touch\_tie\_opt\_t* \*opt)

Get touch sensor charge/discharge speed for each pad.

**Parameters**

- **touch\_num** –touch pad index
- **slope** –pointer to accept touch pad charge/discharge slope
- **opt** –pointer to accept the initial voltage

**Returns**

- ESP\_OK on success
- ESP\_ERR\_INVALID\_ARG if argument is wrong

*esp\_err\_t* **touch\_pad\_isr\_deregister** (void (\*fn)(void\*), void \*arg)

Deregister the handler previously registered using touch\_pad\_isr\_handler\_register.

**Parameters**

- **fn** –handler function to call (as passed to touch\_pad\_isr\_handler\_register)
- **arg** –argument of the handler (as passed to touch\_pad\_isr\_handler\_register)

**Returns**

- ESP\_OK on success
- ESP\_ERR\_INVALID\_STATE if a handler matching both fn and arg isn't registered

*esp\_err\_t* **touch\_pad\_get\_wakeup\_status** (*touch\_pad\_t* \*pad\_num)

Get the touch pad which caused wakeup from deep sleep.

**Parameters** **pad\_num** –pointer to touch pad which caused wakeup

**Returns**

- ESP\_OK Success
- ESP\_ERR\_INVALID\_ARG parameter is NULL

*esp\_err\_t* **touch\_pad\_set\_fsm\_mode** (*touch\_fsm\_mode\_t* mode)

Set touch sensor FSM mode, the test action can be triggered by the timer, as well as by the software.

**Parameters** **mode** –FSM mode

**Returns**

- ESP\_OK on success
- ESP\_ERR\_INVALID\_ARG if argument is wrong

*esp\_err\_t* **touch\_pad\_get\_fsm\_mode** (*touch\_fsm\_mode\_t* \*mode)

Get touch sensor FSM mode.

**Parameters** **mode** –pointer to accept FSM mode

**Returns**

- ESP\_OK on success

*esp\_err\_t* **touch\_pad\_clear\_status** (void)

To clear the touch sensor channel active status.

---

**Note:** The FSM automatically updates the touch sensor status. It is generally not necessary to call this API to clear the status.

---

**Returns**

- ESP\_OK on success

*uint32\_t* **touch\_pad\_get\_status** (void)

Get the touch sensor channel active status mask. The bit position represents the channel number. The 0/1 status of the bit represents the trigger status.

**Returns**

- The touch sensor status. e.g. Touch1 trigger status is `status_mask & (BIT1)`.

*bool* **touch\_pad\_meas\_is\_done** (void)

Check touch sensor measurement status.

**Returns**

- True measurement is under way
- False measurement done

**GPIO Lookup Macros** Some useful macros can be used to specified the GPIO number of a touch pad channel, or vice versa. e.g.

1. TOUCH\_PAD\_NUM5\_GPIO\_NUM is the GPIO number of channel 5 (12);
2. TOUCH\_PAD\_GPIO4\_CHANNEL is the channel number of GPIO 4 (channel 0).

### Header File

- [components/soc/esp32s2/include/soc/touch\\_sensor\\_channel.h](#)

### Macros

TOUCH\_PAD\_GPIO1\_CHANNEL

TOUCH\_PAD\_NUM1\_GPIO\_NUM

TOUCH\_PAD\_GPIO2\_CHANNEL

TOUCH\_PAD\_NUM2\_GPIO\_NUM

TOUCH\_PAD\_GPIO3\_CHANNEL

TOUCH\_PAD\_NUM3\_GPIO\_NUM

TOUCH\_PAD\_GPIO4\_CHANNEL

TOUCH\_PAD\_NUM4\_GPIO\_NUM

TOUCH\_PAD\_GPIO5\_CHANNEL

TOUCH\_PAD\_NUM5\_GPIO\_NUM

TOUCH\_PAD\_GPIO6\_CHANNEL

TOUCH\_PAD\_NUM6\_GPIO\_NUM

TOUCH\_PAD\_GPIO7\_CHANNEL

TOUCH\_PAD\_NUM7\_GPIO\_NUM

TOUCH\_PAD\_GPIO8\_CHANNEL

TOUCH\_PAD\_NUM8\_GPIO\_NUM

TOUCH\_PAD\_GPIO9\_CHANNEL

TOUCH\_PAD\_NUM9\_GPIO\_NUM



`TOUCH_PAD_GPIO10_CHANNEL`

`TOUCH_PAD_NUM10_GPIO_NUM`

`TOUCH_PAD_GPIO11_CHANNEL`

`TOUCH_PAD_NUM11_GPIO_NUM`

`TOUCH_PAD_GPIO12_CHANNEL`

`TOUCH_PAD_NUM12_GPIO_NUM`

`TOUCH_PAD_GPIO13_CHANNEL`

`TOUCH_PAD_NUM13_GPIO_NUM`

`TOUCH_PAD_GPIO14_CHANNEL`

`TOUCH_PAD_NUM14_GPIO_NUM`

### Header File

- [components/hal/include/hal/touch\\_sensor\\_types.h](#)

### Structures

struct `touch_pad_denoise`

Touch sensor denoise configuration

#### Public Members

*touch\_pad\_denoise\_grade\_t* `grade`

Select denoise range of denoise channel. Determined by measuring the noise amplitude of the denoise channel.

*touch\_pad\_denoise\_cap\_t* `cap_level`

Select internal reference capacitance of denoise channel. Ensure that the denoise readings are closest to the readings of the channel being measured. Use `touch_pad_denoise_read_data` to get the reading of denoise channel. The equivalent capacitance of the shielded channel can be calculated from the reading of denoise channel.

struct `touch_pad_waterproof`

Touch sensor waterproof configuration

#### Public Members

***touch\_pad\_t* guard\_ring\_pad**

Waterproof. Select touch channel use for guard pad. Guard pad is used to detect the large area of water covering the touch panel.

***touch\_pad\_shield\_driver\_t* shield\_driver**

Waterproof. Shield channel drive capability configuration. Shield pad is used to shield the influence of water droplets covering the touch panel. When the waterproof function is enabled, Touch14 is set as shield channel by default. The larger the parasitic capacitance on the shielding channel, the higher the drive capability needs to be set. The equivalent capacitance of the shield channel can be estimated through the reading value of the denoise channel(Touch0).

**struct touch\_filter\_config**

Touch sensor filter configuration

**Public Members*****touch\_filter\_mode\_t* mode**

Set filter mode. The input of the filter is the raw value of touch reading, and the output of the filter is involved in the judgment of the touch state.

**uint32\_t debounce\_cnt**

Set debounce count, such as n. If the measured values continue to exceed the threshold for n+1 times, the touch sensor state changes. Range: 0 ~ 7

**uint32\_t noise\_thr**

Noise threshold coefficient. Higher = More noise resistance. The actual noise should be less than (noise coefficient \* touch threshold). Range: 0 ~ 3. The coefficient is 0: 4/8; 1: 3/8; 2: 2/8; 3: 1;

**uint32\_t jitter\_step**

Set jitter filter step size. Range: 0 ~ 15

***touch\_smooth\_mode\_t* smh\_lvl**

Level of filter applied on the original data against large noise interference.

**struct touch\_pad\_sleep\_channel\_t**

Touch sensor channel sleep configuration

**Public Members*****touch\_pad\_t* touch\_num**

Set touch channel number for sleep pad. Only one touch sensor channel is supported in deep sleep mode. If clear the sleep channel, point this pad to TOUCH\_PAD\_NUM0

**bool en\_proximity**

enable proximity function for sleep pad

## Macros

**TOUCH\_PAD\_BIT\_MASK\_ALL**

**TOUCH\_PAD\_SLOPE\_DEFAULT**

**TOUCH\_PAD\_TIE\_OPT\_DEFAULT**

**TOUCH\_PAD\_BIT\_MASK\_MAX**

**TOUCH\_PAD\_HIGH\_VOLTAGE\_THRESHOLD**

**TOUCH\_PAD\_LOW\_VOLTAGE\_THRESHOLD**

**TOUCH\_PAD\_ATTEN\_VOLTAGE\_THRESHOLD**

**TOUCH\_PAD\_IDLE\_CH\_CONNECT\_DEFAULT**

**TOUCH\_PAD\_THRESHOLD\_MAX**

If set touch threshold max value, The touch sensor can't be in touched status

**TOUCH\_PAD\_SLEEP\_CYCLE\_DEFAULT**

Excessive total time will slow down the touch response. Too small measurement time will not be sampled enough, resulting in inaccurate measurements.

---

**Note:** The greater the duty cycle of the measurement time, the more system power is consumed. The number of sleep cycle in each measure process of touch channels. The timer frequency is `RTC_SLOW_CLK` (can be 150k or 32k depending on the options). Range: 0 ~ 0xffff

---

**TOUCH\_PAD\_MEASURE\_CYCLE\_DEFAULT**

The times of charge and discharge in each measure process of touch channels. The timer frequency is 8Mhz. Recommended typical value: Modify this value to make the measurement time around 1ms. Range: 0 ~ 0xffff

**TOUCH\_PAD\_INTR\_MASK\_ALL**

All touch interrupt type enable.

**TOUCH\_PROXIMITY\_MEAS\_NUM\_MAX**

Touch sensor proximity detection configuration

**TOUCH\_DEBOUNCE\_CNT\_MAX**

**TOUCH\_NOISE\_THR\_MAX**

**TOUCH\_JITTER\_STEP\_MAX**

## Type Definitions

typedef struct *touch\_pad\_denoise* touch\_pad\_denoise\_t

Touch sensor denoise configuration

typedef struct *touch\_pad\_waterproof* **touch\_pad\_waterproof\_t**  
Touch sensor waterproof configuration

typedef struct *touch\_filter\_config* **touch\_filter\_config\_t**  
Touch sensor filter configuration

### Enumerations

enum **touch\_pad\_t**

Touch pad channel

*Values:*

enumerator **TOUCH\_PAD\_NUM0**

Touch pad channel 0 is GPIO4(ESP32)

enumerator **TOUCH\_PAD\_NUM1**

Touch pad channel 1 is GPIO0(ESP32) / GPIO1(ESP32-S2)

enumerator **TOUCH\_PAD\_NUM2**

Touch pad channel 2 is GPIO2(ESP32) / GPIO2(ESP32-S2)

enumerator **TOUCH\_PAD\_NUM3**

Touch pad channel 3 is GPIO15(ESP32) / GPIO3(ESP32-S2)

enumerator **TOUCH\_PAD\_NUM4**

Touch pad channel 4 is GPIO13(ESP32) / GPIO4(ESP32-S2)

enumerator **TOUCH\_PAD\_NUM5**

Touch pad channel 5 is GPIO12(ESP32) / GPIO5(ESP32-S2)

enumerator **TOUCH\_PAD\_NUM6**

Touch pad channel 6 is GPIO14(ESP32) / GPIO6(ESP32-S2)

enumerator **TOUCH\_PAD\_NUM7**

Touch pad channel 7 is GPIO27(ESP32) / GPIO7(ESP32-S2)

enumerator **TOUCH\_PAD\_NUM8**

Touch pad channel 8 is GPIO33(ESP32) / GPIO8(ESP32-S2)

enumerator **TOUCH\_PAD\_NUM9**

Touch pad channel 9 is GPIO32(ESP32) / GPIO9(ESP32-S2)

enumerator **TOUCH\_PAD\_NUM10**

Touch channel 10 is GPIO10(ESP32-S2)

enumerator **TOUCH\_PAD\_NUM11**

Touch channel 11 is GPIO11(ESP32-S2)

enumerator **TOUCH\_PAD\_NUM12**

Touch channel 12 is GPIO12(ESP32-S2)

enumerator **TOUCH\_PAD\_NUM13**

Touch channel 13 is GPIO13(ESP32-S2)

enumerator **TOUCH\_PAD\_NUM14**

Touch channel 14 is GPIO14(ESP32-S2)

enumerator **TOUCH\_PAD\_MAX**

enum **touch\_high\_volt\_t**

Touch sensor high reference voltage

*Values:*

enumerator **TOUCH\_HVOLT\_KEEP**

Touch sensor high reference voltage, no change

enumerator **TOUCH\_HVOLT\_2V4**

Touch sensor high reference voltage, 2.4V

enumerator **TOUCH\_HVOLT\_2V5**

Touch sensor high reference voltage, 2.5V

enumerator **TOUCH\_HVOLT\_2V6**

Touch sensor high reference voltage, 2.6V

enumerator **TOUCH\_HVOLT\_2V7**

Touch sensor high reference voltage, 2.7V

enumerator **TOUCH\_HVOLT\_MAX**

enum **touch\_low\_volt\_t**

Touch sensor low reference voltage

*Values:*

enumerator **TOUCH\_LVOLT\_KEEP**

Touch sensor low reference voltage, no change

enumerator **TOUCH\_LVOLT\_0V5**

Touch sensor low reference voltage, 0.5V

enumerator **TOUCH\_LVOLT\_0V6**

Touch sensor low reference voltage, 0.6V

enumerator **TOUCH\_LVOLT\_0V7**

Touch sensor low reference voltage, 0.7V

enumerator **TOUCH\_LVOLT\_0V8**

Touch sensor low reference voltage, 0.8V

enumerator **TOUCH\_LVOLT\_MAX**

enum **touch\_volt\_atten\_t**

Touch sensor high reference voltage attenuation

*Values:*

enumerator **TOUCH\_HVOLT\_ATTEN\_KEEP**

Touch sensor high reference voltage attenuation, no change

enumerator **TOUCH\_HVOLT\_ATTEN\_1V5**

Touch sensor high reference voltage attenuation, 1.5V attenuation

enumerator **TOUCH\_HVOLT\_ATTEN\_1V**

Touch sensor high reference voltage attenuation, 1.0V attenuation

enumerator **TOUCH\_HVOLT\_ATTEN\_0V5**

Touch sensor high reference voltage attenuation, 0.5V attenuation

enumerator **TOUCH\_HVOLT\_ATTEN\_0V**

Touch sensor high reference voltage attenuation, 0V attenuation

enumerator **TOUCH\_HVOLT\_ATTEN\_MAX**

enum **touch\_cnt\_slope\_t**

Touch sensor charge/discharge speed

*Values:*

enumerator **TOUCH\_PAD\_SLOPE\_0**

Touch sensor charge / discharge speed, always zero

enumerator **TOUCH\_PAD\_SLOPE\_1**

Touch sensor charge / discharge speed, slowest

enumerator **TOUCH\_PAD\_SLOPE\_2**

Touch sensor charge / discharge speed

enumerator **TOUCH\_PAD\_SLOPE\_3**

Touch sensor charge / discharge speed

enumerator **TOUCH\_PAD\_SLOPE\_4**

Touch sensor charge / discharge speed

enumerator **TOUCH\_PAD\_SLOPE\_5**

Touch sensor charge / discharge speed

enumerator **TOUCH\_PAD\_SLOPE\_6**

Touch sensor charge / discharge speed

enumerator **TOUCH\_PAD\_SLOPE\_7**

Touch sensor charge / discharge speed, fast

enumerator **TOUCH\_PAD\_SLOPE\_MAX**

enum **touch\_tie\_opt\_t**

Touch sensor initial charge level

*Values:*

enumerator **TOUCH\_PAD\_TIE\_OPT\_LOW**

Initial level of charging voltage, low level

enumerator **TOUCH\_PAD\_TIE\_OPT\_HIGH**

Initial level of charging voltage, high level

enumerator **TOUCH\_PAD\_TIE\_OPT\_MAX**

enum **touch\_fsm\_mode\_t**

Touch sensor FSM mode

*Values:*

enumerator **TOUCH\_FSM\_MODE\_TIMER**

To start touch FSM by timer

enumerator **TOUCH\_FSM\_MODE\_SW**

To start touch FSM by software trigger

enumerator **TOUCH\_FSM\_MODE\_MAX**

enum **touch\_trigger\_mode\_t**

*Values:*

enumerator **TOUCH\_TRIGGER\_BELOW**

Touch interrupt will happen if counter value is less than threshold.

enumerator **TOUCH\_TRIGGER\_ABOVE**

Touch interrupt will happen if counter value is larger than threshold.

enumerator **TOUCH\_TRIGGER\_MAX**

enum **touch\_trigger\_src\_t**

*Values:*

enumerator **TOUCH\_TRIGGER\_SOURCE\_BOTH**

wakeup interrupt is generated if both SET1 and SET2 are “touched”

enumerator **TOUCH\_TRIGGER\_SOURCE\_SET1**  
wakeUp interrupt is generated if SET1 is “touched”

enumerator **TOUCH\_TRIGGER\_SOURCE\_MAX**

enum **touch\_pad\_intr\_mask\_t**

*Values:*

enumerator **TOUCH\_PAD\_INTR\_MASK\_DONE**  
Measurement done for one of the enabled channels.

enumerator **TOUCH\_PAD\_INTR\_MASK\_ACTIVE**  
Active for one of the enabled channels.

enumerator **TOUCH\_PAD\_INTR\_MASK\_INACTIVE**  
Inactive for one of the enabled channels.

enumerator **TOUCH\_PAD\_INTR\_MASK\_SCAN\_DONE**  
Measurement done for all the enabled channels.

enumerator **TOUCH\_PAD\_INTR\_MASK\_TIMEOUT**  
Timeout for one of the enabled channels.

enum **touch\_pad\_denoise\_grade\_t**

*Values:*

enumerator **TOUCH\_PAD\_DENOISE\_BIT12**  
Denoise range is 12bit

enumerator **TOUCH\_PAD\_DENOISE\_BIT10**  
Denoise range is 10bit

enumerator **TOUCH\_PAD\_DENOISE\_BIT8**  
Denoise range is 8bit

enumerator **TOUCH\_PAD\_DENOISE\_BIT4**  
Denoise range is 4bit

enumerator **TOUCH\_PAD\_DENOISE\_MAX**

enum **touch\_pad\_denoise\_cap\_t**

*Values:*

enumerator **TOUCH\_PAD\_DENOISE\_CAP\_L0**  
Denoise channel internal reference capacitance is 5pf

enumerator **TOUCH\_PAD\_DENOISE\_CAP\_L1**  
Denoise channel internal reference capacitance is 6.4pf



enumerator **TOUCH\_PAD\_DENOISE\_CAP\_L2**

Denoise channel internal reference capacitance is 7.8pf

enumerator **TOUCH\_PAD\_DENOISE\_CAP\_L3**

Denoise channel internal reference capacitance is 9.2pf

enumerator **TOUCH\_PAD\_DENOISE\_CAP\_L4**

Denoise channel internal reference capacitance is 10.6pf

enumerator **TOUCH\_PAD\_DENOISE\_CAP\_L5**

Denoise channel internal reference capacitance is 12.0pf

enumerator **TOUCH\_PAD\_DENOISE\_CAP\_L6**

Denoise channel internal reference capacitance is 13.4pf

enumerator **TOUCH\_PAD\_DENOISE\_CAP\_L7**

Denoise channel internal reference capacitance is 14.8pf

enumerator **TOUCH\_PAD\_DENOISE\_CAP\_MAX**

enum **touch\_pad\_shield\_driver\_t**

Touch sensor shield channel drive capability level

*Values:*

enumerator **TOUCH\_PAD\_SHIELD\_DRV\_L0**

The max equivalent capacitance in shield channel is 40pf

enumerator **TOUCH\_PAD\_SHIELD\_DRV\_L1**

The max equivalent capacitance in shield channel is 80pf

enumerator **TOUCH\_PAD\_SHIELD\_DRV\_L2**

The max equivalent capacitance in shield channel is 120pf

enumerator **TOUCH\_PAD\_SHIELD\_DRV\_L3**

The max equivalent capacitance in shield channel is 160pf

enumerator **TOUCH\_PAD\_SHIELD\_DRV\_L4**

The max equivalent capacitance in shield channel is 200pf

enumerator **TOUCH\_PAD\_SHIELD\_DRV\_L5**

The max equivalent capacitance in shield channel is 240pf

enumerator **TOUCH\_PAD\_SHIELD\_DRV\_L6**

The max equivalent capacitance in shield channel is 280pf

enumerator **TOUCH\_PAD\_SHIELD\_DRV\_L7**

The max equivalent capacitance in shield channel is 320pf

enumerator **TOUCH\_PAD\_SHIELD\_DRV\_MAX**

enum **touch\_pad\_conn\_type\_t**

Touch channel idle state configuration

*Values:*

enumerator **TOUCH\_PAD\_CONN\_HIGHZ**

Idle status of touch channel is high resistance state

enumerator **TOUCH\_PAD\_CONN\_GND**

Idle status of touch channel is ground connection

enumerator **TOUCH\_PAD\_CONN\_MAX**

enum **touch\_filter\_mode\_t**

Touch channel IIR filter coefficient configuration.

---

**Note:** On ESP32S2. There is an error in the IIR calculation. The magnitude of the error is twice the filter coefficient. So please select a smaller filter coefficient on the basis of meeting the filtering requirements. Recommended filter coefficient selection `IIR_16`.

---

*Values:*

enumerator **TOUCH\_PAD\_FILTER\_IIR\_4**

The filter mode is first-order IIR filter. The coefficient is 4.

enumerator **TOUCH\_PAD\_FILTER\_IIR\_8**

The filter mode is first-order IIR filter. The coefficient is 8.

enumerator **TOUCH\_PAD\_FILTER\_IIR\_16**

The filter mode is first-order IIR filter. The coefficient is 16 (Typical value).

enumerator **TOUCH\_PAD\_FILTER\_IIR\_32**

The filter mode is first-order IIR filter. The coefficient is 32.

enumerator **TOUCH\_PAD\_FILTER\_IIR\_64**

The filter mode is first-order IIR filter. The coefficient is 64.

enumerator **TOUCH\_PAD\_FILTER\_IIR\_128**

The filter mode is first-order IIR filter. The coefficient is 128.

enumerator **TOUCH\_PAD\_FILTER\_IIR\_256**

The filter mode is first-order IIR filter. The coefficient is 256.

enumerator **TOUCH\_PAD\_FILTER\_JITTER**

The filter mode is jitter filter

enumerator **TOUCH\_PAD\_FILTER\_MAX**

enum **touch\_smooth\_mode\_t**

Level of filter applied on the original data against large noise interference.

---

**Note:** On ESP32S2. There is an error in the IIR calculation. The magnitude of the error is twice the filter coefficient. So please select a smaller filter coefficient on the basis of meeting the filtering requirements. Recommended filter coefficient selection `IIR_2`.

---

*Values:*

enumerator **TOUCH\_PAD\_SMOOTH\_OFF**

No filtering of raw data.

enumerator **TOUCH\_PAD\_SMOOTH\_IIR\_2**

Filter the raw data. The coefficient is 2 (Typical value).

enumerator **TOUCH\_PAD\_SMOOTH\_IIR\_4**

Filter the raw data. The coefficient is 4.

enumerator **TOUCH\_PAD\_SMOOTH\_IIR\_8**

Filter the raw data. The coefficient is 8.

enumerator **TOUCH\_PAD\_SMOOTH\_MAX**

## 2.5.24 Touch Element

### Overview

Touch Element library provides a high level abstraction for building capacitive touch applications. The library's implementation gives a unified and friendly software interface thus allows for smooth and easy capacitive touch application development. The library is implemented atop the touch sensor driver (please see [Touch sensor driver API Reference](#) for more information regarding low level API usage).

**Architecture** Touch Element library configures touch sensor peripherals via touch sensor driver. While some necessary hardware parameters should be passed to `touch_element_install()` and will be configured automatically only after calling `touch_element_start()`, because it will make great influence on the run-time system.

These parameters include touch channel threshold, waterproof shield sensor driver-level and etc. Touch Element library sets touch sensor interrupt and esp-timer routine up and the hardware information of touch sensor (channel state, channel number) will be obtained in touch sensor interrupt service routine. When the specified channel event occurs, and those hardware information will be passed to the esp-timer callback routine, esp-timer callback routine will dispatch the touch sensor channel information to the touch elements (such as button, slider etc). Then runs the specified algorithm to update touch element's state or calculate its position, dispatch the result to user.

So using Touch Element library, user doesn't need to care about the implementation of touch sensor peripheral, Touch Element library will handle most of the hardware information and pass the more meaningful messages to user event handler routine.

Workflow of Touch Element library is illustrated in the picture below.

The features in relation to the Touch Element library in ESP32-S2 are given in the table below.

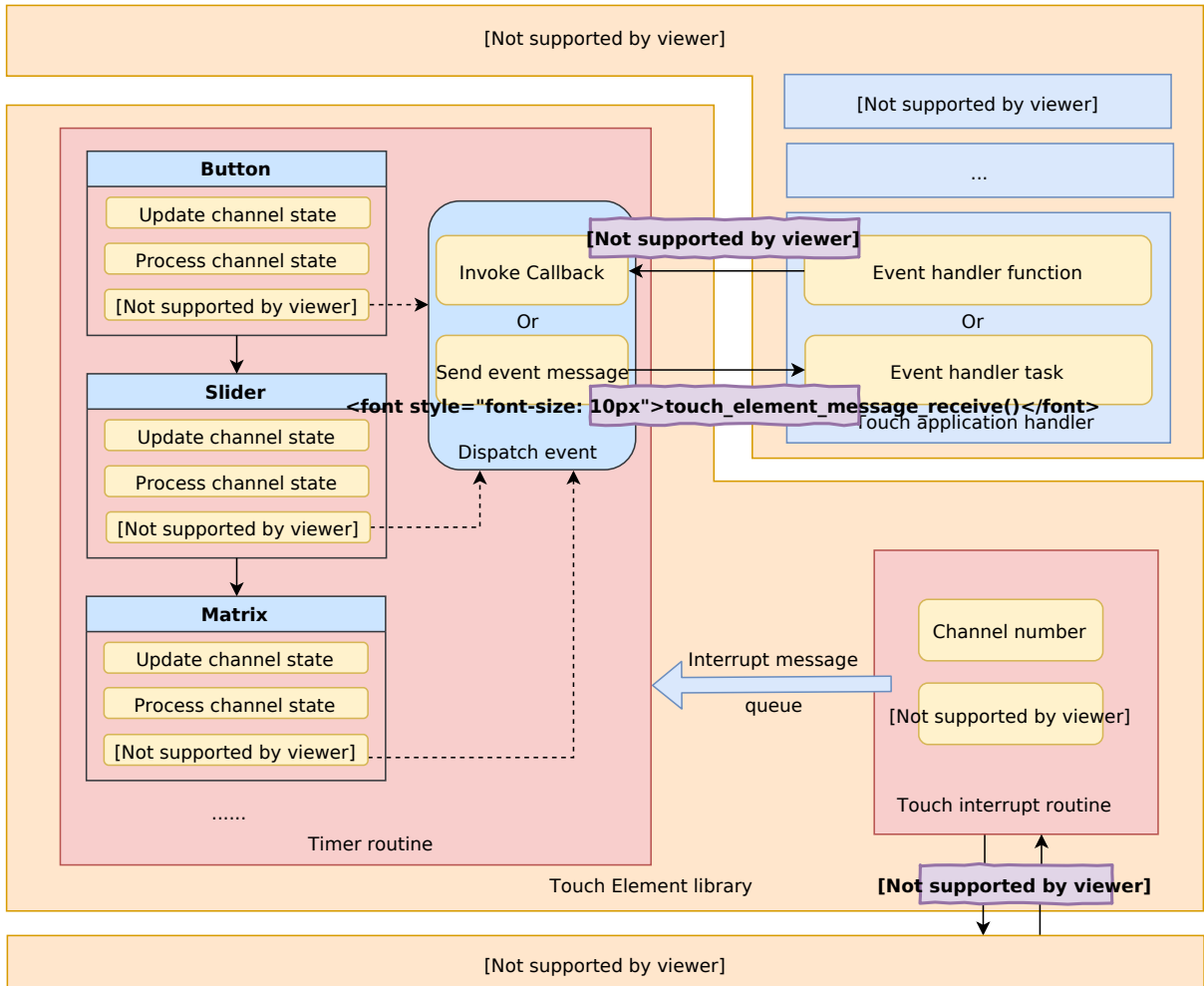

Fig. 17: Touch Element architecture

Features	ESP32S2
Touch Element waterproof	✓
Touch Element button	✓
Touch Element slider	✓
Touch Element matrix button	✓

**Peripheral** ESP32-S2 integrates one touch sensor peripheral with several physical channels.

- 14 physical capacitive touch channels
- Timer or software FSM trigger mode
- Up to 5 kinds of interrupt(Upper threshold and lower threshold interrupt, measure one channel finish and measure all channels finish interrupt, measurement timeout interrupt)
- Sleep mode wakeup source
- Hardware internal de-noise
- Hardware filter
- Hardware waterproof sensor
- Hardware proximity sensor

The channels are located as follows:

Channel	ESP32-S2
<b>Channel 0</b>	<b>GPIO 0 (reserved)</b>
<b>Channel 1</b>	<b>GPIO 1</b>
<b>Channel 2</b>	<b>GPIO 2</b>
<b>Channel 3</b>	<b>GPIO 3</b>
<b>Channel 4</b>	<b>GPIO 4</b>
<b>Channel 5</b>	<b>GPIO 5</b>
<b>Channel 6</b>	<b>GPIO 6</b>
<b>Channel 7</b>	<b>GPIO 7</b>
<b>Channel 8</b>	<b>GPIO 8</b>
<b>Channel 9</b>	<b>GPIO 9</b>
<b>Channel 10</b>	<b>GPIO 10</b>
<b>Channel 11</b>	<b>GPIO 11</b>
<b>Channel 12</b>	<b>GPIO 12</b>
<b>Channel 13</b>	<b>GPIO 13</b>
<b>Channel 14</b>	<b>GPIO 14</b>

### Terminology

The terms used in relation to the Touch Element library are given in the below.

Term	Definition
<b>Touch sensor</b>	Touch sensor peripheral inside the chip
<b>Touch channel</b>	Touch sensor channels inside the touch sensor peripheral
<b>Touch pad</b>	Off-chip physical solder pad (Generally inside the PCB)
<b>De-noise channel</b>	Internal de-noise channel (Is always Channel 0 and it is reserved)
<b>Shield sensor</b>	One of the waterproof sensor, use for compensating the influence of water drop
<b>Guard sensor</b>	One of the waterproof sensor, use for detecting the water stream
<b>Shield channel</b>	The channel that waterproof shield sensor connected to (Is always Channel 14)
<b>Guard channel</b>	The channel that waterproof guard sensor connected to
<b>Shield pad</b>	Off-chip physical solder pad (Generally is grids) and is connected to shield sensor
<b>Guard pad</b>	Off-chip physical solder pad (Is usually a ring) and is connected to guard sensor

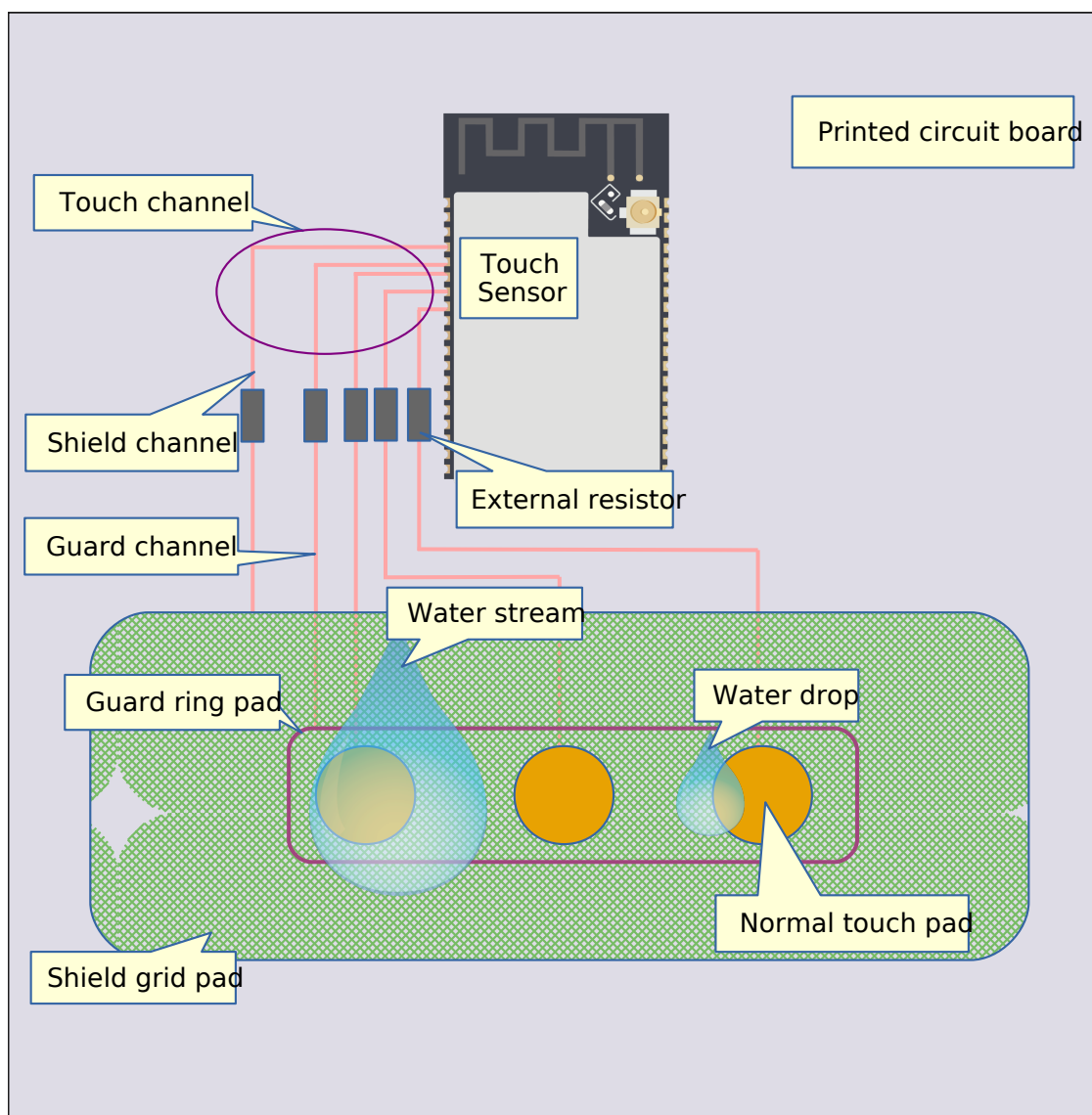

Fig. 18: Touch sensor application system components

**Touch Sensor Signal** Each touch sensor is able to provide the following types of signals:

- Raw: The Raw signal is the unfiltered signal from the touch sensor
- Smooth: The Smooth signal is a filtered version of the Raw signal via an internal hardware filter
- Benchmark: The Benchmark signal is also a filtered signal that filters out extremely low-frequency noise.

All of these signals can be obtained using touch sensor driver API.

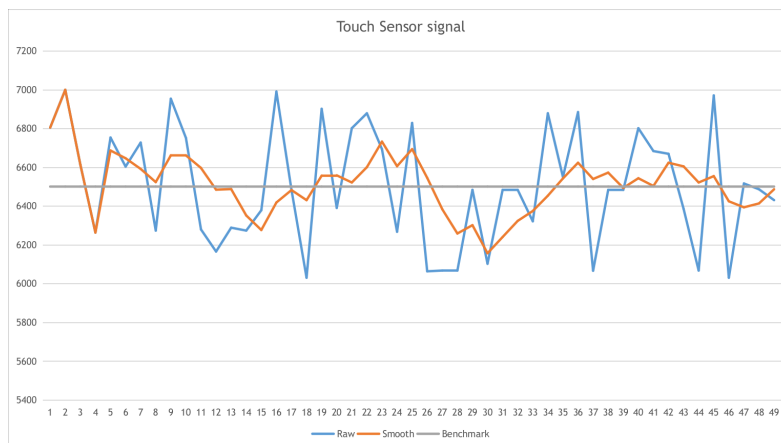

Fig. 19: Touch sensor signals

**Touch Sensor Threshold** The Touch Sensor Threshold value is a configurable threshold value used to determine when a touch sensor is touched or not. When difference between the Smooth signal and the Benchmark signal becomes greater than the threshold value (i.e.,  $(\text{smooth} - \text{benchmark}) > \text{threshold}$ ), the touch channel's state will be changed and a touch interrupt will be triggered simultaneously.

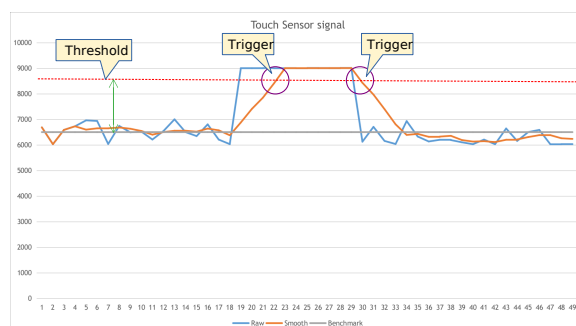

Fig. 20: Touch sensor signal threshold

**Sensitivity** Important performance parameter of touch sensor, the larger it is, the better touch sensor will perform. It could be calculated by the format in below:

$$\text{Sensitivity} = \frac{\text{Signal}_{\text{press}} - \text{Signal}_{\text{release}}}{\text{Signal}_{\text{release}}} = \frac{\text{Signal}_{\text{delta}}}{\text{Signal}_{\text{benchmark}}}$$

**Waterproof** Waterproof is a hardware feature of touch sensor which has guard sensor and shield sensor (Always connect to Channel 14) that has the ability to resist a degree influence of water drop and detect the water stream.

**Touch Button** Touch button consumes one channel of touch sensor, and it looks like as the picture below:

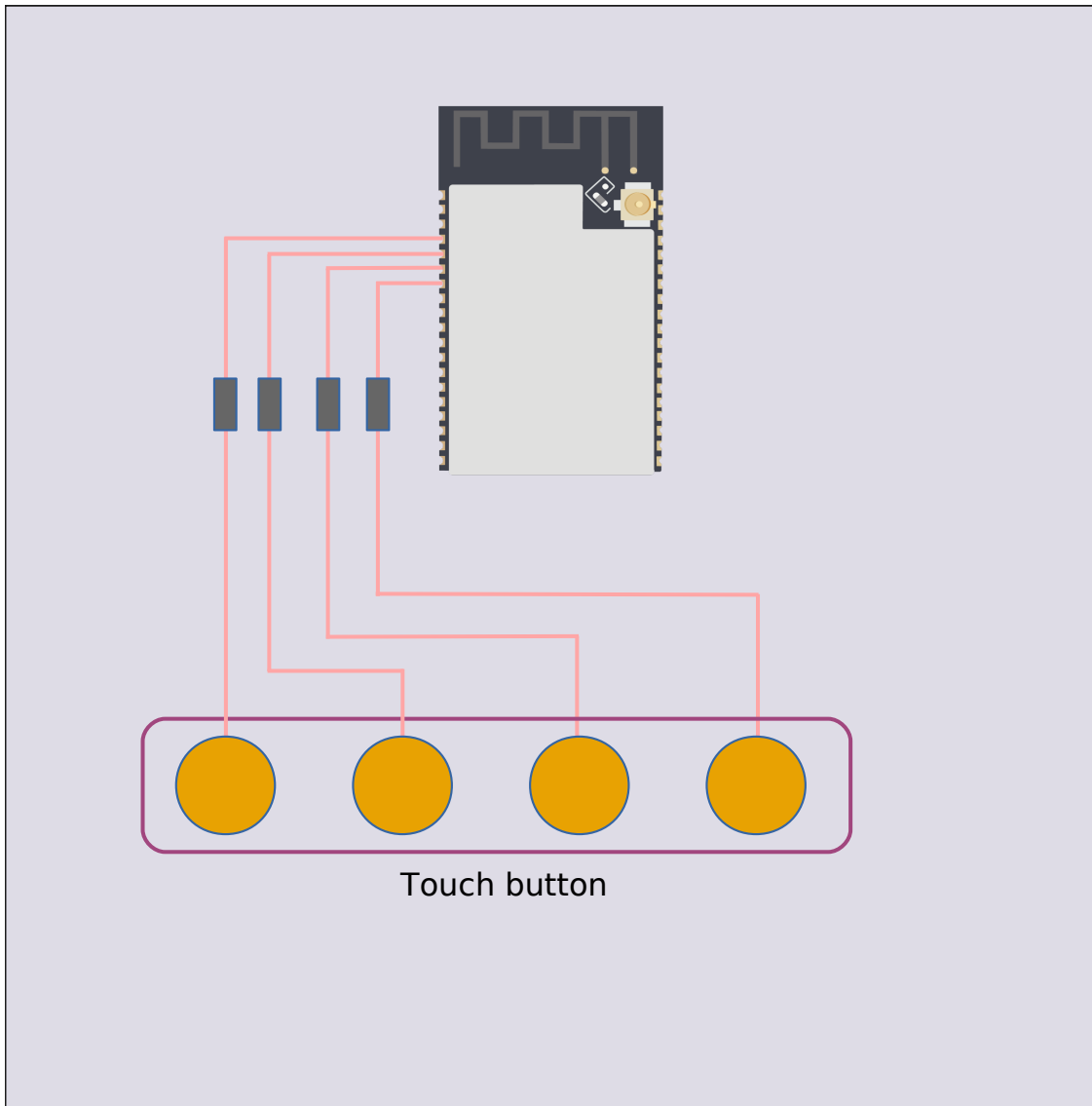

Fig. 21: Touch button



**Touch Slider** Touch slider consumes several channels(at least three channels) of touch sensor, the more channels consumed, the higher resolution and accuracy position it will perform. Touch slider looks like as the picture below:

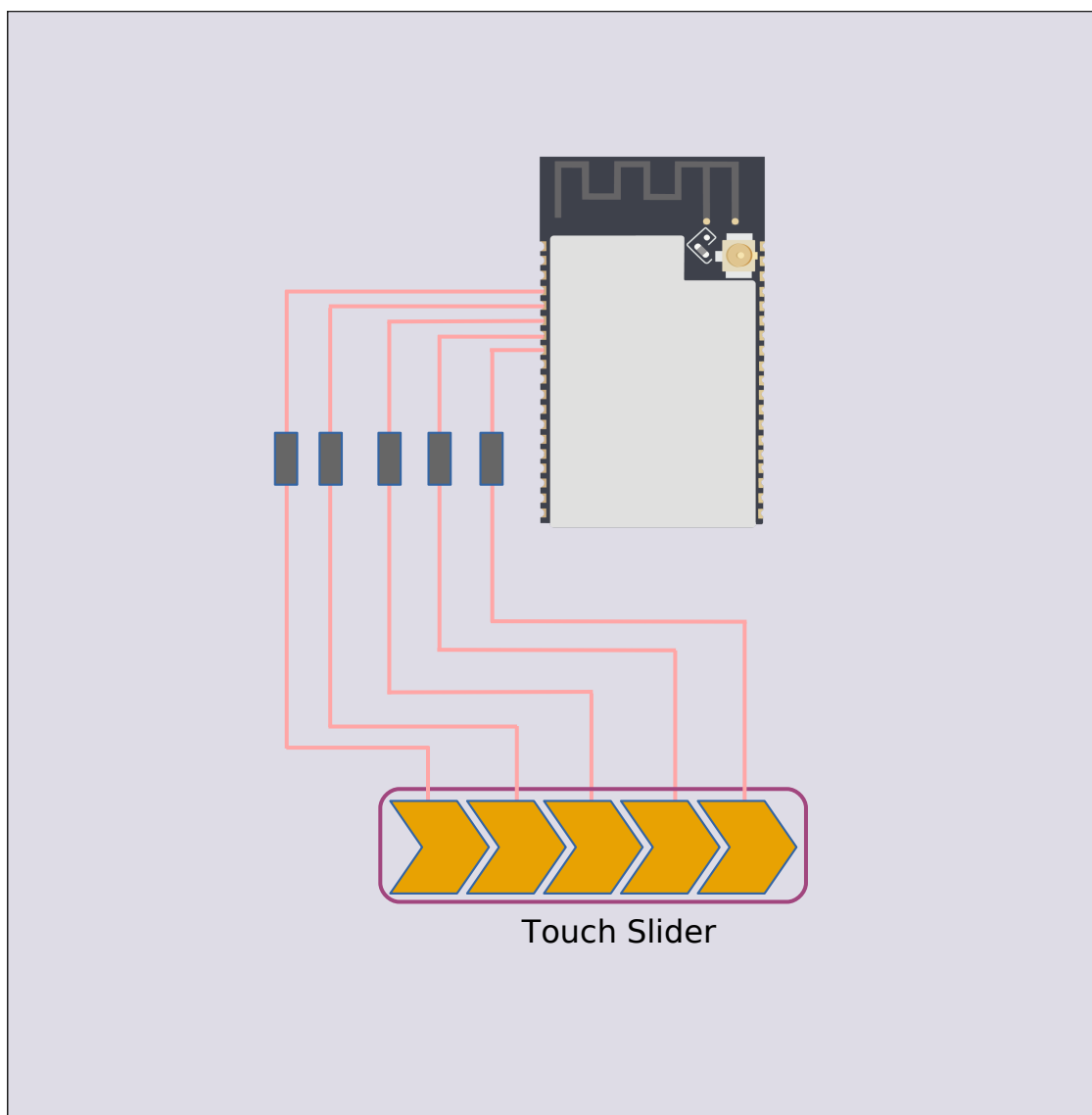

Fig. 22: Touch slider

**Touch Matrix** Touch matrix button consumes several channels(at least  $2 + 2 = 4$  channels), it gives a solution to use fewer channels and get more buttons. ESP32-S2 supports up to 49 buttons. Touch matrix button looks like as the picture below:

### Touch Element Library Usage

Using this library should follow the initialization flow below:

1. To initialize Touch Element library by calling `touch_element_install()`
2. To initialize touch elements(button/slider etc) by calling `touch_xxxx_install()`
3. To create a new element instance by calling `touch_xxxx_create()`
4. To subscribe events by calling `touch_xxxx_subscribe_event()`
5. To choose a dispatch method by calling `touch_xxxx_set_dispatch_method()` that tells the library how to notify you while the subscribed event occur
6. (If dispatch by callback) Call `touch_xxxx_set_callback()` to set the event handler function.

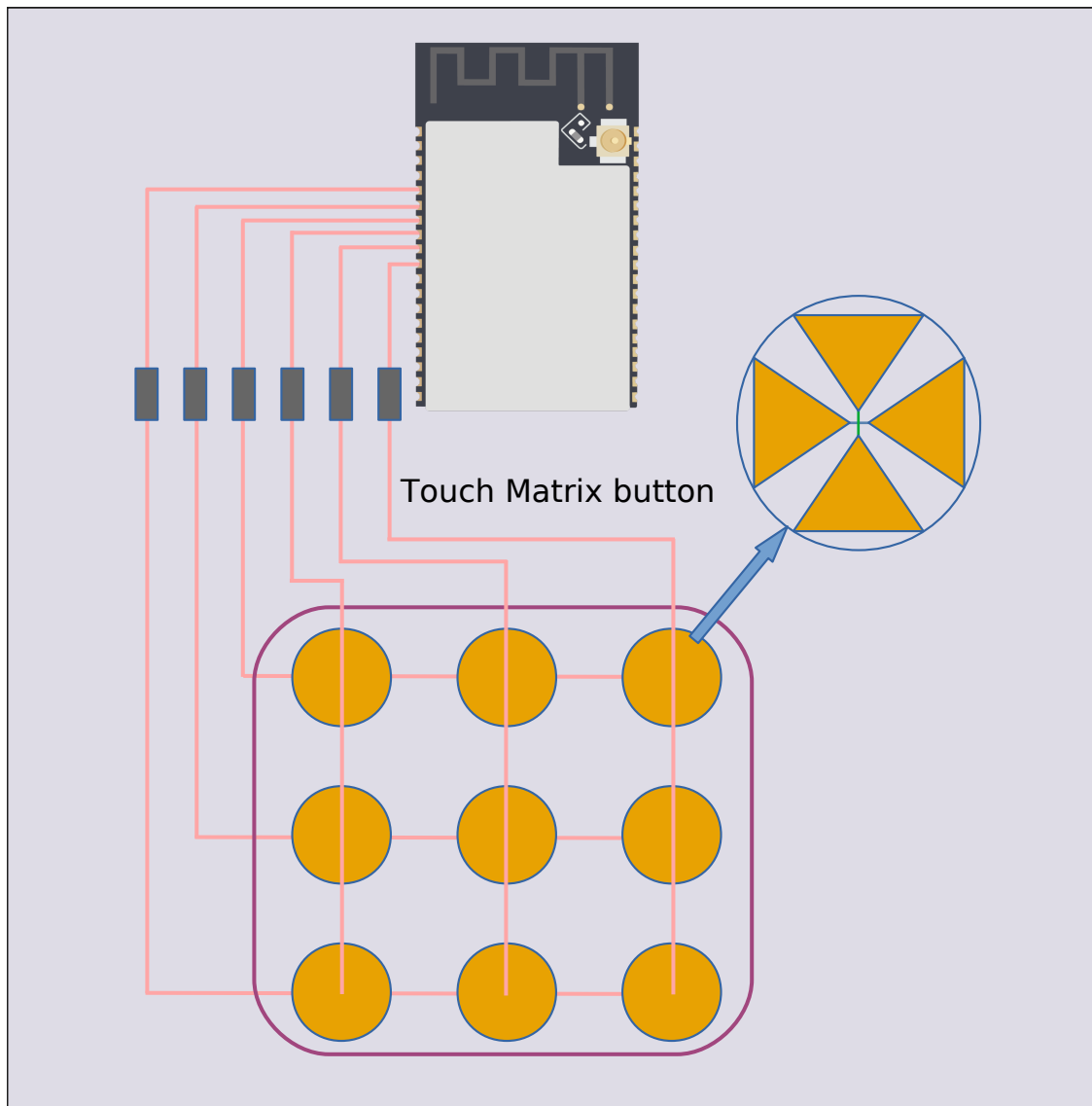

Fig. 23: Touch matrix

7. To start Touch Element library by calling `touch_element_start()`
8. (If dispatch by callback) The callback will be called by the driver core when event happen, no need to do anything; (If dispatch by event task) create an event task and call `touch_element_message_receive()` to obtain messages in a loop.
9. [Optional] If user wants to suspend the Touch Element run-time system or for some reason that could not obtain the touch element message, `touch_element_stop()` should be called to suspend the Touch Element system and then resume it by calling `touch_element_start()` again.

In code, the flow above may look like as follows:

```

static touch_xxx_handle_t element_handle; //Declare a touch element handle

//Define the subscribed event handler
void event_handler(touch_xxx_handle_t out_handle, touch_xxx_message_t out_message,
↳void *arg)
{
    //Event handler logic
}

void app_main()
{
    //Using the default initializer to config Touch Element library
    touch_elem_global_config_t global_config = TOUCH_ELEM_GLOBAL_DEFAULT_CONFIG();
    touch_element_install(&global_config);

    //Using the default initializer to config Touch elements
    touch_xxx_global_config_t elem_global_config = TOUCH_XXXX_GLOBAL_DEFAULT_
↳CONFIG();
    touch_xxx_install(&elem_global_config);

    //Create a new instance
    touch_xxx_config_t element_config = {
        ...
        ...
    };
    touch_xxx_create(&element_config, &element_handle);

    //Subscribe the specified events by using the event mask
    touch_xxx_subscribe_event(element_handle, TOUCH_ELEM_EVENT_ON_PRESS | TOUCH_
↳ELEM_EVENT_ON_RELEASE, NULL);

    //Choose CALLBACK as the dispatch method
    touch_xxx_set_dispatch_method(element_handle, TOUCH_ELEM_DISP_CALLBACK);

    //Register the callback routine
    touch_xxx_set_callback(element_handle, event_handler);

    //Start Touch Element library processing
    touch_element_start();
}

```

### Initialization

1. To initialize Touch Element library, user has to configure touch sensor peripheral and Touch Element library by calling `touch_element_install()` with `touch_elem_global_config_t`, the default initializer is available in `TOUCH_ELEM_GLOBAL_DEFAULT_CONFIG()` and this default configuration is suitable for the most general application scene, and users are suggested not to change the default configuration before fully understanding Touch Sensor peripheral, because some changes might bring several impacts to the system.
2. To initialize the specified element, all the elements will not work before its constructor (`touch_xxxx_install()`) is called so as to save memory, so user has to call the constructor of each used touch element respectively, to set up the specified element.

### Touch Element Instance Startup

1. To create a new touch element instance by calling `touch_xxxx_create()`, selects channel and passes its *Sensitivity* for the new element instance.
2. To subscribe events by calling `touch_xxxx_subscribe_event()`, there several events in Touch Element library and the event mask is available on [components/touch\\_element/include/touch\\_element/touch\\_element.h](#), user could use those events mask to subscribe specified event or combine them to subscribe multiple events.
3. To configure dispatch method by calling `touch_xxxx_subscribe_event()`, there are two dispatch methods in Touch Element library, one is `TOUCH_ELEM_DISP_EVENT`, the other one is `TOUCH_ELEM_DISP_CALLBACK`, it means that user could use two methods to obtain the touch element message and handle it.

**Events Processing** If `TOUCH_ELEM_DISP_EVENT` dispatch method is configured, user need to startup an event handler task to obtain the touch element message, all the elements raw message could be obtained by calling `touch_element_message_receive()`, then extract the element-class-specific message by calling the corresponding message decoder (`touch_xxxx_get_message()`) to get the touch element's extracted message; If `TOUCH_ELEM_DISP_CALLBACK` dispatch method is configured, user need to pass an event handler by calling `touch_xxxx_set_callback()` before the touch elem starts working, all the element's extracted message will be passed to the event handler function.

**Warning:** Since the event handler function runs on the library driver core(The context located in esp-timer callback routine), user should not do something that attempts to block or delay, such as call `vTaskDelay()`.

In code, the events handle procedure may look like as follows:

```

/* ----- TOUCH_ELEM_DISP_EVENT -----
↳----- */
void element_handler_task(void *arg)
{
    touch_elem_message_t element_message;
    while(1) {
        if (touch_element_message_receive(&element_message, Timeout) == ESP_OK) {
            const touch_xxxx_message_t *extracted_message = touch_xxxx_get_
↳message(&element_message); //Decode message
            ... //Event handler logic
        }
    }
}

void app_main()
{
    ...

    touch_xxxx_set_dispatch_method(element_handle, TOUCH_ELEM_DISP_EVENT); //Set_
↳TOUCH_ELEM_DISP_EVENT as the dispatch method
    xTaskCreate(&element_handler_task, "element_handler_task", 2048, NULL, 5, _
↳NULL); //Create a handler task

    ...
}

/* ----- TOUCH_ELEM_DISP_CALLBACK -----
↳----- */

...
/* ----- TOUCH_ELEM_DISP_CALLBACK -----
↳----- */
void element_handler(touch_xxxx_handle_t out_handle, touch_xxxx_message_t out_
↳message, void *arg)
{

```

(continues on next page)

(continued from previous page)

```

    //Event handler logic
}

void app_main()
{
    ...

    touch_xxxx_set_dispatch_method(element_handle, TOUCH_ELEM_DISP_CALLBACK); //
↪Set TOUCH_ELEM_DISP_CALLBACK as the dispatch method
    touch_xxxx_set_callback(element_handle, element_handler); //Register an event_
↪handler function

    ...
}
/* -----
↪----- */

```

### Waterproof Usage

1. To initialize Touch Element waterproof, the waterproof shield sensor is always-on after Touch Element waterproof is initialized, however the waterproof guard sensor is optional, hence if user doesn't need the guard sensor, `TOUCH_WATERPROOF_GUARD_NOUSE` has to be passed to `touch_element_waterproof_install()` by the configuration struct.
2. To associate the touch element with the guard sensor, pass the touch element's handle to the Touch Element waterproof's masked list by calling `touch_element_waterproof_add()`. By associating a touch element with the Guard sensor, the touch element will be disabled when the guard sensor is triggered by a stream of water so as to protect the touch element.

The Touch Element Waterproof example is available in `peripherals/touch_element/touch_element_waterproof` directory.

In code, the waterproof configuration may look like as follows:

```

void app_main()
{
    ...

    touch_xxxx_install(); //Initialize instance (button, slider,
↪etc)
    touch_xxxx_create(&element_handle); //Create a new Touch element

    ...

    touch_element_waterproof_install(); //Initialize Touch Element_
↪waterproof
    touch_element_waterproof_add(element_handle); //Let a element associates_
↪with guard sensor

    ...
}

```

### Application Example

All the Touch Element library examples could be found in the `peripherals/touch_element` directory of ESP-IDF examples.

## API Reference - Touch Element core

### Header File

- `components/touch_element/include/touch_element/touch_element.h`

### Functions

*esp\_err\_t* **touch\_element\_install** (const *touch\_elem\_global\_config\_t* \*global\_config)

Touch element processing initialization.

---

**Note:** To reinitialize the touch element object, call `touch_element_uninstall()` first

---

**Parameters** `global_config` –[in] Global initialization configuration structure

**Returns**

- `ESP_OK`: Successfully initialized
- `ESP_ERR_INVALID_ARG`: Invalid argument
- `ESP_ERR_NO_MEM`: Insufficient memory
- `ESP_ERR_INVALID_STATE`: Touch element is already initialized
- Others: Unknown touch driver layer or lower layer error

*esp\_err\_t* **touch\_element\_start** (void)

Touch element processing start.

This function starts the touch element processing system

---

**Note:** This function must only be called after all the touch element instances finished creating

---

**Returns**

- `ESP_OK`: Successfully started to process
- Others: Unknown touch driver layer or lower layer error

*esp\_err\_t* **touch\_element\_stop** (void)

Touch element processing stop.

This function stops the touch element processing system

---

**Note:** This function must be called before changing the system (hardware, software) parameters

---

**Returns**

- `ESP_OK`: Successfully stopped to process
- Others: Unknown touch driver layer or lower layer error

void **touch\_element\_uninstall** (void)

Release resources allocated using `touch_element_install`.

*esp\_err\_t* **touch\_element\_message\_receive** (*touch\_elem\_message\_t* \*element\_message, uint32\_t ticks\_to\_wait)

Get current event message of touch element instance.

This function will receive the touch element message (handle, event type, etc…) from `te_event_give()`. It will block until a touch element event or a timeout occurs.

**Parameters**

- `element_message` –[out] Touch element event message structure
- `ticks_to_wait` –[in] Number of FreeRTOS ticks to block for waiting event

**Returns**

- ESP\_OK: Successfully received touch element event
- ESP\_ERR\_INVALID\_STATE: Touch element library is not initialized
- ESP\_ERR\_INVALID\_ARG: `element_message` is null
- ESP\_ERR\_TIMEOUT: Timed out waiting for event

*esp\_err\_t* **touch\_element\_waterproof\_install** (const *touch\_elem\_waterproof\_config\_t* \*`waterproof_config`)

Touch element waterproof initialization.

This function enables the hardware waterproof, then touch element system uses Shield-Sensor and Guard-Sensor to mitigate the influence of water-drop and water-stream.

---

**Note:** If the waterproof function is used, Shield-Sensor can not be disabled and it will use channel 14 as it's internal channel. Hence, the user can not use channel 14 for another propose. And the Guard-Sensor is not necessary since it is optional.

---

---

**Note:** Shield-Sensor: It always uses channel 14 as the shield channel, so user must connect the channel 14 and Shield-Layer in PCB since it will generate a synchronous signal automatically

---

---

**Note:** Guard-Sensor: This function is optional. If used, the user must connect the guard channel and Guard-Ring in PCB. Any channels user wants to protect should be added into Guard-Ring in PCB.

---

**Parameters** `waterproof_config` **–[in]** Waterproof configuration

**Returns**

- ESP\_OK: Successfully initialized
- ESP\_ERR\_INVALID\_STATE: Touch element library is not initialized
- ESP\_ERR\_INVALID\_ARG: `waterproof_config` is null or invalid Guard-Sensor channel
- ESP\_ERR\_NO\_MEM: Insufficient memory

void **touch\_element\_waterproof\_uninstall** (void)

Release resources allocated using `touch_element_waterproof_install()`

*esp\_err\_t* **touch\_element\_waterproof\_add** (*touch\_elem\_handle\_t* `element_handle`)

Add a masked handle to protect while Guard-Sensor has been triggered.

This function will add an application handle (button, slider, etc...) as a masked handle. While Guard-Sensor has been triggered, waterproof function will start working and lock the application internal state. While the influence of water is reduced, the application will be unlock and reset into IDLE state.

---

**Note:** The waterproof protection logic must follow the real circuit in PCB, it means that all of the channels inside the input handle must be inside the Guard-Ring in real circuit.

---

**Parameters** `element_handle` **–[in]** Touch element instance handle

**Returns**

- ESP\_OK: Successfully added a masked handle
- ESP\_ERR\_INVALID\_STATE: Waterproof is not initialized
- ESP\_ERR\_INVALID\_ARG: `element_handle` is null

*esp\_err\_t* **touch\_element\_waterproof\_remove** (*touch\_elem\_handle\_t* `element_handle`)

Remove a masked handle to protect.

This function will remove an application handle from masked handle table.

**Parameters** `element_handle` –[in] Touch element instance handle

**Returns**

- `ESP_OK`: Successfully removed a masked handle
- `ESP_ERR_INVALID_STATE`: Waterproof is not initialized
- `ESP_ERR_INVALID_ARG`: `element_handle` is null
- `ESP_ERR_NOT_FOUND`: Failed to search `element_handle` from `waterproof_mask_handle` list

## Structures

struct `touch_elem_sw_config_t`

Touch element software configuration.

### Public Members

float `waterproof_threshold_divider`

Waterproof guard channel threshold divider.

uint8\_t `processing_period`

Processing period(ms)

uint8\_t `intr_message_size`

Interrupt message queue size.

uint8\_t `event_message_size`

Event message queue size.

struct `touch_elem_hw_config_t`

Touch element hardware configuration.

### Public Members

*touch\_high\_volt\_t* `upper_voltage`

Touch sensor channel upper charge voltage.

*touch\_volt\_atten\_t* `voltage_attenuation`

Touch sensor channel upper charge voltage attenuation (Diff voltage is upper - attenuation - lower)

*touch\_low\_volt\_t* `lower_voltage`

Touch sensor channel lower charge voltage.

*touch\_pad\_conn\_type\_t* `suspend_channel_polarity`

Suspend channel polarity (High Impedance State or GND)

*touch\_pad\_denoise\_grade\_t* `denoise_level`

Internal de-noise level.

*touch\_pad\_denoise\_cap\_t* `denoise_equivalent_cap`

Internal de-noise channel (Touch channel 0) equivalent capacitance.



*touch\_smooth\_mode\_t* **smooth\_filter\_mode**

Smooth value filter mode (This only apply to touch\_pad\_filter\_read\_smooth())

*touch\_filter\_mode\_t* **benchmark\_filter\_mode**

Benchmark filter mode.

uint16\_t **sample\_count**

The count of sample in each measurement of touch sensor.

uint16\_t **sleep\_cycle**

The cycle (RTC slow clock) of sleep.

uint8\_t **benchmark\_debounce\_count**

Benchmark debounce count.

uint8\_t **benchmark\_calibration\_threshold**

Benchmark calibration threshold.

uint8\_t **benchmark\_jitter\_step**

Benchmark jitter filter step (This only works at while benchmark filter mode is jitter filter)

struct **touch\_elem\_global\_config\_t**

Touch element global configuration passed to touch\_element\_install.

### Public Members

*touch\_elem\_hw\_config\_t* **hardware**

Hardware configuration.

*touch\_elem\_sw\_config\_t* **software**

Software configuration.

struct **touch\_elem\_waterproof\_config\_t**

Touch element waterproof configuration passed to touch\_element\_waterproof\_install.

### Public Members

*touch\_pad\_t* **guard\_channel**

Waterproof Guard-Sensor channel number (index)

float **guard\_sensitivity**

Waterproof Guard-Sensor sensitivity.

struct **touch\_elem\_message\_t**

Touch element event message type from touch\_element\_message\_receive()

## Public Members

*touch\_elem\_handle\_t* **handle**

Touch element handle.

*touch\_elem\_type\_t* **element\_type**

Touch element type.

void **\*arg**

User input argument.

uint8\_t **child\_msg[8]**

Encoded message.

## Macros

**TOUCH\_ELEM\_GLOBAL\_DEFAULT\_CONFIG()**

**TOUCH\_ELEM\_EVENT\_NONE**

None event.

**TOUCH\_ELEM\_EVENT\_ON\_PRESS**

On Press event.

**TOUCH\_ELEM\_EVENT\_ON\_RELEASE**

On Release event.

**TOUCH\_ELEM\_EVENT\_ON\_LONGPRESS**

On LongPress event.

**TOUCH\_ELEM\_EVENT\_ON\_CALCULATION**

On Calculation event.

**TOUCH\_WATERPROOF\_GUARD\_NOUSE**

Waterproof no use guard sensor.

## Type Definitions

typedef void **\*touch\_elem\_handle\_t**

Touch element handle type.

typedef uint32\_t **touch\_elem\_event\_t**

Touch element event type.

## Enumerations

enum **touch\_elem\_type\_t**

Touch element handle type.

*Values:*

enumerator **TOUCH\_ELEM\_TYPE\_BUTTON**

Touch element button.

enumerator **TOUCH\_ELEM\_TYPE\_SLIDER**

Touch element slider.

enumerator **TOUCH\_ELEM\_TYPE\_MATRIX**

Touch element matrix button.

enum **touch\_elem\_dispatch\_t**

Touch element event dispatch methods (event queue/callback)

*Values:*

enumerator **TOUCH\_ELEM\_DISP\_EVENT**

Event queue dispatch.

enumerator **TOUCH\_ELEM\_DISP\_CALLBACK**

Callback dispatch.

enumerator **TOUCH\_ELEM\_DISP\_MAX**

## API Reference - Touch Button

### Header File

- [components/touch\\_element/include/touch\\_element/touch\\_button.h](#)

### Functions

*esp\_err\_t* **touch\_button\_install** (const *touch\_button\_global\_config\_t* \*global\_config)

Touch Button initialize.

This function initializes touch button global and acts on all touch button instances.

**Parameters** *global\_config* –[in] Button object initialization configuration

**Returns**

- ESP\_OK: Successfully initialized touch button
- ESP\_ERR\_INVALID\_STATE: Touch element library was not initialized
- ESP\_ERR\_INVALID\_ARG: button\_init is NULL
- ESP\_ERR\_NO\_MEM: Insufficient memory

void **touch\_button\_uninstall** (void)

Release resources allocated using touch\_button\_install()

*esp\_err\_t* **touch\_button\_create** (const *touch\_button\_config\_t* \*button\_config, *touch\_button\_handle\_t* \*button\_handle)

Create a new touch button instance.

---

**Note:** The sensitivity has to be explored in experiments, Sensitivity = (Raw(touch) - Raw(release)) / Raw(release) \* 100%

---

### Parameters

- **button\_config** –[in] Button configuration
- **button\_handle** –[out] Button handle

**Returns**

- ESP\_OK: Successfully create touch button
- ESP\_ERR\_INVALID\_STATE: Touch button driver was not initialized
- ESP\_ERR\_NO\_MEM: Insufficient memory
- ESP\_ERR\_INVALID\_ARG: Invalid configuration struct or arguments is NULL

*esp\_err\_t* **touch\_button\_delete** (*touch\_button\_handle\_t* button\_handle)

Release resources allocated using touch\_button\_create()

**Parameters** **button\_handle** –[in] Button handle

**Returns**

- ESP\_OK: Successfully released resources
- ESP\_ERR\_INVALID\_STATE: Touch button driver was not initialized
- ESP\_ERR\_INVALID\_ARG: button\_handle is null
- ESP\_ERR\_NOT\_FOUND: Input handle is not a button handle

*esp\_err\_t* **touch\_button\_subscribe\_event** (*touch\_button\_handle\_t* button\_handle, uint32\_t event\_mask, void \*arg)

Touch button subscribes event.

This function uses event mask to subscribe to touch button events, once one of the subscribed events occurs, the event message could be retrieved by calling touch\_element\_message\_receive() or input callback routine.

---

**Note:** Touch button only support three kind of event masks, they are TOUCH\_ELEM\_EVENT\_ON\_PRESS, TOUCH\_ELEM\_EVENT\_ON\_RELEASE, TOUCH\_ELEM\_EVENT\_ON\_LONGPRESS. You can use those event masks in any combination to achieve the desired effect.

---

**Parameters**

- **button\_handle** –[in] Button handle
- **event\_mask** –[in] Button subscription event mask
- **arg** –[in] User input argument

**Returns**

- ESP\_OK: Successfully subscribed touch button event
- ESP\_ERR\_INVALID\_STATE: Touch button driver was not initialized
- ESP\_ERR\_INVALID\_ARG: button\_handle is null or event is not supported

*esp\_err\_t* **touch\_button\_set\_dispatch\_method** (*touch\_button\_handle\_t* button\_handle, *touch\_elem\_dispatch\_t* dispatch\_method)

Touch button set dispatch method.

This function sets a dispatch method that the driver core will use this method as the event notification method.

**Parameters**

- **button\_handle** –[in] Button handle
- **dispatch\_method** –[in] Dispatch method (By callback/event)

**Returns**

- ESP\_OK: Successfully set dispatch method
- ESP\_ERR\_INVALID\_STATE: Touch button driver was not initialized
- ESP\_ERR\_INVALID\_ARG: button\_handle is null or dispatch\_method is invalid

*esp\_err\_t* **touch\_button\_set\_callback** (*touch\_button\_handle\_t* button\_handle, *touch\_button\_callback\_t* button\_callback)

Touch button set callback.

This function sets a callback routine into touch element driver core, when the subscribed events occur, the callback routine will be called.

---

**Note:** Button message will be passed from the callback function and it will be destroyed when the callback function return.

---

**Warning:** Since this input callback routine runs on driver core (esp-timer callback routine), it should not do something that attempts to Block, such as calling `vTaskDelay()`.

#### Parameters

- **button\_handle** –[in] Button handle
- **button\_callback** –[in] User input callback

#### Returns

- ESP\_OK: Successfully set callback
- ESP\_ERR\_INVALID\_STATE: Touch button driver was not initialized
- ESP\_ERR\_INVALID\_ARG: button\_handle or button\_callback is null

*esp\_err\_t* **touch\_button\_set\_longpress** (*touch\_button\_handle\_t* button\_handle, uint32\_t threshold\_time)

Touch button set long press trigger time.

This function sets the threshold time (ms) for a long press event. If a button is pressed and held for a period of time that exceeds the threshold time, a long press event is triggered.

#### Parameters

- **button\_handle** –[in] Button handle
- **threshold\_time** –[in] Threshold time (ms) of long press event occur

#### Returns

- ESP\_OK: Successfully set the threshold time of long press event
- ESP\_ERR\_INVALID\_STATE: Touch button driver was not initialized
- ESP\_ERR\_INVALID\_ARG: button\_handle is null or time (ms) is not lager than 0

const *touch\_button\_message\_t* \***touch\_button\_get\_message** (const *touch\_elem\_message\_t* \*element\_message)

Touch button get message.

This function decodes the element message from `touch_element_message_receive()` and return a button message pointer.

**Parameters** **element\_message** –[in] element message

**Returns** Touch button message pointer

## Structures

struct **touch\_button\_global\_config\_t**

Button initialization configuration passed to `touch_button_install`.

### Public Members

float **threshold\_divider**

Button channel threshold divider.

uint32\_t **default\_lp\_time**

Button default LongPress event time (ms)

struct **touch\_button\_config\_t**

Button configuration (for new instance) passed to `touch_button_create()`

## Public Members

*touch\_pad\_t* **channel\_num**

Button channel number (index)

float **channel\_sens**

Button channel sensitivity.

struct **touch\_button\_message\_t**

Button message type.

## Public Members

*touch\_button\_event\_t* **event**

Button event.

## Macros

**TOUCH\_BUTTON\_GLOBAL\_DEFAULT\_CONFIG()**

## Type Definitions

typedef *touch\_elem\_handle\_t* **touch\_button\_handle\_t**

Button handle.

typedef void (\***touch\_button\_callback\_t**)(*touch\_button\_handle\_t*, *touch\_button\_message\_t*\*, void\*)

Button callback type.

## Enumerations

enum **touch\_button\_event\_t**

Button event type.

*Values:*

enumerator **TOUCH\_BUTTON\_EVT\_ON\_PRESS**

Button Press event.

enumerator **TOUCH\_BUTTON\_EVT\_ON\_RELEASE**

Button Release event.

enumerator **TOUCH\_BUTTON\_EVT\_ON\_LONGPRESS**

Button LongPress event.

enumerator **TOUCH\_BUTTON\_EVT\_MAX**

## API Reference - Touch Slider

### Header File

- [components/touch\\_element/include/touch\\_element/touch\\_slider.h](#)

## Functions

*esp\_err\_t* **touch\_slider\_install** (const *touch\_slider\_global\_config\_t* \*global\_config)

Touch slider initialize.

This function initializes touch slider object and acts on all touch slider instances.

**Parameters** *global\_config* –[in] Touch slider global initialization configuration

**Returns**

- ESP\_OK: Successfully initialized touch slider
- ESP\_ERR\_INVALID\_STATE: Touch element library was not initialized
- ESP\_ERR\_INVALID\_ARG: slider\_init is NULL
- ESP\_ERR\_NO\_MEM: Insufficient memory

void **touch\_slider\_uninstall** (void)

Release resources allocated using touch\_slider\_install()

*esp\_err\_t* **touch\_slider\_create** (const *touch\_slider\_config\_t* \*slider\_config, *touch\_slider\_handle\_t* \*slider\_handle)

Create a new touch slider instance.

---

**Note:** The index of Channel array and sensitivity array must be one-one correspondence

---

**Parameters**

- *slider\_config* –[in] Slider configuration
- *slider\_handle* –[out] Slider handle

**Returns**

- ESP\_OK: Successfully create touch slider
- ESP\_ERR\_INVALID\_STATE: Touch slider driver was not initialized
- ESP\_ERR\_INVALID\_ARG: Invalid configuration struct or arguments is NULL
- ESP\_ERR\_NO\_MEM: Insufficient memory

*esp\_err\_t* **touch\_slider\_delete** (*touch\_slider\_handle\_t* slider\_handle)

Release resources allocated using touch\_slider\_create.

**Parameters** *slider\_handle* –[in] Slider handle

**Returns**

- ESP\_OK: Successfully released resources
- ESP\_ERR\_INVALID\_STATE: Touch slider driver was not initialized
- ESP\_ERR\_INVALID\_ARG: slider\_handle is null
- ESP\_ERR\_NOT\_FOUND: Input handle is not a slider handle

*esp\_err\_t* **touch\_slider\_subscribe\_event** (*touch\_slider\_handle\_t* slider\_handle, uint32\_t event\_mask, void \*arg)

Touch slider subscribes event.

This function uses event mask to subscribe to touch slider events, once one of the subscribed events occurs, the event message could be retrieved by calling touch\_element\_message\_receive() or input callback routine.

---

**Note:** Touch slider only support three kind of event masks, they are TOUCH\_ELEM\_EVENT\_ON\_PRESS, TOUCH\_ELEM\_EVENT\_ON\_RELEASE. You can use those event masks in any combination to achieve the desired effect.

---

**Parameters**

- *slider\_handle* –[in] Slider handle
- *event\_mask* –[in] Slider subscription event mask
- *arg* –[in] User input argument

**Returns**

- ESP\_OK: Successfully subscribed touch slider event

- `ESP_ERR_INVALID_STATE`: Touch slider driver was not initialized
- `ESP_ERR_INVALID_ARG`: `slider_handle` is null or event is not supported

`esp_err_t touch_slider_set_dispatch_method` (`touch_slider_handle_t` slider\_handle, `touch_elem_dispatch_t` dispatch\_method)

Touch slider set dispatch method.

This function sets a dispatch method that the driver core will use this method as the event notification method.

#### Parameters

- `slider_handle` –[in] Slider handle
- `dispatch_method` –[in] Dispatch method (By callback/event)

#### Returns

- `ESP_OK`: Successfully set dispatch method
- `ESP_ERR_INVALID_STATE`: Touch slider driver was not initialized
- `ESP_ERR_INVALID_ARG`: `slider_handle` is null or `dispatch_method` is invalid

`esp_err_t touch_slider_set_callback` (`touch_slider_handle_t` slider\_handle, `touch_slider_callback_t` slider\_callback)

Touch slider set callback.

This function sets a callback routine into touch element driver core, when the subscribed events occur, the callback routine will be called.

---

**Note:** Slider message will be passed from the callback function and it will be destroyed when the callback function return.

---

**Warning:** Since this input callback routine runs on driver core (esp-timer callback routine), it should not do something that attempts to Block, such as calling `vTaskDelay()`.

#### Parameters

- `slider_handle` –[in] Slider handle
- `slider_callback` –[in] User input callback

#### Returns

- `ESP_OK`: Successfully set callback
- `ESP_ERR_INVALID_STATE`: Touch slider driver was not initialized
- `ESP_ERR_INVALID_ARG`: `slider_handle` or `slider_callback` is null

const `touch_slider_message_t` \*`touch_slider_get_message` (const `touch_elem_message_t` \*element\_message)

Touch slider get message.

This function decodes the element message from `touch_element_message_receive()` and return a slider message pointer.

**Parameters** `element_message` –[in] element message

**Returns** Touch slider message pointer

## Structures

struct `touch_slider_global_config_t`

Slider initialization configuration passed to `touch_slider_install`.

## Public Members



float **quantify\_lower\_threshold**  
Slider signal quantification threshold.

float **threshold\_divider**  
Slider channel threshold divider.

uint16\_t **filter\_reset\_time**  
Slider position filter reset time (Unit is esp\_timer callback tick)

uint16\_t **benchmark\_update\_time**  
Slider benchmark update time (Unit is esp\_timer callback tick)

uint8\_t **position\_filter\_size**  
Moving window filter buffer size.

uint8\_t **position\_filter\_factor**  
One-order IIR filter factor.

uint8\_t **calculate\_channel\_count**  
The number of channels which will take part in calculation.

struct **touch\_slider\_config\_t**  
Slider configuration (for new instance) passed to touch\_slider\_create()

### Public Members

const *touch\_pad\_t* \***channel\_array**  
Slider channel array.

const float \***sensitivity\_array**  
Slider channel sensitivity array.

uint8\_t **channel\_num**  
The number of slider channels.

uint8\_t **position\_range**  
The right region of touch slider position range, [0, position\_range (less than or equal to 255)].

struct **touch\_slider\_message\_t**  
Slider message type.

### Public Members

*touch\_slider\_event\_t* **event**  
Slider event.

*touch\_slider\_position\_t* **position**  
Slider position.

## Macros

`TOUCH_SLIDER_GLOBAL_DEFAULT_CONFIG()`

## Type Definitions

`typedef uint32_t touch_slider_position_t`

Slider position data type.

`typedef touch_elem_handle_t touch_slider_handle_t`

Slider instance handle.

`typedef void (*touch_slider_callback_t)(touch_slider_handle_t, touch_slider_message_t*, void*)`

Slider callback type.

## Enumerations

`enum touch_slider_event_t`

Slider event type.

*Values:*

enumerator `TOUCH_SLIDER_EVT_ON_PRESS`

Slider on Press event.

enumerator `TOUCH_SLIDER_EVT_ON_RELEASE`

Slider on Release event.

enumerator `TOUCH_SLIDER_EVT_ON_CALCULATION`

Slider on Calculation event.

enumerator `TOUCH_SLIDER_EVT_MAX`

## API Reference - Touch Matrix

### Header File

- [components/touch\\_element/include/touch\\_element/touch\\_matrix.h](#)

### Functions

`esp_err_t touch_matrix_install` (const [touch\\_matrix\\_global\\_config\\_t](#) \*global\_config)

Touch matrix button initialize.

This function initializes touch matrix button object and acts on all touch matrix button instances.

**Parameters** `global_config` –[in] Touch matrix global initialization configuration

#### Returns

- `ESP_OK`: Successfully initialized touch matrix button
- `ESP_ERR_INVALID_STATE`: Touch element library was not initialized
- `ESP_ERR_INVALID_ARG`: `matrix_init` is NULL
- `ESP_ERR_NO_MEM`: Insufficient memory

`void touch_matrix_uninstall` (void)

Release resources allocated using `touch_matrix_install()`

*esp\_err\_t* **touch\_matrix\_create** (const *touch\_matrix\_config\_t* \*matrix\_config, *touch\_matrix\_handle\_t* \*matrix\_handle)

Create a new touch matrix button instance.

---

**Note:** Channel array and sensitivity array must be one-one correspondence in those array

---

---

**Note:** Touch matrix button does not support Multi-Touch now

---

#### Parameters

- **matrix\_config** –[in] Matrix button configuration
- **matrix\_handle** –[out] Matrix button handle

#### Returns

- ESP\_OK: Successfully create touch matrix button
- ESP\_ERR\_INVALID\_STATE: Touch matrix driver was not initialized
- ESP\_ERR\_INVALID\_ARG: Invalid configuration struct or arguments is NULL
- ESP\_ERR\_NO\_MEM: Insufficient memory

*esp\_err\_t* **touch\_matrix\_delete** (*touch\_matrix\_handle\_t* matrix\_handle)

Release resources allocated using touch\_matrix\_create()

**Parameters** **matrix\_handle** –[in] Matrix handle

#### Returns

- ESP\_OK: Successfully released resources
- ESP\_ERR\_INVALID\_STATE: Touch matrix driver was not initialized
- ESP\_ERR\_INVALID\_ARG: matrix\_handle is null
- ESP\_ERR\_NOT\_FOUND: Input handle is not a matrix handle

*esp\_err\_t* **touch\_matrix\_subscribe\_event** (*touch\_matrix\_handle\_t* matrix\_handle, uint32\_t event\_mask, void \*arg)

Touch matrix button subscribes event.

This function uses event mask to subscribe to touch matrix events, once one of the subscribed events occurs, the event message could be retrieved by calling touch\_element\_message\_receive() or input callback routine.

---

**Note:** Touch matrix button only support three kind of event masks, they are TOUCH\_ELEM\_EVENT\_ON\_PRESS, TOUCH\_ELEM\_EVENT\_ON\_RELEASE, TOUCH\_ELEM\_EVENT\_ON\_LONGPRESS. You can use those event masks in any combination to achieve the desired effect.

---

#### Parameters

- **matrix\_handle** –[in] Matrix handle
- **event\_mask** –[in] Matrix subscription event mask
- **arg** –[in] User input argument

#### Returns

- ESP\_OK: Successfully subscribed touch matrix event
- ESP\_ERR\_INVALID\_STATE: Touch matrix driver was not initialized
- ESP\_ERR\_INVALID\_ARG: matrix\_handle is null or event is not supported

*esp\_err\_t* **touch\_matrix\_set\_dispatch\_method** (*touch\_matrix\_handle\_t* matrix\_handle, *touch\_elem\_dispatch\_t* dispatch\_method)

Touch matrix button set dispatch method.

This function sets a dispatch method that the driver core will use this method as the event notification method.

#### Parameters

- **matrix\_handle** –[in] Matrix button handle
- **dispatch\_method** –[in] Dispatch method (By callback/event)

**Returns**

- ESP\_OK: Successfully set dispatch method
- ESP\_ERR\_INVALID\_STATE: Touch matrix driver was not initialized
- ESP\_ERR\_INVALID\_ARG: matrix\_handle is null or dispatch\_method is invalid

*esp\_err\_t* **touch\_matrix\_set\_callback** (*touch\_matrix\_handle\_t* matrix\_handle, *touch\_matrix\_callback\_t* matrix\_callback)

Touch matrix button set callback.

This function sets a callback routine into touch element driver core, when the subscribed events occur, the callback routine will be called.

---

**Note:** Matrix message will be passed from the callback function and it will be destroyed when the callback function return.

---

**Warning:** Since this input callback routine runs on driver core (esp-timer callback routine), it should not do something that attempts to Block, such as calling vTaskDelay().

**Parameters**

- **matrix\_handle** –[in] Matrix button handle
- **matrix\_callback** –[in] User input callback

**Returns**

- ESP\_OK: Successfully set callback
- ESP\_ERR\_INVALID\_STATE: Touch matrix driver was not initialized
- ESP\_ERR\_INVALID\_ARG: matrix\_handle or matrix\_callback is null

*esp\_err\_t* **touch\_matrix\_set\_longpress** (*touch\_matrix\_handle\_t* matrix\_handle, uint32\_t threshold\_time)

Touch matrix button set long press trigger time.

This function sets the threshold time (ms) for a long press event. If a matrix button is pressed and held for a period of time that exceeds the threshold time, a long press event is triggered.

**Parameters**

- **matrix\_handle** –[in] Matrix button handle
- **threshold\_time** –[in] Threshold time (ms) of long press event occur

**Returns**

- ESP\_OK: Successfully set the time of long press event
- ESP\_ERR\_INVALID\_STATE: Touch matrix driver was not initialized
- ESP\_ERR\_INVALID\_ARG: matrix\_handle is null or time (ms) is 0

const *touch\_matrix\_message\_t* \***touch\_matrix\_get\_message** (const *touch\_elem\_message\_t* \*element\_message)

Touch matrix get message.

This function decodes the element message from touch\_element\_message\_receive() and return a matrix message pointer.

**Parameters** **element\_message** –[in] element message

**Returns** Touch matrix message pointer

**Structures**

struct **touch\_matrix\_global\_config\_t**

Matrix button initialization configuration passed to touch\_matrix\_install.

### Public Members

float **threshold\_divider**

Matrix button channel threshold divider.

uint32\_t **default\_lp\_time**

Matrix button default LongPress event time (ms)

struct **touch\_matrix\_config\_t**

Matrix button configuration (for new instance) passed to touch\_matrix\_create()

### Public Members

const *touch\_pad\_t* \***x\_channel\_array**

Matrix button x-axis channels array.

const *touch\_pad\_t* \***y\_channel\_array**

Matrix button y-axis channels array.

const float \***x\_sensitivity\_array**

Matrix button x-axis channels sensitivity array.

const float \***y\_sensitivity\_array**

Matrix button y-axis channels sensitivity array.

uint8\_t **x\_channel\_num**

The number of channels in x-axis.

uint8\_t **y\_channel\_num**

The number of channels in y-axis.

struct **touch\_matrix\_position\_t**

Matrix button position data type.

### Public Members

uint8\_t **x\_axis**

Matrix button x axis position.

uint8\_t **y\_axis**

Matrix button y axis position.

uint8\_t **index**

Matrix button position index.

struct **touch\_matrix\_message\_t**

Matrix message type.

## Public Members

*touch\_matrix\_event\_t* **event**

Matrix event.

*touch\_matrix\_position\_t* **position**

Matrix position.

## Macros

**TOUCH\_MATRIX\_GLOBAL\_DEFAULT\_CONFIG** ()

## Type Definitions

typedef *touch\_elem\_handle\_t* **touch\_matrix\_handle\_t**

Matrix button instance handle.

typedef void (\***touch\_matrix\_callback\_t**)(*touch\_matrix\_handle\_t*, *touch\_matrix\_message\_t*\*, void\*)

Matrix button callback type.

## Enumerations

enum **touch\_matrix\_event\_t**

Matrix button event type.

*Values:*

enumerator **TOUCH\_MATRIX\_EVT\_ON\_PRESS**

Matrix button Press event.

enumerator **TOUCH\_MATRIX\_EVT\_ON\_RELEASE**

Matrix button Press event.

enumerator **TOUCH\_MATRIX\_EVT\_ON\_LONGPRESS**

Matrix button LongPress event.

enumerator **TOUCH\_MATRIX\_EVT\_MAX**

## 2.5.25 Two-Wire Automotive Interface (TWAI)

### Overview

The Two-Wire Automotive Interface (TWAI) is a real-time serial communication protocol suited for automotive and industrial applications. It is compatible with ISO11898-1 Classical frames, thus can support Standard Frame Format (11-bit ID) and Extended Frame Format (29-bit ID). The ESP32-S2's peripherals contains a TWAI controller that can be configured to communicate on a TWAI bus via an external transceiver.

**Warning:** The TWAI controller is not compatible with ISO11898-1 FD Format frames, and will interpret such frames as errors.

This programming guide is split into the following sections:

## Sections

- *Two-Wire Automotive Interface (TWAI)*
  - *Overview*
  - *TWAI Protocol Summary*
  - *Signals Lines and Transceiver*
  - *Driver Configuration*
  - *Driver Operation*
  - *Examples*
  - *API Reference*

## TWAI Protocol Summary

The TWAI is a multi-master, multi-cast, asynchronous, serial communication protocol. TWAI also supports error detection and signalling, and inbuilt message prioritization.

**Multi-master:** Any node on the bus can initiate the transfer of a message.

**Multi-cast:** When a node transmits a message, all nodes on the bus will receive the message (i.e., broadcast) thus ensuring data consistency across all nodes. However, some nodes can selectively choose which messages to accept via the use of acceptance filtering (multi-cast).

**Asynchronous:** The bus does not contain a clock signal. All nodes on the bus operate at the same bit rate and synchronize using the edges of the bits transmitted on the bus.

**Error Detection and Signalling:** Every node will constantly monitor the bus. When any node detects an error, it will signal the detection by transmitting an error frame. Other nodes will receive the error frame and transmit their own error frames in response. This will result in an error detection being propagated to all nodes on the bus.

**Message Priorities:** Messages contain an ID field. If two or more nodes attempt to transmit simultaneously, the node transmitting the message with the lower ID value will win arbitration of the bus. All other nodes will become receivers ensuring that there is at most one transmitter at any time.

**TWAI Messages** TWAI Messages are split into Data Frames and Remote Frames. Data Frames are used to deliver a data payload to other nodes, whereas a Remote Frame is used to request a Data Frame from other nodes (other nodes can optionally respond with a Data Frame). Data and Remote Frames have two frame formats known as **Extended Frame** and **Standard Frame** which contain a 29-bit ID and an 11-bit ID respectively. A TWAI message consists of the following fields:

- 29-bit or 11-bit ID: Determines the priority of the message (lower value has higher priority).
- Data Length Code (DLC) between 0 to 8: Indicates the size (in bytes) of the data payload for a Data Frame, or the amount of data to request for a Remote Frame.
- Up to 8 bytes of data for a Data Frame (should match DLC).

**Error States and Counters** The TWAI protocol implements a feature known as “fault confinement” where a persistently erroneous node will eventually eliminate itself from the bus. This is implemented by requiring every node to maintain two internal error counters known as the **Transmit Error Counter (TEC)** and the **Receive Error Counter (REC)**. The two error counters are incremented and decremented according to a set of rules (where the counters increase on an error, and decrease on a successful message transmission/reception). The values of the counters are used to determine a node’s **error state**, namely **Error Active**, **Error Passive**, and **Bus-Off**.

**Error Active:** A node is Error Active when **both TEC and REC are less than 128** and indicates that the node is operating normally. Error Active nodes are allowed to participate in bus communications, and will actively signal the detection of any errors by automatically transmitting an **Active Error Flag** over the bus.

**Error Passive:** A node is Error Passive when **either the TEC or REC becomes greater than or equal to 128**. Error Passive nodes are still able to take part in bus communications, but will instead transmit a **Passive Error Flag** upon detection of an error.

**Bus-Off:** A node becomes Bus-Off when the **TEC becomes greater than or equal to 256**. A Bus-Off node is unable influence the bus in any manner (essentially disconnected from the bus) thus eliminating itself from the bus. A node will remain in the Bus-Off state until it undergoes bus-off recovery.

### Signals Lines and Transceiver

The TWAI controller does not contain an integrated transceiver. Therefore, to connect the TWAI controller to a TWAI bus, **an external transceiver is required**. The type of external transceiver used should depend on the application's physical layer specification (e.g. using SN65HVD23x transceivers for ISO 11898-2 compatibility).

The TWAI controller's interface consists of 4 signal lines known as **TX, RX, BUS-OFF, and CLKOUT**. These four signal lines can be routed through the GPIO Matrix to the ESP32-S2's GPIO pads.

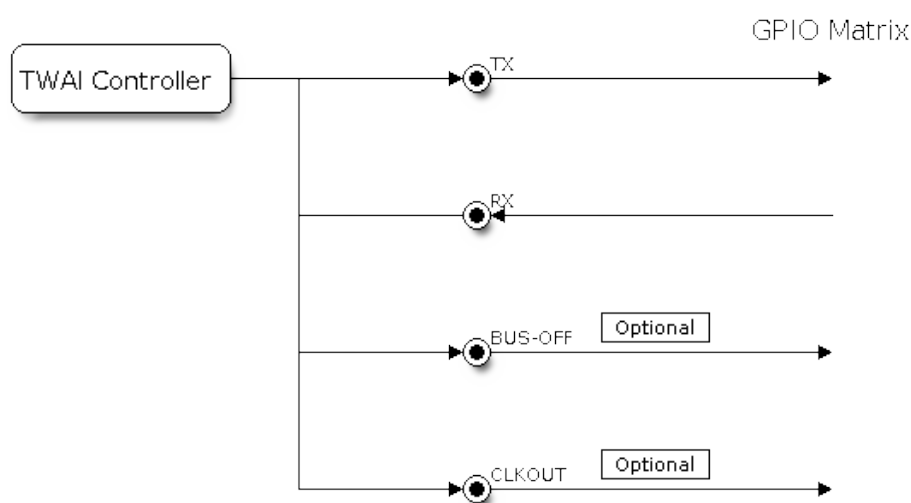

Fig. 24: Signal lines of the TWAI controller

**TX and RX:** The TX and RX signal lines are required to interface with an external transceiver. Both signal lines represent/interpret a dominant bit as a low logic level (0V), and a recessive bit as a high logic level (3.3V).

**BUS-OFF:** The BUS-OFF signal line is **optional** and is set to a low logic level (0V) whenever the TWAI controller reaches a bus-off state. The BUS-OFF signal line is set to a high logic level (3.3V) otherwise.

**CLKOUT:** The CLKOUT signal line is **optional** and outputs a prescaled version of the controller's source clock (APB Clock).

---

**Note:** An external transceiver **must internally loopback the TX to RX** such that a change in logic level to the TX signal line can be observed on the RX line. Failing to do so will cause the TWAI controller to interpret differences in logic levels between the two signal lines as a loss in arbitration or a bit error.

---

### Driver Configuration

This section covers how to configure the TWAI driver.

**Operating Modes** The TWAI driver supports the following modes of operations:



**Normal Mode:** The normal operating mode allows the TWAI controller to take part in bus activities such as transmitting and receiving messages/error frames. Acknowledgement from another node is required when transmitting a message.

**No Ack Mode:** The No Acknowledgement mode is similar to normal mode, however acknowledgements are not required for a message transmission to be considered successful. This mode is useful when self testing the TWAI controller (loopback of transmissions).

**Listen Only Mode:** This mode will prevent the TWAI controller from influencing the bus. Therefore, transmission of messages/acknowledgement/error frames will be disabled. However the TWAI controller will still be able to receive messages but will not acknowledge the message. This mode is suited for bus monitor applications.

**Alerts** The TWAI driver contains an alert feature that is used to notify the application layer of certain TWAI controller or TWAI bus events. Alerts are selectively enabled when the TWAI driver is installed, but can be reconfigured during runtime by calling `twai_reconfigure_alerts()`. The application can then wait for any enabled alerts to occur by calling `twai_read_alerts()`. The TWAI driver supports the following alerts:

Table 6: TWAI Driver Alerts

Alert Flag	Description
TWAI_ALERT_TX_IDLE	No more messages queued for transmission
TWAI_ALERT_TX_SUCCESS	The previous transmission was successful
TWAI_ALERT_RX_DATA	A frame has been received and added to the RX queue
TWAI_ALERT_BELOW_ERR_WARN	Both error counters have dropped below error warning limit
TWAI_ALERT_ERR_ACTIVE	TWAI controller has become error active
TWAI_ALERT_RECOVERY_IN_PROGRESS	TWAI controller is undergoing bus recovery
TWAI_ALERT_BUS_RECOVERED	TWAI controller has successfully completed bus recovery
TWAI_ALERT_ARB_LOST	The previous transmission lost arbitration
TWAI_ALERT_ABOVE_ERR_WARN	One of the error counters have exceeded the error warning limit
TWAI_ALERT_BUS_ERROR	A (Bit, Stuff, CRC, Form, ACK) error has occurred on the bus
TWAI_ALERT_TX_FAILED	The previous transmission has failed
TWAI_ALERT_RX_QUEUE_FULL	The RX queue is full causing a received frame to be lost
TWAI_ALERT_ERR_PASS	TWAI controller has become error passive
TWAI_ALERT_BUS_OFF	Bus-off condition occurred. TWAI controller can no longer influence bus

**Note:** The TWAI controller's **error warning limit** is used to preemptively warn the application of bus errors before the error passive state is reached. By default, the TWAI driver sets the **error warning limit** to **96**. The TWAI\_ALERT\_ABOVE\_ERR\_WARN is raised when the TEC or REC becomes larger than or equal to the error warning limit. The TWAI\_ALERT\_BELOW\_ERR\_WARN is raised when both TEC and REC return back to values below **96**.

**Note:** When enabling alerts, the TWAI\_ALERT\_AND\_LOG flag can be used to cause the TWAI driver to log any raised alerts to UART. However, alert logging is disabled and TWAI\_ALERT\_AND\_LOG if the `CONFIG_TWAI_ISR_IN_IRAM` option is enabled (see *Placing ISR into IRAM*).

**Note:** The TWAI\_ALERT\_ALL and TWAI\_ALERT\_NONE macros can also be used to enable/disable all alerts during configuration/reconfiguration.

**Bit Timing** The operating bit rate of the TWAI driver is configured using the `twai_timing_config_t` structure. The period of each bit is made up of multiple **time quanta**, and the period of a **time quantum** is determined by a prescaled version of the TWAI controller's source clock. A single bit contains the following segments in the following order:

1. The **Synchronization Segment** consists of a single time quantum
2. **Timing Segment 1** consists of 1 to 16 time quanta before sample point
3. **Timing Segment 2** consists of 1 to 8 time quanta after sample point

The **Baudrate Prescaler** is used to determine the period of each time quantum by dividing the TWAI controller's source clock (80 MHz APB clock). On the ESP32-S2, the `brp` can be **any even number from 2 to 32768**.

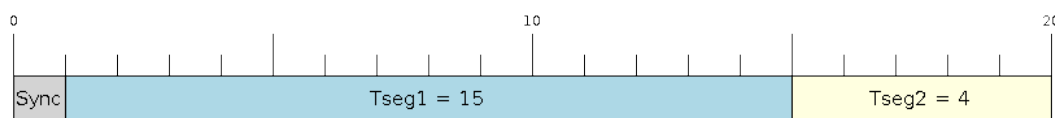

Fig. 25: Bit timing configuration for 500kbit/s given BRP = 8

The sample point of a bit is located on the intersection of Timing Segment 1 and 2. Enabling **Triple Sampling** will cause 3 time quanta to be sampled per bit instead of 1 (extra samples are located at the tail end of Timing Segment 1).

The **Synchronization Jump Width** is used to determine the maximum number of time quanta a single bit time can be lengthened/shortened for synchronization purposes. `sjw` can **range from 1 to 4**.

---

**Note:** Multiple combinations of `brp`, `tseg_1`, `tseg_2`, and `sjw` can achieve the same bit rate. Users should tune these values to the physical characteristics of their bus by taking into account factors such as **propagation delay, node information processing time, and phase errors**.

---

Bit timing **macro initializers** are also available for commonly used bit rates. The following macro initializers are provided by the TWAI driver.

- `TWAI_TIMING_CONFIG_1MBITS()`
- `TWAI_TIMING_CONFIG_800KBITS()`
- `TWAI_TIMING_CONFIG_500KBITS()`
- `TWAI_TIMING_CONFIG_250KBITS()`
- `TWAI_TIMING_CONFIG_125KBITS()`
- `TWAI_TIMING_CONFIG_100KBITS()`
- `TWAI_TIMING_CONFIG_50KBITS()`
- `TWAI_TIMING_CONFIG_25KBITS()`
- `TWAI_TIMING_CONFIG_20KBITS()`
- `TWAI_TIMING_CONFIG_16KBITS()`
- `TWAI_TIMING_CONFIG_12_5KBITS()`
- `TWAI_TIMING_CONFIG_10KBITS()`
- `TWAI_TIMING_CONFIG_5KBITS()`
- `TWAI_TIMING_CONFIG_1KBITS()`

**Acceptance Filter** The TWAI controller contains a hardware acceptance filter which can be used to filter messages of a particular ID. A node that filters out a message **will not receive the message, but will still acknowledge it**. Acceptance filters can make a node more efficient by filtering out messages sent over the bus that are irrelevant to the node. The acceptance filter is configured using two 32-bit values within `twai_filter_config_t` known as the **acceptance code** and the **acceptance mask**.

The **acceptance code** specifies the bit sequence which a message's ID, RTR, and data bytes must match in order for the message to be received by the TWAI controller. The **acceptance mask** is a bit sequence specifying which bits of the acceptance code can be ignored. This allows for a messages of different IDs to be accepted by a single acceptance code.

The acceptance filter can be used under **Single or Dual Filter Mode**. Single Filter Mode will use the acceptance code and mask to define a single filter. This allows for the first two data bytes of a standard frame to be filtered, or the entirety of an extended frame's 29-bit ID. The following diagram illustrates how the 32-bit acceptance code and mask will be interpreted under Single Filter Mode (Note: The yellow and blue fields represent standard and extended frame formats respectively).

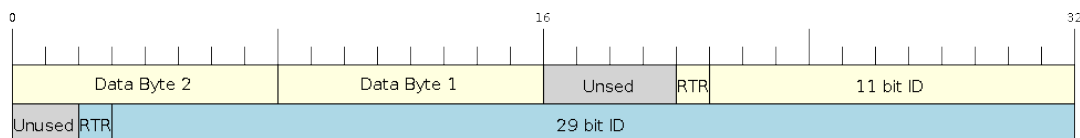

Fig. 26: Bit layout of single filter mode (Right side MSBit)

**Dual Filter Mode** will use the acceptance code and mask to define two separate filters allowing for increased flexibility of ID's to accept, but does not allow for all 29-bits of an extended ID to be filtered. The following diagram illustrates how the 32-bit acceptance code and mask will be interpreted under **Dual Filter Mode** (Note: The yellow and blue fields represent standard and extended frame formats respectively).

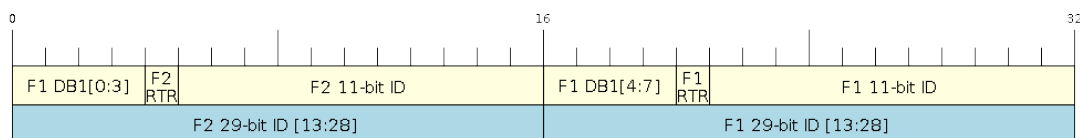

Fig. 27: Bit layout of dual filter mode (Right side MSBit)

**Disabling TX Queue** The TX queue can be disabled during configuration by setting the `tx_queue_len` member of `twai_general_config_t` to 0. This will allow applications that do not require message transmission to save a small amount of memory when using the TWAI driver.

**Placing ISR into IRAM** The TWAI driver's ISR (Interrupt Service Routine) can be placed into IRAM so that the ISR can still run whilst the cache is disabled. Placing the ISR into IRAM may be necessary to maintain the TWAI driver's functionality during lengthy cache disabling operations (such as SPI Flash writes, OTA updates etc). Whilst the cache is disabled, the ISR will continue to:

- Read received messages from the RX buffer and place them into the driver's RX queue.
- Load messages pending transmission from the driver's TX queue and write them into the TX buffer.

To place the TWAI driver's ISR, users must do the following:

- Enable the `CONFIG_TWAI_ISR_IN_IRAM` option using `idf.py menuconfig`.
- When calling `twai_driver_install()`, the `intr_flags` member of `twai_general_config_t` should set the `ESP_INTR_FLAG_IRAM` set.

**Note:** When the `CONFIG_TWAI_ISR_IN_IRAM` option is enabled, the TWAI driver will no longer log any alerts (i.e., the `TWAI_ALERT_AND_LOG` flag will not have any effect).

## Driver Operation

The TWAI driver is designed with distinct states and strict rules regarding the functions or conditions that trigger a state transition. The following diagram illustrates the various states and their transitions.

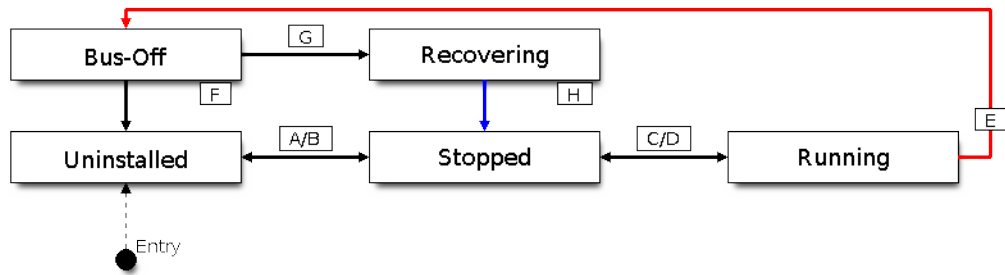

Fig. 28: State transition diagram of the TWAI driver (see table below)

Label	Transition	Action/Condition
A	Uninstalled -> Stopped	<code>twai_driver_install()</code>
B	Stopped -> Uninstalled	<code>twai_driver_uninstall()</code>
C	Stopped -> Running	<code>twai_start()</code>
D	Running -> Stopped	<code>twai_stop()</code>
E	Running -> Bus-Off	Transmit Error Counter $\geq$ 256
F	Bus-Off -> Uninstalled	<code>twai_driver_uninstall()</code>
G	Bus-Off -> Recovering	<code>twai_initiate_recovery()</code>
H	Recovering -> Stopped	128 occurrences of 11 consecutive recessive bits.

**Driver States** **Uninstalled:** In the uninstalled state, no memory is allocated for the driver and the TWAI controller is powered OFF.

**Stopped:** In this state, the TWAI controller is powered ON and the TWAI driver has been installed. However the TWAI controller will be unable to take part in any bus activities such as transmitting, receiving, or acknowledging messages.

**Running:** In the running state, the TWAI controller is able to take part in bus activities. Therefore messages can be transmitted/received/acknowledged. Furthermore the TWAI controller will be able to transmit error frames upon detection of errors on the bus.

**Bus-Off:** The bus-off state is automatically entered when the TWAI controller's Transmit Error Counter becomes greater than or equal to 256. The bus-off state indicates the occurrence of severe errors on the bus or in the TWAI controller. Whilst in the bus-off state, the TWAI controller will be unable to take part in any bus activities. To exit the bus-off state, the TWAI controller must undergo the bus recovery process.

**Recovering:** The recovering state is entered when the TWAI controller undergoes bus recovery. The TWAI controller/TWAI driver will remain in the recovering state until the 128 occurrences of 11 consecutive recessive bits is observed on the bus.

**Message Fields and Flags** The TWAI driver distinguishes different types of messages by using the various bit field members of the `twai_message_t` structure. These bit field members determine whether a message is in standard or extended format, a remote frame, and the type of transmission to use when transmitting such a message.

These bit field members can also be toggled using the the `flags` member of `twai_message_t` and the following message flags:

Message Flag	Description
TWAI_MSG_FLAG_EXTD	Message is in Extended Frame Format (29bit ID)
TWAI_MSG_FLAG_RTR	Message is a Remote Frame (Remote Transmission Request)
TWAI_MSG_FLAG_SS	Transmit message using Single Shot Transmission (Message will not be re-transmitted upon error or loss of arbitration). Unused for received message.
TWAI_MSG_FLAG_SELF	Transmit message using Self Reception Request (Transmitted message will also be received by the same node). Unused for received message.
TWAI_MSG_FLAG_DLC_NON	Message's Data length code is larger than 8. This will break compliance with TWAI
TWAI_MSG_FLAG_NONE	Clears all bit fields. Equivalent to a Standard Frame Format (11bit ID) Data Frame.

## Examples

**Configuration & Installation** The following code snippet demonstrates how to configure, install, and start the TWAI driver via the use of the various configuration structures, macro initializers, the `twai_driver_install()` function, and the `twai_start()` function.

```
#include "driver/gpio.h"
#include "driver/twai.h"

void app_main()
{
    //Initialize configuration structures using macro initializers
    twai_general_config_t g_config = TWAI_GENERAL_CONFIG_DEFAULT(GPIO_NUM_21, GPIO_
    ↪NUM_22, TWAI_MODE_NORMAL);
    twai_timing_config_t t_config = TWAI_TIMING_CONFIG_500KBITS();
    twai_filter_config_t f_config = TWAI_FILTER_CONFIG_ACCEPT_ALL();

    //Install TWAI driver
    if (twai_driver_install(&g_config, &t_config, &f_config) == ESP_OK) {
        printf("Driver installed\n");
    } else {
        printf("Failed to install driver\n");
        return;
    }

    //Start TWAI driver
    if (twai_start() == ESP_OK) {
        printf("Driver started\n");
    } else {
        printf("Failed to start driver\n");
        return;
    }

    ...
}
```

The usage of macro initializers is not mandatory and each of the configuration structures can be manually.

**Message Transmission** The following code snippet demonstrates how to transmit a message via the usage of the `twai_message_t` type and `twai_transmit()` function.

```
#include "driver/twai.h"

...
```

(continues on next page)

(continued from previous page)

```

//Configure message to transmit
twai_message_t message;
message.identifier = 0xAAAA;
message.extd = 1;
message.data_length_code = 4;
for (int i = 0; i < 4; i++) {
    message.data[i] = 0;
}

//Queue message for transmission
if (twai_transmit(&message, pdMS_TO_TICKS(1000)) == ESP_OK) {
    printf("Message queued for transmission\n");
} else {
    printf("Failed to queue message for transmission\n");
}

```

**Message Reception** The following code snippet demonstrates how to receive a message via the usage of the `twai_message_t` type and `twai_receive()` function.

```

#include "driver/twai.h"

...

//Wait for message to be received
twai_message_t message;
if (twai_receive(&message, pdMS_TO_TICKS(10000)) == ESP_OK) {
    printf("Message received\n");
} else {
    printf("Failed to receive message\n");
    return;
}

//Process received message
if (message.extd) {
    printf("Message is in Extended Format\n");
} else {
    printf("Message is in Standard Format\n");
}
printf("ID is %d\n", message.identifier);
if (!(message.rtr)) {
    for (int i = 0; i < message.data_length_code; i++) {
        printf("Data byte %d = %d\n", i, message.data[i]);
    }
}

```

**Reconfiguring and Reading Alerts** The following code snippet demonstrates how to reconfigure and read TWAI driver alerts via the use of the `twai_reconfigure_alerts()` and `twai_read_alerts()` functions.

```

#include "driver/twai.h"

...

//Reconfigure alerts to detect Error Passive and Bus-Off error states
uint32_t alerts_to_enable = TWAI_ALERT_ERR_PASS | TWAI_ALERT_BUS_OFF;
if (twai_reconfigure_alerts(alerts_to_enable, NULL) == ESP_OK) {
    printf("Alerts reconfigured\n");
} else {
    printf("Failed to reconfigure alerts");
}

```

(continues on next page)

(continued from previous page)

```

}

//Block indefinitely until an alert occurs
uint32_t alerts_triggered;
twai_read_alerts(&alerts_triggered, portMAX_DELAY);

```

**Stop and Uninstall** The following code demonstrates how to stop and uninstall the TWAI driver via the use of the `twai_stop()` and `twai_driver_uninstall()` functions.

```

#include "driver/twai.h"

...

//Stop the TWAI driver
if (twai_stop() == ESP_OK) {
    printf("Driver stopped\n");
} else {
    printf("Failed to stop driver\n");
    return;
}

//Uninstall the TWAI driver
if (twai_driver_uninstall() == ESP_OK) {
    printf("Driver uninstalled\n");
} else {
    printf("Failed to uninstall driver\n");
    return;
}

```

**Multiple ID Filter Configuration** The acceptance mask in `twai_filter_config_t` can be configured such that two or more IDs will be accepted for a single filter. For a particular filter to accept multiple IDs, the conflicting bit positions amongst the IDs must be set in the acceptance mask. The acceptance code can be set to any one of the IDs.

The following example shows how to calculate the acceptance mask given multiple IDs:

```

ID1 = 11'b101 1010 0000
ID2 = 11'b101 1010 0001
ID3 = 11'b101 1010 0100
ID4 = 11'b101 1010 1000
//Acceptance Mask
MASK = 11'b000 0000 1101

```

**Application Examples** **Network Example:** The TWAI Network example demonstrates communication between two ESP32-S2s using the TWAI driver API. One TWAI node acts as a network master that initiates and ceases the transfer of a data from another node acting as a network slave. The example can be found via [peripherals/twai/twai\\_network](#).

**Alert and Recovery Example:** This example demonstrates how to use the TWAI driver's alert and bus-off recovery API. The example purposely introduces errors on the bus to put the TWAI controller into the Bus-Off state. An alert is used to detect the Bus-Off state and trigger the bus recovery process. The example can be found via [peripherals/twai/twai\\_alert\\_and\\_recovery](#).

**Self Test Example:** This example uses the No Acknowledge Mode and Self Reception Request to cause the TWAI controller to send and simultaneously receive a series of messages. This example can be used to verify if the connections between the TWAI controller and the external transceiver are working correctly. The example can be found via [peripherals/twai/twai\\_self\\_test](#).

## API Reference

### Header File

- [components/hal/include/hal/twai\\_types.h](#)

### Structures

struct **twai\_message\_t**

Structure to store a TWAI message.

---

**Note:** The flags member is deprecated

---

### Public Members

uint32\_t **extd**

Extended Frame Format (29bit ID)

uint32\_t **rtr**

Message is a Remote Frame

uint32\_t **ss**

Transmit as a Single Shot Transmission. Unused for received.

uint32\_t **self**

Transmit as a Self Reception Request. Unused for received.

uint32\_t **dlc\_non\_comp**

Message's Data length code is larger than 8. This will break compliance with ISO 11898-1

uint32\_t **reserved**

Reserved bits

uint32\_t **flags**

Deprecated: Alternate way to set bits using message flags

uint32\_t **identifier**

11 or 29 bit identifier

uint8\_t **data\_length\_code**

Data length code

uint8\_t **data**[TWAI\_FRAME\_MAX\_DLC]

Data bytes (not relevant in RTR frame)

struct **twai\_timing\_config\_t**

Structure for bit timing configuration of the TWAI driver.

---

**Note:** Macro initializers are available for this structure

---



### Public Members

uint32\_t **brp**

Baudrate prescaler (i.e., APB clock divider). Any even number from 2 to 128 for ESP32, 2 to 32768 for ESP32S2. For ESP32 Rev 2 or later, multiples of 4 from 132 to 256 are also supported

uint8\_t **tseg\_1**

Timing segment 1 (Number of time quanta, between 1 to 16)

uint8\_t **tseg\_2**

Timing segment 2 (Number of time quanta, 1 to 8)

uint8\_t **sjw**

Synchronization Jump Width (Max time quanta jump for synchronize from 1 to 4)

bool **triple\_sampling**

Enables triple sampling when the TWAI controller samples a bit

struct **twai\_filter\_config\_t**

Structure for acceptance filter configuration of the TWAI driver (see documentation)

---

**Note:** Macro initializers are available for this structure

---

### Public Members

uint32\_t **acceptance\_code**

32-bit acceptance code

uint32\_t **acceptance\_mask**

32-bit acceptance mask

bool **single\_filter**

Use Single Filter Mode (see documentation)

### Macros

**TWAI\_EXTD\_ID\_MASK**

TWAI Constants.

Bit mask for 29 bit Extended Frame Format ID

**TWAI\_STD\_ID\_MASK**

Bit mask for 11 bit Standard Frame Format ID

**TWAI\_FRAME\_MAX\_DLC**

Max data bytes allowed in TWAI

**TWAI\_FRAME\_EXTD\_ID\_LEN\_BYTES**

EFF ID requires 4 bytes (29bit)

**TWAI\_FRAME\_STD\_ID\_LEN\_BYTES**

SFF ID requires 2 bytes (11bit)

**TWAI\_ERR\_PASS\_THRESH**

Error counter threshold for error passive

**Enumerations**enum **twai\_mode\_t**

TWAI Controller operating modes.

*Values:*

enumerator **TWAI\_MODE\_NORMAL**

Normal operating mode where TWAI controller can send/receive/acknowledge messages

enumerator **TWAI\_MODE\_NO\_ACK**

Transmission does not require acknowledgment. Use this mode for self testing

enumerator **TWAI\_MODE\_LISTEN\_ONLY**

The TWAI controller will not influence the bus (No transmissions or acknowledgments) but can receive messages

**Header File**

- [components/driver/include/driver/twai.h](#)

**Functions**

*esp\_err\_t* **twai\_driver\_install** (const *twai\_general\_config\_t* \*g\_config, const *twai\_timing\_config\_t* \*t\_config, const *twai\_filter\_config\_t* \*f\_config)

Install TWAI driver.

This function installs the TWAI driver using three configuration structures. The required memory is allocated and the TWAI driver is placed in the stopped state after running this function.

---

**Note:** Macro initializers are available for the configuration structures (see documentation)

---

---

**Note:** To reinstall the TWAI driver, call `twai_driver_uninstall()` first

---

**Parameters**

- **g\_config** –[in] General configuration structure
- **t\_config** –[in] Timing configuration structure
- **f\_config** –[in] Filter configuration structure

**Returns**

- **ESP\_OK**: Successfully installed TWAI driver
- **ESP\_ERR\_INVALID\_ARG**: Arguments are invalid
- **ESP\_ERR\_NO\_MEM**: Insufficient memory
- **ESP\_ERR\_INVALID\_STATE**: Driver is already installed

*esp\_err\_t* **twai\_driver\_uninstall** (void)

Uninstall the TWAI driver.

This function uninstalls the TWAI driver, freeing the memory utilized by the driver. This function can only be called when the driver is in the stopped state or the bus-off state.

**Warning:** The application must ensure that no tasks are blocked on TX/RX queues or alerts when this function is called.

**Returns**

- ESP\_OK: Successfully uninstalled TWAI driver
- ESP\_ERR\_INVALID\_STATE: Driver is not in stopped/bus-off state, or is not installed

*esp\_err\_t* **twai\_start** (void)

Start the TWAI driver.

This function starts the TWAI driver, putting the TWAI driver into the running state. This allows the TWAI driver to participate in TWAI bus activities such as transmitting/receiving messages. The TX and RX queue are reset in this function, clearing any messages that are unread or pending transmission. This function can only be called when the TWAI driver is in the stopped state.

**Returns**

- ESP\_OK: TWAI driver is now running
- ESP\_ERR\_INVALID\_STATE: Driver is not in stopped state, or is not installed

*esp\_err\_t* **twai\_stop** (void)

Stop the TWAI driver.

This function stops the TWAI driver, preventing any further message from being transmitted or received until `twai_start()` is called. Any messages in the TX queue are cleared. Any messages in the RX queue should be read by the application after this function is called. This function can only be called when the TWAI driver is in the running state.

**Warning:** A message currently being transmitted/received on the TWAI bus will be ceased immediately. This may lead to other TWAI nodes interpreting the unfinished message as an error.

**Returns**

- ESP\_OK: TWAI driver is now Stopped
- ESP\_ERR\_INVALID\_STATE: Driver is not in running state, or is not installed

*esp\_err\_t* **twai\_transmit** (const *twai\_message\_t* \*message, TickType\_t ticks\_to\_wait)

Transmit a TWAI message.

This function queues a TWAI message for transmission. Transmission will start immediately if no other messages are queued for transmission. If the TX queue is full, this function will block until more space becomes available or until it times out. If the TX queue is disabled (TX queue length = 0 in configuration), this function will return immediately if another message is undergoing transmission. This function can only be called when the TWAI driver is in the running state and cannot be called under Listen Only Mode.

---

**Note:** This function does not guarantee that the transmission is successful. The TX\_SUCCESS/TX\_FAILED alert can be enabled to alert the application upon the success/failure of a transmission.

---

---

**Note:** The TX\_IDLE alert can be used to alert the application when no other messages are awaiting transmission.

---

**Parameters**

- **message** –[in] Message to transmit
- **ticks\_to\_wait** –[in] Number of FreeRTOS ticks to block on the TX queue

**Returns**

- ESP\_OK: Transmission successfully queued/initiated
- ESP\_ERR\_INVALID\_ARG: Arguments are invalid
- ESP\_ERR\_TIMEOUT: Timed out waiting for space on TX queue
- ESP\_FAIL: TX queue is disabled and another message is currently transmitting
- ESP\_ERR\_INVALID\_STATE: TWAI driver is not in running state, or is not installed
- ESP\_ERR\_NOT\_SUPPORTED: Listen Only Mode does not support transmissions

*esp\_err\_t twai\_receive* (*twai\_message\_t* \*message, TickType\_t ticks\_to\_wait)

Receive a TWAI message.

This function receives a message from the RX queue. The flags field of the message structure will indicate the type of message received. This function will block if there are no messages in the RX queue

**Warning:** The flags field of the received message should be checked to determine if the received message contains any data bytes.

**Parameters**

- **message** –[out] Received message
- **ticks\_to\_wait** –[in] Number of FreeRTOS ticks to block on RX queue

**Returns**

- ESP\_OK: Message successfully received from RX queue
- ESP\_ERR\_TIMEOUT: Timed out waiting for message
- ESP\_ERR\_INVALID\_ARG: Arguments are invalid
- ESP\_ERR\_INVALID\_STATE: TWAI driver is not installed

*esp\_err\_t twai\_read\_alerts* (uint32\_t \*alerts, TickType\_t ticks\_to\_wait)

Read TWAI driver alerts.

This function will read the alerts raised by the TWAI driver. If no alert has been issued when this function is called, this function will block until an alert occurs or until it timeouts.

---

**Note:** Multiple alerts can be raised simultaneously. The application should check for all alerts that have been enabled.

---

**Parameters**

- **alerts** –[out] Bit field of raised alerts (see documentation for alert flags)
- **ticks\_to\_wait** –[in] Number of FreeRTOS ticks to block for alert

**Returns**

- ESP\_OK: Alerts read
- ESP\_ERR\_TIMEOUT: Timed out waiting for alerts
- ESP\_ERR\_INVALID\_ARG: Arguments are invalid
- ESP\_ERR\_INVALID\_STATE: TWAI driver is not installed

*esp\_err\_t twai\_reconfigure\_alerts* (uint32\_t alerts\_enabled, uint32\_t \*current\_alerts)

Reconfigure which alerts are enabled.

This function reconfigures which alerts are enabled. If there are alerts which have not been read whilst reconfiguring, this function can read those alerts.

**Parameters**

- **alerts\_enabled** –[in] Bit field of alerts to enable (see documentation for alert flags)
- **current\_alerts** –[out] Bit field of currently raised alerts. Set to NULL if unused

**Returns**

- ESP\_OK: Alerts reconfigured
- ESP\_ERR\_INVALID\_STATE: TWAI driver is not installed

*esp\_err\_t* **twai\_initiate\_recovery** (void)

Start the bus recovery process.

This function initiates the bus recovery process when the TWAI driver is in the bus-off state. Once initiated, the TWAI driver will enter the recovering state and wait for 128 occurrences of the bus-free signal on the TWAI bus before returning to the stopped state. This function will reset the TX queue, clearing any messages pending transmission.

---

**Note:** The BUS\_RECOVERED alert can be enabled to alert the application when the bus recovery process completes.

---

**Returns**

- ESP\_OK: Bus recovery started
- ESP\_ERR\_INVALID\_STATE: TWAI driver is not in the bus-off state, or is not installed

*esp\_err\_t* **twai\_get\_status\_info** (*twai\_status\_info\_t* \*status\_info)

Get current status information of the TWAI driver.

**Parameters** *status\_info* –[out] Status information

**Returns**

- ESP\_OK: Status information retrieved
- ESP\_ERR\_INVALID\_ARG: Arguments are invalid
- ESP\_ERR\_INVALID\_STATE: TWAI driver is not installed

*esp\_err\_t* **twai\_clear\_transmit\_queue** (void)

Clear the transmit queue.

This function will clear the transmit queue of all messages.

---

**Note:** The transmit queue is automatically cleared when `twai_stop()` or `twai_initiate_recovery()` is called.

---

**Returns**

- ESP\_OK: Transmit queue cleared
- ESP\_ERR\_INVALID\_STATE: TWAI driver is not installed or TX queue is disabled

*esp\_err\_t* **twai\_clear\_receive\_queue** (void)

Clear the receive queue.

This function will clear the receive queue of all messages.

---

**Note:** The receive queue is automatically cleared when `twai_start()` is called.

---

**Returns**

- ESP\_OK: Transmit queue cleared
- ESP\_ERR\_INVALID\_STATE: TWAI driver is not installed

**Structures**

struct **twai\_general\_config\_t**

Structure for general configuration of the TWAI driver.

---

**Note:** Macro initializers are available for this structure

---

### Public Members

#### *twai\_mode\_t* mode

Mode of TWAI controller

#### *gpio\_num\_t* tx\_io

Transmit GPIO number

#### *gpio\_num\_t* rx\_io

Receive GPIO number

#### *gpio\_num\_t* clkout\_io

CLKOUT GPIO number (optional, set to -1 if unused)

#### *gpio\_num\_t* bus\_off\_io

Bus off indicator GPIO number (optional, set to -1 if unused)

#### uint32\_t tx\_queue\_len

Number of messages TX queue can hold (set to 0 to disable TX Queue)

#### uint32\_t rx\_queue\_len

Number of messages RX queue can hold

#### uint32\_t alerts\_enabled

Bit field of alerts to enable (see documentation)

#### uint32\_t clkout\_divider

CLKOUT divider. Can be 1 or any even number from 2 to 14 (optional, set to 0 if unused)

#### int intr\_flags

Interrupt flags to set the priority of the driver's ISR. Note that to use the ESP\_INTR\_FLAG\_IRAM, the CONFIG\_TWAI\_ISR\_IN\_IRAM option should be enabled first.

#### struct twai\_status\_info\_t

Structure to store status information of TWAI driver.

### Public Members

#### *twai\_state\_t* state

Current state of TWAI controller (Stopped/Running/Bus-Off/Recovery)

#### uint32\_t msgs\_to\_tx

Number of messages queued for transmission or awaiting transmission completion

uint32\_t **msgs\_to\_rx**

Number of messages in RX queue waiting to be read

uint32\_t **tx\_error\_counter**

Current value of Transmit Error Counter

uint32\_t **rx\_error\_counter**

Current value of Receive Error Counter

uint32\_t **tx\_failed\_count**

Number of messages that failed transmissions

uint32\_t **rx\_missed\_count**

Number of messages that were lost due to a full RX queue (or errata workaround if enabled)

uint32\_t **rx\_overrun\_count**

Number of messages that were lost due to a RX FIFO overrun

uint32\_t **arb\_lost\_count**

Number of instances arbitration was lost

uint32\_t **bus\_error\_count**

Number of instances a bus error has occurred

## Macros

**TWAI\_IO\_UNUSED**

Marks GPIO as unused in TWAI configuration

## Enumerations

enum **twai\_state\_t**

TWAI driver states.

*Values:*

enumerator **TWAI\_STATE\_STOPPED**

Stopped state. The TWAI controller will not participate in any TWAI bus activities

enumerator **TWAI\_STATE\_RUNNING**

Running state. The TWAI controller can transmit and receive messages

enumerator **TWAI\_STATE\_BUS\_OFF**

Bus-off state. The TWAI controller cannot participate in bus activities until it has recovered

enumerator **TWAI\_STATE\_RECOVERING**

Recovering state. The TWAI controller is undergoing bus recovery

## 2.5.26 Universal Asynchronous Receiver/Transmitter (UART)

### Overview

A Universal Asynchronous Receiver/Transmitter (UART) is a hardware feature that handles communication (i.e., timing requirements and data framing) using widely-adopted asynchronous serial communication interfaces, such as RS232, RS422, RS485. A UART provides a widely adopted and cheap method to realize full-duplex or half-duplex data exchange among different devices.

The ESP32-S2 chip has two UART controllers (also referred to as port), each featuring an identical set of registers to simplify programming and for more flexibility.

Each UART controller is independently configurable with parameters such as baud rate, data bit length, bit ordering, number of stop bits, parity bit etc. All the controllers are compatible with UART-enabled devices from various manufacturers and can also support Infrared Data Association protocols (IrDA).

### Functional Overview

The following overview describes how to establish communication between an ESP32-S2 and other UART devices using the functions and data types of the UART driver. The overview reflects a typical programming workflow and is broken down into the sections provided below:

1. *Setting Communication Parameters* - Setting baud rate, data bits, stop bits, etc.
2. *Setting Communication Pins* - Assigning pins for connection to a device.
3. *Driver Installation* - Allocating ESP32-S2's resources for the UART driver.
4. *Running UART Communication* - Sending / receiving data
5. *Using Interrupts* - Triggering interrupts on specific communication events
6. *Deleting a Driver* - Freeing allocated resources if a UART communication is no longer required

Steps 1 to 3 comprise the configuration stage. Step 4 is where the UART starts operating. Steps 5 and 6 are optional.

The UART driver's functions identify each of the UART controllers using `uart_port_t`. This identification is needed for all the following function calls.

**Setting Communication Parameters** UART communication parameters can be configured all in a single step or individually in multiple steps.

**Single Step** Call the function `uart_param_config()` and pass to it a `uart_config_t` structure. The `uart_config_t` structure should contain all the required parameters. See the example below.

```
const uart_port_t uart_num = UART_NUM_1;
uart_config_t uart_config = {
    .baud_rate = 115200,
    .data_bits = UART_DATA_8_BITS,
    .parity = UART_PARITY_DISABLE,
    .stop_bits = UART_STOP_BITS_1,
    .flow_ctrl = UART_HW_FLOWCTRL_CTS_RTS,
    .rx_flow_ctrl_thresh = 122,
};
// Configure UART parameters
ESP_ERROR_CHECK(uart_param_config(uart_num, &uart_config));
```

For more information on how to configure the hardware flow control options, please refer to [peripherals/uart/uart\\_echo](#).

**Multiple Steps** Configure specific parameters individually by calling a dedicated function from the table given below. These functions are also useful if re-configuring a single parameter.



Table 7: Functions for Configuring specific parameters individually

Parameter to Configure	Function
Baud rate	<code>uart_set_baudrate()</code>
Number of transmitted bits	<code>uart_set_word_length()</code> selected out of <code>uart_word_length_t</code>
Parity control	<code>uart_set_parity()</code> selected out of <code>uart_parity_t</code>
Number of stop bits	<code>uart_set_stop_bits()</code> selected out of <code>uart_stop_bits_t</code>
Hardware flow control mode	<code>uart_set_hw_flow_ctrl()</code> selected out of <code>uart_hw_flowcontrol_t</code>
Communication mode	<code>uart_set_mode()</code> selected out of <code>uart_mode_t</code>

Each of the above functions has a `_get_` counterpart to check the currently set value. For example, to check the current baud rate value, call `uart_get_baudrate()`.

**Setting Communication Pins** After setting communication parameters, configure the physical GPIO pins to which the other UART device will be connected. For this, call the function `uart_set_pin()` and specify the GPIO pin numbers to which the driver should route the Tx, Rx, RTS, and CTS signals. If you want to keep a currently allocated pin number for a specific signal, pass the macro `UART_PIN_NO_CHANGE`.

The same macro should be specified for pins that will not be used.

```
// Set UART pins (TX: IO4, RX: IO5, RTS: IO18, CTS: IO19)
ESP_ERROR_CHECK(uart_set_pin(UART_NUM_1, 4, 5, 18, 19));
```

**Driver Installation** Once the communication pins are set, install the driver by calling `uart_driver_install()` and specify the following parameters:

- Size of Tx ring buffer
- Size of Rx ring buffer
- Event queue handle and size
- Flags to allocate an interrupt

The function will allocate the required internal resources for the UART driver.

```
// Setup UART buffered IO with event queue
const int uart_buffer_size = (1024 * 2);
QueueHandle_t uart_queue;
// Install UART driver using an event queue here
ESP_ERROR_CHECK(uart_driver_install(UART_NUM_1, uart_buffer_size, \
                                   uart_buffer_size, 10, &uart_queue, 0));
```

Once this step is complete, you can connect the external UART device and check the communication.

**Running UART Communication** Serial communication is controlled by each UART controller's finite state machine (FSM).

The process of sending data involves the following steps:

1. Write data into Tx FIFO buffer
2. FSM serializes the data
3. FSM sends the data out

The process of receiving data is similar, but the steps are reversed:

1. FSM processes an incoming serial stream and parallelizes it
2. FSM writes the data into Rx FIFO buffer
3. Read the data from Rx FIFO buffer

Therefore, an application will be limited to writing and reading data from a respective buffer using `uart_write_bytes()` and `uart_read_bytes()` respectively, and the FSM will do the rest.

**Transmitting** After preparing the data for transmission, call the function `uart_write_bytes()` and pass the data buffer's address and data length to it. The function will copy the data to the Tx ring buffer (either immediately or after enough space is available), and then exit. When there is free space in the Tx FIFO buffer, an interrupt service routine (ISR) moves the data from the Tx ring buffer to the Tx FIFO buffer in the background. The code below demonstrates the use of this function.

```
// Write data to UART.
char* test_str = "This is a test string.\n";
uart_write_bytes(uart_num, (const char*)test_str, strlen(test_str));
```

The function `uart_write_bytes_with_break()` is similar to `uart_write_bytes()` but adds a serial break signal at the end of the transmission. A 'serial break signal' means holding the Tx line low for a period longer than one data frame.

```
// Write data to UART, end with a break signal.
uart_write_bytes_with_break(uart_num, "test break\n", strlen("test break\n"), 100);
```

Another function for writing data to the Tx FIFO buffer is `uart_tx_chars()`. Unlike `uart_write_bytes()`, this function will not block until space is available. Instead, it will write all data which can immediately fit into the hardware Tx FIFO, and then return the number of bytes that were written.

There is a 'companion' function `uart_wait_tx_done()` that monitors the status of the Tx FIFO buffer and returns once it is empty.

```
// Wait for packet to be sent
const uart_port_t uart_num = UART_NUM_1;
ESP_ERROR_CHECK(uart_wait_tx_done(uart_num, 100)); // wait timeout is 100 RTOS_
↳ticks (TickType_t)
```

**Receiving** Once the data is received by the UART and saved in the Rx FIFO buffer, it needs to be retrieved using the function `uart_read_bytes()`. Before reading data, you can check the number of bytes available in the Rx FIFO buffer by calling `uart_get_buffered_data_len()`. An example of using these functions is given below.

```
// Read data from UART.
const uart_port_t uart_num = UART_NUM_1;
uint8_t data[128];
int length = 0;
ESP_ERROR_CHECK(uart_get_buffered_data_len(uart_num, (size_t*)&length));
length = uart_read_bytes(uart_num, data, length, 100);
```

If the data in the Rx FIFO buffer is no longer needed, you can clear the buffer by calling `uart_flush()`.

**Software Flow Control** If the hardware flow control is disabled, you can manually set the RTS and DTR signal levels by using the functions `uart_set_rts()` and `uart_set_dtr()` respectively.

**Communication Mode Selection** The UART controller supports a number of communication modes. A mode can be selected using the function `uart_set_mode()`. Once a specific mode is selected, the UART driver will handle the behavior of a connected UART device accordingly. As an example, it can control the RS485 driver chip using the RTS line to allow half-duplex RS485 communication.

```
// Setup UART in rs485 half duplex mode
ESP_ERROR_CHECK(uart_set_mode(uart_num, UART_MODE_RS485_HALF_DUPLEX));
```

**Using Interrupts** There are many interrupts that can be generated following specific UART states or detected errors. The full list of available interrupts is provided in *ESP32-S2 Technical Reference Manual > UART Controller*

(UART) > *UART Interrupts and UHCI Interrupts* [PDF]. You can enable or disable specific interrupts by calling `uart_enable_intr_mask()` or `uart_disable_intr_mask()` respectively.

The `uart_driver_install()` function installs the driver's internal interrupt handler to manage the Tx and Rx ring buffers and provides high-level API functions like events (see below).

The API provides a convenient way to handle specific interrupts discussed in this document by wrapping them into dedicated functions:

- **Event detection:** There are several events defined in `uart_event_type_t` that may be reported to a user application using the FreeRTOS queue functionality. You can enable this functionality when calling `uart_driver_install()` described in *Driver Installation*. An example of using Event detection can be found in `peripherals/uart/uart_events`.
- **FIFO space threshold or transmission timeout reached:** The Tx and Rx FIFO buffers can trigger an interrupt when they are filled with a specific number of characters, or on a timeout of sending or receiving data. To use these interrupts, do the following:
  - Configure respective threshold values of the buffer length and timeout by entering them in the structure `uart_intr_config_t` and calling `uart_intr_config()`
  - Enable the interrupts using the functions `uart_enable_tx_intr()` and `uart_enable_rx_intr()`
  - Disable these interrupts using the corresponding functions `uart_disable_tx_intr()` or `uart_disable_rx_intr()`
- **Pattern detection:** An interrupt triggered on detecting a 'pattern' of the same character being received/sent repeatedly for a number of times. This functionality is demonstrated in the example `peripherals/uart/uart_events`. It can be used, e.g., to detect a command string followed by a specific number of identical characters (the 'pattern') added at the end of the command string. The following functions are available:
  - Configure and enable this interrupt using `uart_enable_pattern_det_baud_intr()`
  - Disable the interrupt using `uart_disable_pattern_det_intr()`

**Macros** The API also defines several macros. For example, `UART_FIFO_LEN` defines the length of hardware FIFO buffers; `UART_BITRATE_MAX` gives the maximum baud rate supported by the UART controllers, etc.

**Deleting a Driver** If the communication established with `uart_driver_install()` is no longer required, the driver can be removed to free allocated resources by calling `uart_driver_delete()`.

## Overview of RS485 specific communication options

---

**Note:** The following section will use `[UART_REGISTER_NAME].[UART_FIELD_BIT]` to refer to UART register fields/bits. For more information on a specific option bit, see *ESP32-S2 Technical Reference Manual > UART Controller (UART) > Register Summary* [PDF]. Use the register name to navigate to the register description and then find the field/bit.

---

- `UART_RS485_CONF_REG.UART_RS485_EN`: setting this bit enables RS485 communication mode support.
- `UART_RS485_CONF_REG.UART_RS485TX_RX_EN`: if this bit is set, the transmitter's output signal loops back to the receiver's input signal.
- `UART_RS485_CONF_REG.UART_RS485RXBY_TX_EN`: if this bit is set, the transmitter will still be sending data if the receiver is busy (remove collisions automatically by hardware).

The ESP32-S2's RS485 UART hardware can detect signal collisions during transmission of a datagram and generate the interrupt `UART_RS485_CLASH_INT` if this interrupt is enabled. The term collision means that a transmitted datagram is not equal to the one received on the other end. Data collisions are usually associated with the presence of other active devices on the bus or might occur due to bus errors.

The collision detection feature allows handling collisions when their interrupts are activated and triggered. The interrupts `UART_RS485_FRM_ERR_INT` and `UART_RS485_PARITY_ERR_INT` can be used with the collision detection feature to control frame errors and parity bit errors accordingly in RS485 mode. This functionality is





- [components/driver/include/driver/uart.h](#)

## Functions

*esp\_err\_t* **uart\_driver\_install** (*uart\_port\_t* uart\_num, int rx\_buffer\_size, int tx\_buffer\_size, int queue\_size, *QueueHandle\_t* \*uart\_queue, int intr\_alloc\_flags)

Install UART driver and set the UART to the default configuration.

UART ISR handler will be attached to the same CPU core that this function is running on.

---

**Note:** Rx\_buffer\_size should be greater than UART\_FIFO\_LEN. Tx\_buffer\_size should be either zero or greater than UART\_FIFO\_LEN.

---

### Parameters

- **uart\_num** –UART port number, the max port number is (UART\_NUM\_MAX -1).
- **rx\_buffer\_size** –UART RX ring buffer size.
- **tx\_buffer\_size** –UART TX ring buffer size. If set to zero, driver will not use TX buffer, TX function will block task until all data have been sent out.
- **queue\_size** –UART event queue size/depth.
- **uart\_queue** –UART event queue handle (out param). On success, a new queue handle is written here to provide access to UART events. If set to NULL, driver will not use an event queue.
- **intr\_alloc\_flags** –Flags used to allocate the interrupt. One or multiple (ORred) ESP\_INTR\_FLAG\_\* values. See esp\_intr\_alloc.h for more info. Do not set ESP\_INTR\_FLAG\_IRAM here (the driver's ISR handler is not located in IRAM)

### Returns

- ESP\_OK Success
- ESP\_FAIL Parameter error

*esp\_err\_t* **uart\_driver\_delete** (*uart\_port\_t* uart\_num)

Uninstall UART driver.

**Parameters** **uart\_num** –UART port number, the max port number is (UART\_NUM\_MAX -1).

### Returns

- ESP\_OK Success
- ESP\_FAIL Parameter error

bool **uart\_is\_driver\_installed** (*uart\_port\_t* uart\_num)

Checks whether the driver is installed or not.

**Parameters** **uart\_num** –UART port number, the max port number is (UART\_NUM\_MAX -1).

### Returns

- true driver is installed
- false driver is not installed

*esp\_err\_t* **uart\_set\_word\_length** (*uart\_port\_t* uart\_num, *uart\_word\_length\_t* data\_bit)

Set UART data bits.

### Parameters

- **uart\_num** –UART port number, the max port number is (UART\_NUM\_MAX -1).
- **data\_bit** –UART data bits

### Returns

- ESP\_OK Success
- ESP\_FAIL Parameter error

*esp\_err\_t* **uart\_get\_word\_length** (*uart\_port\_t* uart\_num, *uart\_word\_length\_t* \*data\_bit)

Get the UART data bit configuration.

### Parameters

- **uart\_num** –UART port number, the max port number is (UART\_NUM\_MAX -1).

- **data\_bit** –Pointer to accept value of UART data bits.

**Returns**

- ESP\_FAIL Parameter error
- ESP\_OK Success, result will be put in (\*data\_bit)

*esp\_err\_t* **uart\_set\_stop\_bits** (*uart\_port\_t* uart\_num, *uart\_stop\_bits\_t* stop\_bits)

Set UART stop bits.

**Parameters**

- **uart\_num** –UART port number, the max port number is (UART\_NUM\_MAX -1).
- **stop\_bits** –UART stop bits

**Returns**

- ESP\_OK Success
- ESP\_FAIL Fail

*esp\_err\_t* **uart\_get\_stop\_bits** (*uart\_port\_t* uart\_num, *uart\_stop\_bits\_t* \*stop\_bits)

Get the UART stop bit configuration.

**Parameters**

- **uart\_num** –UART port number, the max port number is (UART\_NUM\_MAX -1).
- **stop\_bits** –Pointer to accept value of UART stop bits.

**Returns**

- ESP\_FAIL Parameter error
- ESP\_OK Success, result will be put in (\*stop\_bit)

*esp\_err\_t* **uart\_set\_parity** (*uart\_port\_t* uart\_num, *uart\_parity\_t* parity\_mode)

Set UART parity mode.

**Parameters**

- **uart\_num** –UART port number, the max port number is (UART\_NUM\_MAX -1).
- **parity\_mode** –the enum of uart parity configuration

**Returns**

- ESP\_FAIL Parameter error
- ESP\_OK Success

*esp\_err\_t* **uart\_get\_parity** (*uart\_port\_t* uart\_num, *uart\_parity\_t* \*parity\_mode)

Get the UART parity mode configuration.

**Parameters**

- **uart\_num** –UART port number, the max port number is (UART\_NUM\_MAX -1).
- **parity\_mode** –Pointer to accept value of UART parity mode.

**Returns**

- ESP\_FAIL Parameter error
- ESP\_OK Success, result will be put in (\*parity\_mode)

*esp\_err\_t* **uart\_get\_sclk\_freq** (*uart\_sclk\_t* sclk, uint32\_t \*out\_freq\_hz)

Get the frequency of a clock source for the UART.

**Parameters**

- **sclk** –Clock source
- **out\_freq\_hz** –[out] Output of frequency, in Hz

**Returns**

- ESP\_ERR\_INVALID\_ARG: if the clock source is not supported
- otherwise ESP\_OK

*esp\_err\_t* **uart\_set\_baudrate** (*uart\_port\_t* uart\_num, uint32\_t baudrate)

Set UART baud rate.

**Parameters**

- **uart\_num** –UART port number, the max port number is (UART\_NUM\_MAX -1).
- **baudrate** –UART baud rate.

**Returns**

- ESP\_FAIL Parameter error



- ESP\_OK Success

*esp\_err\_t* **uart\_get\_baudrate** (*uart\_port\_t* uart\_num, uint32\_t \*baudrate)

Get the UART baud rate configuration.

**Parameters**

- **uart\_num** –UART port number, the max port number is (UART\_NUM\_MAX -1).
- **baudrate** –Pointer to accept value of UART baud rate

**Returns**

- ESP\_FAIL Parameter error
- ESP\_OK Success, result will be put in (\*baudrate)

*esp\_err\_t* **uart\_set\_line\_inverse** (*uart\_port\_t* uart\_num, uint32\_t inverse\_mask)

Set UART line inverse mode.

**Parameters**

- **uart\_num** –UART port number, the max port number is (UART\_NUM\_MAX -1).
- **inverse\_mask** –Choose the wires that need to be inverted. Using the ORred mask of `uart_signal_inv_t`

**Returns**

- ESP\_OK Success
- ESP\_FAIL Parameter error

*esp\_err\_t* **uart\_set\_hw\_flow\_ctrl** (*uart\_port\_t* uart\_num, *uart\_hw\_flowcontrol\_t* flow\_ctrl, uint8\_t rx\_thresh)

Set hardware flow control.

**Parameters**

- **uart\_num** –UART port number, the max port number is (UART\_NUM\_MAX -1).
- **flow\_ctrl** –Hardware flow control mode
- **rx\_thresh** –Threshold of Hardware RX flow control (0 ~ UART\_FIFO\_LEN). Only when UART\_HW\_FLOWCTRL\_RTS is set, will the rx\_thresh value be set.

**Returns**

- ESP\_OK Success
- ESP\_FAIL Parameter error

*esp\_err\_t* **uart\_set\_sw\_flow\_ctrl** (*uart\_port\_t* uart\_num, bool enable, uint8\_t rx\_thresh\_xon, uint8\_t rx\_thresh\_xoff)

Set software flow control.

**Parameters**

- **uart\_num** –UART\_NUM\_0, UART\_NUM\_1 or UART\_NUM\_2
- **enable** –switch on or off
- **rx\_thresh\_xon** –low water mark
- **rx\_thresh\_xoff** –high water mark

**Returns**

- ESP\_OK Success
- ESP\_FAIL Parameter error

*esp\_err\_t* **uart\_get\_hw\_flow\_ctrl** (*uart\_port\_t* uart\_num, *uart\_hw\_flowcontrol\_t* \*flow\_ctrl)

Get the UART hardware flow control configuration.

**Parameters**

- **uart\_num** –UART port number, the max port number is (UART\_NUM\_MAX -1).
- **flow\_ctrl** –Option for different flow control mode.

**Returns**

- ESP\_FAIL Parameter error
- ESP\_OK Success, result will be put in (\*flow\_ctrl)

*esp\_err\_t* **uart\_clear\_intr\_status** (*uart\_port\_t* uart\_num, uint32\_t clr\_mask)

Clear UART interrupt status.

**Parameters**



- **uart\_num** –UART port number, the max port number is (UART\_NUM\_MAX -1).
- **clr\_mask** –Bit mask of the interrupt status to be cleared.

**Returns**

- ESP\_OK Success
- ESP\_FAIL Parameter error

*esp\_err\_t* **uart\_enable\_intr\_mask** (*uart\_port\_t* uart\_num, uint32\_t enable\_mask)

Set UART interrupt enable.

**Parameters**

- **uart\_num** –UART port number, the max port number is (UART\_NUM\_MAX -1).
- **enable\_mask** –Bit mask of the enable bits.

**Returns**

- ESP\_OK Success
- ESP\_FAIL Parameter error

*esp\_err\_t* **uart\_disable\_intr\_mask** (*uart\_port\_t* uart\_num, uint32\_t disable\_mask)

Clear UART interrupt enable bits.

**Parameters**

- **uart\_num** –UART port number, the max port number is (UART\_NUM\_MAX -1).
- **disable\_mask** –Bit mask of the disable bits.

**Returns**

- ESP\_OK Success
- ESP\_FAIL Parameter error

*esp\_err\_t* **uart\_enable\_rx\_intr** (*uart\_port\_t* uart\_num)

Enable UART RX interrupt (RX\_FULL & RX\_TIMEOUT INTERRUPT)

**Parameters** **uart\_num** –UART port number, the max port number is (UART\_NUM\_MAX -1).

**Returns**

- ESP\_OK Success
- ESP\_FAIL Parameter error

*esp\_err\_t* **uart\_disable\_rx\_intr** (*uart\_port\_t* uart\_num)

Disable UART RX interrupt (RX\_FULL & RX\_TIMEOUT INTERRUPT)

**Parameters** **uart\_num** –UART port number, the max port number is (UART\_NUM\_MAX -1).

**Returns**

- ESP\_OK Success
- ESP\_FAIL Parameter error

*esp\_err\_t* **uart\_disable\_tx\_intr** (*uart\_port\_t* uart\_num)

Disable UART TX interrupt (TX\_FULL & TX\_TIMEOUT INTERRUPT)

**Parameters** **uart\_num** –UART port number

**Returns**

- ESP\_OK Success
- ESP\_FAIL Parameter error

*esp\_err\_t* **uart\_enable\_tx\_intr** (*uart\_port\_t* uart\_num, int enable, int thresh)

Enable UART TX interrupt (TX\_FULL & TX\_TIMEOUT INTERRUPT)

**Parameters**

- **uart\_num** –UART port number, the max port number is (UART\_NUM\_MAX -1).
- **enable** –1: enable; 0: disable
- **thresh** –Threshold of TX interrupt, 0 ~ UART\_FIFO\_LEN

**Returns**

- ESP\_OK Success
- ESP\_FAIL Parameter error

*esp\_err\_t* **uart\_set\_pin** (*uart\_port\_t* uart\_num, int tx\_io\_num, int rx\_io\_num, int rts\_io\_num, int cts\_io\_num)

Assign signals of a UART peripheral to GPIO pins.

---

**Note:** If the GPIO number configured for a UART signal matches one of the IOMUX signals for that GPIO, the signal will be connected directly via the IOMUX. Otherwise the GPIO and signal will be connected via the GPIO Matrix. For example, if on an ESP32 the call `uart_set_pin(0, 1, 3, -1, -1)` is performed, as GPIO1 is UART0's default TX pin and GPIO3 is UART0's default RX pin, both will be connected to respectively U0TXD and U0RXD through the IOMUX, totally bypassing the GPIO matrix. The check is performed on a per-pin basis. Thus, it is possible to have RX pin binded to a GPIO through the GPIO matrix, whereas TX is binded to its GPIO through the IOMUX.

---

---

**Note:** Internal signal can be output to multiple GPIO pads. Only one GPIO pad can connect with input signal.

---

#### Parameters

- **uart\_num** –UART port number, the max port number is (UART\_NUM\_MAX -1).
- **tx\_io\_num** –UART TX pin GPIO number.
- **rx\_io\_num** –UART RX pin GPIO number.
- **rts\_io\_num** –UART RTS pin GPIO number.
- **cts\_io\_num** –UART CTS pin GPIO number.

#### Returns

- ESP\_OK Success
- ESP\_FAIL Parameter error

*esp\_err\_t* `uart_set_rts` (*uart\_port\_t* uart\_num, int level)

Manually set the UART RTS pin level.

---

**Note:** UART must be configured with hardware flow control disabled.

---

#### Parameters

- **uart\_num** –UART port number, the max port number is (UART\_NUM\_MAX -1).
- **level** –1: RTS output low (active); 0: RTS output high (block)

#### Returns

- ESP\_OK Success
- ESP\_FAIL Parameter error

*esp\_err\_t* `uart_set_dtr` (*uart\_port\_t* uart\_num, int level)

Manually set the UART DTR pin level.

#### Parameters

- **uart\_num** –UART port number, the max port number is (UART\_NUM\_MAX -1).
- **level** –1: DTR output low; 0: DTR output high

#### Returns

- ESP\_OK Success
- ESP\_FAIL Parameter error

*esp\_err\_t* `uart_set_tx_idle_num` (*uart\_port\_t* uart\_num, uint16\_t idle\_num)

Set UART idle interval after tx FIFO is empty.

#### Parameters

- **uart\_num** –UART port number, the max port number is (UART\_NUM\_MAX -1).
- **idle\_num** –idle interval after tx FIFO is empty(unit: the time it takes to send one bit under current baudrate)

#### Returns

- ESP\_OK Success

- ESP\_FAIL Parameter error

*esp\_err\_t* **uart\_param\_config** (*uart\_port\_t* uart\_num, const *uart\_config\_t* \*uart\_config)

Set UART configuration parameters.

**Parameters**

- **uart\_num** –UART port number, the max port number is (UART\_NUM\_MAX -1).
- **uart\_config** –UART parameter settings

**Returns**

- ESP\_OK Success
- ESP\_FAIL Parameter error

*esp\_err\_t* **uart\_intr\_config** (*uart\_port\_t* uart\_num, const *uart\_intr\_config\_t* \*intr\_conf)

Configure UART interrupts.

**Parameters**

- **uart\_num** –UART port number, the max port number is (UART\_NUM\_MAX -1).
- **intr\_conf** –UART interrupt settings

**Returns**

- ESP\_OK Success
- ESP\_FAIL Parameter error

*esp\_err\_t* **uart\_wait\_tx\_done** (*uart\_port\_t* uart\_num, TickType\_t ticks\_to\_wait)

Wait until UART TX FIFO is empty.

**Parameters**

- **uart\_num** –UART port number, the max port number is (UART\_NUM\_MAX -1).
- **ticks\_to\_wait** –Timeout, count in RTOS ticks

**Returns**

- ESP\_OK Success
- ESP\_FAIL Parameter error
- ESP\_ERR\_TIMEOUT Timeout

int **uart\_tx\_chars** (*uart\_port\_t* uart\_num, const char \*buffer, uint32\_t len)

Send data to the UART port from a given buffer and length.

This function will not wait for enough space in TX FIFO. It will just fill the available TX FIFO and return when the FIFO is full.

---

**Note:** This function should only be used when UART TX buffer is not enabled.

---

**Parameters**

- **uart\_num** –UART port number, the max port number is (UART\_NUM\_MAX -1).
- **buffer** –data buffer address
- **len** –data length to send

**Returns**

- (-1) Parameter error
- OTHERS (>=0) The number of bytes pushed to the TX FIFO

int **uart\_write\_bytes** (*uart\_port\_t* uart\_num, const void \*src, size\_t size)

Send data to the UART port from a given buffer and length,.

If the UART driver's parameter 'tx\_buffer\_size' is set to zero: This function will not return until all the data have been sent out, or at least pushed into TX FIFO.

Otherwise, if the 'tx\_buffer\_size' > 0, this function will return after copying all the data to tx ring buffer, UART ISR will then move data from the ring buffer to TX FIFO gradually.

**Parameters**

- **uart\_num** –UART port number, the max port number is (UART\_NUM\_MAX -1).
- **src** –data buffer address

- **size** –data length to send

**Returns**

- (-1) Parameter error
- OTHERS (>=0) The number of bytes pushed to the TX FIFO

int **uart\_write\_bytes\_with\_break** (*uart\_port\_t* uart\_num, const void \*src, size\_t size, int brk\_len)

Send data to the UART port from a given buffer and length,.

If the UART driver's parameter 'tx\_buffer\_size' is set to zero: This function will not return until all the data and the break signal have been sent out. After all data is sent out, send a break signal.

Otherwise, if the 'tx\_buffer\_size' > 0, this function will return after copying all the data to tx ring buffer, UART ISR will then move data from the ring buffer to TX FIFO gradually. After all data sent out, send a break signal.

**Parameters**

- **uart\_num** –UART port number, the max port number is (UART\_NUM\_MAX -1).
- **src** –data buffer address
- **size** –data length to send
- **brk\_len** –break signal duration(unit: the time it takes to send one bit at current baudrate)

**Returns**

- (-1) Parameter error
- OTHERS (>=0) The number of bytes pushed to the TX FIFO

int **uart\_read\_bytes** (*uart\_port\_t* uart\_num, void \*buf, uint32\_t length, TickType\_t ticks\_to\_wait)

UART read bytes from UART buffer.

**Parameters**

- **uart\_num** –UART port number, the max port number is (UART\_NUM\_MAX -1).
- **buf** –pointer to the buffer.
- **length** –data length
- **ticks\_to\_wait** –sTimeout, count in RTOS ticks

**Returns**

- (-1) Error
- OTHERS (>=0) The number of bytes read from UART FIFO

*esp\_err\_t* **uart\_flush** (*uart\_port\_t* uart\_num)

Alias of `uart_flush_input`. UART ring buffer flush. This will discard all data in the UART RX buffer.

---

**Note:** Instead of waiting the data sent out, this function will clear UART rx buffer. In order to send all the data in tx FIFO, we can use `uart_wait_tx_done` function.

---

**Parameters** **uart\_num** –UART port number, the max port number is (UART\_NUM\_MAX -1).

**Returns**

- ESP\_OK Success
- ESP\_FAIL Parameter error

*esp\_err\_t* **uart\_flush\_input** (*uart\_port\_t* uart\_num)

Clear input buffer, discard all the data is in the ring-buffer.

---

**Note:** In order to send all the data in tx FIFO, we can use `uart_wait_tx_done` function.

---

**Parameters** **uart\_num** –UART port number, the max port number is (UART\_NUM\_MAX -1).

**Returns**

- ESP\_OK Success
- ESP\_FAIL Parameter error

*esp\_err\_t* **uart\_get\_buffered\_data\_len** (*uart\_port\_t* uart\_num, size\_t \*size)

UART get RX ring buffer cached data length.

**Parameters**

- **uart\_num** –UART port number, the max port number is (UART\_NUM\_MAX -1).
- **size** –Pointer of size\_t to accept cached data length

**Returns**

- ESP\_OK Success
- ESP\_FAIL Parameter error

*esp\_err\_t* **uart\_get\_tx\_buffer\_free\_size** (*uart\_port\_t* uart\_num, size\_t \*size)

UART get TX ring buffer free space size.

**Parameters**

- **uart\_num** –UART port number, the max port number is (UART\_NUM\_MAX -1).
- **size** –Pointer of size\_t to accept the free space size

**Returns**

- ESP\_OK Success
- ESP\_ERR\_INVALID\_ARG Parameter error

*esp\_err\_t* **uart\_disable\_pattern\_det\_intr** (*uart\_port\_t* uart\_num)

UART disable pattern detect function. Designed for applications like ‘AT commands’. When the hardware detects a series of one same character, the interrupt will be triggered.

**Parameters** **uart\_num** –UART port number, the max port number is (UART\_NUM\_MAX -1).

**Returns**

- ESP\_OK Success
- ESP\_FAIL Parameter error

*esp\_err\_t* **uart\_enable\_pattern\_det\_baud\_intr** (*uart\_port\_t* uart\_num, char pattern\_chr, uint8\_t chr\_num, int chr\_tout, int post\_idle, int pre\_idle)

UART enable pattern detect function. Designed for applications like ‘AT commands’. When the hardware detect a series of one same character, the interrupt will be triggered.

**Parameters**

- **uart\_num** –UART port number.
- **pattern\_chr** –character of the pattern.
- **chr\_num** –number of the character, 8bit value.
- **chr\_tout** –timeout of the interval between each pattern characters, 16bit value, unit is the baud-rate cycle you configured. When the duration is more than this value, it will not take this data as at\_cmd char.
- **post\_idle** –idle time after the last pattern character, 16bit value, unit is the baud-rate cycle you configured. When the duration is less than this value, it will not take the previous data as the last at\_cmd char
- **pre\_idle** –idle time before the first pattern character, 16bit value, unit is the baud-rate cycle you configured. When the duration is less than this value, it will not take this data as the first at\_cmd char.

**Returns**

- ESP\_OK Success
- ESP\_FAIL Parameter error

int **uart\_pattern\_pop\_pos** (*uart\_port\_t* uart\_num)

Return the nearest detected pattern position in buffer. The positions of the detected pattern are saved in a queue, this function will dequeue the first pattern position and move the pointer to next pattern position.

The following APIs will modify the pattern position info: `uart_flush_input`, `uart_read_bytes`, `uart_driver_delete`, `uart_pop_pattern_pos` It is the application’s responsibility to ensure atomic access to the pattern queue and the rx data buffer when using pattern detect feature.

---

**Note:** If the RX buffer is full and flow control is not enabled, the detected pattern may not be found in the rx buffer due to overflow.

---

**Parameters** `uart_num` –UART port number, the max port number is (UART\_NUM\_MAX -1).

**Returns**

- (-1) No pattern found for current index or parameter error
- others the pattern position in rx buffer.

`int uart_pattern_get_pos (uart_port_t uart_num)`

Return the nearest detected pattern position in buffer. The positions of the detected pattern are saved in a queue, This function do nothing to the queue.

The following APIs will modify the pattern position info: `uart_flush_input`, `uart_read_bytes`, `uart_driver_delete`, `uart_pop_pattern_pos` It is the application' s responsibility to ensure atomic access to the pattern queue and the rx data buffer when using pattern detect feature.

---

**Note:** If the RX buffer is full and flow control is not enabled, the detected pattern may not be found in the rx buffer due to overflow.

---

**Parameters** `uart_num` –UART port number, the max port number is (UART\_NUM\_MAX -1).

**Returns**

- (-1) No pattern found for current index or parameter error
- others the pattern position in rx buffer.

`esp_err_t uart_pattern_queue_reset (uart_port_t uart_num, int queue_length)`

Allocate a new memory with the given length to save record the detected pattern position in rx buffer.

**Parameters**

- `uart_num` –UART port number, the max port number is (UART\_NUM\_MAX -1).
- `queue_length` –Max queue length for the detected pattern. If the queue length is not large enough, some pattern positions might be lost. Set this value to the maximum number of patterns that could be saved in data buffer at the same time.

**Returns**

- `ESP_ERR_NO_MEM` No enough memory
- `ESP_ERR_INVALID_STATE` Driver not installed
- `ESP_FAIL` Parameter error
- `ESP_OK` Success

`esp_err_t uart_set_mode (uart_port_t uart_num, uart_mode_t mode)`

UART set communication mode.

---

**Note:** This function must be executed after `uart_driver_install()`, when the driver object is initialized.

---

**Parameters**

- `uart_num` –Uart number to configure, the max port number is (UART\_NUM\_MAX -1).
- `mode` –UART UART mode to set

**Returns**

- `ESP_OK` Success
- `ESP_ERR_INVALID_ARG` Parameter error

*esp\_err\_t* **uart\_set\_rx\_full\_threshold** (*uart\_port\_t* uart\_num, int threshold)

Set uart threshold value for RX fifo full.

---

**Note:** If application is using higher baudrate and it is observed that bytes in hardware RX fifo are overwritten then this threshold can be reduced

---

**Parameters**

- **uart\_num** –UART\_NUM\_0, UART\_NUM\_1 or UART\_NUM\_2
- **threshold** –Threshold value above which RX fifo full interrupt is generated

**Returns**

- ESP\_OK Success
- ESP\_ERR\_INVALID\_ARG Parameter error
- ESP\_ERR\_INVALID\_STATE Driver is not installed

*esp\_err\_t* **uart\_set\_tx\_empty\_threshold** (*uart\_port\_t* uart\_num, int threshold)

Set uart threshold values for TX fifo empty.

**Parameters**

- **uart\_num** –UART\_NUM\_0, UART\_NUM\_1 or UART\_NUM\_2
- **threshold** –Threshold value below which TX fifo empty interrupt is generated

**Returns**

- ESP\_OK Success
- ESP\_ERR\_INVALID\_ARG Parameter error
- ESP\_ERR\_INVALID\_STATE Driver is not installed

*esp\_err\_t* **uart\_set\_rx\_timeout** (*uart\_port\_t* uart\_num, const uint8\_t tout\_thresh)

UART set threshold timeout for TOUT feature.

**Parameters**

- **uart\_num** –Uart number to configure, the max port number is (UART\_NUM\_MAX -1).
- **tout\_thresh** –This parameter defines timeout threshold in uart symbol periods. The maximum value of threshold is 126. tout\_thresh = 1, defines TOUT interrupt timeout equal to transmission time of one symbol (~11 bit) on current baudrate. If the time is expired the UART\_RXFIFO\_TOUT\_INT interrupt is triggered. If tout\_thresh == 0, the TOUT feature is disabled.

**Returns**

- ESP\_OK Success
- ESP\_ERR\_INVALID\_ARG Parameter error
- ESP\_ERR\_INVALID\_STATE Driver is not installed

*esp\_err\_t* **uart\_get\_collision\_flag** (*uart\_port\_t* uart\_num, bool \*collision\_flag)

Returns collision detection flag for RS485 mode Function returns the collision detection flag into variable pointed by collision\_flag. \*collision\_flag = true, if collision detected else it is equal to false. This function should be executed when actual transmission is completed (after uart\_write\_bytes()).

**Parameters**

- **uart\_num** –Uart number to configure the max port number is (UART\_NUM\_MAX -1).
- **collision\_flag** –Pointer to variable of type bool to return collision flag.

**Returns**

- ESP\_OK Success
- ESP\_ERR\_INVALID\_ARG Parameter error

*esp\_err\_t* **uart\_set\_wakeup\_threshold** (*uart\_port\_t* uart\_num, int wakeup\_threshold)

Set the number of RX pin signal edges for light sleep wakeup.

UART can be used to wake up the system from light sleep. This feature works by counting the number of positive edges on RX pin and comparing the count to the threshold. When the count exceeds the threshold, system is woken up from light sleep. This function allows setting the threshold value.

Stop bit and parity bits (if enabled) also contribute to the number of edges. For example, letter ‘a’ with ASCII code 97 is encoded as 0100001101 on the wire (with 8n1 configuration), start and stop bits included. This sequence has 3 positive edges (transitions from 0 to 1). Therefore, to wake up the system when ‘a’ is sent, set `wakeup_threshold=3`.

The character that triggers wakeup is not received by UART (i.e. it can not be obtained from UART FIFO). Depending on the baud rate, a few characters after that will also not be received. Note that when the chip enters and exits light sleep mode, APB frequency will be changing. To make sure that UART has correct baud rate all the time, select `UART_SCLK_REF_TICK` or `UART_SCLK_XTAL` as UART clock source in [uart\\_config\\_t::source\\_clk](#).

---

**Note:** in ESP32, the wakeup signal can only be input via IO\_MUX (i.e. GPIO3 should be configured as `function_1` to wake up UART0, GPIO9 should be configured as `function_5` to wake up UART1), UART2 does not support light sleep wakeup feature.

---

#### Parameters

- `uart_num` –UART number, the max port number is (`UART_NUM_MAX -1`).
- `wakeup_threshold` –number of RX edges for light sleep wakeup, value is 3 .. 0x3ff.

#### Returns

- `ESP_OK` on success
- `ESP_ERR_INVALID_ARG` if `uart_num` is incorrect or `wakeup_threshold` is outside of [3, 0x3ff] range.

*esp\_err\_t* `uart_get_wakeup_threshold` (*uart\_port\_t* `uart_num`, int \*`out_wakeup_threshold`)

Get the number of RX pin signal edges for light sleep wakeup.

See description of `uart_set_wakeup_threshold` for the explanation of UART wakeup feature.

#### Parameters

- `uart_num` –UART number, the max port number is (`UART_NUM_MAX -1`).
- `out_wakeup_threshold` –[`out`] output, set to the current value of wakeup threshold for the given UART.

#### Returns

- `ESP_OK` on success
- `ESP_ERR_INVALID_ARG` if `out_wakeup_threshold` is NULL

*esp\_err\_t* `uart_wait_tx_idle_polling` (*uart\_port\_t* `uart_num`)

Wait until UART tx memory empty and the last char send ok (polling mode).

•

#### Returns

- `ESP_OK` on success
- `ESP_ERR_INVALID_ARG` Parameter error
- `ESP_FAIL` Driver not installed

**Parameters** `uart_num` –UART number

*esp\_err\_t* `uart_set_loop_back` (*uart\_port\_t* `uart_num`, bool `loop_back_en`)

Configure TX signal loop back to RX module, just for the test usage.

•

#### Returns

- `ESP_OK` on success
- `ESP_ERR_INVALID_ARG` Parameter error
- `ESP_FAIL` Driver not installed



**Parameters**

- **uart\_num** –UART number
- **loop\_back\_en** –Set ture to enable the loop back function, else set it false.

void **uart\_set\_always\_rx\_timeout** (*uart\_port\_t* uart\_num, bool always\_rx\_timeout\_en)

Configure behavior of UART RX timeout interrupt.

When always\_rx\_timeout is true, timeout interrupt is triggered even if FIFO is full. This function can cause extra timeout interrupts triggered only to send the timeout event. Call this function only if you want to ensure timeout interrupt will always happen after a byte stream.

**Parameters**

- **uart\_num** –UART number
- **always\_rx\_timeout\_en** –Set to false enable the default behavior of timeout interrupt, set it to true to always trigger timeout interrupt.

**Structures**

struct **uart\_intr\_config\_t**

UART interrupt configuration parameters for `uart_intr_config` function.

**Public Members**

uint32\_t **intr\_enable\_mask**

UART interrupt enable mask, choose from `UART_XXXX_INT_ENA_M` under `UART_INT_ENA_REG(i)`, connect with bit-or operator

uint8\_t **rx\_timeout\_thresh**

UART timeout interrupt threshold (unit: time of sending one byte)

uint8\_t **txfifo\_empty\_intr\_thresh**

UART TX empty interrupt threshold.

uint8\_t **rxfifo\_full\_thresh**

UART RX full interrupt threshold.

struct **uart\_event\_t**

Event structure used in UART event queue.

**Public Members**

*uart\_event\_type\_t* **type**

UART event type

size\_t **size**

UART data size for `UART_DATA` event

bool **timeout\_flag**

UART data read timeout flag for `UART_DATA` event (no new data received during configured RX TOUT) If the event is caused by FIFO-full interrupt, then there will be no event with the timeout flag before the next byte coming.

## Macros

**UART\_NUM\_0**

UART port 0

**UART\_NUM\_1**

UART port 1

**UART\_NUM\_MAX**

UART port max

**UART\_PIN\_NO\_CHANGE**

**UART\_FIFO\_LEN**

Length of the UART HW FIFO.

**UART\_BITRATE\_MAX**

Maximum configurable bitrate.

## Type Definitions

typedef *intr\_handle\_t* **uart\_isr\_handle\_t**

## Enumerations

enum **uart\_event\_type\_t**

UART event types used in the ring buffer.

*Values:*

enumerator **UART\_DATA**

UART data event

enumerator **UART\_BREAK**

UART break event

enumerator **UART\_BUFFER\_FULL**

UART RX buffer full event

enumerator **UART\_FIFO\_OVF**

UART FIFO overflow event

enumerator **UART\_FRAME\_ERR**

UART RX frame error event

enumerator **UART\_PARITY\_ERR**

UART RX parity event

enumerator **UART\_DATA\_BREAK**

UART TX data and break event

enumerator **UART\_PATTERN\_DET**

UART pattern detected

enumerator **UART\_WAKEUP**

UART wakeup event

enumerator **UART\_EVENT\_MAX**

UART event max index

### Header File

- [components/hal/include/hal/uart\\_types.h](#)

### Structures

struct **uart\_at\_cmd\_t**

UART AT cmd char configuration parameters Note that this function may different on different chip. Please refer to the TRM at configuration.

#### Public Members

uint8\_t **cmd\_char**

UART AT cmd char

uint8\_t **char\_num**

AT cmd char repeat number

uint32\_t **gap\_tout**

gap time(in baud-rate) between AT cmd char

uint32\_t **pre\_idle**

the idle time(in baud-rate) between the non AT char and first AT char

uint32\_t **post\_idle**

the idle time(in baud-rate) between the last AT char and the none AT char

struct **uart\_sw\_flowctrl\_t**

UART software flow control configuration parameters.

#### Public Members

uint8\_t **xon\_char**

Xon flow control char

uint8\_t **xoff\_char**

Xoff flow control char

uint8\_t **xon\_thrd**

If the software flow control is enabled and the data amount in rxfifo is less than xon\_thrd, an xon\_char will be sent

uint8\_t **xoff\_thrd**

If the software flow control is enabled and the data amount in rxfifo is more than xoff\_thrd, an xoff\_char will be sent

struct **uart\_config\_t**

UART configuration parameters for uart\_param\_config function.

### Public Members

int **baud\_rate**

UART baud rate

*uart\_word\_length\_t* **data\_bits**

UART byte size

*uart\_parity\_t* **parity**

UART parity mode

*uart\_stop\_bits\_t* **stop\_bits**

UART stop bits

*uart\_hw\_flowcontrol\_t* **flow\_ctrl**

UART HW flow control mode (cts/rts)

uint8\_t **rx\_flow\_ctrl\_thresh**

UART HW RTS threshold

*uart\_sclk\_t* **source\_clk**

UART source clock selection

### Type Definitions

typedef int **uart\_port\_t**

UART port number, can be UART\_NUM\_0 ~ (UART\_NUM\_MAX -1).

typedef *soc\_periph\_uart\_clk\_src\_legacy\_t* **uart\_sclk\_t**

UART source clock.

### Enumerations

enum **uart\_mode\_t**

UART mode selection.

*Values:*

enumerator **UART\_MODE\_UART**

mode: regular UART mode

enumerator **UART\_MODE\_RS485\_HALF\_DUPLEX**

mode: half duplex RS485 UART mode control by RTS pin

enumerator **UART\_MODE\_IRDA**

mode: IRDA UART mode

enumerator **UART\_MODE\_RS485\_COLLISION\_DETECT**

mode: RS485 collision detection UART mode (used for test purposes)

enumerator **UART\_MODE\_RS485\_APP\_CTRL**

mode: application control RS485 UART mode (used for test purposes)

enum **uart\_word\_length\_t**

UART word length constants.

*Values:*

enumerator **UART\_DATA\_5\_BITS**

word length: 5bits

enumerator **UART\_DATA\_6\_BITS**

word length: 6bits

enumerator **UART\_DATA\_7\_BITS**

word length: 7bits

enumerator **UART\_DATA\_8\_BITS**

word length: 8bits

enumerator **UART\_DATA\_BITS\_MAX**

enum **uart\_stop\_bits\_t**

UART stop bits number.

*Values:*

enumerator **UART\_STOP\_BITS\_1**

stop bit: 1bit

enumerator **UART\_STOP\_BITS\_1\_5**

stop bit: 1.5bits

enumerator **UART\_STOP\_BITS\_2**

stop bit: 2bits

enumerator **UART\_STOP\_BITS\_MAX**

enum **uart\_parity\_t**

UART parity constants.

*Values:*

enumerator **UART\_PARITY\_DISABLE**

Disable UART parity

enumerator **UART\_PARITY\_EVEN**

Enable UART even parity

enumerator **UART\_PARITY\_ODD**

Enable UART odd parity

enum **uart\_hw\_flowcontrol\_t**

UART hardware flow control modes.

*Values:*

enumerator **UART\_HW\_FLOWCTRL\_DISABLE**

disable hardware flow control

enumerator **UART\_HW\_FLOWCTRL\_RTS**

enable RX hardware flow control (rts)

enumerator **UART\_HW\_FLOWCTRL\_CTS**

enable TX hardware flow control (cts)

enumerator **UART\_HW\_FLOWCTRL\_CTS\_RTS**

enable hardware flow control

enumerator **UART\_HW\_FLOWCTRL\_MAX**

enum **uart\_signal\_inv\_t**

UART signal bit map.

*Values:*

enumerator **UART\_SIGNAL\_INV\_DISABLE**

Disable UART signal inverse

enumerator **UART\_SIGNAL\_IRDA\_TX\_INV**

inverse the UART irda\_tx signal

enumerator **UART\_SIGNAL\_IRDA\_RX\_INV**

inverse the UART irda\_rx signal

enumerator **UART\_SIGNAL\_RXD\_INV**

inverse the UART rxd signal

enumerator **UART\_SIGNAL\_CTS\_INV**

inverse the UART cts signal

enumerator **UART\_SIGNAL\_DSR\_INV**

inverse the UART dsr signal

enumerator **UART\_SIGNAL\_TXD\_INV**

inverse the UART txd signal

enumerator **UART\_SIGNAL\_RTS\_INV**

inverse the UART rts signal

enumerator **UART\_SIGNAL\_DTR\_INV**

inverse the UART dtr signal

**GPIO Lookup Macros** The UART peripherals have dedicated IO\_MUX pins to which they are connected directly. However, signals can also be routed to other pins using the less direct GPIO matrix. To use direct routes, you need to know which pin is a dedicated IO\_MUX pin for a UART channel. GPIO Lookup Macros simplify the process of finding and assigning IO\_MUX pins. You choose a macro based on either the IO\_MUX pin number, or a required UART channel name, and the macro will return the matching counterpart for you. See some examples below.

---

**Note:** These macros are useful if you need very high UART baud rates (over 40 MHz), which means you will have to use IO\_MUX pins only. In other cases, these macros can be ignored, and you can use the GPIO Matrix as it allows you to configure any GPIO pin for any UART function.

---

1. `UART_NUM_2_TXD_DIRECT_GPIO_NUM` returns the IO\_MUX pin number of UART channel 2 TXD pin (pin 17)
2. `UART_GPIO19_DIRECT_CHANNEL` returns the UART number of GPIO 19 when connected to the UART peripheral via IO\_MUX (this is `UART_NUM_0`)
3. `UART_CTS_GPIO19_DIRECT_CHANNEL` returns the UART number of GPIO 19 when used as the UART CTS pin via IO\_MUX (this is `UART_NUM_0`). Similar to the above macro but specifies the pin function which is also part of the IO\_MUX assignment.

### Header File

- [components/soc/esp32s2/include/soc/uart\\_channel.h](#)

### Macros

`UART_GPIO43_DIRECT_CHANNEL`

`UART_NUM_0_TXD_DIRECT_GPIO_NUM`

`UART_GPIO44_DIRECT_CHANNEL`

`UART_NUM_0_RXD_DIRECT_GPIO_NUM`

`UART_GPIO16_DIRECT_CHANNEL`

`UART_NUM_0_CTS_DIRECT_GPIO_NUM`

UART\_GPIO15\_DIRECT\_CHANNEL

UART\_NUM\_0\_RTS\_DIRECT\_GPIO\_NUM

UART\_TXD\_GPIO43\_DIRECT\_CHANNEL

UART\_RXD\_GPIO44\_DIRECT\_CHANNEL

UART\_CTS\_GPIO16\_DIRECT\_CHANNEL

UART\_RTS\_GPIO15\_DIRECT\_CHANNEL

UART\_GPIO17\_DIRECT\_CHANNEL

UART\_NUM\_1\_TXD\_DIRECT\_GPIO\_NUM

UART\_GPIO18\_DIRECT\_CHANNEL

UART\_NUM\_1\_RXD\_DIRECT\_GPIO\_NUM

UART\_GPIO20\_DIRECT\_CHANNEL

UART\_NUM\_1\_CTS\_DIRECT\_GPIO\_NUM

UART\_GPIO19\_DIRECT\_CHANNEL

UART\_NUM\_1\_RTS\_DIRECT\_GPIO\_NUM

UART\_TXD\_GPIO17\_DIRECT\_CHANNEL

UART\_RXD\_GPIO18\_DIRECT\_CHANNEL

UART\_CTS\_GPIO20\_DIRECT\_CHANNEL

UART\_RTS\_GPIO19\_DIRECT\_CHANNEL

## 2.5.27 USB Device Driver

### Overview

The driver allows you to use ESP32-S2 chips to develop USB devices on a top of TinyUSB stack. TinyUSB is integrated with ESP-IDF to provide USB features of the framework. Using this driver the chip works as simple or composite device supporting several USB devices simultaneously.

TinyUSB stack is distributed via [IDF Component Registry](#).

Our USB-OTG implementation is limited to 6 USB endpoints (5 IN/OUT endpoints and 1 IN endpoint) - find more information in [technical reference manual](#).



## Features

- Configuration of device and string USB descriptors
- USB Serial Device (CDC-ACM)
- Input and output streams through USB Serial Device
- Other USB classes (MIDI, MSC, HID…) support directly via TinyUSB
- VBUS monitoring for self-powered devices

## Hardware USB Connection

- Any board with the ESP32-S2 chip with USB connectors or with exposed USB's D+ and D- (DATA+/DATA-) pins.

If the board has no USB connector but has the pins, connect pins directly to the host (e.g. with do-it-yourself cable from any USB connection cable).

On ESP32-S2, connect GPIO 20 and 19 to D+/D- respectively:

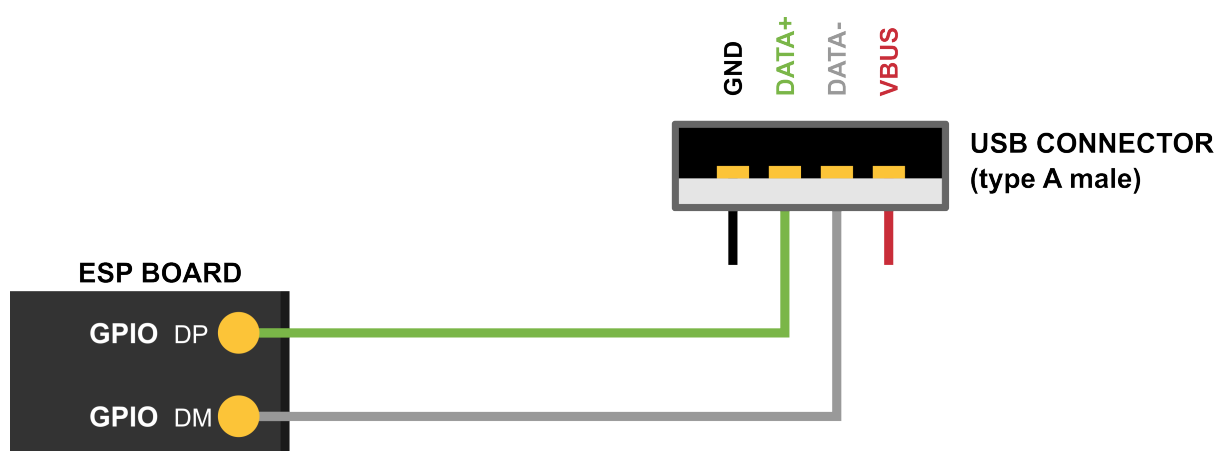

Self-powered devices must also connect VBUS through voltage divider or comparator, more details in [Self-Powered Device](#) subchapter.

## Driver Structure

As the basis is used the TinyUSB stack.

On top of it the driver implements:

- Customization of USB descriptors
- Serial device support
- Redirecting of standard streams through the Serial device
- Encapsulated driver's task servicing the TinyUSB

## Configuration

Via Menuconfig options you can specify:

- Several of descriptor's parameters (see: Descriptors Configuration below)
- USB Serial low-level Configuration
- The verbosity of the TinyUSB's log
- Disable the TinyUSB main task (for the custom implementation)

**Descriptors Configuration** The driver's descriptors are provided by `tinyusb_config_t` structure's `device_descriptor`, `configuration_descriptor` and `string_descriptor` members. Therefore, you should initialize `tinyusb_config_t` with your desired descriptors before calling `tinyusb_driver_install()` to install the driver.

However, the driver also provides default descriptors. You can install the driver with default device and string descriptors by setting the `device_descriptor` and `string_descriptor` members of `tinyusb_config_t` to `NULL` before calling `tinyusb_driver_install()`. To lower your development effort we also provide default configuration descriptor for CDC and MSC class, as these classes rarely require custom configuration. The driver's default device descriptor is specified using `Menuconfig`, where the following fields should be configured:

- PID
- VID
- `bcdDevice`
- Manufacturer
- Product name
- Name of CDC device if it is On
- Serial number

If you want to use your own descriptors with extended modification, you can define them during the driver installation process.

### Install Driver

To initialize the driver, users should call `tinyusb_driver_install()`. The driver's configuration is specified in a `tinyusb_config_t` structure that is passed as an argument to `tinyusb_driver_install()`.

Note that the `tinyusb_config_t` structure can be zero initialized (e.g. `const tinyusb_config_t tusb_cfg = { 0 };`) or partially (as shown below). For any member that is initialized to `0` or `NULL`, the driver will use its default configuration values for that member (see example below)

```
const tinyusb_config_t partial_init = {
    .device_descriptor = NULL, // Use default device descriptor specified in
    ↪Menuconfig
    .string_descriptor = NULL, // Use default string descriptors specified in
    ↪Menuconfig
    .external_phy = false, // Use internal USB PHY
    .configuration_descriptor = NULL, // Use default configuration descriptor
    ↪according to settings in Menuconfig
};
```

### Self-Powered Device

USB specification mandates self-powered devices to monitor voltage level on USB's VBUS signal. As opposed to bus-powered devices, a self-powered device can be fully functional even without USB connection. The self-powered device detects connection and disconnection events by monitoring the VBUS voltage level. VBUS is considered valid if it rises above 4.75V and invalid if it falls below 4.35V.

No ESP32-S2 pin is 5V tolerant, so you must connect the VBUS to ESP32-S2 via a comparator with voltage thresholds as described above, or use a simple resistor voltage divider that will output  $(0.75 \times V_{dd})$  if VBUS is 4.4V (see figure below). In both cases, voltage on the sensing pin must be logic low within 3ms after the device is unplugged from USB host.

To use this feature, in `tinyusb_config_t` you must set `self_powered` to `true` and `vbus_monitor_io` to GPIO number that will be used for VBUS monitoring.

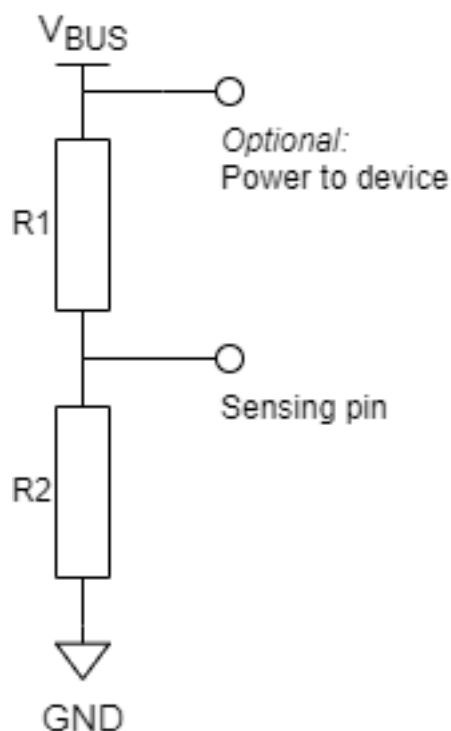

Fig. 29: Simple voltage divider for VBUS monitoring

### USB Serial Device (CDC-ACM)

If the CDC option is enabled in Menuconfig, the USB Serial Device can be initialized with `tusb_cdc_acm_init()` according to the settings from `tinyusb_config_cdcacm_t` (see example below).

```
const tinyusb_config_cdcacm_t acm_cfg = {
    .usb_dev = TINYUSB_USBDEV_0,
    .cdc_port = TINYUSB_CDC_ACM_0,
    .rx_unread_buf_sz = 64,
    .callback_rx = NULL,
    .callback_rx_wanted_char = NULL,
    .callback_line_state_changed = NULL,
    .callback_line_coding_changed = NULL
};
tusb_cdc_acm_init(&acm_cfg);
```

To specify callbacks you can either set the pointer to your `tusb_cdcacm_callback_t` function in the configuration structure or call `tinyusb_cdcacm_register_callback()` after initialization.

**USB Serial Console** The driver allows to redirect all standard application streams (`stdin`, `stdout`, `stderr`) to the USB Serial Device and return them to UART using `esp_tusb_init_console()/esp_tusb_deinit_console()` functions.

### Application Examples

The table below describes the code examples available in the directory [peripherals/usb/](#).

Code Example	Description
<a href="#">peripherals/usb/device/tusb_console</a>	How to set up ESP32-S2 chip to get log output via Serial Device connection
<a href="#">peripherals/usb/device/tusb_serial_device</a>	How to set up ESP32-S2 chip to work as a USB Serial Device
<a href="#">peripherals/usb/device/tusb_midi</a>	How to set up ESP32-S2 chip to work as a USB MIDI Device
<a href="#">peripherals/usb/device/tusb_hid</a>	How to set up ESP32-S2 chip to work as a USB Human Interface Device

## 2.5.28 USB Host

The document provides information regarding the USB Host Library. This document is split into the following sections:

### Sections

- *USB Host*
  - *Overview*
  - *Architecture*
  - *Usage*
  - *Examples*
  - *Host Stack Configuration*
  - *API Reference*

### Overview

The USB Host Library (hereinafter referred to as the Host Library) is the lowest public facing API layer of the ESP-IDF USB Host Stack. In most cases, applications that require USB Host functionality will not need to interface with the Host Library directly. Instead, most applications will use the API provided by a host class driver that is implemented on top of the Host Library.

However, users may want to use the Host Library directly for some of (but not limited to) the following reasons:

- The user needs to implement a custom host class driver such as a vendor specific class driver
- The user has a requirement for a lower level of abstraction due to resource/latency requirements

**Features & Limitations** The Host Library has the following features:

- Supports Full Speed (FS) and Low Speed (LS) Devices
- Supports all four transfer types (Control, Bulk, Interrupt, and Isochronous)
- Allows multiple class drivers to run simultaneously (i.e., multiple clients of the Host Library)
- A single device can be used by multiple clients simultaneously (e.g., composite devices)
- The Host Library itself (and the underlying Host Stack) does not internally instantiate any OS tasks. The number of tasks are entirely controlled by how the Host Library interface is used. However, a general rule of thumb regarding the number of tasks is (the number of host class drivers running + 1).

Currently, the Host Library (and the underlying Host Stack) has the following limitations:

- Only supports a single device, but the Host Library's API is designed for multiple device support.
- Only supports Asynchronous transfers
- Transfer timeouts are not supported yet

### Architecture

The diagram above shows the key entities that are involved when implementing USB Host functionality. These entities are:

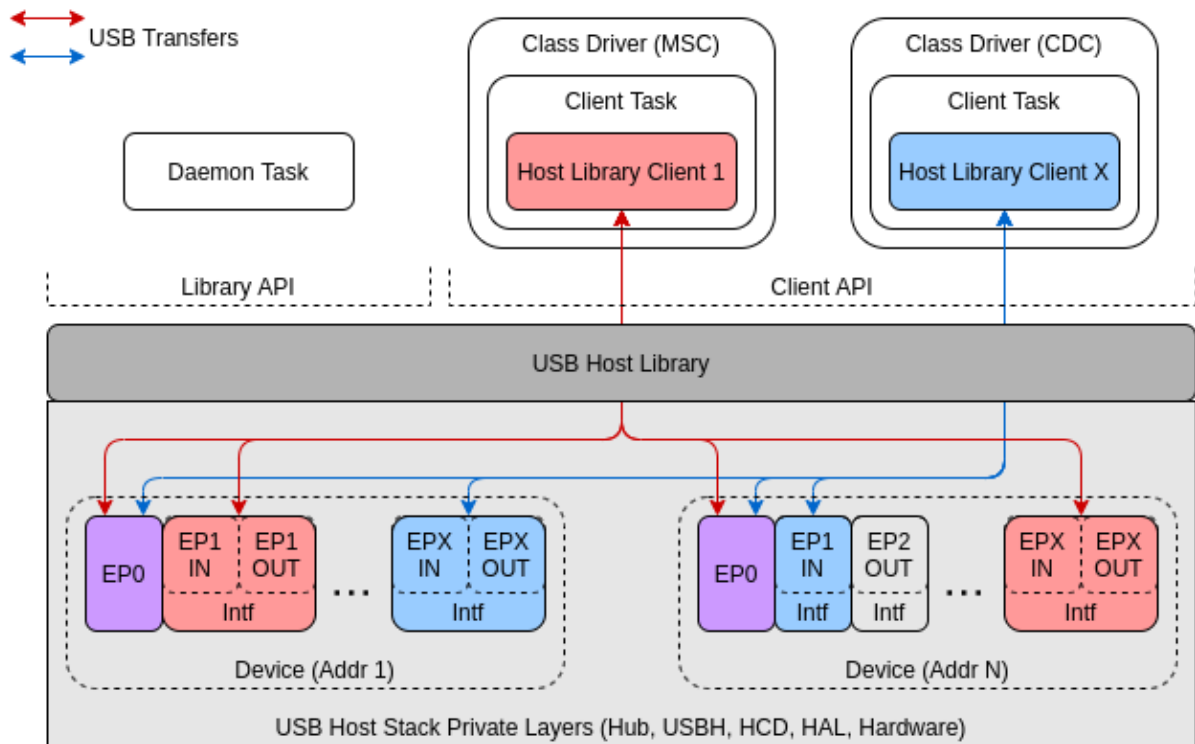

Fig. 30: Diagram of the key entities involved in USB Host functionality

- The **Host Library**
- **Clients** of the Host Library
- **Devices**
- Host Library **Daemon Task**

**Host Library** The Host Library is the a lowest public facing layer of the USB Host Stack. Any other IDF component (such as a class driver or a user component) that needs to communicate with a connected USB device can only do so using the Host Library API either directly or indirectly.

The Host Library's API is split into two sub-sets, namely the **Library API** and **Client API**.

- The Client API handles the communication between a client of the Host Library and one or more USB devices. The Client API should only be called by registered clients of the Host Library.
- The Library API handles all of the Host Library processing that is not specific to a single client (e.g., device enumeration). Usually, the library API is called by a Host Library Daemon Task.

**Clients** A client of the Host Library is a software component (such as a host class driver or user component) that uses the Host Library to communicate with a USB device. Generally each client has a one-to-one relation with a task, meaning that for a particular client, all of its Client API calls should be done from the context of the same task.

By organizing the software components that use the Host Library's into clients, the Host Library can delegate the handling of all client events (i.e., the events specific to that client) to the client's task. In other words, each client task is responsible for all the required processing and event handling associated with the USB communication that the client initiates.

**Daemon Task** Although the Host Library delegates the handling of client events to the clients themselves, there are still Library events (i.e., events that are not specific to a client) that need to be handled. Library event handling can include things such as:

- Handling USB device connection, enumeration, and disconnection
- Rerouting control transfers to/from clients

- Forwarding events to clients

Therefore, in addition to the client tasks, the Host Library also requires a task (usually the Host Library Daemon Task) to handle all of the library events.

**Devices** The Host Library hides the details of device handling (such as connection, memory allocation, and enumeration) from the clients. The clients are provided only with a list of already connected and enumerated devices to choose from. During enumeration, each device is automatically configured to use the first configuration found (i.e., the first configuration descriptor returned on a Get Configuration Descriptor request). For most standard devices, the first configuration will have a `bConfigurationValue` of 1.

It is possible for a two or more clients to simultaneously communicate with the same device as long as they are not communicating to the same interface. However, multiple clients can simultaneously communicate with the same device's default endpoint (EPO), which will result in their control transfers being serialized.

For a client to communicate with a device, the client must:

1. Open the device using the device's address. This lets the Host Library know that the client is using that device.
2. Claim the interface(s) that will be used for communication. This prevents other clients from claiming the same interface(s).
3. Send transfers to the endpoints in the claimed interface. The client's task is responsible for handling its own processing and events.

## Usage

The Host Library (and the underlying Host Stack) will not create any tasks. All tasks (i.e., the client tasks and the Daemon Task) will need to be created by the class drivers or the user. Instead, the Host Library provides two event handler functions that will handle all of the required Host Library processing, thus these functions should be called repeatedly from the client tasks and the Daemon Task. Therefore, the implementation of client tasks and the Daemon Task will be the largely centered around the invocation of these event handler functions.

## Host Library & Daemon Task

**Basic Usage** The Host Library API provides `usb_host_lib_handle_events()` to handle library events. This function should be called repeatedly, typically from the daemon task. Some notable features regarding `usb_host_lib_handle_events()` are:

- The function can block until a library event needs handling
- Event flags are returned on each invocation. These event flags are useful for knowing when the Host Library can be uninstalled.

A bare-bones Daemon Task would resemble something like the following code snippet:

```
#include "usb/usb_host.h"

void daemon_task(void *arg)
{
    ...
    bool exit = false;
    while (!exit) {
        uint32_t event_flags;
        usb_host_lib_handle_events(portMAX_DELAY, &event_flags);
        if (event_flags & USB_HOST_LIB_EVENT_FLAGS_NO_CLIENTS) {
            ...
        }
        if (event_flags & USB_HOST_LIB_EVENT_FLAGS_ALL_FREE) {
            ...
        }
    }
    ...
}
```

(continues on next page)

(continued from previous page)

```

}
...
}

```

**Note:** See the [peripherals/usb/host/usb\\_host\\_lib](#) example for a full implementation of the Daemon Task

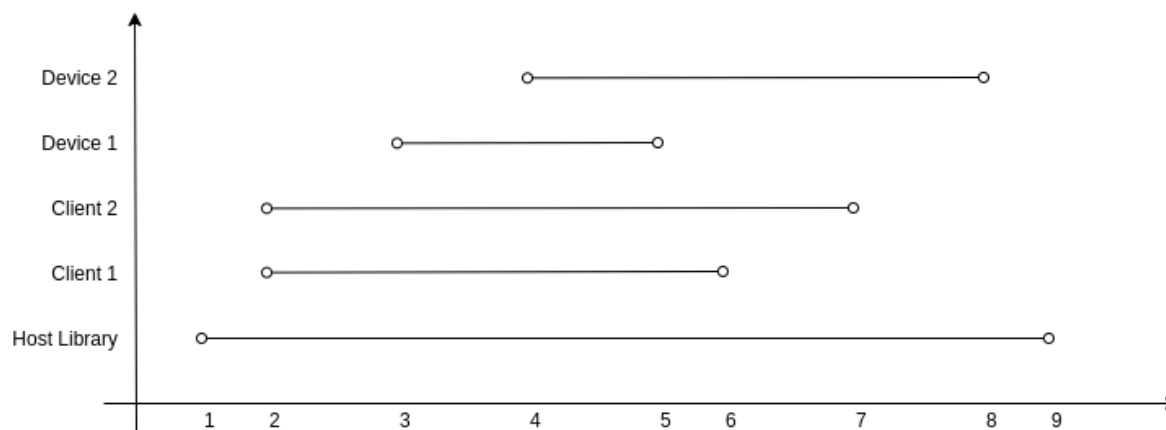

Fig. 31: Graph of Typical USB Host Library Lifecycle

**Lifecycle** The graph above illustrates the typical lifecycle of the Host Library with multiple clients and devices. Specifically, the example involves...

- two registered clients (Client 1 and Client 2)
- two connected devices (Device 1 and Device 2), where Client 1 communicates with Device 1 and Client 2 communicates with Device 2.

With reference the graph above, the typical lifecycle involves the following key stages.

1. **The Host Library is installed by calling `usb_host_install()`.**
  - Installation must be done before any other Host Library API is called.
  - Where `usb_host_install()` is called (e.g., from the Daemon Task or another task) will depend on the synchronization logic between the Daemon Task, client tasks, and the rest of the system.
2. **Once the Host Library is installed, the clients can be registered by calling `usb_host_client_register()`.**
  - This is typically called from the client task (where the client task waits for a signal from the Daemon Task).
  - This can be called elsewhere if necessary as long it is called after `usb_host_install()`.
3. **Device 1 connects and is then enumerated.**
  - Each registered client (in this case Client 1 and Client 2) are notified of the new device by way of the `USB_HOST_CLIENT_EVENT_NEW_DEV` event.
  - Client 1 opens Device 1 and begins communication with it.
4. **Similarly Device 2 connects and is enumerated.**
  - Client 1 and 2 are notified of a new device (via a `USB_HOST_CLIENT_EVENT_NEW_DEV` event).
  - Client 2 opens Device 2 and begins communication with it.
5. **Device 1 suddenly disconnects.**
  - Client 1 is notified by way of `USB_HOST_CLIENT_EVENT_DEV_GONE` and begins its cleanup.
  - Client 2 is not notified as it has not opened Device 1.
6. **Client 1 completes its clean up and deregisters by calling `usb_host_client_deregister()`.**
  - This is typically called from the client task before the task exits.
  - This can be called elsewhere if necessary as long as Client 1 has already completed its clean up.
7. **Client 2 completes its communication with Device 2. Client 2 then closes Device 2 and deregisters itself.**

- The Daemon Task is notified of the deregistration of all clients by way the `USB_HOST_LIB_EVENT_FLAGS_NO_CLIENTS` event flag as Client 2 is the last client to deregister.
- Device 2 is still allocated (i.e., not freed) as it is still connected albeit not currently opened by any client.

#### 8. The Daemon Task decides to cleanup as there are no more clients.

- The Daemon Task must free Device 2 first by calling `usb_host_device_free_all()`.
  - If `usb_host_device_free_all()` was able to free all devices, the function will return `ESP_OK` indicating that all devices have been freed.
  - If `usb_host_device_free_all()` was unable to free all devices (e.g., because the device is still opened by a client), the function will return `ESP_ERR_NOT_FINISHED`.
  - The Daemon Task must wait for `usb_host_lib_handle_events()` to return the `USB_HOST_LIB_EVENT_FLAGS_ALL_FREE` event flag in order to know when all devices have been freed.
9. Once the Daemon Task has verified that all clients have deregistered and all devices have been freed, it can now uninstall the Host Library by calling `usb_host_uninstall()`.

## Clients & Class Driver

**Basic Usage** The Host Library API provides `usb_host_client_handle_events()` to handle a particular client's events. This function should be called repeatedly, typically from the client's task. Some notable features regarding `usb_host_client_handle_events()` are:

- The function can block until a client event needs handling
- The function's primary purpose is to call the various event handling callbacks when a client event occurs.

The following callbacks are called from within `usb_host_client_handle_events()` thus allowing the client task to be notified of events.

- The client event callback of type `usb_host_client_event_cb_t` which delivers client event messages to the client. Client event messages indicate events such as the addition or removal of a device.
- The USB transfer completion callback of type `usb_transfer_cb_t` which indicates that a particular USB transfer previously submitted by the client has completed.

**Note:** Given that the callbacks are called from within `usb_host_client_handle_events()`, users should avoid blocking from within the callbacks as this will result in `usb_host_client_handle_events()` being blocked as well, thus preventing other pending client events from being handled.

The following code snippet demonstrates a bare-bones host class driver and its client task. The code snippet contains:

- A simple client task function `client_task` that calls `usb_host_client_handle_events()` in a loop.
- Implementations of a client event callback and transfer completion callbacks.
- Implementation of a simple state machine for the class driver. The class driver simply opens a device, sends an OUT transfer to EP1, then closes the device.

```
#include <string.h>
#include "usb/usb_host.h"

#define CLASS_DRIVER_ACTION_OPEN_DEV    0x01
#define CLASS_DRIVER_ACTION_TRANSFER   0x02
#define CLASS_DRIVER_ACTION_CLOSE_DEV   0x03

struct class_driver_control {
    uint32_t actions;
    uint8_t dev_addr;
    usb_host_client_handle_t client_hdl;
    usb_device_handle_t dev_hdl;
};
```

(continues on next page)



```

};

static void client_event_cb(const usb_host_client_event_msg_t *event_msg, void_
↳*arg)
{
    //This is function is called from within usb_host_client_handle_events(). Don
↳'t block and try to keep it short
    struct class_driver_control *class_driver_obj = (struct class_driver_control_
↳*)arg;
    switch (event_msg->event) {
        case USB_HOST_CLIENT_EVENT_NEW_DEV:
            class_driver_obj->actions |= CLASS_DRIVER_ACTION_OPEN_DEV;
            class_driver_obj->dev_addr = event_msg->new_dev.address; //Store the_
↳address of the new device
            break;
        case USB_HOST_CLIENT_EVENT_DEV_GONE:
            class_driver_obj->actions |= CLASS_DRIVER_ACTION_CLOSE_DEV;
            break;
        default:
            break;
    }
}

static void transfer_cb(usb_transfer_t *transfer)
{
    //This is function is called from within usb_host_client_handle_events(). Don
↳'t block and try to keep it short
    struct class_driver_control *class_driver_obj = (struct class_driver_control_
↳*)transfer->context;
    printf("Transfer status %d, actual number of bytes transferred %d\n", transfer-
↳>status, transfer->actual_num_bytes);
    class_driver_obj->actions |= CLASS_DRIVER_ACTION_CLOSE_DEV;
}

void client_task(void *arg)
{
    ... //Wait until Host Library is installed
    //Initialize class driver objects
    struct class_driver_control class_driver_obj = {0};
    //Register the client
    usb_host_client_config_t client_config = {
        .is_synchronous = false,
        .max_num_event_msg = 5,
        .async = {
            .client_event_callback = client_event_cb,
            .callback_arg = &class_driver_obj,
        }
    };
    usb_host_client_register(&client_config, &class_driver_obj.client_hdl);
    //Allocate a USB transfer
    usb_transfer_t *transfer;
    usb_host_transfer_alloc(1024, 0, &transfer);

    //Event handling loop
    bool exit = false;
    while (!exit) {
        //Call the client event handler function
        usb_host_client_handle_events(class_driver_obj.client_hdl, portMAX_DELAY);
        //Execute pending class driver actions
        if (class_driver_obj.actions & CLASS_DRIVER_ACTION_OPEN_DEV) {
            //Open the device and claim interface 1

```

(continues on next page)

(continued from previous page)

```

        usb_host_device_open(class_driver_obj.client_hdl, class_driver_obj.dev_
↔addr, &class_driver_obj.dev_hdl);
        usb_host_interface_claim(class_driver_obj.client_hdl, class_driver_obj.
↔dev_hdl, 1, 0);
    }
    if (class_driver_obj.actions & CLASS_DRIVER_ACTION_TRANSFER) {
        //Send an OUT transfer to EP1
        memset(transfer->data_buffer, 0xAA, 1024);
        transfer->num_bytes = 1024;
        transfer->device_handle = class_driver_obj.dev_hdl;
        transfer->bEndpointAddress = 0x01;
        transfer->callback = transfer_cb;
        transfer->context = (void *)&class_driver_obj;
        usb_host_transfer_submit(transfer);
    }
    if (class_driver_obj.actions & CLASS_DRIVER_ACTION_CLOSE_DEV) {
        //Release the interface and close the device
        usb_host_interface_release(class_driver_obj.client_hdl, class_driver_
↔obj.dev_hdl, 1);
        usb_host_device_close(class_driver_obj.client_hdl, class_driver_obj.
↔dev_hdl);
        exit = true;
    }
    ... //Handle any other actions required by the class driver
}

//Cleanup class driver
usb_host_transfer_free(transfer);
usb_host_client_deregister(class_driver_obj.client_hdl);
... //Delete the task and any other signal Daemon Task if required
}

```

**Note:** An actual host class driver will likely supported many more features, thus will have a much more complex state machine. A host class driver will likely also need to:

- Be able to open multiple devices
- Parse an opened device's descriptors to identify if the device is of the target class
- Communicate with multiple endpoints of an interface in a particular order
- Claim multiple interfaces of a device
- Handle various errors

**Lifecycle** The typical life cycle of a client task and class driver will go through the following stages:

1. Wait for some signal regarding the Host Library being installed.
2. Register the client via `usb_host_client_register()` and allocate any other class driver resources (e.g., allocating transfers using `usb_host_transfer_alloc()`).
3. For each new device that the class driver needs to communicate with:
  - a. Check if the device is already connected via `usb_host_device_addr_list_fill()`.
  - b. If the device is not already connected, wait for a `USB_HOST_CLIENT_EVENT_NEW_DEV` event from the client event callback.
  - c. Open the device via `usb_host_device_open()`.
  - d. Parse the device and configuration descriptors via `usb_host_get_device_descriptor()` and `usb_host_get_active_config_descriptor()` respectively.
  - e. Claim the necessary interfaces of the device via `usb_host_interface_claim()`.
4. Submit transfers to the device via `usb_host_transfer_submit()` or `usb_host_transfer_submit_control()`.
5. Once an opened device is no longer needed by the class driver, or has disconnected (as indicated by a `USB_HOST_CLIENT_EVENT_DEV_GONE` event):

- a. Stop any previously submitted transfers to the device's endpoints by calling `usb_host_endpoint_halt()` and `usb_host_endpoint_flush()` on those endpoints.
  - b. Release all previously claimed interfaces via `usb_host_interface_release()`.
  - c. Close the device via `usb_host_device_close()`.
6. Deregister the client via `usb_host_client_deregister()` and free any other class driver resources.
  7. Delete the client task. Signal the Daemon Task if necessary.

## Examples

**Host Library Examples** The [peripherals/usb/host/usb\\_host\\_lib](#) demonstrates basic usage of the USB Host Library's API to implement a pseudo class driver.

**Class Driver Examples** The USB Host Stack provides a number examples that implement host class drivers using the Host Library's API.

## CDC-ACM

- A host class driver for the Communication Device Class (Abstract Control Model) is deployed to [IDF component registry](#).
- The [peripherals/usb/host/cdc/cdc\\_acm\\_host](#) example uses the CDC-ACM host driver component to communicate with CDC-ACM devices
- The [peripherals/usb/host/cdc/cdc\\_acm\\_vcp](#) example shows how can you extend the CDC-ACM host driver to interface Virtual COM Port devices.
- The CDC-ACM driver is also used in [esp\\_modem examples](#), where it is used for communication with cellular modems.

## MSC

- A host class driver for the Mass Storage Class (Bulk-Only Transport) is deployed to [IDF component registry](#). You can find its example in [peripherals/usb/host/msc](#).

## Host Stack Configuration

**Non-Compliant Device Support** To support USB devices that are non-compliant in various scenarios or exhibit specific behaviors, it is possible to configure the USB Host stack.

As a USB device may be hot-plugged, it is essential to have the configurable delays between power switching and device attachment, and when the device's internal power has stabilized.

**Enumeration Configuration** During the process of enumerating connected USB devices, several timeout values ensure the proper functioning of the device.

The figure above shows all the timeouts associated with both turning on port power with a device connected and hot-plugging a device.

- After a port is reset or resumed, the USB system software is expected to provide a “recovery” interval of 10 ms before the device attached to the port is expected to respond to data transfers.
- After the reset/resume recovery interval, if a device receives a `SetAddress()` request, the device must be able to complete processing of the request and be able to successfully complete the Status stage of the request within 50 ms.
- After successful completion of the Status stage, the device is allowed a `SetAddress()` recovery interval of 2 ms.

---

**Note:** For more details regarding connection event timings, please refer to *Universal Serial Bus 2.0 Specification* > Chapter 7.1.7.3 *Connect and Disconnect Signaling*.

---

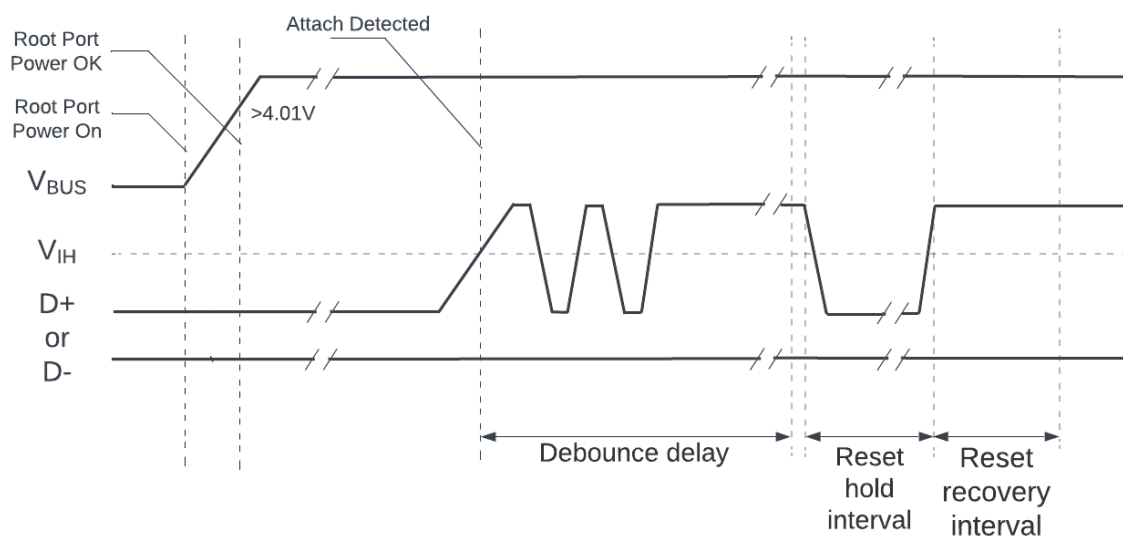

Fig. 32: USB Root Hub Power-on and Connection Events Timing

Configurable parameters of the USB host stack can be configured with multiple options via Menuconfig.

- For debounce delay, refer to [CONFIG\\_USB\\_HOST\\_DEBOUNCE\\_DELAY\\_MS](#).
- For reset hold interval, refer to [CONFIG\\_USB\\_HOST\\_RESET\\_HOLD\\_MS](#).
- For reset recovery interval, refer to [CONFIG\\_USB\\_HOST\\_RESET\\_RECOVERY\\_MS](#).
- For `SetAddress()` recovery interval, refer to [CONFIG\\_USB\\_HOST\\_SET\\_ADDR\\_RECOVERY\\_MS](#).

## API Reference

The API of the USB Host Library is separated into the following header files. However, it is sufficient for applications to only `#include "usb/usb_host.h"` and all of USB Host Library headers will also be included.

- [usb/include/usb/usb\\_host.h](#) contains the functions and types of the USB Host Library
- [usb/include/usb/usb\\_helpers.h](#) contains various helper functions that are related to the USB protocol such as descriptor parsing.
- [usb/include/usb/usb\\_types\\_stack.h](#) contains types that are used across multiple layers of the USB Host stack.
- [usb/include/usb/usb\\_types\\_ch9.h](#) contains types and macros related to Chapter 9 of the USB2.0 specification (i.e., descriptors and standard requests).

## Header File

- [components/usb/include/usb/usb\\_host.h](#)

## Functions

`esp_err_t usb_host_install (const usb\_host\_config\_t *config)`

Install the USB Host Library.

- This function should only be called once to install the USB Host Library
- This function should be called before any other USB Host Library functions are called

---

**Note:** If `skip_phy_setup` is set in the install configuration, the user is responsible for ensuring that the underlying Host Controller is enabled and the USB PHY (internal or external) is already setup before this function is called.

---

**Parameters** `config` –[in] USB Host Library configuration

**Returns** `esp_err_t`

*esp\_err\_t* **usb\_host\_uninstall** (void)

Uninstall the USB Host Library.

- This function should be called to uninstall the USB Host Library, thereby freeing its resources
- All clients must have been deregistered before calling this function
- All devices must have been freed by calling `usb_host_device_free_all()` and receiving the `USB_HOST_LIB_EVENT_FLAGS_ALL_FREE` event flag

---

**Note:** If `skip_phy_setup` was set when the Host Library was installed, the user is responsible for disabling the underlying Host Controller and USB PHY (internal or external).

---

**Returns** `esp_err_t`

*esp\_err\_t* **usb\_host\_lib\_handle\_events** (TickType\_t timeout\_ticks, uint32\_t \*event\_flags\_ret)

Handle USB Host Library events.

- This function handles all of the USB Host Library's processing and should be called repeatedly in a loop
- Check `event_flags_ret` to see if any flags are set indicating particular USB Host Library events
- This function should never be called by multiple threads simultaneously

---

**Note:** This function can block

---

**Parameters**

- `timeout_ticks` –[in] Timeout in ticks to wait for an event to occur
- `event_flags_ret` –[out] Event flags that indicate what USB Host Library event occurred.

**Returns** `esp_err_t`

*esp\_err\_t* **usb\_host\_lib\_unblock** (void)

Unblock the USB Host Library handler.

- This function simply unblocks the USB Host Library event handling function (`usb_host_lib_handle_events()`)

**Returns** `esp_err_t`

*esp\_err\_t* **usb\_host\_lib\_info** (*usb\_host\_lib\_info\_t* \*info\_ret)

Get current information about the USB Host Library.

**Parameters** `info_ret` –[out] USB Host Library Information

**Returns** `esp_err_t`

*esp\_err\_t* **usb\_host\_client\_register** (const *usb\_host\_client\_config\_t* \*client\_config,  
*usb\_host\_client\_handle\_t* \*client\_hdl\_ret)

Register a client of the USB Host Library.

- This function registers a client of the USB Host Library
- Once a client is registered, its processing function `usb_host_client_handle_events()` should be called repeatedly

**Parameters**

- **client\_config** –[in] Client configuration
- **client\_hdl\_ret** –[out] Client handle

**Returns** *esp\_err\_t*

*esp\_err\_t* **usb\_host\_client\_deregister** (*usb\_host\_client\_handle\_t* client\_hdl)

Deregister a USB Host Library client.

- This function deregisters a client of the USB Host Library
- The client must have closed all previously opened devices before attempting to deregister

**Parameters** **client\_hdl** –[in] Client handle

**Returns** *esp\_err\_t*

*esp\_err\_t* **usb\_host\_client\_handle\_events** (*usb\_host\_client\_handle\_t* client\_hdl, TickType\_t  
timeout\_ticks)

USB Host Library client processing function.

- This function handles all of a client's processing and should be called repeatedly in a loop
- For a particular client, this function should never be called by multiple threads simultaneously

---

**Note:** This function can block

---

**Parameters**

- **client\_hdl** –[in] Client handle
- **timeout\_ticks** –[in] Timeout in ticks to wait for an event to occur

**Returns** *esp\_err\_t*

*esp\_err\_t* **usb\_host\_client\_unblock** (*usb\_host\_client\_handle\_t* client\_hdl)

Unblock a client.

- This function simply unblocks a client if it is blocked on the `usb_host_client_handle_events()` function.
- This function is useful when need to unblock a client in order to deregister it.

**Parameters** **client\_hdl** –[in] Client handle

**Returns** *esp\_err\_t*

*esp\_err\_t* **usb\_host\_device\_open** (*usb\_host\_client\_handle\_t* client\_hdl, uint8\_t dev\_addr,  
*usb\_device\_handle\_t* \*dev\_hdl\_ret)

Open a device.

- This function allows a client to open a device

- A client must open a device first before attempting to use it (e.g., sending transfers, device requests etc.)

**Parameters**

- **client\_hdl** –[in] Client handle
- **dev\_addr** –[in] Device' s address
- **dev\_hdl\_ret** –[out] Device' s handle

**Returns** esp\_err\_t

*esp\_err\_t* **usb\_host\_device\_close** (*usb\_host\_client\_handle\_t* client\_hdl, *usb\_device\_handle\_t* dev\_hdl)

Close a device.

- This function allows a client to close a device
- A client must close a device after it has finished using the device (claimed interfaces must also be released)
- A client must close all devices it has opened before deregistering

---

**Note:** This function can block

---

**Parameters**

- **client\_hdl** –[in] Client handle
- **dev\_hdl** –[in] Device handle

**Returns** esp\_err\_t

*esp\_err\_t* **usb\_host\_device\_free\_all** (void)

Indicate that all devices can be freed when possible.

- This function marks all devices as waiting to be freed
- If a device is not opened by any clients, it will be freed immediately
- If a device is opened by at least one client, the device will be free when the last client closes that device.
- Wait for the `USB_HOST_LIB_EVENT_FLAGS_ALL_FREE` flag to be set by `usb_host_lib_handle_events()` in order to know when all devices have been freed
- This function is useful when cleaning up devices before uninstalling the USB Host Library

**Returns**

- `ESP_ERR_NOT_FINISHED`: There are one or more devices that still need to be freed. Wait for `USB_HOST_LIB_EVENT_FLAGS_ALL_FREE` event
- `ESP_OK`: All devices already freed (i.e., there were no devices)
- Other: Error

*esp\_err\_t* **usb\_host\_device\_addr\_list\_fill** (int list\_len, uint8\_t \*dev\_addr\_list, int \*num\_dev\_ret)

Fill a list of device address.

- This function fills an empty list with the address of connected devices
- The Device addresses can then used in `usb_host_device_open()`
- If there are more devices than the list\_len, this function will only fill up to list\_len number of devices.

**Parameters**

- **list\_len** –[in] Length of the empty list
- **dev\_addr\_list** –[inout] Empty list to be filled
- **num\_dev\_ret** –[out] Number of devices

**Returns** esp\_err\_t

*esp\_err\_t* **usb\_host\_device\_info** (*usb\_device\_handle\_t* dev\_hdl, *usb\_device\_info\_t* \*dev\_info)

Get device' s information.

- This function gets some basic information of a device
- The device must be opened first before attempting to get its information

---

**Note:** This function can block

---

**Parameters**

- **dev\_hdl** –[in] Device handle
- **dev\_info** –[out] Device information

**Returns** *esp\_err\_t*

*esp\_err\_t* **usb\_host\_get\_device\_descriptor** (*usb\_device\_handle\_t* dev\_hdl, const *usb\_device\_desc\_t* \*\*device\_desc)

Get device' s device descriptor.

- A client must call `usb_host_device_open()` first
- No control transfer is sent. The device' s descriptor is cached on enumeration
- This function simple returns a pointer to the cached descriptor

---

**Note:** No control transfer is sent. The device' s descriptor is cached on enumeration

---

**Parameters**

- **dev\_hdl** –[in] Device handle
- **device\_desc** –[out] Device descriptor

**Returns** *esp\_err\_t*

*esp\_err\_t* **usb\_host\_get\_active\_config\_descriptor** (*usb\_device\_handle\_t* dev\_hdl, const *usb\_config\_desc\_t* \*\*config\_desc)

Get device' s active configuration descriptor.

- A client must call `usb_host_device_open()` first
- No control transfer is sent. The device' s active configuration descriptor is cached on enumeration
- This function simple returns a pointer to the cached descriptor

---

**Note:** This function can block

---

---

**Note:** No control transfer is sent. A device' s active configuration descriptor is cached on enumeration

---

**Parameters**

- **dev\_hdl** –[in] Device handle
- **config\_desc** –[out] Configuration descriptor

**Returns** *esp\_err\_t*



*esp\_err\_t* **usb\_host\_interface\_claim** (*usb\_host\_client\_handle\_t* client\_hdl, *usb\_device\_handle\_t* dev\_hdl, uint8\_t bInterfaceNumber, uint8\_t bAlternateSetting)

Function for a client to claim a device's interface.

- A client must claim a device's interface before attempting to communicate with any of its endpoints
- Once an interface is claimed by a client, it cannot be claimed by any other client.

---

**Note:** This function can block

---

#### Parameters

- **client\_hdl** –[in] Client handle
- **dev\_hdl** –[in] Device handle
- **bInterfaceNumber** –[in] Interface number
- **bAlternateSetting** –[in] Interface alternate setting number

**Returns** *esp\_err\_t*

*esp\_err\_t* **usb\_host\_interface\_release** (*usb\_host\_client\_handle\_t* client\_hdl, *usb\_device\_handle\_t* dev\_hdl, uint8\_t bInterfaceNumber)

Function for a client to release a previously claimed interface.

- A client should release a device's interface after it no longer needs to communicate with the interface
- A client must release all of its interfaces of a device it has claimed before being able to close the device

---

**Note:** This function can block

---

#### Parameters

- **client\_hdl** –[in] Client handle
- **dev\_hdl** –[in] Device handle
- **bInterfaceNumber** –[in] Interface number

**Returns** *esp\_err\_t*

*esp\_err\_t* **usb\_host\_endpoint\_halt** (*usb\_device\_handle\_t* dev\_hdl, uint8\_t bEndpointAddress)

Halt a particular endpoint.

- The device must have been opened by a client
- The endpoint must be part of an interface claimed by a client
- Once halted, the endpoint must be cleared using `usb_host_endpoint_clear()` before it can communicate again

---

**Note:** This function can block

---

#### Parameters

- **dev\_hdl** –Device handle
- **bEndpointAddress** –Endpoint address

**Returns** *esp\_err\_t*

*esp\_err\_t* **usb\_host\_endpoint\_flush** (*usb\_device\_handle\_t* dev\_hdl, uint8\_t bEndpointAddress)

Flush a particular endpoint.

- The device must have been opened by a client
- The endpoint must be part of an interface claimed by a client
- The endpoint must have been halted (either through a transfer error, or `usb_host_endpoint_halt()`)
- Flushing an endpoint will caused an queued up transfers to be canceled

---

**Note:** This function can block

---

**Parameters**

- **dev\_hdl** –Device handle
- **bEndpointAddress** –Endpoint address

**Returns** `esp_err_t`

`esp_err_t` **usb\_host\_endpoint\_clear** (`usb_device_handle_t` dev\_hdl, `uint8_t` bEndpointAddress)

Clear a halt on a particular endpoint.

- The device must have been opened by a client
- The endpoint must be part of an interface claimed by a client
- The endpoint must have been halted (either through a transfer error, or `usb_host_endpoint_halt()`)
- If the endpoint has any queued up transfers, clearing a halt will resume their execution

---

**Note:** This function can block

---

**Parameters**

- **dev\_hdl** –Device handle
- **bEndpointAddress** –Endpoint address

**Returns** `esp_err_t`

`esp_err_t` **usb\_host\_transfer\_alloc** (`size_t` data\_buffer\_size, `int` num\_isoc\_packets, `usb_transfer_t` \*\*transfer)

Allocate a transfer object.

- This function allocates a transfer object
- Each transfer object has a fixed sized buffer specified on allocation
- A transfer object can be re-used indefinitely
- A transfer can be submitted using `usb_host_transfer_submit()` or `usb_host_transfer_submit_control()`

**Parameters**

- **data\_buffer\_size** –[in] Size of the transfer' s data buffer
- **num\_isoc\_packets** –[in] Number of isochronous packets in transfer (set to 0 for non-isochronous transfers)
- **transfer** –[out] Transfer object

**Returns** `esp_err_t`

`esp_err_t` **usb\_host\_transfer\_free** (`usb_transfer_t` \*transfer)

Free a transfer object.

- Free a transfer object previously allocated using `usb_host_transfer_alloc()`
- The transfer must not be in-flight when attempting to free it
- If a NULL pointer is passed, this function will simply return `ESP_OK`

**Parameters** **transfer** –[in] Transfer object

**Returns** esp\_err\_t

*esp\_err\_t* **usb\_host\_transfer\_submit** (*usb\_transfer\_t* \*transfer)

Submit a non-control transfer.

- Submit a transfer to a particular endpoint. The device and endpoint number is specified inside the transfer
- The transfer must be properly initialized before submitting
- On completion, the transfer's callback will be called from the client's `usb_host_client_handle_events()` function.

**Parameters** **transfer** –[in] Initialized transfer object

**Returns** esp\_err\_t

*esp\_err\_t* **usb\_host\_transfer\_submit\_control** (*usb\_host\_client\_handle\_t* client\_hdl, *usb\_transfer\_t* \*transfer)

Submit a control transfer.

- Submit a control transfer to a particular device. The client must have opened the device first
- The transfer must be properly initialized before submitting. The first 8 bytes of the transfer's data buffer should contain the control transfer setup packet
- On completion, the transfer's callback will be called from the client's `usb_host_client_handle_events()` function.

**Parameters**

- **client\_hdl** –[in] Client handle
- **transfer** –[in] Initialized transfer object

**Returns** esp\_err\_t

## Structures

struct **usb\_host\_client\_event\_msg\_t**

Client event message.

Client event messages are sent to each client of the USB Host Library in order to notify them of various USB Host Library events such as:

- Addition of new devices
- Removal of existing devices

---

**Note:** The event message structure has a union with members corresponding to each particular event. Based on the event type, only the relevant member field should be accessed.

---

## Public Members

*usb\_host\_client\_event\_t* **event**

Type of event

uint8\_t **address**

New device's address

```
struct usb_host_client_event_msg_t::[anonymous]::[anonymous] new_dev
```

New device info

```
usb_device_handle_t dev_hdl
```

The handle of the device that was gone

```
struct usb_host_client_event_msg_t::[anonymous]::[anonymous] dev_gone
```

Gone device info

```
struct usb_host_lib_info_t
```

Current information about the USB Host Library obtained via `usb_host_lib_info()`

### Public Members

```
int num_devices
```

Current number of connected (and enumerated) devices

```
int num_clients
```

Current number of registered clients

```
struct usb_host_config_t
```

USB Host Library configuration.

Configuration structure of the USB Host Library. Provided in the `usb_host_install()` function

### Public Members

```
bool skip_phy_setup
```

If set, the USB Host Library will not configure the USB PHY thus allowing the user to manually configure the USB PHY before calling `usb_host_install()`. Users should set this if they want to use an external USB PHY. Otherwise, the USB Host Library will automatically configure the internal USB PHY

```
int intr_flags
```

Interrupt flags for the underlying ISR used by the USB Host stack

```
struct usb_host_client_config_t
```

USB Host Library Client configuration.

Configuration structure for a USB Host Library client. Provided in `usb_host_client_register()`

### Public Members

```
bool is_synchronous
```

Whether the client is asynchronous or synchronous or not. Set to false for now.

```
int max_num_event_msg
```

Maximum number of event messages that can be stored (e.g., 3)

*usb\_host\_client\_event\_cb\_t* **client\_event\_callback**

Client's event callback function

void \***callback\_arg**

Event callback function argument

struct *usb\_host\_client\_config\_t*::[anonymous]::[anonymous] **async**

Async callback config

## Macros

**USB\_HOST\_LIB\_EVENT\_FLAGS\_NO\_CLIENTS**

All clients have been deregistered from the USB Host Library

**USB\_HOST\_LIB\_EVENT\_FLAGS\_ALL\_FREE**

The USB Host Library has freed all devices

## Type Definitions

typedef struct *usb\_host\_client\_handle\_s* \***usb\_host\_client\_handle\_t**

Handle to a USB Host Library asynchronous client.

An asynchronous client can be registered using `usb_host_client_register()`

---

**Note:** Asynchronous API

---

typedef void (\***usb\_host\_client\_event\_cb\_t**)(const *usb\_host\_client\_event\_msg\_t* \*event\_msg, void \*arg)

Client event callback.

- Each client of the USB Host Library must register an event callback to receive event messages from the USB Host Library.
- The client event callback is run from the context of the clients `usb_host_client_handle_events()` function

## Enumerations

enum **usb\_host\_client\_event\_t**

The type event in a client event message.

*Values:*

enumerator **USB\_HOST\_CLIENT\_EVENT\_NEW\_DEV**

A new device has been enumerated and added to the USB Host Library

enumerator **USB\_HOST\_CLIENT\_EVENT\_DEV\_GONE**

A device opened by the client is now gone

## Header File

- [components/usb/include/usb/usb\\_helpers.h](#)

**Functions**

const *usb\_standard\_desc\_t* \***usb\_parse\_next\_descriptor** (const *usb\_standard\_desc\_t* \*cur\_desc, uint16\_t wTotalLength, int \*offset)

Get the next descriptor.

Given a particular descriptor within a full configuration descriptor, get the next descriptor within the configuration descriptor. This is a convenience function that can be used to walk each individual descriptor within a full configuration descriptor.

**Parameters**

- **cur\_desc** –[in] Current descriptor
- **wTotalLength** –[in] Total length of the configuration descriptor
- **offset** –[inout] Byte offset relative to the start of the configuration descriptor. On input, it is the offset of the current descriptor. On output, it is the offset of the returned descriptor.

**Returns** *usb\_standard\_desc\_t*\* Next descriptor, NULL if end of configuration descriptor reached

const *usb\_standard\_desc\_t* \***usb\_parse\_next\_descriptor\_of\_type** (const *usb\_standard\_desc\_t* \*cur\_desc, uint16\_t wTotalLength, uint8\_t bDescriptorType, int \*offset)

Get the next descriptor of a particular type.

Given a particular descriptor within a full configuration descriptor, get the next descriptor of a particular type (i.e., using the bDescriptorType value) within the configuration descriptor.

**Parameters**

- **cur\_desc** –[in] Current descriptor
- **wTotalLength** –[in] Total length of the configuration descriptor
- **bDescriptorType** –[in] Type of the next descriptor to get
- **offset** –[inout] Byte offset relative to the start of the configuration descriptor. On input, it is the offset of the current descriptor. On output, it is the offset of the returned descriptor.

**Returns** *usb\_standard\_desc\_t*\* Next descriptor, NULL if end descriptor is not found or configuration descriptor reached

int **usb\_parse\_interface\_number\_of\_alternate** (const *usb\_config\_desc\_t* \*config\_desc, uint8\_t bInterfaceNumber)

Get the number of alternate settings for a bInterfaceNumber.

Given a particular configuration descriptor, for a particular bInterfaceNumber, get the number of alternate settings available for that interface (i.e., the max possible value of bAlternateSetting for that bInterfaceNumber).

**Parameters**

- **config\_desc** –[in] Pointer to the start of a full configuration descriptor
- **bInterfaceNumber** –[in] Interface number

**Returns** int The number of alternate settings that the interface has, -1 if bInterfaceNumber not found

const *usb\_intf\_desc\_t* \***usb\_parse\_interface\_descriptor** (const *usb\_config\_desc\_t* \*config\_desc, uint8\_t bInterfaceNumber, uint8\_t bAlternateSetting, int \*offset)

Get a particular interface descriptor (using bInterfaceNumber and bAlternateSetting)

Given a full configuration descriptor, get a particular interface descriptor.

---

**Note:** To get the number of alternate settings for a particular bInterfaceNumber, call `usb_parse_interface_number_of_alternate()`

---

**Parameters**

- **config\_desc** –[in] Pointer to the start of a full configuration descriptor

- **bInterfaceNumber** –[in] Interface number
- **bAlternateSetting** –[in] Alternate setting number
- **offset** –[out] Byte offset of the interface descriptor relative to the start of the configuration descriptor. Can be NULL.

**Returns** const usb\_intf\_desc\_t\* Pointer to interface descriptor, NULL if not found.

```
const usb_ep_desc_t *usb_parse_endpoint_descriptor_by_index (const usb_intf_desc_t *intf_desc,
                                                           int index, uint16_t wTotalLength,
                                                           int *offset)
```

Get an endpoint descriptor within an interface descriptor.

Given an interface descriptor, get the Nth endpoint descriptor of the interface. The number of endpoints in an interface is indicated by the bNumEndpoints field of the interface descriptor.

---

**Note:** If bNumEndpoints is 0, it means the interface uses the default endpoint only

---

#### Parameters

- **intf\_desc** –[in] Pointer to the start of an interface descriptor
- **index** –[in] Endpoint index
- **wTotalLength** –[in] Total length of the containing configuration descriptor
- **offset** –[inout] Byte offset relative to the start of the configuration descriptor. On input, it is the offset of the interface descriptor. On output, it is the offset of the endpoint descriptor.

**Returns** const usb\_ep\_desc\_t\* Pointer to endpoint descriptor, NULL if not found.

```
const usb_ep_desc_t *usb_parse_endpoint_descriptor_by_address (const usb_config_desc_t
                                                             *config_desc, uint8_t
                                                             bInterfaceNumber, uint8_t
                                                             bAlternateSetting, uint8_t
                                                             bEndpointAddress, int
                                                             *offset)
```

Get an endpoint descriptor based on an endpoint's address.

Given a configuration descriptor, get an endpoint descriptor based on its bEndpointAddress, bAlternateSetting, and bInterfaceNumber.

#### Parameters

- **config\_desc** –[in] Pointer to the start of a full configuration descriptor
- **bInterfaceNumber** –[in] Interface number
- **bAlternateSetting** –[in] Alternate setting number
- **bEndpointAddress** –[in] Endpoint address
- **offset** –[out] Byte offset of the endpoint descriptor relative to the start of the configuration descriptor. Can be NULL

**Returns** const usb\_ep\_desc\_t\* Pointer to endpoint descriptor, NULL if not found.

```
void usb_print_device_descriptor (const usb_device_desc_t *devc_desc)
```

Print device descriptor.

**Parameters** devc\_desc –Device descriptor

```
void usb_print_config_descriptor (const usb_config_desc_t *cfg_desc, print_class_descriptor_cb
                                  class_specific_cb)
```

Print configuration descriptor.

- This function prints the full contents of a configuration descriptor (including interface and endpoint descriptors)
- When a non-standard descriptor is encountered, this function will call the class\_specific\_cb if it is provided

**Parameters**

- **cfg\_desc** – Configuration descriptor
- **class\_specific\_cb** – Class specific descriptor callback. Can be NULL

void **usb\_print\_string\_descriptor** (const *usb\_str\_desc\_t* \*str\_desc)

Print a string descriptor.

This function will only print ASCII characters of the UTF-16 encoded string

**Parameters** **str\_desc** – String descriptor

static inline int **usb\_round\_up\_to\_mps** (int num\_bytes, int mps)

Round up to an integer multiple of endpoint's MPS.

This is a convenience function to round up a size/length to an endpoint's MPS (Maximum packet size). This is useful when calculating transfer or buffer lengths of IN endpoints.

- If MPS <= 0, this function will return 0
- If num\_bytes <= 0, this function will return 0

**Parameters**

- **num\_bytes** –[in] Number of bytes
- **mps** –[in] MPS

**Returns** int Round up integer multiple of MPS

**Type Definitions**

typedef void (\***print\_class\_descriptor\_cb**)(const *usb\_standard\_desc\_t*\*)

Print class specific descriptor callback.

Optional callback to be provided to `usb_print_config_descriptor()` function. The callback is called when when a non-standard descriptor is encountered. The callback should decode the descriptor as print it.

**Header File**

- [components/usb/include/usb/usb\\_types\\_stack.h](#)

**Structures**

struct **usb\_device\_info\_t**

Basic information of an enumerated device.

**Public Members**

*usb\_speed\_t* **speed**

Device's speed

uint8\_t **dev\_addr**

Device's address

uint8\_t **bMaxPacketSize0**

The maximum packet size of the device's default endpoint

uint8\_t **bConfigurationValue**

Device's current configuration number



const *usb\_str\_desc\_t* \***str\_desc\_manufacturer**  
Pointer to Manufacturer string descriptor (can be NULL)

const *usb\_str\_desc\_t* \***str\_desc\_product**  
Pointer to Product string descriptor (can be NULL)

const *usb\_str\_desc\_t* \***str\_desc\_serial\_num**  
Pointer to Serial Number string descriptor (can be NULL)

struct **usb\_isoc\_packet\_desc\_t**

Isochronous packet descriptor.

If the number of bytes in an Isochronous transfer is larger than the MPS of the endpoint, the transfer is split into multiple packets transmitted at the endpoint's specified interval. An array of Isochronous packet descriptors describes how an Isochronous transfer should be split into multiple packets.

### Public Members

int **num\_bytes**  
Number of bytes to transmit/receive in the packet. IN packets should be integer multiple of MPS

int **actual\_num\_bytes**  
Actual number of bytes transmitted/received in the packet

*usb\_transfer\_status\_t* **status**  
Status of the packet

struct **usb\_transfer\_s**  
USB transfer structure.

### Public Members

uint8\_t \*const **data\_buffer**  
Pointer to data buffer

const size\_t **data\_buffer\_size**  
Size of the data buffer in bytes

int **num\_bytes**  
Number of bytes to transfer. Control transfers should include the size of the setup packet. Isochronous transfer should be the total transfer size of all packets. For non-control IN transfers, num\_bytes should be an integer multiple of MPS.

int **actual\_num\_bytes**  
Actual number of bytes transferred

uint32\_t **flags**  
Transfer flags

*usb\_device\_handle\_t* **device\_handle**

Device handle

uint8\_t **bEndpointAddress**

Endpoint Address

*usb\_transfer\_status\_t* **status**

Status of the transfer

uint32\_t **timeout\_ms**

Timeout (in milliseconds) of the packet (currently not supported yet)

*usb\_transfer\_cb\_t* **callback**

Transfer callback

void \***context**

Context variable for transfer to associate transfer with something

const int **num\_isoc\_packets**

Only relevant to Isochronous. Number of service periods (i.e., intervals) to transfer data buffer over.

*usb\_isoc\_packet\_desc\_t* **isoc\_packet\_desc[]**

Descriptors for each Isochronous packet

## Macros

### **USB\_TRANSFER\_FLAG\_ZERO\_PACK**

Terminate Bulk/Interrupt OUT transfer with a zero length packet.

OUT transfers normally terminate when the Host has transferred the exact amount of data it needs to the device. However, for bulk and interrupt OUT transfers, if the transfer size just happened to be a multiple of MPS, it will be impossible to know the boundary between two consecutive transfers to the same endpoint.

Therefore, this flag will cause the transfer to automatically add a zero length packet (ZLP) at the end of the transfer if the following conditions are met:

- The target endpoint is a Bulk/Interrupt OUT endpoint (Host to device)
- The transfer's length (i.e., transfer.num\_bytes) is a multiple of the endpoint's MPS

Otherwise, this flag has no effect.

Users should check whether their target device's class requires a ZLP, as not all Bulk/Interrupt OUT endpoints require them. For example:

- For MSC Bulk Only Transport class, the Host MUST NEVER send a ZLP. Bulk transfer boundaries are determined by the CBW and CSW instead
- For CDC Ethernet, the Host MUST ALWAYS send a ZLP if a segment (i.e., a transfer) is a multiple of MPS (See 3.3.1 Segment Delineation)

---

**Note:** See USB2.0 specification 5.7.3 and 5.8.3 for more details

---

---

**Note:** IN transfers normally terminate when the Host as receive the exact amount of data it needs (must be multiple of MPS) or the endpoint sends a short packet to the Host (For bulk OUT only). Indicates that a bulk

OUT transfers should always terminate with a short packet, even if it means adding an extra zero length packet

---

### Type Definitions

```
typedef struct usb_device_handle_s *usb_device_handle_t
```

Handle of a USB Device connected to a USB Host.

```
typedef struct usb_transfer_s usb_transfer_t
```

USB transfer structure.

This structure is used to represent a transfer from a software client to an endpoint over the USB bus. Some of the fields are made const on purpose as they are fixed on allocation. Users should call the appropriate USB Host Library function to allocate a USB transfer structure instead of allocating this structure themselves.

The transfer type is inferred from the endpoint this transfer is sent to. Depending on the transfer type, users should note the following:

- Bulk: This structure represents a single bulk transfer. If the number of bytes exceeds the endpoint's MPS, the transfer will be split into multiple MPS sized packets followed by a short packet.
- Control: This structure represents a single control transfer. This first 8 bytes of the data\_buffer must be filled with the setup packet (see *usb\_setup\_packet\_t*). The num\_bytes field should be the total size of the transfer (i.e., size of setup packet + wLength).
- Interrupt: Represents an interrupt transfer. If num\_bytes exceeds the MPS of the endpoint, the transfer will be split into multiple packets, and each packet is transferred at the endpoint's specified interval.
- Isochronous: Represents a stream of bytes that should be transferred to an endpoint at a fixed rate. The transfer is split into packets according to the each isoc\_packet\_desc. A packet is transferred at each interval of the endpoint. If an entire ISOC URB was transferred without error (skipped packets do not count as errors), the URB's overall status and the status of each packet descriptor will be updated, and the actual\_num\_bytes reflects the total bytes transferred over all packets. If the ISOC URB encounters an error, the entire URB is considered erroneous so only the overall status will be updated.

---

**Note:** For Bulk/Control/Interrupt IN transfers, the num\_bytes must be an integer multiple of the endpoint's MPS

---

---

**Note:** This structure should be allocated via `usb_host_transfer_alloc()`

---

---

**Note:** Once the transfer has been submitted, users should not modify the structure until the transfer has completed

---

```
typedef void (*usb_transfer_cb_t)(usb_transfer_t *transfer)
```

USB transfer completion callback.

### Enumerations

```
enum usb_speed_t
```

USB Standard Speeds.

*Values:*

```
enumerator USB_SPEED_LOW
```

USB Low Speed (1.5 Mbit/s)

enumerator **USB\_SPEED\_FULL**

USB Full Speed (12 Mbit/s)

enum **usb\_transfer\_type\_t**

The type of USB transfer.

---

**Note:** The enum values need to match the bmAttributes field of an EP descriptor

---

*Values:*

enumerator **USB\_TRANSFER\_TYPE\_CTRL**

enumerator **USB\_TRANSFER\_TYPE\_ISOCHRONOUS**

enumerator **USB\_TRANSFER\_TYPE\_BULK**

enumerator **USB\_TRANSFER\_TYPE\_INTR**

enum **usb\_transfer\_status\_t**

The status of a particular transfer.

*Values:*

enumerator **USB\_TRANSFER\_STATUS\_COMPLETED**

The transfer was successful (but may be short)

enumerator **USB\_TRANSFER\_STATUS\_ERROR**

The transfer failed because due to excessive errors (e.g. no response or CRC error)

enumerator **USB\_TRANSFER\_STATUS\_TIMED\_OUT**

The transfer failed due to a time out

enumerator **USB\_TRANSFER\_STATUS\_CANCELED**

The transfer was canceled

enumerator **USB\_TRANSFER\_STATUS\_STALL**

The transfer was stalled

enumerator **USB\_TRANSFER\_STATUS\_OVERFLOW**

The transfer as more data was sent than was requested

enumerator **USB\_TRANSFER\_STATUS\_SKIPPED**

ISOC packets only. The packet was skipped due to system latency or bus overload

enumerator **USB\_TRANSFER\_STATUS\_NO\_DEVICE**

The transfer failed because the target device is gone

### Header File

- [components/usb/include/usb/usb\\_types\\_ch9.h](#)

## Unions

union **usb\_setup\_packet\_t**

*#include* <usb\_types\_ch9.h> Structure representing a USB control transfer setup packet.

See Table 9-2 of USB2.0 specification for more details

### Public Members

uint8\_t **bmRequestType**

Characteristics of request

uint8\_t **bRequest**

Specific request

uint16\_t **wValue**

Word-sized field that varies according to request

uint16\_t **wIndex**

Word-sized field that varies according to request; typically used to pass an index or offset

uint16\_t **wLength**

Number of bytes to transfer if there is a data stage

struct *usb\_setup\_packet\_t*::[anonymous] **[anonymous]**

uint8\_t **val**[USB\_SETUP\_PACKET\_SIZE]

Descriptor value

union **usb\_standard\_desc\_t**

*#include* <usb\_types\_ch9.h> USB standard descriptor.

All USB standard descriptors start with these two bytes. Use this type when traversing over configuration descriptors

### Public Members

uint8\_t **bLength**

Size of the descriptor in bytes

uint8\_t **bDescriptorType**

Descriptor Type

struct *usb\_standard\_desc\_t*::[anonymous] **USB\_DESC\_ATTR**

USB descriptor attributes

uint8\_t **val**[USB\_STANDARD\_DESC\_SIZE]

Descriptor value

union **usb\_device\_desc\_t**

*#include <usb\_types\_ch9.h>* Structure representing a USB device descriptor.

See Table 9-8 of USB2.0 specification for more details

### Public Members

**uint8\_t bLength**

Size of the descriptor in bytes

**uint8\_t bDescriptorType**

DEVICE Descriptor Type

**uint16\_t bcdUSB**

USB Specification Release Number in Binary-Coded Decimal (i.e., 2.10 is 210H)

**uint8\_t bDeviceClass**

Class code (assigned by the USB-IF)

**uint8\_t bDeviceSubClass**

Subclass code (assigned by the USB-IF)

**uint8\_t bDeviceProtocol**

Protocol code (assigned by the USB-IF)

**uint8\_t bMaxPacketSize0**

Maximum packet size for endpoint zero (only 8, 16, 32, or 64 are valid)

**uint16\_t idVendor**

Vendor ID (assigned by the USB-IF)

**uint16\_t idProduct**

Product ID (assigned by the manufacturer)

**uint16\_t bcdDevice**

Device release number in binary-coded decimal

**uint8\_t iManufacturer**

Index of string descriptor describing manufacturer

**uint8\_t iProduct**

Index of string descriptor describing product

**uint8\_t iSerialNumber**

Index of string descriptor describing the device' s serial number

**uint8\_t bNumConfigurations**

Number of possible configurations

struct *usb\_device\_desc\_t*::[anonymous] **USB\_DESC\_ATTR**

USB descriptor attributes

uint8\_t **val**[USB\_DEVICE\_DESC\_SIZE]

Descriptor value

union **usb\_config\_desc\_t**

*#include <usb\_types\_ch9.h>* Structure representing a short USB configuration descriptor.

See Table 9-10 of USB2.0 specification for more details

---

**Note:** The full USB configuration includes all the interface and endpoint descriptors of that configuration.

---

### Public Members

uint8\_t **bLength**

Size of the descriptor in bytes

uint8\_t **bDescriptorType**

CONFIGURATION Descriptor Type

uint16\_t **wTotalLength**

Total length of data returned for this configuration

uint8\_t **bNumInterfaces**

Number of interfaces supported by this configuration

uint8\_t **bConfigurationValue**

Value to use as an argument to the SetConfiguration() request to select this configuration

uint8\_t **iConfiguration**

Index of string descriptor describing this configuration

uint8\_t **bmAttributes**

Configuration characteristics

uint8\_t **bMaxPower**

Maximum power consumption of the USB device from the bus in this specific configuration when the device is fully operational.

struct *usb\_config\_desc\_t*::[anonymous] **USB\_DESC\_ATTR**

USB descriptor attributes

uint8\_t **val**[USB\_CONFIG\_DESC\_SIZE]

Descriptor value

union **usb\_iad\_desc\_t**

*#include <usb\_types\_ch9.h>* Structure representing a USB interface association descriptor.

### Public Members

`uint8_t bLength`

Size of the descriptor in bytes

`uint8_t bDescriptorType`

INTERFACE ASSOCIATION Descriptor Type

`uint8_t bFirstInterface`

Interface number of the first interface that is associated with this function

`uint8_t bInterfaceCount`

Number of contiguous interfaces that are associated with this function

`uint8_t bFunctionClass`

Class code (assigned by USB-IF)

`uint8_t bFunctionSubClass`

Subclass code (assigned by USB-IF)

`uint8_t bFunctionProtocol`

Protocol code (assigned by USB-IF)

`uint8_t iFunction`

Index of string descriptor describing this function

struct `usb_iad_desc_t`::[anonymous] **USB\_DESC\_ATTR**

USB descriptor attributes

`uint8_t val[USB_IAD_DESC_SIZE]`

Descriptor value

union **usb\_intf\_desc\_t**

*#include <usb\_types\_ch9.h>* Structure representing a USB interface descriptor.

See Table 9-12 of USB2.0 specification for more details

### Public Members

`uint8_t bLength`

Size of the descriptor in bytes

`uint8_t bDescriptorType`

INTERFACE Descriptor Type

`uint8_t bInterfaceNumber`

Number of this interface.



**uint8\_t bAlternateSetting**

Value used to select this alternate setting for the interface identified in the prior field

**uint8\_t bNumEndpoints**

Number of endpoints used by this interface (excluding endpoint zero).

**uint8\_t bInterfaceClass**

Class code (assigned by the USB-IF)

**uint8\_t bInterfaceSubClass**

Subclass code (assigned by the USB-IF)

**uint8\_t bInterfaceProtocol**

Protocol code (assigned by the USB)

**uint8\_t iInterface**

Index of string descriptor describing this interface

**struct *usb\_intf\_desc\_t*::[anonymous] USB\_DESC\_ATTR**

USB descriptor attributes

**uint8\_t val[USB\_INTF\_DESC\_SIZE]**

Descriptor value

**union *usb\_ep\_desc\_t***

*#include <usb\_types\_ch9.h>* Structure representing a USB endpoint descriptor.

See Table 9-13 of USB2.0 specification for more details

**Public Members****uint8\_t bLength**

Size of the descriptor in bytes

**uint8\_t bDescriptorType**

ENDPOINT Descriptor Type

**uint8\_t bEndpointAddress**

The address of the endpoint on the USB device described by this descriptor

**uint8\_t bmAttributes**

This field describes the endpoint's attributes when it is configured using the bConfigurationValue.

**uint16\_t wMaxPacketSize**

Maximum packet size this endpoint is capable of sending or receiving when this configuration is selected.

**uint8\_t bInterval**

Interval for polling Isochronous and Interrupt endpoints. Expressed in frames or microframes depending on the device operating speed (1 ms for Low-Speed and Full-Speed or 125 us for USB High-Speed and above).

```
struct usb_ep_desc_t::[anonymous] USB_DESC_ATTR
```

USB descriptor attributes

```
uint8_t val[USB_EP_DESC_SIZE]
```

Descriptor value

```
union usb_str_desc_t
```

*#include <usb\_types\_ch9.h>* Structure representing a USB string descriptor.

### Public Members

```
uint8_t bLength
```

Size of the descriptor in bytes

```
uint8_t bDescriptorType
```

STRING Descriptor Type

```
uint16_t wData[]
```

UTF-16LE encoded

```
struct usb_str_desc_t::[anonymous] USB_DESC_ATTR
```

USB descriptor attributes

```
uint8_t val[USB_STR_DESC_SIZE]
```

Descriptor value

### Macros

```
USB_DESC_ATTR
```

```
USB_B_DESCRIPTOR_TYPE_DEVICE
```

Descriptor types from USB2.0 specification table 9.5.

```
USB_B_DESCRIPTOR_TYPE_CONFIGURATION
```

```
USB_B_DESCRIPTOR_TYPE_STRING
```

```
USB_B_DESCRIPTOR_TYPE_INTERFACE
```

```
USB_B_DESCRIPTOR_TYPE_ENDPOINT
```

```
USB_B_DESCRIPTOR_TYPE_DEVICE_QUALIFIER
```

```
USB_B_DESCRIPTOR_TYPE_OTHER_SPEED_CONFIGURATION
```

```
USB_B_DESCRIPTOR_TYPE_INTERFACE_POWER
```

**USB\_B\_DESCRIPTOR\_TYPE\_OTG**

Descriptor types from USB 2.0 ECN.

**USB\_B\_DESCRIPTOR\_TYPE\_DEBUG**

**USB\_B\_DESCRIPTOR\_TYPE\_INTERFACE\_ASSOCIATION**

**USB\_B\_DESCRIPTOR\_TYPE\_SECURITY**

Descriptor types from Wireless USB spec.

**USB\_B\_DESCRIPTOR\_TYPE\_KEY**

**USB\_B\_DESCRIPTOR\_TYPE\_ENCRYPTION\_TYPE**

**USB\_B\_DESCRIPTOR\_TYPE\_BOS**

**USB\_B\_DESCRIPTOR\_TYPE\_DEVICE\_CAPABILITY**

**USB\_B\_DESCRIPTOR\_TYPE\_WIRELESS\_ENDPOINT\_COMP**

**USB\_B\_DESCRIPTOR\_TYPE\_WIRE\_ADAPTER**

**USB\_B\_DESCRIPTOR\_TYPE\_RPIPE**

**USB\_B\_DESCRIPTOR\_TYPE\_CS\_RADIO\_CONTROL**

**USB\_B\_DESCRIPTOR\_TYPE\_PIPE\_USAGE**

Descriptor types from UAS specification.

**USB\_SETUP\_PACKET\_SIZE**

Size of a USB control transfer setup packet in bytes.

**USB\_BM\_REQUEST\_TYPE\_DIR\_OUT**

Bit masks belonging to the bmRequestType field of a setup packet.

**USB\_BM\_REQUEST\_TYPE\_DIR\_IN**

**USB\_BM\_REQUEST\_TYPE\_TYPE\_STANDARD**

**USB\_BM\_REQUEST\_TYPE\_TYPE\_CLASS**

**USB\_BM\_REQUEST\_TYPE\_TYPE\_VENDOR**

**USB\_BM\_REQUEST\_TYPE\_TYPE\_RESERVED**

**USB\_BM\_REQUEST\_TYPE\_TYPE\_MASK**

**USB\_BM\_REQUEST\_TYPE\_RECIP\_DEVICE**

**USB\_BM\_REQUEST\_TYPE\_RECIP\_INTERFACE**

**USB\_BM\_REQUEST\_TYPE\_RECIP\_ENDPOINT**

**USB\_BM\_REQUEST\_TYPE\_RECIP\_OTHER**

**USB\_BM\_REQUEST\_TYPE\_RECIP\_MASK**

**USB\_B\_REQUEST\_GET\_STATUS**

Bit masks belonging to the bRequest field of a setup packet.

**USB\_B\_REQUEST\_CLEAR\_FEATURE**

**USB\_B\_REQUEST\_SET\_FEATURE**

**USB\_B\_REQUEST\_SET\_ADDRESS**

**USB\_B\_REQUEST\_GET\_DESCRIPTOR**

**USB\_B\_REQUEST\_SET\_DESCRIPTOR**

**USB\_B\_REQUEST\_GET\_CONFIGURATION**

**USB\_B\_REQUEST\_SET\_CONFIGURATION**

**USB\_B\_REQUEST\_GET\_INTERFACE**

**USB\_B\_REQUEST\_SET\_INTERFACE**

**USB\_B\_REQUEST\_SYNCH\_FRAME**

**USB\_W\_VALUE\_DT\_DEVICE**

Bit masks belonging to the wValue field of a setup packet.

**USB\_W\_VALUE\_DT\_CONFIG**

**USB\_W\_VALUE\_DT\_STRING**

**USB\_W\_VALUE\_DT\_INTERFACE**

**USB\_W\_VALUE\_DT\_ENDPOINT**

**USB\_W\_VALUE\_DT\_DEVICE\_QUALIFIER**

**USB\_W\_VALUE\_DT\_OTHER\_SPEED\_CONFIG**

**USB\_W\_VALUE\_DT\_INTERFACE\_POWER**

**USB\_SETUP\_PACKET\_INIT\_SET\_ADDR** (setup\_pkt\_ptr, addr)

Initializer for a SET\_ADDRESS request.

Sets the address of a connected device

**USB\_SETUP\_PACKET\_INIT\_GET\_DEVICE\_DESC** (setup\_pkt\_ptr)

Initializer for a request to get a device's device descriptor.

**USB\_SETUP\_PACKET\_INIT\_GET\_CONFIG** (setup\_pkt\_ptr)

Initializer for a request to get a device's current configuration number.

**USB\_SETUP\_PACKET\_INIT\_GET\_CONFIG\_DESC** (setup\_pkt\_ptr, desc\_index, desc\_len)

Initializer for a request to get one of the device's current configuration descriptor.

- desc\_index indicates the configuration's index number
- Number of bytes of the configuration descriptor to get

**USB\_SETUP\_PACKET\_INIT\_SET\_CONFIG** (setup\_pkt\_ptr, config\_num)

Initializer for a request to set a device's current configuration number.

**USB\_SETUP\_PACKET\_INIT\_SET\_INTERFACE** (setup\_pkt\_ptr, intf\_num, alt\_setting\_num)

Initializer for a request to set an interface's alternate setting.

**USB\_SETUP\_PACKET\_INIT\_GET\_STR\_DESC** (setup\_pkt\_ptr, string\_index, lang\_id, desc\_len)

Initializer for a request to get a string descriptor.

**USB\_STANDARD\_DESC\_SIZE**

Size of dummy USB standard descriptor.

**USB\_DEVICE\_DESC\_SIZE**

Size of a USB device descriptor in bytes.

**USB\_CLASS\_PER\_INTERFACE**

Possible base class values of the bDeviceClass field of a USB device descriptor.

**USB\_CLASS\_AUDIO**

**USB\_CLASS\_COMM**

**USB\_CLASS\_HID**

**USB\_CLASS\_PHYSICAL**

**USB\_CLASS\_STILL\_IMAGE**

**USB\_CLASS\_PRINTER**

**USB\_CLASS\_MASS\_STORAGE**

**USB\_CLASS\_HUB**

**USB\_CLASS\_CDC\_DATA**

**USB\_CLASS\_CSCID**

**USB\_CLASS\_CONTENT\_SEC**

**USB\_CLASS\_VIDEO**

**USB\_CLASS\_WIRELESS\_CONTROLLER**

**USB\_CLASS\_PERSONAL\_HEALTHCARE**

**USB\_CLASS\_AUDIO\_VIDEO**

**USB\_CLASS\_BILLBOARD**

**USB\_CLASS\_USB\_TYPE\_C\_BRIDGE**

**USB\_CLASS\_MISC**

**USB\_CLASS\_APP\_SPEC**

**USB\_CLASS\_VENDOR\_SPEC**

**USB\_SUBCLASS\_VENDOR\_SPEC**

Vendor specific subclass code.

**USB\_CONFIG\_DESC\_SIZE**

Size of a short USB configuration descriptor in bytes.

---

**Note:** The size of a full USB configuration includes all the interface and endpoint descriptors of that configuration.

---

**USB\_BM\_ATTRIBUTES\_ONE**

Bit masks belonging to the bmAttributes field of a configuration descriptor.

Must be set

**USB\_BM\_ATTRIBUTES\_SELFPOWER**

Self powered

**USB\_BM\_ATTRIBUTES\_WAKEUP**

Can wake-up

**USB\_BM\_ATTRIBUTES\_BATTERY**

Battery powered

**USB\_IAD\_DESC\_SIZE**

Size of a USB interface association descriptor in bytes.

**USB\_INTF\_DESC\_SIZE**

Size of a USB interface descriptor in bytes.

**USB\_EP\_DESC\_SIZE**

Size of a USB endpoint descriptor in bytes.

**USB\_B\_ENDPOINT\_ADDRESS\_EP\_NUM\_MASK**

Bit masks belonging to the bEndpointAddress field of an endpoint descriptor.

**USB\_B\_ENDPOINT\_ADDRESS\_EP\_DIR\_MASK**

**USB\_BM\_ATTRIBUTES\_XFERTYPE\_MASK**

Bit masks belonging to the bmAttributes field of an endpoint descriptor.

**USB\_BM\_ATTRIBUTES\_XFER\_CONTROL**

**USB\_BM\_ATTRIBUTES\_XFER\_ISOC**

**USB\_BM\_ATTRIBUTES\_XFER\_BULK**

**USB\_BM\_ATTRIBUTES\_XFER\_INT**

**USB\_BM\_ATTRIBUTES\_SYNC\_TYPE\_MASK**

**USB\_BM\_ATTRIBUTES\_SYNC\_NONE**

**USB\_BM\_ATTRIBUTES\_SYNC\_ASYNC**

**USB\_BM\_ATTRIBUTES\_SYNC\_ADAPTIVE**

**USB\_BM\_ATTRIBUTES\_SYNC\_SYNC**

**USB\_BM\_ATTRIBUTES\_USAGE\_TYPE\_MASK**

**USB\_BM\_ATTRIBUTES\_USAGE\_DATA**

**USB\_BM\_ATTRIBUTES\_USAGE\_FEEDBACK**

**USB\_BM\_ATTRIBUTES\_USAGE\_IMPLICIT\_FB**

**USB\_EP\_DESC\_GET\_XFERTYPE** (desc\_ptr)

Macro helpers to get information about an endpoint from its descriptor.

**USB\_EP\_DESC\_GET\_EP\_NUM** (desc\_ptr)**USB\_EP\_DESC\_GET\_EP\_DIR** (desc\_ptr)**USB\_EP\_DESC\_GET\_MPS** (desc\_ptr)**USB\_STR\_DESC\_SIZE**

Size of a short USB string descriptor in bytes.

**Enumerations**enum **usb\_device\_state\_t**

USB2.0 device states.

See Table 9-1 of USB2.0 specification for more details

---

**Note:** The `USB_DEVICE_STATE_NOT_ATTACHED` is not part of the USB2.0 specification, but is a catch all state for devices that need to be cleaned up after a sudden disconnection or port error.

---

*Values:*enumerator **USB\_DEVICE\_STATE\_NOT\_ATTACHED**

The device was previously configured or suspended, but is no longer attached (either suddenly disconnected or a port error)

enumerator **USB\_DEVICE\_STATE\_ATTACHED**

Device is attached to the USB, but is not powered.

enumerator **USB\_DEVICE\_STATE\_POWERED**

Device is attached to the USB and powered, but has not been reset.

enumerator **USB\_DEVICE\_STATE\_DEFAULT**

Device is attached to the USB and powered and has been reset, but has not been assigned a unique address. Device responds at the default address.

enumerator **USB\_DEVICE\_STATE\_ADDRESS**

Device is attached to the USB, powered, has been reset, and a unique device address has been assigned. Device is not configured.

enumerator **USB\_DEVICE\_STATE\_CONFIGURED**

Device is attached to the USB, powered, has been reset, has a unique address, is configured, and is not suspended. The host may now use the function provided by the device.

enumerator **USB\_DEVICE\_STATE\_SUSPENDED**

Device is, at minimum, attached to the USB and is powered and has not seen bus activity for 3 ms. It may also have a unique address and be configured for use. However, because the device is suspended, the host may not use the device's function.

Code examples for this API section are provided in the [peripherals](#) directory of ESP-IDF examples.



## 2.6 Project Configuration

### 2.6.1 Introduction

ESP-IDF uses `kconfiglib` which is a Python-based extension to the `Kconfig` system which provides a compile-time project configuration mechanism. `Kconfig` is based around options of several types: integer, string, boolean. `Kconfig` files specify dependencies between options, default values of the options, the way the options are grouped together, etc.

For the complete list of available features please see `Kconfig` and `kconfiglib` extentions.

### 2.6.2 Project Configuration Menu

Application developers can open a terminal-based project configuration menu with the `idf.py menuconfig` build target.

After being updated, this configuration is saved inside `sdkconfig` file in the project root directory. Based on `sd-kconfig`, application build targets will generate `sdkconfig.h` file in the build directory, and will make `sdkconfig` options available to the project build system and source files.

### 2.6.3 Using `sdkconfig.defaults`

In some cases, such as when `sdkconfig` file is under revision control, the fact that `sdkconfig` file gets changed by the build system may be inconvenient. The build system offers a way to avoid this, in the form of `sdkconfig.defaults` file. This file is never touched by the build system, and can be created manually or automatically. It can contain all the options which matter for the given application and are different from the default ones. The format is the same as that of the `sdkconfig` file. `sdkconfig.defaults` can be created manually when one remembers all the changed configurations. Otherwise, the file can be generated automatically by running the `idf.py save-defconfig` command.

Once `sdkconfig.defaults` is created, `sdkconfig` can be deleted and added to the ignore list of the revision control system (e.g. `.gitignore` file for `git`). Project build targets will automatically create `sdkconfig` file, populated with the settings from `sdkconfig.defaults` file, and the rest of the settings will be set to their default values. Note that the build process will not override settings that are already in `sdkconfig` by ones from `sdkconfig.defaults`. For more information, see *Custom `sdkconfig` defaults*.

### 2.6.4 `Kconfig` Formatting Rules

The following attributes of `Kconfig` files are standardized:

- Within any menu, option names should have a consistent prefix. The prefix length is currently set to at least 3 characters.
- The indentation style is 4 characters created by spaces. All sub-items belonging to a parent item are indented by one level deeper. For example, `menu` is indented by 0 characters, the `config` inside of the menu by 4 characters, the help of the `config` by 8 characters and the text of the help by 12 characters.
- No trailing spaces are allowed at the end of the lines.
- The maximum length of options is set to 40 characters.
- The maximum length of lines is set to 120 characters.

#### Format checker

`tools/ci/check_kconfigs.py` is provided for checking the `Kconfig` formatting rules. The checker checks all `Kconfig` and `Kconfig.projbuild` files in the ESP-IDF directory and generates a new file with suffix `.new` with some recommendations how to fix issues (if there are any). Please note that the checker cannot correct all rules and the responsibility of the developer is to check and make final corrections in order to pass the tests. For example,

indentations will be corrected if there isn't some misleading previous formatting but it cannot come up with a common prefix for options inside a menu.

## 2.6.5 Backward Compatibility of Kconfig Options

The standard `Kconfig` tools ignore unknown options in `sdkconfig`. So if a developer has custom settings for options which are renamed in newer ESP-IDF releases then the given setting for the option would be silently ignored. Therefore, several features have been adopted to avoid this:

1. `confgen.py` is used by the tool chain to pre-process `sdkconfig` files before anything else, for example `menuconfig`, would read them. As the consequence, the settings for old options will be kept and not ignored.
2. `confgen.py` recursively finds all `sdkconfig.rename` files in ESP-IDF directory which contain old and new `Kconfig` option names. Old options are replaced by new ones in the `sdkconfig` file. Renames that should only appear for a single target can be placed in a target specific rename file: `sdkconfig.rename.TARGET`, where `TARGET` is the target name, e.g. `sdkconfig.rename.esp32s2`.
3. `confgen.py` post-processes `sdkconfig` files and generates all build outputs (`sdkconfig.h`, `sdkconfig.cmake`, `auto.conf`) by adding a list of compatibility statements, i.e. value of the old option is set the value of the new option (after modification). This is done in order to not break customer codes where old option might still be used.
4. *Deprecated options and their replacements* are automatically generated by `confgen.py`.

## 2.6.6 Configuration Options Reference

Subsequent sections contain the list of available ESP-IDF options, automatically generated from `Kconfig` files. Note that depending on the options selected, some options listed here may not be visible by default in the interface of `menuconfig`.

By convention, all option names are upper case with underscores. When `Kconfig` generates `sdkconfig` and `sdkconfig.h` files, option names are prefixed with `CONFIG_`. So if an option `ENABLE_FOO` is defined in a `Kconfig` file and selected in `menuconfig`, then `sdkconfig` and `sdkconfig.h` files will have `CONFIG_ENABLE_FOO` defined. In this reference, option names are also prefixed with `CONFIG_`, same as in the source code.

### Build type

Contains:

- `CONFIG_APP_BUILD_TYPE`
- `CONFIG_APP_REPRODUCIBLE_BUILD`
- `CONFIG_APP_NO_BLOBS`

### `CONFIG_APP_BUILD_TYPE`

Application build type

Found in: *Build type*

Select the way the application is built.

By default, the application is built as a binary file in a format compatible with the ESP-IDF bootloader. In addition to this application, 2nd stage bootloader is also built. Application and bootloader binaries can be written into flash and loaded/executed from there.

Another option, useful for only very small and limited applications, is to only link the `.elf` file of the application, such that it can be loaded directly into RAM over JTAG. Note that since IRAM and DRAM sizes are very limited, it is not possible to build any complex application this way. However for kinds of testing and debugging, this option may provide faster iterations, since the application does not need to be written into flash. Note that at the moment, ESP-IDF does not contain all the startup code required to initialize the CPUs and ROM memory (data/bss). Therefore it is necessary to execute a bit of ROM code prior to executing the application. A `gdbinit` file may look as follows (for ESP32):

```
# Connect to a running instance of OpenOCD target remote :3333 # Reset and halt the target
mon reset halt # Run to a specific point in ROM code, # where most of initialization is
complete. thb *0x40007d54 c # Load the application into RAM load # Run till app_main th
app_main c
```

Execute this gdbinit file as follows:

```
xtensa-esp32-elf-gdb build/app-name.elf -x gdbinit
```

Example gdbinit files for other targets can be found in tools/test\_apps/system/gdb\_loadable\_elf/

Recommended sdkconfig.defaults for building loadable ELF files is as follows. CONFIG\_APP\_BUILD\_TYPE\_ELF\_RAM is required, other options help reduce application memory footprint.

```
CONFIG_APP_BUILD_TYPE_ELF_RAM=y CONFIG_VFS_SUPPORT_TERMIOS=
CONFIG_NEWLIB_NANO_FORMAT=y CONFIG_ESP_SYSTEM_PANIC_PRINT_HALT=y
CONFIG_ESP_DEBUG_STUBS_ENABLE= CONFIG_ESP_ERR_TO_NAME_LOOKUP=
```

**Available options:**

- Default (binary application + 2nd stage bootloader) (APP\_BUILD\_TYPE\_APP\_2NDBOOT)
- ELF file, loadable into RAM (EXPERIMENTAL)) (APP\_BUILD\_TYPE\_ELF\_RAM)

## CONFIG\_APP\_REPRODUCIBLE\_BUILD

Enable reproducible build

*Found in: Build type*

If enabled, all date, time, and path information would be eliminated. A .gdbinit file would be create automatically. (or will be append if you have one already)

**Default value:**

- No (disabled)

## CONFIG\_APP\_NO\_BLOBS

No Binary Blobs

*Found in: Build type*

If enabled, this disables the linking of binary libraries in the application build. Note that after enabling this Wi-Fi/Bluetooth will not work.

**Default value:**

- No (disabled)

## Bootloader config

Contains:

- [CONFIG\\_BOOTLOADER\\_LOG\\_LEVEL](#)
- [CONFIG\\_BOOTLOADER\\_COMPILER\\_OPTIMIZATION](#)
- [CONFIG\\_BOOTLOADER\\_APP\\_ROLLBACK\\_ENABLE](#)
- [CONFIG\\_BOOTLOADER\\_REGION\\_PROTECTION\\_ENABLE](#)
- [CONFIG\\_BOOTLOADER\\_APP\\_TEST](#)
- [CONFIG\\_BOOTLOADER\\_FACTORY\\_RESET](#)
- [CONFIG\\_BOOTLOADER\\_HOLD\\_TIME\\_GPIO](#)
- [CONFIG\\_BOOTLOADER\\_CUSTOM\\_RESERVE\\_RTC](#)
- [Serial Flash Configurations](#)
- [CONFIG\\_BOOTLOADER\\_SKIP\\_VALIDATE\\_ALWAYS](#)
- [CONFIG\\_BOOTLOADER\\_SKIP\\_VALIDATE\\_ON\\_POWER\\_ON](#)

- [CONFIG\\_BOOTLOADER\\_SKIP\\_VALIDATE\\_IN\\_DEEP\\_SLEEP](#)
- [CONFIG\\_BOOTLOADER\\_WDT\\_ENABLE](#)
- [CONFIG\\_BOOTLOADER\\_VDDSDIO\\_BOOST](#)

## CONFIG\_BOOTLOADER\_COMPILER\_OPTIMIZATION

Bootloader optimization Level

*Found in: [Bootloader config](#)*

This option sets compiler optimization level (gcc -O argument) for the bootloader.

- The default “Size” setting will add the -Os flag to CFLAGS.
- The “Debug” setting will add the -Og flag to CFLAGS.
- The “Performance” setting will add the -O2 flag to CFLAGS.
- The “None” setting will add the -O0 flag to CFLAGS.

Note that custom optimization levels may be unsupported.

### Available options:

- Size (-Os) (BOOTLOADER\_COMPILER\_OPTIMIZATION\_SIZE)
- Debug (-Og) (BOOTLOADER\_COMPILER\_OPTIMIZATION\_DEBUG)
- Optimize for performance (-O2) (BOOTLOADER\_COMPILER\_OPTIMIZATION\_PERF)
- Debug without optimization (-O0) (BOOTLOADER\_COMPILER\_OPTIMIZATION\_NONE)

## CONFIG\_BOOTLOADER\_LOG\_LEVEL

Bootloader log verbosity

*Found in: [Bootloader config](#)*

Specify how much output to see in bootloader logs.

### Available options:

- No output (BOOTLOADER\_LOG\_LEVEL\_NONE)
- Error (BOOTLOADER\_LOG\_LEVEL\_ERROR)
- Warning (BOOTLOADER\_LOG\_LEVEL\_WARN)
- Info (BOOTLOADER\_LOG\_LEVEL\_INFO)
- Debug (BOOTLOADER\_LOG\_LEVEL\_DEBUG)
- Verbose (BOOTLOADER\_LOG\_LEVEL\_VERBOSE)

## Serial Flash Configurations

 Contains:

- [CONFIG\\_BOOTLOADER\\_FLASH\\_DC\\_AWARE](#)
- [CONFIG\\_BOOTLOADER\\_FLASH\\_XMC\\_SUPPORT](#)

## CONFIG\_BOOTLOADER\_FLASH\_DC\_AWARE

Allow app adjust Dummy Cycle bits in SPI Flash for higher frequency (READ HELP FIRST)

*Found in: [Bootloader config](#) > [Serial Flash Configurations](#)*

This will force 2nd bootloader to be loaded by DOUT mode, and will restore Dummy Cycle setting by resetting the Flash

## CONFIG\_BOOTLOADER\_FLASH\_XMC\_SUPPORT

Enable the support for flash chips of XMC (READ DOCS FIRST)

*Found in: [Bootloader config](#) > [Serial Flash Configurations](#)*

Perform the startup flow recommended by XMC. Please consult XMC for the details of this flow. XMC chips will be forbidden to be used, when this option is disabled.

DON'T DISABLE THIS UNLESS YOU KNOW WHAT YOU ARE DOING.

comment “Features below require specific hardware (READ DOCS FIRST!)”

**Default value:**

- Yes (enabled)

### CONFIG\_BOOTLOADER\_VDDSDIO\_BOOST

VDDSDIO LDO voltage

*Found in: [Bootloader config](#)*

If this option is enabled, and VDDSDIO LDO is set to 1.8V (using eFuse or MTDI bootstrapping pin), bootloader will change LDO settings to output 1.9V instead. This helps prevent flash chip from browning out during flash programming operations.

This option has no effect if VDDSDIO is set to 3.3V, or if the internal VDDSDIO regulator is disabled via eFuse.

**Available options:**

- 1.8V (BOOTLOADER\_VDDSDIO\_BOOST\_1\_8V)
- 1.9V (BOOTLOADER\_VDDSDIO\_BOOST\_1\_9V)

### CONFIG\_BOOTLOADER\_FACTORY\_RESET

GPIO triggers factory reset

*Found in: [Bootloader config](#)*

Allows to reset the device to factory settings: - clear one or more data partitions; - boot from “factory” partition. The factory reset will occur if there is a GPIO input held at the configured level while device starts up. See settings below.

**Default value:**

- No (disabled)

### CONFIG\_BOOTLOADER\_NUM\_PIN\_FACTORY\_RESET

Number of the GPIO input for factory reset

*Found in: [Bootloader config](#) > [CONFIG\\_BOOTLOADER\\_FACTORY\\_RESET](#)*

The selected GPIO will be configured as an input with internal pull-up enabled (note that on some SoCs, not all pins have an internal pull-up, consult the hardware datasheet for details.) To trigger a factory reset, this GPIO must be held high or low (as configured) on startup.

**Range:**

- from 0 to 44 if [CONFIG\\_BOOTLOADER\\_FACTORY\\_RESET](#)

**Default value:**

- 4 if [CONFIG\\_BOOTLOADER\\_FACTORY\\_RESET](#)

### CONFIG\_BOOTLOADER\_FACTORY\_RESET\_PIN\_LEVEL

Factory reset GPIO level

*Found in: [Bootloader config](#) > [CONFIG\\_BOOTLOADER\\_FACTORY\\_RESET](#)*

Pin level for factory reset, can be triggered on low or high.

**Available options:**

- Reset on GPIO low (BOOTLOADER\_FACTORY\_RESET\_PIN\_LOW)
- Reset on GPIO high (BOOTLOADER\_FACTORY\_RESET\_PIN\_HIGH)

### CONFIG\_BOOTLOADER\_OTA\_DATA\_ERASE

Clear OTA data on factory reset (select factory partition)

*Found in: [Bootloader config](#) > [CONFIG\\_BOOTLOADER\\_FACTORY\\_RESET](#)*

The device will boot from “factory” partition (or OTA slot 0 if no factory partition is present) after a factory reset.

### CONFIG\_BOOTLOADER\_DATA\_FACTORY\_RESET

Comma-separated names of partitions to clear on factory reset

*Found in: [Bootloader config](#) > [CONFIG\\_BOOTLOADER\\_FACTORY\\_RESET](#)*

Allows customers to select which data partitions will be erased while factory reset.

Specify the names of partitions as a comma-delimited with optional spaces for readability. (Like this: “nvs, phy\_init, …” ) Make sure that the name specified in the partition table and here are the same. Partitions of type “app” cannot be specified here.

**Default value:**

- “nvs” if [CONFIG\\_BOOTLOADER\\_FACTORY\\_RESET](#)

### CONFIG\_BOOTLOADER\_APP\_TEST

GPIO triggers boot from test app partition

*Found in: [Bootloader config](#)*

Allows to run the test app from “TEST” partition. A boot from “test” partition will occur if there is a GPIO input pulled low while device starts up. See settings below.

**Default value:**

- No (disabled) if [CONFIG\\_BOOTLOADER\\_APP\\_ANTI\\_ROLLBACK](#)

### CONFIG\_BOOTLOADER\_NUM\_PIN\_APP\_TEST

Number of the GPIO input to boot TEST partition

*Found in: [Bootloader config](#) > [CONFIG\\_BOOTLOADER\\_APP\\_TEST](#)*

The selected GPIO will be configured as an input with internal pull-up enabled. To trigger a test app, this GPIO must be pulled low on reset. After the GPIO input is deactivated and the device reboots, the old application will boot. (factory or OTA[x]). Note that GPIO34-39 do not have an internal pullup and an external one must be provided.

**Range:**

- from 0 to 39 if [CONFIG\\_BOOTLOADER\\_APP\\_TEST](#)

**Default value:**

- 18 if [CONFIG\\_BOOTLOADER\\_APP\\_TEST](#)

### CONFIG\_BOOTLOADER\_APP\_TEST\_PIN\_LEVEL

App test GPIO level

*Found in: [Bootloader config](#) > [CONFIG\\_BOOTLOADER\\_APP\\_TEST](#)*

Pin level for app test, can be triggered on low or high.

**Available options:**

- Enter test app on GPIO low ([BOOTLOADER\\_APP\\_TEST\\_PIN\\_LOW](#))
- Enter test app on GPIO high ([BOOTLOADER\\_APP\\_TEST\\_PIN\\_HIGH](#))

### CONFIG\_BOOTLOADER\_HOLD\_TIME\_GPIO

Hold time of GPIO for reset/test mode (seconds)

*Found in: [Bootloader config](#)*

The GPIO must be held low continuously for this period of time after reset before a factory reset or test partition boot (as applicable) is performed.

**Default value:**

- 5 if `CONFIG_BOOTLOADER_FACTORY_RESET` || `CONFIG_BOOTLOADER_APP_TEST`

### CONFIG\_BOOTLOADER\_REGION\_PROTECTION\_ENABLE

Enable protection for unmapped memory regions

*Found in: [Bootloader config](#)*

Protects the unmapped memory regions of the entire address space from unintended accesses. This will ensure that an exception will be triggered whenever the CPU performs a memory operation on unmapped regions of the address space.

**Default value:**

- Yes (enabled)

### CONFIG\_BOOTLOADER\_WDT\_ENABLE

Use RTC watchdog in start code

*Found in: [Bootloader config](#)*

Tracks the execution time of startup code. If the execution time is exceeded, the RTC\_WDT will restart system. It is also useful to prevent a lock up in start code caused by an unstable power source. NOTE: Tracks the execution time starts from the bootloader code - re-set timeout, while selecting the source for `slow_clk` - and ends calling `app_main`. Re-set timeout is needed due to WDT uses a `SLOW_CLK` clock source. After changing a frequency `slow_clk` a time of WDT needs to re-set for new frequency. `slow_clk` depends on `RTC_CLK_SRC` (`INTERNAL_RC` or `EXTERNAL_CRYSTAL`).

**Default value:**

- Yes (enabled)

### CONFIG\_BOOTLOADER\_WDT\_DISABLE\_IN\_USER\_CODE

Allows RTC watchdog disable in user code

*Found in: [Bootloader config](#) > [CONFIG\\_BOOTLOADER\\_WDT\\_ENABLE](#)*

If this option is set, the ESP-IDF app must explicitly reset, feed, or disable the `rtc_wdt` in the app's own code. If this option is not set (default), then `rtc_wdt` will be disabled by ESP-IDF before calling the `app_main()` function.

Use function `rtc_wdt_feed()` for resetting counter of `rtc_wdt`. Use function `rtc_wdt_disable()` for disabling `rtc_wdt`.

**Default value:**

- No (disabled)

### CONFIG\_BOOTLOADER\_WDT\_TIME\_MS

Timeout for RTC watchdog (ms)

*Found in: [Bootloader config](#) > [CONFIG\\_BOOTLOADER\\_WDT\\_ENABLE](#)*

Verify that this parameter is correct and more then the execution time. Pay attention to options such as reset to factory, trigger test partition and encryption on boot - these options can increase the execution time. Note: RTC\_WDT will reset while encryption operations will be performed.

**Range:**

- from 0 to 120000

**Default value:**

- 9000

### CONFIG\_BOOTLOADER\_APP\_ROLLBACK\_ENABLE

Enable app rollback support

*Found in:* [Bootloader config](#)

After updating the app, the bootloader runs a new app with the “ESP\_OTA\_IMG\_PENDING\_VERIFY” state set. This state prevents the re-run of this app. After the first boot of the new app in the user code, the function should be called to confirm the operability of the app or vice versa about its non-operability. If the app is working, then it is marked as valid. Otherwise, it is marked as not valid and rolls back to the previous working app. A reboot is performed, and the app is booted before the software update. Note: If during the first boot a new app the power goes out or the WDT works, then roll back will happen. Rollback is possible only between the apps with the same security versions.

**Default value:**

- No (disabled)

### CONFIG\_BOOTLOADER\_APP\_ANTI\_ROLLBACK

Enable app anti-rollback support

*Found in:* [Bootloader config](#) > [CONFIG\\_BOOTLOADER\\_APP\\_ROLLBACK\\_ENABLE](#)

This option prevents rollback to previous firmware/application image with lower security version.

**Default value:**

- No (disabled) if [CONFIG\\_BOOTLOADER\\_APP\\_ROLLBACK\\_ENABLE](#)

### CONFIG\_BOOTLOADER\_APP\_SECURE\_VERSION

eFuse secure version of app

*Found in:* [Bootloader config](#) > [CONFIG\\_BOOTLOADER\\_APP\\_ROLLBACK\\_ENABLE](#) > [CONFIG\\_BOOTLOADER\\_APP\\_ANTI\\_ROLLBACK](#)

The secure version is the sequence number stored in the header of each firmware. The security version is set in the bootloader, version is recorded in the eFuse field as the number of set ones. The allocated number of bits in the efuse field for storing the security version is limited (see [BOOTLOADER\\_APP\\_SEC\\_VER\\_SIZE\\_EFUSE\\_FIELD](#) option).

Bootloader: When bootloader selects an app to boot, an app is selected that has a security version greater or equal that recorded in eFuse field. The app is booted with a higher (or equal) secure version.

The security version is worth increasing if in previous versions there is a significant vulnerability and their use is not acceptable.

Your partition table should has a scheme with ota\_0 + ota\_1 (without factory).

**Default value:**

- 0 if [CONFIG\\_BOOTLOADER\\_APP\\_ANTI\\_ROLLBACK](#)



### CONFIG\_BOOTLOADER\_APP\_SEC\_VER\_SIZE\_EFUSE\_FIELD

Size of the efuse secure version field

*Found in:* *Bootloader config* > *CONFIG\_BOOTLOADER\_APP\_ROLLBACK\_ENABLE* > *CONFIG\_BOOTLOADER\_APP\_ANTI\_ROLLBACK*

The size of the efuse secure version field. Its length is limited to 32 bits for ESP32 and 16 bits for ESP32-S2. This determines how many times the security version can be increased.

**Range:**

- from 1 to 16 if *CONFIG\_BOOTLOADER\_APP\_ANTI\_ROLLBACK*

**Default value:**

- 16 if *CONFIG\_BOOTLOADER\_APP\_ANTI\_ROLLBACK*

### CONFIG\_BOOTLOADER\_EFUSE\_SECURE\_VERSION\_EMULATE

Emulate operations with efuse secure version(only test)

*Found in:* *Bootloader config* > *CONFIG\_BOOTLOADER\_APP\_ROLLBACK\_ENABLE* > *CONFIG\_BOOTLOADER\_APP\_ANTI\_ROLLBACK*

This option allows to emulate read/write operations with all eFuses and efuse secure version. It allows to test anti-rollback implementation without permanent write eFuse bits. There should be an entry in partition table with following details: *emul\_efuse, data, efuse, , 0x2000*.

This option enables: EFUSE\_VIRTUAL and EFUSE\_VIRTUAL\_KEEP\_IN\_FLASH.

**Default value:**

- No (disabled) if *CONFIG\_BOOTLOADER\_APP\_ANTI\_ROLLBACK*

### CONFIG\_BOOTLOADER\_SKIP\_VALIDATE\_IN\_DEEP\_SLEEP

Skip image validation when exiting deep sleep

*Found in:* *Bootloader config*

This option disables the normal validation of an image coming out of deep sleep (checksums, SHA256, and signature). This is a trade-off between wakeup performance from deep sleep, and image integrity checks.

Only enable this if you know what you are doing. It should not be used in conjunction with using *deep\_sleep()* entry and changing the active OTA partition as this would skip the validation upon first load of the new OTA partition.

It is possible to enable this option with Secure Boot if “allow insecure options” is enabled, however it’s strongly recommended to NOT enable it as it may allow a Secure Boot bypass.

**Default value:**

- No (disabled) if (*CONFIG\_SECURE\_BOOT* && *CONFIG\_SECURE\_BOOT\_INSECURE*) || *CONFIG\_SECURE\_BOOT*

### CONFIG\_BOOTLOADER\_SKIP\_VALIDATE\_ON\_POWER\_ON

Skip image validation from power on reset (READ HELP FIRST)

*Found in:* *Bootloader config*

Some applications need to boot very quickly from power on. By default, the entire app binary is read from flash and verified which takes up a significant portion of the boot time.

Enabling this option will skip validation of the app when the SoC boots from power on. Note that in this case it’s not possible for the bootloader to detect if an app image is corrupted in the flash, therefore it’s not possible to safely fall back to a different app partition. Flash corruption of this kind is unlikely but can happen if there is a serious firmware bug or physical damage.

Following other reset types, the bootloader will still validate the app image. This increases the chances that flash corruption resulting in a crash can be detected following soft reset, and the bootloader will fall back to a valid app image. To increase the chances of successfully recovering from a flash corruption event, keep the option `BOOTLOADER_WDT_ENABLE` enabled and consider also enabling `BOOTLOADER_WDT_DISABLE_IN_USER_CODE` - then manually disable the RTC Watchdog once the app is running. In addition, enable both the Task and Interrupt watchdog timers with reset options set.

**Default value:**

- No (disabled)

### **CONFIG\_BOOTLOADER\_SKIP\_VALIDATE\_ALWAYS**

Skip image validation always (READ HELP FIRST)

*Found in:* [Bootloader config](#)

Selecting this option prevents the bootloader from ever validating the app image before booting it. Any flash corruption of the selected app partition will make the entire SoC unbootable.

Although flash corruption is a very rare case, it is not recommended to select this option. Consider selecting “Skip image validation from power on reset” instead. However, if boot time is the only important factor then it can be enabled.

**Default value:**

- No (disabled)

### **CONFIG\_BOOTLOADER\_CUSTOM\_RESERVE\_RTC**

Reserve RTC FAST memory for custom purposes

*Found in:* [Bootloader config](#)

This option allows the customer to place data in the RTC FAST memory, this area remains valid when rebooted, except for power loss. This memory is located at a fixed address and is available for both the bootloader and the application. (The application and bootloader must be compiled with the same option). The RTC FAST memory has access only through `PRO_CPU`.

**Default value:**

- No (disabled)

### **CONFIG\_BOOTLOADER\_CUSTOM\_RESERVE\_RTC\_IN\_CRC**

Include custom memory in the CRC calculation

*Found in:* [Bootloader config](#) > [CONFIG\\_BOOTLOADER\\_CUSTOM\\_RESERVE\\_RTC](#)

This option allows the customer to use the legacy bootloader behavior when the RTC FAST memory CRC calculation takes place. When this option is enabled, the allocated user custom data will be taken into account in the CRC calculation. This means that any change to the custom data would need a CRC update to prevent the bootloader from marking this data as corrupted. If this option is disabled, the custom data will not be taken into account when calculating the RTC FAST memory CRC. The user custom data can be changed freely, without the need to update the CRC. **THIS OPTION MUST BE THE SAME FOR BOTH THE BOOTLOADER AND THE APPLICATION BUILDS.**

**Default value:**

- No (disabled) if [CONFIG\\_BOOTLOADER\\_CUSTOM\\_RESERVE\\_RTC](#)

### **CONFIG\_BOOTLOADER\_CUSTOM\_RESERVE\_RTC\_SIZE**

Size in bytes for custom purposes

*Found in:* [Bootloader config](#) > [CONFIG\\_BOOTLOADER\\_CUSTOM\\_RESERVE\\_RTC](#)

This option reserves in RTC FAST memory the area for custom purposes. If you want to create your own bootloader and save more information in this area of memory, you can increase it. It must be a multiple of 4 bytes. This area (`rtc_retain_mem_t`) is reserved and has access from the bootloader and an application.

**Default value:**

- 0 if `CONFIG_BOOTLOADER_CUSTOM_RESERVE_RTC`

**Security features**

Contains:

- `CONFIG_SECURE_BOOT_INSECURE`
- `CONFIG_SECURE_SIGNED_APPS_SCHEME`
- `CONFIG_SECURE_SIGNED_ON_BOOT_NO_SECURE_BOOT`
- `CONFIG_SECURE_FLASH_CHECK_ENC_EN_IN_APP`
- `CONFIG_SECURE_BOOT_ECDSA_KEY_LEN_SIZE`
- `CONFIG_SECURE_BOOT_ENABLE_AGGRESSIVE_KEY_REVOKE`
- `CONFIG_SECURE_FLASH_ENC_ENABLED`
- `CONFIG_SECURE_BOOT`
- `CONFIG_SECURE_FLASH_ENCRYPT_ONLY_IMAGE_LEN_IN_APP_PART`
- `CONFIG_SECURE_BOOTLOADER_KEY_ENCODING`
- *Potentially insecure options*
- `CONFIG_SECURE_SIGNED_APPS_NO_SECURE_BOOT`
- `CONFIG_SECURE_BOOT_VERIFICATION_KEY`
- `CONFIG_SECURE_BOOTLOADER_MODE`
- `CONFIG_SECURE_BOOT_BUILD_SIGNED_BINARIES`
- `CONFIG_SECURE_UART_ROM_DL_MODE`
- `CONFIG_SECURE_SIGNED_ON_UPDATE_NO_SECURE_BOOT`

**CONFIG\_SECURE\_SIGNED\_APPS\_NO\_SECURE\_BOOT**

Require signed app images

*Found in: Security features*

Require apps to be signed to verify their integrity.

This option uses the same app signature scheme as hardware secure boot, but unlike hardware secure boot it does not prevent the bootloader from being physically updated. This means that the device can be secured against remote network access, but not physical access. Compared to using hardware Secure Boot this option is much simpler to implement.

**CONFIG\_SECURE\_SIGNED\_APPS\_SCHEME**

App Signing Scheme

*Found in: Security features*

Select the Secure App signing scheme. Depends on the Chip Revision. There are two secure boot versions:

1. **Secure boot V1**
  - Legacy custom secure boot scheme. Supported in ESP32 SoC.
2. **Secure boot V2**
  - RSA based secure boot scheme. Supported in ESP32-ECO3 (ESP32 Chip Revision 3 onwards), ESP32-S2, ESP32-C3, ESP32-S3 SoCs.
  - ECDSA based secure boot scheme. Supported in ESP32-C2 SoC.

**Available options:**

- ECDSA (SECURE\_SIGNED\_APPS\_ECDSA\_SCHEME)  
Embeds the ECDSA public key in the bootloader and signs the application with an ECDSA key. Refer to the documentation before enabling.
- RSA (SECURE\_SIGNED\_APPS\_RSA\_SCHEME)  
Appends the RSA-3072 based Signature block to the application. Refer to <Secure Boot Version 2 documentation link> before enabling.
- ECDSA (V2) (SECURE\_SIGNED\_APPS\_ECDSA\_V2\_SCHEME)  
For Secure boot V2 (e.g., ESP32-C2 SoC), appends ECDSA based signature block to the application. Refer to documentation before enabling.

### CONFIG\_SECURE\_BOOT\_ECDSA\_KEY\_LEN\_SIZE

ECDSA key size

*Found in: Security features*

Select the ECDSA key size. Two key sizes are supported

- 192 bit key using NISTP192 curve
- 256 bit key using NISTP256 curve (Recommended)

The advantage of using 256 bit key is the extra randomness which makes it difficult to be bruteforced compared to 192 bit key. At present, both key sizes are practically implausible to bruteforce.

**Available options:**

- Using ECC curve NISTP192 (SECURE\_BOOT\_ECDSA\_KEY\_LEN\_192\_BITS)
- Using ECC curve NISTP256 (Recommended) (SECURE\_BOOT\_ECDSA\_KEY\_LEN\_256\_BITS)

### CONFIG\_SECURE\_SIGNED\_ON\_BOOT\_NO\_SECURE\_BOOT

Bootloader verifies app signatures

*Found in: Security features*

If this option is set, the bootloader will be compiled with code to verify that an app is signed before booting it.

If hardware secure boot is enabled, this option is always enabled and cannot be disabled. If hardware secure boot is not enabled, this option doesn't add significant security by itself so most users will want to leave it disabled.

**Default value:**

- No (disabled) if `CONFIG_SECURE_SIGNED_APPS_NO_SECURE_BOOT` && `SECURE_SIGNED_APPS_ECDSA_SCHEME`

### CONFIG\_SECURE\_SIGNED\_ON\_UPDATE\_NO\_SECURE\_BOOT

Verify app signature on update

*Found in: Security features*

If this option is set, any OTA updated apps will have the signature verified before being considered valid.

When enabled, the signature is automatically checked whenever the `esp_ota_ops.h` APIs are used for OTA updates, or `esp_image_format.h` APIs are used to verify apps.

If hardware secure boot is enabled, this option is always enabled and cannot be disabled. If hardware secure boot is not enabled, this option still adds significant security against network-based attackers by preventing spoofing of OTA updates.

**Default value:**

- Yes (enabled) if `CONFIG_SECURE_SIGNED_APPS_NO_SECURE_BOOT`

## CONFIG\_SECURE\_BOOT

Enable hardware Secure Boot in bootloader (READ DOCS FIRST)

*Found in: Security features*

Build a bootloader which enables Secure Boot on first boot.

Once enabled, Secure Boot will not boot a modified bootloader. The bootloader will only load a partition table or boot an app if the data has a verified digital signature. There are implications for reflashing updated apps once secure boot is enabled.

When enabling secure boot, JTAG and ROM BASIC Interpreter are permanently disabled by default.

### Default value:

- No (disabled)

## CONFIG\_SECURE\_BOOT\_VERSION

Select secure boot version

*Found in: Security features > CONFIG\_SECURE\_BOOT*

Select the Secure Boot Version. Depends on the Chip Revision. Secure Boot V2 is the new RSA / ECDSA based secure boot scheme.

- RSA based scheme is supported in ESP32 (Revision 3 onwards), ESP32-S2, ESP32-C3 (ECO3), ESP32-S3.
- ECDSA based scheme is supported in ESP32-C2 SoC.

Please note that, RSA or ECDSA secure boot is property of specific SoC based on its HW design, supported crypto accelerators, die-size, cost and similar parameters. Please note that RSA scheme has requirement for bigger key sizes but at the same time it is comparatively faster than ECDSA verification.

Secure Boot V1 is the AES based (custom) secure boot scheme supported in ESP32 SoC.

### Available options:

- Enable Secure Boot version 1 (SECURE\_BOOT\_V1\_ENABLED)  
Build a bootloader which enables secure boot version 1 on first boot. Refer to the Secure Boot section of the ESP-IDF Programmer's Guide for this version before enabling.
- Enable Secure Boot version 2 (SECURE\_BOOT\_V2\_ENABLED)  
Build a bootloader which enables Secure Boot version 2 on first boot. Refer to Secure Boot V2 section of the ESP-IDF Programmer's Guide for this version before enabling.

## CONFIG\_SECURE\_BOOTLOADER\_MODE

Secure bootloader mode

*Found in: Security features*

### Available options:

- One-time flash (SECURE\_BOOTLOADER\_ONE\_TIME\_FLASH)  
On first boot, the bootloader will generate a key which is not readable externally or by software. A digest is generated from the bootloader image itself. This digest will be verified on each subsequent boot.  
Enabling this option means that the bootloader cannot be changed after the first time it is booted.
- Reflashable (SECURE\_BOOTLOADER\_REFLASHABLE)  
Generate a reusable secure bootloader key, derived (via SHA-256) from the secure boot signing key.  
This allows the secure bootloader to be re-flashed by anyone with access to the secure boot signing key.  
This option is less secure than one-time flash, because a leak of the digest key from one device allows reflashing of any device that uses it.

## CONFIG\_SECURE\_BOOT\_BUILD\_SIGNED\_BINARIES

Sign binaries during build

*Found in: Security features*

Once secure boot or signed app requirement is enabled, app images are required to be signed.

If enabled (default), these binary files are signed as part of the build process. The file named in “Secure boot private signing key” will be used to sign the image.

If disabled, unsigned app/partition data will be built. They must be signed manually using `espsecure.py`. Version 1 to enable ECDSA Based Secure Boot and Version 2 to enable RSA based Secure Boot. (for example, on a remote signing server.)

## CONFIG\_SECURE\_BOOT\_SIGNING\_KEY

Secure boot private signing key

*Found in: Security features > CONFIG\_SECURE\_BOOT\_BUILD\_SIGNED\_BINARIES*

Path to the key file used to sign app images.

Key file is an ECDSA private key (NIST256p curve) in PEM format for Secure Boot V1. Key file is an RSA private key in PEM format for Secure Boot V2.

Path is evaluated relative to the project directory.

You can generate a new signing key by running the following command: `espsecure.py generate_signing_key secure_boot_signing_key.pem`

See the Secure Boot section of the ESP-IDF Programmer’s Guide for this version for details.

### Default value:

- “secure\_boot\_signing\_key.pem” if `CONFIG_SECURE_BOOT_BUILD_SIGNED_BINARIES`

## CONFIG\_SECURE\_BOOT\_VERIFICATION\_KEY

Secure boot public signature verification key

*Found in: Security features*

Path to a public key file used to verify signed images. Secure Boot V1: This ECDSA public key is compiled into the bootloader and/or app, to verify app images.

Key file is in raw binary format, and can be extracted from a PEM formatted private key using the `espsecure.py extract_public_key` command.

Refer to the Secure Boot section of the ESP-IDF Programmer’s Guide for this version before enabling.

## CONFIG\_SECURE\_BOOT\_ENABLE\_AGGRESSIVE\_KEY\_REVOKE

Enable Aggressive key revoke strategy

*Found in: Security features*

If this option is set, ROM bootloader will revoke the public key digest burned in efuse block if it fails to verify the signature of software bootloader with it. Revocation of keys does not happen when enabling secure boot. Once secure boot is enabled, key revocation checks will be done on subsequent boot-up, while verifying the software bootloader

This feature provides a strong resistance against physical attacks on the device.

NOTE: Once a digest slot is revoked, it can never be used again to verify an image This can lead to permanent bricking of the device, in case all keys are revoked because of signature verification failure.

### Default value:

- No (disabled) if `CONFIG_SECURE_BOOT`

## CONFIG\_SECURE\_BOOTLOADER\_KEY\_ENCODING

Hardware Key Encoding

*Found in: Security features*

In reflashable secure bootloader mode, a hardware key is derived from the signing key (with SHA-256) and can be written to eFuse with `espefuse.py`.

Normally this is a 256-bit key, but if 3/4 Coding Scheme is used on the device then the eFuse key is truncated to 192 bits.

This configuration item doesn't change any firmware code, it only changes the size of key binary which is generated at build time.

### Available options:

- No encoding (256 bit key) (`SECURE_BOOTLOADER_KEY_ENCODING_256BIT`)
- 3/4 encoding (192 bit key) (`SECURE_BOOTLOADER_KEY_ENCODING_192BIT`)

## CONFIG\_SECURE\_BOOT\_INSECURE

Allow potentially insecure options

*Found in: Security features*

You can disable some of the default protections offered by secure boot, in order to enable testing or a custom combination of security features.

Only enable these options if you are very sure.

Refer to the Secure Boot section of the ESP-IDF Programmer's Guide for this version before enabling.

### Default value:

- No (disabled) if `CONFIG_SECURE_BOOT`

## CONFIG\_SECURE\_FLASH\_ENC\_ENABLED

Enable flash encryption on boot (READ DOCS FIRST)

*Found in: Security features*

If this option is set, flash contents will be encrypted by the bootloader on first boot.

Note: After first boot, the system will be permanently encrypted. Re-flashing an encrypted system is complicated and not always possible.

Read *Flash Encryption* before enabling.

### Default value:

- No (disabled)

## CONFIG\_SECURE\_FLASH\_ENCRYPTION\_KEYSIZE

Size of generated AES-XTS key

*Found in: Security features > CONFIG\_SECURE\_FLASH\_ENC\_ENABLED*

Size of generated AES-XTS key.

- AES-128 uses a 256-bit key (32 bytes) derived from 128 bits (16 bytes) burned in half Efuse key block. Internally, it calculates SHA256(128 bits)
- AES-128 uses a 256-bit key (32 bytes) which occupies one Efuse key block.
- AES-256 uses a 512-bit key (64 bytes) which occupies two Efuse key blocks.

This setting is ignored if either type of key is already burned to Efuse before the first boot. In this case, the pre-burned key is used and no new key is generated.

### Available options:



- AES-128 key derived from 128 bits (SHA256(128 bits)) (SECURE\_FLASH\_ENCRYPTION\_AES128\_DERIVED)
- AES-128 (256-bit key) (SECURE\_FLASH\_ENCRYPTION\_AES128)
- AES-256 (512-bit key) (SECURE\_FLASH\_ENCRYPTION\_AES256)

## CONFIG\_SECURE\_FLASH\_ENCRYPTION\_MODE

Enable usage mode

*Found in: Security features > CONFIG\_SECURE\_FLASH\_ENC\_ENABLED*

By default Development mode is enabled which allows ROM download mode to perform flash encryption operations (plaintext is sent to the device, and it encrypts it internally and writes ciphertext to flash.) This mode is not secure, it's possible for an attacker to write their own chosen plaintext to flash.

Release mode should always be selected for production or manufacturing. Once enabled it's no longer possible for the device in ROM Download Mode to use the flash encryption hardware.

Refer to the Flash Encryption section of the ESP-IDF Programmer's Guide for details.

### Available options:

- Development (NOT SECURE) (SECURE\_FLASH\_ENCRYPTION\_MODE\_DEVELOPMENT)
- Release (SECURE\_FLASH\_ENCRYPTION\_MODE\_RELEASE)

### Potentially insecure options Contains:

- CONFIG\_SECURE\_BOOT\_V2\_ALLOW\_EFUSE\_RD\_DIS
- CONFIG\_SECURE\_BOOT\_ALLOW\_SHORT\_APP\_PARTITION
- CONFIG\_SECURE\_BOOT\_ALLOW\_JTAG
- CONFIG\_SECURE\_FLASH\_UART\_BOOTLOADER\_ALLOW\_ENC
- CONFIG\_SECURE\_FLASH\_UART\_BOOTLOADER\_ALLOW\_CACHE
- CONFIG\_SECURE\_BOOT\_ALLOW\_UNUSED\_DIGEST\_SLOTS
- CONFIG\_SECURE\_FLASH\_REQUIRE\_ALREADY\_ENABLED

## CONFIG\_SECURE\_BOOT\_ALLOW\_JTAG

Allow JTAG Debugging

*Found in: Security features > Potentially insecure options*

If not set (default), the bootloader will permanently disable JTAG (across entire chip) on first boot when either secure boot or flash encryption is enabled.

Setting this option leaves JTAG on for debugging, which negates all protections of flash encryption and some of the protections of secure boot.

Only set this option in testing environments.

### Default value:

- No (disabled) if CONFIG\_SECURE\_BOOT\_INSECURE || SECURE\_FLASH\_ENCRYPTION\_MODE\_DEVELOPMENT

## CONFIG\_SECURE\_BOOT\_ALLOW\_SHORT\_APP\_PARTITION

Allow app partition length not 64KB aligned

*Found in: Security features > Potentially insecure options*

If not set (default), app partition size must be a multiple of 64KB. App images are padded to 64KB length, and the bootloader checks any trailing bytes after the signature (before the next 64KB boundary) have not been written. This is because flash cache maps entire 64KB pages into the address space. This prevents an attacker from appending unverified data after the app image in the flash, causing it to be mapped into the address space.



Setting this option allows the app partition length to be unaligned, and disables padding of the app image to this length. It is generally not recommended to set this option, unless you have a legacy partitioning scheme which doesn't support 64KB aligned partition lengths.

### **CONFIG\_SECURE\_BOOT\_V2\_ALLOW\_EFUSE\_RD\_DIS**

Allow additional read protecting of efuses

*Found in: Security features > Potentially insecure options*

If not set (default, recommended), on first boot the bootloader will burn the WR\_DIS\_RD\_DIS efuse when Secure Boot is enabled. This prevents any more efuses from being read protected.

If this option is set, it will remain possible to write the EFUSE\_RD\_DIS efuse field after Secure Boot is enabled. This may allow an attacker to read-protect the BLK2 efuse (for ESP32) and BLOCK4-BLOCK10 (i.e. BLOCK\_KEY0-BLOCK\_KEY5)(for other chips) holding the public key digest, causing an immediate denial of service and possibly allowing an additional fault injection attack to bypass the signature protection.

NOTE: Once a BLOCK is read-protected, the application will read all zeros from that block

NOTE: If “UART ROM download mode (Permanently disabled (recommended))” or “UART ROM download mode (Permanently switch to Secure mode (recommended))” is set, then it is NOT possible to read/write efuses using espfuse.py utility. However, efuse can be read/written from the application

### **CONFIG\_SECURE\_BOOT\_ALLOW\_UNUSED\_DIGEST\_SLOTS**

Leave unused digest slots available (not revoke)

*Found in: Security features > Potentially insecure options*

If not set (default), during startup in the app all unused digest slots will be revoked. To revoke unused slot will be called esp\_efuse\_set\_digest\_revoke(num\_digest) for each digest. Revoking unused digest slots makes ensures that no trusted keys can be added later by an attacker. If set, it means that you have a plan to use unused digests slots later.

**Default value:**

- No (disabled) if `CONFIG_SECURE_BOOT_INSECURE`

### **CONFIG\_SECURE\_FLASH\_UART\_BOOTLOADER\_ALLOW\_ENC**

Leave UART bootloader encryption enabled

*Found in: Security features > Potentially insecure options*

If not set (default), the bootloader will permanently disable UART bootloader encryption access on first boot. If set, the UART bootloader will still be able to access hardware encryption.

It is recommended to only set this option in testing environments.

**Default value:**

- No (disabled) if `SECURE_FLASH_ENCRYPTION_MODE_DEVELOPMENT`

### **CONFIG\_SECURE\_FLASH\_UART\_BOOTLOADER\_ALLOW\_CACHE**

Leave UART bootloader flash cache enabled

*Found in: Security features > Potentially insecure options*

If not set (default), the bootloader will permanently disable UART bootloader flash cache access on first boot. If set, the UART bootloader will still be able to access the flash cache.

Only set this option in testing environments.

**Default value:**

- No (disabled) if `SECURE_FLASH_ENCRYPTION_MODE_DEVELOPMENT`

**CONFIG\_SECURE\_FLASH\_REQUIRE\_ALREADY\_ENABLED**

Require flash encryption to be already enabled

*Found in: Security features > Potentially insecure options*

If not set (default), and flash encryption is not yet enabled in eFuses, the 2nd stage bootloader will enable flash encryption: generate the flash encryption key and program eFuses. If this option is set, and flash encryption is not yet enabled, the bootloader will error out and reboot. If flash encryption is enabled in eFuses, this option does not change the bootloader behavior.

Only use this option in testing environments, to avoid accidentally enabling flash encryption on the wrong device. The device needs to have flash encryption already enabled using `espefuse.py`.

**Default value:**

- No (disabled) if `SECURE_FLASH_ENCRYPTION_MODE_DEVELOPMENT`

**CONFIG\_SECURE\_FLASH\_ENCRYPT\_ONLY\_IMAGE\_LEN\_IN\_APP\_PART**

Encrypt only the app image that is present in the partition of type app

*Found in: Security features*

If set, optimise encryption time for the partition of type APP, by only encrypting the app image that is present in the partition, instead of the whole partition. The image length used for encryption is derived from the image metadata, which includes the size of the app image, checksum, hash and also the signature sector when secure boot is enabled.

If not set (default), the whole partition of type APP would be encrypted, which increases the encryption time but might be useful if there is any custom data appended to the firmware image.

**Default value:**

- No (disabled) if `CONFIG_SECURE_FLASH_ENC_ENABLED` && `CONFIG_SECURE_FLASH_REQUIRE_ALREADY_ENABLED`

**CONFIG\_SECURE\_FLASH\_CHECK\_ENC\_EN\_IN\_APP**

Check Flash Encryption enabled on app startup

*Found in: Security features*

If set (default), in an app during startup code, there is a check of the flash encryption eFuse bit is on (as the bootloader should already have set it). The app requires this bit is on to continue work otherwise abort.

If not set, the app does not care if the flash encryption eFuse bit is set or not.

**Default value:**

- Yes (enabled) if `CONFIG_SECURE_FLASH_ENC_ENABLED`

**CONFIG\_SECURE\_UART\_ROM\_DL\_MODE**

UART ROM download mode

*Found in: Security features*

**Available options:**

- UART ROM download mode (Permanently disabled (recommended)) (`SECURE_DISABLE_ROM_DL_MODE`)  
If set, during startup the app will burn an eFuse bit to permanently disable the UART ROM Download Mode. This prevents any future use of `esptool.py`, `espefuse.py` and similar tools.

Once disabled, if the SoC is booted with strapping pins set for ROM Download Mode then an error is printed instead.

It is recommended to enable this option in any production application where Flash Encryption and/or Secure Boot is enabled and access to Download Mode is not required.

It is also possible to permanently disable Download Mode by calling `esp_efuse_disable_rom_download_mode()` at runtime.

- UART ROM download mode (Permanently switch to Secure mode (recommended)) (`SECURE_ENABLE_SECURE_ROM_DL_MODE`)

If set, during startup the app will burn an eFuse bit to permanently switch the UART ROM Download Mode into a separate Secure Download mode. This option can only work if Download Mode is not already disabled by eFuse.

Secure Download mode limits the use of Download Mode functions to update SPI config, changing baud rate, basic flash write and a command to return a summary of currently enabled security features (`get_security_info`).

Secure Download mode is not compatible with the `esptool.py` flasher stub feature, `espefuse.py`, read/writing memory or registers, encrypted download, or any other features that interact with unsupported Download Mode commands.

Secure Download mode should be enabled in any application where Flash Encryption and/or Secure Boot is enabled. Disabling this option does not immediately cancel the benefits of the security features, but it increases the potential “attack surface” for an attacker to try and bypass them with a successful physical attack.

It is also possible to enable secure download mode at runtime by calling `esp_efuse_enable_rom_secure_download_mode()`

Note: Secure Download mode is not available for ESP32 (includes revisions till ECO3).

- UART ROM download mode (Enabled (not recommended)) (`SECURE_INSECURE_ALLOW_DL_MODE`)

This is a potentially insecure option. Enabling this option will allow the full UART download mode to stay enabled. This option **SHOULD NOT BE ENABLED** for production use cases.

## Application manager

Contains:

- `CONFIG_APP_EXCLUDE_PROJECT_NAME_VAR`
- `CONFIG_APP_EXCLUDE_PROJECT_VER_VAR`
- `CONFIG_APP_PROJECT_VER_FROM_CONFIG`
- `CONFIG_APP_RETRIEVE_LEN_ELF_SHA`
- `CONFIG_APP_COMPILE_TIME_DATE`

### `CONFIG_APP_COMPILE_TIME_DATE`

Use time/date stamp for app

*Found in:* [Application manager](#)

If set, then the app will be built with the current time/date stamp. It is stored in the app description structure. If not set, time/date stamp will be excluded from app image. This can be useful for getting the same binary image files made from the same source, but at different times.

#### **Default value:**

- Yes (enabled)

### `CONFIG_APP_EXCLUDE_PROJECT_VER_VAR`

Exclude `PROJECT_VER` from firmware image

*Found in:* [Application manager](#)

The `PROJECT_VER` variable from the build system will not affect the firmware image. This value will not be contained in the `esp_app_desc` structure.

**Default value:**

- No (disabled)

**CONFIG\_APP\_EXCLUDE\_PROJECT\_NAME\_VAR**

Exclude PROJECT\_NAME from firmware image

*Found in: Application manager*

The PROJECT\_NAME variable from the build system will not affect the firmware image. This value will not be contained in the esp\_app\_desc structure.

**Default value:**

- No (disabled)

**CONFIG\_APP\_PROJECT\_VER\_FROM\_CONFIG**

Get the project version from Kconfig

*Found in: Application manager*

If this is enabled, then config item APP\_PROJECT\_VER will be used for the variable PROJECT\_VER. Other ways to set PROJECT\_VER will be ignored.

**Default value:**

- No (disabled)

**CONFIG\_APP\_PROJECT\_VER**

Project version

*Found in: Application manager > CONFIG\_APP\_PROJECT\_VER\_FROM\_CONFIG*

Project version

**Default value:**

- 1 if *CONFIG\_APP\_PROJECT\_VER\_FROM\_CONFIG*

**CONFIG\_APP\_RETRIEVE\_LEN\_ELF\_SHA**

The length of APP ELF SHA is stored in RAM(chars)

*Found in: Application manager*

At startup, the app will read this many hex characters from the embedded APP ELF SHA-256 hash value and store it in static RAM. This ensures the app ELF SHA-256 value is always available if it needs to be printed by the panic handler code. Changing this value will change the size of a static buffer, in bytes.

**Range:**

- from 8 to 64

**Default value:**

- 16

**Boot ROM Behavior**

Contains:

- *CONFIG\_BOOT\_ROM\_LOG\_SCHEME*

## CONFIG\_BOOT\_ROM\_LOG\_SCHEME

Permanently change Boot ROM output

Found in: *Boot ROM Behavior*

Controls the Boot ROM log behavior. The rom log behavior can only be changed for once, specific eFuse bit(s) will be burned at app boot stage.

### Available options:

- Always Log (BOOT\_ROM\_LOG\_ALWAYS\_ON)  
Always print ROM logs, this is the default behavior.
- Permanently disable logging (BOOT\_ROM\_LOG\_ALWAYS\_OFF)  
Don't print ROM logs.
- Log on GPIO High (BOOT\_ROM\_LOG\_ON\_GPIO\_HIGH)  
Print ROM logs when GPIO level is high during start up. The GPIO number is chip dependent, e.g. on ESP32-S2, the control GPIO is GPIO46.
- Log on GPIO Low (BOOT\_ROM\_LOG\_ON\_GPIO\_LOW)  
Print ROM logs when GPIO level is low during start up. The GPIO number is chip dependent, e.g. on ESP32-S2, the control GPIO is GPIO46.

## Serial flasher config

Contains:

- *CONFIG\_ESPTOOLPY\_AFTER*
- *CONFIG\_ESPTOOLPY\_BEFORE*
- *CONFIG\_ESPTOOLPY\_HEADER\_FLASHSIZE\_UPDATE*
- *CONFIG\_ESPTOOLPY\_NO\_STUB*
- *CONFIG\_ESPTOOLPY\_FLASH\_SAMPLE\_MODE*
- *CONFIG\_ESPTOOLPY\_FLASHSIZE*
- *CONFIG\_ESPTOOLPY\_FLASHMODE*
- *CONFIG\_ESPTOOLPY\_FLASHFREQ*

## CONFIG\_ESPTOOLPY\_NO\_STUB

Disable download stub

Found in: *Serial flasher config*

The flasher tool sends a precompiled download stub first by default. That stub allows things like compressed downloads and more. Usually you should not need to disable that feature

### Default value:

- No (disabled)

## CONFIG\_ESPTOOLPY\_FLASHMODE

Flash SPI mode

Found in: *Serial flasher config*

Mode the flash chip is flashed in, as well as the default mode for the binary to run in.

### Available options:

- QIO (ESPTOOLPY\_FLASHMODE\_QIO)
- QOUT (ESPTOOLPY\_FLASHMODE\_QOUT)
- DIO (ESPTOOLPY\_FLASHMODE\_DIO)
- DOUT (ESPTOOLPY\_FLASHMODE\_DOUT)
- OPI (ESPTOOLPY\_FLASHMODE\_OPI)

## CONFIG\_ESPTOOLPY\_FLASH\_SAMPLE\_MODE

Flash Sampling Mode

Found in: *Serial flasher config*

### Available options:

- STR Mode (ESPTOOLPY\_FLASH\_SAMPLE\_MODE\_STR)
- DTR Mode (ESPTOOLPY\_FLASH\_SAMPLE\_MODE\_DTR)

## CONFIG\_ESPTOOLPY\_FLASHFREQ

Flash SPI speed

Found in: *Serial flasher config*

### Available options:

- 120 MHz (READ DOCS FIRST) (ESPTOOLPY\_FLASHFREQ\_120M)
  - Optional feature for QSPI Flash. Read docs and enable `CONFIG_SPI_FLASH_HPM_ENA` first!
- 80 MHz (ESPTOOLPY\_FLASHFREQ\_80M)
- 60 MHz (ESPTOOLPY\_FLASHFREQ\_60M)
- 48 MHz (ESPTOOLPY\_FLASHFREQ\_48M)
- 40 MHz (ESPTOOLPY\_FLASHFREQ\_40M)
- 30 MHz (ESPTOOLPY\_FLASHFREQ\_30M)
- 26 MHz (ESPTOOLPY\_FLASHFREQ\_26M)
- 24 MHz (ESPTOOLPY\_FLASHFREQ\_24M)
- 20 MHz (ESPTOOLPY\_FLASHFREQ\_20M)
- 15 MHz (ESPTOOLPY\_FLASHFREQ\_15M)

## CONFIG\_ESPTOOLPY\_FLASHSIZE

Flash size

Found in: *Serial flasher config*

SPI flash size, in megabytes

### Available options:

- 1 MB (ESPTOOLPY\_FLASHSIZE\_1MB)
- 2 MB (ESPTOOLPY\_FLASHSIZE\_2MB)
- 4 MB (ESPTOOLPY\_FLASHSIZE\_4MB)
- 8 MB (ESPTOOLPY\_FLASHSIZE\_8MB)
- 16 MB (ESPTOOLPY\_FLASHSIZE\_16MB)
- 32 MB (ESPTOOLPY\_FLASHSIZE\_32MB)
- 64 MB (ESPTOOLPY\_FLASHSIZE\_64MB)
- 128 MB (ESPTOOLPY\_FLASHSIZE\_128MB)

## CONFIG\_ESPTOOLPY\_HEADER\_FLASHSIZE\_UPDATE

Detect flash size when flashing bootloader

Found in: *Serial flasher config*

If this option is set, flashing the project will automatically detect the flash size of the target chip and update the bootloader image before it is flashed.

Enabling this option turns off the image protection against corruption by a SHA256 digest. Updating the bootloader image before flashing would invalidate the digest.

### Default value:

- No (disabled)

## CONFIG\_ESPTOOLPY\_BEFORE

Before flashing

*Found in: [Serial flasher config](#)*

Configure whether esptool.py should reset the ESP32 before flashing.

Automatic resetting depends on the RTS & DTR signals being wired from the serial port to the ESP32. Most USB development boards do this internally.

### Available options:

- Reset to bootloader (ESPTOOLPY\_BEFORE\_RESET)
- No reset (ESPTOOLPY\_BEFORE\_NORESET)

## CONFIG\_ESPTOOLPY\_AFTER

After flashing

*Found in: [Serial flasher config](#)*

Configure whether esptool.py should reset the ESP32 after flashing.

Automatic resetting depends on the RTS & DTR signals being wired from the serial port to the ESP32. Most USB development boards do this internally.

### Available options:

- Reset after flashing (ESPTOOLPY\_AFTER\_RESET)
- Stay in bootloader (ESPTOOLPY\_AFTER\_NORESET)

## Partition Table

Contains:

- [CONFIG\\_PARTITION\\_TABLE\\_CUSTOM\\_FILENAME](#)
- [CONFIG\\_PARTITION\\_TABLE\\_MD5](#)
- [CONFIG\\_PARTITION\\_TABLE\\_OFFSET](#)
- [CONFIG\\_PARTITION\\_TABLE\\_TYPE](#)

## CONFIG\_PARTITION\_TABLE\_TYPE

Partition Table

*Found in: [Partition Table](#)*

The partition table to flash to the ESP32. The partition table determines where apps, data and other resources are expected to be found.

The predefined partition table CSV descriptions can be found in the components/partition\_table directory. These are mostly intended for example and development use, it's expected that for production use you will copy one of these CSV files and create a custom partition CSV for your application.

### Available options:

- Single factory app, no OTA (PARTITION\_TABLE\_SINGLE\_APP)  
This is the default partition table, designed to fit into a 2MB or larger flash with a single 1MB app partition.  
The corresponding CSV file in the IDF directory is components/partition\_table/partitions\_singleapp.csv  
This partition table is not suitable for an app that needs OTA (over the air update) capability.
- Single factory app (large), no OTA (PARTITION\_TABLE\_SINGLE\_APP\_LARGE)  
This is a variation of the default partition table, that expands the 1MB app partition size to 1.5MB to fit more code.  
The corresponding CSV file in the IDF directory is components/partition\_table/partitions\_singleapp\_large.csv

- This partition table is not suitable for an app that needs OTA (over the air update) capability.
- **Factory app, two OTA definitions (PARTITION\_TABLE\_TWO\_OTA)**  
This is a basic OTA-enabled partition table with a factory app partition plus two OTA app partitions. All are 1MB, so this partition table requires 4MB or larger flash size.  
The corresponding CSV file in the IDF directory is `components/partition_table/partitions_two_ota.csv`
  - **Custom partition table CSV (PARTITION\_TABLE\_CUSTOM)**  
Specify the path to the partition table CSV to use for your project.  
Consult the Partition Table section in the ESP-IDF Programmers Guide for more information.
  - **Single factory app, no OTA, encrypted NVS (PARTITION\_TABLE\_SINGLE\_APP\_ENCRYPTED\_NVS)**  
This is a variation of the default “Single factory app, no OTA” partition table that supports encrypted NVS when using flash encryption. See the Flash Encryption section in the ESP-IDF Programmers Guide for more information.  
The corresponding CSV file in the IDF directory is `components/partition_table/partitions_singleapp_encr_nvs.csv`
  - **Single factory app (large), no OTA, encrypted NVS (PARTITION\_TABLE\_SINGLE\_APP\_LARGE\_ENC\_NVS)**  
This is a variation of the “Single factory app (large), no OTA” partition table that supports encrypted NVS when using flash encryption. See the Flash Encryption section in the ESP-IDF Programmers Guide for more information.  
The corresponding CSV file in the IDF directory is `components/partition_table/partitions_singleapp_large_encr_nvs.csv`
  - **Factory app, two OTA definitions, encrypted NVS (PARTITION\_TABLE\_TWO\_OTA\_ENCRYPTED\_NVS)**  
This is a variation of the “Factory app, two OTA definitions” partition table that supports encrypted NVS when using flash encryption. See the Flash Encryption section in the ESP-IDF Programmers Guide for more information.  
The corresponding CSV file in the IDF directory is `components/partition_table/partitions_two_ota_encr_nvs.csv`

### CONFIG\_PARTITION\_TABLE\_CUSTOM\_FILENAME

Custom partition CSV file

*Found in:* [Partition Table](#)

Name of the custom partition CSV filename. This path is evaluated relative to the project root directory.

**Default value:**

- “partitions.csv”

### CONFIG\_PARTITION\_TABLE\_OFFSET

Offset of partition table

*Found in:* [Partition Table](#)

The address of partition table (by default 0x8000). Allows you to move the partition table, it gives more space for the bootloader. Note that the bootloader and app will both need to be compiled with the same PARTITION\_TABLE\_OFFSET value.

This number should be a multiple of 0x1000.

Note that partition offsets in the partition table CSV file may need to be changed if this value is set to a higher value. To have each partition offset adapt to the configured partition table offset, leave all partition offsets blank in the CSV file.

**Default value:**

- “0x8000”



## CONFIG\_PARTITION\_TABLE\_MD5

Generate an MD5 checksum for the partition table

*Found in: Partition Table*

Generate an MD5 checksum for the partition table for protecting the integrity of the table. The generation should be turned off for legacy bootloaders which cannot recognize the MD5 checksum in the partition table.

**Default value:**

- Yes (enabled)

## Compiler options

Contains:

- [CONFIG\\_COMPILER\\_OPTIMIZATION\\_ASSERTION\\_LEVEL](#)
- [CONFIG\\_COMPILER\\_FLOAT\\_LIB\\_FROM](#)
- [CONFIG\\_COMPILER\\_OPTIMIZATION\\_CHECKS\\_SILENT](#)
- [CONFIG\\_COMPILER\\_DUMP\\_RTL\\_FILES](#)
- [CONFIG\\_COMPILER\\_WARN\\_WRITE\\_STRINGS](#)
- [CONFIG\\_COMPILER\\_CXX\\_EXCEPTIONS](#)
- [CONFIG\\_COMPILER\\_CXX\\_RTTI](#)
- [CONFIG\\_COMPILER\\_OPTIMIZATION](#)
- [CONFIG\\_COMPILER\\_HIDE\\_PATHS\\_MACROS](#)
- [CONFIG\\_COMPILER\\_STACK\\_CHECK\\_MODE](#)

## CONFIG\_COMPILER\_OPTIMIZATION

Optimization Level

*Found in: Compiler options*

This option sets compiler optimization level (gcc -O argument) for the app.

- The “Default” setting will add the -Og flag to CFLAGS.
- The “Size” setting will add the -Os flag to CFLAGS.
- The “Performance” setting will add the -O2 flag to CFLAGS.
- The “None” setting will add the -O0 flag to CFLAGS.

The “Size” setting cause the compiled code to be smaller and faster, but may lead to difficulties of correlating code addresses to source file lines when debugging.

The “Performance” setting causes the compiled code to be larger and faster, but will be easier to correlated code addresses to source file lines.

“None” with -O0 produces compiled code without optimization.

Note that custom optimization levels may be unsupported.

Compiler optimization for the IDF bootloader is set separately, see the `BOOTLOADER_COMPILER_OPTIMIZATION` setting.

**Available options:**

- Debug (-Og) (`COMPILER_OPTIMIZATION_DEFAULT`)
- Optimize for size (-Os) (`COMPILER_OPTIMIZATION_SIZE`)
- Optimize for performance (-O2) (`COMPILER_OPTIMIZATION_PERF`)
- Debug without optimization (-O0) (`COMPILER_OPTIMIZATION_NONE`)

## CONFIG\_COMPILER\_OPTIMIZATION\_ASSERTION\_LEVEL

Assertion level

*Found in: [Compiler options](#)*

Assertions can be:

- Enabled. Failure will print verbose assertion details. This is the default.
- Set to “silent” to save code size (failed assertions will abort() but user needs to use the aborting address to find the line number with the failed assertion.)
- Disabled entirely (not recommended for most configurations.) -DNDEBUG is added to CPPFLAGS in this case.

### Available options:

- Enabled (COMPILER\_OPTIMIZATION\_ASSERTIONS\_ENABLE)  
Enable assertions. Assertion content and line number will be printed on failure.
- Silent (saves code size) (COMPILER\_OPTIMIZATION\_ASSERTIONS\_SILENT)  
Enable silent assertions. Failed assertions will abort(), user needs to use the aborting address to find the line number with the failed assertion.
- Disabled (sets -DNDEBUG) (COMPILER\_OPTIMIZATION\_ASSERTIONS\_DISABLE)  
If assertions are disabled, -DNDEBUG is added to CPPFLAGS.

## CONFIG\_COMPILER\_FLOAT\_LIB\_FROM

Compiler float lib source

*Found in: [Compiler options](#)*

In the soft-fp part of libgcc, riscv version is written in C, and handles all edge cases in IEEE754, which makes it larger and performance is slow.

RVfplib is an optimized RISC-V library for FP arithmetic on 32-bit integer processors, for single and double-precision FP. RVfplib is “fast” , but it has a few exceptions from IEEE 754 compliance.

### Available options:

- libgcc (COMPILER\_FLOAT\_LIB\_FROM\_GCCLIB)
- librvfp (COMPILER\_FLOAT\_LIB\_FROM\_RVFPLIB)

## CONFIG\_COMPILER\_OPTIMIZATION\_CHECKS\_SILENT

Disable messages in ESP\_RETURN\_ON\_\* and ESP\_EXIT\_ON\_\* macros

*Found in: [Compiler options](#)*

If enabled, the error messages will be discarded in following check macros: -  
ESP\_RETURN\_ON\_ERROR - ESP\_EXIT\_ON\_ERROR - ESP\_RETURN\_ON\_FALSE -  
ESP\_EXIT\_ON\_FALSE

### Default value:

- No (disabled)

## CONFIG\_COMPILER\_HIDE\_PATHS\_MACROS

Replace ESP-IDF and project paths in binaries

*Found in: [Compiler options](#)*

When expanding the \_\_FILE\_\_ and \_\_BASE\_FILE\_\_ macros, replace paths inside ESP-IDF with paths relative to the placeholder string “IDF” , and convert paths inside the project directory to relative paths.

This allows building the project with assertions or other code that embeds file paths, without the binary containing the exact path to the IDF or project directories.

This option passes `-fmacro-prefix-map` options to the GCC command line. To replace additional paths in your binaries, modify the project `CMakeLists.txt` file to pass custom `-fmacro-prefix-map` or `-file-prefix-map` arguments.

**Default value:**

- Yes (enabled)

### CONFIG\_COMPILER\_CXX\_EXCEPTIONS

Enable C++ exceptions

*Found in:* [Compiler options](#)

Enabling this option compiles all IDF C++ files with exception support enabled.

Disabling this option disables C++ exception support in all compiled files, and any `libstdc++` code which throws an exception will abort instead.

Enabling this option currently adds an additional ~500 bytes of heap overhead when an exception is thrown in user code for the first time.

**Default value:**

- No (disabled)

Contains:

- [CONFIG\\_COMPILER\\_CXX\\_EXCEPTIONS\\_EMG\\_POOL\\_SIZE](#)

### CONFIG\_COMPILER\_CXX\_EXCEPTIONS\_EMG\_POOL\_SIZE

Emergency Pool Size

*Found in:* [Compiler options](#) > [CONFIG\\_COMPILER\\_CXX\\_EXCEPTIONS](#)

Size (in bytes) of the emergency memory pool for C++ exceptions. This pool will be used to allocate memory for thrown exceptions when there is not enough memory on the heap.

**Default value:**

- 0 if [CONFIG\\_COMPILER\\_CXX\\_EXCEPTIONS](#)

### CONFIG\_COMPILER\_CXX\_RTTI

Enable C++ run-time type info (RTTI)

*Found in:* [Compiler options](#)

Enabling this option compiles all C++ files with RTTI support enabled. This increases binary size (typically by tens of kB) but allows using `dynamic_cast` conversion and `typeid` operator.

**Default value:**

- No (disabled)

### CONFIG\_COMPILER\_STACK\_CHECK\_MODE

Stack smashing protection mode

*Found in:* [Compiler options](#)

Stack smashing protection mode. Emit extra code to check for buffer overflows, such as stack smashing attacks. This is done by adding a guard variable to functions with vulnerable objects. The guards are initialized when a function is entered and then checked when the function exits. If a guard check fails, program is halted. Protection has the following modes:

- In NORMAL mode (GCC flag: `-fstack-protector`) only functions that call `alloca`, and functions with buffers larger than 8 bytes are protected.

- STRONG mode (GCC flag: `-fstack-protector-strong`) is like NORMAL, but includes additional functions to be protected –those that have local array definitions, or have references to local frame addresses.
- In OVERALL mode (GCC flag: `-fstack-protector-all`) all functions are protected.

Modes have the following impact on code performance and coverage:

- performance: NORMAL > STRONG > OVERALL
- coverage: NORMAL < STRONG < OVERALL

The performance impact includes increasing the amount of stack memory required for each task.

**Available options:**

- None (COMPILER\_STACK\_CHECK\_MODE\_NONE)
- Normal (COMPILER\_STACK\_CHECK\_MODE\_NORM)
- Strong (COMPILER\_STACK\_CHECK\_MODE\_STRONG)
- Overall (COMPILER\_STACK\_CHECK\_MODE\_ALL)

### CONFIG\_COMPILER\_WARN\_WRITE\_STRINGS

Enable `-Wwrite-strings` warning flag

*Found in: [Compiler options](#)*

Adds `-Wwrite-strings` flag for the C/C++ compilers.

For C, this gives string constants the type `const char[]` so that copying the address of one into a non-const `char *` pointer produces a warning. This warning helps to find at compile time code that tries to write into a string constant.

For C++, this warns about the deprecated conversion from string literals to `char *`.

**Default value:**

- No (disabled)

### CONFIG\_COMPILER\_DUMP\_RTL\_FILES

Dump RTL files during compilation

*Found in: [Compiler options](#)*

If enabled, RTL files will be produced during compilation. These files can be used by other tools, for example to calculate call graphs.

### Component config

Contains:

- [ADC and ADC Calibration](#)
- [Application Level Tracing](#)
- [Bluetooth](#)
- [Common ESP-related](#)
- [Core dump](#)
- [Driver Configurations](#)
- [eFuse Bit Manager](#)
- [CONFIG\\_BLE\\_MESH](#)
- [ESP HTTP client](#)
- [ESP HTTPS OTA](#)
- [ESP HTTPS server](#)
- [ESP NETIF Adapter](#)
- [ESP PSRAM](#)
- [ESP Ringbuf](#)
- [ESP System Settings](#)

- *ESP-MQTT Configurations*
- *ESP-TLS*
- *Ethernet*
- *Event Loop Library*
- *FAT Filesystem support*
- *FreeRTOS*
- *GDB Stub*
- *Hardware Abstraction Layer (HAL) and Low Level (LL)*
- *Hardware Settings*
- *Heap memory debugging*
- *High resolution timer (esp\_timer)*
- *HTTP Server*
- *IPC (Inter-Processor Call)*
- *LCD and Touch Panel*
- *Log output*
- *LWIP*
- *Main Flash configuration*
- *mbedTLS*
- *Newlib*
- *NVS*
- *OpenThread*
- *PHY*
- *Power Management*
- *Protocomm*
- *PThreads*
- *SoC Settings*
- *SPI Flash driver*
- *SPIFFS Configuration*
- *Supplicant*
- *TCP Transport*
- *Ultra Low Power (ULP) Co-processor*
- *Unity unit testing library*
- *USB-OTG*
- *Virtual file system*
- *Wear Levelling*
- *Wi-Fi*
- *Wi-Fi Provisioning Manager*

**Application Level Tracing** Contains:

- *CONFIG\_APPTRACE\_DESTINATION1*
- *CONFIG\_APPTRACE\_DESTINATION2*
- *FreeRTOS System View Tracing*
- *CONFIG\_APPTRACE\_GCOV\_ENABLE*
- *CONFIG\_APPTRACE\_BUF\_SIZE*
- *CONFIG\_APPTRACE\_PENDING\_DATA\_SIZE\_MAX*
- *CONFIG\_APPTRACE\_POSTMORTEM\_FLUSH\_THRESH*
- *CONFIG\_APPTRACE\_ONPANIC\_HOST\_FLUSH\_TMO*
- *CONFIG\_APPTRACE\_UART\_BAUDRATE*
- *CONFIG\_APPTRACE\_UART\_RX\_GPIO*
- *CONFIG\_APPTRACE\_UART\_RX\_BUFF\_SIZE*
- *CONFIG\_APPTRACE\_UART\_TASK\_PRIO*
- *CONFIG\_APPTRACE\_UART\_TX\_MSG\_SIZE*
- *CONFIG\_APPTRACE\_UART\_TX\_GPIO*
- *CONFIG\_APPTRACE\_UART\_TX\_BUFF\_SIZE*

**CONFIG\_APPTRACE\_DESTINATION1**

Data Destination 1

*Found in: Component config > Application Level Tracing*

Select destination for application trace: JTAG or none (to disable).

**Available options:**

- JTAG (APPTRACE\_DEST\_JTAG)
- None (APPTRACE\_DEST\_NONE)

## **CONFIG\_APPTRACE\_DESTINATION2**

Data Destination 2

*Found in: Component config > Application Level Tracing*

Select destination for application trace: UART(XX) or none (to disable).

**Available options:**

- UART0 (APPTRACE\_DEST\_UART0)
- UART1 (APPTRACE\_DEST\_UART1)
- UART2 (APPTRACE\_DEST\_UART2)
- USB\_CDC (APPTRACE\_DEST\_USB\_CDC)
- None (APPTRACE\_DEST\_UART\_NONE)

## **CONFIG\_APPTRACE\_UART\_TX\_GPIO**

UART TX on GPIO#

*Found in: Component config > Application Level Tracing*

This GPIO is used for UART TX pin.

## **CONFIG\_APPTRACE\_UART\_RX\_GPIO**

UART RX on GPIO#

*Found in: Component config > Application Level Tracing*

This GPIO is used for UART RX pin.

## **CONFIG\_APPTRACE\_UART\_BAUDRATE**

UART baud rate

*Found in: Component config > Application Level Tracing*

This baud rate is used for UART.

The app's maximum baud rate depends on the UART clock source. If Power Management is disabled, the UART clock source is the APB clock and all baud rates in the available range will be sufficiently accurate. If Power Management is enabled, REF\_TICK clock source is used so the baud rate is divided from 1MHz. Baud rates above 1Mbps are not possible and values between 500Kbps and 1Mbps may not be accurate.

## **CONFIG\_APPTRACE\_UART\_RX\_BUFF\_SIZE**

UART RX ring buffer size

*Found in: Component config > Application Level Tracing*

Size of the UART input ring buffer. This size related to the baudrate, system tick frequency and amount of data to transfer. The data placed to this buffer before sent out to the interface.

**CONFIG\_APPTRACE\_UART\_TX\_BUFF\_SIZE**

UART TX ring buffer size

*Found in: [Component config](#) > [Application Level Tracing](#)*

Size of the UART output ring buffer. This size related to the baudrate, system tick frequency and amount of data to transfer.

**CONFIG\_APPTRACE\_UART\_TX\_MSG\_SIZE**

UART TX message size

*Found in: [Component config](#) > [Application Level Tracing](#)*

Maximum size of the single message to transfer.

**CONFIG\_APPTRACE\_UART\_TASK\_PRIO**

UART Task Priority

*Found in: [Component config](#) > [Application Level Tracing](#)*

UART task priority. In case of high events rate, this parameter could be changed up to (config-MAX\_PRIORITIES-1).

**Range:**

- from 1 to 32

**Default value:**

- 1

**CONFIG\_APPTRACE\_ONPANIC\_HOST\_FLUSH\_TMO**

Timeout for flushing last trace data to host on panic

*Found in: [Component config](#) > [Application Level Tracing](#)*

Timeout for flushing last trace data to host in case of panic. In ms. Use -1 to disable timeout and wait forever.

**CONFIG\_APPTRACE\_POSTMORTEM\_FLUSH\_THRESH**

Threshold for flushing last trace data to host on panic

*Found in: [Component config](#) > [Application Level Tracing](#)*

Threshold for flushing last trace data to host on panic in post-mortem mode. This is minimal amount of data needed to perform flush. In bytes.

**CONFIG\_APPTRACE\_BUF\_SIZE**

Size of the apptrace buffer

*Found in: [Component config](#) > [Application Level Tracing](#)*

Size of the memory buffer for trace data in bytes.

**CONFIG\_APPTRACE\_PENDING\_DATA\_SIZE\_MAX**

Size of the pending data buffer

*Found in: [Component config](#) > [Application Level Tracing](#)*

Size of the buffer for events in bytes. It is useful for buffering events from the time critical code (scheduler, ISRs etc). If this parameter is 0 then events will be discarded when main HW buffer is full.

**FreeRTOS SystemView Tracing** Contains:

- `CONFIG_APPTRACE_SV_CPU`
- `CONFIG_APPTRACE_SV_EVT_ISR_ENTER_ENABLE`
- `CONFIG_APPTRACE_SV_EVT_ISR_EXIT_ENABLE`
- `CONFIG_APPTRACE_SV_EVT_ISR_TO_SCHED_ENABLE`
- `CONFIG_APPTRACE_SV_MAX_TASKS`
- `CONFIG_APPTRACE_SV_EVT_IDLE_ENABLE`
- `CONFIG_APPTRACE_SV_ENABLE`
- `CONFIG_APPTRACE_SV_EVT_TASK_CREATE_ENABLE`
- `CONFIG_APPTRACE_SV_EVT_TASK_START_EXEC_ENABLE`
- `CONFIG_APPTRACE_SV_EVT_TASK_START_READY_ENABLE`
- `CONFIG_APPTRACE_SV_EVT_TASK_STOP_EXEC_ENABLE`
- `CONFIG_APPTRACE_SV_EVT_TASK_STOP_READY_ENABLE`
- `CONFIG_APPTRACE_SV_EVT_TASK_TERMINATE_ENABLE`
- `CONFIG_APPTRACE_SV_EVT_TIMER_ENTER_ENABLE`
- `CONFIG_APPTRACE_SV_EVT_TIMER_EXIT_ENABLE`
- `CONFIG_APPTRACE_SV_TS_SOURCE`
- `CONFIG_APPTRACE_SV_EVT_OVERFLOW_ENABLE`
- `CONFIG_APPTRACE_SV_BUF_WAIT_TMO`

**CONFIG\_APPTRACE\_SV\_ENABLE**

SystemView Tracing Enable

*Found in: Component config > Application Level Tracing > FreeRTOS SystemView Tracing*

Enables support for SEGGER SystemView tracing functionality.

**CONFIG\_APPTRACE\_SV\_DEST**

SystemView destination

*Found in: Component config > Application Level Tracing > FreeRTOS SystemView Tracing > CONFIG\_APPTRACE\_SV\_ENABLE*

SystemView will transfer data through defined interface.

**Available options:**

- Data destination JTAG (`APPTRACE_SV_DEST_JTAG`)  
Send SEGGER SystemView events through JTAG interface.
- Data destination UART (`APPTRACE_SV_DEST_UART`)  
Send SEGGER SystemView events through UART interface.

**CONFIG\_APPTRACE\_SV\_CPU**

CPU to trace

*Found in: Component config > Application Level Tracing > FreeRTOS SystemView Tracing*

Define the CPU to trace by SystemView.

**Available options:**

- CPU0 (`APPTRACE_SV_DEST_CPU_0`)  
Send SEGGER SystemView events for Pro CPU.
- CPU1 (`APPTRACE_SV_DEST_CPU_1`)  
Send SEGGER SystemView events for App CPU.

**CONFIG\_APPTRACE\_SV\_TS\_SOURCE**



Timer to use as timestamp source

*Found in: [Component config](#) > [Application Level Tracing](#) > [FreeRTOS SystemView Tracing](#)*

SystemView needs to use a hardware timer as the source of timestamps when tracing. This option selects the timer for it.

**Available options:**

- CPU cycle counter (CCOUNT) (APPTRACE\_SV\_TS\_SOURCE\_CCOUNT)
- General Purpose Timer (Timer Group) (APPTRACE\_SV\_TS\_SOURCE\_GPTIMER)
- esp\_timer high resolution timer (APPTRACE\_SV\_TS\_SOURCE\_ESP\_TIMER)

### **CONFIG\_APPTRACE\_SV\_MAX\_TASKS**

Maximum supported tasks

*Found in: [Component config](#) > [Application Level Tracing](#) > [FreeRTOS SystemView Tracing](#)*

Configures maximum supported tasks in sysview debug

### **CONFIG\_APPTRACE\_SV\_BUF\_WAIT\_TMO**

Trace buffer wait timeout

*Found in: [Component config](#) > [Application Level Tracing](#) > [FreeRTOS SystemView Tracing](#)*

Configures timeout (in us) to wait for free space in trace buffer. Set to -1 to wait forever and avoid lost events.

### **CONFIG\_APPTRACE\_SV\_EVT\_OVERFLOW\_ENABLE**

Trace Buffer Overflow Event

*Found in: [Component config](#) > [Application Level Tracing](#) > [FreeRTOS SystemView Tracing](#)*

Enables “Trace Buffer Overflow” event.

### **CONFIG\_APPTRACE\_SV\_EVT\_ISR\_ENTER\_ENABLE**

ISR Enter Event

*Found in: [Component config](#) > [Application Level Tracing](#) > [FreeRTOS SystemView Tracing](#)*

Enables “ISR Enter” event.

### **CONFIG\_APPTRACE\_SV\_EVT\_ISR\_EXIT\_ENABLE**

ISR Exit Event

*Found in: [Component config](#) > [Application Level Tracing](#) > [FreeRTOS SystemView Tracing](#)*

Enables “ISR Exit” event.

### **CONFIG\_APPTRACE\_SV\_EVT\_ISR\_TO\_SCHED\_ENABLE**

ISR Exit to Scheduler Event

*Found in: [Component config](#) > [Application Level Tracing](#) > [FreeRTOS SystemView Tracing](#)*

Enables “ISR to Scheduler” event.

### **CONFIG\_APPTRACE\_SV\_EVT\_TASK\_START\_EXEC\_ENABLE**

Task Start Execution Event

*Found in: [Component config](#) > [Application Level Tracing](#) > [FreeRTOS System View Tracing](#)*

Enables “Task Start Execution” event.

### **CONFIG\_APPTRACE\_SV\_EVT\_TASK\_STOP\_EXEC\_ENABLE**

Task Stop Execution Event

*Found in: [Component config](#) > [Application Level Tracing](#) > [FreeRTOS System View Tracing](#)*

Enables “Task Stop Execution” event.

### **CONFIG\_APPTRACE\_SV\_EVT\_TASK\_START\_READY\_ENABLE**

Task Start Ready State Event

*Found in: [Component config](#) > [Application Level Tracing](#) > [FreeRTOS System View Tracing](#)*

Enables “Task Start Ready State” event.

### **CONFIG\_APPTRACE\_SV\_EVT\_TASK\_STOP\_READY\_ENABLE**

Task Stop Ready State Event

*Found in: [Component config](#) > [Application Level Tracing](#) > [FreeRTOS System View Tracing](#)*

Enables “Task Stop Ready State” event.

### **CONFIG\_APPTRACE\_SV\_EVT\_TASK\_CREATE\_ENABLE**

Task Create Event

*Found in: [Component config](#) > [Application Level Tracing](#) > [FreeRTOS System View Tracing](#)*

Enables “Task Create” event.

### **CONFIG\_APPTRACE\_SV\_EVT\_TASK\_TERMINATE\_ENABLE**

Task Terminate Event

*Found in: [Component config](#) > [Application Level Tracing](#) > [FreeRTOS System View Tracing](#)*

Enables “Task Terminate” event.

### **CONFIG\_APPTRACE\_SV\_EVT\_IDLE\_ENABLE**

System Idle Event

*Found in: [Component config](#) > [Application Level Tracing](#) > [FreeRTOS System View Tracing](#)*

Enables “System Idle” event.

### **CONFIG\_APPTRACE\_SV\_EVT\_TIMER\_ENTER\_ENABLE**

Timer Enter Event

*Found in: [Component config](#) > [Application Level Tracing](#) > [FreeRTOS System View Tracing](#)*

Enables “Timer Enter” event.

### CONFIG\_APPTRACE\_SV\_EVT\_TIMER\_EXIT\_ENABLE

Timer Exit Event

*Found in: Component config > Application Level Tracing > FreeRTOS System View Tracing*

Enables “Timer Exit” event.

### CONFIG\_APPTRACE\_GCOV\_ENABLE

GCOV to Host Enable

*Found in: Component config > Application Level Tracing*

Enables support for GCOV data transfer to host.

### CONFIG\_APPTRACE\_GCOV\_DUMP\_TASK\_STACK\_SIZE

Gcov dump task stack size

*Found in: Component config > Application Level Tracing > CONFIG\_APPTRACE\_GCOV\_ENABLE*

Configures stack size of Gcov dump task

**Default value:**

- 2048 if *CONFIG\_APPTRACE\_GCOV\_ENABLE*

**Bluetooth** Contains:

- *Bluedroid Options*
- *CONFIG\_BT\_ENABLED*
- *Common Options*
- *Controller Options*
- *CONFIG\_BT\_HCI\_LOG\_DEBUG\_EN*
- *NimBLE Options*
- *CONFIG\_BT\_RELEASE\_IRAM*

### CONFIG\_BT\_ENABLED

Bluetooth

*Found in: Component config > Bluetooth*

Select this option to enable Bluetooth and show the submenu with Bluetooth configuration choices.

### CONFIG\_BT\_HOST

Host

*Found in: Component config > Bluetooth > CONFIG\_BT\_ENABLED*

This helps to choose Bluetooth host stack

**Available options:**

- **Bluedroid - Dual-mode (BT\_BLUEDROID\_ENABLED)**  
This option is recommended for classic Bluetooth or for dual-mode usecases
- **NimBLE - BLE only (BT\_NIMBLE\_ENABLED)**  
This option is recommended for BLE only usecases to save on memory
- **Disabled (BT\_CONTROLLER\_ONLY)**  
This option is recommended when you want to communicate directly with the controller (without any host) or when you are using any other host stack not supported by Espressif (not mentioned here).

## CONFIG\_BT\_CONTROLLER

Controller

*Found in: Component config > Bluetooth > CONFIG\_BT\_ENABLED*

This helps to choose Bluetooth controller stack

### Available options:

- Enabled (BT\_CONTROLLER\_ENABLED)  
This option is recommended for Bluetooth controller usecases
- Disabled (BT\_CONTROLLER\_DISABLED)  
This option is recommended for Bluetooth Host only usecases

### Bluedroid Options

 Contains:

- *CONFIG\_BT\_ABORT\_WHEN\_ALLOCATION\_FAILS*
- *CONFIG\_BT\_BLE\_HOST\_QUEUE\_CONG\_CHECK*
- *CONFIG\_BT\_BLUEDROID\_MEM\_DEBUG*
- *CONFIG\_BT\_BTU\_TASK\_STACK\_SIZE*
- *CONFIG\_BT\_BTC\_TASK\_STACK\_SIZE*
- *CONFIG\_BT\_BLE\_ENABLED*
- *BT\_DEBUG\_LOG\_LEVEL*
- *CONFIG\_BT\_ACL\_CONNECTIONS*
- *CONFIG\_BT\_SMP\_MAX\_BONDS*
- *CONFIG\_BT\_ALLOCATION\_FROM\_SPIRAM\_FIRST*
- *CONFIG\_BT\_STACK\_NO\_LOG*
- *CONFIG\_BT\_BLE\_42\_FEATURES\_SUPPORTED*
- *CONFIG\_BT\_BLE\_50\_FEATURES\_SUPPORTED*
- *CONFIG\_BT\_BLE\_HIGH\_DUTY\_ADV\_INTERVAL*
- *CONFIG\_BT\_MULTI\_CONNECTION\_ENBALE*
- *CONFIG\_BT\_BLE\_FEAT\_PERIODIC\_ADV\_SYNC\_TRANSFER*
- *CONFIG\_BT\_BLE\_FEAT\_CREATE\_SYNC\_ENH*
- *CONFIG\_BT\_BLE\_FEAT\_PERIODIC\_ADV\_ENH*
- *CONFIG\_BT\_MAX\_DEVICE\_NAME\_LEN*
- *CONFIG\_BT\_BLE\_ACT\_SCAN\_REP\_ADV\_SCAN*
- *CONFIG\_BT\_BLUEDROID\_PINNED\_TO\_CORE\_CHOICE*
- *CONFIG\_BT\_BLE\_ESTAB\_LINK\_CONN\_TOUT*
- *CONFIG\_BT\_BLE\_RPA\_TIMEOUT*
- *CONFIG\_BT\_BLE\_RPA\_SUPPORTED*
- *CONFIG\_BT\_BLE\_DYNAMIC\_ENV\_MEMORY*

## CONFIG\_BT\_BTC\_TASK\_STACK\_SIZE

Bluetooth event (callback to application) task stack size

*Found in: Component config > Bluetooth > Bluedroid Options*

This select btc task stack size

### Default value:

- 3072 if BT\_BLUEDROID\_ENABLED && BT\_BLUEDROID\_ENABLED

## CONFIG\_BT\_BLUEDROID\_PINNED\_TO\_CORE\_CHOICE

The cpu core which Bluedroid run

*Found in: Component config > Bluetooth > Bluedroid Options*

Which the cpu core to run Bluedroid. Can choose core0 and core1. Can not specify no-affinity.

### Available options:

- Core 0 (PRO CPU) (BT\_BLUEDROID\_PINNED\_TO\_CORE\_0)
- Core 1 (APP CPU) (BT\_BLUEDROID\_PINNED\_TO\_CORE\_1)

### CONFIG\_BT\_BTU\_TASK\_STACK\_SIZE

Bluetooth Bluedroid Host Stack task stack size

*Found in: Component config > Bluetooth > Bluedroid Options*

This select btu task stack size

**Default value:**

- 4352 if BT\_BLUEDROID\_ENABLED && BT\_BLUEDROID\_ENABLED

### CONFIG\_BT\_BLUEDROID\_MEM\_DEBUG

Bluedroid memory debug

*Found in: Component config > Bluetooth > Bluedroid Options*

Bluedroid memory debug

**Default value:**

- No (disabled) if BT\_BLUEDROID\_ENABLED && BT\_BLUEDROID\_ENABLED

### CONFIG\_BT\_BLE\_ENABLED

Bluetooth Low Energy

*Found in: Component config > Bluetooth > Bluedroid Options*

This enables Bluetooth Low Energy

**Default value:**

- Yes (enabled) if BT\_BLUEDROID\_ENABLED && BT\_BLUEDROID\_ENABLED

### CONFIG\_BT\_GATTS\_ENABLE

Include GATT server module(GATTS)

*Found in: Component config > Bluetooth > Bluedroid Options > CONFIG\_BT\_BLE\_ENABLED*

This option can be disabled when the app work only on gatt client mode

**Default value:**

- Yes (enabled) if *CONFIG\_BT\_BLE\_ENABLED* && BT\_BLUEDROID\_ENABLED

### CONFIG\_BT\_GATTS\_PPCP\_CHAR\_GAP

Enable Peripheral Preferred Connection Parameters characteristic in GAP service

*Found in: Component config > Bluetooth > Bluedroid Options > CONFIG\_BT\_BLE\_ENABLED > CONFIG\_BT\_GATTS\_ENABLE*

This enables “Peripheral Preferred Connection Parameters” characteristic (UUID: 0x2A04) in GAP service that has connection parameters like min/max connection interval, slave latency and supervision timeout multiplier

**Default value:**

- No (disabled) if *CONFIG\_BT\_GATTS\_ENABLE* && BT\_BLUEDROID\_ENABLED

### CONFIG\_BT\_BLE\_BLUFI\_ENABLE

Include blufi function

*Found in: Component config > Bluetooth > Bluedroid Options > CONFIG\_BT\_BLE\_ENABLED > CONFIG\_BT\_GATTS\_ENABLE*

This option can be close when the app does not require blufi function.

**Default value:**

- No (disabled) if `CONFIG_BT_GATTS_ENABLE` && `BT_BLUEDROID_ENABLED`

### CONFIG\_BT\_GATT\_MAX\_SR\_PROFILES

Max GATT Server Profiles

*Found in: Component config > Bluetooth > Bluedroid Options > CONFIG\_BT\_BLE\_ENABLED > CONFIG\_BT\_GATTS\_ENABLE*

Maximum GATT Server Profiles Count

**Range:**

- from 1 to 32 if `CONFIG_BT_GATTS_ENABLE` && `BT_BLUEDROID_ENABLED` && `BT_BLUEDROID_ENABLED`

**Default value:**

- 8 if `CONFIG_BT_GATTS_ENABLE` && `BT_BLUEDROID_ENABLED` && `BT_BLUEDROID_ENABLED`

### CONFIG\_BT\_GATT\_MAX\_SR\_ATTRIBUTES

Max GATT Service Attributes

*Found in: Component config > Bluetooth > Bluedroid Options > CONFIG\_BT\_BLE\_ENABLED > CONFIG\_BT\_GATTS\_ENABLE*

Maximum GATT Service Attributes Count

**Range:**

- from 1 to 500 if `CONFIG_BT_GATTS_ENABLE` && `BT_BLUEDROID_ENABLED` && `BT_BLUEDROID_ENABLED`

**Default value:**

- 100 if `CONFIG_BT_GATTS_ENABLE` && `BT_BLUEDROID_ENABLED` && `BT_BLUEDROID_ENABLED`

### CONFIG\_BT\_GATTS\_SEND\_SERVICE\_CHANGE\_MODE

GATTS Service Change Mode

*Found in: Component config > Bluetooth > Bluedroid Options > CONFIG\_BT\_BLE\_ENABLED > CONFIG\_BT\_GATTS\_ENABLE*

Service change indication mode for GATT Server.

**Available options:**

- GATTS manually send service change indication (`BT_GATTS_SEND_SERVICE_CHANGE_MANUAL`)  
Manually send service change indication through API `esp_ble_gatts_send_service_change_indication()`
- GATTS automatically send service change indication (`BT_GATTS_SEND_SERVICE_CHANGE_AUTO`)  
Let Bluedroid handle the service change indication internally

### CONFIG\_BT\_GATTS\_ROBUST\_CACHING\_ENABLED

Enable Robust Caching on Server Side

*Found in: Component config > Bluetooth > Bluedroid Options > CONFIG\_BT\_BLE\_ENABLED > CONFIG\_BT\_GATTS\_ENABLE*

This option enables the GATT robust caching feature on the server. If turned on, the Client Supported Features characteristic, Database Hash characteristic, and Server Supported Features characteristic will be included in the GAP SERVICE.

**Default value:**

- No (disabled) if *CONFIG\_BT\_GATTS\_ENABLE* && BT\_BLUEDROID\_ENABLED

### CONFIG\_BT\_GATTS\_DEVICE\_NAME\_WRITABLE

Allow to write device name by GATT clients

*Found in: Component config > Bluetooth > Bluedroid Options > CONFIG\_BT\_BLE\_ENABLED > CONFIG\_BT\_GATTS\_ENABLE*

Enabling this option allows remote GATT clients to write device name

**Default value:**

- No (disabled) if *CONFIG\_BT\_GATTS\_ENABLE* && BT\_BLUEDROID\_ENABLED

### CONFIG\_BT\_GATTS\_APPEARANCE\_WRITABLE

Allow to write appearance by GATT clients

*Found in: Component config > Bluetooth > Bluedroid Options > CONFIG\_BT\_BLE\_ENABLED > CONFIG\_BT\_GATTS\_ENABLE*

Enabling this option allows remote GATT clients to write appearance

**Default value:**

- No (disabled) if *CONFIG\_BT\_GATTS\_ENABLE* && BT\_BLUEDROID\_ENABLED

### CONFIG\_BT\_GATTC\_ENABLE

Include GATT client module(GATTC)

*Found in: Component config > Bluetooth > Bluedroid Options > CONFIG\_BT\_BLE\_ENABLED*

This option can be close when the app work only on gatt server mode

**Default value:**

- Yes (enabled) if *CONFIG\_BT\_BLE\_ENABLED* && BT\_BLUEDROID\_ENABLED

### CONFIG\_BT\_GATTC\_MAX\_CACHE\_CHAR

Max gattc cache characteristic for discover

*Found in: Component config > Bluetooth > Bluedroid Options > CONFIG\_BT\_BLE\_ENABLED > CONFIG\_BT\_GATTC\_ENABLE*

Maximum GATTC cache characteristic count

**Range:**

- from 1 to 500 if *CONFIG\_BT\_GATTC\_ENABLE* && BT\_BLUEDROID\_ENABLED

**Default value:**

- 40 if *CONFIG\_BT\_GATTC\_ENABLE* && BT\_BLUEDROID\_ENABLED

### CONFIG\_BT\_GATTC\_NOTIF\_REG\_MAX

Max gattc notify(indication) register number

*Found in: Component config > Bluetooth > Bluedroid Options > CONFIG\_BT\_BLE\_ENABLED > CONFIG\_BT\_GATTC\_ENABLE*

Maximum GATTC notify(indication) register number

**Range:**

- from 1 to 64 if *CONFIG\_BT\_GATTC\_ENABLE* && BT\_BLUEDROID\_ENABLED

**Default value:**

- 5 if *CONFIG\_BT\_GATTC\_ENABLE* && BT\_BLUEDROID\_ENABLED

### CONFIG\_BT\_GATTC\_CACHE\_NVS\_FLASH

Save gattc cache data to nvs flash

*Found in: Component config > Bluetooth > Bluedroid Options > CONFIG\_BT\_BLE\_ENABLED > CONFIG\_BT\_GATTC\_ENABLE*

This select can save gattc cache data to nvs flash

**Default value:**

- No (disabled) if *CONFIG\_BT\_GATTC\_ENABLE* && BT\_BLUEDROID\_ENABLED

### CONFIG\_BT\_GATTC\_CONNECT\_RETRY\_COUNT

The number of attempts to reconnect if the connection establishment failed

*Found in: Component config > Bluetooth > Bluedroid Options > CONFIG\_BT\_BLE\_ENABLED > CONFIG\_BT\_GATTC\_ENABLE*

The number of attempts to reconnect if the connection establishment failed

**Range:**

- from 0 to 255 if *CONFIG\_BT\_GATTC\_ENABLE* && BT\_BLUEDROID\_ENABLED

**Default value:**

- 3 if *CONFIG\_BT\_GATTC\_ENABLE* && BT\_BLUEDROID\_ENABLED

### CONFIG\_BT\_BLE\_SMP\_ENABLE

Include BLE security module(SMP)

*Found in: Component config > Bluetooth > Bluedroid Options > CONFIG\_BT\_BLE\_ENABLED*

This option can be close when the app not used the ble security connect.

**Default value:**

- Yes (enabled) if *CONFIG\_BT\_BLE\_ENABLED* && BT\_BLUEDROID\_ENABLED

### CONFIG\_BT\_SMP\_SLAVE\_CON\_PARAMS\_UPD\_ENABLE

Slave enable connection parameters update during pairing

*Found in: Component config > Bluetooth > Bluedroid Options > CONFIG\_BT\_BLE\_ENABLED > CONFIG\_BT\_BLE\_SMP\_ENABLE*

In order to reduce the pairing time, slave actively initiates connection parameters update during pairing.

**Default value:**

- No (disabled) if *CONFIG\_BT\_BLE\_SMP\_ENABLE* && BT\_BLUEDROID\_ENABLED



### CONFIG\_BT\_BLE\_SMP\_ID\_RESET\_ENABLE

Reset device identity when all bonding records are deleted

*Found in: Component config > Bluetooth > Bluedroid Options > CONFIG\_BT\_BLE\_ENABLED > CONFIG\_BT\_BLE\_SMP\_ENABLE*

There are tracking risks associated with using a fixed or static IRK. If enabled this option, Bluedroid will assign a new randomly-generated IRK when all pairing and bonding records are deleted. This would decrease the ability of a previously paired peer to be used to determine whether a device with which it previously shared an IRK is within range.

**Default value:**

- No (disabled) if *CONFIG\_BT\_BLE\_SMP\_ENABLE* && BT\_BLUEDROID\_ENABLED

### CONFIG\_BT\_STACK\_NO\_LOG

Disable BT debug logs (minimize bin size)

*Found in: Component config > Bluetooth > Bluedroid Options*

This select can save the rodata code size

**Default value:**

- No (disabled) if BT\_BLUEDROID\_ENABLED && BT\_BLUEDROID\_ENABLED

### BT DEBUG LOG LEVEL

 Contains:

- *CONFIG\_BT\_LOG\_A2D\_TRACE\_LEVEL*
- *CONFIG\_BT\_LOG\_APPL\_TRACE\_LEVEL*
- *CONFIG\_BT\_LOG\_AVCT\_TRACE\_LEVEL*
- *CONFIG\_BT\_LOG\_AVDT\_TRACE\_LEVEL*
- *CONFIG\_BT\_LOG\_AVRC\_TRACE\_LEVEL*
- *CONFIG\_BT\_LOG\_BLUFI\_TRACE\_LEVEL*
- *CONFIG\_BT\_LOG\_BNEP\_TRACE\_LEVEL*
- *CONFIG\_BT\_LOG\_BTC\_TRACE\_LEVEL*
- *CONFIG\_BT\_LOG\_BTIF\_TRACE\_LEVEL*
- *CONFIG\_BT\_LOG\_BTM\_TRACE\_LEVEL*
- *CONFIG\_BT\_LOG\_GAP\_TRACE\_LEVEL*
- *CONFIG\_BT\_LOG\_GATT\_TRACE\_LEVEL*
- *CONFIG\_BT\_LOG\_HCI\_TRACE\_LEVEL*
- *CONFIG\_BT\_LOG\_HID\_TRACE\_LEVEL*
- *CONFIG\_BT\_LOG\_L2CAP\_TRACE\_LEVEL*
- *CONFIG\_BT\_LOG\_MCA\_TRACE\_LEVEL*
- *CONFIG\_BT\_LOG\_OSI\_TRACE\_LEVEL*
- *CONFIG\_BT\_LOG\_PAN\_TRACE\_LEVEL*
- *CONFIG\_BT\_LOG\_RFCOMM\_TRACE\_LEVEL*
- *CONFIG\_BT\_LOG\_SDP\_TRACE\_LEVEL*
- *CONFIG\_BT\_LOG\_SMP\_TRACE\_LEVEL*

### CONFIG\_BT\_LOG\_HCI\_TRACE\_LEVEL

HCI layer

*Found in: Component config > Bluetooth > Bluedroid Options > BT\_DEBUG\_LOG\_LEVEL*

Define BT trace level for HCI layer

**Available options:**

- NONE (BT\_LOG\_HCI\_TRACE\_LEVEL\_NONE)
- ERROR (BT\_LOG\_HCI\_TRACE\_LEVEL\_ERROR)
- WARNING (BT\_LOG\_HCI\_TRACE\_LEVEL\_WARNING)

- API (BT\_LOG\_HCI\_TRACE\_LEVEL\_API)
- EVENT (BT\_LOG\_HCI\_TRACE\_LEVEL\_EVENT)
- DEBUG (BT\_LOG\_HCI\_TRACE\_LEVEL\_DEBUG)
- VERBOSE (BT\_LOG\_HCI\_TRACE\_LEVEL\_VERBOSE)

### CONFIG\_BT\_LOG\_BTM\_TRACE\_LEVEL

BTM layer

*Found in: [Component config](#) > [Bluetooth](#) > [Bluedroid Options](#) > [BT DEBUG LOG LEVEL](#)*

Define BT trace level for BTM layer

**Available options:**

- NONE (BT\_LOG\_BTM\_TRACE\_LEVEL\_NONE)
- ERROR (BT\_LOG\_BTM\_TRACE\_LEVEL\_ERROR)
- WARNING (BT\_LOG\_BTM\_TRACE\_LEVEL\_WARNING)
- API (BT\_LOG\_BTM\_TRACE\_LEVEL\_API)
- EVENT (BT\_LOG\_BTM\_TRACE\_LEVEL\_EVENT)
- DEBUG (BT\_LOG\_BTM\_TRACE\_LEVEL\_DEBUG)
- VERBOSE (BT\_LOG\_BTM\_TRACE\_LEVEL\_VERBOSE)

### CONFIG\_BT\_LOG\_L2CAP\_TRACE\_LEVEL

L2CAP layer

*Found in: [Component config](#) > [Bluetooth](#) > [Bluedroid Options](#) > [BT DEBUG LOG LEVEL](#)*

Define BT trace level for L2CAP layer

**Available options:**

- NONE (BT\_LOG\_L2CAP\_TRACE\_LEVEL\_NONE)
- ERROR (BT\_LOG\_L2CAP\_TRACE\_LEVEL\_ERROR)
- WARNING (BT\_LOG\_L2CAP\_TRACE\_LEVEL\_WARNING)
- API (BT\_LOG\_L2CAP\_TRACE\_LEVEL\_API)
- EVENT (BT\_LOG\_L2CAP\_TRACE\_LEVEL\_EVENT)
- DEBUG (BT\_LOG\_L2CAP\_TRACE\_LEVEL\_DEBUG)
- VERBOSE (BT\_LOG\_L2CAP\_TRACE\_LEVEL\_VERBOSE)

### CONFIG\_BT\_LOG\_RFCOMM\_TRACE\_LEVEL

RFCOMM layer

*Found in: [Component config](#) > [Bluetooth](#) > [Bluedroid Options](#) > [BT DEBUG LOG LEVEL](#)*

Define BT trace level for RFCOMM layer

**Available options:**

- NONE (BT\_LOG\_RFCOMM\_TRACE\_LEVEL\_NONE)
- ERROR (BT\_LOG\_RFCOMM\_TRACE\_LEVEL\_ERROR)
- WARNING (BT\_LOG\_RFCOMM\_TRACE\_LEVEL\_WARNING)
- API (BT\_LOG\_RFCOMM\_TRACE\_LEVEL\_API)
- EVENT (BT\_LOG\_RFCOMM\_TRACE\_LEVEL\_EVENT)
- DEBUG (BT\_LOG\_RFCOMM\_TRACE\_LEVEL\_DEBUG)
- VERBOSE (BT\_LOG\_RFCOMM\_TRACE\_LEVEL\_VERBOSE)

### CONFIG\_BT\_LOG\_SDP\_TRACE\_LEVEL

SDP layer

*Found in: [Component config](#) > [Bluetooth](#) > [Bluedroid Options](#) > [BT DEBUG LOG LEVEL](#)*

Define BT trace level for SDP layer

**Available options:**

- NONE (BT\_LOG\_SDP\_TRACE\_LEVEL\_NONE)
- ERROR (BT\_LOG\_SDP\_TRACE\_LEVEL\_ERROR)
- WARNING (BT\_LOG\_SDP\_TRACE\_LEVEL\_WARNING)
- API (BT\_LOG\_SDP\_TRACE\_LEVEL\_API)
- EVENT (BT\_LOG\_SDP\_TRACE\_LEVEL\_EVENT)
- DEBUG (BT\_LOG\_SDP\_TRACE\_LEVEL\_DEBUG)
- VERBOSE (BT\_LOG\_SDP\_TRACE\_LEVEL\_VERBOSE)

**CONFIG\_BT\_LOG\_GAP\_TRACE\_LEVEL**

GAP layer

*Found in: [Component config](#) > [Bluetooth](#) > [Bluedroid Options](#) > [BT DEBUG LOG LEVEL](#)*

Define BT trace level for GAP layer

**Available options:**

- NONE (BT\_LOG\_GAP\_TRACE\_LEVEL\_NONE)
- ERROR (BT\_LOG\_GAP\_TRACE\_LEVEL\_ERROR)
- WARNING (BT\_LOG\_GAP\_TRACE\_LEVEL\_WARNING)
- API (BT\_LOG\_GAP\_TRACE\_LEVEL\_API)
- EVENT (BT\_LOG\_GAP\_TRACE\_LEVEL\_EVENT)
- DEBUG (BT\_LOG\_GAP\_TRACE\_LEVEL\_DEBUG)
- VERBOSE (BT\_LOG\_GAP\_TRACE\_LEVEL\_VERBOSE)

**CONFIG\_BT\_LOG\_BNEP\_TRACE\_LEVEL**

BNEP layer

*Found in: [Component config](#) > [Bluetooth](#) > [Bluedroid Options](#) > [BT DEBUG LOG LEVEL](#)*

Define BT trace level for BNEP layer

**Available options:**

- NONE (BT\_LOG\_BNEP\_TRACE\_LEVEL\_NONE)
- ERROR (BT\_LOG\_BNEP\_TRACE\_LEVEL\_ERROR)
- WARNING (BT\_LOG\_BNEP\_TRACE\_LEVEL\_WARNING)
- API (BT\_LOG\_BNEP\_TRACE\_LEVEL\_API)
- EVENT (BT\_LOG\_BNEP\_TRACE\_LEVEL\_EVENT)
- DEBUG (BT\_LOG\_BNEP\_TRACE\_LEVEL\_DEBUG)
- VERBOSE (BT\_LOG\_BNEP\_TRACE\_LEVEL\_VERBOSE)

**CONFIG\_BT\_LOG\_PAN\_TRACE\_LEVEL**

PAN layer

*Found in: [Component config](#) > [Bluetooth](#) > [Bluedroid Options](#) > [BT DEBUG LOG LEVEL](#)*

Define BT trace level for PAN layer

**Available options:**

- NONE (BT\_LOG\_PAN\_TRACE\_LEVEL\_NONE)
- ERROR (BT\_LOG\_PAN\_TRACE\_LEVEL\_ERROR)
- WARNING (BT\_LOG\_PAN\_TRACE\_LEVEL\_WARNING)
- API (BT\_LOG\_PAN\_TRACE\_LEVEL\_API)
- EVENT (BT\_LOG\_PAN\_TRACE\_LEVEL\_EVENT)
- DEBUG (BT\_LOG\_PAN\_TRACE\_LEVEL\_DEBUG)
- VERBOSE (BT\_LOG\_PAN\_TRACE\_LEVEL\_VERBOSE)

### CONFIG\_BT\_LOG\_A2D\_TRACE\_LEVEL

A2D layer

*Found in: [Component config](#) > [Bluetooth](#) > [Bluedroid Options](#) > [BT DEBUG LOG LEVEL](#)*

Define BT trace level for A2D layer

**Available options:**

- NONE (BT\_LOG\_A2D\_TRACE\_LEVEL\_NONE)
- ERROR (BT\_LOG\_A2D\_TRACE\_LEVEL\_ERROR)
- WARNING (BT\_LOG\_A2D\_TRACE\_LEVEL\_WARNING)
- API (BT\_LOG\_A2D\_TRACE\_LEVEL\_API)
- EVENT (BT\_LOG\_A2D\_TRACE\_LEVEL\_EVENT)
- DEBUG (BT\_LOG\_A2D\_TRACE\_LEVEL\_DEBUG)
- VERBOSE (BT\_LOG\_A2D\_TRACE\_LEVEL\_VERBOSE)

### CONFIG\_BT\_LOG\_AVDT\_TRACE\_LEVEL

AVDT layer

*Found in: [Component config](#) > [Bluetooth](#) > [Bluedroid Options](#) > [BT DEBUG LOG LEVEL](#)*

Define BT trace level for AVDT layer

**Available options:**

- NONE (BT\_LOG\_AVDT\_TRACE\_LEVEL\_NONE)
- ERROR (BT\_LOG\_AVDT\_TRACE\_LEVEL\_ERROR)
- WARNING (BT\_LOG\_AVDT\_TRACE\_LEVEL\_WARNING)
- API (BT\_LOG\_AVDT\_TRACE\_LEVEL\_API)
- EVENT (BT\_LOG\_AVDT\_TRACE\_LEVEL\_EVENT)
- DEBUG (BT\_LOG\_AVDT\_TRACE\_LEVEL\_DEBUG)
- VERBOSE (BT\_LOG\_AVDT\_TRACE\_LEVEL\_VERBOSE)

### CONFIG\_BT\_LOG\_AVCT\_TRACE\_LEVEL

AVCT layer

*Found in: [Component config](#) > [Bluetooth](#) > [Bluedroid Options](#) > [BT DEBUG LOG LEVEL](#)*

Define BT trace level for AVCT layer

**Available options:**

- NONE (BT\_LOG\_AVCT\_TRACE\_LEVEL\_NONE)
- ERROR (BT\_LOG\_AVCT\_TRACE\_LEVEL\_ERROR)
- WARNING (BT\_LOG\_AVCT\_TRACE\_LEVEL\_WARNING)
- API (BT\_LOG\_AVCT\_TRACE\_LEVEL\_API)
- EVENT (BT\_LOG\_AVCT\_TRACE\_LEVEL\_EVENT)
- DEBUG (BT\_LOG\_AVCT\_TRACE\_LEVEL\_DEBUG)
- VERBOSE (BT\_LOG\_AVCT\_TRACE\_LEVEL\_VERBOSE)

### CONFIG\_BT\_LOG\_AVRC\_TRACE\_LEVEL

AVRC layer

*Found in: [Component config](#) > [Bluetooth](#) > [Bluedroid Options](#) > [BT DEBUG LOG LEVEL](#)*

Define BT trace level for AVRC layer

**Available options:**

- NONE (BT\_LOG\_AVRC\_TRACE\_LEVEL\_NONE)
- ERROR (BT\_LOG\_AVRC\_TRACE\_LEVEL\_ERROR)
- WARNING (BT\_LOG\_AVRC\_TRACE\_LEVEL\_WARNING)
- API (BT\_LOG\_AVRC\_TRACE\_LEVEL\_API)

- EVENT (BT\_LOG\_AVRC\_TRACE\_LEVEL\_EVENT)
- DEBUG (BT\_LOG\_AVRC\_TRACE\_LEVEL\_DEBUG)
- VERBOSE (BT\_LOG\_AVRC\_TRACE\_LEVEL\_VERBOSE)

### CONFIG\_BT\_LOG\_MCA\_TRACE\_LEVEL

MCA layer

*Found in: [Component config](#) > [Bluetooth](#) > [Bluedroid Options](#) > [BT DEBUG LOG LEVEL](#)*

Define BT trace level for MCA layer

**Available options:**

- NONE (BT\_LOG\_MCA\_TRACE\_LEVEL\_NONE)
- ERROR (BT\_LOG\_MCA\_TRACE\_LEVEL\_ERROR)
- WARNING (BT\_LOG\_MCA\_TRACE\_LEVEL\_WARNING)
- API (BT\_LOG\_MCA\_TRACE\_LEVEL\_API)
- EVENT (BT\_LOG\_MCA\_TRACE\_LEVEL\_EVENT)
- DEBUG (BT\_LOG\_MCA\_TRACE\_LEVEL\_DEBUG)
- VERBOSE (BT\_LOG\_MCA\_TRACE\_LEVEL\_VERBOSE)

### CONFIG\_BT\_LOG\_HID\_TRACE\_LEVEL

HID layer

*Found in: [Component config](#) > [Bluetooth](#) > [Bluedroid Options](#) > [BT DEBUG LOG LEVEL](#)*

Define BT trace level for HID layer

**Available options:**

- NONE (BT\_LOG\_HID\_TRACE\_LEVEL\_NONE)
- ERROR (BT\_LOG\_HID\_TRACE\_LEVEL\_ERROR)
- WARNING (BT\_LOG\_HID\_TRACE\_LEVEL\_WARNING)
- API (BT\_LOG\_HID\_TRACE\_LEVEL\_API)
- EVENT (BT\_LOG\_HID\_TRACE\_LEVEL\_EVENT)
- DEBUG (BT\_LOG\_HID\_TRACE\_LEVEL\_DEBUG)
- VERBOSE (BT\_LOG\_HID\_TRACE\_LEVEL\_VERBOSE)

### CONFIG\_BT\_LOG\_APPL\_TRACE\_LEVEL

APPL layer

*Found in: [Component config](#) > [Bluetooth](#) > [Bluedroid Options](#) > [BT DEBUG LOG LEVEL](#)*

Define BT trace level for APPL layer

**Available options:**

- NONE (BT\_LOG\_APPL\_TRACE\_LEVEL\_NONE)
- ERROR (BT\_LOG\_APPL\_TRACE\_LEVEL\_ERROR)
- WARNING (BT\_LOG\_APPL\_TRACE\_LEVEL\_WARNING)
- API (BT\_LOG\_APPL\_TRACE\_LEVEL\_API)
- EVENT (BT\_LOG\_APPL\_TRACE\_LEVEL\_EVENT)
- DEBUG (BT\_LOG\_APPL\_TRACE\_LEVEL\_DEBUG)
- VERBOSE (BT\_LOG\_APPL\_TRACE\_LEVEL\_VERBOSE)

### CONFIG\_BT\_LOG\_GATT\_TRACE\_LEVEL

GATT layer

*Found in: [Component config](#) > [Bluetooth](#) > [Bluedroid Options](#) > [BT DEBUG LOG LEVEL](#)*

Define BT trace level for GATT layer

**Available options:**

- NONE (BT\_LOG\_GATT\_TRACE\_LEVEL\_NONE)
- ERROR (BT\_LOG\_GATT\_TRACE\_LEVEL\_ERROR)
- WARNING (BT\_LOG\_GATT\_TRACE\_LEVEL\_WARNING)
- API (BT\_LOG\_GATT\_TRACE\_LEVEL\_API)
- EVENT (BT\_LOG\_GATT\_TRACE\_LEVEL\_EVENT)
- DEBUG (BT\_LOG\_GATT\_TRACE\_LEVEL\_DEBUG)
- VERBOSE (BT\_LOG\_GATT\_TRACE\_LEVEL\_VERBOSE)

**CONFIG\_BT\_LOG\_SMP\_TRACE\_LEVEL**

SMP layer

*Found in: [Component config](#) > [Bluetooth](#) > [Bluedroid Options](#) > [BT DEBUG LOG LEVEL](#)*

Define BT trace level for SMP layer

**Available options:**

- NONE (BT\_LOG\_SMP\_TRACE\_LEVEL\_NONE)
- ERROR (BT\_LOG\_SMP\_TRACE\_LEVEL\_ERROR)
- WARNING (BT\_LOG\_SMP\_TRACE\_LEVEL\_WARNING)
- API (BT\_LOG\_SMP\_TRACE\_LEVEL\_API)
- EVENT (BT\_LOG\_SMP\_TRACE\_LEVEL\_EVENT)
- DEBUG (BT\_LOG\_SMP\_TRACE\_LEVEL\_DEBUG)
- VERBOSE (BT\_LOG\_SMP\_TRACE\_LEVEL\_VERBOSE)

**CONFIG\_BT\_LOG\_BTIF\_TRACE\_LEVEL**

BTIF layer

*Found in: [Component config](#) > [Bluetooth](#) > [Bluedroid Options](#) > [BT DEBUG LOG LEVEL](#)*

Define BT trace level for BTIF layer

**Available options:**

- NONE (BT\_LOG\_BTIF\_TRACE\_LEVEL\_NONE)
- ERROR (BT\_LOG\_BTIF\_TRACE\_LEVEL\_ERROR)
- WARNING (BT\_LOG\_BTIF\_TRACE\_LEVEL\_WARNING)
- API (BT\_LOG\_BTIF\_TRACE\_LEVEL\_API)
- EVENT (BT\_LOG\_BTIF\_TRACE\_LEVEL\_EVENT)
- DEBUG (BT\_LOG\_BTIF\_TRACE\_LEVEL\_DEBUG)
- VERBOSE (BT\_LOG\_BTIF\_TRACE\_LEVEL\_VERBOSE)

**CONFIG\_BT\_LOG\_BTC\_TRACE\_LEVEL**

BTC layer

*Found in: [Component config](#) > [Bluetooth](#) > [Bluedroid Options](#) > [BT DEBUG LOG LEVEL](#)*

Define BT trace level for BTC layer

**Available options:**

- NONE (BT\_LOG\_BTC\_TRACE\_LEVEL\_NONE)
- ERROR (BT\_LOG\_BTC\_TRACE\_LEVEL\_ERROR)
- WARNING (BT\_LOG\_BTC\_TRACE\_LEVEL\_WARNING)
- API (BT\_LOG\_BTC\_TRACE\_LEVEL\_API)
- EVENT (BT\_LOG\_BTC\_TRACE\_LEVEL\_EVENT)
- DEBUG (BT\_LOG\_BTC\_TRACE\_LEVEL\_DEBUG)
- VERBOSE (BT\_LOG\_BTC\_TRACE\_LEVEL\_VERBOSE)

### CONFIG\_BT\_LOG\_OSI\_TRACE\_LEVEL

OSI layer

*Found in: Component config > Bluetooth > Blueroid Options > BT DEBUG LOG LEVEL*

Define BT trace level for OSI layer

**Available options:**

- NONE (BT\_LOG\_OSI\_TRACE\_LEVEL\_NONE)
- ERROR (BT\_LOG\_OSI\_TRACE\_LEVEL\_ERROR)
- WARNING (BT\_LOG\_OSI\_TRACE\_LEVEL\_WARNING)
- API (BT\_LOG\_OSI\_TRACE\_LEVEL\_API)
- EVENT (BT\_LOG\_OSI\_TRACE\_LEVEL\_EVENT)
- DEBUG (BT\_LOG\_OSI\_TRACE\_LEVEL\_DEBUG)
- VERBOSE (BT\_LOG\_OSI\_TRACE\_LEVEL\_VERBOSE)

### CONFIG\_BT\_LOG\_BLUFI\_TRACE\_LEVEL

BLUFI layer

*Found in: Component config > Bluetooth > Blueroid Options > BT DEBUG LOG LEVEL*

Define BT trace level for BLUFI layer

**Available options:**

- NONE (BT\_LOG\_BLUFI\_TRACE\_LEVEL\_NONE)
- ERROR (BT\_LOG\_BLUFI\_TRACE\_LEVEL\_ERROR)
- WARNING (BT\_LOG\_BLUFI\_TRACE\_LEVEL\_WARNING)
- API (BT\_LOG\_BLUFI\_TRACE\_LEVEL\_API)
- EVENT (BT\_LOG\_BLUFI\_TRACE\_LEVEL\_EVENT)
- DEBUG (BT\_LOG\_BLUFI\_TRACE\_LEVEL\_DEBUG)
- VERBOSE (BT\_LOG\_BLUFI\_TRACE\_LEVEL\_VERBOSE)

### CONFIG\_BT\_ACL\_CONNECTIONS

BT/BLE MAX ACL CONNECTIONS(1~9)

*Found in: Component config > Bluetooth > Blueroid Options*

Maximum BT/BLE connection count. The ESP32-C3/S3 chip supports a maximum of 10 instances, including ADV, SCAN and connections. The ESP32-C3/S3 chip can connect up to 9 devices if ADV or SCAN uses only one. If ADV and SCAN are both used, The ESP32-C3/S3 chip is connected to a maximum of 8 devices. Because Bluetooth cannot reclaim used instances once ADV or SCAN is used.

**Range:**

- from 1 to 9 if BT\_BLUEDROID\_ENABLED && BT\_BLUEDROID\_ENABLED

**Default value:**

- 4 if BT\_BLUEDROID\_ENABLED && BT\_BLUEDROID\_ENABLED

### CONFIG\_BT\_MULTI\_CONNECTION\_ENBALE

Enable BLE multi-conections

*Found in: Component config > Bluetooth > Blueroid Options*

Enable this option if there are multiple connections

**Default value:**

- Yes (enabled) if *CONFIG\_BT\_BLE\_ENABLED* && BT\_BLUEDROID\_ENABLED

### CONFIG\_BT\_ALLOCATION\_FROM\_SPIRAM\_FIRST

BT/BLE will first malloc the memory from the PSRAM

*Found in: [Component config](#) > [Bluetooth](#) > [Bluedroid Options](#)*

This select can save the internal RAM if there have the PSRAM

**Default value:**

- No (disabled) if BT\_BLUEDROID\_ENABLED && BT\_BLUEDROID\_ENABLED

### CONFIG\_BT\_BLE\_DYNAMIC\_ENV\_MEMORY

Use dynamic memory allocation in BT/BLE stack

*Found in: [Component config](#) > [Bluetooth](#) > [Bluedroid Options](#)*

This select can make the allocation of memory will become more flexible

**Default value:**

- No (disabled) if BT\_BLUEDROID\_ENABLED && BT\_BLUEDROID\_ENABLED

### CONFIG\_BT\_BLE\_HOST\_QUEUE\_CONG\_CHECK

BLE queue congestion check

*Found in: [Component config](#) > [Bluetooth](#) > [Bluedroid Options](#)*

When scanning and scan duplicate is not enabled, if there are a lot of adv packets around or application layer handling adv packets is slow, it will cause the controller memory to run out. if enabled, adv packets will be lost when host queue is congested.

**Default value:**

- No (disabled) if [CONFIG\\_BT\\_BLE\\_ENABLED](#) && BT\_BLUEDROID\_ENABLED

### CONFIG\_BT\_SMP\_MAX BONDS

BT/BLE maximum bond device count

*Found in: [Component config](#) > [Bluetooth](#) > [Bluedroid Options](#)*

The number of security records for peer devices.

### CONFIG\_BT\_BLE\_ACT\_SCAN\_REP\_ADV\_SCAN

Report adv data and scan response individually when BLE active scan

*Found in: [Component config](#) > [Bluetooth](#) > [Bluedroid Options](#)*

Originally, when doing BLE active scan, Bluedroid will not report adv to application layer until receive scan response. This option is used to disable the behavior. When enable this option, Bluedroid will report adv data or scan response to application layer immediately.

# Memory reserved at start of DRAM for Bluetooth stack

**Default value:**

- No (disabled) if BT\_BLUEDROID\_ENABLED && [CONFIG\\_BT\\_BLE\\_ENABLED](#) && BT\_BLUEDROID\_ENABLED



### CONFIG\_BT\_BLE\_ESTAB\_LINK\_CONN\_TOUT

Timeout of BLE connection establishment

*Found in: [Component config](#) > [Bluetooth](#) > [Bluedroid Options](#)*

Bluetooth Connection establishment maximum time, if connection time exceeds this value, the connection establishment fails, ESP\_GATTC\_OPEN\_EVT or ESP\_GATTS\_OPEN\_EVT is triggered.

**Range:**

- from 1 to 60 if [CONFIG\\_BT\\_BLE\\_ENABLED](#) && BT\_BLUEDROID\_ENABLED

**Default value:**

- 30 if [CONFIG\\_BT\\_BLE\\_ENABLED](#) && BT\_BLUEDROID\_ENABLED

### CONFIG\_BT\_MAX\_DEVICE\_NAME\_LEN

length of bluetooth device name

*Found in: [Component config](#) > [Bluetooth](#) > [Bluedroid Options](#)*

Bluetooth Device name length shall be no larger than 248 octets, If the broadcast data cannot contain the complete device name, then only the shortname will be displayed, the rest parts that can't fit in will be truncated.

**Range:**

- from 32 to 248 if BT\_BLUEDROID\_ENABLED && BT\_BLUEDROID\_ENABLED

**Default value:**

- 32 if BT\_BLUEDROID\_ENABLED && BT\_BLUEDROID\_ENABLED

### CONFIG\_BT\_BLE\_RPA\_SUPPORTED

Update RPA to Controller

*Found in: [Component config](#) > [Bluetooth](#) > [Bluedroid Options](#)*

This enables controller RPA list function. For ESP32, ESP32 only support network privacy mode. If this option is enabled, ESP32 will only accept advertising packets from peer devices that contain private address, HW will not receive the advertising packets contain identity address after IRK changed. If this option is disabled, address resolution will be performed in the host, so the functions that require controller to resolve address in the white list cannot be used. This option is disabled by default on ESP32, please enable or disable this option according to your own needs.

For other BLE chips, devices support network privacy mode and device privacy mode, users can switch the two modes according to their own needs. So this option is enabled by default.

**Default value:**

- No (disabled) if BT\_BLUEDROID\_ENABLED && SOC\_BLE\_DEVICE\_PRIVACY\_SUPPORTED && BT\_BLUEDROID\_ENABLED

### CONFIG\_BT\_BLE\_RPA\_TIMEOUT

Timeout of resolvable private address

*Found in: [Component config](#) > [Bluetooth](#) > [Bluedroid Options](#)*

This set RPA timeout of Controller and Host. Default is 900 s (15 minutes). Range is 1 s to 1 hour (3600 s).

**Range:**

- from 1 to 3600 if [CONFIG\\_BT\\_BLE\\_ENABLED](#) && BT\_BLUEDROID\_ENABLED

**Default value:**

- 900 if [CONFIG\\_BT\\_BLE\\_ENABLED](#) && BT\_BLUEDROID\_ENABLED

### CONFIG\_BT\_BLE\_50\_FEATURES\_SUPPORTED

Enable BLE 5.0 features

*Found in: [Component config](#) > [Bluetooth](#) > [Bluedroid Options](#)*

Enabling this option activates BLE 5.0 features. This option is universally supported in chips that support BLE, except for ESP32.

**Default value:**

- Yes (enabled) if `CONFIG_BT_BLE_ENABLED` && `SOC_ESP_NIMBLE_CONTROLLER` && `BT_BLUEDROID_ENABLED`

### CONFIG\_BT\_BLE\_42\_FEATURES\_SUPPORTED

Enable BLE 4.2 features

*Found in: [Component config](#) > [Bluetooth](#) > [Bluedroid Options](#)*

This enables BLE 4.2 features.

**Default value:**

- No (disabled) if `CONFIG_BT_BLE_ENABLED` && `SOC_ESP_NIMBLE_CONTROLLER` && `BT_BLUEDROID_ENABLED`

### CONFIG\_BT\_BLE\_FEAT\_PERIODIC\_ADV\_SYNC\_TRANSFER

Enable BLE periodic advertising sync transfer feature

*Found in: [Component config](#) > [Bluetooth](#) > [Bluedroid Options](#)*

This enables BLE periodic advertising sync transfer feature

**Default value:**

- No (disabled) if `CONFIG_BT_BLE_50_FEATURES_SUPPORTED` && `SOC_ESP_NIMBLE_CONTROLLER` && `BT_BLUEDROID_ENABLED`

### CONFIG\_BT\_BLE\_FEAT\_PERIODIC\_ADV\_ENH

Enable periodic adv enhancements(adi support)

*Found in: [Component config](#) > [Bluetooth](#) > [Bluedroid Options](#)*

Enable the periodic advertising enhancements

**Default value:**

- No (disabled) if `CONFIG_BT_BLE_50_FEATURES_SUPPORTED` && `SOC_ESP_NIMBLE_CONTROLLER` && `BT_BLUEDROID_ENABLED`

### CONFIG\_BT\_BLE\_FEAT\_CREATE\_SYNC\_ENH

Enable create sync enhancements(reporting disable and duplicate filtering enable support)

*Found in: [Component config](#) > [Bluetooth](#) > [Bluedroid Options](#)*

Enable the create sync enhancements

**Default value:**

- No (disabled) if `CONFIG_BT_BLE_50_FEATURES_SUPPORTED` && `SOC_ESP_NIMBLE_CONTROLLER` && `BT_BLUEDROID_ENABLED`

### CONFIG\_BT\_BLE\_HIGH\_DUTY\_ADV\_INTERVAL

Enable BLE high duty advertising interval feature

*Found in: Component config > Bluetooth > Blueroid Options*

This enable BLE high duty advertising interval feature

**Default value:**

- No (disabled) if `CONFIG_BT_BLE_ENABLED` && `BT_BLUEDROID_ENABLED`

### CONFIG\_BT\_ABORT\_WHEN\_ALLOCATION\_FAILS

Abort when memory allocation fails in BT/BLE stack

*Found in: Component config > Bluetooth > Blueroid Options*

This enables abort when memory allocation fails

**Default value:**

- No (disabled) if `BT_BLUEDROID_ENABLED` && `BT_BLUEDROID_ENABLED`

### NimBLE Options

 Contains:

- `CONFIG_BT_NIMBLE_SVC_GAP_DEVICE_NAME`
- `CONFIG_BT_NIMBLE_HS_STOP_TIMEOUT_MS`
- `CONFIG_BT_NIMBLE_HOST_QUEUE_CONG_CHECK`
- `CONFIG_BT_NIMBLE_WHITELIST_SIZE`
- `CONFIG_BT_NIMBLE_BLE_GATT_BLOB_TRANSFER`
- `CONFIG_BT_NIMBLE_50_FEATURE_SUPPORT`
- `CONFIG_BT_NIMBLE_ROLE_BROADCASTER`
- `CONFIG_BT_NIMBLE_ROLE_CENTRAL`
- `CONFIG_BT_NIMBLE_HIGH_DUTY_ADV_ITVL`
- `CONFIG_BT_NIMBLE_MESH`
- `CONFIG_BT_NIMBLE_ROLE_OBSERVER`
- `CONFIG_BT_NIMBLE_ROLE_PERIPHERAL`
- `CONFIG_BT_NIMBLE_SECURITY_ENABLE`
- `CONFIG_BT_NIMBLE_BLUFI_ENABLE`
- `CONFIG_BT_NIMBLE_ENABLE_CONN_REATTEMPT`
- `CONFIG_BT_NIMBLE_USE_ESP_TIMER`
- `CONFIG_BT_NIMBLE_DEBUG`
- `CONFIG_BT_NIMBLE_HS_FLOW_CTRL`
- `CONFIG_BT_NIMBLE_VS_SUPPORT`
- `CONFIG_BT_NIMBLE_ENC_ADV_DATA`
- `CONFIG_BT_NIMBLE_SVC_GAP_APPEARANCE`
- `CONFIG_BT_NIMBLE_GAP_DEVICE_NAME_MAX_LEN`
- `CONFIG_BT_NIMBLE_MAX_BONDS`
- `CONFIG_BT_NIMBLE_MAX_CCCDS`
- `CONFIG_BT_NIMBLE_MAX_CONNECTIONS`
- `CONFIG_BT_NIMBLE_L2CAP_COC_MAX_NUM`
- `CONFIG_BT_NIMBLE_GATT_MAX_PROCS`
- `CONFIG_BT_NIMBLE_MEM_ALLOC_MODE`
- *Memory Settings*
- `CONFIG_BT_NIMBLE_LOG_LEVEL`
- `CONFIG_BT_NIMBLE_HOST_TASK_STACK_SIZE`
- `CONFIG_BT_NIMBLE_CRYPTO_STACK_MBEDTLS`
- `CONFIG_BT_NIMBLE_NVS_PERSIST`
- `CONFIG_BT_NIMBLE_ATT_PREFERRED_MTU`
- `CONFIG_BT_NIMBLE_SMP_ID_RESET`
- `CONFIG_BT_NIMBLE_RPA_TIMEOUT`
- `CONFIG_BT_NIMBLE_PINNED_TO_CORE_CHOICE`

- [CONFIG\\_BT\\_NIMBLE\\_TEST\\_THROUGHPUT\\_TEST](#)

## CONFIG\_BT\_NIMBLE\_MEM\_ALLOC\_MODE

Memory allocation strategy

*Found in: [Component config](#) > [Bluetooth](#) > [NimBLE Options](#)*

Allocation strategy for NimBLE host stack, essentially provides ability to allocate all required dynamic allocations from,

- Internal DRAM memory only
- External SPIRAM memory only
- Either internal or external memory based on default malloc() behavior in ESP-IDF
- Internal IRAM memory wherever applicable else internal DRAM

### Available options:

- Internal memory (BT\_NIMBLE\_MEM\_ALLOC\_MODE\_INTERNAL)
- External SPIRAM (BT\_NIMBLE\_MEM\_ALLOC\_MODE\_EXTERNAL)
- Default alloc mode (BT\_NIMBLE\_MEM\_ALLOC\_MODE\_DEFAULT)
- Internal IRAM (BT\_NIMBLE\_MEM\_ALLOC\_MODE\_IRAM\_8BIT)  
Allows to use IRAM memory region as 8bit accessible region.  
Every unaligned (8bit or 16bit) access will result in an exception and incur penalty of certain clock cycles per unaligned read/write.

## CONFIG\_BT\_NIMBLE\_LOG\_LEVEL

NimBLE Host log verbosity

*Found in: [Component config](#) > [Bluetooth](#) > [NimBLE Options](#)*

Select NimBLE log level. Please make a note that the selected NimBLE log verbosity can not exceed the level set in “Component config → Log output → Default log verbosity” .

### Available options:

- No logs (BT\_NIMBLE\_LOG\_LEVEL\_NONE)
- Error logs (BT\_NIMBLE\_LOG\_LEVEL\_ERROR)
- Warning logs (BT\_NIMBLE\_LOG\_LEVEL\_WARNING)
- Info logs (BT\_NIMBLE\_LOG\_LEVEL\_INFO)
- Debug logs (BT\_NIMBLE\_LOG\_LEVEL\_DEBUG)

## CONFIG\_BT\_NIMBLE\_MAX\_CONNECTIONS

Maximum number of concurrent connections

*Found in: [Component config](#) > [Bluetooth](#) > [NimBLE Options](#)*

Defines maximum number of concurrent BLE connections. For ESP32, user is expected to configure BTDM\_CTRL\_BLE\_MAX\_CONN from controller menu along with this option. Similarly for ESP32-C3 or ESP32-S3, user is expected to configure BT\_CTRL\_BLE\_MAX\_ACT from controller menu. For ESP32C2, ESP32C6 and ESP32H2, each connection will take about 1k DRAM.

### Range:

- from 1 to 9 if SOC\_ESP\_NIMBLE\_CONTROLLER && BT\_NIMBLE\_ENABLED && BT\_NIMBLE\_ENABLED

## CONFIG\_BT\_NIMBLE\_MAX BONDS

Maximum number of bonds to save across reboots

*Found in: [Component config](#) > [Bluetooth](#) > [NimBLE Options](#)*

Defines maximum number of bonds to save for peer security and our security

**Default value:**

- 3 if BT\_NIMBLE\_ENABLED && BT\_NIMBLE\_ENABLED

**CONFIG\_BT\_NIMBLE\_MAX\_CCCDS**

Maximum number of CCC descriptors to save across reboots

*Found in: [Component config](#) > [Bluetooth](#) > [NimBLE Options](#)*

Defines maximum number of CCC descriptors to save

**Default value:**

- 8 if BT\_NIMBLE\_ENABLED && BT\_NIMBLE\_ENABLED

**CONFIG\_BT\_NIMBLE\_L2CAP\_COC\_MAX\_NUM**

Maximum number of connection oriented channels

*Found in: [Component config](#) > [Bluetooth](#) > [NimBLE Options](#)*

Defines maximum number of BLE Connection Oriented Channels. When set to (0), BLE COC is not compiled in

**Range:**

- from 0 to 9 if BT\_NIMBLE\_ENABLED && BT\_NIMBLE\_ENABLED

**Default value:**

- 0 if BT\_NIMBLE\_ENABLED && BT\_NIMBLE\_ENABLED

**CONFIG\_BT\_NIMBLE\_PINNED\_TO\_CORE\_CHOICE**

The CPU core on which NimBLE host will run

*Found in: [Component config](#) > [Bluetooth](#) > [NimBLE Options](#)*

The CPU core on which NimBLE host will run. You can choose Core 0 or Core 1. Cannot specify no-affinity

**Available options:**

- Core 0 (PRO CPU) (BT\_NIMBLE\_PINNED\_TO\_CORE\_0)
- Core 1 (APP CPU) (BT\_NIMBLE\_PINNED\_TO\_CORE\_1)

**CONFIG\_BT\_NIMBLE\_HOST\_TASK\_STACK\_SIZE**

NimBLE Host task stack size

*Found in: [Component config](#) > [Bluetooth](#) > [NimBLE Options](#)*

This configures stack size of NimBLE host task

**Default value:**

- 5120 if `CONFIG_BLE_MESH` && BT\_NIMBLE\_ENABLED && BT\_NIMBLE\_ENABLED
- 4096 if BT\_NIMBLE\_ENABLED && BT\_NIMBLE\_ENABLED

**CONFIG\_BT\_NIMBLE\_ROLE\_CENTRAL**

Enable BLE Central role

*Found in: [Component config](#) > [Bluetooth](#) > [NimBLE Options](#)*

Enables central role

**Default value:**

- Yes (enabled) if BT\_NIMBLE\_ENABLED && BT\_NIMBLE\_ENABLED

### CONFIG\_BT\_NIMBLE\_ROLE\_PERIPHERAL

Enable BLE Peripheral role

*Found in: [Component config](#) > [Bluetooth](#) > [NimBLE Options](#)*

Enable peripheral role

**Default value:**

- Yes (enabled) if BT\_NIMBLE\_ENABLED && BT\_NIMBLE\_ENABLED

### CONFIG\_BT\_NIMBLE\_ROLE\_BROADCASTER

Enable BLE Broadcaster role

*Found in: [Component config](#) > [Bluetooth](#) > [NimBLE Options](#)*

Enables broadcaster role

**Default value:**

- Yes (enabled) if BT\_NIMBLE\_ENABLED && BT\_NIMBLE\_ENABLED

### CONFIG\_BT\_NIMBLE\_ROLE\_OBSERVER

Enable BLE Observer role

*Found in: [Component config](#) > [Bluetooth](#) > [NimBLE Options](#)*

Enables observer role

**Default value:**

- Yes (enabled) if BT\_NIMBLE\_ENABLED && BT\_NIMBLE\_ENABLED

### CONFIG\_BT\_NIMBLE\_NVS\_PERSIST

Persist the BLE Bonding keys in NVS

*Found in: [Component config](#) > [Bluetooth](#) > [NimBLE Options](#)*

Enable this flag to make bonding persistent across device reboots

**Default value:**

- No (disabled) if BT\_NIMBLE\_ENABLED && BT\_NIMBLE\_ENABLED

### CONFIG\_BT\_NIMBLE\_SMP\_ID\_RESET

Reset device identity when all bonding records are deleted

*Found in: [Component config](#) > [Bluetooth](#) > [NimBLE Options](#)*

There are tracking risks associated with using a fixed or static IRK. If enabled this option, Bluedroid will assign a new randomly-generated IRK when all pairing and bonding records are deleted. This would decrease the ability of a previously paired peer to be used to determine whether a device with which it previously shared an IRK is within range.

**Default value:**

- No (disabled) if BT\_NIMBLE\_ENABLED

### CONFIG\_BT\_NIMBLE\_SECURITY\_ENABLE

Enable BLE SM feature

*Found in: [Component config](#) > [Bluetooth](#) > [NimBLE Options](#)*

Enable BLE sm feature

**Default value:**

- Yes (enabled) if BT\_NIMBLE\_ENABLED && BT\_NIMBLE\_ENABLED

Contains:

- [CONFIG\\_BT\\_NIMBLE\\_LL\\_CFG\\_FEAT\\_LE\\_ENCRYPTION](#)
- [CONFIG\\_BT\\_NIMBLE\\_SM\\_LEGACY](#)
- [CONFIG\\_BT\\_NIMBLE\\_SM\\_SC](#)

### CONFIG\_BT\_NIMBLE\_SM\_LEGACY

Security manager legacy pairing

*Found in:* [Component config](#) > [Bluetooth](#) > [NimBLE Options](#) > [CONFIG\\_BT\\_NIMBLE\\_SECURITY\\_ENABLE](#)

Enable security manager legacy pairing

**Default value:**

- Yes (enabled) if [CONFIG\\_BT\\_NIMBLE\\_SECURITY\\_ENABLE](#) && BT\_NIMBLE\_ENABLED

### CONFIG\_BT\_NIMBLE\_SM\_SC

Security manager secure connections (4.2)

*Found in:* [Component config](#) > [Bluetooth](#) > [NimBLE Options](#) > [CONFIG\\_BT\\_NIMBLE\\_SECURITY\\_ENABLE](#)

Enable security manager secure connections

**Default value:**

- Yes (enabled) if [CONFIG\\_BT\\_NIMBLE\\_SECURITY\\_ENABLE](#) && BT\_NIMBLE\_ENABLED

### CONFIG\_BT\_NIMBLE\_SM\_SC\_DEBUG\_KEYS

Use predefined public-private key pair

*Found in:* [Component config](#) > [Bluetooth](#) > [NimBLE Options](#) > [CONFIG\\_BT\\_NIMBLE\\_SECURITY\\_ENABLE](#) > [CONFIG\\_BT\\_NIMBLE\\_SM\\_SC](#)

If this option is enabled, SM uses predefined DH key pair as described in Core Specification, Vol. 3, Part H, 2.3.5.6.1. This allows to decrypt air traffic easily and thus should only be used for debugging.

**Default value:**

- No (disabled) if [CONFIG\\_BT\\_NIMBLE\\_SECURITY\\_ENABLE](#) && [CONFIG\\_BT\\_NIMBLE\\_SM\\_SC](#) && BT\_NIMBLE\_ENABLED

### CONFIG\_BT\_NIMBLE\_LL\_CFG\_FEAT\_LE\_ENCRYPTION

Enable LE encryption

*Found in:* [Component config](#) > [Bluetooth](#) > [NimBLE Options](#) > [CONFIG\\_BT\\_NIMBLE\\_SECURITY\\_ENABLE](#)

Enable encryption connection

**Default value:**

- Yes (enabled) if [CONFIG\\_BT\\_NIMBLE\\_SECURITY\\_ENABLE](#) && BT\_NIMBLE\_ENABLED && BT\_NIMBLE\_ENABLED

### CONFIG\_BT\_NIMBLE\_DEBUG

Enable extra runtime asserts and host debugging

*Found in: [Component config](#) > [Bluetooth](#) > [NimBLE Options](#)*

This enables extra runtime asserts and host debugging

**Default value:**

- No (disabled) if BT\_NIMBLE\_ENABLED && BT\_NIMBLE\_ENABLED

### CONFIG\_BT\_NIMBLE\_SVC\_GAP\_DEVICE\_NAME

BLE GAP default device name

*Found in: [Component config](#) > [Bluetooth](#) > [NimBLE Options](#)*

The Device Name characteristic shall contain the name of the device as an UTF-8 string. This name can be changed by using API `ble_svc_gap_device_name_set()`

**Default value:**

- “nimble” if BT\_NIMBLE\_ENABLED && BT\_NIMBLE\_ENABLED

### CONFIG\_BT\_NIMBLE\_GAP\_DEVICE\_NAME\_MAX\_LEN

Maximum length of BLE device name in octets

*Found in: [Component config](#) > [Bluetooth](#) > [NimBLE Options](#)*

Device Name characteristic value shall be 0 to 248 octets in length

**Default value:**

- 31 if BT\_NIMBLE\_ENABLED && BT\_NIMBLE\_ENABLED

### CONFIG\_BT\_NIMBLE\_ATT\_PREFERRED\_MTU

Preferred MTU size in octets

*Found in: [Component config](#) > [Bluetooth](#) > [NimBLE Options](#)*

This is the default value of ATT MTU indicated by the device during an ATT MTU exchange. This value can be changed using API `ble_att_set_preferred_mtu()`

**Default value:**

- 256 if BT\_NIMBLE\_ENABLED && BT\_NIMBLE\_ENABLED

### CONFIG\_BT\_NIMBLE\_SVC\_GAP\_APPEARANCE

External appearance of the device

*Found in: [Component config](#) > [Bluetooth](#) > [NimBLE Options](#)*

Standard BLE GAP Appearance value in HEX format e.g. 0x02C0

**Default value:**

- 0 if BT\_NIMBLE\_ENABLED && BT\_NIMBLE\_ENABLED

**Memory Settings** Contains:

- [CONFIG\\_BT\\_NIMBLE\\_ACL\\_BUF\\_COUNT](#)
- [CONFIG\\_BT\\_NIMBLE\\_ACL\\_BUF\\_SIZE](#)
- [CONFIG\\_BT\\_NIMBLE\\_HCI\\_EVT\\_BUF\\_SIZE](#)
- [CONFIG\\_BT\\_NIMBLE\\_HCI\\_EVT\\_HI\\_BUF\\_COUNT](#)
- [CONFIG\\_BT\\_NIMBLE\\_HCI\\_EVT\\_LO\\_BUF\\_COUNT](#)
- [CONFIG\\_BT\\_NIMBLE\\_MSYS\\_1\\_BLOCK\\_COUNT](#)



- [CONFIG\\_BT\\_NIMBLE\\_MSYS\\_1\\_BLOCK\\_SIZE](#)
- [CONFIG\\_BT\\_NIMBLE\\_MSYS\\_2\\_BLOCK\\_COUNT](#)
- [CONFIG\\_BT\\_NIMBLE\\_MSYS\\_2\\_BLOCK\\_SIZE](#)

### CONFIG\_BT\_NIMBLE\_MSYS\_1\_BLOCK\_COUNT

MSYS\_1 Block Count

*Found in: [Component config](#) > [Bluetooth](#) > [NimBLE Options](#) > [Memory Settings](#)*

MSYS is a system level mbuf registry. For prepare write & prepare responses Mbufs are allocated out of msys\_1 pool. For NIMBLE\_MESH enabled cases, this block count is increased by 8 than user defined count.

**Default value:**

- 24 if SOC\_ESP\_NIMBLE\_CONTROLLER && BT\_NIMBLE\_ENABLED
- 12 if SOC\_ESP\_NIMBLE\_CONTROLLER && BT\_NIMBLE\_ENABLED

### CONFIG\_BT\_NIMBLE\_MSYS\_1\_BLOCK\_SIZE

MSYS\_1 Block Size

*Found in: [Component config](#) > [Bluetooth](#) > [NimBLE Options](#) > [Memory Settings](#)*

Dynamic memory size of block 1

**Default value:**

- 128 if SOC\_ESP\_NIMBLE\_CONTROLLER && BT\_NIMBLE\_ENABLED
- 256 if SOC\_ESP\_NIMBLE\_CONTROLLER && BT\_NIMBLE\_ENABLED

### CONFIG\_BT\_NIMBLE\_MSYS\_2\_BLOCK\_COUNT

MSYS\_2 Block Count

*Found in: [Component config](#) > [Bluetooth](#) > [NimBLE Options](#) > [Memory Settings](#)*

Dynamic memory count

**Default value:**

- 24 if BT\_NIMBLE\_ENABLED

### CONFIG\_BT\_NIMBLE\_MSYS\_2\_BLOCK\_SIZE

MSYS\_2 Block Size

*Found in: [Component config](#) > [Bluetooth](#) > [NimBLE Options](#) > [Memory Settings](#)*

Dynamic memory size of block 2

**Default value:**

- 320 if BT\_NIMBLE\_ENABLED

### CONFIG\_BT\_NIMBLE\_ACL\_BUF\_COUNT

ACL Buffer count

*Found in: [Component config](#) > [Bluetooth](#) > [NimBLE Options](#) > [Memory Settings](#)*

The number of ACL data buffers.

**Default value:**

- 24 if BT\_NIMBLE\_ENABLED && BT\_NIMBLE\_ENABLED

### CONFIG\_BT\_NIMBLE\_ACL\_BUF\_SIZE

ACL Buffer size

*Found in: [Component config](#) > [Bluetooth](#) > [NimBLE Options](#) > [Memory Settings](#)*

This is the maximum size of the data portion of HCI ACL data packets. It does not include the HCI data header (of 4 bytes)

**Default value:**

- 255 if BT\_NIMBLE\_ENABLED && BT\_NIMBLE\_ENABLED

### CONFIG\_BT\_NIMBLE\_HCI\_EVT\_BUF\_SIZE

HCI Event Buffer size

*Found in: [Component config](#) > [Bluetooth](#) > [NimBLE Options](#) > [Memory Settings](#)*

This is the size of each HCI event buffer in bytes. In case of extended advertising, packets can be fragmented. 257 bytes is the maximum size of a packet.

**Default value:**

- 257 if [CONFIG\\_BT\\_NIMBLE\\_EXT\\_ADV](#) && BT\_NIMBLE\_ENABLED && BT\_NIMBLE\_ENABLED
- 70 if BT\_NIMBLE\_ENABLED && BT\_NIMBLE\_ENABLED

### CONFIG\_BT\_NIMBLE\_HCI\_EVT\_HI\_BUF\_COUNT

High Priority HCI Event Buffer count

*Found in: [Component config](#) > [Bluetooth](#) > [NimBLE Options](#) > [Memory Settings](#)*

This is the high priority HCI events' buffer size. High-priority event buffers are for everything except advertising reports. If there are no free high-priority event buffers then host will try to allocate a low-priority buffer instead

**Default value:**

- 30 if BT\_NIMBLE\_ENABLED && BT\_NIMBLE\_ENABLED

### CONFIG\_BT\_NIMBLE\_HCI\_EVT\_LO\_BUF\_COUNT

Low Priority HCI Event Buffer count

*Found in: [Component config](#) > [Bluetooth](#) > [NimBLE Options](#) > [Memory Settings](#)*

This is the low priority HCI events' buffer size. Low-priority event buffers are only used for advertising reports. If there are no free low-priority event buffers, then an incoming advertising report will get dropped

**Default value:**

- 8 if BT\_NIMBLE\_ENABLED && BT\_NIMBLE\_ENABLED

### CONFIG\_BT\_NIMBLE\_GATT\_MAX\_PROCS

Maximum number of GATT client procedures

*Found in: [Component config](#) > [Bluetooth](#) > [NimBLE Options](#)*

Maximum number of GATT client procedures that can be executed.

**Default value:**

- 4 if BT\_NIMBLE\_ENABLED && BT\_NIMBLE\_ENABLED

### CONFIG\_BT\_NIMBLE\_HS\_FLOW\_CTRL

Enable Host Flow control

*Found in: [Component config](#) > [Bluetooth](#) > [NimBLE Options](#)*

Enable Host Flow control

**Default value:**

- No (disabled) if `BT_NIMBLE_ENABLED` && `BT_NIMBLE_ENABLED`

### CONFIG\_BT\_NIMBLE\_HS\_FLOW\_CTRL\_ITVL

Host Flow control interval

*Found in: [Component config](#) > [Bluetooth](#) > [NimBLE Options](#) > [CONFIG\\_BT\\_NIMBLE\\_HS\\_FLOW\\_CTRL](#)*

Host flow control interval in msec

**Default value:**

- 1000 if `CONFIG_BT_NIMBLE_HS_FLOW_CTRL` && `BT_NIMBLE_ENABLED`

### CONFIG\_BT\_NIMBLE\_HS\_FLOW\_CTRL\_THRESH

Host Flow control threshold

*Found in: [Component config](#) > [Bluetooth](#) > [NimBLE Options](#) > [CONFIG\\_BT\\_NIMBLE\\_HS\\_FLOW\\_CTRL](#)*

Host flow control threshold, if the number of free buffers are at or below this threshold, send an immediate number-of-completed-packets event

**Default value:**

- 2 if `CONFIG_BT_NIMBLE_HS_FLOW_CTRL` && `BT_NIMBLE_ENABLED`

### CONFIG\_BT\_NIMBLE\_HS\_FLOW\_CTRL\_TX\_ON\_DISCONNECT

Host Flow control on disconnect

*Found in: [Component config](#) > [Bluetooth](#) > [NimBLE Options](#) > [CONFIG\\_BT\\_NIMBLE\\_HS\\_FLOW\\_CTRL](#)*

Enable this option to send number-of-completed-packets event to controller after disconnection

**Default value:**

- Yes (enabled) if `CONFIG_BT_NIMBLE_HS_FLOW_CTRL` && `BT_NIMBLE_ENABLED`

### CONFIG\_BT\_NIMBLE\_RPA\_TIMEOUT

RPA timeout in seconds

*Found in: [Component config](#) > [Bluetooth](#) > [NimBLE Options](#)*

Time interval between RPA address change.

**Range:**

- from 1 to 41400 if `BT_NIMBLE_ENABLED` && `BT_NIMBLE_ENABLED`

**Default value:**

- 900 if `BT_NIMBLE_ENABLED` && `BT_NIMBLE_ENABLED`

### CONFIG\_BT\_NIMBLE\_MESH

Enable BLE mesh functionality

*Found in: [Component config](#) > [Bluetooth](#) > [NimBLE Options](#)*

Enable BLE Mesh example present in upstream mynewt-nimble and not maintained by Espressif.

IDF maintains ESP-BLE-MESH as the official Mesh solution. Please refer to ESP-BLE-MESH guide at: `./doc/./esp32/api-guides/esp-ble-mesh/ble-mesh-index`

**Default value:**

- No (disabled) if `BT_NIMBLE_ENABLED` && `BT_NIMBLE_ENABLED`

Contains:

- [CONFIG\\_BT\\_NIMBLE\\_MESH\\_PROVISIONER](#)
- [CONFIG\\_BT\\_NIMBLE\\_MESH\\_PROV](#)
- [CONFIG\\_BT\\_NIMBLE\\_MESH\\_GATT\\_PROXY](#)
- [CONFIG\\_BT\\_NIMBLE\\_MESH\\_FRIEND](#)
- [CONFIG\\_BT\\_NIMBLE\\_MESH\\_LOW\\_POWER](#)
- [CONFIG\\_BT\\_NIMBLE\\_MESH\\_PROXY](#)
- [CONFIG\\_BT\\_NIMBLE\\_MESH\\_RELAY](#)
- [CONFIG\\_BT\\_NIMBLE\\_MESH\\_DEVICE\\_NAME](#)
- [CONFIG\\_BT\\_NIMBLE\\_MESH\\_NODE\\_COUNT](#)

### CONFIG\_BT\_NIMBLE\_MESH\_PROXY

Enable mesh proxy functionality

*Found in:* [Component config](#) > [Bluetooth](#) > [NimBLE Options](#) > [CONFIG\\_BT\\_NIMBLE\\_MESH](#)

Enable proxy. This is automatically set whenever `NIMBLE_MESH_PB_GATT` or `NIMBLE_MESH_GATT_PROXY` is set

**Default value:**

- No (disabled) if [CONFIG\\_BT\\_NIMBLE\\_MESH](#) && `BT_NIMBLE_ENABLED`

### CONFIG\_BT\_NIMBLE\_MESH\_PROV

Enable BLE mesh provisioning

*Found in:* [Component config](#) > [Bluetooth](#) > [NimBLE Options](#) > [CONFIG\\_BT\\_NIMBLE\\_MESH](#)

Enable mesh provisioning

**Default value:**

- Yes (enabled) if [CONFIG\\_BT\\_NIMBLE\\_MESH](#) && `BT_NIMBLE_ENABLED`

### CONFIG\_BT\_NIMBLE\_MESH\_PB\_ADV

Enable mesh provisioning over advertising bearer

*Found in:* [Component config](#) > [Bluetooth](#) > [NimBLE Options](#) > [CONFIG\\_BT\\_NIMBLE\\_MESH](#) > [CONFIG\\_BT\\_NIMBLE\\_MESH\\_PROV](#)

Enable this option to allow the device to be provisioned over the advertising bearer

**Default value:**

- Yes (enabled) if [CONFIG\\_BT\\_NIMBLE\\_MESH\\_PROV](#) && `BT_NIMBLE_ENABLED`

### CONFIG\_BT\_NIMBLE\_MESH\_PB\_GATT

Enable mesh provisioning over GATT bearer

*Found in:* [Component config](#) > [Bluetooth](#) > [NimBLE Options](#) > [CONFIG\\_BT\\_NIMBLE\\_MESH](#) > [CONFIG\\_BT\\_NIMBLE\\_MESH\\_PROV](#)

Enable this option to allow the device to be provisioned over the GATT bearer

**Default value:**

- Yes (enabled) if [CONFIG\\_BT\\_NIMBLE\\_MESH\\_PROV](#) && `BT_NIMBLE_ENABLED`

### CONFIG\_BT\_NIMBLE\_MESH\_GATT\_PROXY

Enable GATT Proxy functionality

*Found in: [Component config](#) > [Bluetooth](#) > [NimBLE Options](#) > [CONFIG\\_BT\\_NIMBLE\\_MESH](#)*

This option enables support for the Mesh GATT Proxy Service, i.e. the ability to act as a proxy between a Mesh GATT Client and a Mesh network

**Default value:**

- Yes (enabled) if [CONFIG\\_BT\\_NIMBLE\\_MESH](#) && BT\_NIMBLE\_ENABLED

### CONFIG\_BT\_NIMBLE\_MESH\_RELAY

Enable mesh relay functionality

*Found in: [Component config](#) > [Bluetooth](#) > [NimBLE Options](#) > [CONFIG\\_BT\\_NIMBLE\\_MESH](#)*

Support for acting as a Mesh Relay Node

**Default value:**

- No (disabled) if [CONFIG\\_BT\\_NIMBLE\\_MESH](#) && BT\_NIMBLE\_ENABLED

### CONFIG\_BT\_NIMBLE\_MESH\_LOW\_POWER

Enable mesh low power mode

*Found in: [Component config](#) > [Bluetooth](#) > [NimBLE Options](#) > [CONFIG\\_BT\\_NIMBLE\\_MESH](#)*

Enable this option to be able to act as a Low Power Node

**Default value:**

- No (disabled) if [CONFIG\\_BT\\_NIMBLE\\_MESH](#) && BT\_NIMBLE\_ENABLED

### CONFIG\_BT\_NIMBLE\_MESH\_FRIEND

Enable mesh friend functionality

*Found in: [Component config](#) > [Bluetooth](#) > [NimBLE Options](#) > [CONFIG\\_BT\\_NIMBLE\\_MESH](#)*

Enable this option to be able to act as a Friend Node

**Default value:**

- No (disabled) if [CONFIG\\_BT\\_NIMBLE\\_MESH](#) && BT\_NIMBLE\_ENABLED

### CONFIG\_BT\_NIMBLE\_MESH\_DEVICE\_NAME

Set mesh device name

*Found in: [Component config](#) > [Bluetooth](#) > [NimBLE Options](#) > [CONFIG\\_BT\\_NIMBLE\\_MESH](#)*

This value defines Bluetooth Mesh device/node name

**Default value:**

- “nimble-mesh-node” if [CONFIG\\_BT\\_NIMBLE\\_MESH](#) && BT\_NIMBLE\_ENABLED

### CONFIG\_BT\_NIMBLE\_MESH\_NODE\_COUNT

Set mesh node count

*Found in: [Component config](#) > [Bluetooth](#) > [NimBLE Options](#) > [CONFIG\\_BT\\_NIMBLE\\_MESH](#)*

Defines mesh node count.

**Default value:**

- 1 if [CONFIG\\_BT\\_NIMBLE\\_MESH](#) && BT\_NIMBLE\_ENABLED

### CONFIG\_BT\_NIMBLE\_MESH\_PROVISIONER

Enable BLE mesh provisioner

*Found in: [Component config](#) > [Bluetooth](#) > [NimBLE Options](#) > [CONFIG\\_BT\\_NIMBLE\\_MESH](#)*

Enable mesh provisioner.

**Default value:**

- 0 if [CONFIG\\_BT\\_NIMBLE\\_MESH](#) && [BT\\_NIMBLE\\_ENABLED](#)

### CONFIG\_BT\_NIMBLE\_CRYPTO\_STACK\_MBEDTLS

Override TinyCrypt with mbedTLS for crypto computations

*Found in: [Component config](#) > [Bluetooth](#) > [NimBLE Options](#)*

Enable this option to choose mbedTLS instead of TinyCrypt for crypto computations.

**Default value:**

- Yes (enabled) if [BT\\_NIMBLE\\_ENABLED](#) && [BT\\_NIMBLE\\_ENABLED](#)

### CONFIG\_BT\_NIMBLE\_HS\_STOP\_TIMEOUT\_MS

BLE host stop timeout in msec

*Found in: [Component config](#) > [Bluetooth](#) > [NimBLE Options](#)*

BLE Host stop procedure timeout in milliseconds.

**Default value:**

- 2000 if [BT\\_NIMBLE\\_ENABLED](#) && [BT\\_NIMBLE\\_ENABLED](#)

### CONFIG\_BT\_NIMBLE\_ENABLE\_CONN\_REATTEMPT

Enable connection reattempts on connection establishment error

*Found in: [Component config](#) > [Bluetooth](#) > [NimBLE Options](#)*

Enable to make the NimBLE host to reattempt GAP connection on connection establishment failure.

### CONFIG\_BT\_NIMBLE\_MAX\_CONN\_REATTEMPT

Maximum number connection reattempts

*Found in: [Component config](#) > [Bluetooth](#) > [NimBLE Options](#) > [CONFIG\\_BT\\_NIMBLE\\_ENABLE\\_CONN\\_REATTEMPT](#)*

Defines maximum number of connection reattempts.

**Range:**

- from 1 to 255 if [BT\\_NIMBLE\\_ENABLED](#) && [CONFIG\\_BT\\_NIMBLE\\_ENABLE\\_CONN\\_REATTEMPT](#) && [BT\\_NIMBLE\\_ENABLED](#)

**Default value:**

- 3 if [BT\\_NIMBLE\\_ENABLED](#) && [CONFIG\\_BT\\_NIMBLE\\_ENABLE\\_CONN\\_REATTEMPT](#) && [BT\\_NIMBLE\\_ENABLED](#)

### CONFIG\_BT\_NIMBLE\_50\_FEATURE\_SUPPORT

Enable BLE 5 feature

*Found in: [Component config](#) > [Bluetooth](#) > [NimBLE Options](#)*

Enable BLE 5 feature

**Default value:**

- Yes (enabled) if `BT_NIMBLE_ENABLED` && (`SOC_BLE_50_SUPPORTED` || `BT_CONTROLLER_ENABLED`) && `BT_NIMBLE_ENABLED`

Contains:

- [CONFIG\\_BT\\_NIMBLE\\_LL\\_CFG\\_FEAT\\_LE\\_2M\\_PHY](#)
- [CONFIG\\_BT\\_NIMBLE\\_LL\\_CFG\\_FEAT\\_LE\\_CODED\\_PHY](#)
- [CONFIG\\_BT\\_NIMBLE\\_EXT\\_ADV](#)
- [CONFIG\\_BT\\_NIMBLE\\_BLE\\_POWER\\_CONTROL](#)
- [CONFIG\\_BT\\_NIMBLE\\_MAX\\_PERIODIC\\_SYNC](#)

### CONFIG\_BT\_NIMBLE\_LL\_CFG\_FEAT\_LE\_2M\_PHY

Enable 2M Phy

*Found in:* [Component config](#) > [Bluetooth](#) > [NimBLE Options](#) > [CONFIG\\_BT\\_NIMBLE\\_50\\_FEATURE\\_SUPPORT](#)

Enable 2M-PHY

**Default value:**

- Yes (enabled) if `CONFIG_BT_NIMBLE_50_FEATURE_SUPPORT` && `BT_NIMBLE_ENABLED`

### CONFIG\_BT\_NIMBLE\_LL\_CFG\_FEAT\_LE\_CODED\_PHY

Enable coded Phy

*Found in:* [Component config](#) > [Bluetooth](#) > [NimBLE Options](#) > [CONFIG\\_BT\\_NIMBLE\\_50\\_FEATURE\\_SUPPORT](#)

Enable coded-PHY

**Default value:**

- Yes (enabled) if `CONFIG_BT_NIMBLE_50_FEATURE_SUPPORT` && `BT_NIMBLE_ENABLED`

### CONFIG\_BT\_NIMBLE\_EXT\_ADV

Enable extended advertising

*Found in:* [Component config](#) > [Bluetooth](#) > [NimBLE Options](#) > [CONFIG\\_BT\\_NIMBLE\\_50\\_FEATURE\\_SUPPORT](#)

Enable this option to do extended advertising. Extended advertising will be supported from BLE 5.0 onwards.

**Default value:**

- No (disabled) if `CONFIG_BT_NIMBLE_50_FEATURE_SUPPORT` && `BT_NIMBLE_ENABLED`

### CONFIG\_BT\_NIMBLE\_MAX\_EXT\_ADV\_INSTANCES

Maximum number of extended advertising instances.

*Found in:* [Component config](#) > [Bluetooth](#) > [NimBLE Options](#) > [CONFIG\\_BT\\_NIMBLE\\_50\\_FEATURE\\_SUPPORT](#) > [CONFIG\\_BT\\_NIMBLE\\_EXT\\_ADV](#)

Change this option to set maximum number of extended advertising instances. Minimum there is always one instance of advertising. Enter how many more advertising instances you want. For ESP32C2, ESP32C6 and ESP32H2, each extended advertising instance will take about 0.5k DRAM.

**Range:**

- from 0 to 4 if `CONFIG_BT_NIMBLE_EXT_ADV` && `CONFIG_BT_NIMBLE_EXT_ADV` && `BT_NIMBLE_ENABLED`

**Default value:**

- 1 if `CONFIG_BT_NIMBLE_EXT_ADV` && `CONFIG_BT_NIMBLE_EXT_ADV` && `CONFIG_BT_NIMBLE_EXT_ADV` && `BT_NIMBLE_ENABLED`
- 0 if `CONFIG_BT_NIMBLE_EXT_ADV` && `CONFIG_BT_NIMBLE_EXT_ADV` && `BT_NIMBLE_ENABLED`

**CONFIG\_BT\_NIMBLE\_EXT\_ADV\_MAX\_SIZE**

Maximum length of the advertising data.

*Found in:* [Component config](#) > [Bluetooth](#) > [NimBLE Options](#) > [CONFIG\\_BT\\_NIMBLE\\_50\\_FEATURE\\_SUPPORT](#) > [CONFIG\\_BT\\_NIMBLE\\_EXT\\_ADV](#)

Defines the length of the extended adv data. The value should not exceed 1650.

**Range:**

- from 0 to 1650 if `CONFIG_BT_NIMBLE_EXT_ADV` && `CONFIG_BT_NIMBLE_EXT_ADV` && `BT_NIMBLE_ENABLED`

**Default value:**

- 1650 if `CONFIG_BT_NIMBLE_EXT_ADV` && `CONFIG_BT_NIMBLE_EXT_ADV` && `CONFIG_BT_NIMBLE_EXT_ADV` && `BT_NIMBLE_ENABLED`
- 0 if `CONFIG_BT_NIMBLE_EXT_ADV` && `CONFIG_BT_NIMBLE_EXT_ADV` && `BT_NIMBLE_ENABLED`

**CONFIG\_BT\_NIMBLE\_ENABLE\_PERIODIC\_ADV**

Enable periodic advertisement.

*Found in:* [Component config](#) > [Bluetooth](#) > [NimBLE Options](#) > [CONFIG\\_BT\\_NIMBLE\\_50\\_FEATURE\\_SUPPORT](#) > [CONFIG\\_BT\\_NIMBLE\\_EXT\\_ADV](#)

Enable this option to start periodic advertisement.

**Default value:**

- Yes (enabled) if `CONFIG_BT_NIMBLE_EXT_ADV` && `CONFIG_BT_NIMBLE_EXT_ADV` && `BT_NIMBLE_ENABLED`

**CONFIG\_BT\_NIMBLE\_PERIODIC\_ADV\_SYNC\_TRANSFER**

Enable Transfer Sync Events

*Found in:* [Component config](#) > [Bluetooth](#) > [NimBLE Options](#) > [CONFIG\\_BT\\_NIMBLE\\_50\\_FEATURE\\_SUPPORT](#) > [CONFIG\\_BT\\_NIMBLE\\_EXT\\_ADV](#) > [CONFIG\\_BT\\_NIMBLE\\_ENABLE\\_PERIODIC\\_ADV](#)

This enables controller transfer periodic sync events to host

**Default value:**

- Yes (enabled) if `CONFIG_BT_NIMBLE_ENABLE_PERIODIC_ADV` && `CONFIG_BT_NIMBLE_EXT_ADV` && `BT_NIMBLE_ENABLED`

**CONFIG\_BT\_NIMBLE\_PERIODIC\_ADV\_ENH**

Periodic adv enhancements(adi support)

*Found in:* [Component config](#) > [Bluetooth](#) > [NimBLE Options](#) > [CONFIG\\_BT\\_NIMBLE\\_50\\_FEATURE\\_SUPPORT](#) > [CONFIG\\_BT\\_NIMBLE\\_EXT\\_ADV](#) > [CONFIG\\_BT\\_NIMBLE\\_ENABLE\\_PERIODIC\\_ADV](#)

Enable the periodic advertising enhancements



### CONFIG\_BT\_NIMBLE\_MAX\_PERIODIC\_SYNC

Maximum number of periodic advertising syncs

*Found in:* [Component config](#) > [Bluetooth](#) > [NimBLE Options](#) > [CONFIG\\_BT\\_NIMBLE\\_50\\_FEATURE\\_SUPPORT](#)

Set this option to set the upper limit for number of periodic sync connections. This should be less than maximum connections allowed by controller.

**Range:**

- from 0 to 8 if [CONFIG\\_BT\\_NIMBLE\\_50\\_FEATURE\\_SUPPORT](#) && [BT\\_NIMBLE\\_ENABLED](#)

**Default value:**

- 1 if [CONFIG\\_BT\\_NIMBLE\\_ENABLE\\_PERIODIC\\_ADV](#) && [CONFIG\\_BT\\_NIMBLE\\_50\\_FEATURE\\_SUPPORT](#) && [BT\\_NIMBLE\\_ENABLED](#)
- 0 if [CONFIG\\_BT\\_NIMBLE\\_50\\_FEATURE\\_SUPPORT](#) && [BT\\_NIMBLE\\_ENABLED](#)

### CONFIG\_BT\_NIMBLE\_BLE\_POWER\_CONTROL

Enable support for BLE Power Control

*Found in:* [Component config](#) > [Bluetooth](#) > [NimBLE Options](#) > [CONFIG\\_BT\\_NIMBLE\\_50\\_FEATURE\\_SUPPORT](#)

Set this option to enable the Power Control feature

### CONFIG\_BT\_NIMBLE\_WHITELIST\_SIZE

BLE white list size

*Found in:* [Component config](#) > [Bluetooth](#) > [NimBLE Options](#)

BLE list size

**Range:**

- from 1 to 15 if [BT\\_NIMBLE\\_ENABLED](#) && [BT\\_NIMBLE\\_ENABLED](#)

**Default value:**

- 12 if [BT\\_NIMBLE\\_ENABLED](#) && [BT\\_NIMBLE\\_ENABLED](#)

### CONFIG\_BT\_NIMBLE\_TEST\_THROUGHPUT\_TEST

Throughput Test Mode enable

*Found in:* [Component config](#) > [Bluetooth](#) > [NimBLE Options](#)

Enable the throughput test mode

**Default value:**

- No (disabled) if [BT\\_NIMBLE\\_ENABLED](#)

### CONFIG\_BT\_NIMBLE\_BLUFI\_ENABLE

Enable blufi functionality

*Found in:* [Component config](#) > [Bluetooth](#) > [NimBLE Options](#)

Set this option to enable blufi functionality.

**Default value:**

- No (disabled) if [BT\\_NIMBLE\\_ENABLED](#) && [BT\\_NIMBLE\\_ENABLED](#)

### CONFIG\_BT\_NIMBLE\_USE\_ESP\_TIMER

Enable Esp Timer for Nimble

*Found in: [Component config](#) > [Bluetooth](#) > [NimBLE Options](#)*

Set this option to use Esp Timer which has higher priority timer instead of FreeRTOS timer

**Default value:**

- Yes (enabled) if BT\_NIMBLE\_ENABLED

### CONFIG\_BT\_NIMBLE\_BLE\_GATT\_BLOB\_TRANSFER

Blob transfer

*Found in: [Component config](#) > [Bluetooth](#) > [NimBLE Options](#)*

This option is used when data to be sent is more than 512 bytes. For peripheral role, BT\_NIMBLE\_MSYS\_1\_BLOCK\_COUNT needs to be increased according to the need.

### CONFIG\_BT\_NIMBLE\_HIGH\_DUTY\_ADV\_ITVL

Enable BLE high duty advertising interval feature

*Found in: [Component config](#) > [Bluetooth](#) > [NimBLE Options](#)*

This enable BLE high duty advertising interval feature

### CONFIG\_BT\_NIMBLE\_HOST\_QUEUE\_CONG\_CHECK

BLE queue congestion check

*Found in: [Component config](#) > [Bluetooth](#) > [NimBLE Options](#)*

When scanning and scan duplicate is not enabled, if there are a lot of adv packets around or application layer handling adv packets is slow, it will cause the controller memory to run out. if enabled, adv packets will be lost when host queue is congested.

**Default value:**

- No (disabled) if BT\_NIMBLE\_ENABLED && BT\_NIMBLE\_ENABLED

### CONFIG\_BT\_NIMBLE\_VS\_SUPPORT

Enable support for VSC and VSE

*Found in: [Component config](#) > [Bluetooth](#) > [NimBLE Options](#)*

This option is used to enable support for sending Vendor Specific HCI commands and handling Vendor Specific HCI Events.

### CONFIG\_BT\_NIMBLE\_ENC\_ADV\_DATA

Encrypted Advertising Data

*Found in: [Component config](#) > [Bluetooth](#) > [NimBLE Options](#)*

This option is used to enable encrypted advertising data.

### CONFIG\_BT\_NIMBLE\_MAX\_EADS

Maximum number of EAD devices to save across reboots

Found in: *Component config > Bluetooth > NimBLE Options > CONFIG\_BT\_NIMBLE\_ENC\_ADV\_DATA*

Defines maximum number of encrypted advertising data key material to save

**Default value:**

- 10 if `BT_NIMBLE_ENABLED` && `CONFIG_BT_NIMBLE_ENC_ADV_DATA` && `BT_NIMBLE_ENABLED`

### Controller Options

### CONFIG\_BT\_RELEASE\_IRAM

Release Bluetooth text (READ DOCS FIRST)

Found in: *Component config > Bluetooth*

This option release Bluetooth text section and merge Bluetooth data, bss & text into a large free heap region when `esp_bt_mem_release` is called, total saving ~21kB or more of IRAM. ESP32-C2 only 3 configurable PMP entries available, rest of them are hard-coded. We cannot split the memory into 3 different regions (IRAM, BLE-IRAM, DRAM). So this option will disable the PMP (`ESP_SYSTEM_PMP_IDRAM_SPLIT`)

**Default value:**

- No (disabled) if `CONFIG_BT_ENABLED` && `BT_LE_RELEASE_IRAM_SUPPORTED`

### CONFIG\_BT\_HCI\_LOG\_DEBUG\_EN

Enable Bluetooth HCI debug mode

Found in: *Component config > Bluetooth*

This option is used to enable bluetooth debug mode, which saves the hci layer data stream.

**Default value:**

- No (disabled) if `BT_BLUEDROID_ENABLED` || `BT_NIMBLE_ENABLED`

### CONFIG\_BT\_HCI\_LOG\_DATA\_BUFFER\_SIZE

Size of the cache used for HCI data in Bluetooth HCI debug mode (N\*1024 bytes)

Found in: *Component config > Bluetooth > CONFIG\_BT\_HCI\_LOG\_DEBUG\_EN*

This option is to configure the buffer size of the hci data steam cache in hci debug mode. This is a ring buffer, the new data will overwrite the oldest data if the buffer is full.

**Range:**

- from 1 to 100 if `CONFIG_BT_HCI_LOG_DEBUG_EN`

**Default value:**

- 5 if `CONFIG_BT_HCI_LOG_DEBUG_EN`

### CONFIG\_BT\_HCI\_LOG\_ADV\_BUFFER\_SIZE

Size of the cache used for adv report in Bluetooth HCI debug mode (N\*1024 bytes)

Found in: *Component config > Bluetooth > CONFIG\_BT\_HCI\_LOG\_DEBUG\_EN*

This option is to configure the buffer size of the hci adv report cache in hci debug mode. This is a ring buffer, the new data will overwrite the oldest data if the buffer is full.

**Range:**

- from 1 to 100 if `CONFIG_BT_HCI_LOG_DEBUG_EN`

**Default value:**

- 8 if `CONFIG_BT_HCI_LOG_DEBUG_EN`

**Common Options** Contains:

- `CONFIG_BT_ALARM_MAX_NUM`

**CONFIG\_BT\_ALARM\_MAX\_NUM**

Maximum number of Bluetooth alarms

*Found in: Component config > Bluetooth > Common Options*

This option decides the maximum number of alarms which could be used by Bluetooth host.

**Default value:**

- 50

**CONFIG\_BLE\_MESH**

ESP BLE Mesh Support

*Found in: Component config*

This option enables ESP BLE Mesh support. The specific features that are available may depend on other features that have been enabled in the stack, such as Bluetooth Support, Bluedroid Support & GATT support.

## Contains:

- *BLE Mesh and BLE coexistence support*
- `CONFIG_BLE_MESH_GATT_PROXY_CLIENT`
- `CONFIG_BLE_MESH_GATT_PROXY_SERVER`
- `BLE Mesh NET BUF DEBUG LOG LEVEL`
- `CONFIG_BLE_MESH_PROV`
- `CONFIG_BLE_MESH_PROXY`
- *BLE Mesh specific test option*
- `BLE Mesh STACK DEBUG LOG LEVEL`
- `CONFIG_BLE_MESH_NO_LOG`
- `CONFIG_BLE_MESH_IVU_DIVIDER`
- `CONFIG_BLE_MESH_FAST_PROV`
- `CONFIG_BLE_MESH_FREERTOS_STATIC_ALLOC`
- `CONFIG_BLE_MESH_EXPERIMENTAL`
- `CONFIG_BLE_MESH_CRPL`
- `CONFIG_BLE_MESH_RX_SDU_MAX`
- `CONFIG_BLE_MESH_MODEL_KEY_COUNT`
- `CONFIG_BLE_MESH_APP_KEY_COUNT`
- `CONFIG_BLE_MESH_MODEL_GROUP_COUNT`
- `CONFIG_BLE_MESH_LABEL_COUNT`
- `CONFIG_BLE_MESH_SUBNET_COUNT`
- `CONFIG_BLE_MESH_TX_SEG_MAX`
- `CONFIG_BLE_MESH_RX_SEG_MSG_COUNT`
- `CONFIG_BLE_MESH_TX_SEG_MSG_COUNT`
- `CONFIG_BLE_MESH_MEM_ALLOC_MODE`
- `CONFIG_BLE_MESH_MSG_CACHE_SIZE`
- `CONFIG_BLE_MESH_NOT_RELAY_REPLAY_MSG`
- `CONFIG_BLE_MESH_ADV_BUF_COUNT`
- `CONFIG_BLE_MESH_PB_GATT`
- `CONFIG_BLE_MESH_PB_ADV`
- `CONFIG_BLE_MESH_IVU_RECOVERY_IVI`
- `CONFIG_BLE_MESH_RELAY`

- `CONFIG_BLE_MESH_SETTINGS`
- `CONFIG_BLE_MESH_DEINIT`
- `CONFIG_BLE_MESH_USE_DUPLICATE_SCAN`
- Support for BLE Mesh Client/Server models
- Support for BLE Mesh Foundation models
- `CONFIG_BLE_MESH_NODE`
- `CONFIG_BLE_MESH_PROVISIONER`
- `CONFIG_BLE_MESH_FRIEND`
- `CONFIG_BLE_MESH_LOW_POWER`
- `CONFIG_BLE_MESH_HCI_5_0`
- `CONFIG_BLE_MESH_RANDOM_ADV_INTERVAL`
- `CONFIG_BLE_MESH_IV_UPDATE_TEST`
- `CONFIG_BLE_MESH_CLIENT_MSG_TIMEOUT`

### **CONFIG\_BLE\_MESH\_HCI\_5\_0**

Support sending 20ms non-connectable adv packets

*Found in: Component config > CONFIG\_BLE\_MESH*

It is a temporary solution and needs further modifications.

**Default value:**

- Yes (enabled) if `CONFIG_BLE_MESH`

### **CONFIG\_BLE\_MESH\_RANDOM\_ADV\_INTERVAL**

Support using random adv interval for mesh packets

*Found in: Component config > CONFIG\_BLE\_MESH*

Enable this option to allow using random advertising interval for mesh packets. And this could help avoid collision of advertising packets.

**Default value:**

- No (disabled) if `CONFIG_BLE_MESH`

### **CONFIG\_BLE\_MESH\_USE\_DUPLICATE\_SCAN**

Support Duplicate Scan in BLE Mesh

*Found in: Component config > CONFIG\_BLE\_MESH*

Enable this option to allow using specific duplicate scan filter in BLE Mesh, and Scan Duplicate Type must be set by choosing the option in the Bluetooth Controller section in menuconfig, which is “Scan Duplicate By Device Address and Advertising Data” .

**Default value:**

- Yes (enabled) if `CONFIG_BLE_MESH`

### **CONFIG\_BLE\_MESH\_MEM\_ALLOC\_MODE**

Memory allocation strategy

*Found in: Component config > CONFIG\_BLE\_MESH*

Allocation strategy for BLE Mesh stack, essentially provides ability to allocate all required dynamic allocations from,

- Internal DRAM memory only
- External SPIRAM memory only
- Either internal or external memory based on default malloc() behavior in ESP-IDF
- Internal IRAM memory wherever applicable else internal DRAM

Recommended mode here is always internal (\*), since that is most preferred from security perspective. But if application requirement does not allow sufficient free internal memory then alternate mode can be selected.

(\*) In case of ESP32-S2/ESP32-S3, hardware allows encryption of external SPIRAM contents provided hardware flash encryption feature is enabled. In that case, using external SPIRAM allocation strategy is also safe choice from security perspective.

**Available options:**

- Internal DRAM (BLE\_MESH\_MEM\_ALLOC\_MODE\_INTERNAL)
- External SPIRAM (BLE\_MESH\_MEM\_ALLOC\_MODE\_EXTERNAL)
- Default alloc mode (BLE\_MESH\_MEM\_ALLOC\_MODE\_DEFAULT)  
Enable this option to use the default memory allocation strategy when external SPIRAM is enabled. See the SPIRAM options for more details.
- Internal IRAM (BLE\_MESH\_MEM\_ALLOC\_MODE\_IRAM\_8BIT)  
Allows to use IRAM memory region as 8bit accessible region. Every unaligned (8bit or 16bit) access will result in an exception and incur penalty of certain clock cycles per unaligned read/write.

### CONFIG\_BLE\_MESH\_FREERTOS\_STATIC\_ALLOC

Enable FreeRTOS static allocation

Found in: *Component config* > *CONFIG\_BLE\_MESH*

Enable this option to use FreeRTOS static allocation APIs for BLE Mesh, which provides the ability to use different dynamic memory (i.e. SPIRAM or IRAM) for FreeRTOS objects. If this option is disabled, the FreeRTOS static allocation APIs will not be used, and internal DRAM will be allocated for FreeRTOS objects.

**Default value:**

- No (disabled) if ESP32\_IRAM\_AS\_8BIT\_ACCESSIBLE\_MEMORY && *CONFIG\_BLE\_MESH*

### CONFIG\_BLE\_MESH\_FREERTOS\_STATIC\_ALLOC\_MODE

Memory allocation for FreeRTOS objects

Found in: *Component config* > *CONFIG\_BLE\_MESH* > *CONFIG\_BLE\_MESH\_FREERTOS\_STATIC\_ALLOC*

Choose the memory to be used for FreeRTOS objects.

**Available options:**

- External SPIRAM (BLE\_MESH\_FREERTOS\_STATIC\_ALLOC\_EXTERNAL)  
If enabled, BLE Mesh allocates dynamic memory from external SPIRAM for FreeRTOS objects, i.e. mutex, queue, and task stack. External SPIRAM can only be used for task stack when SPIRAM\_ALLOW\_STACK\_EXTERNAL\_MEMORY is enabled. See the SPIRAM options for more details.
- Internal IRAM (BLE\_MESH\_FREERTOS\_STATIC\_ALLOC\_IRAM\_8BIT)  
If enabled, BLE Mesh allocates dynamic memory from internal IRAM for FreeRTOS objects, i.e. mutex, queue. Note: IRAM region cannot be used as task stack.

### CONFIG\_BLE\_MESH\_DEINIT

Support de-initialize BLE Mesh stack

Found in: *Component config* > *CONFIG\_BLE\_MESH*

If enabled, users can use the function `esp_ble_mesh_deinit()` to de-initialize the whole BLE Mesh stack.

**Default value:**

- Yes (enabled) if *CONFIG\_BLE\_MESH*

**BLE Mesh and BLE coexistence support** Contains:

- [CONFIG\\_BLE\\_MESH\\_SUPPORT\\_BLE\\_SCAN](#)
- [CONFIG\\_BLE\\_MESH\\_SUPPORT\\_BLE\\_ADV](#)

### **CONFIG\_BLE\_MESH\_SUPPORT\_BLE\_ADV**

Support sending normal BLE advertising packets

*Found in: Component config > CONFIG\_BLE\_MESH > BLE Mesh and BLE coexistence support*

When selected, users can send normal BLE advertising packets with specific API.

**Default value:**

- No (disabled) if [CONFIG\\_BLE\\_MESH](#)

### **CONFIG\_BLE\_MESH\_BLE\_ADV\_BUF\_COUNT**

Number of advertising buffers for BLE advertising packets

*Found in: Component config > CONFIG\_BLE\_MESH > BLE Mesh and BLE coexistence support > CONFIG\_BLE\_MESH\_SUPPORT\_BLE\_ADV*

Number of advertising buffers for BLE packets available.

**Range:**

- from 1 to 255 if [CONFIG\\_BLE\\_MESH\\_SUPPORT\\_BLE\\_ADV](#) && [CONFIG\\_BLE\\_MESH](#)

**Default value:**

- 3 if [CONFIG\\_BLE\\_MESH\\_SUPPORT\\_BLE\\_ADV](#) && [CONFIG\\_BLE\\_MESH](#)

### **CONFIG\_BLE\_MESH\_SUPPORT\_BLE\_SCAN**

Support scanning normal BLE advertising packets

*Found in: Component config > CONFIG\_BLE\_MESH > BLE Mesh and BLE coexistence support*

When selected, users can register a callback and receive normal BLE advertising packets in the application layer.

**Default value:**

- No (disabled) if [CONFIG\\_BLE\\_MESH](#)

### **CONFIG\_BLE\_MESH\_FAST\_PROV**

Enable BLE Mesh Fast Provisioning

*Found in: Component config > CONFIG\_BLE\_MESH*

Enable this option to allow BLE Mesh fast provisioning solution to be used. When there are multiple unprovisioned devices around, fast provisioning can greatly reduce the time consumption of the whole provisioning process. When this option is enabled, and after an unprovisioned device is provisioned into a node successfully, it can be changed to a temporary Provisioner.

**Default value:**

- No (disabled) if [CONFIG\\_BLE\\_MESH](#)

### **CONFIG\_BLE\_MESH\_NODE**

Support for BLE Mesh Node

*Found in: Component config > CONFIG\_BLE\_MESH*

Enable the device to be provisioned into a node. This option should be enabled when an unprovisioned device is going to be provisioned into a node and communicate with other nodes in the BLE Mesh network.

### CONFIG\_BLE\_MESH\_PROVISIONER

Support for BLE Mesh Provisioner

*Found in: Component config > CONFIG\_BLE\_MESH*

Enable the device to be a Provisioner. The option should be enabled when a device is going to act as a Provisioner and provision unprovisioned devices into the BLE Mesh network.

### CONFIG\_BLE\_MESH\_WAIT\_FOR\_PROV\_MAX\_DEV\_NUM

Maximum number of unprovisioned devices that can be added to device queue

*Found in: Component config > CONFIG\_BLE\_MESH > CONFIG\_BLE\_MESH\_PROVISIONER*

This option specifies how many unprovisioned devices can be added to device queue for provisioning. Users can use this option to define the size of the queue in the bottom layer which is used to store unprovisioned device information (e.g. Device UUID, address).

**Range:**

- from 1 to 100 if *CONFIG\_BLE\_MESH\_PROVISIONER* && *CONFIG\_BLE\_MESH*

**Default value:**

- 10 if *CONFIG\_BLE\_MESH\_PROVISIONER* && *CONFIG\_BLE\_MESH*

### CONFIG\_BLE\_MESH\_MAX\_PROV\_NODES

Maximum number of devices that can be provisioned by Provisioner

*Found in: Component config > CONFIG\_BLE\_MESH > CONFIG\_BLE\_MESH\_PROVISIONER*

This option specifies how many devices can be provisioned by a Provisioner. This value indicates the maximum number of unprovisioned devices which can be provisioned by a Provisioner. For instance, if the value is 6, it means the Provisioner can provision up to 6 unprovisioned devices. Theoretically a Provisioner without the limitation of its memory can provision up to 32766 unprovisioned devices, here we limit the maximum number to 100 just to limit the memory used by a Provisioner. The bigger the value is, the more memory it will cost by a Provisioner to store the information of nodes.

**Range:**

- from 1 to 1000 if *CONFIG\_BLE\_MESH\_PROVISIONER* && *CONFIG\_BLE\_MESH*

**Default value:**

- 10 if *CONFIG\_BLE\_MESH\_PROVISIONER* && *CONFIG\_BLE\_MESH*

### CONFIG\_BLE\_MESH\_PBA\_SAME\_TIME

Maximum number of PB-ADV running at the same time by Provisioner

*Found in: Component config > CONFIG\_BLE\_MESH > CONFIG\_BLE\_MESH\_PROVISIONER*

This option specifies how many devices can be provisioned at the same time using PB-ADV. For examples, if the value is 2, it means a Provisioner can provision two unprovisioned devices with PB-ADV at the same time.

**Range:**

- from 1 to 10 if *CONFIG\_BLE\_MESH\_PB\_ADV* && *CONFIG\_BLE\_MESH\_PROVISIONER* && *CONFIG\_BLE\_MESH*

**Default value:**

- 2 if *CONFIG\_BLE\_MESH\_PB\_ADV* && *CONFIG\_BLE\_MESH\_PROVISIONER* && *CONFIG\_BLE\_MESH*



### CONFIG\_BLE\_MESH\_PBG\_SAME\_TIME

Maximum number of PB-GATT running at the same time by Provisioner

*Found in: Component config > CONFIG\_BLE\_MESH > CONFIG\_BLE\_MESH\_PROVISIONER*

This option specifies how many devices can be provisioned at the same time using PB-GATT. For example, if the value is 2, it means a Provisioner can provision two unprovisioned devices with PB-GATT at the same time.

**Range:**

- from 1 to 5 if *CONFIG\_BLE\_MESH\_PB\_GATT* && *CONFIG\_BLE\_MESH\_PROVISIONER* && *CONFIG\_BLE\_MESH*

**Default value:**

- 1 if *CONFIG\_BLE\_MESH\_PB\_GATT* && *CONFIG\_BLE\_MESH\_PROVISIONER* && *CONFIG\_BLE\_MESH*

### CONFIG\_BLE\_MESH\_PROVISIONER\_SUBNET\_COUNT

Maximum number of mesh subnets that can be created by Provisioner

*Found in: Component config > CONFIG\_BLE\_MESH > CONFIG\_BLE\_MESH\_PROVISIONER*

This option specifies how many subnets per network a Provisioner can create. Indeed, this value decides the number of network keys which can be added by a Provisioner.

**Range:**

- from 1 to 4096 if *CONFIG\_BLE\_MESH\_PROVISIONER* && *CONFIG\_BLE\_MESH*

**Default value:**

- 3 if *CONFIG\_BLE\_MESH\_PROVISIONER* && *CONFIG\_BLE\_MESH*

### CONFIG\_BLE\_MESH\_PROVISIONER\_APP\_KEY\_COUNT

Maximum number of application keys that can be owned by Provisioner

*Found in: Component config > CONFIG\_BLE\_MESH > CONFIG\_BLE\_MESH\_PROVISIONER*

This option specifies how many application keys the Provisioner can have. Indeed, this value decides the number of the application keys which can be added by a Provisioner.

**Range:**

- from 1 to 4096 if *CONFIG\_BLE\_MESH\_PROVISIONER* && *CONFIG\_BLE\_MESH*

**Default value:**

- 3 if *CONFIG\_BLE\_MESH\_PROVISIONER* && *CONFIG\_BLE\_MESH*

### CONFIG\_BLE\_MESH\_PROVISIONER\_RECV\_HB

Support receiving Heartbeat messages

*Found in: Component config > CONFIG\_BLE\_MESH > CONFIG\_BLE\_MESH\_PROVISIONER*

When this option is enabled, Provisioner can call specific functions to enable or disable receiving Heartbeat messages and notify them to the application layer.

**Default value:**

- No (disabled) if *CONFIG\_BLE\_MESH\_PROVISIONER* && *CONFIG\_BLE\_MESH*

### CONFIG\_BLE\_MESH\_PROVISIONER\_RECV\_HB\_FILTER\_SIZE

Maximum number of filter entries for receiving Heartbeat messages

*Found in: Component config > CONFIG\_BLE\_MESH > CONFIG\_BLE\_MESH\_PROVISIONER > CONFIG\_BLE\_MESH\_PROVISIONER\_RECV\_HB*

This option specifies how many heartbeat filter entries Provisioner supports. The heartbeat filter (acceptlist or rejectlist) entries are used to store a list of SRC and DST which can be used to decide if a heartbeat message will be processed and notified to the application layer by Provisioner. Note: The filter is an empty rejectlist by default.

**Range:**

- from 1 to 1000 if `CONFIG_BLE_MESH_PROVISIONER_RECV_HB` && `CONFIG_BLE_MESH_PROVISIONER` && `CONFIG_BLE_MESH`

**Default value:**

- 3 if `CONFIG_BLE_MESH_PROVISIONER_RECV_HB` && `CONFIG_BLE_MESH_PROVISIONER` && `CONFIG_BLE_MESH`

**CONFIG\_BLE\_MESH\_PROV**

BLE Mesh Provisioning support

*Found in:* `Component config > CONFIG_BLE_MESH`

Enable this option to support BLE Mesh Provisioning functionality. For BLE Mesh, this option should be always enabled.

**Default value:**

- Yes (enabled) if `CONFIG_BLE_MESH`

**CONFIG\_BLE\_MESH\_PB\_ADV**

Provisioning support using the advertising bearer (PB-ADV)

*Found in:* `Component config > CONFIG_BLE_MESH`

Enable this option to allow the device to be provisioned over the advertising bearer. This option should be enabled if PB-ADV is going to be used during provisioning procedure.

**Default value:**

- Yes (enabled) if `CONFIG_BLE_MESH`

**CONFIG\_BLE\_MESH\_UNPROVISIONED\_BEACON\_INTERVAL**

Interval between two consecutive Unprovisioned Device Beacon

*Found in:* `Component config > CONFIG_BLE_MESH > CONFIG_BLE_MESH_PB_ADV`

This option specifies the interval of sending two consecutive unprovisioned device beacon, users can use this option to change the frequency of sending unprovisioned device beacon. For example, if the value is 5, it means the unprovisioned device beacon will send every 5 seconds. When the option of `BLE_MESH_FAST_PROV` is selected, the value is better to be 3 seconds, or less.

**Range:**

- from 1 to 100 if `CONFIG_BLE_MESH_NODE` && `CONFIG_BLE_MESH_PB_ADV` && `CONFIG_BLE_MESH`

**Default value:**

- 5 if `CONFIG_BLE_MESH_NODE` && `CONFIG_BLE_MESH_PB_ADV` && `CONFIG_BLE_MESH`
- 3 if `CONFIG_BLE_MESH_FAST_PROV` && `CONFIG_BLE_MESH_NODE` && `CONFIG_BLE_MESH_PB_ADV` && `CONFIG_BLE_MESH`

**CONFIG\_BLE\_MESH\_PB\_GATT**

Provisioning support using GATT (PB-GATT)

*Found in:* `Component config > CONFIG_BLE_MESH`

Enable this option to allow the device to be provisioned over GATT. This option should be enabled if PB-GATT is going to be used during provisioning procedure.

# Virtual option enabled whenever any Proxy protocol is needed

### CONFIG\_BLE\_MESH\_PROXY

BLE Mesh Proxy protocol support

*Found in: Component config > CONFIG\_BLE\_MESH*

Enable this option to support BLE Mesh Proxy protocol used by PB-GATT and other proxy pdu transmission.

**Default value:**

- Yes (enabled) if *CONFIG\_BLE\_MESH*

### CONFIG\_BLE\_MESH\_GATT\_PROXY\_SERVER

BLE Mesh GATT Proxy Server

*Found in: Component config > CONFIG\_BLE\_MESH*

This option enables support for Mesh GATT Proxy Service, i.e. the ability to act as a proxy between a Mesh GATT Client and a Mesh network. This option should be enabled if a node is going to be a Proxy Server.

**Default value:**

- Yes (enabled) if *CONFIG\_BLE\_MESH\_NODE* && *CONFIG\_BLE\_MESH*

### CONFIG\_BLE\_MESH\_NODE\_ID\_TIMEOUT

Node Identity advertising timeout

*Found in: Component config > CONFIG\_BLE\_MESH > CONFIG\_BLE\_MESH\_GATT\_PROXY\_SERVER*

This option determines for how long the local node advertises using Node Identity. The given value is in seconds. The specification limits this to 60 seconds and lists it as the recommended value as well. So leaving the default value is the safest option. When an unprovisioned device is provisioned successfully and becomes a node, it will start to advertise using Node Identity during the time set by this option. And after that, Network ID will be advertised.

**Range:**

- from 1 to 60 if *CONFIG\_BLE\_MESH\_GATT\_PROXY\_SERVER* && *CONFIG\_BLE\_MESH*

**Default value:**

- 60 if *CONFIG\_BLE\_MESH\_GATT\_PROXY\_SERVER* && *CONFIG\_BLE\_MESH*

### CONFIG\_BLE\_MESH\_PROXY\_FILTER\_SIZE

Maximum number of filter entries per Proxy Client

*Found in: Component config > CONFIG\_BLE\_MESH > CONFIG\_BLE\_MESH\_GATT\_PROXY\_SERVER*

This option specifies how many Proxy Filter entries the local node supports. The entries of Proxy filter (whitelist or blacklist) are used to store a list of addresses which can be used to decide which messages will be forwarded to the Proxy Client by the Proxy Server.

**Range:**

- from 1 to 32767 if *CONFIG\_BLE\_MESH\_GATT\_PROXY\_SERVER* && *CONFIG\_BLE\_MESH*

**Default value:**

- 4 if *CONFIG\_BLE\_MESH\_GATT\_PROXY\_SERVER* && *CONFIG\_BLE\_MESH*

## CONFIG\_BLE\_MESH\_GATT\_PROXY\_CLIENT

BLE Mesh GATT Proxy Client

Found in: *Component config* > *CONFIG\_BLE\_MESH*

This option enables support for Mesh GATT Proxy Client. The Proxy Client can use the GATT bearer to send mesh messages to a node that supports the advertising bearer.

**Default value:**

- No (disabled) if *CONFIG\_BLE\_MESH*

## CONFIG\_BLE\_MESH\_SETTINGS

Store BLE Mesh configuration persistently

Found in: *Component config* > *CONFIG\_BLE\_MESH*

When selected, the BLE Mesh stack will take care of storing/restoring the BLE Mesh configuration persistently in flash. If the device is a BLE Mesh node, when this option is enabled, the configuration of the device will be stored persistently, including unicast address, NetKey, AppKey, etc. And if the device is a BLE Mesh Provisioner, the information of the device will be stored persistently, including the information of provisioned nodes, NetKey, AppKey, etc.

**Default value:**

- No (disabled) if *CONFIG\_BLE\_MESH*

## CONFIG\_BLE\_MESH\_STORE\_TIMEOUT

Delay (in seconds) before storing anything persistently

Found in: *Component config* > *CONFIG\_BLE\_MESH* > *CONFIG\_BLE\_MESH\_SETTINGS*

This value defines in seconds how soon any pending changes are actually written into persistent storage (flash) after a change occurs. The option allows nodes to delay a certain period of time to save proper information to flash. The default value is 0, which means information will be stored immediately once there are updates.

**Range:**

- from 0 to 1000000 if *CONFIG\_BLE\_MESH\_SETTINGS* && *CONFIG\_BLE\_MESH*

**Default value:**

- 0 if *CONFIG\_BLE\_MESH\_SETTINGS* && *CONFIG\_BLE\_MESH*

## CONFIG\_BLE\_MESH\_SEQ\_STORE\_RATE

How often the sequence number gets updated in storage

Found in: *Component config* > *CONFIG\_BLE\_MESH* > *CONFIG\_BLE\_MESH\_SETTINGS*

This value defines how often the local sequence number gets updated in persistent storage (i.e. flash). e.g. a value of 100 means that the sequence number will be stored to flash on every 100th increment. If the node sends messages very frequently a higher value makes more sense, whereas if the node sends infrequently a value as low as 0 (update storage for every increment) can make sense. When the stack gets initialized it will add sequence number to the last stored one, so that it starts off with a value that's guaranteed to be larger than the last one used before power off.

**Range:**

- from 0 to 1000000 if *CONFIG\_BLE\_MESH\_SETTINGS* && *CONFIG\_BLE\_MESH*

**Default value:**

- 0 if *CONFIG\_BLE\_MESH\_SETTINGS* && *CONFIG\_BLE\_MESH*

### CONFIG\_BLE\_MESH\_RPL\_STORE\_TIMEOUT

Minimum frequency that the RPL gets updated in storage

*Found in: [Component config](#) > [CONFIG\\_BLE\\_MESH](#) > [CONFIG\\_BLE\\_MESH\\_SETTINGS](#)*

This value defines in seconds how soon the RPL (Replay Protection List) gets written to persistent storage after a change occurs. If the node receives messages frequently, then a large value is recommended. If the node receives messages rarely, then the value can be as low as 0 (which means the RPL is written into the storage immediately). Note that if the node operates in a security-sensitive case, and there is a risk of sudden power-off, then a value of 0 is strongly recommended. Otherwise, a power loss before RPL being written into the storage may introduce message replay attacks and system security will be in a vulnerable state.

**Range:**

- from 0 to 1000000 if [CONFIG\\_BLE\\_MESH\\_SETTINGS](#) && [CONFIG\\_BLE\\_MESH](#)

**Default value:**

- 0 if [CONFIG\\_BLE\\_MESH\\_SETTINGS](#) && [CONFIG\\_BLE\\_MESH](#)

### CONFIG\_BLE\_MESH\_SETTINGS\_BACKWARD\_COMPATIBILITY

A specific option for settings backward compatibility

*Found in: [Component config](#) > [CONFIG\\_BLE\\_MESH](#) > [CONFIG\\_BLE\\_MESH\\_SETTINGS](#)*

This option is created to solve the issue of failure in recovering node information after mesh stack updates. In the old version mesh stack, there is no key of “mesh/role” in nvs. In the new version mesh stack, key of “mesh/role” is added in nvs, recovering node information needs to check “mesh/role” key in nvs and implements selective recovery of mesh node information. Therefore, there may be failure in recovering node information during node restarting after OTA.

The new version mesh stack adds the option of “mesh/role” because we have added the support of storing Provisioner information, while the old version only supports storing node information.

If users are updating their nodes from old version to new version, we recommend enabling this option, so that system could set the flag in advance before recovering node information and make sure the node information recovering could work as expected.

**Default value:**

- No (disabled) if [CONFIG\\_BLE\\_MESH\\_NODE](#) && [CONFIG\\_BLE\\_MESH\\_SETTINGS](#) && [CONFIG\\_BLE\\_MESH](#)

### CONFIG\_BLE\_MESH\_SPECIFIC\_PARTITION

Use a specific NVS partition for BLE Mesh

*Found in: [Component config](#) > [CONFIG\\_BLE\\_MESH](#) > [CONFIG\\_BLE\\_MESH\\_SETTINGS](#)*

When selected, the mesh stack will use a specified NVS partition instead of default NVS partition. Note that the specified partition must be registered with NVS using `nvs_flash_init_partition()` API, and the partition must exist in the csv file. When Provisioner needs to store a large amount of nodes' information in the flash (e.g. more than 20), this option is recommended to be enabled.

**Default value:**

- No (disabled) if [CONFIG\\_BLE\\_MESH\\_SETTINGS](#) && [CONFIG\\_BLE\\_MESH](#)

### CONFIG\_BLE\_MESH\_PARTITION\_NAME

Name of the NVS partition for BLE Mesh

*Found in: [Component config](#) > [CONFIG\\_BLE\\_MESH](#) > [CONFIG\\_BLE\\_MESH\\_SETTINGS](#) > [CONFIG\\_BLE\\_MESH\\_SPECIFIC\\_PARTITION](#)*

This value defines the name of the specified NVS partition used by the mesh stack.

**Default value:**

- “ble\_mesh” if `CONFIG_BLE_MESH_SPECIFIC_PARTITION` && `CONFIG_BLE_MESH_SETTINGS` && `CONFIG_BLE_MESH`

**CONFIG\_BLE\_MESH\_USE\_MULTIPLE\_NAMESPACE**

Support using multiple NVS namespaces by Provisioner

*Found in: [Component config](#) > [CONFIG\\_BLE\\_MESH](#) > [CONFIG\\_BLE\\_MESH\\_SETTINGS](#)*

When selected, Provisioner can use different NVS namespaces to store different instances of mesh information. For example, if in the first room, Provisioner uses NetKey A, AppKey A and provisions three devices, these information will be treated as mesh information instance A. When the Provisioner moves to the second room, it uses NetKey B, AppKey B and provisions two devices, then the information will be treated as mesh information instance B. Here instance A and instance B will be stored in different namespaces. With this option enabled, Provisioner needs to use specific functions to open the corresponding NVS namespace, restore the mesh information, release the mesh information or erase the mesh information.

**Default value:**

- No (disabled) if `CONFIG_BLE_MESH_PROVISIONER` && `CONFIG_BLE_MESH_SETTINGS` && `CONFIG_BLE_MESH`

**CONFIG\_BLE\_MESH\_MAX\_NVS\_NAMESPACE**

Maximum number of NVS namespaces

*Found in: [Component config](#) > [CONFIG\\_BLE\\_MESH](#) > [CONFIG\\_BLE\\_MESH\\_SETTINGS](#) > [CONFIG\\_BLE\\_MESH\\_USE\\_MULTIPLE\\_NAMESPACE](#)*

This option specifies the maximum NVS namespaces supported by Provisioner.

**Range:**

- from 1 to 255 if `CONFIG_BLE_MESH_USE_MULTIPLE_NAMESPACE` && `CONFIG_BLE_MESH_SETTINGS` && `CONFIG_BLE_MESH`

**Default value:**

- 2 if `CONFIG_BLE_MESH_USE_MULTIPLE_NAMESPACE` && `CONFIG_BLE_MESH_SETTINGS` && `CONFIG_BLE_MESH`

**CONFIG\_BLE\_MESH\_SUBNET\_COUNT**

Maximum number of mesh subnets per network

*Found in: [Component config](#) > [CONFIG\\_BLE\\_MESH](#)*

This option specifies how many subnets a Mesh network can have at the same time. Indeed, this value decides the number of the network keys which can be owned by a node.

**Range:**

- from 1 to 4096 if `CONFIG_BLE_MESH`

**Default value:**

- 3 if `CONFIG_BLE_MESH`

**CONFIG\_BLE\_MESH\_APP\_KEY\_COUNT**

Maximum number of application keys per network

*Found in: [Component config](#) > [CONFIG\\_BLE\\_MESH](#)*

This option specifies how many application keys the device can store per network. Indeed, this value decides the number of the application keys which can be owned by a node.

**Range:**

- from 1 to 4096 if *CONFIG\_BLE\_MESH*

**Default value:**

- 3 if *CONFIG\_BLE\_MESH*

**CONFIG\_BLE\_MESH\_MODEL\_KEY\_COUNT**

Maximum number of application keys per model

*Found in: Component config > CONFIG\_BLE\_MESH*

This option specifies the maximum number of application keys to which each model can be bound.

**Range:**

- from 1 to 4096 if *CONFIG\_BLE\_MESH*

**Default value:**

- 3 if *CONFIG\_BLE\_MESH*

**CONFIG\_BLE\_MESH\_MODEL\_GROUP\_COUNT**

Maximum number of group address subscriptions per model

*Found in: Component config > CONFIG\_BLE\_MESH*

This option specifies the maximum number of addresses to which each model can be subscribed.

**Range:**

- from 1 to 4096 if *CONFIG\_BLE\_MESH*

**Default value:**

- 3 if *CONFIG\_BLE\_MESH*

**CONFIG\_BLE\_MESH\_LABEL\_COUNT**

Maximum number of Label UUIDs used for Virtual Addresses

*Found in: Component config > CONFIG\_BLE\_MESH*

This option specifies how many Label UUIDs can be stored. Indeed, this value decides the number of the Virtual Addresses can be supported by a node.

**Range:**

- from 0 to 4096 if *CONFIG\_BLE\_MESH*

**Default value:**

- 3 if *CONFIG\_BLE\_MESH*

**CONFIG\_BLE\_MESH\_CRPL**

Maximum capacity of the replay protection list

*Found in: Component config > CONFIG\_BLE\_MESH*

This option specifies the maximum capacity of the replay protection list. It is similar to Network message cache size, but has a different purpose. The replay protection list is used to prevent a node from replay attack, which will store the source address and sequence number of the received mesh messages. For Provisioner, the replay protection list size should not be smaller than the maximum number of nodes whose information can be stored. And the element number of each node should also be taken into consideration. For example, if Provisioner can provision up to 20 nodes and each node contains two elements, then the replay protection list size of Provisioner should be at least 40.

**Range:**

- from 2 to 65535 if *CONFIG\_BLE\_MESH*

**Default value:**

- 10 if *CONFIG\_BLE\_MESH*



### CONFIG\_BLE\_MESH\_NOT\_RELAY\_REPLAY\_MSG

Not relay replayed messages in a mesh network

*Found in: [Component config](#) > [CONFIG\\_BLE\\_MESH](#)*

There may be many expired messages in a complex mesh network that would be considered replayed messages. Enable this option will refuse to relay such messages, which could help to reduce invalid packets in the mesh network. However, it should be noted that enabling this option may result in packet loss in certain environments. Therefore, users need to decide whether to enable this option according to the actual usage situation.

**Default value:**

- No (disabled) if [CONFIG\\_BLE\\_MESH\\_EXPERIMENTAL](#) && [CONFIG\\_BLE\\_MESH](#)

### CONFIG\_BLE\_MESH\_MSG\_CACHE\_SIZE

Network message cache size

*Found in: [Component config](#) > [CONFIG\\_BLE\\_MESH](#)*

Number of messages that are cached for the network. This helps prevent unnecessary decryption operations and unnecessary relays. This option is similar to Replay protection list, but has a different purpose. A node is not required to cache the entire Network PDU and may cache only part of it for tracking, such as values for SRC/SEQ or others.

**Range:**

- from 2 to 65535 if [CONFIG\\_BLE\\_MESH](#)

**Default value:**

- 10 if [CONFIG\\_BLE\\_MESH](#)

### CONFIG\_BLE\_MESH\_ADV\_BUF\_COUNT

Number of advertising buffers

*Found in: [Component config](#) > [CONFIG\\_BLE\\_MESH](#)*

Number of advertising buffers available. The transport layer reserves ADV\_BUF\_COUNT - 3 buffers for outgoing segments. The maximum outgoing SDU size is 12 times this value (out of which 4 or 8 bytes are used for the Transport Layer MIC). For example, 5 segments means the maximum SDU size is 60 bytes, which leaves 56 bytes for application layer data using a 4-byte MIC, or 52 bytes using an 8-byte MIC.

**Range:**

- from 6 to 256 if [CONFIG\\_BLE\\_MESH](#)

**Default value:**

- 60 if [CONFIG\\_BLE\\_MESH](#)

### CONFIG\_BLE\_MESH\_IVU\_DIVIDER

Divider for IV Update state refresh timer

*Found in: [Component config](#) > [CONFIG\\_BLE\\_MESH](#)*

When the IV Update state enters Normal operation or IV Update in Progress, we need to keep track of how many hours has passed in the state, since the specification requires us to remain in the state at least for 96 hours (Update in Progress has an additional upper limit of 144 hours).

In order to fulfill the above requirement, even if the node might be powered off once in a while, we need to store persistently how many hours the node has been in the state. This doesn't necessarily need to happen every hour (thanks to the flexible duration range). The exact cadence will depend a lot on the ways that the node will be used and what kind of power source it has.

Since there is no single optimal answer, this configuration option allows specifying a divider, i.e. how many intervals the 96 hour minimum gets split into. After each interval the duration that the node has



been in the current state gets stored to flash. E.g. the default value of 4 means that the state is saved every 24 hours (96 / 4).

**Range:**

- from 2 to 96 if `CONFIG_BLE_MESH`

**Default value:**

- 4 if `CONFIG_BLE_MESH`

### **CONFIG\_BLE\_MESH\_IVU\_RECOVERY\_IVI**

Recovery the IV index when the latest whole IV update procedure is missed

*Found in: `Component config > CONFIG_BLE_MESH`*

According to Section 3.10.5 of Mesh Specification v1.0.1. If a node in Normal Operation receives a Secure Network beacon with an IV index equal to the last known IV index+1 and the IV Update Flag set to 0, the node may update its IV without going to the IV Update in Progress state, or it may initiate an IV Index Recovery procedure (Section 3.10.6), or it may ignore the Secure Network beacon. The node makes the choice depending on the time since last IV update and the likelihood that the node has missed the Secure Network beacons with the IV update Flag. When the above situation is encountered, this option can be used to decide whether to perform the IV index recovery procedure.

**Default value:**

- No (disabled) if `CONFIG_BLE_MESH`

### **CONFIG\_BLE\_MESH\_TX\_SEG\_MSG\_COUNT**

Maximum number of simultaneous outgoing segmented messages

*Found in: `Component config > CONFIG_BLE_MESH`*

Maximum number of simultaneous outgoing multi-segment and/or reliable messages. The default value is 1, which means the device can only send one segmented message at a time. And if another segmented message is going to be sent, it should wait for the completion of the previous one. If users are going to send multiple segmented messages at the same time, this value should be configured properly.

**Range:**

- from 1 to if `CONFIG_BLE_MESH`

**Default value:**

- 1 if `CONFIG_BLE_MESH`

### **CONFIG\_BLE\_MESH\_RX\_SEG\_MSG\_COUNT**

Maximum number of simultaneous incoming segmented messages

*Found in: `Component config > CONFIG_BLE_MESH`*

Maximum number of simultaneous incoming multi-segment and/or reliable messages. The default value is 1, which means the device can only receive one segmented message at a time. And if another segmented message is going to be received, it should wait for the completion of the previous one. If users are going to receive multiple segmented messages at the same time, this value should be configured properly.

**Range:**

- from 1 to 255 if `CONFIG_BLE_MESH`

**Default value:**

- 1 if `CONFIG_BLE_MESH`

### **CONFIG\_BLE\_MESH\_RX\_SDU\_MAX**

Maximum incoming Upper Transport Access PDU length

*Found in: [Component config](#) > [CONFIG\\_BLE\\_MESH](#)*

Maximum incoming Upper Transport Access PDU length. Leave this to the default value, unless you really need to optimize memory usage.

**Range:**

- from 36 to 384 if [CONFIG\\_BLE\\_MESH](#)

**Default value:**

- 384 if [CONFIG\\_BLE\\_MESH](#)

### **CONFIG\_BLE\_MESH\_TX\_SEG\_MAX**

Maximum number of segments in outgoing messages

*Found in: [Component config](#) > [CONFIG\\_BLE\\_MESH](#)*

Maximum number of segments supported for outgoing messages. This value should typically be fine-tuned based on what models the local node supports, i.e. what's the largest message payload that the node needs to be able to send. This value affects memory and call stack consumption, which is why the default is lower than the maximum that the specification would allow (32 segments).

The maximum outgoing SDU size is 12 times this number (out of which 4 or 8 bytes is used for the Transport Layer MIC). For example, 5 segments means the maximum SDU size is 60 bytes, which leaves 56 bytes for application layer data using a 4-byte MIC and 52 bytes using an 8-byte MIC.

Be sure to specify a sufficient number of advertising buffers when setting this option to a higher value. There must be at least three more advertising buffers ([BLE\\_MESH\\_ADV\\_BUF\\_COUNT](#)) as there are outgoing segments.

**Range:**

- from 2 to 32 if [CONFIG\\_BLE\\_MESH](#)

**Default value:**

- 32 if [CONFIG\\_BLE\\_MESH](#)

### **CONFIG\_BLE\_MESH\_RELAY**

Relay support

*Found in: [Component config](#) > [CONFIG\\_BLE\\_MESH](#)*

Support for acting as a Mesh Relay Node. Enabling this option will allow a node to support the Relay feature, and the Relay feature can still be enabled or disabled by proper configuration messages. Disabling this option will let a node not support the Relay feature.

**Default value:**

- Yes (enabled) if [CONFIG\\_BLE\\_MESH\\_NODE](#) && [CONFIG\\_BLE\\_MESH](#)

### **CONFIG\_BLE\_MESH\_RELAY\_ADV\_BUF**

Use separate advertising buffers for relay packets

*Found in: [Component config](#) > [CONFIG\\_BLE\\_MESH](#) > [CONFIG\\_BLE\\_MESH\\_RELAY](#)*

When selected, self-send packets will be put in a high-priority queue and relay packets will be put in a low-priority queue.

**Default value:**

- No (disabled) if [CONFIG\\_BLE\\_MESH\\_RELAY](#) && [CONFIG\\_BLE\\_MESH](#)

### CONFIG\_BLE\_MESH\_RELAY\_ADV\_BUF\_COUNT

Number of advertising buffers for relay packets

*Found in:* *Component config* > *CONFIG\_BLE\_MESH* > *CONFIG\_BLE\_MESH\_RELAY* > *CONFIG\_BLE\_MESH\_RELAY\_ADV\_BUF*

Number of advertising buffers for relay packets available.

**Range:**

- from 6 to 256 if *CONFIG\_BLE\_MESH\_RELAY\_ADV\_BUF* && *CONFIG\_BLE\_MESH\_RELAY* && *CONFIG\_BLE\_MESH*

**Default value:**

- 60 if *CONFIG\_BLE\_MESH\_RELAY\_ADV\_BUF* && *CONFIG\_BLE\_MESH\_RELAY* && *CONFIG\_BLE\_MESH*

### CONFIG\_BLE\_MESH\_LOW\_POWER

Support for Low Power features

*Found in:* *Component config* > *CONFIG\_BLE\_MESH*

Enable this option to operate as a Low Power Node. If low power consumption is required by a node, this option should be enabled. And once the node enters the mesh network, it will try to find a Friend node and establish a friendship.

### CONFIG\_BLE\_MESH\_LPN\_ESTABLISHMENT

Perform Friendship establishment using low power

*Found in:* *Component config* > *CONFIG\_BLE\_MESH* > *CONFIG\_BLE\_MESH\_LOW\_POWER*

Perform the Friendship establishment using low power with the help of a reduced scan duty cycle. The downside of this is that the node may miss out on messages intended for it until it has successfully set up Friendship with a Friend node. When this option is enabled, the node will stop scanning for a period of time after a Friend Request or Friend Poll is sent, so as to reduce more power consumption.

**Default value:**

- No (disabled) if *CONFIG\_BLE\_MESH\_LOW\_POWER* && *CONFIG\_BLE\_MESH*

### CONFIG\_BLE\_MESH\_LPN\_AUTO

Automatically start looking for Friend nodes once provisioned

*Found in:* *Component config* > *CONFIG\_BLE\_MESH* > *CONFIG\_BLE\_MESH\_LOW\_POWER*

Once provisioned, automatically enable LPN functionality and start looking for Friend nodes. If this option is disabled LPN mode needs to be manually enabled by calling `bt_mesh_lpn_set(true)`. When an unprovisioned device is provisioned successfully and becomes a node, enabling this option will trigger the node starts to send Friend Request at a certain period until it finds a proper Friend node.

**Default value:**

- No (disabled) if *CONFIG\_BLE\_MESH\_LOW\_POWER* && *CONFIG\_BLE\_MESH*

### CONFIG\_BLE\_MESH\_LPN\_AUTO\_TIMEOUT

Time from last received message before going to LPN mode

*Found in:* *Component config* > *CONFIG\_BLE\_MESH* > *CONFIG\_BLE\_MESH\_LOW\_POWER* > *CONFIG\_BLE\_MESH\_LPN\_AUTO*

Time in seconds from the last received message, that the node waits out before starting to look for Friend nodes.

**Range:**

- from 0 to 3600 if `CONFIG_BLE_MESH_LPN_AUTO` && `CONFIG_BLE_MESH_LOW_POWER` && `CONFIG_BLE_MESH`

**Default value:**

- 15 if `CONFIG_BLE_MESH_LPN_AUTO` && `CONFIG_BLE_MESH_LOW_POWER` && `CONFIG_BLE_MESH`

### **CONFIG\_BLE\_MESH\_LPN\_RETRY\_TIMEOUT**

Retry timeout for Friend requests

*Found in:* `Component config` > `CONFIG_BLE_MESH` > `CONFIG_BLE_MESH_LOW_POWER`

Time in seconds between Friend Requests, if a previous Friend Request did not yield any acceptable Friend Offers.

**Range:**

- from 1 to 3600 if `CONFIG_BLE_MESH_LOW_POWER` && `CONFIG_BLE_MESH`

**Default value:**

- 6 if `CONFIG_BLE_MESH_LOW_POWER` && `CONFIG_BLE_MESH`

### **CONFIG\_BLE\_MESH\_LPN\_RSSI\_FACTOR**

RSSIFactor, used in Friend Offer Delay calculation

*Found in:* `Component config` > `CONFIG_BLE_MESH` > `CONFIG_BLE_MESH_LOW_POWER`

The contribution of the RSSI, measured by the Friend node, used in Friend Offer Delay calculations. 0 = 1, 1 = 1.5, 2 = 2, 3 = 2.5. RSSIFactor, one of the parameters carried by Friend Request sent by Low Power node, which is used to calculate the Friend Offer Delay.

**Range:**

- from 0 to 3 if `CONFIG_BLE_MESH_LOW_POWER` && `CONFIG_BLE_MESH`

**Default value:**

- 0 if `CONFIG_BLE_MESH_LOW_POWER` && `CONFIG_BLE_MESH`

### **CONFIG\_BLE\_MESH\_LPN\_RECV\_WIN\_FACTOR**

ReceiveWindowFactor, used in Friend Offer Delay calculation

*Found in:* `Component config` > `CONFIG_BLE_MESH` > `CONFIG_BLE_MESH_LOW_POWER`

The contribution of the supported Receive Window used in Friend Offer Delay calculations. 0 = 1, 1 = 1.5, 2 = 2, 3 = 2.5. ReceiveWindowFactor, one of the parameters carried by Friend Request sent by Low Power node, which is used to calculate the Friend Offer Delay.

**Range:**

- from 0 to 3 if `CONFIG_BLE_MESH_LOW_POWER` && `CONFIG_BLE_MESH`

**Default value:**

- 0 if `CONFIG_BLE_MESH_LOW_POWER` && `CONFIG_BLE_MESH`

### **CONFIG\_BLE\_MESH\_LPN\_MIN\_QUEUE\_SIZE**

Minimum size of the acceptable friend queue (MinQueueSizeLog)

*Found in:* `Component config` > `CONFIG_BLE_MESH` > `CONFIG_BLE_MESH_LOW_POWER`

The MinQueueSizeLog field is defined as  $\log_2(N)$ , where N is the minimum number of maximum size Lower Transport PDUs that the Friend node can store in its Friend Queue. As an example, MinQueueSizeLog value 1 gives N = 2, and value 7 gives N = 128.

**Range:**

- from 1 to 7 if `CONFIG_BLE_MESH_LOW_POWER` && `CONFIG_BLE_MESH`

**Default value:**

- 1 if `CONFIG_BLE_MESH_LOW_POWER` && `CONFIG_BLE_MESH`

### **CONFIG\_BLE\_MESH\_LPN\_RECV\_DELAY**

Receive delay requested by the local node

*Found in: Component config > CONFIG\_BLE\_MESH > CONFIG\_BLE\_MESH\_LOW\_POWER*

The ReceiveDelay is the time between the Low Power node sending a request and listening for a response. This delay allows the Friend node time to prepare the response. The value is in units of milliseconds.

**Range:**

- from 10 to 255 if `CONFIG_BLE_MESH_LOW_POWER` && `CONFIG_BLE_MESH`

**Default value:**

- 100 if `CONFIG_BLE_MESH_LOW_POWER` && `CONFIG_BLE_MESH`

### **CONFIG\_BLE\_MESH\_LPN\_POLL\_TIMEOUT**

The value of the PollTimeout timer

*Found in: Component config > CONFIG\_BLE\_MESH > CONFIG\_BLE\_MESH\_LOW\_POWER*

PollTimeout timer is used to measure time between two consecutive requests sent by a Low Power node. If no requests are received the Friend node before the PollTimeout timer expires, then the friendship is considered terminated. The value is in units of 100 milliseconds, so e.g. a value of 300 means 30 seconds. The smaller the value, the faster the Low Power node tries to get messages from corresponding Friend node and vice versa.

**Range:**

- from 10 to 244735 if `CONFIG_BLE_MESH_LOW_POWER` && `CONFIG_BLE_MESH`

**Default value:**

- 300 if `CONFIG_BLE_MESH_LOW_POWER` && `CONFIG_BLE_MESH`

### **CONFIG\_BLE\_MESH\_LPN\_INIT\_POLL\_TIMEOUT**

The starting value of the PollTimeout timer

*Found in: Component config > CONFIG\_BLE\_MESH > CONFIG\_BLE\_MESH\_LOW\_POWER*

The initial value of the PollTimeout timer when Friendship is to be established for the first time. After this, the timeout gradually grows toward the actual PollTimeout, doubling in value for each iteration. The value is in units of 100 milliseconds, so e.g. a value of 300 means 30 seconds.

**Range:**

- from 10 to if `CONFIG_BLE_MESH_LOW_POWER` && `CONFIG_BLE_MESH`

**Default value:**

- if `CONFIG_BLE_MESH_LOW_POWER` && `CONFIG_BLE_MESH`

### **CONFIG\_BLE\_MESH\_LPN\_SCAN\_LATENCY**

Latency for enabling scanning

*Found in: Component config > CONFIG\_BLE\_MESH > CONFIG\_BLE\_MESH\_LOW\_POWER*

Latency (in milliseconds) is the time it takes to enable scanning. In practice, it means how much time in advance of the Receive Window, the request to enable scanning is made.

**Range:**

- from 0 to 50 if `CONFIG_BLE_MESH_LOW_POWER` && `CONFIG_BLE_MESH`

**Default value:**

- 10 if `CONFIG_BLE_MESH_LOW_POWER` && `CONFIG_BLE_MESH`

### CONFIG\_BLE\_MESH\_LPN\_GROUPS

Number of groups the LPN can subscribe to

*Found in: Component config > CONFIG\_BLE\_MESH > CONFIG\_BLE\_MESH\_LOW\_POWER*

Maximum number of groups to which the LPN can subscribe.

**Range:**

- from 0 to 16384 if *CONFIG\_BLE\_MESH\_LOW\_POWER* && *CONFIG\_BLE\_MESH*

**Default value:**

- 8 if *CONFIG\_BLE\_MESH\_LOW\_POWER* && *CONFIG\_BLE\_MESH*

### CONFIG\_BLE\_MESH\_LPN\_SUB\_ALL\_NODES\_ADDR

Automatically subscribe all nodes address

*Found in: Component config > CONFIG\_BLE\_MESH > CONFIG\_BLE\_MESH\_LOW\_POWER*

Automatically subscribe all nodes address when friendship established.

**Default value:**

- No (disabled) if *CONFIG\_BLE\_MESH\_LOW\_POWER* && *CONFIG\_BLE\_MESH*

### CONFIG\_BLE\_MESH\_FRIEND

Support for Friend feature

*Found in: Component config > CONFIG\_BLE\_MESH*

Enable this option to be able to act as a Friend Node.

### CONFIG\_BLE\_MESH\_FRIEND\_RECV\_WIN

Friend Receive Window

*Found in: Component config > CONFIG\_BLE\_MESH > CONFIG\_BLE\_MESH\_FRIEND*

Receive Window in milliseconds supported by the Friend node.

**Range:**

- from 1 to 255 if *CONFIG\_BLE\_MESH\_FRIEND* && *CONFIG\_BLE\_MESH*

**Default value:**

- 255 if *CONFIG\_BLE\_MESH\_FRIEND* && *CONFIG\_BLE\_MESH*

### CONFIG\_BLE\_MESH\_FRIEND\_QUEUE\_SIZE

Minimum number of buffers supported per Friend Queue

*Found in: Component config > CONFIG\_BLE\_MESH > CONFIG\_BLE\_MESH\_FRIEND*

Minimum number of buffers available to be stored for each local Friend Queue. This option decides the size of each buffer which can be used by a Friend node to store messages for each Low Power node.

**Range:**

- from 2 to 65536 if *CONFIG\_BLE\_MESH\_FRIEND* && *CONFIG\_BLE\_MESH*

**Default value:**

- 16 if *CONFIG\_BLE\_MESH\_FRIEND* && *CONFIG\_BLE\_MESH*

### CONFIG\_BLE\_MESH\_FRIEND\_SUB\_LIST\_SIZE

Friend Subscription List Size

*Found in: Component config > CONFIG\_BLE\_MESH > CONFIG\_BLE\_MESH\_FRIEND*

Size of the Subscription List that can be supported by a Friend node for a Low Power node. And Low Power node can send Friend Subscription List Add or Friend Subscription List Remove messages to the Friend node to add or remove subscription addresses.

**Range:**

- from 0 to 1023 if *CONFIG\_BLE\_MESH\_FRIEND* && *CONFIG\_BLE\_MESH*

**Default value:**

- 3 if *CONFIG\_BLE\_MESH\_FRIEND* && *CONFIG\_BLE\_MESH*

### CONFIG\_BLE\_MESH\_FRIEND\_LPN\_COUNT

Number of supported LPN nodes

*Found in: Component config > CONFIG\_BLE\_MESH > CONFIG\_BLE\_MESH\_FRIEND*

Number of Low Power Nodes with which a Friend can have Friendship simultaneously. A Friend node can have friendship with multiple Low Power nodes at the same time, while a Low Power node can only establish friendship with only one Friend node at the same time.

**Range:**

- from 1 to 1000 if *CONFIG\_BLE\_MESH\_FRIEND* && *CONFIG\_BLE\_MESH*

**Default value:**

- 2 if *CONFIG\_BLE\_MESH\_FRIEND* && *CONFIG\_BLE\_MESH*

### CONFIG\_BLE\_MESH\_FRIEND\_SEG\_RX

Number of incomplete segment lists per LPN

*Found in: Component config > CONFIG\_BLE\_MESH > CONFIG\_BLE\_MESH\_FRIEND*

Number of incomplete segment lists tracked for each Friends' LPN. In other words, this determines from how many elements can segmented messages destined for the Friend queue be received simultaneously.

**Range:**

- from 1 to 1000 if *CONFIG\_BLE\_MESH\_FRIEND* && *CONFIG\_BLE\_MESH*

**Default value:**

- 1 if *CONFIG\_BLE\_MESH\_FRIEND* && *CONFIG\_BLE\_MESH*

### CONFIG\_BLE\_MESH\_NO\_LOG

Disable BLE Mesh debug logs (minimize bin size)

*Found in: Component config > CONFIG\_BLE\_MESH*

Select this to save the BLE Mesh related rodata code size. Enabling this option will disable the output of BLE Mesh debug log.

**Default value:**

- No (disabled) if *CONFIG\_BLE\_MESH* && *CONFIG\_BLE\_MESH*

### BLE Mesh STACK DEBUG LOG LEVEL

 Contains:

- *CONFIG\_BLE\_MESH\_STACK\_TRACE\_LEVEL*



## CONFIG\_BLE\_MESH\_STACK\_TRACE\_LEVEL

BLE\_MESH\_STACK

Found in: *Component config* > *CONFIG\_BLE\_MESH* > *BLE Mesh STACK DEBUG LOG LEVEL*

Define BLE Mesh trace level for BLE Mesh stack.

### Available options:

- NONE (BLE\_MESH\_TRACE\_LEVEL\_NONE)
- ERROR (BLE\_MESH\_TRACE\_LEVEL\_ERROR)
- WARNING (BLE\_MESH\_TRACE\_LEVEL\_WARNING)
- INFO (BLE\_MESH\_TRACE\_LEVEL\_INFO)
- DEBUG (BLE\_MESH\_TRACE\_LEVEL\_DEBUG)
- VERBOSE (BLE\_MESH\_TRACE\_LEVEL\_VERBOSE)

## BLE Mesh NET BUF DEBUG LOG LEVEL

 Contains:

- *CONFIG\_BLE\_MESH\_NET\_BUF\_TRACE\_LEVEL*

## CONFIG\_BLE\_MESH\_NET\_BUF\_TRACE\_LEVEL

BLE\_MESH\_NET\_BUF

Found in: *Component config* > *CONFIG\_BLE\_MESH* > *BLE Mesh NET BUF DEBUG LOG LEVEL*

Define BLE Mesh trace level for BLE Mesh net buffer.

### Available options:

- NONE (BLE\_MESH\_NET\_BUF\_TRACE\_LEVEL\_NONE)
- ERROR (BLE\_MESH\_NET\_BUF\_TRACE\_LEVEL\_ERROR)
- WARNING (BLE\_MESH\_NET\_BUF\_TRACE\_LEVEL\_WARNING)
- INFO (BLE\_MESH\_NET\_BUF\_TRACE\_LEVEL\_INFO)
- DEBUG (BLE\_MESH\_NET\_BUF\_TRACE\_LEVEL\_DEBUG)
- VERBOSE (BLE\_MESH\_NET\_BUF\_TRACE\_LEVEL\_VERBOSE)

## CONFIG\_BLE\_MESH\_CLIENT\_MSG\_TIMEOUT

Timeout(ms) for client message response

Found in: *Component config* > *CONFIG\_BLE\_MESH*

Timeout value used by the node to get response of the acknowledged message which is sent by the client model. This value indicates the maximum time that a client model waits for the response of the sent acknowledged messages. If a client model uses 0 as the timeout value when sending acknowledged messages, then the default value will be used which is four seconds.

### Range:

- from 100 to 1200000 if *CONFIG\_BLE\_MESH*

### Default value:

- 4000 if *CONFIG\_BLE\_MESH*

## Support for BLE Mesh Foundation models

 Contains:

- *CONFIG\_BLE\_MESH\_CFG\_CLI*
- *CONFIG\_BLE\_MESH\_HEALTH\_CLI*
- *CONFIG\_BLE\_MESH\_HEALTH\_SRV*



### **CONFIG\_BLE\_MESH\_CFG\_CLI**

Configuration Client model

*Found in: Component config > CONFIG\_BLE\_MESH > Support for BLE Mesh Foundation models*

Enable support for Configuration Client model.

### **CONFIG\_BLE\_MESH\_HEALTH\_CLI**

Health Client model

*Found in: Component config > CONFIG\_BLE\_MESH > Support for BLE Mesh Foundation models*

Enable support for Health Client model.

### **CONFIG\_BLE\_MESH\_HEALTH\_SRV**

Health Server model

*Found in: Component config > CONFIG\_BLE\_MESH > Support for BLE Mesh Foundation models*

Enable support for Health Server model.

#### **Default value:**

- Yes (enabled) if *CONFIG\_BLE\_MESH*

#### **Support for BLE Mesh Client/Server models** Contains:

- *CONFIG\_BLE\_MESH\_GENERIC\_BATTERY\_CLI*
- *CONFIG\_BLE\_MESH\_GENERIC\_DEF\_TRANS\_TIME\_CLI*
- *CONFIG\_BLE\_MESH\_GENERIC\_LEVEL\_CLI*
- *CONFIG\_BLE\_MESH\_GENERIC\_LOCATION\_CLI*
- *CONFIG\_BLE\_MESH\_GENERIC\_ONOFF\_CLI*
- *CONFIG\_BLE\_MESH\_GENERIC\_POWER\_LEVEL\_CLI*
- *CONFIG\_BLE\_MESH\_GENERIC\_POWER\_ONOFF\_CLI*
- *CONFIG\_BLE\_MESH\_GENERIC\_PROPERTY\_CLI*
- *CONFIG\_BLE\_MESH\_GENERIC\_SERVER*
- *CONFIG\_BLE\_MESH\_LIGHT\_CTL\_CLI*
- *CONFIG\_BLE\_MESH\_LIGHT\_HSL\_CLI*
- *CONFIG\_BLE\_MESH\_LIGHT\_LC\_CLI*
- *CONFIG\_BLE\_MESH\_LIGHT\_LIGHTNESS\_CLI*
- *CONFIG\_BLE\_MESH\_LIGHT\_XYL\_CLI*
- *CONFIG\_BLE\_MESH\_LIGHTING\_SERVER*
- *CONFIG\_BLE\_MESH\_SCENE\_CLI*
- *CONFIG\_BLE\_MESH\_SCHEDULER\_CLI*
- *CONFIG\_BLE\_MESH\_SENSOR\_CLI*
- *CONFIG\_BLE\_MESH\_SENSOR\_SERVER*
- *CONFIG\_BLE\_MESH\_TIME\_SCENE\_SERVER*
- *CONFIG\_BLE\_MESH\_TIME\_CLI*

### **CONFIG\_BLE\_MESH\_GENERIC\_ONOFF\_CLI**

Generic OnOff Client model

*Found in: Component config > CONFIG\_BLE\_MESH > Support for BLE Mesh Client/Server models*

Enable support for Generic OnOff Client model.

### **CONFIG\_BLE\_MESH\_GENERIC\_LEVEL\_CLI**

Generic Level Client model

*Found in: [Component config](#) > [CONFIG\\_BLE\\_MESH](#) > [Support for BLE Mesh Client/Server models](#)*

Enable support for Generic Level Client model.

### **CONFIG\_BLE\_MESH\_GENERIC\_DEF\_TRANS\_TIME\_CLI**

Generic Default Transition Time Client model

*Found in: [Component config](#) > [CONFIG\\_BLE\\_MESH](#) > [Support for BLE Mesh Client/Server models](#)*

Enable support for Generic Default Transition Time Client model.

### **CONFIG\_BLE\_MESH\_GENERIC\_POWER\_ONOFF\_CLI**

Generic Power OnOff Client model

*Found in: [Component config](#) > [CONFIG\\_BLE\\_MESH](#) > [Support for BLE Mesh Client/Server models](#)*

Enable support for Generic Power OnOff Client model.

### **CONFIG\_BLE\_MESH\_GENERIC\_POWER\_LEVEL\_CLI**

Generic Power Level Client model

*Found in: [Component config](#) > [CONFIG\\_BLE\\_MESH](#) > [Support for BLE Mesh Client/Server models](#)*

Enable support for Generic Power Level Client model.

### **CONFIG\_BLE\_MESH\_GENERIC\_BATTERY\_CLI**

Generic Battery Client model

*Found in: [Component config](#) > [CONFIG\\_BLE\\_MESH](#) > [Support for BLE Mesh Client/Server models](#)*

Enable support for Generic Battery Client model.

### **CONFIG\_BLE\_MESH\_GENERIC\_LOCATION\_CLI**

Generic Location Client model

*Found in: [Component config](#) > [CONFIG\\_BLE\\_MESH](#) > [Support for BLE Mesh Client/Server models](#)*

Enable support for Generic Location Client model.

### **CONFIG\_BLE\_MESH\_GENERIC\_PROPERTY\_CLI**

Generic Property Client model

*Found in: [Component config](#) > [CONFIG\\_BLE\\_MESH](#) > [Support for BLE Mesh Client/Server models](#)*

Enable support for Generic Property Client model.

### **CONFIG\_BLE\_MESH\_SENSOR\_CLI**

Sensor Client model

*Found in: [Component config](#) > [CONFIG\\_BLE\\_MESH](#) > [Support for BLE Mesh Client/Server models](#)*

Enable support for Sensor Client model.

### **CONFIG\_BLE\_MESH\_TIME\_CLI**

Time Client model

*Found in: [Component config](#) > [CONFIG\\_BLE\\_MESH](#) > [Support for BLE Mesh Client/Server models](#)*

Enable support for Time Client model.

### **CONFIG\_BLE\_MESH\_SCENE\_CLI**

Scene Client model

*Found in: [Component config](#) > [CONFIG\\_BLE\\_MESH](#) > [Support for BLE Mesh Client/Server models](#)*

Enable support for Scene Client model.

### **CONFIG\_BLE\_MESH\_SCHEDULER\_CLI**

Scheduler Client model

*Found in: [Component config](#) > [CONFIG\\_BLE\\_MESH](#) > [Support for BLE Mesh Client/Server models](#)*

Enable support for Scheduler Client model.

### **CONFIG\_BLE\_MESH\_LIGHT\_LIGHTNESS\_CLI**

Light Lightness Client model

*Found in: [Component config](#) > [CONFIG\\_BLE\\_MESH](#) > [Support for BLE Mesh Client/Server models](#)*

Enable support for Light Lightness Client model.

### **CONFIG\_BLE\_MESH\_LIGHT\_CTL\_CLI**

Light CTL Client model

*Found in: [Component config](#) > [CONFIG\\_BLE\\_MESH](#) > [Support for BLE Mesh Client/Server models](#)*

Enable support for Light CTL Client model.

### **CONFIG\_BLE\_MESH\_LIGHT\_HSL\_CLI**

Light HSL Client model

*Found in: [Component config](#) > [CONFIG\\_BLE\\_MESH](#) > [Support for BLE Mesh Client/Server models](#)*

Enable support for Light HSL Client model.

### **CONFIG\_BLE\_MESH\_LIGHT\_XYL\_CLI**

Light XYL Client model

*Found in: [Component config](#) > [CONFIG\\_BLE\\_MESH](#) > [Support for BLE Mesh Client/Server models](#)*

Enable support for Light XYL Client model.

### **CONFIG\_BLE\_MESH\_LIGHT\_LC\_CLI**

Light LC Client model

*Found in: [Component config](#) > [CONFIG\\_BLE\\_MESH](#) > [Support for BLE Mesh Client/Server models](#)*

Enable support for Light LC Client model.

### CONFIG\_BLE\_MESH\_GENERIC\_SERVER

Generic server models

*Found in: Component config > CONFIG\_BLE\_MESH > Support for BLE Mesh Client/Server models*

Enable support for Generic server models.

**Default value:**

- Yes (enabled) if *CONFIG\_BLE\_MESH*

### CONFIG\_BLE\_MESH\_SENSOR\_SERVER

Sensor server models

*Found in: Component config > CONFIG\_BLE\_MESH > Support for BLE Mesh Client/Server models*

Enable support for Sensor server models.

**Default value:**

- Yes (enabled) if *CONFIG\_BLE\_MESH*

### CONFIG\_BLE\_MESH\_TIME\_SCENE\_SERVER

Time and Scenes server models

*Found in: Component config > CONFIG\_BLE\_MESH > Support for BLE Mesh Client/Server models*

Enable support for Time and Scenes server models.

**Default value:**

- Yes (enabled) if *CONFIG\_BLE\_MESH*

### CONFIG\_BLE\_MESH\_LIGHTING\_SERVER

Lighting server models

*Found in: Component config > CONFIG\_BLE\_MESH > Support for BLE Mesh Client/Server models*

Enable support for Lighting server models.

**Default value:**

- Yes (enabled) if *CONFIG\_BLE\_MESH*

### CONFIG\_BLE\_MESH\_IV\_UPDATE\_TEST

Test the IV Update Procedure

*Found in: Component config > CONFIG\_BLE\_MESH*

This option removes the 96 hour limit of the IV Update Procedure and lets the state to be changed at any time. If IV Update test mode is going to be used, this option should be enabled.

**Default value:**

- No (disabled) if *CONFIG\_BLE\_MESH*

**BLE Mesh specific test option** Contains:

- *CONFIG\_BLE\_MESH\_DEBUG*
- *CONFIG\_BLE\_MESH\_SHELL*
- *CONFIG\_BLE\_MESH\_BQB\_TEST*
- *CONFIG\_BLE\_MESH\_SELF\_TEST*
- *CONFIG\_BLE\_MESH\_TEST\_AUTO\_ENTER\_NETWORK*
- *CONFIG\_BLE\_MESH\_TEST\_USE\_WHITE\_LIST*

### CONFIG\_BLE\_MESH\_SELF\_TEST

Perform BLE Mesh self-tests

*Found in: Component config > CONFIG\_BLE\_MESH > BLE Mesh specific test option*

This option adds extra self-tests which are run every time BLE Mesh networking is initialized.

**Default value:**

- No (disabled) if *CONFIG\_BLE\_MESH*

### CONFIG\_BLE\_MESH\_BQB\_TEST

Enable BLE Mesh specific internal test

*Found in: Component config > CONFIG\_BLE\_MESH > BLE Mesh specific test option*

This option is used to enable some internal functions for auto-pts test.

**Default value:**

- No (disabled) if *CONFIG\_BLE\_MESH*

### CONFIG\_BLE\_MESH\_TEST\_AUTO\_ENTER\_NETWORK

Unprovisioned device enters mesh network automatically

*Found in: Component config > CONFIG\_BLE\_MESH > BLE Mesh specific test option*

With this option enabled, an unprovisioned device can automatically enters mesh network using a specific test function without the provisioning procedure. And on the Provisioner side, a test function needs to be invoked to add the node information into the mesh stack.

**Default value:**

- Yes (enabled) if *CONFIG\_BLE\_MESH\_SELF\_TEST* && *CONFIG\_BLE\_MESH*

### CONFIG\_BLE\_MESH\_TEST\_USE\_WHITE\_LIST

Use white list to filter mesh advertising packets

*Found in: Component config > CONFIG\_BLE\_MESH > BLE Mesh specific test option*

With this option enabled, users can use white list to filter mesh advertising packets while scanning.

**Default value:**

- No (disabled) if *CONFIG\_BLE\_MESH\_SELF\_TEST* && *CONFIG\_BLE\_MESH*

### CONFIG\_BLE\_MESH\_SHELL

Enable BLE Mesh shell

*Found in: Component config > CONFIG\_BLE\_MESH > BLE Mesh specific test option*

Activate shell module that provides BLE Mesh commands to the console.

**Default value:**

- No (disabled) if *CONFIG\_BLE\_MESH*

### CONFIG\_BLE\_MESH\_DEBUG

Enable BLE Mesh debug logs

*Found in: Component config > CONFIG\_BLE\_MESH > BLE Mesh specific test option*

Enable debug logs for the BLE Mesh functionality.

**Default value:**

- No (disabled) if *CONFIG\_BLE\_MESH*

### **CONFIG\_BLE\_MESH\_DEBUG\_NET**

Network layer debug

*Found in: Component config > CONFIG\_BLE\_MESH > BLE Mesh specific test option > CONFIG\_BLE\_MESH\_DEBUG*

Enable Network layer debug logs for the BLE Mesh functionality.

### **CONFIG\_BLE\_MESH\_DEBUG\_TRANS**

Transport layer debug

*Found in: Component config > CONFIG\_BLE\_MESH > BLE Mesh specific test option > CONFIG\_BLE\_MESH\_DEBUG*

Enable Transport layer debug logs for the BLE Mesh functionality.

### **CONFIG\_BLE\_MESH\_DEBUG\_BEACON**

Beacon debug

*Found in: Component config > CONFIG\_BLE\_MESH > BLE Mesh specific test option > CONFIG\_BLE\_MESH\_DEBUG*

Enable Beacon-related debug logs for the BLE Mesh functionality.

### **CONFIG\_BLE\_MESH\_DEBUG\_CRYPTO**

Crypto debug

*Found in: Component config > CONFIG\_BLE\_MESH > BLE Mesh specific test option > CONFIG\_BLE\_MESH\_DEBUG*

Enable cryptographic debug logs for the BLE Mesh functionality.

### **CONFIG\_BLE\_MESH\_DEBUG\_PROV**

Provisioning debug

*Found in: Component config > CONFIG\_BLE\_MESH > BLE Mesh specific test option > CONFIG\_BLE\_MESH\_DEBUG*

Enable Provisioning debug logs for the BLE Mesh functionality.

### **CONFIG\_BLE\_MESH\_DEBUG\_ACCESS**

Access layer debug

*Found in: Component config > CONFIG\_BLE\_MESH > BLE Mesh specific test option > CONFIG\_BLE\_MESH\_DEBUG*

Enable Access layer debug logs for the BLE Mesh functionality.

### **CONFIG\_BLE\_MESH\_DEBUG\_MODEL**

Foundation model debug

*Found in: Component config > CONFIG\_BLE\_MESH > BLE Mesh specific test option > CONFIG\_BLE\_MESH\_DEBUG*

Enable Foundation Models debug logs for the BLE Mesh functionality.

**CONFIG\_BLE\_MESH\_DEBUG\_ADV**

Advertising debug

*Found in:* [Component config](#) > [CONFIG\\_BLE\\_MESH](#) > [BLE Mesh specific test option](#) > [CONFIG\\_BLE\\_MESH\\_DEBUG](#)

Enable advertising debug logs for the BLE Mesh functionality.

**CONFIG\_BLE\_MESH\_DEBUG\_LOW\_POWER**

Low Power debug

*Found in:* [Component config](#) > [CONFIG\\_BLE\\_MESH](#) > [BLE Mesh specific test option](#) > [CONFIG\\_BLE\\_MESH\\_DEBUG](#)

Enable Low Power debug logs for the BLE Mesh functionality.

**CONFIG\_BLE\_MESH\_DEBUG\_FRIEND**

Friend debug

*Found in:* [Component config](#) > [CONFIG\\_BLE\\_MESH](#) > [BLE Mesh specific test option](#) > [CONFIG\\_BLE\\_MESH\\_DEBUG](#)

Enable Friend debug logs for the BLE Mesh functionality.

**CONFIG\_BLE\_MESH\_DEBUG\_PROXY**

Proxy debug

*Found in:* [Component config](#) > [CONFIG\\_BLE\\_MESH](#) > [BLE Mesh specific test option](#) > [CONFIG\\_BLE\\_MESH\\_DEBUG](#)

Enable Proxy protocol debug logs for the BLE Mesh functionality.

**CONFIG\_BLE\_MESH\_EXPERIMENTAL**

Make BLE Mesh experimental features visible

*Found in:* [Component config](#) > [CONFIG\\_BLE\\_MESH](#)

Make BLE Mesh Experimental features visible. Experimental features list: - [CONFIG\\_BLE\\_MESH\\_NOT\\_RELAY\\_REPLAY\\_MSG](#)

**Default value:**

- No (disabled) if [CONFIG\\_BLE\\_MESH](#)

**Driver Configurations** Contains:

- [GPIO Configuration](#)
- [GPTimer Configuration](#)
- [I2S Configuration](#)
- [Legacy ADC Configuration](#)
- [MCPWM Configuration](#)
- [PCNT Configuration](#)
- [RMT Configuration](#)
- [Sigma Delta Modulator Configuration](#)
- [SPI Configuration](#)
- [Temperature sensor Configuration](#)
- [TWAI Configuration](#)
- [UART Configuration](#)

**Legacy ADC Configuration** Contains:

- [CONFIG\\_ADC\\_DISABLE\\_DAC](#)
- [Legacy ADC Calibration Configuration](#)
- [CONFIG\\_ADC\\_SUPPRESS\\_DEPRECATED\\_WARN](#)

**CONFIG\_ADC\_DISABLE\_DAC**

Disable DAC when ADC2 is used on GPIO 25 and 26

*Found in: [Component config](#) > [Driver Configurations](#) > [Legacy ADC Configuration](#)*

If this is set, the ADC2 driver will disable the output of the DAC corresponding to the specified channel. This is the default value.

For testing, disable this option so that we can measure the output of DAC by internal ADC.

**Default value:**

- Yes (enabled)

**CONFIG\_ADC\_SUPPRESS\_DEPRECATED\_WARN**

Suppress legacy driver deprecated warning

*Found in: [Component config](#) > [Driver Configurations](#) > [Legacy ADC Configuration](#)*

Whether to suppress the deprecation warnings when using legacy adc driver (driver/adc.h). If you want to continue using the legacy driver, and don't want to see related deprecation warnings, you can enable this option.

**Default value:**

- No (disabled)

**Legacy ADC Calibration Configuration** Contains:

- [CONFIG\\_ADC\\_CALI\\_SUPPRESS\\_DEPRECATED\\_WARN](#)

**CONFIG\_ADC\_CALI\_SUPPRESS\_DEPRECATED\_WARN**

Suppress legacy driver deprecated warning

*Found in: [Component config](#) > [Driver Configurations](#) > [Legacy ADC Configuration](#) > [Legacy ADC Calibration Configuration](#)*

Whether to suppress the deprecation warnings when using legacy adc calibration driver (esp\_adc\_cal.h). If you want to continue using the legacy driver, and don't want to see related deprecation warnings, you can enable this option.

**Default value:**

- No (disabled)

**SPI Configuration** Contains:

- [CONFIG\\_SPI\\_MASTER\\_ISR\\_IN\\_IRAM](#)
- [CONFIG\\_SPI\\_SLAVE\\_ISR\\_IN\\_IRAM](#)
- [CONFIG\\_SPI\\_MASTER\\_IN\\_IRAM](#)
- [CONFIG\\_SPI\\_SLAVE\\_IN\\_IRAM](#)



### CONFIG\_SPI\_MASTER\_IN\_IRAM

Place transmitting functions of SPI master into IRAM

*Found in: [Component config](#) > [Driver Configurations](#) > [SPI Configuration](#)*

Normally only the ISR of SPI master is placed in the IRAM, so that it can work without the flash when interrupt is triggered. For other functions, there's some possibility that the flash cache miss when running inside and out of SPI functions, which may increase the interval of SPI transactions. Enable this to put `queue\_trans`, `get\_trans\_result` and `transmit` functions into the IRAM to avoid possible cache miss.

During unit test, this is enabled to measure the ideal case of api.

**Default value:**

- No (disabled)

### CONFIG\_SPI\_MASTER\_ISR\_IN\_IRAM

Place SPI master ISR function into IRAM

*Found in: [Component config](#) > [Driver Configurations](#) > [SPI Configuration](#)*

Place the SPI master ISR in to IRAM to avoid possible cache miss.

Also you can forbid the ISR being disabled during flash writing access, by add `ESP_INTR_FLAG_IRAM` when initializing the driver.

**Default value:**

- Yes (enabled)

### CONFIG\_SPI\_SLAVE\_IN\_IRAM

Place transmitting functions of SPI slave into IRAM

*Found in: [Component config](#) > [Driver Configurations](#) > [SPI Configuration](#)*

Normally only the ISR of SPI slave is placed in the IRAM, so that it can work without the flash when interrupt is triggered. For other functions, there's some possibility that the flash cache miss when running inside and out of SPI functions, which may increase the interval of SPI transactions. Enable this to put `queue\_trans`, `get\_trans\_result` and `transmit` functions into the IRAM to avoid possible cache miss.

**Default value:**

- No (disabled)

### CONFIG\_SPI\_SLAVE\_ISR\_IN\_IRAM

Place SPI slave ISR function into IRAM

*Found in: [Component config](#) > [Driver Configurations](#) > [SPI Configuration](#)*

Place the SPI slave ISR in to IRAM to avoid possible cache miss.

Also you can forbid the ISR being disabled during flash writing access, by add `ESP_INTR_FLAG_IRAM` when initializing the driver.

**Default value:**

- Yes (enabled)

**TWAI Configuration** Contains:

- [CONFIG\\_TWAI\\_ERRATA\\_FIX\\_LISTEN\\_ONLY\\_DOM](#)
- [CONFIG\\_TWAI\\_ISR\\_IN\\_IRAM](#)

### CONFIG\_TWAI\_ISR\_IN\_IRAM

Place TWAI ISR function into IRAM

*Found in: [Component config](#) > [Driver Configurations](#) > [TWAI Configuration](#)*

Place the TWAI ISR in to IRAM. This will allow the ISR to avoid cache misses, and also be able to run whilst the cache is disabled (such as when writing to SPI Flash). Note that if this option is enabled: - Users should also set the ESP\_INTR\_FLAG\_IRAM in the driver configuration structure when installing the driver (see docs for specifics). - Alert logging (i.e., setting of the TWAI\_ALERT\_AND\_LOG flag) will have no effect.

**Default value:**

- No (disabled)

### CONFIG\_TWAI\_ERRATA\_FIX\_LISTEN\_ONLY\_DOM

Add SW workaround for listen only transmits dominant bit errata

*Found in: [Component config](#) > [Driver Configurations](#) > [TWAI Configuration](#)*

When in the listen only mode, the TWAI controller must not influence the TWAI bus (i.e., must not send any dominant bits). However, while in listen only mode on the ESP32/ESP32-S2/ESP32-S3/ESP32-C3, the TWAI controller will still transmit dominant bits when it detects an error (i.e., as part of an active error frame). Enabling this option will add a workaround that forces the TWAI controller into an error passive state on initialization, thus preventing any dominant bits from being sent.

**Default value:**

- Yes (enabled)

**Temperature sensor Configuration** Contains:

- [CONFIG\\_TEMP\\_SENSOR\\_ENABLE\\_DEBUG\\_LOG](#)
- [CONFIG\\_TEMP\\_SENSOR\\_SUPPRESS\\_DEPRECATED\\_WARN](#)

### CONFIG\_TEMP\_SENSOR\_SUPPRESS\_DEPRECATED\_WARN

Suppress legacy driver deprecated warning

*Found in: [Component config](#) > [Driver Configurations](#) > [Temperature sensor Configuration](#)*

Whether to suppress the deprecation warnings when using legacy temperature sensor driver (driver/temp\_sensor.h). If you want to continue using the legacy driver, and don't want to see related deprecation warnings, you can enable this option.

**Default value:**

- No (disabled)

### CONFIG\_TEMP\_SENSOR\_ENABLE\_DEBUG\_LOG

Enable debug log

*Found in: [Component config](#) > [Driver Configurations](#) > [Temperature sensor Configuration](#)*

Whether to enable the debug log message for temperature sensor driver. Note that, this option only controls the temperature sensor driver log, won't affect other drivers.

**Default value:**

- No (disabled)

**UART Configuration** Contains:

- [CONFIG\\_UART\\_ISR\\_IN\\_IRAM](#)

### CONFIG\_UART\_ISR\_IN\_IRAM

Place UART ISR function into IRAM

*Found in: [Component config](#) > [Driver Configurations](#) > [UART Configuration](#)*

If this option is not selected, UART interrupt will be disabled for a long time and may cause data lost when doing spi flash operation.

**Default value:**

- No (disabled) if [CONFIG\\_RINGBUF\\_PLACE\\_ISR\\_FUNCTIONS\\_INTO\\_FLASH](#)

### GPIO Configuration

 Contains:

- [CONFIG\\_GPIO\\_CTRL\\_FUNC\\_IN\\_IRAM](#)

### CONFIG\_GPIO\_CTRL\_FUNC\_IN\_IRAM

Place GPIO control functions into IRAM

*Found in: [Component config](#) > [Driver Configurations](#) > [GPIO Configuration](#)*

Place GPIO control functions (like `intr_disable/set_level`) into IRAM, so that these functions can be IRAM-safe and able to be called in the other IRAM interrupt context.

**Default value:**

- No (disabled)

### Sigma Delta Modulator Configuration

 Contains:

- [CONFIG\\_SDM\\_ENABLE\\_DEBUG\\_LOG](#)
- [CONFIG\\_SDM\\_CTRL\\_FUNC\\_IN\\_IRAM](#)
- [CONFIG\\_SDM\\_SUPPRESS\\_DEPRECATED\\_WARN](#)

### CONFIG\_SDM\_CTRL\_FUNC\_IN\_IRAM

Place SDM control functions into IRAM

*Found in: [Component config](#) > [Driver Configurations](#) > [Sigma Delta Modulator Configuration](#)*

Place SDM control functions (like `set_duty`) into IRAM, so that these functions can be IRAM-safe and able to be called in the other IRAM interrupt context. Enabling this option can improve driver performance as well.

**Default value:**

- No (disabled)

### CONFIG\_SDM\_SUPPRESS\_DEPRECATED\_WARN

Suppress legacy driver deprecated warning

*Found in: [Component config](#) > [Driver Configurations](#) > [Sigma Delta Modulator Configuration](#)*

Whether to suppress the deprecation warnings when using legacy sigma delta driver. If you want to continue using the legacy driver, and don't want to see related deprecation warnings, you can enable this option.

**Default value:**

- No (disabled)

### CONFIG\_SDM\_ENABLE\_DEBUG\_LOG

Enable debug log

*Found in: [Component config](#) > [Driver Configurations](#) > [Sigma Delta Modulator Configuration](#)*

Whether to enable the debug log message for SDM driver. Note that, this option only controls the SDM driver log, won't affect other drivers.

**Default value:**

- No (disabled)

### GPTimer Configuration

 Contains:

- [CONFIG\\_GPTIMER\\_ENABLE\\_DEBUG\\_LOG](#)
- [CONFIG\\_GPTIMER\\_ISR\\_IRAM\\_SAFE](#)
- [CONFIG\\_GPTIMER\\_CTRL\\_FUNC\\_IN\\_IRAM](#)
- [CONFIG\\_GPTIMER\\_SUPPRESS\\_DEPRECATED\\_WARN](#)

### CONFIG\_GPTIMER\_CTRL\_FUNC\_IN\_IRAM

Place GPTimer control functions into IRAM

*Found in: [Component config](#) > [Driver Configurations](#) > [GPTimer Configuration](#)*

Place GPTimer control functions (like start/stop) into IRAM, so that these functions can be IRAM-safe and able to be called in the other IRAM interrupt context. Enabling this option can improve driver performance as well.

**Default value:**

- No (disabled)

### CONFIG\_GPTIMER\_ISR\_IRAM\_SAFE

GPTimer ISR IRAM-Safe

*Found in: [Component config](#) > [Driver Configurations](#) > [GPTimer Configuration](#)*

Ensure the GPTimer interrupt is IRAM-Safe by allowing the interrupt handler to be executable when the cache is disabled (e.g. SPI Flash write).

**Default value:**

- No (disabled)

### CONFIG\_GPTIMER\_SUPPRESS\_DEPRECATED\_WARN

Suppress legacy driver deprecated warning

*Found in: [Component config](#) > [Driver Configurations](#) > [GPTimer Configuration](#)*

Whether to suppress the deprecation warnings when using legacy timer group driver (driver/timer.h). If you want to continue using the legacy driver, and don't want to see related deprecation warnings, you can enable this option.

**Default value:**

- No (disabled)

### CONFIG\_GPTIMER\_ENABLE\_DEBUG\_LOG

Enable debug log

*Found in: [Component config](#) > [Driver Configurations](#) > [GPTimer Configuration](#)*

Whether to enable the debug log message for GPTimer driver. Note that, this option only controls the GPTimer driver log, won't affect other drivers.

**Default value:**

- No (disabled)

**PCNT Configuration** Contains:

- [CONFIG\\_PCNT\\_ENABLE\\_DEBUG\\_LOG](#)
- [CONFIG\\_PCNT\\_ISR\\_IRAM\\_SAFE](#)
- [CONFIG\\_PCNT\\_CTRL\\_FUNC\\_IN\\_IRAM](#)
- [CONFIG\\_PCNT\\_SUPPRESS\\_DEPRECATED\\_WARN](#)

### **CONFIG\_PCNT\_CTRL\_FUNC\_IN\_IRAM**

Place PCNT control functions into IRAM

*Found in: [Component config](#) > [Driver Configurations](#) > [PCNT Configuration](#)*

Place PCNT control functions (like start/stop) into IRAM, so that these functions can be IRAM-safe and able to be called in the other IRAM interrupt context. Enabling this option can improve driver performance as well.

**Default value:**

- No (disabled)

### **CONFIG\_PCNT\_ISR\_IRAM\_SAFE**

PCNT ISR IRAM-Safe

*Found in: [Component config](#) > [Driver Configurations](#) > [PCNT Configuration](#)*

Ensure the PCNT interrupt is IRAM-Safe by allowing the interrupt handler to be executable when the cache is disabled (e.g. SPI Flash write).

**Default value:**

- No (disabled)

### **CONFIG\_PCNT\_SUPPRESS\_DEPRECATED\_WARN**

Suppress legacy driver deprecated warning

*Found in: [Component config](#) > [Driver Configurations](#) > [PCNT Configuration](#)*

Whether to suppress the deprecation warnings when using legacy PCNT driver (driver/pcnt.h). If you want to continue using the legacy driver, and don't want to see related deprecation warnings, you can enable this option.

**Default value:**

- No (disabled)

### **CONFIG\_PCNT\_ENABLE\_DEBUG\_LOG**

Enable debug log

*Found in: [Component config](#) > [Driver Configurations](#) > [PCNT Configuration](#)*

Whether to enable the debug log message for PCNT driver. Note that, this option only controls the PCNT driver log, won't affect other drivers.

**Default value:**

- No (disabled)

**RMT Configuration** Contains:

- [CONFIG\\_RMT\\_ENABLE\\_DEBUG\\_LOG](#)
- [CONFIG\\_RMT\\_RECV\\_FUNC\\_IN\\_IRAM](#)
- [CONFIG\\_RMT\\_ISR\\_IRAM\\_SAFE](#)
- [CONFIG\\_RMT\\_SUPPRESS\\_DEPRECATED\\_WARN](#)

### **CONFIG\_RMT\_ISR\_IRAM\_SAFE**

RMT ISR IRAM-Safe

*Found in: [Component config](#) > [Driver Configurations](#) > [RMT Configuration](#)*

Ensure the RMT interrupt is IRAM-Safe by allowing the interrupt handler to be executable when the cache is disabled (e.g. SPI Flash write).

**Default value:**

- No (disabled)

### **CONFIG\_RMT\_RECV\_FUNC\_IN\_IRAM**

Place RMT receive function into IRAM

*Found in: [Component config](#) > [Driver Configurations](#) > [RMT Configuration](#)*

Place RMT receive function into IRAM, so that the receive function can be IRAM-safe and able to be called when the flash cache is disabled. Enabling this option can improve driver performance as well.

**Default value:**

- No (disabled)

### **CONFIG\_RMT\_SUPPRESS\_DEPRECATED\_WARN**

Suppress legacy driver deprecated warning

*Found in: [Component config](#) > [Driver Configurations](#) > [RMT Configuration](#)*

Whether to suppress the deprecation warnings when using legacy rmt driver (driver/rmt.h). If you want to continue using the legacy driver, and don't want to see related deprecation warnings, you can enable this option.

**Default value:**

- No (disabled)

### **CONFIG\_RMT\_ENABLE\_DEBUG\_LOG**

Enable debug log

*Found in: [Component config](#) > [Driver Configurations](#) > [RMT Configuration](#)*

Whether to enable the debug log message for RMT driver. Note that, this option only controls the RMT driver log, won't affect other drivers.

**Default value:**

- No (disabled)

**MCPWM Configuration** Contains:

- [CONFIG\\_MCPWM\\_ENABLE\\_DEBUG\\_LOG](#)
- [CONFIG\\_MCPWM\\_CTRL\\_FUNC\\_IN\\_IRAM](#)
- [CONFIG\\_MCPWM\\_ISR\\_IRAM\\_SAFE](#)
- [CONFIG\\_MCPWM\\_SUPPRESS\\_DEPRECATED\\_WARN](#)

### CONFIG\_MCPWM\_ISR\_IRAM\_SAFE

Place MCPWM ISR function into IRAM

*Found in: [Component config](#) > [Driver Configurations](#) > [MCPWM Configuration](#)*

This will ensure the MCPWM interrupt handle is IRAM-Safe, allow to avoid flash cache misses, and also be able to run whilst the cache is disabled. (e.g. SPI Flash write)

**Default value:**

- No (disabled) if SOC\_MCPWM\_SUPPORTED

### CONFIG\_MCPWM\_CTRL\_FUNC\_IN\_IRAM

Place MCPWM control functions into IRAM

*Found in: [Component config](#) > [Driver Configurations](#) > [MCPWM Configuration](#)*

Place MCPWM control functions (like set\_compare\_value) into IRAM, so that these functions can be IRAM-safe and able to be called in the other IRAM interrupt context. Enabling this option can improve driver performance as well.

**Default value:**

- No (disabled) if SOC\_MCPWM\_SUPPORTED

### CONFIG\_MCPWM\_SUPPRESS\_DEPRECATED\_WARN

Suppress legacy driver deprecated warning

*Found in: [Component config](#) > [Driver Configurations](#) > [MCPWM Configuration](#)*

Whether to suppress the deprecation warnings when using legacy MCPWM driver (driver/mcpwm.h). If you want to continue using the legacy driver, and don't want to see related deprecation warnings, you can enable this option.

**Default value:**

- No (disabled) if SOC\_MCPWM\_SUPPORTED

### CONFIG\_MCPWM\_ENABLE\_DEBUG\_LOG

Enable debug log

*Found in: [Component config](#) > [Driver Configurations](#) > [MCPWM Configuration](#)*

Whether to enable the debug log message for MCPWM driver. Note that, this option only controls the MCPWM driver log, won't affect other drivers.

**Default value:**

- No (disabled) if SOC\_MCPWM\_SUPPORTED

**I2S Configuration** Contains:

- [CONFIG\\_I2S\\_ENABLE\\_DEBUG\\_LOG](#)
- [CONFIG\\_I2S\\_ISR\\_IRAM\\_SAFE](#)
- [CONFIG\\_I2S\\_SUPPRESS\\_DEPRECATED\\_WARN](#)

### CONFIG\_I2S\_ISR\_IRAM\_SAFE

I2S ISR IRAM-Safe

*Found in: [Component config](#) > [Driver Configurations](#) > [I2S Configuration](#)*

Ensure the I2S interrupt is IRAM-Safe by allowing the interrupt handler to be executable when the cache is disabled (e.g. SPI Flash write).

**Default value:**

- No (disabled)

**CONFIG\_I2S\_SUPPRESS\_DEPRECATED\_WARN**

Suppress legacy driver deprecated warning

*Found in: [Component config](#) > [Driver Configurations](#) > [I2S Configuration](#)*

Enable this option will suppress the deprecation warnings of using APIs in legacy I2S driver.

**Default value:**

- No (disabled)

**CONFIG\_I2S\_ENABLE\_DEBUG\_LOG**

Enable I2S debug log

*Found in: [Component config](#) > [Driver Configurations](#) > [I2S Configuration](#)*

Whether to enable the debug log message for I2S driver. Note that, this option only controls the I2S driver log, will not affect other drivers.

**Default value:**

- No (disabled)

**eFuse Bit Manager** Contains:

- [CONFIG\\_EFUSE\\_VIRTUAL](#)
- [CONFIG\\_EFUSE\\_CUSTOM\\_TABLE](#)

**CONFIG\_EFUSE\_CUSTOM\_TABLE**

Use custom eFuse table

*Found in: [Component config](#) > [eFuse Bit Manager](#)*

Allows to generate a structure for eFuse from the CSV file.

**Default value:**

- No (disabled)

**CONFIG\_EFUSE\_CUSTOM\_TABLE\_FILENAME**

Custom eFuse CSV file

*Found in: [Component config](#) > [eFuse Bit Manager](#) > [CONFIG\\_EFUSE\\_CUSTOM\\_TABLE](#)*

Name of the custom eFuse CSV filename. This path is evaluated relative to the project root directory.

**Default value:**

- “main/esp\_efuse\_custom\_table.csv” if [CONFIG\\_EFUSE\\_CUSTOM\\_TABLE](#)

**CONFIG\_EFUSE\_VIRTUAL**

Simulate eFuse operations in RAM

*Found in: [Component config](#) > [eFuse Bit Manager](#)*

If “n” - No virtual mode. All eFuse operations are real and use eFuse registers. If “y” - The virtual mode is enabled and all eFuse operations (read and write) are redirected to RAM instead of eFuse registers, all permanent changes (via eFuse) are disabled. Log output will state changes that would be applied, but they will not be.

During startup, the eFuses are copied into RAM. This mode is useful for fast tests.



**Default value:**

- No (disabled)

**CONFIG\_EFUSE\_VIRTUAL\_KEEP\_IN\_FLASH**

Keep eFuses in flash

*Found in: [Component config](#) > [eFuse Bit Manager](#) > [CONFIG\\_EFUSE\\_VIRTUAL](#)*

In addition to the “Simulate eFuse operations in RAM” option, this option just adds a feature to keep eFuses after reboots in flash memory. To use this mode the partition\_table should have the *efuse* partition. partition.csv: “efuse\_em, data, efuse, , 0x2000,”

During startup, the eFuses are copied from flash or, in case if flash is empty, from real eFuse to RAM and then update flash. This mode is useful when need to keep changes after reboot (testing secure\_boot and flash\_encryption).

**ESP-TLS** Contains:

- [CONFIG\\_ESP\\_TLS\\_INSECURE](#)
- [CONFIG\\_ESP\\_TLS\\_LIBRARY\\_CHOOSE](#)
- [CONFIG\\_ESP\\_TLS\\_CLIENT\\_SESSION\\_TICKETS](#)
- [CONFIG\\_ESP\\_DEBUG\\_WOLFSSL](#)
- [CONFIG\\_ESP\\_TLS\\_SERVER](#)
- [CONFIG\\_ESP\\_TLS\\_PSK\\_VERIFICATION](#)
- [CONFIG\\_ESP\\_WOLFSSL\\_SMALL\\_CERT\\_VERIFY](#)
- [CONFIG\\_ESP\\_TLS\\_USE\\_DS\\_PERIPHERAL](#)

**CONFIG\_ESP\_TLS\_LIBRARY\_CHOOSE**

Choose SSL/TLS library for ESP-TLS (See help for more Info)

*Found in: [Component config](#) > [ESP-TLS](#)*

The ESP-TLS APIs support multiple backend TLS libraries. Currently mbedTLS and WolfSSL are supported. Different TLS libraries may support different features and have different resource usage. Consult the ESP-TLS documentation in ESP-IDF Programming guide for more details.

**Available options:**

- mbedTLS ([ESP\\_TLS\\_USING\\_MBEDTLS](#))
- wolfSSL (License info in wolfSSL directory README) ([ESP\\_TLS\\_USING\\_WOLFSSL](#))

**CONFIG\_ESP\_TLS\_USE\_DS\_PERIPHERAL**

Use Digital Signature (DS) Peripheral with ESP-TLS

*Found in: [Component config](#) > [ESP-TLS](#)*

Enable use of the Digital Signature Peripheral for ESP-TLS. The DS peripheral can only be used when it is appropriately configured for TLS. Consult the ESP-TLS documentation in ESP-IDF Programming Guide for more details.

**Default value:**

- Yes (enabled)

**CONFIG\_ESP\_TLS\_CLIENT\_SESSION\_TICKETS**

Enable client session tickets

*Found in: [Component config](#) > [ESP-TLS](#)*

Enable session ticket support as specified in RFC5077.

### CONFIG\_ESP\_TLS\_SERVER

Enable ESP-TLS Server

*Found in:* [Component config](#) > [ESP-TLS](#)

Enable support for creating server side SSL/TLS session, available for mbedTLS as well as wolfSSL TLS library.

### CONFIG\_ESP\_TLS\_SERVER\_SESSION\_TICKETS

Enable server session tickets

*Found in:* [Component config](#) > [ESP-TLS](#) > [CONFIG\\_ESP\\_TLS\\_SERVER](#)

Enable session ticket support as specified in RFC5077

### CONFIG\_ESP\_TLS\_SERVER\_SESSION\_TICKET\_TIMEOUT

Server session ticket timeout in seconds

*Found in:* [Component config](#) > [ESP-TLS](#) > [CONFIG\\_ESP\\_TLS\\_SERVER](#) > [CONFIG\\_ESP\\_TLS\\_SERVER\\_SESSION\\_TICKETS](#)

Sets the session ticket timeout used in the tls server.

**Default value:**

- 86400 if [CONFIG\\_ESP\\_TLS\\_SERVER\\_SESSION\\_TICKETS](#)

### CONFIG\_ESP\_TLS\_SERVER\_CERT\_SELECT\_HOOK

Certificate selection hook

*Found in:* [Component config](#) > [ESP-TLS](#) > [CONFIG\\_ESP\\_TLS\\_SERVER](#)

Ability to configure and use a certificate selection callback during server handshake, to select a certificate to present to the client based on the TLS extensions supplied in the client hello (alpn, sni, etc).

### CONFIG\_ESP\_TLS\_SERVER\_MIN\_AUTH\_MODE\_OPTIONAL

ESP-TLS Server: Set minimum Certificate Verification mode to Optional

*Found in:* [Component config](#) > [ESP-TLS](#) > [CONFIG\\_ESP\\_TLS\\_SERVER](#)

When this option is enabled, the peer (here, the client) certificate is checked by the server, however the handshake continues even if verification failed. By default, the peer certificate is not checked and ignored by the server.

`mbedtls_ssl_get_verify_result()` can be called after the handshake is complete to retrieve status of verification.

### CONFIG\_ESP\_TLS\_PSK\_VERIFICATION

Enable PSK verification

*Found in:* [Component config](#) > [ESP-TLS](#)

Enable support for pre shared key ciphers, supported for both mbedTLS as well as wolfSSL TLS library.

### CONFIG\_ESP\_TLS\_INSECURE

Allow potentially insecure options

Found in: [Component config](#) > [ESP-TLS](#)

You can enable some potentially insecure options. These options should only be used for testing purposes. Only enable these options if you are very sure.

### CONFIG\_ESP\_TLS\_SKIP\_SERVER\_CERT\_VERIFY

Skip server certificate verification by default (WARNING: ONLY FOR TESTING PURPOSE, READ HELP)

Found in: [Component config](#) > [ESP-TLS](#) > [CONFIG\\_ESP\\_TLS\\_INSECURE](#)

After enabling this option the esp-tls client will skip the server certificate verification by default. Note that this option will only modify the default behaviour of esp-tls client regarding server cert verification. The default behaviour should only be applicable when no other option regarding the server cert verification is opted in the esp-tls config (e.g. `cert_bundle_attach`, `use_global_ca_store` etc.). WARNING : Enabling this option comes with a potential risk of establishing a TLS connection with a server which has a fake identity, provided that the server certificate is not provided either through API or other mechanism like `ca_store` etc.

### CONFIG\_ESP\_WOLFSSL\_SMALL\_CERT\_VERIFY

Enable SMALL\_CERT\_VERIFY

Found in: [Component config](#) > [ESP-TLS](#)

Enables server verification with Intermediate CA cert, does not authenticate full chain of trust up to the root CA cert (After Enabling this option client only needs to have Intermediate CA certificate of the server to authenticate server, root CA cert is not necessary).

**Default value:**

- Yes (enabled) if `ESP_TLS_USING_WOLFSSL`

### CONFIG\_ESP\_DEBUG\_WOLFSSL

Enable debug logs for wolfSSL

Found in: [Component config](#) > [ESP-TLS](#)

Enable detailed debug prints for wolfSSL SSL library.

### ADC and ADC Calibration

 Contains:

- [ADC Calibration Configurations](#)
- [CONFIG\\_ADC\\_CONTINUOUS\\_ISR\\_IRAM\\_SAFE](#)
- [CONFIG\\_ADC\\_DISABLE\\_DAC\\_OUTPUT](#)
- [CONFIG\\_ADC\\_ONESHOT\\_CTRL\\_FUNC\\_IN\\_IRAM](#)

### CONFIG\_ADC\_ONESHOT\_CTRL\_FUNC\_IN\_IRAM

Place ISR version ADC oneshot mode read function into IRAM

Found in: [Component config](#) > [ADC and ADC Calibration](#)

Place ISR version ADC oneshot mode read function into IRAM.

**Default value:**

- No (disabled)

### **CONFIG\_ADC\_CONTINUOUS\_ISR\_IRAM\_SAFE**

ADC continuous mode driver ISR IRAM-Safe

*Found in: [Component config > ADC and ADC Calibration](#)*

Ensure the ADC continuous mode ISR is IRAM-Safe. When enabled, the ISR handler will be available when the cache is disabled.

**Default value:**

- No (disabled)

### **ADC Calibration Configurations**

### **CONFIG\_ADC\_DISABLE\_DAC\_OUTPUT**

Disable DAC when ADC2 is in use

*Found in: [Component config > ADC and ADC Calibration](#)*

By default, this is set. The ADC oneshot driver will disable the output of the corresponding DAC channels: ESP32: IO25 and IO26 ESP32S2: IO17 and IO18

Disable this option so as to measure the output of DAC by internal ADC, for test usage.

**Default value:**

- Yes (enabled)

### **Common ESP-related** Contains:

- [CONFIG\\_ESP\\_ERR\\_TO\\_NAME\\_LOOKUP](#)

### **CONFIG\_ESP\_ERR\_TO\_NAME\_LOOKUP**

Enable lookup of error code strings

*Found in: [Component config > Common ESP-related](#)*

Functions `esp_err_to_name()` and `esp_err_to_name_r()` return string representations of error codes from a pre-generated lookup table. This option can be used to turn off the use of the look-up table in order to save memory but this comes at the price of sacrificing distinguishable (meaningful) output string representations.

**Default value:**

- Yes (enabled)

### **Ethernet** Contains:

- [CONFIG\\_ETH\\_TRANSMIT\\_MUTEX](#)
- [CONFIG\\_ETH\\_USE\\_OPENETH](#)
- [CONFIG\\_ETH\\_USE\\_SPI\\_ETHERNET](#)

### **CONFIG\_ETH\_USE\_SPI\_ETHERNET**

Support SPI to Ethernet Module

*Found in: [Component config > Ethernet](#)*

ESP-IDF can also support some SPI-Ethernet modules.

**Default value:**

- Yes (enabled)

Contains:

- [CONFIG\\_ETH\\_SPI\\_ETHERNET\\_DM9051](#)
- [CONFIG\\_ETH\\_SPI\\_ETHERNET\\_KSZ8851SNL](#)
- [CONFIG\\_ETH\\_SPI\\_ETHERNET\\_W5500](#)

### **CONFIG\_ETH\_SPI\_ETHERNET\_DM9051**

Use DM9051

*Found in: [Component config](#) > [Ethernet](#) > [CONFIG\\_ETH\\_USE\\_SPI\\_ETHERNET](#)*

DM9051 is a fast Ethernet controller with an SPI interface. It's also integrated with a 10/100M PHY and MAC. Select this to enable DM9051 driver.

### **CONFIG\_ETH\_SPI\_ETHERNET\_W5500**

Use W5500 (MAC RAW)

*Found in: [Component config](#) > [Ethernet](#) > [CONFIG\\_ETH\\_USE\\_SPI\\_ETHERNET](#)*

W5500 is a HW TCP/IP embedded Ethernet controller. TCP/IP stack, 10/100 Ethernet MAC and PHY are embedded in a single chip. However the driver in ESP-IDF only enables the RAW MAC mode, making it compatible with the software TCP/IP stack. Say yes to enable W5500 driver.

### **CONFIG\_ETH\_SPI\_ETHERNET\_KSZ8851SNL**

Use KSZ8851SNL

*Found in: [Component config](#) > [Ethernet](#) > [CONFIG\\_ETH\\_USE\\_SPI\\_ETHERNET](#)*

The KSZ8851SNL is a single-chip Fast Ethernet controller consisting of a 10/100 physical layer transceiver (PHY), a MAC, and a Serial Peripheral Interface (SPI). Select this to enable KSZ8851SNL driver.

### **CONFIG\_ETH\_USE\_OPENETH**

Support OpenCores Ethernet MAC (for use with QEMU)

*Found in: [Component config](#) > [Ethernet](#)*

OpenCores Ethernet MAC driver can be used when an ESP-IDF application is executed in QEMU. This driver is not supported when running on a real chip.

**Default value:**

- No (disabled)

Contains:

- [CONFIG\\_ETH\\_OPENETH\\_DMA\\_RX\\_BUFFER\\_NUM](#)
- [CONFIG\\_ETH\\_OPENETH\\_DMA\\_TX\\_BUFFER\\_NUM](#)

### **CONFIG\_ETH\_OPENETH\_DMA\_RX\_BUFFER\_NUM**

Number of Ethernet DMA Rx buffers

*Found in: [Component config](#) > [Ethernet](#) > [CONFIG\\_ETH\\_USE\\_OPENETH](#)*

Number of DMA receive buffers, each buffer is 1600 bytes.

**Range:**

- from 1 to 64 if [CONFIG\\_ETH\\_USE\\_OPENETH](#)

**Default value:**

- 4 if [CONFIG\\_ETH\\_USE\\_OPENETH](#)

### CONFIG\_ETH\_OPENETH\_DMA\_TX\_BUFFER\_NUM

Number of Ethernet DMA Tx buffers

*Found in: [Component config](#) > [Ethernet](#) > [CONFIG\\_ETH\\_USE\\_OPENETH](#)*

Number of DMA transmit buffers, each buffer is 1600 bytes.

**Range:**

- from 1 to 64 if [CONFIG\\_ETH\\_USE\\_OPENETH](#)

**Default value:**

- 1 if [CONFIG\\_ETH\\_USE\\_OPENETH](#)

### CONFIG\_ETH\_TRANSMIT\_MUTEX

Enable Transmit Mutex

*Found in: [Component config](#) > [Ethernet](#)*

Prevents multiple accesses when Ethernet interface is used as shared resource and multiple functionalities might try to access it at a time.

**Default value:**

- No (disabled)

**Event Loop Library** Contains:

- [CONFIG\\_ESP\\_EVENT\\_LOOP\\_PROFILING](#)
- [CONFIG\\_ESP\\_EVENT\\_POST\\_FROM\\_ISR](#)

### CONFIG\_ESP\_EVENT\_LOOP\_PROFILING

Enable event loop profiling

*Found in: [Component config](#) > [Event Loop Library](#)*

Enables collections of statistics in the event loop library such as the number of events posted to/received by an event loop, number of callbacks involved, number of events dropped to a full event loop queue, run time of event handlers, and number of times/run time of each event handler.

**Default value:**

- No (disabled)

### CONFIG\_ESP\_EVENT\_POST\_FROM\_ISR

Support posting events from ISRs

*Found in: [Component config](#) > [Event Loop Library](#)*

Enable posting events from interrupt handlers.

**Default value:**

- Yes (enabled)

### CONFIG\_ESP\_EVENT\_POST\_FROM\_IRAM\_ISR

Support posting events from ISRs placed in IRAM

*Found in: [Component config](#) > [Event Loop Library](#) > [CONFIG\\_ESP\\_EVENT\\_POST\\_FROM\\_ISR](#)*

Enable posting events from interrupt handlers placed in IRAM. Enabling this option places API functions `esp_event_post` and `esp_event_post_to` in IRAM.

**Default value:**

- Yes (enabled)

**GDB Stub** Contains:

- [CONFIG\\_ESP\\_GDBSTUB\\_SUPPORT\\_TASKS](#)

### **CONFIG\_ESP\_GDBSTUB\_SUPPORT\_TASKS**

Enable listing FreeRTOS tasks through GDB Stub

*Found in:* [Component config](#) > [GDB Stub](#)

If enabled, GDBStub can supply the list of FreeRTOS tasks to GDB. Thread list can be queried from GDB using 'info threads' command. Note that if GDB task lists were corrupted, this feature may not work. If GDBStub fails, try disabling this feature.

### **CONFIG\_ESP\_GDBSTUB\_MAX\_TASKS**

Maximum number of tasks supported by GDB Stub

*Found in:* [Component config](#) > [GDB Stub](#) > [CONFIG\\_ESP\\_GDBSTUB\\_SUPPORT\\_TASKS](#)

Set the number of tasks which GDB Stub will support.

**Default value:**

- 32 if [CONFIG\\_ESP\\_GDBSTUB\\_SUPPORT\\_TASKS](#)

**ESP HTTP client** Contains:

- [CONFIG\\_ESP\\_HTTP\\_CLIENT\\_ENABLE\\_BASIC\\_AUTH](#)
- [CONFIG\\_ESP\\_HTTP\\_CLIENT\\_ENABLE\\_DIGEST\\_AUTH](#)
- [CONFIG\\_ESP\\_HTTP\\_CLIENT\\_ENABLE\\_HTTPS](#)

### **CONFIG\_ESP\_HTTP\_CLIENT\_ENABLE\_HTTPS**

Enable https

*Found in:* [Component config](#) > [ESP HTTP client](#)

This option will enable https protocol by linking esp-tls library and initializing SSL transport

**Default value:**

- Yes (enabled)

### **CONFIG\_ESP\_HTTP\_CLIENT\_ENABLE\_BASIC\_AUTH**

Enable HTTP Basic Authentication

*Found in:* [Component config](#) > [ESP HTTP client](#)

This option will enable HTTP Basic Authentication. It is disabled by default as Basic auth uses unencrypted encoding, so it introduces a vulnerability when not using TLS

**Default value:**

- No (disabled)

### **CONFIG\_ESP\_HTTP\_CLIENT\_ENABLE\_DIGEST\_AUTH**

Enable HTTP Digest Authentication

*Found in:* [Component config](#) > [ESP HTTP client](#)

This option will enable HTTP Digest Authentication. It is enabled by default, but use of this configuration is not recommended as the password can be derived from the exchange, so it introduces a vulnerability when not using TLS

**Default value:**

- No (disabled)

**HTTP Server** Contains:

- `CONFIG_HTTPD_QUEUE_WORK_BLOCKING`
- `CONFIG_HTTPD_PURGE_BUF_LEN`
- `CONFIG_HTTPD_LOG_PURGE_DATA`
- `CONFIG_HTTPD_MAX_REQ_HDR_LEN`
- `CONFIG_HTTPD_MAX_URI_LEN`
- `CONFIG_HTTPD_ERR_RESP_NO_DELAY`
- `CONFIG_HTTPD_WS_SUPPORT`

**CONFIG\_HTTPD\_MAX\_REQ\_HDR\_LEN**

Max HTTP Request Header Length

*Found in: [Component config](#) > [HTTP Server](#)*

This sets the maximum supported size of headers section in HTTP request packet to be processed by the server

**Default value:**

- 512

**CONFIG\_HTTPD\_MAX\_URI\_LEN**

Max HTTP URI Length

*Found in: [Component config](#) > [HTTP Server](#)*

This sets the maximum supported size of HTTP request URI to be processed by the server

**Default value:**

- 512

**CONFIG\_HTTPD\_ERR\_RESP\_NO\_DELAY**

Use TCP\_NODELAY socket option when sending HTTP error responses

*Found in: [Component config](#) > [HTTP Server](#)*

Using TCP\_NODELAY socket option ensures that HTTP error response reaches the client before the underlying socket is closed. Please note that turning this off may cause multiple test failures

**Default value:**

- Yes (enabled)

**CONFIG\_HTTPD\_PURGE\_BUF\_LEN**

Length of temporary buffer for purging data

*Found in: [Component config](#) > [HTTP Server](#)*

This sets the size of the temporary buffer used to receive and discard any remaining data that is received from the HTTP client in the request, but not processed as part of the server HTTP request handler.

If the remaining data is larger than the available buffer size, the buffer will be filled in multiple iterations. The buffer should be small enough to fit on the stack, but large enough to avoid excessive iterations.

**Default value:**

- 32



### CONFIG\_HTTPD\_LOG\_PURGE\_DATA

Log purged content data at Debug level

*Found in: [Component config](#) > [HTTP Server](#)*

Enabling this will log discarded binary HTTP request data at Debug level. For large content data this may not be desirable as it will clutter the log.

**Default value:**

- No (disabled)

### CONFIG\_HTTPD\_WS\_SUPPORT

WebSocket server support

*Found in: [Component config](#) > [HTTP Server](#)*

This sets the WebSocket server support.

**Default value:**

- No (disabled)

### CONFIG\_HTTPD\_QUEUE\_WORK\_BLOCKING

httpd\_queue\_work as blocking API

*Found in: [Component config](#) > [HTTP Server](#)*

This makes httpd\_queue\_work() API to wait until a message space is available on UDP control socket. It internally uses a counting semaphore with count set to `LWIP_UDP_RECVMBOX_SIZE` to achieve this. This config will slightly change API behavior to block until message gets delivered on control socket.

### ESP HTTPS OTA Contains:

- [CONFIG\\_ESP\\_HTTPS\\_OTA\\_ALLOW\\_HTTP](#)
- [CONFIG\\_ESP\\_HTTPS\\_OTA\\_DECRYPT\\_CB](#)

### CONFIG\_ESP\_HTTPS\_OTA\_DECRYPT\_CB

Provide decryption callback

*Found in: [Component config](#) > [ESP HTTPS OTA](#)*

Exposes an additional callback whereby firmware data could be decrypted before being processed by OTA update component. This can help to integrate external encryption related format and removal of such encapsulation layer from firmware image.

**Default value:**

- No (disabled)

### CONFIG\_ESP\_HTTPS\_OTA\_ALLOW\_HTTP

Allow HTTP for OTA (WARNING: ONLY FOR TESTING PURPOSE, READ HELP)

*Found in: [Component config](#) > [ESP HTTPS OTA](#)*

It is highly recommended to keep HTTPS (along with server certificate validation) enabled. Enabling this option comes with potential risk of: - Non-encrypted communication channel with server - Accepting firmware upgrade image from server with fake identity

**Default value:**

- No (disabled)

**ESP HTTPS server** Contains:

- [CONFIG\\_ESP\\_HTTPS\\_SERVER\\_ENABLE](#)

### **CONFIG\_ESP\_HTTPS\_SERVER\_ENABLE**

Enable ESP\_HTTPS\_SERVER component

*Found in: Component config > ESP HTTPS server*

Enable ESP HTTPS server component

**Hardware Settings** Contains:

- [Chip revision](#)
- [GDMA Configuration](#)
- [MAC Config](#)
- [Main XTAL Config](#)
- [Peripheral Control](#)
- [RTC Clock Config](#)
- [Sleep Config](#)

**Chip revision** Contains:

- [CONFIG\\_ESP32S2\\_REV\\_MIN](#)

### **CONFIG\_ESP32S2\_REV\_MIN**

Minimum Supported ESP32-S2 Revision

*Found in: Component config > Hardware Settings > Chip revision*

Required minimum chip revision. ESP-IDF will check for it and reject to boot if the chip revision fails the check. This ensures the chip used will have some modifications (features, or bugfixes).

The compiled binary will only support chips above this revision, this will also help to reduce binary size.

**Available options:**

- Rev v0.0 (ECO0) (ESP32S2\_REV\_MIN\_0)
- Rev v1.0 (ECO1) (ESP32S2\_REV\_MIN\_1)

**MAC Config** Contains:

- [CONFIG\\_ESP32S2\\_UNIVERSAL\\_MAC\\_ADDRESSES](#)

### **CONFIG\_ESP32S2\_UNIVERSAL\_MAC\_ADDRESSES**

Number of universally administered (by IEEE) MAC address

*Found in: Component config > Hardware Settings > MAC Config*

Configure the number of universally administered (by IEEE) MAC addresses. During initialization, MAC addresses for each network interface are generated or derived from a single base MAC address. If the number of universal MAC addresses is Two, all interfaces (WiFi station, WiFi softap) receive a universally administered MAC address. They are generated sequentially by adding 0, and 1 (respectively) to the final octet of the base MAC address. If the number of universal MAC addresses is one, only WiFi station receives a universally administered MAC address. It's generated by adding 0 to the base MAC address. The WiFi softap receives local MAC addresses. It's derived from the universal WiFi station MAC addresses. When using the default (Espressif-assigned) base MAC address, either setting can be used. When using a custom universal MAC address range, the correct setting will depend on the allocation of MAC addresses in this range (either 1 or 2 per device.)

**Available options:**

- One (ESP32S2\_UNIVERSAL\_MAC\_ADDRESSES\_ONE)
- Two (ESP32S2\_UNIVERSAL\_MAC\_ADDRESSES\_TWO)

**Sleep Config** Contains:

- [CONFIG\\_ESP\\_SLEEP\\_GPIO\\_ENABLE\\_INTERNAL\\_RESISTORS](#)
- [CONFIG\\_ESP\\_SLEEP\\_GPIO\\_RESET\\_WORKAROUND](#)
- [CONFIG\\_ESP\\_SLEEP\\_POWER\\_DOWN\\_FLASH](#)
- [CONFIG\\_ESP\\_SLEEP\\_MSPI\\_NEED\\_ALL\\_IO\\_PU](#)
- [CONFIG\\_ESP\\_SLEEP\\_FLASH\\_LEAKAGE\\_WORKAROUND](#)
- [CONFIG\\_ESP\\_SLEEP\\_PSRAM\\_LEAKAGE\\_WORKAROUND](#)

**CONFIG\_ESP\_SLEEP\_POWER\_DOWN\_FLASH**

Power down flash in light sleep when there is no SPIRAM

*Found in: [Component config](#) > [Hardware Settings](#) > [Sleep Config](#)*

If enabled, chip will try to power down flash as part of `esp_light_sleep_start()`, which costs more time when chip wakes up. Can only be enabled if there is no SPIRAM configured.

This option will power down flash under a strict but relatively safe condition. Also, it is possible to power down flash under a relaxed condition by using `esp_sleep_pd_config()` to set `ESP_PD_DOMAIN_VDDSDIO` to `ESP_PD_OPTION_OFF`. It should be noted that there is a risk in powering down flash, you can refer *ESP-IDF Programming Guide/API Reference/System API/Sleep Modes/Power-down of Flash* for more details.

**Default value:**

- No (disabled) if [CONFIG\\_SPIRAM](#)

**CONFIG\_ESP\_SLEEP\_FLASH\_LEAKAGE\_WORKAROUND**

Pull-up Flash CS pin in light sleep

*Found in: [Component config](#) > [Hardware Settings](#) > [Sleep Config](#)*

All IOs will be set to isolate(floating) state by default during sleep. Since the power supply of SPI Flash is not lost during lightsleep, if its CS pin is recognized as low level(selected state) in the floating state, there will be a large current leakage, and the data in Flash may be corrupted by random signals on other SPI pins. Select this option will set the CS pin of Flash to PULL-UP state during sleep, but this will increase the sleep current about 10 uA. If you are developing with esp32xx modules, you must select this option, but if you are developing with chips, you can also pull up the CS pin of SPI Flash in the external circuit to save power consumption caused by internal pull-up during sleep. (!!! Don't deselect this option if you don't have external SPI Flash CS pin pullups.)

**Default value:**

- Yes (enabled) if [CONFIG\\_ESP\\_SLEEP\\_POWER\\_DOWN\\_FLASH](#)

**CONFIG\_ESP\_SLEEP\_PSRAM\_LEAKAGE\_WORKAROUND**

Pull-up PSRAM CS pin in light sleep

*Found in: [Component config](#) > [Hardware Settings](#) > [Sleep Config](#)*

All IOs will be set to isolate(floating) state by default during sleep. Since the power supply of PSRAM is not lost during lightsleep, if its CS pin is recognized as low level(selected state) in the floating state, there will be a large current leakage, and the data in PSRAM may be corrupted by random signals on other SPI pins. Select this option will set the CS pin of PSRAM to PULL-UP state during sleep, but this will increase the sleep current about 10 uA. If you are developing with esp32xx modules, you must select this option, but if you are developing with chips, you can also pull up the CS pin of PSRAM in the

external circuit to save power consumption caused by internal pull-up during sleep. (!!! Don't deselect this option if you don't have external PSRAM CS pin pullups.)

**Default value:**

- Yes (enabled) if `CONFIG_SPIRAM`

### CONFIG\_ESP\_SLEEP\_MSPI\_NEED\_ALL\_IO\_PU

Pull-up all SPI pins in light sleep

*Found in: Component config > Hardware Settings > Sleep Config*

To reduce leakage current, some types of SPI Flash/RAM only need to pull up the CS pin during light sleep. But there are also some kinds of SPI Flash/RAM that need to pull up all pins. It depends on the SPI Flash/RAM chip used.

### CONFIG\_ESP\_SLEEP\_GPIO\_RESET\_WORKAROUND

light sleep GPIO reset workaround

*Found in: Component config > Hardware Settings > Sleep Config*

esp32c2, esp32c3 and esp32s3 will reset at wake-up if GPIO is received a small electrostatic pulse during light sleep, with specific condition

- GPIO needs to be configured as input-mode only
- The pin receives a small electrostatic pulse, and reset occurs when the pulse voltage is higher than 6 V

For GPIO set to input mode only, it is not a good practice to leave it open/floating, The hardware design needs to controlled it with determined supply or ground voltage is necessary.

This option provides a software workaround for this issue. Configure to isolate all GPIO pins in sleep state.

### CONFIG\_ESP\_SLEEP\_GPIO\_ENABLE\_INTERNAL\_RESISTORS

Allow to enable internal pull-up/downs for the Deep-Sleep wakeup IOs

*Found in: Component config > Hardware Settings > Sleep Config*

When using rtc gpio wakeup source during deepsleep without external pull-up/downs, you may want to make use of the internal ones.

**Default value:**

- Yes (enabled)

### RTC Clock Config

 Contains:

- `CONFIG_RTC_XTAL_CAL_RETRY`
- `CONFIG_RTC_CLK_CAL_CYCLES`
- `CONFIG_RTC_CLK_SRC`

### CONFIG\_RTC\_CLK\_SRC

RTC clock source

*Found in: Component config > Hardware Settings > RTC Clock Config*

Choose which clock is used as RTC clock source.

- **“Internal 90kHz oscillator” option provides lowest deep sleep current** consumption, and does not require extra external components. However frequency stability with respect to temperature is poor, so time may drift in deep/light sleep modes.

- “**External 32kHz crystal**” provides better frequency stability, at the expense of slightly higher (1uA) deep sleep current consumption.
- “**External 32kHz oscillator**” allows using 32kHz clock generated by an external circuit. In this case, external clock signal must be connected to 32K\_XP pin. Amplitude should be <1.2V in case of sine wave signal, and <1V in case of square wave signal. Common mode voltage should be  $0.1 < V_{cm} < 0.5V_{amp}$ , where  $V_{amp}$  is the signal amplitude.
- “**Internal 8MHz oscillator divided by 256**” option results in higher deep sleep current (by 5uA) but has better frequency stability than the internal 90kHz oscillator. It does not require external components.

**Available options:**

- Internal 90kHz RC oscillator (RTC\_CLK\_SRC\_INT\_RC)
- External 32kHz crystal (RTC\_CLK\_SRC\_EXT\_CRYST)
- External 32kHz oscillator at 32K\_XN pin (RTC\_CLK\_SRC\_EXT\_OSC)
- Internal 8MHz oscillator, divided by 256 (~32kHz) (RTC\_CLK\_SRC\_INT\_8MD256)

**CONFIG\_RTC\_CLK\_CAL\_CYCLES**

Number of cycles for RTC\_SLOW\_CLK calibration

*Found in: [Component config](#) > [Hardware Settings](#) > [RTC Clock Config](#)*

When the startup code initializes RTC\_SLOW\_CLK, it can perform calibration by comparing the RTC\_SLOW\_CLK frequency with main XTAL frequency. This option sets the number of RTC\_SLOW\_CLK cycles measured by the calibration routine. Higher numbers increase calibration precision, which may be important for applications which spend a lot of time in deep sleep. Lower numbers reduce startup time.

When this option is set to 0, clock calibration will not be performed at startup, and approximate clock frequencies will be assumed:

- 90000 Hz if internal RC oscillator is used as clock source. For this use value 1024.
- **32768 Hz if the 32k crystal oscillator is used. For this use value 3000 or more.** In case more value will help improve the definition of the launch of the crystal. If the crystal could not start, it will be switched to internal RC.

**Range:**

- from 0 to 8190 if RTC\_CLK\_SRC\_EXT\_CRYST || RTC\_CLK\_SRC\_EXT\_OSC || RTC\_CLK\_SRC\_INT\_8MD256
- from 0 to 32766

**Default value:**

- 3000 if RTC\_CLK\_SRC\_EXT\_CRYST || RTC\_CLK\_SRC\_EXT\_OSC || RTC\_CLK\_SRC\_INT\_8MD256
- 576

**CONFIG\_RTC\_XTAL\_CAL\_RETRY**

Number of attempts to repeat 32k XTAL calibration

*Found in: [Component config](#) > [Hardware Settings](#) > [RTC Clock Config](#)*

Number of attempts to repeat 32k XTAL calibration before giving up and switching to the internal RC. Increase this option if the 32k crystal oscillator does not start and switches to internal RC.

**Default value:**

- 3 if RTC\_CLK\_SRC\_EXT\_CRYST

**Peripheral Control** Contains:

- [CONFIG\\_PERIPH\\_CTRL\\_FUNC\\_IN\\_IRAM](#)

### CONFIG\_PERIPH\_CTRL\_FUNC\_IN\_IRAM

Place peripheral control functions into IRAM

*Found in: [Component config](#) > [Hardware Settings](#) > [Peripheral Control](#)*

Place peripheral control functions (e.g. `periph_module_reset`) into IRAM, so that these functions can be IRAM-safe and able to be called in the other IRAM interrupt context.

**Default value:**

- No (disabled)

**GDMA Configuration** Contains:

- [CONFIG\\_GDMA\\_ISR\\_IRAM\\_SAFE](#)
- [CONFIG\\_GDMA\\_CTRL\\_FUNC\\_IN\\_IRAM](#)

### CONFIG\_GDMA\_CTRL\_FUNC\_IN\_IRAM

Place GDMA control functions into IRAM

*Found in: [Component config](#) > [Hardware Settings](#) > [GDMA Configuration](#)*

Place GDMA control functions (like start/stop/append/reset) into IRAM, so that these functions can be IRAM-safe and able to be called in the other IRAM interrupt context. Enabling this option can improve driver performance as well.

**Default value:**

- No (disabled) if `SOC_GDMA_SUPPORTED`

### CONFIG\_GDMA\_ISR\_IRAM\_SAFE

GDMA ISR IRAM-Safe

*Found in: [Component config](#) > [Hardware Settings](#) > [GDMA Configuration](#)*

This will ensure the GDMA interrupt handler is IRAM-Safe, allow to avoid flash cache misses, and also be able to run whilst the cache is disabled. (e.g. SPI Flash write).

**Default value:**

- No (disabled) if `SOC_GDMA_SUPPORTED`

**Main XTAL Config** Contains:

- [CONFIG\\_XTAL\\_FREQ\\_SEL](#)

### CONFIG\_XTAL\_FREQ\_SEL

Main XTAL frequency

*Found in: [Component config](#) > [Hardware Settings](#) > [Main XTAL Config](#)*

This option selects the operating frequency of the XTAL (crystal) clock used to drive the ESP target. The selected value MUST reflect the frequency of the given hardware.

Note: The `XTAL_FREQ_AUTO` option allows the ESP target to automatically estimating XTAL clock's operating frequency. However, this feature is only supported on the ESP32. The ESP32 uses the internal 8MHz as a reference when estimating. Due to the internal oscillator's frequency being temperature dependent, usage of the `XTAL_FREQ_AUTO` is not recommended in applications that operate in high ambient temperatures or use high-temperature qualified chips and modules.

**Available options:**

- 24 MHz (`XTAL_FREQ_24`)
- 26 MHz (`XTAL_FREQ_26`)

- 32 MHz (XTAL\_FREQ\_32)
- 40 MHz (XTAL\_FREQ\_40)
- Autodetect (XTAL\_FREQ\_AUTO)

**LCD and Touch Panel** Contains:

- [LCD Peripheral Configuration](#)

**LCD Peripheral Configuration** Contains:

- [CONFIG\\_LCD\\_ENABLE\\_DEBUG\\_LOG](#)
- [CONFIG\\_LCD\\_PANEL\\_IO\\_FORMAT\\_BUF\\_SIZE](#)
- [CONFIG\\_LCD\\_RGB\\_RESTART\\_IN\\_VSYNC](#)
- [CONFIG\\_LCD\\_RGB\\_ISR\\_IRAM\\_SAFE](#)

### **CONFIG\_LCD\_PANEL\_IO\_FORMAT\_BUF\_SIZE**

LCD panel io format buffer size

*Found in: [Component config](#) > [LCD and Touch Panel](#) > [LCD Peripheral Configuration](#)*

LCD driver allocates an internal buffer to transform the data into a proper format, because of the endian order mismatch. This option is to set the size of the buffer, in bytes.

**Default value:**

- 32

### **CONFIG\_LCD\_ENABLE\_DEBUG\_LOG**

Enable debug log

*Found in: [Component config](#) > [LCD and Touch Panel](#) > [LCD Peripheral Configuration](#)*

Whether to enable the debug log message for LCD driver. Note that, this option only controls the LCD driver log, won't affect other drivers.

**Default value:**

- No (disabled)

### **CONFIG\_LCD\_RGB\_ISR\_IRAM\_SAFE**

RGB LCD ISR IRAM-Safe

*Found in: [Component config](#) > [LCD and Touch Panel](#) > [LCD Peripheral Configuration](#)*

Ensure the LCD interrupt is IRAM-Safe by allowing the interrupt handler to be executable when the cache is disabled (e.g. SPI Flash write). If you want the LCD driver to keep flushing the screen even when cache ops disabled, you can enable this option. Note, this will also increase the IRAM usage.

**Default value:**

- No (disabled) if SOC\_LCD\_RGB\_SUPPORTED

### **CONFIG\_LCD\_RGB\_RESTART\_IN\_VSYNC**

Restart transmission in VSYNC

*Found in: [Component config](#) > [LCD and Touch Panel](#) > [LCD Peripheral Configuration](#)*

Reset the GDMA channel every VBlank to stop permanent desyncs from happening. Only need to enable it when in your application, the DMA can't deliver data as fast as the LCD consumes it.

**Default value:**

- No (disabled) if SOC\_LCD\_RGB\_SUPPORTED

**ESP NETIF Adapter** Contains:

- [CONFIG\\_ESP\\_NETIF\\_BRIDGE\\_EN](#)
- [CONFIG\\_ESP\\_NETIF\\_L2\\_TAP](#)
- [CONFIG\\_ESP\\_NETIF\\_IP\\_LOST\\_TIMER\\_INTERVAL](#)
- [CONFIG\\_ESP\\_NETIF\\_USE\\_TCPIP\\_STACK\\_LIB](#)
- [CONFIG\\_ESP\\_NETIF\\_RECEIVE\\_REPORT\\_ERRORS](#)

### **CONFIG\_ESP\_NETIF\_IP\_LOST\_TIMER\_INTERVAL**

IP Address lost timer interval (seconds)

*Found in:* [Component config > ESP NETIF Adapter](#)

The value of 0 indicates the IP lost timer is disabled, otherwise the timer is enabled.

The IP address may be lost because of some reasons, e.g. when the station disconnects from soft-AP, or when DHCP IP renew fails etc. If the IP lost timer is enabled, it will be started everytime the IP is lost. Event SYSTEM\_EVENT\_STA\_LOST\_IP will be raised if the timer expires. The IP lost timer is stopped if the station get the IP again before the timer expires.

**Range:**

- from 0 to 65535

**Default value:**

- 120

### **CONFIG\_ESP\_NETIF\_USE\_TCPIP\_STACK\_LIB**

TCP/IP Stack Library

*Found in:* [Component config > ESP NETIF Adapter](#)

Choose the TCP/IP Stack to work, for example, LwIP, uIP, etc.

**Available options:**

- LwIP (ESP\_NETIF\_TCPIP\_LWIP)  
lwIP is a small independent implementation of the TCP/IP protocol suite.
- Loopback (ESP\_NETIF\_LOOPBACK)  
Dummy implementation of esp-netif functionality which connects driver transmit to receive function. This option is for testing purpose only

### **CONFIG\_ESP\_NETIF\_RECEIVE\_REPORT\_ERRORS**

Use esp\_err\_t to report errors from esp\_netif\_receive

*Found in:* [Component config > ESP NETIF Adapter](#)

Enable if esp\_netif\_receive() should return error code. This is useful to inform upper layers that packet input to TCP/IP stack failed, so the upper layers could implement flow control. This option is disabled by default due to backward compatibility and will be enabled in v6.0 (IDF-7194)

**Default value:**

- No (disabled)

### **CONFIG\_ESP\_NETIF\_L2\_TAP**

Enable netif L2 TAP support

*Found in:* [Component config > ESP NETIF Adapter](#)

A user program can read/write link layer (L2) frames from/to ESP TAP device. The ESP TAP device can be currently associated only with Ethernet physical interfaces.



### CONFIG\_ESP\_NETIF\_L2\_TAP\_MAX\_FDS

Maximum number of opened L2 TAP File descriptors

*Found in:* [Component config](#) > [ESP NETIF Adapter](#) > [CONFIG\\_ESP\\_NETIF\\_L2\\_TAP](#)

Maximum number of opened File descriptors (FD' s) associated with ESP TAP device. ESP TAP FD' s take up a certain amount of memory, and allowing fewer FD' s to be opened at the same time conserves memory.

**Range:**

- from 1 to 10 if [CONFIG\\_ESP\\_NETIF\\_L2\\_TAP](#)

**Default value:**

- 5 if [CONFIG\\_ESP\\_NETIF\\_L2\\_TAP](#)

### CONFIG\_ESP\_NETIF\_L2\_TAP\_RX\_QUEUE\_SIZE

Size of L2 TAP Rx queue

*Found in:* [Component config](#) > [ESP NETIF Adapter](#) > [CONFIG\\_ESP\\_NETIF\\_L2\\_TAP](#)

Maximum number of frames queued in opened File descriptor. Once the queue is full, the newly arriving frames are dropped until the queue has enough room to accept incoming traffic (Tail Drop queue management).

**Range:**

- from 1 to 100 if [CONFIG\\_ESP\\_NETIF\\_L2\\_TAP](#)

**Default value:**

- 20 if [CONFIG\\_ESP\\_NETIF\\_L2\\_TAP](#)

### CONFIG\_ESP\_NETIF\_BRIDGE\_EN

Enable LwIP IEEE 802.1D bridge

*Found in:* [Component config](#) > [ESP NETIF Adapter](#)

Enable LwIP IEEE 802.1D bridge support in ESP-NETIF. Note that “Number of clients store data in netif” (LWIP\_NUM\_NETIF\_CLIENT\_DATA) option needs to be properly configured to be LwIP bridge available!

**Default value:**

- No (disabled)

**PHY** Contains:

- [CONFIG\\_ESP\\_PHY\\_CALIBRATION\\_MODE](#)
- [CONFIG\\_ESP\\_PHY\\_ENABLE\\_USB](#)
- [CONFIG\\_ESP\\_PHY\\_IMPROVE\\_RX\\_11B](#)
- [CONFIG\\_ESP\\_PHY\\_MAX\\_WIFI\\_TX\\_POWER](#)
- [CONFIG\\_ESP\\_PHY\\_REDUCE\\_TX\\_POWER](#)
- [CONFIG\\_ESP\\_PHY\\_CALIBRATION\\_AND\\_DATA\\_STORAGE](#)
- [CONFIG\\_ESP\\_PHY\\_INIT\\_DATA\\_IN\\_PARTITION](#)

### CONFIG\_ESP\_PHY\_CALIBRATION\_AND\_DATA\_STORAGE

Store phy calibration data in NVS

*Found in:* [Component config](#) > [PHY](#)

If this option is enabled, NVS will be initialized and calibration data will be loaded from there. PHY calibration will be skipped on deep sleep wakeup. If calibration data is not found, full calibration will be performed and stored in NVS. Normally, only partial calibration will be performed. If this option is disabled, full calibration will be performed.

If it's easy that your board calibrate bad data, choose 'n'. Two cases for example, you should choose 'n': 1.If your board is easy to be booted up with antenna disconnected. 2.Because of your board design, each time when you do calibration, the result are too unstable. If unsure, choose 'y'.

**Default value:**

- Yes (enabled)

### CONFIG\_ESP\_PHY\_INIT\_DATA\_IN\_PARTITION

Use a partition to store PHY init data

*Found in:* [Component config > PHY](#)

If enabled, PHY init data will be loaded from a partition. When using a custom partition table, make sure that PHY data partition is included (type: 'data', subtype: 'phy'). With default partition tables, this is done automatically. If PHY init data is stored in a partition, it has to be flashed there, otherwise runtime error will occur.

If this option is not enabled, PHY init data will be embedded into the application binary.

If unsure, choose 'n'.

**Default value:**

- No (disabled)

Contains:

- [CONFIG\\_ESP\\_PHY\\_DEFAULT\\_INIT\\_IF\\_INVALID](#)
- [CONFIG\\_ESP\\_PHY\\_MULTIPLE\\_INIT\\_DATA\\_BIN](#)

### CONFIG\_ESP\_PHY\_DEFAULT\_INIT\_IF\_INVALID

Reset default PHY init data if invalid

*Found in:* [Component config > PHY > CONFIG\\_ESP\\_PHY\\_INIT\\_DATA\\_IN\\_PARTITION](#)

If enabled, PHY init data will be restored to default if it cannot be verified successfully to avoid endless bootloops.

If unsure, choose 'n'.

**Default value:**

- No (disabled) if [CONFIG\\_ESP\\_PHY\\_INIT\\_DATA\\_IN\\_PARTITION](#)

### CONFIG\_ESP\_PHY\_MULTIPLE\_INIT\_DATA\_BIN

Support multiple PHY init data bin

*Found in:* [Component config > PHY > CONFIG\\_ESP\\_PHY\\_INIT\\_DATA\\_IN\\_PARTITION](#)

If enabled, the corresponding PHY init data type can be automatically switched according to the country code. China's PHY init data bin is used by default. Can be modified by country information in API `esp_wifi_set_country()`. The priority of switching the PHY init data type is: 1. Country configured by API `esp_wifi_set_country()` and the parameter policy is `WIFI_COUNTRY_POLICY_MANUAL`. 2. Country notified by the connected AP. 3. Country configured by API `esp_wifi_set_country()` and the parameter policy is `WIFI_COUNTRY_POLICY_AUTO`.

**Default value:**

- No (disabled) if [CONFIG\\_ESP\\_PHY\\_INIT\\_DATA\\_IN\\_PARTITION](#) && [CONFIG\\_ESP\\_PHY\\_INIT\\_DATA\\_IN\\_PARTITION](#)

### CONFIG\_ESP\_PHY\_MULTIPLE\_INIT\_DATA\_BIN\_EMBED

Support embedded multiple phy init data bin to app bin

*Found in:* *Component config > PHY > CONFIG\_ESP\_PHY\_INIT\_DATA\_IN\_PARTITION > CONFIG\_ESP\_PHY\_MULTIPLE\_INIT\_DATA\_BIN*

If enabled, multiple phy init data bin will embedded into app bin If not enabled, multiple phy init data bin will still leave alone, and need to be flashed by users.

**Default value:**

- No (disabled) if *CONFIG\_ESP\_PHY\_MULTIPLE\_INIT\_DATA\_BIN* && *CONFIG\_ESP\_PHY\_INIT\_DATA\_IN\_PARTITION*

### CONFIG\_ESP\_PHY\_INIT\_DATA\_ERROR

Terminate operation when PHY init data error

*Found in:* *Component config > PHY > CONFIG\_ESP\_PHY\_INIT\_DATA\_IN\_PARTITION > CONFIG\_ESP\_PHY\_MULTIPLE\_INIT\_DATA\_BIN*

If enabled, when an error occurs while the PHY init data is updated, the program will terminate and restart. If not enabled, the PHY init data will not be updated when an error occurs.

**Default value:**

- No (disabled) if *CONFIG\_ESP\_PHY\_MULTIPLE\_INIT\_DATA\_BIN* && *CONFIG\_ESP\_PHY\_INIT\_DATA\_IN\_PARTITION*

### CONFIG\_ESP\_PHY\_MAX\_WIFI\_TX\_POWER

Max WiFi TX power (dBm)

*Found in:* *Component config > PHY*

Set maximum transmit power for WiFi radio. Actual transmit power for high data rates may be lower than this setting.

**Range:**

- from 10 to 20

**Default value:**

- 20

### CONFIG\_ESP\_PHY\_REDUCE\_TX\_POWER

Reduce PHY TX power when brownout reset

*Found in:* *Component config > PHY*

When brownout reset occurs, reduce PHY TX power to keep the code running.

**Default value:**

- No (disabled)

### CONFIG\_ESP\_PHY\_ENABLE\_USB

Enable USB when phy init

*Found in:* *Component config > PHY*

When using USB Serial/JTAG/OTG/CDC, PHY should enable USB, otherwise USB module can not work properly. Notice: Enabling this configuration option will slightly impact wifi performance.

**Default value:**

- No (disabled)

## CONFIG\_ESP\_PHY\_CALIBRATION\_MODE

Calibration mode

Found in: *Component config > PHY*

Select PHY calibration mode. During RF initialization, the partial calibration method is used by default for RF calibration. Full calibration takes about 100ms more than partial calibration. If boot duration is not critical, it is suggested to use the full calibration method. No calibration method is only used when the device wakes up from deep sleep.

### Available options:

- Calibration partial (ESP\_PHY\_RF\_CAL\_PARTIAL)
- Calibration none (ESP\_PHY\_RF\_CAL\_NONE)
- Calibration full (ESP\_PHY\_RF\_CAL\_FULL)

## CONFIG\_ESP\_PHY\_IMPROVE\_RX\_11B

Improve Wi-Fi receive 11b pkts

Found in: *Component config > PHY*

This is a workaround to improve Wi-Fi receive 11b pkts for some modules using AC-DC power supply with high interference, enable this option will sacrifice Wi-Fi OFDM receive performance. But to guarantee 11b receive performance serves as a bottom line in this case.

### Default value:

- No (disabled) if SOC\_PHY\_IMPROVE\_RX\_11B

**Power Management** Contains:

- *CONFIG\_PM\_SLP\_DISABLE\_GPIO*
- *CONFIG\_PM\_SLP\_IRAM\_OPT*
- *CONFIG\_PM\_RTOS\_IDLE\_OPT*
- *CONFIG\_PM\_ENABLE*

## CONFIG\_PM\_ENABLE

Support for power management

Found in: *Component config > Power Management*

If enabled, application is compiled with support for power management. This option has run-time overhead (increased interrupt latency, longer time to enter idle state), and it also reduces accuracy of RTOS ticks and timers used for timekeeping. Enable this option if application uses power management APIs.

### Default value:

- No (disabled) if *CONFIG\_FREERTOS\_SMP*

## CONFIG\_PM\_DFS\_INIT\_AUTO

Enable dynamic frequency scaling (DFS) at startup

Found in: *Component config > Power Management > CONFIG\_PM\_ENABLE*

If enabled, startup code configures dynamic frequency scaling. Max CPU frequency is set to DEFAULT\_CPU\_FREQ\_MHZ setting, min frequency is set to XTAL frequency. If disabled, DFS will not be active until the application configures it using esp\_pm\_configure function.

### Default value:

- No (disabled) if *CONFIG\_PM\_ENABLE*

## CONFIG\_PM\_PROFILING

Enable profiling counters for PM locks

*Found in: [Component config](#) > [Power Management](#) > [CONFIG\\_PM\\_ENABLE](#)*

If enabled, esp\_pm\_\* functions will keep track of the amount of time each of the power management locks has been held, and esp\_pm\_dump\_locks function will print this information. This feature can be used to analyze which locks are preventing the chip from going into a lower power state, and see what time the chip spends in each power saving mode. This feature does incur some run-time overhead, so should typically be disabled in production builds.

**Default value:**

- No (disabled) if [CONFIG\\_PM\\_ENABLE](#)

## CONFIG\_PM\_TRACE

Enable debug tracing of PM using GPIOs

*Found in: [Component config](#) > [Power Management](#) > [CONFIG\\_PM\\_ENABLE](#)*

If enabled, some GPIOs will be used to signal events such as RTOS ticks, frequency switching, entry/exit from idle state. Refer to pm\_trace.c file for the list of GPIOs. This feature is intended to be used when analyzing/debugging behavior of power management implementation, and should be kept disabled in applications.

**Default value:**

- No (disabled) if [CONFIG\\_PM\\_ENABLE](#)

## CONFIG\_PM\_SLP\_IRAM\_OPT

Put lightsleep related codes in internal RAM

*Found in: [Component config](#) > [Power Management](#)*

If enabled, about 1.8KB of lightsleep related source code would be in IRAM and chip would sleep longer for 760us at most each time. This feature is intended to be used when lower power consumption is needed while there is enough place in IRAM to place source code.

## CONFIG\_PM\_RTOS\_IDLE\_OPT

Put RTOS IDLE related codes in internal RAM

*Found in: [Component config](#) > [Power Management](#)*

If enabled, about 260B of RTOS\_IDLE related source code would be in IRAM and chip would sleep longer for 40us at most each time. This feature is intended to be used when lower power consumption is needed while there is enough place in IRAM to place source code.

## CONFIG\_PM\_SLP\_DISABLE\_GPIO

Disable all GPIO when chip at sleep

*Found in: [Component config](#) > [Power Management](#)*

This feature is intended to disable all GPIO pins at automatic sleep to get a lower power mode. If enabled, chips will disable all GPIO pins at automatic sleep to reduce about 200~300 uA current. If you want to specifically use some pins normally as chip wakes when chip sleeps, you can call 'gpio\_sleep\_sel\_dis' to disable this feature on those pins. You can also keep this feature on and call 'gpio\_sleep\_set\_direction' and 'gpio\_sleep\_set\_pull\_mode' to have a different GPIO configuration at sleep. Waring: If you want to enable this option on ESP32, you should enable [GPIO\\_ESP32\\_SUPPORT\\_SWITCH\\_SLP\\_PULL](#) at first, otherwise you will not be able to switch pullup/pulldown mode.

**ESP PSRAM** Contains:

- [CONFIG\\_SPIRAM](#)

### CONFIG\_SPIRAM

Support for external, SPI-connected RAM

*Found in:* [Component config](#) > [ESP PSRAM](#)

This enables support for an external SPI RAM chip, connected in parallel with the main SPI flash chip.

**Default value:**

- No (disabled)

**SPI RAM config** Contains:

- [CONFIG\\_SPIRAM\\_ALLOW\\_BSS\\_SEG\\_EXTERNAL\\_MEMORY](#)
- [CONFIG\\_SPIRAM\\_ALLOW\\_STACK\\_EXTERNAL\\_MEMORY](#)
- [CONFIG\\_SPIRAM\\_FETCH\\_INSTRUCTIONS](#)
- [CONFIG\\_SPIRAM\\_RODATA](#)
- [CONFIG\\_SPIRAM\\_BOOT\\_INIT](#)
- [CONFIG\\_SPIRAM\\_MALLOC\\_ALWAYSINTERNAL](#)
- [CONFIG\\_SPIRAM\\_MALLOC\\_RESERVE\\_INTERNAL](#)
- [CONFIG\\_SPIRAM\\_MEMTEST](#)
- [CONFIG\\_SPIRAM\\_SPEED](#)
- [CONFIG\\_SPIRAM\\_USE](#)
- [CONFIG\\_SPIRAM\\_TRY\\_ALLOCATE\\_WIFI\\_LWIP](#)
- [CONFIG\\_SPIRAM\\_TYPE](#)

### CONFIG\_SPIRAM\_TYPE

Type of SPI RAM chip in use

*Found in:* [Component config](#) > [ESP PSRAM](#) > [CONFIG\\_SPIRAM](#) > [SPI RAM config](#)

**Available options:**

- Auto-detect (SPIRAM\_TYPE\_AUTO)
- ESP-PSRAM16 or APS1604 (SPIRAM\_TYPE\_ESPPSRAM16)
- ESP-PSRAM32 (SPIRAM\_TYPE\_ESPPSRAM32)
- ESP-PSRAM64 or LY68L6400 (SPIRAM\_TYPE\_ESPPSRAM64)

### CONFIG\_SPIRAM\_ALLOW\_STACK\_EXTERNAL\_MEMORY

Allow external memory as an argument to `xTaskCreateStatic`

*Found in:* [Component config](#) > [ESP PSRAM](#) > [CONFIG\\_SPIRAM](#) > [SPI RAM config](#)

Accessing memory in SPIRAM has certain restrictions, so task stacks allocated by `xTaskCreate` are by default allocated from internal RAM.

This option allows for passing memory allocated from SPIRAM to be passed to `xTaskCreateStatic`. This should only be used for tasks where the stack is never accessed while the cache is disabled.

**Default value:**

- Yes (enabled) if [CONFIG\\_SPIRAM](#)

### CONFIG\_SPIRAM\_FETCH\_INSTRUCTIONS

Cache fetch instructions from SPI RAM

*Found in: [Component config](#) > [ESP PSRAM](#) > [CONFIG\\_SPIRAM](#) > [SPI RAM config](#)*

If enabled, instruction in flash will be copied into SPIRAM. If SPIRAM\_RODATA also enabled, you can run the instruction when erasing or programming the flash.

**Default value:**

- No (disabled) if [CONFIG\\_SPIRAM](#)

### CONFIG\_SPIRAM\_RODATA

Cache load read only data from SPI RAM

*Found in: [Component config](#) > [ESP PSRAM](#) > [CONFIG\\_SPIRAM](#) > [SPI RAM config](#)*

If enabled, radata in flash will be copied into SPIRAM. If SPIRAM\_FETCH\_INSTRUCTIONS also enabled, you can run the instruction when erasing or programming the flash.

**Default value:**

- No (disabled) if [CONFIG\\_SPIRAM](#)

### CONFIG\_SPIRAM\_SPEED

Set RAM clock speed

*Found in: [Component config](#) > [ESP PSRAM](#) > [CONFIG\\_SPIRAM](#) > [SPI RAM config](#)*

Select the speed for the SPI RAM chip.

**Available options:**

- 80MHz clock speed (SPIRAM\_SPEED\_80M)
- 40Mhz clock speed (SPIRAM\_SPEED\_40M)
- 26Mhz clock speed (SPIRAM\_SPEED\_26M)
- 20Mhz clock speed (SPIRAM\_SPEED\_20M)

### CONFIG\_SPIRAM\_BOOT\_INIT

Initialize SPI RAM during startup

*Found in: [Component config](#) > [ESP PSRAM](#) > [CONFIG\\_SPIRAM](#) > [SPI RAM config](#)*

If this is enabled, the SPI RAM will be enabled during initial boot. Unless you have specific requirements, you'll want to leave this enabled so memory allocated during boot-up can also be placed in SPI RAM.

**Default value:**

- Yes (enabled) if [CONFIG\\_SPIRAM](#)

### CONFIG\_SPIRAM\_IGNORE\_NOTFOUND

Ignore PSRAM when not found

*Found in: [Component config](#) > [ESP PSRAM](#) > [CONFIG\\_SPIRAM](#) > [SPI RAM config](#) > [CONFIG\\_SPIRAM\\_BOOT\\_INIT](#)*

Normally, if psram initialization is enabled during compile time but not found at runtime, it is seen as an error making the CPU panic. If this is enabled, booting will complete but no PSRAM will be available. If PSRAM failed to initialize, the following configs may be affected and may need to be corrected manually. SPIRAM\_TRY\_ALLOCATE\_WIFI\_LWIP will affect some LWIP and WiFi buffer default values and range values. Enable SPIRAM\_TRY\_ALLOCATE\_WIFI\_LWIP, ESP\_WIFI\_AMSDU\_TX\_ENABLED, ESP\_WIFI\_CACHE\_TX\_BUFFER\_NUM and use static WiFi Tx buffer may cause potential memory exhaustion issues. Suggest disable SPIRAM\_TRY\_ALLOCATE\_WIFI\_LWIP. Suggest disable ESP\_WIFI\_AMSDU\_TX\_ENABLED. Suggest disable ESP\_WIFI\_CACHE\_TX\_BUFFER\_NUM,

need clear `CONFIG_FEATURE_CACHE_TX_BUF_BIT` of `config->feature_caps`. Suggest change `ESP_WIFI_TX_BUFFER` from static to dynamic. Also suggest to adjust some buffer numbers to the values used without PSRAM case. Such as, `ESP_WIFI_STATIC_TX_BUFFER_NUM`, `ESP_WIFI_DYNAMIC_TX_BUFFER_NUM`.

**Default value:**

- No (disabled) if `CONFIG_SPIRAM_BOOT_INIT` && `CONFIG_SPIRAM_ALLOW_BSS_SEG_EXTERNAL_MEMORY` && `CONFIG_SPIRAM`

## CONFIG\_SPIRAM\_USE

SPI RAM access method

*Found in: Component config > ESP PSRAM > CONFIG\_SPIRAM > SPI RAM config*

The SPI RAM can be accessed in multiple methods: by just having it available as an unmanaged memory region in the CPU's memory map, by integrating it in the heap as 'special' memory needing `heap_caps_malloc` to allocate, or by fully integrating it making `malloc()` also able to return SPI RAM pointers.

**Available options:**

- Integrate RAM into memory map (`SPIRAM_USE_MEMMAP`)
- Make RAM allocatable using `heap_caps_malloc(..., MALLOC_CAP_SPIRAM)` (`SPIRAM_USE_CAPS_ALLOC`)
- Make RAM allocatable using `malloc()` as well (`SPIRAM_USE_MALLOC`)

## CONFIG\_SPIRAM\_MEMTEST

Run memory test on SPI RAM initialization

*Found in: Component config > ESP PSRAM > CONFIG\_SPIRAM > SPI RAM config*

Runs a rudimentary memory test on initialization. Aborts when memory test fails. Disable this for slightly faster startup.

**Default value:**

- Yes (enabled) if `CONFIG_SPIRAM_BOOT_INIT` && `CONFIG_SPIRAM`

## CONFIG\_SPIRAM\_MALLOC\_ALWAYSINTERNAL

Maximum `malloc()` size, in bytes, to always put in internal memory

*Found in: Component config > ESP PSRAM > CONFIG\_SPIRAM > SPI RAM config*

If `malloc()` is capable of also allocating SPI-connected ram, its allocation strategy will prefer to allocate chunks less than this size in internal memory, while allocations larger than this will be done from external RAM. If allocation from the preferred region fails, an attempt is made to allocate from the non-preferred region instead, so `malloc()` will not suddenly fail when either internal or external memory is full.

**Range:**

- from 0 to 131072 if `SPIRAM_USE_MALLOC` && `CONFIG_SPIRAM`

**Default value:**

- 16384 if `SPIRAM_USE_MALLOC` && `CONFIG_SPIRAM`

## CONFIG\_SPIRAM\_TRY\_ALLOCATE\_WIFI\_LWIP

Try to allocate memories of WiFi and LWIP in SPIRAM firstly. If failed, allocate internal memory

*Found in: Component config > ESP PSRAM > CONFIG\_SPIRAM > SPI RAM config*

Try to allocate memories of WiFi and LWIP in SPIRAM firstly. If failed, try to allocate internal memory then.

**Default value:**



- No (disabled) if (SPIRAM\_USE\_CAPS\_ALLOC || SPIRAM\_USE\_MALLOC) && *CONFIG\_SPIRAM*

### **CONFIG\_SPIRAM\_MALLOC\_RESERVE\_INTERNAL**

Reserve this amount of bytes for data that specifically needs to be in DMA or internal memory

*Found in: Component config > ESP PSRAM > CONFIG\_SPIRAM > SPI RAM config*

Because the external/internal RAM allocation strategy is not always perfect, it sometimes may happen that the internal memory is entirely filled up. This causes allocations that are specifically done in internal memory, for example the stack for new tasks or memory to service DMA or have memory that's also available when SPI cache is down, to fail. This option reserves a pool specifically for requests like that; the memory in this pool is not given out when a normal malloc() is called.

Set this to 0 to disable this feature.

Note that because FreeRTOS stacks are forced to internal memory, they will also use this memory pool; be sure to keep this in mind when adjusting this value.

Note also that the DMA reserved pool may not be one single contiguous memory region, depending on the configured size and the static memory usage of the app.

**Range:**

- from 0 to 262144 if SPIRAM\_USE\_MALLOC && *CONFIG\_SPIRAM*

**Default value:**

- 32768 if SPIRAM\_USE\_MALLOC && *CONFIG\_SPIRAM*

### **CONFIG\_SPIRAM\_ALLOW\_BSS\_SEG\_EXTERNAL\_MEMORY**

Allow .bss segment placed in external memory

*Found in: Component config > ESP PSRAM > CONFIG\_SPIRAM > SPI RAM config*

If enabled, variables with EXT\_RAM\_BSS\_ATTR attribute will be placed in SPIRAM instead of internal DRAM. BSS section of *lwip*, *net80211*, *pp*, *bt* libraries will be automatically placed in SPIRAM. BSS sections from other object files and libraries can also be placed in SPIRAM through linker fragment scheme *extram\_bss*.

Note that the variables placed in SPIRAM using EXT\_RAM\_BSS\_ATTR will be zero initialized.

**Default value:**

- No (disabled) if *CONFIG\_SPIRAM* && *CONFIG\_SPIRAM*

**ESP Ringbuf** Contains:

- *CONFIG\_RINGBUF\_PLACE\_FUNCTIONS\_INTO\_FLASH*

### **CONFIG\_RINGBUF\_PLACE\_FUNCTIONS\_INTO\_FLASH**

Place non-ISR ringbuf functions into flash

*Found in: Component config > ESP Ringbuf*

Place non-ISR ringbuf functions (like xRingbufferCreate/xRingbufferSend) into flash. This frees up IRAM, but the functions can no longer be called when the cache is disabled.

**Default value:**

- No (disabled)

## CONFIG\_RINGBUF\_PLACE\_ISR\_FUNCTIONS\_INTO\_FLASH

Place ISR ringbuf functions into flash

*Found in: Component config > ESP Ringbuf > CONFIG\_RINGBUF\_PLACE\_FUNCTIONS\_INTO\_FLASH*

Place ISR ringbuf functions (like xRingbufferSendFromISR/xRingbufferReceiveFromISR) into flash. This frees up IRAM, but the functions can no longer be called when the cache is disabled or from an IRAM interrupt context.

This option is not compatible with ESP-IDF drivers which are configured to run the ISR from an IRAM context, e.g. CONFIG\_UART\_ISR\_IN\_IRAM.

### Default value:

- No (disabled) if *CONFIG\_RINGBUF\_PLACE\_FUNCTIONS\_INTO\_FLASH*

## ESP System Settings

 Contains:

- *CONFIG\_ESP\_SYSTEM\_RTC\_EXT\_XTAL\_BOOTSTRAP\_CYCLES*
- *Brownout Detector*
- *Cache config*
- *CONFIG\_ESP\_CONSOLE\_UART*
- *CONFIG\_ESP\_DEFAULT\_CPU\_FREQ\_MHZ*
- *CONFIG\_ESP\_CONSOLE\_USB\_CDC\_SUPPORT\_ETS\_PRINTF*
- *CONFIG\_ESP\_SYSTEM\_ALLOW\_RTC\_FAST\_MEM\_AS\_HEAP*
- *CONFIG\_ESP\_TASK\_WDT\_EN*
- *CONFIG\_ESP\_SYSTEM\_EVENT\_TASK\_STACK\_SIZE*
- *CONFIG\_ESP\_XT\_WDT*
- *CONFIG\_ESP\_SYSTEM\_CHECK\_INT\_LEVEL*
- *CONFIG\_ESP\_INT\_WDT*
- *CONFIG\_ESP32S2\_KEEP\_USB\_ALIVE*
- *CONFIG\_ESP\_MAIN\_TASK\_AFFINITY*
- *CONFIG\_ESP\_MAIN\_TASK\_STACK\_SIZE*
- *CONFIG\_ESP\_DEBUG\_OCDAWARE*
- *Memory*
- *Memory protection*
- *CONFIG\_ESP\_MINIMAL\_SHARED\_STACK\_SIZE*
- *CONFIG\_ESP\_DEBUG\_STUBS\_ENABLE*
- *CONFIG\_ESP\_SYSTEM\_PANIC*
- *CONFIG\_ESP\_PANIC\_HANDLER\_IRAM*
- *CONFIG\_ESP\_CONSOLE\_USB\_CDC\_RX\_BUF\_SIZE*
- *CONFIG\_ESP\_SYSTEM\_EVENT\_QUEUE\_SIZE*
- *Trace memory*
- *CONFIG\_ESP\_CONSOLE\_UART\_BAUDRATE*
- *CONFIG\_ESP\_CONSOLE\_UART\_NUM*
- *CONFIG\_ESP\_CONSOLE\_UART\_RX\_GPIO*
- *CONFIG\_ESP\_CONSOLE\_UART\_TX\_GPIO*

## CONFIG\_ESP\_DEFAULT\_CPU\_FREQ\_MHZ

CPU frequency

*Found in: Component config > ESP System Settings*

CPU frequency to be set on application startup.

### Available options:

- 40 MHz (ESP\_DEFAULT\_CPU\_FREQ\_MHZ\_40)
- 80 MHz (ESP\_DEFAULT\_CPU\_FREQ\_MHZ\_80)
- 160 MHz (ESP\_DEFAULT\_CPU\_FREQ\_MHZ\_160)
- 240 MHz (ESP\_DEFAULT\_CPU\_FREQ\_MHZ\_240)

**Cache config** Contains:

- `CONFIG_ESP32S2_DATA_CACHE_LINE_SIZE`
- `CONFIG_ESP32S2_DATA_CACHE_SIZE`
- `CONFIG_ESP32S2_DATA_CACHE_WRAP`
- `CONFIG_ESP32S2_INSTRUCTION_CACHE_WRAP`
- `CONFIG_ESP32S2_INSTRUCTION_CACHE_LINE_SIZE`
- `CONFIG_ESP32S2_INSTRUCTION_CACHE_SIZE`

### **CONFIG\_ESP32S2\_INSTRUCTION\_CACHE\_SIZE**

Instruction cache size

*Found in: Component config > ESP System Settings > Cache config*

Instruction cache size to be set on application startup. If you use 8KB instruction cache rather than 16KB instruction cache, then the other 8KB will be added to the heap.

**Available options:**

- 8KB (`ESP32S2_INSTRUCTION_CACHE_8KB`)
- 16KB (`ESP32S2_INSTRUCTION_CACHE_16KB`)

### **CONFIG\_ESP32S2\_INSTRUCTION\_CACHE\_LINE\_SIZE**

Instruction cache line size

*Found in: Component config > ESP System Settings > Cache config*

Instruction cache line size to be set on application startup.

**Available options:**

- 16 Bytes (`ESP32S2_INSTRUCTION_CACHE_LINE_16B`)
- 32 Bytes (`ESP32S2_INSTRUCTION_CACHE_LINE_32B`)

### **CONFIG\_ESP32S2\_DATA\_CACHE\_SIZE**

Data cache size

*Found in: Component config > ESP System Settings > Cache config*

Data cache size to be set on application startup. If you use 0KB data cache, the other 16KB will be added to the heap. If you use 8KB data cache rather than 16KB data cache, the other 8KB will be added to the heap.

**Available options:**

- 0KB (`ESP32S2_DATA_CACHE_0KB`)
- 8KB (`ESP32S2_DATA_CACHE_8KB`)
- 16KB (`ESP32S2_DATA_CACHE_16KB`)

### **CONFIG\_ESP32S2\_DATA\_CACHE\_LINE\_SIZE**

Data cache line size

*Found in: Component config > ESP System Settings > Cache config*

Data cache line size to be set on application startup.

**Available options:**

- 16 Bytes (`ESP32S2_DATA_CACHE_LINE_16B`)
- 32 Bytes (`ESP32S2_DATA_CACHE_LINE_32B`)

### CONFIG\_ESP32S2\_INSTRUCTION\_CACHE\_WRAP

Enable instruction cache wrap

*Found in: [Component config](#) > [ESP System Settings](#) > [Cache config](#)*

If enabled, instruction cache will use wrap mode to read spi flash (maybe spiram). The wrap length equals to INSTRUCTION\_CACHE\_LINE\_SIZE. However, it depends on complex conditions.

**Default value:**

- No (disabled)

### CONFIG\_ESP32S2\_DATA\_CACHE\_WRAP

Enable data cache wrap

*Found in: [Component config](#) > [ESP System Settings](#) > [Cache config](#)*

If enabled, data cache will use wrap mode to read spiram (maybe spi flash). The wrap length equals to DATA\_CACHE\_LINE\_SIZE. However, it depends on complex conditions.

**Default value:**

- No (disabled)

**Memory** Contains:

- [CONFIG\\_ESP32S2\\_RTCDATA\\_IN\\_FAST\\_MEM](#)
- [CONFIG\\_ESP32S2\\_USE\\_FIXED\\_STATIC\\_RAM\\_SIZE](#)

### CONFIG\_ESP32S2\_RTCDATA\_IN\_FAST\_MEM

Place RTC\_DATA\_ATTR and RTC\_RODATA\_ATTR variables into RTC fast memory segment

*Found in: [Component config](#) > [ESP System Settings](#) > [Memory](#)*

This option allows to place .rtc\_data and .rtc\_rodata sections into RTC fast memory segment to free the slow memory region for ULP programs.

**Default value:**

- No (disabled)

### CONFIG\_ESP32S2\_USE\_FIXED\_STATIC\_RAM\_SIZE

Use fixed static RAM size

*Found in: [Component config](#) > [ESP System Settings](#) > [Memory](#)*

If this option is disabled, the DRAM part of the heap starts right after the .bss section, within the dram0\_0 region. As a result, adding or removing some static variables will change the available heap size.

If this option is enabled, the DRAM part of the heap starts right after the dram0\_0 region, where its length is set with ESP32S2\_FIXED\_STATIC\_RAM\_SIZE

**Default value:**

- No (disabled)

### CONFIG\_ESP32S2\_FIXED\_STATIC\_RAM\_SIZE

Fixed Static RAM size

*Found in: [Component config](#) > [ESP System Settings](#) > [Memory](#) > [CONFIG\\_ESP32S2\\_USE\\_FIXED\\_STATIC\\_RAM\\_SIZE](#)*

RAM size dedicated for static variables (.data & .bss sections). This value is less than the chips total memory, as not all of it can be used for this purpose. E.g. parts are used by the software bootloader, and will only be available as heap memory after app startup.

**Range:**

- from 0 to 0x34000 if `CONFIG_ESP32S2_USE_FIXED_STATIC_RAM_SIZE`

**Default value:**

- “0x10000” if `CONFIG_ESP32S2_USE_FIXED_STATIC_RAM_SIZE`

**Trace memory** Contains:

- `CONFIG_ESP32S2_TRAX`

### CONFIG\_ESP32S2\_TRAX

Use TRAX tracing feature

*Found in: [Component config](#) > [ESP System Settings](#) > [Trace memory](#)*

The ESP32S2 contains a feature which allows you to trace the execution path the processor has taken through the program. This is stored in a chunk of 32K (16K for single-processor) of memory that can't be used for general purposes anymore. Disable this if you do not know what this is.

**Default value:**

- No (disabled)

### CONFIG\_ESP\_SYSTEM\_PANIC

Panic handler behaviour

*Found in: [Component config](#) > [ESP System Settings](#)*

If FreeRTOS detects unexpected behaviour or an unhandled exception, the panic handler is invoked. Configure the panic handler's action here.

**Available options:**

- Print registers and halt (`ESP_SYSTEM_PANIC_PRINT_HALT`)  
Outputs the relevant registers over the serial port and halt the processor. Needs a manual reset to restart.
- Print registers and reboot (`ESP_SYSTEM_PANIC_PRINT_REBOOT`)  
Outputs the relevant registers over the serial port and immediately reset the processor.
- Silent reboot (`ESP_SYSTEM_PANIC_SILENT_REBOOT`)  
Just resets the processor without outputting anything
- GDBStub on panic (`ESP_SYSTEM_PANIC_GDBSTUB`)  
Invoke gdbstub on the serial port, allowing for gdb to attach to it to do a postmortem of the crash.
- GDBStub at runtime (`ESP_SYSTEM_GDBSTUB_RUNTIME`)  
Invoke gdbstub on the serial port, allowing for gdb to attach to it and to do a debug on runtime.

### CONFIG\_ESP\_SYSTEM\_RTC\_EXT\_XTAL\_BOOTSTRAP\_CYCLES

Bootstrap cycles for external 32kHz crystal

*Found in: [Component config](#) > [ESP System Settings](#)*

To reduce the startup time of an external RTC crystal, we bootstrap it with a 32kHz square wave for a fixed number of cycles. Setting 0 will disable bootstrapping (if disabled, the crystal may take longer to start up or fail to oscillate under some conditions).

If this value is too high, a faulty crystal may initially start and then fail. If this value is too low, an otherwise good crystal may not start.

To accurately determine if the crystal has started, set a larger “Number of cycles for RTC\_SLOW\_CLK calibration” (about 3000).

### **CONFIG\_ESP\_SYSTEM\_ALLOW\_RTC\_FAST\_MEM\_AS\_HEAP**

Enable RTC fast memory for dynamic allocations

*Found in: [Component config](#) > [ESP System Settings](#)*

This config option allows to add RTC fast memory region to system heap with capability similar to that of DRAM region but without DMA. This memory will be consumed first per heap initialization order by early startup services and scheduler related code. Speed wise RTC fast memory operates on APB clock and hence does not have much performance impact.

**Default value:**

- Yes (enabled)

**Memory protection** Contains:

- [CONFIG\\_ESP\\_SYSTEM\\_PMP\\_IDRAM\\_SPLIT](#)
- [CONFIG\\_ESP\\_SYSTEM\\_MEMPROT\\_FEATURE](#)

### **CONFIG\_ESP\_SYSTEM\_PMP\_IDRAM\_SPLIT**

Enable IRAM/DRAM split protection

*Found in: [Component config](#) > [ESP System Settings](#) > [Memory protection](#)*

If enabled, the CPU watches all the memory access and raises an exception in case of any memory violation. This feature automatically splits the SRAM memory, using PMP, into data and instruction segments and sets Read/Execute permissions for the instruction part (below given splitting address) and Read/Write permissions for the data part (above the splitting address). The memory protection is effective on all access through the IRAM0 and DRAM0 buses.

**Default value:**

- Yes (enabled) if `SOC_CPU_IDRAM_SPLIT_USING_PMP`

### **CONFIG\_ESP\_SYSTEM\_MEMPROT\_FEATURE**

Enable memory protection

*Found in: [Component config](#) > [ESP System Settings](#) > [Memory protection](#)*

If enabled, the permission control module watches all the memory access and fires the panic handler if a permission violation is detected. This feature automatically splits the SRAM memory into data and instruction segments and sets Read/Execute permissions for the instruction part (below given splitting address) and Read/Write permissions for the data part (above the splitting address). The memory protection is effective on all access through the IRAM0 and DRAM0 buses.

**Default value:**

- Yes (enabled)

### **CONFIG\_ESP\_SYSTEM\_MEMPROT\_FEATURE\_LOCK**

Lock memory protection settings

*Found in: [Component config](#) > [ESP System Settings](#) > [Memory protection](#) > [CONFIG\\_ESP\\_SYSTEM\\_MEMPROT\\_FEATURE](#)*

Once locked, memory protection settings cannot be changed anymore. The lock is reset only on the chip startup.

**Default value:**

- Yes (enabled)

### **CONFIG\_ESP\_SYSTEM\_EVENT\_QUEUE\_SIZE**

System event queue size

*Found in: [Component config](#) > [ESP System Settings](#)*

Config system event queue size in different application.

**Default value:**

- 32

### **CONFIG\_ESP\_SYSTEM\_EVENT\_TASK\_STACK\_SIZE**

Event loop task stack size

*Found in: [Component config](#) > [ESP System Settings](#)*

Config system event task stack size in different application.

**Default value:**

- 2304

### **CONFIG\_ESP\_MAIN\_TASK\_STACK\_SIZE**

Main task stack size

*Found in: [Component config](#) > [ESP System Settings](#)*

Configure the “main task” stack size. This is the stack of the task which calls `app_main()`. If `app_main()` returns then this task is deleted and its stack memory is freed.

**Default value:**

- 3584

### **CONFIG\_ESP\_MAIN\_TASK\_AFFINITY**

Main task core affinity

*Found in: [Component config](#) > [ESP System Settings](#)*

Configure the “main task” core affinity. This is the used core of the task which calls `app_main()`. If `app_main()` returns then this task is deleted.

**Available options:**

- CPU0 (`ESP_MAIN_TASK_AFFINITY_CPU0`)
- CPU1 (`ESP_MAIN_TASK_AFFINITY_CPU1`)
- No affinity (`ESP_MAIN_TASK_AFFINITY_NO_AFFINITY`)

### **CONFIG\_ESP\_MINIMAL\_SHARED\_STACK\_SIZE**

Minimal allowed size for shared stack

*Found in: [Component config](#) > [ESP System Settings](#)*

Minimal value of size, in bytes, accepted to execute a expression with shared stack.

**Default value:**

- 2048

## CONFIG\_ESP\_CONSOLE\_UART

Channel for console output

*Found in: [Component config](#) > [ESP System Settings](#)*

Select where to send console output (through stdout and stderr).

- Default is to use UART0 on pre-defined GPIOs.
- If “Custom” is selected, UART0 or UART1 can be chosen, and any pins can be selected.
- If “None” is selected, there will be no console output on any UART, except for initial output from ROM bootloader. This ROM output can be suppressed by GPIO strapping or EFUSE, refer to chip datasheet for details.
- On chips with USB OTG peripheral, “USB CDC” option redirects output to the CDC port. This option uses the CDC driver in the chip ROM. This option is incompatible with TinyUSB stack.
- On chips with an USB serial/JTAG debug controller, selecting the option for that redirects output to the CDC/ACM (serial port emulation) component of that device.

### Available options:

- Default: UART0 (ESP\_CONSOLE\_UART\_DEFAULT)
- USB CDC (ESP\_CONSOLE\_USB\_CDC)
- USB Serial/JTAG Controller (ESP\_CONSOLE\_USB\_SERIAL\_JTAG)
- Custom UART (ESP\_CONSOLE\_UART\_CUSTOM)
- None (ESP\_CONSOLE\_NONE)

## CONFIG\_ESP\_CONSOLE\_UART\_NUM

UART peripheral to use for console output (0-1)

*Found in: [Component config](#) > [ESP System Settings](#)*

This UART peripheral is used for console output from the ESP-IDF Bootloader and the app.

If the configuration is different in the Bootloader binary compared to the app binary, UART is reconfigured after the bootloader exits and the app starts.

Due to an ESP32 ROM bug, UART2 is not supported for console output via `esp_rom_printf`.

### Available options:

- UART0 (ESP\_CONSOLE\_UART\_CUSTOM\_NUM\_0)
- UART1 (ESP\_CONSOLE\_UART\_CUSTOM\_NUM\_1)

## CONFIG\_ESP\_CONSOLE\_UART\_TX\_GPIO

UART TX on GPIO#

*Found in: [Component config](#) > [ESP System Settings](#)*

This GPIO is used for console UART TX output in the ESP-IDF Bootloader and the app (including boot log output and default standard output and standard error of the app).

If the configuration is different in the Bootloader binary compared to the app binary, UART is reconfigured after the bootloader exits and the app starts.

### Range:

- from 0 to 46 if ESP\_CONSOLE\_UART\_CUSTOM

### Default value:

- 43 if ESP\_CONSOLE\_UART\_CUSTOM

## CONFIG\_ESP\_CONSOLE\_UART\_RX\_GPIO

UART RX on GPIO#

*Found in: [Component config](#) > [ESP System Settings](#)*



This GPIO is used for UART RX input in the ESP-IDF Bootloader and the app (including default standard input of the app).

Note: The default ESP-IDF Bootloader configures this pin but doesn't read anything from the UART.

If the configuration is different in the Bootloader binary compared to the app binary, UART is reconfigured after the bootloader exits and the app starts.

**Range:**

- from 0 to 46 if `ESP_CONSOLE_UART_CUSTOM`

**Default value:**

- 44 if `ESP_CONSOLE_UART_CUSTOM`

## CONFIG\_ESP\_CONSOLE\_UART\_BAUDRATE

UART console baud rate

*Found in: [Component config](#) > [ESP System Settings](#)*

This baud rate is used by both the ESP-IDF Bootloader and the app (including boot log output and default standard input/output/error of the app).

The app's maximum baud rate depends on the UART clock source. If Power Management is disabled, the UART clock source is the APB clock and all baud rates in the available range will be sufficiently accurate. If Power Management is enabled, REF\_TICK clock source is used so the baud rate is divided from 1MHz. Baud rates above 1Mbps are not possible and values between 500Kbps and 1Mbps may not be accurate.

If the configuration is different in the Bootloader binary compared to the app binary, UART is reconfigured after the bootloader exits and the app starts.

**Range:**

- from 1200 to 4000000 if [CONFIG\\_PM\\_ENABLE](#)
- from 1200 to 1000000 if [CONFIG\\_PM\\_ENABLE](#)

**Default value:**

- 115200

## CONFIG\_ESP\_CONSOLE\_USB\_CDC\_RX\_BUF\_SIZE

Size of USB CDC RX buffer

*Found in: [Component config](#) > [ESP System Settings](#)*

Set the size of USB CDC RX buffer. Increase the buffer size if your application is often receiving data over USB CDC.

**Range:**

- from 4 to 16384 if `ESP_CONSOLE_USB_CDC`

**Default value:**

- 64 if `ESP_CONSOLE_USB_CDC`

## CONFIG\_ESP\_CONSOLE\_USB\_CDC\_SUPPORT\_ETS\_PRINTF

Enable `esp_rom_printf` / `ESP_EARLY_LOG` via USB CDC

*Found in: [Component config](#) > [ESP System Settings](#)*

If enabled, `esp_rom_printf` and `ESP_EARLY_LOG` output will also be sent over USB CDC. Disabling this option saves about 1kB of RAM.

**Default value:**

- No (disabled) if `ESP_CONSOLE_USB_CDC`

### CONFIG\_ESP\_INT\_WDT

Interrupt watchdog

*Found in: [Component config](#) > [ESP System Settings](#)*

This watchdog timer can detect if the FreeRTOS tick interrupt has not been called for a certain time, either because a task turned off interrupts and did not turn them on for a long time, or because an interrupt handler did not return. It will try to invoke the panic handler first and failing that reset the SoC.

**Default value:**

- Yes (enabled)

### CONFIG\_ESP\_INT\_WDT\_TIMEOUT\_MS

Interrupt watchdog timeout (ms)

*Found in: [Component config](#) > [ESP System Settings](#) > [CONFIG\\_ESP\\_INT\\_WDT](#)*

The timeout of the watchdog, in milliseconds. Make this higher than the FreeRTOS tick rate.

**Range:**

- from 10 to 10000

**Default value:**

- 300

### CONFIG\_ESP\_INT\_WDT\_CHECK\_CPU1

Also watch CPU1 tick interrupt

*Found in: [Component config](#) > [ESP System Settings](#) > [CONFIG\\_ESP\\_INT\\_WDT](#)*

Also detect if interrupts on CPU 1 are disabled for too long.

**Default value:**

- Yes (enabled)

### CONFIG\_ESP\_TASK\_WDT\_EN

Enable Task Watchdog Timer

*Found in: [Component config](#) > [ESP System Settings](#)*

The Task Watchdog Timer can be used to make sure individual tasks are still running. Enabling this option will enable the Task Watchdog Timer. It can be either initialized automatically at startup or initialized after startup (see Task Watchdog Timer API Reference)

**Default value:**

- Yes (enabled)

### CONFIG\_ESP\_TASK\_WDT\_INIT

Initialize Task Watchdog Timer on startup

*Found in: [Component config](#) > [ESP System Settings](#) > [CONFIG\\_ESP\\_TASK\\_WDT\\_EN](#)*

Enabling this option will cause the Task Watchdog Timer to be initialized automatically at startup.

**Default value:**

- Yes (enabled)

### CONFIG\_ESP\_TASK\_WDT\_PANIC

Invoke panic handler on Task Watchdog timeout

*Found in:* [Component config](#) > [ESP System Settings](#) > [CONFIG\\_ESP\\_TASK\\_WDT\\_EN](#) > [CONFIG\\_ESP\\_TASK\\_WDT\\_INIT](#)

If this option is enabled, the Task Watchdog Timer will be configured to trigger the panic handler when it times out. This can also be configured at run time (see Task Watchdog Timer API Reference)

**Default value:**

- No (disabled)

### CONFIG\_ESP\_TASK\_WDT\_TIMEOUT\_S

Task Watchdog timeout period (seconds)

*Found in:* [Component config](#) > [ESP System Settings](#) > [CONFIG\\_ESP\\_TASK\\_WDT\\_EN](#) > [CONFIG\\_ESP\\_TASK\\_WDT\\_INIT](#)

Timeout period configuration for the Task Watchdog Timer in seconds. This is also configurable at run time (see Task Watchdog Timer API Reference)

**Range:**

- from 1 to 60

**Default value:**

- 5

### CONFIG\_ESP\_TASK\_WDT\_CHECK\_IDLE\_TASK\_CPU0

Watch CPU0 Idle Task

*Found in:* [Component config](#) > [ESP System Settings](#) > [CONFIG\\_ESP\\_TASK\\_WDT\\_EN](#) > [CONFIG\\_ESP\\_TASK\\_WDT\\_INIT](#)

If this option is enabled, the Task Watchdog Timer will watch the CPU0 Idle Task. Having the Task Watchdog watch the Idle Task allows for detection of CPU starvation as the Idle Task not being called is usually a symptom of CPU starvation. Starvation of the Idle Task is detrimental as FreeRTOS household tasks depend on the Idle Task getting some runtime every now and then.

**Default value:**

- Yes (enabled)

### CONFIG\_ESP\_TASK\_WDT\_CHECK\_IDLE\_TASK\_CPU1

Watch CPU1 Idle Task

*Found in:* [Component config](#) > [ESP System Settings](#) > [CONFIG\\_ESP\\_TASK\\_WDT\\_EN](#) > [CONFIG\\_ESP\\_TASK\\_WDT\\_INIT](#)

If this option is enabled, the Task Watchdog Timer will watch the CPU1 Idle Task.

**Default value:**

- Yes (enabled)

### CONFIG\_ESP\_XT\_WDT

Initialize XTAL32K watchdog timer on startup

*Found in:* [Component config](#) > [ESP System Settings](#)

This watchdog timer can detect oscillation failure of the XTAL32K\_CLK. When such a failure is detected the hardware can be set up to automatically switch to BACKUP32K\_CLK and generate an interrupt.

### CONFIG\_ESP\_XT\_WDT\_TIMEOUT

XTAL32K watchdog timeout period

*Found in: Component config > ESP System Settings > CONFIG\_ESP\_XT\_WDT*

Timeout period configuration for the XTAL32K watchdog timer based on RTC\_CLK.

**Range:**

- from 1 to 255 if *CONFIG\_ESP\_XT\_WDT*

**Default value:**

- 200 if *CONFIG\_ESP\_XT\_WDT*

### CONFIG\_ESP\_XT\_WDT\_BACKUP\_CLK\_ENABLE

Automatically switch to BACKUP32K\_CLK when timer expires

*Found in: Component config > ESP System Settings > CONFIG\_ESP\_XT\_WDT*

Enable this to automatically switch to BACKUP32K\_CLK as the source of RTC\_SLOW\_CLK when the watchdog timer expires.

**Default value:**

- Yes (enabled) if *CONFIG\_ESP\_XT\_WDT*

### CONFIG\_ESP\_PANIC\_HANDLER\_IRAM

Place panic handler code in IRAM

*Found in: Component config > ESP System Settings*

If this option is disabled (default), the panic handler code is placed in flash not IRAM. This means that if ESP-IDF crashes while flash cache is disabled, the panic handler will automatically re-enable flash cache before running GDB Stub or Core Dump. This adds some minor risk, if the flash cache status is also corrupted during the crash.

If this option is enabled, the panic handler code (including required UART functions) is placed in IRAM. This may be necessary to debug some complex issues with crashes while flash cache is disabled (for example, when writing to SPI flash) or when flash cache is corrupted when an exception is triggered.

**Default value:**

- No (disabled)

### CONFIG\_ESP\_DEBUG\_STUBS\_ENABLE

OpenOCD debug stubs

*Found in: Component config > ESP System Settings*

Debug stubs are used by OpenOCD to execute pre-compiled onboard code which does some useful debugging stuff, e.g. GCOV data dump.

**Default value:**

- “COMPILER\_OPTIMIZATION\_LEVEL\_DEBUG” if `ESP32_TRAX` && *CONFIG\_ESP32S2\_TRAX* && *ESP32S3\_TRAX*

### CONFIG\_ESP\_DEBUG\_OCDAWARE

Make exception and panic handlers JTAG/OCD aware

*Found in: Component config > ESP System Settings*

The FreeRTOS panic and unhandled exception handlers can detect a JTAG OCD debugger and instead of panicking, have the debugger stop on the offending instruction.

**Default value:**

- Yes (enabled)

### CONFIG\_ESP\_SYSTEM\_CHECK\_INT\_LEVEL

Interrupt level to use for Interrupt Watchdog and other system checks

*Found in: [Component config](#) > [ESP System Settings](#)*

Interrupt level to use for Interrupt Watchdog and other system checks.

#### Available options:

- Level 5 interrupt (ESP\_SYSTEM\_CHECK\_INT\_LEVEL\_5)  
Using level 5 interrupt for Interrupt Watchdog and other system checks.
- Level 4 interrupt (ESP\_SYSTEM\_CHECK\_INT\_LEVEL\_4)  
Using level 4 interrupt for Interrupt Watchdog and other system checks.

**Brownout Detector** Contains:

- [CONFIG\\_ESP\\_BROWNOUT\\_DET](#)

### CONFIG\_ESP\_BROWNOUT\_DET

Hardware brownout detect & reset

*Found in: [Component config](#) > [ESP System Settings](#) > [Brownout Detector](#)*

The ESP32-S2 has a built-in brownout detector which can detect if the voltage is lower than a specific value. If this happens, it will reset the chip in order to prevent unintended behaviour.

#### Default value:

- Yes (enabled)

### CONFIG\_ESP\_BROWNOUT\_DET\_LVL\_SEL

Brownout voltage level

*Found in: [Component config](#) > [ESP System Settings](#) > [Brownout Detector](#) > [CONFIG\\_ESP\\_BROWNOUT\\_DET](#)*

The brownout detector will reset the chip when the supply voltage is approximately below this level. Note that there may be some variation of brownout voltage level between each ESP3-S2 chip.

#The voltage levels here are estimates, more work needs to be done to figure out the exact voltages #of the brownout threshold levels.

#### Available options:

- 2.44V (ESP\_BROWNOUT\_DET\_LVL\_SEL\_7)
- 2.56V (ESP\_BROWNOUT\_DET\_LVL\_SEL\_6)
- 2.67V (ESP\_BROWNOUT\_DET\_LVL\_SEL\_5)
- 2.84V (ESP\_BROWNOUT\_DET\_LVL\_SEL\_4)
- 2.98V (ESP\_BROWNOUT\_DET\_LVL\_SEL\_3)
- 3.19V (ESP\_BROWNOUT\_DET\_LVL\_SEL\_2)
- 3.30V (ESP\_BROWNOUT\_DET\_LVL\_SEL\_1)

### CONFIG\_ESP32S2\_KEEP\_USB\_ALIVE

Keep USB peripheral enabled at start up

*Found in: [Component config](#) > [ESP System Settings](#)*

During the application initialization process, all the peripherals except UARTs and timers are reset. Enable this option to keep USB peripheral enabled. This option is automatically enabled if “USB CDC” console is selected.

**Default value:**

- Yes (enabled) if ESP\_CONSOLE\_USB\_CDC

**IPC (Inter-Processor Call)** Contains:

- [CONFIG\\_ESP\\_IPC\\_TASK\\_STACK\\_SIZE](#)
- [CONFIG\\_ESP\\_IPC\\_USES\\_CALLERS\\_PRIORITY](#)

**CONFIG\_ESP\_IPC\_TASK\_STACK\_SIZE**

Inter-Processor Call (IPC) task stack size

*Found in: [Component config](#) > [IPC \(Inter-Processor Call\)](#)*

Configure the IPC tasks stack size. An IPC task runs on each core (in dual core mode), and allows for cross-core function calls. See IPC documentation for more details. The default IPC stack size should be enough for most common simple use cases. However, users can increase/decrease the stack size to their needs.

**Range:**

- from 512 to 65536

**Default value:**

- 1024

**CONFIG\_ESP\_IPC\_USES\_CALLERS\_PRIORITY**

IPC runs at caller's priority

*Found in: [Component config](#) > [IPC \(Inter-Processor Call\)](#)*

If this option is not enabled then the IPC task will keep behavior same as prior to that of ESP-IDF v4.0, hence IPC task will run at (configMAX\_PRIORITIES - 1) priority.

**Default value:**

- Yes (enabled)

**High resolution timer (esp\_timer)** Contains:

- [CONFIG\\_ESP\\_TIMER\\_PROFILING](#)
- [CONFIG\\_ESP\\_TIMER\\_TASK\\_STACK\\_SIZE](#)
- [CONFIG\\_ESP\\_TIMER\\_INTERRUPT\\_LEVEL](#)
- [CONFIG\\_ESP\\_TIMER\\_SUPPORTS\\_ISR\\_DISPATCH\\_METHOD](#)

**CONFIG\_ESP\_TIMER\_PROFILING**

Enable esp\_timer profiling features

*Found in: [Component config](#) > [High resolution timer \(esp\\_timer\)](#)*

If enabled, esp\_timer\_dump will dump information such as number of times the timer was started, number of times the timer has triggered, and the total time it took for the callback to run. This option has some effect on timer performance and the amount of memory used for timer storage, and should only be used for debugging/testing purposes.

**Default value:**

- No (disabled)

### CONFIG\_ESP\_TIMER\_TASK\_STACK\_SIZE

High-resolution timer task stack size

*Found in: Component config > High resolution timer (esp\_timer)*

Configure the stack size of “timer\_task” task. This task is used to dispatch callbacks of timers created using ets\_timer and esp\_timer APIs. If you are seeing stack overflow errors in timer task, increase this value.

Note that this is not the same as FreeRTOS timer task. To configure FreeRTOS timer task size, see “FreeRTOS timer task stack size” option in “FreeRTOS” menu.

**Range:**

- from 2048 to 65536

**Default value:**

- 3584

### CONFIG\_ESP\_TIMER\_INTERRUPT\_LEVEL

Interrupt level

*Found in: Component config > High resolution timer (esp\_timer)*

It sets the interrupt level for esp\_timer ISR in range 1..3. A higher level (3) helps to decrease the ISR esp\_timer latency.

**Range:**

- from 1 to 1

**Default value:**

- 1

### CONFIG\_ESP\_TIMER\_SUPPORTS\_ISR\_DISPATCH\_METHOD

Support ISR dispatch method

*Found in: Component config > High resolution timer (esp\_timer)*

Allows using ESP\_TIMER\_ISR dispatch method (ESP\_TIMER\_TASK dispatch method is also available). - ESP\_TIMER\_TASK - Timer callbacks are dispatched from a high-priority esp\_timer task. - ESP\_TIMER\_ISR - Timer callbacks are dispatched directly from the timer interrupt handler. The ISR dispatch can be used, in some cases, when a callback is very simple or need a lower-latency.

**Default value:**

- No (disabled)

**Wi-Fi** Contains:

- *CONFIG\_ESP\_WIFI\_ENTERPRISE\_SUPPORT*
- *CONFIG\_ESP32\_WIFI\_ENABLE\_WPA3\_OWE\_STA*
- *CONFIG\_ESP32\_WIFI\_ENABLE\_WPA3\_SAE*
- *CONFIG\_ESP\_WIFI\_WPS\_PASSPHRASE*
- *CONFIG\_ESP32\_WIFI\_SOFTAP\_BEACON\_MAX\_LEN*
- *CONFIG\_ESP32\_WIFI\_CACHE\_TX\_BUFFER\_NUM*
- *CONFIG\_ESP32\_WIFI\_DYNAMIC\_RX\_BUFFER\_NUM*
- *CONFIG\_ESP32\_WIFI\_DYNAMIC\_TX\_BUFFER\_NUM*
- *CONFIG\_ESP\_WIFI\_RX\_MGMT\_BUF\_NUM\_DEF*
- *CONFIG\_ESP32\_WIFI\_STATIC\_RX\_BUFFER\_NUM*
- *CONFIG\_ESP32\_WIFI\_STATIC\_TX\_BUFFER\_NUM*
- *CONFIG\_ESP\_WIFI\_ESPNOW\_MAX\_ENCRYPT\_NUM*
- *CONFIG\_ESP\_WIFI\_STA\_DISCONNECTED\_PM\_ENABLE*
- *CONFIG\_ESP32\_WIFI\_SW\_COEXIST\_ENABLE*
- *CONFIG\_ESP\_WIFI\_MGMT\_RX\_BUFFER*

- `CONFIG_ESP32_WIFI_TX_BUFFER`
- `CONFIG_ESP32_WIFI_AMPDU_RX_ENABLED`
- `CONFIG_ESP32_WIFI_AMPDU_TX_ENABLED`
- `CONFIG_ESP32_WIFI_AMSDU_TX_ENABLED`
- `CONFIG_ESP32_WIFI_CSI_ENABLED`
- `CONFIG_ESP_WIFI_EXTERNAL_COEXIST_ENABLE`
- `CONFIG_ESP_WIFI_FTM_ENABLE`
- `CONFIG_ESP_WIFI_GCMP_SUPPORT`
- `CONFIG_ESP_WIFI_GMAC_SUPPORT`
- `CONFIG_ESP32_WIFI_IRAM_OPT`
- `CONFIG_ESP32_WIFI_MGMT_SBUF_NUM`
- `CONFIG_ESP32_WIFI_NVS_ENABLED`
- `CONFIG_ESP32_WIFI_RX_IRAM_OPT`
- `CONFIG_ESP_WIFI_SLP_BEACON_LOST_OPT`
- `CONFIG_ESP_WIFI_SLP_IRAM_OPT`
- `CONFIG_ESP_WIFI_SOFTAP_SUPPORT`
- `CONFIG_ESP32_WIFI_TASK_CORE_ID`

### **CONFIG\_ESP32\_WIFI\_SW\_COEXIST\_ENABLE**

Software controls WiFi/Bluetooth coexistence

*Found in: [Component config](#) > [Wi-Fi](#)*

If enabled, WiFi & Bluetooth coexistence is controlled by software rather than hardware. Recommended for heavy traffic scenarios. Both coexistence configuration options are automatically managed, no user intervention is required. If only Bluetooth is used, it is recommended to disable this option to reduce binary file size.

**Default value:**

- Yes (enabled) if `CONFIG_BT_ENABLED`

### **CONFIG\_ESP\_COEX\_POWER\_MANAGEMENT**

Support power management under coexistence

*Found in: [Component config](#) > [Wi-Fi](#) > `CONFIG_ESP32_WIFI_SW_COEXIST_ENABLE`*

If enabled, coexist power management will be enabled.

**Default value:**

- No (disabled) if `CONFIG_ESP32_WIFI_SW_COEXIST_ENABLE`

### **CONFIG\_ESP32\_WIFI\_STATIC\_RX\_BUFFER\_NUM**

Max number of WiFi static RX buffers

*Found in: [Component config](#) > [Wi-Fi](#)*

Set the number of WiFi static RX buffers. Each buffer takes approximately 1.6KB of RAM. The static rx buffers are allocated when `esp_wifi_init` is called, they are not freed until `esp_wifi_deinit` is called.

WiFi hardware use these buffers to receive all 802.11 frames. A higher number may allow higher throughput but increases memory use. If `ESP32_WIFI_AMPDU_RX_ENABLED` is enabled, this value is recommended to set equal or bigger than `ESP32_WIFI_RX_BA_WIN` in order to achieve better throughput and compatibility with both stations and APs.

**Range:**

- from 2 to 25

**Default value:**

- 10 if `CONFIG_SPIRAM_TRY_ALLOCATE_WIFI_LWIP`
- 16 if `CONFIG_SPIRAM_TRY_ALLOCATE_WIFI_LWIP`



## CONFIG\_ESP32\_WIFI\_DYNAMIC\_RX\_BUFFER\_NUM

Max number of WiFi dynamic RX buffers

*Found in: [Component config](#) > [Wi-Fi](#)*

Set the number of WiFi dynamic RX buffers, 0 means unlimited RX buffers will be allocated (provided sufficient free RAM). The size of each dynamic RX buffer depends on the size of the received data frame.

For each received data frame, the WiFi driver makes a copy to an RX buffer and then delivers it to the high layer TCP/IP stack. The dynamic RX buffer is freed after the higher layer has successfully received the data frame.

For some applications, WiFi data frames may be received faster than the application can process them. In these cases we may run out of memory if RX buffer number is unlimited (0).

If a dynamic RX buffer limit is set, it should be at least the number of static RX buffers.

**Range:**

- from 0 to 128 if [CONFIG\\_LWIP\\_WND\\_SCALE](#)
- from 0 to 1024 if [CONFIG\\_LWIP\\_WND\\_SCALE](#)

**Default value:**

- 32

## CONFIG\_ESP32\_WIFI\_TX\_BUFFER

Type of WiFi TX buffers

*Found in: [Component config](#) > [Wi-Fi](#)*

Select type of WiFi TX buffers:

If “Static” is selected, WiFi TX buffers are allocated when WiFi is initialized and released when WiFi is de-initialized. The size of each static TX buffer is fixed to about 1.6KB.

If “Dynamic” is selected, each WiFi TX buffer is allocated as needed when a data frame is delivered to the Wifi driver from the TCP/IP stack. The buffer is freed after the data frame has been sent by the WiFi driver. The size of each dynamic TX buffer depends on the length of each data frame sent by the TCP/IP layer.

If PSRAM is enabled, “Static” should be selected to guarantee enough WiFi TX buffers. If PSRAM is disabled, “Dynamic” should be selected to improve the utilization of RAM.

**Available options:**

- Static (ESP32\_WIFI\_STATIC\_TX\_BUFFER)
- Dynamic (ESP32\_WIFI\_DYNAMIC\_TX\_BUFFER)

## CONFIG\_ESP32\_WIFI\_STATIC\_TX\_BUFFER\_NUM

Max number of WiFi static TX buffers

*Found in: [Component config](#) > [Wi-Fi](#)*

Set the number of WiFi static TX buffers. Each buffer takes approximately 1.6KB of RAM. The static RX buffers are allocated when `esp_wifi_init()` is called, they are not released until `esp_wifi_deinit()` is called.

For each transmitted data frame from the higher layer TCP/IP stack, the WiFi driver makes a copy of it in a TX buffer. For some applications especially UDP applications, the upper layer can deliver frames faster than WiFi layer can transmit. In these cases, we may run out of TX buffers.

**Range:**

- from 1 to 64 if `ESP32_WIFI_STATIC_TX_BUFFER`

**Default value:**

- 16 if `ESP32_WIFI_STATIC_TX_BUFFER`

### CONFIG\_ESP32\_WIFI\_CACHE\_TX\_BUFFER\_NUM

Max number of WiFi cache TX buffers

*Found in: [Component config](#) > [Wi-Fi](#)*

Set the number of WiFi cache TX buffer number.

For each TX packet from uplayer, such as LWIP etc, WiFi driver needs to allocate a static TX buffer and makes a copy of uplayer packet. If WiFi driver fails to allocate the static TX buffer, it caches the uplayer packets to a dedicated buffer queue, this option is used to configure the size of the cached TX queue.

**Range:**

- from 16 to 128 if [CONFIG\\_SPIRAM](#)

**Default value:**

- 32 if [CONFIG\\_SPIRAM](#)

### CONFIG\_ESP32\_WIFI\_DYNAMIC\_TX\_BUFFER\_NUM

Max number of WiFi dynamic TX buffers

*Found in: [Component config](#) > [Wi-Fi](#)*

Set the number of WiFi dynamic TX buffers. The size of each dynamic TX buffer is not fixed, it depends on the size of each transmitted data frame.

For each transmitted frame from the higher layer TCP/IP stack, the WiFi driver makes a copy of it in a TX buffer. For some applications, especially UDP applications, the upper layer can deliver frames faster than WiFi layer can transmit. In these cases, we may run out of TX buffers.

**Range:**

- from 1 to 128

**Default value:**

- 32

### CONFIG\_ESP\_WIFI\_MGMT\_RX\_BUFFER

Type of WiFi RX MGMT buffers

*Found in: [Component config](#) > [Wi-Fi](#)*

Select type of WiFi RX MGMT buffers:

If “Static” is selected, WiFi RX MGMT buffers are allocated when WiFi is initialized and released when WiFi is de-initialized. The size of each static RX MGMT buffer is fixed to about 500 Bytes.

If “Dynamic” is selected, each WiFi RX MGMT buffer is allocated as needed when a MGMT data frame is received. The MGMT buffer is freed after the MGMT data frame has been processed by the WiFi driver.

**Available options:**

- Static (ESP\_WIFI\_STATIC\_RX\_MGMT\_BUFFER)
- Dynamic (ESP\_WIFI\_DYNAMIC\_RX\_MGMT\_BUFFER)

### CONFIG\_ESP\_WIFI\_RX\_MGMT\_BUF\_NUM\_DEF

Max number of WiFi RX MGMT buffers

*Found in: [Component config](#) > [Wi-Fi](#)*

Set the number of WiFi RX\_MGMT buffers.

For Management buffers, the number of dynamic and static management buffers is the same. In order to prevent memory fragmentation, the management buffer type should be set to static first.

**Range:**

- from 1 to 10

**Default value:**

- 5

**CONFIG\_ESP32\_WIFI\_CSI\_ENABLED**

WiFi CSI(Channel State Information)

*Found in: [Component config](#) > [Wi-Fi](#)*

Select this option to enable CSI(Channel State Information) feature. CSI takes about CONFIG\_ESP32\_WIFI\_STATIC\_RX\_BUFFER\_NUM KB of RAM. If CSI is not used, it is better to disable this feature in order to save memory.

**Default value:**

- No (disabled)

**CONFIG\_ESP32\_WIFI\_AMPDU\_TX\_ENABLED**

WiFi AMPDU TX

*Found in: [Component config](#) > [Wi-Fi](#)*

Select this option to enable AMPDU TX feature

**Default value:**

- Yes (enabled)

**CONFIG\_ESP32\_WIFI\_TX\_BA\_WIN**

WiFi AMPDU TX BA window size

*Found in: [Component config](#) > [Wi-Fi](#) > [CONFIG\\_ESP32\\_WIFI\\_AMPDU\\_TX\\_ENABLED](#)*

Set the size of WiFi Block Ack TX window. Generally a bigger value means higher throughput but more memory. Most of time we should NOT change the default value unless special reason, e.g. test the maximum UDP TX throughput with iperf etc. For iperf test in shieldbox, the recommended value is 9~12.

**Range:**

- from 2 to 32

**Default value:**

- 6

**CONFIG\_ESP32\_WIFI\_AMPDU\_RX\_ENABLED**

WiFi AMPDU RX

*Found in: [Component config](#) > [Wi-Fi](#)*

Select this option to enable AMPDU RX feature

**Default value:**

- Yes (enabled)

**CONFIG\_ESP32\_WIFI\_RX\_BA\_WIN**

WiFi AMPDU RX BA window size

*Found in: [Component config](#) > [Wi-Fi](#) > [CONFIG\\_ESP32\\_WIFI\\_AMPDU\\_RX\\_ENABLED](#)*

Set the size of WiFi Block Ack RX window. Generally a bigger value means higher throughput and better compatibility but more memory. Most of time we should NOT change the default value unless

special reason, e.g. test the maximum UDP RX throughput with iperf etc. For iperf test in shieldbox, the recommended value is 9~12. If PSRAM is used and WiFi memory is preferred to be allocated in PSRAM first, the default and minimum value should be 16 to achieve better throughput and compatibility with both stations and APs.

**Range:**

- from 2 to 32

**Default value:**

- 6 if `CONFIG_SPIRAM_TRY_ALLOCATE_WIFI_LWIP` && `CONFIG_ESP32_WIFI_AMPDU_RX_ENABLED`
- 16 if `CONFIG_SPIRAM_TRY_ALLOCATE_WIFI_LWIP` && `CONFIG_ESP32_WIFI_AMPDU_RX_ENABLED`

**CONFIG\_ESP32\_WIFI\_AMSDU\_TX\_ENABLED**

WiFi AMSDU TX

Found in: [Component config](#) > [Wi-Fi](#)

Select this option to enable AMSDU TX feature

**Default value:**

- No (disabled) if `CONFIG_SPIRAM`

**CONFIG\_ESP32\_WIFI\_NVS\_ENABLED**

WiFi NVS flash

Found in: [Component config](#) > [Wi-Fi](#)

Select this option to enable WiFi NVS flash

**Default value:**

- Yes (enabled)

**CONFIG\_ESP32\_WIFI\_TASK\_CORE\_ID**

WiFi Task Core ID

Found in: [Component config](#) > [Wi-Fi](#)

Pinned WiFi task to core 0 or core 1.

**Available options:**

- Core 0 (`ESP32_WIFI_TASK_PINNED_TO_CORE_0`)
- Core 1 (`ESP32_WIFI_TASK_PINNED_TO_CORE_1`)

**CONFIG\_ESP32\_WIFI\_SOFTAP\_BEACON\_MAX\_LEN**

Max length of WiFi SoftAP Beacon

Found in: [Component config](#) > [Wi-Fi](#)

ESP-MESH utilizes beacon frames to detect and resolve root node conflicts (see documentation). However the default length of a beacon frame can simultaneously hold only five root node identifier structures, meaning that a root node conflict of up to five nodes can be detected at one time. In the occurrence of more root nodes conflict involving more than five root nodes, the conflict resolution process will detect five of the root nodes, resolve the conflict, and re-detect more root nodes. This process will repeat until all root node conflicts are resolved. However this process can generally take a very long time.

To counter this situation, the beacon frame length can be increased such that more root nodes can be detected simultaneously. Each additional root node will require 36 bytes and should be added on top of the default beacon frame length of 752 bytes. For example, if you want to detect 10 root nodes simultaneously, you need to set the beacon frame length as 932 ( $752+36*5$ ).

Setting a longer beacon length also assists with debugging as the conflicting root nodes can be identified more quickly.

**Range:**

- from 752 to 1256

**Default value:**

- 752

### CONFIG\_ESP32\_WIFI\_MGMT\_SBUF\_NUM

WiFi mgmt short buffer number

*Found in: [Component config](#) > [Wi-Fi](#)*

Set the number of WiFi management short buffer.

**Range:**

- from 6 to 32

**Default value:**

- 32

### CONFIG\_ESP32\_WIFI\_IRAM\_OPT

WiFi IRAM speed optimization

*Found in: [Component config](#) > [Wi-Fi](#)*

Select this option to place frequently called Wi-Fi library functions in IRAM. When this option is disabled, more than 10Kbytes of IRAM memory will be saved but Wi-Fi throughput will be reduced.

**Default value:**

- Yes (enabled)

### CONFIG\_ESP32\_WIFI\_RX\_IRAM\_OPT

WiFi RX IRAM speed optimization

*Found in: [Component config](#) > [Wi-Fi](#)*

Select this option to place frequently called Wi-Fi library RX functions in IRAM. When this option is disabled, more than 17Kbytes of IRAM memory will be saved but Wi-Fi performance will be reduced.

**Default value:**

- Yes (enabled)

### CONFIG\_ESP32\_WIFI\_ENABLE\_WPA3\_SAE

Enable WPA3-Personal

*Found in: [Component config](#) > [Wi-Fi](#)*

Select this option to allow the device to establish a WPA3-Personal connection with eligible AP's. PMF (Protected Management Frames) is a prerequisite feature for a WPA3 connection, it needs to be explicitly configured before attempting connection. Please refer to the Wi-Fi Driver API Guide for details.

**Default value:**

- Yes (enabled)

### CONFIG\_ESP32\_WIFI\_ENABLE\_WPA3\_OWE\_STA

Enable OWE STA

*Found in: [Component config](#) > [Wi-Fi](#)*

Select this option to allow the device to establish OWE connection with eligible AP's. PMF (Protected Management Frames) is a prerequisite feature for a WPA3 connection, it needs to be explicitly configured before attempting connection. Please refer to the Wi-Fi Driver API Guide for details.

**Default value:**

- Yes (enabled)

### CONFIG\_ESP\_WIFI\_SLP\_IRAM\_OPT

WiFi SLP IRAM speed optimization

*Found in: [Component config](#) > [Wi-Fi](#)*

Select this option to place called Wi-Fi library TBTT process and receive beacon functions in IRAM. Some functions can be put in IRAM either by ESP32\_WIFI\_IRAM\_OPT and ESP32\_WIFI\_RX\_IRAM\_OPT, or this one. If already enabled ESP32\_WIFI\_IRAM\_OPT, the other 7.3KB IRAM memory would be taken by this option. If already enabled ESP32\_WIFI\_RX\_IRAM\_OPT, the other 1.3KB IRAM memory would be taken by this option. If neither of them are enabled, the other 7.4KB IRAM memory would be taken by this option. Wi-Fi power-save mode average current would be reduced if this option is enabled.

### CONFIG\_ESP\_WIFI\_SLP\_DEFAULT\_MIN\_ACTIVE\_TIME

Minimum active time

*Found in: [Component config](#) > [Wi-Fi](#) > [CONFIG\\_ESP\\_WIFI\\_SLP\\_IRAM\\_OPT](#)*

The minimum timeout for waiting to receive data, unit: milliseconds.

**Range:**

- from 8 to 60 if [CONFIG\\_ESP\\_WIFI\\_SLP\\_IRAM\\_OPT](#)

**Default value:**

- 50 if [CONFIG\\_ESP\\_WIFI\\_SLP\\_IRAM\\_OPT](#)

### CONFIG\_ESP\_WIFI\_SLP\_DEFAULT\_MAX\_ACTIVE\_TIME

Maximum keep alive time

*Found in: [Component config](#) > [Wi-Fi](#) > [CONFIG\\_ESP\\_WIFI\\_SLP\\_IRAM\\_OPT](#)*

The maximum time that wifi keep alive, unit: seconds.

**Range:**

- from 10 to 60 if [CONFIG\\_ESP\\_WIFI\\_SLP\\_IRAM\\_OPT](#)

**Default value:**

- 10 if [CONFIG\\_ESP\\_WIFI\\_SLP\\_IRAM\\_OPT](#)

### CONFIG\_ESP\_WIFI\_FTM\_ENABLE

WiFi FTM

*Found in: [Component config](#) > [Wi-Fi](#)*

Enable feature Fine Timing Measurement for calculating WiFi Round-Trip-Time (RTT).

**Default value:**

- No (disabled)

### CONFIG\_ESP\_WIFI\_FTM\_INITIATOR\_SUPPORT

FTM Initiator support

Found in: *Component config* > *Wi-Fi* > *CONFIG\_ESP\_WIFI\_FTM\_ENABLE*

**Default value:**

- Yes (enabled) if *CONFIG\_ESP\_WIFI\_FTM\_ENABLE*

### CONFIG\_ESP\_WIFI\_FTM\_RESPONDER\_SUPPORT

FTM Responder support

Found in: *Component config* > *Wi-Fi* > *CONFIG\_ESP\_WIFI\_FTM\_ENABLE*

**Default value:**

- Yes (enabled) if *CONFIG\_ESP\_WIFI\_FTM\_ENABLE*

### CONFIG\_ESP\_WIFI\_STA\_DISCONNECTED\_PM\_ENABLE

Power Management for station at disconnected

Found in: *Component config* > *Wi-Fi*

Select this option to enable power\_management for station when disconnected. Chip will do modem-sleep when rf module is not in use any more.

**Default value:**

- Yes (enabled)

### CONFIG\_ESP\_WIFI\_EXTERNAL\_COEXIST\_ENABLE

WiFi External Coexistence

Found in: *Component config* > *Wi-Fi*

If enabled, HW External coexistence arbitration is managed by GPIO pins. It can support three types of wired combinations so far which are 1-wired/2-wired/3-wired. User can select GPIO pins in application code with configure interfaces.

This function depends on BT-off because currently we do not support external coex and internal coex simultaneously.

**Default value:**

- No (disabled) if *CONFIG\_BT\_ENABLED* || *NIMBLE\_ENABLED*

### CONFIG\_ESP\_WIFI\_GCMP\_SUPPORT

WiFi GCMP Support(GCMP128 and GCMP256)

Found in: *Component config* > *Wi-Fi*

Select this option to enable GCMP support. GCMP support is compulsory for WiFi Suite-B support.

### CONFIG\_ESP\_WIFI\_GMAC\_SUPPORT

WiFi GMAC Support(GMAC128 and GMAC256)

Found in: *Component config* > *Wi-Fi*

Select this option to enable GMAC support. GMAC support is compulsory for WiFi 192 bit certification.

**Default value:**

- Yes (enabled)

### CONFIG\_ESP\_WIFI\_SOFTAP\_SUPPORT

WiFi SoftAP Support

Found in: [Component config](#) > [Wi-Fi](#)

WiFi module can be compiled without SoftAP to save code size.

**Default value:**

- Yes (enabled)

### CONFIG\_ESP\_WIFI\_SLP\_BEACON\_LOST\_OPT

Wifi sleep optimize when beacon lost

Found in: [Component config](#) > [Wi-Fi](#)

Enable wifi sleep optimization when beacon loss occurs and immediately enter sleep mode when the WiFi module detects beacon loss.

### CONFIG\_ESP\_WIFI\_SLP\_BEACON\_LOST\_TIMEOUT

Beacon loss timeout

Found in: [Component config](#) > [Wi-Fi](#) > [CONFIG\\_ESP\\_WIFI\\_SLP\\_BEACON\\_LOST\\_OPT](#)

Timeout time for close rf phy when beacon loss occurs, Unit: 1024 microsecond.

**Range:**

- from 5 to 100 if [CONFIG\\_ESP\\_WIFI\\_SLP\\_BEACON\\_LOST\\_OPT](#)

**Default value:**

- 10 if [CONFIG\\_ESP\\_WIFI\\_SLP\\_BEACON\\_LOST\\_OPT](#)

### CONFIG\_ESP\_WIFI\_SLP\_BEACON\_LOST\_THRESHOLD

Maximum number of consecutive lost beacons allowed

Found in: [Component config](#) > [Wi-Fi](#) > [CONFIG\\_ESP\\_WIFI\\_SLP\\_BEACON\\_LOST\\_OPT](#)

Maximum number of consecutive lost beacons allowed, WiFi keeps Rx state when the number of consecutive beacons lost is greater than the given threshold.

**Range:**

- from 0 to 8 if [CONFIG\\_ESP\\_WIFI\\_SLP\\_BEACON\\_LOST\\_OPT](#)

**Default value:**

- 3 if [CONFIG\\_ESP\\_WIFI\\_SLP\\_BEACON\\_LOST\\_OPT](#)

### CONFIG\_ESP\_WIFI\_SLP\_PHY\_ON\_DELTA\_EARLY\_TIME

Delta early time for RF PHY on

Found in: [Component config](#) > [Wi-Fi](#) > [CONFIG\\_ESP\\_WIFI\\_SLP\\_BEACON\\_LOST\\_OPT](#)

Delta early time for rf phy on, When the beacon is lost, the next rf phy on will be earlier the time specified by the configuration item, Unit: 32 microsecond.

**Range:**

- from 0 to 100 if [CONFIG\\_ESP\\_WIFI\\_SLP\\_BEACON\\_LOST\\_OPT](#)

**Default value:**

- 2 if [CONFIG\\_ESP\\_WIFI\\_SLP\\_BEACON\\_LOST\\_OPT](#)



### CONFIG\_ESP\_WIFI\_SLP\_PHY\_OFF\_DELTA\_TIMEOUT\_TIME

Delta timeout time for RF PHY off

*Found in: [Component config](#) > [Wi-Fi](#) > [CONFIG\\_ESP\\_WIFI\\_SLP\\_BEACON\\_LOST\\_OPT](#)*

Delta timeout time for rf phy off, When the beacon is lost, the next rf phy off will be delayed for the time specified by the configuration item. Unit: 1024 microsecond.

**Range:**

- from 0 to 8 if [CONFIG\\_ESP\\_WIFI\\_SLP\\_BEACON\\_LOST\\_OPT](#)

**Default value:**

- 2 if [CONFIG\\_ESP\\_WIFI\\_SLP\\_BEACON\\_LOST\\_OPT](#)

### CONFIG\_ESP\_WIFI\_ESPNOW\_MAX\_ENCRYPT\_NUM

Maximum espnow encrypt peers number

*Found in: [Component config](#) > [Wi-Fi](#)*

Maximum number of encrypted peers supported by espnow. The number of hardware keys for encryption is fixed. And the espnow and SoftAP share the same hardware keys. So this configuration will affect the maximum connection number of SoftAP. Maximum espnow encrypted peers number + maximum number of connections of SoftAP = Max hardware keys number.

When using ESP mesh, this value should be set to a maximum of 6.

**Range:**

- from 0 to 17

**Default value:**

- 7

### CONFIG\_ESP\_WIFI\_WPS\_PASSPHRASE

Get WPA2 passphrase in WPS config

*Found in: [Component config](#) > [Wi-Fi](#)*

Select this option to get passphrase during WPS configuration. This option fakes the virtual display capabilities to get the configuration in passphrase mode. Not recommended to be used since WPS credentials should not be shared to other devices, making it in readable format increases that risk, also passphrase requires pbkdf2 to convert in psk.

**Default value:**

- No (disabled)

### CONFIG\_ESP\_WIFI\_ENTERPRISE\_SUPPORT

Enable enterprise option

*Found in: [Component config](#) > [Wi-Fi](#)*

Select this to enable/disable enterprise connection support.

disabling this will reduce binary size. disabling this will disable the use of any esp\_wifi\_sta\_wpa2\_ent\_\* (as APIs will be meaningless)

**Default value:**

- Yes (enabled)

## CONFIG\_ESP\_WIFI\_ENT\_FREE\_DYNAMIC\_BUFFER

Free dynamic buffers during WiFi enterprise connection

*Found in: [Component config](#) > [Wi-Fi](#) > [CONFIG\\_ESP\\_WIFI\\_ENTERPRISE\\_SUPPORT](#)*

Select this configuration to free dynamic buffers during WiFi enterprise connection. This will enable chip to reduce heap consumption during WiFi enterprise connection.

**Default value:**

- No (disabled)

### Core dump Contains:

- [CONFIG\\_ESP\\_COREDUMP\\_CHECK\\_BOOT](#)
- [CONFIG\\_ESP\\_COREDUMP\\_DATA\\_FORMAT](#)
- [CONFIG\\_ESP\\_COREDUMP\\_CHECKSUM](#)
- [CONFIG\\_ESP\\_COREDUMP\\_TO\\_FLASH\\_OR\\_UART](#)
- [CONFIG\\_ESP\\_COREDUMP\\_UART\\_DELAY](#)
- [CONFIG\\_ESP\\_COREDUMP\\_LOGS](#)
- [CONFIG\\_ESP\\_COREDUMP\\_DECODE](#)
- [CONFIG\\_ESP\\_COREDUMP\\_MAX\\_TASKS\\_NUM](#)
- [CONFIG\\_ESP\\_COREDUMP\\_STACK\\_SIZE](#)

## CONFIG\_ESP\_COREDUMP\_TO\_FLASH\_OR\_UART

Data destination

*Found in: [Component config](#) > [Core dump](#)*

Select place to store core dump: flash, uart or none (to disable core dumps generation).

Core dumps to Flash are not available if PSRAM is used for task stacks.

If core dump is configured to be stored in flash and custom partition table is used add corresponding entry to your CSV. For examples, please see predefined partition table CSV descriptions in the `components/partition_table` directory.

**Available options:**

- Flash ([ESP\\_COREDUMP\\_ENABLE\\_TO\\_FLASH](#))
- UART ([ESP\\_COREDUMP\\_ENABLE\\_TO\\_UART](#))
- None ([ESP\\_COREDUMP\\_ENABLE\\_TO\\_NONE](#))

## CONFIG\_ESP\_COREDUMP\_DATA\_FORMAT

Core dump data format

*Found in: [Component config](#) > [Core dump](#)*

Select the data format for core dump.

**Available options:**

- Binary format ([ESP\\_COREDUMP\\_DATA\\_FORMAT\\_BIN](#))
- ELF format ([ESP\\_COREDUMP\\_DATA\\_FORMAT\\_ELF](#))

## CONFIG\_ESP\_COREDUMP\_CHECKSUM

Core dump data integrity check

*Found in: [Component config](#) > [Core dump](#)*

Select the integrity check for the core dump.

**Available options:**

- Use CRC32 for integrity verification ([ESP\\_COREDUMP\\_CHECKSUM\\_CRC32](#))

- Use SHA256 for integrity verification (ESP\_COREDUMP\_CHECKSUM\_SHA256)

### CONFIG\_ESP\_COREDUMP\_CHECK\_BOOT

Check core dump data integrity on boot

*Found in: [Component config](#) > [Core dump](#)*

When enabled, if any data are found on the flash core dump partition, they will be checked by calculating their checksum.

**Default value:**

- Yes (enabled) if ESP\_COREDUMP\_ENABLE\_TO\_FLASH

### CONFIG\_ESP\_COREDUMP\_LOGS

Enable coredump logs for debugging

*Found in: [Component config](#) > [Core dump](#)*

Enable/disable coredump logs. Logs strings from espcoredump component are placed in DRAM. Disabling these helps to save ~5KB of internal memory.

### CONFIG\_ESP\_COREDUMP\_MAX\_TASKS\_NUM

Maximum number of tasks

*Found in: [Component config](#) > [Core dump](#)*

Maximum number of tasks snapshots in core dump.

### CONFIG\_ESP\_COREDUMP\_UART\_DELAY

Delay before print to UART

*Found in: [Component config](#) > [Core dump](#)*

Config delay (in ms) before printing core dump to UART. Delay can be interrupted by pressing Enter key.

**Default value:**

- 0 if ESP\_COREDUMP\_ENABLE\_TO\_UART

### CONFIG\_ESP\_COREDUMP\_STACK\_SIZE

Reserved stack size

*Found in: [Component config](#) > [Core dump](#)*

Size of the memory to be reserved for core dump stack. If 0 core dump process will run on the stack of crashed task/ISR, otherwise special stack will be allocated. To ensure that core dump itself will not overflow task/ISR stack set this to the value above 800. NOTE: It eats DRAM.

### CONFIG\_ESP\_COREDUMP\_DECODE

Handling of UART core dumps in IDF Monitor

*Found in: [Component config](#) > [Core dump](#)*

**Available options:**

- Decode and show summary (info\_corefile) (ESP\_COREDUMP\_DECODE\_INFO)
- Don't decode (ESP\_COREDUMP\_DECODE\_DISABLE)

**FAT Filesystem support** Contains:

- `CONFIG_FATFS_API_ENCODING`
- `CONFIG_FATFS_USE_FASTSEEK`
- `CONFIG_FATFS_CHOOSE_TYPE`
- `CONFIG_FATFS_LONG_FILENAMES`
- `CONFIG_FATFS_MAX_LFN`
- `CONFIG_FATFS_FS_LOCK`
- `CONFIG_FATFS_VOLUME_COUNT`
- `CONFIG_FATFS_CHOOSE_CODEPAGE`
- `CONFIG_FATFS_ALLOC_PREFER_EXTRAM`
- `CONFIG_FATFS_SECTOR_SIZE`
- `CONFIG_FATFS_SECTORS_PER_CLUSTER`
- `CONFIG_FATFS_TIMEOUT_MS`
- `CONFIG_FATFS_PER_FILE_CACHE`

**CONFIG\_FATFS\_VOLUME\_COUNT**

Number of volumes

*Found in: Component config > FAT Filesystem support*

Number of volumes (logical drives) to use.

**Range:**

- from 1 to 10

**Default value:**

- 2

**CONFIG\_FATFS\_SECTOR\_SIZE**

Sector size

*Found in: Component config > FAT Filesystem support*

Specify the size of the sector in bytes for FATFS partition generator.

**Available options:**

- 512 (FATFS\_SECTOR\_512)
- 1024 (FATFS\_SECTOR\_1024)
- 2048 (FATFS\_SECTOR\_2048)
- 4096 (FATFS\_SECTOR\_4096)

**CONFIG\_FATFS\_SECTORS\_PER\_CLUSTER**

Sectors per cluster

*Found in: Component config > FAT Filesystem support*

This value specifies how many sectors there are in one cluster.

**Available options:**

- 1 (FATFS\_SECTORS\_PER\_CLUSTER\_1)
- 2 (FATFS\_SECTORS\_PER\_CLUSTER\_2)
- 4 (FATFS\_SECTORS\_PER\_CLUSTER\_4)
- 8 (FATFS\_SECTORS\_PER\_CLUSTER\_8)
- 16 (FATFS\_SECTORS\_PER\_CLUSTER\_16)
- 32 (FATFS\_SECTORS\_PER\_CLUSTER\_32)
- 64 (FATFS\_SECTORS\_PER\_CLUSTER\_64)
- 128 (FATFS\_SECTORS\_PER\_CLUSTER\_128)

## CONFIG\_FATFS\_CHOOSE\_CODEPAGE

OEM Code Page

*Found in: [Component config](#) > [FAT Filesystem support](#)*

OEM code page used for file name encodings.

If “Dynamic” is selected, code page can be chosen at runtime using `f_setcp` function. Note that choosing this option will increase application size by ~480kB.

### Available options:

- Dynamic (all code pages supported) (FATFS\_CODEPAGE\_DYNAMIC)
- US (CP437) (FATFS\_CODEPAGE\_437)
- Arabic (CP720) (FATFS\_CODEPAGE\_720)
- Greek (CP737) (FATFS\_CODEPAGE\_737)
- KBL (CP771) (FATFS\_CODEPAGE\_771)
- Baltic (CP775) (FATFS\_CODEPAGE\_775)
- Latin 1 (CP850) (FATFS\_CODEPAGE\_850)
- Latin 2 (CP852) (FATFS\_CODEPAGE\_852)
- Cyrillic (CP855) (FATFS\_CODEPAGE\_855)
- Turkish (CP857) (FATFS\_CODEPAGE\_857)
- Portugese (CP860) (FATFS\_CODEPAGE\_860)
- Icelandic (CP861) (FATFS\_CODEPAGE\_861)
- Hebrew (CP862) (FATFS\_CODEPAGE\_862)
- Canadian French (CP863) (FATFS\_CODEPAGE\_863)
- Arabic (CP864) (FATFS\_CODEPAGE\_864)
- Nordic (CP865) (FATFS\_CODEPAGE\_865)
- Russian (CP866) (FATFS\_CODEPAGE\_866)
- Greek 2 (CP869) (FATFS\_CODEPAGE\_869)
- Japanese (DBCS) (CP932) (FATFS\_CODEPAGE\_932)
- Simplified Chinese (DBCS) (CP936) (FATFS\_CODEPAGE\_936)
- Korean (DBCS) (CP949) (FATFS\_CODEPAGE\_949)
- Traditional Chinese (DBCS) (CP950) (FATFS\_CODEPAGE\_950)

## CONFIG\_FATFS\_CHOOSE\_TYPE

FAT type

*Found in: [Component config](#) > [FAT Filesystem support](#)*

If user specifies automatic detection of the FAT type, the FATFS generator will determine the type by the size.

### Available options:

- Select a suitable FATFS type automatically. (FATFS\_AUTO\_TYPE)
- FAT12 (FATFS\_FAT12)
- FAT16 (FATFS\_FAT16)

## CONFIG\_FATFS\_LONG\_FILENAMES

Long filename support

*Found in: [Component config](#) > [FAT Filesystem support](#)*

Support long filenames in FAT. Long filename data increases memory usage. FATFS can be configured to store the buffer for long filename data in stack or heap (Currently not supported by FATFS partition generator).

### Available options:

- No long filenames (FATFS\_LFN\_NONE)
- Long filename buffer in heap (FATFS\_LFN\_HEAP)
- Long filename buffer on stack (FATFS\_LFN\_STACK)

### CONFIG\_FATFS\_MAX\_LFN

Max long filename length

*Found in: [Component config](#) > [FAT Filesystem support](#)*

Maximum long filename length. Can be reduced to save RAM.

**Range:**

- from 12 to 255

**Default value:**

- 255

### CONFIG\_FATFS\_API\_ENCODING

API character encoding

*Found in: [Component config](#) > [FAT Filesystem support](#)*

Choose encoding for character and string arguments/returns when using FATFS APIs. The encoding of arguments will usually depend on text editor settings.

**Available options:**

- API uses ANSI/OEM encoding (FATFS\_API\_ENCODING\_ANSI\_OEM)
- API uses UTF-8 encoding (FATFS\_API\_ENCODING\_UTF\_8)

### CONFIG\_FATFS\_FS\_LOCK

Number of simultaneously open files protected by lock function

*Found in: [Component config](#) > [FAT Filesystem support](#)*

This option sets the FATFS configuration value `_FS_LOCK`. The option `_FS_LOCK` switches file lock function to control duplicated file open and illegal operation to open objects.

\* 0: Disable file lock function. To avoid volume corruption, application should avoid illegal open, remove and rename to the open objects.

\* >0: Enable file lock function. The value defines how many files/sub-directories can be opened simultaneously under file lock control.

Note that the file lock control is independent of re-entrancy.

**Range:**

- from 0 to 65535

**Default value:**

- 0

### CONFIG\_FATFS\_TIMEOUT\_MS

Timeout for acquiring a file lock, ms

*Found in: [Component config](#) > [FAT Filesystem support](#)*

This option sets FATFS configuration value `_FS_TIMEOUT`, scaled to milliseconds. Sets the number of milliseconds FATFS will wait to acquire a mutex when operating on an open file. For example, if one task is performing a lengthy operation, another task will wait for the first task to release the lock, and time out after amount of time set by this option.

**Default value:**

- 10000

### CONFIG\_FATFS\_PER\_FILE\_CACHE

Use separate cache for each file

*Found in: [Component config](#) > [FAT Filesystem support](#)*

This option affects FATFS configuration value `_FS_TINY`.

If this option is set, `_FS_TINY` is 0, and each open file has its own cache, size of the cache is equal to the `_MAX_SS` variable (512 or 4096 bytes). This option uses more RAM if more than 1 file is open, but needs less reads and writes to the storage for some operations.

If this option is not set, `_FS_TINY` is 1, and single cache is used for all open files, size is also equal to `_MAX_SS` variable. This reduces the amount of heap used when multiple files are open, but increases the number of read and write operations which FATFS needs to make.

**Default value:**

- Yes (enabled)

### CONFIG\_FATFS\_ALLOC\_PREFER\_EXTRAM

Prefer external RAM when allocating FATFS buffers

*Found in: [Component config](#) > [FAT Filesystem support](#)*

When the option is enabled, internal buffers used by FATFS will be allocated from external RAM. If the allocation from external RAM fails, the buffer will be allocated from the internal RAM. Disable this option if optimizing for performance. Enable this option if optimizing for internal memory size.

**Default value:**

- Yes (enabled) if `SPIRAM_USE_CAPS_ALLOC` || `SPIRAM_USE_MALLOC`

### CONFIG\_FATFS\_USE\_FASTSEEK

Enable fast seek algorithm when using `lseek` function through VFS FAT

*Found in: [Component config](#) > [FAT Filesystem support](#)*

The fast seek feature enables fast backward/long seek operations without FAT access by using an in-memory CLMT (cluster link map table). Please note, fast-seek is only allowed for read-mode files, if a file is opened in write-mode, the seek mechanism will automatically fallback to the default implementation.

**Default value:**

- No (disabled)

### CONFIG\_FATFS\_FAST\_SEEK\_BUFFER\_SIZE

Fast seek CLMT buffer size

*Found in: [Component config](#) > [FAT Filesystem support](#) > [CONFIG\\_FATFS\\_USE\\_FASTSEEK](#)*

If fast seek algorithm is enabled, this defines the size of CLMT buffer used by this algorithm in 32-bit word units. This value should be chosen based on prior knowledge of maximum elements of each file entry would store.

**Default value:**

- 64 if [CONFIG\\_FATFS\\_USE\\_FASTSEEK](#)

**FreeRTOS** Contains:

- [Kernel](#)
- [Port](#)

**Kernel** Contains:

- `CONFIG_FREERTOS_CHECK_STACKOVERFLOW`
- `CONFIG_FREERTOS_ENABLE_BACKWARD_COMPATIBILITY`
- `CONFIG_FREERTOS_GENERATE_RUN_TIME_STATS`
- `CONFIG_FREERTOS_MAX_TASK_NAME_LEN`
- `CONFIG_FREERTOS_IDLE_TASK_STACKSIZE`
- `CONFIG_FREERTOS_THREAD_LOCAL_STORAGE_POINTERS`
- `CONFIG_FREERTOS_QUEUE_REGISTRY_SIZE`
- `CONFIG_FREERTOS_HZ`
- `CONFIG_FREERTOS_TIMER_QUEUE_LENGTH`
- `CONFIG_FREERTOS_TIMER_TASK_PRIORITY`
- `CONFIG_FREERTOS_TIMER_TASK_STACK_DEPTH`
- `CONFIG_FREERTOS_USE_IDLE_HOOK`
- `CONFIG_FREERTOS_OPTIMIZED_SCHEDULER`
- `CONFIG_FREERTOS_USE_TICK_HOOK`
- `CONFIG_FREERTOS_USE_TICKLESS_IDLE`
- `CONFIG_FREERTOS_USE_TRACE_FACILITY`
- `CONFIG_FREERTOS_UNICORE`
- `CONFIG_FREERTOS_SMP`
- `CONFIG_FREERTOS_USE_MINIMAL_IDLE_HOOK`

### **CONFIG\_FREERTOS\_SMP**

Run the Amazon SMP FreeRTOS kernel instead (FEATURE UNDER DEVELOPMENT)

*Found in: [Component config](#) > [FreeRTOS](#) > [Kernel](#)*

Amazon has released an SMP version of the FreeRTOS Kernel which can be found via the following link: <https://github.com/FreeRTOS/FreeRTOS-Kernel/tree/smp>

IDF has added an experimental port of this SMP kernel located in components/freertos/FreeRTOS-Kernel-SMP. Enabling this option will cause IDF to use the Amazon SMP kernel. Note that THIS FEATURE IS UNDER ACTIVE DEVELOPMENT, users use this at their own risk.

Leaving this option disabled will mean the IDF FreeRTOS kernel is used instead, which is located in: components/freertos/FreeRTOS-Kernel. Both kernel versions are SMP capable, but differ in their implementation and features.

**Default value:**

- No (disabled)

### **CONFIG\_FREERTOS\_UNICORE**

Run FreeRTOS only on first core

*Found in: [Component config](#) > [FreeRTOS](#) > [Kernel](#)*

This version of FreeRTOS normally takes control of all cores of the CPU. Select this if you only want to start it on the first core. This is needed when e.g. another process needs complete control over the second core.

**Default value:**

- Yes (enabled)

### **CONFIG\_FREERTOS\_HZ**

`configTICK_RATE_HZ`

*Found in: [Component config](#) > [FreeRTOS](#) > [Kernel](#)*

Sets the FreeRTOS tick interrupt frequency in Hz (see `configTICK_RATE_HZ` documentation for more details).



**Range:**

- from 1 to 1000

**Default value:**

- 100

**CONFIG\_FREERTOS\_OPTIMIZED\_SCHEDULER**

configUSE\_PORT\_OPTIMISED\_TASK\_SELECTION

*Found in: [Component config](#) > [FreeRTOS](#) > [Kernel](#)*

Enables port specific task selection method. This option can will speed up the search of ready tasks when scheduling (see configUSE\_PORT\_OPTIMISED\_TASK\_SELECTION documentation for more details).

**Default value:**

- Yes (enabled)

**CONFIG\_FREERTOS\_CHECK\_STACKOVERFLOW**

configCHECK\_FOR\_STACK\_OVERFLOW

*Found in: [Component config](#) > [FreeRTOS](#) > [Kernel](#)*

Enables FreeRTOS to check for stack overflows (see configCHECK\_FOR\_STACK\_OVERFLOW documentation for more details).

Note: If users do not provide their own `vApplicationStackOverflowHook()` function, a default function will be provided by ESP-IDF.

**Available options:**

- No checking (FREERTOS\_CHECK\_STACKOVERFLOW\_NONE)  
Do not check for stack overflows (configCHECK\_FOR\_STACK\_OVERFLOW = 0)
- Check by stack pointer value (Method 1) (FREERTOS\_CHECK\_STACKOVERFLOW\_PTRVAL)  
Check for stack overflows on each context switch by checking if the stack pointer is in a valid range. Quick but does not detect stack overflows that happened between context switches (configCHECK\_FOR\_STACK\_OVERFLOW = 1)
- Check using canary bytes (Method 2) (FREERTOS\_CHECK\_STACKOVERFLOW\_CANARY)  
Places some magic bytes at the end of the stack area and on each context switch, check if these bytes are still intact. More thorough than just checking the pointer, but also slightly slower. (configCHECK\_FOR\_STACK\_OVERFLOW = 2)

**CONFIG\_FREERTOS\_THREAD\_LOCAL\_STORAGE\_POINTERS**

configNUM\_THREAD\_LOCAL\_STORAGE\_POINTERS

*Found in: [Component config](#) > [FreeRTOS](#) > [Kernel](#)*

Set the number of thread local storage pointers in each task (see configNUM\_THREAD\_LOCAL\_STORAGE\_POINTERS documentation for more details).

Note: In ESP-IDF, this value must be at least 1. Index 0 is reserved for use by the pthreads API thread-local-storage. Other indexes can be used for any desired purpose.

**Range:**

- from 1 to 256

**Default value:**

- 1

### CONFIG\_FREERTOS\_IDLE\_TASK\_STACKSIZE

configMINIMAL\_STACK\_SIZE (Idle task stack size)

*Found in: [Component config](#) > [FreeRTOS](#) > [Kernel](#)*

Sets the idle task stack size in bytes (see configMINIMAL\_STACK\_SIZE documentation for more details).

Note:

- ESP-IDF specifies stack sizes in bytes instead of words.
- The default size is enough for most use cases.
- The stack size may need to be increased above the default if the app installs idle or thread local storage cleanup hooks that use a lot of stack memory.
- Conversely, the stack size can be reduced to the minimum if non of the idle features are used.

**Range:**

- from 768 to 32768

**Default value:**

- 1536

### CONFIG\_FREERTOS\_USE\_IDLE\_HOOK

configUSE\_IDLE\_HOOK

*Found in: [Component config](#) > [FreeRTOS](#) > [Kernel](#)*

Enables the idle task application hook (see configUSE\_IDLE\_HOOK documentation for more details).

Note:

- The application must provide the hook function `void vApplicationIdleHook( void ) ;`
- `vApplicationIdleHook()` is called from FreeRTOS idle task(s)
- The FreeRTOS idle hook is NOT the same as the ESP-IDF Idle Hook, but both can be enabled simultaneously.

**Default value:**

- No (disabled)

### CONFIG\_FREERTOS\_USE\_MINIMAL\_IDLE\_HOOK

Use FreeRTOS minimal idle hook

*Found in: [Component config](#) > [FreeRTOS](#) > [Kernel](#)*

Enables the minimal idle task application hook (see configUSE\_IDLE\_HOOK documentation for more details).

Note:

- The application must provide the hook function `void vApplicationMinimalIdleHook( void ) ;`
- `vApplicationMinimalIdleHook()` is called from FreeRTOS minimal idle task(s)

**Default value:**

- No (disabled) if [CONFIG\\_FREERTOS\\_SMP](#)

### CONFIG\_FREERTOS\_USE\_TICK\_HOOK

configUSE\_TICK\_HOOK

*Found in: [Component config](#) > [FreeRTOS](#) > [Kernel](#)*

Enables the tick hook (see configUSE\_TICK\_HOOK documentation for more details).

Note:

- The application must provide the hook function `void vApplicationTickHook( void ) ;`
- `vApplicationTickHook()` is called from FreeRTOS' s tick handling function `xTaskIncrementTick()`
- The FreeRTOS tick hook is NOT the same as the ESP-IDF Tick Interrupt Hook, but both can be enabled simultaneously.

**Default value:**

- No (disabled)

### **CONFIG\_FREERTOS\_MAX\_TASK\_NAME\_LEN**

`configMAX_TASK_NAME_LEN`

*Found in: [Component config](#) > [FreeRTOS](#) > [Kernel](#)*

Sets the maximum number of characters for task names (see `configMAX_TASK_NAME_LEN` documentation for more details).

Note: For most uses, the default of 16 characters is sufficient.

**Range:**

- from 1 to 256

**Default value:**

- 16

### **CONFIG\_FREERTOS\_ENABLE\_BACKWARD\_COMPATIBILITY**

`configENABLE_BACKWARD_COMPATIBILITY`

*Found in: [Component config](#) > [FreeRTOS](#) > [Kernel](#)*

Enable backward compatibility with APIs prior to FreeRTOS v8.0.0. (see `configENABLE_BACKWARD_COMPATIBILITY` documentation for more details).

**Default value:**

- No (disabled)

### **CONFIG\_FREERTOS\_TIMER\_TASK\_PRIORITY**

`configTIMER_TASK_PRIORITY`

*Found in: [Component config](#) > [FreeRTOS](#) > [Kernel](#)*

Sets the timer task' s priority (see `configTIMER_TASK_PRIORITY` documentation for more details).

**Range:**

- from 1 to 25

**Default value:**

- 1

### **CONFIG\_FREERTOS\_TIMER\_TASK\_STACK\_DEPTH**

`configTIMER_TASK_STACK_DEPTH`

*Found in: [Component config](#) > [FreeRTOS](#) > [Kernel](#)*

Set the timer task' s stack size (see `configTIMER_TASK_STACK_DEPTH` documentation for more details).

**Range:**

- from 1536 to 32768

**Default value:**

- 2048

### CONFIG\_FREERTOS\_TIMER\_QUEUE\_LENGTH

configTIMER\_QUEUE\_LENGTH

*Found in: [Component config](#) > [FreeRTOS](#) > [Kernel](#)*

Set the timer task's command queue length (see configTIMER\_QUEUE\_LENGTH documentation for more details).

**Range:**

- from 5 to 20

**Default value:**

- 10

### CONFIG\_FREERTOS\_QUEUE\_REGISTRY\_SIZE

configQUEUE\_REGISTRY\_SIZE

*Found in: [Component config](#) > [FreeRTOS](#) > [Kernel](#)*

Set the size of the queue registry (see configQUEUE\_REGISTRY\_SIZE documentation for more details).

Note: A value of 0 will disable queue registry functionality

**Range:**

- from 0 to 20

**Default value:**

- 0

### CONFIG\_FREERTOS\_USE\_TRACE\_FACILITY

configUSE\_TRACE\_FACILITY

*Found in: [Component config](#) > [FreeRTOS](#) > [Kernel](#)*

Enables additional structure members and functions to assist with execution visualization and tracing (see configUSE\_TRACE\_FACILITY documentation for more details).

**Default value:**

- No (disabled)

### CONFIG\_FREERTOS\_USE\_STATS\_FORMATTING\_FUNCTIONS

configUSE\_STATS\_FORMATTING\_FUNCTIONS

*Found in: [Component config](#) > [FreeRTOS](#) > [Kernel](#) > [CONFIG\\_FREERTOS\\_USE\\_TRACE\\_FACILITY](#)*

Set configUSE\_TRACE\_FACILITY and configUSE\_STATS\_FORMATTING\_FUNCTIONS to 1 to include the vTaskList() and vTaskGetRunTimeStats() functions in the build (see configUSE\_STATS\_FORMATTING\_FUNCTIONS documentation for more details).

**Default value:**

- No (disabled) if [CONFIG\\_FREERTOS\\_USE\\_TRACE\\_FACILITY](#)

### CONFIG\_FREERTOS\_VTASKLIST\_INCLUDE\_COREID

Enable display of xCoreID in vTaskList

*Found in: [Component config](#) > [FreeRTOS](#) > [Kernel](#) > [CONFIG\\_FREERTOS\\_USE\\_TRACE\\_FACILITY](#) > [CONFIG\\_FREERTOS\\_USE\\_STATS\\_FORMATTING\\_FUNCTIONS](#)*

If enabled, this will include an extra column when `vTaskList` is called to display the CoreID the task is pinned to (0,1) or -1 if not pinned.

**Default value:**

- No (disabled) if `CONFIG_FREERTOS_USE_STATS_FORMATTING_FUNCTIONS`

### **CONFIG\_FREERTOS\_GENERATE\_RUN\_TIME\_STATS**

`configGENERATE_RUN_TIME_STATS`

*Found in: [Component config](#) > [FreeRTOS](#) > [Kernel](#)*

Enables collection of run time statistics for each task (see `configGENERATE_RUN_TIME_STATS` documentation for more details).

Note: The clock used for run time statistics can be configured in `FREERTOS_RUN_TIME_STATS_CLK`.

**Default value:**

- No (disabled)

### **CONFIG\_FREERTOS\_USE\_TICKLESS\_IDLE**

`configUSE_TICKLESS_IDLE`

*Found in: [Component config](#) > [FreeRTOS](#) > [Kernel](#)*

If power management support is enabled, FreeRTOS will be able to put the system into light sleep mode when no tasks need to run for a number of ticks. This number can be set using `FREERTOS_IDLE_TIME_BEFORE_SLEEP` option. This feature is also known as “automatic light sleep”.

Note that timers created using `esp_timer` APIs may prevent the system from entering sleep mode, even when no tasks need to run. To skip unnecessary wake-up initialize a timer with the “`skip_unhandled_events`” option as true.

If disabled, automatic light sleep support will be disabled.

**Default value:**

- No (disabled) if `CONFIG_PM_ENABLE`

### **CONFIG\_FREERTOS\_IDLE\_TIME\_BEFORE\_SLEEP**

`configEXPECTED_IDLE_TIME_BEFORE_SLEEP`

*Found in: [Component config](#) > [FreeRTOS](#) > [Kernel](#) > [CONFIG\\_FREERTOS\\_USE\\_TICKLESS\\_IDLE](#)*

FreeRTOS will enter light sleep mode if no tasks need to run for this number of ticks.

**Range:**

- from 2 to 4294967295 if `CONFIG_FREERTOS_USE_TICKLESS_IDLE`

**Default value:**

- 3 if `CONFIG_FREERTOS_USE_TICKLESS_IDLE`

**Port** Contains:

- `CONFIG_FREERTOS_CHECK_MUTEX_GIVEN_BY_OWNER`
- `CONFIG_FREERTOS_RUN_TIME_STATS_CLK`
- `CONFIG_FREERTOS_INTERRUPT_BACKTRACE`
- `CONFIG_FREERTOS_WATCHPOINT_END_OF_STACK`
- `CONFIG_FREERTOS_ENABLE_STATIC_TASK_CLEAN_UP`
- `CONFIG_FREERTOS_ENABLE_TASK_SNAPSHOT`
- `CONFIG_FREERTOS_TLSP_DELETION_CALLBACKS`
- `CONFIG_FREERTOS_ASSERT_ON_UNTESTED_FUNCTION`

- [CONFIG\\_FREERTOS\\_ISR\\_STACKSIZE](#)
- [CONFIG\\_FREERTOS\\_PLACE\\_FUNCTIONS\\_INTO\\_FLASH](#)
- [CONFIG\\_FREERTOS\\_PLACE\\_SNAPSHOT\\_FUNS\\_INTO\\_FLASH](#)
- [CONFIG\\_FREERTOS\\_CHECK\\_PORT\\_CRITICAL\\_COMPLIANCE](#)
- [CONFIG\\_FREERTOS\\_CORETIMER](#)
- [CONFIG\\_FREERTOS\\_TASK\\_FUNCTION\\_WRAPPER](#)

### CONFIG\_FREERTOS\_TASK\_FUNCTION\_WRAPPER

Wrap task functions

*Found in:* [Component config](#) > [FreeRTOS](#) > [Port](#)

If enabled, all FreeRTOS task functions will be enclosed in a wrapper function. If a task function mistakenly returns (i.e. does not delete), the call flow will return to the wrapper function. The wrapper function will then log an error and abort the application. This option is also required for GDB backtraces and C++ exceptions to work correctly inside top-level task functions.

**Default value:**

- Yes (enabled)

### CONFIG\_FREERTOS\_WATCHPOINT\_END\_OF\_STACK

Enable stack overflow debug watchpoint

*Found in:* [Component config](#) > [FreeRTOS](#) > [Port](#)

FreeRTOS can check if a stack has overflowed its bounds by checking either the value of the stack pointer or by checking the integrity of canary bytes. (See [FREERTOS\\_CHECK\\_STACKOVERFLOW](#) for more information.) These checks only happen on a context switch, and the situation that caused the stack overflow may already be long gone by then. This option will use the last debug memory watchpoint to allow breaking into the debugger (or panic'ing) as soon as any of the last 32 bytes on the stack of a task are overwritten. The side effect is that using gdb, you effectively have one hardware watchpoint less because the last one is overwritten as soon as a task switch happens.

Another consequence is that due to alignment requirements of the watchpoint, the usable stack size decreases by up to 60 bytes. This is because the watchpoint region has to be aligned to its size and the size for the stack watchpoint in IDF is 32 bytes.

This check only triggers if the stack overflow writes within 32 bytes near the end of the stack, rather than overshooting further, so it is worth combining this approach with one of the other stack overflow check methods.

When this watchpoint is hit, gdb will stop with a SIGTRAP message. When no JTAG OCD is attached, esp-idf will panic on an unhandled debug exception.

**Default value:**

- No (disabled)

### CONFIG\_FREERTOS\_TLSP\_DELETION\_CALLBACKS

Enable thread local storage pointers deletion callbacks

*Found in:* [Component config](#) > [FreeRTOS](#) > [Port](#)

ESP-IDF provides users with the ability to free TLSP memory by registering TLSP deletion callbacks. These callbacks are automatically called by FreeRTOS when a task is deleted. When this option is turned on, the memory reserved for TLSPs in the TCB is doubled to make space for storing the deletion callbacks. If the user does not wish to use TLSP deletion callbacks then this option could be turned off to save space in the TCB memory.

**Default value:**

- Yes (enabled) if [CONFIG\\_FREERTOS\\_SMP](#) && [CONFIG\\_FREERTOS\\_THREAD\\_LOCAL\\_STORAGE\\_POINTERS](#) > 0

### CONFIG\_FREERTOS\_ENABLE\_STATIC\_TASK\_CLEAN\_UP

Enable static task clean up hook

*Found in: [Component config](#) > [FreeRTOS](#) > [Port](#)*

Enable this option to make FreeRTOS call the static task clean up hook when a task is deleted.

Note: Users will need to provide a `void vPortCleanUpTCB ( void *pxTCB )` callback

**Default value:**

- No (disabled) if [CONFIG\\_FREERTOS\\_SMP](#)

### CONFIG\_FREERTOS\_CHECK\_MUTEX\_GIVEN\_BY\_OWNER

Check that mutex semaphore is given by owner task

*Found in: [Component config](#) > [FreeRTOS](#) > [Port](#)*

If enabled, assert that when a mutex semaphore is given, the task giving the semaphore is the task which is currently holding the mutex.

**Default value:**

- Yes (enabled)

### CONFIG\_FREERTOS\_ISR\_STACKSIZE

ISR stack size

*Found in: [Component config](#) > [FreeRTOS](#) > [Port](#)*

The interrupt handlers have their own stack. The size of the stack can be defined here. Each processor has its own stack, so the total size occupied will be twice this.

**Range:**

- from 2096 to 32768 if [ESP\\_COREDUMP\\_DATA\\_FORMAT\\_ELF](#)
- from 1536 to 32768

**Default value:**

- 2096 if [ESP\\_COREDUMP\\_DATA\\_FORMAT\\_ELF](#)
- 1536

### CONFIG\_FREERTOS\_INTERRUPT\_BACKTRACE

Enable backtrace from interrupt to task context

*Found in: [Component config](#) > [FreeRTOS](#) > [Port](#)*

If this option is enabled, interrupt stack frame will be modified to point to the code of the interrupted task as its return address. This helps the debugger (or the panic handler) show a backtrace from the interrupt to the task which was interrupted. This also works for nested interrupts: higher level interrupt stack can be traced back to the lower level interrupt. This option adds 4 instructions to the interrupt dispatching code.

**Default value:**

- Yes (enabled)

### CONFIG\_FREERTOS\_CORETIMER

Tick timer source (Xtensa Only)

*Found in: [Component config](#) > [FreeRTOS](#) > [Port](#)*

FreeRTOS needs a timer with an associated interrupt to use as the main tick source to increase counters, run timers and do pre-emptive multitasking with. There are multiple timers available to do this, with different interrupt priorities.

**Available options:**

- Timer 0 (int 6, level 1) (FREERTOS\_CORETIMER\_0)  
Select this to use timer 0
- Timer 1 (int 15, level 3) (FREERTOS\_CORETIMER\_1)  
Select this to use timer 1
- SYSTIMER 0 (level 1) (FREERTOS\_CORETIMER\_SYSTIMER\_LVL1)  
Select this to use systimer with the 1 interrupt priority.
- SYSTIMER 0 (level 3) (FREERTOS\_CORETIMER\_SYSTIMER\_LVL3)  
Select this to use systimer with the 3 interrupt priority.

**CONFIG\_FREERTOS\_RUN\_TIME\_STATS\_CLK**

Choose the clock source for run time stats

*Found in: [Component config](#) > [FreeRTOS](#) > [Port](#)*

Choose the clock source for FreeRTOS run time stats. Options are CPU0's CPU Clock or the ESP Timer. Both clock sources are 32 bits. The CPU Clock can run at a higher frequency hence provide a finer resolution but will overflow much quicker. Note that run time stats are only valid until the clock source overflows.

**Available options:**

- Use ESP TIMER for run time stats (FREERTOS\_RUN\_TIME\_STATS\_USING\_ESP\_TIMER)  
ESP Timer will be used as the clock source for FreeRTOS run time stats. The ESP Timer runs at a frequency of 1MHz regardless of Dynamic Frequency Scaling. Therefore the ESP Timer will overflow in approximately 4290 seconds.
- Use CPU Clock for run time stats (FREERTOS\_RUN\_TIME\_STATS\_USING\_CPU\_CLK)  
CPU Clock will be used as the clock source for the generation of run time stats. The CPU Clock has a frequency dependent on ESP\_DEFAULT\_CPU\_FREQ\_MHZ and Dynamic Frequency Scaling (DFS). Therefore the CPU Clock frequency can fluctuate between 80 to 240MHz. Run time stats generated using the CPU Clock represents the number of CPU cycles each task is allocated and DOES NOT reflect the amount of time each task runs for (as CPU clock frequency can change). If the CPU clock consistently runs at the maximum frequency of 240MHz, it will overflow in approximately 17 seconds.

**CONFIG\_FREERTOS\_PLACE\_FUNCTIONS\_INTO\_FLASH**

Place FreeRTOS functions into Flash

*Found in: [Component config](#) > [FreeRTOS](#) > [Port](#)*

When enabled the selected Non-ISR FreeRTOS functions will be placed into Flash memory instead of IRAM. This saves up to 8KB of IRAM depending on which functions are used.

**Default value:**

- No (disabled)

**CONFIG\_FREERTOS\_PLACE\_SNAPSHOT\_FUNS\_INTO\_FLASH**

Place task snapshot functions into flash

*Found in: [Component config](#) > [FreeRTOS](#) > [Port](#)*

When enabled, the functions related to snapshots, such as vTaskGetSnapshot or uxTaskGetSnapshotAll, will be placed in flash. Note that if enabled, these functions cannot be called when cache is disabled.

**Default value:**

- No (disabled) if `CONFIG_FREERTOS_ENABLE_TASK_SNAPSHOT` && `CONFIG_ESP_PANIC_HANDLER_IRAM`



### CONFIG\_FREERTOS\_CHECK\_PORT\_CRITICAL\_COMPLIANCE

Tests compliance with Vanilla FreeRTOS port\*\_CRITICAL calls

*Found in: [Component config](#) > [FreeRTOS](#) > [Port](#)*

If enabled, context of port\*\_CRITICAL calls (ISR or Non-ISR) would be checked to be in compliance with Vanilla FreeRTOS. e.g Calling port\*\_CRITICAL from ISR context would cause assert failure

**Default value:**

- No (disabled)

### CONFIG\_FREERTOS\_ASSERT\_ON\_UNTESTED\_FUNCTION

Halt when an SMP-untested function is called

*Found in: [Component config](#) > [FreeRTOS](#) > [Port](#)*

Some functions in FreeRTOS have not been thoroughly tested yet when moving to the SMP implementation of FreeRTOS. When this option is enabled, these functions will throw an `assert()`.

**Default value:**

- Yes (enabled)

### CONFIG\_FREERTOS\_ENABLE\_TASK\_SNAPSHOT

Enable task snapshot functions

*Found in: [Component config](#) > [FreeRTOS](#) > [Port](#)*

When enabled, the functions related to snapshots, such as `vTaskGetSnapshot` or `uxTaskGetSnapshotAll`, are compiled and linked. Task snapshots are used by Task Watchdog (TWDT), GDB Stub and Core dump.

**Default value:**

- Yes (enabled)

### Hardware Abstraction Layer (HAL) and Low Level (LL) Contains:

- [CONFIG\\_HAL\\_DEFAULT\\_ASSERTION\\_LEVEL](#)
- [CONFIG\\_HAL\\_LOG\\_LEVEL](#)
- [CONFIG\\_HAL\\_SYSTIMER\\_USE\\_ROM\\_IMPL](#)
- [CONFIG\\_HAL\\_WDT\\_USE\\_ROM\\_IMPL](#)

### CONFIG\_HAL\_DEFAULT\_ASSERTION\_LEVEL

Default HAL assertion level

*Found in: [Component config](#) > [Hardware Abstraction Layer \(HAL\) and Low Level \(LL\)](#)*

Set the assert behavior / level for HAL component. HAL component assert level can be set separately, but the level can't exceed the system assertion level. e.g. If the system assertion is disabled, then the HAL assertion can't be enabled either. If the system assertion is enable, then the HAL assertion can still be disabled by this Kconfig option.

**Available options:**

- Same as system assertion level (HAL\_ASSERTION\_EQUALS\_SYSTEM)
- Disabled (HAL\_ASSERTION\_DISABLE)
- Silent (HAL\_ASSERTION\_SILENT)
- Enabled (HAL\_ASSERTION\_ENABLE)

## CONFIG\_HAL\_LOG\_LEVEL

HAL layer log verbosity

*Found in: [Component config](#) > [Hardware Abstraction Layer \(HAL\) and Low Level \(LL\)](#)*

Specify how much output to see in HAL logs.

### Available options:

- No output (HAL\_LOG\_LEVEL\_NONE)
- Error (HAL\_LOG\_LEVEL\_ERROR)
- Warning (HAL\_LOG\_LEVEL\_WARN)
- Info (HAL\_LOG\_LEVEL\_INFO)
- Debug (HAL\_LOG\_LEVEL\_DEBUG)
- Verbose (HAL\_LOG\_LEVEL\_VERBOSE)

## CONFIG\_HAL\_SYSTIMER\_USE\_ROM\_IMPL

Use ROM implementation of SysTimer HAL driver

*Found in: [Component config](#) > [Hardware Abstraction Layer \(HAL\) and Low Level \(LL\)](#)*

Enable this flag to use HAL functions from ROM instead of ESP-IDF.

If keeping this as “n” in your project, you will have less free IRAM. If making this as “y” in your project, you will increase free IRAM, but you will lose the possibility to debug this module, and some new features will be added and bugs will be fixed in the IDF source but cannot be synced to ROM.

### Default value:

- Yes (enabled) if ESP\_ROM\_HAS\_HAL\_SYSTIMER

## CONFIG\_HAL\_WDT\_USE\_ROM\_IMPL

Use ROM implementation of WDT HAL driver

*Found in: [Component config](#) > [Hardware Abstraction Layer \(HAL\) and Low Level \(LL\)](#)*

Enable this flag to use HAL functions from ROM instead of ESP-IDF.

If keeping this as “n” in your project, you will have less free IRAM. If making this as “y” in your project, you will increase free IRAM, but you will lose the possibility to debug this module, and some new features will be added and bugs will be fixed in the IDF source but cannot be synced to ROM.

### Default value:

- Yes (enabled) if ESP\_ROM\_HAS\_HAL\_WDT

## Heap memory debugging

 Contains:

- [CONFIG\\_HEAP\\_ABORT\\_WHEN\\_ALLOCATION\\_FAILS](#)
- [CONFIG\\_HEAP\\_TASK\\_TRACKING](#)
- [CONFIG\\_HEAP\\_CORRUPTION\\_DETECTION](#)
- [CONFIG\\_HEAP\\_TRACING\\_DEST](#)
- [CONFIG\\_HEAP\\_TRACING\\_STACK\\_DEPTH](#)
- [CONFIG\\_HEAP\\_TLSF\\_USE\\_ROM\\_IMPL](#)

## CONFIG\_HEAP\_CORRUPTION\_DETECTION

Heap corruption detection

*Found in: [Component config](#) > [Heap memory debugging](#)*

Enable heap poisoning features to detect heap corruption caused by out-of-bounds access to heap memory.

See the “Heap Memory Debugging” page of the IDF documentation for a description of each level of heap corruption detection.

**Available options:**

- Basic (no poisoning) (HEAP\_POISONING\_DISABLED)
- Light impact (HEAP\_POISONING\_LIGHT)
- Comprehensive (HEAP\_POISONING\_COMPREHENSIVE)

**CONFIG\_HEAP\_TRACING\_DEST**

Heap tracing

*Found in: [Component config](#) > [Heap memory debugging](#)*

Enables the heap tracing API defined in esp\_heap\_trace.h.

This function causes a moderate increase in IRAM code size and a minor increase in heap function (malloc/free/realloc) CPU overhead, even when the tracing feature is not used. So it's best to keep it disabled unless tracing is being used.

**Available options:**

- Disabled (HEAP\_TRACING\_OFF)
- Standalone (HEAP\_TRACING\_STANDALONE)
- Host-based (HEAP\_TRACING\_TOHOST)

**CONFIG\_HEAP\_TRACING\_STACK\_DEPTH**

Heap tracing stack depth

*Found in: [Component config](#) > [Heap memory debugging](#)*

Number of stack frames to save when tracing heap operation callers.

More stack frames uses more memory in the heap trace buffer (and slows down allocation), but can provide useful information.

**CONFIG\_HEAP\_TASK\_TRACKING**

Enable heap task tracking

*Found in: [Component config](#) > [Heap memory debugging](#)*

Enables tracking the task responsible for each heap allocation.

This function depends on heap poisoning being enabled and adds four more bytes of overhead for each block allocated.

**CONFIG\_HEAP\_ABORT\_WHEN\_ALLOCATION\_FAILS**

Abort if memory allocation fails

*Found in: [Component config](#) > [Heap memory debugging](#)*

When enabled, if a memory allocation operation fails it will cause a system abort.

**Default value:**

- No (disabled)

**CONFIG\_HEAP\_TLSF\_USE\_ROM\_IMPL**

Use ROM implementation of heap tlsf library

*Found in: [Component config](#) > [Heap memory debugging](#)*

Enable this flag to use heap functions from ROM instead of ESP-IDF.

If keeping this as “n” in your project, you will have less free IRAM. If making this as “y” in your project, you will increase free IRAM, but you will lose the possibility to debug this module, and some new features will be added and bugs will be fixed in the IDF source but cannot be synced to ROM.

**Default value:**

- Yes (enabled) if ESP\_ROM\_HAS\_HEAP\_TLSF

**Log output** Contains:

- [CONFIG\\_LOG\\_DEFAULT\\_LEVEL](#)
- [CONFIG\\_LOG\\_TIMESTAMP\\_SOURCE](#)
- [CONFIG\\_LOG\\_MAXIMUM\\_LEVEL](#)
- [CONFIG\\_LOG\\_COLORS](#)

### CONFIG\_LOG\_DEFAULT\_LEVEL

Default log verbosity

*Found in: [Component config](#) > [Log output](#)*

Specify how much output to see in logs by default. You can set lower verbosity level at runtime using `esp_log_level_set` function.

By default, this setting limits which log statements are compiled into the program. For example, selecting “Warning” would mean that changing log level to “Debug” at runtime will not be possible. To allow increasing log level above the default at runtime, see the next option.

**Available options:**

- No output (LOG\_DEFAULT\_LEVEL\_NONE)
- Error (LOG\_DEFAULT\_LEVEL\_ERROR)
- Warning (LOG\_DEFAULT\_LEVEL\_WARN)
- Info (LOG\_DEFAULT\_LEVEL\_INFO)
- Debug (LOG\_DEFAULT\_LEVEL\_DEBUG)
- Verbose (LOG\_DEFAULT\_LEVEL\_VERBOSE)

### CONFIG\_LOG\_MAXIMUM\_LEVEL

Maximum log verbosity

*Found in: [Component config](#) > [Log output](#)*

This config option sets the highest log verbosity that it’s possible to select at runtime by calling `esp_log_level_set()`. This level may be higher than the default verbosity level which is set when the app starts up.

This can be used enable debugging output only at a critical point, for a particular tag, or to minimize startup time but then enable more logs once the firmware has loaded.

Note that increasing the maximum available log level will increase the firmware binary size.

This option only applies to logging from the app, the bootloader log level is fixed at compile time to the separate “Bootloader log verbosity” setting.

**Available options:**

- Same as default (LOG\_MAXIMUM\_EQUALS\_DEFAULT)
- Error (LOG\_MAXIMUM\_LEVEL\_ERROR)
- Warning (LOG\_MAXIMUM\_LEVEL\_WARN)
- Info (LOG\_MAXIMUM\_LEVEL\_INFO)
- Debug (LOG\_MAXIMUM\_LEVEL\_DEBUG)
- Verbose (LOG\_MAXIMUM\_LEVEL\_VERBOSE)

## CONFIG\_LOG\_COLORS

Use ANSI terminal colors in log output

*Found in: Component config > Log output*

Enable ANSI terminal color codes in bootloader output.

In order to view these, your terminal program must support ANSI color codes.

### Default value:

- Yes (enabled)

## CONFIG\_LOG\_TIMESTAMP\_SOURCE

Log Timestamps

*Found in: Component config > Log output*

Choose what sort of timestamp is displayed in the log output:

- Milliseconds since boot is calculated from the RTOS tick count multiplied by the tick period. This time will reset after a software reboot. e.g. (90000)
- System time is taken from POSIX time functions which use the chip's RTC and high resolution timers to maintain an accurate time. The system time is initialized to 0 on startup, it can be set with an SNTP sync, or with POSIX time functions. This time will not reset after a software reboot. e.g. (00:01:30.000)
- NOTE: Currently this will not get used in logging from binary blobs (i.e WiFi & Bluetooth libraries), these will always print milliseconds since boot.

### Available options:

- Milliseconds Since Boot (LOG\_TIMESTAMP\_SOURCE\_RTOS)
- System Time (LOG\_TIMESTAMP\_SOURCE\_SYSTEM)

**LWIP** Contains:

- *CONFIG\_LWIP\_CHECK\_THREAD\_SAFETY*
- *Checksums*
- *CONFIG\_LWIP\_DHCP\_COARSE\_TIMER\_SECS*
- *DHCP server*
- *CONFIG\_LWIP\_DHCP\_OPTIONS\_LEN*
- *CONFIG\_LWIP\_DHCP\_DISABLE\_CLIENT\_ID*
- *CONFIG\_LWIP\_DHCP\_DISABLE\_VENDOR\_CLASS\_ID*
- *CONFIG\_LWIP\_DHCP\_DOES\_ARP\_CHECK*
- *CONFIG\_LWIP\_DHCP\_RESTORE\_LAST\_IP*
- *DNS*
- *CONFIG\_LWIP\_PPP\_CHAP\_SUPPORT*
- *CONFIG\_LWIP\_L2\_TO\_L3\_COPY*
- *CONFIG\_LWIP\_IPV6\_DHCP6*
- *CONFIG\_LWIP\_IP4\_FRAG*
- *CONFIG\_LWIP\_IP6\_FRAG*
- *CONFIG\_LWIP\_IP\_FORWARD*
- *CONFIG\_LWIP\_NETBUF\_RECVINFO*
- *CONFIG\_LWIP\_AUTOIP*
- *CONFIG\_LWIP\_IPV6*
- *CONFIG\_LWIP\_ENABLE\_LCP\_ECHO*
- *CONFIG\_LWIP\_ESP\_LWIP\_ASSERT*
- *CONFIG\_LWIP\_DEBUG*
- *CONFIG\_LWIP\_IRAM\_OPTIMIZATION*
- *CONFIG\_LWIP\_STATS*
- *CONFIG\_LWIP\_TIMERS\_ONDEMAND*
- *CONFIG\_LWIP\_DNS\_SUPPORT\_MDNS\_QUERIES*

- `CONFIG_LWIP_PPP_MPPE_SUPPORT`
- `CONFIG_LWIP_PPP_MSCHAP_SUPPORT`
- `CONFIG_LWIP_PPP_NOTIFY_PHASE_SUPPORT`
- `CONFIG_LWIP_PPP_PAP_SUPPORT`
- `CONFIG_LWIP_PPP_DEBUG_ON`
- `CONFIG_LWIP_PPP_SUPPORT`
- `CONFIG_LWIP_IP4_REASSEMBLY`
- `CONFIG_LWIP_IP6_REASSEMBLY`
- `CONFIG_LWIP_SLIP_SUPPORT`
- `CONFIG_LWIP_SO_LINGER`
- `CONFIG_LWIP_SO_RCVBUF`
- `CONFIG_LWIP_SO_REUSE`
- `CONFIG_LWIP_NETIF_STATUS_CALLBACK`
- `CONFIG_LWIP_TCPIP_CORE_LOCKING`
- `CONFIG_LWIP_NETIF_API`
- *Hooks*
- *ICMP*
- `CONFIG_LWIP_LOCAL_HOSTNAME`
- `CONFIG_LWIP_ND6`
- *LWIP RAW API*
- `CONFIG_LWIP_TCPIP_TASK_PRIO`
- `CONFIG_LWIP_IPV6_ND6_NUM_NEIGHBORS`
- `CONFIG_LWIP_IPV6_MEMP_NUM_ND6_QUEUE`
- `CONFIG_LWIP_MAX_SOCKETS`
- `CONFIG_LWIP_BRIDGEIF_MAX_PORTS`
- `CONFIG_LWIP_NUM_NETIF_CLIENT_DATA`
- `CONFIG_LWIP_ESP_GRATUITOUS_ARP`
- `CONFIG_LWIP_ESP_MLDV6_REPORT`
- *SNTP*
- `CONFIG_LWIP_USE_ONLY_LWIP_SELECT`
- `CONFIG_LWIP_NETIF_LOOPBACK`
- *TCP*
- `CONFIG_LWIP_TCPIP_TASK_AFFINITY`
- `CONFIG_LWIP_TCPIP_TASK_STACK_SIZE`
- `CONFIG_LWIP_TCPIP_RECVMBOX_SIZE`
- `CONFIG_LWIP_IP_DEFAULT_TTL`
- *UDP*
- `CONFIG_LWIP_IPV6_RDNSS_MAX_DNS_SERVERS`

### **CONFIG\_LWIP\_LOCAL\_HOSTNAME**

Local netif hostname

*Found in: Component config > LWIP*

The default name this device will report to other devices on the network. Could be updated at runtime with `esp_netif_set_hostname()`

**Default value:**

- “espressif”

### **CONFIG\_LWIP\_NETIF\_API**

Enable usage of standard POSIX APIs in LWIP

*Found in: Component config > LWIP*

If this feature is enabled, standard POSIX APIs: `if_indextoname()`, `if_nametoindex()` could be used to convert network interface index to name instead of IDF specific esp-netif APIs (such as `esp_netif_get_netif_impl_name()`)

**Default value:**

- No (disabled)

**CONFIG\_LWIP\_TCPIP\_TASK\_PRIO**

LWIP TCP/IP Task Priority

*Found in: [Component config](#) > [LWIP](#)*

LWIP tcpip task priority. In case of high throughput, this parameter could be changed up to (config-MAX\_PRIORITIES-1).

**Range:**

- from 1 to 24

**Default value:**

- 18

**CONFIG\_LWIP\_TCPIP\_CORE\_LOCKING**

Enable tcpip core locking

*Found in: [Component config](#) > [LWIP](#)*

If Enable tcpip core locking, Creates a global mutex that is held during TCPIP thread operations. Can be locked by client code to perform lwIP operations without changing into TCPIP thread using callbacks. See LOCK\_TCPIP\_CORE() and UNLOCK\_TCPIP\_CORE().

If disable tcpip core locking, TCP IP will perform tasks through context switching

**Default value:**

- No (disabled)

**CONFIG\_LWIP\_TCPIP\_CORE\_LOCKING\_INPUT**

Enable tcpip core locking input

*Found in: [Component config](#) > [LWIP](#) > [CONFIG\\_LWIP\\_TCPIP\\_CORE\\_LOCKING](#)*

when LWIP\_TCPIP\_CORE\_LOCKING is enabled, this lets tcpip\_input() grab the mutex for input packets as well, instead of allocating a message and passing it to tcpip\_thread.

**Default value:**

- No (disabled) if [CONFIG\\_LWIP\\_TCPIP\\_CORE\\_LOCKING](#)

**CONFIG\_LWIP\_CHECK\_THREAD\_SAFETY**

Checks that lwip API runs in expected context

*Found in: [Component config](#) > [LWIP](#)*

Enable to check that the project does not violate lwip thread safety. If enabled, all lwip functions that require thread awareness run an assertion to verify that the TCP/IP core functionality is either locked or accessed from the correct thread.

**Default value:**

- No (disabled)

**CONFIG\_LWIP\_DNS\_SUPPORT\_MDNS\_QUERIES**

Enable mDNS queries in resolving host name

*Found in: [Component config](#) > [LWIP](#)*

If this feature is enabled, standard API such as gethostbyname support .local addresses by sending one shot multicast mDNS query

**Default value:**

- Yes (enabled)

**CONFIG\_LWIP\_L2\_TO\_L3\_COPY**

Enable copy between Layer2 and Layer3 packets

*Found in: [Component config](#) > [LWIP](#)*

If this feature is enabled, all traffic from layer2(WIFI Driver) will be copied to a new buffer before sending it to layer3(LWIP stack), freeing the layer2 buffer. Please be notified that the total layer2 receiving buffer is fixed and ESP32 currently supports 25 layer2 receiving buffer, when layer2 buffer runs out of memory, then the incoming packets will be dropped in hardware. The layer3 buffer is allocated from the heap, so the total layer3 receiving buffer depends on the available heap size, when heap runs out of memory, no copy will be sent to layer3 and packet will be dropped in layer2. Please make sure you fully understand the impact of this feature before enabling it.

**Default value:**

- No (disabled)

**CONFIG\_LWIP\_IRAM\_OPTIMIZATION**

Enable LWIP IRAM optimization

*Found in: [Component config](#) > [LWIP](#)*

If this feature is enabled, some functions relating to RX/TX in LWIP will be put into IRAM, it can improve UDP/TCP throughput by >10% for single core mode, it doesn't help too much for dual core mode. On the other hand, it needs about 10KB IRAM for these optimizations.

If this feature is disabled, all lwip functions will be put into FLASH.

**Default value:**

- No (disabled)

**CONFIG\_LWIP\_TIMERS\_ONDEMAND**

Enable LWIP Timers on demand

*Found in: [Component config](#) > [LWIP](#)*

If this feature is enabled, IGMP and MLD6 timers will be activated only when joining groups or receiving QUERY packets.

This feature will reduce the power consumption for applications which do not use IGMP and MLD6.

**Default value:**

- Yes (enabled)

**CONFIG\_LWIP\_MAX\_SOCKETS**

Max number of open sockets

*Found in: [Component config](#) > [LWIP](#)*

Sockets take up a certain amount of memory, and allowing fewer sockets to be open at the same time conserves memory. Specify the maximum amount of sockets here. The valid value is from 1 to 16.

**Range:**

- from 1 to 16

**Default value:**

- 10



### CONFIG\_LWIP\_USE\_ONLY\_LWIP\_SELECT

Support LWIP socket select() only (DEPRECATED)

Found in: [Component config](#) > [LWIP](#)

This option is deprecated. Do not use this option, use VFS\_SUPPORT\_SELECT instead.

**Default value:**

- No (disabled)

### CONFIG\_LWIP\_SO\_LINGER

Enable SO\_LINGER processing

Found in: [Component config](#) > [LWIP](#)

Enabling this option allows SO\_LINGER processing. l\_onoff = 1,l\_linger can set the timeout.

If l\_linger=0, When a connection is closed, TCP will terminate the connection. This means that TCP will discard any data packets stored in the socket send buffer and send an RST to the peer.

If l\_linger!=0,Then closesocket() calls to block the process until the remaining data packets has been sent or timed out.

**Default value:**

- No (disabled)

### CONFIG\_LWIP\_SO\_REUSE

Enable SO\_REUSEADDR option

Found in: [Component config](#) > [LWIP](#)

Enabling this option allows binding to a port which remains in TIME\_WAIT.

**Default value:**

- Yes (enabled)

### CONFIG\_LWIP\_SO\_REUSE\_RXTOALL

SO\_REUSEADDR copies broadcast/multicast to all matches

Found in: [Component config](#) > [LWIP](#) > [CONFIG\\_LWIP\\_SO\\_REUSE](#)

Enabling this option means that any incoming broadcast or multicast packet will be copied to all of the local sockets that it matches (may be more than one if SO\_REUSEADDR is set on the socket.)

This increases memory overhead as the packets need to be copied, however they are only copied per matching socket. You can safely disable it if you don't plan to receive broadcast or multicast traffic on more than one socket at a time.

**Default value:**

- Yes (enabled)

### CONFIG\_LWIP\_SO\_RCVBUF

Enable SO\_RCVBUF option

Found in: [Component config](#) > [LWIP](#)

Enabling this option allows checking for available data on a netconn.

**Default value:**

- No (disabled)

**CONFIG\_LWIP\_NETBUF\_RECVINFO**

Enable IP\_PKTINFO option

*Found in: [Component config](#) > [LWIP](#)*

Enabling this option allows checking for the destination address of a received IPv4 Packet.

**Default value:**

- No (disabled)

**CONFIG\_LWIP\_IP\_DEFAULT\_TTL**

The value for Time-To-Live used by transport layers

*Found in: [Component config](#) > [LWIP](#)*

Set value for Time-To-Live used by transport layers.

**Range:**

- from 1 to 255

**Default value:**

- 64

**CONFIG\_LWIP\_IP4\_FRAG**

Enable fragment outgoing IP4 packets

*Found in: [Component config](#) > [LWIP](#)*

Enabling this option allows fragmenting outgoing IP4 packets if their size exceeds MTU.

**Default value:**

- Yes (enabled)

**CONFIG\_LWIP\_IP6\_FRAG**

Enable fragment outgoing IP6 packets

*Found in: [Component config](#) > [LWIP](#)*

Enabling this option allows fragmenting outgoing IP6 packets if their size exceeds MTU.

**Default value:**

- Yes (enabled)

**CONFIG\_LWIP\_IP4\_REASSEMBLY**

Enable reassembly incoming fragmented IP4 packets

*Found in: [Component config](#) > [LWIP](#)*

Enabling this option allows reassembling incoming fragmented IP4 packets.

**Default value:**

- No (disabled)

**CONFIG\_LWIP\_IP6\_REASSEMBLY**

Enable reassembly incoming fragmented IP6 packets

*Found in: [Component config](#) > [LWIP](#)*

Enabling this option allows reassembling incoming fragmented IP6 packets.

**Default value:**

- No (disabled)

### CONFIG\_LWIP\_IP\_FORWARD

Enable IP forwarding

*Found in: [Component config](#) > [LWIP](#)*

Enabling this option allows packets forwarding across multiple interfaces.

**Default value:**

- No (disabled)

### CONFIG\_LWIP\_IPV4\_NAPT

Enable NAT (new/experimental)

*Found in: [Component config](#) > [LWIP](#) > [CONFIG\\_LWIP\\_IP\\_FORWARD](#)*

Enabling this option allows Network Address and Port Translation.

**Default value:**

- No (disabled) if [CONFIG\\_LWIP\\_IP\\_FORWARD](#)

### CONFIG\_LWIP\_STATS

Enable LWIP statistics

*Found in: [Component config](#) > [LWIP](#)*

Enabling this option allows LWIP statistics

**Default value:**

- No (disabled)

### CONFIG\_LWIP\_ESP\_GRATUITOUS\_ARP

Send gratuitous ARP periodically

*Found in: [Component config](#) > [LWIP](#)*

Enable this option allows to send gratuitous ARP periodically.

This option solve the compatibility issues.If the ARP table of the AP is old, and the AP doesn't send ARP request to update it's ARP table, this will lead to the STA sending IP packet fail. Thus we send gratuitous ARP periodically to let AP update it's ARP table.

**Default value:**

- Yes (enabled)

### CONFIG\_LWIP\_GARP\_TMR\_INTERVAL

GARP timer interval(seconds)

*Found in: [Component config](#) > [LWIP](#) > [CONFIG\\_LWIP\\_ESP\\_GRATUITOUS\\_ARP](#)*

Set the timer interval for gratuitous ARP. The default value is 60s

**Default value:**

- 60

### CONFIG\_LWIP\_ESP\_MLDV6\_REPORT

Send mldv6 report periodically

*Found in: [Component config](#) > [LWIP](#)*

Enable this option allows to send mldv6 report periodically.

This option solve the issue that failed to receive multicast data. Some routers fail to forward multicast packets. To solve this problem, send multicast mldv6 report to routers regularly.

**Default value:**

- Yes (enabled)

### CONFIG\_LWIP\_MLDV6\_TMR\_INTERVAL

mldv6 report timer interval(seconds)

*Found in: [Component config](#) > [LWIP](#) > [CONFIG\\_LWIP\\_ESP\\_MLDV6\\_REPORT](#)*

Set the timer interval for mldv6 report. The default value is 30s

**Default value:**

- 40

### CONFIG\_LWIP\_TCPIP\_RECVMBOX\_SIZE

TCPIP task receive mail box size

*Found in: [Component config](#) > [LWIP](#)*

Set TCPIP task receive mail box size. Generally bigger value means higher throughput but more memory. The value should be bigger than UDP/TCP mail box size.

**Range:**

- from 6 to 64 if [CONFIG\\_LWIP\\_WND\\_SCALE](#)
- from 6 to 1024 if [CONFIG\\_LWIP\\_WND\\_SCALE](#)

**Default value:**

- 32

### CONFIG\_LWIP\_DHCP\_DOES\_ARP\_CHECK

DHCP: Perform ARP check on any offered address

*Found in: [Component config](#) > [LWIP](#)*

Enabling this option performs a check (via ARP request) if the offered IP address is not already in use by another host on the network.

**Default value:**

- Yes (enabled)

### CONFIG\_LWIP\_DHCP\_DISABLE\_CLIENT\_ID

DHCP: Disable Use of HW address as client identification

*Found in: [Component config](#) > [LWIP](#)*

This option could be used to disable DHCP client identification with its MAC address. (Client id is used by DHCP servers to uniquely identify clients and are included in the DHCP packets as an option 61) Set this option to “y” in order to exclude option 61 from DHCP packets.

**Default value:**

- No (disabled)

### CONFIG\_LWIP\_DHCP\_DISABLE\_VENDOR\_CLASS\_ID

DHCP: Disable Use of vendor class identification

Found in: *Component config > LWIP*

This option could be used to disable DHCP client vendor class identification. Set this option to “y” in order to exclude option 60 from DHCP packets.

**Default value:**

- Yes (enabled)

### CONFIG\_LWIP\_DHCP\_RESTORE\_LAST\_IP

DHCP: Restore last IP obtained from DHCP server

Found in: *Component config > LWIP*

When this option is enabled, DHCP client tries to re-obtain last valid IP address obtained from DHCP server. Last valid DHCP configuration is stored in nvs and restored after reset/power-up. If IP is still available, there is no need for sending discovery message to DHCP server and save some time.

**Default value:**

- No (disabled)

### CONFIG\_LWIP\_DHCP\_OPTIONS\_LEN

DHCP total option length

Found in: *Component config > LWIP*

Set total length of outgoing DHCP option msg. Generally bigger value means it can carry more options and values. If your code meets LWIP\_ASSERT due to option value is too long. Please increase the LWIP\_DHCP\_OPTIONS\_LEN value.

**Range:**

- from 68 to 255

**Default value:**

- 68
- 108

### CONFIG\_LWIP\_NUM\_NETIF\_CLIENT\_DATA

Number of clients store data in netif

Found in: *Component config > LWIP*

Number of clients that may store data in client\_data member array of struct netif.

**Range:**

- from 0 to 256

**Default value:**

- 0

### CONFIG\_LWIP\_DHCP\_COARSE\_TIMER\_SECS

DHCP coarse timer interval(s)

Found in: *Component config > LWIP*

Set DHCP coarse interval in seconds. A higher value will be less precise but cost less power consumption.

**Range:**

- from 1 to 10

**Default value:**

- 1

**DHCP server** Contains:

- [CONFIG\\_LWIP\\_DHCPS](#)

### **CONFIG\_LWIP\_DHCPS**

DHCPS: Enable IPv4 Dynamic Host Configuration Protocol Server (DHCPS)

*Found in:* [Component config](#) > [LWIP](#) > [DHCP server](#)

Enabling this option allows the device to run the DHCP server (to dynamically assign IPv4 addresses to clients).

**Default value:**

- Yes (enabled)

### **CONFIG\_LWIP\_DHCPS\_LEASE\_UNIT**

Multiplier for lease time, in seconds

*Found in:* [Component config](#) > [LWIP](#) > [DHCP server](#) > [CONFIG\\_LWIP\\_DHCPS](#)

The DHCP server is calculating lease time multiplying the sent and received times by this number of seconds per unit. The default is 60, that equals one minute.

**Range:**

- from 1 to 3600

**Default value:**

- 60

### **CONFIG\_LWIP\_DHCPS\_MAX\_STATION\_NUM**

Maximum number of stations

*Found in:* [Component config](#) > [LWIP](#) > [DHCP server](#) > [CONFIG\\_LWIP\\_DHCPS](#)

The maximum number of DHCP clients that are connected to the server. After this number is exceeded, DHCP server removes of the oldest device from it's address pool, without notification.

**Range:**

- from 1 to 64

**Default value:**

- 8

### **CONFIG\_LWIP\_AUTOIP**

Enable IPV4 Link-Local Addressing (AUTOIP)

*Found in:* [Component config](#) > [LWIP](#)

Enabling this option allows the device to self-assign an address in the 169.256/16 range if none is assigned statically or via DHCP.

See RFC 3927.

**Default value:**

- No (disabled)

Contains:

- [CONFIG\\_LWIP\\_AUTOIP\\_TRIES](#)
- [CONFIG\\_LWIP\\_AUTOIP\\_MAX\\_CONFLICTS](#)
- [CONFIG\\_LWIP\\_AUTOIP\\_RATE\\_LIMIT\\_INTERVAL](#)

### CONFIG\_LWIP\_AUTOIP\_TRIES

DHCP Probes before self-assigning IPv4 LL address

*Found in: [Component config](#) > [LWIP](#) > [CONFIG\\_LWIP\\_AUTOIP](#)*

DHCP client will send this many probes before self-assigning a link local address.

From LWIP help: “This can be set as low as 1 to get an AutoIP address very quickly, but you should be prepared to handle a changing IP address when DHCP overrides AutoIP.” (In the case of ESP-IDF, this means multiple SYSTEM\_EVENT\_STA\_GOT\_IP events.)

**Range:**

- from 1 to 100 if [CONFIG\\_LWIP\\_AUTOIP](#)

**Default value:**

- 2 if [CONFIG\\_LWIP\\_AUTOIP](#)

### CONFIG\_LWIP\_AUTOIP\_MAX\_CONFLICTS

Max IP conflicts before rate limiting

*Found in: [Component config](#) > [LWIP](#) > [CONFIG\\_LWIP\\_AUTOIP](#)*

If the AUTOIP functionality detects this many IP conflicts while self-assigning an address, it will go into a rate limited mode.

**Range:**

- from 1 to 100 if [CONFIG\\_LWIP\\_AUTOIP](#)

**Default value:**

- 9 if [CONFIG\\_LWIP\\_AUTOIP](#)

### CONFIG\_LWIP\_AUTOIP\_RATE\_LIMIT\_INTERVAL

Rate limited interval (seconds)

*Found in: [Component config](#) > [LWIP](#) > [CONFIG\\_LWIP\\_AUTOIP](#)*

If rate limiting self-assignment requests, wait this long between each request.

**Range:**

- from 5 to 120 if [CONFIG\\_LWIP\\_AUTOIP](#)

**Default value:**

- 20 if [CONFIG\\_LWIP\\_AUTOIP](#)

### CONFIG\_LWIP\_IPV6

Enable IPv6

*Found in: [Component config](#) > [LWIP](#)*

Enable IPv6 function. If not use IPv6 function, set this option to n. If disabling LWIP\_IPV6 then some other components (coap and asio) will no longer be available.

**Default value:**

- Yes (enabled)

### CONFIG\_LWIP\_IPV6\_AUTOCONFIG

Enable IPV6 stateless address autoconfiguration (SLAAC)

*Found in: [Component config](#) > [LWIP](#) > [CONFIG\\_LWIP\\_IPV6](#)*

Enabling this option allows the devices to IPV6 stateless address autoconfiguration (SLAAC).

See RFC 4862.

**Default value:**

- No (disabled)

**CONFIG\_LWIP\_IPV6\_NUM\_ADDRESSES**

Number of IPv6 addresses on each network interface

*Found in: [Component config](#) > [LWIP](#) > [CONFIG\\_LWIP\\_IPV6](#)*

The maximum number of IPv6 addresses on each interface. Any additional addresses will be discarded.

**Default value:**

- 3

**CONFIG\_LWIP\_IPV6\_FORWARD**

Enable IPv6 forwarding between interfaces

*Found in: [Component config](#) > [LWIP](#) > [CONFIG\\_LWIP\\_IPV6](#)*

Forwarding IPv6 packets between interfaces is only required when acting as a router.

**Default value:**

- No (disabled)

**CONFIG\_LWIP\_IPV6\_RDNSS\_MAX\_DNS\_SERVERS**

Use IPv6 Router Advertisement Recursive DNS Server Option

*Found in: [Component config](#) > [LWIP](#)*

Use IPv6 Router Advertisement Recursive DNS Server Option (as per RFC 6106) to copy a defined maximum number of DNS servers to the DNS module. Set this option to a number of desired DNS servers advertised in the RA protocol. This feature is disabled when set to 0.

**Default value:**

- 0 if [CONFIG\\_LWIP\\_IPV6\\_AUTOCONFIG](#)

**CONFIG\_LWIP\_IPV6\_DHCP6**

Enable DHCPv6 stateless address autoconfiguration

*Found in: [Component config](#) > [LWIP](#)*

Enable DHCPv6 for IPv6 stateless address autoconfiguration. Note that the dhcpv6 client has to be started using `dhcp6_enable_stateless(netif)`; Note that the stateful address autoconfiguration is not supported.

**Default value:**

- No (disabled) if [CONFIG\\_LWIP\\_IPV6\\_AUTOCONFIG](#)

**CONFIG\_LWIP\_NETIF\_STATUS\_CALLBACK**

Enable status callback for network interfaces

*Found in: [Component config](#) > [LWIP](#)*

Enable callbacks when the network interface is up/down and addresses are changed.

**Default value:**

- No (disabled)



## CONFIG\_LWIP\_NETIF\_LOOPBACK

Support per-interface loopback

*Found in: [Component config](#) > [LWIP](#)*

Enabling this option means that if a packet is sent with a destination address equal to the interface's own IP address, it will “loop back” and be received by this interface. Disabling this option disables support of loopback interface in lwIP

**Default value:**

- Yes (enabled)

Contains:

- [CONFIG\\_LWIP\\_LOOPBACK\\_MAX\\_PBUFS](#)

## CONFIG\_LWIP\_LOOPBACK\_MAX\_PBUFS

Max queued loopback packets per interface

*Found in: [Component config](#) > [LWIP](#) > [CONFIG\\_LWIP\\_NETIF\\_LOOPBACK](#)*

Configure the maximum number of packets which can be queued for loopback on a given interface. Reducing this number may cause packets to be dropped, but will avoid filling memory with queued packet data.

**Range:**

- from 0 to 16

**Default value:**

- 8

**TCP** Contains:

- [CONFIG\\_LWIP\\_TCP\\_WND\\_DEFAULT](#)
- [CONFIG\\_LWIP\\_TCP\\_SND\\_BUF\\_DEFAULT](#)
- [CONFIG\\_LWIP\\_TCP\\_RECVMBOX\\_SIZE](#)
- [CONFIG\\_LWIP\\_TCP\\_RTO\\_TIME](#)
- [CONFIG\\_LWIP\\_MAX\\_ACTIVE\\_TCP](#)
- [CONFIG\\_LWIP\\_TCP\\_FIN\\_WAIT\\_TIMEOUT](#)
- [CONFIG\\_LWIP\\_MAX\\_LISTENING\\_TCP](#)
- [CONFIG\\_LWIP\\_TCP\\_MAXRTX](#)
- [CONFIG\\_LWIP\\_TCP\\_SYNMAXRTX](#)
- [CONFIG\\_LWIP\\_TCP\\_MSL](#)
- [CONFIG\\_LWIP\\_TCP\\_MSS](#)
- [CONFIG\\_LWIP\\_TCP\\_OVERSIZE](#)
- [CONFIG\\_LWIP\\_TCP\\_QUEUE\\_OOSEQ](#)
- [CONFIG\\_LWIP\\_WND\\_SCALE](#)
- [CONFIG\\_LWIP\\_TCP\\_HIGH\\_SPEED\\_RETRANSMISSION](#)
- [CONFIG\\_LWIP\\_TCP\\_TMR\\_INTERVAL](#)

## CONFIG\_LWIP\_MAX\_ACTIVE\_TCP

Maximum active TCP Connections

*Found in: [Component config](#) > [LWIP](#) > [TCP](#)*

The maximum number of simultaneously active TCP connections. The practical maximum limit is determined by available heap memory at runtime.

Changing this value by itself does not substantially change the memory usage of LWIP, except for preventing new TCP connections after the limit is reached.

**Range:**

- from 1 to 1024

**Default value:**

- 16

**CONFIG\_LWIP\_MAX\_LISTENING\_TCP**

Maximum listening TCP Connections

*Found in: [Component config](#) > [LWIP](#) > [TCP](#)*

The maximum number of simultaneously listening TCP connections. The practical maximum limit is determined by available heap memory at runtime.

Changing this value by itself does not substantially change the memory usage of LWIP, except for preventing new listening TCP connections after the limit is reached.

**Range:**

- from 1 to 1024

**Default value:**

- 16

**CONFIG\_LWIP\_TCP\_HIGH\_SPEED\_RETRANSMISSION**

TCP high speed retransmissions

*Found in: [Component config](#) > [LWIP](#) > [TCP](#)*

Speed up the TCP retransmission interval. If disabled, it is recommended to change the number of SYN retransmissions to 6, and TCP initial rto time to 3000.

**Default value:**

- Yes (enabled)

**CONFIG\_LWIP\_TCP\_MAXRTX**

Maximum number of retransmissions of data segments

*Found in: [Component config](#) > [LWIP](#) > [TCP](#)*

Set maximum number of retransmissions of data segments.

**Range:**

- from 3 to 12

**Default value:**

- 12

**CONFIG\_LWIP\_TCP\_SYNMAXRTX**

Maximum number of retransmissions of SYN segments

*Found in: [Component config](#) > [LWIP](#) > [TCP](#)*

Set maximum number of retransmissions of SYN segments.

**Range:**

- from 3 to 12

**Default value:**

- 6
- 12

### CONFIG\_LWIP\_TCP\_MSS

Maximum Segment Size (MSS)

*Found in: [Component config](#) > [LWIP](#) > [TCP](#)*

Set maximum segment size for TCP transmission.

Can be set lower to save RAM, the default value 1460(ipv4)/1440(ipv6) will give best throughput. IPv4 TCP\_MSS Range: 576 <= TCP\_MSS <= 1460 IPv6 TCP\_MSS Range: 1220<= TCP\_MSS <= 1440

**Range:**

- from 536 to 1460

**Default value:**

- 1440

### CONFIG\_LWIP\_TCP\_TMR\_INTERVAL

TCP timer interval(ms)

*Found in: [Component config](#) > [LWIP](#) > [TCP](#)*

Set TCP timer interval in milliseconds.

Can be used to speed connections on bad networks. A lower value will redeliver unacked packets faster.

**Default value:**

- 250

### CONFIG\_LWIP\_TCP\_MSL

Maximum segment lifetime (MSL)

*Found in: [Component config](#) > [LWIP](#) > [TCP](#)*

Set maximum segment lifetime in milliseconds.

**Default value:**

- 60000

### CONFIG\_LWIP\_TCP\_FIN\_WAIT\_TIMEOUT

Maximum FIN segment lifetime

*Found in: [Component config](#) > [LWIP](#) > [TCP](#)*

Set maximum segment lifetime in milliseconds.

**Default value:**

- 20000

### CONFIG\_LWIP\_TCP\_SND\_BUF\_DEFAULT

Default send buffer size

*Found in: [Component config](#) > [LWIP](#) > [TCP](#)*

Set default send buffer size for new TCP sockets.

Per-socket send buffer size can be changed at runtime with `lwip_setsockopt(s, TCP_SNDBUF, ...)`.

This value must be at least 2x the MSS size, and the default is 4x the default MSS size.

Setting a smaller default SNDBUF size can save some RAM, but will decrease performance.

**Range:**

- from 2440 to 65535 if [CONFIG\\_LWIP\\_WND\\_SCALE](#)
- from 2440 to 1024000 if [CONFIG\\_LWIP\\_WND\\_SCALE](#)

**Default value:**

- 5760

**CONFIG\_LWIP\_TCP\_WND\_DEFAULT**

Default receive window size

*Found in: [Component config](#) > [LWIP](#) > [TCP](#)*

Set default TCP receive window size for new TCP sockets.

Per-socket receive window size can be changed at runtime with `lwip_setsockopt(s, TCP_WINDOW, ...)`.

Setting a smaller default receive window size can save some RAM, but will significantly decrease performance.

**Range:**

- from 2440 to 65535 if [CONFIG\\_LWIP\\_WND\\_SCALE](#)
- from 2440 to 1024000 if [CONFIG\\_LWIP\\_WND\\_SCALE](#)

**Default value:**

- 5760

**CONFIG\_LWIP\_TCP\_RECVMBOX\_SIZE**

Default TCP receive mail box size

*Found in: [Component config](#) > [LWIP](#) > [TCP](#)*

Set TCP receive mail box size. Generally bigger value means higher throughput but more memory. The recommended value is:  $LWIP\_TCP\_WND\_DEFAULT/TCP\_MSS + 2$ , e.g. if  $LWIP\_TCP\_WND\_DEFAULT=14360$ ,  $TCP\_MSS=1436$ , then the recommended receive mail box size is  $(14360/1436 + 2) = 12$ .

TCP receive mail box is a per socket mail box, when the application receives packets from TCP socket, LWIP core firstly posts the packets to TCP receive mail box and the application then fetches the packets from mail box. It means LWIP can cache maximum `LWIP_TCP_RECVMBOX_SIZE` packets for each TCP socket, so the maximum possible cached TCP packets for all TCP sockets is `LWIP_TCP_RECVMBOX_SIZE` multiples the maximum TCP socket number. In other words, the bigger `LWIP_TCP_RECVMBOX_SIZE` means more memory. On the other hand, if the receive mail box is too small, the mail box may be full. If the mail box is full, the LWIP drops the packets. So generally we need to make sure the TCP receive mail box is big enough to avoid packet drop between LWIP core and application.

**Range:**

- from 6 to 64 if [CONFIG\\_LWIP\\_WND\\_SCALE](#)
- from 6 to 1024 if [CONFIG\\_LWIP\\_WND\\_SCALE](#)

**Default value:**

- 6

**CONFIG\_LWIP\_TCP\_QUEUE\_OOSEQ**

Queue incoming out-of-order segments

*Found in: [Component config](#) > [LWIP](#) > [TCP](#)*

Queue incoming out-of-order segments for later use.

Disable this option to save some RAM during TCP sessions, at the expense of increased retransmissions if segments arrive out of order.

**Default value:**

- Yes (enabled)

### CONFIG\_LWIP\_TCP\_OOSEQ\_TIMEOUT

Timeout for each pbuf queued in TCP OOSEQ, in RTOs.

*Found in:* [Component config](#) > [LWIP](#) > [TCP](#) > [CONFIG\\_LWIP\\_TCP\\_QUEUE\\_OOSEQ](#)

The timeout value is TCP\_OOSEQ\_TIMEOUT \* RTO.

**Range:**

- from 1 to 30

**Default value:**

- 6

### CONFIG\_LWIP\_TCP\_OOSEQ\_MAX\_PBUFS

The maximum number of pbufs queued on OOSEQ per pcb

*Found in:* [Component config](#) > [LWIP](#) > [TCP](#) > [CONFIG\\_LWIP\\_TCP\\_QUEUE\\_OOSEQ](#)

If LWIP\_TCP\_OOSEQ\_MAX\_PBUFS = 0, TCP will not control the number of OOSEQ pbufs.

In a poor network environment, many out-of-order tcp pbufs will be received. These out-of-order pbufs will be cached in the TCP out-of-order queue which will cause Wi-Fi/Ethernet fail to release RX buffer in time. It is possible that all RX buffers for MAC layer are used by OOSEQ.

Control the number of out-of-order pbufs to ensure that the MAC layer has enough RX buffer to receive packets.

In the Wi-Fi scenario, recommended OOSEQ PBUFS Range:  $0 \leq \text{TCP\_OOSEQ\_MAX\_PBUFS} \leq \text{CONFIG\_ESP\_WIFI\_DYNAMIC\_RX\_BUFFER\_NUM}/(\text{MAX\_TCP\_NUMBER} + 1)$

In the Ethernet scenario, recommended Ethernet OOSEQ PBUFS Range:  $0 \leq \text{TCP\_OOSEQ\_MAX\_PBUFS} \leq \text{CONFIG\_ETH\_DMA\_RX\_BUFFER\_NUM}/(\text{MAX\_TCP\_NUMBER} + 1)$

Within the recommended value range, the larger the value, the better the performance.

MAX\_TCP\_NUMBER represent Maximum number of TCP connections in Wi-Fi(STA+SoftAP) and Ethernet scenario.

**Range:**

- from 0 to 12

**Default value:**

- 4 if [CONFIG\\_SPIRAM\\_TRY\\_ALLOCATE\\_WIFI\\_LWIP](#) && [CONFIG\\_LWIP\\_TCP\\_QUEUE\\_OOSEQ](#)
- 0 if [CONFIG\\_SPIRAM\\_TRY\\_ALLOCATE\\_WIFI\\_LWIP](#) && [CONFIG\\_LWIP\\_TCP\\_QUEUE\\_OOSEQ](#)

### CONFIG\_LWIP\_TCP\_SACK\_OUT

Support sending selective acknowledgements

*Found in:* [Component config](#) > [LWIP](#) > [TCP](#) > [CONFIG\\_LWIP\\_TCP\\_QUEUE\\_OOSEQ](#)

TCP will support sending selective acknowledgements (SACKs).

**Default value:**

- No (disabled)

### CONFIG\_LWIP\_TCP\_OVERSIZE

Pre-allocate transmit PBUF size

*Found in:* [Component config](#) > [LWIP](#) > [TCP](#)

Allows enabling “oversize” allocation of TCP transmission pbufs ahead of time, which can reduce the length of pbuf chains used for transmission.

This will not make a difference to sockets where Nagle’s algorithm is disabled.

Default value of MSS is fine for most applications, 25% MSS may save some RAM when only transmitting small amounts of data. Disabled will have worst performance and fragmentation characteristics, but uses least RAM overall.

**Available options:**

- MSS (LWIP\_TCP\_OVERSIZE\_MSS)
- 25% MSS (LWIP\_TCP\_OVERSIZE\_QUARTER\_MSS)
- Disabled (LWIP\_TCP\_OVERSIZE\_DISABLE)

### CONFIG\_LWIP\_WND\_SCALE

Support TCP window scale

*Found in: [Component config](#) > [LWIP](#) > [TCP](#)*

Enable this feature to support TCP window scaling.

**Default value:**

- No (disabled) if [CONFIG\\_SPIRAM\\_TRY\\_ALLOCATE\\_WIFI\\_LWIP](#)

### CONFIG\_LWIP\_TCP\_RCV\_SCALE

Set TCP receiving window scaling factor

*Found in: [Component config](#) > [LWIP](#) > [TCP](#) > [CONFIG\\_LWIP\\_WND\\_SCALE](#)*

Enable this feature to support TCP window scaling.

**Range:**

- from 0 to 14 if [CONFIG\\_LWIP\\_WND\\_SCALE](#)

**Default value:**

- 0 if [CONFIG\\_LWIP\\_WND\\_SCALE](#)

### CONFIG\_LWIP\_TCP\_RTO\_TIME

Default TCP rto time

*Found in: [Component config](#) > [LWIP](#) > [TCP](#)*

Set default TCP rto time for a reasonable initial rto. In bad network environment, recommend set value of rto time to 1500.

**Default value:**

- 3000
- 1500

### UDP

 Contains:

- [CONFIG\\_LWIP\\_UDP\\_RECVMBOX\\_SIZE](#)
- [CONFIG\\_LWIP\\_MAX\\_UDP\\_PCBS](#)

### CONFIG\_LWIP\_MAX\_UDP\_PCBS

Maximum active UDP control blocks

*Found in: [Component config](#) > [LWIP](#) > [UDP](#)*

The maximum number of active UDP “connections” (ie UDP sockets sending/receiving data). The practical maximum limit is determined by available heap memory at runtime.

**Range:**

- from 1 to 1024

**Default value:**

- 16

**CONFIG\_LWIP\_UDP\_RECVMBOX\_SIZE**

Default UDP receive mail box size

*Found in: [Component config](#) > [LWIP](#) > [UDP](#)*

Set UDP receive mail box size. The recommended value is 6.

UDP receive mail box is a per socket mail box, when the application receives packets from UDP socket, LWIP core firstly posts the packets to UDP receive mail box and the application then fetches the packets from mail box. It means LWIP can cache maximum `UDP_RECVMBOX_SIZE` packets for each UDP socket, so the maximum possible cached UDP packets for all UDP sockets is `UDP_RECVMBOX_SIZE` multiplies the maximum UDP socket number. In other words, the bigger `UDP_RECVMBOX_SIZE` means more memory. On the other hand, if the receive mail box is too small, the mail box may be full. If the mail box is full, the LWIP drops the packets. So generally we need to make sure the UDP receive mail box is big enough to avoid packet drop between LWIP core and application.

**Range:**

- from 6 to 64

**Default value:**

- 6

**Checksums** Contains:

- [CONFIG\\_LWIP\\_CHECKSUM\\_CHECK\\_ICMP](#)
- [CONFIG\\_LWIP\\_CHECKSUM\\_CHECK\\_IP](#)
- [CONFIG\\_LWIP\\_CHECKSUM\\_CHECK\\_UDP](#)

**CONFIG\_LWIP\_CHECKSUM\_CHECK\_IP**

Enable LWIP IP checksums

*Found in: [Component config](#) > [LWIP](#) > [Checksums](#)*

Enable checksum checking for received IP messages

**Default value:**

- No (disabled)

**CONFIG\_LWIP\_CHECKSUM\_CHECK\_UDP**

Enable LWIP UDP checksums

*Found in: [Component config](#) > [LWIP](#) > [Checksums](#)*

Enable checksum checking for received UDP messages

**Default value:**

- No (disabled)

**CONFIG\_LWIP\_CHECKSUM\_CHECK\_ICMP**

Enable LWIP ICMP checksums

*Found in: [Component config](#) > [LWIP](#) > [Checksums](#)*

Enable checksum checking for received ICMP messages

**Default value:**

- Yes (enabled)

**CONFIG\_LWIP\_TCPIP\_TASK\_STACK\_SIZE**

TCP/IP Task Stack Size

*Found in: [Component config](#) > [LWIP](#)*

Configure TCP/IP task stack size, used by LWIP to process multi-threaded TCP/IP operations. Setting this stack too small will result in stack overflow crashes.

**Range:**

- from 2048 to 65536

**Default value:**

- 3072

**CONFIG\_LWIP\_TCPIP\_TASK\_AFFINITY**

TCP/IP task affinity

*Found in: [Component config](#) > [LWIP](#)*

Allows setting LwIP tasks affinity, i.e. whether the task is pinned to CPU0, pinned to CPU1, or allowed to run on any CPU. Currently this applies to “TCP/IP” task and “Ping” task.

**Available options:**

- No affinity (LWIP\_TCPIP\_TASK\_AFFINITY\_NO\_AFFINITY)
- CPU0 (LWIP\_TCPIP\_TASK\_AFFINITY\_CPU0)
- CPU1 (LWIP\_TCPIP\_TASK\_AFFINITY\_CPU1)

**CONFIG\_LWIP\_PPP\_SUPPORT**

Enable PPP support (new/experimental)

*Found in: [Component config](#) > [LWIP](#)*

Enable PPP stack. Now only PPP over serial is possible.

PPP over serial support is experimental and unsupported.

**Default value:**

- No (disabled)

Contains:

- [CONFIG\\_LWIP\\_PPP\\_ENABLE\\_IPV6](#)

**CONFIG\_LWIP\_PPP\_ENABLE\_IPV6**

Enable IPV6 support for PPP connections (IPV6CP)

*Found in: [Component config](#) > [LWIP](#) > [CONFIG\\_LWIP\\_PPP\\_SUPPORT](#)*

Enable IPV6 support in PPP for the local link between the DTE (processor) and DCE (modem). There are some modems which do not support the IPV6 addressing in the local link. If they are requested for IPV6CP negotiation, they may time out. This would in turn fail the configuration for the whole link. If your modem is not responding correctly to PPP Phase Network, try to disable IPV6 support.

**Default value:**

- Yes (enabled) if [CONFIG\\_LWIP\\_PPP\\_SUPPORT](#) && [CONFIG\\_LWIP\\_IPV6](#)



**CONFIG\_LWIP\_IPV6\_MEMP\_NUM\_ND6\_QUEUE**

Max number of IPv6 packets to queue during MAC resolution

*Found in: [Component config](#) > [LWIP](#)*

Config max number of IPv6 packets to queue during MAC resolution.

**Range:**

- from 3 to 20

**Default value:**

- 3

**CONFIG\_LWIP\_IPV6\_ND6\_NUM\_NEIGHBORS**

Max number of entries in IPv6 neighbor cache

*Found in: [Component config](#) > [LWIP](#)*

Config max number of entries in IPv6 neighbor cache

**Range:**

- from 3 to 10

**Default value:**

- 5

**CONFIG\_LWIP\_ND6**

LWIP NDP6 Enable/Disable

*Found in: [Component config](#) > [LWIP](#)*

This option is used to disable the Network Discovery Protocol (NDP) if it is not required. Please use this option with caution, as the NDP is essential for IPv6 functionality within a local network.

**Default value:**

- Yes (enabled)

**CONFIG\_LWIP\_FORCE\_ROUTER\_FORWARDING**

LWIP Force Router Forwarding Enable/Disable

*Found in: [Component config](#) > [LWIP](#) > [CONFIG\\_LWIP\\_ND6](#)*

This option is used to set the the router flag for the NA packets. When enabled, the router flag in NA packet will always set to 1, otherwise, never set router flag for NA packets.

**Default value:**

- No (disabled)

**CONFIG\_LWIP\_PPP\_NOTIFY\_PHASE\_SUPPORT**

Enable Notify Phase Callback

*Found in: [Component config](#) > [LWIP](#)*

Enable to set a callback which is called on change of the internal PPP state machine.

**Default value:**

- No (disabled) if [CONFIG\\_LWIP\\_PPP\\_SUPPORT](#)

### CONFIG\_LWIP\_PPP\_PAP\_SUPPORT

Enable PAP support

*Found in: [Component config](#) > [LWIP](#)*

Enable Password Authentication Protocol (PAP) support

**Default value:**

- No (disabled) if [CONFIG\\_LWIP\\_PPP\\_SUPPORT](#)

### CONFIG\_LWIP\_PPP\_CHAP\_SUPPORT

Enable CHAP support

*Found in: [Component config](#) > [LWIP](#)*

Enable Challenge Handshake Authentication Protocol (CHAP) support

**Default value:**

- No (disabled) if [CONFIG\\_LWIP\\_PPP\\_SUPPORT](#)

### CONFIG\_LWIP\_PPP\_MSCHAP\_SUPPORT

Enable MSCHAP support

*Found in: [Component config](#) > [LWIP](#)*

Enable Microsoft version of the Challenge-Handshake Authentication Protocol (MSCHAP) support

**Default value:**

- No (disabled) if [CONFIG\\_LWIP\\_PPP\\_SUPPORT](#)

### CONFIG\_LWIP\_PPP\_MPPE\_SUPPORT

Enable MPPE support

*Found in: [Component config](#) > [LWIP](#)*

Enable Microsoft Point-to-Point Encryption (MPPE) support

**Default value:**

- No (disabled) if [CONFIG\\_LWIP\\_PPP\\_SUPPORT](#)

### CONFIG\_LWIP\_ENABLE\_LCP\_ECHO

Enable LCP ECHO

*Found in: [Component config](#) > [LWIP](#)*

Enable LCP echo keepalive requests

**Default value:**

- No (disabled) if [CONFIG\\_LWIP\\_PPP\\_SUPPORT](#)

### CONFIG\_LWIP\_LCP\_ECHOINTERVAL

Echo interval (s)

*Found in: [Component config](#) > [LWIP](#) > [CONFIG\\_LWIP\\_ENABLE\\_LCP\\_ECHO](#)*

Interval in seconds between keepalive LCP echo requests, 0 to disable.

**Range:**

- from 0 to 1000000 if [CONFIG\\_LWIP\\_ENABLE\\_LCP\\_ECHO](#)

**Default value:**

- 3 if [CONFIG\\_LWIP\\_ENABLE\\_LCP\\_ECHO](#)

### CONFIG\_LWIP\_LCP\_MAXECHOFAILS

Maximum echo failures

*Found in: Component config > LWIP > CONFIG\_LWIP\_ENABLE\_LCP\_ECHO*

Number of consecutive unanswered echo requests before failure is indicated.

**Range:**

- from 0 to 100000 if *CONFIG\_LWIP\_ENABLE\_LCP\_ECHO*

**Default value:**

- 3 if *CONFIG\_LWIP\_ENABLE\_LCP\_ECHO*

### CONFIG\_LWIP\_PPP\_DEBUG\_ON

Enable PPP debug log output

*Found in: Component config > LWIP*

Enable PPP debug log output

**Default value:**

- No (disabled) if *CONFIG\_LWIP\_PPP\_SUPPORT*

### CONFIG\_LWIP\_SLIP\_SUPPORT

Enable SLIP support (new/experimental)

*Found in: Component config > LWIP*

Enable SLIP stack. Now only SLIP over serial is possible.

SLIP over serial support is experimental and unsupported.

**Default value:**

- No (disabled)

Contains:

- *CONFIG\_LWIP\_SLIP\_DEBUG\_ON*

### CONFIG\_LWIP\_SLIP\_DEBUG\_ON

Enable SLIP debug log output

*Found in: Component config > LWIP > CONFIG\_LWIP\_SLIP\_SUPPORT*

Enable SLIP debug log output

**Default value:**

- No (disabled) if *CONFIG\_LWIP\_SLIP\_SUPPORT*

**ICMP** Contains:

- *CONFIG\_LWIP\_ICMP*
- *CONFIG\_LWIP\_BROADCAST\_PING*
- *CONFIG\_LWIP\_MULTICAST\_PING*

### CONFIG\_LWIP\_ICMP

ICMP: Enable ICMP

*Found in: Component config > LWIP > ICMP*

Enable ICMP module for check network stability

**Default value:**

- Yes (enabled)

### **CONFIG\_LWIP\_MULTICAST\_PING**

Respond to multicast pings

*Found in: [Component config](#) > [LWIP](#) > [ICMP](#)*

**Default value:**

- No (disabled)

### **CONFIG\_LWIP\_BROADCAST\_PING**

Respond to broadcast pings

*Found in: [Component config](#) > [LWIP](#) > [ICMP](#)*

**Default value:**

- No (disabled)

**LWIP RAW API** Contains:

- [CONFIG\\_LWIP\\_MAX\\_RAW\\_PCBS](#)

### **CONFIG\_LWIP\_MAX\_RAW\_PCBS**

Maximum LWIP RAW PCBs

*Found in: [Component config](#) > [LWIP](#) > [LWIP RAW API](#)*

The maximum number of simultaneously active LWIP RAW protocol control blocks. The practical maximum limit is determined by available heap memory at runtime.

**Range:**

- from 1 to 1024

**Default value:**

- 16

**SNTP** Contains:

- [CONFIG\\_LWIP\\_SNTP\\_MAX\\_SERVERS](#)
- [CONFIG\\_LWIP\\_SNTP\\_UPDATE\\_DELAY](#)
- [CONFIG\\_LWIP\\_DHCP\\_GET\\_NTP\\_SRV](#)

### **CONFIG\_LWIP\_SNTP\_MAX\_SERVERS**

Maximum number of NTP servers

*Found in: [Component config](#) > [LWIP](#) > [SNTP](#)*

Set maximum number of NTP servers used by LwIP SNTP module. First argument of `sntp_setserver/sntp_setservername` functions is limited to this value.

**Range:**

- from 1 to 16

**Default value:**

- 1

### CONFIG\_LWIP\_DHCP\_GET\_NTP\_SRV

Request NTP servers from DHCP

Found in: *Component config > LWIP > SNTP*

If enabled, LWIP will add ‘NTP’ to Parameter-Request Option sent via DHCP-request. DHCP server might reply with an NTP server address in option 42. SNTP callback for such replies should be set accordingly (see `sntp_servermode_dhcp()` func.)

**Default value:**

- No (disabled)

### CONFIG\_LWIP\_DHCP\_MAX\_NTP\_SERVERS

Maximum number of NTP servers aquired via DHCP

Found in: *Component config > LWIP > SNTP > CONFIG\_LWIP\_DHCP\_GET\_NTP\_SRV*

Set maximum number of NTP servers aquired via DHCP-offer. Should be less or equal to “Maximum number of NTP servers” , any extra servers would be just ignored.

**Range:**

- from 1 to 16 if *CONFIG\_LWIP\_DHCP\_GET\_NTP\_SRV*

**Default value:**

- 1 if *CONFIG\_LWIP\_DHCP\_GET\_NTP\_SRV*

### CONFIG\_LWIP\_SNTP\_UPDATE\_DELAY

Request interval to update time (ms)

Found in: *Component config > LWIP > SNTP*

This option allows you to set the time update period via SNTP. Default is 1 hour. Must not be below 15 seconds by specification. (SNTPv4 RFC 4330 enforces a minimum update time of 15 seconds).

**Range:**

- from 15000 to 4294967295

**Default value:**

- 3600000

### CONFIG\_LWIP\_BRIDGEIF\_MAX\_PORTS

Maximum number of bridge ports

Found in: *Component config > LWIP*

Set maximum number of ports a bridge can consists of.

**Range:**

- from 1 to 63

**Default value:**

- 7

**DNS** Contains:

- *CONFIG\_LWIP\_FALLBACK\_DNS\_SERVER\_SUPPORT*
- *CONFIG\_LWIP\_DNS\_MAX\_SERVERS*

### CONFIG\_LWIP\_DNS\_MAX\_SERVERS

Maximum number of DNS servers

*Found in: [Component config](#) > [LWIP](#) > [DNS](#)*

Set maximum number of DNS servers. If fallback DNS servers are supported, the number of DNS servers needs to be greater than or equal to 3.

**Range:**

- from 1 to 4

**Default value:**

- 3

### CONFIG\_LWIP\_FALLBACK\_DNS\_SERVER\_SUPPORT

Enable DNS fallback server support

*Found in: [Component config](#) > [LWIP](#) > [DNS](#)*

Enable this feature to support DNS fallback server.

**Default value:**

- No (disabled)

### CONFIG\_LWIP\_FALLBACK\_DNS\_SERVER\_ADDRESS

DNS fallback server address

*Found in: [Component config](#) > [LWIP](#) > [DNS](#) > [CONFIG\\_LWIP\\_FALLBACK\\_DNS\\_SERVER\\_SUPPORT](#)*

This option allows you to config dns fallback server address.

**Default value:**

- “114.114.114.114” if [CONFIG\\_LWIP\\_FALLBACK\\_DNS\\_SERVER\\_SUPPORT](#)

### CONFIG\_LWIP\_ESP\_LWIP\_ASSERT

Enable LWIP ASSERT checks

*Found in: [Component config](#) > [LWIP](#)*

Enable this option keeps LWIP assertion checks enabled. It is recommended to keep this option enabled.

If asserts are disabled for the entire project, they are also disabled for LWIP and this option is ignored.

**Default value:**

- Yes (enabled) if [COMPILER\\_OPTIMIZATION\\_ASSERTIONS\\_DISABLE](#)

**Hooks** Contains:

- [CONFIG\\_LWIP\\_HOOK\\_ND6\\_GET\\_GW](#)
- [CONFIG\\_LWIP\\_HOOK\\_IP6\\_INPUT](#)
- [CONFIG\\_LWIP\\_HOOK\\_IP6\\_ROUTE](#)
- [CONFIG\\_LWIP\\_HOOK\\_NETCONN\\_EXTERNAL\\_RESOLVE](#)
- [CONFIG\\_LWIP\\_HOOK\\_TCP\\_ISN](#)

### CONFIG\_LWIP\_HOOK\_TCP\_ISN

TCP ISN Hook

*Found in: [Component config](#) > [LWIP](#) > [Hooks](#)*

Enables to define a TCP ISN hook to randomize initial sequence number in TCP connection. The default TCP ISN algorithm used in IDF (standardized in RFC 6528) produces ISN by combining an MD5 of

the new TCP id and a stable secret with the current time. This is because the lwIP implementation (*tcp\_next\_iss*) is not very strong, as it does not take into consideration any platform specific entropy source.

Set to `LWIP_HOOK_TCP_ISN_CUSTOM` to provide custom implementation. Set to `LWIP_HOOK_TCP_ISN_NONE` to use lwIP implementation.

**Available options:**

- No hook declared (`LWIP_HOOK_TCP_ISN_NONE`)
- Default implementation (`LWIP_HOOK_TCP_ISN_DEFAULT`)
- Custom implementation (`LWIP_HOOK_TCP_ISN_CUSTOM`)

## **CONFIG\_LWIP\_HOOK\_IP6\_ROUTE**

IPv6 route Hook

*Found in: Component config > LWIP > Hooks*

Enables custom IPv6 route hook. Setting this to “default” provides weak implementation stub that could be overwritten in application code. Setting this to “custom” provides hook’s declaration only and expects the application to implement it.

**Available options:**

- No hook declared (`LWIP_HOOK_IP6_ROUTE_NONE`)
- Default (weak) implementation (`LWIP_HOOK_IP6_ROUTE_DEFAULT`)
- Custom implementation (`LWIP_HOOK_IP6_ROUTE_CUSTOM`)

## **CONFIG\_LWIP\_HOOK\_ND6\_GET\_GW**

IPv6 get gateway Hook

*Found in: Component config > LWIP > Hooks*

Enables custom IPv6 route hook. Setting this to “default” provides weak implementation stub that could be overwritten in application code. Setting this to “custom” provides hook’s declaration only and expects the application to implement it.

**Available options:**

- No hook declared (`LWIP_HOOK_ND6_GET_GW_NONE`)
- Default (weak) implementation (`LWIP_HOOK_ND6_GET_GW_DEFAULT`)
- Custom implementation (`LWIP_HOOK_ND6_GET_GW_CUSTOM`)

## **CONFIG\_LWIP\_HOOK\_NETCONN\_EXTERNAL\_RESOLVE**

Netconn external resolve Hook

*Found in: Component config > LWIP > Hooks*

Enables custom DNS resolve hook. Setting this to “default” provides weak implementation stub that could be overwritten in application code. Setting this to “custom” provides hook’s declaration only and expects the application to implement it.

**Available options:**

- No hook declared (`LWIP_HOOK_NETCONN_EXT_RESOLVE_NONE`)
- Default (weak) implementation (`LWIP_HOOK_NETCONN_EXT_RESOLVE_DEFAULT`)
- Custom implementation (`LWIP_HOOK_NETCONN_EXT_RESOLVE_CUSTOM`)

## **CONFIG\_LWIP\_HOOK\_IP6\_INPUT**

IPv6 packet input

*Found in: Component config > LWIP > Hooks*

Enables custom IPv6 packet input. Setting this to “default” provides weak implementation stub that could be overwritten in application code. Setting this to “custom” provides hook’s declaration only and expects the application to implement it.

**Available options:**

- No hook declared (LWIP\_HOOK\_IP6\_INPUT\_NONE)
- Default (weak) implementation (LWIP\_HOOK\_IP6\_INPUT\_DEFAULT)
- Custom implementation (LWIP\_HOOK\_IP6\_INPUT\_CUSTOM)

## CONFIG\_LWIP\_DEBUG

Enable LWIP Debug

*Found in: [Component config](#) > [LWIP](#)*

Enabling this option allows different kinds of lwIP debug output.

All lwIP debug features increase the size of the final binary.

**Default value:**

- No (disabled)

Contains:

- [CONFIG\\_LWIP\\_API\\_LIB\\_DEBUG](#)
- [CONFIG\\_LWIP\\_BRIDGEIF\\_FDB\\_DEBUG](#)
- [CONFIG\\_LWIP\\_BRIDGEIF\\_FW\\_DEBUG](#)
- [CONFIG\\_LWIP\\_BRIDGEIF\\_DEBUG](#)
- [CONFIG\\_LWIP\\_DHCP\\_DEBUG](#)
- [CONFIG\\_LWIP\\_DHCP\\_STATE\\_DEBUG](#)
- [CONFIG\\_LWIP\\_DNS\\_DEBUG](#)
- [CONFIG\\_LWIP\\_ETHARP\\_DEBUG](#)
- [CONFIG\\_LWIP\\_ICMP\\_DEBUG](#)
- [CONFIG\\_LWIP\\_ICMP6\\_DEBUG](#)
- [CONFIG\\_LWIP\\_IP\\_DEBUG](#)
- [CONFIG\\_LWIP\\_IP6\\_DEBUG](#)
- [CONFIG\\_LWIP\\_NETIF\\_DEBUG](#)
- [CONFIG\\_LWIP\\_PBUF\\_DEBUG](#)
- [CONFIG\\_LWIP\\_SNTP\\_DEBUG](#)
- [CONFIG\\_LWIP\\_SOCKETS\\_DEBUG](#)
- [CONFIG\\_LWIP\\_TCP\\_DEBUG](#)
- [CONFIG\\_LWIP\\_DEBUG\\_ESP\\_LOG](#)

## CONFIG\_LWIP\_DEBUG\_ESP\_LOG

Route LWIP debugs through ESP\_LOG interface

*Found in: [Component config](#) > [LWIP](#) > [CONFIG\\_LWIP\\_DEBUG](#)*

Enabling this option routes all enabled LWIP debugs through ESP\_LOGD.

**Default value:**

- No (disabled) if [CONFIG\\_LWIP\\_DEBUG](#)

## CONFIG\_LWIP\_NETIF\_DEBUG

Enable netif debug messages

*Found in: [Component config](#) > [LWIP](#) > [CONFIG\\_LWIP\\_DEBUG](#)*

**Default value:**

- No (disabled) if [CONFIG\\_LWIP\\_DEBUG](#)



### **CONFIG\_LWIP\_PBUF\_DEBUG**

Enable pbuf debug messages

*Found in: Component config > LWIP > CONFIG\_LWIP\_DEBUG*

**Default value:**

- No (disabled) if *CONFIG\_LWIP\_DEBUG*

### **CONFIG\_LWIP\_ETHARP\_DEBUG**

Enable etharp debug messages

*Found in: Component config > LWIP > CONFIG\_LWIP\_DEBUG*

**Default value:**

- No (disabled) if *CONFIG\_LWIP\_DEBUG*

### **CONFIG\_LWIP\_API\_LIB\_DEBUG**

Enable api lib debug messages

*Found in: Component config > LWIP > CONFIG\_LWIP\_DEBUG*

**Default value:**

- No (disabled) if *CONFIG\_LWIP\_DEBUG*

### **CONFIG\_LWIP\_SOCKETS\_DEBUG**

Enable socket debug messages

*Found in: Component config > LWIP > CONFIG\_LWIP\_DEBUG*

**Default value:**

- No (disabled) if *CONFIG\_LWIP\_DEBUG*

### **CONFIG\_LWIP\_IP\_DEBUG**

Enable IP debug messages

*Found in: Component config > LWIP > CONFIG\_LWIP\_DEBUG*

**Default value:**

- No (disabled) if *CONFIG\_LWIP\_DEBUG*

### **CONFIG\_LWIP\_ICMP\_DEBUG**

Enable ICMP debug messages

*Found in: Component config > LWIP > CONFIG\_LWIP\_DEBUG*

**Default value:**

- No (disabled) if *CONFIG\_LWIP\_DEBUG* && *CONFIG\_LWIP\_ICMP*

### **CONFIG\_LWIP\_DHCP\_STATE\_DEBUG**

Enable DHCP state tracking

*Found in: Component config > LWIP > CONFIG\_LWIP\_DEBUG*

**Default value:**

- No (disabled) if *CONFIG\_LWIP\_DEBUG*

### **CONFIG\_LWIP\_DHCP\_DEBUG**

Enable DHCP debug messages

*Found in: Component config > LWIP > CONFIG\_LWIP\_DEBUG*

**Default value:**

- No (disabled) if *CONFIG\_LWIP\_DEBUG*

### **CONFIG\_LWIP\_IP6\_DEBUG**

Enable IP6 debug messages

*Found in: Component config > LWIP > CONFIG\_LWIP\_DEBUG*

**Default value:**

- No (disabled) if *CONFIG\_LWIP\_DEBUG*

### **CONFIG\_LWIP\_ICMP6\_DEBUG**

Enable ICMP6 debug messages

*Found in: Component config > LWIP > CONFIG\_LWIP\_DEBUG*

**Default value:**

- No (disabled) if *CONFIG\_LWIP\_DEBUG*

### **CONFIG\_LWIP\_TCP\_DEBUG**

Enable TCP debug messages

*Found in: Component config > LWIP > CONFIG\_LWIP\_DEBUG*

**Default value:**

- No (disabled) if *CONFIG\_LWIP\_DEBUG*

### **CONFIG\_LWIP\_SNTP\_DEBUG**

Enable SNTP debug messages

*Found in: Component config > LWIP > CONFIG\_LWIP\_DEBUG*

**Default value:**

- No (disabled) if *CONFIG\_LWIP\_DEBUG*

### **CONFIG\_LWIP\_DNS\_DEBUG**

Enable DNS debug messages

*Found in: Component config > LWIP > CONFIG\_LWIP\_DEBUG*

**Default value:**

- No (disabled) if *CONFIG\_LWIP\_DEBUG*

### **CONFIG\_LWIP\_BRIDGEIF\_DEBUG**

Enable bridge generic debug messages

*Found in: Component config > LWIP > CONFIG\_LWIP\_DEBUG*

**Default value:**

- No (disabled) if *CONFIG\_LWIP\_DEBUG*

**CONFIG\_LWIP\_BRIDGEIF\_FDB\_DEBUG**

Enable bridge FDB debug messages

Found in: *Component config* > *LWIP* > *CONFIG\_LWIP\_DEBUG*

**Default value:**

- No (disabled) if *CONFIG\_LWIP\_DEBUG*

**CONFIG\_LWIP\_BRIDGEIF\_FW\_DEBUG**

Enable bridge forwarding debug messages

Found in: *Component config* > *LWIP* > *CONFIG\_LWIP\_DEBUG*

**Default value:**

- No (disabled) if *CONFIG\_LWIP\_DEBUG*

**MBEDTLS** Contains:

- *CONFIG\_MBEDTLS\_ASYMMETRIC\_CONTENT\_LEN*
- *Certificate Bundle*
- *Certificates*
- *CONFIG\_MBEDTLS\_CHACHA20\_C*
- *CONFIG\_MBEDTLS\_DHM\_C*
- *CONFIG\_MBEDTLS\_ECP\_C*
- *CONFIG\_MBEDTLS\_ECDH\_C*
- *CONFIG\_MBEDTLS\_ECJPAKE\_C*
- *CONFIG\_MBEDTLS\_ECP\_DP\_BP256R1\_ENABLED*
- *CONFIG\_MBEDTLS\_ECP\_DP\_BP384R1\_ENABLED*
- *CONFIG\_MBEDTLS\_ECP\_DP\_BP512R1\_ENABLED*
- *CONFIG\_MBEDTLS\_CMAC\_C*
- *CONFIG\_MBEDTLS\_ECP\_DP\_CURVE25519\_ENABLED*
- *CONFIG\_MBEDTLS\_ECDSA\_DETERMINISTIC*
- *CONFIG\_MBEDTLS\_ECP\_FIXED\_POINT\_OPTIM*
- *CONFIG\_MBEDTLS\_HARDWARE\_AES*
- *CONFIG\_MBEDTLS\_HARDWARE\_ECC*
- *CONFIG\_MBEDTLS\_ATCA\_HW\_ECDSA\_SIGN*
- *CONFIG\_MBEDTLS\_ATCA\_HW\_ECDSA\_VERIFY*
- *CONFIG\_MBEDTLS\_HARDWARE\_MPI*
- *CONFIG\_MBEDTLS\_HARDWARE\_SHA*
- *CONFIG\_MBEDTLS\_DEBUG*
- *CONFIG\_MBEDTLS\_ECP\_RESTARTABLE*
- *CONFIG\_MBEDTLS\_HAVE\_TIME*
- *CONFIG\_MBEDTLS\_RIPEMD160\_C*
- *CONFIG\_MBEDTLS\_ECP\_DP\_SECP192K1\_ENABLED*
- *CONFIG\_MBEDTLS\_ECP\_DP\_SECP192R1\_ENABLED*
- *CONFIG\_MBEDTLS\_ECP\_DP\_SECP224K1\_ENABLED*
- *CONFIG\_MBEDTLS\_ECP\_DP\_SECP224R1\_ENABLED*
- *CONFIG\_MBEDTLS\_ECP\_DP\_SECP256K1\_ENABLED*
- *CONFIG\_MBEDTLS\_ECP\_DP\_SECP256R1\_ENABLED*
- *CONFIG\_MBEDTLS\_ECP\_DP\_SECP384R1\_ENABLED*
- *CONFIG\_MBEDTLS\_ECP\_DP\_SECP521R1\_ENABLED*
- *CONFIG\_MBEDTLS\_SHA512\_C*
- *CONFIG\_MBEDTLS\_THREADING\_C*
- *CONFIG\_MBEDTLS\_LARGE\_KEY\_SOFTWARE\_MPI*
- *CONFIG\_MBEDTLS\_HKDF\_C*
- *mbedtls v3.x related*
- *CONFIG\_MBEDTLS\_MEM\_ALLOC\_MODE*
- *CONFIG\_MBEDTLS\_ECP\_NIST\_OPTIM*

- `CONFIG_MBEDTLS_POLY1305_C`
- `CONFIG_MBEDTLS_SSL_ALPN`
- `CONFIG_MBEDTLS_SSL_PROTO_DTLS`
- `CONFIG_MBEDTLS_SSL_PROTO_GMTSSL1_1`
- `CONFIG_MBEDTLS_SSL_PROTO_TLS1_2`
- `CONFIG_MBEDTLS_SSL_RENEGOTIATION`
- *Symmetric Ciphers*
- *TLS Key Exchange Methods*
- `CONFIG_MBEDTLS_SSL_MAX_CONTENT_LEN`
- `CONFIG_MBEDTLS_TLS_MODE`
- `CONFIG_MBEDTLS_CLIENT_SSL_SESSION_TICKETS`
- `CONFIG_MBEDTLS_SERVER_SSL_SESSION_TICKETS`
- `CONFIG_MBEDTLS_ROM_MD5`
- `CONFIG_MBEDTLS_USE_CRYPTO_ROM_IMPL`
- `CONFIG_MBEDTLS_DYNAMIC_BUFFER`

### **CONFIG\_MBEDTLS\_MEM\_ALLOC\_MODE**

Memory allocation strategy

*Found in: `Component config > mbedTLS`*

Allocation strategy for mbedTLS, essentially provides ability to allocate all required dynamic allocations from,

- Internal DRAM memory only
- External SPIRAM memory only
- Either internal or external memory based on default `malloc()` behavior in ESP-IDF
- Custom allocation mode, by overwriting `calloc()/free()` using `mbedtls_platform_set_calloc_free()` function
- Internal IRAM memory wherever applicable else internal DRAM

Recommended mode here is always internal (\*), since that is most preferred from security perspective. But if application requirement does not allow sufficient free internal memory then alternate mode can be selected.

(\*) In case of ESP32-S2/ESP32-S3, hardware allows encryption of external SPIRAM contents provided hardware flash encryption feature is enabled. In that case, using external SPIRAM allocation strategy is also safe choice from security perspective.

#### **Available options:**

- Internal memory (`MBEDTLS_INTERNAL_MEM_ALLOC`)
- External SPIRAM (`MBEDTLS_EXTERNAL_MEM_ALLOC`)
- Default alloc mode (`MBEDTLS_DEFAULT_MEM_ALLOC`)
- Custom alloc mode (`MBEDTLS_CUSTOM_MEM_ALLOC`)
- Internal IRAM (`MBEDTLS_IRAM_8BIT_MEM_ALLOC`)  
Allows to use IRAM memory region as 8bit accessible region.  
TLS input and output buffers will be allocated in IRAM section which is 32bit aligned memory. Every unaligned (8bit or 16bit) access will result in an exception and incur penalty of certain clock cycles per unaligned read/write.

### **CONFIG\_MBEDTLS\_SSL\_MAX\_CONTENT\_LEN**

TLS maximum message content length

*Found in: `Component config > mbedTLS`*

Maximum TLS message length (in bytes) supported by mbedTLS.

16384 is the default and this value is required to comply fully with TLS standards.

However you can set a lower value in order to save RAM. This is safe if the other end of the connection supports Maximum Fragment Length Negotiation Extension (`max_fragment_length`, see RFC6066) or you know for certain that it will never send a message longer than a certain number of bytes.

If the value is set too low, symptoms are a failed TLS handshake or a return value of `MBEDTLS_ERR_SSL_INVALID_RECORD` (-0x7200).

**Range:**

- from 512 to 16384

**Default value:**

- 16384

### **CONFIG\_MBEDTLS\_ASYMMETRIC\_CONTENT\_LEN**

Asymmetric in/out fragment length

*Found in: [Component config](#) > [mbedtls](#)*

If enabled, this option allows customizing TLS in/out fragment length in asymmetric way. Please note that enabling this with default values saves 12KB of dynamic memory per TLS connection.

**Default value:**

- Yes (enabled)

### **CONFIG\_MBEDTLS\_SSL\_IN\_CONTENT\_LEN**

TLS maximum incoming fragment length

*Found in: [Component config](#) > [mbedtls](#) > [CONFIG\\_MBEDTLS\\_ASYMMETRIC\\_CONTENT\\_LEN](#)*

This defines maximum incoming fragment length, overriding default maximum content length (`MBEDTLS_SSL_MAX_CONTENT_LEN`).

**Range:**

- from 512 to 16384

**Default value:**

- 16384

### **CONFIG\_MBEDTLS\_SSL\_OUT\_CONTENT\_LEN**

TLS maximum outgoing fragment length

*Found in: [Component config](#) > [mbedtls](#) > [CONFIG\\_MBEDTLS\\_ASYMMETRIC\\_CONTENT\\_LEN](#)*

This defines maximum outgoing fragment length, overriding default maximum content length (`MBEDTLS_SSL_MAX_CONTENT_LEN`).

**Range:**

- from 512 to 16384

**Default value:**

- 4096

### **CONFIG\_MBEDTLS\_DYNAMIC\_BUFFER**

Using dynamic TX/RX buffer

*Found in: [Component config](#) > [mbedtls](#)*

Using dynamic TX/RX buffer. After enabling this option, mbedtls will allocate TX buffer when need to send data and then free it if all data is sent, allocate RX buffer when need to receive data and then free it when all data is used or read by upper layer.

By default, when SSL is initialized, mbedTLS also allocate TX and RX buffer with the default value of “MBEDTLS\_SSL\_OUT\_CONTENT\_LEN” or “MBEDTLS\_SSL\_IN\_CONTENT\_LEN” , so to save more heap, users can set the options to be an appropriate value.

**Default value:**

- No (disabled) if `CONFIG_MBEDTLS_SSL_PROTO_DTLS` && `CONFIG_MBEDTLS_SSL_VARIABLE_BUFFER_LENGTH`

**CONFIG\_MBEDTLS\_DYNAMIC\_FREE\_CONFIG\_DATA**

Free private key and DHM data after its usage

*Found in:* `Component config > mbedTLS > CONFIG_MBEDTLS_DYNAMIC_BUFFER`

Free private key and DHM data after its usage in handshake process.

The option will decrease heap cost when handshake, but also lead to problem:

Because all certificate, private key and DHM data are freed so users should register certificate and private key to ssl config object again.

**Default value:**

- No (disabled) if `CONFIG_MBEDTLS_DYNAMIC_BUFFER`

**CONFIG\_MBEDTLS\_DYNAMIC\_FREE\_CA\_CERT**

Free SSL CA certificate after its usage

*Found in:* `Component config > mbedTLS > CONFIG_MBEDTLS_DYNAMIC_BUFFER > CONFIG_MBEDTLS_DYNAMIC_FREE_CONFIG_DATA`

Free CA certificate after its usage in the handshake process. This option will decrease the heap footprint for the TLS handshake, but may lead to a problem: If the respective ssl object needs to perform the TLS handshake again, the CA certificate should once again be registered to the ssl object.

**Default value:**

- Yes (enabled) if `CONFIG_MBEDTLS_DYNAMIC_FREE_CONFIG_DATA`

**CONFIG\_MBEDTLS\_DEBUG**

Enable mbedTLS debugging

*Found in:* `Component config > mbedTLS`

Enable mbedTLS debugging functions at compile time.

If this option is enabled, you can include “mbedtls/esp\_debug.h” and call `mbedtls_esp_enable_debug_log()` at runtime in order to enable mbedTLS debug output via the ESP log mechanism.

**Default value:**

- No (disabled)

**CONFIG\_MBEDTLS\_DEBUG\_LEVEL**

Set mbedTLS debugging level

*Found in:* `Component config > mbedTLS > CONFIG_MBEDTLS_DEBUG`

Set mbedTLS debugging level

**Available options:**

- Warning (MBEDTLS\_DEBUG\_LEVEL\_WARN)
- Info (MBEDTLS\_DEBUG\_LEVEL\_INFO)
- Debug (MBEDTLS\_DEBUG\_LEVEL\_DEBUG)

- Verbose (MBEDTLS\_DEBUG\_LEVEL\_VERBOSE)

**MBEDTLS v3.x related** Contains:

- *DTLS-based configurations*
- *CONFIG\_MBEDTLS\_PKCS7\_C*
- *CONFIG\_MBEDTLS\_SSL\_CONTEXT\_SERIALIZATION*
- *CONFIG\_MBEDTLS\_X509\_TRUSTED\_CERT\_CALLBACK*
- *CONFIG\_MBEDTLS\_SSL\_KEEP\_PEER\_CERTIFICATE*
- *CONFIG\_MBEDTLS\_SSL\_CID\_PADDING\_GRANULARITY*
- *CONFIG\_MBEDTLS\_SSL\_PROTO\_TLS1\_3*
- *CONFIG\_MBEDTLS\_ECDH\_LEGACY\_CONTEXT*
- *CONFIG\_MBEDTLS\_SSL\_VARIABLE\_BUFFER\_LENGTH*

### **CONFIG\_MBEDTLS\_SSL\_PROTO\_TLS1\_3**

Support TLS 1.3 protocol

*Found in: Component config > mbedtls > mbedtls v3.x related*

**Default value:**

- No (disabled) if *CONFIG\_MBEDTLS\_SSL\_KEEP\_PEER\_CERTIFICATE* && *CONFIG\_MBEDTLS\_DYNAMIC\_BUFFER*

**TLS 1.3 related configurations** Contains:

- *CONFIG\_MBEDTLS\_SSL\_TLS1\_3\_KEXM\_EPHEMERAL*
- *CONFIG\_MBEDTLS\_SSL\_TLS1\_3\_COMPATIBILITY\_MODE*
- *CONFIG\_MBEDTLS\_SSL\_TLS1\_3\_KEXM\_PSK\_EPHEMERAL*
- *CONFIG\_MBEDTLS\_SSL\_TLS1\_3\_KEXM\_PSK*

### **CONFIG\_MBEDTLS\_SSL\_TLS1\_3\_COMPATIBILITY\_MODE**

TLS 1.3 middlebox compatibility mode

*Found in: Component config > mbedtls > mbedtls v3.x related > CONFIG\_MBEDTLS\_SSL\_PROTO\_TLS1\_3 > TLS 1.3 related configurations*

**Default value:**

- Yes (enabled) if *CONFIG\_MBEDTLS\_SSL\_PROTO\_TLS1\_3*

### **CONFIG\_MBEDTLS\_SSL\_TLS1\_3\_KEXM\_PSK**

TLS 1.3 PSK key exchange mode

*Found in: Component config > mbedtls > mbedtls v3.x related > CONFIG\_MBEDTLS\_SSL\_PROTO\_TLS1\_3 > TLS 1.3 related configurations*

**Default value:**

- Yes (enabled) if *CONFIG\_MBEDTLS\_SSL\_PROTO\_TLS1\_3*

### **CONFIG\_MBEDTLS\_SSL\_TLS1\_3\_KEXM\_EPHEMERAL**

TLS 1.3 ephemeral key exchange mode

*Found in: Component config > mbedtls > mbedtls v3.x related > CONFIG\_MBEDTLS\_SSL\_PROTO\_TLS1\_3 > TLS 1.3 related configurations*

**Default value:**

- Yes (enabled) if *CONFIG\_MBEDTLS\_SSL\_PROTO\_TLS1\_3*

### CONFIG\_MBEDTLS\_SSL\_TLS1\_3\_KEXM\_PSK\_EPHEMERAL

TLS 1.3 PSK ephemeral key exchange mode

*Found in:* [Component config](#) > [mbedtls](#) > [mbedtls v3.x related](#) > [CONFIG\\_MBEDTLS\\_SSL\\_PROTO\\_TLS1\\_3](#) > [TLS 1.3 related configurations](#)

**Default value:**

- Yes (enabled) if [CONFIG\\_MBEDTLS\\_SSL\\_PROTO\\_TLS1\\_3](#)

### CONFIG\_MBEDTLS\_SSL\_VARIABLE\_BUFFER\_LENGTH

Variable SSL buffer length

*Found in:* [Component config](#) > [mbedtls](#) > [mbedtls v3.x related](#)

This enables the SSL buffer to be resized automatically based on the negotiated maximum fragment length in each direction.

**Default value:**

- No (disabled)

### CONFIG\_MBEDTLS\_ECDH\_LEGACY\_CONTEXT

Use a backward compatible ECDH context (Experimental)

*Found in:* [Component config](#) > [mbedtls](#) > [mbedtls v3.x related](#)

Use the legacy ECDH context format. Define this option only if you enable [MBEDTLS\\_ECP\\_RESTARTABLE](#) or if you want to access ECDH context fields directly.

**Default value:**

- No (disabled) if [CONFIG\\_MBEDTLS\\_ECDH\\_C](#) && [CONFIG\\_MBEDTLS\\_ECP\\_RESTARTABLE](#)

### CONFIG\_MBEDTLS\_X509\_TRUSTED\_CERT\_CALLBACK

Enable trusted certificate callbacks

*Found in:* [Component config](#) > [mbedtls](#) > [mbedtls v3.x related](#)

Enables users to configure the set of trusted certificates through a callback instead of a linked list.

See mbedtls documentation for required API and more details.

**Default value:**

- No (disabled)

### CONFIG\_MBEDTLS\_SSL\_CONTEXT\_SERIALIZATION

Enable serialization of the TLS context structures

*Found in:* [Component config](#) > [mbedtls](#) > [mbedtls v3.x related](#)

Enable serialization of the TLS context structures This is a local optimization in handling a single, potentially long-lived connection.

See mbedtls documentation for required API and more details. Disabling this option will save some code size.

**Default value:**

- No (disabled)



### CONFIG\_MBEDTLS\_SSL\_KEEP\_PEER\_CERTIFICATE

Keep peer certificate after handshake completion

*Found in: Component config > mbedTLS > mbedTLS v3.x related*

Keep the peer's certificate after completion of the handshake. Disabling this option will save about 4kB of heap and some code size.

See mbedTLS documentation for required API and more details.

**Default value:**

- Yes (enabled)

### CONFIG\_MBEDTLS\_PKCS7\_C

Enable PKCS #7

*Found in: Component config > mbedTLS > mbedTLS v3.x related*

Enable PKCS #7 core for using PKCS #7-formatted signatures.

**Default value:**

- Yes (enabled)

### CONFIG\_MBEDTLS\_SSL\_CID\_PADDING\_GRANULARITY

Record plaintext padding

*Found in: Component config > mbedTLS > mbedTLS v3.x related*

Controls the use of record plaintext padding in TLS 1.3 and when using the Connection ID extension in DTLS 1.2.

The padding will always be chosen so that the length of the padded plaintext is a multiple of the value of this option.

**Notes:** A value of 1 means that no padding will be used for outgoing records. On systems lacking division instructions, a power of two should be preferred.

**Range:**

- from 0 to 32 if `CONFIG_MBEDTLS_SSL_PROTO_TLS1_3` || `CONFIG_MBEDTLS_SSL_DTLS_CONNECTION_ID`

**Default value:**

- 16 if `CONFIG_MBEDTLS_SSL_PROTO_TLS1_3` || `CONFIG_MBEDTLS_SSL_DTLS_CONNECTION_ID`

**DTLS-based configurations** Contains:

- `CONFIG_MBEDTLS_SSL_DTLS_SRTP`
- `CONFIG_MBEDTLS_SSL_DTLS_CONNECTION_ID`

### CONFIG\_MBEDTLS\_SSL\_DTLS\_CONNECTION\_ID

Support for the DTLS Connection ID extension

*Found in: Component config > mbedTLS > mbedTLS v3.x related > DTLS-based configurations*

Enable support for the DTLS Connection ID extension which allows to identify DTLS connections across changes in the underlying transport.

**Default value:**

- No (disabled) if `CONFIG_MBEDTLS_SSL_PROTO_DTLS`

### CONFIG\_MBEDTLS\_SSL\_CID\_IN\_LEN\_MAX

Maximum length of CIDs used for incoming DTLS messages

*Found in: Component config > mbedTLS > mbedTLS v3.x related > DTLS-based configurations > CONFIG\_MBEDTLS\_SSL\_DTLS\_CONNECTION\_ID*

Maximum length of CIDs used for incoming DTLS messages

**Range:**

- from 0 to 32 if *CONFIG\_MBEDTLS\_SSL\_DTLS\_CONNECTION\_ID* && *CONFIG\_MBEDTLS\_SSL\_PROTO\_DTLS*

**Default value:**

- 32 if *CONFIG\_MBEDTLS\_SSL\_DTLS\_CONNECTION\_ID* && *CONFIG\_MBEDTLS\_SSL\_PROTO\_DTLS*

### CONFIG\_MBEDTLS\_SSL\_CID\_OUT\_LEN\_MAX

Maximum length of CIDs used for outgoing DTLS messages

*Found in: Component config > mbedTLS > mbedTLS v3.x related > DTLS-based configurations > CONFIG\_MBEDTLS\_SSL\_DTLS\_CONNECTION\_ID*

Maximum length of CIDs used for outgoing DTLS messages

**Range:**

- from 0 to 32 if *CONFIG\_MBEDTLS\_SSL\_DTLS\_CONNECTION\_ID* && *CONFIG\_MBEDTLS\_SSL\_PROTO\_DTLS*

**Default value:**

- 32 if *CONFIG\_MBEDTLS\_SSL\_DTLS\_CONNECTION\_ID* && *CONFIG\_MBEDTLS\_SSL\_PROTO\_DTLS*

### CONFIG\_MBEDTLS\_SSL\_DTLS\_SRTP

Enable support for negotiation of DTLS-SRTP (RFC 5764)

*Found in: Component config > mbedTLS > mbedTLS v3.x related > DTLS-based configurations*

Enable support for negotiation of DTLS-SRTP (RFC 5764) through the use\_srtp extension.

See mbedTLS documentation for required API and more details. Disabling this option will save some code size.

**Default value:**

- No (disabled) if *CONFIG\_MBEDTLS\_SSL\_PROTO\_DTLS*

**Certificate Bundle** Contains:

- *CONFIG\_MBEDTLS\_CERTIFICATE\_BUNDLE*

### CONFIG\_MBEDTLS\_CERTIFICATE\_BUNDLE

Enable trusted root certificate bundle

*Found in: Component config > mbedTLS > Certificate Bundle*

Enable support for large number of default root certificates

When enabled this option allows user to store default as well as customer specific root certificates in compressed format rather than storing full certificate. For the root certificates the public key and the subject name will be stored.

**Default value:**

- Yes (enabled)

## CONFIG\_MBEDTLS\_DEFAULT\_CERTIFICATE\_BUNDLE

Default certificate bundle options

*Found in:* [Component config](#) > [mbedtls](#) > [Certificate Bundle](#) > [CONFIG\\_MBEDTLS\\_CERTIFICATE\\_BUNDLE](#)

### Available options:

- Use the full default certificate bundle (MBEDTLS\_CERTIFICATE\_BUNDLE\_DEFAULT\_FULL)
- Use only the most common certificates from the default bundles (MBEDTLS\_CERTIFICATE\_BUNDLE\_DEFAULT\_CMN)  
Use only the most common certificates from the default bundles, reducing the size with 50%, while still having around 99% coverage.
- Do not use the default certificate bundle (MBEDTLS\_CERTIFICATE\_BUNDLE\_DEFAULT\_NONE)

## CONFIG\_MBEDTLS\_CUSTOM\_CERTIFICATE\_BUNDLE

Add custom certificates to the default bundle

*Found in:* [Component config](#) > [mbedtls](#) > [Certificate Bundle](#) > [CONFIG\\_MBEDTLS\\_CERTIFICATE\\_BUNDLE](#)

### Default value:

- No (disabled)

## CONFIG\_MBEDTLS\_CUSTOM\_CERTIFICATE\_BUNDLE\_PATH

Custom certificate bundle path

*Found in:* [Component config](#) > [mbedtls](#) > [Certificate Bundle](#) > [CONFIG\\_MBEDTLS\\_CERTIFICATE\\_BUNDLE](#) > [CONFIG\\_MBEDTLS\\_CUSTOM\\_CERTIFICATE\\_BUNDLE](#)

Name of the custom certificate directory or file. This path is evaluated relative to the project root directory.

## CONFIG\_MBEDTLS\_CERTIFICATE\_BUNDLE\_MAX\_CERTS

Maximum no of certificates allowed in certificate bundle

*Found in:* [Component config](#) > [mbedtls](#) > [Certificate Bundle](#) > [CONFIG\\_MBEDTLS\\_CERTIFICATE\\_BUNDLE](#)

### Default value:

- 200

## CONFIG\_MBEDTLS\_ECP\_RESTARTABLE

Enable mbedtls ecp restartable

*Found in:* [Component config](#) > [mbedtls](#)

Enable “non-blocking” ECC operations that can return early and be resumed.

### Default value:

- No (disabled)

## CONFIG\_MBEDTLS\_CMAC\_C

Enable CMAC mode for block ciphers

*Found in:* [Component config](#) > [mbedtls](#)

Enable the CMAC (Cipher-based Message Authentication Code) mode for block ciphers.

### Default value:

- No (disabled)

### CONFIG\_MBEDTLS\_HARDWARE\_AES

Enable hardware AES acceleration

*Found in: [Component config](#) > [mbedtls](#)*

Enable hardware accelerated AES encryption & decryption.

Note that if the ESP32 CPU is running at 240MHz, hardware AES does not offer any speed boost over software AES.

**Default value:**

- Yes (enabled) if SPIRAM\_CACHE\_WORKAROUND\_STRATEGY\_DUPLDST

### CONFIG\_MBEDTLS\_AES\_USE\_INTERRUPT

Use interrupt for long AES operations

*Found in: [Component config](#) > [mbedtls](#) > [CONFIG\\_MBEDTLS\\_HARDWARE\\_AES](#)*

Use an interrupt to coordinate long AES operations.

This allows other code to run on the CPU while an AES operation is pending. Otherwise the CPU busy-waits.

**Default value:**

- Yes (enabled)

### CONFIG\_MBEDTLS\_HARDWARE\_GCM

Enable partially hardware accelerated GCM

*Found in: [Component config](#) > [mbedtls](#) > [CONFIG\\_MBEDTLS\\_HARDWARE\\_AES](#)*

Enable partially hardware accelerated GCM. GHASH calculation is still done in software.

If MBEDTLS\_HARDWARE\_GCM is disabled and MBEDTLS\_HARDWARE\_AES is enabled then mbedtls will still use the hardware accelerated AES block operation, but on a single block at a time.

**Default value:**

- Yes (enabled)

### CONFIG\_MBEDTLS\_GCM\_SUPPORT\_NON\_AES\_CIPHER

Enable support for non-AES ciphers in GCM operation

*Found in: [Component config](#) > [mbedtls](#) > [CONFIG\\_MBEDTLS\\_HARDWARE\\_AES](#)*

Enable this config to support fallback to software definitions for a non-AES cipher GCM operation as we support hardware acceleration only for AES cipher. Some of the non-AES ciphers used in a GCM operation are DES, ARIA, CAMELLIA, CHACHA20, BLOWFISH.

If this config is disabled, performing a non-AES cipher GCM operation with the config MBEDTLS\_HARDWARE\_AES enabled will result in calculation of an AES-GCM operation instead for the given input values and thus could lead to failure in certificate validation which would ultimately lead to a SSL handshake failure.

This config being by-default enabled leads to an increase in binary size footprint of ~2.5KB. In case you are sure that your use case (for example, client and server configurations in case of a TLS handshake) would not involve any GCM operations using a non-AES cipher, you can safely disable this config, leading to reduction in binary size footprint.

**Default value:**

- No (disabled)

### CONFIG\_MBEDTLS\_HARDWARE\_MPI

Enable hardware MPI (bignum) acceleration

*Found in: [Component config](#) > [mbedtls](#)*

Enable hardware accelerated multiple precision integer operations.

Hardware accelerated multiplication, modulo multiplication, and modular exponentiation for up to SOC\_RSA\_MAX\_BIT\_LEN bit results.

These operations are used by RSA.

**Default value:**

- Yes (enabled) if SPIRAM\_CACHE\_WORKAROUND\_STRATEGY\_DUPLDST

### CONFIG\_MBEDTLS\_MPI\_USE\_INTERRUPT

Use interrupt for MPI exp-mod operations

*Found in: [Component config](#) > [mbedtls](#) > [CONFIG\\_MBEDTLS\\_HARDWARE\\_MPI](#)*

Use an interrupt to coordinate long MPI operations.

This allows other code to run on the CPU while an MPI operation is pending. Otherwise the CPU busy-waits.

**Default value:**

- Yes (enabled)

### CONFIG\_MBEDTLS\_HARDWARE\_SHA

Enable hardware SHA acceleration

*Found in: [Component config](#) > [mbedtls](#)*

Enable hardware accelerated SHA1, SHA256, SHA384 & SHA512 in mbedtls.

Due to a hardware limitation, on the ESP32 hardware acceleration is only guaranteed if SHA digests are calculated one at a time. If more than one SHA digest is calculated at the same time, one will be calculated fully in hardware and the rest will be calculated (at least partially calculated) in software. This happens automatically.

SHA hardware acceleration is faster than software in some situations but slower in others. You should benchmark to find the best setting for you.

**Default value:**

- Yes (enabled) if SPIRAM\_CACHE\_WORKAROUND\_STRATEGY\_DUPLDST

### CONFIG\_MBEDTLS\_HARDWARE\_ECC

Enable hardware ECC acceleration

*Found in: [Component config](#) > [mbedtls](#)*

Enable hardware accelerated ECC point multiplication and point verification for points on curve SECP192R1 and SECP256R1 in mbedtls

**Default value:**

- Yes (enabled) if SOC\_ECC\_SUPPORTED

### CONFIG\_MBEDTLS\_ECC\_OTHER\_CURVES\_SOFT\_FALLBACK

Fallback to software implementation for curves not supported in hardware

*Found in: [Component config](#) > [mbedtls](#) > [CONFIG\\_MBEDTLS\\_HARDWARE\\_ECC](#)*

Fallback to software implementation of ECC point multiplication and point verification for curves not supported in hardware.

**Default value:**

- Yes (enabled) if [CONFIG\\_MBEDTLS\\_HARDWARE\\_ECC](#)

### CONFIG\_MBEDTLS\_ROM\_MD5

Use MD5 implementation in ROM

*Found in: [Component config](#) > [mbedtls](#)*

Use ROM MD5 in mbedtls.

**Default value:**

- Yes (enabled)

### CONFIG\_MBEDTLS\_ATCA\_HW\_ECDSA\_SIGN

Enable hardware ECDSA sign acceleration when using ATECC608A

*Found in: [Component config](#) > [mbedtls](#)*

This option enables hardware acceleration for ECDSA sign function, only when using ATECC608A cryptoauth chip (integrated with ESP32-WROOM-32SE)

**Default value:**

- No (disabled)

### CONFIG\_MBEDTLS\_ATCA\_HW\_ECDSA\_VERIFY

Enable hardware ECDSA verify acceleration when using ATECC608A

*Found in: [Component config](#) > [mbedtls](#)*

This option enables hardware acceleration for ECDSA sign function, only when using ATECC608A cryptoauth chip (integrated with ESP32-WROOM-32SE)

**Default value:**

- No (disabled)

### CONFIG\_MBEDTLS\_HAVE\_TIME

Enable mbedtls time support

*Found in: [Component config](#) > [mbedtls](#)*

Enable use of time.h functions (time() and gmtime()) by mbedtls.

This option doesn't require the system time to be correct, but enables functionality that requires relative timekeeping - for example periodic expiry of TLS session tickets or session cache entries.

Disabling this option will save some firmware size, particularly if the rest of the firmware doesn't call any standard timekeeping functions.

**Default value:**

- Yes (enabled)

### CONFIG\_MBEDTLS\_PLATFORM\_TIME\_ALT

Enable mbedtls time support: platform-specific

*Found in: [Component config](#) > [mbedtls](#) > [CONFIG\\_MBEDTLS\\_HAVE\\_TIME](#)*

Enabling this config will provide users with a function “mbedtls\_platform\_set\_time()” that allows to set an alternative time function pointer.

**Default value:**

- No (disabled)

### CONFIG\_MBEDTLS\_HAVE\_TIME\_DATE

Enable mbedtls certificate expiry check

*Found in: [Component config](#) > [mbedtls](#) > [CONFIG\\_MBEDTLS\\_HAVE\\_TIME](#)*

Enables X.509 certificate expiry checks in mbedtls.

If this option is disabled (default) then X.509 certificate “valid from” and “valid to” timestamp fields are ignored.

If this option is enabled, these fields are compared with the current system date and time. The time is retrieved using the standard time() and gmtime() functions. If the certificate is not valid for the current system time then verification will fail with code MBEDTLS\_X509\_BADCERT\_FUTURE or MBEDTLS\_X509\_BADCERT\_EXPIRED.

Enabling this option requires adding functionality in the firmware to set the system clock to a valid timestamp before using TLS. The recommended way to do this is via ESP-IDF’s SNTP functionality, but any method can be used.

In the case where only a small number of certificates are trusted by the device, please carefully consider the tradeoffs of enabling this option. There may be undesired consequences, for example if all trusted certificates expire while the device is offline and a TLS connection is required to update. Or if an issue with the SNTP server means that the system time is invalid for an extended period after a reset.

**Default value:**

- No (disabled)

### CONFIG\_MBEDTLS\_ECDSA\_DETERMINISTIC

Enable deterministic ECDSA

*Found in: [Component config](#) > [mbedtls](#)*

Standard ECDSA is “fragile” in the sense that lack of entropy when signing may result in a compromise of the long-term signing key.

**Default value:**

- Yes (enabled)

### CONFIG\_MBEDTLS\_SHA512\_C

Enable the SHA-384 and SHA-512 cryptographic hash algorithms

*Found in: [Component config](#) > [mbedtls](#)*

Enable MBEDTLS\_SHA512\_C adds support for SHA-384 and SHA-512.

**Default value:**

- Yes (enabled)

## CONFIG\_MBEDTLS\_TLS\_MODE

TLS Protocol Role

Found in: *Component config > mbedTLS*

mbedTLS can be compiled with protocol support for the TLS server, TLS client, or both server and client.

Reducing the number of TLS roles supported saves code size.

### Available options:

- Server & Client (MBEDTLS\_TLS\_SERVER\_AND\_CLIENT)
- Server (MBEDTLS\_TLS\_SERVER\_ONLY)
- Client (MBEDTLS\_TLS\_CLIENT\_ONLY)
- None (MBEDTLS\_TLS\_DISABLED)

## TLS Key Exchange Methods Contains:

- *CONFIG\_MBEDTLS\_KEY\_EXCHANGE\_DHE\_RSA*
- *CONFIG\_MBEDTLS\_KEY\_EXCHANGE\_ECJPAKE*
- *CONFIG\_MBEDTLS\_PSK\_MODES*
- *CONFIG\_MBEDTLS\_KEY\_EXCHANGE\_RSA*
- *CONFIG\_MBEDTLS\_KEY\_EXCHANGE\_ELLIPTIC\_CURVE*

## CONFIG\_MBEDTLS\_PSK\_MODES

Enable pre-shared-key ciphersuites

Found in: *Component config > mbedTLS > TLS Key Exchange Methods*

Enable to show configuration for different types of pre-shared-key TLS authentication methods.

Leaving this options disabled will save code size if they are not used.

### Default value:

- No (disabled)

## CONFIG\_MBEDTLS\_KEY\_EXCHANGE\_PSK

Enable PSK based ciphersuite modes

Found in: *Component config > mbedTLS > TLS Key Exchange Methods > CONFIG\_MBEDTLS\_PSK\_MODES*

Enable to support symmetric key PSK (pre-shared-key) TLS key exchange modes.

### Default value:

- No (disabled) if *CONFIG\_MBEDTLS\_PSK\_MODES*

## CONFIG\_MBEDTLS\_KEY\_EXCHANGE\_DHE\_PSK

Enable DHE-PSK based ciphersuite modes

Found in: *Component config > mbedTLS > TLS Key Exchange Methods > CONFIG\_MBEDTLS\_PSK\_MODES*

Enable to support Diffie-Hellman PSK (pre-shared-key) TLS authentication modes.

### Default value:

- Yes (enabled) if *CONFIG\_MBEDTLS\_PSK\_MODES* && *CONFIG\_MBEDTLS\_DHM\_C*



### CONFIG\_MBEDTLS\_KEY\_EXCHANGE\_ECDHE\_PSK

Enable ECDHE-PSK based ciphersuite modes

*Found in:* [Component config](#) > [mbedtls](#) > [TLS Key Exchange Methods](#) > [CONFIG\\_MBEDTLS\\_PSK\\_MODES](#)

Enable to support Elliptic-Curve-Diffie-Hellman PSK (pre-shared-key) TLS authentication modes.

**Default value:**

- Yes (enabled) if [CONFIG\\_MBEDTLS\\_PSK\\_MODES](#) && [CONFIG\\_MBEDTLS\\_ECDH\\_C](#)

### CONFIG\_MBEDTLS\_KEY\_EXCHANGE\_RSA\_PSK

Enable RSA-PSK based ciphersuite modes

*Found in:* [Component config](#) > [mbedtls](#) > [TLS Key Exchange Methods](#) > [CONFIG\\_MBEDTLS\\_PSK\\_MODES](#)

Enable to support RSA PSK (pre-shared-key) TLS authentication modes.

**Default value:**

- Yes (enabled) if [CONFIG\\_MBEDTLS\\_PSK\\_MODES](#)

### CONFIG\_MBEDTLS\_KEY\_EXCHANGE\_RSA

Enable RSA-only based ciphersuite modes

*Found in:* [Component config](#) > [mbedtls](#) > [TLS Key Exchange Methods](#)

Enable to support ciphersuites with prefix TLS-RSA-WITH-

**Default value:**

- Yes (enabled)

### CONFIG\_MBEDTLS\_KEY\_EXCHANGE\_DHE\_RSA

Enable DHE-RSA based ciphersuite modes

*Found in:* [Component config](#) > [mbedtls](#) > [TLS Key Exchange Methods](#)

Enable to support ciphersuites with prefix TLS-DHE-RSA-WITH-

**Default value:**

- Yes (enabled) if [CONFIG\\_MBEDTLS\\_DHM\\_C](#)

### CONFIG\_MBEDTLS\_KEY\_EXCHANGE\_ELLIPTIC\_CURVE

Support Elliptic Curve based ciphersuites

*Found in:* [Component config](#) > [mbedtls](#) > [TLS Key Exchange Methods](#)

Enable to show Elliptic Curve based ciphersuite mode options.

Disabling all Elliptic Curve ciphersuites saves code size and can give slightly faster TLS handshakes, provided the server supports RSA-only ciphersuite modes.

**Default value:**

- Yes (enabled)

### CONFIG\_MBEDTLS\_KEY\_EXCHANGE\_ECDHE\_RSA

Enable ECDHE-RSA based ciphersuite modes

*Found in:* [Component config > mbedTLS > TLS Key Exchange Methods > CONFIG\\_MBEDTLS\\_KEY\\_EXCHANGE\\_ELLIPTIC\\_CURVE](#)

Enable to support ciphersuites with prefix TLS-ECDHE-RSA-WITH-

**Default value:**

- Yes (enabled)

### CONFIG\_MBEDTLS\_KEY\_EXCHANGE\_ECDHE\_ECDSA

Enable ECDHE-ECDSA based ciphersuite modes

*Found in:* [Component config > mbedTLS > TLS Key Exchange Methods > CONFIG\\_MBEDTLS\\_KEY\\_EXCHANGE\\_ELLIPTIC\\_CURVE](#)

Enable to support ciphersuites with prefix TLS-ECDHE-RSA-WITH-

**Default value:**

- Yes (enabled)

### CONFIG\_MBEDTLS\_KEY\_EXCHANGE\_ECDH\_ECDSA

Enable ECDH-ECDSA based ciphersuite modes

*Found in:* [Component config > mbedTLS > TLS Key Exchange Methods > CONFIG\\_MBEDTLS\\_KEY\\_EXCHANGE\\_ELLIPTIC\\_CURVE](#)

Enable to support ciphersuites with prefix TLS-ECDHE-RSA-WITH-

**Default value:**

- Yes (enabled)

### CONFIG\_MBEDTLS\_KEY\_EXCHANGE\_ECDH\_RSA

Enable ECDH-RSA based ciphersuite modes

*Found in:* [Component config > mbedTLS > TLS Key Exchange Methods > CONFIG\\_MBEDTLS\\_KEY\\_EXCHANGE\\_ELLIPTIC\\_CURVE](#)

Enable to support ciphersuites with prefix TLS-ECDHE-RSA-WITH-

**Default value:**

- Yes (enabled)

### CONFIG\_MBEDTLS\_KEY\_EXCHANGE\_ECJPAKE

Enable ECJPAKE based ciphersuite modes

*Found in:* [Component config > mbedTLS > TLS Key Exchange Methods](#)

Enable to support ciphersuites with prefix TLS-ECJPAKE-WITH-

**Default value:**

- No (disabled) if [CONFIG\\_MBEDTLS\\_ECJPAKE\\_C](#) && [CONFIG\\_MBEDTLS\\_ECP\\_DP\\_SECP256R1\\_ENABLED](#)

### CONFIG\_MBEDTLS\_SSL\_RENEGOTIATION

Support TLS renegotiation

*Found in: [Component config](#) > [mbedtls](#)*

The two main uses of renegotiation are (1) refresh keys on long-lived connections and (2) client authentication after the initial handshake. If you don't need renegotiation, disabling it will save code size and reduce the possibility of abuse/vulnerability.

**Default value:**

- Yes (enabled)

### CONFIG\_MBEDTLS\_SSL\_PROTO\_TLS1\_2

Support TLS 1.2 protocol

*Found in: [Component config](#) > [mbedtls](#)*

**Default value:**

- Yes (enabled)

### CONFIG\_MBEDTLS\_SSL\_PROTO\_GMTSSL1\_1

Support GM/T SSL 1.1 protocol

*Found in: [Component config](#) > [mbedtls](#)*

Provisions for GM/T SSL 1.1 support

**Default value:**

- No (disabled)

### CONFIG\_MBEDTLS\_SSL\_PROTO\_DTLS

Support DTLS protocol (all versions)

*Found in: [Component config](#) > [mbedtls](#)*

Requires TLS 1.2 to be enabled for DTLS 1.2

**Default value:**

- No (disabled)

### CONFIG\_MBEDTLS\_SSL\_ALPN

Support ALPN (Application Layer Protocol Negotiation)

*Found in: [Component config](#) > [mbedtls](#)*

Disabling this option will save some code size if it is not needed.

**Default value:**

- Yes (enabled)

### CONFIG\_MBEDTLS\_CLIENT\_SSL\_SESSION\_TICKETS

TLS: Client Support for RFC 5077 SSL session tickets

*Found in: [Component config](#) > [mbedtls](#)*

Client support for RFC 5077 session tickets. See mbedtls documentation for more details. Disabling this option will save some code size.

**Default value:**

- Yes (enabled)

## CONFIG\_MBEDTLS\_SERVER\_SSL\_SESSION\_TICKETS

TLS: Server Support for RFC 5077 SSL session tickets

*Found in: [Component config](#) > [mbedtls](#)*

Server support for RFC 5077 session tickets. See mbedtls documentation for more details. Disabling this option will save some code size.

**Default value:**

- Yes (enabled)

## Symmetric Ciphers Contains:

- [CONFIG\\_MBEDTLS\\_AES\\_C](#)
- [CONFIG\\_MBEDTLS\\_BLOWFISH\\_C](#)
- [CONFIG\\_MBEDTLS\\_CAMELLIA\\_C](#)
- [CONFIG\\_MBEDTLS\\_CCM\\_C](#)
- [CONFIG\\_MBEDTLS\\_DES\\_C](#)
- [CONFIG\\_MBEDTLS\\_GCM\\_C](#)
- [CONFIG\\_MBEDTLS\\_NIST\\_KW\\_C](#)
- [CONFIG\\_MBEDTLS\\_XTEA\\_C](#)

## CONFIG\_MBEDTLS\_AES\_C

AES block cipher

*Found in: [Component config](#) > [mbedtls](#) > [Symmetric Ciphers](#)*

**Default value:**

- Yes (enabled)

## CONFIG\_MBEDTLS\_CAMELLIA\_C

Camellia block cipher

*Found in: [Component config](#) > [mbedtls](#) > [Symmetric Ciphers](#)*

**Default value:**

- No (disabled)

## CONFIG\_MBEDTLS\_DES\_C

DES block cipher (legacy, insecure)

*Found in: [Component config](#) > [mbedtls](#) > [Symmetric Ciphers](#)*

Enables the DES block cipher to support 3DES-based TLS ciphersuites.

3DES is vulnerable to the Sweet32 attack and should only be enabled if absolutely necessary.

**Default value:**

- No (disabled)

## CONFIG\_MBEDTLS\_BLOWFISH\_C

Blowfish block cipher (read help)

*Found in: [Component config](#) > [mbedtls](#) > [Symmetric Ciphers](#)*

Enables the Blowfish block cipher (not used for TLS sessions.)

The Blowfish cipher is not used for mbedtls TLS sessions but can be used for other purposes. Read up on the limitations of Blowfish (including Sweet32) before enabling.

**Default value:**

- No (disabled)

### **CONFIG\_MBEDTLS\_XTEA\_C**

XTEA block cipher

*Found in: [Component config](#) > [mbedtls](#) > [Symmetric Ciphers](#)*

Enables the XTEA block cipher.

**Default value:**

- No (disabled)

### **CONFIG\_MBEDTLS\_CCM\_C**

CCM (Counter with CBC-MAC) block cipher modes

*Found in: [Component config](#) > [mbedtls](#) > [Symmetric Ciphers](#)*

Enable Counter with CBC-MAC (CCM) modes for AES and/or Camellia ciphers.

Disabling this option saves some code size.

**Default value:**

- Yes (enabled)

### **CONFIG\_MBEDTLS\_GCM\_C**

GCM (Galois/Counter) block cipher modes

*Found in: [Component config](#) > [mbedtls](#) > [Symmetric Ciphers](#)*

Enable Galois/Counter Mode for AES and/or Camellia ciphers.

This option is generally faster than CCM.

**Default value:**

- Yes (enabled)

### **CONFIG\_MBEDTLS\_NIST\_KW\_C**

NIST key wrapping (KW) and KW padding (KWP)

*Found in: [Component config](#) > [mbedtls](#) > [Symmetric Ciphers](#)*

Enable NIST key wrapping and key wrapping padding.

**Default value:**

- No (disabled)

### **CONFIG\_MBEDTLS\_RIPEMD160\_C**

Enable RIPEMD-160 hash algorithm

*Found in: [Component config](#) > [mbedtls](#)*

Enable the RIPEMD-160 hash algorithm.

**Default value:**

- No (disabled)

**Certificates** Contains:

- [CONFIG\\_MBEDTLS\\_PEM\\_PARSE\\_C](#)
- [CONFIG\\_MBEDTLS\\_PEM\\_WRITE\\_C](#)
- [CONFIG\\_MBEDTLS\\_X509\\_CRL\\_PARSE\\_C](#)
- [CONFIG\\_MBEDTLS\\_X509\\_CSR\\_PARSE\\_C](#)

### **CONFIG\_MBEDTLS\_PEM\_PARSE\_C**

Read & Parse PEM formatted certificates

*Found in: [Component config](#) > [mbedtls](#) > [Certificates](#)*

Enable decoding/parsing of PEM formatted certificates.

If your certificates are all in the simpler DER format, disabling this option will save some code size.

**Default value:**

- Yes (enabled)

### **CONFIG\_MBEDTLS\_PEM\_WRITE\_C**

Write PEM formatted certificates

*Found in: [Component config](#) > [mbedtls](#) > [Certificates](#)*

Enable writing of PEM formatted certificates.

If writing certificate data only in DER format, disabling this option will save some code size.

**Default value:**

- Yes (enabled)

### **CONFIG\_MBEDTLS\_X509\_CRL\_PARSE\_C**

X.509 CRL parsing

*Found in: [Component config](#) > [mbedtls](#) > [Certificates](#)*

Support for parsing X.509 Certificate Revocation Lists.

**Default value:**

- Yes (enabled)

### **CONFIG\_MBEDTLS\_X509\_CSR\_PARSE\_C**

X.509 CSR parsing

*Found in: [Component config](#) > [mbedtls](#) > [Certificates](#)*

Support for parsing X.509 Certificate Signing Requests

**Default value:**

- Yes (enabled)

### **CONFIG\_MBEDTLS\_ECP\_C**

Elliptic Curve Ciphers

*Found in: [Component config](#) > [mbedtls](#)*

**Default value:**

- Yes (enabled)

### CONFIG\_MBEDTLS\_DHM\_C

Diffie-Hellman-Merkle key exchange (DHM)

*Found in: [Component config](#) > [mbedtls](#)*

Enable DHM. Needed to use DHE-xxx TLS ciphersuites.

Note that the security of Diffie-Hellman key exchanges depends on a suitable prime being used for the exchange. Please see detailed warning text about this in file *mbedtls/dhm.h* file.

**Default value:**

- No (disabled)

### CONFIG\_MBEDTLS\_ECDH\_C

Elliptic Curve Diffie-Hellman (ECDH)

*Found in: [Component config](#) > [mbedtls](#)*

Enable ECDH. Needed to use ECDHE-xxx TLS ciphersuites.

**Default value:**

- Yes (enabled)

### CONFIG\_MBEDTLS\_ECDSA\_C

Elliptic Curve DSA

*Found in: [Component config](#) > [mbedtls](#) > [CONFIG\\_MBEDTLS\\_ECDH\\_C](#)*

Enable ECDSA. Needed to use ECDSA-xxx TLS ciphersuites.

**Default value:**

- Yes (enabled)

### CONFIG\_MBEDTLS\_ECJPAKE\_C

Elliptic curve J-PAKE

*Found in: [Component config](#) > [mbedtls](#)*

Enable ECJPAKE. Needed to use ECJPAKE-xxx TLS ciphersuites.

**Default value:**

- No (disabled)

### CONFIG\_MBEDTLS\_ECP\_DP\_SECP192R1\_ENABLED

Enable SECP192R1 curve

*Found in: [Component config](#) > [mbedtls](#)*

Enable support for SECP192R1 Elliptic Curve.

**Default value:**

- Yes (enabled) if `(CONFIG_MBEDTLS_ATCA_HW_ECDSA_SIGN || CONFIG_MBEDTLS_ATCA_HW_ECDSA_VERIFY) && CONFIG_MBEDTLS_ECP_C`

### CONFIG\_MBEDTLS\_ECP\_DP\_SECP224R1\_ENABLED

Enable SECP224R1 curve

*Found in: [Component config](#) > [mbedtls](#)*

Enable support for SECP224R1 Elliptic Curve.

**Default value:**

- Yes (enabled) if (`CONFIG_MBEDTLS_ATCA_HW_ECDSA_SIGN` || `CONFIG_MBEDTLS_ATCA_HW_ECDSA_VERIFY`) && `CONFIG_MBEDTLS_ECP_C`

**CONFIG\_MBEDTLS\_ECP\_DP\_SECP256R1\_ENABLED**

Enable SECP256R1 curve

*Found in:* `Component config > mbedTLS`

Enable support for SECP256R1 Elliptic Curve.

**Default value:**

- Yes (enabled)

**CONFIG\_MBEDTLS\_ECP\_DP\_SECP384R1\_ENABLED**

Enable SECP384R1 curve

*Found in:* `Component config > mbedTLS`

Enable support for SECP384R1 Elliptic Curve.

**Default value:**

- Yes (enabled) if (`CONFIG_MBEDTLS_ATCA_HW_ECDSA_SIGN` || `CONFIG_MBEDTLS_ATCA_HW_ECDSA_VERIFY`) && `CONFIG_MBEDTLS_ECP_C`

**CONFIG\_MBEDTLS\_ECP\_DP\_SECP521R1\_ENABLED**

Enable SECP521R1 curve

*Found in:* `Component config > mbedTLS`

Enable support for SECP521R1 Elliptic Curve.

**Default value:**

- Yes (enabled) if (`CONFIG_MBEDTLS_ATCA_HW_ECDSA_SIGN` || `CONFIG_MBEDTLS_ATCA_HW_ECDSA_VERIFY`) && `CONFIG_MBEDTLS_ECP_C`

**CONFIG\_MBEDTLS\_ECP\_DP\_SECP192K1\_ENABLED**

Enable SECP192K1 curve

*Found in:* `Component config > mbedTLS`

Enable support for SECP192K1 Elliptic Curve.

**Default value:**

- Yes (enabled) if (`CONFIG_MBEDTLS_ATCA_HW_ECDSA_SIGN` || `CONFIG_MBEDTLS_ATCA_HW_ECDSA_VERIFY`) && `CONFIG_MBEDTLS_ECP_C`

**CONFIG\_MBEDTLS\_ECP\_DP\_SECP224K1\_ENABLED**

Enable SECP224K1 curve

*Found in:* `Component config > mbedTLS`

Enable support for SECP224K1 Elliptic Curve.

**Default value:**

- Yes (enabled) if (`CONFIG_MBEDTLS_ATCA_HW_ECDSA_SIGN` || `CONFIG_MBEDTLS_ATCA_HW_ECDSA_VERIFY`) && `CONFIG_MBEDTLS_ECP_C`



**CONFIG\_MBEDTLS\_ECP\_DP\_SECP256K1\_ENABLED**

Enable SECP256K1 curve

*Found in: Component config > mbedTLS*

Enable support for SECP256K1 Elliptic Curve.

**Default value:**

- Yes (enabled) if (`CONFIG_MBEDTLS_ATCA_HW_ECDSA_SIGN` || `CONFIG_MBEDTLS_ATCA_HW_ECDSA_VERIFY`) && `CONFIG_MBEDTLS_ECP_C`

**CONFIG\_MBEDTLS\_ECP\_DP\_BP256R1\_ENABLED**

Enable BP256R1 curve

*Found in: Component config > mbedTLS*

support for DP Elliptic Curve.

**Default value:**

- Yes (enabled) if (`CONFIG_MBEDTLS_ATCA_HW_ECDSA_SIGN` || `CONFIG_MBEDTLS_ATCA_HW_ECDSA_VERIFY`) && `CONFIG_MBEDTLS_ECP_C`

**CONFIG\_MBEDTLS\_ECP\_DP\_BP384R1\_ENABLED**

Enable BP384R1 curve

*Found in: Component config > mbedTLS*

support for DP Elliptic Curve.

**Default value:**

- Yes (enabled) if (`CONFIG_MBEDTLS_ATCA_HW_ECDSA_SIGN` || `CONFIG_MBEDTLS_ATCA_HW_ECDSA_VERIFY`) && `CONFIG_MBEDTLS_ECP_C`

**CONFIG\_MBEDTLS\_ECP\_DP\_BP512R1\_ENABLED**

Enable BP512R1 curve

*Found in: Component config > mbedTLS*

support for DP Elliptic Curve.

**Default value:**

- Yes (enabled) if (`CONFIG_MBEDTLS_ATCA_HW_ECDSA_SIGN` || `CONFIG_MBEDTLS_ATCA_HW_ECDSA_VERIFY`) && `CONFIG_MBEDTLS_ECP_C`

**CONFIG\_MBEDTLS\_ECP\_DP\_CURVE25519\_ENABLED**

Enable CURVE25519 curve

*Found in: Component config > mbedTLS*

Enable support for CURVE25519 Elliptic Curve.

**Default value:**

- Yes (enabled) if (`CONFIG_MBEDTLS_ATCA_HW_ECDSA_SIGN` || `CONFIG_MBEDTLS_ATCA_HW_ECDSA_VERIFY`) && `CONFIG_MBEDTLS_ECP_C`

### CONFIG\_MBEDTLS\_ECP\_NIST\_OPTIM

NIST ‘modulo p’ optimisations

*Found in: [Component config](#) > [mbedtls](#)*

NIST ‘modulo p’ optimisations increase Elliptic Curve operation performance.

Disabling this option saves some code size.

**Default value:**

- Yes (enabled)

### CONFIG\_MBEDTLS\_ECP\_FIXED\_POINT\_OPTIM

Enable fixed-point multiplication optimisations

*Found in: [Component config](#) > [mbedtls](#)*

This configuration option enables optimizations to speedup (about 3 ~ 4 times) the ECP fixed point multiplication using pre-computed tables in the flash memory. Disabling this configuration option saves flash footprint (about 29KB if all Elliptic Curve selected) in the application binary.

# end of Elliptic Curve options

**Default value:**

- Yes (enabled)

### CONFIG\_MBEDTLS\_POLY1305\_C

Poly1305 MAC algorithm

*Found in: [Component config](#) > [mbedtls](#)*

Enable support for Poly1305 MAC algorithm.

**Default value:**

- No (disabled)

### CONFIG\_MBEDTLS\_CHACHA20\_C

Chacha20 stream cipher

*Found in: [Component config](#) > [mbedtls](#)*

Enable support for Chacha20 stream cipher.

**Default value:**

- No (disabled)

### CONFIG\_MBEDTLS\_CHACHAPOLY\_C

ChaCha20-Poly1305 AEAD algorithm

*Found in: [Component config](#) > [mbedtls](#) > [CONFIG\\_MBEDTLS\\_CHACHA20\\_C](#)*

Enable support for ChaCha20-Poly1305 AEAD algorithm.

**Default value:**

- No (disabled) if [CONFIG\\_MBEDTLS\\_CHACHA20\\_C](#) && [CONFIG\\_MBEDTLS\\_POLY1305\\_C](#)

### CONFIG\_MBEDTLS\_HKDF\_C

HKDF algorithm (RFC 5869)

*Found in:* [Component config > mbedTLS](#)

Enable support for the Hashed Message Authentication Code (HMAC)-based key derivation function (HKDF).

**Default value:**

- No (disabled)

### CONFIG\_MBEDTLS\_THREADING\_C

Enable the threading abstraction layer

*Found in:* [Component config > mbedTLS](#)

If you do intend to use contexts between threads, you will need to enable this layer to prevent race conditions.

**Default value:**

- No (disabled)

### CONFIG\_MBEDTLS\_THREADING\_ALT

Enable threading alternate implementation

*Found in:* [Component config > mbedTLS > CONFIG\\_MBEDTLS\\_THREADING\\_C](#)

Enable threading alt to allow your own alternate threading implementation.

**Default value:**

- Yes (enabled) if [CONFIG\\_MBEDTLS\\_THREADING\\_C](#)

### CONFIG\_MBEDTLS\_THREADING\_PTHREAD

Enable threading pthread implementation

*Found in:* [Component config > mbedTLS > CONFIG\\_MBEDTLS\\_THREADING\\_C](#)

Enable the pthread wrapper layer for the threading layer.

**Default value:**

- No (disabled) if [CONFIG\\_MBEDTLS\\_THREADING\\_C](#)

### CONFIG\_MBEDTLS\_LARGE\_KEY\_SOFTWARE\_MPI

Fallback to software implementation for larger MPI values

*Found in:* [Component config > mbedTLS](#)

Fallback to software implementation for RSA key lengths larger than SOC\_RSA\_MAX\_BIT\_LEN. If this is not active then the ESP will be unable to process keys greater than SOC\_RSA\_MAX\_BIT\_LEN.

**Default value:**

- No (disabled)

### CONFIG\_MBEDTLS\_USE\_CRYPTO\_ROM\_IMPL

Use ROM implementation of the crypto algorithm

*Found in:* [Component config > mbedTLS](#)

Enable this flag to use mbedtls crypto algorithm from ROM instead of ESP-IDF.

This configuration option saves flash footprint in the application binary. Note that the version of mbedtls crypto algorithm library in ROM is v2.16.12. We have done the security analysis of the mbedtls revision in ROM (v2.16.12) and ensured that affected symbols have been patched (removed). If in the future mbedtls revisions there are security issues that also affects the version in ROM (v2.16.12) then we shall patch the relevant symbols. This would increase the flash footprint and hence care must be taken to keep some reserved space for the application binary in flash layout.

**Default value:**

- No (disabled) if ESP\_ROM\_HAS\_MBEDTLS\_CRYPTOLIB

**ESP-MQTT Configurations** Contains:

- [CONFIG\\_MQTT\\_CUSTOM\\_OUTBOX](#)
- [CONFIG\\_MQTT\\_TRANSPORT\\_SSL](#)
- [CONFIG\\_MQTT\\_TRANSPORT\\_WEBSOCKET](#)
- [CONFIG\\_MQTT\\_PROTOCOL\\_311](#)
- [CONFIG\\_MQTT\\_PROTOCOL\\_5](#)
- [CONFIG\\_MQTT\\_TASK\\_CORE\\_SELECTION\\_ENABLED](#)
- [CONFIG\\_MQTT\\_USE\\_CUSTOM\\_CONFIG](#)
- [CONFIG\\_MQTT\\_OUTBOX\\_EXPIRED\\_TIMEOUT\\_MS](#)
- [CONFIG\\_MQTT\\_REPORT\\_DELETED\\_MESSAGES](#)
- [CONFIG\\_MQTT\\_SKIP\\_PUBLISH\\_IF\\_DISCONNECTED](#)
- [CONFIG\\_MQTT\\_MSG\\_ID\\_INCREMENTAL](#)

**CONFIG\_MQTT\_PROTOCOL\_311**

Enable MQTT protocol 3.1.1

*Found in: [Component config](#) > [ESP-MQTT Configurations](#)*

If not, this library will use MQTT protocol 3.1

**Default value:**

- Yes (enabled)

**CONFIG\_MQTT\_PROTOCOL\_5**

Enable MQTT protocol 5.0

*Found in: [Component config](#) > [ESP-MQTT Configurations](#)*

If not, this library will not support MQTT 5.0

**Default value:**

- No (disabled)

**CONFIG\_MQTT\_TRANSPORT\_SSL**

Enable MQTT over SSL

*Found in: [Component config](#) > [ESP-MQTT Configurations](#)*

Enable MQTT transport over SSL with mbedtls

**Default value:**

- Yes (enabled)

**CONFIG\_MQTT\_TRANSPORT\_WEBSOCKET**

Enable MQTT over Websocket

*Found in: [Component config](#) > [ESP-MQTT Configurations](#)*

Enable MQTT transport over Websocket.

**Default value:**

- Yes (enabled)

### **CONFIG\_MQTT\_TRANSPORT\_WEBSOCKET\_SECURE**

Enable MQTT over Websocket Secure

*Found in: [Component config](#) > [ESP-MQTT Configurations](#) > [CONFIG\\_MQTT\\_TRANSPORT\\_WEBSOCKET\\_SECURE](#)*

Enable MQTT transport over Websocket Secure.

**Default value:**

- Yes (enabled)

### **CONFIG\_MQTT\_MSG\_ID\_INCREMENTAL**

Use Incremental Message Id

*Found in: [Component config](#) > [ESP-MQTT Configurations](#)*

Set this to true for the message id (2.3.1 Packet Identifier) to be generated as an incremental number rather than a random value (used by default)

**Default value:**

- No (disabled)

### **CONFIG\_MQTT\_SKIP\_PUBLISH\_IF\_DISCONNECTED**

Skip publish if disconnected

*Found in: [Component config](#) > [ESP-MQTT Configurations](#)*

Set this to true to avoid publishing (enqueueing messages) if the client is disconnected. The MQTT client tries to publish all messages by default, even in the disconnected state (where the qos1 and qos2 packets are stored in the internal outbox to be published later) The MQTT\_SKIP\_PUBLISH\_IF\_DISCONNECTED option allows applications to override this behaviour and not enqueue publish packets in the disconnected state.

**Default value:**

- No (disabled)

### **CONFIG\_MQTT\_REPORT\_DELETED\_MESSAGES**

Report deleted messages

*Found in: [Component config](#) > [ESP-MQTT Configurations](#)*

Set this to true to post events for all messages which were deleted from the outbox before being correctly sent and confirmed.

**Default value:**

- No (disabled)

### CONFIG\_MQTT\_USE\_CUSTOM\_CONFIG

MQTT Using custom configurations

*Found in: [Component config](#) > [ESP-MQTT Configurations](#)*

Custom MQTT configurations.

**Default value:**

- No (disabled)

### CONFIG\_MQTT\_TCP\_DEFAULT\_PORT

Default MQTT over TCP port

*Found in: [Component config](#) > [ESP-MQTT Configurations](#) > [CONFIG\\_MQTT\\_USE\\_CUSTOM\\_CONFIG](#)*

Default MQTT over TCP port

**Default value:**

- 1883 if [CONFIG\\_MQTT\\_USE\\_CUSTOM\\_CONFIG](#)

### CONFIG\_MQTT\_SSL\_DEFAULT\_PORT

Default MQTT over SSL port

*Found in: [Component config](#) > [ESP-MQTT Configurations](#) > [CONFIG\\_MQTT\\_USE\\_CUSTOM\\_CONFIG](#)*

Default MQTT over SSL port

**Default value:**

- 8883 if [CONFIG\\_MQTT\\_USE\\_CUSTOM\\_CONFIG](#) && [CONFIG\\_MQTT\\_TRANSPORT\\_SSL](#)

### CONFIG\_MQTT\_WS\_DEFAULT\_PORT

Default MQTT over Websocket port

*Found in: [Component config](#) > [ESP-MQTT Configurations](#) > [CONFIG\\_MQTT\\_USE\\_CUSTOM\\_CONFIG](#)*

Default MQTT over Websocket port

**Default value:**

- 80 if [CONFIG\\_MQTT\\_USE\\_CUSTOM\\_CONFIG](#) && [CONFIG\\_MQTT\\_TRANSPORT\\_WEBSOCKET](#)

### CONFIG\_MQTT\_WSS\_DEFAULT\_PORT

Default MQTT over Websocket Secure port

*Found in: [Component config](#) > [ESP-MQTT Configurations](#) > [CONFIG\\_MQTT\\_USE\\_CUSTOM\\_CONFIG](#)*

Default MQTT over Websocket Secure port

**Default value:**

- 443 if [CONFIG\\_MQTT\\_USE\\_CUSTOM\\_CONFIG](#) && [CONFIG\\_MQTT\\_TRANSPORT\\_WEBSOCKET](#) && [CONFIG\\_MQTT\\_TRANSPORT\\_WEBSOCKET\\_SECURE](#)

### CONFIG\_MQTT\_BUFFER\_SIZE

Default MQTT Buffer Size

*Found in: [Component config](#) > [ESP-MQTT Configurations](#) > [CONFIG\\_MQTT\\_USE\\_CUSTOM\\_CONFIG](#)*

This buffer size using for both transmit and receive

**Default value:**

- 1024 if [CONFIG\\_MQTT\\_USE\\_CUSTOM\\_CONFIG](#)

### CONFIG\_MQTT\_TASK\_STACK\_SIZE

MQTT task stack size

*Found in:* [Component config](#) > [ESP-MQTT Configurations](#) > [CONFIG\\_MQTT\\_USE\\_CUSTOM\\_CONFIG](#)

MQTT task stack size

**Default value:**

- 6144 if [CONFIG\\_MQTT\\_USE\\_CUSTOM\\_CONFIG](#)

### CONFIG\_MQTT\_DISABLE\_API\_LOCKS

Disable API locks

*Found in:* [Component config](#) > [ESP-MQTT Configurations](#) > [CONFIG\\_MQTT\\_USE\\_CUSTOM\\_CONFIG](#)

Default config employs API locks to protect internal structures. It is possible to disable these locks if the user code doesn't access MQTT API from multiple concurrent tasks

**Default value:**

- No (disabled) if [CONFIG\\_MQTT\\_USE\\_CUSTOM\\_CONFIG](#)

### CONFIG\_MQTT\_TASK\_PRIORITY

MQTT task priority

*Found in:* [Component config](#) > [ESP-MQTT Configurations](#) > [CONFIG\\_MQTT\\_USE\\_CUSTOM\\_CONFIG](#)

MQTT task priority. Higher number denotes higher priority.

**Default value:**

- 5 if [CONFIG\\_MQTT\\_USE\\_CUSTOM\\_CONFIG](#)

### CONFIG\_MQTT\_TASK\_CORE\_SELECTION\_ENABLED

Enable MQTT task core selection

*Found in:* [Component config](#) > [ESP-MQTT Configurations](#)

This will enable core selection

### CONFIG\_MQTT\_TASK\_CORE\_SELECTION

Core to use ?

*Found in:* [Component config](#) > [ESP-MQTT Configurations](#) > [CONFIG\\_MQTT\\_TASK\\_CORE\\_SELECTION\\_ENABLED](#)

**Available options:**

- Core 0 (MQTT\_USE\_CORE\_0)
- Core 1 (MQTT\_USE\_CORE\_1)

### CONFIG\_MQTT\_CUSTOM\_OUTBOX

Enable custom outbox implementation

*Found in:* [Component config](#) > [ESP-MQTT Configurations](#)

Set to true if a specific implementation of message outbox is needed (e.g. persistent outbox in NVM or similar). Note: Implementation of the custom outbox must be added to the mqtt component. These CMake commands could be used to append the custom implementation to lib-mqtt sources: `idf_component_get_property(mqtt mqtt COMPONENT_LIB) set_property(TARGET ${mqtt} PROPERTY SOURCES ${PROJECT_DIR}/custom_outbox.c APPEND)`

**Default value:**

- No (disabled)

### CONFIG\_MQTT\_OUTBOX\_EXPIRED\_TIMEOUT\_MS

Outbox message expired timeout[ms]

*Found in: [Component config > ESP-MQTT Configurations](#)*

Messages which stays in the outbox longer than this value before being published will be discarded.

**Default value:**

- 30000 if [CONFIG\\_MQTT\\_USE\\_CUSTOM\\_CONFIG](#)

**Newlib** Contains:

- [CONFIG\\_NEWLIB\\_NANO\\_FORMAT](#)
- [CONFIG\\_NEWLIB\\_STDIN\\_LINE\\_ENDING](#)
- [CONFIG\\_NEWLIB\\_STDOUT\\_LINE\\_ENDING](#)
- [CONFIG\\_NEWLIB\\_TIME\\_SYSCALL](#)

### CONFIG\_NEWLIB\_STDOUT\_LINE\_ENDING

Line ending for UART output

*Found in: [Component config > Newlib](#)*

This option allows configuring the desired line endings sent to UART when a newline ( ' n ' , LF) appears on stdout. Three options are possible:

CRLF: whenever LF is encountered, prepend it with CR

LF: no modification is applied, stdout is sent as is

CR: each occurrence of LF is replaced with CR

This option doesn't affect behavior of the UART driver (drivers/uart.h).

**Available options:**

- CRLF (NEWLIB\_STDOUT\_LINE\_ENDING\_CRLF)
- LF (NEWLIB\_STDOUT\_LINE\_ENDING\_LF)
- CR (NEWLIB\_STDOUT\_LINE\_ENDING\_CR)

### CONFIG\_NEWLIB\_STDIN\_LINE\_ENDING

Line ending for UART input

*Found in: [Component config > Newlib](#)*

This option allows configuring which input sequence on UART produces a newline ( ' n ' , LF) on stdin. Three options are possible:

CRLF: CRLF is converted to LF

LF: no modification is applied, input is sent to stdin as is

CR: each occurrence of CR is replaced with LF

This option doesn't affect behavior of the UART driver (drivers/uart.h).

**Available options:**

- CRLF (NEWLIB\_STDIN\_LINE\_ENDING\_CRLF)
- LF (NEWLIB\_STDIN\_LINE\_ENDING\_LF)
- CR (NEWLIB\_STDIN\_LINE\_ENDING\_CR)



## CONFIG\_NEWLIB\_NANO\_FORMAT

Enable ‘nano’ formatting options for printf/scanf family

*Found in: [Component config](#) > [Newlib](#)*

ESP32 ROM contains parts of newlib C library, including printf/scanf family of functions. These functions have been compiled with so-called “nano” formatting option. This option doesn’t support 64-bit integer formats and C99 features, such as positional arguments.

For more details about “nano” formatting option, please see newlib readme file, search for ‘enable-newlib-nano-formatted-io’ : <https://sourceware.org/newlib/README>

If this option is enabled, build system will use functions available in ROM, reducing the application binary size. Functions available in ROM run faster than functions which run from flash. Functions available in ROM can also run when flash instruction cache is disabled.

If you need 64-bit integer formatting support or C99 features, keep this option disabled.

## CONFIG\_NEWLIB\_TIME\_SYSCALL

Timers used for gettimeofday function

*Found in: [Component config](#) > [Newlib](#)*

This setting defines which hardware timers are used to implement ‘gettimeofday’ and ‘time’ functions in C library.

- **If both high-resolution (systimer for all targets except ESP32) and RTC timers are used,** timekeeping will continue in deep sleep. Time will be reported at 1 microsecond resolution. This is the default, and the recommended option.
- **If only high-resolution timer (systimer) is used, gettimeofday will** provide time at microsecond resolution. Time will not be preserved when going into deep sleep mode.
- **If only RTC timer is used, timekeeping will continue in** deep sleep, but time will be measured at 6.(6) microsecond resolution. Also the gettimeofday function itself may take longer to run.
- **If no timers are used, gettimeofday and time functions** return -1 and set errno to ENOSYS.
- **When RTC is used for timekeeping, two RTC\_STORE registers are** used to keep time in deep sleep mode.

**Available options:**

- RTC and high-resolution timer (NEWLIB\_TIME\_SYSCALL\_USE\_RTC\_HRT)
- RTC (NEWLIB\_TIME\_SYSCALL\_USE\_RTC)
- High-resolution timer (NEWLIB\_TIME\_SYSCALL\_USE\_HRT)
- None (NEWLIB\_TIME\_SYSCALL\_USE\_NONE)

**NVS** Contains:

- [CONFIG\\_NVS\\_ENCRYPTION](#)
- [CONFIG\\_NVS\\_COMPATIBLE\\_PRE\\_V4\\_3\\_ENCRYPTION\\_FLAG](#)
- [CONFIG\\_NVS\\_ASSERT\\_ERROR\\_CHECK](#)

## CONFIG\_NVS\_ENCRYPTION

Enable NVS encryption

*Found in: [Component config](#) > [NVS](#)*

This option enables encryption for NVS. When enabled, AES-XTS is used to encrypt the complete NVS data, except the page headers. It requires XTS encryption keys to be stored in an encrypted partition. This means enabling flash encryption is a pre-requisite for this feature.

**Default value:**

- Yes (enabled) if [CONFIG\\_SECURE\\_FLASH\\_ENC\\_ENABLED](#)

### CONFIG\_NVS\_COMPATIBLE\_PRE\_V4\_3\_ENCRYPTION\_FLAG

NVS partition encrypted flag compatible with ESP-IDF before v4.3

*Found in: [Component config](#) > [NVS](#)*

Enabling this will ignore “encrypted” flag for NVS partitions. NVS encryption scheme is different than hardware flash encryption and hence it is not recommended to have “encrypted” flag for NVS partitions. This was not being checked in pre v4.3 IDF. Hence, if you have any devices where this flag is kept enabled in partition table then enabling this config will allow to have same behavior as pre v4.3 IDF.

### CONFIG\_NVS\_ASSERT\_ERROR\_CHECK

Use assertions for error checking

*Found in: [Component config](#) > [NVS](#)*

This option switches error checking type between assertions (y) or return codes (n).

**Default value:**

- No (disabled)

**OpenThread** Contains:

- [CONFIG\\_OPENTHREAD\\_ENABLED](#)

### CONFIG\_OPENTHREAD\_ENABLED

OpenThread

*Found in: [Component config](#) > [OpenThread](#)*

Select this option to enable OpenThread and show the submenu with OpenThread configuration choices.

**Default value:**

- No (disabled)

### CONFIG\_OPENTHREAD\_LOG\_LEVEL\_DYNAMIC

Enable dynamic log level control

*Found in: [Component config](#) > [OpenThread](#) > [CONFIG\\_OPENTHREAD\\_ENABLED](#)*

Select this option to enable dynamic log level control for OpenThread

**Default value:**

- Yes (enabled) if [CONFIG\\_OPENTHREAD\\_ENABLED](#)

### CONFIG\_OPENTHREAD\_LOG\_LEVEL

OpenThread log verbosity

*Found in: [Component config](#) > [OpenThread](#) > [CONFIG\\_OPENTHREAD\\_ENABLED](#)*

Select OpenThread log level.

**Available options:**

- No logs (OPENTHREAD\_LOG\_LEVEL\_NONE)
- Error logs (OPENTHREAD\_LOG\_LEVEL\_CRIT)
- Warning logs (OPENTHREAD\_LOG\_LEVEL\_WARN)
- Notice logs (OPENTHREAD\_LOG\_LEVEL\_NOTE)
- Info logs (OPENTHREAD\_LOG\_LEVEL\_INFO)
- Debug logs (OPENTHREAD\_LOG\_LEVEL\_DEBUG)

## CONFIG\_OPENTHREAD\_RADIO\_TYPE

Config the Thread radio type

*Found in: [Component config](#) > [OpenThread](#) > [CONFIG\\_OPENTHREAD\\_ENABLED](#)*

Configure how OpenThread connects to the 15.4 radio

### Available options:

- Native 15.4 radio (OPENTHREAD\_RADIO\_NATIVE)  
Select this to use the native 15.4 radio.
- Connect via UART (OPENTHREAD\_RADIO\_SPINEL\_UART)  
Select this to connect to a Radio Co-Processor via UART.

## CONFIG\_OPENTHREAD\_DEVICE\_TYPE

Config the Thread device type

*Found in: [Component config](#) > [OpenThread](#) > [CONFIG\\_OPENTHREAD\\_ENABLED](#)*

OpenThread can be configured to different device types (FTD, MTD, Radio)

### Available options:

- Full Thread Device (OPENTHREAD\_FTD)  
Select this to enable Full Thread Device which can act as router and leader in a Thread network.
- Minimal Thread Device (OPENTHREAD\_MTD)  
Select this to enable Minimal Thread Device which can only act as end device in a Thread network. This will reduce the code size of the OpenThread stack.
- Radio Only Device (OPENTHREAD\_RADIO)  
Select this to enable Radio Only Device which can only forward 15.4 packets to the host. The OpenThread stack will be run on the host and OpenThread will have minimal footprint on the radio only device.

## CONFIG\_OPENTHREAD\_CLI

Enable Openthread Command-Line Interface

*Found in: [Component config](#) > [OpenThread](#) > [CONFIG\\_OPENTHREAD\\_ENABLED](#)*

Select this option to enable Command-Line Interface in OpenThread.

### Default value:

- Yes (enabled) if [CONFIG\\_OPENTHREAD\\_ENABLED](#)

## CONFIG\_OPENTHREAD\_DIAG

Enable diag

*Found in: [Component config](#) > [OpenThread](#) > [CONFIG\\_OPENTHREAD\\_ENABLED](#)*

Select this option to enable Diag in OpenThread. This will enable diag mode and a series of diag commands in the OpenThread command line. These commands allow users to manipulate low-level features of the storage and 15.4 radio.

### Default value:

- Yes (enabled) if [CONFIG\\_OPENTHREAD\\_ENABLED](#)

## CONFIG\_OPENTHREAD\_COMMISSIONER

Enable Commissioner

*Found in: [Component config](#) > [OpenThread](#) > [CONFIG\\_OPENTHREAD\\_ENABLED](#)*

Select this option to enable commissioner in OpenThread. This will enable the device to act as a commissioner in the Thread network. A commissioner checks the pre-shared key from a joining device with the Thread commissioning protocol and shares the network parameter with the joining device upon success.

**Default value:**

- No (disabled) if *CONFIG\_OPENTHREAD\_ENABLED*

**CONFIG\_OPENTHREAD\_JOINER**

Enable Joiner

*Found in: Component config > OpenThread > CONFIG\_OPENTHREAD\_ENABLED*

Select this option to enable Joiner in OpenThread. This allows a device to join the Thread network with a pre-shared key using the Thread commissioning protocol.

**Default value:**

- No (disabled) if *CONFIG\_OPENTHREAD\_ENABLED*

**CONFIG\_OPENTHREAD\_SRP\_CLIENT**

Enable SRP Client

*Found in: Component config > OpenThread > CONFIG\_OPENTHREAD\_ENABLED*

Select this option to enable SRP Client in OpenThread. This allows a device to register SRP services to SRP Server.

**Default value:**

- No (disabled) if *CONFIG\_OPENTHREAD\_ENABLED*

**CONFIG\_OPENTHREAD\_BORDER\_ROUTER**

Enable Border Router

*Found in: Component config > OpenThread > CONFIG\_OPENTHREAD\_ENABLED*

Select this option to enable border router features in OpenThread.

**Default value:**

- No (disabled) if *CONFIG\_OPENTHREAD\_ENABLED*

**CONFIG\_OPENTHREAD\_NUM\_MESSAGE\_BUFFERS**

The number of openthread message buffers

*Found in: Component config > OpenThread > CONFIG\_OPENTHREAD\_ENABLED*

**Range:**

- from 50 to 100 if *CONFIG\_OPENTHREAD\_ENABLED*

**Default value:**

- 65 if *CONFIG\_OPENTHREAD\_ENABLED*

**CONFIG\_OPENTHREAD\_DNS64\_CLIENT**

Use dns64 client

*Found in: Component config > OpenThread > CONFIG\_OPENTHREAD\_ENABLED*

Select this option to acquire NAT64 address from dns servers.

**Default value:**

- No (disabled) if *CONFIG\_OPENTHREAD\_ENABLED*

**Protocomm** Contains:

- [CONFIG\\_ESP\\_PROTOCOMM\\_SUPPORT\\_SECURITY\\_VERSION\\_0](#)
- [CONFIG\\_ESP\\_PROTOCOMM\\_SUPPORT\\_SECURITY\\_VERSION\\_1](#)
- [CONFIG\\_ESP\\_PROTOCOMM\\_SUPPORT\\_SECURITY\\_VERSION\\_2](#)

### **CONFIG\_ESP\_PROTOCOMM\_SUPPORT\_SECURITY\_VERSION\_0**

Support protocomm security version 0 (no security)

*Found in:* [Component config](#) > [Protocomm](#)

Enable support of security version 0. Disabling this option saves some code size. Consult the Enabling protocomm security version section of the Protocomm documentation in ESP-IDF Programming guide for more details.

**Default value:**

- Yes (enabled)

### **CONFIG\_ESP\_PROTOCOMM\_SUPPORT\_SECURITY\_VERSION\_1**

Support protocomm security version 1 (Curve25519 key exchange + AES-CTR encryption/decryption)

*Found in:* [Component config](#) > [Protocomm](#)

Enable support of security version 1. Disabling this option saves some code size. Consult the Enabling protocomm security version section of the Protocomm documentation in ESP-IDF Programming guide for more details.

**Default value:**

- Yes (enabled)

### **CONFIG\_ESP\_PROTOCOMM\_SUPPORT\_SECURITY\_VERSION\_2**

Support protocomm security version 2 (SRP6a-based key exchange + AES-GCM encryption/decryption)

*Found in:* [Component config](#) > [Protocomm](#)

Enable support of security version 2. Disabling this option saves some code size. Consult the Enabling protocomm security version section of the Protocomm documentation in ESP-IDF Programming guide for more details.

**Default value:**

- Yes (enabled)

**PThreads** Contains:

- [CONFIG\\_PTHREAD\\_TASK\\_NAME\\_DEFAULT](#)
- [CONFIG\\_PTHREAD\\_TASK\\_CORE\\_DEFAULT](#)
- [CONFIG\\_PTHREAD\\_TASK\\_PRIO\\_DEFAULT](#)
- [CONFIG\\_PTHREAD\\_TASK\\_STACK\\_SIZE\\_DEFAULT](#)
- [CONFIG\\_PTHREAD\\_STACK\\_MIN](#)

### **CONFIG\_PTHREAD\_TASK\_PRIO\_DEFAULT**

Default task priority

*Found in:* [Component config](#) > [PThreads](#)

Priority used to create new tasks with default pthread parameters.

**Range:**

- from 0 to 255

**Default value:**

- 5

### **CONFIG\_PTHREAD\_TASK\_STACK\_SIZE\_DEFAULT**

Default task stack size

*Found in: [Component config](#) > [PThreads](#)*

Stack size used to create new tasks with default pthread parameters.

**Default value:**

- 3072

### **CONFIG\_PTHREAD\_STACK\_MIN**

Minimum allowed pthread stack size

*Found in: [Component config](#) > [PThreads](#)*

Minimum allowed pthread stack size set in attributes passed to pthread\_create

**Default value:**

- 768

### **CONFIG\_PTHREAD\_TASK\_CORE\_DEFAULT**

Default pthread core affinity

*Found in: [Component config](#) > [PThreads](#)*

The default core to which pthreads are pinned.

**Available options:**

- No affinity (PTHREAD\_DEFAULT\_CORE\_NO\_AFFINITY)
- Core 0 (PTHREAD\_DEFAULT\_CORE\_0)
- Core 1 (PTHREAD\_DEFAULT\_CORE\_1)

### **CONFIG\_PTHREAD\_TASK\_NAME\_DEFAULT**

Default name of pthreads

*Found in: [Component config](#) > [PThreads](#)*

The default name of pthreads.

**Default value:**

- “pthread”

**SoC Settings** Contains:

- [MMU Config](#)

### **MMU Config**

**Main Flash configuration** Contains:

- [Optional and Experimental Features \(READ DOCS FIRST\)](#)
- [SPI Flash behavior when brownout](#)

**SPI Flash behavior when brownout** Contains:

- [CONFIG\\_SPI\\_FLASH\\_BROWNOUT\\_RESET\\_XMC](#)

**CONFIG\_SPI\_FLASH\_BROWNOUT\_RESET\_XMC**

Enable sending reset when brownout for XMC flash chips

*Found in:* [Component config](#) > [Main Flash configuration](#) > [SPI Flash behavior when brownout](#)

When this option is selected, the patch will be enabled for XMC. Follow the recommended flow by XMC for better stability.

DO NOT DISABLE UNLESS YOU KNOW WHAT YOU ARE DOING.

**Default value:**

- Yes (enabled) if APP\_BUILD\_TYPE\_PURE\_RAM\_APP

**Optional and Experimental Features (READ DOCS FIRST)** Contains:

- [CONFIG\\_SPI\\_FLASH\\_HPM\\_DC](#)

**CONFIG\_SPI\_FLASH\_HPM\_DC**

Support HPM using DC (READ DOCS FIRST)

*Found in:* [Component config](#) > [Main Flash configuration](#) > [Optional and Experimental Features \(READ DOCS FIRST\)](#)

This feature needs your bootloader to be compiled DC-aware (BOOTLOADER\_FLASH\_DC\_AWARE=y). Otherwise the chip will not be able to boot after a reset.

**Available options:**

- Auto (Enable when bootloader support enabled (BOOTLOADER\_FLASH\_DC\_AWARE)) (SPI\_FLASH\_HPM\_DC\_AUTO)
- Disable (READ DOCS FIRST) (SPI\_FLASH\_HPM\_DC\_DISABLE)

**SPI Flash driver** Contains:

- [Auto-detect flash chips](#)
- [CONFIG\\_SPI\\_FLASH\\_BYPASS\\_BLOCK\\_ERASE](#)
- [CONFIG\\_SPI\\_FLASH\\_ENABLE\\_ENCRYPTED\\_READ\\_WRITE](#)
- [CONFIG\\_SPI\\_FLASH\\_ENABLE\\_COUNTERS](#)
- [CONFIG\\_SPI\\_FLASH\\_ROM\\_DRIVER\\_PATCH](#)
- [CONFIG\\_SPI\\_FLASH\\_YIELD\\_DURING\\_ERASE](#)
- [CONFIG\\_SPI\\_FLASH\\_CHECK\\_ERASE\\_TIMEOUT\\_DISABLED](#)
- [CONFIG\\_SPI\\_FLASH\\_WRITE\\_CHUNK\\_SIZE](#)
- [CONFIG\\_SPI\\_FLASH\\_OVERRIDE\\_CHIP\\_DRIVER\\_LIST](#)
- [CONFIG\\_SPI\\_FLASH\\_SIZE\\_OVERRIDE](#)
- [CONFIG\\_SPI\\_FLASH\\_VERIFY\\_WRITE](#)
- [CONFIG\\_SPI\\_FLASH\\_DANGEROUS\\_WRITE](#)

**CONFIG\_SPI\_FLASH\_VERIFY\_WRITE**

Verify SPI flash writes

*Found in:* [Component config](#) > [SPI Flash driver](#)

If this option is enabled, any time SPI flash is written then the data will be read back and verified. This can catch hardware problems with SPI flash, or flash which was not erased before verification.

**Default value:**

- No (disabled)

### CONFIG\_SPI\_FLASH\_LOG\_FAILED\_WRITE

Log errors if verification fails

*Found in: [Component config](#) > [SPI Flash driver](#) > [CONFIG\\_SPI\\_FLASH\\_VERIFY\\_WRITE](#)*

If this option is enabled, if SPI flash write verification fails then a log error line will be written with the address, expected & actual values. This can be useful when debugging hardware SPI flash problems.

**Default value:**

- No (disabled) if [CONFIG\\_SPI\\_FLASH\\_VERIFY\\_WRITE](#)

### CONFIG\_SPI\_FLASH\_WARN\_SETTING\_ZERO\_TO\_ONE

Log warning if writing zero bits to ones

*Found in: [Component config](#) > [SPI Flash driver](#) > [CONFIG\\_SPI\\_FLASH\\_VERIFY\\_WRITE](#)*

If this option is enabled, any SPI flash write which tries to set zero bits in the flash to ones will log a warning. Such writes will not result in the requested data appearing identically in flash once written, as SPI NOR flash can only set bits to one when an entire sector is erased. After erasing, individual bits can only be written from one to zero.

Note that some software (such as SPIFFS) which is aware of SPI NOR flash may write one bits as an optimisation, relying on the data in flash becoming a bitwise AND of the new data and any existing data. Such software will log spurious warnings if this option is enabled.

**Default value:**

- No (disabled) if [CONFIG\\_SPI\\_FLASH\\_VERIFY\\_WRITE](#)

### CONFIG\_SPI\_FLASH\_ENABLE\_COUNTERS

Enable operation counters

*Found in: [Component config](#) > [SPI Flash driver](#)*

This option enables the following APIs:

- `spi_flash_reset_counters`
- `spi_flash_dump_counters`
- `spi_flash_get_counters`

These APIs may be used to collect performance data for `spi_flash` APIs and to help understand behaviour of libraries which use SPI flash.

**Default value:**

- 0

### CONFIG\_SPI\_FLASH\_ROM\_DRIVER\_PATCH

Enable SPI flash ROM driver patched functions

*Found in: [Component config](#) > [SPI Flash driver](#)*

Enable this flag to use patched versions of SPI flash ROM driver functions. This option should be enabled, if any one of the following is true: (1) need to write to flash on ESP32-D2WD; (2) main SPI flash is connected to non-default pins; (3) main SPI flash chip is manufactured by ISSI.

**Default value:**

- Yes (enabled)



## CONFIG\_SPI\_FLASH\_DANGEROUS\_WRITE

Writing to dangerous flash regions

*Found in: [Component config](#) > [SPI Flash driver](#)*

SPI flash APIs can optionally abort or return a failure code if erasing or writing addresses that fall at the beginning of flash (covering the bootloader and partition table) or that overlap the app partition that contains the running app.

It is not recommended to ever write to these regions from an IDF app, and this check prevents logic errors or corrupted firmware memory from damaging these regions.

Note that this feature *\*does not\** check calls to the `esp_rom_XXX` SPI flash ROM functions. These functions should not be called directly from IDF applications.

### Available options:

- Aborts (`SPI_FLASH_DANGEROUS_WRITE_ABORTS`)
- Fails (`SPI_FLASH_DANGEROUS_WRITE_FAILS`)
- Allowed (`SPI_FLASH_DANGEROUS_WRITE_ALLOWED`)

## CONFIG\_SPI\_FLASH\_BYPASS\_BLOCK\_ERASE

Bypass a block erase and always do sector erase

*Found in: [Component config](#) > [SPI Flash driver](#)*

Some flash chips can have very high “max” erase times, especially for block erase (32KB or 64KB). This option allows to bypass “block erase” and always do sector erase commands. This will be much slower overall in most cases, but improves latency for other code to run.

### Default value:

- No (disabled)

## CONFIG\_SPI\_FLASH\_YIELD\_DURING\_ERASE

Enables yield operation during flash erase

*Found in: [Component config](#) > [SPI Flash driver](#)*

This allows to yield the CPUs between erase commands. Prevents starvation of other tasks. Please use this configuration together with `SPI_FLASH_ERASE_YIELD_DURATION_MS` and `SPI_FLASH_ERASE_YIELD_TICKS` after carefully checking flash datasheet to avoid a watchdog timeout. For more information, please check *SPI Flash API* reference documentation under section *OS Function*.

### Default value:

- Yes (enabled)

## CONFIG\_SPI\_FLASH\_ERASE\_YIELD\_DURATION\_MS

Duration of erasing to yield CPUs (ms)

*Found in: [Component config](#) > [SPI Flash driver](#) > [CONFIG\\_SPI\\_FLASH\\_YIELD\\_DURING\\_ERASE](#)*

If a duration of one erase command is large then it will yield CPUs after finishing a current command.

### Default value:

- 20

### CONFIG\_SPI\_FLASH\_ERASE\_YIELD\_TICKS

CPU release time (tick) for an erase operation

*Found in: [Component config](#) > [SPI Flash driver](#) > [CONFIG\\_SPI\\_FLASH\\_YIELD\\_DURING\\_ERASE](#)*

Defines how many ticks will be before returning to continue a erasing.

**Default value:**

- 1

### CONFIG\_SPI\_FLASH\_WRITE\_CHUNK\_SIZE

Flash write chunk size

*Found in: [Component config](#) > [SPI Flash driver](#)*

Flash write is broken down in terms of multiple (smaller) write operations. This configuration options helps to set individual write chunk size, smaller value here ensures that cache (and non-IRAM resident interrupts) remains disabled for shorter duration.

**Range:**

- from 256 to 8192

**Default value:**

- 8192

### CONFIG\_SPI\_FLASH\_SIZE\_OVERRIDE

Override flash size in bootloader header by ESPTOOLPY\_FLASHSIZE

*Found in: [Component config](#) > [SPI Flash driver](#)*

SPI Flash driver uses the flash size configured in bootloader header by default. Enable this option to override flash size with latest ESPTOOLPY\_FLASHSIZE value from the app header if the size in the bootloader header is incorrect.

**Default value:**

- No (disabled)

### CONFIG\_SPI\_FLASH\_CHECK\_ERASE\_TIMEOUT\_DISABLED

Flash timeout checkout disabled

*Found in: [Component config](#) > [SPI Flash driver](#)*

This option is helpful if you are using a flash chip whose timeout is quite large or unpredictable.

**Default value:**

- No (disabled)

### CONFIG\_SPI\_FLASH\_OVERRIDE\_CHIP\_DRIVER\_LIST

Override default chip driver list

*Found in: [Component config](#) > [SPI Flash driver](#)*

This option allows the chip driver list to be customized, instead of using the default list provided by ESP-IDF.

When this option is enabled, the default list is no longer compiled or linked. Instead, the *default\_registered\_chips* structure must be provided by the user.

See example: `custom_chip_driver` under `examples/storage` for more details.

**Default value:**

- No (disabled)

**Auto-detect flash chips** Contains:

- [CONFIG\\_SPI\\_FLASH\\_SUPPORT\\_BOYA\\_CHIP](#)
- [CONFIG\\_SPI\\_FLASH\\_SUPPORT\\_GD\\_CHIP](#)
- [CONFIG\\_SPI\\_FLASH\\_SUPPORT\\_ISSI\\_CHIP](#)
- [CONFIG\\_SPI\\_FLASH\\_SUPPORT\\_MXIC\\_CHIP](#)
- [CONFIG\\_SPI\\_FLASH\\_SUPPORT\\_TH\\_CHIP](#)
- [CONFIG\\_SPI\\_FLASH\\_SUPPORT\\_WINBOND\\_CHIP](#)

**CONFIG\_SPI\_FLASH\_SUPPORT\_ISSI\_CHIP**

ISSI

*Found in: Component config > SPI Flash driver > Auto-detect flash chips*

Enable this to support auto detection of ISSI chips if chip vendor not directly given by `chip\_drv` member of the chip struct. This adds support for variant chips, however will extend detecting time.

**Default value:**

- Yes (enabled)

**CONFIG\_SPI\_FLASH\_SUPPORT\_MXIC\_CHIP**

MXIC

*Found in: Component config > SPI Flash driver > Auto-detect flash chips*

Enable this to support auto detection of MXIC chips if chip vendor not directly given by `chip\_drv` member of the chip struct. This adds support for variant chips, however will extend detecting time.

**Default value:**

- Yes (enabled)

**CONFIG\_SPI\_FLASH\_SUPPORT\_GD\_CHIP**

GigaDevice

*Found in: Component config > SPI Flash driver > Auto-detect flash chips*

Enable this to support auto detection of GD (GigaDevice) chips if chip vendor not directly given by `chip\_drv` member of the chip struct. If you are using Wrover modules, please don't disable this, otherwise your flash may not work in 4-bit mode.

This adds support for variant chips, however will extend detecting time and image size. Note that the default chip driver supports the GD chips with product ID 60H.

**Default value:**

- Yes (enabled)

**CONFIG\_SPI\_FLASH\_SUPPORT\_WINBOND\_CHIP**

Winbond

*Found in: Component config > SPI Flash driver > Auto-detect flash chips*

Enable this to support auto detection of Winbond chips if chip vendor not directly given by `chip\_drv` member of the chip struct. This adds support for variant chips, however will extend detecting time.

**Default value:**

- Yes (enabled)

### CONFIG\_SPI\_FLASH\_SUPPORT\_BOYA\_CHIP

BOYA

*Found in: Component config > SPI Flash driver > Auto-detect flash chips*

Enable this to support auto detection of BOYA chips if chip vendor not directly given by `chip\_drv` member of the chip struct. This adds support for variant chips, however will extend detecting time.

**Default value:**

- Yes (enabled)

### CONFIG\_SPI\_FLASH\_SUPPORT\_TH\_CHIP

TH

*Found in: Component config > SPI Flash driver > Auto-detect flash chips*

Enable this to support auto detection of TH chips if chip vendor not directly given by `chip\_drv` member of the chip struct. This adds support for variant chips, however will extend detecting time.

**Default value:**

- Yes (enabled)

### CONFIG\_SPI\_FLASH\_ENABLE\_ENCRYPTED\_READ\_WRITE

Enable encrypted partition read/write operations

*Found in: Component config > SPI Flash driver*

This option enables flash read/write operations to encrypted partition/s. This option is kept enabled irrespective of state of flash encryption feature. However, in case application is not using flash encryption feature and is in need of some additional memory from IRAM region (~1KB) then this config can be disabled.

**Default value:**

- Yes (enabled)

### SPIFFS Configuration Contains:

- *Debug Configuration*
- *CONFIG\_SPIFFS\_USE\_MAGIC*
- *CONFIG\_SPIFFS\_GC\_STATS*
- *CONFIG\_SPIFFS\_PAGE\_CHECK*
- *CONFIG\_SPIFFS\_FOLLOW\_SYMLINKS*
- *CONFIG\_SPIFFS\_MAX\_PARTITIONS*
- *CONFIG\_SPIFFS\_USE\_MTIME*
- *CONFIG\_SPIFFS\_GC\_MAX\_RUNS*
- *CONFIG\_SPIFFS\_OBJ\_NAME\_LEN*
- *CONFIG\_SPIFFS\_META\_LENGTH*
- *SPIFFS Cache Configuration*
- *CONFIG\_SPIFFS\_PAGE\_SIZE*
- *CONFIG\_SPIFFS\_MTIME\_WIDE\_64\_BITS*

### CONFIG\_SPIFFS\_MAX\_PARTITIONS

Maximum Number of Partitions

*Found in: Component config > SPIFFS Configuration*

Define maximum number of partitions that can be mounted.

**Range:**

- from 1 to 10

**Default value:**

- 3

**SPIFFS Cache Configuration** Contains:

- [CONFIG\\_SPIFFS\\_CACHE](#)

**CONFIG\_SPIFFS\_CACHE**

Enable SPIFFS Cache

*Found in:* [Component config](#) > [SPIFFS Configuration](#) > [SPIFFS Cache Configuration](#)

Enables/disable memory read caching of nucleus file system operations.

**Default value:**

- Yes (enabled)

**CONFIG\_SPIFFS\_CACHE\_WR**

Enable SPIFFS Write Caching

*Found in:* [Component config](#) > [SPIFFS Configuration](#) > [SPIFFS Cache Configuration](#) > [CONFIG\\_SPIFFS\\_CACHE](#)

Enables memory write caching for file descriptors in hydrogen.

**Default value:**

- Yes (enabled)

**CONFIG\_SPIFFS\_CACHE\_STATS**

Enable SPIFFS Cache Statistics

*Found in:* [Component config](#) > [SPIFFS Configuration](#) > [SPIFFS Cache Configuration](#) > [CONFIG\\_SPIFFS\\_CACHE](#)

Enable/disable statistics on caching. Debug/test purpose only.

**Default value:**

- No (disabled)

**CONFIG\_SPIFFS\_PAGE\_CHECK**

Enable SPIFFS Page Check

*Found in:* [Component config](#) > [SPIFFS Configuration](#)

Always check header of each accessed page to ensure consistent state. If enabled it will increase number of reads from flash, especially if cache is disabled.

**Default value:**

- Yes (enabled)

**CONFIG\_SPIFFS\_GC\_MAX\_RUNS**

Set Maximum GC Runs

*Found in:* [Component config](#) > [SPIFFS Configuration](#)

Define maximum number of GC runs to perform to reach desired free pages.

**Range:**

- from 1 to 10000

**Default value:**

- 10

**CONFIG\_SPIFFS\_GC\_STATS**

Enable SPIFFS GC Statistics

*Found in: [Component config](#) > [SPIFFS Configuration](#)*

Enable/disable statistics on gc. Debug/test purpose only.

**Default value:**

- No (disabled)

**CONFIG\_SPIFFS\_PAGE\_SIZE**

SPIFFS logical page size

*Found in: [Component config](#) > [SPIFFS Configuration](#)*

Logical page size of SPIFFS partition, in bytes. Must be multiple of flash page size (which is usually 256 bytes). Larger page sizes reduce overhead when storing large files, and improve filesystem performance when reading large files. Smaller page sizes reduce overhead when storing small (< page size) files.

**Range:**

- from 256 to 1024

**Default value:**

- 256

**CONFIG\_SPIFFS\_OBJ\_NAME\_LEN**

Set SPIFFS Maximum Name Length

*Found in: [Component config](#) > [SPIFFS Configuration](#)*

Object name maximum length. Note that this length include the zero-termination character, meaning maximum string of characters can at most be SPIFFS\_OBJ\_NAME\_LEN - 1.

SPIFFS\_OBJ\_NAME\_LEN + SPIFFS\_META\_LENGTH should not exceed SPIFFS\_PAGE\_SIZE - 64.

**Range:**

- from 1 to 256

**Default value:**

- 32

**CONFIG\_SPIFFS\_FOLLOW\_SYMLINKS**

Enable symbolic links for image creation

*Found in: [Component config](#) > [SPIFFS Configuration](#)*

If this option is enabled, symbolic links are taken into account during partition image creation.

**Default value:**

- No (disabled)

**CONFIG\_SPIFFS\_USE\_MAGIC**

Enable SPIFFS Filesystem Magic

*Found in: [Component config](#) > [SPIFFS Configuration](#)*

Enable this to have an identifiable spiffs filesystem. This will look for a magic in all sectors to determine if this is a valid spiffs system or not at mount time.

**Default value:**

- Yes (enabled)

**CONFIG\_SPIFFS\_USE\_MAGIC\_LENGTH**

Enable SPIFFS Filesystem Length Magic

*Found in: [Component config](#) > [SPIFFS Configuration](#) > [CONFIG\\_SPIFFS\\_USE\\_MAGIC](#)*

If this option is enabled, the magic will also be dependent on the length of the filesystem. For example, a filesystem configured and formatted for 4 megabytes will not be accepted for mounting with a configuration defining the filesystem as 2 megabytes.

**Default value:**

- Yes (enabled)

**CONFIG\_SPIFFS\_META\_LENGTH**

Size of per-file metadata field

*Found in: [Component config](#) > [SPIFFS Configuration](#)*

This option sets the number of extra bytes stored in the file header. These bytes can be used in an application-specific manner. Set this to at least 4 bytes to enable support for saving file modification time.

`SPIFFS_OBJ_NAME_LEN + SPIFFS_META_LENGTH` should not exceed `SPIFFS_PAGE_SIZE - 64`.

**Default value:**

- 4

**CONFIG\_SPIFFS\_USE\_MTIME**

Save file modification time

*Found in: [Component config](#) > [SPIFFS Configuration](#)*

If enabled, then the first 4 bytes of per-file metadata will be used to store file modification time (mtime), accessible through `stat/fstat` functions. Modification time is updated when the file is opened.

**Default value:**

- Yes (enabled)

**CONFIG\_SPIFFS\_MTIME\_WIDE\_64\_BITS**

The time field occupies 64 bits in the image instead of 32 bits

*Found in: [Component config](#) > [SPIFFS Configuration](#)*

If this option is not set, the time field is 32 bits (up to 2106 year), otherwise it is 64 bits and make sure it matches `SPIFFS_META_LENGTH`. If the chip already has the spiffs image with the time field = 32 bits then this option cannot be applied in this case. Erase it first before using this option. To resolve the Y2K38 problem for the spiffs, use a toolchain with 64-bit `time_t` support.

**Default value:**

- No (disabled) if `CONFIG_SPIFFS_META_LENGTH`  $\geq$  8

**Debug Configuration** Contains:

- [CONFIG\\_SPIFFS\\_DBG](#)
- [CONFIG\\_SPIFFS\\_API\\_DBG](#)
- [CONFIG\\_SPIFFS\\_CACHE\\_DBG](#)
- [CONFIG\\_SPIFFS\\_CHECK\\_DBG](#)

- *CONFIG\_SPIFFS\_TEST\_VISUALISATION*
- *CONFIG\_SPIFFS\_GC\_DBG*

### **CONFIG\_SPIFFS\_DBG**

Enable general SPIFFS debug

*Found in: Component config > SPIFFS Configuration > Debug Configuration*

Enabling this option will print general debug messages to the console.

**Default value:**

- No (disabled)

### **CONFIG\_SPIFFS\_API\_DBG**

Enable SPIFFS API debug

*Found in: Component config > SPIFFS Configuration > Debug Configuration*

Enabling this option will print API debug messages to the console.

**Default value:**

- No (disabled)

### **CONFIG\_SPIFFS\_GC\_DBG**

Enable SPIFFS Garbage Cleaner debug

*Found in: Component config > SPIFFS Configuration > Debug Configuration*

Enabling this option will print GC debug messages to the console.

**Default value:**

- No (disabled)

### **CONFIG\_SPIFFS\_CACHE\_DBG**

Enable SPIFFS Cache debug

*Found in: Component config > SPIFFS Configuration > Debug Configuration*

Enabling this option will print cache debug messages to the console.

**Default value:**

- No (disabled)

### **CONFIG\_SPIFFS\_CHECK\_DBG**

Enable SPIFFS Filesystem Check debug

*Found in: Component config > SPIFFS Configuration > Debug Configuration*

Enabling this option will print Filesystem Check debug messages to the console.

**Default value:**

- No (disabled)



### CONFIG\_SPIFFS\_TEST\_VISUALISATION

Enable SPIFFS Filesystem Visualization

*Found in: [Component config](#) > [SPIFFS Configuration](#) > [Debug Configuration](#)*

Enable this option to enable SPIFFS\_vis function in the API.

**Default value:**

- No (disabled)

**TCP Transport** Contains:

- [Websocket](#)

**Websocket** Contains:

- [CONFIG\\_WS\\_TRANSPORT](#)

### CONFIG\_WS\_TRANSPORT

Enable Websocket Transport

*Found in: [Component config](#) > [TCP Transport](#) > [Websocket](#)*

Enable support for creating websocket transport.

**Default value:**

- Yes (enabled)

### CONFIG\_WS\_BUFFER\_SIZE

Websocket transport buffer size

*Found in: [Component config](#) > [TCP Transport](#) > [Websocket](#) > [CONFIG\\_WS\\_TRANSPORT](#)*

Size of the buffer used for constructing the HTTP Upgrade request during connect

**Default value:**

- 1024

### CONFIG\_WS\_DYNAMIC\_BUFFER

Using dynamic websocket transport buffer

*Found in: [Component config](#) > [TCP Transport](#) > [Websocket](#) > [CONFIG\\_WS\\_TRANSPORT](#)*

If enable this option, websocket transport buffer will be freed after connection succeed to save more heap.

**Default value:**

- No (disabled)

**Ultra Low Power (ULP) Co-processor** Contains:

- [CONFIG\\_ULP\\_COPROC\\_ENABLED](#)
- [ULP RISC-V Settings](#)

### CONFIG\_ULP\_COPROC\_ENABLED

Enable Ultra Low Power (ULP) Co-processor

*Found in:* [Component config](#) > [Ultra Low Power \(ULP\) Co-processor](#)

Enable this feature if you plan to use the ULP Co-processor. Once this option is enabled, further ULP co-processor configuration will appear in the menu.

**Default value:**

- No (disabled)

### CONFIG\_ULP\_COPROC\_TYPE

ULP Co-processor type

*Found in:* [Component config](#) > [Ultra Low Power \(ULP\) Co-processor](#) > [CONFIG\\_ULP\\_COPROC\\_ENABLED](#)

Choose the ULP Coprocessor type: ULP FSM (Finite State Machine) or ULP RISC-V. Please note that ESP32 only supports ULP FSM.

**Available options:**

- ULP FSM (Finite State Machine) (ULP\_COPROC\_TYPE\_FSM)
- ULP RISC-V (ULP\_COPROC\_TYPE\_RISCV)

### CONFIG\_ULP\_COPROC\_RESERVE\_MEM

RTC slow memory reserved for coprocessor

*Found in:* [Component config](#) > [Ultra Low Power \(ULP\) Co-processor](#) > [CONFIG\\_ULP\\_COPROC\\_ENABLED](#)

Bytes of memory to reserve for ULP Co-processor firmware & data. Data is reserved at the beginning of RTC slow memory.

**Range:**

- from 32 to 8176 if [CONFIG\\_ULP\\_COPROC\\_ENABLED](#)

**Default value:**

- 4096 if [CONFIG\\_ULP\\_COPROC\\_ENABLED](#)

### ULP RISC-V Settings

 Contains:

- [CONFIG\\_ULP\\_RISCV\\_UART\\_BAUDRATE](#)

### CONFIG\_ULP\_RISCV\_UART\_BAUDRATE

Baudrate used by the bitbanged ULP RISC-V UART driver

*Found in:* [Component config](#) > [Ultra Low Power \(ULP\) Co-processor](#) > [ULP RISC-V Settings](#)

The accuracy of the bitbanged UART driver is limited, it is not recommend to increase the value above 19200.

**Default value:**

- 9600 if ULP\_COPROC\_TYPE\_RISCV

### Unity unit testing library

 Contains:

- [CONFIG\\_UNITY\\_ENABLE\\_COLOR](#)
- [CONFIG\\_UNITY\\_ENABLE\\_IDF\\_TEST\\_RUNNER](#)
- [CONFIG\\_UNITY\\_ENABLE\\_FIXTURE](#)
- [CONFIG\\_UNITY\\_ENABLE\\_BACKTRACE\\_ON\\_FAIL](#)
- [CONFIG\\_UNITY\\_ENABLE\\_64BIT](#)

- [CONFIG\\_UNITY\\_ENABLE\\_DOUBLE](#)
- [CONFIG\\_UNITY\\_ENABLE\\_FLOAT](#)

### CONFIG\_UNITY\_ENABLE\_FLOAT

Support for float type

*Found in: [Component config](#) > [Unity unit testing library](#)*

If not set, assertions on float arguments will not be available.

**Default value:**

- Yes (enabled)

### CONFIG\_UNITY\_ENABLE\_DOUBLE

Support for double type

*Found in: [Component config](#) > [Unity unit testing library](#)*

If not set, assertions on double arguments will not be available.

**Default value:**

- Yes (enabled)

### CONFIG\_UNITY\_ENABLE\_64BIT

Support for 64-bit integer types

*Found in: [Component config](#) > [Unity unit testing library](#)*

If not set, assertions on 64-bit integer types will always fail. If this feature is enabled, take care not to pass pointers (which are 32 bit) to UNITY\_ASSERT\_EQUAL, as that will cause pointer-to-int-cast warnings.

**Default value:**

- No (disabled)

### CONFIG\_UNITY\_ENABLE\_COLOR

Colorize test output

*Found in: [Component config](#) > [Unity unit testing library](#)*

If set, Unity will colorize test results using console escape sequences.

**Default value:**

- No (disabled)

### CONFIG\_UNITY\_ENABLE\_IDF\_TEST\_RUNNER

Include ESP-IDF test registration/running helpers

*Found in: [Component config](#) > [Unity unit testing library](#)*

If set, then the following features will be available:

- TEST\_CASE macro which performs automatic registration of test functions
- Functions to run registered test functions: `unity_run_all_tests`, `unity_run_tests_with_filter`, `unity_run_single_test_by_name`.
- Interactive menu which lists test cases and allows choosing the tests to be run, available via `unity_run_menu` function.

Disable if a different test registration mechanism is used.

**Default value:**

- Yes (enabled)

### CONFIG\_UNITY\_ENABLE\_FIXTURE

Include Unity test fixture

*Found in: [Component config](#) > [Unity unit testing library](#)*

If set, unity\_fixture.h header file and associated source files are part of the build. These provide an optional set of macros and functions to implement test groups.

**Default value:**

- No (disabled)

### CONFIG\_UNITY\_ENABLE\_BACKTRACE\_ON\_FAIL

Print a backtrace when a unit test fails

*Found in: [Component config](#) > [Unity unit testing library](#)*

If set, the unity framework will print the backtrace information before jumping back to the test menu. The jumping is usually occurs in assert functions such as TEST\_ASSERT, TEST\_FAIL etc.

**Default value:**

- No (disabled)

### USB-OTG Contains:

- [CONFIG\\_USB\\_HOST\\_HW\\_BUFFER\\_BIAS](#)
- [CONFIG\\_USB\\_HOST\\_CONTROL\\_TRANSFER\\_MAX\\_SIZE](#)
- [Root Hub configuration](#)

### CONFIG\_USB\_HOST\_CONTROL\_TRANSFER\_MAX\_SIZE

Largest size (in bytes) of transfers to/from default endpoints

*Found in: [Component config](#) > [USB-OTG](#)*

Each USB device attached is allocated a dedicated buffer for its OUT/IN transfers to/from the device's control endpoint. The maximum size of that buffer is determined by this option. The limited size of the transfer buffer have the following implications: - The maximum length of control transfers is limited - Device's with configuration descriptors larger than this limit cannot be supported

**Default value:**

- 256

### CONFIG\_USB\_HOST\_HW\_BUFFER\_BIAS

Hardware FIFO size biasing

*Found in: [Component config](#) > [USB-OTG](#)*

The underlying hardware has size adjustable FIFOs to cache USB packets on reception (IN) or for transmission (OUT). The size of these FIFOs will affect the largest MPS (maximum packet size) and the maximum number of packets that can be cached at any one time. The hardware contains the following FIFOs: RX (for all IN packets), Non-periodic TX (for Bulk and Control OUT packets), and Periodic TX (for Interrupt and Isochronous OUT packets). This configuration option allows biasing the FIFO sizes towards a particular use case, which may be necessary for devices that have endpoints with large MPS. The MPS limits for each biasing are listed below:

Balanced: - IN (all transfer types), 408 bytes - OUT non-periodic (Bulk/Control), 192 bytes (i.e., 3 x 64 byte packets) - OUT periodic (Interrupt/Isochronous), 192 bytes

Bias IN: - IN (all transfer types), 600 bytes - OUT non-periodic (Bulk/Control), 64 bytes (i.e., 1 x 64 byte packets) - OUT periodic (Interrupt/Isochronous), 128 bytes

Bias Periodic OUT: - IN (all transfer types), 128 bytes - OUT non-periodic (Bulk/Control), 64 bytes (i.e., 1 x 64 byte packets) - OUT periodic (Interrupt/Isochronous), 600 bytes

**Available options:**

- Balanced (USB\_HOST\_HW\_BUFFER\_BIAS\_BALANCED)
- Bias IN (USB\_HOST\_HW\_BUFFER\_BIAS\_IN)
- Periodic OUT (USB\_HOST\_HW\_BUFFER\_BIAS\_PERIODIC\_OUT)

**Root Hub configuration** Contains:

- [CONFIG\\_USB\\_HOST\\_DEBOUNCE\\_DELAY\\_MS](#)
- [CONFIG\\_USB\\_HOST\\_RESET\\_HOLD\\_MS](#)
- [CONFIG\\_USB\\_HOST\\_RESET\\_RECOVERY\\_MS](#)
- [CONFIG\\_USB\\_HOST\\_SET\\_ADDR\\_RECOVERY\\_MS](#)

### **CONFIG\_USB\_HOST\_DEBOUNCE\_DELAY\_MS**

Debounce delay in ms

*Found in: [Component config](#) > [USB-OTG](#) > [Root Hub configuration](#)*

On connection of a USB device, the USB 2.0 specification requires a “debounce interval with a minimum duration of 100ms” to allow the connection to stabilize (see USB 2.0 chapter 7.1.7.3 for more details). During the debounce interval, no new connection/disconnection events are registered.

The default value is set to 250 ms to be safe.

**Default value:**

- 250

### **CONFIG\_USB\_HOST\_RESET\_HOLD\_MS**

Reset hold in ms

*Found in: [Component config](#) > [USB-OTG](#) > [Root Hub configuration](#)*

The reset signaling can be generated on any Hub or Host Controller port by request from the USB System Software. The USB 2.0 specification requires that “the reset signaling must be driven for a minimum of 10ms” (see USB 2.0 chapter 7.1.7.5 for more details). After the reset, the hub port will transition to the Enabled state (refer to Section 11.5).

The default value is set to 30 ms to be safe.

**Default value:**

- 30

### **CONFIG\_USB\_HOST\_RESET\_RECOVERY\_MS**

Reset recovery delay in ms

*Found in: [Component config](#) > [USB-OTG](#) > [Root Hub configuration](#)*

After a port stops driving the reset signal, the USB 2.0 specification requires that the “USB System Software guarantees a minimum of 10 ms for reset recovery” before the attached device is expected to respond to data transfers (see USB 2.0 chapter 7.1.7.3 for more details). The device may ignore any data transfers during the recovery interval.

The default value is set to 30 ms to be safe.

**Default value:**

- 30

## CONFIG\_USB\_HOST\_SET\_ADDR\_RECOVERY\_MS

SetAddress() recovery time in ms

*Found in: [Component config](#) > [USB-OTG](#) > [Root Hub configuration](#)*

“After successful completion of the Status stage, the device is allowed a SetAddress() recovery interval of 2 ms. At the end of this interval, the device must be able to accept Setup packets addressed to the new address. Also, at the end of the recovery interval, the device must not respond to tokens sent to the old address (unless, of course, the old and new address is the same).” See USB 2.0 chapter 9.2.6.3 for more details.

The default value is set to 10 ms to be safe.

### Default value:

- 10

**Virtual file system** Contains:

- [CONFIG\\_VFS\\_SUPPORT\\_IO](#)

## CONFIG\_VFS\_SUPPORT\_IO

Provide basic I/O functions

*Found in: [Component config](#) > [Virtual file system](#)*

If enabled, the following functions are provided by the VFS component.

open, close, read, write, pread, pwrite, lseek, fstat, fsync, ioctl, fcntl

Filesystem drivers can then be registered to handle these functions for specific paths.

Disabling this option can save memory when the support for these functions is not required.

Note that the following functions can still be used with socket file descriptors when this option is disabled:

close, read, write, ioctl, fcntl.

### Default value:

- Yes (enabled)

## CONFIG\_VFS\_SUPPORT\_DIR

Provide directory related functions

*Found in: [Component config](#) > [Virtual file system](#) > [CONFIG\\_VFS\\_SUPPORT\\_IO](#)*

If enabled, the following functions are provided by the VFS component.

stat, link, unlink, rename, utime, access, truncate, rmdir, mkdir, opendir, closedir, readdir, readdir\_r, seekdir, telldir, rewinddir

Filesystem drivers can then be registered to handle these functions for specific paths.

Disabling this option can save memory when the support for these functions is not required.

### Default value:

- Yes (enabled)

## CONFIG\_VFS\_SUPPORT\_SELECT

Provide select function

*Found in: [Component config](#) > [Virtual file system](#) > [CONFIG\\_VFS\\_SUPPORT\\_IO](#)*

If enabled, select function is provided by the VFS component, and can be used on peripheral file descriptors (such as UART) and sockets at the same time.

If disabled, the default select implementation will be provided by LWIP for sockets only.

Disabling this option can reduce code size if support for “select” on UART file descriptors is not required.

**Default value:**

- Yes (enabled) if `CONFIG_VFS_SUPPORT_IO` && `CONFIG_LWIP_USE_ONLY_LWIP_SELECT`

### **CONFIG\_VFS\_SUPPRESS\_SELECT\_DEBUG\_OUTPUT**

Suppress select() related debug outputs

*Found in:* `Component config` > `Virtual file system` > `CONFIG_VFS_SUPPORT_IO` > `CONFIG_VFS_SUPPORT_SELECT`

Select() related functions might produce an inconveniently lot of debug outputs when one sets the default log level to DEBUG or higher. It is possible to suppress these debug outputs by enabling this option.

**Default value:**

- Yes (enabled)

### **CONFIG\_VFS\_SUPPORT\_TERMIOS**

Provide termios.h functions

*Found in:* `Component config` > `Virtual file system` > `CONFIG_VFS_SUPPORT_IO`

Disabling this option can save memory when the support for termios.h is not required.

**Default value:**

- Yes (enabled)

### **Host File System I/O (Semihosting)** Contains:

- `CONFIG_VFS_SEMIHOSTFS_MAX_MOUNT_POINTS`

### **CONFIG\_VFS\_SEMIHOSTFS\_MAX\_MOUNT\_POINTS**

Host FS: Maximum number of the host filesystem mount points

*Found in:* `Component config` > `Virtual file system` > `CONFIG_VFS_SUPPORT_IO` > `Host File System I/O (Semihosting)`

Define maximum number of host filesystem mount points.

**Default value:**

- 1

### **Wear Levelling** Contains:

- `CONFIG_WL_SECTOR_MODE`
- `CONFIG_WL_SECTOR_SIZE`

### **CONFIG\_WL\_SECTOR\_SIZE**

Wear Levelling library sector size

*Found in:* `Component config` > `Wear Levelling`

Sector size used by wear levelling library. You can set default sector size or size that will fit to the flash device sector size.

With sector size set to 4096 bytes, wear levelling library is more efficient. However if FAT filesystem is used on top of wear levelling library, it will need more temporary storage: 4096 bytes for each mounted filesystem and 4096 bytes for each opened file.

With sector size set to 512 bytes, wear levelling library will perform more operations with flash memory, but less RAM will be used by FAT filesystem library (512 bytes for the filesystem and 512 bytes for each file opened).

**Available options:**

- 512 (WL\_SECTOR\_SIZE\_512)
- 4096 (WL\_SECTOR\_SIZE\_4096)

## CONFIG\_WL\_SECTOR\_MODE

Sector store mode

*Found in: Component config > Wear Levelling*

Specify the mode to store data into flash:

- In Performance mode a data will be stored to the RAM and then stored back to the flash. Compared to the Safety mode, this operation is faster, but if power will be lost when erase sector operation is in progress, then the data from complete flash device sector will be lost.
- In Safety mode data from complete flash device sector will be read from flash, modified, and then stored back to flash. Compared to the Performance mode, this operation is slower, but if power is lost during erase sector operation, then the data from full flash device sector will not be lost.

**Available options:**

- Performance (WL\_SECTOR\_MODE\_PERF)
- Safety (WL\_SECTOR\_MODE\_SAFE)

**Wi-Fi Provisioning Manager** Contains:

- *CONFIG\_WIFI\_PROV\_BLE\_BONDING*
- *CONFIG\_WIFI\_PROV\_BLE\_SEC\_CONN*
- *CONFIG\_WIFI\_PROV\_BLE\_FORCE\_ENCRYPTION*
- *CONFIG\_WIFI\_PROV\_KEEP\_BLE\_ON\_AFTER\_PROV*
- *CONFIG\_WIFI\_PROV\_SCAN\_MAX\_ENTRIES*
- *CONFIG\_WIFI\_PROV\_AUTOSTOP\_TIMEOUT*
- *CONFIG\_WIFI\_PROV\_STA\_SCAN\_METHOD*

## CONFIG\_WIFI\_PROV\_SCAN\_MAX\_ENTRIES

Max Wi-Fi Scan Result Entries

*Found in: Component config > Wi-Fi Provisioning Manager*

This sets the maximum number of entries of Wi-Fi scan results that will be kept by the provisioning manager

**Range:**

- from 1 to 255

**Default value:**

- 16

## CONFIG\_WIFI\_PROV\_AUTOSTOP\_TIMEOUT

Provisioning auto-stop timeout

*Found in: Component config > Wi-Fi Provisioning Manager*

Time (in seconds) after which the Wi-Fi provisioning manager will auto-stop after connecting to a Wi-Fi network successfully.



**Range:**

- from 5 to 600

**Default value:**

- 30

**CONFIG\_WIFI\_PROV\_BLE\_BONDING**

Enable BLE bonding

*Found in: [Component config](#) > [Wi-Fi Provisioning Manager](#)*

This option is applicable only when provisioning transport is BLE.

**CONFIG\_WIFI\_PROV\_BLE\_SEC\_CONN**

Enable BLE Secure connection flag

*Found in: [Component config](#) > [Wi-Fi Provisioning Manager](#)*

Used to enable Secure connection support when provisioning transport is BLE.

**Default value:**

- Yes (enabled) if `BT_NIMBLE_ENABLED`

**CONFIG\_WIFI\_PROV\_BLE\_FORCE\_ENCRYPTION**

Force Link Encryption during characteristic Read / Write

*Found in: [Component config](#) > [Wi-Fi Provisioning Manager](#)*

Used to enforce link encryption when attempting to read / write characteristic

**CONFIG\_WIFI\_PROV\_KEEP\_BLE\_ON\_AFTER\_PROV**

Keep BT on after provisioning is done

*Found in: [Component config](#) > [Wi-Fi Provisioning Manager](#)*

**CONFIG\_WIFI\_PROV\_DISCONNECT\_AFTER\_PROV**

Terminate connection after provisioning is done

*Found in: [Component config](#) > [Wi-Fi Provisioning Manager](#) > [CONFIG\\_WIFI\\_PROV\\_KEEP\\_BLE\\_ON\\_AFTER\\_PROV](#)*

**Default value:**

- Yes (enabled) if `CONFIG_WIFI_PROV_KEEP_BLE_ON_AFTER_PROV`

**CONFIG\_WIFI\_PROV\_STA\_SCAN\_METHOD**

Wifi Provisioning Scan Method

*Found in: [Component config](#) > [Wi-Fi Provisioning Manager](#)*

**Available options:**

- All Channel Scan (`WIFI_PROV_STA_ALL_CHANNEL_SCAN`)  
Scan will end after scanning the entire channel. This option is useful in Mesh WiFi Systems.
- Fast Scan (`WIFI_PROV_STA_FAST_SCAN`)  
Scan will end after an AP matching with the SSID has been detected.

**Supplicant** Contains:

- [CONFIG\\_WPA\\_TESTING\\_OPTIONS](#)
- [CONFIG\\_WPA\\_WPS\\_SOFTAP\\_REGISTRAR](#)
- [CONFIG\\_WPA\\_11KV\\_SUPPORT](#)
- [CONFIG\\_WPA\\_11R\\_SUPPORT](#)
- [CONFIG\\_WPA\\_DPP\\_SUPPORT](#)
- [CONFIG\\_WPA\\_MBO\\_SUPPORT](#)
- [CONFIG\\_WPA\\_SUITE\\_B\\_192](#)
- [CONFIG\\_WPA\\_WAPI\\_PSK](#)
- [CONFIG\\_WPA\\_DEBUG\\_PRINT](#)
- [CONFIG\\_WPA\\_WPS\\_STRICT](#)
- [CONFIG\\_WPA\\_MBEDTLS\\_CRYPT0](#)

### **CONFIG\_WPA\_MBEDTLS\_CRYPT0**

Use MbedTLS crypto APIs

*Found in:* [Component config](#) > [Supplicant](#)

Select this option to enable the use of MbedTLS crypto APIs. The internal crypto support within the supplicant is limited and may not suffice for all new security features, including WPA3.

It is recommended to always keep this option enabled. Additionally, note that MbedTLS can leverage hardware acceleration if available, resulting in significantly faster cryptographic operations.

**Default value:**

- Yes (enabled)

### **CONFIG\_WPA\_MBEDTLS\_TLS\_CLIENT**

Use MbedTLS TLS client for WiFi Enterprise connection

*Found in:* [Component config](#) > [Supplicant](#) > [CONFIG\\_WPA\\_MBEDTLS\\_CRYPT0](#)

Select this option to use MbedTLS TLS client for WPA2 enterprise connection. Please note that from MbedTLS-3.0 onwards, MbedTLS does not support SSL-3.0 TLS-v1.0, TLS-v1.1 versions. In case your server is using one of these version, it is advisable to update your server. Please disable this option for compatibility with older TLS versions.

**Default value:**

- Yes (enabled)

### **CONFIG\_WPA\_WAPI\_PSK**

Enable WAPI PSK support

*Found in:* [Component config](#) > [Supplicant](#)

Select this option to enable WAPI-PSK which is a Chinese National Standard Encryption for Wireless LANs (GB 15629.11-2003).

**Default value:**

- No (disabled)

### **CONFIG\_WPA\_SUITE\_B\_192**

Enable NSA suite B support with 192 bit key

*Found in:* [Component config](#) > [Supplicant](#)

Select this option to enable 192 bit NSA suite-B. This is necessary to support WPA3 192 bit security.

### CONFIG\_WPA\_DEBUG\_PRINT

Print debug messages from WPA Supplicant

*Found in: [Component config](#) > [Supplicant](#)*

Select this option to print logging information from WPA supplicant, this includes handshake information and key hex dumps depending on the project logging level.

Enabling this could increase the build size ~60kb depending on the project logging level.

**Default value:**

- No (disabled)

### CONFIG\_WPA\_TESTING\_OPTIONS

Add DPP testing code

*Found in: [Component config](#) > [Supplicant](#)*

Select this to enable unity test for DPP.

**Default value:**

- No (disabled)

### CONFIG\_WPA\_WPS\_STRICT

Strictly validate all WPS attributes

*Found in: [Component config](#) > [Supplicant](#)*

Select this option to enable validate each WPS attribute rigorously. Disabling this add the workarounds with various APs. Enabling this may cause inter operability issues with some APs.

**Default value:**

- No (disabled)

### CONFIG\_WPA\_11KV\_SUPPORT

Enable 802.11k, 802.11v APIs Support

*Found in: [Component config](#) > [Supplicant](#)*

Select this option to enable 802.11k 802.11v APIs(RRM and BTM support). Only APIs which are helpful for network assisted roaming are supported for now. Enable this option with BTM and RRM enabled in sta config to make device ready for network assisted roaming. BTM: BSS transition management enables an AP to request a station to transition to a specific AP, or to indicate to a station a set of preferred APs. RRM: Radio measurements enable STAs to understand the radio environment, it enables STAs to observe and gather data on radio link performance and on the radio environment. Current implementation adds beacon report, link measurement, neighbor report.

**Default value:**

- No (disabled)

### CONFIG\_WPA\_SCAN\_CACHE

Keep scan results in cache

*Found in: [Component config](#) > [Supplicant](#) > [CONFIG\\_WPA\\_11KV\\_SUPPORT](#)*

Keep scan results in cache, if not enabled, those will be flushed immediately.

**Default value:**

- No (disabled) if [CONFIG\\_WPA\\_11KV\\_SUPPORT](#)

### CONFIG\_WPA\_MBO\_SUPPORT

Enable Multi Band Operation Certification Support

*Found in: [Component config](#) > [Supplicant](#)*

Select this option to enable WiFi Multiband operation certification support.

**Default value:**

- No (disabled)

### CONFIG\_WPA\_DPP\_SUPPORT

Enable DPP support

*Found in: [Component config](#) > [Supplicant](#)*

Select this option to enable WiFi Easy Connect Support.

**Default value:**

- No (disabled)

### CONFIG\_WPA\_11R\_SUPPORT

Enable 802.11R (Fast Transition) Support

*Found in: [Component config](#) > [Supplicant](#)*

Select this option to enable WiFi Fast Transition Support.

**Default value:**

- No (disabled)

### CONFIG\_WPA\_WPS\_SOFTAP\_REGISTRAR

Add WPS Registrar support in SoftAP mode

*Found in: [Component config](#) > [Supplicant](#)*

Select this option to enable WPS registrar support in softAP mode.

**Default value:**

- No (disabled)

### Deprecated options and their replacements

- **CONFIG\_A2D\_INITIAL\_TRACE\_LEVEL** ([CONFIG\\_BT\\_LOG\\_A2D\\_TRACE\\_LEVEL](#))
  - CONFIG\_A2D\_TRACE\_LEVEL\_NONE
  - CONFIG\_A2D\_TRACE\_LEVEL\_ERROR
  - CONFIG\_A2D\_TRACE\_LEVEL\_WARNING
  - CONFIG\_A2D\_TRACE\_LEVEL\_API
  - CONFIG\_A2D\_TRACE\_LEVEL\_EVENT
  - CONFIG\_A2D\_TRACE\_LEVEL\_DEBUG
  - CONFIG\_A2D\_TRACE\_LEVEL\_VERBOSE
- **CONFIG\_ADC2\_DISABLE\_DAC** ([CONFIG\\_ADC\\_DISABLE\\_DAC](#))
- **CONFIG\_APPL\_INITIAL\_TRACE\_LEVEL** ([CONFIG\\_BT\\_LOG\\_APPL\\_TRACE\\_LEVEL](#))
  - CONFIG\_APPL\_TRACE\_LEVEL\_NONE
  - CONFIG\_APPL\_TRACE\_LEVEL\_ERROR
  - CONFIG\_APPL\_TRACE\_LEVEL\_WARNING
  - CONFIG\_APPL\_TRACE\_LEVEL\_API
  - CONFIG\_APPL\_TRACE\_LEVEL\_EVENT
  - CONFIG\_APPL\_TRACE\_LEVEL\_DEBUG
  - CONFIG\_APPL\_TRACE\_LEVEL\_VERBOSE

- CONFIG\_APP\_ANTI\_ROLLBACK ([CONFIG\\_BOOTLOADER\\_APP\\_ANTI\\_ROLLBACK](#))
- CONFIG\_APP\_ROLLBACK\_ENABLE ([CONFIG\\_BOOTLOADER\\_APP\\_ROLLBACK\\_ENABLE](#))
- CONFIG\_APP\_SECURE\_VERSION ([CONFIG\\_BOOTLOADER\\_APP\\_SECURE\\_VERSION](#))
- CONFIG\_APP\_SECURE\_VERSION\_SIZE\_EFUSE\_FIELD ([CONFIG\\_BOOTLOADER\\_APP\\_SEC\\_VER\\_SIZE\\_EFUSE\\_FIELD](#))
- **CONFIG\_AVCT\_INITIAL\_TRACE\_LEVEL** ([CONFIG\\_BT\\_LOG\\_AVCT\\_TRACE\\_LEVEL](#))
  - CONFIG\_AVCT\_TRACE\_LEVEL\_NONE
  - CONFIG\_AVCT\_TRACE\_LEVEL\_ERROR
  - CONFIG\_AVCT\_TRACE\_LEVEL\_WARNING
  - CONFIG\_AVCT\_TRACE\_LEVEL\_API
  - CONFIG\_AVCT\_TRACE\_LEVEL\_EVENT
  - CONFIG\_AVCT\_TRACE\_LEVEL\_DEBUG
  - CONFIG\_AVCT\_TRACE\_LEVEL\_VERBOSE
- **CONFIG\_AVDT\_INITIAL\_TRACE\_LEVEL** ([CONFIG\\_BT\\_LOG\\_AVDT\\_TRACE\\_LEVEL](#))
  - CONFIG\_AVDT\_TRACE\_LEVEL\_NONE
  - CONFIG\_AVDT\_TRACE\_LEVEL\_ERROR
  - CONFIG\_AVDT\_TRACE\_LEVEL\_WARNING
  - CONFIG\_AVDT\_TRACE\_LEVEL\_API
  - CONFIG\_AVDT\_TRACE\_LEVEL\_EVENT
  - CONFIG\_AVDT\_TRACE\_LEVEL\_DEBUG
  - CONFIG\_AVDT\_TRACE\_LEVEL\_VERBOSE
- **CONFIG\_AVRC\_INITIAL\_TRACE\_LEVEL** ([CONFIG\\_BT\\_LOG\\_AVRC\\_TRACE\\_LEVEL](#))
  - CONFIG\_AVRC\_TRACE\_LEVEL\_NONE
  - CONFIG\_AVRC\_TRACE\_LEVEL\_ERROR
  - CONFIG\_AVRC\_TRACE\_LEVEL\_WARNING
  - CONFIG\_AVRC\_TRACE\_LEVEL\_API
  - CONFIG\_AVRC\_TRACE\_LEVEL\_EVENT
  - CONFIG\_AVRC\_TRACE\_LEVEL\_DEBUG
  - CONFIG\_AVRC\_TRACE\_LEVEL\_VERBOSE
- CONFIG\_BLE\_ACTIVE\_SCAN\_REPORT\_ADV\_SCAN\_RSP\_INDIVIDUALLY ([CONFIG\\_BT\\_BLE\\_ACT\\_SCAN\\_REP\\_ADV\\_SCAN](#))
- CONFIG\_BLE\_ESTABLISH\_LINK\_CONNECTION\_TIMEOUT ([CONFIG\\_BT\\_BLE\\_ESTAB\\_LINK\\_CONN\\_TOUT](#))
- CONFIG\_BLE\_HOST\_QUEUE\_CONGESTION\_CHECK ([CONFIG\\_BT\\_BLE\\_HOST\\_QUEUE\\_CONG\\_CHECK](#))
- CONFIG\_BLE\_MESH\_GATT\_PROXY ([CONFIG\\_BLE\\_MESH\\_GATT\\_PROXY\\_SERVER](#))
- CONFIG\_BLE\_SMP\_ENABLE ([CONFIG\\_BT\\_BLE\\_SMP\\_ENABLE](#))
- CONFIG\_BLUEDROID\_MEM\_DEBUG ([CONFIG\\_BT\\_BLUEDROID\\_MEM\\_DEBUG](#))
- **CONFIG\_BLUEDROID\_PINNED\_TO\_CORE\_CHOICE** ([CONFIG\\_BT\\_BLUEDROID\\_PINNED\\_TO\\_CORE\\_CHOICE](#))
  - CONFIG\_BLUEDROID\_PINNED\_TO\_CORE\_0
  - CONFIG\_BLUEDROID\_PINNED\_TO\_CORE\_1
- **CONFIG\_BLUFI\_INITIAL\_TRACE\_LEVEL** ([CONFIG\\_BT\\_LOG\\_BLUFI\\_TRACE\\_LEVEL](#))
  - CONFIG\_BLUFI\_TRACE\_LEVEL\_NONE
  - CONFIG\_BLUFI\_TRACE\_LEVEL\_ERROR
  - CONFIG\_BLUFI\_TRACE\_LEVEL\_WARNING
  - CONFIG\_BLUFI\_TRACE\_LEVEL\_API
  - CONFIG\_BLUFI\_TRACE\_LEVEL\_EVENT
  - CONFIG\_BLUFI\_TRACE\_LEVEL\_DEBUG
  - CONFIG\_BLUFI\_TRACE\_LEVEL\_VERBOSE
- CONFIG\_BNEP\_INITIAL\_TRACE\_LEVEL ([CONFIG\\_BT\\_LOG\\_BNEP\\_TRACE\\_LEVEL](#))
- CONFIG\_BROWNOUT\_DET ([CONFIG\\_ESP\\_BROWNOUT\\_DET](#))
- **CONFIG\_BROWNOUT\_DET\_LVL\_SEL** ([CONFIG\\_ESP\\_BROWNOUT\\_DET\\_LVL\\_SEL](#))
  - CONFIG\_BROWNOUT\_DET\_LVL\_SEL\_7
  - CONFIG\_BROWNOUT\_DET\_LVL\_SEL\_6
  - CONFIG\_BROWNOUT\_DET\_LVL\_SEL\_5
  - CONFIG\_BROWNOUT\_DET\_LVL\_SEL\_4
  - CONFIG\_BROWNOUT\_DET\_LVL\_SEL\_3
  - CONFIG\_BROWNOUT\_DET\_LVL\_SEL\_2
  - CONFIG\_BROWNOUT\_DET\_LVL\_SEL\_1

- **CONFIG\_BT\_INITIAL\_TRACE\_LEVEL** (*CONFIG\_BT\_LOG\_BT\_TRACE\_LEVEL*)
  - CONFIG\_BT\_TRACE\_LEVEL\_NONE
  - CONFIG\_BT\_TRACE\_LEVEL\_ERROR
  - CONFIG\_BT\_TRACE\_LEVEL\_WARNING
  - CONFIG\_BT\_TRACE\_LEVEL\_API
  - CONFIG\_BT\_TRACE\_LEVEL\_EVENT
  - CONFIG\_BT\_TRACE\_LEVEL\_DEBUG
  - CONFIG\_BT\_TRACE\_LEVEL\_VERBOSE
- CONFIG\_BT\_TASK\_STACK\_SIZE (*CONFIG\_BT\_BT\_TASK\_STACK\_SIZE*)
- **CONFIG\_BTH\_LOG\_SDP\_INITIAL\_TRACE\_LEVEL** (*CONFIG\_BT\_LOG\_SDP\_TRACE\_LEVEL*)
  - CONFIG\_SDP\_TRACE\_LEVEL\_NONE
  - CONFIG\_SDP\_TRACE\_LEVEL\_ERROR
  - CONFIG\_SDP\_TRACE\_LEVEL\_WARNING
  - CONFIG\_SDP\_TRACE\_LEVEL\_API
  - CONFIG\_SDP\_TRACE\_LEVEL\_EVENT
  - CONFIG\_SDP\_TRACE\_LEVEL\_DEBUG
  - CONFIG\_SDP\_TRACE\_LEVEL\_VERBOSE
- **CONFIG\_BTIF\_INITIAL\_TRACE\_LEVEL** (*CONFIG\_BT\_LOG\_BTIF\_TRACE\_LEVEL*)
  - CONFIG\_BTIF\_TRACE\_LEVEL\_NONE
  - CONFIG\_BTIF\_TRACE\_LEVEL\_ERROR
  - CONFIG\_BTIF\_TRACE\_LEVEL\_WARNING
  - CONFIG\_BTIF\_TRACE\_LEVEL\_API
  - CONFIG\_BTIF\_TRACE\_LEVEL\_EVENT
  - CONFIG\_BTIF\_TRACE\_LEVEL\_DEBUG
  - CONFIG\_BTIF\_TRACE\_LEVEL\_VERBOSE
- **CONFIG\_BTM\_INITIAL\_TRACE\_LEVEL** (*CONFIG\_BT\_LOG\_BTM\_TRACE\_LEVEL*)
  - CONFIG\_BTM\_TRACE\_LEVEL\_NONE
  - CONFIG\_BTM\_TRACE\_LEVEL\_ERROR
  - CONFIG\_BTM\_TRACE\_LEVEL\_WARNING
  - CONFIG\_BTM\_TRACE\_LEVEL\_API
  - CONFIG\_BTM\_TRACE\_LEVEL\_EVENT
  - CONFIG\_BTM\_TRACE\_LEVEL\_DEBUG
  - CONFIG\_BTM\_TRACE\_LEVEL\_VERBOSE
- CONFIG\_BTU\_TASK\_STACK\_SIZE (*CONFIG\_BT\_BTU\_TASK\_STACK\_SIZE*)
- CONFIG\_BT\_NIMBLE\_MSYS1\_BLOCK\_COUNT (*CONFIG\_BT\_NIMBLE\_MSYS1\_BLOCK\_COUNT*)
- CONFIG\_BT\_NIMBLE\_TASK\_STACK\_SIZE (*CONFIG\_BT\_NIMBLE\_HOST\_TASK\_STACK\_SIZE*)
- **CONFIG\_CONSOLE\_UART** (*CONFIG\_ESP\_CONSOLE\_UART*)
  - CONFIG\_CONSOLE\_UART\_DEFAULT
  - CONFIG\_CONSOLE\_UART\_CUSTOM
  - CONFIG\_CONSOLE\_UART\_NONE, CONFIG\_ESP\_CONSOLE\_UART\_NONE
- CONFIG\_CONSOLE\_UART\_BAUDRATE (*CONFIG\_ESP\_CONSOLE\_UART\_BAUDRATE*)
- **CONFIG\_CONSOLE\_UART\_NUM** (*CONFIG\_ESP\_CONSOLE\_UART\_NUM*)
  - CONFIG\_CONSOLE\_UART\_CUSTOM\_NUM\_0
  - CONFIG\_CONSOLE\_UART\_CUSTOM\_NUM\_1
- CONFIG\_CONSOLE\_UART\_RX\_GPIO (*CONFIG\_ESP\_CONSOLE\_UART\_RX\_GPIO*)
- CONFIG\_CONSOLE\_UART\_TX\_GPIO (*CONFIG\_ESP\_CONSOLE\_UART\_TX\_GPIO*)
- CONFIG\_CXX\_EXCEPTIONS (*CONFIG\_COMPILER\_CXX\_EXCEPTIONS*)
- CONFIG\_CXX\_EXCEPTIONS\_EMG\_POOL\_SIZE (*CONFIG\_COMPILER\_CXX\_EXCEPTIONS\_EMG\_POOL\_SIZE*)
- CONFIG\_EFUSE\_SECURE\_VERSION\_EMULATE (*CONFIG\_BOOTLOADER\_EFUSE\_SECURE\_VERSION\_EMULATE*)
- CONFIG\_ENABLE\_STATIC\_TASK\_CLEAN\_UP\_HOOK (*CONFIG\_FREERTOS\_ENABLE\_STATIC\_TASK\_CLEAN\_UP*)
- CONFIG\_ESP32\_APPTRACE\_ONPANIC\_HOST\_FLUSH\_TMO (*CONFIG\_APPTTRACE\_ONPANIC\_HOST\_FLUSH\_TMO*)
- CONFIG\_ESP32\_APPTRACE\_PENDING\_DATA\_SIZE\_MAX (*CONFIG\_APPTTRACE\_PENDING\_DATA\_SIZE\_MAX*)
- CONFIG\_ESP32\_APPTRACE\_POSTMORTEM\_FLUSH\_TRAX\_THRESH (*CONFIG\_APPTTRACE\_POSTMORTEM\_FLUSH\_THRESH*)
- **CONFIG\_ESP32\_CORE\_DUMP\_DECODE** (*CONFIG\_ESP\_COREDUMP\_DECODE*)
  - CONFIG\_ESP32\_CORE\_DUMP\_DECODE\_INFO
  - CONFIG\_ESP32\_CORE\_DUMP\_DECODE\_DISABLE



- `CONFIG_ESP32_CORE_DUMP_MAX_TASKS_NUM` (`CONFIG_ESP_COREDUMP_MAX_TASKS_NUM`)
- `CONFIG_ESP32_CORE_DUMP_STACK_SIZE` (`CONFIG_ESP_COREDUMP_STACK_SIZE`)
- `CONFIG_ESP32_CORE_DUMP_UART_DELAY` (`CONFIG_ESP_COREDUMP_UART_DELAY`)
- `CONFIG_ESP32_DEBUG_STUBS_ENABLE` (`CONFIG_ESP_DEBUG_STUBS_ENABLE`)
- `CONFIG_ESP32_GCOV_ENABLE` (`CONFIG_APPTRACE_GCOV_ENABLE`)
- `CONFIG_ESP32_PHY_CALIBRATION_AND_DATA_STORAGE` (`CONFIG_ESP_PHY_CALIBRATION_AND_DATA_STORAGE`)
- `CONFIG_ESP32_PHY_DEFAULT_INIT_IF_INVALID` (`CONFIG_ESP_PHY_DEFAULT_INIT_IF_INVALID`)
- `CONFIG_ESP32_PHY_INIT_DATA_ERROR` (`CONFIG_ESP_PHY_INIT_DATA_ERROR`)
- `CONFIG_ESP32_PHY_INIT_DATA_IN_PARTITION` (`CONFIG_ESP_PHY_INIT_DATA_IN_PARTITION`)
- `CONFIG_ESP32_PHY_MAX_WIFI_TX_POWER` (`CONFIG_ESP_PHY_MAX_WIFI_TX_POWER`)
- `CONFIG_ESP32_PTHREAD_STACK_MIN` (`CONFIG_PTHREAD_STACK_MIN`)
- **`CONFIG_ESP32_PTHREAD_TASK_CORE_DEFAULT` (`CONFIG_PTHREAD_TASK_CORE_DEFAULT`)**
  - `CONFIG_ESP32_DEFAULT_PTHREAD_CORE_NO_AFFINITY`
  - `CONFIG_ESP32_DEFAULT_PTHREAD_CORE_0`
  - `CONFIG_ESP32_DEFAULT_PTHREAD_CORE_1`
- `CONFIG_ESP32_PTHREAD_TASK_NAME_DEFAULT` (`CONFIG_PTHREAD_TASK_NAME_DEFAULT`)
- `CONFIG_ESP32_PTHREAD_TASK_PRIO_DEFAULT` (`CONFIG_PTHREAD_TASK_PRIO_DEFAULT`)
- `CONFIG_ESP32_PTHREAD_TASK_STACK_SIZE_DEFAULT` (`CONFIG_PTHREAD_TASK_STACK_SIZE_DEFAULT`)
- `CONFIG_ESP32_REDUCE_PHY_TX_POWER` (`CONFIG_ESP_PHY_REDUCE_TX_POWER`)
- `CONFIG_ESP32_RTC_XTAL_BOOTSTRAP_CYCLES` (`CONFIG_ESP_SYSTEM_RTC_EXT_XTAL_BOOTSTRAP_CYCLES`)
- `CONFIG_ESP32_SUPPORT_MULTIPLE_PHY_INIT_DATA_BIN` (`CONFIG_ESP_PHY_MULTIPLE_INIT_DATA_BIN`)
- `CONFIG_ESP_GRATUITOUS_ARP` (`CONFIG_LWIP_ESP_GRATUITOUS_ARP`)
- `CONFIG_ESP_SYSTEM_PD_FLASH` (`CONFIG_ESP_SLEEP_POWER_DOWN_FLASH`)
- `CONFIG_ESP_TASK_WDT` (`CONFIG_ESP_TASK_WDT_INIT`)
- `CONFIG_EVENT_LOOP_PROFILING` (`CONFIG_ESP_EVENT_LOOP_PROFILING`)
- `CONFIG_EXTERNAL_COEX_ENABLE` (`CONFIG_ESP_WIFI_EXTERNAL_COEXIST_ENABLE`)
- `CONFIG_FLASH_ENCRYPTION_ENABLED` (`CONFIG_SECURE_FLASH_ENC_ENABLED`)
- `CONFIG_FLASH_ENCRYPTION_UART_BOOTLOADER_ALLOW_CACHE` (`CONFIG_SECURE_FLASH_UART_BOOTLOADER_ALLOW_CACHE`)
- `CONFIG_FLASH_ENCRYPTION_UART_BOOTLOADER_ALLOW_ENCRYPT` (`CONFIG_SECURE_FLASH_UART_BOOTLOADER_ALLOW_ENC`)
- **`CONFIG_GAP_INITIAL_TRACE_LEVEL` (`CONFIG_BT_LOG_GAP_TRACE_LEVEL`)**
  - `CONFIG_GAP_TRACE_LEVEL_NONE`
  - `CONFIG_GAP_TRACE_LEVEL_ERROR`
  - `CONFIG_GAP_TRACE_LEVEL_WARNING`
  - `CONFIG_GAP_TRACE_LEVEL_API`
  - `CONFIG_GAP_TRACE_LEVEL_EVENT`
  - `CONFIG_GAP_TRACE_LEVEL_DEBUG`
  - `CONFIG_GAP_TRACE_LEVEL_VERBOSE`
- `CONFIG_GARP_TMR_INTERVAL` (`CONFIG_LWIP_GARP_TMR_INTERVAL`)
- `CONFIG_GATTC_CACHE_NVS_FLASH` (`CONFIG_BT_GATTC_CACHE_NVS_FLASH`)
- `CONFIG_GATTC_ENABLE` (`CONFIG_BT_GATTC_ENABLE`)
- `CONFIG_GATTS_ENABLE` (`CONFIG_BT_GATTS_ENABLE`)
- **`CONFIG_GATTS_SEND_SERVICE_CHANGE_MODE` (`CONFIG_BT_GATTS_SEND_SERVICE_CHANGE_MODE`)**
  - `CONFIG_GATTS_SEND_SERVICE_CHANGE_MANUAL`
  - `CONFIG_GATTS_SEND_SERVICE_CHANGE_AUTO`
- **`CONFIG_GATT_INITIAL_TRACE_LEVEL` (`CONFIG_BT_LOG_GATT_TRACE_LEVEL`)**
  - `CONFIG_GATT_TRACE_LEVEL_NONE`
  - `CONFIG_GATT_TRACE_LEVEL_ERROR`
  - `CONFIG_GATT_TRACE_LEVEL_WARNING`
  - `CONFIG_GATT_TRACE_LEVEL_API`
  - `CONFIG_GATT_TRACE_LEVEL_EVENT`
  - `CONFIG_GATT_TRACE_LEVEL_DEBUG`
  - `CONFIG_GATT_TRACE_LEVEL_VERBOSE`

- **CONFIG\_GDBSTUB\_MAX\_TASKS** (*CONFIG\_ESP\_GDBSTUB\_MAX\_TASKS*)
- **CONFIG\_GDBSTUB\_SUPPORT\_TASKS** (*CONFIG\_ESP\_GDBSTUB\_SUPPORT\_TASKS*)
- **CONFIG\_HCI\_INITIAL\_TRACE\_LEVEL** (*CONFIG\_BT\_LOG\_HCI\_TRACE\_LEVEL*)
  - CONFIG\_HCI\_TRACE\_LEVEL\_NONE
  - CONFIG\_HCI\_TRACE\_LEVEL\_ERROR
  - CONFIG\_HCI\_TRACE\_LEVEL\_WARNING
  - CONFIG\_HCI\_TRACE\_LEVEL\_API
  - CONFIG\_HCI\_TRACE\_LEVEL\_EVENT
  - CONFIG\_HCI\_TRACE\_LEVEL\_DEBUG
  - CONFIG\_HCI\_TRACE\_LEVEL\_VERBOSE
- **CONFIG\_HID\_INITIAL\_TRACE\_LEVEL** (*CONFIG\_BT\_LOG\_HID\_TRACE\_LEVEL*)
  - CONFIG\_HID\_TRACE\_LEVEL\_NONE
  - CONFIG\_HID\_TRACE\_LEVEL\_ERROR
  - CONFIG\_HID\_TRACE\_LEVEL\_WARNING
  - CONFIG\_HID\_TRACE\_LEVEL\_API
  - CONFIG\_HID\_TRACE\_LEVEL\_EVENT
  - CONFIG\_HID\_TRACE\_LEVEL\_DEBUG
  - CONFIG\_HID\_TRACE\_LEVEL\_VERBOSE
- **CONFIG\_INT\_WDT** (*CONFIG\_ESP\_INT\_WDT*)
- **CONFIG\_INT\_WDT\_CHECK\_CPU1** (*CONFIG\_ESP\_INT\_WDT\_CHECK\_CPU1*)
- **CONFIG\_INT\_WDT\_TIMEOUT\_MS** (*CONFIG\_ESP\_INT\_WDT\_TIMEOUT\_MS*)
- **CONFIG\_IPC\_TASK\_STACK\_SIZE** (*CONFIG\_ESP\_IPC\_TASK\_STACK\_SIZE*)
- **CONFIG\_L2CAP\_INITIAL\_TRACE\_LEVEL** (*CONFIG\_BT\_LOG\_L2CAP\_TRACE\_LEVEL*)
  - CONFIG\_L2CAP\_TRACE\_LEVEL\_NONE
  - CONFIG\_L2CAP\_TRACE\_LEVEL\_ERROR
  - CONFIG\_L2CAP\_TRACE\_LEVEL\_WARNING
  - CONFIG\_L2CAP\_TRACE\_LEVEL\_API
  - CONFIG\_L2CAP\_TRACE\_LEVEL\_EVENT
  - CONFIG\_L2CAP\_TRACE\_LEVEL\_DEBUG
  - CONFIG\_L2CAP\_TRACE\_LEVEL\_VERBOSE
- **CONFIG\_L2\_TO\_L3\_COPY** (*CONFIG\_LWIP\_L2\_TO\_L3\_COPY*)
- **CONFIG\_LOG\_BOOTLOADER\_LEVEL** (*CONFIG\_BOOTLOADER\_LOG\_LEVEL*)
  - CONFIG\_LOG\_BOOTLOADER\_LEVEL\_NONE
  - CONFIG\_LOG\_BOOTLOADER\_LEVEL\_ERROR
  - CONFIG\_LOG\_BOOTLOADER\_LEVEL\_WARN
  - CONFIG\_LOG\_BOOTLOADER\_LEVEL\_INFO
  - CONFIG\_LOG\_BOOTLOADER\_LEVEL\_DEBUG
  - CONFIG\_LOG\_BOOTLOADER\_LEVEL\_VERBOSE
- **CONFIG\_MAIN\_TASK\_STACK\_SIZE** (*CONFIG\_ESP\_MAIN\_TASK\_STACK\_SIZE*)
- **CONFIG\_MCA\_INITIAL\_TRACE\_LEVEL** (*CONFIG\_BT\_LOG\_MCA\_TRACE\_LEVEL*)
  - CONFIG\_MCA\_TRACE\_LEVEL\_NONE
  - CONFIG\_MCA\_TRACE\_LEVEL\_ERROR
  - CONFIG\_MCA\_TRACE\_LEVEL\_WARNING
  - CONFIG\_MCA\_TRACE\_LEVEL\_API
  - CONFIG\_MCA\_TRACE\_LEVEL\_EVENT
  - CONFIG\_MCA\_TRACE\_LEVEL\_DEBUG
  - CONFIG\_MCA\_TRACE\_LEVEL\_VERBOSE
- **CONFIG\_MCPWM\_ISR\_IN\_IRAM** (*CONFIG\_MCPWM\_ISR\_IRAM\_SAFE*)
- **CONFIG\_NIMBLE\_ACL\_BUF\_COUNT** (*CONFIG\_BT\_NIMBLE\_ACL\_BUF\_COUNT*)
- **CONFIG\_NIMBLE\_ACL\_BUF\_SIZE** (*CONFIG\_BT\_NIMBLE\_ACL\_BUF\_SIZE*)
- **CONFIG\_NIMBLE\_ATT\_PREFERRED\_MTU** (*CONFIG\_BT\_NIMBLE\_ATT\_PREFERRED\_MTU*)
- **CONFIG\_NIMBLE\_CRYPTOSTACK\_MBEDTLS** (*CONFIG\_BT\_NIMBLE\_CRYPTOSTACK\_MBEDTLS*)
- **CONFIG\_NIMBLE\_DEBUG** (*CONFIG\_BT\_NIMBLE\_DEBUG*)
- **CONFIG\_NIMBLE\_GAP\_DEVICE\_NAME\_MAX\_LEN** (*CONFIG\_BT\_NIMBLE\_GAP\_DEVICE\_NAME\_MAX\_LEN*)
- **CONFIG\_NIMBLE\_HCI\_EVT\_BUF\_SIZE** (*CONFIG\_BT\_NIMBLE\_HCI\_EVT\_BUF\_SIZE*)
- **CONFIG\_NIMBLE\_HCI\_EVT\_HI\_BUF\_COUNT** (*CONFIG\_BT\_NIMBLE\_HCI\_EVT\_HI\_BUF\_COUNT*)
- **CONFIG\_NIMBLE\_HCI\_EVT\_LO\_BUF\_COUNT** (*CONFIG\_BT\_NIMBLE\_HCI\_EVT\_LO\_BUF\_COUNT*)
- **CONFIG\_NIMBLE\_HS\_FLOW\_CTRL** (*CONFIG\_BT\_NIMBLE\_HS\_FLOW\_CTRL*)



- `CONFIG_NIMBLE_HS_FLOW_CTRL_ITVL` ([CONFIG\\_BT\\_NIMBLE\\_HS\\_FLOW\\_CTRL\\_ITVL](#))
- `CONFIG_NIMBLE_HS_FLOW_CTRL_THRESH` ([CONFIG\\_BT\\_NIMBLE\\_HS\\_FLOW\\_CTRL\\_THRESH](#))
- `CONFIG_NIMBLE_HS_FLOW_CTRL_TX_ON_DISCONNECT` ([CONFIG\\_BT\\_NIMBLE\\_HS\\_FLOW\\_CTRL\\_TX\\_ON\\_DISCONNECT](#))
- `CONFIG_NIMBLE_L2CAP_COC_MAX_NUM` ([CONFIG\\_BT\\_NIMBLE\\_L2CAP\\_COC\\_MAX\\_NUM](#))
- `CONFIG_NIMBLE_MAX_BONDS` ([CONFIG\\_BT\\_NIMBLE\\_MAX\\_BONDS](#))
- `CONFIG_NIMBLE_MAX_CCCDS` ([CONFIG\\_BT\\_NIMBLE\\_MAX\\_CCCDS](#))
- `CONFIG_NIMBLE_MAX_CONNECTIONS` ([CONFIG\\_BT\\_NIMBLE\\_MAX\\_CONNECTIONS](#))
- **`CONFIG_NIMBLE_MEM_ALLOC_MODE`** ([CONFIG\\_BT\\_NIMBLE\\_MEM\\_ALLOC\\_MODE](#))
  - `CONFIG_NIMBLE_MEM_ALLOC_MODE_INTERNAL`
  - `CONFIG_NIMBLE_MEM_ALLOC_MODE_EXTERNAL`
  - `CONFIG_NIMBLE_MEM_ALLOC_MODE_DEFAULT`
- `CONFIG_NIMBLE_MESH` ([CONFIG\\_BT\\_NIMBLE\\_MESH](#))
- `CONFIG_NIMBLE_MESH_DEVICE_NAME` ([CONFIG\\_BT\\_NIMBLE\\_MESH\\_DEVICE\\_NAME](#))
- `CONFIG_NIMBLE_MESH_FRIEND` ([CONFIG\\_BT\\_NIMBLE\\_MESH\\_FRIEND](#))
- `CONFIG_NIMBLE_MESH_GATT_PROXY` ([CONFIG\\_BT\\_NIMBLE\\_MESH\\_GATT\\_PROXY](#))
- `CONFIG_NIMBLE_MESH_LOW_POWER` ([CONFIG\\_BT\\_NIMBLE\\_MESH\\_LOW\\_POWER](#))
- `CONFIG_NIMBLE_MESH_PB_ADV` ([CONFIG\\_BT\\_NIMBLE\\_MESH\\_PB\\_ADV](#))
- `CONFIG_NIMBLE_MESH_PB_GATT` ([CONFIG\\_BT\\_NIMBLE\\_MESH\\_PB\\_GATT](#))
- `CONFIG_NIMBLE_MESH_PROV` ([CONFIG\\_BT\\_NIMBLE\\_MESH\\_PROV](#))
- `CONFIG_NIMBLE_MESH_PROXY` ([CONFIG\\_BT\\_NIMBLE\\_MESH\\_PROXY](#))
- `CONFIG_NIMBLE_MESH_RELAY` ([CONFIG\\_BT\\_NIMBLE\\_MESH\\_RELAY](#))
- `CONFIG_NIMBLE_NVS_PERSIST` ([CONFIG\\_BT\\_NIMBLE\\_NVS\\_PERSIST](#))
- **`CONFIG_NIMBLE_PINNED_TO_CORE_CHOICE`** ([CONFIG\\_BT\\_NIMBLE\\_PINNED\\_TO\\_CORE\\_CHOICE](#))
  - `CONFIG_NIMBLE_PINNED_TO_CORE_0`
  - `CONFIG_NIMBLE_PINNED_TO_CORE_1`
- `CONFIG_NIMBLE_ROLE_BROADCASTER` ([CONFIG\\_BT\\_NIMBLE\\_ROLE\\_BROADCASTER](#))
- `CONFIG_NIMBLE_ROLE_CENTRAL` ([CONFIG\\_BT\\_NIMBLE\\_ROLE\\_CENTRAL](#))
- `CONFIG_NIMBLE_ROLE_OBSERVER` ([CONFIG\\_BT\\_NIMBLE\\_ROLE\\_OBSERVER](#))
- `CONFIG_NIMBLE_ROLE_PERIPHERAL` ([CONFIG\\_BT\\_NIMBLE\\_ROLE\\_PERIPHERAL](#))
- `CONFIG_NIMBLE_RPA_TIMEOUT` ([CONFIG\\_BT\\_NIMBLE\\_RPA\\_TIMEOUT](#))
- `CONFIG_NIMBLE_SM_LEGACY` ([CONFIG\\_BT\\_NIMBLE\\_SM\\_LEGACY](#))
- `CONFIG_NIMBLE_SM_SC` ([CONFIG\\_BT\\_NIMBLE\\_SM\\_SC](#))
- `CONFIG_NIMBLE_SM_SC_DEBUG_KEYS` ([CONFIG\\_BT\\_NIMBLE\\_SM\\_SC\\_DEBUG\\_KEYS](#))
- `CONFIG_NIMBLE_SVC_GAP_APPEARANCE` ([CONFIG\\_BT\\_NIMBLE\\_SVC\\_GAP\\_APPEARANCE](#))
- `CONFIG_NIMBLE_SVC_GAP_DEVICE_NAME` ([CONFIG\\_BT\\_NIMBLE\\_SVC\\_GAP\\_DEVICE\\_NAME](#))
- `CONFIG_NIMBLE_TASK_STACK_SIZE` ([CONFIG\\_BT\\_NIMBLE\\_HOST\\_TASK\\_STACK\\_SIZE](#))
- `CONFIG_NO_BLOBS` ([CONFIG\\_APP\\_NO\\_BLOBS](#))
- **`CONFIG_OPTIMIZATION_ASSERTION_LEVEL`** ([CONFIG\\_COMPILER\\_OPTIMIZATION\\_ASSERTION\\_LEVEL](#))
  - `CONFIG_OPTIMIZATION_ASSERTIONS_ENABLED`
  - `CONFIG_OPTIMIZATION_ASSERTIONS_SILENT`
  - `CONFIG_OPTIMIZATION_ASSERTIONS_DISABLED`
- **`CONFIG_OPTIMIZATION_COMPILER`** ([CONFIG\\_COMPILER\\_OPTIMIZATION](#))
  - `CONFIG_OPTIMIZATION_LEVEL_DEBUG`, `CONFIG_COMPILER_OPTIMIZATION_LEVEL_DEBUG`
  - `CONFIG_OPTIMIZATION_LEVEL_RELEASE`, `CONFIG_COMPILER_OPTIMIZATION_LEVEL_RELEASE`
- **`CONFIG_OSI_INITIAL_TRACE_LEVEL`** ([CONFIG\\_BT\\_LOG\\_OSI\\_TRACE\\_LEVEL](#))
  - `CONFIG_OSI_TRACE_LEVEL_NONE`
  - `CONFIG_OSI_TRACE_LEVEL_ERROR`
  - `CONFIG_OSI_TRACE_LEVEL_WARNING`
  - `CONFIG_OSI_TRACE_LEVEL_API`
  - `CONFIG_OSI_TRACE_LEVEL_EVENT`
  - `CONFIG_OSI_TRACE_LEVEL_DEBUG`
  - `CONFIG_OSI_TRACE_LEVEL_VERBOSE`
- `CONFIG_OTA_ALLOW_HTTP` ([CONFIG\\_ESP\\_HTTPS\\_OTA\\_ALLOW\\_HTTP](#))
- **`CONFIG_PAN_INITIAL_TRACE_LEVEL`** ([CONFIG\\_BT\\_LOG\\_PAN\\_TRACE\\_LEVEL](#))
  - `CONFIG_PAN_TRACE_LEVEL_NONE`

- CONFIG\_PAN\_TRACE\_LEVEL\_ERROR
- CONFIG\_PAN\_TRACE\_LEVEL\_WARNING
- CONFIG\_PAN\_TRACE\_LEVEL\_API
- CONFIG\_PAN\_TRACE\_LEVEL\_EVENT
- CONFIG\_PAN\_TRACE\_LEVEL\_DEBUG
- CONFIG\_PAN\_TRACE\_LEVEL\_VERBOSE
- CONFIG\_POST\_EVENTS\_FROM\_IRAM\_ISR (*CONFIG\_ESP\_EVENT\_POST\_FROM\_IRAM\_ISR*)
- CONFIG\_POST\_EVENTS\_FROM\_ISR (*CONFIG\_ESP\_EVENT\_POST\_FROM\_ISR*)
- CONFIG\_PPP\_CHAP\_SUPPORT (*CONFIG\_LWIP\_PPP\_CHAP\_SUPPORT*)
- CONFIG\_PPP\_DEBUG\_ON (*CONFIG\_LWIP\_PPP\_DEBUG\_ON*)
- CONFIG\_PPP\_MPPE\_SUPPORT (*CONFIG\_LWIP\_PPP\_MPPE\_SUPPORT*)
- CONFIG\_PPP\_MSCHAP\_SUPPORT (*CONFIG\_LWIP\_PPP\_MSCHAP\_SUPPORT*)
- CONFIG\_PPP\_NOTIFY\_PHASE\_SUPPORT (*CONFIG\_LWIP\_PPP\_NOTIFY\_PHASE\_SUPPORT*)
- CONFIG\_PPP\_PAP\_SUPPORT (*CONFIG\_LWIP\_PPP\_PAP\_SUPPORT*)
- CONFIG\_PPP\_SUPPORT (*CONFIG\_LWIP\_PPP\_SUPPORT*)
- CONFIG\_REDUCE\_PHY\_TX\_POWER (*CONFIG\_ESP\_PHY\_REDUCE\_TX\_POWER*)
- **CONFIG\_RFCOMM\_INITIAL\_TRACE\_LEVEL** (*CONFIG\_BT\_LOG\_RFCOMM\_TRACE\_LEVEL*)
  - CONFIG\_RFCOMM\_TRACE\_LEVEL\_NONE
  - CONFIG\_RFCOMM\_TRACE\_LEVEL\_ERROR
  - CONFIG\_RFCOMM\_TRACE\_LEVEL\_WARNING
  - CONFIG\_RFCOMM\_TRACE\_LEVEL\_API
  - CONFIG\_RFCOMM\_TRACE\_LEVEL\_EVENT
  - CONFIG\_RFCOMM\_TRACE\_LEVEL\_DEBUG
  - CONFIG\_RFCOMM\_TRACE\_LEVEL\_VERBOSE
- CONFIG\_SEMIHOSTFS\_MAX\_MOUNT\_POINTS (*CONFIG\_VFS\_SEMIHOSTFS\_MAX\_MOUNT\_POINTS*)
- **CONFIG\_SMP\_INITIAL\_TRACE\_LEVEL** (*CONFIG\_BT\_LOG\_SMP\_TRACE\_LEVEL*)
  - CONFIG\_SMP\_TRACE\_LEVEL\_NONE
  - CONFIG\_SMP\_TRACE\_LEVEL\_ERROR
  - CONFIG\_SMP\_TRACE\_LEVEL\_WARNING
  - CONFIG\_SMP\_TRACE\_LEVEL\_API
  - CONFIG\_SMP\_TRACE\_LEVEL\_EVENT
  - CONFIG\_SMP\_TRACE\_LEVEL\_DEBUG
  - CONFIG\_SMP\_TRACE\_LEVEL\_VERBOSE
- CONFIG\_SMP\_SLAVE\_CON\_PARAMS\_UPD\_ENABLE (*CONFIG\_BT\_SMP\_SLAVE\_CON\_PARAMS\_UPD\_ENABLE*)
- **CONFIG\_SPI\_FLASH\_WRITING\_DANGEROUS\_REGIONS** (*CONFIG\_SPI\_FLASH\_DANGEROUS\_WRITE*)
  - CONFIG\_SPI\_FLASH\_WRITING\_DANGEROUS\_REGIONS\_ABORTS
  - CONFIG\_SPI\_FLASH\_WRITING\_DANGEROUS\_REGIONS\_FAILS
  - CONFIG\_SPI\_FLASH\_WRITING\_DANGEROUS\_REGIONS\_ALLOWED
- **CONFIG\_STACK\_CHECK\_MODE** (*CONFIG\_COMPILER\_STACK\_CHECK\_MODE*)
  - CONFIG\_STACK\_CHECK\_NONE
  - CONFIG\_STACK\_CHECK\_NORM
  - CONFIG\_STACK\_CHECK\_STRONG
  - CONFIG\_STACK\_CHECK\_ALL
- CONFIG\_SUPPORT\_TERMIOS (*CONFIG\_VFS\_SUPPORT\_TERMIOS*)
- CONFIG\_SUPPRESS\_SELECT\_DEBUG\_OUTPUT (*CONFIG\_VFS\_SUPPRESS\_SELECT\_DEBUG\_OUTPUT*)
- CONFIG\_SW\_COEXIST\_ENABLE (*CONFIG\_ESP32\_WIFI\_SW\_COEXIST\_ENABLE*)
- CONFIG\_SYSTEM\_EVENT\_QUEUE\_SIZE (*CONFIG\_ESP\_SYSTEM\_EVENT\_QUEUE\_SIZE*)
- CONFIG\_SYSTEM\_EVENT\_TASK\_STACK\_SIZE (*CONFIG\_ESP\_SYSTEM\_EVENT\_TASK\_STACK\_SIZE*)
- CONFIG\_SYSVIEW\_BUF\_WAIT\_TMO (*CONFIG\_APPTTRACE\_SV\_BUF\_WAIT\_TMO*)
- CONFIG\_SYSVIEW\_ENABLE (*CONFIG\_APPTTRACE\_SV\_ENABLE*)
- CONFIG\_SYSVIEW\_EVT\_IDLE\_ENABLE (*CONFIG\_APPTTRACE\_SV\_EVT\_IDLE\_ENABLE*)
- CONFIG\_SYSVIEW\_EVT\_ISR\_ENTER\_ENABLE (*CONFIG\_APPTTRACE\_SV\_EVT\_ISR\_ENTER\_ENABLE*)
- CONFIG\_SYSVIEW\_EVT\_ISR\_EXIT\_ENABLE (*CONFIG\_APPTTRACE\_SV\_EVT\_ISR\_EXIT\_ENABLE*)
- CONFIG\_SYSVIEW\_EVT\_ISR\_TO\_SCHEDULER\_ENABLE (*CONFIG\_APPTTRACE\_SV\_EVT\_ISR\_TO\_SCHED\_ENABLE*)
- CONFIG\_SYSVIEW\_EVT\_OVERFLOW\_ENABLE (*CONFIG\_APPTTRACE\_SV\_EVT\_OVERFLOW\_ENABLE*)
- CONFIG\_SYSVIEW\_EVT\_TASK\_CREATE\_ENABLE (*CONFIG\_APPTTRACE\_SV\_EVT\_TASK\_CREATE\_ENABLE*)
- CONFIG\_SYSVIEW\_EVT\_TASK\_START\_EXEC\_ENABLE (*CONFIG\_APPTTRACE\_SV\_EVT\_TASK\_START\_EXEC\_ENABLE*)

- CONFIG\_SYSVIEW\_EVT\_TASK\_START\_READY\_ENABLE (*CONFIG\_APPTRACE\_SV\_EVT\_TASK\_START\_READY\_ENABLE*)
- CONFIG\_SYSVIEW\_EVT\_TASK\_STOP\_EXEC\_ENABLE (*CONFIG\_APPTRACE\_SV\_EVT\_TASK\_STOP\_EXEC\_ENABLE*)
- CONFIG\_SYSVIEW\_EVT\_TASK\_STOP\_READY\_ENABLE (*CONFIG\_APPTRACE\_SV\_EVT\_TASK\_STOP\_READY\_ENABLE*)
- CONFIG\_SYSVIEW\_EVT\_TASK\_TERMINATE\_ENABLE (*CONFIG\_APPTRACE\_SV\_EVT\_TASK\_TERMINATE\_ENABLE*)
- CONFIG\_SYSVIEW\_EVT\_TIMER\_ENTER\_ENABLE (*CONFIG\_APPTRACE\_SV\_EVT\_TIMER\_ENTER\_ENABLE*)
- CONFIG\_SYSVIEW\_EVT\_TIMER\_EXIT\_ENABLE (*CONFIG\_APPTRACE\_SV\_EVT\_TIMER\_EXIT\_ENABLE*)
- CONFIG\_SYSVIEW\_MAX\_TASKS (*CONFIG\_APPTRACE\_SV\_MAX\_TASKS*)
- **CONFIG\_SYSVIEW\_TS\_SOURCE** (*CONFIG\_APPTRACE\_SV\_TS\_SOURCE*)
  - CONFIG\_SYSVIEW\_TS\_SOURCE\_CCOUNT
  - CONFIG\_SYSVIEW\_TS\_SOURCE\_ESP\_TIMER
- CONFIG\_TASK\_WDT (*CONFIG\_ESP\_TASK\_WDT\_INIT*)
- CONFIG\_TASK\_WDT\_CHECK\_IDLE\_TASK\_CPU0 (*CONFIG\_ESP\_TASK\_WDT\_CHECK\_IDLE\_TASK\_CPU0*)
- CONFIG\_TASK\_WDT\_CHECK\_IDLE\_TASK\_CPU1 (*CONFIG\_ESP\_TASK\_WDT\_CHECK\_IDLE\_TASK\_CPU1*)
- CONFIG\_TASK\_WDT\_PANIC (*CONFIG\_ESP\_TASK\_WDT\_PANIC*)
- CONFIG\_TASK\_WDT\_TIMEOUT\_S (*CONFIG\_ESP\_TASK\_WDT\_TIMEOUT\_S*)
- CONFIG\_TCPIP\_RECVMBOX\_SIZE (*CONFIG\_LWIP\_TCPIP\_RECVMBOX\_SIZE*)
- **CONFIG\_TCPIP\_TASK\_AFFINITY** (*CONFIG\_LWIP\_TCPIP\_TASK\_AFFINITY*)
  - CONFIG\_TCPIP\_TASK\_AFFINITY\_NO\_AFFINITY
  - CONFIG\_TCPIP\_TASK\_AFFINITY\_CPU0
  - CONFIG\_TCPIP\_TASK\_AFFINITY\_CPU1
- CONFIG\_TCPIP\_TASK\_STACK\_SIZE (*CONFIG\_LWIP\_TCPIP\_TASK\_STACK\_SIZE*)
- CONFIG\_TCP\_MAXRTX (*CONFIG\_LWIP\_TCP\_MAXRTX*)
- CONFIG\_TCP\_MSL (*CONFIG\_LWIP\_TCP\_MSL*)
- CONFIG\_TCP\_MSS (*CONFIG\_LWIP\_TCP\_MSS*)
- **CONFIG\_TCP\_OVERSIZE** (*CONFIG\_LWIP\_TCP\_OVERSIZE*)
  - CONFIG\_TCP\_OVERSIZE\_MSS
  - CONFIG\_TCP\_OVERSIZE\_QUARTER\_MSS
  - CONFIG\_TCP\_OVERSIZE\_DISABLE
- CONFIG\_TCP\_QUEUE\_OOSEQ (*CONFIG\_LWIP\_TCP\_QUEUE\_OOSEQ*)
- CONFIG\_TCP\_RECVMBOX\_SIZE (*CONFIG\_LWIP\_TCP\_RECVMBOX\_SIZE*)
- CONFIG\_TCP\_SND\_BUF\_DEFAULT (*CONFIG\_LWIP\_TCP\_SND\_BUF\_DEFAULT*)
- CONFIG\_TCP\_SYNMAXRTX (*CONFIG\_LWIP\_TCP\_SYNMAXRTX*)
- CONFIG\_TCP\_WND\_DEFAULT (*CONFIG\_LWIP\_TCP\_WND\_DEFAULT*)
- CONFIG\_TIMER\_QUEUE\_LENGTH (*CONFIG\_FREERTOS\_TIMER\_QUEUE\_LENGTH*)
- CONFIG\_TIMER\_TASK\_PRIORITY (*CONFIG\_FREERTOS\_TIMER\_TASK\_PRIORITY*)
- CONFIG\_TIMER\_TASK\_STACK\_DEPTH (*CONFIG\_FREERTOS\_TIMER\_TASK\_STACK\_DEPTH*)
- CONFIG\_TIMER\_TASK\_STACK\_SIZE (*CONFIG\_ESP\_TIMER\_TASK\_STACK\_SIZE*)
- CONFIG\_UDP\_RECVMBOX\_SIZE (*CONFIG\_LWIP\_UDP\_RECVMBOX\_SIZE*)
- CONFIG\_WARN\_WRITE\_STRINGS (*CONFIG\_COMPILER\_WARN\_WRITE\_STRINGS*)

## 2.7 Provisioning API

### 2.7.1 Protocol Communication

#### Overview

The Protocol Communication (protocomm) component manages secure sessions and provides the framework for multiple transports. The application can also use the protocomm layer directly to have application-specific extensions for the provisioning or non-provisioning use cases.

Following features are available for provisioning:

- Communication security at the application level
  - `protocomm_security0` (no security)
  - `protocomm_security1` (Curve25519 key exchange + AES-CTR encryption/decryption)
  - `protocomm_security2` (SRP6a-based key exchange + AES-GCM encryption/decryption)
- Proof-of-possession (support with `protocomm_security1` only)
- Salt and Verifier (support with `protocomm_security2` only)

Protocomm internally uses protobuf (protocol buffers) for secure session establishment. Users can choose to implement their own security (even without using protobuf). Protocomm can also be used without any security layer.

Protocomm provides the framework for various transports:

- Wi-Fi (SoftAP + HTTPD)
- Console, in which case the handler invocation is automatically taken care of on the device side. See Transport Examples below for code snippets.

Note that for `protocomm_security1` and `protocomm_security2`, the client still needs to establish sessions by performing the two-way handshake. See [Unified Provisioning](#) for more details about the secure handshake logic.

### Enabling Protocomm Security Version

The protocomm component provides a project configuration menu to enable/disable support of respective security versions. The respective configuration options are as follows:

- Support `protocomm_security0`, with no security: `CONFIG_ESP_PROTOCOMM_SUPPORT_SECURITY_VERSION_0`, this option is enabled by default.
- Support `protocomm_security1` with Curve25519 key exchange + AES-CTR encryption/decryption: `CONFIG_ESP_PROTOCOMM_SUPPORT_SECURITY_VERSION_1`, this option is enabled by default.
- Support `protocomm_security2` with SRP6a-based key exchange + AES-GCM encryption/decryption: `CONFIG_ESP_PROTOCOMM_SUPPORT_SECURITY_VERSION_2`.

**Note:** Enabling multiple security versions at once offers the ability to control them dynamically but also increases the firmware size.

### SoftAP + HTTP Transport Example with Security 2

For sample usage, see [wifi\\_provisioning/src/scheme\\_softap.c](#).

```

/* The endpoint handler to be registered with protocomm. This simply echoes back
↳the received data. */
esp_err_t echo_req_handler (uint32_t session_id,
                           const uint8_t *inbuf, ssize_t inlen,
                           uint8_t **outbuf, ssize_t *outlen,
                           void *priv_data)
{
    /* Session ID may be used for persistence. */
    printf("Session ID : %d", session_id);

    /* Echo back the received data. */
    *outlen = inlen;          /* Output the data length updated. */
    *outbuf = malloc(inlen); /* This is to be deallocated outside. */
    memcpy(*outbuf, inbuf, inlen);

    /* Private data that was passed at the time of endpoint creation. */
    uint32_t *priv = (uint32_t *) priv_data;
    if (priv) {
        printf("Private data : %d", *priv);
    }
}

```

(continues on next page)

```

}

return ESP_OK;
}

static const char sec2_salt[] = {0xf7, 0x5f, 0xe2, 0xbe, 0xba, 0x7c, 0x81, 0xcd};
static const char sec2_verifier[] = {0xbf, 0x86, 0xce, 0x63, 0x8a, 0xbb, 0x7e, ↵
↵0x2f, 0x38, 0xa8, 0x19, 0x1b, 0x35,
    0xc9, 0xe3, 0xbe, 0xc3, 0x2b, 0x45, 0xee, 0x10, 0x74, 0x22, 0x1a, 0x95, 0xbe, ↵
↵0x62, 0xf7, 0x0c, 0x65, 0x83, 0x50,
    0x08, 0xef, 0xaf, 0xa5, 0x94, 0x4b, 0xcb, 0xe1, 0xce, 0x59, 0x2a, 0xe8, 0x7b, ↵
↵0x27, 0xc8, 0x72, 0x26, 0x71, 0xde,
    0xb2, 0xf2, 0x80, 0x02, 0xdd, 0x11, 0xf0, 0x38, 0x0e, 0x95, 0x25, 0x00, 0xcf, ↵
↵0xb3, 0x3f, 0xf0, 0x73, 0x2a, 0x25,
    0x03, 0xe8, 0x51, 0x72, 0xef, 0x6d, 0x3e, 0x14, 0xb9, 0x2e, 0x9f, 0x2a, 0x90, ↵
↵0x9e, 0x26, 0xb6, 0x3e, 0xc7, 0xe4,
    0x9f, 0xe3, 0x20, 0xce, 0x28, 0x7c, 0xbf, 0x89, 0x50, 0xc9, 0xb6, 0xec, 0xdd, ↵
↵0x81, 0x18, 0xf1, 0x1a, 0xd9, 0x7a,
    0x21, 0x99, 0xf1, 0xee, 0x71, 0x2f, 0xcc, 0x93, 0x16, 0x34, 0x0c, 0x79, 0x46, ↵
↵0x23, 0xe4, 0x32, 0xec, 0x2d, 0x9e,
    0x18, 0xa6, 0xb9, 0xbb, 0x0a, 0xcf, 0xc4, 0xa8, 0x32, 0xc0, 0x1c, 0x32, 0xa3, ↵
↵0x97, 0x66, 0xf8, 0x30, 0xb2, 0xda,
    0xf9, 0x8d, 0xc3, 0x72, 0x72, 0x5f, 0xe5, 0xee, 0xc3, 0x5c, 0x24, 0xc8, 0xdd, ↵
↵0x54, 0x49, 0xfc, 0x12, 0x91, 0x81,
    0x9c, 0xc3, 0xac, 0x64, 0x5e, 0xd6, 0x41, 0x88, 0x2f, 0x23, 0x66, 0xc8, 0xac, ↵
↵0xb0, 0x35, 0x0b, 0xf6, 0x9c, 0x88,
    0x6f, 0xac, 0xe1, 0xf4, 0xca, 0xc9, 0x07, 0x04, 0x11, 0xda, 0x90, 0x42, 0xa9, ↵
↵0xf1, 0x97, 0x3d, 0x94, 0x65, 0xe4,
    0xfb, 0x52, 0x22, 0x3b, 0x7a, 0x7b, 0x9e, 0xe9, 0xee, 0x1c, 0x44, 0xd0, 0x73, ↵
↵0x72, 0x2a, 0xca, 0x85, 0x19, 0x4a,
    0x60, 0xce, 0x0a, 0xc8, 0x7d, 0x57, 0xa4, 0xf8, 0x77, 0x22, 0xc1, 0xa5, 0xfa, ↵
↵0xfb, 0x7b, 0x91, 0x3b, 0xfe, 0x87,
    0x5f, 0xfe, 0x05, 0xd2, 0xd6, 0xd3, 0x74, 0xe5, 0x2e, 0x68, 0x79, 0x34, 0x70, ↵
↵0x40, 0x12, 0xa8, 0xe1, 0xb4, 0x6c,
    0xaa, 0x46, 0x73, 0xcd, 0x8d, 0x17, 0x72, 0x67, 0x32, 0x42, 0xdc, 0x10, 0xd3, ↵
↵0x71, 0x7e, 0x8b, 0x00, 0x46, 0x9b,
    0x0a, 0xe9, 0xb4, 0x0f, 0xeb, 0x70, 0x52, 0xdd, 0x0a, 0x1c, 0x7e, 0x2e, 0xb0, ↵
↵0x61, 0xa6, 0xe1, 0xa3, 0x34, 0x4b,
    0x2a, 0x3c, 0xc4, 0x5d, 0x42, 0x05, 0x58, 0x25, 0xd3, 0xca, 0x96, 0x5c, 0xb9, ↵
↵0x52, 0xf9, 0xe9, 0x80, 0x75, 0x3d,
    0xc8, 0x9f, 0xc7, 0xb2, 0xaa, 0x95, 0x2e, 0x76, 0xb3, 0xe1, 0x48, 0xc1, 0x0a, ↵
↵0xa1, 0x0a, 0xe8, 0xaf, 0x41, 0x28,
    0xd2, 0x16, 0xe1, 0xa6, 0xd0, 0x73, 0x51, 0x73, 0x79, 0x98, 0xd9, 0xb9, 0x00, ↵
↵0x50, 0xa2, 0x4d, 0x99, 0x18, 0x90,
    0x70, 0x27, 0xe7, 0x8d, 0x56, 0x45, 0x34, 0x1f, 0xb9, 0x30, 0xda, 0xec, 0x4a, ↵
↵0x08, 0x27, 0x9f, 0xfa, 0x59, 0x2e,
    0x36, 0x77, 0x00, 0xe2, 0xb6, 0xeb, 0xd1, 0x56, 0x50, 0x8e};

/* The example function for launching a protocomm instance over HTTP. */
protocomm_t *start_pc()
{
    protocomm_t *pc = protocomm_new();

    /* Config for protocomm_httpd_start(). */
    protocomm_httpd_config_t pc_config = {
        .data = {
            .config = PROTOCOMM_HTTPD_DEFAULT_CONFIG()
        }
    };
};

```

(continues on next page)



(continued from previous page)

```

/* Start the protocomm server on top of HTTP. */
protocomm_httpd_start(pc, &pc_config);

/* Create Security2 params object from salt and verifier. It must be valid
↳throughout the scope of protocomm endpoint. This does not need to be static, i.e.
↳, could be dynamically allocated and freed at the time of endpoint removal. */
const static protocomm_security2_params_t sec2_params = {
    .salt = (const uint8_t *) salt,
    .salt_len = sizeof(salt),
    .verifier = (const uint8_t *) verifier,
    .verifier_len = sizeof(verifier),
};

/* Set security for communication at the application level. Just like for
↳request handlers, setting security creates an endpoint and registers the handler
↳provided by protocomm_security1. One can similarly use protocomm_security0. Only
↳one type of security can be set for a protocomm instance at a time. */
protocomm_set_security(pc, "security_endpoint", &protocomm_security2, &sec2_
↳params);

/* Private data passed to the endpoint must be valid throughout the scope of
↳protocomm endpoint. This need not be static, i.e., could be dynamically
↳allocated and freed at the time of endpoint removal. */
static uint32_t priv_data = 1234;

/* Add a new endpoint for the protocomm instance, identified by a unique name,
↳and register a handler function along with the private data to be passed at the
↳time of handler execution. Multiple endpoints can be added as long as they are
↳identified by unique names. */
protocomm_add_endpoint(pc, "echo_req_endpoint",
    echo_req_handler, (void *) &priv_data);

return pc;
}

/* The example function for stopping a protocomm instance. */
void stop_pc(protocomm_t *pc)
{
    /* Remove the endpoint identified by its unique name. */
    protocomm_remove_endpoint(pc, "echo_req_endpoint");

    /* Remove the security endpoint identified by its name. */
    protocomm_unset_security(pc, "security_endpoint");

    /* Stop the HTTP server. */
    protocomm_httpd_stop(pc);

    /* Delete, namely deallocate the protocomm instance. */
    protocomm_delete(pc);
}

```

### SoftAP + HTTP Transport Example with Security 1

For sample usage, see [wifi\\_provisioning/src/scheme\\_softap.c](#).

```

/* The endpoint handler to be registered with protocomm. This simply echoes back
↳the received data. */
esp_err_t echo_req_handler (uint32_t session_id,
    const uint8_t *inbuf, ssize_t inlen,
    uint8_t **outbuf, ssize_t *outlen,
    void *priv_data)

```

(continues on next page)

(continued from previous page)

```

{
    /* Session ID may be used for persistence. */
    printf("Session ID : %d", session_id);

    /* Echo back the received data. */
    *outlen = inlen;          /* Output the data length updated. */
    *outbuf = malloc(inlen);  /* This is to be deallocated outside. */
    memcpy(*outbuf, inbuf, inlen);

    /* Private data that was passed at the time of endpoint creation. */
    uint32_t *priv = (uint32_t *) priv_data;
    if (priv) {
        printf("Private data : %d", *priv);
    }

    return ESP_OK;
}

/* The example function for launching a protocomm instance over HTTP. */
protocomm_t *start_pc(const char *pop_string)
{
    protocomm_t *pc = protocomm_new();

    /* Config for protocomm_httpd_start(). */
    protocomm_httpd_config_t pc_config = {
        .data = {
            .config = PROTOCOMM_HTTPD_DEFAULT_CONFIG()
        }
    };

    /* Start the protocomm server on top of HTTP. */
    protocomm_httpd_start(pc, &pc_config);

    /* Create security1 params object from pop_string. It must be valid throughout
    ↪ the scope of protocomm endpoint. This need not be static, i.e., could be
    ↪ dynamically allocated and freed at the time of endpoint removal. */
    const static protocomm_security1_params_t sec1_params = {
        .data = (const uint8_t *) strdup(pop_string),
        .len = strlen(pop_string)
    };

    /* Set security for communication at the application level. Just like for
    ↪ request handlers, setting security creates an endpoint and registers the handler
    ↪ provided by protocomm_security1. One can similarly use protocomm_security0. Only
    ↪ one type of security can be set for a protocomm instance at a time. */
    protocomm_set_security(pc, "security_endpoint", &protocomm_security1, &sec1_
    ↪ params);

    /* Private data passed to the endpoint must be valid throughout the scope of
    ↪ protocomm endpoint. This need not be static, i.e., could be dynamically
    ↪ allocated and freed at the time of endpoint removal. */
    static uint32_t priv_data = 1234;

    /* Add a new endpoint for the protocomm instance identified by a unique name,
    ↪ and register a handler function along with the private data to be passed at the
    ↪ time of handler execution. Multiple endpoints can be added as long as they are
    ↪ identified by unique names. */
    protocomm_add_endpoint(pc, "echo_req_endpoint",
        echo_req_handler, (void *) &priv_data);

    return pc;
}

```

(continues on next page)

```

}

/* The example function for stopping a protocomm instance. */
void stop_pc(protocomm_t *pc)
{
    /* Remove the endpoint identified by its unique name. */
    protocomm_remove_endpoint(pc, "echo_req_endpoint");

    /* Remove the security endpoint identified by its name. */
    protocomm_unset_security(pc, "security_endpoint");

    /* Stop the HTTP server. */
    protocomm_httpd_stop(pc);

    /* Delete, namely deallocate the protocomm instance. */
    protocomm_delete(pc);
}

```

## API Reference

### Header File

- [components/protocomm/include/common/protocomm.h](#)

### Functions

*protocomm\_t* \***protocomm\_new** (void)

Create a new protocomm instance.

This API will return a new dynamically allocated protocomm instance with all elements of the *protocomm\_t* structure initialized to NULL.

#### Returns

- *protocomm\_t*\* : On success
- NULL : No memory for allocating new instance

void **protocomm\_delete** (*protocomm\_t* \*pc)

Delete a protocomm instance.

This API will deallocate a protocomm instance that was created using `protocomm_new()`.

**Parameters** *pc* –[in] Pointer to the protocomm instance to be deleted

*esp\_err\_t* **protocomm\_add\_endpoint** (*protocomm\_t* \*pc, const char \*ep\_name, *protocomm\_req\_handler\_t* h, void \*priv\_data)

Add endpoint request handler for a protocomm instance.

This API will bind an endpoint handler function to the specified endpoint name, along with any private data that needs to be pass to the handler at the time of call.

---

#### Note:

- An endpoint must be bound to a valid protocomm instance, created using `protocomm_new()`.
  - This function internally calls the registered `add_endpoint()` function of the selected transport which is a member of the *protocomm\_t* instance structure.
- 

#### Parameters

- *pc* –[in] Pointer to the protocomm instance
- *ep\_name* –[in] Endpoint identifier(name) string
- *h* –[in] Endpoint handler function



- **priv\_data** –[in] Pointer to private data to be passed as a parameter to the handler function on call. Pass NULL if not needed.

**Returns**

- ESP\_OK : Success
- ESP\_FAIL : Error adding endpoint / Endpoint with this name already exists
- ESP\_ERR\_NO\_MEM : Error allocating endpoint resource
- ESP\_ERR\_INVALID\_ARG : Null instance/name/handler arguments

*esp\_err\_t* **protocomm\_remove\_endpoint** (*protocomm\_t* \*pc, const char \*ep\_name)

Remove endpoint request handler for a protocomm instance.

This API will remove a registered endpoint handler identified by an endpoint name.

---

**Note:**

- This function internally calls the registered `remove_endpoint()` function which is a member of the `protocomm_t` instance structure.

---

**Parameters**

- **pc** –[in] Pointer to the protocomm instance
- **ep\_name** –[in] Endpoint identifier(name) string

**Returns**

- ESP\_OK : Success
- ESP\_ERR\_NOT\_FOUND : Endpoint with specified name doesn't exist
- ESP\_ERR\_INVALID\_ARG : Null instance/name arguments

*esp\_err\_t* **protocomm\_open\_session** (*protocomm\_t* \*pc, uint32\_t session\_id)

Allocates internal resources for new transport session.

---

**Note:**

- An endpoint must be bound to a valid protocomm instance, created using `protocomm_new()`.

---

**Parameters**

- **pc** –[in] Pointer to the protocomm instance
- **session\_id** –[in] Unique ID for a communication session

**Returns**

- ESP\_OK : Request handled successfully
- ESP\_ERR\_NO\_MEM : Error allocating internal resource
- ESP\_ERR\_INVALID\_ARG : Null instance/name arguments

*esp\_err\_t* **protocomm\_close\_session** (*protocomm\_t* \*pc, uint32\_t session\_id)

Frees internal resources used by a transport session.

---

**Note:**

- An endpoint must be bound to a valid protocomm instance, created using `protocomm_new()`.

---

**Parameters**

- **pc** –[in] Pointer to the protocomm instance
- **session\_id** –[in] Unique ID for a communication session

**Returns**

- ESP\_OK : Request handled successfully
- ESP\_ERR\_INVALID\_ARG : Null instance/name arguments

*esp\_err\_t* **protocomm\_req\_handle** (*protocomm\_t* \*pc, const char \*ep\_name, uint32\_t session\_id, const uint8\_t \*inbuf, ssize\_t inlen, uint8\_t \*\*outbuf, ssize\_t \*outlen)

Calls the registered handler of an endpoint session for processing incoming data and generating the response.

---

**Note:**

- An endpoint must be bound to a valid protocomm instance, created using `protocomm_new()`.
  - Resulting output buffer must be deallocated by the caller.
- 

**Parameters**

- **pc** –[in] Pointer to the protocomm instance
- **ep\_name** –[in] Endpoint identifier(name) string
- **session\_id** –[in] Unique ID for a communication session
- **inbuf** –[in] Input buffer contains input request data which is to be processed by the registered handler
- **inlen** –[in] Length of the input buffer
- **outbuf** –[out] Pointer to internally allocated output buffer, where the resulting response data output from the registered handler is to be stored
- **outlen** –[out] Buffer length of the allocated output buffer

**Returns**

- ESP\_OK : Request handled successfully
- ESP\_FAIL : Internal error in execution of registered handler
- ESP\_ERR\_NO\_MEM : Error allocating internal resource
- ESP\_ERR\_NOT\_FOUND : Endpoint with specified name doesn't exist
- ESP\_ERR\_INVALID\_ARG : Null instance/name arguments

*esp\_err\_t* **protocomm\_set\_security** (*protocomm\_t* \*pc, const char \*ep\_name, const *protocomm\_security\_t* \*sec, const void \*sec\_params)

Add endpoint security for a protocomm instance.

This API will bind a security session establisher to the specified endpoint name, along with any proof of possession that may be required for authenticating a session client.

---

**Note:**

- An endpoint must be bound to a valid protocomm instance, created using `protocomm_new()`.
  - The choice of security can be any `protocomm_security_t` instance. Choices `protocomm_security0` and `protocomm_security1` and `protocomm_security2` are readily available.
- 

**Parameters**

- **pc** –[in] Pointer to the protocomm instance
- **ep\_name** –[in] Endpoint identifier(name) string
- **sec** –[in] Pointer to endpoint security instance
- **sec\_params** –[in] Pointer to security params (NULL if not needed) The pointer should contain the security params struct of appropriate security version. For protocomm security version 1 and 2 `sec_params` should contain pointer to struct of type `protocomm_security1_params_t` and `protocomm_security2_params_t` respectively. The contents of this pointer must be valid till the security session has been running and is not closed.

**Returns**

- ESP\_OK : Success
- ESP\_FAIL : Error adding endpoint / Endpoint with this name already exists
- ESP\_ERR\_INVALID\_STATE : Security endpoint already set
- ESP\_ERR\_NO\_MEM : Error allocating endpoint resource
- ESP\_ERR\_INVALID\_ARG : Null instance/name/handler arguments

*esp\_err\_t* **protocomm\_unset\_security** (*protocomm\_t* \*pc, const char \*ep\_name)

Remove endpoint security for a protocomm instance.

This API will remove a registered security endpoint identified by an endpoint name.

#### Parameters

- **pc** –[in] Pointer to the protocomm instance
- **ep\_name** –[in] Endpoint identifier(name) string

#### Returns

- ESP\_OK : Success
- ESP\_ERR\_NOT\_FOUND : Endpoint with specified name doesn't exist
- ESP\_ERR\_INVALID\_ARG : Null instance/name arguments

*esp\_err\_t* **protocomm\_set\_version** (*protocomm\_t* \*pc, const char \*ep\_name, const char \*version)

Set endpoint for version verification.

This API can be used for setting an application specific protocol version which can be verified by clients through the endpoint.

---

#### Note:

- An endpoint must be bound to a valid protocomm instance, created using `protocomm_new()`.
- 

#### Parameters

- **pc** –[in] Pointer to the protocomm instance
- **ep\_name** –[in] Endpoint identifier(name) string
- **version** –[in] Version identifier(name) string

#### Returns

- ESP\_OK : Success
- ESP\_FAIL : Error adding endpoint / Endpoint with this name already exists
- ESP\_ERR\_INVALID\_STATE : Version endpoint already set
- ESP\_ERR\_NO\_MEM : Error allocating endpoint resource
- ESP\_ERR\_INVALID\_ARG : Null instance/name/handler arguments

*esp\_err\_t* **protocomm\_unset\_version** (*protocomm\_t* \*pc, const char \*ep\_name)

Remove version verification endpoint from a protocomm instance.

This API will remove a registered version endpoint identified by an endpoint name.

#### Parameters

- **pc** –[in] Pointer to the protocomm instance
- **ep\_name** –[in] Endpoint identifier(name) string

#### Returns

- ESP\_OK : Success
- ESP\_ERR\_NOT\_FOUND : Endpoint with specified name doesn't exist
- ESP\_ERR\_INVALID\_ARG : Null instance/name arguments

### Type Definitions

```
typedef esp_err_t (*protocomm_req_handler_t)(uint32_t session_id, const uint8_t *inbuf, ssize_t inlen, uint8_t **outbuf, ssize_t *outlen, void *priv_data)
```

Function prototype for protocomm endpoint handler.

```
typedef struct protocomm protocomm_t
```

This structure corresponds to a unique instance of protocomm returned when the API `protocomm_new()` is called. The remaining Protocomm APIs require this object as the first parameter.

---

**Note:** Structure of the protocomm object is kept private

---

## Header File

- `components/protocomm/include/security/protocomm_security.h`

## Structures

struct **protocomm\_security1\_params**

Protocomm Security 1 parameters: Proof Of Possession.

### Public Members

const uint8\_t \***data**

Pointer to buffer containing the proof of possession data

uint16\_t **len**

Length (in bytes) of the proof of possession data

struct **protocomm\_security2\_params**

Protocomm Security 2 parameters: Salt and Verifier.

### Public Members

const char \***salt**

Pointer to the buffer containing the salt

uint16\_t **salt\_len**

Length (in bytes) of the salt

const char \***verifier**

Pointer to the buffer containing the verifier

uint16\_t **verifier\_len**

Length (in bytes) of the verifier

struct **protocomm\_security**

Protocomm security object structure.

The member functions are used for implementing secure protocomm sessions.

---

**Note:** This structure should not have any dynamic members to allow re-entrancy

---

### Public Members

int **ver**

Unique version number of security implementation

*esp\_err\_t* (**\*init**)(*protocomm\_security\_handle\_t* \*handle)

Function for initializing/allocating security infrastructure

*esp\_err\_t* (\***cleanup**)(*protocomm\_security\_handle\_t* handle)

Function for deallocating security infrastructure

*esp\_err\_t* (\***new\_transport\_session**)(*protocomm\_security\_handle\_t* handle, uint32\_t session\_id)

Starts new secure transport session with specified ID

*esp\_err\_t* (\***close\_transport\_session**)(*protocomm\_security\_handle\_t* handle, uint32\_t session\_id)

Closes a secure transport session with specified ID

*esp\_err\_t* (\***security\_req\_handler**)(*protocomm\_security\_handle\_t* handle, const void \*sec\_params, uint32\_t session\_id, const uint8\_t \*inbuf, ssize\_t inlen, uint8\_t \*\*outbuf, ssize\_t \*outlen, void \*priv\_data)

Handler function for authenticating connection request and establishing secure session

*esp\_err\_t* (\***encrypt**)(*protocomm\_security\_handle\_t* handle, uint32\_t session\_id, const uint8\_t \*inbuf, ssize\_t inlen, uint8\_t \*\*outbuf, ssize\_t \*outlen)

Function which implements the encryption algorithm

*esp\_err\_t* (\***decrypt**)(*protocomm\_security\_handle\_t* handle, uint32\_t session\_id, const uint8\_t \*inbuf, ssize\_t inlen, uint8\_t \*\*outbuf, ssize\_t \*outlen)

Function which implements the decryption algorithm

### Type Definitions

```
typedef struct protocomm_security1_params protocomm_security1_params_t
```

Protocomm Security 1 parameters: Proof Of Possession.

```
typedef protocomm_security1_params_t protocomm_security_pop_t
```

```
typedef struct protocomm_security2_params protocomm_security2_params_t
```

Protocomm Security 2 parameters: Salt and Verifier.

```
typedef void *protocomm_security_handle_t
```

```
typedef struct protocomm_security protocomm_security_t
```

Protocomm security object structure.

The member functions are used for implementing secure protocomm sessions.

---

**Note:** This structure should not have any dynamic members to allow re-entrancy

---

### Header File

- [components/protocomm/include/security/protocomm\\_security0.h](#)

### Header File

- [components/protocomm/include/security/protocomm\\_security1.h](#)

### Header File

- [components/protocomm/include/transports/protocomm\\_httpd.h](#)

## Functions

*esp\_err\_t* **protocomm\_httpd\_start** (*protocomm\_t* \*pc, const *protocomm\_httpd\_config\_t* \*config)

Start HTTPD protocomm transport.

This API internally creates a framework to allow endpoint registration and security configuration for the protocomm.

---

**Note:** This is a singleton. ie. Protocomm can have multiple instances, but only one instance can be bound to an HTTP transport layer.

---

### Parameters

- **pc** –[in] Protocomm instance pointer obtained from `protocomm_new()`
- **config** –[in] Pointer to config structure for initializing HTTP server

### Returns

- `ESP_OK` : Success
- `ESP_ERR_INVALID_ARG` : Null arguments
- `ESP_ERR_NOT_SUPPORTED` : Transport layer bound to another protocomm instance
- `ESP_ERR_INVALID_STATE` : Transport layer already bound to this protocomm instance
- `ESP_ERR_NO_MEM` : Memory allocation for server resource failed
- `ESP_ERR_HTTPD_*` : HTTP server error on start

*esp\_err\_t* **protocomm\_httpd\_stop** (*protocomm\_t* \*pc)

Stop HTTPD protocomm transport.

This API cleans up the HTTPD transport protocomm and frees all the handlers registered with the protocomm.

**Parameters** **pc** –[in] Same protocomm instance that was passed to `protocomm_httpd_start()`

### Returns

- `ESP_OK` : Success
- `ESP_ERR_INVALID_ARG` : Null / incorrect protocomm instance pointer

## Unions

union **protocomm\_httpd\_config\_data\_t**

*#include <protocomm\_httpd.h>* Protocomm HTTPD Configuration Data

### Public Members

void \***handle**

HTTP Server Handle, if `ext_handle_provided` is set to true

*protocomm\_http\_server\_config\_t* **config**

HTTP Server Configuration, if a server is not already active

## Structures

struct **protocomm\_http\_server\_config\_t**

Config parameters for protocomm HTTP server.

### Public Members

uint16\_t **port**

Port on which the HTTP server will listen

size\_t **stack\_size**

Stack size of server task, adjusted depending upon stack usage of endpoint handler

unsigned **task\_priority**

Priority of server task

struct **protocomm\_httpd\_config\_t**

Config parameters for protocomm HTTP server.

### Public Members

bool **ext\_handle\_provided**

Flag to indicate of an external HTTP Server Handle has been provided. In such as case, protocomm will use the same HTTP Server and not start a new one internally.

*protocomm\_httpd\_config\_data\_t* **data**

Protocomm HTTPD Configuration Data

### Macros

**PROTocomm\_HTTPD\_DEFAULT\_CONFIG** ()

### Header File

- [components/protocomm/include/transport/protocomm\\_ble.h](#)

### Functions

*esp\_err\_t* **protocomm\_ble\_start** (*protocomm\_t* \*pc, const *protocomm\_ble\_config\_t* \*config)

Start Bluetooth Low Energy based transport layer for provisioning.

Initialize and start required BLE service for provisioning. This includes the initialization for characteristics/service for BLE.

#### Parameters

- **pc** –[in] Protocomm instance pointer obtained from `protocomm_new()`
- **config** –[in] Pointer to config structure for initializing BLE

#### Returns

- `ESP_OK` : Success
- `ESP_FAIL` : Simple BLE start error
- `ESP_ERR_NO_MEM` : Error allocating memory for internal resources
- `ESP_ERR_INVALID_STATE` : Error in ble config
- `ESP_ERR_INVALID_ARG` : Null arguments

*esp\_err\_t* **protocomm\_ble\_stop** (*protocomm\_t* \*pc)

Stop Bluetooth Low Energy based transport layer for provisioning.

Stops service/task responsible for BLE based interactions for provisioning

---

**Note:** You might want to optionally reclaim memory from Bluetooth. Refer to the documentation of `esp_bt_mem_release` in that case.

---

**Parameters** `pc` –[in] Same protocomm instance that was passed to `protocomm_ble_start()`

**Returns**

- `ESP_OK` : Success
- `ESP_FAIL` : Simple BLE stop error
- `ESP_ERR_INVALID_ARG` : Null / incorrect protocomm instance

## Structures

struct **name\_uuid**

This structure maps handler required by protocomm layer to UUIDs which are used to uniquely identify BLE characteristics from a smartphone or a similar client device.

### Public Members

const char \***name**

Name of the handler, which is passed to protocomm layer

uint16\_t **uuid**

UUID to be assigned to the BLE characteristic which is mapped to the handler

struct **protocomm\_ble\_config**

Config parameters for protocomm BLE service.

### Public Members

char **device\_name**[MAX\_BLE\_DEVNAME\_LEN + 1]

BLE device name being broadcast at the time of provisioning

uint8\_t **service\_uuid**[BLE\_UUID128\_VAL\_LENGTH]

128 bit UUID of the provisioning service

uint8\_t \***manufacturer\_data**

BLE device manufacturer data pointer in advertisement

ssize\_t **manufacturer\_data\_len**

BLE device manufacturer data length in advertisement

ssize\_t **nu\_lookup\_count**

Number of entries in the Name-UUID lookup table

*protocomm\_ble\_name\_uuid\_t* \***nu\_lookup**

Pointer to the Name-UUID lookup table

unsigned **ble\_bonding**

BLE bonding

unsigned **ble\_sm\_sc**

BLE security flag



unsigned **ble\_link\_encryption**

BLE security flag

uint8\_t \***ble\_addr**

BLE address

## Macros

### **MAX\_BLE\_DEVNAME\_LEN**

BLE device name cannot be larger than this value 31 bytes (max scan response size) - 1 byte (length) - 1 byte (type) = 29 bytes

### **BLE\_UUID128\_VAL\_LENGTH**

### **MAX\_BLE\_MANUFACTURER\_DATA\_LEN**

Theoretically, the limit for max manufacturer length remains same as BLE device name i.e. 31 bytes (max scan response size) - 1 byte (length) - 1 byte (type) = 29 bytes However, manufacturer data goes along with BLE device name in scan response. So, it is important to understand the actual length should be smaller than (29 - (BLE device name length) - 2).

### **BLE\_ADDR\_LEN**

## Type Definitions

typedef struct *name\_uuid* **protocomm\_ble\_name\_uuid\_t**

This structure maps handler required by protocomm layer to UUIDs which are used to uniquely identify BLE characteristics from a smartphone or a similar client device.

typedef struct *protocomm\_ble\_config* **protocomm\_ble\_config\_t**

Config parameters for protocomm BLE service.

## 2.7.2 Unified Provisioning

### Overview

The unified provisioning support in the ESP-IDF provides an extensible mechanism to the developers to configure the device with the Wi-Fi credentials and/or other custom configuration using various transports and different security schemes. Depending on the use case, it provides a complete and ready solution for Wi-Fi network provisioning along with example iOS and Android applications. The developers can choose to extend the device-side and phone-app side implementations to accommodate their requirements for sending additional configuration data. The followings are the important features of this implementation:

#### 1. Extensible Protocol

The protocol is completely flexible and it offers the ability for the developers to send custom configuration in the provisioning process. The data representation is also left to the application to decide.

#### 2. Transport Flexibility

The protocol can work on Wi-Fi (SoftAP + HTTP server) or on Bluetooth LE as a transport protocol. The framework provides an ability to add support for any other transport easily as long as command-response behavior can be supported on the transport.

### 3. Security Scheme Flexibility

It is understood that each use case may require different security scheme to secure the data that is exchanged in the provisioning process. Some applications may work with SoftAP that is WPA2 protected or Bluetooth LE with the “just-works” security. Or the applications may consider the transport to be insecure and may want application-level security. The unified provisioning framework allows the application to choose the security as deemed suitable.

### 4. Compact Data Representation

The protocol uses [Google Protobufs](#) as a data representation for session setup and Wi-Fi provisioning. They provide a compact data representation and ability to parse the data in multiple programming languages in native format. Please note that this data representation is not forced on application-specific data and the developers may choose the representation of their choice.

## Typical Provisioning Process

### Deciding on Transport

The unified provisioning subsystem supports Wi-Fi (SoftAP+HTTP server) and Bluetooth LE (GATT based) transport schemes. The following points need to be considered while selecting the best possible transport for provisioning:

1. The Bluetooth LE-based transport has the advantage of maintaining an intact communication channel between the device and the client during the provisioning, which ensures reliable provisioning feedback.
2. The Bluetooth LE-based provisioning implementation makes the user experience better from the phone apps as on Android and iOS both, the phone app can discover and connect to the device without requiring the user to go out of the phone app.
3. However, the Bluetooth LE transport consumes about 110 KB memory at runtime. If the product does not use the Bluetooth LE or Bluetooth functionality after provisioning is done, almost all the memory can be reclaimed and added into the heap.
4. The SoftAP-based transport is highly interoperable. However, there are a few considerations:
  - The device uses the same radio to host the SoftAP and also to connect to the configured AP. Since these could potentially be on different channels, it may cause connection status updates not to be reliably received by the phone
  - The phone (client) has to disconnect from its current AP in order to connect to the SoftAP. The original network will get restored only when the provisioning process is complete, and the softAP is taken down.
5. The SoftAP transport does not require much additional memory for the Wi-Fi use cases.
6. The SoftAP-based provisioning requires the phone-app user to go to `System Settings` to connect to the Wi-Fi network hosted by the device in the iOS system. The discovery (scanning) as well as connection APIs are not available for the iOS applications.

### Deciding on Security

Depending on the transport and other constraints, the security scheme needs to be selected by the application developers. The following considerations need to be given from the provisioning-security perspective:

1. The configuration data sent from the client to the device and the response have to be secured.
2. The client should authenticate the device that it is connected to.
3. The device manufacturer may choose proof-of-possession (PoP), a unique per-device secret to be entered on the provisioning client as a security measure to make sure that only the user can provision the device in their possession.

There are two levels of security schemes, of which the developer may select one or a combination, depending on requirements.

#### 1. Transport Security

For SoftAP provisioning, developers may choose WPA2-protected security with unique per-device passphrase. Unique per-device passphrase can also act as a proof-of-possession. For Bluetooth LE, the “just-works” security can be used as a transport-level security after assessing its provided level of security.

#### 2. Application Security

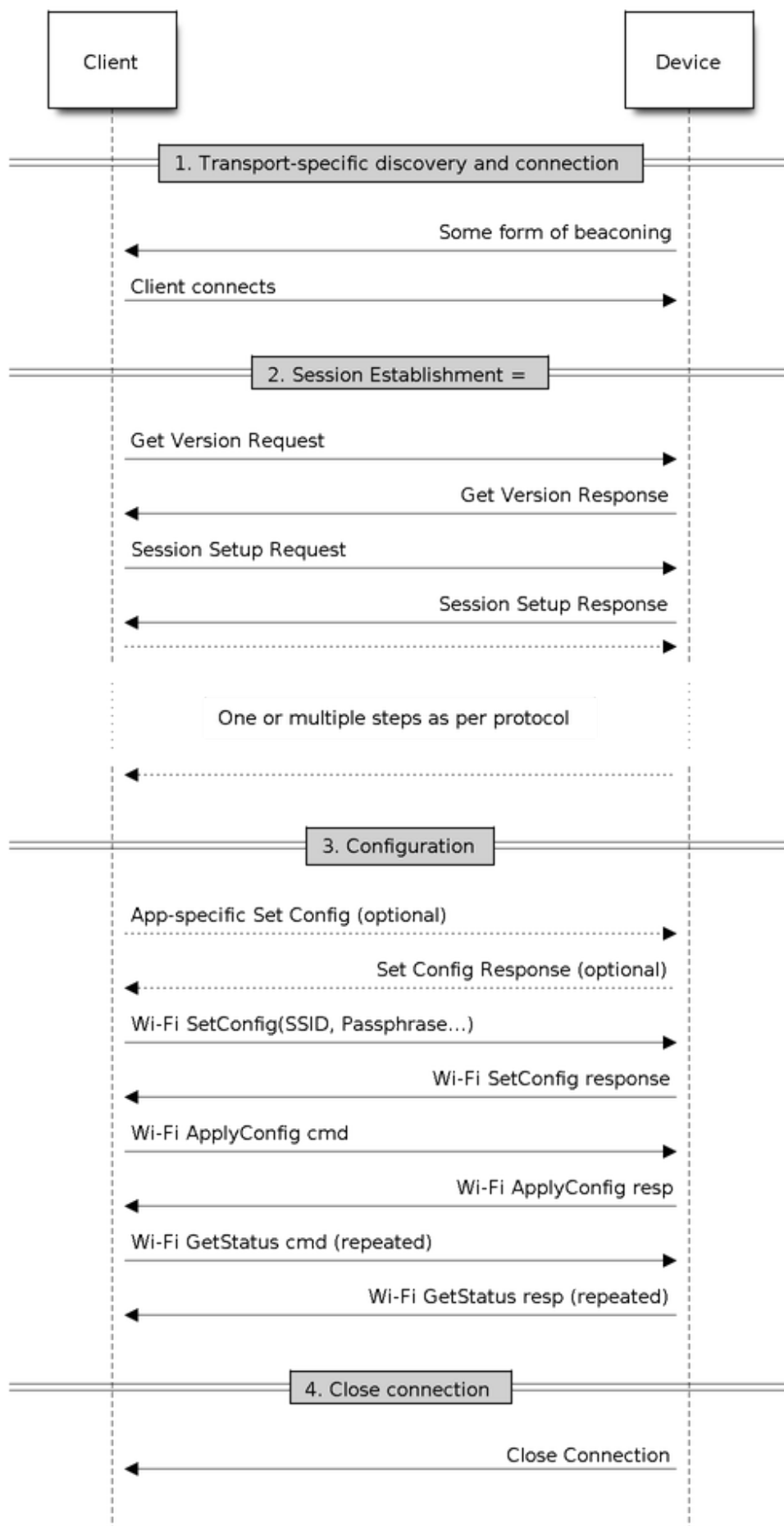

Fig. 33: Typical Provisioning Process

The unified provisioning subsystem provides the application-level security (*Security 1 Scheme*) that provides data protection and authentication through PoP, if the application does not use the transport-level security, or if the transport-level security is not sufficient for the use case.

### Device Discovery

The advertisement and device discovery is left to the application and depending on the protocol chosen, the phone apps and device-firmware application can choose appropriate method for advertisement and discovery.

For the SoftAP+HTTP transport, typically the SSID (network name) of the AP hosted by the device can be used for discovery.

For the Bluetooth LE transport, device name or primary service included in the advertisement or a combination of both can be used for discovery.

### Architecture

The below diagram shows the architecture of unified provisioning:

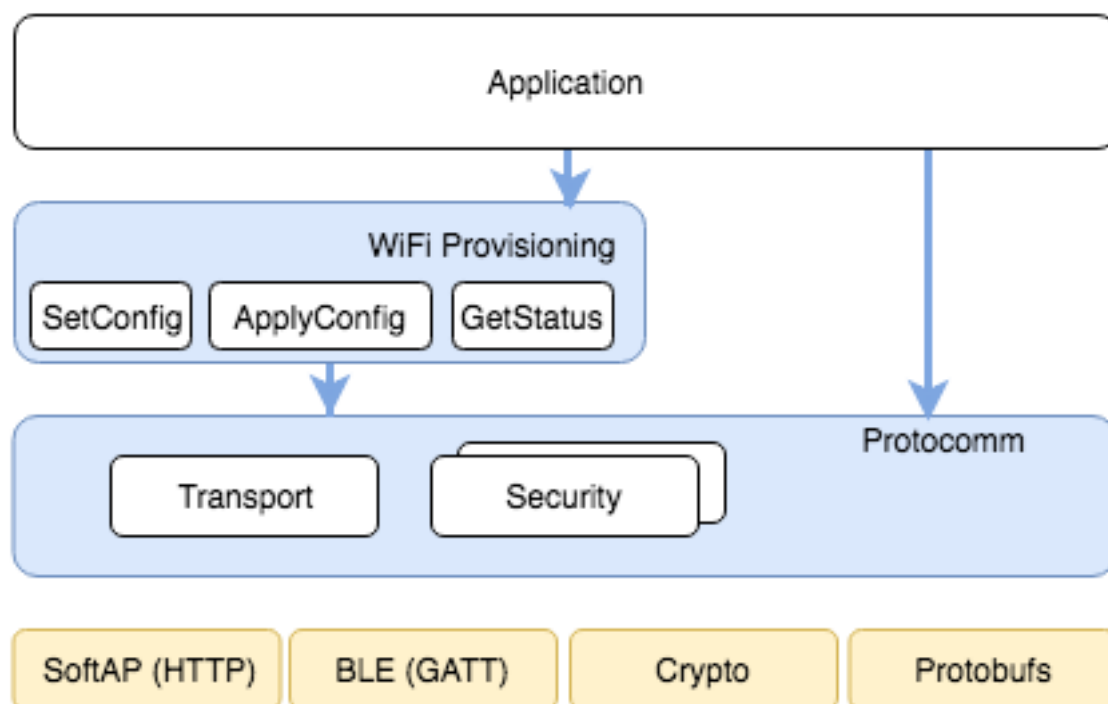

Fig. 34: Unified Provisioning Architecture

It relies on the base layer called *Protocol Communication* (protocomm) which provides a framework for security schemes and transport mechanisms. The Wi-Fi Provisioning layer uses protocomm to provide simple callbacks to the application for setting the configuration and getting the Wi-Fi status. The application has control over implementation of these callbacks. In addition, the application can directly use protocomm to register custom handlers.

The application creates a protocomm instance which is mapped to a specific transport and specific security scheme. Each transport in the protocomm has a concept of an “end-point” which corresponds to the logical channel for communication for specific type of information. For example, security handshake happens on a different endpoint from the Wi-Fi configuration endpoint. Each end-point is identified using a string and depending on the transport internal representation of the end-point changes. In case of the SoftAP+HTTP transport, the end-point corresponds to URI, whereas in case of Bluetooth LE, the end-point corresponds to the GATT characteristic with specific UUID.

Developers can create custom end-points and implement handler for the data that is received or sent over the same end-point.

## Security Schemes

At present, the unified provisioning supports the following security schemes:

1. Security 0

No security (No encryption).

2. Security 1

Curve25519-based key exchange, shared key derivation and AES256-CTR mode encryption of the data. It supports two modes :

- a. Authorized - Proof of Possession (PoP) string used to authorize session and derive shared key.
- b. No Auth (Null PoP) - Shared key derived through key exchange only.

3. Security 2

SRP6a-based shared key derivation and AES256-GCM mode encryption of the data.

---

**Note:** The respective security schemes need to be enabled through the project configuration menu. Please refer to [Enabling Protocomm Security Version](#) for more details.

---

## Security 1 Scheme

The Security 1 scheme details are shown in the below sequence diagram:

## Security 2 Scheme

The Security 2 scheme is based on the Secure Remote Password (SRP6a) protocol, see [RFC 5054](#).

The protocol requires the Salt and Verifier to be generated beforehand with the help of the identifying username  $I$  and the plaintext password  $p$ . The Salt and Verifier are then stored on ESP32-S2.

- The password  $p$  and the username  $I$  are to be provided to the Phone App (Provisioning entity) by suitable means, e.g., QR code sticker.

Details about the Security 2 scheme are shown in the below sequence diagram:

## Sample Code

Please refer to [Protocol Communication](#) and [Wi-Fi Provisioning](#) for API guides and code snippets on example usage. Application implementation can be found as an example under [provisioning](#).

## Provisioning Tools

Provisioning applications are available for various platforms, along with source code:

- **Android:**
  - [Bluetooth LE Provisioning app on Play Store](#).
  - [SoftAP Provisioning app on Play Store](#).
  - Source code on GitHub: [esp-idf-provisioning-android](#).
- **iOS:**
  - [Bluetooth LE Provisioning app on App Store](#).
  - [SoftAP Provisioning app on App Store](#).

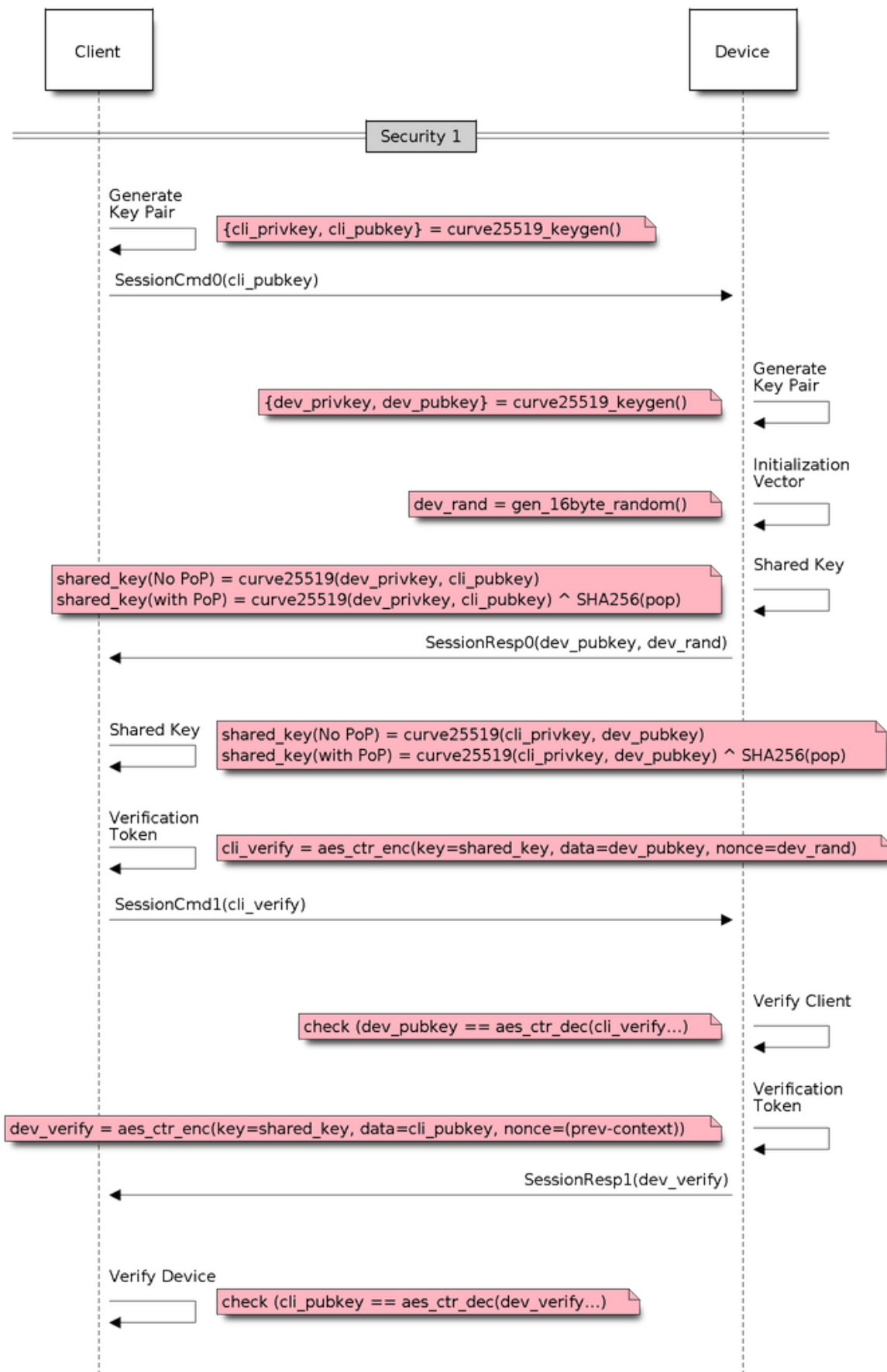

Fig. 35: Security 1

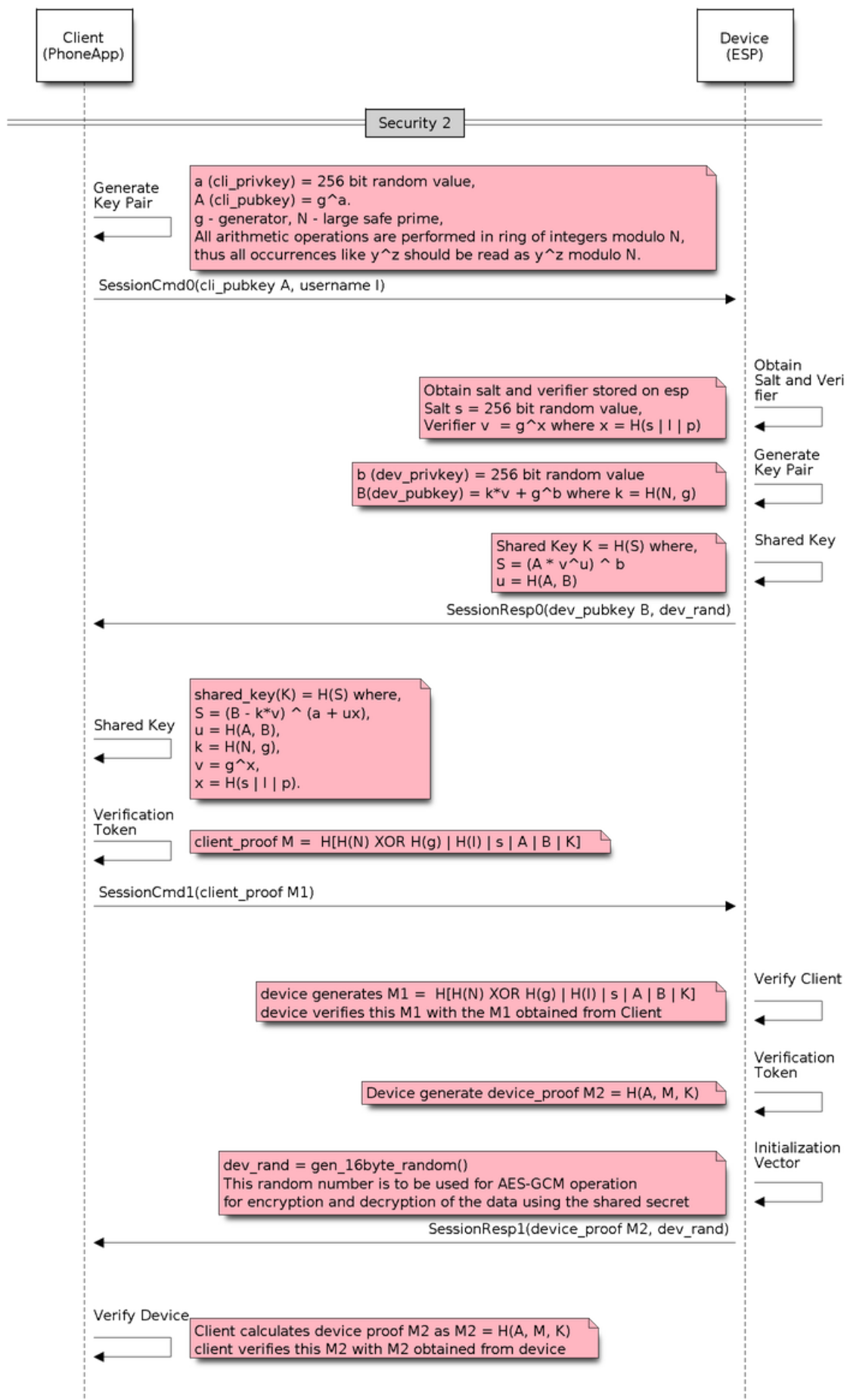

Fig. 36: Security 2

- Source code on GitHub: [esp-idf-provisioning-ios](#).
- Linux/macOS/Windows: [tools/esp\\_prov](#), a Python-based command line tool for provisioning.

The phone applications offer simple UI and are thus more user centric, while the command-line application is useful as a debugging tool for developers.

### 2.7.3 Wi-Fi Provisioning

#### Overview

This component provides APIs that control the Wi-Fi provisioning service for receiving and configuring Wi-Fi credentials over SoftAP or Bluetooth LE transport via secure *Protocol Communication* sessions. The set of `wifi_prov_mgr_` APIs help quickly implement a provisioning service that has necessary features with minimal amount of code and sufficient flexibility.

**Initialization** `wifi_prov_mgr_init()` is called to configure and initialize the provisioning manager, and thus must be called prior to invoking any other `wifi_prov_mgr_` APIs. Note that the manager relies on other components of ESP-IDF, namely NVS, TCP/IP, Event Loop and Wi-Fi, and optionally mDNS, hence these components must be initialized beforehand. The manager can be de-initialized at any moment by making a call to `wifi_prov_mgr_deinit()`.

```
wifi_prov_mgr_config_t config = {
    .scheme = wifi_prov_scheme_ble,
    .scheme_event_handler = WIFI_PROV_SCHEME_BLE_EVENT_HANDLER_FREE_BTDM
};

ESP_ERROR_CHECK( wifi_prov_mgr_init(config) );
```

The configuration structure `wifi_prov_mgr_config_t` has a few fields to specify the desired behavior of the manager:

- `wifi_prov_mgr_config_t::scheme` - This is used to specify the provisioning scheme. Each scheme corresponds to one of the modes of transport supported by protocomm. Hence, support the following options:
  - `wifi_prov_scheme_ble` - Bluetooth LE transport and GATT Server for handling the provisioning commands.
  - `wifi_prov_scheme_softap` - Wi-Fi SoftAP transport and HTTP Server for handling the provisioning commands.
  - `wifi_prov_scheme_console` - Serial transport and console for handling the provisioning commands.
- `wifi_prov_mgr_config_t::scheme_event_handler`: An event handler defined along with the scheme. Choosing the appropriate scheme-specific event handler allows the manager to take care of certain matters automatically. Presently, this option is not used for either the SoftAP or Console-based provisioning, but is very convenient for Bluetooth LE. To understand how, we must recall that Bluetooth requires a substantial amount of memory to function, and once the provisioning is finished, the main application may want to reclaim back this memory (or part of it) if it needs to use either Bluetooth LE or classic Bluetooth. Also, upon every future reboot of a provisioned device, this reclamation of memory needs to be performed again. To reduce this complication in using `wifi_prov_scheme_ble`, the scheme-specific handlers have been defined, and depending upon the chosen handler, the Bluetooth LE/classic Bluetooth/BTDM memory is freed automatically when the provisioning manager is de-initialized. The available options are:
  - `WIFI_PROV_SCHEME_BLE_EVENT_HANDLER_FREE_BTDM` - Free both classic Bluetooth and Bluetooth LE/BTDM memory. Used when the main application does not require Bluetooth at all.



- `WIFI_PROV_SCHEME_BLE_EVENT_HANDLER_FREE_BLE` - Free only Bluetooth LE memory. Used when main application requires classic Bluetooth.
- `WIFI_PROV_SCHEME_BLE_EVENT_HANDLER_FREE_BT` - Free only classic Bluetooth. Used when main application requires Bluetooth LE. In this case freeing happens right when the manager is initialized.
- `WIFI_PROV_EVENT_HANDLER_NONE` - Do not use any scheme specific handler. Used when the provisioning scheme is not Bluetooth LE, i.e., using SoftAP or Console, or when main application wants to handle the memory reclaiming on its own, or needs both Bluetooth LE and classic Bluetooth to function.
- `wifi_prov_mgr_config_t::app_event_handler` (Deprecated) - It is now recommended to catch `WIFI_PROV_EVENT` that is emitted to the default event loop handler. See definition of `wifi_prov_cb_event_t` for the list of events that are generated by the provisioning service. Here is an excerpt showing some of the provisioning events:

```
static void event_handler(void* arg, esp_event_base_t event_base,
                        int event_id, void* event_data)
{
    if (event_base == WIFI_PROV_EVENT) {
        switch (event_id) {
            case WIFI_PROV_START:
                ESP_LOGI(TAG, "Provisioning started");
                break;
            case WIFI_PROV_CRED_RECV: {
                wifi_sta_config_t *wifi_sta_cfg = (wifi_sta_config_t_
↳*)event_data;
                ESP_LOGI(TAG, "Received Wi-Fi credentials"
                        "\n\tSSID      : %s\n\tPassword : %s",
                        (const char *) wifi_sta_cfg->ssid,
                        (const char *) wifi_sta_cfg->password);
                break;
            }
            case WIFI_PROV_CRED_FAIL: {
                wifi_prov_sta_fail_reason_t *reason = (wifi_prov_sta_fail_
↳reason_t *)event_data;
                ESP_LOGE(TAG, "Provisioning failed!\n\tReason : %s"
                        "\n\tPlease reset to factory and retry_
↳provisioning",
                        (*reason == WIFI_PROV_STA_AUTH_ERROR) ?
                        "Wi-Fi station authentication failed" : "Wi-Fi_
↳access-point not found");
                break;
            }
            case WIFI_PROV_CRED_SUCCESS:
                ESP_LOGI(TAG, "Provisioning successful");
                break;
            case WIFI_PROV_END:
                /* De-initialize manager once provisioning is finished */
                wifi_prov_mgr_deinit();
                break;
            default:
                break;
        }
    }
}
```

The manager can be de-initialized at any moment by making a call to `wifi_prov_mgr_deinit()`.

**Check the Provisioning State** Whether the device is provisioned or not can be checked at runtime by calling `wifi_prov_mgr_is_provisioned()`. This internally checks if the Wi-Fi credentials are stored in NVS.

Note that presently the manager does not have its own NVS namespace for storage of Wi-Fi credentials, instead it

relies on the `esp_wifi_` APIs to set and get the credentials stored in NVS from the default location.

If the provisioning state needs to be reset, any of the following approaches may be taken:

- The associated part of NVS partition has to be erased manually
- The main application must implement some logic to call `esp_wifi_` APIs for erasing the credentials at runtime
- The main application must implement some logic to force start the provisioning irrespective of the provisioning state

```
bool provisioned = false;
ESP_ERROR_CHECK( wifi_prov_mgr_is_provisioned(&provisioned) );
```

**Start the Provisioning Service** At the time of starting provisioning we need to specify a service name and the corresponding key, that is to say:

- A Wi-Fi SoftAP SSID and a passphrase, respectively, when the scheme is `wifi_prov_scheme_softap`.
- Bluetooth LE device name with the service key ignored when the scheme is `wifi_prov_scheme_ble`.

Also, since internally the manager uses `protocomm`, we have the option of choosing one of the security features provided by it:

- Security 1 is secure communication which consists of a prior handshake involving X25519 key exchange along with authentication using a proof of possession `pop`, followed by AES-CTR for encryption or decryption of subsequent messages.
- Security 0 is simply plain text communication. In this case the `pop` is simply ignored.

See *Unified Provisioning* for details about the security features.

```
const char *service_name = "my_device";
const char *service_key = "password";

wifi_prov_security_t security = WIFI_PROV_SECURITY_1;
const char *pop = "abcd1234";

ESP_ERROR_CHECK( wifi_prov_mgr_start_provisioning(security, pop, service_
↪name, service_key) );
```

The provisioning service automatically finishes only if it receives valid Wi-Fi AP credentials followed by successful connection of device to the AP with IP obtained. Regardless of that, the provisioning service can be stopped at any moment by making a call to `wifi_prov_mgr_stop_provisioning()`.

---

**Note:** If the device fails to connect with the provided credentials, it does not accept new credentials anymore, but the provisioning service keeps on running, only to convey failure to the client, until the device is restarted. Upon restart, the provisioning state turns out to be true this time, as credentials are found in NVS, but the device does fail again to connect with those same credentials, unless an AP with the matching credentials somehow does become available. This situation can be fixed by resetting the credentials in NVS or force starting the provisioning service. This has been explained above in *Check the Provisioning State*.

---

**Waiting for Completion** Typically, the main application waits for the provisioning to finish, then de-initializes the manager to free up resources, and finally starts executing its own logic.

There are two ways for making this possible. The simpler way is to use a blocking call to `wifi_prov_mgr_wait()`.

```
// Start provisioning service
ESP_ERROR_CHECK( wifi_prov_mgr_start_provisioning(security, pop, service_
↪name, service_key) );
```

(continues on next page)

(continued from previous page)

```
// Wait for service to complete
wifi_prov_mgr_wait();

// Finally de-initialize the manager
wifi_prov_mgr_deinit();
```

The other way is to use the default event loop handler to catch `WIFI_PROV_EVENT` and call `wifi_prov_mgr_deinit()` when event ID is `WIFI_PROV_END`:

```
static void event_handler(void* arg, esp_event_base_t event_base,
                          int event_id, void* event_data)
{
    if (event_base == WIFI_PROV_EVENT && event_id == WIFI_PROV_END) {
        /* De-initialize the manager once the provisioning is finished */
        wifi_prov_mgr_deinit();
    }
}
```

**User Side Implementation** When the service is started, the device to be provisioned is identified by the advertised service name, which, depending upon the selected transport, is either the Bluetooth LE device name or the SoftAP SSID.

When using SoftAP transport, for allowing service discovery, mDNS must be initialized before starting provisioning. In this case, the host name set by the main application is used, and the service type is internally set to `_esp_wifi_prov`.

When using Bluetooth LE transport, a custom 128-bit UUID should be set using `wifi_prov_scheme_ble_set_service_uuid()`. This UUID is to be included in the Bluetooth LE advertisement and corresponds to the primary GATT service that provides provisioning endpoints as GATT characteristics. Each GATT characteristic is formed using the primary service UUID as the base, with different auto-assigned 12th and 13th bytes, presumably counting from the 0th byte. Since an endpoint characteristic UUID is auto-assigned, it should not be used to identify the endpoint. Instead, client-side applications should identify the endpoints by reading the User Characteristic Description (0x2901) descriptor for each characteristic, which contains the endpoint name of the characteristic. For example, if the service UUID is set to 55cc035e-fb27-4f80-be02-3c60828b7451, each endpoint characteristic is assigned a UUID like 55cc\_\_\_\_-fb27-4f80-be02-3c60828b7451, with unique values at the 12th and 13th bytes.

Once connected to the device, the provisioning-related protocomm endpoints can be identified as follows:

Table 8: Endpoints Provided by the Provisioning Service

Endpoint Name i.e., Bluetooth LE + GATT Server	URI, i.e., SoftAP + HTTP Server + mDNS	Description
prov-session	<a href="http://&lt;mdns-hostname&gt;.local/prov-session">http://&lt;mdns-hostname&gt;.local/prov-session</a>	Security endpoint used for session establishment
prov-scan	<a href="http://wifi-prov.local/prov-scan">http://wifi-prov.local/prov-scan</a>	the endpoint used for starting Wi-Fi scan and receiving scan results
prov-ctrl	<a href="http://wifi-prov.local/prov-ctrl">http://wifi-prov.local/prov-ctrl</a>	the endpoint used for controlling Wi-Fi provisioning state
prov-config	<a href="http://&lt;mdns-hostname&gt;.local/prov-config">http://&lt;mdns-hostname&gt;.local/prov-config</a>	the endpoint used for configuring Wi-Fi credentials on device
proto-ver	<a href="http://&lt;mdns-hostname&gt;.local/proto-ver">http://&lt;mdns-hostname&gt;.local/proto-ver</a>	the endpoint for retrieving version info

Immediately after connecting, the client application may fetch the version/capabilities information from the `proto-ver` endpoint. All communications to this endpoint are unencrypted, hence necessary information, which may be relevant for deciding compatibility, can be retrieved before establishing a secure session. The response is in

JSON format and looks like: `prov: { ver: v1.1, cap: [no_pop] }, my_app: { ver: 1.345, cap: [cloud, local_ctrl] }, ...`. Here label `prov` provides provisioning service version `ver` and capabilities `cap`. For now, only the `no_pop` capability is supported, which indicates that the service does not require proof of possession for authentication. Any application-related version or capabilities are given by other labels, e.g., `my_app` in this example. These additional fields are set using `wifi_prov_mgr_set_app_info()`.

User side applications need to implement the signature handshaking required for establishing and authenticating secure protocomm sessions as per the security scheme configured for use, which is not needed when the manager is configured to use protocomm security 0.

See *Unified Provisioning* for more details about the secure handshake and encryption used. Applications must use the `.proto` files found under `protocomm/proto`, which define the Protobuf message structures supported by `prov-session` endpoint.

Once a session is established, Wi-Fi credentials are configured using the following set of `wifi_config` commands, serialized as Protobuf messages with the corresponding `.proto` files that can be found under `wifi_provisioning/proto`:

- `get_status` - For querying the Wi-Fi connection status. The device responds with a status which is one of connecting, connected or disconnected. If the status is disconnected, a disconnection reason is also to be included in the status response.
- `set_config` - For setting the Wi-Fi connection credentials.
- `apply_config` - For applying the credentials saved during `set_config` and starting the Wi-Fi station.

After session establishment, the client can also request Wi-Fi scan results from the device. The results returned is a list of AP SSIDs, sorted in descending order of signal strength. This allows client applications to display APs nearby to the device at the time of provisioning, and users can select one of the SSIDs and provide the password which is then sent using the `wifi_config` commands described above. The `wifi_scan` endpoint supports the following protobuf commands:

- `scan_start` - For starting Wi-Fi scan with various options:
  - `blocking` (input) - If true, the command returns only when the scanning is finished.
  - `passive` (input) - If true, the scan is started in passive mode, which may be slower, instead of active mode.
  - `group_channels` (input) - This specifies whether to scan all channels in one go when zero, or perform scanning of channels in groups, with 120 ms delay between scanning of consecutive groups, and the value of this parameter sets the number of channels in each group. This is useful when transport mode is SoftAP, where scanning all channels in one go may not give the Wi-Fi driver enough time to send out beacons, and hence may cause disconnection with any connected stations. When scanning in groups, the manager waits for at least 120 ms after completing the scan on a group of channels, and thus allows the driver to send out the beacons. For example, given that the total number of Wi-Fi channels is 14, then setting `group_channels` to 3 creates 5 groups, with each group having 3 channels, except the last one which has  $14 \% 3 = 2$  channels. So, when the scan is started, the first 3 channels will be scanned, followed by a 120 ms delay, and then the next 3 channels, and so on, until all the 14 channels have been scanned. One may need to adjust this parameter as having only a few channels in a group may increase the overall scan time, while having too many may again cause disconnection. Usually, a value of 4 should work for most cases. Note that for any other mode of transport, e.g. Bluetooth LE, this can be safely set to 0, and hence achieve the shortest overall scanning time.
  - `period_ms` (input) - The scan parameter specifying how long to wait on each channel.
- `scan_status` - It gives the status of scanning process:
  - `scan_finished` (output) - When the scan has finished, this returns true.
  - `result_count` (output) - This gives the total number of results obtained till now. If the scan is yet happening, this number keeps on updating.
- `scan_result` - For fetching the scan results. This can be called even if the scan is still on going.
  - `start_index` (input) - Where the index starts from to fetch the entries from the results list.
  - `count` (input) - The number of entries to fetch from the starting index.
  - `entries` (output) - The list of entries returned. Each entry consists of `ssid`, `channel` and `rssi` information.

The client can also control the provisioning state of the device using `wifi_ctrl` endpoint. The `wifi_ctrl` endpoint supports the following protobuf commands:

- `ctrl_reset` - Resets internal state machine of the device and clears provisioned credentials only in case of provisioning failures.
- `ctrl_reprov` - Resets internal state machine of the device and clears provisioned credentials only in case the device is to be provisioned again for new credentials after a previous successful provisioning.

**Additional Endpoints** In case users want to have some additional protocol endpoints customized to their requirements, this is done in two steps. First is creation of an endpoint with a specific name, and the second step is the registration of a handler for this endpoint. See *Protocol Communication* for the function signature of an endpoint handler. A custom endpoint must be created after initialization and before starting the provisioning service. Whereas, the protocol handler is registered for this endpoint only after starting the provisioning service.

```
wifi_prov_mgr_init(config);  
wifi_prov_mgr_endpoint_create("custom-endpoint");  
wifi_prov_mgr_start_provisioning(security, pop, service_name, service_  
→key);  
wifi_prov_mgr_endpoint_register("custom-endpoint", custom_ep_handler, ↵  
→custom_ep_data);
```

When the provisioning service stops, the endpoint is unregistered automatically.

One can also choose to call `wifi_prov_mgr_endpoint_unregister()` to manually deactivate an endpoint at runtime. This can also be used to deactivate the internal endpoints used by the provisioning service.

**When/How to Stop the Provisioning Service?** The default behavior is that once the device successfully connects using the Wi-Fi credentials set by the `apply_config` command, the provisioning service stops, and Bluetooth LE or SoftAP turns off, automatically after responding to the next `get_status` command. If `get_status` command is not received by the device, the service stops after a 30s timeout.

On the other hand, if device is not able to connect using the provided Wi-Fi credentials, due to incorrect SSID or passphrase, the service keeps running, and `get_status` keeps responding with disconnected status and reason for disconnection. Any further attempts to provide another set of Wi-Fi credentials, are to be rejected. These credentials are preserved, unless the provisioning service is force started, or NVS erased.

If this default behavior is not desired, it can be disabled by calling `wifi_prov_mgr_disable_auto_stop()`. Now the provisioning service stops only after an explicit call to `wifi_prov_mgr_stop_provisioning()`, which returns immediately after scheduling a task for stopping the service. The service stops after a certain delay and `WIFI_PROV_END` event gets emitted. This delay is specified by the argument to `wifi_prov_mgr_disable_auto_stop()`.

The customized behavior is useful for applications which want the provisioning service to be stopped some time after the Wi-Fi connection is successfully established. For example, if the application requires the device to connect to some cloud service and obtain another set of credentials, and exchange these credentials over a custom protocol endpoint, then after successfully doing so, stop the provisioning service by calling `wifi_prov_mgr_stop_provisioning()` inside the protocol handler itself. The right amount of delay ensures that the transport resources are freed only after the response from the protocol handler reaches the client side application.

## Application Examples

For complete example implementation see [provisioning/wifi\\_prov\\_mgr](#).

## Provisioning Tools

Provisioning applications are available for various platforms, along with source code:

- **Android:**
  - [Bluetooth LE Provisioning app on Play Store](#).
  - [SoftAP Provisioning app on Play Store](#).

- Source code on GitHub: [esp-idf-provisioning-android](#).
- **iOS:**
  - [Bluetooth LE Provisioning app on App Store](#).
  - [SoftAP Provisioning app on App Store](#).
  - Source code on GitHub: [esp-idf-provisioning-ios](#).
- Linux/MacOS/Windows: [tools/esp\\_prov](#), a Python-based command-line tool for provisioning.

The phone applications offer simple UI and are thus more user centric, while the command-line application is useful as a debugging tool for developers.

## API Reference

### Header File

- [components/wifi\\_provisioning/include/wifi\\_provisioning/manager.h](#)

### Functions

*esp\_err\_t* **wifi\_prov\_mgr\_init** (*wifi\_prov\_mgr\_config\_t* config)

Initialize provisioning manager instance.

Configures the manager and allocates internal resources

Configuration specifies the provisioning scheme (transport) and event handlers

Event WIFI\_PROV\_INIT is emitted right after initialization is complete

**Parameters** **config** –[in] Configuration structure

#### Returns

- ESP\_OK : Success
- ESP\_FAIL : Fail

void **wifi\_prov\_mgr\_deinit** (void)

Stop provisioning (if running) and release resource used by the manager.

Event WIFI\_PROV\_DEINIT is emitted right after de-initialization is finished

If provisioning service is still active when this API is called, it first stops the service, hence emitting WIFI\_PROV\_END, and then performs the de-initialization

*esp\_err\_t* **wifi\_prov\_mgr\_is\_provisioned** (bool \*provisioned)

Checks if device is provisioned.

This checks if Wi-Fi credentials are present on the NVS

The Wi-Fi credentials are assumed to be kept in the same NVS namespace as used by esp\_wifi component

If one were to call esp\_wifi\_set\_config() directly instead of going through the provisioning process, this function will still yield true (i.e. device will be found to be provisioned)

---

**Note:** Calling wifi\_prov\_mgr\_start\_provisioning() automatically resets the provision state, irrespective of what the state was prior to making the call.

---

**Parameters** **provisioned** –[out] True if provisioned, else false

#### Returns

- ESP\_OK : Retrieved provision state successfully
- ESP\_FAIL : Wi-Fi not initialized
- ESP\_ERR\_INVALID\_ARG : Null argument supplied

*esp\_err\_t* **wifi\_prov\_mgr\_start\_provisioning** (*wifi\_prov\_security\_t* security, const void \*wifi\_prov\_sec\_params, const char \*service\_name, const char \*service\_key)

Start provisioning service.

This starts the provisioning service according to the scheme configured at the time of initialization. For scheme :

- `wifi_prov_scheme_ble` : This starts `protocomm_ble`, which internally initializes BLE transport and starts GATT server for handling provisioning requests
- `wifi_prov_scheme_softap` : This activates SoftAP mode of Wi-Fi and starts `protocomm_httpd`, which internally starts an HTTP server for handling provisioning requests (If mDNS is active it also starts advertising service with type `_esp_wifi_prov._tcp`)

Event `WIFI_PROV_START` is emitted right after provisioning starts without failure

---

**Note:** This API will start provisioning service even if device is found to be already provisioned, i.e. `wifi_prov_mgr_is_provisioned()` yields true

---

### Parameters

- **security** `–[in]` Specify which `protocomm` security scheme to use :
  - `WIFI_PROV_SECURITY_0` : For no security
  - `WIFI_PROV_SECURITY_1` : x25519 secure handshake for session establishment followed by AES-CTR encryption of provisioning messages
  - `WIFI_PROV_SECURITY_2`: SRP6a based authentication and key exchange followed by AES-GCM encryption/decryption of provisioning messages
- **wifi\_prov\_sec\_params** `–[in]` Pointer to security params (NULL if not needed). This is not needed for `protocomm` security 0 This pointer should hold the struct of type `wifi_prov_security1_params_t` for `protocomm` security 1 and `wifi_prov_security2_params_t` for `protocomm` security 2 respectively. This pointer and its contents should be valid till the provisioning service is running and has not been stopped or de-initiated.
- **service\_name** `–[in]` Unique name of the service. This translates to:
  - Wi-Fi SSID when provisioning mode is softAP
  - Device name when provisioning mode is BLE
- **service\_key** `–[in]` Key required by client to access the service (NULL if not needed). This translates to:
  - Wi-Fi password when provisioning mode is softAP
  - ignored when provisioning mode is BLE

### Returns

- `ESP_OK` : Provisioning started successfully
- `ESP_FAIL` : Failed to start provisioning service
- `ESP_ERR_INVALID_STATE` : Provisioning manager not initialized or already started

void **wifi\_prov\_mgr\_stop\_provisioning** (void)

Stop provisioning service.

If provisioning service is active, this API will initiate a process to stop the service and return. Once the service actually stops, the event `WIFI_PROV_END` will be emitted.

If `wifi_prov_mgr_deinit()` is called without calling this API first, it will automatically stop the provisioning service and emit the `WIFI_PROV_END`, followed by `WIFI_PROV_DEINIT`, before returning.

This API will generally be used along with `wifi_prov_mgr_disable_auto_stop()` in the scenario when the main application has registered its own endpoints, and wishes that the provisioning service is stopped only when some `protocomm` command from the client side application is received.

Calling this API inside an endpoint handler, with sufficient `cleanup_delay`, will allow the response / acknowledgment to be sent successfully before the underlying `protocomm` service is stopped.

`Cleanup_delay` is set when calling `wifi_prov_mgr_disable_auto_stop()`. If not specified, it defaults to 1000ms.



For straightforward cases, using this API is usually not necessary as provisioning is stopped automatically once `WIFI_PROV_CRED_SUCCESS` is emitted. Stopping is delayed (maximum 30 seconds) thus allowing the client side application to query for Wi-Fi state, i.e. after receiving the first query and sending `Wi-Fi state connected` response the service is stopped immediately.

void **wifi\_prov\_mgr\_wait** (void)

Wait for provisioning service to finish.

Calling this API will block until provisioning service is stopped i.e. till event `WIFI_PROV_END` is emitted.

This will not block if provisioning is not started or not initialized.

*esp\_err\_t* **wifi\_prov\_mgr\_disable\_auto\_stop** (uint32\_t cleanup\_delay)

Disable auto stopping of provisioning service upon completion.

By default, once provisioning is complete, the provisioning service is automatically stopped, and all endpoints (along with those registered by main application) are deactivated.

This API is useful in the case when main application wishes to close provisioning service only after it receives some protocomm command from the client side app. For example, after connecting to Wi-Fi, the device may want to connect to the cloud, and only once that is successfully, the device is said to be fully configured. But, then it is upto the main application to explicitly call `wifi_prov_mgr_stop_provisioning()` later when the device is fully configured and the provisioning service is no longer required.

---

**Note:** This must be called before executing `wifi_prov_mgr_start_provisioning()`

---

**Parameters** **cleanup\_delay** **–[in]** Sets the delay after which the actual cleanup of transport related resources is done after a call to `wifi_prov_mgr_stop_provisioning()` returns. Minimum allowed value is 100ms. If not specified, this will default to 1000ms.

**Returns**

- `ESP_OK` : Success
- `ESP_ERR_INVALID_STATE` : Manager not initialized or provisioning service already started

*esp\_err\_t* **wifi\_prov\_mgr\_set\_app\_info** (const char \*label, const char \*version, const char \*\*capabilities, size\_t total\_capabilities)

Set application version and capabilities in the JSON data returned by proto-ver endpoint.

This function can be called multiple times, to specify information about the various application specific services running on the device, identified by unique labels.

The provisioning service itself registers an entry in the JSON data, by the label “prov” , containing only provisioning service version and capabilities. Application services should use a label other than “prov” so as not to overwrite this.

---

**Note:** This must be called before executing `wifi_prov_mgr_start_provisioning()`

---

**Parameters**

- **label** **–[in]** String indicating the application name.
- **version** **–[in]** String indicating the application version. There is no constraint on format.
- **capabilities** **–[in]** Array of strings with capabilities. These could be used by the client side app to know the application registered endpoint capabilities
- **total\_capabilities** **–[in]** Size of capabilities array

**Returns**

- `ESP_OK` : Success
- `ESP_ERR_INVALID_STATE` : Manager not initialized or provisioning service already started
- `ESP_ERR_NO_MEM` : Failed to allocate memory for version string



- `ESP_ERR_INVALID_ARG` : Null argument

*esp\_err\_t* **wifi\_prov\_mgr\_endpoint\_create** (const char \*ep\_name)

Create an additional endpoint and allocate internal resources for it.

This API is to be called by the application if it wants to create an additional endpoint. All additional endpoints will be assigned UUIDs starting from 0xFF54 and so on in the order of execution.

protocomm handler for the created endpoint is to be registered later using `wifi_prov_mgr_endpoint_register()` after provisioning has started.

---

**Note:** This API can only be called BEFORE provisioning is started

---

---

**Note:** Additional endpoints can be used for configuring client provided parameters other than Wi-Fi credentials, that are necessary for the main application and hence must be set prior to starting the application

---

---

**Note:** After session establishment, the additional endpoints must be targeted first by the client side application before sending Wi-Fi configuration, because once Wi-Fi configuration finishes the provisioning service is stopped and hence all endpoints are unregistered

---

**Parameters** `ep_name` –[in] unique name of the endpoint

**Returns**

- `ESP_OK` : Success
- `ESP_FAIL` : Failure

*esp\_err\_t* **wifi\_prov\_mgr\_endpoint\_register** (const char \*ep\_name, *protocomm\_req\_handler\_t* handler, void \*user\_ctx)

Register a handler for the previously created endpoint.

This API can be called by the application to register a protocomm handler to any endpoint that was created using `wifi_prov_mgr_endpoint_create()`.

---

**Note:** This API can only be called AFTER provisioning has started

---

---

**Note:** Additional endpoints can be used for configuring client provided parameters other than Wi-Fi credentials, that are necessary for the main application and hence must be set prior to starting the application

---

---

**Note:** After session establishment, the additional endpoints must be targeted first by the client side application before sending Wi-Fi configuration, because once Wi-Fi configuration finishes the provisioning service is stopped and hence all endpoints are unregistered

---

**Parameters**

- `ep_name` –[in] Name of the endpoint
- `handler` –[in] Endpoint handler function
- `user_ctx` –[in] User data

**Returns**

- `ESP_OK` : Success
- `ESP_FAIL` : Failure

void **wifi\_prov\_mgr\_endpoint\_unregister** (const char \*ep\_name)

Unregister the handler for an endpoint.

This API can be called if the application wants to selectively unregister the handler of an endpoint while the provisioning is still in progress.

All the endpoint handlers are unregistered automatically when the provisioning stops.

**Parameters** **ep\_name** –[in] Name of the endpoint

*esp\_err\_t* **wifi\_prov\_mgr\_get\_wifi\_state** (*wifi\_prov\_sta\_state\_t* \*state)

Get state of Wi-Fi Station during provisioning.

**Parameters** **state** –[out] Pointer to *wifi\_prov\_sta\_state\_t* variable to be filled

**Returns**

- ESP\_OK : Successfully retrieved Wi-Fi state
- ESP\_FAIL : Provisioning app not running

*esp\_err\_t* **wifi\_prov\_mgr\_get\_wifi\_disconnect\_reason** (*wifi\_prov\_sta\_fail\_reason\_t* \*reason)

Get reason code in case of Wi-Fi station disconnection during provisioning.

**Parameters** **reason** –[out] Pointer to *wifi\_prov\_sta\_fail\_reason\_t* variable to be filled

**Returns**

- ESP\_OK : Successfully retrieved Wi-Fi disconnect reason
- ESP\_FAIL : Provisioning app not running

*esp\_err\_t* **wifi\_prov\_mgr\_configure\_sta** (*wifi\_config\_t* \*wifi\_cfg)

Runs Wi-Fi as Station with the supplied configuration.

Configures the Wi-Fi station mode to connect to the AP with SSID and password specified in config structure and sets Wi-Fi to run as station.

This is automatically called by provisioning service upon receiving new credentials.

If credentials are to be supplied to the manager via a different mode other than through protocomm, then this API needs to be called.

Event WIFI\_PROV\_CRED\_RECV is emitted after credentials have been applied and Wi-Fi station started

**Parameters** **wifi\_cfg** –[in] Pointer to Wi-Fi configuration structure

**Returns**

- ESP\_OK : Wi-Fi configured and started successfully
- ESP\_FAIL : Failed to set configuration

*esp\_err\_t* **wifi\_prov\_mgr\_reset\_provisioning** (void)

Reset Wi-Fi provisioning config.

Calling this API will restore WiFi stack persistent settings to default values.

**Returns**

- ESP\_OK : Reset provisioning config successfully
- ESP\_FAIL : Failed to reset provisioning config

*esp\_err\_t* **wifi\_prov\_mgr\_reset\_sm\_state\_on\_failure** (void)

Reset internal state machine and clear provisioned credentials.

This API can be used to restart provisioning in case invalid credentials are entered.

**Returns**

- ESP\_OK : Reset provisioning state machine successfully
- ESP\_FAIL : Failed to reset provisioning state machine
- ESP\_ERR\_INVALID\_STATE : Manager not initialized

## Structures

struct **wifi\_prov\_event\_handler\_t**

Event handler that is used by the manager while provisioning service is active.

## Public Members

*wifi\_prov\_cb\_func\_t* **event\_cb**

Callback function to be executed on provisioning events

void **\*user\_data**

User context data to pass as parameter to callback function

struct **wifi\_prov\_scheme**

Structure for specifying the provisioning scheme to be followed by the manager.

---

**Note:** Ready to use schemes are available:

- `wifi_prov_scheme_ble` : for provisioning over BLE transport + GATT server
  - `wifi_prov_scheme_softap` : for provisioning over SoftAP transport + HTTP server
  - `wifi_prov_scheme_console` : for provisioning over Serial UART transport + Console (for debugging)
- 

## Public Members

*esp\_err\_t* (**\*prov\_start**)(*protocomm\_t* \*pc, void \*config)

Function which is to be called by the manager when it is to start the provisioning service associated with a protocomm instance and a scheme specific configuration

*esp\_err\_t* (**\*prov\_stop**)(*protocomm\_t* \*pc)

Function which is to be called by the manager to stop the provisioning service previously associated with a protocomm instance

void (**\*new\_config**)(void)

Function which is to be called by the manager to generate a new configuration for the provisioning service, that is to be passed to *prov\_start()*

void (**\*delete\_config**)(void \*config)

Function which is to be called by the manager to delete a configuration generated using *new\_config()*

*esp\_err\_t* (**\*set\_config\_service**)(void \*config, const char \*service\_name, const char \*service\_key)

Function which is to be called by the manager to set the service name and key values in the configuration structure

*esp\_err\_t* (**\*set\_config\_endpoint**)(void \*config, const char \*endpoint\_name, uint16\_t uuid)

Function which is to be called by the manager to set a protocomm endpoint with an identifying name and UUID in the configuration structure

*wifi\_mode\_t* **wifi\_mode**

Sets mode of operation of Wi-Fi during provisioning This is set to :

- `WIFI_MODE_APSTA` for SoftAP transport
- `WIFI_MODE_STA` for BLE transport

struct `wifi_prov_mgr_config_t`

Structure for specifying the manager configuration.

### Public Members

`wifi_prov_scheme_t` **scheme**

Provisioning scheme to use. Following schemes are already available:

- `wifi_prov_scheme_ble` : for provisioning over BLE transport + GATT server
- `wifi_prov_scheme_softap` : for provisioning over SoftAP transport + HTTP server + mDNS (optional)
- `wifi_prov_scheme_console` : for provisioning over Serial UART transport + Console (for debugging)

`wifi_prov_event_handler_t` **scheme\_event\_handler**

Event handler required by the scheme for incorporating scheme specific behavior while provisioning manager is running. Various options may be provided by the scheme for setting this field. Use `WIFI_PROV_EVENT_HANDLER_NONE` when not used. When using scheme `wifi_prov_scheme_ble`, the following options are available:

- `WIFI_PROV_SCHEME_BLE_EVENT_HANDLER_FREE_BTDM`
- `WIFI_PROV_SCHEME_BLE_EVENT_HANDLER_FREE_BLE`
- `WIFI_PROV_SCHEME_BLE_EVENT_HANDLER_FREE_BT`

`wifi_prov_event_handler_t` **app\_event\_handler**

Event handler that can be set for the purpose of incorporating application specific behavior. Use `WIFI_PROV_EVENT_HANDLER_NONE` when not used.

### Macros

`WIFI_PROV_EVENT_HANDLER_NONE`

Event handler can be set to none if not used.

### Type Definitions

typedef void (\*`wifi_prov_cb_func_t`)(void \*user\_data, `wifi_prov_cb_event_t` event, void \*event\_data)

typedef struct `wifi_prov_scheme` `wifi_prov_scheme_t`

Structure for specifying the provisioning scheme to be followed by the manager.

---

**Note:** Ready to use schemes are available:

- `wifi_prov_scheme_ble` : for provisioning over BLE transport + GATT server
  - `wifi_prov_scheme_softap` : for provisioning over SoftAP transport + HTTP server
  - `wifi_prov_scheme_console` : for provisioning over Serial UART transport + Console (for debugging)
- 

typedef enum `wifi_prov_security` `wifi_prov_security_t`

Security modes supported by the Provisioning Manager.

These are same as the security modes provided by protocomm

typedef *protocomm\_security2\_params\_t* **wifi\_prov\_security2\_params\_t**

Security 2 params structure This needs to be passed when using `WIFI_PROV_SECURITY_2`.

### Enumerations

enum **wifi\_prov\_cb\_event\_t**

Events generated by manager.

These events are generated in order of declaration and, for the stretch of time between initialization and de-initialization of the manager, each event is signaled only once

*Values:*

enumerator **WIFI\_PROV\_INIT**

Emitted when the manager is initialized

enumerator **WIFI\_PROV\_START**

Indicates that provisioning has started

enumerator **WIFI\_PROV\_CRED\_RECV**

Emitted when Wi-Fi AP credentials are received via `protocomm` endpoint `wifi_config`. The event data in this case is a pointer to the corresponding *wifi\_sta\_config\_t* structure

enumerator **WIFI\_PROV\_CRED\_FAIL**

Emitted when device fails to connect to the AP of which the credentials were received earlier on event `WIFI_PROV_CRED_RECV`. The event data in this case is a pointer to the disconnection reason code with type `wifi_prov_sta_fail_reason_t`

enumerator **WIFI\_PROV\_CRED\_SUCCESS**

Emitted when device successfully connects to the AP of which the credentials were received earlier on event `WIFI_PROV_CRED_RECV`

enumerator **WIFI\_PROV\_END**

Signals that provisioning service has stopped

enumerator **WIFI\_PROV\_DEINIT**

Signals that manager has been de-initialized

enum **wifi\_prov\_security**

Security modes supported by the Provisioning Manager.

These are same as the security modes provided by `protocomm`

*Values:*

enumerator **WIFI\_PROV\_SECURITY\_0**

No security (plain-text communication)

enumerator **WIFI\_PROV\_SECURITY\_1**

This secure communication mode consists of X25519 key exchange

- proof of possession (pop) based authentication
- AES-CTR encryption

enumerator **WIFI\_PROV\_SECURITY\_2**

This secure communication mode consists of SRP6a based authentication and key exchange

- AES-GCM encryption/decryption

### Header File

- [components/wifi\\_provisioning/include/wifi\\_provisioning/scheme\\_ble.h](#)

### Functions

void **wifi\_prov\_scheme\_ble\_event\_cb\_free\_bt***dm* (void \*user\_data, *wifi\_prov\_cb\_event\_t* event, void \*event\_data)

void **wifi\_prov\_scheme\_ble\_event\_cb\_free\_ble** (void \*user\_data, *wifi\_prov\_cb\_event\_t* event, void \*event\_data)

void **wifi\_prov\_scheme\_ble\_event\_cb\_free\_bt** (void \*user\_data, *wifi\_prov\_cb\_event\_t* event, void \*event\_data)

*esp\_err\_t* **wifi\_prov\_scheme\_ble\_set\_service\_uuid** (uint8\_t \*uuid128)

Set the 128 bit GATT service UUID used for provisioning.

This API is used to override the default 128 bit provisioning service UUID, which is 0000ffff-0000-1000-8000-00805f9b34fb.

This must be called before starting provisioning, i.e. before making a call to `wifi_prov_mgr_start_provisioning()`, otherwise the default UUID will be used.

---

**Note:** The data being pointed to by the argument must be valid at least till provisioning is started. Upon start, the manager will store an internal copy of this UUID, and this data can be freed or invalidated afterwards.

---

**Parameters** **uuid128** –[in] A custom 128 bit UUID

#### Returns

- **ESP\_OK** : Success
- **ESP\_ERR\_INVALID\_ARG** : Null argument

*esp\_err\_t* **wifi\_prov\_scheme\_ble\_set\_mfg\_data** (uint8\_t \*mfg\_data, ssize\_t mfg\_data\_len)

Set manufacturer specific data in scan response.

This must be called before starting provisioning, i.e. before making a call to `wifi_prov_mgr_start_provisioning()`.

---

**Note:** It is important to understand that length of custom manufacturer data should be within limits. The manufacturer data goes into scan response along with BLE device name. By default, BLE device name length is of 11 Bytes, however it can vary as per application use case. So, one has to honour the scan response data size limits i.e.  $(mfg\_data\_len + 2) < 31 - (device\_name\_length + 2)$ . If the `mfg_data` length exceeds this limit, the length will be truncated.

---

#### Parameters

- **mfg\_data** –[in] Custom manufacturer data
- **mfg\_data\_len** –[in] Manufacturer data length

#### Returns

- **ESP\_OK** : Success
- **ESP\_ERR\_INVALID\_ARG** : Null argument

*esp\_err\_t* **wifi\_prov\_scheme\_ble\_set\_random\_addr** (const uint8\_t \*rand\_addr)

Set Bluetooth Random address.

This must be called before starting provisioning, i.e. before making a call to `wifi_prov_mgr_start_provisioning()`.

This API can be used in cases where a new identity address is to be used during provisioning. This will result in this device being treated as a new device by remote devices.

This API is only to be called to set random address. Re-invoking this API after provisioning is started will have no effect.

---

**Note:** This API will change the existing BD address for the device. The address once set will remain unchanged until BLE stack tear down happens when `wifi_prov_mgr_deinit` is invoked.

---

**Parameters** **rand\_addr** –[in] The static random address to be set of length 6 bytes.

**Returns**

- ESP\_OK : Success
- ESP\_ERR\_INVALID\_ARG : Null argument

## Macros

**WIFI\_PROV\_SCHEME\_BLE\_EVENT\_HANDLER\_FREE\_BTDM**

**WIFI\_PROV\_SCHEME\_BLE\_EVENT\_HANDLER\_FREE\_BLE**

**WIFI\_PROV\_SCHEME\_BLE\_EVENT\_HANDLER\_FREE\_BT**

## Header File

- `components/wifi_provisioning/include/wifi_provisioning/scheme_softap.h`

## Functions

void **wifi\_prov\_scheme\_softap\_set\_httpd\_handle** (void \*handle)

Provide HTTPD Server handle externally.

Useful in cases wherein applications need the webserver for some different operations, and do not want the wifi provisioning component to start/stop a new instance.

---

**Note:** This API should be called before `wifi_prov_mgr_start_provisioning()`

---

**Parameters** **handle** –[in] Handle to HTTPD server instance

## Header File

- `components/wifi_provisioning/include/wifi_provisioning/scheme_console.h`

## Header File

- `components/wifi_provisioning/include/wifi_provisioning/wifi_config.h`

## Functions

*esp\_err\_t* **wifi\_prov\_config\_data\_handler** (uint32\_t session\_id, const uint8\_t \*inbuf, ssize\_t inlen, uint8\_t \*\*outbuf, ssize\_t \*outlen, void \*priv\_data)

Handler for receiving and responding to requests from master.

This is to be registered as the `wifi_config` endpoint handler (protocomm proto-comm\_req\_handler\_t) using `protocomm_add_endpoint()`

## Structures

struct **wifi\_prov\_sta\_conn\_info\_t**

WiFi STA connected status information.

### Public Members

char **ip\_addr**[IP4ADDR\_STRLEN\_MAX]

IP Address received by station

char **bssid**[6]

BSSID of the AP to which connection was established

char **ssid**[33]

SSID of the to which connection was established

uint8\_t **channel**

Channel of the AP

uint8\_t **auth\_mode**

Authorization mode of the AP

struct **wifi\_prov\_config\_get\_data\_t**

WiFi status data to be sent in response to `get_status` request from master.

### Public Members

*wifi\_prov\_sta\_state\_t* **wifi\_state**

WiFi state of the station

*wifi\_prov\_sta\_fail\_reason\_t* **fail\_reason**

Reason for disconnection (valid only when `wifi_state` is `WIFI_STATION_DISCONNECTED`)

*wifi\_prov\_sta\_conn\_info\_t* **conn\_info**

Connection information (valid only when `wifi_state` is `WIFI_STATION_CONNECTED`)

struct **wifi\_prov\_config\_set\_data\_t**

WiFi config data received by slave during `set_config` request from master.



### Public Members

char **ssid**[33]  
SSID of the AP to which the slave is to be connected

char **password**[64]  
Password of the AP

char **bssid**[6]  
BSSID of the AP

uint8\_t **channel**  
Channel of the AP

struct **wifi\_prov\_config\_handlers**

Internal handlers for receiving and responding to protocomm requests from master.

This is to be passed as `priv_data` for protocomm request handler (refer to `wifi_prov_config_data_handler()`) when calling `protocomm_add_endpoint()`.

### Public Members

*esp\_err\_t* (\***get\_status\_handler**)(*wifi\_prov\_config\_get\_data\_t* \*resp\_data, *wifi\_prov\_ctx\_t* \*\*ctx)  
Handler function called when connection status of the slave (in WiFi station mode) is requested

*esp\_err\_t* (\***set\_config\_handler**)(const *wifi\_prov\_config\_set\_data\_t* \*req\_data, *wifi\_prov\_ctx\_t* \*\*ctx)  
Handler function called when WiFi connection configuration (eg. AP SSID, password, etc.) of the slave (in WiFi station mode) is to be set to user provided values

*esp\_err\_t* (\***apply\_config\_handler**)(*wifi\_prov\_ctx\_t* \*\*ctx)  
Handler function for applying the configuration that was set in `set_config_handler`. After applying the station may get connected to the AP or may fail to connect. The slave must be ready to convey the updated connection status information when `get_status_handler` is invoked again by the master.

*wifi\_prov\_ctx\_t* \***ctx**  
Context pointer to be passed to above handler functions upon invocation

### Type Definitions

typedef struct *wifi\_prov\_ctx* **wifi\_prov\_ctx\_t**

Type of context data passed to each get/set/apply handler function set in `wifi_prov_config_handlers` structure.

This is passed as an opaque pointer, thereby allowing it be defined later in application code as per requirements.

typedef struct *wifi\_prov\_config\_handlers* **wifi\_prov\_config\_handlers\_t**

Internal handlers for receiving and responding to protocomm requests from master.

This is to be passed as `priv_data` for protocomm request handler (refer to `wifi_prov_config_data_handler()`) when calling `protocomm_add_endpoint()`.

## Enumerations

enum `wifi_prov_sta_state_t`

WiFi STA status for conveying back to the provisioning master.

*Values:*

enumerator `WIFI_PROV_STA_CONNECTING`

enumerator `WIFI_PROV_STA_CONNECTED`

enumerator `WIFI_PROV_STA_DISCONNECTED`

enum `wifi_prov_sta_fail_reason_t`

WiFi STA connection fail reason.

*Values:*

enumerator `WIFI_PROV_STA_AUTH_ERROR`

enumerator `WIFI_PROV_STA_AP_NOT_FOUND`

Code examples for above API are provided in the [provisioning](#) directory of ESP-IDF examples.

Code example for above API is provided in [wifi/smart\\_config](#).

Code example for above API is provided in [wifi/wifi\\_easy\\_connect/dpp-enrollee](#).

## 2.8 Storage API

### 2.8.1 FAT Filesystem Support

ESP-IDF uses the [FatFs](#) library to work with FAT filesystems. FatFs resides in the `fatfs` component. Although the library can be used directly, many of its features can be accessed via VFS using the C standard library and POSIX API functions.

Additionally, FatFs has been modified to support the runtime pluggable disk I/O layer. This allows mapping of FatFs drives to physical disks at runtime.

#### Using FatFs with VFS

The header file `fatfs/vfs/esp_vfs_fat.h` defines the functions for connecting FatFs and VFS.

The function `esp_vfs_fat_register()` allocates a FATFS structure and registers a given path prefix in VFS. Subsequent operations on files starting with this prefix are forwarded to FatFs APIs.

The function `esp_vfs_fat_unregister_path()` deletes the registration with VFS, and frees the FATFS structure.

Most applications use the following workflow when working with `esp_vfs_fat_` functions:

1. Call `esp_vfs_fat_register()` to specify:
  - Path prefix where to mount the filesystem (e.g., `"/sdcard"`, `"/spiflash"`)
  - FatFs drive number

- A variable which will receive the pointer to the FATFS structure
2. Call `ff_diskio_register()` to register the disk I/O driver for the drive number used in Step 1.
  3. Call the FatFs function `f_mount`, and optionally `f_fdisk`, `f_mkfs`, to mount the filesystem using the same drive number which was passed to `esp_vfs_fat_register()`. For more information, see [FatFs documentation](#).
  4. Call the C standard library and POSIX API functions to perform such actions on files as open, read, write, erase, copy, etc. Use paths starting with the path prefix passed to `esp_vfs_register()` (for example, `"/sdcard/hello.txt"`). The filesystem uses [8.3 filenames](#) format (SFN) by default. If you need to use long filenames (LFN), enable the `CONFIG_FATFS_LONG_FILENAMES` option. More details on the FatFs filenames are available [here](#).
  5. Optionally, by enabling the option `CONFIG_FATFS_USE_FASTSEEK`, you can use the POSIX lseek function to perform it faster. The fast seek will not work for files in write mode, so to take advantage of fast seek, you should open (or close and then reopen) the file in read-only mode.
  6. Optionally, call the FatFs library functions directly. In this case, use paths without a VFS prefix (for example, `"/hello.txt"`).
  7. Close all open files.
  8. Call the FatFs function `f_mount` for the same drive number with NULL FATFS\* argument to unmount the filesystem.
  9. Call the FatFs function `ff_diskio_register()` with NULL `ff_diskio_impl_t*` argument and the same drive number to unregister the disk I/O driver.
  10. Call `esp_vfs_fat_unregister_path()` with the path where the file system is mounted to remove FatFs from VFS, and free the FATFS structure allocated in Step 1.

The convenience functions `esp_vfs_fat_sdmmc_mount()`, `esp_vfs_fat_sdspi_mount()`, and `esp_vfs_fat_sdcard_unmount()` wrap the steps described above and also handle SD card initialization. These functions are described in the next section.

### Using FatFs with VFS and SD Cards

The header file `fatfs/vfs/esp_vfs_fat.h` defines convenience functions `esp_vfs_fat_sdmmc_mount()`, `esp_vfs_fat_sdspi_mount()`, and `esp_vfs_fat_sdcard_unmount()`. These functions perform Steps 1–3 and 7–9 respectively and handle SD card initialization, but provide only limited error handling. Developers are encouraged to check its source code and incorporate more advanced features into production applications.

The convenience function `esp_vfs_fat_sdmmc_unmount()` unmounts the filesystem and releases the resources acquired by `esp_vfs_fat_sdmmc_mount()`.

### Using FatFs with VFS in Read-Only Mode

The header file `fatfs/vfs/esp_vfs_fat.h` also defines the convenience functions `esp_vfs_fat_spiflash_mount_ro()` and `esp_vfs_fat_spiflash_unmount_ro()`. These functions perform Steps 1-3 and 7-9 respectively for read-only FAT partitions. These are particularly helpful for data partitions written only once during factory provisioning which will not be changed by production application throughout the lifetime of the hardware.

### FatFS Disk IO Layer

FatFs has been extended with API functions that register the disk I/O driver at runtime.

These APIs provide implementation of disk I/O functions for SD/MMC cards and can be registered for the given FatFs drive number using the function `ff_diskio_register_sdmmc()`.

void **ff\_diskio\_register** (BYTE pdrv, const `ff_diskio_impl_t` \*discio\_impl)

Register or unregister diskio driver for given drive number.

When FATFS library calls one of `disk_XXX` functions for driver number pdrv, corresponding function in `discio_impl` for given pdrv will be called.

#### Parameters

- **pdrv** –drive number
- **diskio\_impl** –pointer to *ff\_diskio\_impl\_t* structure with diskio functions or NULL to unregister and free previously registered drive

struct **ff\_diskio\_impl\_t**

Structure of pointers to disk IO driver functions.

See FatFs documentation for details about these functions

### Public Members

DSTATUS (**\*init**)(unsigned char pdrv)

disk initialization function

DSTATUS (**\*status**)(unsigned char pdrv)

disk status check function

DRESULT (**\*read**)(unsigned char pdrv, unsigned char \*buff, uint32\_t sector, unsigned count)

sector read function

DRESULT (**\*write**)(unsigned char pdrv, const unsigned char \*buff, uint32\_t sector, unsigned count)

sector write function

DRESULT (**\*ioctl**)(unsigned char pdrv, unsigned char cmd, void \*buff)

function to get info about disk and do some misc operations

void **ff\_diskio\_register\_sdmmc** (unsigned char pdrv, *sdmmc\_card\_t* \*card)

Register SD/MMC diskio driver

#### Parameters

- **pdrv** –drive number
- **card** –pointer to *sdmmc\_card\_t* structure describing a card; card should be initialized before calling *f\_mount*.

*esp\_err\_t* **ff\_diskio\_register\_wl\_partition** (unsigned char pdrv, *wl\_handle\_t* flash\_handle)

Register spi flash partition

#### Parameters

- **pdrv** –drive number
- **flash\_handle** –handle of the wear levelling partition.

*esp\_err\_t* **ff\_diskio\_register\_raw\_partition** (unsigned char pdrv, const *esp\_partition\_t* \*part\_handle)

Register spi flash partition

#### Parameters

- **pdrv** –drive number
- **part\_handle** –pointer to raw flash partition.

### FatFs Partition Generator

We provide a partition generator for FatFs ([wl\\_fatfsgen.py](#)) which is integrated into the build system and could be easily used in the user project.

The tool is used to create filesystem images on a host and populate it with content of the specified host folder.

The script is based on the partition generator ([fatfsgen.py](#)). Apart from generating partition, it can also initialize wear levelling.

The latest version supports both short and long file names, FAT12 and FAT16. The long file names are limited to 255 characters and can contain multiple periods (.) characters within the filename and additional characters +, , ;, =, [ and ].

**Build System Integration with FatFs Partition Generator** It is possible to invoke FatFs generator directly from the CMake build system by calling `fatfs_create_spiflash_image`:

```
fatfs_create_spiflash_image(<partition> <base_dir> [FLASH_IN_PROJECT])
```

If you prefer generating partition without wear levelling support, you can use `fatfs_create_rawflash_image`:

```
fatfs_create_rawflash_image(<partition> <base_dir> [FLASH_IN_PROJECT])
```

`fatfs_create_spiflash_image` respectively `fatfs_create_rawflash_image` must be called from project's CMakeLists.txt.

If you decide for any reason to use `fatfs_create_rawflash_image` (without wear levelling support), beware that it supports mounting only in read-only mode in the device.

The arguments of the function are as follows:

1. `partition` - the name of the partition as defined in the partition table (e.g. [storage/fatfsgen/partitions\\_example.csv](#)).
2. `base_dir` - the directory that will be encoded to FatFs partition and optionally flashed into the device. Beware that you have to specify the suitable size of the partition in the partition table.
3. flag `FLASH_IN_PROJECT` - optionally, users can have the image automatically flashed together with the app binaries, partition tables, etc. on `idf.py flash -p <PORT>` by specifying `FLASH_IN_PROJECT`.
4. flag `PRESERVE_TIME` - optionally, users can force preserving the timestamps from the source folder to the target image. Without preserving the time, every timestamp will be set to the FATFS default initial time (1st January 1980).

For example:

```
fatfs_create_spiflash_image(my_fatfs_partition my_folder FLASH_IN_PROJECT)
```

If `FLASH_IN_PROJECT` is not specified, the image will still be generated, but you will have to flash it manually using `esptool.py` or a custom build system target.

For an example, see [storage/fatfsgen](#).

### FatFs Partition Analyzer

([fatfsparse.py](#)) is a partition analyzing tool for FatFs.

It is a reverse tool of ([fatfsgen.py](#)), i.e. it can generate the folder structure on the host based on the FatFs image.

Usage:

```
./fatfsparse.py [-h] [--long-name-support] [--wear-leveling] fatfs_image.img
```

### High-level API Reference

#### Header File

- [components/fatfs/vfs/esp\\_vfs\\_fat.h](#)

## Functions

*esp\_err\_t* **esp\_vfs\_fat\_register** (const char \*base\_path, const char \*fat\_drive, size\_t max\_files, FATFS \*\*out\_fs)

Register FATFS with VFS component.

This function registers given FAT drive in VFS, at the specified base path. If only one drive is used, fat\_drive argument can be an empty string. Refer to FATFS library documentation on how to specify FAT drive. This function also allocates FATFS structure which should be used for f\_mount call.

---

**Note:** This function doesn't mount the drive into FATFS, it just connects POSIX and C standard library IO function with FATFS. You need to mount desired drive into FATFS separately.

---

### Parameters

- **base\_path** –path prefix where FATFS should be registered
- **fat\_drive** –FATFS drive specification; if only one drive is used, can be an empty string
- **max\_files** –maximum number of files which can be open at the same time
- **out\_fs** –[out] pointer to FATFS structure which can be used for FATFS f\_mount call is returned via this argument.

### Returns

- ESP\_OK on success
- ESP\_ERR\_INVALID\_STATE if esp\_vfs\_fat\_register was already called
- ESP\_ERR\_NO\_MEM if not enough memory or too many VFSes already registered

*esp\_err\_t* **esp\_vfs\_fat\_unregister\_path** (const char \*base\_path)

Un-register FATFS from VFS.

---

**Note:** FATFS structure returned by esp\_vfs\_fat\_register is destroyed after this call. Make sure to call f\_mount function to unmount it before calling esp\_vfs\_fat\_unregister\_ctx. Difference between this function and the one above is that this one will release the correct drive, while the one above will release the last registered one

---

**Parameters** **base\_path** –path prefix where FATFS is registered. This is the same used when esp\_vfs\_fat\_register was called

### Returns

- ESP\_OK on success
- ESP\_ERR\_INVALID\_STATE if FATFS is not registered in VFS

*esp\_err\_t* **esp\_vfs\_fat\_sdmmc\_mount** (const char \*base\_path, const *sdmmc\_host\_t* \*host\_config, const void \*slot\_config, const *esp\_vfs\_fat\_mount\_config\_t* \*mount\_config, *sdmmc\_card\_t* \*\*out\_card)

Convenience function to get FAT filesystem on SD card registered in VFS.

This is an all-in-one function which does the following:

- initializes SDMMC driver or SPI driver with configuration in host\_config
- initializes SD card with configuration in slot\_config
- mounts FAT partition on SD card using FATFS library, with configuration in mount\_config
- registers FATFS library with VFS, with prefix given by base\_prefix variable

This function is intended to make example code more compact. For real world applications, developers should implement the logic of probing SD card, locating and mounting partition, and registering FATFS in VFS, with proper error checking and handling of exceptional conditions.

---

**Note:** Use this API to mount a card through SDSPI is deprecated. Please call esp\_vfs\_fat\_sdspi\_mount () instead for that case.

---

**Parameters**

- **base\_path** –path where partition should be registered (e.g. “/sdcard” )
- **host\_config** –Pointer to structure describing SDMMC host. When using SDMMC peripheral, this structure can be initialized using SDMMC\_HOST\_DEFAULT() macro. When using SPI peripheral, this structure can be initialized using SDSPI\_HOST\_DEFAULT() macro.
- **slot\_config** –Pointer to structure with slot configuration. For SDMMC peripheral, pass a pointer to sdmmc\_slot\_config\_t structure initialized using SDMMC\_SLOT\_CONFIG\_DEFAULT.
- **mount\_config** –pointer to structure with extra parameters for mounting FATFS
- **out\_card** –[out] if not NULL, pointer to the card information structure will be returned via this argument

**Returns**

- ESP\_OK on success
- ESP\_ERR\_INVALID\_STATE if esp\_vfs\_fat\_sdmmc\_mount was already called
- ESP\_ERR\_NO\_MEM if memory can not be allocated
- ESP\_FAIL if partition can not be mounted
- other error codes from SDMMC or SPI drivers, SDMMC protocol, or FATFS drivers

*esp\_err\_t* **esp\_vfs\_fat\_sdspi\_mount** (const char \*base\_path, const *sdmmc\_host\_t* \*host\_config\_input, const *sdspi\_device\_config\_t* \*slot\_config, const *esp\_vfs\_fat\_mount\_config\_t* \*mount\_config, *sdmmc\_card\_t* \*\*out\_card)

Convenience function to get FAT filesystem on SD card registered in VFS.

This is an all-in-one function which does the following:

- initializes an SPI Master device based on the SPI Master driver with configuration in slot\_config, and attach it to an initialized SPI bus.
- initializes SD card with configuration in host\_config\_input
- mounts FAT partition on SD card using FATFS library, with configuration in mount\_config
- registers FATFS library with VFS, with prefix given by base\_prefix variable

This function is intended to make example code more compact. For real world applications, developers should implement the logic of probing SD card, locating and mounting partition, and registering FATFS in VFS, with proper error checking and handling of exceptional conditions.

---

**Note:** This function try to attach the new SD SPI device to the bus specified in host\_config. Make sure the SPI bus specified in host\_config->slot have been initialized by spi\_bus\_initialize() before.

---

**Parameters**

- **base\_path** –path where partition should be registered (e.g. “/sdcard” )
- **host\_config\_input** –Pointer to structure describing SDMMC host. This structure can be initialized using SDSPI\_HOST\_DEFAULT() macro.
- **slot\_config** –Pointer to structure with slot configuration. For SPI peripheral, pass a pointer to *sdspi\_device\_config\_t* structure initialized using SDSPI\_DEVICE\_CONFIG\_DEFAULT().
- **mount\_config** –pointer to structure with extra parameters for mounting FATFS
- **out\_card** –[out] If not NULL, pointer to the card information structure will be returned via this argument. It is suggested to hold this handle and use it to unmount the card later if needed. Otherwise it’ s not suggested to use more than one card at the same time and unmount one of them in your application.

**Returns**

- ESP\_OK on success
- ESP\_ERR\_INVALID\_STATE if esp\_vfs\_fat\_sdmmc\_mount was already called
- ESP\_ERR\_NO\_MEM if memory can not be allocated
- ESP\_FAIL if partition can not be mounted
- other error codes from SDMMC or SPI drivers, SDMMC protocol, or FATFS drivers



*esp\_err\_t* **esp\_vfs\_fat\_sdmmc\_unmount** (void)

Unmount FAT filesystem and release resources acquired using `esp_vfs_fat_sdmmc_mount`.

*Deprecated:*

Use `esp_vfs_fat_sdcard_unmount()` instead.

#### Returns

- ESP\_OK on success
- ESP\_ERR\_INVALID\_STATE if `esp_vfs_fat_sdmmc_mount` hasn't been called

*esp\_err\_t* **esp\_vfs\_fat\_sdcard\_unmount** (const char \*base\_path, *sdmmc\_card\_t* \*card)

Unmount an SD card from the FAT filesystem and release resources acquired using `esp_vfs_fat_sdmmc_mount()` or `esp_vfs_fat_sdspi_mount()`

#### Returns

- ESP\_OK on success
- ESP\_ERR\_INVALID\_ARG if the card argument is unregistered
- ESP\_ERR\_INVALID\_STATE if `esp_vfs_fat_sdmmc_mount` hasn't been called

*esp\_err\_t* **esp\_vfs\_fat\_spiflash\_mount\_rw\_wl** (const char \*base\_path, const char \*partition\_label, const *esp\_vfs\_fat\_mount\_config\_t* \*mount\_config, *wl\_handle\_t* \*wl\_handle)

Convenience function to initialize FAT filesystem in SPI flash and register it in VFS.

This is an all-in-one function which does the following:

- finds the partition with defined partition\_label. Partition label should be configured in the partition table.
- initializes flash wear levelling library on top of the given partition
- mounts FAT partition using FATFS library on top of flash wear levelling library
- registers FATFS library with VFS, with prefix given by base\_prefix variable

This function is intended to make example code more compact.

#### Parameters

- **base\_path** –path where FATFS partition should be mounted (e.g. “/spiflash” )
- **partition\_label** –label of the partition which should be used
- **mount\_config** –pointer to structure with extra parameters for mounting FATFS
- **wl\_handle** –[out] wear levelling driver handle

#### Returns

- ESP\_OK on success
- ESP\_ERR\_NOT\_FOUND if the partition table does not contain FATFS partition with given label
- ESP\_ERR\_INVALID\_STATE if `esp_vfs_fat_spiflash_mount_rw_wl` was already called
- ESP\_ERR\_NO\_MEM if memory can not be allocated
- ESP\_FAIL if partition can not be mounted
- other error codes from wear levelling library, SPI flash driver, or FATFS drivers

*esp\_err\_t* **esp\_vfs\_fat\_spiflash\_unmount\_rw\_wl** (const char \*base\_path, *wl\_handle\_t* wl\_handle)

Unmount FAT filesystem and release resources acquired using `esp_vfs_fat_spiflash_mount_rw_wl`.

#### Parameters

- **base\_path** –path where partition should be registered (e.g. “/spiflash” )
- **wl\_handle** –wear levelling driver handle returned by `esp_vfs_fat_spiflash_mount_rw_wl`

#### Returns

- ESP\_OK on success
- ESP\_ERR\_INVALID\_STATE if `esp_vfs_fat_spiflash_mount_rw_wl` hasn't been called



*esp\_err\_t* **esp\_vfs\_fat\_spiflash\_mount\_ro** (const char \*base\_path, const char \*partition\_label, const *esp\_vfs\_fat\_mount\_config\_t* \*mount\_config)

Convenience function to initialize read-only FAT filesystem and register it in VFS.

This is an all-in-one function which does the following:

- finds the partition with defined partition\_label. Partition label should be configured in the partition table.
- mounts FAT partition using FATFS library
- registers FATFS library with VFS, with prefix given by base\_prefix variable

---

**Note:** Wear levelling is not used when FAT is mounted in read-only mode using this function.

---

#### Parameters

- **base\_path** –path where FATFS partition should be mounted (e.g. “/spiflash” )
- **partition\_label** –label of the partition which should be used
- **mount\_config** –pointer to structure with extra parameters for mounting FATFS

#### Returns

- ESP\_OK on success
- ESP\_ERR\_NOT\_FOUND if the partition table does not contain FATFS partition with given label
- ESP\_ERR\_INVALID\_STATE if esp\_vfs\_fat\_spiflash\_mount\_ro was already called for the same partition
- ESP\_ERR\_NO\_MEM if memory can not be allocated
- ESP\_FAIL if partition can not be mounted
- other error codes from SPI flash driver, or FATFS drivers

*esp\_err\_t* **esp\_vfs\_fat\_spiflash\_unmount\_ro** (const char \*base\_path, const char \*partition\_label)

Unmount FAT filesystem and release resources acquired using esp\_vfs\_fat\_spiflash\_mount\_ro.

#### Parameters

- **base\_path** –path where partition should be registered (e.g. “/spiflash” )
- **partition\_label** –label of partition to be unmounted

#### Returns

- ESP\_OK on success
- ESP\_ERR\_INVALID\_STATE if esp\_vfs\_fat\_spiflash\_mount\_rw\_wl hasn't been called

*esp\_err\_t* **esp\_vfs\_fat\_info** (const char \*base\_path, uint64\_t \*out\_total\_bytes, uint64\_t \*out\_free\_bytes)

Get information for FATFS partition.

#### Parameters

- **base\_path** –Base path of the partition examined (e.g. “/spiflash” )
- **out\_total\_bytes** –[out] Size of the file system
- **out\_free\_bytes** –[out] Free bytes available in the file system

#### Returns

- ESP\_OK on success
- ESP\_ERR\_INVALID\_STATE if partition not found
- ESP\_FAIL if another FRESULT error (saved in errno)

## Structures

struct **esp\_vfs\_fat\_mount\_config\_t**

Configuration arguments for esp\_vfs\_fat\_sdmmc\_mount and esp\_vfs\_fat\_spiflash\_mount\_rw\_wl functions.

## Public Members

bool **format\_if\_mount\_failed**

If FAT partition can not be mounted, and this parameter is true, create partition table and format the filesystem.

int **max\_files**

Max number of open files.

size\_t **allocation\_unit\_size**

If `format_if_mount_failed` is set, and mount fails, format the card with given allocation unit size. Must be a power of 2, between sector size and  $128 * \text{sector size}$ . For SD cards, sector size is always 512 bytes. For wear\_leveling, sector size is determined by `CONFIG_WL_SECTOR_SIZE` option.

Using larger allocation unit size will result in higher read/write performance and higher overhead when storing small files.

Setting this field to 0 will result in allocation unit set to the sector size.

bool **disk\_status\_check\_enable**

Enables real `ff_disk_status` function implementation for SD cards (`ff_sdmmc_status`). Possibly slows down IO performance.

Try to enable if you need to handle situations when SD cards are not unmounted properly before physical removal or you are experiencing issues with SD cards.

Doesn't do anything for other memory storage media.

## Type Definitions

typedef [esp\\_vfs\\_fat\\_mount\\_config\\_t](#) **esp\_vfs\_fat\_sdmmc\_mount\_config\_t**

## 2.8.2 Manufacturing Utility

### Introduction

This utility is designed to create instances of factory NVS partition images on a per-device basis for mass manufacturing purposes. The NVS partition images are created from CSV files containing user-provided configurations and values.

Please note that this utility only creates manufacturing binary images which then need to be flashed onto your devices using:

- [esptool.py](#)
- [Flash Download tool](#) (available on Windows only). Just download it, unzip, and follow the instructions inside the *doc* folder.
- Direct flash programming using custom production tools.

### Prerequisites

This utility is dependent on `esp-idf`'s NVS partition utility.

- **Operating System requirements:**
  - Linux / MacOS / Windows (standard distributions)
- **The following packages are needed to use this utility:**
  - [Python](#)

**Note:****Before using this utility, please make sure that:**

- The path to Python is added to the PATH environment variable.
  - You have installed the packages from *requirement.txt*, the file in the root of the esp-idf directory.
- 

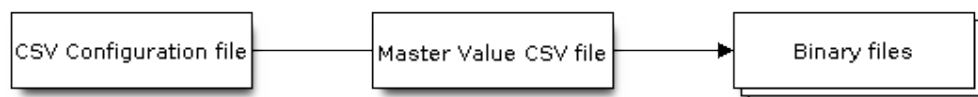
**Workflow****CSV Configuration File**

This file contains the configuration of the device to be flashed.

The data in the configuration file has the following format (the *REPEAT* tag is optional):

```
name1,namespace,    <-- First entry should be of type "namespace"
key1,type1,encoding1
key2,type2,encoding2,REPEAT
name2,namespace,
key3,type3,encoding3
key4,type4,encoding4
```

---

**Note:** The first line in this file should always be the `namespace` entry.

---

Each line should have three parameters: `key`, `type`, `encoding`, separated by a comma. If the `REPEAT` tag is present, the value corresponding to this key in the master value CSV file will be the same for all devices.

*Please refer to README of the NVS Partition Generator utility for detailed description of each parameter.*

Below is a sample example of such a configuration file:

```
app,namespace,
firmware_key,data,hex2bin
serial_no,data,string,REPEAT
device_no,data,i32
```

**Note:****Make sure there are no spaces:**

- before and after `'`,
  - at the end of each line in a CSV file
- 

**Master Value CSV File**

This file contains details of the devices to be flashed. Each line in this file corresponds to a device instance.

The data in the master value CSV file has the following format:

```
key1, key2, key3, .....  
value1, value2, value3, .....
```

**Note:** The first line in the file should always contain the `key` names. All the keys from the configuration file should be present here in the **same order**. This file can have additional columns (keys). The additional keys will be treated as metadata and would not be part of the final binary files.

Each line should contain the `value` of the corresponding keys, separated by a comma. If the key has the `REPEAT` tag, its corresponding value **must** be entered in the second line only. Keep the entry empty for this value in the following lines.

The description of this parameter is as follows:

**value** Data value

Data value is the value of data corresponding to the key.

Below is a sample example of a master value CSV file:

```
id, firmware_key, serial_no, device_no  
1, 1a2b3c4d5e6faabb, A1, 101  
2, 1a2b3c4d5e6fccdd, , 102  
3, 1a2b3c4d5e6feeff, , 103
```

**Note:** If the `'REPEAT'` tag is present, a new master value CSV file will be created in the same folder as the input Master CSV File with the values inserted at each line for the key with the `'REPEAT'` tag.

This utility creates intermediate CSV files which are used as input for the NVS partition utility to generate the binary files.

The format of this intermediate CSV file is as follows:

```
key, type, encoding, value  
key, namespace, ,  
key1, type1, encoding1, value1  
key2, type2, encoding2, value2
```

An instance of an intermediate CSV file will be created for each device on an individual basis.

## Running the utility

**Usage:**

```
python mfg_gen.py [-h] {generate, generate-key} ...
```

**Optional Arguments:**

No.	Parameter	Description
1	-h, -help	show this help message and exit

**Commands:**

Run `mfg_gen.py {command} -h` for additional help

No.	Parameter	Description
1	generate	Generate NVS partition
2	generate-key	Generate keys for encryption

**To generate factory images for each device (Default):****Usage:**

```
python mfg_gen.py generate [-h] [--fileid FILEID] [--version {1,2}] [--keygen]
                          [--keyfile KEYFILE] [--inputkey INPUTKEY]
                          [--outdir OUTDIR]
                          conf values prefix size
```

**Positional Arguments:**

Parameter	Description
conf	Path to configuration csv file to parse
values	Path to values csv file to parse
prefix	Unique name for each output filename prefix
size	<b>Size of NVS partition in bytes</b> (must be multiple of 4096)

**Optional Arguments:**

Parameter	Description
-h, -help	show this help message and exit
-fileid FILEID	Unique file identifier(any key in values file) for each filename suffix (Default: numeric value(1,2,3...))
-version {1,2}	Set multipage blob version. Version 1 - Multipage blob support disabled. Version 2 - Multipage blob support enabled. Default: Version 2
-keygen	Generates key for encrypting NVS partition
-inputkey INPUTKEY	File having key for encrypting NVS partition
-outdir OUTDIR	Output directory to store files created (Default: current directory)

You can run the utility to generate factory images for each device using the command below. A sample CSV file is provided with the utility:

```
python mfg_gen.py generate samples/sample_config.csv samples/sample_values_
↪singlepage_blob.csv Sample 0x3000
```

The master value CSV file should have the path in the `file` type relative to the directory from which you are running the utility.

**To generate encrypted factory images for each device:**

You can run the utility to encrypt factory images for each device using the command below. A sample CSV file is provided with the utility:

- Encrypt by allowing the utility to generate encryption keys:

```
python mfg_gen.py generate samples/sample_config.csv samples/sample_values_
↪singlepage_blob.csv Sample 0x3000 --keygen
```

**Note:** Encryption key of the following format `<outdir>/keys/keys-<prefix>-<fileid>.bin` is created. This newly created file having encryption keys in `keys/` directory is compatible with NVS key-partition structure. Refer to [NVS Key Partition](#) for more details.

- Encrypt by providing the encryption keys as input binary file:

```
python mfg_gen.py generate samples/sample_config.csv samples/sample_values_
↪singlepage_blob.csv Sample 0x3000 --inputkey keys/sample_keys.bin
```

**To generate only encryption keys:**

**Usage::** python mfg\_gen.py generate-key [-h] [--keyfile KEYFILE] [--outdir OUTDIR]

**Optional Arguments:**

Parameter	Description
-h, -help	show this help message and exit
--keyfile KEYFILE	Path to output encryption keys file
--outdir OUTDIR	Output directory to store files created. (Default: current directory)

You can run the utility to generate only encryption keys using the command below:

```
python mfg_gen.py generate-key
```

**Note:** Encryption key of the following format <outdir>/keys/keys-<timestamp>.bin is created. Timestamp format is: %m-%d\_%H-%M. To provide custom target filename use the -keyfile argument.

Generated encryption key binary file can further be used to encrypt factory images created on the per device basis.

The default numeric value: 1,2,3...of the `fileid` argument corresponds to each line bearing device instance values in the master value CSV file.

While running the manufacturing utility, the following folders will be created in the specified `outdir` directory:

- `bin/` for storing the generated binary files
- `csv/` for storing the generated intermediate CSV files
- `keys/` for storing encryption keys (when generating encrypted factory images)

## 2.8.3 Non-volatile Storage Library

### Introduction

Non-volatile storage (NVS) library is designed to store key-value pairs in flash. This section introduces some concepts used by NVS.

**Underlying Storage** Currently, NVS uses a portion of main flash memory through the `esp_partition` API. The library uses all the partitions with `data` type and `nvs` subtype. The application can choose to use the partition with the label `nvs` through the `nvs_open()` API function or any other partition by specifying its name using the `nvs_open_from_partition()` API function.

Future versions of this library may have other storage backends to keep data in another flash chip (SPI or I2C), RTC, FRAM, etc.

**Note:** if an NVS partition is truncated (for example, when the partition table layout is changed), its contents should be erased. ESP-IDF build system provides a `idf.py erase-flash` target to erase all contents of the flash chip.

**Note:** NVS works best for storing many small values, rather than a few large values of the type 'string' and 'blob'. If you need to store large blobs or strings, consider using the facilities provided by the FAT filesystem on top of the wear levelling library.

**Keys and Values** NVS operates on key-value pairs. Keys are ASCII strings; the maximum key length is currently 15 characters. Values can have one of the following types:

- integer types: `uint8_t`, `int8_t`, `uint16_t`, `int16_t`, `uint32_t`, `int32_t`, `uint64_t`, `int64_t`
- zero-terminated string
- variable length binary data (blob)

---

**Note:** String values are currently limited to 4000 bytes. This includes the null terminator. Blob values are limited to 508,000 bytes or 97.6% of the partition size - 4000 bytes, whichever is lower.

---

Additional types, such as `float` and `double` might be added later.

Keys are required to be unique. Assigning a new value to an existing key works as follows:

- If the new value is of the same type as the old one, value is updated.
- If the new value has a different data type, an error is returned.

Data type check is also performed when reading a value. An error is returned if the data type of the read operation does not match the data type of the value.

**Namespaces** To mitigate potential conflicts in key names between different components, NVS assigns each key-value pair to one of namespaces. Namespace names follow the same rules as key names, i.e., the maximum length is 15 characters. Furthermore, there can be no more than 254 different namespaces in one NVS partition. Namespace name is specified in the `nvs_open()` or `nvs_open_from_partition` call. This call returns an opaque handle, which is used in subsequent calls to the `nvs_get_*`, `nvs_set_*`, and `nvs_commit()` functions. This way, a handle is associated with a namespace, and key names will not collide with same names in other namespaces. Please note that the namespaces with the same name in different NVS partitions are considered as separate namespaces.

**NVS Iterators** Iterators allow to list key-value pairs stored in NVS, based on specified partition name, namespace, and data type.

There are the following functions available:

- `nvs_entry_find()` creates an opaque handle, which is used in subsequent calls to the `nvs_entry_next()` and `nvs_entry_info()` functions.
- `nvs_entry_next()` advances an iterator to the next key-value pair.
- `nvs_entry_info()` returns information about each key-value pair

In general, all iterators obtained via `nvs_entry_find()` have to be released using `nvs_release_iterator()`, which also tolerates NULL iterators. `nvs_entry_find()` and `nvs_entry_next()` will set the given iterator to NULL or a valid iterator in all cases except a parameter error occurred (i.e., return `ESP_ERR_NVS_NOT_FOUND`). In case of a parameter error, the given iterator will not be modified. Hence, it is best practice to initialize the iterator to NULL before calling `nvs_entry_find()` to avoid complicated error checking before releasing the iterator.

**Security, Tampering, and Robustness** NVS is not directly compatible with the ESP32-S2 flash encryption system. However, data can still be stored in encrypted form if NVS encryption is used together with ESP32-S2 flash encryption. Please refer to [NVS Encryption](#) for more details.

If NVS encryption is not used, it is possible for anyone with physical access to the flash chip to alter, erase, or add key-value pairs. With NVS encryption enabled, it is not possible to alter or add a key-value pair and get recognized as a valid pair without knowing corresponding NVS encryption keys. However, there is no tamper-resistance against the erase operation.

The library does try to recover from conditions when flash memory is in an inconsistent state. In particular, one should be able to power off the device at any point and time and then power it back on. This should not result in loss of data, except for the new key-value pair if it was being written at the moment of powering off. The library should also be able to initialize properly with any random data present in flash memory.





This option will be required by the user when keys in the *NVS Key Partition* are not generated by the application. The *NVS Key Partition* containing the XTS encryption keys can be generated with the help of *NVS Partition Generator Utility*. Then the user can store the pre generated key partition on the flash with help of the following two commands:

i) Build and flash the partition table

```
idf.py partition-table partition-table-flash
```

ii) Store the keys in the *NVS Key Partition* (on the flash) with the help of `parttool.py` (see Partition Tool section in *partition-tables* for more details)

```
parttool.py --port PORT --partition-table-offset PARTITION_TABLE_
↪OFFSET write_partition --partition-name="name of nvs_key partition" -
↪-input NVS_KEY_PARTITION_FILE
```

**Note:** If the device is encrypted in flash encryption development mode and you want to renew the NVS key partition, you need to tell `parttool.py` to encrypt the NVS key partition and you also need to give it a pointer to the unencrypted partition table in your build directory (build/partition\_table) since the partition table on the device is encrypted, too. You can use the following command:

```
parttool.py --esptool-write-args encrypt --port PORT --partition-table-
↪file=PARTITION_TABLE_FILE --partition-table-offset PARTITION_TABLE_
↪OFFSET write_partition --partition-name="name of nvs_key partition" -
↪-input NVS_KEY_PARTITION_FILE
```

Since the key partition is marked as *encrypted* and *Flash Encryption* is enabled, the bootloader will encrypt this partition using flash encryption key on the first boot.

It is possible for an application to use different keys for different NVS partitions and thereby have multiple key-partitions. However, it is a responsibility of the application to provide correct key-partition/keys for the purpose of encryption/decryption.

**Encrypted Read/Write** The same NVS API functions `nvs_get_*` or `nvs_set_*` can be used for reading of, and writing to an encrypted nvs partition as well.

**Encrypt the default NVS partition:** To enable encryption for the default NVS partition no additional steps are necessary. When *CONFIG\_NVS\_ENCRYPTION* is enabled, the `nvs_flash_init()` API function internally performs some additional steps using the first *NVS Key Partition* found to enable encryption for the default NVS partition (refer to the API documentation for more details). Alternatively, `nvs_flash_secure_init()` API function can also be used to enable encryption for the default NVS partition.

**Encrypt a custom NVS partition:** To enable encryption for a custom NVS partition, `nvs_flash_secure_init_partition()` API function is used instead of `nvs_flash_init_partition()`.

When `nvs_flash_secure_init()` and `nvs_flash_secure_init_partition()` API functions are used, the applications are expected to follow the steps below in order to perform NVS read/write operations with encryption enabled.

1. Find key partition and NVS data partition using `esp_partition_find*` API functions.
2. Populate the `nvs_sec_cfg_t` struct using the `nvs_flash_read_security_cfg()` or `nvs_flash_generate_keys()` API functions.
3. Initialise NVS flash partition using the `nvs_flash_secure_init()` or `nvs_flash_secure_init_partition()` API functions.
4. Open a namespace using the `nvs_open()` or `nvs_open_from_partition()` API functions.
5. Perform NVS read/write operations using `nvs_get_*` or `nvs_set_*`.
6. Deinitialise an NVS partition using `nvs_flash_deinit()`.

## NVS Partition Generator Utility

This utility helps generate NVS partition binary files which can be flashed separately on a dedicated partition via a flashing utility. Key-value pairs to be flashed onto the partition can be provided via a CSV file. For more details, please refer to [NVS Partition Generator Utility](#).

### Application Example

You can find code examples in the [storage](#) directory of ESP-IDF examples:

#### [storage/nvs\\_rw\\_value](#)

Demonstrates how to read a single integer value from, and write it to NVS.

The value checked in this example holds the number of the ESP32-S2 module restarts. The value's function as a counter is only possible due to its storing in NVS.

The example also shows how to check if a read / write operation was successful, or if a certain value has not been initialized in NVS. The diagnostic procedure is provided in plain text to help you track the program flow and capture any issues on the way.

#### [storage/nvs\\_rw\\_blob](#)

Demonstrates how to read a single integer value and a blob (binary large object), and write them to NVS to preserve this value between ESP32-S2 module restarts.

- value - tracks the number of the ESP32-S2 module soft and hard restarts.
- blob - contains a table with module run times. The table is read from NVS to dynamically allocated RAM. A new run time is added to the table on each manually triggered soft restart, and then the added run time is written to NVS. Triggering is done by pulling down GPIO0.

The example also shows how to implement the diagnostic procedure to check if the read / write operation was successful.

#### [storage/nvs\\_rw\\_value\\_cxx](#)

This example does exactly the same as [storage/nvs\\_rw\\_value](#), except that it uses the C++ NVS handle class.

## Internals

**Log of Key-Value Pairs** NVS stores key-value pairs sequentially, with new key-value pairs being added at the end. When a value of any given key has to be updated, a new key-value pair is added at the end of the log and the old key-value pair is marked as erased.

**Pages and Entries** NVS library uses two main entities in its operation: pages and entries. Page is a logical structure which stores a portion of the overall log. Logical page corresponds to one physical sector of flash memory. Pages which are in use have a *sequence number* associated with them. Sequence numbers impose an ordering on pages. Higher sequence numbers correspond to pages which were created later. Each page can be in one of the following states:

**Empty/uninitialized** Flash storage for the page is empty (all bytes are `0xff`). Page is not used to store any data at this point and does not have a sequence number.

**Active** Flash storage is initialized, page header has been written to flash, page has a valid sequence number. Page has some empty entries and data can be written there. No more than one page can be in this state at any given moment.

**Full** Flash storage is in a consistent state and is filled with key-value pairs. Writing new key-value pairs into this page is not possible. It is still possible to mark some key-value pairs as erased.

**Erasing** Non-erased key-value pairs are being moved into another page so that the current page can be erased. This is a transient state, i.e., page should never stay in this state at the time when any API call returns. In case of a sudden power off, the move-and-erase process will be completed upon the next power-on.

**Corrupted** Page header contains invalid data, and further parsing of page data was canceled. Any items previously written into this page will not be accessible. The corresponding flash sector will not be erased immediately and will be kept along with sectors in *uninitialized* state for later use. This may be useful for debugging.

Mapping from flash sectors to logical pages does not have any particular order. The library will inspect sequence numbers of pages found in each flash sector and organize pages in a list based on these numbers.

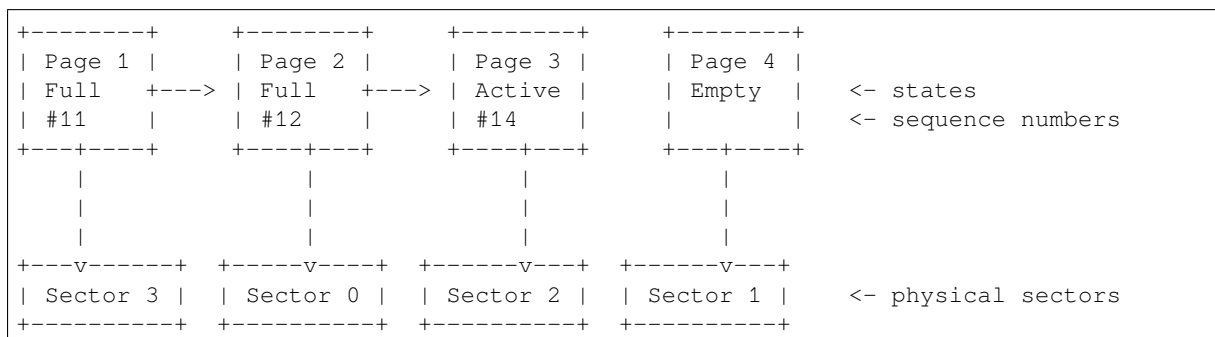

**Structure of a Page** For now, we assume that flash sector size is 4096 bytes and that ESP32-S2 flash encryption hardware operates on 32-byte blocks. It is possible to introduce some settings configurable at compile-time (e.g., via `menuconfig`) to accommodate flash chips with different sector sizes (although it is not clear if other components in the system, e.g., SPI flash driver and SPI flash cache can support these other sizes).

Page consists of three parts: header, entry state bitmap, and entries themselves. To be compatible with ESP32-S2 flash encryption, the entry size is 32 bytes. For integer types, an entry holds one key-value pair. For strings and blobs, an entry holds part of key-value pair (more on that in the entry structure description).

The following diagram illustrates the page structure. Numbers in parentheses indicate the size of each part in bytes.

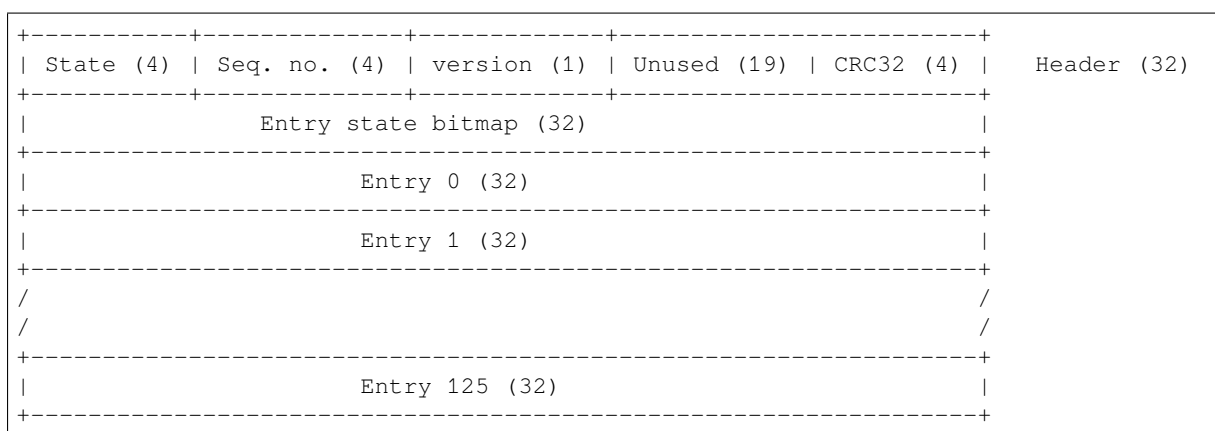

Page header and entry state bitmap are always written to flash unencrypted. Entries are encrypted if flash encryption feature of ESP32-S2 is used.

Page state values are defined in such a way that changing state is possible by writing 0 into some of the bits. Therefore it is not necessary to erase the page to change its state unless that is a change to the *erased* state.

The version field in the header reflects the NVS format version used. For backward compatibility reasons, it is decremented for every version upgrade starting at 0xff (i.e., 0xff for version-1, 0xfe for version-2 and so on).

CRC32 value in the header is calculated over the part which does not include a state value (bytes 4 to 28). The unused part is currently filled with 0xff bytes.

The following sections describe the structure of entry state bitmap and entry itself.

**Entry and Entry State Bitmap** Each entry can be in one of the following three states represented with two bits in the entry state bitmap. The final four bits in the bitmap (256 - 2 \* 126) are not used.

**Empty (2' b11)** Nothing is written into the specific entry yet. It is in an uninitialized state (all bytes are 0xff).

**Written (2' b10)** A key-value pair (or part of key-value pair which spans multiple entries) has been written into the entry.

**Erased (2' b00)** A key-value pair in this entry has been discarded. Contents of this entry will not be parsed anymore.

**Structure of Entry** For values of primitive types (currently integers from 1 to 8 bytes long), entry holds one key-value pair. For string and blob types, entry holds part of the whole key-value pair. For strings, in case when a key-value pair spans multiple entries, all entries are stored in the same page. Blobs are allowed to span over multiple pages by dividing them into smaller chunks. For tracking these chunks, an additional fixed length metadata entry is stored called “blob index”. Earlier formats of blobs are still supported (can be read and modified). However, once the blobs are modified, they are stored using the new format.

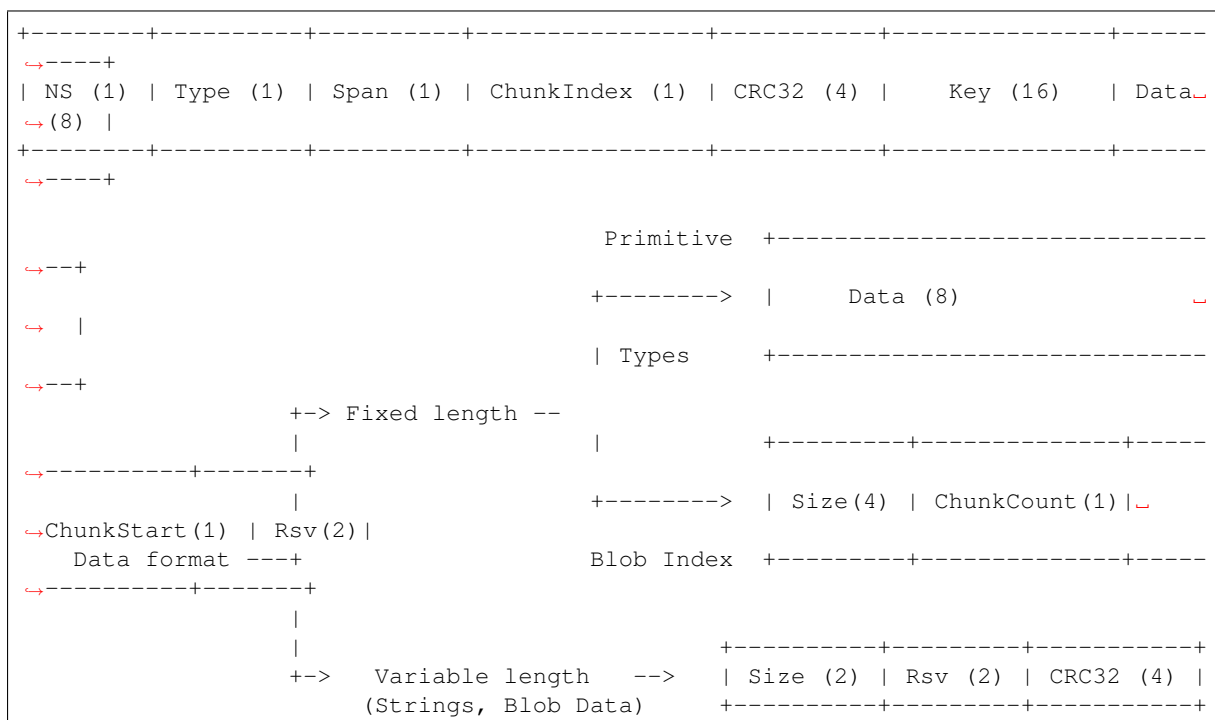

Individual fields in entry structure have the following meanings:

**NS** Namespace index for this entry. For more information on this value, see the section on namespaces implementation.

**Type** One byte indicating the value data type. See the `ItemType` enumeration in `nvs_flash/include/nvs_handle.hpp` for possible values.

**Span** Number of entries used by this key-value pair. For integer types, this is equal to 1. For strings and blobs, this depends on value length.

**ChunkIndex** Used to store the index of a blob-data chunk for blob types. For other types, this should be `0xff`.

**CRC32** Checksum calculated over all the bytes in this entry, except for the CRC32 field itself.

**Key** Zero-terminated ASCII string containing a key name. Maximum string length is 15 bytes, excluding a zero terminator.

**Data** For integer types, this field contains the value itself. If the value itself is shorter than 8 bytes, it is padded to the right, with unused bytes filled with `0xff`.

For “blob index” entry, these 8 bytes hold the following information about data-chunks:

- **Size** (Only for blob index.) Size, in bytes, of complete blob data.
- **ChunkCount** (Only for blob index.) Total number of blob-data chunks into which the blob was divided during storage.
- **ChunkStart** (Only for blob index.) `ChunkIndex` of the first blob-data chunk of this blob. Subsequent chunks have `chunkIndex` incrementally allocated (step of 1).

For string and blob data chunks, these 8 bytes hold additional data about the value, which are described below:

- **Size** (Only for strings and blobs.) Size, in bytes, of actual data. For strings, this includes zero terminators.
- **CRC32** (Only for strings and blobs.) Checksum calculated over all bytes of data.

Variable length values (strings and blobs) are written into subsequent entries, 32 bytes per entry. The *Span* field of the first entry indicates how many entries are used.

**Namespaces** As mentioned above, each key-value pair belongs to one of the namespaces. Namespace identifiers (strings) are stored as keys of key-value pairs in namespace with index 0. Values corresponding to these keys are indexes of these namespaces.

+-----+   NS=0 Type=uint8_t Key="wifi" Value=1   +-----+	Entry describing namespace "wifi"
+-----+   NS=1 Type=uint32_t Key="channel" Value=6   +-----+	Key "channel" in namespace "wifi"
+-----+   NS=0 Type=uint8_t Key="pwm" Value=2   +-----+	Entry describing namespace "pwm"
+-----+   NS=2 Type=uint16_t Key="channel" Value=20   +-----+	Key "channel" in namespace "pwm"

**Item Hash List** To reduce the number of reads from flash memory, each member of the Page class maintains a list of pairs: item index; item hash. This list makes searches much quicker. Instead of iterating over all entries, reading them from flash one at a time, *Page::findItem* first performs a search for the item hash in the hash list. This gives the item index within the page if such an item exists. Due to a hash collision, it is possible that a different item will be found. This is handled by falling back to iteration over items in flash.

Each node in the hash list contains a 24-bit hash and 8-bit item index. Hash is calculated based on item namespace, key name, and ChunkIndex. CRC32 is used for calculation; the result is truncated to 24 bits. To reduce the overhead for storing 32-bit entries in a linked list, the list is implemented as a double-linked list of arrays. Each array holds 29 entries, for the total size of 128 bytes, together with linked list pointers and a 32-bit count field. The minimum amount of extra RAM usage per page is therefore 128 bytes; maximum is 640 bytes.

## API Reference

### Header File

- `components/nvs_flash/include/nvs_flash.h`

### Functions

`esp_err_t nvs_flash_init` (void)

Initialize the default NVS partition.

This API initialises the default NVS partition. The default NVS partition is the one that is labeled “nvs” in the partition table.

When “NVS\_ENCRYPTION” is enabled in the menuconfig, this API enables the NVS encryption for the default NVS partition as follows

- Read security configurations from the first NVS key partition listed in the partition table. (NVS key partition is any “data” type partition which has the subtype value set to “nvs\_keys” )
- If the NVS key partition obtained in the previous step is empty, generate and store new keys in that NVS key partition.
- Internally call “nvs\_flash\_secure\_init()” with the security configurations obtained/generated in the previous steps.

Post initialization NVS read/write APIs remain the same irrespective of NVS encryption.

### Returns

- ESP\_OK if storage was successfully initialized.
- ESP\_ERR\_NVS\_NO\_FREE\_PAGES if the NVS storage contains no empty pages (which may happen if NVS partition was truncated)
- ESP\_ERR\_NOT\_FOUND if no partition with label “nvs” is found in the partition table

- ESP\_ERR\_NO\_MEM in case memory could not be allocated for the internal structures
- one of the error codes from the underlying flash storage driver
- error codes from `nvs_flash_read_security_cfg` API (when “NVS\_ENCRYPTION” is enabled).
- error codes from `nvs_flash_generate_keys` API (when “NVS\_ENCRYPTION” is enabled).
- error codes from `nvs_flash_secure_init_partition` API (when “NVS\_ENCRYPTION” is enabled) .

*esp\_err\_t* **nvs\_flash\_init\_partition** (const char \*partition\_label)

Initialize NVS flash storage for the specified partition.

**Parameters** `partition_label` –[in] Label of the partition. Must be no longer than 16 characters.

**Returns**

- ESP\_OK if storage was successfully initialized.
- ESP\_ERR\_NVS\_NO\_FREE\_PAGES if the NVS storage contains no empty pages (which may happen if NVS partition was truncated)
- ESP\_ERR\_NOT\_FOUND if specified partition is not found in the partition table
- ESP\_ERR\_NO\_MEM in case memory could not be allocated for the internal structures
- one of the error codes from the underlying flash storage driver

*esp\_err\_t* **nvs\_flash\_init\_partition\_ptr** (const *esp\_partition\_t* \*partition)

Initialize NVS flash storage for the partition specified by partition pointer.

**Parameters** `partition` –[in] pointer to a partition obtained by the ESP partition API.

**Returns**

- ESP\_OK if storage was successfully initialized
- ESP\_ERR\_NVS\_NO\_FREE\_PAGES if the NVS storage contains no empty pages (which may happen if NVS partition was truncated)
- ESP\_ERR\_INVALID\_ARG in case partition is NULL
- ESP\_ERR\_NO\_MEM in case memory could not be allocated for the internal structures
- one of the error codes from the underlying flash storage driver

*esp\_err\_t* **nvs\_flash\_deinit** (void)

Deinitialize NVS storage for the default NVS partition.

Default NVS partition is the partition with “nvs” label in the partition table.

**Returns**

- ESP\_OK on success (storage was deinitialized)
- ESP\_ERR\_NVS\_NOT\_INITIALIZED if the storage was not initialized prior to this call

*esp\_err\_t* **nvs\_flash\_deinit\_partition** (const char \*partition\_label)

Deinitialize NVS storage for the given NVS partition.

**Parameters** `partition_label` –[in] Label of the partition

**Returns**

- ESP\_OK on success
- ESP\_ERR\_NVS\_NOT\_INITIALIZED if the storage for given partition was not initialized prior to this call

*esp\_err\_t* **nvs\_flash\_erase** (void)

Erase the default NVS partition.

Erases all contents of the default NVS partition (one with label “nvs” ).

---

**Note:** If the partition is initialized, this function first de-initializes it. Afterwards, the partition has to be initialized again to be used.

---

**Returns**

- ESP\_OK on success
- ESP\_ERR\_NOT\_FOUND if there is no NVS partition labeled “nvs” in the partition table
- different error in case de-initialization fails (shouldn't happen)

*esp\_err\_t* **nvs\_flash\_erase\_partition** (const char \*part\_name)

Erase specified NVS partition.

Erase all content of a specified NVS partition

---

**Note:** If the partition is initialized, this function first de-initializes it. Afterwards, the partition has to be initialized again to be used.

---

**Parameters** **part\_name** –[in] Name (label) of the partition which should be erased

**Returns**

- ESP\_OK on success
- ESP\_ERR\_NOT\_FOUND if there is no NVS partition with the specified name in the partition table
- different error in case de-initialization fails (shouldn't happen)

*esp\_err\_t* **nvs\_flash\_erase\_partition\_ptr** (const *esp\_partition\_t* \*partition)

Erase custom partition.

Erase all content of specified custom partition.

---

**Note:** If the partition is initialized, this function first de-initializes it. Afterwards, the partition has to be initialized again to be used.

---

**Parameters** **partition** –[in] pointer to a partition obtained by the ESP partition API.

**Returns**

- ESP\_OK on success
- ESP\_ERR\_NOT\_FOUND if there is no partition with the specified parameters in the partition table
- ESP\_ERR\_INVALID\_ARG in case partition is NULL
- one of the error codes from the underlying flash storage driver

*esp\_err\_t* **nvs\_flash\_secure\_init** (*nvs\_sec\_cfg\_t* \*cfg)

Initialize the default NVS partition.

This API initialises the default NVS partition. The default NVS partition is the one that is labeled “nvs” in the partition table.

**Parameters** **cfg** –[in] Security configuration (keys) to be used for NVS encryption/decryption. If **cfg** is NULL, no encryption is used.

**Returns**

- ESP\_OK if storage has been initialized successfully.
- ESP\_ERR\_NVS\_NO\_FREE\_PAGES if the NVS storage contains no empty pages (which may happen if NVS partition was truncated)
- ESP\_ERR\_NOT\_FOUND if no partition with label “nvs” is found in the partition table
- ESP\_ERR\_NO\_MEM in case memory could not be allocated for the internal structures
- one of the error codes from the underlying flash storage driver

*esp\_err\_t* **nvs\_flash\_secure\_init\_partition** (const char \*partition\_label, *nvs\_sec\_cfg\_t* \*cfg)

Initialize NVS flash storage for the specified partition.

**Parameters**



- **partition\_label** –[in] Label of the partition. Note that internally, a reference to passed value is kept and it should be accessible for future operations
- **cfg** –[in] Security configuration (keys) to be used for NVS encryption/decryption. If **cfg** is null, no encryption/decryption is used.

**Returns**

- ESP\_OK if storage has been initialized successfully.
- ESP\_ERR\_NVS\_NO\_FREE\_PAGES if the NVS storage contains no empty pages (which may happen if NVS partition was truncated)
- ESP\_ERR\_NOT\_FOUND if specified partition is not found in the partition table
- ESP\_ERR\_NO\_MEM in case memory could not be allocated for the internal structures
- one of the error codes from the underlying flash storage driver

*esp\_err\_t* **nvs\_flash\_generate\_keys** (const *esp\_partition\_t* \*partition, *nvs\_sec\_cfg\_t* \*cfg)

Generate and store NVS keys in the provided esp partition.

**Parameters**

- **partition** –[in] Pointer to partition structure obtained using `esp_partition_find_first` or `esp_partition_get`. Must be non-NULL.
- **cfg** –[out] Pointer to nvs security configuration structure. Pointer must be non-NULL. Generated keys will be populated in this structure.

**Returns** -ESP\_OK, if **cfg** was read successfully; -ESP\_INVALID\_ARG, if **partition** or **cfg**; -or error codes from `esp_partition_write/erase` APIs.

*esp\_err\_t* **nvs\_flash\_read\_security\_cfg** (const *esp\_partition\_t* \*partition, *nvs\_sec\_cfg\_t* \*cfg)

Read NVS security configuration from a partition.

---

**Note:** Provided partition is assumed to be marked ‘encrypted’ .

---

**Parameters**

- **partition** –[in] Pointer to partition structure obtained using `esp_partition_find_first` or `esp_partition_get`. Must be non-NULL.
- **cfg** –[out] Pointer to nvs security configuration structure. Pointer must be non-NULL.

**Returns** -ESP\_OK, if **cfg** was read successfully; -ESP\_INVALID\_ARG, if **partition** or **cfg**; -ESP\_ERR\_NVS\_KEYS\_NOT\_INITIALIZED, if the partition is not yet written with keys. -ESP\_ERR\_NVS\_CORRUPT\_KEY\_PART, if the partition containing keys is found to be corrupt -or error codes from `esp_partition_read` API.

**Structures**

struct **nvs\_sec\_cfg\_t**

Key for encryption and decryption.

**Public Members**

uint8\_t **eky**[NVS\_KEY\_SIZE]

XTS encryption and decryption key

uint8\_t **tky**[NVS\_KEY\_SIZE]

XTS tweak key

**Macros**

**NVS\_KEY\_SIZE**



## Header File

- `components/nvs_flash/include/nvs.h`

## Functions

`esp_err_t nvs_set_i8(nvs_handle_t handle, const char *key, int8_t value)`

set `int8_t` value for given key

Set value for the key, given its name. Note that the actual storage will not be updated until `nvs_commit` is called.

### Parameters

- **handle** –[in] Handle obtained from `nvs_open` function. Handles that were opened read only cannot be used.
- **key** –[in] Key name. Maximum length is `(NVS_KEY_NAME_MAX_SIZE-1)` characters. Shouldn't be empty.
- **value** –[in] The value to set.

### Returns

- `ESP_OK` if value was set successfully
- `ESP_FAIL` if there is an internal error; most likely due to corrupted NVS partition (only if NVS assertion checks are disabled)
- `ESP_ERR_NVS_INVALID_HANDLE` if handle has been closed or is `NULL`
- `ESP_ERR_NVS_READ_ONLY` if storage handle was opened as read only
- `ESP_ERR_NVS_INVALID_NAME` if key name doesn't satisfy constraints
- `ESP_ERR_NVS_NOT_ENOUGH_SPACE` if there is not enough space in the underlying storage to save the value
- `ESP_ERR_NVS_REMOVE_FAILED` if the value wasn't updated because flash write operation has failed. The value was written however, and update will be finished after re-initialization of `nvs`, provided that flash operation doesn't fail again.

`esp_err_t nvs_set_u8(nvs_handle_t handle, const char *key, uint8_t value)`

set `uint8_t` value for given key

This function is the same as `nvs_set_i8` except for the data type.

`esp_err_t nvs_set_i16(nvs_handle_t handle, const char *key, int16_t value)`

set `int16_t` value for given key

This function is the same as `nvs_set_i8` except for the data type.

`esp_err_t nvs_set_u16(nvs_handle_t handle, const char *key, uint16_t value)`

set `uint16_t` value for given key

This function is the same as `nvs_set_i8` except for the data type.

`esp_err_t nvs_set_i32(nvs_handle_t handle, const char *key, int32_t value)`

set `int32_t` value for given key

This function is the same as `nvs_set_i8` except for the data type.

`esp_err_t nvs_set_u32(nvs_handle_t handle, const char *key, uint32_t value)`

set `uint32_t` value for given key

This function is the same as `nvs_set_i8` except for the data type.

`esp_err_t nvs_set_i64(nvs_handle_t handle, const char *key, int64_t value)`

set `int64_t` value for given key

This function is the same as `nvs_set_i8` except for the data type.

`esp_err_t nvs_set_u64(nvs_handle_t handle, const char *key, uint64_t value)`

set `uint64_t` value for given key

This function is the same as `nvs_set_i8` except for the data type.

`esp_err_t nvs_set_str(nvs_handle_t handle, const char *key, const char *value)`

set string for given key

Set value for the key, given its name. Note that the actual storage will not be updated until `nvs_commit` is called.

#### Parameters

- **handle** –[in] Handle obtained from `nvs_open` function. Handles that were opened read only cannot be used.
- **key** –[in] Key name. Maximum length is `(NVS_KEY_NAME_MAX_SIZE-1)` characters. Shouldn't be empty.
- **value** –[in] The value to set. For strings, the maximum length (including null character) is 4000 bytes, if there is one complete page free for writing. This decreases, however, if the free space is fragmented.

#### Returns

- `ESP_OK` if value was set successfully
- `ESP_ERR_NVS_INVALID_HANDLE` if handle has been closed or is `NULL`
- `ESP_ERR_NVS_READ_ONLY` if storage handle was opened as read only
- `ESP_ERR_NVS_INVALID_NAME` if key name doesn't satisfy constraints
- `ESP_ERR_NVS_NOT_ENOUGH_SPACE` if there is not enough space in the underlying storage to save the value
- `ESP_ERR_NVS_REMOVE_FAILED` if the value wasn't updated because flash write operation has failed. The value was written however, and update will be finished after re-initialization of `nvs`, provided that flash operation doesn't fail again.
- `ESP_ERR_NVS_VALUE_TOO_LONG` if the string value is too long

`esp_err_t nvs_get_i8(nvs_handle_t handle, const char *key, int8_t *out_value)`

get `int8_t` value for given key

These functions retrieve value for the key, given its name. If `key` does not exist, or the requested variable type doesn't match the type which was used when setting a value, an error is returned.

In case of any error, `out_value` is not modified.

`out_value` has to be a pointer to an already allocated variable of the given type.

```
// Example of using nvs_get_i32:
int32_t max_buffer_size = 4096; // default value
esp_err_t err = nvs_get_i32(my_handle, "max_buffer_size", &max_buffer_size);
assert(err == ESP_OK || err == ESP_ERR_NVS_NOT_FOUND);
// if ESP_ERR_NVS_NOT_FOUND was returned, max_buffer_size will still
// have its default value.
```

#### Parameters

- **handle** –[in] Handle obtained from `nvs_open` function.
- **key** –[in] Key name. Maximum length is `(NVS_KEY_NAME_MAX_SIZE-1)` characters. Shouldn't be empty.
- **out\_value** –Pointer to the output value. May be `NULL` for `nvs_get_str` and `nvs_get_blob`, in this case required length will be returned in `length` argument.

#### Returns

- `ESP_OK` if the value was retrieved successfully
- `ESP_FAIL` if there is an internal error; most likely due to corrupted NVS partition (only if NVS assertion checks are disabled)
- `ESP_ERR_NVS_NOT_FOUND` if the requested key doesn't exist
- `ESP_ERR_NVS_INVALID_HANDLE` if handle has been closed or is `NULL`
- `ESP_ERR_NVS_INVALID_NAME` if key name doesn't satisfy constraints
- `ESP_ERR_NVS_INVALID_LENGTH` if `length` is not sufficient to store data

*esp\_err\_t* **nvs\_get\_u8** (*nvs\_handle\_t* handle, const char \*key, uint8\_t \*out\_value)

get uint8\_t value for given key

This function is the same as `nvs_get_i8` except for the data type.

*esp\_err\_t* **nvs\_get\_i16** (*nvs\_handle\_t* handle, const char \*key, int16\_t \*out\_value)

get int16\_t value for given key

This function is the same as `nvs_get_i8` except for the data type.

*esp\_err\_t* **nvs\_get\_u16** (*nvs\_handle\_t* handle, const char \*key, uint16\_t \*out\_value)

get uint16\_t value for given key

This function is the same as `nvs_get_i8` except for the data type.

*esp\_err\_t* **nvs\_get\_i32** (*nvs\_handle\_t* handle, const char \*key, int32\_t \*out\_value)

get int32\_t value for given key

This function is the same as `nvs_get_i8` except for the data type.

*esp\_err\_t* **nvs\_get\_u32** (*nvs\_handle\_t* handle, const char \*key, uint32\_t \*out\_value)

get uint32\_t value for given key

This function is the same as `nvs_get_i8` except for the data type.

*esp\_err\_t* **nvs\_get\_i64** (*nvs\_handle\_t* handle, const char \*key, int64\_t \*out\_value)

get int64\_t value for given key

This function is the same as `nvs_get_i8` except for the data type.

*esp\_err\_t* **nvs\_get\_u64** (*nvs\_handle\_t* handle, const char \*key, uint64\_t \*out\_value)

get uint64\_t value for given key

This function is the same as `nvs_get_i8` except for the data type.

*esp\_err\_t* **nvs\_get\_str** (*nvs\_handle\_t* handle, const char \*key, char \*out\_value, size\_t \*length)

get string value for given key

These functions retrieve the data of an entry, given its key. If key does not exist, or the requested variable type doesn't match the type which was used when setting a value, an error is returned.

In case of any error, `out_value` is not modified.

All functions expect `out_value` to be a pointer to an already allocated variable of the given type.

`nvs_get_str` and `nvs_get_blob` functions support WinAPI-style length queries. To get the size necessary to store the value, call `nvs_get_str` or `nvs_get_blob` with zero `out_value` and non-zero pointer to length. Variable pointed to by length argument will be set to the required length. For `nvs_get_str`, this length includes the zero terminator. When calling `nvs_get_str` and `nvs_get_blob` with non-zero `out_value`, length has to be non-zero and has to point to the length available in `out_value`. It is suggested that `nvs_get/set_str` is used for zero-terminated C strings, and `nvs_get/set_blob` used for arbitrary data structures.

```
// Example (without error checking) of using nvs_get_str to get a string into
↳dynamic array:
size_t required_size;
nvs_get_str(my_handle, "server_name", NULL, &required_size);
char* server_name = malloc(required_size);
nvs_get_str(my_handle, "server_name", server_name, &required_size);

// Example (without error checking) of using nvs_get_blob to get a binary data
into a static array:
uint8_t mac_addr[6];
size_t size = sizeof(mac_addr);
nvs_get_blob(my_handle, "dst_mac_addr", mac_addr, &size);
```

**Parameters**

- **handle** –[in] Handle obtained from `nvs_open` function.
- **key** –[in] Key name. Maximum length is `(NVS_KEY_NAME_MAX_SIZE-1)` characters. Shouldn't be empty.
- **out\_value** –[out] Pointer to the output value. May be `NULL` for `nvs_get_str` and `nvs_get_blob`, in this case required length will be returned in `length` argument.
- **length** –[inout] A non-zero pointer to the variable holding the length of `out_value`. In case `out_value` a zero, will be set to the length required to hold the value. In case `out_value` is not zero, will be set to the actual length of the value written. For `nvs_get_str` this includes zero terminator.

**Returns**

- `ESP_OK` if the value was retrieved successfully
- `ESP_FAIL` if there is an internal error; most likely due to corrupted NVS partition (only if NVS assertion checks are disabled)
- `ESP_ERR_NVS_NOT_FOUND` if the requested key doesn't exist
- `ESP_ERR_NVS_INVALID_HANDLE` if handle has been closed or is `NULL`
- `ESP_ERR_NVS_INVALID_NAME` if key name doesn't satisfy constraints
- `ESP_ERR_NVS_INVALID_LENGTH` if `length` is not sufficient to store data

`esp_err_t nvs_get_blob` (`nvs_handle_t` handle, const char \*key, void \*out\_value, size\_t \*length)  
get blob value for given key

This function behaves the same as `nvs_get_str`, except for the data type.

`esp_err_t nvs_open` (const char \*namespace\_name, `nvs_open_mode_t` open\_mode, `nvs_handle_t` \*out\_handle)  
Open non-volatile storage with a given namespace from the default NVS partition.

Multiple internal ESP-IDF and third party application modules can store their key-value pairs in the NVS module. In order to reduce possible conflicts on key names, each module can use its own namespace. The default NVS partition is the one that is labelled “nvs” in the partition table.

**Parameters**

- **namespace\_name** –[in] Namespace name. Maximum length is `(NVS_KEY_NAME_MAX_SIZE-1)` characters. Shouldn't be empty.
- **open\_mode** –[in] `NVS_READWRITE` or `NVS_READONLY`. If `NVS_READONLY`, will open a handle for reading only. All write requests will be rejected for this handle.
- **out\_handle** –[out] If successful (return code is zero), handle will be returned in this argument.

**Returns**

- `ESP_OK` if storage handle was opened successfully
- `ESP_FAIL` if there is an internal error; most likely due to corrupted NVS partition (only if NVS assertion checks are disabled)
- `ESP_ERR_NVS_NOT_INITIALIZED` if the storage driver is not initialized
- `ESP_ERR_NVS_PART_NOT_FOUND` if the partition with label “nvs” is not found
- `ESP_ERR_NVS_NOT_FOUND` id namespace doesn't exist yet and mode is `NVS_READONLY`
- `ESP_ERR_NVS_INVALID_NAME` if namespace name doesn't satisfy constraints
- `ESP_ERR_NO_MEM` in case memory could not be allocated for the internal structures
- `ESP_ERR_NVS_NOT_ENOUGH_SPACE` if there is no space for a new entry or there are too many different namespaces (maximum allowed different namespaces: 254)
- other error codes from the underlying storage driver

`esp_err_t nvs_open_from_partition` (const char \*part\_name, const char \*namespace\_name, `nvs_open_mode_t` open\_mode, `nvs_handle_t` \*out\_handle)

Open non-volatile storage with a given namespace from specified partition.

The behaviour is same as `nvs_open()` API. However this API can operate on a specified NVS partition instead of default NVS partition. Note that the specified partition must be registered with NVS using `nvs_flash_init_partition()` API.

**Parameters**

- **part\_name** –[in] Label (name) of the partition of interest for object read/write/erase
- **namespace\_name** –[in] Namespace name. Maximum length is (NVS\_KEY\_NAME\_MAX\_SIZE-1) characters. Shouldn't be empty.
- **open\_mode** –[in] NVS\_READWRITE or NVS\_READONLY. If NVS\_READONLY, will open a handle for reading only. All write requests will be rejected for this handle.
- **out\_handle** –[out] If successful (return code is zero), handle will be returned in this argument.

#### Returns

- ESP\_OK if storage handle was opened successfully
- ESP\_FAIL if there is an internal error; most likely due to corrupted NVS partition (only if NVS assertion checks are disabled)
- ESP\_ERR\_NVS\_NOT\_INITIALIZED if the storage driver is not initialized
- ESP\_ERR\_NVS\_PART\_NOT\_FOUND if the partition with specified name is not found
- ESP\_ERR\_NVS\_NOT\_FOUND id namespace doesn't exist yet and mode is NVS\_READONLY
- ESP\_ERR\_NVS\_INVALID\_NAME if namespace name doesn't satisfy constraints
- ESP\_ERR\_NO\_MEM in case memory could not be allocated for the internal structures
- ESP\_ERR\_NVS\_NOT\_ENOUGH\_SPACE if there is no space for a new entry or there are too many different namespaces (maximum allowed different namespaces: 254)
- other error codes from the underlying storage driver

*esp\_err\_t* **nvs\_set\_blob** (*nvs\_handle\_t* handle, const char \*key, const void \*value, size\_t length)

set variable length binary value for given key

This family of functions set value for the key, given its name. Note that actual storage will not be updated until `nvs_commit` function is called.

#### Parameters

- **handle** –[in] Handle obtained from `nvs_open` function. Handles that were opened read only cannot be used.
- **key** –[in] Key name. Maximum length is (NVS\_KEY\_NAME\_MAX\_SIZE-1) characters. Shouldn't be empty.
- **value** –[in] The value to set.
- **length** –[in] length of binary value to set, in bytes; Maximum length is 508000 bytes or (97.6% of the partition size - 4000) bytes whichever is lower.

#### Returns

- ESP\_OK if value was set successfully
- ESP\_FAIL if there is an internal error; most likely due to corrupted NVS partition (only if NVS assertion checks are disabled)
- ESP\_ERR\_NVS\_INVALID\_HANDLE if handle has been closed or is NULL
- ESP\_ERR\_NVS\_READ\_ONLY if storage handle was opened as read only
- ESP\_ERR\_NVS\_INVALID\_NAME if key name doesn't satisfy constraints
- ESP\_ERR\_NVS\_NOT\_ENOUGH\_SPACE if there is not enough space in the underlying storage to save the value
- ESP\_ERR\_NVS\_REMOVE\_FAILED if the value wasn't updated because flash write operation has failed. The value was written however, and update will be finished after re-initialization of `nvs`, provided that flash operation doesn't fail again.
- ESP\_ERR\_NVS\_VALUE\_TOO\_LONG if the value is too long

*esp\_err\_t* **nvs\_erase\_key** (*nvs\_handle\_t* handle, const char \*key)

Erase key-value pair with given key name.

Note that actual storage may not be updated until `nvs_commit` function is called.

#### Parameters

- **handle** –[in] Storage handle obtained with `nvs_open`. Handles that were opened read only cannot be used.
- **key** –[in] Key name. Maximum length is (NVS\_KEY\_NAME\_MAX\_SIZE-1) characters. Shouldn't be empty.

#### Returns

- ESP\_OK if erase operation was successful

- ESP\_FAIL if there is an internal error; most likely due to corrupted NVS partition (only if NVS assertion checks are disabled)
- ESP\_ERR\_NVS\_INVALID\_HANDLE if handle has been closed or is NULL
- ESP\_ERR\_NVS\_READ\_ONLY if handle was opened as read only
- ESP\_ERR\_NVS\_NOT\_FOUND if the requested key doesn't exist
- other error codes from the underlying storage driver

*esp\_err\_t* **nvs\_erase\_all** (*nvs\_handle\_t* handle)

Erase all key-value pairs in a namespace.

Note that actual storage may not be updated until `nvs_commit` function is called.

**Parameters** **handle** –[in] Storage handle obtained with `nvs_open`. Handles that were opened read only cannot be used.

**Returns**

- ESP\_OK if erase operation was successful
- ESP\_FAIL if there is an internal error; most likely due to corrupted NVS partition (only if NVS assertion checks are disabled)
- ESP\_ERR\_NVS\_INVALID\_HANDLE if handle has been closed or is NULL
- ESP\_ERR\_NVS\_READ\_ONLY if handle was opened as read only
- other error codes from the underlying storage driver

*esp\_err\_t* **nvs\_commit** (*nvs\_handle\_t* handle)

Write any pending changes to non-volatile storage.

After setting any values, `nvs_commit()` must be called to ensure changes are written to non-volatile storage. Individual implementations may write to storage at other times, but this is not guaranteed.

**Parameters** **handle** –[in] Storage handle obtained with `nvs_open`. Handles that were opened read only cannot be used.

**Returns**

- ESP\_OK if the changes have been written successfully
- ESP\_ERR\_NVS\_INVALID\_HANDLE if handle has been closed or is NULL
- other error codes from the underlying storage driver

void **nvs\_close** (*nvs\_handle\_t* handle)

Close the storage handle and free any allocated resources.

This function should be called for each handle opened with `nvs_open` once the handle is not in use any more. Closing the handle may not automatically write the changes to nonvolatile storage. This has to be done explicitly using `nvs_commit` function. Once this function is called on a handle, the handle should no longer be used.

**Parameters** **handle** –[in] Storage handle to close

*esp\_err\_t* **nvs\_get\_stats** (const char \*part\_name, *nvs\_stats\_t* \*nvs\_stats)

Fill structure *nvs\_stats\_t*. It provides info about used memory the partition.

This function calculates to runtime the number of used entries, free entries, total entries, and amount namespace in partition.

```
// Example of nvs_get_stats() to get the number of used entries and free_
↪entries:
nvs_stats_t nvs_stats;
nvs_get_stats(NULL, &nvs_stats);
printf("Count: UsedEntries = (%d), FreeEntries = (%d), AllEntries = (%d)\n",
      nvs_stats.used_entries, nvs_stats.free_entries, nvs_stats.total_
↪entries);
```

**Parameters**

- **part\_name** –[in] Partition name NVS in the partition table. If pass a NULL than will use `NVS_DEFAULT_PART_NAME` ( "nvs" ).

- **nvs\_stats** –[out] Returns filled structure `nvs_states_t`. It provides info about used memory the partition.

#### Returns

- `ESP_OK` if the changes have been written successfully. Return param `nvs_stats` will be filled.
- `ESP_ERR_NVS_PART_NOT_FOUND` if the partition with label “name” is not found. Return param `nvs_stats` will be filled 0.
- `ESP_ERR_NVS_NOT_INITIALIZED` if the storage driver is not initialized. Return param `nvs_stats` will be filled 0.
- `ESP_ERR_INVALID_ARG` if `nvs_stats` equal to `NULL`.
- `ESP_ERR_INVALID_STATE` if there is page with the status of `INVALID`. Return param `nvs_stats` will be filled not with correct values because not all pages will be counted. Counting will be interrupted at the first `INVALID` page.

*esp\_err\_t* **nvs\_get\_used\_entry\_count** (*nvs\_handle\_t* handle, *size\_t* \*used\_entries)

Calculate all entries in a namespace.

An entry represents the smallest storage unit in NVS. Strings and blobs may occupy more than one entry. Note that to find out the total number of entries occupied by the namespace, add one to the returned value `used_entries` (if `err` is equal to `ESP_OK`). Because the name space entry takes one entry.

```
// Example of nvs_get_used_entry_count() to get amount of all key-value pairs.
↳in one namespace:
nvs_handle_t handle;
nvs_open("namespace1", NVS_READWRITE, &handle);
...
size_t used_entries;
size_t total_entries_namespace;
if(nvs_get_used_entry_count(handle, &used_entries) == ESP_OK){
    // the total number of entries occupied by the namespace
    total_entries_namespace = used_entries + 1;
}
```

#### Parameters

- **handle** –[in] Handle obtained from `nvs_open` function.
- **used\_entries** –[out] Returns amount of used entries from a namespace.

#### Returns

- `ESP_OK` if the changes have been written successfully. Return param `used_entries` will be filled valid value.
- `ESP_ERR_NVS_NOT_INITIALIZED` if the storage driver is not initialized. Return param `used_entries` will be filled 0.
- `ESP_ERR_NVS_INVALID_HANDLE` if handle has been closed or is `NULL`. Return param `used_entries` will be filled 0.
- `ESP_ERR_INVALID_ARG` if `used_entries` equal to `NULL`.
- Other error codes from the underlying storage driver. Return param `used_entries` will be filled 0.

*esp\_err\_t* **nvs\_entry\_find** (const char \*part\_name, const char \*namespace\_name, *nvs\_type\_t* type, *nvs\_iterator\_t* \*output\_iterator)

Create an iterator to enumerate NVS entries based on one or more parameters.

```
// Example of listing all the key-value pairs of any type under specified
↳partition and namespace
nvs_iterator_t it = NULL;
esp_err_t res = nvs_entry_find(<nvs_partition_name>, <namespace>, NVS_TYPE_
↳ANY, &it);
```

(continues on next page)



```

while(res == ESP_OK) {
    nvs_entry_info_t info;
    nvs_entry_info(it, &info); // Can omit error check if parameters are
    ↪ guaranteed to be non-NULL
    printf("key '%s', type '%d' \n", info.key, info.type);
    res = nvs_entry_next(&it);
}
nvs_release_iterator(it);

```

**Parameters**

- **part\_name** **–[in]** Partition name
- **namespace\_name** **–[in]** Set this value if looking for entries with a specific namespace. Pass NULL otherwise.
- **type** **–[in]** One of `nvs_type_t` values.
- **output\_iterator** **–[out]** Set to a valid iterator to enumerate all the entries found. Set to NULL if no entry for specified criteria was found. If any other error except `ESP_ERR_INVALID_ARG` occurs, `output_iterator` is NULL, too. If `ESP_ERR_INVALID_ARG` occurs, `output_iterator` is not changed. If a valid iterator is obtained through this function, it has to be released using `nvs_release_iterator` when not used any more, unless `ESP_ERR_INVALID_ARG` is returned.

**Returns**

- `ESP_OK` if no internal error or programming error occurred.
- `ESP_ERR_NVS_NOT_FOUND` if no element of specified criteria has been found.
- `ESP_ERR_NO_MEM` if memory has been exhausted during allocation of internal structures.
- `ESP_ERR_INVALID_ARG` if any of the parameters is NULL. Note: don't release `output_iterator` in case `ESP_ERR_INVALID_ARG` has been returned

`esp_err_t nvs_entry_next` (`nvs_iterator_t` \*iterator)

Advances the iterator to next item matching the iterator criteria.

Note that any copies of the iterator will be invalid after this call.

**Parameters** **iterator** **–[inout]** Iterator obtained from `nvs_entry_find` function. Must be non-NULL. If any error except `ESP_ERR_INVALID_ARG` occurs, `iterator` is set to NULL. If `ESP_ERR_INVALID_ARG` occurs, `iterator` is not changed.

**Returns**

- `ESP_OK` if no internal error or programming error occurred.
- `ESP_ERR_NVS_NOT_FOUND` if no next element matching the iterator criteria.
- `ESP_ERR_INVALID_ARG` if `iterator` is NULL.
- Possibly other errors in the future for internal programming or flash errors.

`esp_err_t nvs_entry_info` (const `nvs_iterator_t` iterator, `nvs_entry_info_t` \*out\_info)

Fills `nvs_entry_info_t` structure with information about entry pointed to by the iterator.

**Parameters**

- **iterator** **–[in]** Iterator obtained from `nvs_entry_find` function. Must be non-NULL.
- **out\_info** **–[out]** Structure to which entry information is copied.

**Returns**

- `ESP_OK` if all parameters are valid; current iterator data has been written to `out_info`
- `ESP_ERR_INVALID_ARG` if one of the parameters is NULL.

void `nvs_release_iterator` (`nvs_iterator_t` iterator)

Release iterator.

**Parameters** **iterator** **–[in]** Release iterator obtained from `nvs_entry_find` function. NULL argument is allowed.



## Structures

struct **nvs\_entry\_info\_t**

information about entry obtained from `nvs_entry_info` function

### Public Members

char **namespace\_name**[16]

Namespace to which key-value belong

char **key**[NVS\_KEY\_NAME\_MAX\_SIZE]

Key of stored key-value pair

*nvs\_type\_t* **type**

Type of stored key-value pair

struct **nvs\_stats\_t**

---

**Note:** Info about storage space NVS.

---

### Public Members

size\_t **used\_entries**

Amount of used entries.

size\_t **free\_entries**

Amount of free entries.

size\_t **total\_entries**

Amount all available entries.

size\_t **namespace\_count**

Amount name space.

## Macros

**ESP\_ERR\_NVS\_BASE**

Starting number of error codes

**ESP\_ERR\_NVS\_NOT\_INITIALIZED**

The storage driver is not initialized

**ESP\_ERR\_NVS\_NOT\_FOUND**

A requested entry couldn't be found or namespace doesn't exist yet and mode is `NVS_READONLY`

**ESP\_ERR\_NVS\_TYPE\_MISMATCH**

The type of set or get operation doesn't match the type of value stored in NVS

**ESP\_ERR\_NVS\_READ\_ONLY**

Storage handle was opened as read only

**ESP\_ERR\_NVS\_NOT\_ENOUGH\_SPACE**

There is not enough space in the underlying storage to save the value

**ESP\_ERR\_NVS\_INVALID\_NAME**

Namespace name doesn't satisfy constraints

**ESP\_ERR\_NVS\_INVALID\_HANDLE**

Handle has been closed or is NULL

**ESP\_ERR\_NVS\_REMOVE\_FAILED**

The value wasn't updated because flash write operation has failed. The value was written however, and update will be finished after re-initialization of nvs, provided that flash operation doesn't fail again.

**ESP\_ERR\_NVS\_KEY\_TOO\_LONG**

Key name is too long

**ESP\_ERR\_NVS\_PAGE\_FULL**

Internal error; never returned by nvs API functions

**ESP\_ERR\_NVS\_INVALID\_STATE**

NVS is in an inconsistent state due to a previous error. Call `nvs_flash_init` and `nvs_open` again, then retry.

**ESP\_ERR\_NVS\_INVALID\_LENGTH**

String or blob length is not sufficient to store data

**ESP\_ERR\_NVS\_NO\_FREE\_PAGES**

NVS partition doesn't contain any empty pages. This may happen if NVS partition was truncated. Erase the whole partition and call `nvs_flash_init` again.

**ESP\_ERR\_NVS\_VALUE\_TOO\_LONG**

Value doesn't fit into the entry or string or blob length is longer than supported by the implementation

**ESP\_ERR\_NVS\_PART\_NOT\_FOUND**

Partition with specified name is not found in the partition table

**ESP\_ERR\_NVS\_NEW\_VERSION\_FOUND**

NVS partition contains data in new format and cannot be recognized by this version of code

**ESP\_ERR\_NVS\_XTS\_ENCR\_FAILED**

XTS encryption failed while writing NVS entry

**ESP\_ERR\_NVS\_XTS\_DECR\_FAILED**

XTS decryption failed while reading NVS entry

**ESP\_ERR\_NVS\_XTS\_CFG\_FAILED**

XTS configuration setting failed

**ESP\_ERR\_NVS\_XTS\_CFG\_NOT\_FOUND**

XTS configuration not found

**ESP\_ERR\_NVS\_ENCR\_NOT\_SUPPORTED**

NVS encryption is not supported in this version

**ESP\_ERR\_NVS\_KEYS\_NOT\_INITIALIZED**

NVS key partition is uninitialized

**ESP\_ERR\_NVS\_CORRUPT\_KEY\_PART**

NVS key partition is corrupt

**ESP\_ERR\_NVS\_WRONG\_ENCRYPTION**

NVS partition is marked as encrypted with generic flash encryption. This is forbidden since the NVS encryption works differently.

**ESP\_ERR\_NVS\_CONTENT\_DIFFERS**

Internal error; never returned by nvs API functions. NVS key is different in comparison

**NVS\_DEFAULT\_PART\_NAME**

Default partition name of the NVS partition in the partition table

**NVS\_PART\_NAME\_MAX\_SIZE**

maximum length of partition name (excluding null terminator)

**NVS\_KEY\_NAME\_MAX\_SIZE**

Maximum length of NVS key name (including null terminator)

### Type Definitions

```
typedef uint32_t nvs_handle_t
```

Opaque pointer type representing non-volatile storage handle

```
typedef nvs_handle_t nvs_handle
```

```
typedef nvs_open_mode_t nvs_open_mode
```

```
typedef struct nvs_opaque_iterator_t *nvs_iterator_t
```

Opaque pointer type representing iterator to nvs entries

### Enumerations

```
enum nvs_open_mode_t
```

Mode of opening the non-volatile storage.

*Values:*

enumerator **NVS\_READONLY**

Read only

enumerator **NVS\_READWRITE**

Read and write

enum **nvs\_type\_t**

Types of variables.

*Values:*

enumerator **NVS\_TYPE\_U8**

Type uint8\_t

enumerator **NVS\_TYPE\_I8**

Type int8\_t

enumerator **NVS\_TYPE\_U16**

Type uint16\_t

enumerator **NVS\_TYPE\_I16**

Type int16\_t

enumerator **NVS\_TYPE\_U32**

Type uint32\_t

enumerator **NVS\_TYPE\_I32**

Type int32\_t

enumerator **NVS\_TYPE\_U64**

Type uint64\_t

enumerator **NVS\_TYPE\_I64**

Type int64\_t

enumerator **NVS\_TYPE\_STR**

Type string

enumerator **NVS\_TYPE\_BLOB**

Type blob

enumerator **NVS\_TYPE\_ANY**

Must be last

## 2.8.4 NVS Partition Generator Utility

### Introduction

The utility `nvs_flash/nvs_partition_generator/nvs_partition_gen.py` creates a binary file based on key-value pairs provided in a CSV file. The binary file is compatible with NVS architecture defined in *Non-Volatile Storage*. This utility is ideally suited for generating a binary blob, containing data specific to ODM/OEM, which can be flashed externally

at the time of device manufacturing. This allows manufacturers to generate many instances of the same application firmware with customized parameters for each device, such as a serial number.

### Prerequisites

To use this utility in encryption mode, install the following packages:

- cryptography package

All the required packages are included in *requirements.txt* in the root of the esp-idf directory.

### CSV File Format

Each line of a CSV file should contain 4 parameters, separated by a comma. The table below provides the description for each of these parameters.

No.	Parameter	Description	Notes
1	Key	Key of the data. The data can be accessed later from an application using this key.	
2	Type	Supported values are <code>file</code> , <code>data</code> , and <code>namespace</code> .	
3	Encoding	Supported values are: <code>u8</code> , <code>i8</code> , <code>u16</code> , <code>i16</code> , <code>u32</code> , <code>i32</code> , <code>u64</code> , <code>i64</code> , <code>string</code> , <code>hex2bin</code> , <code>base64</code> , and <code>binary</code> . This specifies how actual data values are encoded in the resulting binary file. The difference between the <code>string</code> and <code>binary</code> encoding is that <code>string</code> data is terminated with a NULL character, whereas <code>binary</code> data is not.	As of now, for the <code>file</code> type, only <code>hex2bin</code> , <code>base64</code> , <code>string</code> , and <code>binary</code> encoding is supported.
4	Value	Data value	Encoding and Value cells for the <code>namespace</code> field type should be empty. Encoding and Value of <code>namespace</code> are fixed and are not configurable. Any values in these cells are ignored.

**Note:** The first line of the CSV file should always be the column header and it is not configurable.

Below is an example dump of such a CSV file:

```
key,type,encoding,value      <-- column header
namespace_name,namespace,,  <-- First entry should be of type "namespace"
key1,data,u8,1
key2,file,string,/path/to/file
```

**Note:**

**Make sure there are no spaces:**

- before and after `'`
- at the end of each line in a CSV file

## NVS Entry and Namespace Association

When a namespace entry is encountered in a CSV file, each following entry will be treated as part of that namespace until the next namespace entry is found. At this point, all the following entries will be treated as part of the new namespace.

---

**Note:** First entry in a CSV file should always be a namespace entry.

---

## Multipage Blob Support

By default, binary blobs are allowed to span over multiple pages and are written in the format mentioned in Section [Structure of Entry](#). If you intend to use an older format, the utility provides an option to disable this feature.

## Encryption Support

The NVS Partition Generator utility also allows you to create an encrypted binary file. The utility uses the AES-XTS encryption. Please refer to [NVS Encryption](#) for more details.

## Decryption Support

This utility allows you to decrypt an encrypted NVS binary file. The utility uses an NVS binary file encrypted using AES-XTS encryption. Please refer to [NVS Encryption](#) for more details.

## Running the Utility

### Usage:

```
python nvs_partition_gen.py [-h] {generate,generate-key,encrypt,decrypt} ...
```

### Optional Arguments:

No.	Parameter	Description
1	-h, -help	Show this help message and exit

### Commands:

```
Run nvs_partition_gen.py {command} -h for additional help
```

No.	Parameter	Description
1	generate	Generate NVS partition
2	generate-key	Generate keys for encryption
3	encrypt	Generate NVS encrypted partition
4	decrypt	Decrypt NVS encrypted partition

### To Generate NVS Partition (Default): Usage:

```
python nvs_partition_gen.py generate [-h] [--version {1,2}] [--outdir OUTDIR]
                                     input output size
```

**Positional Arguments:**

Parameter	Description
input	Path to CSV file to parse
output	Path to output NVS binary file
size	Size of NVS partition in bytes (must be multiple of 4096)

**Optional Arguments:**

Parameter	Description
-h, -help	Show this help message and exit
-version {1,2}	Set multipage blob version Version 1 - Multipage blob support disabled Version 2 - Multipage blob support enabled Default: Version 2
-outdir OUTDIR	Output directory to store files created (Default: current directory)

You can run the utility to generate NVS partition using the command below. A sample CSV file is provided with the utility:

```
python nvs_partition_gen.py generate sample_singlepage_blob.csv sample.bin 0x3000
```

**To Generate Only Encryption Key Partition: Usage:**

```
python nvs_partition_gen.py generate-key [-h] [--keyfile KEYFILE]
                                         [--outdir OUTDIR]
```

**Optional Arguments:**

Parameter	Description
-h, -help	Show this help message and exit
-keyfile KEYFILE	Path to output encryption key partition file
-outdir OUTDIR	Output directory to store file created (Default: current directory)

You can run the utility to generate only the encryption key partition using the command below:

```
python nvs_partition_gen.py generate-key
```

**To Generate Encrypted NVS Partition: Usage:**

```
python nvs_partition_gen.py encrypt [-h] [--version {1,2}] [--keygen]
                                     [--keyfile KEYFILE] [--inputkey INPUTKEY]
                                     [--outdir OUTDIR]
                                     input output size
```

**Positional Arguments:**

Parameter	Description
input	Path to CSV file to parse
output	Path to output NVS binary file
size	Size of NVS partition in bytes (must be multiple of 4096)

**Optional Arguments:**

Parameter	Description
-h, -help	Show this help message and exit
-version {1,2}	Set multipage blob version Version 1 - Multipage blob support disabled Version 2 - Multipage blob support enabled Default: Version 2
-keygen	Generates key for encrypting NVS partition
-keyfile KEY-FILE	Path to output encryption keys file
-inputkey INPUTKEY	File having key for encrypting NVS partition
-outdir OUTDIR	Output directory to store files created (Default: current directory)

You can run the utility to encrypt NVS partition using the command below. A sample CSV file is provided with the utility:

- Encrypt by allowing the utility to generate encryption keys:

```
python nvs_partition_gen.py encrypt sample_singlepage_blob.csv sample_encr.bin_
↪0x3000 --keygen
```

**Note:** Encryption key of the following format <outdir>/keys/keys-<timestamp>.bin is created.

- Encrypt by allowing the utility to generate encryption keys and store it in provided custom filename:

```
python nvs_partition_gen.py encrypt sample_singlepage_blob.csv sample_encr.bin_
↪0x3000 --keygen --keyfile sample_keys.bin
```

**Note:** Encryption key of the following format <outdir>/keys/sample\_keys.bin is created.

**Note:** This newly created file having encryption keys in keys/ directory is compatible with NVS key-partition structure. Refer to [NVS Key Partition](#) for more details.

- Encrypt by providing the encryption keys as input binary file:

```
python nvs_partition_gen.py encrypt sample_singlepage_blob.csv sample_encr.bin_
↪0x3000 --inputkey sample_keys.bin
```

### To Decrypt Encrypted NVS Partition: Usage:

```
python nvs_partition_gen.py decrypt [-h] [--outdir OUTDIR] input key output
```

#### Positional Arguments:

Parameter	Description
input	Path to encrypted NVS partition file to parse
key	Path to file having keys for decryption
output	Path to output decrypted binary file

#### Optional Arguments:

Parameter	Description
-h, -help	Show this help message and exit
-outdir OUTDIR	Output directory to store files created (Default: current directory)



You can run the utility to decrypt encrypted NVS partition using the command below:

```
python nvs_partition_gen.py decrypt sample_encr.bin sample_keys.bin sample_decr.bin
```

**You can also provide the format version number:**

- Multipage Blob Support Disabled (Version 1)
- Multipage Blob Support Enabled (Version 2)

**Multipage Blob Support Disabled (Version 1):** You can run the utility in this format by setting the version parameter to 1, as shown below. A sample CSV file is provided with the utility:

```
python nvs_partition_gen.py generate sample_singlepage_blob.csv sample.bin 0x3000 -  
↪-version 1
```

**Multipage Blob Support Enabled (Version 2):** You can run the utility in this format by setting the version parameter to 2, as shown below. A sample CSV file is provided with the utility:

```
python nvs_partition_gen.py generate sample_multipage_blob.csv sample.bin 0x4000 --  
↪version 2
```

---

**Note:** *Minimum NVS Partition Size needed is 0x3000 bytes.*

---

---

**Note:** *When flashing the binary onto the device, make sure it is consistent with the application's sdkconfig.*

---

### Caveats

- Utility does not check for duplicate keys and will write data pertaining to both keys. You need to make sure that the keys are distinct.
- Once a new page is created, no data will be written in the space left on the previous page. Fields in the CSV file need to be ordered in such a way as to optimize memory.
- 64-bit datatype is not yet supported.

## 2.8.5 SD/SDIO/MMC Driver

### Overview

The SD/SDIO/MMC driver currently supports SD memory, SDIO cards, and eMMC chips. This is a protocol level driver built on top of SDMMC and SD SPI host drivers.

SDMMC and SD SPI host drivers ([driver/include/driver/sdmmc\\_host.h](#) and [driver/include/driver/sdsp\\_i\\_host.h](#)) provide API functions for:

- Sending commands to slave devices
- Sending and receiving data
- Handling error conditions within the bus

For functions used to initialize and configure:

- SD SPI host, see [SD SPI Host API](#)

## Application Example

An example which combines the SDMMC driver with the FATFS library is provided in the [storage/sd\\_card](#) directory of ESP-IDF examples. This example initializes the card, then writes and reads data from it using POSIX and C library APIs. See README.md file in the example directory for more information.

**Combo (memory + IO) cards** The driver does not support SD combo cards. Combo cards are treated as IO cards.

**Thread safety** Most applications need to use the protocol layer only in one task. For this reason, the protocol layer does not implement any kind of locking on the `sdmmc_card_t` structure, or when accessing SDMMC or SD SPI host drivers. Such locking is usually implemented on a higher layer, e.g., in the filesystem driver.

## API Reference

### Header File

- `components/sdmmc/include/sdmmc_cmd.h`

### Functions

`esp_err_t sdmmc_card_init` (const `sdmmc_host_t` \*host, `sdmmc_card_t` \*out\_card)

Probe and initialize SD/MMC card using given host

---

**Note:** Only SD cards (SDSC and SDHC/SDXC) are supported now. Support for MMC/eMMC cards will be added later.

---

#### Parameters

- **host** –pointer to structure defining host controller
- **out\_card** –pointer to structure which will receive information about the card when the function completes

#### Returns

- ESP\_OK on success
- One of the error codes from SDMMC host controller

void `sdmmc_card_print_info` (FILE \*stream, const `sdmmc_card_t` \*card)

Print information about the card to a stream.

#### Parameters

- **stream** –stream obtained using fopen or fdopen
- **card** –card information structure initialized using `sdmmc_card_init`

`esp_err_t sdmmc_get_status` (`sdmmc_card_t` \*card)

Get status of SD/MMC card

**Parameters** **card** –pointer to card information structure previously initialized using `sdmmc_card_init`

#### Returns

- ESP\_OK on success
- One of the error codes from SDMMC host controller

`esp_err_t sdmmc_write_sectors` (`sdmmc_card_t` \*card, const void \*src, size\_t start\_sector, size\_t sector\_count)

Write given number of sectors to SD/MMC card

#### Parameters

- **card** –pointer to card information structure previously initialized using `sdmmc_card_init`

- **src** –pointer to data buffer to read data from; data size must be equal to `sector_count * card->csd.sector_size`
- **start\_sector** –sector where to start writing
- **sector\_count** –number of sectors to write

**Returns**

- ESP\_OK on success
- One of the error codes from SDMMC host controller

*esp\_err\_t* **sdmmc\_read\_sectors** (*sdmmc\_card\_t* \*card, void \*dst, size\_t start\_sector, size\_t sector\_count)

Read given number of sectors from the SD/MMC card

**Parameters**

- **card** –pointer to card information structure previously initialized using `sdmmc_card_init`
- **dst** –pointer to data buffer to write into; buffer size must be at least `sector_count * card->csd.sector_size`
- **start\_sector** –sector where to start reading
- **sector\_count** –number of sectors to read

**Returns**

- ESP\_OK on success
- One of the error codes from SDMMC host controller

*esp\_err\_t* **sdmmc\_erase\_sectors** (*sdmmc\_card\_t* \*card, size\_t start\_sector, size\_t sector\_count, *sdmmc\_erase\_arg\_t* arg)

Erase given number of sectors from the SD/MMC card

---

**Note:** When `sdmmc_erase_sectors` used with cards in SDSPI mode, it was observed that card requires re-init after erase operation.

---

**Parameters**

- **card** –pointer to card information structure previously initialized using `sdmmc_card_init`
- **start\_sector** –sector where to start erase
- **sector\_count** –number of sectors to erase
- **arg** –erase command (CMD38) argument

**Returns**

- ESP\_OK on success
- One of the error codes from SDMMC host controller

*esp\_err\_t* **sdmmc\_can\_discard** (*sdmmc\_card\_t* \*card)

Check if SD/MMC card supports discard

**Parameters** **card** –pointer to card information structure previously initialized using `sdmmc_card_init`

**Returns**

- ESP\_OK if supported by the card/device
- ESP\_FAIL if not supported by the card/device

*esp\_err\_t* **sdmmc\_can\_trim** (*sdmmc\_card\_t* \*card)

Check if SD/MMC card supports trim

**Parameters** **card** –pointer to card information structure previously initialized using `sdmmc_card_init`

**Returns**

- ESP\_OK if supported by the card/device
- ESP\_FAIL if not supported by the card/device

*esp\_err\_t* **sdmmc\_mmc\_can\_sanitize** (*sdmmc\_card\_t* \*card)

Check if SD/MMC card supports sanitize

**Parameters** **card** –pointer to card information structure previously initialized using `sdmmc_card_init`

**Returns**

- ESP\_OK if supported by the card/device
- ESP\_FAIL if not supported by the card/device

*esp\_err\_t* **sdmmc\_mmc\_sanitize** (*sdmmc\_card\_t* \*card, uint32\_t timeout\_ms)

Sanitize the data that was unmapped by a Discard command

---

**Note:** Discard command has to precede sanitize operation. To discard, use MMC\_DICARD\_ARG with sdmmc\_erase\_sectors argument

---

**Parameters**

- **card** –pointer to card information structure previously initialized using sdmmc\_card\_init
- **timeout\_ms** –timeout value in milliseconds required to sanitize the selected range of sectors.

**Returns**

- ESP\_OK on success
- One of the error codes from SDMMC host controller

*esp\_err\_t* **sdmmc\_full\_erase** (*sdmmc\_card\_t* \*card)

Erase complete SD/MMC card

**Parameters** **card** –pointer to card information structure previously initialized using sdmmc\_card\_init

**Returns**

- ESP\_OK on success
- One of the error codes from SDMMC host controller

*esp\_err\_t* **sdmmc\_io\_read\_byte** (*sdmmc\_card\_t* \*card, uint32\_t function, uint32\_t reg, uint8\_t \*out\_byte)

Read one byte from an SDIO card using IO\_RW\_DIRECT (CMD52)

**Parameters**

- **card** –pointer to card information structure previously initialized using sdmmc\_card\_init
- **function** –IO function number
- **reg** –byte address within IO function
- **out\_byte** –[out] output, receives the value read from the card

**Returns**

- ESP\_OK on success
- One of the error codes from SDMMC host controller

*esp\_err\_t* **sdmmc\_io\_write\_byte** (*sdmmc\_card\_t* \*card, uint32\_t function, uint32\_t reg, uint8\_t in\_byte, uint8\_t \*out\_byte)

Write one byte to an SDIO card using IO\_RW\_DIRECT (CMD52)

**Parameters**

- **card** –pointer to card information structure previously initialized using sdmmc\_card\_init
- **function** –IO function number
- **reg** –byte address within IO function
- **in\_byte** –value to be written
- **out\_byte** –[out] if not NULL, receives new byte value read from the card (read-after-write).

**Returns**

- ESP\_OK on success
- One of the error codes from SDMMC host controller

*esp\_err\_t* **sdmmc\_io\_read\_bytes** (*sdmmc\_card\_t* \*card, uint32\_t function, uint32\_t addr, void \*dst, size\_t size)

Read multiple bytes from an SDIO card using IO\_RW\_EXTENDED (CMD53)

This function performs read operation using CMD53 in byte mode. For block mode, see sdmmc\_io\_read\_blocks.

**Parameters**

- **card** –pointer to card information structure previously initialized using `sdmmc_card_init`
- **function** –IO function number
- **addr** –byte address within IO function where reading starts
- **dst** –buffer which receives the data read from card
- **size** –number of bytes to read

**Returns**

- ESP\_OK on success
- ESP\_ERR\_INVALID\_SIZE if size exceeds 512 bytes
- One of the error codes from SDMMC host controller

*esp\_err\_t* `sdmmc_io_write_bytes` (*sdmmc\_card\_t* \*card, uint32\_t function, uint32\_t addr, const void \*src, size\_t size)

Write multiple bytes to an SDIO card using IO\_RW\_EXTENDED (CMD53)

This function performs write operation using CMD53 in byte mode. For block mode, see `sdmmc_io_write_blocks`.

**Parameters**

- **card** –pointer to card information structure previously initialized using `sdmmc_card_init`
- **function** –IO function number
- **addr** –byte address within IO function where writing starts
- **src** –data to be written
- **size** –number of bytes to write

**Returns**

- ESP\_OK on success
- ESP\_ERR\_INVALID\_SIZE if size exceeds 512 bytes
- One of the error codes from SDMMC host controller

*esp\_err\_t* `sdmmc_io_read_blocks` (*sdmmc\_card\_t* \*card, uint32\_t function, uint32\_t addr, void \*dst, size\_t size)

Read blocks of data from an SDIO card using IO\_RW\_EXTENDED (CMD53)

This function performs read operation using CMD53 in block mode. For byte mode, see `sdmmc_io_read_bytes`.

**Parameters**

- **card** –pointer to card information structure previously initialized using `sdmmc_card_init`
- **function** –IO function number
- **addr** –byte address within IO function where writing starts
- **dst** –buffer which receives the data read from card
- **size** –number of bytes to read, must be divisible by the card block size.

**Returns**

- ESP\_OK on success
- ESP\_ERR\_INVALID\_SIZE if size is not divisible by 512 bytes
- One of the error codes from SDMMC host controller

*esp\_err\_t* `sdmmc_io_write_blocks` (*sdmmc\_card\_t* \*card, uint32\_t function, uint32\_t addr, const void \*src, size\_t size)

Write blocks of data to an SDIO card using IO\_RW\_EXTENDED (CMD53)

This function performs write operation using CMD53 in block mode. For byte mode, see `sdmmc_io_write_bytes`.

**Parameters**

- **card** –pointer to card information structure previously initialized using `sdmmc_card_init`
- **function** –IO function number
- **addr** –byte address within IO function where writing starts
- **src** –data to be written
- **size** –number of bytes to read, must be divisible by the card block size.

**Returns**

- ESP\_OK on success

- ESP\_ERR\_INVALID\_SIZE if size is not divisible by 512 bytes
- One of the error codes from SDMMC host controller

*esp\_err\_t* **sdmmc\_io\_enable\_int** (*sdmmc\_card\_t* \*card)

Enable SDIO interrupt in the SDMMC host

**Parameters** **card** –pointer to card information structure previously initialized using `sdmmc_card_init`

**Returns**

- ESP\_OK on success
- ESP\_ERR\_NOT\_SUPPORTED if the host controller does not support IO interrupts

*esp\_err\_t* **sdmmc\_io\_wait\_int** (*sdmmc\_card\_t* \*card, TickType\_t timeout\_ticks)

Block until an SDIO interrupt is received

Slave uses D1 line to signal interrupt condition to the host. This function can be used to wait for the interrupt.

**Parameters**

- **card** –pointer to card information structure previously initialized using `sdmmc_card_init`
- **timeout\_ticks** –time to wait for the interrupt, in RTOS ticks

**Returns**

- ESP\_OK if the interrupt is received
- ESP\_ERR\_NOT\_SUPPORTED if the host controller does not support IO interrupts
- ESP\_ERR\_TIMEOUT if the interrupt does not happen in `timeout_ticks`

*esp\_err\_t* **sdmmc\_io\_get\_cis\_data** (*sdmmc\_card\_t* \*card, uint8\_t \*out\_buffer, size\_t buffer\_size, size\_t \*inout\_cis\_size)

Get the data of CIS region of an SDIO card.

You may provide a buffer not sufficient to store all the CIS data. In this case, this function stores as much data into your buffer as possible. Also, this function will try to get and return the size required for you.

**Parameters**

- **card** –pointer to card information structure previously initialized using `sdmmc_card_init`
- **out\_buffer** –Output buffer of the CIS data
- **buffer\_size** –Size of the buffer.
- **inout\_cis\_size** –Mandatory, pointer to a size, input and output.
  - input: Limitation of maximum searching range, should be 0 or larger than `buffer_size`. The function searches for `CIS_CODE_END` until this range. Set to 0 to search infinitely.
  - output: The size required to store all the CIS data, if `CIS_CODE_END` is found.

**Returns**

- ESP\_OK: on success
- ESP\_ERR\_INVALID\_RESPONSE: if the card does not (correctly) support CIS.
- ESP\_ERR\_INVALID\_SIZE: `CIS_CODE_END` found, but `buffer_size` is less than required size, which is stored in the `inout_cis_size` then.
- ESP\_ERR\_NOT\_FOUND: if the `CIS_CODE_END` not found. Increase input value of `inout_cis_size` or set it to 0, if you still want to search for the end; output value of `inout_cis_size` is invalid in this case.
- and other error code return from `sdmmc_io_read_bytes`

*esp\_err\_t* **sdmmc\_io\_print\_cis\_info** (uint8\_t \*buffer, size\_t buffer\_size, FILE \*fp)

Parse and print the CIS information of an SDIO card.

**Note:** Not all the CIS codes and all kinds of tuples are supported. If you see some unresolved code, you can add the parsing of these code in `sdmmc_io.c` and contribute to the IDF through the Github repository.

```
using sdmmc_card_init
```

**Parameters**

- **buffer** –Buffer to parse
- **buffer\_size** –Size of the buffer.
- **fp** –File pointer to print to, set to NULL to print to stdout.

**Returns**

- ESP\_OK: on success
- ESP\_ERR\_NOT\_SUPPORTED: if the value from the card is not supported to be parsed.
- ESP\_ERR\_INVALID\_SIZE: if the CIS size fields are not correct.

**Header File**

- [components/driver/include/driver/sdmmc\\_types.h](#)

**Structures**struct **sdmmc\_csd\_t**

Decoded values from SD card Card Specific Data register

**Public Members**int **csd\_ver**

CSD structure format

int **mmc\_ver**

MMC version (for CID format)

int **capacity**

total number of sectors

int **sector\_size**

sector size in bytes

int **read\_block\_len**

block length for reads

int **card\_command\_class**

Card Command Class for SD

int **tr\_speed**

Max transfer speed

struct **sdmmc\_cid\_t**

Decoded values from SD card Card IDentification register

**Public Members**int **mfg\_id**

manufacturer identification number

int **oem\_id**

OEM/product identification number

char **name**[8]  
product name (MMC v1 has the longest)

int **revision**  
product revision

int **serial**  
product serial number

int **date**  
manufacturing date

struct **sdmmc\_scr\_t**

Decoded values from SD Configuration Register Note: When new member is added, update reserved bits accordingly

### Public Members

uint32\_t **sd\_spec**  
SD Physical layer specification version, reported by card

uint32\_t **erase\_mem\_state**  
data state on card after erase whether 0 or 1 (card vendor dependent)

uint32\_t **bus\_width**  
bus widths supported by card: BIT(0) —1-bit bus, BIT(2) —4-bit bus

uint32\_t **reserved**  
reserved for future expansion

uint32\_t **rsvd\_mnf**  
reserved for manufacturer usage

struct **sdmmc\_ssr\_t**

Decoded values from SD Status Register Note: When new member is added, update reserved bits accordingly

### Public Members

uint32\_t **alloc\_unit\_kb**  
Allocation unit of the card, in multiples of kB (1024 bytes)

uint32\_t **erase\_size\_au**  
Erase size for the purpose of timeout calculation, in multiples of allocation unit

uint32\_t **cur\_bus\_width**  
SD current bus width



uint32\_t **discard\_support**

SD discard feature support

uint32\_t **fule\_support**

SD FULE (Full User Area Logical Erase) feature support

uint32\_t **erase\_timeout**

Timeout (in seconds) for erase of a single allocation unit

uint32\_t **erase\_offset**

Constant timeout offset (in seconds) for any erase operation

uint32\_t **reserved**

reserved for future expansion

struct **sdmmc\_ext\_csd\_t**

Decoded values of Extended Card Specific Data

### Public Members

uint8\_t **rev**

Extended CSD Revision

uint8\_t **power\_class**

Power class used by the card

uint8\_t **erase\_mem\_state**

data state on card after erase whether 0 or 1 (card vendor dependent)

uint8\_t **sec\_feature**

secure data management features supported by the card

struct **sdmmc\_switch\_func\_rsp\_t**

SD SWITCH\_FUNC response buffer

### Public Members

uint32\_t **data**[512 / 8 / sizeof(uint32\_t)]

response data

struct **sdmmc\_command\_t**

SD/MMC command information

### Public Members

uint32\_t **opcode**  
SD or MMC command index

uint32\_t **arg**  
SD/MMC command argument

*sdmmc\_response\_t* **response**  
response buffer

void \***data**  
buffer to send or read into

size\_t **datalen**  
length of data buffer

size\_t **blklen**  
block length

int **flags**  
see below

*esp\_err\_t* **error**  
error returned from transfer

uint32\_t **timeout\_ms**  
response timeout, in milliseconds

struct **sdmmc\_host\_t**

SD/MMC Host description

This structure defines properties of SD/MMC host and functions of SD/MMC host which can be used by upper layers.

### Public Members

uint32\_t **flags**  
flags defining host properties

int **slot**  
slot number, to be passed to host functions

int **max\_freq\_khz**  
max frequency supported by the host

float **io\_voltage**  
I/O voltage used by the controller (voltage switching is not supported)

*esp\_err\_t* (\***init**)(void)  
Host function to initialize the driver

*esp\_err\_t* (\***set\_bus\_width**)(int slot, size\_t width)

host function to set bus width

size\_t (\***get\_bus\_width**)(int slot)

host function to get bus width

*esp\_err\_t* (\***set\_bus\_ddr\_mode**)(int slot, bool ddr\_enable)

host function to set DDR mode

*esp\_err\_t* (\***set\_card\_clk**)(int slot, uint32\_t freq\_khz)

host function to set card clock frequency

*esp\_err\_t* (\***set\_cclk\_always\_on**)(int slot, bool cclk\_always\_on)

host function to set whether the clock is always enabled

*esp\_err\_t* (\***do\_transaction**)(int slot, *sdmmc\_command\_t* \*cmdinfo)

host function to do a transaction

*esp\_err\_t* (\***deinit**)(void)

host function to deinitialize the driver

*esp\_err\_t* (\***deinit\_p**)(int slot)

host function to deinitialize the driver, called with the `slot`

*esp\_err\_t* (\***io\_int\_enable**)(int slot)

Host function to enable SDIO interrupt line

*esp\_err\_t* (\***io\_int\_wait**)(int slot, TickType\_t timeout\_ticks)

Host function to wait for SDIO interrupt line to be active

int **command\_timeout\_ms**

timeout, in milliseconds, of a single command. Set to 0 to use the default value.

struct **sdmmc\_card\_t**

SD/MMC card information structure

### Public Members

*sdmmc\_host\_t* **host**

Host with which the card is associated

uint32\_t **ocr**

OCR (Operation Conditions Register) value

*sdmmc\_cid\_t* **cid**

decoded CID (Card Identification) register value

***sdmmc\_response\_t* raw\_cid**

raw CID of MMC card to be decoded after the CSD is fetched in the data transfer mode

***sdmmc\_csd\_t* csd**

decoded CSD (Card-Specific Data) register value

***sdmmc\_scr\_t* scr**

decoded SCR (SD card Configuration Register) value

***sdmmc\_ssr\_t* ssr**

decoded SSR (SD Status Register) value

***sdmmc\_ext\_csd\_t* ext\_csd**

decoded EXT\_CSD (Extended Card Specific Data) register value

**uint16\_t rca**

RCA (Relative Card Address)

**uint16\_t max\_freq\_khz**

Maximum frequency, in kHz, supported by the card

**uint32\_t is\_mem**

Bit indicates if the card is a memory card

**uint32\_t is\_sdio**

Bit indicates if the card is an IO card

**uint32\_t is\_mmc**

Bit indicates if the card is MMC

**uint32\_t num\_io\_functions**

If is\_sdio is 1, contains the number of IO functions on the card

**uint32\_t log\_bus\_width**

log<sub>2</sub>(bus width supported by card)

**uint32\_t is\_ddr**

Card supports DDR mode

**uint32\_t reserved**

Reserved for future expansion

**Macros****SDMMC\_HOST\_FLAG\_1BIT**

host supports 1-line SD and MMC protocol

**SDMMC\_HOST\_FLAG\_4BIT**

host supports 4-line SD and MMC protocol

**SDMMC\_HOST\_FLAG\_8BIT**

host supports 8-line MMC protocol

**SDMMC\_HOST\_FLAG\_SPI**

host supports SPI protocol

**SDMMC\_HOST\_FLAG\_DDR**

host supports DDR mode for SD/MMC

**SDMMC\_HOST\_FLAG\_DEINIT\_ARG**

host `deinit` function called with the slot argument

**SDMMC\_FREQ\_DEFAULT**

SD/MMC Default speed (limited by clock divider)

**SDMMC\_FREQ\_HIGHSPEED**

SD High speed (limited by clock divider)

**SDMMC\_FREQ\_PROBING**

SD/MMC probing speed

**SDMMC\_FREQ\_52M**

MMC 52MHz speed

**SDMMC\_FREQ\_26M**

MMC 26MHz speed

### Type Definitions

```
typedef uint32_t sdmmc_response_t[4]
```

SD/MMC command response buffer

### Enumerations

```
enum sdmmc_erase_arg_t
```

SD/MMC erase command(38) arguments SD: ERASE: Erase the write blocks, physical/hard erase.

DISCARD: Card may deallocate the discarded blocks partially or completely. After discard operation the previously written data may be partially or fully read by the host depending on card implementation.

MMC: ERASE: Does TRIM, applies erase operation to write blocks instead of Erase Group.

DISCARD: The Discard function allows the host to identify data that is no longer required so that the device can erase the data if necessary during background erase events. Applies to write blocks instead of Erase Group. After discard operation, the original data may be remained partially or fully accessible to the host dependent on device.

*Values:*

enumerator **SDMMC\_ERASE\_ARG**

Erase operation on SD, Trim operation on MMC

enumerator **SDMMC\_DISCARD\_ARG**

Discard operation for SD/MMC

## 2.8.6 SPI Flash API

### Overview

The `spi_flash` component contains API functions related to reading, writing, erasing, memory mapping for data in the external flash. The `spi_flash` component also has higher-level API functions which work with partitions defined in the [partition table](#).

Different from the API before IDF v4.0, the functionality of `esp_flash_*` APIs is not limited to the “main” SPI flash chip (the same SPI flash chip from which program runs). With different chip pointers, you can access external flash chips connected to not only SPI0/1 but also other SPI buses like SPI2.

---

**Note:** Instead of going through the cache connected to the SPI0 peripheral, most `esp_flash_*` APIs go through other SPI peripherals like SPI1, SPI2, etc. This makes them able to access not only the main flash, but also external flash.

However, due to limitations of the cache, operations through the cache are limited to the main flash. The address range limitation for these operations are also on the cache side. The cache is not able to access external flash chips or address range above its capabilities. These cache operations include: mmap, encrypted read/write, executing code or access to variables in the flash.

---

**Note:** Flash APIs after ESP-IDF v4.0 are no longer *atomic*. If a write operation occurs during another on-going read operation, and the flash addresses of both operations overlap, the data returned from the read operation may contain both old data and new data (that was updated written by the write operation).

---

**Note:** Encrypted flash operations are only supported with the main flash chip (and not with other flash chips, that is on SPI1 with different CS, or on other SPI buses). Reading through cache is only supported on the main flash, which is determined by the HW.

---

### Support for Features of Flash Chips

**Quad/Dual Mode Chips** Features of different flashes are implemented in different ways and thus need special support. The fast/slow read and Dual mode (DOUT/DIO) of almost all 24-bits address flash chips are supported, because they don't need any vendor-specific commands.

Quad mode (QIO/QOUT) is supported on following chip types:

1. ISSI
2. GD
3. MXIC
4. FM
5. Winbond
6. XMC
7. BOYA

### Optional Features

**Optional features for flash** Some features are not supported on all ESP chips and Flash chips. You can check the list below for more information.

- *Auto Suspend & Resume*
- *Flash unique ID*
- *High performance mode*
- *OPI flash support*
- *32-bit Address Flash Chips*

---

**Note:** When Flash optional features listed in this page are used, aside from the capability of ESP chips, and ESP-IDF version you are using, you will also need to make sure these features are supported by flash chips used.

- If you are using an official Espressif modules/SiP. Some of the modules/SiPs always support the feature, in this case you can see these features listed in the datasheet. Otherwise please contact [Espressif's business team](#) to know if we can supply such products for you.
- If you are making your own modules with your own bought flash chips, and you need features listed above. Please contact your vendor if they support the those features, and make sure that the chips can be supplied continuously.

**Attention:** This document only shows that IDF code has supported the features of those flash chips. It's not a list of stable flash chips certified by Espressif. If you build your own hardware from flash chips with your own brought flash chips (even with flash listed in this page), you need to validate the reliability of flash chips yourself.

**Auto Suspend & Resume** This feature is only supported on ESP32-C3 for now.

The support for ESP32-S3, ESP32-C2 may be added in the future.

**Flash unique ID** This feature is supported on all Espressif chips.

Unique ID is not flash id, which means flash has 64-Bit unique ID for each device. The instruction to read the unique ID (4Bh) accesses a factory-set read-only 64-bit number that is unique to each flash device. This ID number helps you to recognize each single device. Not all flash vendors support this feature. If you try to read the unique ID on a chip which does not have this feature, the behavior is not determined. The support list is as follows.

List of Flash chips that support this feature:

1. ISSI
2. GD
3. TH
4. FM
5. Winbond
6. XMC
7. BOYA

**High performance mode** This feature is only supported on ESP32-S3 for now.

The support for ESP32-S2, ESP32-C3 may be added in the future.

**OPI flash support** This feature is only supported on ESP32-S3 for now.

OPI flash means that the flash chip supports octal peripheral interface, which has octal I/O pins. Different octal flash has different configurations and different commands. Hence, it is necessary to carefully check the support list.

**32-bit Address Flash Chips** This feature is supported on all Espressif chips (with various restrictions to application).

Most NOR flash chips used by Espressif chips use 24-bits address, which can cover 16 MBytes memory. However, for larger memory (usually equal to or larger than 16 MBytes), flash uses a 32-bits address to address larger memory. Regretfully, 32-bits address chips have vendor-specific commands, so we need to support the chips one by one.

List of Flash chips that support this feature:

1. W25Q256
2. GD25Q256

---

**Important:** Over 16 MBytes space on flash mentioned above can be only used for `data saving`, like file system. If your data/instructions over 16 MBytes spaces need to be mapped to MMU (so as to be accessed by the CPU), please upgrade to ESP-IDF v5.2 and read the latest docs.

---

There are some features that are not supported by all flash chips, or not supported by all Espressif chips. These features include:

- 32-bit address flash - usually means that the flash has higher capacity (equal to or larger than 16 MB) that needs longer addresses.
- Flash unique ID - means that flash supports its unique 64-bits ID.

If you want to use these features, please ensure both ESP32-S2 and ALL flash chips in your product support these features. For more details, refer to [Optional features for flash](#).

You may also customise your own flash chip driver. See [Overriding Default Chip Drivers](#) for more details.

**Warning:** Customizing SPI Flash Chip Drivers is considered an “expert” feature. Users should only do so at their own risk. (See the notes below)

**Overriding Default Chip Drivers** During the SPI Flash driver’s initialization (i.e., `esp_flash_init()`), there is a chip detection step during which the driver will iterate through a Default Chip Driver List and determine which chip driver can properly support the currently connected flash chip. The Default Chip Drivers are provided by the IDF, thus are updated in together with each IDF version. However IDF also allows users to customize their own chip drivers.

Users should note the following when customizing chip drivers:

1. You may need to rely on some non-public IDF functions, which have slight possibility to change between IDF versions. On the one hand, these changes may be useful bug fixes for your driver, on the other hand, they may also be breaking changes (i.e., breaks your code).
2. Some IDF bug fixes to other chip drivers will not be automatically applied to your own custom chip drivers.
3. If the protection of flash is not handled properly, there may be some random reliability issues.
4. If you update to a newer IDF version that has support for more chips, you will have to manually add those new chip drivers into your custom chip driver list. Otherwise the driver will only search for the drivers in custom list you provided.

### Steps For Creating Custom Chip Drivers and Overriding the IDF Default Driver List

1. Enable the `CONFIG_SPI_FLASH_OVERRIDE_CHIP_DRIVER_LIST` config option. This will prevent compilation and linking of the Default Chip Driver List (`default_registered_chips`) provided by IDF. Instead, the linker will search for the structure of the same name (`default_registered_chips`) that must be provided by the user.
2. Add a new component in your project, e.g. `custom_chip_driver`.
3. Copy the necessary chip driver files from the `spi_flash` component in IDF. This may include:
  - `spi_flash_chip_drivers.c` (to provide the `default_registered_chips` structure)
  - Any of the `spi_flash_chip_*.c` files that matches your own flash model best
  - `CMakeLists.txt` and `linker.lf` files



Modify the files above properly. Including:

- Change the `default_registered_chips` variable to non-static and remove the `#ifdef` logic around it.
- Update `linker.lf` file to rename the fragment header and the library name to match the new component.
- If reusing other drivers, some header names need prefixing with `spi_flash/` when included from outside `spi_flash` component.

#### Note:

- When writing your own flash chip driver, you can set your flash chip capabilities through `spi_flash_chip_***(vendor)_get_caps` and points the function pointer `get_chip_caps` for protection to the `spi_flash_chip_***_get_caps` function. The steps are as follows.
  1. Please check whether your flash chip have the capabilities listed in `spi_flash_caps_t` by checking the flash datasheet.
  2. Write a function named `spi_flash_chip_***(vendor)_get_caps`. Take the example below as a reference. (if the flash support `suspend` and `read unique id`).
  3. Points the the pointer `get_chip_caps` (in `spi_flash_chip_t`) to the function mentioned above.

```
spi_flash_caps_t spi_flash_chip_***(vendor)_get_caps(esp_flash_t *chip)
{
    spi_flash_caps_t caps_flags = 0;
    // 32-bit-address flash is not supported
    flash-suspend is supported
    caps_flags |= SPI_FLASH_CHIP_CAP_SUSPEND;
    // flash read unique id.
    caps_flags |= SPI_FLASH_CHIP_CAP_UNIQUE_ID;
    return caps_flags;
}
```

```
const spi_flash_chip_t esp_flash_chip_eon = {
    // Other function pointers
    .get_chip_caps = spi_flash_chip_eon_get_caps,
};
```

- You also can see how to implement this in the example [storage/custom\\_flash\\_driver](#).

4. Write a new `CMakeLists.txt` file for the `custom_chip_driver` component, including an additional line to add a linker dependency from `spi_flash` to `custom_chip_driver`:

```
idf_component_register(SRCS "spi_flash_chip_drivers.c"
                      "spi_flash_chip_mychip.c" # modify as needed
                      REQUIRES hal
                      PRIV_REQUIRES spi_flash
                      LDFRAGMENTS linker.lf)
idf_component_add_link_dependency(FROM spi_flash)
```

- An example of this component `CMakeLists.txt` can be found in [storage/custom\\_flash\\_driver/components/custom\\_chip\\_driver/CMakeLists.txt](#)
5. The `linker.lf` is used to put every chip driver that you are going to use whilst cache is disabled into internal RAM. See [Linker Script Generation](#) for more details. Make sure this file covers all the source files that you add.
  6. Build your project, and you will see the new flash driver is used.

**Example** See also [storage/custom\\_flash\\_driver](#).

## Initializing a Flash Device

To use the `esp_flash_*` APIs, you need to initialise a flash chip on a certain SPI bus, as shown below:

1. Call `spi_bus_initialize()` to properly initialize an SPI bus. This function initializes the resources (I/O, DMA, interrupts) shared among devices attached to this bus.

2. Call `spi_bus_add_flash_device()` to attach the flash device to the bus. This function allocates memory and fills the members for the `esp_flash_t` structure. The CS I/O is also initialized here.
3. Call `esp_flash_init()` to actually communicate with the chip. This will also detect the chip type, and influence the following operations.

---

**Note:** Multiple flash chips can be attached to the same bus now.

---

### SPI Flash Access API

This is the set of API functions for working with data in flash:

- `esp_flash_read()` reads data from flash to RAM
- `esp_flash_write()` writes data from RAM to flash
- `esp_flash_erase_region()` erases specific region of flash
- `esp_flash_erase_chip()` erases the whole flash
- `esp_flash_get_chip_size()` returns flash chip size, in bytes, as configured in menuconfig

Generally, try to avoid using the raw SPI flash functions to the “main” SPI flash chip in favour of *partition-specific functions*.

### SPI Flash Size

The SPI flash size is configured by writing a field in the software bootloader image header, flashed at offset 0x1000.

By default, the SPI flash size is detected by `esptool.py` when this bootloader is written to flash, and the header is updated with the correct size. Alternatively, it is possible to generate a fixed flash size by setting `CONFIG_ESPTOOLPY_FLASHSIZE` in the project configuration.

If it is necessary to override the configured flash size at runtime, it is possible to set the `chip_size` member of the `g_rom_flashchip` structure. This size is used by `esp_flash_*` functions (in both software & ROM) to check the bounds.

### Concurrency Constraints for Flash on SPI1

**Concurrency Constraints for flash on SPI1** The SPI0/1 bus is shared between the instruction & data cache (for firmware execution) and the SPI1 peripheral (controlled by the drivers including this SPI Flash driver). Hence, operations to SPI1 will cause significant influence to the whole system. This kind of operations include calling SPI Flash API or other drivers on SPI1 bus, any operations like read/write/erase or other user defined SPI operations, regardless to the main flash or other SPI slave devices.

On ESP32-S2, these caches must be disabled while reading/writing/erasing.

**When the caches are disabled** Under this condition, all CPUs should always execute code and access data from internal RAM. The APIs documented in this file will disable the caches automatically and transparently.

The way that these APIs disable the caches will also disable non-IRAM-safe interrupts. These will be restored until the Flash operation completes.

See also *OS Functions* and *SPI Bus Lock*.

There are no such constraints and impacts for flash chips on other SPI buses than SPI0/1.

For differences between internal RAM (e.g. IRAM, DRAM) and flash cache, please refer to the *application memory layout* documentation.

**IRAM-Safe Interrupt Handlers** For interrupt handlers which need to execute when the cache is disabled (e.g., for low latency operations), set the `ESP_INTR_FLAG_IRAM` flag when the *interrupt handler is registered*.

You must ensure that all data and functions accessed by these interrupt handlers, including the ones that handlers call, are located in IRAM or DRAM. See *How to place code in IRAM*.

If a function or symbol is not correctly put into IRAM/DRAM, and the interrupt handler reads from the flash cache during a flash operation, it will cause a crash due to Illegal Instruction exception (for code which should be in IRAM) or garbage data to be read (for constant data which should be in DRAM).

---

**Note:** When working with strings in ISRs, it is not advised to use `printf` and other output functions. For debugging purposes, use `ESP_DRAM_LOGE()` and similar macros when logging from ISRs. Make sure that both TAG and format string are placed into DRAM in that case.

---

**Non-IRAM-Safe Interrupt Handlers** If the `ESP_INTR_FLAG_IRAM` flag is not set when registering, the interrupt handler will not get executed when the caches are disabled. Once the caches are restored, the non-IRAM-safe interrupts will be re-enabled. After this moment, the interrupt handler will run normally again. This means that as long as caches are disabled, users won't see the corresponding hardware event happening.

**Attention:** The SPI0/1 bus is shared between the instruction & data cache (for firmware execution) and the SPI1 peripheral (controlled by the drivers including this SPI flash driver). Hence, calling SPI Flash API on SPI1 bus (including the main flash) will cause significant influence to the whole system. See *Concurrency Constraints for flash on SPI1* for more details.

## Partition Table API

ESP-IDF projects use a partition table to maintain information about various regions of SPI flash memory (bootloader, various application binaries, data, filesystems). More information can be found in *Partition Tables*.

This component provides API functions to enumerate partitions found in the partition table and perform operations on them. These functions are declared in `esp_partition.h`:

- `esp_partition_find()` checks a partition table for entries with specific type, returns an opaque iterator.
- `esp_partition_get()` returns a structure describing the partition for a given iterator.
- `esp_partition_next()` shifts the iterator to the next found partition.
- `esp_partition_iterator_release()` releases iterator returned by `esp_partition_find`.
- `esp_partition_find_first()` is a convenience function which returns the structure describing the first partition found by `esp_partition_find`.
- `esp_partition_read()`, `esp_partition_write()`, `esp_partition_erase_range()` are equivalent to `esp_flash_read()`, `esp_flash_write()`, `esp_flash_erase_region()`, but operate within partition boundaries.

---

**Note:** Application code should mostly use these `esp_partition_*` API functions instead of lower level `esp_flash_*` API functions. Partition table API functions do bounds checking and calculate correct offsets in flash, based on data stored in a partition table.

---

## SPI Flash Encryption

It is possible to encrypt the contents of SPI flash and have it transparently decrypted by hardware.

Refer to the *Flash Encryption documentation* for more details.

## Memory Mapping API

ESP32-S2 features memory hardware which allows regions of flash memory to be mapped into instruction and data address spaces. This mapping works only for read operations. It is not possible to modify contents of flash memory by writing to a mapped memory region.

Mapping happens in 64 KB pages. Memory mapping hardware can map flash into the data address space and the instruction address space. See the technical reference manual for more details and limitations about memory mapping hardware.

Note that some pages are used to map the application itself into memory, so the actual number of available pages may be less than the capability of the hardware.

Reading data from flash using a memory mapped region is the only way to decrypt contents of flash when *flash encryption* is enabled. Decryption is performed at the hardware level.

Memory mapping API are declared in `spi_flash_mmap.h` and `esp_partition.h`:

- `spi_flash_mmap()` maps a region of physical flash addresses into instruction space or data space of the CPU.
- `spi_flash_munmap()` unmaps previously mapped region.
- `esp_partition_mmap()` maps part of a partition into the instruction space or data space of the CPU.

Differences between `spi_flash_mmap()` and `esp_partition_mmap()` are as follows:

- `spi_flash_mmap()` must be given a 64 KB aligned physical address.
- `esp_partition_mmap()` may be given any arbitrary offset within the partition. It will adjust the returned pointer to mapped memory as necessary.

Note that since memory mapping happens in pages, it may be possible to read data outside of the partition provided to `esp_partition_mmap`, regardless of the partition boundary.

---

**Note:** `mmap` is supported by cache, so it can only be used on main flash.

---

## SPI Flash Implementation

The `esp_flash_t` structure holds chip data as well as three important parts of this API:

1. The host driver, which provides the hardware support to access the chip;
2. The chip driver, which provides compatibility service to different chips;
3. The OS functions, provide support of some OS functions (e.g. lock, delay) in different stages (1st/2nd boot, or the app).

**Host driver** The host driver relies on an interface (`spi_flash_host_driver_t`) defined in the `spi_flash_types.h` (in the `hal/include/hal` folder). This interface provides some common functions to communicate with the chip.

In other files of the SPI HAL, some of these functions are implemented with existing ESP32-S2 memory-spi functionalities. However, due to the speed limitations of ESP32-S2, the HAL layer cannot provide high-speed implementations to some reading commands (so the support for it was dropped). The files (`memspi_host_driver.h` and `.c`) implement the high-speed version of these commands with the `common_command` function provided in the HAL, and wrap these functions as `spi_flash_host_driver_t` for upper layer to use.

You can also implement your own host driver, even with the GPIO. As long as all the functions in the `spi_flash_host_driver_t` are implemented, the `esp_flash` API can access the flash regardless of the low-level hardware.

**Chip Driver** The chip driver, defined in `spi_flash_chip_driver.h`, wraps basic functions provided by the host driver for the API layer to use.

Some operations need some commands to be sent first, or read some status afterwards. Some chips need different commands or values, or need special communication ways.

There is a type of chip called `generic_chip` which stands for common chips. Other special chip drivers can be developed on the base of the generic chip.

The chip driver relies on the host driver.

**OS Functions** Currently the OS function layer provides entries of a lock and delay.

The lock (see [SPI Bus Lock](#)) is used to resolve the conflicts among the access of devices on the same SPI bus, and the SPI Flash chip access. E.g.

1. On SPI1 bus, the cache (used to fetch the data (code) in the Flash and PSRAM) should be disabled when the flash chip on the SPI0/1 is being accessed.
2. On the other buses, the flash driver needs to disable the ISR registered by SPI Master driver, to avoid conflicts.
3. Some devices of SPI Master driver may require to use the bus monopolized during a period (especially when the device doesn't have a CS wire, or the wire is controlled by software like SDSPI driver).

The delay is used by some long operations which requires the master to wait or polling periodically.

The top API wraps these the chip driver and OS functions into an entire component, and also provides some argument checking.

OS functions can also help to avoid a watchdog timeout when erasing large flash areas. During this time, the CPU is occupied with the flash erasing task. This stops other tasks from being executed. Among these tasks is the idle task to feed the watchdog timer (WDT). If the configuration option `CONFIG_ESP_TASK_WDT_PANIC` is selected and the flash operation time is longer than the watchdog timeout period, the system will reboot.

It's pretty hard to totally eliminate this risk, because the erasing time varies with different flash chips, making it hard to be compatible in flash drivers. Therefore, users need to pay attention to it. Please use the following guidelines:

1. It is recommended to enable the `CONFIG_SPI_FLASH_YIELD_DURING_ERASE` option to allow the scheduler to re-schedule during erasing flash memory. Besides, following parameters can also be used.
  - Increase `CONFIG_SPI_FLASH_ERASE_YIELD_TICKS` or decrease `CONFIG_SPI_FLASH_ERASE_YIELD_DURATION_MS` in menuconfig.
  - You can also increase `CONFIG_ESP_TASK_WDT_TIMEOUT_S` in menuconfig for a larger watchdog timeout period. However, with larger watchdog timeout period, previously detected timeouts may no longer be detected.
2. Please be aware of the consequences of enabling the `CONFIG_ESP_TASK_WDT_PANIC` option when doing long-running SPI flash operations which will trigger the panic handler when it times out. However, this option can also help dealing with unexpected exceptions in your application. Please decide whether this is needed to be enabled according to actual condition.
3. During your development, please carefully review the actual flash operation according to the specific requirements and time limits on erasing flash memory of your projects. Always allow reasonable redundancy based on your specific product requirements when configuring the flash erasing timeout threshold, thus improving the reliability of your product.

## See Also

- [Partition Table documentation](#)
- [Over The Air Update \(OTA\) API](#) provides high-level API for updating app firmware stored in flash.
- [Non-Volatile Storage \(NVS\) API](#) provides a structured API for storing small pieces of data in SPI flash.

## Implementation Details

In order to perform some flash operations, it is necessary to make sure that both CPUs are not running any code from flash for the duration of the flash operation: - In a single-core setup, the SDK needs to disable interrupts or scheduler

before performing the flash operation. - In a dual-core setup, the SDK needs to make sure that both CPUs are not running any code from flash.

When SPI flash API is called on CPU A (can be PRO or APP), start the `spi_flash_op_block_func` function on CPU B using the `esp_ipc_call` API. This API wakes up a high priority task on CPU B and tells it to execute a given function, in this case, `spi_flash_op_block_func`. This function disables cache on CPU B and signals that the cache is disabled by setting the `s_flash_op_can_start` flag. Then the task on CPU A disables cache as well and proceeds to execute flash operation.

While a flash operation is running, interrupts can still run on CPUs A and B. It is assumed that all interrupt code is placed into RAM. Once the interrupt allocation API is added, a flag should be added to request the interrupt to be disabled for the duration of a flash operations.

Once the flash operation is complete, the function on CPU A sets another flag, `s_flash_op_complete`, to let the task on CPU B know that it can re-enable cache and release the CPU. Then the function on CPU A re-enables the cache on CPU A as well and returns control to the calling code.

Additionally, all API functions are protected with a mutex (`s_flash_op_mutex`).

In a single core environment (`CONFIG_FREERTOS_UNICORE` enabled), you need to disable both caches, so that no inter-CPU communication can take place.

## API Reference - SPI Flash

### Header File

- `components/spi_flash/include/esp_flash_spi_init.h`

### Functions

`esp_err_t spi_bus_add_flash_device(esp_flash_t **out_chip, const esp_flash_spi_device_config_t *config)`

Add a SPI Flash device onto the SPI bus.

The bus should be already initialized by `spi_bus_initialization`.

#### Parameters

- `out_chip` –Pointer to hold the initialized chip.
- `config` –Configuration of the chips to initialize.

#### Returns

- `ESP_ERR_INVALID_ARG`: `out_chip` is NULL, or some field in the config is invalid.
- `ESP_ERR_NO_MEM`: failed to allocate memory for the chip structures.
- `ESP_OK`: success.

`esp_err_t spi_bus_remove_flash_device(esp_flash_t *chip)`

Remove a SPI Flash device from the SPI bus.

**Parameters** `chip` –The flash device to remove.

#### Returns

- `ESP_ERR_INVALID_ARG`: The chip is invalid.
- `ESP_OK`: success.

### Structures

struct `esp_flash_spi_device_config_t`

Configurations for the SPI Flash to init.

### Public Members

*spi\_host\_device\_t* **host\_id**

Bus to use.

int **cs\_io\_num**

GPIO pin to output the CS signal.

*esp\_flash\_io\_mode\_t* **io\_mode**

IO mode to read from the Flash.

enum *esp\_flash\_speed\_s* **speed**

Speed of the Flash clock. Replaced by `freq_mhz`.

int **input\_delay\_ns**

Input delay of the data pins, in ns. Set to 0 if unknown.

int **cs\_id**

CS line ID, ignored when not `host_id` is not `SPI1_HOST`, or `CONFIG_SPI_FLASH_SHARE_SPI1_BUS` is enabled. In this case, the CS line used is automatically assigned by the SPI bus lock.

int **freq\_mhz**

The frequency of flash chip(MHZ)

## Header File

- `components/spi_flash/include/esp_flash.h`

## Functions

*esp\_err\_t* **esp\_flash\_init** (*esp\_flash\_t* \*chip)

Initialise SPI flash chip interface.

This function must be called before any other API functions are called for this chip.

---

**Note:** Only the `host` and `read_mode` fields of the chip structure must be initialised before this function is called. Other fields may be auto-detected if left set to zero or NULL.

---

---

**Note:** If the `chip->drv` pointer is NULL, `chip chip_drv` will be auto-detected based on its manufacturer & product IDs. See `esp_flash_registered_flash_drivers` pointer for details of this process.

---

**Parameters** **chip** –Pointer to SPI flash chip to use. If NULL, `esp_flash_default_chip` is substituted.

**Returns** `ESP_OK` on success, or a flash error code if initialisation fails.

bool **esp\_flash\_chip\_driver\_initialized** (const *esp\_flash\_t* \*chip)

Check if appropriate chip driver is set.

**Parameters** **chip** –Pointer to SPI flash chip to use. If NULL, `esp_flash_default_chip` is substituted.

**Returns** true if set, otherwise false.



*esp\_err\_t* **esp\_flash\_read\_id** (*esp\_flash\_t* \*chip, uint32\_t \*out\_id)

Read flash ID via the common “RDID” SPI flash command.

ID is a 24-bit value. Lower 16 bits of ‘id’ are the chip ID, upper 8 bits are the manufacturer ID.

**Parameters**

- **chip** –Pointer to identify flash chip. Must have been successfully initialised via `esp_flash_init()`
- **out\_id** –[out] Pointer to receive ID value.

**Returns** ESP\_OK on success, or a flash error code if operation failed.

*esp\_err\_t* **esp\_flash\_get\_size** (*esp\_flash\_t* \*chip, uint32\_t \*out\_size)

Detect flash size based on flash ID.

---

**Note:** 1. Most flash chips use a common format for flash ID, where the lower 4 bits specify the size as a power of 2. If the manufacturer doesn’t follow this convention, the size may be incorrectly detected.

- a. The `out_size` returned only stands for The `out_size` stands for the size in the binary image header. If you want to get the real size of the chip, please call `esp_flash_get_physical_size` instead.
- 

**Parameters**

- **chip** –Pointer to identify flash chip. Must have been successfully initialised via `esp_flash_init()`
- **out\_size** –[out] Detected size in bytes, standing for the size in the binary image header.

**Returns** ESP\_OK on success, or a flash error code if operation failed.

*esp\_err\_t* **esp\_flash\_get\_physical\_size** (*esp\_flash\_t* \*chip, uint32\_t \*flash\_size)

Detect flash size based on flash ID.

---

**Note:** Most flash chips use a common format for flash ID, where the lower 4 bits specify the size as a power of 2. If the manufacturer doesn’t follow this convention, the size may be incorrectly detected.

---

**Parameters**

- **chip** –Pointer to identify flash chip. Must have been successfully initialised via `esp_flash_init()`
- **flash\_size** –[out] Detected size in bytes.

**Returns** ESP\_OK on success, or a flash error code if operation failed.

*esp\_err\_t* **esp\_flash\_read\_unique\_chip\_id** (*esp\_flash\_t* \*chip, uint64\_t \*out\_id)

Read flash unique ID via the common “RDUID” SPI flash command.

ID is a 64-bit value.

---

**Note:** This is an optional feature, which is not supported on all flash chips. READ PROGRAMMING GUIDE FIRST!

---

**Parameters**

- **chip** –Pointer to identify flash chip. Must have been successfully initialised via `esp_flash_init()`.
- **out\_id** –[out] Pointer to receive unique ID value.

**Returns**

- ESP\_OK on success, or a flash error code if operation failed.



- `ESP_ERR_NOT_SUPPORTED` if the chip doesn't support read id.

*esp\_err\_t* **esp\_flash\_erase\_chip** (*esp\_flash\_t* \*chip)

Erase flash chip contents.

**Parameters** **chip** –Pointer to identify flash chip. Must have been successfully initialised via `esp_flash_init()`

**Returns**

- `ESP_OK` on success,
- `ESP_ERR_NOT_SUPPORTED` if the chip is not able to perform the operation. This is indicated by `WREN = 1` after the command is sent.
- Other flash error code if operation failed.

*esp\_err\_t* **esp\_flash\_erase\_region** (*esp\_flash\_t* \*chip, *uint32\_t* start, *uint32\_t* len)

Erase a region of the flash chip.

Sector size is specified in `chip->drv->sector_size` field (typically 4096 bytes.) `ESP_ERR_INVALID_ARG` will be returned if the start & length are not a multiple of this size.

Erase is performed using block (multi-sector) erases where possible (block size is specified in `chip->drv->block_erase_size` field, typically 65536 bytes). Remaining sectors are erased using individual sector erase commands.

**Parameters**

- **chip** –Pointer to identify flash chip. If `NULL`, `esp_flash_default_chip` is substituted. Must have been successfully initialised via `esp_flash_init()`
- **start** –Address to start erasing flash. Must be sector aligned.
- **len** –Length of region to erase. Must also be sector aligned.

**Returns**

- `ESP_OK` on success,
- `ESP_ERR_NOT_SUPPORTED` if the chip is not able to perform the operation. This is indicated by `WREN = 1` after the command is sent.
- Other flash error code if operation failed.

*esp\_err\_t* **esp\_flash\_get\_chip\_write\_protect** (*esp\_flash\_t* \*chip, *bool* \*write\_protected)

Read if the entire chip is write protected.

---

**Note:** A correct result for this flag depends on the SPI flash chip model and `chip_drv` in use (via the 'chip->drv' field).

---

**Parameters**

- **chip** –Pointer to identify flash chip. If `NULL`, `esp_flash_default_chip` is substituted. Must have been successfully initialised via `esp_flash_init()`
- **write\_protected** –[out] Pointer to boolean, set to the value of the write protect flag.

**Returns** `ESP_OK` on success, or a flash error code if operation failed.

*esp\_err\_t* **esp\_flash\_set\_chip\_write\_protect** (*esp\_flash\_t* \*chip, *bool* write\_protect)

Set write protection for the SPI flash chip.

Some SPI flash chips may require a power cycle before write protect status can be cleared. Otherwise, write protection can be removed via a follow-up call to this function.

---

**Note:** Correct behaviour of this function depends on the SPI flash chip model and `chip_drv` in use (via the 'chip->drv' field).

---

**Parameters**

- **chip** –Pointer to identify flash chip. If NULL, `esp_flash_default_chip` is substituted. Must have been successfully initialised via `esp_flash_init()`
- **write\_protect** –Boolean value for the write protect flag

**Returns** ESP\_OK on success, or a flash error code if operation failed.

*esp\_err\_t* **esp\_flash\_get\_protectable\_regions** (const *esp\_flash\_t* \*chip, const *esp\_flash\_region\_t* \*\*out\_regions, uint32\_t \*out\_num\_regions)

Read the list of individually protectable regions of this SPI flash chip.

---

**Note:** Correct behaviour of this function depends on the SPI flash chip model and `chip_drv` in use (via the `'chip->drv'` field).

---

**Parameters**

- **chip** –Pointer to identify flash chip. Must have been successfully initialised via `esp_flash_init()`
- **out\_regions** –[out] Pointer to receive a pointer to the array of protectable regions of the chip.
- **out\_num\_regions** –[out] Pointer to an integer receiving the count of protectable regions in the array returned in `'regions'` .

**Returns** ESP\_OK on success, or a flash error code if operation failed.

*esp\_err\_t* **esp\_flash\_get\_protected\_region** (*esp\_flash\_t* \*chip, const *esp\_flash\_region\_t* \*region, bool \*out\_protected)

Detect if a region of the SPI flash chip is protected.

---

**Note:** It is possible for this result to be false and write operations to still fail, if protection is enabled for the entire chip.

---

---

**Note:** Correct behaviour of this function depends on the SPI flash chip model and `chip_drv` in use (via the `'chip->drv'` field).

---

**Parameters**

- **chip** –Pointer to identify flash chip. Must have been successfully initialised via `esp_flash_init()`
- **region** –Pointer to a struct describing a protected region. This must match one of the regions returned from `esp_flash_get_protectable_regions(...)`.
- **out\_protected** –[out] Pointer to a flag which is set based on the protected status for this region.

**Returns** ESP\_OK on success, or a flash error code if operation failed.

*esp\_err\_t* **esp\_flash\_set\_protected\_region** (*esp\_flash\_t* \*chip, const *esp\_flash\_region\_t* \*region, bool protect)

Update the protected status for a region of the SPI flash chip.

---

**Note:** It is possible for the region protection flag to be cleared and write operations to still fail, if protection is enabled for the entire chip.

---

---

**Note:** Correct behaviour of this function depends on the SPI flash chip model and `chip_drv` in use (via the `'chip->drv'` field).

---

**Parameters**

- **chip** –Pointer to identify flash chip. Must have been successfully initialised via `esp_flash_init()`
- **region** –Pointer to a struct describing a protected region. This must match one of the regions returned from `esp_flash_get_protectable_regions(...)`.
- **protect** –Write protection flag to set.

**Returns** ESP\_OK on success, or a flash error code if operation failed.

*esp\_err\_t* **esp\_flash\_read** (*esp\_flash\_t* \*chip, void \*buffer, uint32\_t address, uint32\_t length)

Read data from the SPI flash chip.

There are no alignment constraints on buffer, address or length.

---

**Note:** If on-chip flash encryption is used, this function returns raw (ie encrypted) data. Use the flash cache to transparently decrypt data.

---

**Parameters**

- **chip** –Pointer to identify flash chip. If NULL, `esp_flash_default_chip` is substituted. Must have been successfully initialised via `esp_flash_init()`
- **buffer** –Pointer to a buffer where the data will be read. To get better performance, this should be in the DRAM and word aligned.
- **address** –Address on flash to read from. Must be less than `chip->size` field.
- **length** –Length (in bytes) of data to read.

**Returns**

- ESP\_OK: success
- ESP\_ERR\_NO\_MEM: Buffer is in external PSRAM which cannot be concurrently accessed, and a temporary internal buffer could not be allocated.
- or a flash error code if operation failed.

*esp\_err\_t* **esp\_flash\_write** (*esp\_flash\_t* \*chip, const void \*buffer, uint32\_t address, uint32\_t length)

Write data to the SPI flash chip.

There are no alignment constraints on buffer, address or length.

**Parameters**

- **chip** –Pointer to identify flash chip. If NULL, `esp_flash_default_chip` is substituted. Must have been successfully initialised via `esp_flash_init()`
- **address** –Address on flash to write to. Must be previously erased (SPI NOR flash can only write bits 1->0).
- **buffer** –Pointer to a buffer with the data to write. To get better performance, this should be in the DRAM and word aligned.
- **length** –Length (in bytes) of data to write.

**Returns**

- ESP\_OK on success,
- ESP\_ERR\_NOT\_SUPPORTED if the chip is not able to perform the operation. This is indicated by `WREN = 1` after the command is sent.
- Other flash error code if operation failed.

*esp\_err\_t* **esp\_flash\_write\_encrypted** (*esp\_flash\_t* \*chip, uint32\_t address, const void \*buffer, uint32\_t length)

Encrypted and write data to the SPI flash chip using on-chip hardware flash encryption.

---

**Note:** Both address & length must be 16 byte aligned, as this is the encryption block size

---

**Parameters**

- **chip** –Pointer to identify flash chip. Must be NULL (the main flash chip). For other chips, encrypted write is not supported.
- **address** –Address on flash to write to. 16 byte aligned. Must be previously erased (SPI NOR flash can only write bits 1->0).
- **buffer** –Pointer to a buffer with the data to write.
- **length** –Length (in bytes) of data to write. 16 byte aligned.

**Returns**

- ESP\_OK: on success
- ESP\_ERR\_NOT\_SUPPORTED: encrypted write not supported for this chip.
- ESP\_ERR\_INVALID\_ARG: Either the address, buffer or length is invalid.

`esp_err_t esp_flash_read_encrypted(esp_flash_t *chip, uint32_t address, void *out_buffer, uint32_t length)`

Read and decrypt data from the SPI flash chip using on-chip hardware flash encryption.

**Parameters**

- **chip** –Pointer to identify flash chip. Must be NULL (the main flash chip). For other chips, encrypted read is not supported.
- **address** –Address on flash to read from.
- **out\_buffer** –Pointer to a buffer for the data to read to.
- **length** –Length (in bytes) of data to read.

**Returns**

- ESP\_OK: on success
- ESP\_ERR\_NOT\_SUPPORTED: encrypted read not supported for this chip.

static inline bool `esp_flash_is_quad_mode` (const `esp_flash_t` \*chip)

Returns true if chip is configured for Quad I/O or Quad Fast Read.

**Parameters** **chip** –Pointer to SPI flash chip to use. If NULL, `esp_flash_default_chip` is substituted.

**Returns** true if flash works in quad mode, otherwise false

**Structures**

struct `esp_flash_region_t`

Structure for describing a region of flash.

**Public Members**

uint32\_t **offset**

Start address of this region.

uint32\_t **size**

Size of the region.

struct `esp_flash_os_functions_t`

OS-level integration hooks for accessing flash chips inside a running OS.

It' s in the public header because some instances should be allocated statically in the startup code. May be updated according to hardware version and new flash chip feature requirements, shouldn' t be treated as public API.

For advanced developers, you may replace some of them with your implementations at your own risk.

## Public Members

*esp\_err\_t* (\***start**)(void \*arg)

Called before commencing any flash operation. Does not need to be recursive (ie is called at most once for each call to 'end').

*esp\_err\_t* (\***end**)(void \*arg)

Called after completing any flash operation.

*esp\_err\_t* (\***region\_protected**)(void \*arg, size\_t start\_addr, size\_t size)

Called before any erase/write operations to check whether the region is limited by the OS

*esp\_err\_t* (\***delay\_us**)(void \*arg, uint32\_t us)

Delay for at least 'us' microseconds. Called in between 'start' and 'end'.

void (\***get\_temp\_buffer**)(void \*arg, size\_t request\_size, size\_t \*out\_size)

Called for get temp buffer when buffer from application cannot be directly read into/write from.

void (\***release\_temp\_buffer**)(void \*arg, void \*temp\_buf)

Called for release temp buffer.

*esp\_err\_t* (\***check\_yield**)(void \*arg, uint32\_t chip\_status, uint32\_t \*out\_request)

Yield to other tasks. Called during erase operations.

**Return** ESP\_OK means yield needs to be called (got an event to handle), while ESP\_ERR\_TIMEOUT means skip yield.

*esp\_err\_t* (\***yield**)(void \*arg, uint32\_t \*out\_status)

Yield to other tasks. Called during erase operations.

int64\_t (\***get\_system\_time**)(void \*arg)

Called for get system time.

void (\***set\_flash\_op\_status**)(uint32\_t op\_status)

Call to set flash operation status

struct **esp\_flash\_t**

Structure to describe a SPI flash chip connected to the system.

Structure must be initialized before use (passed to esp\_flash\_init()). It's in the public header because some instances should be allocated statically in the startup code. May be updated according to hardware version and new flash chip feature requirements, shouldn't be treated as public API.

For advanced developers, you may replace some of them with your implementations at your own risk.

## Public Members

*spi\_flash\_host\_inst\_t* \***host**

Pointer to hardware-specific "host\_driver" structure. Must be initialized before used.

const *spi\_flash\_chip\_t* \***chip\_drv**

Pointer to chip-model-specific “adapter” structure. If NULL, will be detected during initialisation.

const *esp\_flash\_os\_functions\_t* \***os\_func**

Pointer to os-specific hook structure. Call `esp_flash_init_os_functions()` to setup this field, after the host is properly initialized.

void \***os\_func\_data**

Pointer to argument for os-specific hooks. Left NULL and will be initialized with `os_func`.

*esp\_flash\_io\_mode\_t* **read\_mode**

Configured SPI flash read mode. Set before `esp_flash_init` is called.

uint32\_t **size**

Size of SPI flash in bytes. If 0, size will be detected during initialisation. Note: this stands for the size in the binary image header. If you want to get the flash physical size, please call `esp_flash_get_physical_size`.

uint32\_t **chip\_id**

Detected chip id.

uint32\_t **busy**

This flag is used to verify chip’ s status.

uint32\_t **hpm\_dummy\_ena**

This flag is used to verify whether flash works under HPM status.

uint32\_t **reserved\_flags**

reserved.

## Macros

**SPI\_FLASH\_YIELD\_REQ\_YIELD**

**SPI\_FLASH\_YIELD\_REQ\_SUSPEND**

**SPI\_FLASH\_YIELD\_STA\_RESUME**

**SPI\_FLASH\_OS\_IS\_ERASING\_STATUS\_FLAG**

## Type Definitions

typedef struct *spi\_flash\_chip\_t* **spi\_flash\_chip\_t**

typedef struct *esp\_flash\_t* **esp\_flash\_t**

## Header File

- `components/spi_flash/include/spi_flash_mmap.h`

## Functions

`esp_err_t spi_flash_mmap` (size\_t src\_addr, size\_t size, `spi_flash_mmap_memory_t` memory, const void \*\*out\_ptr, `spi_flash_mmap_handle_t` \*out\_handle)

Map region of flash memory into data or instruction address space.

This function allocates sufficient number of 64kB MMU pages and configures them to map the requested region of flash memory into the address space. It may reuse MMU pages which already provide the required mapping.

As with any allocator, if mmap/munmap are heavily used then the address space may become fragmented. To troubleshoot issues with page allocation, use `spi_flash_mmap_dump`() function.

### Parameters

- **src\_addr** –Physical address in flash where requested region starts. This address *must* be aligned to 64kB boundary (`SPI_FLASH_MMU_PAGE_SIZE`)
- **size** –Size of region to be mapped. This size will be rounded up to a 64kB boundary
- **memory** –Address space where the region should be mapped (data or instruction)
- **out\_ptr** –[out] Output, pointer to the mapped memory region
- **out\_handle** –[out] Output, handle which should be used for `spi_flash_munmap` call

**Returns** `ESP_OK` on success, `ESP_ERR_NO_MEM` if pages can not be allocated

`esp_err_t spi_flash_mmap_pages` (const int \*pages, size\_t page\_count, `spi_flash_mmap_memory_t` memory, const void \*\*out\_ptr, `spi_flash_mmap_handle_t` \*out\_handle)

Map sequences of pages of flash memory into data or instruction address space.

This function allocates sufficient number of 64kB MMU pages and configures them to map the indicated pages of flash memory contiguously into address space. In this respect, it works in a similar way as `spi_flash_mmap`() but it allows mapping a (maybe non-contiguous) set of pages into a contiguous region of memory.

### Parameters

- **pages** –An array of numbers indicating the 64kB pages in flash to be mapped contiguously into memory. These indicate the indexes of the 64kB pages, not the byte-size addresses as used in other functions. Array must be located in internal memory.
- **page\_count** –Number of entries in the pages array
- **memory** –Address space where the region should be mapped (instruction or data)
- **out\_ptr** –[out] Output, pointer to the mapped memory region
- **out\_handle** –[out] Output, handle which should be used for `spi_flash_munmap` call

### Returns

- `ESP_OK` on success
- `ESP_ERR_NO_MEM` if pages can not be allocated
- `ESP_ERR_INVALID_ARG` if pagecount is zero or pages array is not in internal memory

void `spi_flash_munmap` (`spi_flash_mmap_handle_t` handle)

Release region previously obtained using `spi_flash_mmap`.

---

**Note:** Calling this function will not necessarily unmap memory region. Region will only be unmapped when there are no other handles which reference this region. In case of partially overlapping regions it is possible that memory will be unmapped partially.

---

**Parameters** **handle** –Handle obtained from `spi_flash_mmap`

void `spi_flash_mmap_dump` (void)

Display information about mapped regions.

This function lists handles obtained using `spi_flash_mmap`, along with range of pages allocated to each handle. It also lists all non-zero entries of MMU table and corresponding reference counts.

uint32\_t `spi_flash_mmap_get_free_pages` (`spi_flash_mmap_memory_t` memory)

get free pages number which can be mmap

This function will return number of free pages available in mmu table. This could be useful before calling actual `spi_flash_mmap` (maps flash range to DCache or ICache memory) to check if there is sufficient space available for mapping.

**Parameters** `memory` –memory type of MMU table free page

**Returns** number of free pages which can be mmaped

size\_t **spi\_flash\_cache2phys** (const void \*cached)

Given a memory address where flash is mapped, return the corresponding physical flash offset.

Cache address does not have have been assigned via `spi_flash_mmap()`, any address in memory mapped flash space can be looked up.

**Parameters** `cached` –Pointer to flashed cached memory.

**Returns**

- `SPI_FLASH_CACHE2PHYS_FAIL` If cache address is outside flash cache region, or the address is not mapped.
- Otherwise, returns physical offset in flash

const void \***spi\_flash\_phys2cache** (size\_t phys\_offs, *spi\_flash\_mmap\_memory\_t* memory)

Given a physical offset in flash, return the address where it is mapped in the memory space.

Physical address does not have to have been assigned via `spi_flash_mmap()`, any address in flash can be looked up.

---

**Note:** Only the first matching cache address is returned. If MMU flash cache table is configured so multiple entries point to the same physical address, there may be more than one cache address corresponding to that physical address. It is also possible for a single physical address to be mapped to both the IROM and DROM regions.

---

---

**Note:** This function doesn't impose any alignment constraints, but if memory argument is `SPI_FLASH_MMAP_INST` and `phys_offs` is not 4-byte aligned, then reading from the returned pointer will result in a crash.

---

**Parameters**

- **phys\_offs** –Physical offset in flash memory to look up.
- **memory** –Address space type to look up a flash cache address mapping for (instruction or data)

**Returns**

- NULL if the physical address is invalid or not mapped to flash cache of the specified memory type.
- Cached memory address (in IROM or DROM space) corresponding to `phys_offs`.

## Macros

### **ESP\_ERR\_FLASH\_OP\_FAIL**

This file contains `spi_flash_mmap_xx` APIs, mainly for doing memory mapping to an SPI0-connected external Flash, as well as some helper functions to convert between virtual and physical address

### **ESP\_ERR\_FLASH\_OP\_TIMEOUT**

### **SPI\_FLASH\_SEC\_SIZE**

SPI Flash sector size

### **SPI\_FLASH\_MMU\_PAGE\_SIZE**

Flash cache MMU mapping page size



**SPI\_FLASH\_CACHE2PHYS\_FAIL**

### Type Definitions

typedef uint32\_t **spi\_flash\_mmap\_handle\_t**

Opaque handle for memory region obtained from `spi_flash_mmap`.

### Enumerations

enum **spi\_flash\_mmap\_memory\_t**

Enumeration which specifies memory space requested in an `mmap` call.

*Values:*

enumerator **SPI\_FLASH\_MMAP\_DATA**

map to data memory (Vaddr0), allows byte-aligned access, 4 MB total

enumerator **SPI\_FLASH\_MMAP\_INST**

map to instruction memory (Vaddr1-3), allows only 4-byte-aligned access, 11 MB total

### Header File

- [components/hal/include/hal/spi\\_flash\\_types.h](#)

### Structures

struct **spi\_flash\_trans\_t**

Definition of a common transaction. Also holds the return value.

### Public Members

uint8\_t **reserved**

Reserved, must be 0.

uint8\_t **mosi\_len**

Output data length, in bytes.

uint8\_t **miso\_len**

Input data length, in bytes.

uint8\_t **address\_bitlen**

Length of address in bits, set to 0 if command does not need an address.

uint32\_t **address**

Address to perform operation on.

const uint8\_t \***mosi\_data**

Output data to salve.

uint8\_t \***miso\_data**

[out] Input data from slave, little endian

uint32\_t **flags**

Flags for this transaction. Set to 0 for now.

uint16\_t **command**

Command to send.

uint8\_t **dummy\_bitlen**

Basic dummy bits to use.

uint32\_t **io\_mode**

Flash working mode when `SPI_FLASH_IGNORE_BASEIO` is specified.

struct **spi\_flash\_sus\_cmd\_conf**

Configuration structure for the flash chip suspend feature.

### Public Members

uint32\_t **sus\_mask**

SUS/SUS1/SUS2 bit in flash register.

uint32\_t **cmd\_rdsr**

Read flash status register(2) command.

uint32\_t **sus\_cmd**

Flash suspend command.

uint32\_t **res\_cmd**

Flash resume command.

uint32\_t **reserved**

Reserved, set to 0.

struct **spi\_flash\_encryption\_t**

Structure for flash encryption operations.

### Public Members

void (\***flash\_encryption\_enable**)(void)

Enable the flash encryption.

void (\***flash\_encryption\_disable**)(void)

Disable the flash encryption.

void (**\*flash\_encryption\_data\_prepare**)(uint32\_t address, const uint32\_t \*buffer, uint32\_t size)  
Prepare flash encryption before operation.

---

**Note:** address and buffer must be 8-word aligned.

---

**Param address** The destination address in flash for the write operation.

**Param buffer** Data for programming

**Param size** Size to program.

void (**\*flash\_encryption\_done**)(void)  
flash data encryption operation is done.

void (**\*flash\_encryption\_destroy**)(void)  
Destroy encrypted result

bool (**\*flash\_encryption\_check**)(uint32\_t address, uint32\_t length)  
Check if is qualified to encrypt the buffer

**Param address** the address of written flash partition.

**Param length** Buffer size.

struct **spi\_flash\_host\_inst\_t**  
SPI Flash Host driver instance

### Public Members

const struct *spi\_flash\_host\_driver\_s* \***driver**  
Pointer to the implementation function table.

struct **spi\_flash\_host\_driver\_s**  
Host driver configuration and context structure.

### Public Members

*esp\_err\_t* (**\*dev\_config**)(*spi\_flash\_host\_inst\_t* \*host)

Configure the device-related register before transactions. This saves some time to re-configure those registers when we send continuously

*esp\_err\_t* (**\*common\_command**)(*spi\_flash\_host\_inst\_t* \*host, *spi\_flash\_trans\_t* \*t)

Send an user-defined spi transaction to the device.

*esp\_err\_t* (**\*read\_id**)(*spi\_flash\_host\_inst\_t* \*host, uint32\_t \*id)

Read flash ID.

void (**\*erase\_chip**)(*spi\_flash\_host\_inst\_t* \*host)

Erase whole flash chip.

`void (*erase_sector)(spi_flash_host_inst_t *host, uint32_t start_address)`

Erase a specific sector by its start address.

`void (*erase_block)(spi_flash_host_inst_t *host, uint32_t start_address)`

Erase a specific block by its start address.

`esp_err_t (*read_status)(spi_flash_host_inst_t *host, uint8_t *out_sr)`

Read the status of the flash chip.

`esp_err_t (*set_write_protect)(spi_flash_host_inst_t *host, bool wp)`

Disable write protection.

`void (*program_page)(spi_flash_host_inst_t *host, const void *buffer, uint32_t address, uint32_t length)`

Program a page of the flash. Check `max_write_bytes` for the maximum allowed writing length.

`bool (*supports_direct_write)(spi_flash_host_inst_t *host, const void *p)`

Check whether the SPI host supports direct write.

When cache is disabled, SPI1 doesn't support directly write when buffer isn't internal.

`int (*write_data_slicer)(spi_flash_host_inst_t *host, uint32_t address, uint32_t len, uint32_t *align_addr, uint32_t page_size)`

Slicer for write data. The `program_page` should be called iteratively with the return value of this function.

**Param address** Beginning flash address to write

**Param len** Length request to write

**Param align\_addr** Output of the aligned address to write to

**Param page\_size** Physical page size of the flash chip

**Return** Length that can be actually written in one `program_page` call

`esp_err_t (*read)(spi_flash_host_inst_t *host, void *buffer, uint32_t address, uint32_t read_len)`

Read data from the flash. Check `max_read_bytes` for the maximum allowed reading length.

`bool (*supports_direct_read)(spi_flash_host_inst_t *host, const void *p)`

Check whether the SPI host supports direct read.

When cache is disabled, SPI1 doesn't support directly read when the given buffer isn't internal.

`int (*read_data_slicer)(spi_flash_host_inst_t *host, uint32_t address, uint32_t len, uint32_t *align_addr, uint32_t page_size)`

Slicer for read data. The `read` should be called iteratively with the return value of this function.

**Param address** Beginning flash address to read

**Param len** Length request to read

**Param align\_addr** Output of the aligned address to read

**Param page\_size** Physical page size of the flash chip

**Return** Length that can be actually read in one `read` call

`uint32_t (*host_status)(spi_flash_host_inst_t *host)`

Check the host status, 0:busy, 1:idle, 2:suspended.

`esp_err_t (*configure_host_io_mode)(spi_flash_host_inst_t *host, uint32_t command, uint32_t addr_bitlen, int dummy_bitlen_base, spi_flash_io_mode_t io_mode)`

Configure the host to work at different read mode. Responsible to compensate the timing and set IO mode.

void (**\*poll\_cmd\_done**)(*spi\_flash\_host\_inst\_t* \*host)

Internal use, poll the HW until the last operation is done.

*esp\_err\_t* (**\*flush\_cache**)(*spi\_flash\_host\_inst\_t* \*host, uint32\_t addr, uint32\_t size)

For some host (SPI1), they are shared with a cache. When the data is modified, the cache needs to be flushed. Left NULL if not supported.

void (**\*check\_suspend**)(*spi\_flash\_host\_inst\_t* \*host)

Suspend check erase/program operation, reserved for ESP32-C3 and ESP32-S3 spi flash ROM IMPL.

void (**\*resume**)(*spi\_flash\_host\_inst\_t* \*host)

Resume flash from suspend manually

void (**\*suspend**)(*spi\_flash\_host\_inst\_t* \*host)

Set flash in suspend status manually

*esp\_err\_t* (**\*sus\_setup**)(*spi\_flash\_host\_inst\_t* \*host, const *spi\_flash\_sus\_cmd\_conf* \*sus\_conf)

Suspend feature setup for setting cmd and status register mask.

## Macros

### **SPI\_FLASH\_TRANS\_FLAG\_CMD16**

Send command of 16 bits.

### **SPI\_FLASH\_TRANS\_FLAG\_IGNORE\_BASEIO**

Not applying the basic io mode configuration for this transaction.

### **SPI\_FLASH\_TRANS\_FLAG\_BYTE\_SWAP**

Used for DTR mode, to swap the bytes of a pair of rising/falling edge.

### **SPI\_FLASH\_CONFIG\_CONF\_BITS**

OR the `io_mode` with this mask, to enable the dummy output feature or replace the first several dummy bits into address to meet the requirements of conf bits. (Used in DIO/QIO/OIO mode)

### **SPI\_FLASH\_OPI\_FLAG**

A flag for flash work in opi mode, the io mode below are opi, above are SPI/QSPI mode. DO NOT use this value in any API.

### **SPI\_FLASH\_READ\_MODE\_MIN**

Slowest io mode supported by ESP32, currently SlowRd.

## Type Definitions

typedef enum *esp\_flash\_speed\_s* **esp\_flash\_speed\_t**

SPI flash clock speed values, always refer to them by the enum rather than the actual value (more speed may be appended into the list).

A strategy to select the maximum allowed speed is to enumerate from the `ESP_FLASH_SPEED_MAX-1` or highest frequency supported by your flash, and decrease the speed until the probing success.

typedef struct *spi\_flash\_host\_driver\_s* **spi\_flash\_host\_driver\_t**

### Enumerations

enum **esp\_flash\_speed\_s**

SPI flash clock speed values, always refer to them by the enum rather than the actual value (more speed may be appended into the list).

A strategy to select the maximum allowed speed is to enumerate from the `ESP_FLASH_SPEED_MAX-1` or highest frequency supported by your flash, and decrease the speed until the probing success.

*Values:*

enumerator **ESP\_FLASH\_5MHZ**

The flash runs under 5MHz.

enumerator **ESP\_FLASH\_10MHZ**

The flash runs under 10MHz.

enumerator **ESP\_FLASH\_20MHZ**

The flash runs under 20MHz.

enumerator **ESP\_FLASH\_26MHZ**

The flash runs under 26MHz.

enumerator **ESP\_FLASH\_40MHZ**

The flash runs under 40MHz.

enumerator **ESP\_FLASH\_80MHZ**

The flash runs under 80MHz.

enumerator **ESP\_FLASH\_120MHZ**

The flash runs under 120MHz, 120MHZ can only be used by main flash after timing tuning in system. Do not use this directly in any API.

enumerator **ESP\_FLASH\_SPEED\_MAX**

The maximum frequency supported by the host is `ESP_FLASH_SPEED_MAX-1`.

enum **esp\_flash\_io\_mode\_t**

Mode used for reading from SPI flash.

*Values:*

enumerator **SPI\_FLASH\_SLOWRD**

Data read using single I/O, some limits on speed.

enumerator **SPI\_FLASH\_FASTRD**

Data read using single I/O, no limit on speed.

enumerator **SPI\_FLASH\_DOUT**

Data read using dual I/O.

enumerator **SPI\_FLASH\_DIO**

Both address & data transferred using dual I/O.

enumerator **SPI\_FLASH\_QOUT**

Data read using quad I/O.

enumerator **SPI\_FLASH\_QIO**

Both address & data transferred using quad I/O.

enumerator **SPI\_FLASH\_OPI\_STR**

Only support on OPI flash, flash read and write under STR mode.

enumerator **SPI\_FLASH\_OPI\_DTR**

Only support on OPI flash, flash read and write under DTR mode.

enumerator **SPI\_FLASH\_READ\_MODE\_MAX**

The fastest io mode supported by the host is `ESP_FLASH_READ_MODE_MAX-1`.

### Header File

- [components/hal/include/hal/esp\\_flash\\_err.h](#)

### Macros

**ESP\_ERR\_FLASH\_NOT\_INITIALISED**

`esp_flash_chip_t` structure not correctly initialised by `esp_flash_init()`.

**ESP\_ERR\_FLASH\_UNSUPPORTED\_HOST**

Requested operation isn't supported via this host SPI bus (`chip->spi` field).

**ESP\_ERR\_FLASH\_UNSUPPORTED\_CHIP**

Requested operation isn't supported by this model of SPI flash chip.

**ESP\_ERR\_FLASH\_PROTECTED**

Write operation failed due to chip's write protection being enabled.

### Enumerations

enum [**anonymous**]

*Values:*

enumerator **ESP\_ERR\_FLASH\_SIZE\_NOT\_MATCH**

The chip doesn't have enough space for the current partition table.

enumerator **ESP\_ERR\_FLASH\_NO\_RESPONSE**

Chip did not respond to the command, or timed out.

## API Reference - Partition Table

### Header File

- `components/esp_partition/include/esp_partition.h`

### Functions

`esp_partition_iterator_t esp_partition_find` (`esp_partition_type_t` type, `esp_partition_subtype_t` subtype, `const char *label`)

Find partition based on one or more parameters.

#### Parameters

- **type** –Partition type, one of `esp_partition_type_t` values or an 8-bit unsigned integer. To find all partitions, no matter the type, use `ESP_PARTITION_TYPE_ANY`, and set subtype argument to `ESP_PARTITION_SUBTYPE_ANY`.
- **subtype** –Partition subtype, one of `esp_partition_subtype_t` values or an 8-bit unsigned integer. To find all partitions of given type, use `ESP_PARTITION_SUBTYPE_ANY`.
- **label** –(optional) Partition label. Set this value if looking for partition with a specific name. Pass `NULL` otherwise.

**Returns** iterator which can be used to enumerate all the partitions found, or `NULL` if no partitions were found. Iterator obtained through this function has to be released using `esp_partition_iterator_release` when not used any more.

`const esp_partition_t *esp_partition_find_first` (`esp_partition_type_t` type, `esp_partition_subtype_t` subtype, `const char *label`)

Find first partition based on one or more parameters.

#### Parameters

- **type** –Partition type, one of `esp_partition_type_t` values or an 8-bit unsigned integer. To find all partitions, no matter the type, use `ESP_PARTITION_TYPE_ANY`, and set subtype argument to `ESP_PARTITION_SUBTYPE_ANY`.
- **subtype** –Partition subtype, one of `esp_partition_subtype_t` values or an 8-bit unsigned integer. To find all partitions of given type, use `ESP_PARTITION_SUBTYPE_ANY`.
- **label** –(optional) Partition label. Set this value if looking for partition with a specific name. Pass `NULL` otherwise.

**Returns** pointer to `esp_partition_t` structure, or `NULL` if no partition is found. This pointer is valid for the lifetime of the application.

`const esp_partition_t *esp_partition_get` (`esp_partition_iterator_t` iterator)

Get `esp_partition_t` structure for given partition.

**Parameters** **iterator** –Iterator obtained using `esp_partition_find`. Must be non-`NULL`.

**Returns** pointer to `esp_partition_t` structure. This pointer is valid for the lifetime of the application.

`esp_partition_iterator_t esp_partition_next` (`esp_partition_iterator_t` iterator)

Move partition iterator to the next partition found.

Any copies of the iterator will be invalid after this call.

**Parameters** **iterator** –Iterator obtained using `esp_partition_find`. Must be non-`NULL`.

**Returns** `NULL` if no partition was found, valid `esp_partition_iterator_t` otherwise.

`void esp_partition_iterator_release` (`esp_partition_iterator_t` iterator)

Release partition iterator.

**Parameters** **iterator** –Iterator obtained using `esp_partition_find`. The iterator is allowed to be `NULL`, so it is not necessary to check its value before calling this function.

`const esp_partition_t *esp_partition_verify` (`const esp_partition_t *partition`)

Verify partition data.

Given a pointer to partition data, verify this partition exists in the partition table (all fields match.)



This function is also useful to take partition data which may be in a RAM buffer and convert it to a pointer to the permanent partition data stored in flash.

Pointers returned from this function can be compared directly to the address of any pointer returned from *esp\_partition\_get()*, as a test for equality.

**Parameters** **partition** –Pointer to partition data to verify. Must be non-NULL. All fields of this structure must match the partition table entry in flash for this function to return a successful match.

**Returns**

- If partition not found, returns NULL.
- If found, returns a pointer to the *esp\_partition\_t* structure in flash. This pointer is always valid for the lifetime of the application.

*esp\_err\_t* **esp\_partition\_read** (const *esp\_partition\_t* \*partition, size\_t src\_offset, void \*dst, size\_t size)

Read data from the partition.

Partitions marked with an encryption flag will automatically be read and decrypted via a cache mapping.

**Parameters**

- **partition** –Pointer to partition structure obtained using *esp\_partition\_find\_first* or *esp\_partition\_get*. Must be non-NULL.
- **dst** –Pointer to the buffer where data should be stored. Pointer must be non-NULL and buffer must be at least ‘size’ bytes long.
- **src\_offset** –Address of the data to be read, relative to the beginning of the partition.
- **size** –Size of data to be read, in bytes.

**Returns** ESP\_OK, if data was read successfully; ESP\_ERR\_INVALID\_ARG, if *src\_offset* exceeds partition size; ESP\_ERR\_INVALID\_SIZE, if read would go out of bounds of the partition; or one of error codes from lower-level flash driver.

*esp\_err\_t* **esp\_partition\_write** (const *esp\_partition\_t* \*partition, size\_t dst\_offset, const void \*src, size\_t size)

Write data to the partition.

Before writing data to flash, corresponding region of flash needs to be erased. This can be done using *esp\_partition\_erase\_range* function.

Partitions marked with an encryption flag will automatically be written via the *esp\_flash\_write\_encrypted()* function. If writing to an encrypted partition, all write offsets and lengths must be multiples of 16 bytes. See the *esp\_flash\_write\_encrypted()* function for more details. Unencrypted partitions do not have this restriction.

---

**Note:** Prior to writing to flash memory, make sure it has been erased with *esp\_partition\_erase\_range* call.

---

**Parameters**

- **partition** –Pointer to partition structure obtained using *esp\_partition\_find\_first* or *esp\_partition\_get*. Must be non-NULL.
- **dst\_offset** –Address where the data should be written, relative to the beginning of the partition.
- **src** –Pointer to the source buffer. Pointer must be non-NULL and buffer must be at least ‘size’ bytes long.
- **size** –Size of data to be written, in bytes.

**Returns** ESP\_OK, if data was written successfully; ESP\_ERR\_INVALID\_ARG, if *dst\_offset* exceeds partition size; ESP\_ERR\_INVALID\_SIZE, if write would go out of bounds of the partition; or one of error codes from lower-level flash driver.

*esp\_err\_t* **esp\_partition\_read\_raw** (const *esp\_partition\_t* \*partition, size\_t src\_offset, void \*dst, size\_t size)

Read data from the partition without any transformation/decryption.

---

**Note:** This function is essentially the same as `esp_partition_read()` above. It just never decrypts data but returns it as is.

---

#### Parameters

- **partition** –Pointer to partition structure obtained using `esp_partition_find_first` or `esp_partition_get`. Must be non-NULL.
- **dst** –Pointer to the buffer where data should be stored. Pointer must be non-NULL and buffer must be at least ‘size’ bytes long.
- **src\_offset** –Address of the data to be read, relative to the beginning of the partition.
- **size** –Size of data to be read, in bytes.

**Returns** ESP\_OK, if data was read successfully; ESP\_ERR\_INVALID\_ARG, if `src_offset` exceeds partition size; ESP\_ERR\_INVALID\_SIZE, if read would go out of bounds of the partition; or one of error codes from lower-level flash driver.

*esp\_err\_t* **esp\_partition\_write\_raw** (const *esp\_partition\_t* \*partition, size\_t dst\_offset, const void \*src, size\_t size)

Write data to the partition without any transformation/encryption.

Before writing data to flash, corresponding region of flash needs to be erased. This can be done using `esp_partition_erase_range` function.

---

**Note:** This function is essentially the same as `esp_partition_write()` above. It just never encrypts data but writes it as is.

---

---

**Note:** Prior to writing to flash memory, make sure it has been erased with `esp_partition_erase_range` call.

---

#### Parameters

- **partition** –Pointer to partition structure obtained using `esp_partition_find_first` or `esp_partition_get`. Must be non-NULL.
- **dst\_offset** –Address where the data should be written, relative to the beginning of the partition.
- **src** –Pointer to the source buffer. Pointer must be non-NULL and buffer must be at least ‘size’ bytes long.
- **size** –Size of data to be written, in bytes.

**Returns** ESP\_OK, if data was written successfully; ESP\_ERR\_INVALID\_ARG, if `dst_offset` exceeds partition size; ESP\_ERR\_INVALID\_SIZE, if write would go out of bounds of the partition; or one of the error codes from lower-level flash driver.

*esp\_err\_t* **esp\_partition\_erase\_range** (const *esp\_partition\_t* \*partition, size\_t offset, size\_t size)

Erase part of the partition.

#### Parameters

- **partition** –Pointer to partition structure obtained using `esp_partition_find_first` or `esp_partition_get`. Must be non-NULL.
- **offset** –Offset from the beginning of partition where erase operation should start. Must be aligned to `partition->erase_size`.
- **size** –Size of the range which should be erased, in bytes. Must be divisible by `partition->erase_size`.

**Returns** ESP\_OK, if the range was erased successfully; ESP\_ERR\_INVALID\_ARG, if iterator or `dst` are NULL; ESP\_ERR\_INVALID\_SIZE, if erase would go out of bounds of the partition; or one of error codes from lower-level flash driver.

*esp\_err\_t* **esp\_partition\_mmap** (const *esp\_partition\_t* \*partition, size\_t offset, size\_t size, *esp\_partition\_mmap\_memory\_t* memory, const void \*\*out\_ptr, *esp\_partition\_mmap\_handle\_t* \*out\_handle)

Configure MMU to map partition into data memory.

Unlike `spi_flash_mmap` function, which requires a 64kB aligned base address, this function doesn't impose such a requirement. If offset results in a flash address which is not aligned to 64kB boundary, address will be rounded to the lower 64kB boundary, so that mapped region includes requested range. Pointer returned via `out_ptr` argument will be adjusted to point to the requested offset (not necessarily to the beginning of mmap-ed region).

To release mapped memory, pass handle returned via `out_handle` argument to `esp_partition_munmap` function.

#### Parameters

- **partition** –Pointer to partition structure obtained using `esp_partition_find_first` or `esp_partition_get`. Must be non-NULL.
- **offset** –Offset from the beginning of partition where mapping should start.
- **size** –Size of the area to be mapped.
- **memory** –Memory space where the region should be mapped
- **out\_ptr** –Output, pointer to the mapped memory region
- **out\_handle** –Output, handle which should be used for `esp_partition_munmap` call

**Returns** ESP\_OK, if successful

void **esp\_partition\_munmap** (*esp\_partition\_mmap\_handle\_t* handle)

Release region previously obtained using `esp_partition_mmap`.

---

**Note:** Calling this function will not necessarily unmap memory region. Region will only be unmapped when there are no other handles which reference this region. In case of partially overlapping regions it is possible that memory will be unmapped partially.

---

**Parameters** **handle** –Handle obtained from `spi_flash_mmap`

*esp\_err\_t* **esp\_partition\_get\_sha256** (const *esp\_partition\_t* \*partition, uint8\_t \*sha\_256)

Get SHA-256 digest for required partition.

For apps with SHA-256 appended to the app image, the result is the appended SHA-256 value for the app image content. The hash is verified before returning, if app content is invalid then the function returns ESP\_ERR\_IMAGE\_INVALID. For apps without SHA-256 appended to the image, the result is the SHA-256 of all bytes in the app image. For other partition types, the result is the SHA-256 of the entire partition.

#### Parameters

- **partition** –[in] Pointer to info for partition containing app or data. (fields: address, size and type, are required to be filled).
- **sha\_256** –[out] Returned SHA-256 digest for a given partition.

#### Returns

- ESP\_OK: In case of successful operation.
- ESP\_ERR\_INVALID\_ARG: The size was 0 or the sha\_256 was NULL.
- ESP\_ERR\_NO\_MEM: Cannot allocate memory for sha256 operation.
- ESP\_ERR\_IMAGE\_INVALID: App partition doesn't contain a valid app image.
- ESP\_FAIL: An allocation error occurred.

bool **esp\_partition\_check\_identity** (const *esp\_partition\_t* \*partition\_1, const *esp\_partition\_t* \*partition\_2)

Check for the identity of two partitions by SHA-256 digest.

#### Parameters

- **partition\_1** –[in] Pointer to info for partition 1 containing app or data. (fields: address, size and type, are required to be filled).
- **partition\_2** –[in] Pointer to info for partition 2 containing app or data. (fields: address, size and type, are required to be filled).

**Returns**

- True: In case of the two firmware is equal.
- False: Otherwise

*esp\_err\_t* **esp\_partition\_register\_external** (*esp\_flash\_t* \*flash\_chip, size\_t offset, size\_t size, const char \*label, *esp\_partition\_type\_t* type, *esp\_partition\_subtype\_t* subtype, const *esp\_partition\_t* \*\*out\_partition)

Register a partition on an external flash chip.

This API allows designating certain areas of external flash chips (identified by the *esp\_flash\_t* structure) as partitions. This allows using them with components which access SPI flash through the *esp\_partition* API.

**Parameters**

- **flash\_chip** –Pointer to the structure identifying the flash chip
- **offset** –Address in bytes, where the partition starts
- **size** –Size of the partition in bytes
- **label** –Partition name
- **type** –One of the partition types (ESP\_PARTITION\_TYPE\_\*), or an integer. Note that applications can not be booted from external flash chips, so using ESP\_PARTITION\_TYPE\_APP is not supported.
- **subtype** –One of the partition subtypes (ESP\_PARTITION\_SUBTYPE\_\*), or an integer.
- **out\_partition** –[out] Output, if non-NULL, receives the pointer to the resulting *esp\_partition\_t* structure

**Returns**

- ESP\_OK on success
- ESP\_ERR\_NO\_MEM if memory allocation has failed
- ESP\_ERR\_INVALID\_ARG if the new partition overlaps another partition on the same flash chip
- ESP\_ERR\_INVALID\_SIZE if the partition doesn't fit into the flash chip size

*esp\_err\_t* **esp\_partition\_deregister\_external** (const *esp\_partition\_t* \*partition)

Deregister the partition previously registered using *esp\_partition\_register\_external*.

**Parameters** **partition** –pointer to the partition structure obtained from *esp\_partition\_register\_external*,

**Returns**

- ESP\_OK on success
- ESP\_ERR\_NOT\_FOUND if the partition pointer is not found
- ESP\_ERR\_INVALID\_ARG if the partition comes from the partition table
- ESP\_ERR\_INVALID\_ARG if the partition was not registered using *esp\_partition\_register\_external* function.

**Structures**

struct **esp\_partition\_t**

partition information structure

This is not the format in flash, that format is *esp\_partition\_info\_t*.

However, this is the format used by this API.

**Public Members**

*esp\_flash\_t* \***flash\_chip**

SPI flash chip on which the partition resides

***esp\_partition\_type\_t* type**

partition type (app/data)

***esp\_partition\_subtype\_t* subtype**

partition subtype

**uint32\_t address**

starting address of the partition in flash

**uint32\_t size**

size of the partition, in bytes

**uint32\_t erase\_size**

size the erase operation should be aligned to

**char label[17]**

partition label, zero-terminated ASCII string

**bool encrypted**

flag is set to true if partition is encrypted

**Macros****ESP\_PARTITION\_SUBTYPE\_OTA** (i)Convenience macro to get `esp_partition_subtype_t` value for the *i*-th OTA partition.**Type Definitions**typedef uint32\_t **esp\_partition\_mmap\_handle\_t**Opaque handle for memory region obtained from `esp_partition_mmap`.typedef struct esp\_partition\_iterator\_opaque\_ \***esp\_partition\_iterator\_t**

Opaque partition iterator type.

**Enumerations**enum **esp\_partition\_mmap\_memory\_t**Enumeration which specifies memory space requested in an `mmap` call.*Values:*enumerator **ESP\_PARTITION\_MMAP\_DATA**

map to data memory (Vaddr0), allows byte-aligned access, 4 MB total

enumerator **ESP\_PARTITION\_MMAP\_INST**

map to instruction memory (Vaddr1-3), allows only 4-byte-aligned access, 11 MB total

enum **esp\_partition\_type\_t**

Partition type.

---

**Note:** Partition types with integer value 0x00-0x3F are reserved for partition types defined by ESP-IDF. Any other integer value 0x40-0xFE can be used by individual applications, without restriction.

---

*Values:*

enumerator **ESP\_PARTITION\_TYPE\_APP**

Application partition type.

enumerator **ESP\_PARTITION\_TYPE\_DATA**

Data partition type.

enumerator **ESP\_PARTITION\_TYPE\_ANY**

Used to search for partitions with any type.

enum **esp\_partition\_subtype\_t**

Partition subtype.

Application-defined partition types (0x40-0xFE) can set any numeric subtype value.

---

**Note:** These ESP-IDF-defined partition subtypes apply to partitions of type **ESP\_PARTITION\_TYPE\_APP** and **ESP\_PARTITION\_TYPE\_DATA**.

---

*Values:*

enumerator **ESP\_PARTITION\_SUBTYPE\_APP\_FACTORY**

Factory application partition.

enumerator **ESP\_PARTITION\_SUBTYPE\_APP\_OTA\_MIN**

Base for OTA partition subtypes.

enumerator **ESP\_PARTITION\_SUBTYPE\_APP\_OTA\_0**

OTA partition 0.

enumerator **ESP\_PARTITION\_SUBTYPE\_APP\_OTA\_1**

OTA partition 1.

enumerator **ESP\_PARTITION\_SUBTYPE\_APP\_OTA\_2**

OTA partition 2.

enumerator **ESP\_PARTITION\_SUBTYPE\_APP\_OTA\_3**

OTA partition 3.

enumerator **ESP\_PARTITION\_SUBTYPE\_APP\_OTA\_4**

OTA partition 4.

enumerator **ESP\_PARTITION\_SUBTYPE\_APP\_OTA\_5**

OTA partition 5.

enumerator **ESP\_PARTITION\_SUBTYPE\_APP\_OTA\_6**

OTA partition 6.

enumerator **ESP\_PARTITION\_SUBTYPE\_APP\_OTA\_7**

OTA partition 7.

enumerator **ESP\_PARTITION\_SUBTYPE\_APP\_OTA\_8**

OTA partition 8.

enumerator **ESP\_PARTITION\_SUBTYPE\_APP\_OTA\_9**

OTA partition 9.

enumerator **ESP\_PARTITION\_SUBTYPE\_APP\_OTA\_10**

OTA partition 10.

enumerator **ESP\_PARTITION\_SUBTYPE\_APP\_OTA\_11**

OTA partition 11.

enumerator **ESP\_PARTITION\_SUBTYPE\_APP\_OTA\_12**

OTA partition 12.

enumerator **ESP\_PARTITION\_SUBTYPE\_APP\_OTA\_13**

OTA partition 13.

enumerator **ESP\_PARTITION\_SUBTYPE\_APP\_OTA\_14**

OTA partition 14.

enumerator **ESP\_PARTITION\_SUBTYPE\_APP\_OTA\_15**

OTA partition 15.

enumerator **ESP\_PARTITION\_SUBTYPE\_APP\_OTA\_MAX**

Max subtype of OTA partition.

enumerator **ESP\_PARTITION\_SUBTYPE\_APP\_TEST**

Test application partition.

enumerator **ESP\_PARTITION\_SUBTYPE\_DATA\_OTA**

OTA selection partition.

enumerator **ESP\_PARTITION\_SUBTYPE\_DATA\_PHY**

PHY init data partition.

enumerator **ESP\_PARTITION\_SUBTYPE\_DATA\_NVS**

NVS partition.

enumerator **ESP\_PARTITION\_SUBTYPE\_DATA\_COREDUMP**

COREDUMP partition.

enumerator **ESP\_PARTITION\_SUBTYPE\_DATA\_NVS\_KEYS**

Partition for NVS keys.

enumerator **ESP\_PARTITION\_SUBTYPE\_DATA\_EFUSE\_EM**

Partition for emulate eFuse bits.

enumerator **ESP\_PARTITION\_SUBTYPE\_DATA\_UNDEFINED**

Undefined (or unspecified) data partition.

enumerator **ESP\_PARTITION\_SUBTYPE\_DATA\_ESPHTTPD**

ESPHTTPD partition.

enumerator **ESP\_PARTITION\_SUBTYPE\_DATA\_FAT**

FAT partition.

enumerator **ESP\_PARTITION\_SUBTYPE\_DATA\_SPIFFS**

SPIFFS partition.

enumerator **ESP\_PARTITION\_SUBTYPE\_DATA\_LITTLEFS**

LITTLEFS partition.

enumerator **ESP\_PARTITION\_SUBTYPE\_ANY**

Used to search for partitions with any subtype.

## API Reference - Flash Encrypt

### Header File

- [components/bootloader\\_support/include/esp\\_flash\\_encrypt.h](#)

### Functions

bool **esp\_flash\_encryption\_enabled** (void)

Is flash encryption currently enabled in hardware?

Flash encryption is enabled if the FLASH\_CRYPT\_CNT efuse has an odd number of bits set.

**Returns** true if flash encryption is enabled.

*esp\_err\_t* **esp\_flash\_encrypt\_check\_and\_update** (void)

bool **esp\_flash\_encrypt\_state** (void)

Returns the Flash Encryption state and prints it.

**Returns** True - Flash Encryption is enabled False - Flash Encryption is not enabled

bool **esp\_flash\_encrypt\_initialized\_once** (void)

Checks if the first initialization was done.

If the first initialization was done then FLASH\_CRYPT\_CNT != 0

**Returns** true - the first initialization was done false - the first initialization was NOT done

*esp\_err\_t* **esp\_flash\_encrypt\_init** (void)

The first initialization of Flash Encryption key and related eFuses.

**Returns** ESP\_OK if all operations succeeded



*esp\_err\_t* **esp\_flash\_encrypt\_contents** (void)

Encrypts flash content.

**Returns** ESP\_OK if all operations succeeded

*esp\_err\_t* **esp\_flash\_encrypt\_enable** (void)

Activates Flash encryption on the chip.

It burns FLASH\_CRYPT\_CNT eFuse based on the CONFIG\_SECURE\_FLASH\_ENCRYPTION\_MODE\_RELEASE option.

**Returns** ESP\_OK if all operations succeeded

bool **esp\_flash\_encrypt\_is\_write\_protected** (bool print\_error)

Returns True if the write protection of FLASH\_CRYPT\_CNT is set.

**Parameters** *print\_error* –Print error if it is write protected

**Returns** true - if FLASH\_CRYPT\_CNT is write protected

*esp\_err\_t* **esp\_flash\_encrypt\_region** (uint32\_t src\_addr, size\_t data\_length)

Encrypt-in-place a block of flash sectors.

---

**Note:** This function resets RTC\_WDT between operations with sectors.

---

#### Parameters

- **src\_addr** –Source offset in flash. Should be multiple of 4096 bytes.
- **data\_length** –Length of data to encrypt in bytes. Will be rounded up to next multiple of 4096 bytes.

**Returns** ESP\_OK if all operations succeeded, ESP\_ERR\_FLASH\_OP\_FAIL if SPI flash fails, ESP\_ERR\_FLASH\_OP\_TIMEOUT if flash times out.

void **esp\_flash\_write\_protect\_crypt\_cnt** (void)

Write protect FLASH\_CRYPT\_CNT.

Intended to be called as a part of boot process if flash encryption is enabled but secure boot is not used. This should protect against serial re-flashing of an unauthorised code in absence of secure boot.

---

**Note:** On ESP32 V3 only, write protecting FLASH\_CRYPT\_CNT will also prevent disabling UART Download Mode. If both are wanted, call `esp_efuse_disable_rom_download_mode()` before calling this function.

---

*esp\_flash\_enc\_mode\_t* **esp\_get\_flash\_encryption\_mode** (void)

Return the flash encryption mode.

The API is called during boot process but can also be called by application to check the current flash encryption mode of ESP32

#### Returns

void **esp\_flash\_encryption\_init\_checks** (void)

Check the flash encryption mode during startup.

Verifies the flash encryption config during startup:

- Correct any insecure flash encryption settings if hardware Secure Boot is enabled.
- Log warnings if the efuse config doesn't match the project config in any way

---

**Note:** This function is called automatically during app startup, it doesn't need to be called from the app.

---

`esp_err_t esp_flash_encryption_enable_secure_features` (void)

Set all secure eFuse features related to flash encryption.

**Returns**

- ESP\_OK - Successfully

bool `esp_flash_encryption_cfg_verify_release_mode` (void)

Returns the verification status for all physical security features of flash encryption in release mode.

If the device has flash encryption feature configured in the release mode, then it is highly recommended to call this API in the application startup code. This API verifies the sanity of the eFuse configuration against the release (production) mode of the flash encryption feature.

**Returns**

- True - all eFuses are configured correctly
- False - not all eFuses are configured correctly.

void `esp_flash_encryption_set_release_mode` (void)

Switches Flash Encryption from “Development” to “Release” .

If already in “Release” mode, the function will do nothing. If flash encryption efuse is not enabled yet then abort. It burns:

- ” disable encrypt in dl mode”
- set FLASH\_CRYPT\_CNT efuse to max

## Enumerations

enum `esp_flash_enc_mode_t`

*Values:*

enumerator `ESP_FLASH_ENC_MODE_DISABLED`

enumerator `ESP_FLASH_ENC_MODE_DEVELOPMENT`

enumerator `ESP_FLASH_ENC_MODE_RELEASE`

## 2.8.7 SPIFFS Filesystem

### Overview

SPIFFS is a file system intended for SPI NOR flash devices on embedded targets. It supports wear levelling, file system consistency checks, and more.

### Notes

- Currently, SPIFFS does not support directories, it produces a flat structure. If SPIFFS is mounted under `/spiffs`, then creating a file with the path `/spiffs/tmp/myfile.txt` will create a file called `/tmp/myfile.txt` in SPIFFS, instead of `myfile.txt` in the directory `/spiffs/tmp`.
- It is not a real-time stack. One write operation might take much longer than another.
- For now, it does not detect or handle bad blocks.

- SPIFFS is able to reliably utilize only around 75% of assigned partition space.
- When the filesystem is running out of space, the garbage collector is trying to find free space by scanning the filesystem multiple times, which can take up to several seconds per write function call, depending on required space. This is caused by the SPIFFS design and the issue has been reported multiple times (e.g. [here](#)) and in the official [SPIFFS github repository](#). The issue can be partially mitigated by the [SPIFFS configuration](#).
- Deleting a file does not always remove the whole file, which leaves unusable sections throughout the filesystem.
- When the chip experiences a power loss during a file system operation it could result in SPIFFS corruption. However the file system still might be recovered via `esp_spiffs_check` function. More details in the official SPIFFS [FAQ](#).

## Tools

**spiffsgen.py** `spiffsgen.py` is a write-only Python SPIFFS implementation used to create filesystem images from the contents of a host folder. To use `spiffsgen.py`, open Terminal and run:

```
python spiffsgen.py <image_size> <base_dir> <output_file>
```

The required arguments are as follows:

- **image\_size**: size of the partition onto which the created SPIFFS image will be flashed.
- **base\_dir**: directory for which the SPIFFS image needs to be created.
- **output\_file**: SPIFFS image output file.

There are also other arguments that control image generation. Documentation on these arguments can be found in the tool's help:

```
python spiffsgen.py --help
```

These optional arguments correspond to a possible SPIFFS build configuration. To generate the right image, please make sure that you use the same arguments/configuration as were used to build SPIFFS. As a guide, the help output indicates the SPIFFS build configuration to which the argument corresponds. In cases when these arguments are not specified, the default values shown in the help output will be used.

When the image is created, it can be flashed using `esptool.py` or `parttool.py`.

Aside from invoking the `spiffsgen.py` standalone by manually running it from the command line or a script, it is also possible to invoke `spiffsgen.py` directly from the build system by calling `spiffs_create_partition_image`:

```
spiffs_create_partition_image(<partition> <base_dir> [FLASH_IN_PROJECT] [DEPENDS_
↳dep dep dep...])
```

This is more convenient as the build configuration is automatically passed to the tool, ensuring that the generated image is valid for that build. An example of this is while the `image_size` is required for the standalone invocation, only the `partition` name is required when using `spiffs_create_partition_image`—the image size is automatically obtained from the project's partition table.

`spiffs_create_partition_image` must be called from one of the component CMakeLists.txt files.

Optionally, users can opt to have the image automatically flashed together with the app binaries, partition tables, etc. on `idf.py flash` by specifying `FLASH_IN_PROJECT`. For example:

```
spiffs_create_partition_image(my_spiffs_partition my_folder FLASH_IN_PROJECT)
```

If `FLASH_IN_PROJECT/SPIFFS_IMAGE_FLASH_IN_PROJECT` is not specified, the image will still be generated, but you will have to flash it manually using `esptool.py`, `parttool.py`, or a custom build system target.

There are cases where the contents of the base directory itself is generated at build time. Users can use `DEPENDS/SPIFFS_IMAGE_DEPENDS` to specify targets that should be executed before generating the image:

```
add_custom_target(dep COMMAND ...)  
spiffs_create_partition_image(my_spiffs_partition my_folder DEPENDS dep)
```

For an example, see [storage/spiffsgen](#).

**mkspiffs** Another tool for creating SPIFFS partition images is [mkspiffs](#). Similar to `spiffsgen.py`, it can be used to create an image from a given folder and then flash that image using `esptool.py`

For that, you need to obtain the following parameters:

- **Block Size:** 4096 (standard for SPI Flash)
- **Page Size:** 256 (standard for SPI Flash)
- **Image Size:** Size of the partition in bytes (can be obtained from a partition table)
- **Partition Offset:** Starting address of the partition (can be obtained from a partition table)

To pack a folder into a 1-Megabyte image, run:

```
mkspiffs -c [src_folder] -b 4096 -p 256 -s 0x100000 spiffs.bin
```

To flash the image onto ESP32-S2 at offset 0x110000, run:

```
python esptool.py --chip esp32s2 --port [port] --baud [baud] write_flash -z  
↪0x110000 spiffs.bin
```

**Notes on which SPIFFS tool to use** The two tools presented above offer very similar functionality. However, there are reasons to prefer one over the other, depending on the use case.

Use `spiffsgen.py` in the following cases:

1. If you want to simply generate a SPIFFS image during the build. `spiffsgen.py` makes it very convenient by providing functions/commands from the build system itself.
2. If the host has no C/C++ compiler available, because `spiffsgen.py` does not require compilation.

Use `mkspiffs` in the following cases:

1. If you need to unpack SPIFFS images in addition to image generation. For now, it is not possible with `spiffsgen.py`.
2. If you have an environment where a Python interpreter is not available, but a host compiler is available. Otherwise, a pre-compiled `mkspiffs` binary can do the job. However, there is no build system integration for `mkspiffs` and the user has to do the corresponding work: compiling `mkspiffs` during build (if a pre-compiled binary is not used), creating build rules/targets for the output files, passing proper parameters to the tool, etc.

### See also

- [Partition Table documentation](#)

### Application Example

An example of using SPIFFS is provided in the [storage/spiffs](#) directory. This example initializes and mounts a SPIFFS partition, then writes and reads data from it using POSIX and C library APIs. See the `README.md` file in the example directory for more information.

## High-level API Reference

### Header File

- `components/spiffs/include/esp_spiffs.h`

### Functions

*esp\_err\_t* **esp\_vfs\_spiffs\_register** (const *esp\_vfs\_spiffs\_conf\_t* \*conf)

Register and mount SPIFFS to VFS with given path prefix.

**Parameters** *conf* –Pointer to *esp\_vfs\_spiffs\_conf\_t* configuration structure

**Returns**

- ESP\_OK if success
- ESP\_ERR\_NO\_MEM if objects could not be allocated
- ESP\_ERR\_INVALID\_STATE if already mounted or partition is encrypted
- ESP\_ERR\_NOT\_FOUND if partition for SPIFFS was not found
- ESP\_FAIL if mount or format fails

*esp\_err\_t* **esp\_vfs\_spiffs\_unregister** (const char \*partition\_label)

Unregister and unmount SPIFFS from VFS

**Parameters** *partition\_label* –Same label as passed to `esp_vfs_spiffs_register`.

**Returns**

- ESP\_OK if successful
- ESP\_ERR\_INVALID\_STATE already unregistered

bool **esp\_spiffs\_mounted** (const char \*partition\_label)

Check if SPIFFS is mounted

**Parameters** *partition\_label* –Optional, label of the partition to check. If not specified, first partition with subtype=spiffs is used.

**Returns**

- true if mounted
- false if not mounted

*esp\_err\_t* **esp\_spiffs\_format** (const char \*partition\_label)

Format the SPIFFS partition

**Parameters** *partition\_label* –Same label as passed to `esp_vfs_spiffs_register`.

**Returns**

- ESP\_OK if successful
- ESP\_FAIL on error

*esp\_err\_t* **esp\_spiffs\_info** (const char \*partition\_label, size\_t \*total\_bytes, size\_t \*used\_bytes)

Get information for SPIFFS

**Parameters**

- *partition\_label* –Same label as passed to `esp_vfs_spiffs_register`
- *total\_bytes* –[out] Size of the file system
- *used\_bytes* –[out] Current used bytes in the file system

**Returns**

- ESP\_OK if success
- ESP\_ERR\_INVALID\_STATE if not mounted

*esp\_err\_t* **esp\_spiffs\_check** (const char \*partition\_label)

Check integrity of SPIFFS

**Parameters** *partition\_label* –Same label as passed to `esp_vfs_spiffs_register`

**Returns**

- ESP\_OK if successful
- ESP\_ERR\_INVALID\_STATE if not mounted
- ESP\_FAIL on error

*esp\_err\_t* **esp\_spiffs\_gc** (const char \*partition\_label, size\_t size\_to\_gc)

Perform garbage collection in SPIFFS partition.

Call this function to run GC and ensure that at least the given amount of space is available in the partition. This function will fail with `ESP_ERR_NOT_FINISHED` if it is not possible to reclaim the requested space (that is, not enough free or deleted pages in the filesystem). This function will also fail if it fails to reclaim the requested space after `CONFIG_SPIFFS_GC_MAX_RUNS` number of GC iterations. On one GC iteration, SPIFFS will erase one logical block (4kB). Therefore the value of `CONFIG_SPIFFS_GC_MAX_RUNS` should be set at least to the maximum expected `size_to_gc`, divided by 4096. For example, if the application expects to make room for a 1MB file and calls `esp_spiffs_gc(label, 1024 * 1024)`, `CONFIG_SPIFFS_GC_MAX_RUNS` should be set to at least 256. On the other hand, increasing `CONFIG_SPIFFS_GC_MAX_RUNS` value increases the maximum amount of time for which any SPIFFS GC or write operation may potentially block.

#### Parameters

- **partition\_label** –Label of the partition to be garbage-collected. The partition must be already mounted.
- **size\_to\_gc** –The number of bytes that the GC process should attempt to make available.

#### Returns

- `ESP_OK` on success
- `ESP_ERR_NOT_FINISHED` if GC fails to reclaim the size given by `size_to_gc`
- `ESP_ERR_INVALID_STATE` if the partition is not mounted
- `ESP_FAIL` on all other errors

## Structures

struct **esp\_vfs\_spiffs\_conf\_t**

Configuration structure for `esp_vfs_spiffs_register`.

#### Public Members

const char \***base\_path**

File path prefix associated with the filesystem.

const char \***partition\_label**

Optional, label of SPIFFS partition to use. If set to `NULL`, first partition with subtype=`spiffs` will be used.

size\_t **max\_files**

Maximum files that could be open at the same time.

bool **format\_if\_mount\_failed**

If true, it will format the file system if it fails to mount.

## 2.8.8 Virtual filesystem component

### Overview

Virtual filesystem (VFS) component provides a unified interface for drivers which can perform operations on file-like objects. These can be real filesystems (FAT, SPIFFS, etc.) or device drivers which provide a file-like interface.

This component allows C library functions, such as `fopen` and `fprintf`, to work with FS drivers. At a high level, each FS driver is associated with some path prefix. When one of C library functions needs to open a file, the VFS component searches for the FS driver associated with the file path and forwards the call to that driver. VFS also forwards read, write, and other calls for the given file to the same FS driver.

For example, one can register a FAT filesystem driver with the `/fat` prefix and call `fopen("/fat/file.txt", "w")`. The VFS component will then call the function `open` of the FAT driver and pass the argument `/file.txt` to it together with appropriate mode flags. All subsequent calls to C library functions for the returned `FILE*` stream will also be forwarded to the FAT driver.

### FS registration

To register an FS driver, an application needs to define an instance of the `esp_vfs_t` structure and populate it with function pointers to FS APIs:

```
esp_vfs_t myfs = {
    .flags = ESP_VFS_FLAG_DEFAULT,
    .write = &myfs_write,
    .open = &myfs_open,
    .fstat = &myfs_fstat,
    .close = &myfs_close,
    .read = &myfs_read,
};

ESP_ERROR_CHECK(esp_vfs_register("/data", &myfs, NULL));
```

Depending on the way how the FS driver declares its API functions, either `read`, `write`, etc., or `read_p`, `write_p`, etc., should be used.

Case 1: API functions are declared without an extra context pointer (the FS driver is a singleton):

```
ssize_t myfs_write(int fd, const void * data, size_t size);

// In definition of esp_vfs_t:
    .flags = ESP_VFS_FLAG_DEFAULT,
    .write = &myfs_write,
// ... other members initialized

// When registering FS, context pointer (third argument) is NULL:
ESP_ERROR_CHECK(esp_vfs_register("/data", &myfs, NULL));
```

Case 2: API functions are declared with an extra context pointer (the FS driver supports multiple instances):

```
ssize_t myfs_write(myfs_t* fs, int fd, const void * data, size_t size);

// In definition of esp_vfs_t:
    .flags = ESP_VFS_FLAG_CONTEXT_PTR,
    .write_p = &myfs_write,
// ... other members initialized

// When registering FS, pass the FS context pointer into the third argument
// (hypothetical myfs_mount function is used for illustrative purposes)
myfs_t* myfs_inst1 = myfs_mount(partition1->offset, partition1->size);
ESP_ERROR_CHECK(esp_vfs_register("/data1", &myfs, myfs_inst1));

// Can register another instance:
myfs_t* myfs_inst2 = myfs_mount(partition2->offset, partition2->size);
ESP_ERROR_CHECK(esp_vfs_register("/data2", &myfs, myfs_inst2));
```

**Synchronous input/output multiplexing** Synchronous input/output multiplexing by `select()` is supported in the VFS component. The implementation works in the following way.

1. `select()` is called with file descriptors which could belong to various VFS drivers.
2. The file descriptors are divided into groups each belonging to one VFS driver.
3. The file descriptors belonging to non-socket VFS drivers are handed over to the given VFS drivers by `start_select()`, described later on this page. This function represents the driver-specific implementation of `select()` for the given driver. This should be a non-blocking call which means the function should immediately return after setting up the environment for checking events related to the given file descriptors.
4. The file descriptors belonging to the socket VFS driver are handed over to the socket driver by `socket_select()` described later on this page. This is a blocking call which means that it will return only if there is an event related to socket file descriptors or a non-socket driver signals `socket_select()` to exit.
5. Results are collected from each VFS driver and all drivers are stopped by de-initialization of the environment for checking events.
6. The `select()` call ends and returns the appropriate results.

**Non-socket VFS drivers** If you want to use `select()` with a file descriptor belonging to a non-socket VFS driver, then you need to register the driver with functions `start_select()` and `end_select()` similarly to the following example:

```
// In definition of esp_vfs_t:  
    .start_select = &uart_start_select,  
    .end_select = &uart_end_select,  
// ... other members initialized
```

`start_select()` is called for setting up the environment for detection of read/write/error conditions on file descriptors belonging to the given VFS driver.

`end_select()` is called to stop/deinitialize/free the environment which was setup by `start_select()`.

---

**Note:** `end_select()` might be called without a previous `start_select()` call in some rare circumstances. `end_select()` should fail gracefully if this is the case (i.e., should not crash but return an error instead).

---

Please refer to the reference implementation for the UART peripheral in [vfs/vfs\\_uart.c](#) and most particularly to the functions `esp_vfs_dev_uart_register()`, `uart_start_select()`, and `uart_end_select()` for more information.

Please check the following examples that demonstrate the use of `select()` with VFS file descriptors:

- [peripherals/uart/uart\\_select](#)
- [system/select](#)

**Socket VFS drivers** A socket VFS driver is using its own internal implementation of `select()` and non-socket VFS drivers notify it upon read/write/error conditions.

A socket VFS driver needs to be registered with the following functions defined:

```
// In definition of esp_vfs_t:  
    .socket_select = &lwip_select,  
    .get_socket_select_semaphore = &lwip_get_socket_select_semaphore,  
    .stop_socket_select = &lwip_stop_socket_select,  
    .stop_socket_select_isr = &lwip_stop_socket_select_isr,  
// ... other members initialized
```

`socket_select()` is the internal implementation of `select()` for the socket driver. It works only with file descriptors belonging to the socket VFS.

`get_socket_select_semaphore()` returns the signalization object (semaphore) which will be used in non-socket drivers to stop the waiting in `socket_select()`.

`stop_socket_select()` call is used to stop the waiting in `socket_select()` by passing the object returned by `get_socket_select_semaphore()`.



`stop_socket_select_isr()` has the same functionality as `stop_socket_select()` but it can be used from ISR.

Please see [lwip/port/esp32/vfs\\_lwip.c](#) for a reference socket driver implementation using LWIP.

---

**Note:** If you use `select()` for socket file descriptors only then you can disable the `CONFIG_VFS_SUPPORT_SELECT` option to reduce the code size and improve performance. You should not change the socket driver during an active `select()` call or you might experience some undefined behavior.

---

## Paths

Each registered FS has a path prefix associated with it. This prefix can be considered as a “mount point” of this partition.

In case when mount points are nested, the mount point with the longest matching path prefix is used when opening the file. For instance, suppose that the following filesystems are registered in VFS:

- FS 1 on /data
- FS 2 on /data/static

Then:

- FS 1 will be used when opening a file called `/data/log.txt`
- FS 2 will be used when opening a file called `/data/static/index.html`
- Even if `/index.html` does not exist in FS 2, FS 1 will *not* be searched for `/static/index.html`.

As a general rule, mount point names must start with the path separator (`/`) and must contain at least one character after path separator. However, an empty mount point name is also supported and might be used in cases when an application needs to provide a “fallback” filesystem or to override VFS functionality altogether. Such filesystem will be used if no prefix matches the path given.

VFS does not handle dots (`.`) in path names in any special way. VFS does not treat `..` as a reference to the parent directory. In the above example, using a path `/data/static/../log.txt` will not result in a call to FS 1 to open `/log.txt`. Specific FS drivers (such as FATFS) might handle dots in file names differently.

When opening files, the FS driver receives only relative paths to files. For example:

1. The `myfs` driver is registered with `/data` as a path prefix.
2. The application calls `fopen("/data/config.json", ...)`.
3. The VFS component calls `myfs_open("/config.json", ...)`.
4. The `myfs` driver opens the `/config.json` file.

VFS does not impose any limit on total file path length, but it does limit the FS path prefix to `ESP_VFS_PATH_MAX` characters. Individual FS drivers may have their own filename length limitations.

## File descriptors

File descriptors are small positive integers from 0 to `FD_SETSIZE - 1`, where `FD_SETSIZE` is defined in `newlib's sys/types.h`. The largest file descriptors (configured by `CONFIG_LWIP_MAX_SOCKETS`) are reserved for sockets. The VFS component contains a lookup-table called `s_fd_table` for mapping global file descriptors to VFS driver indexes registered in the `s_vfs` array.

## Standard IO streams (stdin, stdout, stderr)

If the menuconfig option `UART` for console output is not set to `None`, then `stdin`, `stdout`, and `stderr` are configured to read from, and write to, a UART. It is possible to use `UART0` or `UART1` for standard IO. By default, `UART0` is used with 115200 baud rate; TX pin is `GPIO1`; RX pin is `GPIO3`. These parameters can be changed in menuconfig.

Writing to `stdout` or `stderr` will send characters to the UART transmit FIFO. Reading from `stdin` will retrieve characters from the UART receive FIFO.

By default, VFS uses simple functions for reading from and writing to UART. Writes busy-wait until all data is put into UART FIFO, and reads are non-blocking, returning only the data present in the FIFO. Due to this non-blocking read behavior, higher level C library calls, such as `fscanf("%d\n", &var);`, might not have desired results.

Applications which use the UART driver can instruct VFS to use the driver's interrupt driven, blocking read and write functions instead. This can be done using a call to the `esp_vfs_dev_uart_use_driver` function. It is also possible to revert to the basic non-blocking functions using a call to `esp_vfs_dev_uart_use_nonblocking`.

VFS also provides an optional newline conversion feature for input and output. Internally, most applications send and receive lines terminated by the LF ( ' ' n ' ' ) character. Different terminal programs may require different line termination, such as CR or CRLF. Applications can configure this separately for input and output either via `menuconfig`, or by calls to the functions `esp_vfs_dev_uart_port_set_rx_line_endings` and `esp_vfs_dev_uart_port_set_tx_line_endings`.

**Standard streams and FreeRTOS tasks** FILE objects for `stdin`, `stdout`, and `stderr` are shared between all FreeRTOS tasks, but the pointers to these objects are stored in per-task `struct _reent`.

The following code is transferred to `fprintf(__getreent()->_stderr, "42\n");` by the preprocessor:

```
fprintf(stderr, "42\n");
```

The `__getreent()` function returns a per-task pointer to `struct _reent` in `newlib` libc. This structure is allocated on the TCB of each task. When a task is initialized, `_stdin`, `_stdout`, and `_stderr` members of `struct _reent` are set to the values of `_stdin`, `_stdout`, and `_stderr` of `_GLOBAL_REENT` (i.e., the structure which is used before FreeRTOS is started).

Such a design has the following consequences:

- It is possible to set `stdin`, `stdout`, and `stderr` for any given task without affecting other tasks, e.g., by doing `stdin = fopen("/dev/uart/1", "r")`.
- Closing default `stdin`, `stdout`, or `stderr` using `fclose` will close the FILE stream object, which will affect all other tasks.
- To change the default `stdin`, `stdout`, `stderr` streams for new tasks, modify `_GLOBAL_REENT->_stdin(_stdout,_stderr)` before creating the task.

## Event fds

`eventfd()` call is a powerful tool to notify a `select()` based loop of custom events. The `eventfd()` implementation in ESP-IDF is generally the same as described in [man\(2\) eventfd](#) except for:

- `esp_vfs_eventfd_register()` has to be called before calling `eventfd()`
- Options `EFD_CLOEXEC`, `EFD_NONBLOCK` and `EFD_SEMAPHORE` are not supported in flags.
- Option `EFD_SUPPORT_ISR` has been added in flags. This flag is required to read and write the `eventfd` in an interrupt handler.

Note that creating an `eventfd` with `EFD_SUPPORT_ISR` will cause interrupts to be temporarily disabled when reading, writing the file and during the beginning and the ending of the `select()` when this file is set.

## API Reference

### Header File

- `components/vfs/include/esp_vfs.h`

## Functions

`ssize_t esp_vfs_write` (struct `_reent` \*r, int fd, const void \*data, size\_t size)

These functions are to be used in newlib syscall table. They will be called by newlib when it needs to use any of the syscalls.

`off_t esp_vfs_lseek` (struct `_reent` \*r, int fd, off\_t size, int mode)

`ssize_t esp_vfs_read` (struct `_reent` \*r, int fd, void \*dst, size\_t size)

`int esp_vfs_open` (struct `_reent` \*r, const char \*path, int flags, int mode)

`int esp_vfs_close` (struct `_reent` \*r, int fd)

`int esp_vfs_fstat` (struct `_reent` \*r, int fd, struct stat \*st)

`int esp_vfs_stat` (struct `_reent` \*r, const char \*path, struct stat \*st)

`int esp_vfs_link` (struct `_reent` \*r, const char \*n1, const char \*n2)

`int esp_vfs_unlink` (struct `_reent` \*r, const char \*path)

`int esp_vfs_rename` (struct `_reent` \*r, const char \*src, const char \*dst)

`int esp_vfs_utime` (const char \*path, const struct utimbuf \*times)

`esp_err_t esp_vfs_register` (const char \*base\_path, const `esp_vfs_t` \*vfs, void \*ctx)

Register a virtual filesystem for given path prefix.

### Parameters

- **base\_path** –file path prefix associated with the filesystem. Must be a zero-terminated C string, may be empty. If not empty, must be up to `ESP_VFS_PATH_MAX` characters long, and at least 2 characters long. Name must start with a “/” and must not end with “/”. For example, “/data” or “/dev/spi” are valid. These VFSes would then be called to handle file paths such as “/data/myfile.txt” or “/dev/spi/0”. In the special case of an empty `base_path`, a “fallback” VFS is registered. Such VFS will handle paths which are not matched by any other registered VFS.
- **vfs** –Pointer to `esp_vfs_t`, a structure which maps syscalls to the filesystem driver functions. VFS component doesn't assume ownership of this pointer.
- **ctx** –If `vfs->flags` has `ESP_VFS_FLAG_CONTEXT_PTR` set, a pointer which should be passed to VFS functions. Otherwise, `NULL`.

**Returns** `ESP_OK` if successful, `ESP_ERR_NO_MEM` if too many VFSes are registered.

`esp_err_t esp_vfs_register_fd_range` (const `esp_vfs_t` \*vfs, void \*ctx, int min\_fd, int max\_fd)

Special case function for registering a VFS that uses a method other than `open()` to open new file descriptors from the interval `<min_fd; max_fd)`.

This is a special-purpose function intended for registering LWIP sockets to VFS.

### Parameters

- **vfs** –Pointer to `esp_vfs_t`. Meaning is the same as for `esp_vfs_register()`.
- **ctx** –Pointer to context structure. Meaning is the same as for `esp_vfs_register()`.
- **min\_fd** –The smallest file descriptor this VFS will use.
- **max\_fd** –Upper boundary for file descriptors this VFS will use (the biggest file descriptor plus one).

**Returns** `ESP_OK` if successful, `ESP_ERR_NO_MEM` if too many VFSes are registered, `ESP_ERR_INVALID_ARG` if the file descriptor boundaries are incorrect.

`esp_err_t esp_vfs_register_with_id` (const `esp_vfs_t` \*vfs, void \*ctx, `esp_vfs_id_t` \*vfs\_id)

Special case function for registering a VFS that uses a method other than `open()` to open new file descriptors. In comparison with `esp_vfs_register_fd_range`, this function doesn't pre-register an interval of file descriptors. File descriptors can be registered later, by using `esp_vfs_register_fd`.

### Parameters

- **vfs** –Pointer to `esp_vfs_t`. Meaning is the same as for `esp_vfs_register()`.

- **ctx** –Pointer to context structure. Meaning is the same as for `esp_vfs_register()`.
- **vfs\_id** –Here will be written the VFS ID which can be passed to `esp_vfs_register_fd` for registering file descriptors.

**Returns** `ESP_OK` if successful, `ESP_ERR_NO_MEM` if too many VFSes are registered, `ESP_ERR_INVALID_ARG` if the file descriptor boundaries are incorrect.

*esp\_err\_t* **esp\_vfs\_unregister** (const char \*base\_path)

Unregister a virtual filesystem for given path prefix

**Parameters** **base\_path** –file prefix previously used in `esp_vfs_register` call

**Returns** `ESP_OK` if successful, `ESP_ERR_INVALID_STATE` if VFS for given prefix hasn't been registered

*esp\_err\_t* **esp\_vfs\_unregister\_with\_id** (*esp\_vfs\_id\_t* vfs\_id)

Unregister a virtual filesystem with the given index

**Parameters** **vfs\_id** –The VFS ID returned by `esp_vfs_register_with_id`

**Returns** `ESP_OK` if successful, `ESP_ERR_INVALID_STATE` if VFS for the given index hasn't been registered

*esp\_err\_t* **esp\_vfs\_register\_fd** (*esp\_vfs\_id\_t* vfs\_id, int \*fd)

Special function for registering another file descriptor for a VFS registered by `esp_vfs_register_with_id`. This function should only be used to register permanent file descriptors (socket fd) that are not removed after being closed.

**Parameters**

- **vfs\_id** –VFS identifier returned by `esp_vfs_register_with_id`.
- **fd** –The registered file descriptor will be written to this address.

**Returns** `ESP_OK` if the registration is successful, `ESP_ERR_NO_MEM` if too many file descriptors are registered, `ESP_ERR_INVALID_ARG` if the arguments are incorrect.

*esp\_err\_t* **esp\_vfs\_register\_fd\_with\_local\_fd** (*esp\_vfs\_id\_t* vfs\_id, int local\_fd, bool permanent, int \*fd)

Special function for registering another file descriptor with given `local_fd` for a VFS registered by `esp_vfs_register_with_id`.

**Parameters**

- **vfs\_id** –VFS identifier returned by `esp_vfs_register_with_id`.
- **local\_fd** –The fd in the local vfs. Passing -1 will set the local fd as the (\*fd) value.
- **permanent** –Whether the fd should be treated as permanent (not removed after close())
- **fd** –The registered file descriptor will be written to this address.

**Returns** `ESP_OK` if the registration is successful, `ESP_ERR_NO_MEM` if too many file descriptors are registered, `ESP_ERR_INVALID_ARG` if the arguments are incorrect.

*esp\_err\_t* **esp\_vfs\_unregister\_fd** (*esp\_vfs\_id\_t* vfs\_id, int fd)

Special function for unregistering a file descriptor belonging to a VFS registered by `esp_vfs_register_with_id`.

**Parameters**

- **vfs\_id** –VFS identifier returned by `esp_vfs_register_with_id`.
- **fd** –File descriptor which should be unregistered.

**Returns** `ESP_OK` if the registration is successful, `ESP_ERR_INVALID_ARG` if the arguments are incorrect.

int **esp\_vfs\_select** (int nfd, fd\_set \*readfds, fd\_set \*writefds, fd\_set \*errorfds, struct timeval \*timeout)

Synchronous I/O multiplexing which implements the functionality of POSIX `select()` for VFS.

**Parameters**

- **nfd** –Specifies the range of descriptors which should be checked. The first `nfd` descriptors will be checked in each set.
- **readfds** –If not NULL, then points to a descriptor set that on input specifies which descriptors should be checked for being ready to read, and on output indicates which descriptors are ready to read.

- **writelfds** –If not NULL, then points to a descriptor set that on input specifies which descriptors should be checked for being ready to write, and on output indicates which descriptors are ready to write.
- **errorfds** –If not NULL, then points to a descriptor set that on input specifies which descriptors should be checked for error conditions, and on output indicates which descriptors have error conditions.
- **timeout** –If not NULL, then points to timeval structure which specifies the time period after which the functions should time-out and return. If it is NULL, then the function will not time-out. Note that the timeout period is rounded up to the system tick and incremented by one.

**Returns** The number of descriptors set in the descriptor sets, or -1 when an error (specified by `errno`) have occurred.

void **esp\_vfs\_select\_triggered** (*esp\_vfs\_select\_sem\_t* sem)

Notification from a VFS driver about a read/write/error condition.

This function is called when the VFS driver detects a read/write/error condition as it was requested by the previous call to `start_select`.

**Parameters** **sem** –semaphore structure which was passed to the driver by the `start_select` call

void **esp\_vfs\_select\_triggered\_isr** (*esp\_vfs\_select\_sem\_t* sem, BaseType\_t \*woken)

Notification from a VFS driver about a read/write/error condition (ISR version)

This function is called when the VFS driver detects a read/write/error condition as it was requested by the previous call to `start_select`.

#### Parameters

- **sem** –semaphore structure which was passed to the driver by the `start_select` call
- **woken** –is set to `pdTRUE` if the function wakes up a task with higher priority

ssize\_t **esp\_vfs\_pread** (int fd, void \*dst, size\_t size, off\_t offset)

Implements the VFS layer of POSIX `pread()`

#### Parameters

- **fd** –File descriptor used for read
- **dst** –Pointer to the buffer where the output will be written
- **size** –Number of bytes to be read
- **offset** –Starting offset of the read

**Returns** A positive return value indicates the number of bytes read. -1 is return on failure and `errno` is set accordingly.

ssize\_t **esp\_vfs\_pwrite** (int fd, const void \*src, size\_t size, off\_t offset)

Implements the VFS layer of POSIX `pwrite()`

#### Parameters

- **fd** –File descriptor used for write
- **src** –Pointer to the buffer from where the output will be read
- **size** –Number of bytes to write
- **offset** –Starting offset of the write

**Returns** A positive return value indicates the number of bytes written. -1 is return on failure and `errno` is set accordingly.

## Structures

struct **esp\_vfs\_select\_sem\_t**

VFS semaphore type for `select()`

## Public Members

bool **is\_sem\_local**

type of “sem” is SemaphoreHandle\_t when true, defined by socket driver otherwise

void \***sem**

semaphore instance

struct **esp\_vfs\_t**

VFS definition structure.

This structure should be filled with pointers to corresponding FS driver functions.

VFS component will translate all FDs so that the filesystem implementation sees them starting at zero. The caller sees a global FD which is prefixed with an pre-filesystem-implementation.

Some FS implementations expect some state (e.g. pointer to some structure) to be passed in as a first argument. For these implementations, populate the members of this structure which have `_p` suffix, set flags member to `ESP_VFS_FLAG_CONTEXT_PTR` and provide the context pointer to `esp_vfs_register` function. If the implementation doesn't use this extra argument, populate the members without `_p` suffix and set flags member to `ESP_VFS_FLAG_DEFAULT`.

If the FS driver doesn't provide some of the functions, set corresponding members to `NULL`.

### Public Members

int **flags**

`ESP_VFS_FLAG_CONTEXT_PTR` or `ESP_VFS_FLAG_DEFAULT`

`ssize_t (*write_p)(void *p, int fd, const void *data, size_t size)`

Write with context pointer

`ssize_t (*write)(int fd, const void *data, size_t size)`

Write without context pointer

`off_t (*lseek_p)(void *p, int fd, off_t size, int mode)`

Seek with context pointer

`off_t (*lseek)(int fd, off_t size, int mode)`

Seek without context pointer

`ssize_t (*read_p)(void *ctx, int fd, void *dst, size_t size)`

Read with context pointer

`ssize_t (*read)(int fd, void *dst, size_t size)`

Read without context pointer

`ssize_t (*pread_p)(void *ctx, int fd, void *dst, size_t size, off_t offset)`

pread with context pointer

`ssize_t (*pread)(int fd, void *dst, size_t size, off_t offset)`

pread without context pointer

ssize\_t (\***pwrite\_p**)(void \*ctx, int fd, const void \*src, size\_t size, off\_t offset)

pwrite with context pointer

ssize\_t (\***pwrite**)(int fd, const void \*src, size\_t size, off\_t offset)

pwrite without context pointer

int (\***open\_p**)(void \*ctx, const char \*path, int flags, int mode)

open with context pointer

int (\***open**)(const char \*path, int flags, int mode)

open without context pointer

int (\***close\_p**)(void \*ctx, int fd)

close with context pointer

int (\***close**)(int fd)

close without context pointer

int (\***fstat\_p**)(void \*ctx, int fd, struct *stat* \*st)

fstat with context pointer

int (\***fstat**)(int fd, struct *stat* \*st)

fstat without context pointer

int (\***stat\_p**)(void \*ctx, const char \*path, struct *stat* \*st)

stat with context pointer

int (\***stat**)(const char \*path, struct *stat* \*st)

stat without context pointer

int (\***link\_p**)(void \*ctx, const char \*n1, const char \*n2)

link with context pointer

int (\***link**)(const char \*n1, const char \*n2)

link without context pointer

int (\***unlink\_p**)(void \*ctx, const char \*path)

unlink with context pointer

int (\***unlink**)(const char \*path)

unlink without context pointer

int (\***rename\_p**)(void \*ctx, const char \*src, const char \*dst)

rename with context pointer

int (\***rename**)(const char \*src, const char \*dst)

rename without context pointer

DIR **(\*opendir\_p)**(void \*ctx, const char \*name)

opendir with context pointer

DIR **(\*opendir)**(const char \*name)

opendir without context pointer

struct dirent **(\*readdir\_p)**(void \*ctx, DIR \*pdir)

readdir with context pointer

struct dirent **(\*readdir)**(DIR \*pdir)

readdir without context pointer

int **(\*readdir\_r\_p)**(void \*ctx, DIR \*pdir, struct dirent \*entry, struct dirent \*\*out\_dirent)

readdir\_r with context pointer

int **(\*readdir\_r)**(DIR \*pdir, struct dirent \*entry, struct dirent \*\*out\_dirent)

readdir\_r without context pointer

long **(\*telldir\_p)**(void \*ctx, DIR \*pdir)

telldir with context pointer

long **(\*telldir)**(DIR \*pdir)

telldir without context pointer

void **(\*seekdir\_p)**(void \*ctx, DIR \*pdir, long offset)

seekdir with context pointer

void **(\*seekdir)**(DIR \*pdir, long offset)

seekdir without context pointer

int **(\*closedir\_p)**(void \*ctx, DIR \*pdir)

closedir with context pointer

int **(\*closedir)**(DIR \*pdir)

closedir without context pointer

int **(\*mkdir\_p)**(void \*ctx, const char \*name, mode\_t mode)

mkdir with context pointer

int **(\*mkdir)**(const char \*name, mode\_t mode)

mkdir without context pointer

int **(\*rmdir\_p)**(void \*ctx, const char \*name)

rmdir with context pointer

int **(\*rmdir)**(const char \*name)

rmdir without context pointer



`int (*fcntl_p)(void *ctx, int fd, int cmd, int arg)`  
fcntl with context pointer

`int (*fcntl)(int fd, int cmd, int arg)`  
fcntl without context pointer

`int (*ioctl_p)(void *ctx, int fd, int cmd, va_list args)`  
ioctl with context pointer

`int (*ioctl)(int fd, int cmd, va_list args)`  
ioctl without context pointer

`int (*fsync_p)(void *ctx, int fd)`  
fsync with context pointer

`int (*fsync)(int fd)`  
fsync without context pointer

`int (*access_p)(void *ctx, const char *path, int amode)`  
access with context pointer

`int (*access)(const char *path, int amode)`  
access without context pointer

`int (*truncate_p)(void *ctx, const char *path, off_t length)`  
truncate with context pointer

`int (*truncate)(const char *path, off_t length)`  
truncate without context pointer

`int (*ftruncate_p)(void *ctx, int fd, off_t length)`  
ftruncate with context pointer

`int (*ftruncate)(int fd, off_t length)`  
ftruncate without context pointer

`int (*utime_p)(void *ctx, const char *path, const struct utimbuf *times)`  
utime with context pointer

`int (*utime)(const char *path, const struct utimbuf *times)`  
utime without context pointer

`int (*tcsetattr_p)(void *ctx, int fd, int optional_actions, const struct termios *p)`  
tcsetattr with context pointer

`int (*tcsetattr)(int fd, int optional_actions, const struct termios *p)`  
tcsetattr without context pointer

int (\***tcgetattr\_p**)(void \*ctx, int fd, struct termios \*p)  
tcgetattr with context pointer

int (\***tcgetattr**)(int fd, struct termios \*p)  
tcgetattr without context pointer

int (\***tcdrain\_p**)(void \*ctx, int fd)  
tcdrain with context pointer

int (\***tcdrain**)(int fd)  
tcdrain without context pointer

int (\***tcflush\_p**)(void \*ctx, int fd, int select)  
tcflush with context pointer

int (\***tcflush**)(int fd, int select)  
tcflush without context pointer

int (\***tcflow\_p**)(void \*ctx, int fd, int action)  
tcflow with context pointer

int (\***tcflow**)(int fd, int action)  
tcflow without context pointer

pid\_t (\***tcgetsid\_p**)(void \*ctx, int fd)  
tcgetsid with context pointer

pid\_t (\***tcgetsid**)(int fd)  
tcgetsid without context pointer

int (\***tcsendbreak\_p**)(void \*ctx, int fd, int duration)  
tcsendbreak with context pointer

int (\***tcsendbreak**)(int fd, int duration)  
tcsendbreak without context pointer

*esp\_err\_t* (\***start\_select**)(int nfds, fd\_set \*readfds, fd\_set \*writefds, fd\_set \*exceptfds,  
*esp\_vfs\_select\_sem\_t* sem, void \*\*end\_select\_args)  
start\_select is called for setting up synchronous I/O multiplexing of the desired file descriptors in the given VFS

int (\***socket\_select**)(int nfds, fd\_set \*readfds, fd\_set \*writefds, fd\_set \*errorfds, struct timeval \*timeout)  
socket select function for socket FDs with the functionality of POSIX select(); this should be set only for the socket VFS

void (\***stop\_socket\_select**)(void \*sem)  
called by VFS to interrupt the socket\_select call when select is activated from a non-socket VFS driver; set only for the socket driver

void (**\*stop\_socket\_select\_isr**)(void \*sem, BaseType\_t \*woken)  
stop\_socket\_select which can be called from ISR; set only for the socket driver

void (**\*get\_socket\_select\_semaphore**)(void)  
end\_select is called to stop the I/O multiplexing and deinitialize the environment created by start\_select for the given VFS

*esp\_err\_t* (**\*end\_select**)(void \*end\_select\_args)  
get\_socket\_select\_semaphore returns semaphore allocated in the socket driver; set only for the socket driver

## Macros

### MAX\_FDS

Maximum number of (global) file descriptors.

### ESP\_VFS\_PATH\_MAX

Maximum length of path prefix (not including zero terminator)

### ESP\_VFS\_FLAG\_DEFAULT

Default value of flags member in *esp\_vfs\_t* structure.

### ESP\_VFS\_FLAG\_CONTEXT\_PTR

Flag which indicates that FS needs extra context pointer in syscalls.

## Type Definitions

typedef int **esp\_vfs\_id\_t**

## Header File

- [components/vfs/include/esp\\_vfs\\_dev.h](#)

## Functions

void **esp\_vfs\_dev\_uart\_register** (void)  
add /dev/uart virtual filesystem driver

This function is called from startup code to enable serial output

void **esp\_vfs\_dev\_uart\_set\_rx\_line\_endings** (esp\_line\_endings\_t mode)  
Set the line endings expected to be received on UART.

This specifies the conversion between line endings received on UART and newlines ('  
' , LF) passed into stdin:

- ESP\_LINE\_ENDINGS\_CRLF: convert CRLF to LF
- ESP\_LINE\_ENDINGS\_CR: convert CR to LF
- ESP\_LINE\_ENDINGS\_LF: no modification

---

**Note:** this function is not thread safe w.r.t. reading from UART

---

**Parameters** `mode` –line endings expected on UART

void `esp_vfs_dev_uart_set_tx_line_endings` (`esp_line_endings_t mode`)

Set the line endings to sent to UART.

This specifies the conversion between newlines (‘  
’, LF) on stdout and line endings sent over UART:

- `ESP_LINE_ENDINGS_CRLF`: convert LF to CRLF
- `ESP_LINE_ENDINGS_CR`: convert LF to CR
- `ESP_LINE_ENDINGS_LF`: no modification

---

**Note:** this function is not thread safe w.r.t. writing to UART

---

**Parameters** `mode` –line endings to send to UART

int `esp_vfs_dev_uart_port_set_rx_line_endings` (int `uart_num`, `esp_line_endings_t mode`)

Set the line endings expected to be received on specified UART.

This specifies the conversion between line endings received on UART and newlines (‘  
’, LF) passed into stdin:

- `ESP_LINE_ENDINGS_CRLF`: convert CRLF to LF
- `ESP_LINE_ENDINGS_CR`: convert CR to LF
- `ESP_LINE_ENDINGS_LF`: no modification

---

**Note:** this function is not thread safe w.r.t. reading from UART

---

**Parameters**

- `uart_num` –the UART number
- `mode` –line endings to send to UART

**Returns** 0 if succeeded, or -1 when an error (specified by `errno`) have occurred.

int `esp_vfs_dev_uart_port_set_tx_line_endings` (int `uart_num`, `esp_line_endings_t mode`)

Set the line endings to sent to specified UART.

This specifies the conversion between newlines (‘  
’, LF) on stdout and line endings sent over UART:

- `ESP_LINE_ENDINGS_CRLF`: convert LF to CRLF
- `ESP_LINE_ENDINGS_CR`: convert LF to CR
- `ESP_LINE_ENDINGS_LF`: no modification

---

**Note:** this function is not thread safe w.r.t. writing to UART

---

**Parameters**

- **uart\_num** –the UART number
- **mode** –line endings to send to UART

**Returns** 0 if succeeded, or -1 when an error (specified by `errno`) have occurred.

void **esp\_vfs\_dev\_uart\_use\_nonblocking** (int `uart_num`)

set VFS to use simple functions for reading and writing UART Read is non-blocking, write is busy waiting until TX FIFO has enough space. These functions are used by default.

**Parameters** `uart_num` –UART peripheral number

void **esp\_vfs\_dev\_uart\_use\_driver** (int `uart_num`)

set VFS to use UART driver for reading and writing

---

**Note:** application must configure UART driver before calling these functions With these functions, read and write are blocking and interrupt-driven.

---

**Parameters** `uart_num` –UART peripheral number

void **esp\_vfs\_usb\_serial\_jtag\_use\_driver** (void)

set VFS to use USB-SERIAL-JTAG driver for reading and writing

---

**Note:** application must configure USB-SERIAL-JTAG driver before calling these functions With these functions, read and write are blocking and interrupt-driven.

---

void **esp\_vfs\_usb\_serial\_jtag\_use\_nonblocking** (void)

set VFS to use simple functions for reading and writing UART Read is non-blocking, write is busy waiting until TX FIFO has enough space. These functions are used by default.

**Header File**

- [components/vfs/include/esp\\_vfs\\_eventfd.h](#)

**Functions**

*esp\_err\_t* **esp\_vfs\_eventfd\_register** (const *esp\_vfs\_eventfd\_config\_t* \*`config`)

Registers the event vfs.

**Returns** `ESP_OK` if successful, `ESP_ERR_NO_MEM` if too many VFSes are registered.

*esp\_err\_t* **esp\_vfs\_eventfd\_unregister** (void)

Unregisters the event vfs.

**Returns** `ESP_OK` if successful, `ESP_ERR_INVALID_STATE` if VFS for given prefix hasn't been registered

int **eventfd** (unsigned int `initval`, int `flags`)

**Structures**

struct **esp\_vfs\_eventfd\_config\_t**

Eventfd vfs initialization settings.

## Public Members

size\_t **max\_fds**

The maximum number of eventfds supported

## Macros

**EFD\_SUPPORT\_ISR**

**ESP\_VFS\_EVENTD\_CONFIG\_DEFAULT** ()

## 2.8.9 Wear Levelling API

### Overview

Most of flash memory and especially SPI flash that is used in ESP32-S2 has a sector-based organization and also has a limited number of erase/modification cycles per memory sector. The wear levelling component helps to distribute wear and tear among sectors more evenly without requiring any attention from the user.

The wear levelling component provides API functions related to reading, writing, erasing, and memory mapping of data in external SPI flash through the partition component. The component also has higher-level API functions which work with the FAT filesystem defined in *FAT filesystem*.

The wear levelling component, together with the FAT FS component, uses FAT FS sectors of 4096 bytes, which is a standard size for flash memory. With this size, the component shows the best performance but needs additional memory in RAM.

To save internal memory, the component has two additional modes which both use sectors of 512 bytes:

- **Performance mode.** Erase sector operation data is stored in RAM, the sector is erased, and then data is copied back to flash memory. However, if a device is powered off for any reason, all 4096 bytes of data is lost.
- **Safety mode.** The data is first saved to flash memory, and after the sector is erased, the data is saved back. If a device is powered off, the data can be recovered as soon as the device boots up.

The default settings are as follows:

- Sector size is 512 bytes
- Performance mode

You can change the settings through the configuration menu.

The wear levelling component does not cache data in RAM. The write and erase functions modify flash directly, and flash contents are consistent when the function returns.

### Wear Levelling access API functions

This is the set of API functions for working with data in flash:

- `wl_mount` - initializes the wear levelling module and mounts the specified partition
- `wl_unmount` - unmounts the partition and deinitializes the wear levelling module
- `wl_erase_range` - erases a range of addresses in flash
- `wl_write` - writes data to a partition
- `wl_read` - reads data from a partition
- `wl_size` - returns the size of available memory in bytes
- `wl_sector_size` - returns the size of one sector

As a rule, try to avoid using raw wear levelling functions and use filesystem-specific functions instead.

## Memory Size

The memory size is calculated in the wear levelling module based on partition parameters. The module uses some sectors of flash for internal data.

### See also

- [FAT Filesystem Support](#)
- [Partition Tables](#)

## Application Example

An example that combines the wear levelling driver with the FATFS library is provided in the [storage/wear\\_levelling](#) directory. This example initializes the wear levelling driver, mounts FatFs partition, as well as writes and reads data from it using POSIX and C library APIs. See [storage/wear\\_levelling/README.md](#) for more information.

## High-level API Reference

### Header Files

- [fatfs/vfs/esp\\_vfs\\_fat.h](#)

High-level wear levelling functions `esp_vfs_fat_spiflash_mount_rw_wl()`, `esp_vfs_fat_spiflash_unmount_rw_wl()` and struct `esp_vfs_fat_mount_config_t` are described in [FAT Filesystem Support](#).

## Mid-level API Reference

### Header File

- [components/wear\\_levelling/include/wear\\_levelling.h](#)

### Functions

`esp_err_t wl_mount` (const `esp_partition_t` \*partition, `wl_handle_t` \*out\_handle)

Mount WL for defined partition.

#### Parameters

- **partition** –that will be used for access
- **out\_handle** –handle of the WL instance

#### Returns

- ESP\_OK, if the allocation was successfully;
- ESP\_ERR\_INVALID\_ARG, if WL allocation was unsuccessful;
- ESP\_ERR\_NO\_MEM, if there was no memory to allocate WL components;

`esp_err_t wl_unmount` (`wl_handle_t` handle)

Unmount WL for defined partition.

**Parameters** **handle** –WL partition handle

#### Returns

- ESP\_OK, if the operation completed successfully;
- or one of error codes from lower-level flash driver.

`esp_err_t wl_erase_range` (`wl_handle_t` handle, `size_t` start\_addr, `size_t` size)

Erase part of the WL storage.

#### Parameters

- **handle** –WL handle that are related to the partition

- **start\_addr** –Address where erase operation should start. Must be aligned to the result of function `wl_sector_size(...)`.
- **size** –Size of the range which should be erased, in bytes. Must be divisible by result of function `wl_sector_size(...)`.

**Returns**

- ESP\_OK, if the range was erased successfully;
- ESP\_ERR\_INVALID\_ARG, if iterator or dst are NULL;
- ESP\_ERR\_INVALID\_SIZE, if erase would go out of bounds of the partition;
- or one of error codes from lower-level flash driver.

*esp\_err\_t* **wl\_write** (*wl\_handle\_t* handle, size\_t dest\_addr, const void \*src, size\_t size)

Write data to the WL storage.

Before writing data to flash, corresponding region of flash needs to be erased. This can be done using `wl_erase_range` function.

---

**Note:** Prior to writing to WL storage, make sure it has been erased with `wl_erase_range` call.

---

**Parameters**

- **handle** –WL handle that are related to the partition
- **dest\_addr** –Address where the data should be written, relative to the beginning of the partition.
- **src** –Pointer to the source buffer. Pointer must be non-NULL and buffer must be at least ‘size’ bytes long.
- **size** –Size of data to be written, in bytes.

**Returns**

- ESP\_OK, if data was written successfully;
- ESP\_ERR\_INVALID\_ARG, if dst\_offset exceeds partition size;
- ESP\_ERR\_INVALID\_SIZE, if write would go out of bounds of the partition;
- or one of error codes from lower-level flash driver.

*esp\_err\_t* **wl\_read** (*wl\_handle\_t* handle, size\_t src\_addr, void \*dest, size\_t size)

Read data from the WL storage.

**Parameters**

- **handle** –WL module instance that was initialized before
- **dest** –Pointer to the buffer where data should be stored. Pointer must be non-NULL and buffer must be at least ‘size’ bytes long.
- **src\_addr** –Address of the data to be read, relative to the beginning of the partition.
- **size** –Size of data to be read, in bytes.

**Returns**

- ESP\_OK, if data was read successfully;
- ESP\_ERR\_INVALID\_ARG, if src\_offset exceeds partition size;
- ESP\_ERR\_INVALID\_SIZE, if read would go out of bounds of the partition;
- or one of error codes from lower-level flash driver.

size\_t **wl\_size** (*wl\_handle\_t* handle)

Get size of the WL storage.

**Parameters** **handle** –WL module handle that was initialized before

**Returns** usable size, in bytes

size\_t **wl\_sector\_size** (*wl\_handle\_t* handle)

Get sector size of the WL instance.

**Parameters** **handle** –WL module handle that was initialized before

**Returns** sector size, in bytes



## Macros

**WL\_INVALID\_HANDLE**

## Type Definitions

```
typedef int32_t wl_handle_t
```

wear levelling handle

Code examples for this API section are provided in the [storage](#) directory of ESP-IDF examples.

## 2.9 System API

### 2.9.1 App Image Format

An application image consists of the following structures:

1. The `esp_image_header_t` structure describes the mode of SPI flash and the count of memory segments.
2. The `esp_image_segment_header_t` structure describes each segment, its length, and its location in ESP32-S2's memory, followed by the data with a length of `data_len`. The data offset for each segment in the image is calculated in the following way:
  - offset for 0 Segment = `sizeof(esp_image_header_t) + sizeof(esp_image_segment_header_t)`.
  - offset for 1 Segment = offset for 0 Segment + length of 0 Segment + `sizeof(esp_image_segment_header_t)`.
  - offset for 2 Segment = offset for 1 Segment + length of 1 Segment + `sizeof(esp_image_segment_header_t)`.
  - ...

The count of each segment is defined in the `segment_count` field that is stored in `esp_image_header_t`. The count cannot be more than `ESP_IMAGE_MAX_SEGMENTS`.

To get the list of your image segments, please run the following command:

```
esptool.py --chip esp32s2 image_info build/app.bin
```

```

esptool.py v2.3.1
Image version: 1
Entry point: 40080ea4
13 segments
Segment 1: len 0x13ce0 load 0x3f400020 file_offs 0x00000018 SOC_DROM
Segment 2: len 0x00000 load 0x3ff80000 file_offs 0x00013d00 SOC_RTC_DRAM
Segment 3: len 0x00000 load 0x3ff80000 file_offs 0x00013d08 SOC_RTC_DRAM
Segment 4: len 0x028e0 load 0x3ffb0000 file_offs 0x00013d10 DRAM
Segment 5: len 0x00000 load 0x3ffb28e0 file_offs 0x000165f8 DRAM
Segment 6: len 0x00400 load 0x40080000 file_offs 0x00016600 SOC_IRAM
Segment 7: len 0x09600 load 0x40080400 file_offs 0x00016a08 SOC_IRAM
Segment 8: len 0x62e4c load 0x400d0018 file_offs 0x00020010 SOC_IROM
Segment 9: len 0x06cec load 0x40089a00 file_offs 0x00082e64 SOC_IROM
Segment 10: len 0x00000 load 0x400c0000 file_offs 0x00089b58 SOC_RTC_IRAM
Segment 11: len 0x00004 load 0x50000000 file_offs 0x00089b60 SOC_RTC_DATA
Segment 12: len 0x00000 load 0x50000004 file_offs 0x00089b6c SOC_RTC_DATA
Segment 13: len 0x00000 load 0x50000004 file_offs 0x00089b74 SOC_RTC_DATA
Checksum: e8 (valid)Validation Hash:↵
↵407089ca0eae2bbf83b4120979d3354b1c938a49cb7a0c997f240474ef2ec76b (valid)

```

You can also see the information on segments in the ESP-IDF logs while your application is booting:

```

I (443) esp_image: segment 0: paddr=0x00020020 vaddr=0x3f400020 size=0x13ce0 ( 0) ↵
↵81120) map
I (489) esp_image: segment 1: paddr=0x00033d08 vaddr=0x3ff80000 size=0x00000 ( 0) ↵
↵load
I (530) esp_image: segment 2: paddr=0x00033d10 vaddr=0x3ff80000 size=0x00000 ( 0) ↵
↵load
I (571) esp_image: segment 3: paddr=0x00033d18 vaddr=0x3ffb0000 size=0x028e0 ( 0) ↵
↵10464) load
I (612) esp_image: segment 4: paddr=0x00036600 vaddr=0x3ffb28e0 size=0x00000 ( 0) ↵
↵load
I (654) esp_image: segment 5: paddr=0x00036608 vaddr=0x40080000 size=0x00400 ( 0) ↵
↵1024) load
I (695) esp_image: segment 6: paddr=0x00036a10 vaddr=0x40080400 size=0x09600 ( 0) ↵
↵38400) load
I (737) esp_image: segment 7: paddr=0x00040018 vaddr=0x400d0018 size=0x62e4c ( 0) ↵
↵405068) map
I (847) esp_image: segment 8: paddr=0x000a2e6c vaddr=0x40089a00 size=0x06cec ( 0) ↵
↵27884) load
I (888) esp_image: segment 9: paddr=0x000a9b60 vaddr=0x400c0000 size=0x00000 ( 0) ↵
↵load
I (929) esp_image: segment 10: paddr=0x000a9b68 vaddr=0x50000000 size=0x00004 ( 4) ↵
↵load
I (971) esp_image: segment 11: paddr=0x000a9b74 vaddr=0x50000004 size=0x00000 ( 0) ↵
↵load
I (1012) esp_image: segment 12: paddr=0x000a9b7c vaddr=0x50000004 size=0x00000 ( 0) ↵
↵0) load

```

For more details on the type of memory segments and their address ranges, see *ESP32-S2 Technical Reference Manual > System and Memory > Internal Memory* [PDF].

3. The image has a single checksum byte after the last segment. This byte is written on a sixteen byte padded boundary, so the application image might need padding.
4. If the `hash_appended` field from `esp_image_header_t` is set then a SHA256 checksum will be appended. The value of SHA256 is calculated on the range from the first byte and up to this field. The length of this field is 32 bytes.
5. If the options `CONFIG_SECURE_SIGNED_APPS_SCHEME` is set to ECDSA then the application image will have additional 68 bytes for an ECDSA signature, which includes:
  - version word (4 bytes),
  - signature data (64 bytes).

### Application Description

The DROM segment starts with the `esp_app_desc_t` structure which carries specific fields describing the application:

- `magic_word` - the magic word for the `esp_app_desc` structure.
- `secure_version` - see *Anti-rollback*.
- `version` - see *App version*. \*
- `project_name` is filled from `PROJECT_NAME`. \*
- `time and date` - compile time and date.
- `idf_ver` - version of ESP-IDF. \*
- `app_elf_sha256` - contains sha256 for the elf application file.

\* - The maximum length is 32 characters, including null-termination character. For example, if the length of `PROJECT_NAME` exceeds 32 characters, the excess characters will be disregarded.

This structure is useful for identification of images uploaded OTA because it has a fixed offset = `sizeof(esp_image_header_t) + sizeof(esp_image_segment_header_t)`. As soon as a device receives the first fragment containing this structure, it has all the information to determine whether the update should be continued or not.

## Adding a Custom Structure to an Application

Users also have the opportunity to have similar structure with a fixed offset relative to the beginning of the image. The following pattern can be used to add a custom structure to your image:

```
const __attribute__((section(".rodata_custom_desc"))) esp_custom_app_desc_t custom_
↪app_desc = { ... }
```

Offset for custom structure is `sizeof(esp_image_header_t) + sizeof(esp_image_segment_header_t) + sizeof(esp_app_desc_t)`.

To guarantee that the custom structure is located in the image even if it is not used, you need to add `target_link_libraries(${COMPONENT_TARGET} "-u custom_app_desc")` into `CMakeLists.txt`.

## API Reference

### Header File

- [components/bootloader\\_support/include/esp\\_app\\_format.h](#)

### Structures

struct **esp\_image\_header\_t**

Main header of binary image.

### Public Members

uint8\_t **magic**

Magic word `ESP_IMAGE_HEADER_MAGIC`

uint8\_t **segment\_count**

Count of memory segments

uint8\_t **spi\_mode**

flash read mode (`esp_image_spi_mode_t` as `uint8_t`)

uint8\_t **spi\_speed**

flash frequency (`esp_image_spi_freq_t` as `uint8_t`)

uint8\_t **spi\_size**

flash chip size (`esp_image_flash_size_t` as `uint8_t`)

uint32\_t **entry\_addr**

Entry address

uint8\_t **wp\_pin**

WP pin when SPI pins set via efuse (read by ROM bootloader, the IDF bootloader uses software to configure the WP pin and sets this field to `0xEE=disabled`)

uint8\_t **spi\_pin\_drv**[3]

Drive settings for the SPI flash pins (read by ROM bootloader)

***esp\_chip\_id\_t* chip\_id**

Chip identification number

**uint8\_t min\_chip\_rev**

Minimal chip revision supported by image After the Major and Minor revision eFuses were introduced into the chips, this field is no longer used. But for compatibility reasons, we keep this field and the data in it. Use `min_chip_rev_full` instead. The software interprets this as a Major version for most of the chips and as a Minor version for the ESP32-C3.

**uint16\_t min\_chip\_rev\_full**

Minimal chip revision supported by image, in format: `major * 100 + minor`

**uint16\_t max\_chip\_rev\_full**

Maximal chip revision supported by image, in format: `major * 100 + minor`

**uint8\_t reserved[4]**

Reserved bytes in additional header space, currently unused

**uint8\_t hash\_appended**

If 1, a SHA256 digest “simple hash” (of the entire image) is appended after the checksum. Included in image length. This digest is separate to secure boot and only used for detecting corruption. For secure boot signed images, the signature is appended after this (and the simple hash is included in the signed data).

**struct esp\_image\_segment\_header\_t**

Header of binary image segment.

**Public Members****uint32\_t load\_addr**

Address of segment

**uint32\_t data\_len**

Length of data

**Macros****ESP\_IMAGE\_HEADER\_MAGIC**

The magic word for the *esp\_image\_header\_t* structure.

**ESP\_IMAGE\_MAX\_SEGMENTS**

Max count of segments in the image.

**Enumerations****enum esp\_chip\_id\_t**

ESP chip ID.

*Values:*

enumerator **ESP\_CHIP\_ID\_ESP32**

chip ID: ESP32

enumerator **ESP\_CHIP\_ID\_ESP32S2**

chip ID: ESP32-S2

enumerator **ESP\_CHIP\_ID\_ESP32C3**

chip ID: ESP32-C3

enumerator **ESP\_CHIP\_ID\_ESP32S3**

chip ID: ESP32-S3

enumerator **ESP\_CHIP\_ID\_ESP32C2**

chip ID: ESP32-C2

enumerator **ESP\_CHIP\_ID\_INVALID**

Invalid chip ID (we defined it to make sure the `esp_chip_id_t` is 2 bytes size)

enum **esp\_image\_spi\_mode\_t**

SPI flash mode, used in [esp\\_image\\_header\\_t](#).

*Values:*

enumerator **ESP\_IMAGE\_SPI\_MODE\_QIO**

SPI mode QIO

enumerator **ESP\_IMAGE\_SPI\_MODE\_QOUT**

SPI mode QOUT

enumerator **ESP\_IMAGE\_SPI\_MODE\_DIO**

SPI mode DIO

enumerator **ESP\_IMAGE\_SPI\_MODE\_DOUT**

SPI mode DOUT

enumerator **ESP\_IMAGE\_SPI\_MODE\_FAST\_READ**

SPI mode FAST\_READ

enumerator **ESP\_IMAGE\_SPI\_MODE\_SLOW\_READ**

SPI mode SLOW\_READ

enum **esp\_image\_spi\_freq\_t**

SPI flash clock division factor.

*Values:*

enumerator **ESP\_IMAGE\_SPI\_SPEED\_DIV\_2**

The SPI flash clock frequency is divided by 2 of the clock source

enumerator **ESP\_IMAGE\_SPI\_SPEED\_DIV\_3**

The SPI flash clock frequency is divided by 3 of the clock source

enumerator **ESP\_IMAGE\_SPI\_SPEED\_DIV\_4**

The SPI flash clock frequency is divided by 4 of the clock source

enumerator **ESP\_IMAGE\_SPI\_SPEED\_DIV\_1**

The SPI flash clock frequency equals to the clock source

enum **esp\_image\_flash\_size\_t**

Supported SPI flash sizes.

*Values:*

enumerator **ESP\_IMAGE\_FLASH\_SIZE\_1MB**

SPI flash size 1 MB

enumerator **ESP\_IMAGE\_FLASH\_SIZE\_2MB**

SPI flash size 2 MB

enumerator **ESP\_IMAGE\_FLASH\_SIZE\_4MB**

SPI flash size 4 MB

enumerator **ESP\_IMAGE\_FLASH\_SIZE\_8MB**

SPI flash size 8 MB

enumerator **ESP\_IMAGE\_FLASH\_SIZE\_16MB**

SPI flash size 16 MB

enumerator **ESP\_IMAGE\_FLASH\_SIZE\_32MB**

SPI flash size 32 MB

enumerator **ESP\_IMAGE\_FLASH\_SIZE\_64MB**

SPI flash size 64 MB

enumerator **ESP\_IMAGE\_FLASH\_SIZE\_128MB**

SPI flash size 128 MB

enumerator **ESP\_IMAGE\_FLASH\_SIZE\_MAX**

SPI flash size MAX

## 2.9.2 Application Level Tracing

### Overview

IDF provides a useful feature for program behavior analysis called **Application Level Tracing**. The feature can be enabled in menuconfig and allows transfer of arbitrary data between the host and ESP32-S2 via JTAG interface with minimal overhead on program execution. Developers can use this library to send application specific state of execution to the host and receive commands or other type of info in the opposite direction at runtime. The main use cases of this library are:

1. Collecting application specific data, see [Application Specific Tracing](#)
2. Lightweight logging to the host, see [Logging to Host](#)
3. System behaviour analysis, see [System Behavior Analysis with SEGGER System View](#)

## API Reference

### Header File

- `components/app_trace/include/esp_app_trace.h`

### Functions

*esp\_err\_t* **esp\_apptrace\_init** (void)

Initializes application tracing module.

---

**Note:** Should be called before any `esp_apptrace_xxx` call.

---

**Returns** `ESP_OK` on success, otherwise see `esp_err_t`

void **esp\_apptrace\_down\_buffer\_config** (uint8\_t \*buf, uint32\_t size)

Configures down buffer.

---

**Note:** Needs to be called before attempting to receive any data using `esp_apptrace_down_buffer_get` and `esp_apptrace_read`. This function does not protect internal data by lock.

---

#### Parameters

- **buf** –Address of buffer to use for down channel (host to target) data.
- **size** –Size of the buffer.

uint8\_t \***esp\_apptrace\_buffer\_get** (*esp\_apptrace\_dest\_t* dest, uint32\_t size, uint32\_t tmo)

Allocates buffer for trace data. Once the data in the buffer is ready to be sent, `esp_apptrace_buffer_put` must be called to indicate it.

#### Parameters

- **dest** –Indicates HW interface to send data.
- **size** –Size of data to write to trace buffer.
- **tmo** –Timeout for operation (in us). Use `ESP_APPTRACE_TMO_INFINITE` to wait indefinitely.

**Returns** non-NULL on success, otherwise NULL.

*esp\_err\_t* **esp\_apptrace\_buffer\_put** (*esp\_apptrace\_dest\_t* dest, uint8\_t \*ptr, uint32\_t tmo)

Indicates that the data in the buffer is ready to be sent. This function is a counterpart of and must be preceded by `esp_apptrace_buffer_get`.

#### Parameters

- **dest** –Indicates HW interface to send data. Should be identical to the same parameter in call to `esp_apptrace_buffer_get`.
- **ptr** –Address of trace buffer to release. Should be the value returned by call to `esp_apptrace_buffer_get`.
- **tmo** –Timeout for operation (in us). Use `ESP_APPTRACE_TMO_INFINITE` to wait indefinitely.

**Returns** `ESP_OK` on success, otherwise see `esp_err_t`

*esp\_err\_t* **esp\_apptrace\_write** (*esp\_apptrace\_dest\_t* dest, const void \*data, uint32\_t size, uint32\_t tmo)

Writes data to trace buffer.

#### Parameters

- **dest** –Indicates HW interface to send data.
- **data** –Address of data to write to trace buffer.
- **size** –Size of data to write to trace buffer.
- **tmo** –Timeout for operation (in us). Use `ESP_APPTRACE_TMO_INFINITE` to wait indefinitely.

**Returns** ESP\_OK on success, otherwise see esp\_err\_t

int **esp\_apptrace\_vprintf\_to** (*esp\_apptrace\_dest\_t* dest, uint32\_t tmo, const char \*fmt, va\_list ap)  
vprintf-like function to send log messages to host via specified HW interface.

**Parameters**

- **dest** –Indicates HW interface to send data.
- **tmo** –Timeout for operation (in us). Use ESP\_APPTRACE\_TMO\_INFINITE to wait indefinitely.
- **fmt** –Address of format string.
- **ap** –List of arguments.

**Returns** Number of bytes written.

int **esp\_apptrace\_vprintf** (const char \*fmt, va\_list ap)  
vprintf-like function to send log messages to host.

**Parameters**

- **fmt** –Address of format string.
- **ap** –List of arguments.

**Returns** Number of bytes written.

*esp\_err\_t* **esp\_apptrace\_flush** (*esp\_apptrace\_dest\_t* dest, uint32\_t tmo)

Flushes remaining data in trace buffer to host.

**Parameters**

- **dest** –Indicates HW interface to flush data on.
- **tmo** –Timeout for operation (in us). Use ESP\_APPTRACE\_TMO\_INFINITE to wait indefinitely.

**Returns** ESP\_OK on success, otherwise see esp\_err\_t

*esp\_err\_t* **esp\_apptrace\_flush\_nolock** (*esp\_apptrace\_dest\_t* dest, uint32\_t min\_sz, uint32\_t tmo)

Flushes remaining data in trace buffer to host without locking internal data. This is a special version of esp\_apptrace\_flush which should be called from panic handler.

**Parameters**

- **dest** –Indicates HW interface to flush data on.
- **min\_sz** –Threshold for flushing data. If current filling level is above this value, data will be flushed. TRAX destinations only.
- **tmo** –Timeout for operation (in us). Use ESP\_APPTRACE\_TMO\_INFINITE to wait indefinitely.

**Returns** ESP\_OK on success, otherwise see esp\_err\_t

*esp\_err\_t* **esp\_apptrace\_read** (*esp\_apptrace\_dest\_t* dest, void \*data, uint32\_t \*size, uint32\_t tmo)

Reads host data from trace buffer.

**Parameters**

- **dest** –Indicates HW interface to read the data on.
- **data** –Address of buffer to put data from trace buffer.
- **size** –Pointer to store size of read data. Before call to this function pointed memory must hold requested size of data
- **tmo** –Timeout for operation (in us). Use ESP\_APPTRACE\_TMO\_INFINITE to wait indefinitely.

**Returns** ESP\_OK on success, otherwise see esp\_err\_t

uint8\_t \***esp\_apptrace\_down\_buffer\_get** (*esp\_apptrace\_dest\_t* dest, uint32\_t \*size, uint32\_t tmo)

Retrieves incoming data buffer if any. Once data in the buffer is processed, esp\_apptrace\_down\_buffer\_put must be called to indicate it.

**Parameters**

- **dest** –Indicates HW interface to receive data.
- **size** –Address to store size of available data in down buffer. Must be initialized with requested value.



- **tmo** –Timeout for operation (in us). Use `ESP_APPTRACE_TMO_INFINITE` to wait indefinitely.

**Returns** non-NULL on success, otherwise NULL.

`esp_err_t esp_apprace_down_buffer_put` (`esp_apprace_dest_t` dest, `uint8_t *ptr`, `uint32_t tmo`)

Indicates that the data in the down buffer is processed. This function is a counterpart of and must be preceded by `esp_apprace_down_buffer_get`.

**Parameters**

- **dest** –Indicates HW interface to receive data. Should be identical to the same parameter in call to `esp_apprace_down_buffer_get`.
- **ptr** –Address of trace buffer to release. Should be the value returned by call to `esp_apprace_down_buffer_get`.
- **tmo** –Timeout for operation (in us). Use `ESP_APPTRACE_TMO_INFINITE` to wait indefinitely.

**Returns** `ESP_OK` on success, otherwise see `esp_err_t`

bool `esp_apprace_host_is_connected` (`esp_apprace_dest_t` dest)

Checks whether host is connected.

**Parameters** **dest** –Indicates HW interface to use.

**Returns** true if host is connected, otherwise false

void \*`esp_apprace_fopen` (`esp_apprace_dest_t` dest, const char \*path, const char \*mode)

Opens file on host. This function has the same semantic as ‘fopen’ except for the first argument.

**Parameters**

- **dest** –Indicates HW interface to use.
- **path** –Path to file.
- **mode** –Mode string. See `fopen` for details.

**Returns** non zero file handle on success, otherwise 0

int `esp_apprace_fclose` (`esp_apprace_dest_t` dest, void \*stream)

Closes file on host. This function has the same semantic as ‘fclose’ except for the first argument.

**Parameters**

- **dest** –Indicates HW interface to use.
- **stream** –File handle returned by `esp_apprace_fopen`.

**Returns** Zero on success, otherwise non-zero. See `fclose` for details.

size\_t `esp_apprace_fwrite` (`esp_apprace_dest_t` dest, const void \*ptr, size\_t size, size\_t nmemb, void \*stream)

Writes to file on host. This function has the same semantic as ‘fwrite’ except for the first argument.

**Parameters**

- **dest** –Indicates HW interface to use.
- **ptr** –Address of data to write.
- **size** –Size of an item.
- **nmemb** –Number of items to write.
- **stream** –File handle returned by `esp_apprace_fopen`.

**Returns** Number of written items. See `fwrite` for details.

size\_t `esp_apprace_fread` (`esp_apprace_dest_t` dest, void \*ptr, size\_t size, size\_t nmemb, void \*stream)

Read file on host. This function has the same semantic as ‘fread’ except for the first argument.

**Parameters**

- **dest** –Indicates HW interface to use.
- **ptr** –Address to store read data.
- **size** –Size of an item.
- **nmemb** –Number of items to read.
- **stream** –File handle returned by `esp_apprace_fopen`.

**Returns** Number of read items. See `fread` for details.

int **esp\_apptrace\_fseek** (*esp\_apptrace\_dest\_t* dest, void \*stream, long offset, int whence)

Set position indicator in file on host. This function has the same semantic as ‘fseek’ except for the first argument.

**Parameters**

- **dest** –Indicates HW interface to use.
- **stream** –File handle returned by esp\_apptrace\_fopen.
- **offset** –Offset. See fseek for details.
- **whence** –Position in file. See fseek for details.

**Returns** Zero on success, otherwise non-zero. See fseek for details.

int **esp\_apptrace\_ftell** (*esp\_apptrace\_dest\_t* dest, void \*stream)

Get current position indicator for file on host. This function has the same semantic as ‘ftell’ except for the first argument.

**Parameters**

- **dest** –Indicates HW interface to use.
- **stream** –File handle returned by esp\_apptrace\_fopen.

**Returns** Current position in file. See ftell for details.

int **esp\_apptrace\_fstop** (*esp\_apptrace\_dest\_t* dest)

Indicates to the host that all file operations are complete. This function should be called after all file operations are finished and indicate to the host that it can perform cleanup operations (close open files etc.).

**Parameters** **dest** –Indicates HW interface to use.

**Returns** ESP\_OK on success, otherwise see esp\_err\_t

void **esp\_gcov\_dump** (void)

Triggers gcov info dump. This function waits for the host to connect to target before dumping data.

## Enumerations

enum **esp\_apptrace\_dest\_t**

Application trace data destinations bits.

*Values:*

enumerator **ESP\_APPTRACE\_DEST\_JTAG**

JTAG destination.

enumerator **ESP\_APPTRACE\_DEST\_TRAX**

xxx\_TRAX name is obsolete, use more common xxx\_JTAG

enumerator **ESP\_APPTRACE\_DEST\_UART**

UART destination.

enumerator **ESP\_APPTRACE\_DEST\_MAX**

enumerator **ESP\_APPTRACE\_DEST\_NUM**

## Header File

- [components/app\\_trace/include/esp\\_sysview\\_trace.h](#)

## Functions

static inline *esp\_err\_t* **esp\_sysview\_flush** (uint32\_t tmo)

Flushes remaining data in SystemView trace buffer to host.

**Parameters** **tmo** –Timeout for operation (in us). Use ESP\_APPTRACE\_TMO\_INFINITE to wait indefinitely.

**Returns** ESP\_OK.

int **esp\_sysview\_vprintf** (const char \*format, va\_list args)

vprintf-like function to sent log messages to the host.

**Parameters**

- **format** –Address of format string.
- **args** –List of arguments.

**Returns** Number of bytes written.

*esp\_err\_t* **esp\_sysview\_heap\_trace\_start** (uint32\_t tmo)

Starts SystemView heap tracing.

**Parameters** **tmo** –Timeout (in us) to wait for the host to be connected. Use -1 to wait forever.

**Returns** ESP\_OK on success, ESP\_ERR\_TIMEOUT if operation has been timed out.

*esp\_err\_t* **esp\_sysview\_heap\_trace\_stop** (void)

Stops SystemView heap tracing.

**Returns** ESP\_OK.

void **esp\_sysview\_heap\_trace\_alloc** (void \*addr, uint32\_t size, const void \*callers)

Sends heap allocation event to the host.

**Parameters**

- **addr** –Address of allocated block.
- **size** –Size of allocated block.
- **callers** –Pointer to array with callstack addresses. Array size must be CONFIG\_HEAP\_TRACING\_STACK\_DEPTH.

void **esp\_sysview\_heap\_trace\_free** (void \*addr, const void \*callers)

Sends heap de-allocation event to the host.

**Parameters**

- **addr** –Address of de-allocated block.
- **callers** –Pointer to array with callstack addresses. Array size must be CONFIG\_HEAP\_TRACING\_STACK\_DEPTH.

## 2.9.3 Call function with external stack

### Overview

A given function can be executed with a user allocated stack space which is independent of current task stack, this mechanism can be used to save stack space wasted by tasks which call a common function with intensive stack usage such as *printf*. The given function can be called inside the shared stack space which is a callback function deferred by calling *esp\_execute\_shared\_stack\_function()*, passing that function as parameter.

### Usage

*esp\_execute\_shared\_stack\_function()* takes four arguments:

- a mutex object allocated by the caller, which is used to protect if the same function shares its allocated stack
- a pointer to the top of stack used for that function
- the size of stack in bytes
- a pointer to the shared stack function

The user defined function will be deferred as a callback and can be called using the user allocated space without taking space from current task stack.

The usage may look like the code below:

```
void external_stack_function(void)
{
    printf("Executing this printf from external stack! \n");
}

//Let's suppose we want to call printf using a separated stack space
//allowing the app to reduce its stack size.
void app_main()
{
    //Allocate a stack buffer, from heap or as a static form:
    portSTACK_TYPE *shared_stack = malloc(8192 * sizeof(portSTACK_TYPE));
    assert(shared_stack != NULL);

    //Allocate a mutex to protect its usage:
    SemaphoreHandle_t printf_lock = xSemaphoreCreateMutex();
    assert(printf_lock != NULL);

    //Call the desired function using the macro helper:
    esp_execute_shared_stack_function(printf_lock,
                                     shared_stack,
                                     8192,
                                     external_stack_function);

    vSemaphoreDelete(printf_lock);
    free(shared_stack);
}
```

## API Reference

### Header File

- [components/esp\\_system/include/esp\\_expression\\_with\\_stack.h](#)

### Functions

void **esp\_execute\_shared\_stack\_function** (*SemaphoreHandle\_t* lock, void \*stack, size\_t stack\_size, *shared\_stack\_function* function)

Calls user defined shared stack space function.

---

**Note:** if either lock, stack or stack size is invalid, the expression will be called using the current stack.

---

#### Parameters

- **lock** –Mutex object to protect in case of shared stack
- **stack** –Pointer to user allocated stack
- **stack\_size** –Size of current stack in bytes
- **function** –pointer to the shared stack function to be executed

### Macros

**ESP\_EXECUTE\_EXPRESSION\_WITH\_STACK** (lock, stack, stack\_size, expression)

### Type Definitions

```
typedef void (*shared_stack_function)(void)
```

## 2.9.4 Chip Revision

### Overview

A new chip versioning logic was introduced in new chips. Chips have several eFuse version fields:

- Major wafer version (WAFER\_VERSION\_MAJOR eFuse)
- Minor wafer version (WAFER\_VERSION\_MINOR eFuse)
- Ignore maximal revision (DISABLE\_WAFER\_VERSION\_MAJOR eFuse)

The new versioning logic is being introduced to distinguish changes in chips as breaking changes and non-breaking changes. Chips with non-breaking changes can run the same software as the previous chip. The previous chip means that the major version is the same.

If the newly released chip does not have breaking changes, that means it can run the same software as the previous chip, then in that chip we keep the same major version and increment the minor version by 1. Otherwise, if there is a breaking change in the newly released chip, meaning it can not run the same software as the previous chip, then in that chip we increase the major version and set the minor version to 0.

The software supports a number of revisions, from the minimum to the maximum (the min/max configs are defined in Kconfig). If the software is unaware of a new chip (when the chip version is out of range), it will refuse to run on it unless the Ignore maximum revision restrictions bit is set. This bit removes the upper revision limit.

Minimum versions limits the software to only run on a chip revision that is high enough to support some features. Maximum version is the maximum version that is well-supported by current software. When chip version is above the maximum version, software will reject to boot, because it may not work on, or work with risk on the chip.

Adding the major and minor wafer revision make the versioning logic is branchable.

---

**Note:** The previous versioning logic was based on a single eFuse version field (WAFER\_VERSION). This approach makes it impossible to mark chips as breaking or non-breaking changes, and the versioning logic becomes linear.

---

Using the branched versioning scheme allows us to support more chips in the software without updating the software when a new released compatible chip is used. Thus, the software will be compatible with as many new chip revisions as possible. If the software is no longer compatible with a new chip with breaking changes, the software will abort.

### Revisions

ECO	Revision (Major.Minor)
ECO0	v0.0
ECO1	v1.0

Chip Revision  $vX.Y$ , where:

- $X$  means Major wafer version. If it is changed, it means that the current software version is not compatible with this released chip and the software must be updated to use this chip.
- $Y$  means Minor wafer version. If it is changed that means the current software version is compatible with the released chip, and there is no need to update the software.

The  $vX.Y$  chip version format will be used further instead of the ECO number.

### Representing Revision Requirement Of A Binary Image

The 2nd stage bootloader and the application binary images have the `esp_image_header_t` header, which stores the revision numbers of the chip on which the software can be run. This header has 3 fields related to revisions:

- `min_chip_rev` - Minimal chip MAJOR revision required by image (but for ESP32-C3 it is MINOR revision). Its value is determined by `CONFIG_ESP32S2_REV_MIN`.
- `min_chip_rev_full` - Minimal chip MINOR revision required by image in format: `major * 100 + minor`. Its value is determined by `CONFIG_ESP32S2_REV_MIN`.
- `max_chip_rev_full` - Maximal chip revision required by image in format: `major * 100 + minor`. Its value is determined by `CONFIG_ESP32S2_REV_MAX_FULL`. It can not be changed by user. Only Espressif can change it when a new version will be supported in IDF.

### Chip Revision APIs

These APIs helps to get chip revision from eFuses:

- `efuse_hal_chip_revision()`. It returns revision in the `major * 100 + minor` format.
- `efuse_hal_get_major_chip_version()`. It returns Major revision.
- `efuse_hal_get_minor_chip_version()`. It returns Minor revision.

The following Kconfig definitions (in `major * 100 + minor` format) that can help add the chip revision dependency to the code:

- `CONFIG_ESP32S2_REV_MIN_FULL`
- `CONFIG_ESP_REV_MIN_FULL`
- `CONFIG_ESP32S2_REV_MAX_FULL`
- `CONFIG_ESP_REV_MAX_FULL`

### Maximal And Minimal Revision Restrictions

The order for checking the minimum and maximum revisions:

1. The 1st stage bootloader (ROM bootloader) does not check minimal and maximal revision fields from `esp_image_header_t` before running the 2nd stage bootloader.
2. The 2nd stage bootloader checks at the initialization phase that bootloader itself can be launched on the chip of this revision. It extracts the minimum revision from the header of the bootloader image and checks against the chip revision from eFuses. If the chip revision is less than the minimum revision, the bootloader refuses to boot up and aborts. The maximum revision is not checked at this phase.
3. Then the 2nd stage bootloader checks the revision requirements of the application. It extracts the minimum and maximum revisions from the header of the application image and checks against the chip revision from eFuses. If the chip revision is less than the minimum revision or higher than the maximum revision, the bootloader refuses to boot up and aborts. However, if the Ignore maximal revision bit is set, the maximum revision constraint can be ignored. The ignore bit is set by the customer themselves when there is confirmation that the software is able to work with this chip revision.
4. Further, at the OTA update stage, the running application checks if the new software matches the chip revision. It extracts the minimum and maximum revisions from the header of the new application image and checks against the chip revision from eFuses. It checks for revision matching in the same way that the bootloader does, so that the chip revision is between the min and max revisions (logic of ignoring max revision also applies).

### Issues

1. If the 2nd stage bootloader is run on the chip revision < minimum revision shown in the image, a reboot occurs. The following message will be printed:

```
Image requires chip rev >= v3.0, but chip is v1.0
```

To resolve this issue:

- make sure the chip you are using is suitable for the software, or use a chip with the required minimum revision or higher.
- update the software with `CONFIG_ESP32S2_REV_MIN` to get it `<=` the revision of chip being used

2. If application does not match minimal and maximal chip revisions, a reboot occurs. The following message will be printed:

```
Image requires chip rev <= v2.99, but chip is v3.0
```

To resolve this issue, update the IDF to a newer version that supports the used chip (`CONFIG_ESP32S2_REV_MAX_FULL`). Another way to fix this is to set the Ignore maximal revision bit in eFuse or use a chip that is suitable for the software.

### Backward Compatible With Bootloaders Built By Older ESP-IDF Versions

The old bootloaders (IDF < 5.0) do not know about Major and Minor wafer version eFuses. They use one single eFuse for this - wafer version.

ESP32-S2 chip support was added in IDF 4.2. ESP32-S2 chips have `rev_min` in `esp_image_header_t` header = 0 because `Minimum Supported ESP32-S2 Revision Kconfig` option was not introduced, it means that the old bootloader does not check the chip revision. Any app can be loaded by such bootloader in range v0.0 - v3.15.

Please check the chip version using `esptool chip_id` command.

## API Reference

### Header File

- [components/hal/include/hal/efuse\\_hal.h](#)

### Functions

void **efuse\_hal\_get\_mac** (uint8\_t \*mac)

get factory mac address

uint32\_t **efuse\_hal\_chip\_revision** (void)

Returns chip version.

**Returns** Chip version in format: Major \* 100 + Minor

bool **efuse\_hal\_flash\_encryption\_enabled** (void)

Is flash encryption currently enabled in hardware?

Flash encryption is enabled if the `FLASH_CRYPT_CNT` efuse has an odd number of bits set.

**Returns** true if flash encryption is enabled.

uint32\_t **efuse\_hal\_get\_major\_chip\_version** (void)

Returns major chip version.

uint32\_t **efuse\_hal\_get\_minor\_chip\_version** (void)

Returns minor chip version.

## 2.9.5 Console

ESP-IDF provides `console` component, which includes building blocks needed to develop an interactive console over serial port. This component includes following facilities:

- Line editing, provided by [linenoise](#) library. This includes handling of backspace and arrow keys, scrolling through command history, command auto-completion, and argument hints.
- Splitting of command line into arguments.
- Argument parsing, provided by [argtable3](#) library. This library includes APIs used for parsing GNU style command line arguments.

- Functions for registration and dispatching of commands.
- Functions to establish a basic REPL (Read-Evaluate-Print-Loop) environment.

---

**Note:** These facilities can be used together or independently. For example, it is possible to use line editing and command registration features, but use `getopt` or custom code for argument parsing, instead of [argtable3](#). Likewise, it is possible to use simpler means of command input (such as `fgets`) together with the rest of the means for command splitting and argument parsing.

---

### Line editing

Line editing feature lets users compose commands by typing them, erasing symbols using ‘backspace’ key, navigating within the command using left/right keys, navigating to previously typed commands using up/down keys, and performing autocompletion using ‘tab’ key.

---

**Note:** This feature relies on ANSI escape sequence support in the terminal application. As such, serial monitors which display raw UART data can not be used together with the line editing library. If you see `[\6n` or similar escape sequence when running `system/console` example instead of a command prompt (e.g. `esp>`), it means that the serial monitor does not support escape sequences. Programs which are known to work are GNU `screen`, `minicom`, and `idf_monitor.py` (which can be invoked using `idf.py monitor` from project directory).

---

Here is an overview of functions provided by [linenoise](#) library.

**Configuration** `linenoise` library does not need explicit initialization. However, some configuration defaults may need to be changed before invoking the main line editing function.

```
linenoiseClearScreen()
```

Clear terminal screen using an escape sequence and position the cursor at the top left corner.

```
linenoiseSetMultiLine()
```

Switch between single line and multi line editing modes. In single line mode, if the length of the command exceeds the width of the terminal, the command text is scrolled within the line to show the end of the text. In this case the beginning of the text is hidden. Single line needs less data to be sent to refresh screen on each key press, so exhibits less glitching compared to the multi line mode. On the flip side, editing commands and copying command text from terminal in single line mode is harder. Default is single line mode.

```
linenoiseAllowEmpty()
```

Set whether `linenoise` library will return a zero-length string (if `true`) or `NULL` (if `false`) for empty lines. By default, zero-length strings are returned.

```
linenoiseSetMaxLineLen()
```

Set maximum length of the line for `linenoise` library. Default length is 4096. If you need optimize RAM memory usage, you can do it by this function by setting a value less than default 4 KB.

**Main loop** `linenoise()`

In most cases, console applications have some form of read/eval loop. `linenoise()` is the single function which handles user’s key presses and returns completed line once ‘enter’ key is pressed. As such, it handles the ‘read’ part of the loop.

```
linenoiseFree()
```

This function must be called to release the command line buffer obtained from `linenoise()` function.



**Hints and completions** `linenoiseSetCompletionCallback()`

When user presses ‘tab’ key, linenoise library invokes completion callback. The callback should inspect the contents of the command typed so far and provide a list of possible completions using calls to `linenoiseAddCompletion()` function. `linenoiseSetCompletionCallback()` function should be called to register this completion callback, if completion feature is desired.

`console` component provides a ready made function to provide completions for registered commands, `esp_console_get_completion()` (see below).

```
linenoiseAddCompletion()
```

Function to be called by completion callback to inform the library about possible completions of the currently typed command.

```
linenoiseSetHintsCallback()
```

Whenever user input changes, linenoise invokes hints callback. This callback can inspect the command line typed so far, and provide a string with hints (which can include list of command arguments, for example). The library then displays the hint text on the same line where editing happens, possibly with a different color.

```
linenoiseSetFreeHintsCallback()
```

If hint string returned by hints callback is dynamically allocated or needs to be otherwise recycled, the function which performs such cleanup should be registered via `linenoiseSetFreeHintsCallback()`.

**History** `linenoiseHistorySetMaxLen()`

This function sets the number of most recently typed commands to be kept in memory. Users can navigate the history using up/down arrows.

```
linenoiseHistoryAdd()
```

Linenoise does not automatically add commands to history. Instead, applications need to call this function to add command strings to the history.

```
linenoiseHistorySave()
```

Function saves command history from RAM to a text file, for example on an SD card or on a filesystem in flash memory.

```
linenoiseHistoryLoad()
```

Counterpart to `linenoiseHistorySave()`, loads history from a file.

```
linenoiseHistoryFree()
```

Releases memory used to store command history. Call this function when done working with linenoise library.

**Splitting of command line into arguments**

`console` component provides `esp_console_split_argv()` function to split command line string into arguments. The function returns the number of arguments found (`argc`) and fills an array of pointers which can be passed as `argv` argument to any function which accepts arguments in `argc, argv` format.

The command line is split into arguments according to the following rules:

- Arguments are separated by spaces
- If spaces within arguments are required, they can be escaped using \ (backslash) character.
- Other escape sequences which are recognized are \\ (which produces literal backslash) and \", which produces a double quote.

- Arguments can be quoted using double quotes. Quotes may appear only in the beginning and at the end of the argument. Quotes within the argument must be escaped as mentioned above. Quotes surrounding the argument are stripped by `esp_console_split_argv` function.

Examples:

- `abc def 1 20 .3` → `[ abc, def, 1, 20, .3 ]`
- `abc "123 456" def` → `[ abc, 123 456, def ]`
- ``a\ b\\c\"` → `[ a b\c" ]`

### Argument parsing

For argument parsing, `console` component includes [argtable3](#) library. Please see [tutorial](#) for an introduction to [argtable3](#). Github repository also includes [examples](#).

### Command registration and dispatching

`console` component includes utility functions which handle registration of commands, matching commands typed by the user to registered ones, and calling these commands with the arguments given on the command line.

Application first initializes command registration module using a call to `esp_console_init()`, and calls `esp_console_cmd_register()` function to register command handlers.

For each command, application provides the following information (in the form of `esp_console_cmd_t` structure):

- Command name (string without spaces)
- Help text explaining what the command does
- Optional hint text listing the arguments of the command. If application uses `Argtable3` for argument parsing, hint text can be generated automatically by providing a pointer to `argtable` argument definitions structure instead.
- The command handler function.

A few other functions are provided by the command registration module:

`esp_console_run()`

This function takes the command line string, splits it into `argc/argv` argument list using `esp_console_split_argv()`, looks up the command in the list of registered components, and if it is found, executes its handler.

`esp_console_register_help_command()`

Adds `help` command to the list of registered commands. This command prints the list of all the registered commands, along with their arguments and help texts.

`esp_console_get_completion()`

Callback function to be used with `linenoiseSetCompletionCallback()` from `linenoise` library. Provides completions to `linenoise` based on the list of registered commands.

`esp_console_get_hint()`

Callback function to be used with `linenoiseSetHintsCallback()` from `linenoise` library. Provides argument hints for registered commands to `linenoise`.

### Initialize console REPL environment

To establish a basic REPL environment, `console` component provides several useful APIs, combining those functions described above.

In a typical application, you only need to call `esp_console_new_repl_uart()` to initialize the REPL environment based on UART device, including driver install, basic console configuration, spawning a thread to do REPL task and register several useful commands (e.g. `help`).

After that, you can register your own commands with `esp_console_cmd_register()`. The REPL environment keeps in init state until you call `esp_console_start_repl()`.

### Application Example

Example application illustrating usage of the `console` component is available in `system/console` directory. This example shows how to initialize UART and VFS functions, set up linenoise library, read and handle commands from UART, and store command history in Flash. See README.md in the example directory for more details.

Besides that, ESP-IDF contains several useful examples which based on `console` component and can be treated as “tools” when developing applications. For example, [peripherals/i2c/i2c\\_tools](#), [wifi/iperf](#).

## API Reference

### Header File

- [components/console/esp\\_console.h](#)

### Functions

`esp_err_t esp_console_init` (const `esp_console_config_t` \*config)

initialize console module

---

**Note:** Call this once before using other console module features

---

**Parameters** `config` –console configuration

**Returns**

- ESP\_OK on success
- ESP\_ERR\_NO\_MEM if out of memory
- ESP\_ERR\_INVALID\_STATE if already initialized
- ESP\_ERR\_INVALID\_ARG if the configuration is invalid

`esp_err_t esp_console_deinit` (void)

de-initialize console module

---

**Note:** Call this once when done using console module functions

---

**Returns**

- ESP\_OK on success
- ESP\_ERR\_INVALID\_STATE if not initialized yet

`esp_err_t esp_console_cmd_register` (const `esp_console_cmd_t` \*cmd)

Register console command.

**Parameters** `cmd` –pointer to the command description; can point to a temporary value

**Returns**

- ESP\_OK on success
- ESP\_ERR\_NO\_MEM if out of memory
- ESP\_ERR\_INVALID\_ARG if command description includes invalid arguments

`esp_err_t esp_console_run` (const char \*cmdline, int \*cmd\_ret)

Run command line.

#### Parameters

- **cmdline** –command line (command name followed by a number of arguments)
- **cmd\_ret** –[out] return code from the command (set if command was run)

#### Returns

- ESP\_OK, if command was run
- ESP\_ERR\_INVALID\_ARG, if the command line is empty, or only contained whitespace
- ESP\_ERR\_NOT\_FOUND, if command with given name wasn't registered
- ESP\_ERR\_INVALID\_STATE, if esp\_console\_init wasn't called

size\_t `esp_console_split_argv` (char \*line, char \*\*argv, size\_t argv\_size)

Split command line into arguments in place.

```
* - This function finds whitespace-separated arguments in the given input line.
*
*   'abc def 1 20 .3' -> [ 'abc', 'def', '1', '20', '.3' ]
*
* - Argument which include spaces may be surrounded with quotes. In this case
*   spaces are preserved and quotes are stripped.
*
*   'abc "123 456" def' -> [ 'abc', '123 456', 'def' ]
*
* - Escape sequences may be used to produce backslash, double quote, and space:
*
*   'a\ b\\c\"' -> [ 'a b\c"' ]
*
```

---

**Note:** Pointers to at most argv\_size - 1 arguments are returned in argv array. The pointer after the last one (i.e. argv[argc]) is set to NULL.

---

#### Parameters

- **line** –pointer to buffer to parse; it is modified in place
- **argv** –array where the pointers to arguments are written
- **argv\_size** –number of elements in argv\_array (max. number of arguments)

**Returns** number of arguments found (argc)

void `esp_console_get_completion` (const char \*buf, *linenoiseCompletions* \*lc)

Callback which provides command completion for linenoise library.

When using linenoise for line editing, command completion support can be enabled like this:

```
linenoiseSetCompletionCallback(&esp_console_get_completion);
```

#### Parameters

- **buf** –the string typed by the user
- **lc** –linenoiseCompletions to be filled in

const char \*`esp_console_get_hint` (const char \*buf, int \*color, int \*bold)

Callback which provides command hints for linenoise library.

When using linenoise for line editing, hints support can be enabled as follows:

```
linenoiseSetHintsCallback((linenoiseHintsCallback*) &esp_console_get_hint);
```

The extra cast is needed because linenoiseHintsCallback is defined as returning a char\* instead of const char\*.

#### Parameters

- **buf** –line typed by the user

- **color** –[out] ANSI color code to be used when displaying the hint
- **bold** –[out] set to 1 if hint has to be displayed in bold

**Returns** string containing the hint text. This string is persistent and should not be freed (i.e. `linenoiseSetFreeHintsCallback` should not be used).

*esp\_err\_t* **esp\_console\_register\_help\_command** (void)

Register a ‘help’ command.

Default ‘help’ command prints the list of registered commands along with hints and help strings.

**Returns**

- ESP\_OK on success
- ESP\_ERR\_INVALID\_STATE, if `esp_console_init` wasn’t called

*esp\_err\_t* **esp\_console\_new\_repl\_uart** (const *esp\_console\_dev\_uart\_config\_t* \*dev\_config, const *esp\_console\_repl\_config\_t* \*repl\_config, *esp\_console\_repl\_t* \*\*ret\_repl)

Establish a console REPL environment over UART driver.

**Attention** This function is meant to be used in the examples to make the code more compact. Applications which use console functionality should be based on the underlying `linenoise` and `esp_console` functions.

---

**Note:** This is an all-in-one function to establish the environment needed for REPL, includes:

- Install the UART driver on the console UART (8n1, 115200, REF\_TICK clock source)
- Configures the stdin/stdout to go through the UART driver
- Initializes `linenoise`
- Spawn new thread to run REPL in the background

---

**Parameters**

- **dev\_config** –[in] UART device configuration
- **repl\_config** –[in] REPL configuration
- **ret\_repl** –[out] return REPL handle after initialization succeed, return NULL otherwise

**Returns**

- ESP\_OK on success
- ESP\_FAIL Parameter error

*esp\_err\_t* **esp\_console\_new\_repl\_usb\_cdc** (const *esp\_console\_dev\_usb\_cdc\_config\_t* \*dev\_config, const *esp\_console\_repl\_config\_t* \*repl\_config, *esp\_console\_repl\_t* \*\*ret\_repl)

Establish a console REPL environment over USB CDC.

**Attention** This function is meant to be used in the examples to make the code more compact. Applications which use console functionality should be based on the underlying `linenoise` and `esp_console` functions.

---

**Note:** This is a all-in-one function to establish the environment needed for REPL, includes:

- Initializes `linenoise`
- Spawn new thread to run REPL in the background

---

**Parameters**

- **dev\_config** –[in] USB CDC configuration
- **repl\_config** –[in] REPL configuration

- **ret\_repl** **–[out]** return REPL handle after initialization succeed, return NULL otherwise

**Returns**

- ESP\_OK on success
- ESP\_FAIL Parameter error

*esp\_err\_t* **esp\_console\_start\_repl** (*esp\_console\_repl\_t* \*repl)

Start REPL environment.

---

**Note:** Once the REPL gets started, it won't be stopped until the user calls `repl->del(repl)` to destroy the REPL environment.

---

**Parameters** **repl** **–[in]** REPL handle returned from `esp_console_new_repl_xxx`

**Returns**

- ESP\_OK on success
- ESP\_ERR\_INVALID\_STATE, if repl has started already

## Structures

struct **esp\_console\_config\_t**

Parameters for console initialization.

### Public Members

size\_t **max\_cmdline\_length**

length of command line buffer, in bytes

size\_t **max\_cmdline\_args**

maximum number of command line arguments to parse

int **hint\_color**

ASCII color code of hint text.

int **hint\_bold**

Set to 1 to print hint text in bold.

struct **esp\_console\_repl\_config\_t**

Parameters for console REPL (Read Eval Print Loop)

### Public Members

uint32\_t **max\_history\_len**

maximum length for the history

const char \***history\_save\_path**

file path used to save history commands, set to NULL won't save to file system

uint32\_t **task\_stack\_size**

repl task stack size

uint32\_t **task\_priority**

repl task priority

const char \***prompt**

prompt (NULL represents default: “esp> “)

size\_t **max\_cmdline\_length**

maximum length of a command line. If 0, default value will be used

struct **esp\_console\_dev\_uart\_config\_t**

Parameters for console device: UART.

### Public Members

int **channel**

UART channel number (count from zero)

int **baud\_rate**

Communication baud rate.

int **tx\_gpio\_num**

GPIO number for TX path, -1 means using default one.

int **rx\_gpio\_num**

GPIO number for RX path, -1 means using default one.

struct **esp\_console\_dev\_usb\_cdc\_config\_t**

Parameters for console device: USB CDC.

---

**Note:** It’ s an empty structure for now, reserved for future

---

struct **esp\_console\_cmd\_t**

Console command description.

### Public Members

const char \***command**

Command name. Must not be NULL, must not contain spaces. The pointer must be valid until the call to esp\_console\_deinit.

const char \***help**

Help text for the command, shown by help command. If set, the pointer must be valid until the call to esp\_console\_deinit. If not set, the command will not be listed in ‘help’ output.

const char \***hint**

Hint text, usually lists possible arguments. If set to NULL, and ‘argtable’ field is non-NULL, hint will be generated automatically

*esp\_console\_cmd\_func\_t* **func**

Pointer to a function which implements the command.

void **\*argtable**

Array or structure of pointers to arg\_xxx structures, may be NULL. Used to generate hint text if 'hint' is set to NULL. Array/structure which this field points to must end with an arg\_end. Only used for the duration of esp\_console\_cmd\_register call.

struct **esp\_console\_repl\_s**

Console REPL base structure.

## Public Members

*esp\_err\_t* (\***del**)(*esp\_console\_repl\_t* \*repl)

Delete console REPL environment.

**Param repl [in]** REPL handle returned from esp\_console\_new\_repl\_xxx

**Return**

- ESP\_OK on success
- ESP\_FAIL on errors

## Macros

**ESP\_CONSOLE\_CONFIG\_DEFAULT** ()

Default console configuration value.

**ESP\_CONSOLE\_REPL\_CONFIG\_DEFAULT** ()

Default console repl configuration value.

**ESP\_CONSOLE\_DEV\_UART\_CONFIG\_DEFAULT** ()

**ESP\_CONSOLE\_DEV\_CDC\_CONFIG\_DEFAULT** ()

## Type Definitions

typedef struct *linenoiseCompletions* **linenoiseCompletions**

typedef int (\***esp\_console\_cmd\_func\_t**)(int argc, char \*\*argv)

Console command main function.

**Param argc** number of arguments

**Param argv** array with argc entries, each pointing to a zero-terminated string argument

**Return** console command return code, 0 indicates "success"

typedef struct *esp\_console\_repl\_s* **esp\_console\_repl\_t**

Type defined for console REPL.

## 2.9.6 eFuse Manager

### Introduction

The eFuse Manager library is designed to structure access to eFuse bits and make using these easy. This library operates eFuse bits by a structure name which is assigned in eFuse table. This sections introduces some concepts used by eFuse Manager.



## Hardware description

The ESP32-S2 has a number of eFuses which can store system and user parameters. Each eFuse is a one-bit field which can be programmed to 1 after which it cannot be reverted back to 0. Some of system parameters are using these eFuse bits directly by hardware modules and have special place (for example EFUSE\_BLK0).

For more details, see *ESP32-S2 Technical Reference Manual > eFuse Controller (eFuse)* [PDF]. Some eFuse bits are available for user applications.

ESP32-S2 has 11 eFuse blocks each of the size of 256 bits (not all bits are available):

- EFUSE\_BLK0 is used entirely for system purposes;
- EFUSE\_BLK1 is used entirely for system purposes;
- EFUSE\_BLK2 is used entirely for system purposes;
- EFUSE\_BLK3 (also named EFUSE\_BLK\_USER\_DATA) can be used for user purposes;
- EFUSE\_BLK4 (also named EFUSE\_BLK\_KEY0) can be used as key (for secure\_boot or flash\_encryption) or for user purposes;
- EFUSE\_BLK5 (also named EFUSE\_BLK\_KEY1) can be used as key (for secure\_boot or flash\_encryption) or for user purposes;
- EFUSE\_BLK6 (also named EFUSE\_BLK\_KEY2) can be used as key (for secure\_boot or flash\_encryption) or for user purposes;
- EFUSE\_BLK7 (also named EFUSE\_BLK\_KEY3) can be used as key (for secure\_boot or flash\_encryption) or for user purposes;
- EFUSE\_BLK8 (also named EFUSE\_BLK\_KEY4) can be used as key (for secure\_boot or flash\_encryption) or for user purposes;
- EFUSE\_BLK9 (also named EFUSE\_BLK\_KEY5) can be used as key (for secure\_boot or flash\_encryption) or for user purposes;
- EFUSE\_BLK10 (also named EFUSE\_BLK\_SYS\_DATA\_PART2) is reserved for system purposes.

Each block is divided into 8 32-bits registers.

## eFuse Manager component

The component has API functions for reading and writing fields. Access to the fields is carried out through the structures that describe the location of the eFuse bits in the blocks. The component provides the ability to form fields of any length and from any number of individual bits. The description of the fields is made in a CSV file in a table form. To generate from a tabular form (CSV file) in the C-source uses the tool *efuse\_table\_gen.py*. The tool checks the CSV file for uniqueness of field names and bit intersection, in case of using a *custom* file from the user's project directory, the utility will check with the *common* CSV file.

CSV files:

- common (*esp\_efuse\_table.csv*) - contains eFuse fields which are used inside the IDF. C-source generation should be done manually when changing this file (run command `idf.py efuse-common-table`). Note that changes in this file can lead to incorrect operation.
- custom - (optional and can be enabled by [CONFIG\\_EFUSE\\_CUSTOM\\_TABLE](#)) contains eFuse fields that are used by the user in their application. C-source generation should be done manually when changing this file and running `idf.py efuse-custom-table`.

## Description CSV file

The CSV file contains a description of the eFuse fields. In the simple case, one field has one line of description. Table header:

```
# field_name, efuse_block(EFUSE_BLK0..EFUSE_BLK10), bit_start(0..255), bit_
↪count(1..256), comment
```

Individual params in CSV file the following meanings:

**field\_name** Name of field. The prefix `ESP_EFUSE_` will be added to the name, and this field name will be available in the code. This name will be used to access the fields. The name must be unique for all fields. If the line has an empty name, then this line is combined with the previous field. This allows you to set an arbitrary order of bits in the field, and expand the field as well (see `MAC_FACTORY` field in the common table). The `field_name` supports structured format using `.` to show that the field belongs to another field (see `WR_DIS` and `RD_DIS` in the common table).

**efuse\_block** Block number. It determines where the eFuse bits will be placed for this field. Available `EFUSE_BLK0..EFUSE_BLK10`.

**bit\_start** Start bit number (0..255). The `bit_start` field can be omitted. In this case, it will be set to `bit_start + bit_count` from the previous record, if it has the same `efuse_block`. Otherwise (if `efuse_block` is different, or this is the first entry), an error will be generated.

**bit\_count** The number of bits to use in this field (1..-). This parameter can not be omitted. This field also may be `MAX_BLK_LEN` in this case, the field length will have the maximum block length.

**comment** This param is using for comment field, it also move to C-header file. The comment field can be omitted.

If a non-sequential bit order is required to describe a field, then the field description in the following lines should be continued without specifying a name, this will indicate that it belongs to one field. For example two fields `MAC_FACTORY` and `MAC_FACTORY_CRC`:

```
# Factory MAC address #
#####
MAC_FACTORY,          EFUSE_BLK0,    72,    8,    Factory MAC addr [0]
,                    EFUSE_BLK0,    64,    8,    Factory MAC addr [1]
,                    EFUSE_BLK0,    56,    8,    Factory MAC addr [2]
,                    EFUSE_BLK0,    48,    8,    Factory MAC addr [3]
,                    EFUSE_BLK0,    40,    8,    Factory MAC addr [4]
,                    EFUSE_BLK0,    32,    8,    Factory MAC addr [5]
MAC_FACTORY_CRC,     EFUSE_BLK0,    80,    8,    CRC8 for factory MAC address
```

This field will available in code as `ESP_EFUSE_MAC_FACTORY` and `ESP_EFUSE_MAC_FACTORY_CRC`.

### Structured efuse fields

```
WR_DIS,              EFUSE_BLK0,    0,    32,    Write protection
WR_DIS.RD_DIS,      EFUSE_BLK0,    0,    1,    Write protection for
↳RD_DIS
WR_DIS.FIELD_1,     EFUSE_BLK0,    1,    1,    Write protection for
↳FIELD_1
WR_DIS.FIELD_2,     EFUSE_BLK0,    2,    4,    Write protection for
↳FIELD_2 (includes B1 and B2)
WR_DIS.FIELD_2.B1,  EFUSE_BLK0,    2,    2,    Write protection for
↳FIELD_2.B1
WR_DIS.FIELD_2.B2,  EFUSE_BLK0,    4,    2,    Write protection for
↳FIELD_2.B2
WR_DIS.FIELD_3,     EFUSE_BLK0,    5,    1,    Write protection for
↳FIELD_3
WR_DIS.FIELD_3.ALIAS, EFUSE_BLK0,    5,    1,    Write protection for
↳FIELD_3 (just a alias for WR_DIS.FIELD_3)
WR_DIS.FIELD_4,     EFUSE_BLK0,    7,    1,    Write protection for
↳FIELD_4
```

The structured eFuse field looks like `WR_DIS.RD_DIS` where the dot points that this field belongs to the parent field - `WR_DIS` and can not be out of the parent's range.

It is possible to use some levels of structured fields as `WR_DIS.FIELD_2.B1` and `B2`. These fields should not be crossed each other and should be in the range of two fields: `WR_DIS` and `WR_DIS.FIELD_2`.

It is possible to create aliases for fields with the same range, see `WR_DIS.FIELD_3` and `WR_DIS.FIELD_3.ALIAS`.

The IDF names for structured efuse fields should be unique. The `efuse_table_gen` tool will generate the final names where the dot will be replaced by `_`. The names for using in IDF are `ESP_EFUSE_WR_DIS`, `ESP_EFUSE_WR_DIS_RD_DIS`, `ESP_EFUSE_WR_DIS_FIELD_2_B1`, etc.

The `efuse_table_gen` tool checks that the fields do not overlap each other and must be within the range of a field if there is a violation, then throws the following error:

```
Field at USER_DATA, EFUSE_BLK3, 0, 256 intersected with SERIAL_NUMBER, EFUSE_
↪BLK3, 0, 32
```

**Solution:** Describe `SERIAL_NUMBER` to be included in `USER_DATA`. (`USER_DATA.SERIAL_NUMBER`).

```
Field at FEILD, EFUSE_BLK3, 0, 50 out of range FEILD.MAJOR_NUMBER, EFUSE_BLK3, ↪
↪60, 32
```

**Solution:** Change `bit_start` for `FIELD.MAJOR_NUMBER` from 60 to 0, so `MAJOR_NUMBER` is in the `FEILD` range.

### efuse\_table\_gen.py tool

The tool is designed to generate C-source files from CSV file and validate fields. First of all, the check is carried out on the uniqueness of the names and overlaps of the field bits. If an additional *custom* file is used, it will be checked with the existing *common* file (`esp_efuse_table.csv`). In case of errors, a message will be displayed and the string that caused the error. C-source files contain structures of type `esp_efuse_desc_t`.

To generate a *common* files, use the following command `idf.py efuse-common-table` or:

```
cd $IDF_PATH/components/efuse/
./efuse_table_gen.py --idf_target esp32s2 esp32s2/esp_efuse_table.csv
```

After generation in the folder `$IDF_PATH/components/efuse/esp32s2` create:

- `esp_efuse_table.c` file.
- In *include* folder `esp_efuse_table.c` file.

To generate a *custom* files, use the following command `idf.py efuse-custom-table` or:

```
cd $IDF_PATH/components/efuse/
./efuse_table_gen.py --idf_target esp32s2 esp32s2/esp_efuse_table.csv PROJECT_PATH/
↪main/esp_efuse_custom_table.csv
```

After generation in the folder `PROJECT_PATH/main` create:

- `esp_efuse_custom_table.c` file.
- In *include* folder `esp_efuse_custom_table.c` file.

To use the generated fields, you need to include two files:

```
#include "esp_efuse.h"
#include "esp_efuse_table.h" // or "esp_efuse_custom_table.h"
```

### Supported coding scheme

Coding schemes are used to protect against data corruption. ESP32-S2 supports two coding schemes:

- None. `EFUSE_BLK0` is stored with four backups, meaning each bit is stored four times. This backup scheme is automatically applied by the hardware and is not visible to software. `EFUSE_BLK0` can be written many times.
- RS. `EFUSE_BLK1` - `EFUSE_BLK10` use Reed-Solomon coding scheme that supports up to 5 bytes of automatic error correction. Software will encode the 32-byte `EFUSE_BLKx` using RS (44, 32) to generate a 12-byte check code, and then burn the `EFUSE_BLKx` and the check code into eFuse at the same time. The

eFuse Controller automatically decodes the RS encoding and applies error correction when reading back the eFuse block. Because the RS check codes are generated across the entire 256-bit eFuse block, each block can only be written to one time.

To write some fields into one block, or different blocks in one time, you need to use the `batch writing` mode. Firstly set this mode through `esp_efuse_batch_write_begin()` function then write some fields as usual using the `esp_efuse_write_...` functions. At the end to burn them, call the `esp_efuse_batch_write_commit()` function. It burns prepared data to the eFuse blocks and disables the batch recording mode.

---

**Note:** If there is already pre-written data in the eFuse block using the Reed-Solomon encoding scheme, then it is not possible to write anything extra (even if the required bits are empty) without breaking the previous encoding data. This encoding data will be overwritten with new encoding data and completely destroyed (however, the payload eFuses are not damaged). It can be related to: `CUSTOM_MAC`, `SPI_PAD_CONFIG_HD`, `SPI_PAD_CONFIG_CS`, etc. Please contact Espressif to order the required pre-burnt eFuses.

FOR TESTING ONLY (NOT RECOMMENDED): You can ignore or suppress errors that violate encoding scheme data in order to burn the necessary bits in the eFuse block.

---

## eFuse API

Access to the fields is via a pointer to the description structure. API functions have some basic operation:

- `esp_efuse_read_field_blob()` - returns an array of read eFuse bits.
- `esp_efuse_read_field_cnt()` - returns the number of bits programmed as "1".
- `esp_efuse_write_field_blob()` - writes an array.
- `esp_efuse_write_field_cnt()` - writes a required count of bits as "1".
- `esp_efuse_get_field_size()` - returns the number of bits by the field name.
- `esp_efuse_read_reg()` - returns value of eFuse register.
- `esp_efuse_write_reg()` - writes value to eFuse register.
- `esp_efuse_get_coding_scheme()` - returns eFuse coding scheme for blocks.
- `esp_efuse_read_block()` - reads key to eFuse block starting at the offset and the required size.
- `esp_efuse_write_block()` - writes key to eFuse block starting at the offset and the required size.
- `esp_efuse_batch_write_begin()` - set the batch mode of writing fields.
- `esp_efuse_batch_write_commit()` - writes all prepared data for batch writing mode and reset the batch writing mode.
- `esp_efuse_batch_write_cancel()` - reset the batch writing mode and prepared data.
- `esp_efuse_get_key_dis_read()` - Returns a read protection for the key block.
- `esp_efuse_set_key_dis_read()` - Sets a read protection for the key block.
- `esp_efuse_get_key_dis_write()` - Returns a write protection for the key block.
- `esp_efuse_set_key_dis_write()` - Sets a write protection for the key block.
- `esp_efuse_get_key_purpose()` - Returns the current purpose set for an eFuse key block.
- `esp_efuse_write_key()` - Programs a block of key data to an eFuse block
- `esp_efuse_write_keys()` - Programs keys to unused eFuse blocks
- `esp_efuse_find_purpose()` - Finds a key block with the particular purpose set.
- `esp_efuse_get_keypurpose_dis_write()` - Returns a write protection of the key purpose field for an eFuse key block (for esp32 always true).
- `esp_efuse_key_block_unused()` - Returns true if the key block is unused, false otherwise.

For frequently used fields, special functions are made, like this `esp_efuse_get_pkg_ver()`.

### eFuse API for keys

`EFUSE_BLK_KEY0` - `EFUSE_BLK_KEY5` are intended to keep up to 6 keys with a length of 256-bits. Each key has an `ESP_EFUSE_KEY_PURPOSE_x` field which defines the purpose of these keys. The purpose field is described in `esp_efuse_purpose_t`.

The purposes like `ESP_EFUSE_KEY_PURPOSE_XTS_AES...` are used for flash encryption.

The purposes like `ESP_EFUSE_KEY_PURPOSE_SECURE_BOOT_DIGEST...` are used for secure boot.

There are some eFuse APIs useful to work with states of keys.

- `esp_efuse_get_purpose_field()` - Returns a pointer to a key purpose for an eFuse key block.
- `esp_efuse_get_key()` - Returns a pointer to a key block.
- `esp_efuse_set_key_purpose()` - Sets a key purpose for an eFuse key block.
- `esp_efuse_set_keypurpose_dis_write()` - Sets a write protection of the key purpose field for an eFuse key block.
- `esp_efuse_find_unused_key_block()` - Search for an unused key block and return the first one found.
- `esp_efuse_count_unused_key_blocks()` - Returns the number of unused eFuse key blocks in the range `EFUSE_BLK_KEY0..EFUSE_BLK_KEY_MAX`
- `esp_efuse_get_digest_revoke()` - Returns the status of the Secure Boot public key digest revocation bit.
- `esp_efuse_set_digest_revoke()` - Sets the Secure Boot public key digest revocation bit.
- `esp_efuse_get_write_protect_of_digest_revoke()` - Returns a write protection of the Secure Boot public key digest revocation bit.
- `esp_efuse_set_write_protect_of_digest_revoke()` - Sets a write protection of the Secure Boot public key digest revocation bit.

### How to add a new field

1. Find a free bits for field. Show `esp_efuse_table.csv` file or run `idf.py show-efuse-table` or the next command:

```
$ ./efuse_table_gen.py esp32s2/esp_efuse_table.csv --info
Parsing efuse CSV input file $IDF_PATH/components/efuse/esp32s2/esp_efuse_table.
↳csv ...
Verifying efuse table...
Max number of bits in BLK 256
Sorted efuse table:
#      field_name                efuse_block    bit_start    bit_count
1      WR_DIS                        EFUSE_BLK0     0             32
2      WR_DIS.RD_DIS                 EFUSE_BLK0     0             1
3      WR_DIS.DIS_RTC_RAM_BOOT       EFUSE_BLK0     1             1
4      WR_DIS.GROUP_1                EFUSE_BLK0     2             1
5      WR_DIS.GROUP_2                EFUSE_BLK0     3             1
6      WR_DIS.SPI_BOOT_CRYPT_CNT     EFUSE_BLK0     4             1
7      WR_DIS.SECURE_BOOT_KEY_REVOKE0 EFUSE_BLK0     5             1
8      WR_DIS.SECURE_BOOT_KEY_REVOKE1 EFUSE_BLK0     6             1
9      WR_DIS.SECURE_BOOT_KEY_REVOKE2 EFUSE_BLK0     7             1
10     WR_DIS.KEY0_PURPOSE           EFUSE_BLK0     8             1
11     WR_DIS.KEY1_PURPOSE           EFUSE_BLK0     9             1
12     WR_DIS.KEY2_PURPOSE           EFUSE_BLK0    10            1
13     WR_DIS.KEY3_PURPOSE           EFUSE_BLK0    11            1
14     WR_DIS.KEY4_PURPOSE           EFUSE_BLK0    12            1
15     WR_DIS.KEY5_PURPOSE           EFUSE_BLK0    13            1
16     WR_DIS.SECURE_BOOT_EN         EFUSE_BLK0    15            1
17     WR_DIS.SECURE_BOOT_AGGRESSIVE_REVOKE EFUSE_BLK0    16            1
↳1
18     WR_DIS.GROUP_3                EFUSE_BLK0    18            1
19     WR_DIS.BLK1                   EFUSE_BLK0    20            1
20     WR_DIS.SYS_DATA_PART1         EFUSE_BLK0    21            1
21     WR_DIS.USER_DATA              EFUSE_BLK0    22            1
22     WR_DIS.KEY0                   EFUSE_BLK0    23            1
23     WR_DIS.KEY1                   EFUSE_BLK0    24            1
24     WR_DIS.KEY2                   EFUSE_BLK0    25            1
25     WR_DIS.KEY3                   EFUSE_BLK0    26            1
```

(continues on next page)

(continued from previous page)

26	WR_DIS.KEY4	EFUSE_BLK0	27	1
27	WR_DIS.KEY5	EFUSE_BLK0	28	1
28	WR_DIS.SYS_DATA_PART2	EFUSE_BLK0	29	1
29	WR_DIS.USB_EXCHG_PINS	EFUSE_BLK0	30	1
30	RD_DIS	EFUSE_BLK0	32	7
31	RD_DIS.KEY0	EFUSE_BLK0	32	1
32	RD_DIS.KEY1	EFUSE_BLK0	33	1
33	RD_DIS.KEY2	EFUSE_BLK0	34	1
34	RD_DIS.KEY3	EFUSE_BLK0	35	1
35	RD_DIS.KEY4	EFUSE_BLK0	36	1
36	RD_DIS.KEY5	EFUSE_BLK0	37	1
37	RD_DIS.SYS_DATA_PART2	EFUSE_BLK0	38	1
38	DIS_RTC_RAM_BOOT	EFUSE_BLK0	39	1
39	DIS_ICACHE	EFUSE_BLK0	40	1
40	DIS_DCACHE	EFUSE_BLK0	41	1
41	DIS_DOWNLOAD_ICACHE	EFUSE_BLK0	42	1
42	DIS_DOWNLOAD_DCACHE	EFUSE_BLK0	43	1
43	DIS_FORCE_DOWNLOAD	EFUSE_BLK0	44	1
44	DIS_USB	EFUSE_BLK0	45	1
45	DIS_CAN	EFUSE_BLK0	46	1
46	DIS_BOOT_REMAP	EFUSE_BLK0	47	1
47	SOFT_DIS_JTAG	EFUSE_BLK0	49	1
48	HARD_DIS_JTAG	EFUSE_BLK0	50	1
49	DIS_DOWNLOAD_MANUAL_ENCRYPT	EFUSE_BLK0	51	1
50	USB_EXCHG_PINS	EFUSE_BLK0	56	1
51	USB_EXT_PHY_ENABLE	EFUSE_BLK0	57	1
52	BLOCK0_VERSION	EFUSE_BLK0	59	2
53	VDD_SPI_XPD	EFUSE_BLK0	68	1
54	VDD_SPI_TIEH	EFUSE_BLK0	69	1
55	VDD_SPI_FORCE	EFUSE_BLK0	70	1
56	WDT_DELAY_SEL	EFUSE_BLK0	80	2
57	SPI_BOOT_CRYPT_CNT	EFUSE_BLK0	82	3
58	SECURE_BOOT_KEY_REVOKE0	EFUSE_BLK0	85	1
59	SECURE_BOOT_KEY_REVOKE1	EFUSE_BLK0	86	1
60	SECURE_BOOT_KEY_REVOKE2	EFUSE_BLK0	87	1
61	KEY_PURPOSE_0	EFUSE_BLK0	88	4
62	KEY_PURPOSE_1	EFUSE_BLK0	92	4
63	KEY_PURPOSE_2	EFUSE_BLK0	96	4
64	KEY_PURPOSE_3	EFUSE_BLK0	100	4
65	KEY_PURPOSE_4	EFUSE_BLK0	104	4
66	KEY_PURPOSE_5	EFUSE_BLK0	108	4
67	SECURE_BOOT_EN	EFUSE_BLK0	116	1
68	SECURE_BOOT_AGGRESSIVE_REVOKE	EFUSE_BLK0	117	1
69	FLASH_TPUW	EFUSE_BLK0	124	4
70	DIS_DOWNLOAD_MODE	EFUSE_BLK0	128	1
71	DIS_LEGACY_SPI_BOOT	EFUSE_BLK0	129	1
72	UART_PRINT_CHANNEL	EFUSE_BLK0	130	1
73	DIS_USB_DOWNLOAD_MODE	EFUSE_BLK0	132	1
74	ENABLE_SECURITY_DOWNLOAD	EFUSE_BLK0	133	1
75	UART_PRINT_CONTROL	EFUSE_BLK0	134	2
76	PIN_POWER_SELECTION	EFUSE_BLK0	136	1
77	FLASH_TYPE	EFUSE_BLK0	137	1
78	FORCE_SEND_RESUME	EFUSE_BLK0	138	1
79	SECURE_VERSION	EFUSE_BLK0	139	16
80	MAC_FACTORY	EFUSE_BLK1	0	8
81	MAC_FACTORY	EFUSE_BLK1	8	8
82	MAC_FACTORY	EFUSE_BLK1	16	8
83	MAC_FACTORY	EFUSE_BLK1	24	8
84	MAC_FACTORY	EFUSE_BLK1	32	8
85	MAC_FACTORY	EFUSE_BLK1	40	8
86	SPI_PAD_CONFIG_CLK	EFUSE_BLK1	48	6

(continues on next page)

(continued from previous page)

87	SPI_PAD_CONFIG_Q_D1	EFUSE_BLK1	54	6
88	SPI_PAD_CONFIG_D_D0	EFUSE_BLK1	60	6
89	SPI_PAD_CONFIG_CS	EFUSE_BLK1	66	6
90	SPI_PAD_CONFIG_HD_D3	EFUSE_BLK1	72	6
91	SPI_PAD_CONFIG_WP_D2	EFUSE_BLK1	78	6
92	SPI_PAD_CONFIG_DQS	EFUSE_BLK1	84	6
93	SPI_PAD_CONFIG_D4	EFUSE_BLK1	90	6
94	SPI_PAD_CONFIG_D5	EFUSE_BLK1	96	6
95	SPI_PAD_CONFIG_D6	EFUSE_BLK1	102	6
96	SPI_PAD_CONFIG_D7	EFUSE_BLK1	108	6
97	WAFER_VERSION	EFUSE_BLK1	114	3
98	FLASH_VERSION	EFUSE_BLK1	117	4
99	BLOCK1_VERSION	EFUSE_BLK1	121	3
100	PSRAM_VERSION	EFUSE_BLK1	124	4
101	PKG_VERSION	EFUSE_BLK1	128	4
102	SYS_DATA_PART2	EFUSE_BLK10	0	256
103	OPTIONAL_UNIQUE_ID	EFUSE_BLK2	0	128
104	BLOCK2_VERSION	EFUSE_BLK2	132	3
105	USER_DATA	EFUSE_BLK3	0	256
106	USER_DATA.MAC_CUSTOM	EFUSE_BLK3	200	48
107	KEY0	EFUSE_BLK4	0	256
108	KEY1	EFUSE_BLK5	0	256
109	KEY2	EFUSE_BLK6	0	256
110	KEY3	EFUSE_BLK7	0	256
111	KEY4	EFUSE_BLK8	0	256
112	KEY5	EFUSE_BLK9	0	256

Used bits in efuse table:

EFUSE\_BLK0

[0 31] [0 13] [15 16] [18 18] [20 30] [32 38] [32 47] [49 51] [56 57] [59 60] [68-  
→70] [80 111] [116 117] [124 130] [132 154]

EFUSE\_BLK1

[0 131]

EFUSE\_BLK10

[0 255]

EFUSE\_BLK2

[0 127] [132 134]

EFUSE\_BLK3

[0 255] [200 247]

EFUSE\_BLK4

[0 255]

EFUSE\_BLK5

[0 255]

EFUSE\_BLK6

[0 255]

EFUSE\_BLK7

[0 255]

EFUSE\_BLK8

[0 255]

EFUSE\_BLK9

[0 255]

(continues on next page)

(continued from previous page)

Note: Not printed ranges are free for using. (bits in EFUSE\_BLK0 are reserved for ↪Espressif)

The number of bits not included in square brackets is free (some bits are reserved for Espressif). All fields are checked for overlapping.

To add fields to an existing field, use the *Structured efuse fields* technique. For example, adding the fields: SERIAL\_NUMBER, MODEL\_NUMBER and HARDWARE REV to an existing USER\_DATA field. Use . (dot) to show an attachment in a field.

USER_DATA.SERIAL_NUMBER,	EFUSE_BLK3,	0,	32,
USER_DATA.MODEL_NUMBER,	EFUSE_BLK3,	32,	10,
USER_DATA.HARDWARE_REV,	EFUSE_BLK3,	42,	10,

2. Fill a line for field: field\_name, efuse\_block, bit\_start, bit\_count, comment.
3. Run a show\_efuse\_table command to check eFuse table. To generate source files run efuse\_common\_table or efuse\_custom\_table command.

You may get errors such as intersects with or out of range. Please see how to solve them in the *Structured efuse fields* article.

### Bit Order

The eFuses bit order is little endian (see the example below), it means that eFuse bits are read and written from LSB to MSB:

```
$ espefuse.py dump

USER_DATA      (BLOCK3      ) [3 ] read_regs: 03020100 07060504 0B0A0908 ↪
↪0F0E0D0C 13121111 17161514 1B1A1918 1F1E1D1C
BLOCK4        (BLOCK4      ) [4 ] read_regs: 03020100 07060504 0B0A0908 ↪
↪0F0E0D0C 13121111 17161514 1B1A1918 1F1E1D1C

where is the register representation:

EFUSE_RD_USR_DATA0_REG = 0x03020100
EFUSE_RD_USR_DATA1_REG = 0x07060504
EFUSE_RD_USR_DATA2_REG = 0x0B0A0908
EFUSE_RD_USR_DATA3_REG = 0x0F0E0D0C
EFUSE_RD_USR_DATA4_REG = 0x13121111
EFUSE_RD_USR_DATA5_REG = 0x17161514
EFUSE_RD_USR_DATA6_REG = 0x1B1A1918
EFUSE_RD_USR_DATA7_REG = 0x1F1E1D1C

where is the byte representation:

byte[0] = 0x00, byte[1] = 0x01, ... byte[3] = 0x03, byte[4] = 0x04, ..., byte[31] ↪
↪= 0x1F
```

For example, csv file describes the USER\_DATA field, which occupies all 256 bits (a whole block).

USER_DATA,	EFUSE_BLK3,	0,	256,	User data
USER_DATA.FIELD1,	EFUSE_BLK3,	16,	16,	Field1
ID,	EFUSE_BLK4,	8,	3,	ID bit[0..2]
,	EFUSE_BLK4,	16,	2,	ID bit[3..4]
,	EFUSE_BLK4,	32,	3,	ID bit[5..7]

Thus, reading the eFuse USER\_DATA block written as above gives the following results:



```

uint8_t buf[32] = { 0 };
esp_efuse_read_field_blob(ESP_EFUSE_USER_DATA, &buf, sizeof(buf) * 8);
// buf[0] = 0x00, buf[1] = 0x01, ... buf[31] = 0x1F

uint32_t field1 = 0;
size_t field1_size = ESP_EFUSE_USER_DATA[0]->bit_count; // can be used for this_
↳case because it only consists of one entry
esp_efuse_read_field_blob(ESP_EFUSE_USER_DATA, &field1, field1_size);
// field1 = 0x0302

uint32_t field1_1 = 0;
esp_efuse_read_field_blob(ESP_EFUSE_USER_DATA, &field1_1, 2); // reads only first_
↳2 bits
// field1 = 0x0002

uint8_t id = 0;
size_t id_size = esp_efuse_get_field_size(ESP_EFUSE_ID); // returns 6
// size_t id_size = ESP_EFUSE_USER_DATA[0]->bit_count; // can NOT be used because_
↳it consists of 3 entries. It returns 3 not 6.
esp_efuse_read_field_blob(ESP_EFUSE_ID, &id, id_size);
// id = 0x91
// b'100 10 001
//   [3] [2] [3]

uint8_t id_1 = 0;
esp_efuse_read_field_blob(ESP_EFUSE_ID, &id_1, 3);
// id = 0x01
// b'001

```

## Debug eFuse & Unit tests

**Virtual eFuses** The Kconfig option `CONFIG_EFUSE_VIRTUAL` will virtualize eFuse values inside the eFuse Manager, so writes are emulated and no eFuse values are permanently changed. This can be useful for debugging app and unit tests. During startup, the eFuses are copied to RAM. All eFuse operations (read and write) are performed with RAM instead of the real eFuse registers.

In addition to the `CONFIG_EFUSE_VIRTUAL` option there is `CONFIG_EFUSE_VIRTUAL_KEEP_IN_FLASH` option that adds a feature to keep eFuses in flash memory. To use this mode the partition\_table should have the `efuse` partition. partition.csv: "efuse\_em, data, efuse, , 0x2000, ". During startup, the eFuses are copied from flash or, in case if flash is empty, from real eFuse to RAM and then update flash. This option allows keeping eFuses after reboots (possible to test `secure_boot` and `flash_encryption` features with this option).

**Flash Encryption Testing** Flash Encryption (FE) is a hardware feature that requires the physical burning of eFuses: `key` and `FLASH_CRYPT_CNT`. If FE is not actually enabled then enabling the `CONFIG_EFUSE_VIRTUAL_KEEP_IN_FLASH` option just gives testing possibilities and does not encrypt anything in the flash, even though the logs say encryption happens. The `bootloader_flash_write()` is adapted for this purpose. But if FE is already enabled on the chip and you run an application or bootloader created with the `CONFIG_EFUSE_VIRTUAL_KEEP_IN_FLASH` option then the flash encryption/decryption operations will work properly (data are encrypted as it is written into an encrypted flash partition and decrypted when they are read from an encrypted partition).

**espefuse.py** esptool includes a useful tool for reading/writing ESP32-S2 eFuse bits - `espefuse.py`.

```

espefuse.py -p PORT summary

Connecting....
Detecting chip type... ESP32-S2

```

(continues on next page)

(continued from previous page)

```

espefuse.py v3.1-dev
EFUSE_NAME (Block)                Description = [Meaningful Value]
↳[Readable/Writeable] (Hex Value)
-----
↳-----
Calibration fuses:
TEMP_SENSOR_CAL (BLOCK2)           Temperature calibration
↳ = -9.200000000000001 R/W (0b101011100)
ADC1_MODE0_D2 (BLOCK2)             ADC1 calibration 1
↳ = -28 R/W (0x87)
ADC1_MODE1_D2 (BLOCK2)             ADC1 calibration 2
↳ = -28 R/W (0x87)
ADC1_MODE2_D2 (BLOCK2)             ADC1 calibration 3
↳ = -28 R/W (0x87)
ADC1_MODE3_D2 (BLOCK2)             ADC1 calibration 4
↳ = -24 R/W (0x86)
ADC2_MODE0_D2 (BLOCK2)             ADC2 calibration 5
↳ = 12 R/W (0x03)
ADC2_MODE1_D2 (BLOCK2)             ADC2 calibration 6
↳ = 8 R/W (0x02)
ADC2_MODE2_D2 (BLOCK2)             ADC2 calibration 7
↳ = 12 R/W (0x03)
ADC2_MODE3_D2 (BLOCK2)             ADC2 calibration 8
↳ = 16 R/W (0x04)
ADC1_MODE0_D1 (BLOCK2)             ADC1 calibration 9
↳ = -20 R/W (0b100101)
ADC1_MODE1_D1 (BLOCK2)             ADC1 calibration 10
↳ = -12 R/W (0b100011)
ADC1_MODE2_D1 (BLOCK2)             ADC1 calibration 11
↳ = -12 R/W (0b100011)
ADC1_MODE3_D1 (BLOCK2)             ADC1 calibration 12
↳ = -4 R/W (0b100001)
ADC2_MODE0_D1 (BLOCK2)             ADC2 calibration 13
↳ = -12 R/W (0b100011)
ADC2_MODE1_D1 (BLOCK2)             ADC2 calibration 14
↳ = -8 R/W (0b100010)
ADC2_MODE2_D1 (BLOCK2)             ADC2 calibration 15
↳ = -8 R/W (0b100010)
ADC2_MODE3_D1 (BLOCK2)             ADC2 calibration 16
↳ = -4 R/W (0b100001)

Config fuses:
DIS_RTC_RAM_BOOT (BLOCK0)          Disables boot from RTC RAM
↳ = False R/W (0b0)
DIS_ICACHE (BLOCK0)                Disables ICache
↳ = False R/W (0b0)
DIS_DCACHE (BLOCK0)                Disables DCache
↳ = False R/W (0b0)
DIS_DOWNLOAD_ICACHE (BLOCK0)       Disables Icache when SoC is in Download
↳mode = False R/W (0b0)
DIS_DOWNLOAD_DCACHE (BLOCK0)       Disables Dcache when SoC is in Download
↳mode = False R/W (0b0)
DIS_FORCE_DOWNLOAD (BLOCK0)        Disables forcing chip into Download mode
↳ = False R/W (0b0)
DIS_CAN (BLOCK0)                   Disables the TWAI Controller hardware
↳ = False R/W (0b0)
DIS_BOOT_REMAP (BLOCK0)            Disables capability to Remap RAM to ROM
↳address sp = False R/W (0b0)

FLASH_TPUW (BLOCK0)                ace
↳power-up, = 0 R/W (0x0)

```

(continues on next page)





(continued from previous page)

Spi_Pad_Config fuses:		
SPI_PAD_CONFIG_CLK (BLOCK1)	SPI CLK pad	↪
↪ = 0 R/W (0b000000)		
SPI_PAD_CONFIG_Q (BLOCK1)	SPI Q (D1) pad	↪
↪ = 0 R/W (0b000000)		
SPI_PAD_CONFIG_D (BLOCK1)	SPI D (D0) pad	↪
↪ = 0 R/W (0b000000)		
SPI_PAD_CONFIG_CS (BLOCK1)	SPI CS pad	↪
↪ = 0 R/W (0b000000)		
SPI_PAD_CONFIG_HD (BLOCK1)	SPI HD (D3) pad	↪
↪ = 0 R/W (0b000000)		
SPI_PAD_CONFIG_WP (BLOCK1)	SPI WP (D2) pad	↪
↪ = 0 R/W (0b000000)		
SPI_PAD_CONFIG_DQS (BLOCK1)	SPI DQS pad	↪
↪ = 0 R/W (0b000000)		
SPI_PAD_CONFIG_D4 (BLOCK1)	SPI D4 pad	↪
↪ = 0 R/W (0b000000)		
SPI_PAD_CONFIG_D5 (BLOCK1)	SPI D5 pad	↪
↪ = 0 R/W (0b000000)		
SPI_PAD_CONFIG_D6 (BLOCK1)	SPI D6 pad	↪
↪ = 0 R/W (0b000000)		
SPI_PAD_CONFIG_D7 (BLOCK1)	SPI D7 pad	↪
↪ = 0 R/W (0b000000)		
Usb Config fuses:		
DIS_USB (BLOCK0)	Disables the USB OTG hardware	↪
↪ = False R/W (0b0)		
USB_EXCHG_PINS (BLOCK0)	Exchanges USB D+ and D- pins	↪
↪ = False R/W (0b0)		
EXT_PHY_ENABLE (BLOCK0)	Enables external USB PHY	↪
↪ = False R/W (0b0)		
USB_FORCE_NOPERSIST (BLOCK0)	Forces to set USB BVALID to 1	↪
↪ = False R/W (0b0)		
Vdd_Spi Config fuses:		
VDD_SPI_FORCE (BLOCK0)	Force using VDD_SPI_XPD and VDD_SPI_TIEH	↪
↪to config = False R/W (0b0)	ure VDD_SPI LDO	
VDD_SPI_XPD (BLOCK0)	The VDD_SPI regulator is powered on	↪
↪ = False R/W (0b0)		
VDD_SPI_TIEH (BLOCK0)	The VDD_SPI power supply voltage at reset	↪
↪ = Connect to 1.8V LDO R/W (0b0)		
PIN_POWER_SELECTION (BLOCK0)	Sets default power supply for GPIO33..37,	↪
↪set when = VDD3P3_CPU R/W (0b0)	SPI flash is initialized	
Wdt Config fuses:		
WDT_DELAY_SEL (BLOCK0)	Selects RTC WDT timeout threshold at	↪
↪startup = 0 R/W (0b00)		
Flash voltage (VDD_SPI) determined by GPIO45 on reset (GPIO45=High: VDD_SPI pin is		
↪powered from internal 1.8V LDO		
GPIO45=Low or NC: VDD_SPI pin is powered directly from VDD3P3_RTC_IO via resistor		
↪Rspi. Typically this voltage is 3.3 V).		

To get a dump for all eFuse registers.

```
espefuse.py -p PORT dump
Connecting....
```

(continues on next page)

(continued from previous page)

```

Detecting chip type... ESP32-S2
BLOCK0      (          ) [0 ] read_regs: 00000000 00000000 00000000_
↳00000000 00000000 00000000
MAC_SPI_8M_0 (BLOCK1    ) [1 ] read_regs: a1003a6e 00007cdf 00000000_
↳00000000 00000000 00000000
BLOCK_SYS_DATA (BLOCK2    ) [2 ] read_regs: bbb8337d c8b3130b e80e3771_
↳92d5ab7c 8787ae10 02038687 38e50403 8628a386
BLOCK_USR_DATA (BLOCK3    ) [3 ] read_regs: 00000000 00000000 00000000_
↳00000000 00000000 00000000 00000000 00000000
BLOCK_KEY0     (BLOCK4    ) [4 ] read_regs: 00000000 00000000 00000000_
↳00000000 00000000 00000000 00000000 00000000
BLOCK_KEY1     (BLOCK5    ) [5 ] read_regs: 00000000 00000000 00000000_
↳00000000 00000000 00000000 00000000 00000000
BLOCK_KEY2     (BLOCK6    ) [6 ] read_regs: 00000000 00000000 00000000_
↳00000000 00000000 00000000 00000000 00000000
BLOCK_KEY3     (BLOCK7    ) [7 ] read_regs: 00000000 00000000 00000000_
↳00000000 00000000 00000000 00000000 00000000
BLOCK_KEY4     (BLOCK8    ) [8 ] read_regs: 00000000 00000000 00000000_
↳00000000 00000000 00000000 00000000 00000000
BLOCK_KEY5     (BLOCK9    ) [9 ] read_regs: 00000000 00000000 00000000_
↳00000000 00000000 00000000 00000000 00000000
BLOCK_SYS_DATA2 (BLOCK10   ) [10] read_regs: 00000000 00000000 00000000_
↳00000000 00000000 00000000 00000000 00000000
espefuse.py v3.1-dev

```

## Header File

- [components/efuse/esp32s2/include/esp\\_efuse\\_chip.h](#)

## Enumerations

enum **esp\_efuse\_block\_t**

Type of eFuse blocks ESP32S2.

*Values:*

enumerator **EFUSE\_BLK0**

Number of eFuse BLOCK0. REPEAT\_DATA

enumerator **EFUSE\_BLK1**

Number of eFuse BLOCK1. MAC\_SPI\_8M\_SYS

enumerator **EFUSE\_BLK2**

Number of eFuse BLOCK2. SYS\_DATA\_PART1

enumerator **EFUSE\_BLK\_SYS\_DATA\_PART1**

Number of eFuse BLOCK2. SYS\_DATA\_PART1

enumerator **EFUSE\_BLK3**

Number of eFuse BLOCK3. USER\_DATA

enumerator **EFUSE\_BLK\_USER\_DATA**

Number of eFuse BLOCK3. USER\_DATA

enumerator **EFUSE\_BLK4**

Number of eFuse BLOCK4. KEY0

enumerator **EFUSE\_BLK\_KEY0**

Number of eFuse BLOCK4. KEY0

enumerator **EFUSE\_BLK5**

Number of eFuse BLOCK5. KEY1

enumerator **EFUSE\_BLK\_KEY1**

Number of eFuse BLOCK5. KEY1

enumerator **EFUSE\_BLK6**

Number of eFuse BLOCK6. KEY2

enumerator **EFUSE\_BLK\_KEY2**

Number of eFuse BLOCK6. KEY2

enumerator **EFUSE\_BLK7**

Number of eFuse BLOCK7. KEY3

enumerator **EFUSE\_BLK\_KEY3**

Number of eFuse BLOCK7. KEY3

enumerator **EFUSE\_BLK8**

Number of eFuse BLOCK8. KEY4

enumerator **EFUSE\_BLK\_KEY4**

Number of eFuse BLOCK8. KEY4

enumerator **EFUSE\_BLK9**

Number of eFuse BLOCK9. KEY5

enumerator **EFUSE\_BLK\_KEY5**

Number of eFuse BLOCK9. KEY5

enumerator **EFUSE\_BLK\_KEY\_MAX**

enumerator **EFUSE\_BLK10**

Number of eFuse BLOCK10. SYS\_DATA\_PART2

enumerator **EFUSE\_BLK\_SYS\_DATA\_PART2**

Number of eFuse BLOCK10. SYS\_DATA\_PART2

enumerator **EFUSE\_BLK\_MAX**

enum **esp\_efuse\_coding\_scheme\_t**

Type of coding scheme.

*Values:*

enumerator **EFUSE\_CODING\_SCHEME\_NONE**

None

enumerator **EFUSE\_CODING\_SCHEME\_RS**

Reed-Solomon coding

enum **esp\_efuse\_purpose\_t**

Type of key purpose.

*Values:*

enumerator **ESP\_EFUSE\_KEY\_PURPOSE\_USER**

User purposes (software-only use)

enumerator **ESP\_EFUSE\_KEY\_PURPOSE\_RESERVED**

Reserved

enumerator **ESP\_EFUSE\_KEY\_PURPOSE\_XTS\_AES\_256\_KEY\_1**

XTS\_AES\_256\_KEY\_1 (flash/PSRAM encryption)

enumerator **ESP\_EFUSE\_KEY\_PURPOSE\_XTS\_AES\_256\_KEY\_2**

XTS\_AES\_256\_KEY\_2 (flash/PSRAM encryption)

enumerator **ESP\_EFUSE\_KEY\_PURPOSE\_XTS\_AES\_128\_KEY**

XTS\_AES\_128\_KEY (flash/PSRAM encryption)

enumerator **ESP\_EFUSE\_KEY\_PURPOSE\_HMAC\_DOWN\_ALL**

HMAC Downstream mode

enumerator **ESP\_EFUSE\_KEY\_PURPOSE\_HMAC\_DOWN\_JTAG**

JTAG soft enable key (uses HMAC Downstream mode)

enumerator **ESP\_EFUSE\_KEY\_PURPOSE\_HMAC\_DOWN\_DIGITAL\_SIGNATURE**

Digital Signature peripheral key (uses HMAC Downstream mode)

enumerator **ESP\_EFUSE\_KEY\_PURPOSE\_HMAC\_UP**

HMAC Upstream mode

enumerator **ESP\_EFUSE\_KEY\_PURPOSE\_SECURE\_BOOT\_DIGEST0**

SECURE\_BOOT\_DIGEST0 (Secure Boot key digest)

enumerator **ESP\_EFUSE\_KEY\_PURPOSE\_SECURE\_BOOT\_DIGEST1**

SECURE\_BOOT\_DIGEST1 (Secure Boot key digest)

enumerator **ESP\_EFUSE\_KEY\_PURPOSE\_SECURE\_BOOT\_DIGEST2**

SECURE\_BOOT\_DIGEST2 (Secure Boot key digest)

enumerator **ESP\_EFUSE\_KEY\_PURPOSE\_MAX**

MAX PURPOSE



## Header File

- [components/efuse/include/esp\\_efuse.h](#)

## Functions

*esp\_err\_t* **esp\_efuse\_read\_field\_blob** (const *esp\_efuse\_desc\_t* \*field[], void \*dst, size\_t dst\_size\_bits)

Reads bits from EFUSE field and writes it into an array.

The number of read bits will be limited to the minimum value from the description of the bits in “field” structure or “dst\_size\_bits” required size. Use “esp\_efuse\_get\_field\_size()” function to determine the length of the field.

---

**Note:** Please note that reading in the batch mode does not show uncommitted changes.

---

### Parameters

- **field** –[in] A pointer to the structure describing the fields of efuse.
- **dst** –[out] A pointer to array that will contain the result of reading.
- **dst\_size\_bits** –[in] The number of bits required to read. If the requested number of bits is greater than the field, the number will be limited to the field size.

### Returns

- ESP\_OK: The operation was successfully completed.
- ESP\_ERR\_INVALID\_ARG: Error in the passed arguments.

bool **esp\_efuse\_read\_field\_bit** (const *esp\_efuse\_desc\_t* \*field[])

Read a single bit eFuse field as a boolean value.

---

**Note:** The value must exist and must be a single bit wide. If there is any possibility of an error in the provided arguments, call esp\_efuse\_read\_field\_blob() and check the returned value instead.

---

---

**Note:** If assertions are enabled and the parameter is invalid, execution will abort

---

---

**Note:** Please note that reading in the batch mode does not show uncommitted changes.

---

**Parameters** **field** –[in] A pointer to the structure describing the fields of efuse.

### Returns

- true: The field parameter is valid and the bit is set.
- false: The bit is not set, or the parameter is invalid and assertions are disabled.

*esp\_err\_t* **esp\_efuse\_read\_field\_cnt** (const *esp\_efuse\_desc\_t* \*field[], size\_t \*out\_cnt)

Reads bits from EFUSE field and returns number of bits programmed as “1” .

If the bits are set not sequentially, they will still be counted.

---

**Note:** Please note that reading in the batch mode does not show uncommitted changes.

---

### Parameters

- **field** –[in] A pointer to the structure describing the fields of efuse.
- **out\_cnt** –[out] A pointer that will contain the number of programmed as “1” bits.

### Returns

- ESP\_OK: The operation was successfully completed.
- ESP\_ERR\_INVALID\_ARG: Error in the passed arguments.

*esp\_err\_t* **esp\_efuse\_write\_field\_blob** (const *esp\_efuse\_desc\_t* \*field[], const void \*src, size\_t src\_size\_bits)

Writes array to EFUSE field.

The number of write bits will be limited to the minimum value from the description of the bits in “field” structure or “src\_size\_bits” required size. Use “esp\_efuse\_get\_field\_size()” function to determine the length of the field. After the function is completed, the writing registers are cleared.

#### Parameters

- **field** –[in] A pointer to the structure describing the fields of efuse.
- **src** –[in] A pointer to array that contains the data for writing.
- **src\_size\_bits** –[in] The number of bits required to write.

#### Returns

- ESP\_OK: The operation was successfully completed.
- ESP\_ERR\_INVALID\_ARG: Error in the passed arguments.
- ESP\_ERR\_EFUSE\_REPEATED\_PROG: Error repeated programming of programmed bits is strictly forbidden.
- ESP\_ERR\_CODING: Error range of data does not match the coding scheme.

*esp\_err\_t* **esp\_efuse\_write\_field\_cnt** (const *esp\_efuse\_desc\_t* \*field[], size\_t cnt)

Writes a required count of bits as “1” to EFUSE field.

If there are no free bits in the field to set the required number of bits to “1”, ESP\_ERR\_EFUSE\_CNT\_IS\_FULL error is returned, the field will not be partially recorded. After the function is completed, the writing registers are cleared.

#### Parameters

- **field** –[in] A pointer to the structure describing the fields of efuse.
- **cnt** –[in] Required number of programmed as “1” bits.

#### Returns

- ESP\_OK: The operation was successfully completed.
- ESP\_ERR\_INVALID\_ARG: Error in the passed arguments.
- ESP\_ERR\_EFUSE\_CNT\_IS\_FULL: Not all requested cnt bits is set.

*esp\_err\_t* **esp\_efuse\_write\_field\_bit** (const *esp\_efuse\_desc\_t* \*field[])

Write a single bit eFuse field to 1.

For use with eFuse fields that are a single bit. This function will write the bit to value 1 if it is not already set, or does nothing if the bit is already set.

This is equivalent to calling esp\_efuse\_write\_field\_cnt() with the cnt parameter equal to 1, except that it will return ESP\_OK if the field is already set to 1.

**Parameters** **field** –[in] Pointer to the structure describing the efuse field.

#### Returns

- ESP\_OK: The operation was successfully completed, or the bit was already set to value 1.
- ESP\_ERR\_INVALID\_ARG: Error in the passed arguments, including if the efuse field is not 1 bit wide.

*esp\_err\_t* **esp\_efuse\_set\_write\_protect** (*esp\_efuse\_block\_t* blk)

Sets a write protection for the whole block.

After that, it is impossible to write to this block. The write protection does not apply to block 0.

**Parameters** **blk** –[in] Block number of eFuse. (EFUSE\_BLK1, EFUSE\_BLK2 and EFUSE\_BLK3)

#### Returns

- ESP\_OK: The operation was successfully completed.
- ESP\_ERR\_INVALID\_ARG: Error in the passed arguments.
- ESP\_ERR\_EFUSE\_CNT\_IS\_FULL: Not all requested cnt bits is set.
- ESP\_ERR\_NOT\_SUPPORTED: The block does not support this command.

*esp\_err\_t* **esp\_efuse\_set\_read\_protect** (*esp\_efuse\_block\_t* blk)

Sets a read protection for the whole block.

After that, it is impossible to read from this block. The read protection does not apply to block 0.

**Parameters** **blk** **–[in]** Block number of eFuse. (EFUSE\_BLK1, EFUSE\_BLK2 and EFUSE\_BLK3)

**Returns**

- ESP\_OK: The operation was successfully completed.
- ESP\_ERR\_INVALID\_ARG: Error in the passed arguments.
- ESP\_ERR\_EFUSE\_CNT\_IS\_FULL: Not all requested cnt bits is set.
- ESP\_ERR\_NOT\_SUPPORTED: The block does not support this command.

int **esp\_efuse\_get\_field\_size** (const *esp\_efuse\_desc\_t* \*field[])

Returns the number of bits used by field.

**Parameters** **field** **–[in]** A pointer to the structure describing the fields of efuse.

**Returns** Returns the number of bits used by field.

uint32\_t **esp\_efuse\_read\_reg** (*esp\_efuse\_block\_t* blk, unsigned int num\_reg)

Returns value of efuse register.

This is a thread-safe implementation. Example: EFUSE\_BLK2\_RDATA3\_REG where (blk=2, num\_reg=3)

---

**Note:** Please note that reading in the batch mode does not show uncommitted changes.

---

**Parameters**

- **blk** **–[in]** Block number of eFuse.
- **num\_reg** **–[in]** The register number in the block.

**Returns** Value of register

*esp\_err\_t* **esp\_efuse\_write\_reg** (*esp\_efuse\_block\_t* blk, unsigned int num\_reg, uint32\_t val)

Write value to efuse register.

Apply a coding scheme if necessary. This is a thread-safe implementation. Example: EFUSE\_BLK3\_WDATA0\_REG where (blk=3, num\_reg=0)

**Parameters**

- **blk** **–[in]** Block number of eFuse.
- **num\_reg** **–[in]** The register number in the block.
- **val** **–[in]** Value to write.

**Returns**

- ESP\_OK: The operation was successfully completed.
- ESP\_ERR\_EFUSE\_REPEATED\_PROG: Error repeated programming of programmed bits is strictly forbidden.

*esp\_efuse\_coding\_scheme\_t* **esp\_efuse\_get\_coding\_scheme** (*esp\_efuse\_block\_t* blk)

Return efuse coding scheme for blocks.

Note: The coding scheme is applicable only to 1, 2 and 3 blocks. For 0 block, the coding scheme is always NONE.

**Parameters** **blk** **–[in]** Block number of eFuse.

**Returns** Return efuse coding scheme for blocks

*esp\_err\_t* **esp\_efuse\_read\_block** (*esp\_efuse\_block\_t* blk, void \*dst\_key, size\_t offset\_in\_bits, size\_t size\_bits)

Read key to efuse block starting at the offset and the required size.

---

**Note:** Please note that reading in the batch mode does not show uncommitted changes.

---

**Parameters**

- **blk** –[in] Block number of eFuse.
- **dst\_key** –[in] A pointer to array that will contain the result of reading.
- **offset\_in\_bits** –[in] Start bit in block.
- **size\_bits** –[in] The number of bits required to read.

**Returns**

- ESP\_OK: The operation was successfully completed.
- ESP\_ERR\_INVALID\_ARG: Error in the passed arguments.
- ESP\_ERR\_CODING: Error range of data does not match the coding scheme.

*esp\_err\_t* **esp\_efuse\_write\_block** (*esp\_efuse\_block\_t* blk, const void \*src\_key, size\_t offset\_in\_bits, size\_t size\_bits)

Write key to efuse block starting at the offset and the required size.

**Parameters**

- **blk** –[in] Block number of eFuse.
- **src\_key** –[in] A pointer to array that contains the key for writing.
- **offset\_in\_bits** –[in] Start bit in block.
- **size\_bits** –[in] The number of bits required to write.

**Returns**

- ESP\_OK: The operation was successfully completed.
- ESP\_ERR\_INVALID\_ARG: Error in the passed arguments.
- ESP\_ERR\_CODING: Error range of data does not match the coding scheme.
- ESP\_ERR\_EFUSE\_REPEATED\_PROG: Error repeated programming of programmed bits

uint32\_t **esp\_efuse\_get\_pkg\_ver** (void)

Returns chip package from efuse.

**Returns** chip package

void **esp\_efuse\_reset** (void)

Reset efuse write registers.

Efuse write registers are written to zero, to negate any changes that have been staged here.

---

**Note:** This function is not threadsafe, if calling code updates efuse values from multiple tasks then this is caller's responsibility to serialise.

---

*esp\_err\_t* **esp\_efuse\_disable\_rom\_download\_mode** (void)

Disable ROM Download Mode via eFuse.

Permanently disables the ROM Download Mode feature. Once disabled, if the SoC is booted with strapping pins set for ROM Download Mode then an error is printed instead.

---

**Note:** Not all SoCs support this option. An error will be returned if called on an ESP32 with a silicon revision lower than 3, as these revisions do not support this option.

---

---

**Note:** If ROM Download Mode is already disabled, this function does nothing and returns success.

---

**Returns**

- ESP\_OK If the eFuse was successfully burned, or had already been burned.
- ESP\_ERR\_NOT\_SUPPORTED (ESP32 only) This SoC is not capable of disabling UART download mode
- ESP\_ERR\_INVALID\_STATE (ESP32 only) This eFuse is write protected and cannot be written

*esp\_err\_t* **esp\_efuse\_set\_rom\_log\_scheme** (*esp\_efuse\_rom\_log\_scheme\_t* log\_scheme)

Set boot ROM log scheme via eFuse.

---

**Note:** By default, the boot ROM will always print to console. This API can be called to set the log scheme only once per chip, once the value is changed from the default it can't be changed again.

---

**Parameters** **log\_scheme** –Supported ROM log scheme

**Returns**

- ESP\_OK If the eFuse was successfully burned, or had already been burned.
- ESP\_ERR\_NOT\_SUPPORTED (ESP32 only) This SoC is not capable of setting ROM log scheme
- ESP\_ERR\_INVALID\_STATE This eFuse is write protected or has been burned already

*esp\_err\_t* **esp\_efuse\_enable\_rom\_secure\_download\_mode** (void)

Switch ROM Download Mode to Secure Download mode via eFuse.

Permanently enables Secure Download mode. This mode limits the use of ROM Download Mode functions to simple flash read, write and erase operations, plus a command to return a summary of currently enabled security features.

---

**Note:** If Secure Download mode is already enabled, this function does nothing and returns success.

---

---

**Note:** Disabling the ROM Download Mode also disables Secure Download Mode.

---

**Returns**

- ESP\_OK If the eFuse was successfully burned, or had already been burned.
- ESP\_ERR\_INVALID\_STATE ROM Download Mode has been disabled via eFuse, so Secure Download mode is unavailable.

uint32\_t **esp\_efuse\_read\_secure\_version** (void)

Return secure\_version from efuse field.

**Returns** Secure version from efuse field

bool **esp\_efuse\_check\_secure\_version** (uint32\_t secure\_version)

Check secure\_version from app and secure\_version and from efuse field.

**Parameters** **secure\_version** –Secure version from app.

**Returns**

- True: If version of app is equal or more then secure\_version from efuse.

*esp\_err\_t* **esp\_efuse\_update\_secure\_version** (uint32\_t secure\_version)

Write efuse field by secure\_version value.

Update the secure\_version value is available if the coding scheme is None. Note: Do not use this function in your applications. This function is called as part of the other API.

**Parameters** **secure\_version** –[in] Secure version from app.

**Returns**

- ESP\_OK: Successful.
- ESP\_FAIL: secure version of app cannot be set to efuse field.
- ESP\_ERR\_NOT\_SUPPORTED: Anti rollback is not supported with the 3/4 and Repeat coding scheme.

**esp\_err\_t esp\_efuse\_batch\_write\_begin** (void)

Set the batch mode of writing fields.

This mode allows you to write the fields in the batch mode when need to burn several efuses at one time. To enable batch mode call begin() then perform as usually the necessary operations read and write and at the end call commit() to actually burn all written efuses. The batch mode can be used nested. The commit will be done by the last commit() function. The number of begin() functions should be equal to the number of commit() functions.

**Note:** If batch mode is enabled by the first task, at this time the second task cannot write/read efuses. The second task will wait for the first task to complete the batch operation.

```
// Example of using the batch writing mode.

// set the batch writing mode
esp_efuse_batch_write_begin();

// use any writing functions as usual
esp_efuse_write_field_blob(ESP_EFUSE_...);
esp_efuse_write_field_cnt(ESP_EFUSE_...);
esp_efuse_set_write_protect(EFUSE_BLKx);
esp_efuse_write_reg(EFUSE_BLKx, ...);
esp_efuse_write_block(EFUSE_BLKx, ...);
esp_efuse_write(ESP_EFUSE_1, 3); // ESP_EFUSE_1 == 1, here we write a new
↪value = 3. The changes will be burn by the commit() function.
esp_efuse_read...(ESP_EFUSE_1); // this function returns ESP_EFUSE_1 == 1
↪because uncommitted changes are not readable, it will be available only
↪after commit.
...

// esp_efuse_batch_write APIs can be called recursively.
esp_efuse_batch_write_begin();
esp_efuse_set_write_protect(EFUSE_BLKx);
esp_efuse_batch_write_commit(); // the burn will be skipped here, it will be
↪done in the last commit().

...

// Write all of these fields to the efuse registers
esp_efuse_batch_write_commit();
esp_efuse_read...(ESP_EFUSE_1); // this function returns ESP_EFUSE_1 == 3.
```

**Note:** Please note that reading in the batch mode does not show uncommitted changes.

**Returns**

- ESP\_OK: Successful.

**esp\_err\_t esp\_efuse\_batch\_write\_cancel** (void)

Reset the batch mode of writing fields.

It will reset the batch writing mode and any written changes.

**Returns**

- ESP\_OK: Successful.
- ESP\_ERR\_INVALID\_STATE: The batch mode was not set.

*esp\_err\_t* **esp\_efuse\_batch\_write\_commit** (void)

Writes all prepared data for the batch mode.

Must be called to ensure changes are written to the efuse registers. After this the batch writing mode will be reset.

**Returns**

- ESP\_OK: Successful.
- ESP\_ERR\_INVALID\_STATE: The deferred writing mode was not set.

bool **esp\_efuse\_block\_is\_empty** (*esp\_efuse\_block\_t* block)

Checks that the given block is empty.

**Returns**

- True: The block is empty.
- False: The block is not empty or was an error.

bool **esp\_efuse\_get\_key\_dis\_read** (*esp\_efuse\_block\_t* block)

Returns a read protection for the key block.

**Parameters** **block** –[in] A key block in the range EFUSE\_BLK\_KEY0..EFUSE\_BLK\_KEY\_MAX

**Returns** True: The key block is read protected False: The key block is readable.

*esp\_err\_t* **esp\_efuse\_set\_key\_dis\_read** (*esp\_efuse\_block\_t* block)

Sets a read protection for the key block.

**Parameters** **block** –[in] A key block in the range EFUSE\_BLK\_KEY0..EFUSE\_BLK\_KEY\_MAX

**Returns**

- ESP\_OK: Successful.
- ESP\_ERR\_INVALID\_ARG: Error in the passed arguments.
- ESP\_ERR\_EFUSE\_REPEATED\_PROG: Error repeated programming of programmed bits is strictly forbidden.
- ESP\_ERR\_CODING: Error range of data does not match the coding scheme.

bool **esp\_efuse\_get\_key\_dis\_write** (*esp\_efuse\_block\_t* block)

Returns a write protection for the key block.

**Parameters** **block** –[in] A key block in the range EFUSE\_BLK\_KEY0..EFUSE\_BLK\_KEY\_MAX

**Returns** True: The key block is write protected False: The key block is writable.

*esp\_err\_t* **esp\_efuse\_set\_key\_dis\_write** (*esp\_efuse\_block\_t* block)

Sets a write protection for the key block.

**Parameters** **block** –[in] A key block in the range EFUSE\_BLK\_KEY0..EFUSE\_BLK\_KEY\_MAX

**Returns**

- ESP\_OK: Successful.
- ESP\_ERR\_INVALID\_ARG: Error in the passed arguments.
- ESP\_ERR\_EFUSE\_REPEATED\_PROG: Error repeated programming of programmed bits is strictly forbidden.
- ESP\_ERR\_CODING: Error range of data does not match the coding scheme.

bool **esp\_efuse\_key\_block\_unused** (*esp\_efuse\_block\_t* block)

Returns true if the key block is unused, false otherwise.

An unused key block is all zero content, not read or write protected, and has purpose 0 (ESP\_EFUSE\_KEY\_PURPOSE\_USER)

**Parameters** **block** –key block to check.

**Returns**

- True if key block is unused,
- False if key block is used or the specified block index is not a key block.

bool **esp\_efuse\_find\_purpose** (*esp\_efuse\_purpose\_t* purpose, *esp\_efuse\_block\_t* \*block)

Find a key block with the particular purpose set.

**Parameters**

- **purpose** –[in] Purpose to search for.
- **block** –[out] Pointer in the range EFUSE\_BLK\_KEY0..EFUSE\_BLK\_KEY\_MAX which will be set to the key block if found. Can be NULL, if only need to test the key block exists.

**Returns**

- True: If found,
- False: If not found (value at block pointer is unchanged).

bool **esp\_efuse\_get\_keypurpose\_dis\_write** (*esp\_efuse\_block\_t* block)

Returns a write protection of the key purpose field for an efuse key block.

---

**Note:** For ESP32: no keypurpose, it returns always True.

---

**Parameters** **block** –[in] A key block in the range EFUSE\_BLK\_KEY0..EFUSE\_BLK\_KEY\_MAX

**Returns** True: The key purpose is write protected. False: The key purpose is writeable.

*esp\_efuse\_purpose\_t* **esp\_efuse\_get\_key\_purpose** (*esp\_efuse\_block\_t* block)

Returns the current purpose set for an efuse key block.

**Parameters** **block** –[in] A key block in the range EFUSE\_BLK\_KEY0..EFUSE\_BLK\_KEY\_MAX

**Returns**

- Value: If Successful, it returns the value of the purpose related to the given key block.
- ESP\_EFUSE\_KEY\_PURPOSE\_MAX: Otherwise.

const *esp\_efuse\_desc\_t* \*\***esp\_efuse\_get\_purpose\_field** (*esp\_efuse\_block\_t* block)

Returns a pointer to a key purpose for an efuse key block.

To get the value of this field use `esp_efuse_read_field_blob()` or `esp_efuse_get_key_purpose()`.

**Parameters** **block** –[in] A key block in the range EFUSE\_BLK\_KEY0..EFUSE\_BLK\_KEY\_MAX

**Returns** Pointer: If Successful returns a pointer to the corresponding efuse field otherwise NULL.

const *esp\_efuse\_desc\_t* \*\***esp\_efuse\_get\_key** (*esp\_efuse\_block\_t* block)

Returns a pointer to a key block.

**Parameters** **block** –[in] A key block in the range EFUSE\_BLK\_KEY0..EFUSE\_BLK\_KEY\_MAX

**Returns** Pointer: If Successful returns a pointer to the corresponding efuse field otherwise NULL.

*esp\_err\_t* **esp\_efuse\_set\_key\_purpose** (*esp\_efuse\_block\_t* block, *esp\_efuse\_purpose\_t* purpose)

Sets a key purpose for an efuse key block.

**Parameters**

- **block** –[in] A key block in the range EFUSE\_BLK\_KEY0..EFUSE\_BLK\_KEY\_MAX
- **purpose** –[in] Key purpose.

**Returns**

- ESP\_OK: Successful.
- ESP\_ERR\_INVALID\_ARG: Error in the passed arguments.
- ESP\_ERR\_EFUSE\_REPEATED\_PROG: Error repeated programming of programmed bits is strictly forbidden.
- ESP\_ERR\_CODING: Error range of data does not match the coding scheme.

*esp\_err\_t* **esp\_efuse\_set\_keypurpose\_dis\_write** (*esp\_efuse\_block\_t* block)

Sets a write protection of the key purpose field for an efuse key block.

**Parameters** **block** –[in] A key block in the range EFUSE\_BLK\_KEY0..EFUSE\_BLK\_KEY\_MAX

**Returns**

- ESP\_OK: Successful.
- ESP\_ERR\_INVALID\_ARG: Error in the passed arguments.



- `ESP_ERR_EFUSE_REPEATED_PROG`: Error repeated programming of programmed bits is strictly forbidden.
- `ESP_ERR_CODING`: Error range of data does not match the coding scheme.

*esp\_efuse\_block\_t* **esp\_efuse\_find\_unused\_key\_block** (void)

Search for an unused key block and return the first one found.

See `esp_efuse_key_block_unused` for a description of an unused key block.

**Returns** First unused key block, or `EFUSE_BLK_KEY_MAX` if no unused key block is found.

unsigned **esp\_efuse\_count\_unused\_key\_blocks** (void)

Return the number of unused efuse key blocks in the range `EFUSE_BLK_KEY0..EFUSE_BLK_KEY_MAX`.

bool **esp\_efuse\_get\_digest\_revoke** (unsigned num\_digest)

Returns the status of the Secure Boot public key digest revocation bit.

**Parameters** `num_digest` **–[in]** The number of digest in range 0..2

**Returns**

- True: If key digest is revoked,
- False; If key digest is not revoked.

*esp\_err\_t* **esp\_efuse\_set\_digest\_revoke** (unsigned num\_digest)

Sets the Secure Boot public key digest revocation bit.

**Parameters** `num_digest` **–[in]** The number of digest in range 0..2

**Returns**

- `ESP_OK`: Successful.
- `ESP_ERR_INVALID_ARG`: Error in the passed arguments.
- `ESP_ERR_EFUSE_REPEATED_PROG`: Error repeated programming of programmed bits is strictly forbidden.
- `ESP_ERR_CODING`: Error range of data does not match the coding scheme.

bool **esp\_efuse\_get\_write\_protect\_of\_digest\_revoke** (unsigned num\_digest)

Returns a write protection of the Secure Boot public key digest revocation bit.

**Parameters** `num_digest` **–[in]** The number of digest in range 0..2

**Returns** True: The revocation bit is write protected. False: The revocation bit is writeable.

*esp\_err\_t* **esp\_efuse\_set\_write\_protect\_of\_digest\_revoke** (unsigned num\_digest)

Sets a write protection of the Secure Boot public key digest revocation bit.

**Parameters** `num_digest` **–[in]** The number of digest in range 0..2

**Returns**

- `ESP_OK`: Successful.
- `ESP_ERR_INVALID_ARG`: Error in the passed arguments.
- `ESP_ERR_EFUSE_REPEATED_PROG`: Error repeated programming of programmed bits is strictly forbidden.
- `ESP_ERR_CODING`: Error range of data does not match the coding scheme.

*esp\_err\_t* **esp\_efuse\_write\_key** (*esp\_efuse\_block\_t* block, *esp\_efuse\_purpose\_t* purpose, const void \*key, size\_t key\_size\_bytes)

Program a block of key data to an efuse block.

The burn of a key, protection bits, and a purpose happens in batch mode.

**Parameters**

- **block** **–[in]** Block to read purpose for. Must be in range `EFUSE_BLK_KEY0` to `EFUSE_BLK_KEY_MAX`. Key block must be unused (`esp_efuse_key_block_unused`).
- **purpose** **–[in]** Purpose to set for this key. Purpose must be already unset.
- **key** **–[in]** Pointer to data to write.
- **key\_size\_bytes** **–[in]** Bytes length of data to write.

**Returns**

- `ESP_OK`: Successful.

- `ESP_ERR_INVALID_ARG`: Error in the passed arguments.
- `ESP_ERR_INVALID_STATE`: Error in efuses state, unused block not found.
- `ESP_ERR_EFUSE_REPEATED_PROG`: Error repeated programming of programmed bits is strictly forbidden.
- `ESP_ERR_CODING`: Error range of data does not match the coding scheme.

`esp_err_t esp_efuse_write_keys` (const `esp_efuse_purpose_t` purposes[], uint8\_t keys[][32], unsigned number\_of\_keys)

Program keys to unused efuse blocks.

The burn of keys, protection bits, and purposes happens in batch mode.

#### Parameters

- **purposes** –[in] Array of purposes (purpose[number\_of\_keys]).
- **keys** –[in] Array of keys (uint8\_t keys[number\_of\_keys][32]). Each key is 32 bytes long.
- **number\_of\_keys** –[in] The number of keys to write (up to 6 keys).

#### Returns

- `ESP_OK`: Successful.
- `ESP_ERR_INVALID_ARG`: Error in the passed arguments.
- `ESP_ERR_INVALID_STATE`: Error in efuses state, unused block not found.
- `ESP_ERR_NOT_ENOUGH_UNUSED_KEY_BLOCKS`: Error not enough unused key blocks available
- `ESP_ERR_EFUSE_REPEATED_PROG`: Error repeated programming of programmed bits is strictly forbidden.
- `ESP_ERR_CODING`: Error range of data does not match the coding scheme.

`esp_err_t esp_secure_boot_read_key_digests` (`esp_secure_boot_key_digests_t` \*trusted\_key\_digests)

Read key digests from efuse. Any revoked/missing digests will be marked as NULL.

**Parameters** `trusted_key_digests` –[out] Trusted keys digests, stored in this parameter after successfully completing this function. The number of digests depends on the SOC' s capabilities.

#### Returns

- `ESP_OK`: Successful.
- `ESP_FAIL`: If `trusted_keys` is NULL or there is no valid digest.

`esp_err_t esp_efuse_check_errors` (void)

Checks eFuse errors in BLOCK0.

It does a BLOCK0 check if eFuse `EFUSE_ERR_RST_ENABLE` is set. If BLOCK0 has an error, it prints the error and returns `ESP_FAIL`, which should be treated as `esp_restart`.

---

**Note:** Refers to ESP32-C3 only.

---

#### Returns

- `ESP_OK`: No errors in BLOCK0.
- `ESP_FAIL`: Error in BLOCK0 requiring reboot.

## Structures

struct `esp_efuse_desc_t`

Type definition for an eFuse field.

## Public Members

*esp\_efuse\_block\_t* **efuse\_block**

Block of eFuse

uint8\_t **bit\_start**

Start bit [0..255]

uint16\_t **bit\_count**

Length of bit field [1..-]

struct **esp\_secure\_boot\_key\_digests\_t**

Pointers to the trusted key digests.

The number of digests depends on the SOC' s capabilities.

### Public Members

const void \***key\_digests**[3]

Pointers to the key digests

### Macros

**ESP\_ERR\_EFUSE**

Base error code for efuse api.

**ESP\_OK\_EFUSE\_CNT**

OK the required number of bits is set.

**ESP\_ERR\_EFUSE\_CNT\_IS\_FULL**

Error field is full.

**ESP\_ERR\_EFUSE\_REPEATED\_PROG**

Error repeated programming of programmed bits is strictly forbidden.

**ESP\_ERR\_CODING**

Error while a encoding operation.

**ESP\_ERR\_NOT\_ENOUGH\_UNUSED\_KEY\_BLOCKS**

Error not enough unused key blocks available

**ESP\_ERR\_DAMAGED\_READING**

Error. Burn or reset was done during a reading operation leads to damage read data. This error is internal to the efuse component and not returned by any public API.

### Enumerations

enum **esp\_efuse\_rom\_log\_scheme\_t**

Type definition for ROM log scheme.

*Values:*

enumerator **ESP\_EFUSE\_ROM\_LOG\_ALWAYS\_ON**

Always enable ROM logging

enumerator **ESP\_EFUSE\_ROM\_LOG\_ON\_GPIO\_LOW**

ROM logging is enabled when specific GPIO level is low during start up

enumerator **ESP\_EFUSE\_ROM\_LOG\_ON\_GPIO\_HIGH**

ROM logging is enabled when specific GPIO level is high during start up

enumerator **ESP\_EFUSE\_ROM\_LOG\_ALWAYS\_OFF**

Disable ROM logging permanently

## 2.9.7 Error Codes and Helper Functions

This section lists definitions of common ESP-IDF error codes and several helper functions related to error handling.

For general information about error codes in ESP-IDF, see [Error Handling](#).

For the full list of error codes defined in ESP-IDF, see [Error Code Reference](#).

### API Reference

#### Header File

- [components/esp\\_common/include/esp\\_check.h](#)

#### Macros

**ESP\_RETURN\_ON\_ERROR** (x, log\_tag, format, ...)

Macro which can be used to check the error code. If the code is not ESP\_OK, it prints the message and returns. In the future, we want to switch to C++20. We also want to become compatible with clang. Hence, we provide two versions of the following macros. The first one is using the GNU extension `#__VA_ARGS__`. The second one is using the C++20 feature `VA_OPT(,)`. This allows users to compile their code with standard C++20 enabled instead of the GNU extension. Below C++20, we haven't found any good alternative to using `#__VA_ARGS__`. Macro which can be used to check the error code. If the code is not ESP\_OK, it prints the message and returns.

**ESP\_RETURN\_ON\_ERROR\_ISR** (x, log\_tag, format, ...)

A version of ESP\_RETURN\_ON\_ERROR() macro that can be called from ISR.

**ESP\_GOTO\_ON\_ERROR** (x, goto\_tag, log\_tag, format, ...)

Macro which can be used to check the error code. If the code is not ESP\_OK, it prints the message, sets the local variable 'ret' to the code, and then exits by jumping to 'goto\_tag'.

**ESP\_GOTO\_ON\_ERROR\_ISR** (x, goto\_tag, log\_tag, format, ...)

A version of ESP\_GOTO\_ON\_ERROR() macro that can be called from ISR.

**ESP\_RETURN\_ON\_FALSE** (a, err\_code, log\_tag, format, ...)

Macro which can be used to check the condition. If the condition is not 'true', it prints the message and returns with the supplied 'err\_code'.

**ESP\_RETURN\_ON\_FALSE\_ISR** (a, err\_code, log\_tag, format, ...)

A version of ESP\_RETURN\_ON\_FALSE() macro that can be called from ISR.

**ESP\_GOTO\_ON\_FALSE** (a, err\_code, goto\_tag, log\_tag, format, ...)

Macro which can be used to check the condition. If the condition is not 'true', it prints the message, sets the local variable 'ret' to the supplied 'err\_code', and then exits by jumping to 'goto\_tag'.

**ESP\_GOTO\_ON\_FALSE\_ISR** (a, err\_code, goto\_tag, log\_tag, format, ...)

A version of ESP\_GOTO\_ON\_FALSE() macro that can be called from ISR.

### Header File

- [components/esp\\_common/include/esp\\_err.h](#)

### Functions

const char \***esp\_err\_to\_name** (*esp\_err\_t* code)

Returns string for esp\_err\_t error codes.

This function finds the error code in a pre-generated lookup-table and returns its string representation.

The function is generated by the Python script tools/gen\_esp\_err\_to\_name.py which should be run each time an esp\_err\_t error is modified, created or removed from the IDF project.

**Parameters** **code** –esp\_err\_t error code

**Returns** string error message

const char \***esp\_err\_to\_name\_r** (*esp\_err\_t* code, char \*buf, size\_t buflen)

Returns string for esp\_err\_t and system error codes.

This function finds the error code in a pre-generated lookup-table of esp\_err\_t errors and returns its string representation. If the error code is not found then it is attempted to be found among system errors.

The function is generated by the Python script tools/gen\_esp\_err\_to\_name.py which should be run each time an esp\_err\_t error is modified, created or removed from the IDF project.

#### Parameters

- **code** –esp\_err\_t error code
- **buf** –[out] buffer where the error message should be written
- **buflen** –Size of buffer buf. At most buflen bytes are written into the buf buffer (including the terminating null byte).

**Returns** buf containing the string error message

### Macros

**ESP\_OK**

esp\_err\_t value indicating success (no error)

**ESP\_FAIL**

Generic esp\_err\_t code indicating failure

**ESP\_ERR\_NO\_MEM**

Out of memory

**ESP\_ERR\_INVALID\_ARG**

Invalid argument

**ESP\_ERR\_INVALID\_STATE**

Invalid state

**ESP\_ERR\_INVALID\_SIZE**

Invalid size

**ESP\_ERR\_NOT\_FOUND**

Requested resource not found

**ESP\_ERR\_NOT\_SUPPORTED**

Operation or feature not supported

**ESP\_ERR\_TIMEOUT**

Operation timed out

**ESP\_ERR\_INVALID\_RESPONSE**

Received response was invalid

**ESP\_ERR\_INVALID\_CRC**

CRC or checksum was invalid

**ESP\_ERR\_INVALID\_VERSION**

Version was invalid

**ESP\_ERR\_INVALID\_MAC**

MAC address was invalid

**ESP\_ERR\_NOT\_FINISHED**

There are items remained to retrieve

**ESP\_ERR\_WIFI\_BASE**

Starting number of WiFi error codes

**ESP\_ERR\_MESH\_BASE**

Starting number of MESH error codes

**ESP\_ERR\_FLASH\_BASE**

Starting number of flash error codes

**ESP\_ERR\_HW\_CRYPTO\_BASE**

Starting number of HW cryptography module error codes

**ESP\_ERR\_MEMPROT\_BASE**

Starting number of Memory Protection API error codes

**ESP\_ERROR\_CHECK** (x)

Macro which can be used to check the error code, and terminate the program in case the code is not ESP\_OK. Prints the error code, error location, and the failed statement to serial output.

Disabled if assertions are disabled.

**ESP\_ERROR\_CHECK\_WITHOUT\_ABORT** (x)

Macro which can be used to check the error code. Prints the error code, error location, and the failed statement to serial output. In comparison with ESP\_ERROR\_CHECK(), this prints the same error message but isn't terminating the program.

**Type Definitions**

typedef int **esp\_err\_t**

## 2.9.8 ESP HTTPS OTA

### Overview

`esp_https_ota` provides simplified APIs to perform firmware upgrades over HTTPS. It's an abstraction layer over existing OTA APIs.

### Application Example

```
esp_err_t do_firmware_upgrade()
{
    esp_http_client_config_t config = {
        .url = CONFIG_FIRMWARE_UPGRADE_URL,
        .cert_pem = (char *)server_cert_pem_start,
    };
    esp_https_ota_config_t ota_config = {
        .http_config = &config,
    };
    esp_err_t ret = esp_https_ota(&ota_config);
    if (ret == ESP_OK) {
        esp_restart();
    } else {
        return ESP_FAIL;
    }
    return ESP_OK;
}
```

### Server Verification

Please refer to [ESP-TLS: TLS Server Verification](#) for more information on server verification. The root certificate (in PEM format) needs to be provided to the `esp_http_client_config_t::cert_pem` member.

---

**Note:** The server-endpoint **root** certificate should be used for verification instead of any intermediate ones from the certificate chain. The reason being that the root certificate has the maximum validity and usually remains the same for a long period of time. Users can also use the ESP x509 Certificate Bundle feature for verification, which covers most of the trusted root certificates (using the `esp_http_client_config_t::cert_bundle_attach` member).

---

### Partial Image Download over HTTPS

To use partial image download feature, enable `partial_http_download` configuration in `esp_https_ota_config_t`. When this configuration is enabled, firmware image will be downloaded in multiple HTTP requests of specified size. Maximum content length of each request can be specified by setting `max_http_request_size` to required value.

This option is useful while fetching image from a service like AWS S3, where mbedTLS Rx buffer size (`CONFIG_MBEDTLS_SSL_IN_CONTENT_LEN`) can be set to lower value which is not possible without enabling this configuration.

Default value of mbedTLS Rx buffer size is set to 16K. By using `partial_http_download` with `max_http_request_size` of 4K, size of mbedTLS Rx buffer can be reduced to 4K. With this configuration, memory saving of around 12K is expected.

## Signature Verification

For additional security, signature of OTA firmware images can be verified. For that, refer [Secure OTA Updates Without Secure boot](#)

## Advanced APIs

`esp_https_ota` also provides advanced APIs which can be used if more information and control is needed during the OTA process.

Example that uses advanced ESP\_HTTPS\_OTA APIs: [system/ota/advanced\\_https\\_ota](#).

## OTA Upgrades with Pre-Encrypted Firmware

To perform OTA upgrades with Pre-Encrypted Firmware, please enable `CONFIG_ESP_HTTPS_OTA_DECRYPT_CB` in component menuconfig.

Example that performs OTA upgrade with Pre-Encrypted Firmware: [system/ota/pre\\_encrypted\\_ota](#).

## OTA System Events

ESP HTTPS OTA has various events for which a handler can be triggered by *the Event Loop library* when the particular event occurs. The handler has to be registered using `esp_event_handler_register()`. This helps in event handling for ESP HTTPS OTA. `esp_https_ota_event_t` has all the events which can happen when performing OTA upgrade using ESP HTTPS OTA.

## Event Handler Example

```

/* Event handler for catching system events */
static void event_handler(void* arg, esp_event_base_t event_base,
                          int32_t event_id, void* event_data)
{
    if (event_base == ESP_HTTPS_OTA_EVENT) {
        switch (event_id) {
            case ESP_HTTPS_OTA_START:
                ESP_LOGI(TAG, "OTA started");
                break;
            case ESP_HTTPS_OTA_CONNECTED:
                ESP_LOGI(TAG, "Connected to server");
                break;
            case ESP_HTTPS_OTA_GET_IMG_DESC:
                ESP_LOGI(TAG, "Reading Image Description");
                break;
            case ESP_HTTPS_OTA_VERIFY_CHIP_ID:
                ESP_LOGI(TAG, "Verifying chip id of new image: %d", *(esp_
↳chip_id_t *)event_data);
                break;
            case ESP_HTTPS_OTA_DECRYPT_CB:
                ESP_LOGI(TAG, "Callback to decrypt function");
                break;
            case ESP_HTTPS_OTA_WRITE_FLASH:
                ESP_LOGD(TAG, "Writing to flash: %d written", *(int_
↳*)event_data);
                break;
            case ESP_HTTPS_OTA_UPDATE_BOOT_PARTITION:
                ESP_LOGI(TAG, "Boot partition updated. Next Partition: %d
↳", *(esp_partition_subtype_t *)event_data);
                break;
        }
    }
}

```

(continues on next page)



(continued from previous page)

```

        case ESP_HTTPS_OTA_FINISH:
            ESP_LOGI(TAG, "OTA finish");
            break;
        case ESP_HTTPS_OTA_ABORT:
            ESP_LOGI(TAG, "OTA abort");
            break;
    }
}

```

**Expected data type for different ESP HTTPS OTA events in the system event loop:**

- ESP\_HTTPS\_OTA\_START : NULL
- ESP\_HTTPS\_OTA\_CONNECTED : NULL
- ESP\_HTTPS\_OTA\_GET\_IMG\_DESC : NULL
- ESP\_HTTPS\_OTA\_VERIFY\_CHIP\_ID : esp\_chip\_id\_t
- ESP\_HTTPS\_OTA\_DECRYPT\_CB : NULL
- ESP\_HTTPS\_OTA\_WRITE\_FLASH : int
- ESP\_HTTPS\_OTA\_UPDATE\_BOOT\_PARTITION : esp\_partition\_subtype\_t
- ESP\_HTTPS\_OTA\_FINISH : NULL
- ESP\_HTTPS\_OTA\_ABORT : NULL

**API Reference****Header File**

- components/esp\_https\_ota/include/esp\_https\_ota.h

**Functions**

*esp\_err\_t* **esp\_https\_ota** (const *esp\_https\_ota\_config\_t* \*ota\_config)

HTTPS OTA Firmware upgrade.

This function allocates HTTPS OTA Firmware upgrade context, establishes HTTPS connection, reads image data from HTTP stream and writes it to OTA partition and finishes HTTPS OTA Firmware upgrade operation. This API supports URL redirection, but if CA cert of URLs differ then it should be appended to *cert\_pem* member of *ota\_config->http\_config*.

---

**Note:** This API handles the entire OTA operation, so if this API is being used then no other APIs from *esp\_https\_ota* component should be called. If more information and control is needed during the HTTPS OTA process, then one can use *esp\_https\_ota\_begin* and subsequent APIs. If this API returns successfully, *esp\_restart()* must be called to boot from the new firmware image.

---

**Parameters** *ota\_config* –[in] pointer to *esp\_https\_ota\_config\_t* structure.

**Returns**

- ESP\_OK: OTA data updated, next reboot will use specified partition.
- ESP\_FAIL: For generic failure.
- ESP\_ERR\_INVALID\_ARG: Invalid argument
- ESP\_ERR\_OTA\_VALIDATE\_FAILED: Invalid app image
- ESP\_ERR\_NO\_MEM: Cannot allocate memory for OTA operation.
- ESP\_ERR\_FLASH\_OP\_TIMEOUT or ESP\_ERR\_FLASH\_OP\_FAIL: Flash write failed.
- For other return codes, refer OTA documentation in esp-idf's app\_update component.

*esp\_err\_t* **esp\_https\_ota\_begin** (const *esp\_https\_ota\_config\_t* \*ota\_config, *esp\_https\_ota\_handle\_t* \*handle)

Start HTTPS OTA Firmware upgrade.

This function initializes ESP HTTPS OTA context and establishes HTTPS connection. This function must be invoked first. If this function returns successfully, then `esp_https_ota_perform` should be called to continue with the OTA process and there should be a call to `esp_https_ota_finish` on completion of OTA operation or on failure in subsequent operations. This API supports URL redirection, but if CA cert of URLs differ then it should be appended to `cert_pem` member of `http_config`, which is a part of `ota_config`. In case of error, this API explicitly sets `handle` to NULL.

---

**Note:** This API is blocking, so setting `is_async` member of `http_config` structure will result in an error.

---

#### Parameters

- **ota\_config** –[in] pointer to `esp_https_ota_config_t` structure
- **handle** –[out] pointer to an allocated data of type `esp_https_ota_handle_t` which will be initialised in this function

#### Returns

- `ESP_OK`: HTTPS OTA Firmware upgrade context initialised and HTTPS connection established
- `ESP_FAIL`: For generic failure.
- `ESP_ERR_INVALID_ARG`: Invalid argument (missing/incorrect config, certificate, etc.)
- For other return codes, refer documentation in `app_update` component and `esp_http_client` component in `esp-idf`.

*esp\_err\_t* **esp\_https\_ota\_perform** (*esp\_https\_ota\_handle\_t* https\_ota\_handle)

Read image data from HTTP stream and write it to OTA partition.

This function reads image data from HTTP stream and writes it to OTA partition. This function must be called only if `esp_https_ota_begin()` returns successfully. This function must be called in a loop since it returns after every HTTP read operation thus giving you the flexibility to stop OTA operation midway.

**Parameters** `https_ota_handle` –[in] pointer to `esp_https_ota_handle_t` structure

#### Returns

- `ESP_ERR_HTTPS_OTA_IN_PROGRESS`: OTA update is in progress, call this API again to continue.
- `ESP_OK`: OTA update was successful
- `ESP_FAIL`: OTA update failed
- `ESP_ERR_INVALID_ARG`: Invalid argument
- `ESP_ERR_INVALID_VERSION`: Invalid chip revision in image header
- `ESP_ERR_OTA_VALIDATE_FAILED`: Invalid app image
- `ESP_ERR_NO_MEM`: Cannot allocate memory for OTA operation.
- `ESP_ERR_FLASH_OP_TIMEOUT` or `ESP_ERR_FLASH_OP_FAIL`: Flash write failed.
- For other return codes, refer OTA documentation in `esp-idf`'s `app_update` component.

bool **esp\_https\_ota\_is\_complete\_data\_received** (*esp\_https\_ota\_handle\_t* https\_ota\_handle)

Checks if complete data was received or not.

---

**Note:** This API can be called just before `esp_https_ota_finish()` to validate if the complete image was indeed received.

---

**Parameters** `https_ota_handle` –[in] pointer to `esp_https_ota_handle_t` structure

#### Returns

- false
- true

*esp\_err\_t* **esp\_https\_ota\_finish** (*esp\_https\_ota\_handle\_t* https\_ota\_handle)

Clean-up HTTPS OTA Firmware upgrade and close HTTPS connection.

This function closes the HTTP connection and frees the ESP HTTPS OTA context. This function switches the boot partition to the OTA partition containing the new firmware image.

---

**Note:** If this API returns successfully, `esp_restart()` must be called to boot from the new firmware image. `esp_https_ota_finish` should not be called after calling `esp_https_ota_abort`.

---

**Parameters** `https_ota_handle` –[in] pointer to `esp_https_ota_handle_t` structure

**Returns**

- `ESP_OK`: Clean-up successful
- `ESP_ERR_INVALID_STATE`
- `ESP_ERR_INVALID_ARG`: Invalid argument
- `ESP_ERR_OTA_VALIDATE_FAILED`: Invalid app image

*esp\_err\_t* `esp_https_ota_abort` (*esp\_https\_ota\_handle\_t* https\_ota\_handle)

Clean-up HTTPS OTA Firmware upgrade and close HTTPS connection.

This function closes the HTTP connection and frees the ESP HTTPS OTA context.

---

**Note:** `esp_https_ota_abort` should not be called after calling `esp_https_ota_finish`.

---

**Parameters** `https_ota_handle` –[in] pointer to `esp_https_ota_handle_t` structure

**Returns**

- `ESP_OK`: Clean-up successful
- `ESP_ERR_INVALID_STATE`: Invalid ESP HTTPS OTA state
- `ESP_FAIL`: OTA not started
- `ESP_ERR_NOT_FOUND`: OTA handle not found
- `ESP_ERR_INVALID_ARG`: Invalid argument

*esp\_err\_t* `esp_https_ota_get_img_desc` (*esp\_https\_ota\_handle\_t* https\_ota\_handle, *esp\_app\_desc\_t* \*new\_app\_info)

Reads app description from image header. The app description provides information like the “Firmware version” of the image.

---

**Note:** This API can be called only after `esp_https_ota_begin()` and before `esp_https_ota_perform()`. Calling this API is not mandatory.

---

**Parameters**

- `https_ota_handle` –[in] pointer to `esp_https_ota_handle_t` structure
- `new_app_info` –[out] pointer to an allocated *esp\_app\_desc\_t* structure

**Returns**

- `ESP_ERR_INVALID_ARG`: Invalid arguments
- `ESP_ERR_INVALID_STATE`: Invalid state to call this API. `esp_https_ota_begin()` not called yet.
- `ESP_FAIL`: Failed to read image descriptor
- `ESP_OK`: Successfully read image descriptor

int `esp_https_ota_get_image_len_read` (*esp\_https\_ota\_handle\_t* https\_ota\_handle)

This function returns OTA image data read so far.

---

**Note:** This API should be called only if `esp_https_ota_perform()` has been called at least once or if `esp_https_ota_get_img_desc` has been called before.

---

**Parameters** `https_ota_handle` –[in] pointer to `esp_https_ota_handle_t` structure

**Returns**

- -1 On failure
- total bytes read so far

int `esp_https_ota_get_image_size` (*esp\_https\_ota\_handle\_t* https\_ota\_handle)

This function returns OTA image total size.

---

**Note:** This API should be called after `esp_https_ota_begin()` has been already called. This can be used to create some sort of progress indication (in combination with `esp_https_ota_get_image_len_read()`)

---

**Parameters** `https_ota_handle` –[in] pointer to `esp_https_ota_handle_t` structure

**Returns**

- -1 On failure or chunked encoding
- total bytes of image

## Structures

struct `esp_https_ota_config_t`

ESP HTTPS OTA configuration.

## Public Members

const *esp\_http\_client\_config\_t* \*`http_config`

ESP HTTP client configuration

*http\_client\_init\_cb\_t* `http_client_init_cb`

Callback after ESP HTTP client is initialised

bool `bulk_flash_erase`

Erase entire flash partition during initialization. By default flash partition is erased during write operation and in chunk of 4K sector size

bool `partial_http_download`

Enable Firmware image to be downloaded over multiple HTTP requests

int `max_http_request_size`

Maximum request size for partial HTTP download

## Macros

`ESP_ERR_HTTPS_OTA_BASE`

`ESP_ERR_HTTPS_OTA_IN_PROGRESS`

## Type Definitions

typedef void \*`esp_https_ota_handle_t`

typedef *esp\_err\_t* (\*`http_client_init_cb_t`)(*esp\_http\_client\_handle\_t*)

## Enumerations

enum **esp\_https\_ota\_event\_t**

Events generated by OTA process.

*Values:*

enumerator **ESP\_HTTPS\_OTA\_START**

OTA started

enumerator **ESP\_HTTPS\_OTA\_CONNECTED**

Connected to server

enumerator **ESP\_HTTPS\_OTA\_GET\_IMG\_DESC**

Read app description from image header

enumerator **ESP\_HTTPS\_OTA\_VERIFY\_CHIP\_ID**

Verify chip id of new image

enumerator **ESP\_HTTPS\_OTA\_DECRYPT\_CB**

Callback to decrypt function

enumerator **ESP\_HTTPS\_OTA\_WRITE\_FLASH**

Flash write operation

enumerator **ESP\_HTTPS\_OTA\_UPDATE\_BOOT\_PARTITION**

Boot partition update after successful ota update

enumerator **ESP\_HTTPS\_OTA\_FINISH**

OTA finished

enumerator **ESP\_HTTPS\_OTA\_ABORT**

OTA aborted

## 2.9.9 Event Loop Library

### Overview

The event loop library allows components to declare events to which other components can register handlers –code which will execute when those events occur. This allows loosely coupled components to attach desired behavior to changes in state of other components without application involvement. For instance, a high level connection handling library may subscribe to events produced by the Wi-Fi subsystem directly and act on those events. This also simplifies event processing by serializing and deferring code execution to another context.

### Using **esp\_event** APIs

There are two objects of concern for users of this library: events and event loops.

Events are occurrences of note. For example, for Wi-Fi, a successful connection to the access point may be an event. Events are referenced using a two part identifier which are discussed more [here](#). Event loops are the vehicle by which events get posted by event sources and handled by event handler functions. These two appear prominently in the event loop library APIs.

Using this library roughly entails the following flow:

1. A user defines a function that should run when an event is posted to a loop. This function is referred to as the event handler. It should have the same signature as `esp_event_handler_t`.
2. An event loop is created using `esp_event_loop_create()`, which outputs a handle to the loop of type `esp_event_loop_handle_t`. Event loops created using this API are referred to as user event loops. There is, however, a special type of event loop called the default event loop which are discussed [here](#).
3. Components register event handlers to the loop using `esp_event_handler_register_with()`. Handlers can be registered with multiple loops, more on that [here](#).
4. Event sources post an event to the loop using `esp_event_post_to()`.
5. Components wanting to remove their handlers from being called can do so by unregistering from the loop using `esp_event_handler_unregister_with()`.
6. Event loops which are no longer needed can be deleted using `esp_event_loop_delete()`.

In code, the flow above may look like as follows:

```
// 1. Define the event handler
void run_on_event(void* handler_arg, esp_event_base_t base, int32_t id, void*
↳event_data)
{
    // Event handler logic
}

void app_main()
{
    // 2. A configuration structure of type esp_event_loop_args_t is needed to
↳specify the properties of the loop to be
    // created. A handle of type esp_event_loop_handle_t is obtained, which is
↳needed by the other APIs to reference the loop
    // to perform their operations on.
    esp_event_loop_args_t loop_args = {
        .queue_size = ...,
        .task_name = ...
        .task_priority = ...,
        .task_stack_size = ...,
        .task_core_id = ...
    };

    esp_event_loop_handle_t loop_handle;

    esp_event_loop_create(&loop_args, &loop_handle);

    // 3. Register event handler defined in (1). MY_EVENT_BASE and MY_EVENT_ID
↳specifies a hypothetical
    // event that handler run_on_event should execute on when it gets posted to
↳the loop.
    esp_event_handler_register_with(loop_handle, MY_EVENT_BASE, MY_EVENT_ID, run_
↳on_event, ...);

    ...

    // 4. Post events to the loop. This queues the event on the event loop. At
↳some point in time
    // the event loop executes the event handler registered to the posted event,
↳in this case run_on_event.
    // For simplicity sake this example calls esp_event_post_to from app_main, but
↳posting can be done from
    // any other tasks (which is the more interesting use case).
    esp_event_post_to(loop_handle, MY_EVENT_BASE, MY_EVENT_ID, ...);

    ...

    // 5. Unregistering an unneeded handler
    esp_event_handler_unregister_with(loop_handle, MY_EVENT_BASE, MY_EVENT_ID, run_
↳on_event);
```

(continues on next page)

```

...

// 6. Deleting an unneeded event loop
esp_event_loop_delete(loop_handle);
}

```

### Declaring and defining events

As mentioned previously, events consists of two-part identifiers: the event base and the event ID. The event base identifies an independent group of events; the event ID identifies the event within that group. Think of the event base and event ID as a person's last name and first name, respectively. A last name identifies a family, and the first name identifies a person within that family.

The event loop library provides macros to declare and define the event base easily.

Event base declaration:

```
ESP_EVENT_DECLARE_BASE(EVENT_BASE)
```

Event base definition:

```
ESP_EVENT_DEFINE_BASE(EVENT_BASE)
```

**Note:** In IDF, the base identifiers for system events are uppercase and are postfixed with `_EVENT`. For example, the base for Wi-Fi events is declared and defined as `WIFI_EVENT`, the ethernet event base `ETHERNET_EVENT`, and so on. The purpose is to have event bases look like constants (although they are global variables considering the definitions of macros `ESP_EVENT_DECLARE_BASE` and `ESP_EVENT_DEFINE_BASE`).

For event ID's, declaring them as enumerations is recommended. Once again, for visibility, these are typically placed in public header files.

Event ID:

```

enum {
    EVENT_ID_1,
    EVENT_ID_2,
    EVENT_ID_3,
    ...
}

```

### Default Event Loop

The default event loop is a special type of loop used for system events (Wi-Fi events, for example). The handle for this loop is hidden from the user. The creation, deletion, handler registration/unregistration and posting of events is done through a variant of the APIs for user event loops. The table below enumerates those variants, and the user event loops equivalent.

User Event Loops	Default Event Loops
<code>esp_event_loop_create()</code>	<code>esp_event_loop_create_default()</code>
<code>esp_event_loop_delete()</code>	<code>esp_event_loop_delete_default()</code>
<code>esp_event_handler_register_with()</code>	<code>esp_event_handler_register()</code>
<code>esp_event_handler_unregister_with()</code>	<code>esp_event_handler_unregister()</code>
<code>esp_event_post_to()</code>	<code>esp_event_post()</code>

If you compare the signatures for both, they are mostly similar except the for the lack of loop handle specification for the default event loop APIs.

Other than the API difference and the special designation to which system events are posted to, there is no difference to how default event loops and user event loops behave. It is even possible for users to post their own events to the default event loop, should the user opt to not create their own loops to save memory.

### Notes on Handler Registration

It is possible to register a single handler to multiple events individually, i.e. using multiple calls to `esp_event_handler_register_with()`. For those multiple calls, the specific event base and event ID can be specified with which the handler should execute.

However, in some cases it is desirable for a handler to execute on (1) all events that get posted to a loop or (2) all events of a particular base identifier. This is possible using the special event base identifier `ESP_EVENT_ANY_BASE` and special event ID `ESP_EVENT_ANY_ID`. These special identifiers may be passed as the event base and event ID arguments for `esp_event_handler_register_with()`.

Therefore, the valid arguments to `esp_event_handler_register_with()` are:

1. <event base>, <event ID> - handler executes when the event with base <event base> and event ID <event ID> gets posted to the loop
2. <event base>, `ESP_EVENT_ANY_ID` - handler executes when any event with base <event base> gets posted to the loop
3. `ESP_EVENT_ANY_BASE`, `ESP_EVENT_ANY_ID` - handler executes when any event gets posted to the loop

As an example, suppose the following handler registrations were performed:

```
esp_event_handler_register_with(loop_handle, MY_EVENT_BASE, MY_EVENT_ID, run_on_
↳event_1, ...);
esp_event_handler_register_with(loop_handle, MY_EVENT_BASE, ESP_EVENT_ANY_ID, run_
↳on_event_2, ...);
esp_event_handler_register_with(loop_handle, ESP_EVENT_ANY_BASE, ESP_EVENT_ANY_ID,
↳run_on_event_3, ...);
```

If the hypothetical event `MY_EVENT_BASE`, `MY_EVENT_ID` is posted, all three handlers `run_on_event_1`, `run_on_event_2`, and `run_on_event_3` would execute.

If the hypothetical event `MY_EVENT_BASE`, `MY_OTHER_EVENT_ID` is posted, only `run_on_event_2` and `run_on_event_3` would execute.

If the hypothetical event `MY_OTHER_EVENT_BASE`, `MY_OTHER_EVENT_ID` is posted, only `run_on_event_3` would execute.

**Handler Registration and Handler Dispatch Order** The general rule is that for handlers that match a certain posted event during dispatch, those which are registered first also gets executed first. The user can then control which handlers get executed first by registering them before other handlers, provided that all registrations are performed using a single task. If the user plans to take advantage of this behavior, caution must be exercised if there are multiple tasks registering handlers. While the ‘first registered, first executed’ behavior still holds true, the task which gets executed first will also get their handlers registered first. Handlers registered one after the other by a single task will still be dispatched in the order relative to each other, but if that task gets pre-empted in between registration by another task which also registers handlers; then during dispatch those handlers will also get executed in between.

### Event loop profiling

A configuration option `CONFIG_ESP_EVENT_LOOP_PROFILING` can be enabled in order to activate statistics collection for all event loops created. The function `esp_event_dump()` can be used to output the collected statistics to a file stream. More details on the information included in the dump can be found in the `esp_event_dump()` API Reference.



## Application Example

Examples on using the `esp_event` library can be found in [system/esp\\_event](#). The examples cover event declaration, loop creation, handler registration and unregistration and event posting.

Other examples which also adopt `esp_event` library:

- [NMEA Parser](#) , which will decode the statements received from GPS.

## API Reference

### Header File

- [components/esp\\_event/include/esp\\_event.h](#)

### Functions

*esp\_err\_t* **esp\_event\_loop\_create** (const *esp\_event\_loop\_args\_t* \*event\_loop\_args, *esp\_event\_loop\_handle\_t* \*event\_loop)

Create a new event loop.

#### Parameters

- **event\_loop\_args** –[in] configuration structure for the event loop to create
- **event\_loop** –[out] handle to the created event loop

#### Returns

- ESP\_OK: Success
- ESP\_ERR\_INVALID\_ARG: event\_loop\_args or event\_loop was NULL
- ESP\_ERR\_NO\_MEM: Cannot allocate memory for event loops list
- ESP\_FAIL: Failed to create task loop
- Others: Fail

*esp\_err\_t* **esp\_event\_loop\_delete** (*esp\_event\_loop\_handle\_t* event\_loop)

Delete an existing event loop.

**Parameters** **event\_loop** –[in] event loop to delete, must not be NULL

#### Returns

- ESP\_OK: Success
- Others: Fail

*esp\_err\_t* **esp\_event\_loop\_create\_default** (void)

Create default event loop.

#### Returns

- ESP\_OK: Success
- ESP\_ERR\_NO\_MEM: Cannot allocate memory for event loops list
- ESP\_ERR\_INVALID\_STATE: Default event loop has already been created
- ESP\_FAIL: Failed to create task loop
- Others: Fail

*esp\_err\_t* **esp\_event\_loop\_delete\_default** (void)

Delete the default event loop.

#### Returns

- ESP\_OK: Success
- Others: Fail

*esp\_err\_t* **esp\_event\_loop\_run** (*esp\_event\_loop\_handle\_t* event\_loop, TickType\_t ticks\_to\_run)

Dispatch events posted to an event loop.

This function is used to dispatch events posted to a loop with no dedicated task, i.e. task name was set to NULL in event\_loop\_args argument during loop creation. This function includes an argument to limit the amount of time it runs, returning control to the caller when that time expires (or some time afterwards). There is no guarantee that a call to this function will exit at exactly the time of expiry. There is also no guarantee that

events have been dispatched during the call, as the function might have spent all the allotted time waiting on the event queue. Once an event has been dequeued, however, it is guaranteed to be dispatched. This guarantee contributes to not being able to exit exactly at time of expiry as (1) blocking on internal mutexes is necessary for dispatching the dequeued event, and (2) during dispatch of the dequeued event there is no way to control the time occupied by handler code execution. The guaranteed time of exit is therefore the allotted time + amount of time required to dispatch the last dequeued event.

In cases where waiting on the queue times out, `ESP_OK` is returned and not `ESP_ERR_TIMEOUT`, since it is normal behavior.

---

**Note:** encountering an unknown event that has been posted to the loop will only generate a warning, not an error.

---

#### Parameters

- **event\_loop** –[in] event loop to dispatch posted events from, must not be NULL
- **ticks\_to\_run** –[in] number of ticks to run the loop

#### Returns

- `ESP_OK`: Success
- Others: Fail

*esp\_err\_t* **esp\_event\_handler\_register** (*esp\_event\_base\_t* event\_base, *int32\_t* event\_id, *esp\_event\_handler\_t* event\_handler, void \*event\_handler\_arg)

Register an event handler to the system event loop (legacy).

This function can be used to register a handler for either: (1) specific events, (2) all events of a certain event base, or (3) all events known by the system event loop.

- specific events: specify exact `event_base` and `event_id`
- all events of a certain base: specify exact `event_base` and use `ESP_EVENT_ANY_ID` as the `event_id`
- all events known by the loop: use `ESP_EVENT_ANY_BASE` for `event_base` and `ESP_EVENT_ANY_ID` as the `event_id`

Registering multiple handlers to events is possible. Registering a single handler to multiple events is also possible. However, registering the same handler to the same event multiple times would cause the previous registrations to be overwritten.

---

**Note:** This function is obsolete and will be deprecated soon, please use `esp_event_handler_instance_register()` instead.

---

---

**Note:** the event loop library does not maintain a copy of `event_handler_arg`, therefore the user should ensure that `event_handler_arg` still points to a valid location by the time the handler gets called

---

#### Parameters

- **event\_base** –[in] the base ID of the event to register the handler for
- **event\_id** –[in] the ID of the event to register the handler for
- **event\_handler** –[in] the handler function which gets called when the event is dispatched
- **event\_handler\_arg** –[in] data, aside from event data, that is passed to the handler when it is called

#### Returns

- `ESP_OK`: Success
- `ESP_ERR_NO_MEM`: Cannot allocate memory for the handler

- ESP\_ERR\_INVALID\_ARG: Invalid combination of event base and event ID
- Others: Fail

```
esp_err_t esp_event_handler_register_with(esp_event_loop_handle_t event_loop, esp_event_base_t event_base, int32_t event_id, esp_event_handler_t event_handler, void *event_handler_arg)
```

Register an event handler to a specific loop (legacy).

This function behaves in the same manner as `esp_event_handler_register`, except the additional specification of the event loop to register the handler to.

---

**Note:** This function is obsolete and will be deprecated soon, please use `esp_event_handler_instance_register_with()` instead.

---

---

**Note:** the event loop library does not maintain a copy of `event_handler_arg`, therefore the user should ensure that `event_handler_arg` still points to a valid location by the time the handler gets called

---

#### Parameters

- **event\_loop** –[in] the event loop to register this handler function to, must not be NULL
- **event\_base** –[in] the base ID of the event to register the handler for
- **event\_id** –[in] the ID of the event to register the handler for
- **event\_handler** –[in] the handler function which gets called when the event is dispatched
- **event\_handler\_arg** –[in] data, aside from event data, that is passed to the handler when it is called

#### Returns

- ESP\_OK: Success
- ESP\_ERR\_NO\_MEM: Cannot allocate memory for the handler
- ESP\_ERR\_INVALID\_ARG: Invalid combination of event base and event ID
- Others: Fail

```
esp_err_t esp_event_handler_instance_register_with(esp_event_loop_handle_t event_loop, esp_event_base_t event_base, int32_t event_id, esp_event_handler_t event_handler, void *event_handler_arg, esp_event_handler_instance_t *instance)
```

Register an instance of event handler to a specific loop.

This function can be used to register a handler for either: (1) specific events, (2) all events of a certain event base, or (3) all events known by the system event loop.

- specific events: specify exact `event_base` and `event_id`
- all events of a certain base: specify exact `event_base` and use `ESP_EVENT_ANY_ID` as the `event_id`
- all events known by the loop: use `ESP_EVENT_ANY_BASE` for `event_base` and `ESP_EVENT_ANY_ID` as the `event_id`

Besides the error, the function returns an instance object as output parameter to identify each registration. This is necessary to remove (unregister) the registration before the event loop is deleted.

Registering multiple handlers to events, registering a single handler to multiple events as well as registering the same handler to the same event multiple times is possible. Each registration yields a distinct instance object which identifies it over the registration lifetime.

---

**Note:** the event loop library does not maintain a copy of `event_handler_arg`, therefore the user should ensure that `event_handler_arg` still points to a valid location by the time the handler gets called

---

#### Parameters

- **event\_loop** –[in] the event loop to register this handler function to, must not be NULL
- **event\_base** –[in] the base ID of the event to register the handler for
- **event\_id** –[in] the ID of the event to register the handler for
- **event\_handler** –[in] the handler function which gets called when the event is dispatched
- **event\_handler\_arg** –[in] data, aside from event data, that is passed to the handler when it is called
- **instance** –[out] An event handler instance object related to the registered event handler and data, can be NULL. This needs to be kept if the specific callback instance should be unregistered before deleting the whole event loop. Registering the same event handler multiple times is possible and yields distinct instance objects. The data can be the same for all registrations. If no unregistration is needed, but the handler should be deleted when the event loop is deleted, instance can be NULL.

#### Returns

- ESP\_OK: Success
- ESP\_ERR\_NO\_MEM: Cannot allocate memory for the handler
- ESP\_ERR\_INVALID\_ARG: Invalid combination of event base and event ID or instance is NULL
- Others: Fail

`esp_err_t esp_event_handler_instance_register` (`esp_event_base_t event_base`, `int32_t event_id`, `esp_event_handler_t event_handler`, `void *event_handler_arg`, `esp_event_handler_instance_t *instance`)

Register an instance of event handler to the default loop.

This function does the same as `esp_event_handler_instance_register_with`, except that it registers the handler to the default event loop.

---

**Note:** the event loop library does not maintain a copy of `event_handler_arg`, therefore the user should ensure that `event_handler_arg` still points to a valid location by the time the handler gets called

---

#### Parameters

- **event\_base** –[in] the base ID of the event to register the handler for
- **event\_id** –[in] the ID of the event to register the handler for
- **event\_handler** –[in] the handler function which gets called when the event is dispatched
- **event\_handler\_arg** –[in] data, aside from event data, that is passed to the handler when it is called
- **instance** –[out] An event handler instance object related to the registered event handler and data, can be NULL. This needs to be kept if the specific callback instance should be unregistered before deleting the whole event loop. Registering the same event handler multiple times is possible and yields distinct instance objects. The data can be the same for all registrations. If no unregistration is needed, but the handler should be deleted when the event loop is deleted, instance can be NULL.

#### Returns

- ESP\_OK: Success
- ESP\_ERR\_NO\_MEM: Cannot allocate memory for the handler
- ESP\_ERR\_INVALID\_ARG: Invalid combination of event base and event ID or instance is NULL
- Others: Fail

*esp\_err\_t* **esp\_event\_handler\_unregister** (*esp\_event\_base\_t* event\_base, *int32\_t* event\_id, *esp\_event\_handler\_t* event\_handler)

Unregister a handler with the system event loop (legacy).

Unregisters a handler, so it will no longer be called during dispatch. Handlers can be unregistered for any combination of event\_base and event\_id which were previously registered. To unregister a handler, the event\_base and event\_id arguments must match exactly the arguments passed to esp\_event\_handler\_register() when that handler was registered. Passing ESP\_EVENT\_ANY\_BASE and/or ESP\_EVENT\_ANY\_ID will only unregister handlers that were registered with the same wildcard arguments.

---

**Note:** This function is obsolete and will be deprecated soon, please use esp\_event\_handler\_instance\_unregister() instead.

---

---

**Note:** When using ESP\_EVENT\_ANY\_ID, handlers registered to specific event IDs using the same base will not be unregistered. When using ESP\_EVENT\_ANY\_BASE, events registered to specific bases will also not be unregistered. This avoids accidental unregistration of handlers registered by other users or components.

---

#### Parameters

- **event\_base** –[in] the base of the event with which to unregister the handler
- **event\_id** –[in] the ID of the event with which to unregister the handler
- **event\_handler** –[in] the handler to unregister

**Returns** ESP\_OK success

**Returns** ESP\_ERR\_INVALID\_ARG invalid combination of event base and event ID

**Returns** others fail

*esp\_err\_t* **esp\_event\_handler\_unregister\_with** (*esp\_event\_loop\_handle\_t* event\_loop, *esp\_event\_base\_t* event\_base, *int32\_t* event\_id, *esp\_event\_handler\_t* event\_handler)

Unregister a handler from a specific event loop (legacy).

This function behaves in the same manner as esp\_event\_handler\_unregister, except the additional specification of the event loop to unregister the handler with.

---

**Note:** This function is obsolete and will be deprecated soon, please use esp\_event\_handler\_instance\_unregister\_with() instead.

---

#### Parameters

- **event\_loop** –[in] the event loop with which to unregister this handler function, must not be NULL
- **event\_base** –[in] the base of the event with which to unregister the handler
- **event\_id** –[in] the ID of the event with which to unregister the handler
- **event\_handler** –[in] the handler to unregister

#### Returns

- ESP\_OK: Success
- ESP\_ERR\_INVALID\_ARG: Invalid combination of event base and event ID
- Others: Fail

*esp\_err\_t* **esp\_event\_handler\_instance\_unregister\_with** (*esp\_event\_loop\_handle\_t* event\_loop, *esp\_event\_base\_t* event\_base, *int32\_t* event\_id, *esp\_event\_handler\_instance\_t* instance)

Unregister a handler instance from a specific event loop.

Unregisters a handler instance, so it will no longer be called during dispatch. Handler instances can be unregistered for any combination of `event_base` and `event_id` which were previously registered. To unregister a handler instance, the `event_base` and `event_id` arguments must match exactly the arguments passed to `esp_event_handler_instance_register()` when that handler instance was registered. Passing `ESP_EVENT_ANY_BASE` and/or `ESP_EVENT_ANY_ID` will only unregister handler instances that were registered with the same wildcard arguments.

---

**Note:** When using `ESP_EVENT_ANY_ID`, handlers registered to specific event IDs using the same base will not be unregistered. When using `ESP_EVENT_ANY_BASE`, events registered to specific bases will also not be unregistered. This avoids accidental unregistration of handlers registered by other users or components.

---

#### Parameters

- **event\_loop** –[in] the event loop with which to unregister this handler function, must not be NULL
- **event\_base** –[in] the base of the event with which to unregister the handler
- **event\_id** –[in] the ID of the event with which to unregister the handler
- **instance** –[in] the instance object of the registration to be unregistered

#### Returns

- `ESP_OK`: Success
- `ESP_ERR_INVALID_ARG`: Invalid combination of event base and event ID
- Others: Fail

*esp\_err\_t* **esp\_event\_handler\_instance\_unregister** (*esp\_event\_base\_t* event\_base, *int32\_t* event\_id, *esp\_event\_handler\_instance\_t* instance)

Unregister a handler from the system event loop.

This function does the same as `esp_event_handler_instance_unregister_with`, except that it unregisters the handler instance from the default event loop.

#### Parameters

- **event\_base** –[in] the base of the event with which to unregister the handler
- **event\_id** –[in] the ID of the event with which to unregister the handler
- **instance** –[in] the instance object of the registration to be unregistered

#### Returns

- `ESP_OK`: Success
- `ESP_ERR_INVALID_ARG`: Invalid combination of event base and event ID
- Others: Fail

*esp\_err\_t* **esp\_event\_post** (*esp\_event\_base\_t* event\_base, *int32\_t* event\_id, *const void \**event\_data, *size\_t* event\_data\_size, *TickType\_t* ticks\_to\_wait)

Posts an event to the system default event loop. The event loop library keeps a copy of `event_data` and manages the copy's lifetime automatically (allocation + deletion); this ensures that the data the handler receives is always valid.

#### Parameters

- **event\_base** –[in] the event base that identifies the event
- **event\_id** –[in] the event ID that identifies the event
- **event\_data** –[in] the data, specific to the event occurrence, that gets passed to the handler
- **event\_data\_size** –[in] the size of the event data
- **ticks\_to\_wait** –[in] number of ticks to block on a full event queue

#### Returns

- `ESP_OK`: Success
- `ESP_ERR_TIMEOUT`: Time to wait for event queue to unblock expired, queue full when posting from ISR

- ESP\_ERR\_INVALID\_ARG: Invalid combination of event base and event ID
- Others: Fail

*esp\_err\_t* **esp\_event\_post\_to** (*esp\_event\_loop\_handle\_t* event\_loop, *esp\_event\_base\_t* event\_base, *int32\_t* event\_id, const void \*event\_data, *size\_t* event\_data\_size, *TickType\_t* ticks\_to\_wait)

Posts an event to the specified event loop. The event loop library keeps a copy of event\_data and manages the copy's lifetime automatically (allocation + deletion); this ensures that the data the handler receives is always valid.

This function behaves in the same manner as esp\_event\_post\_to, except the additional specification of the event loop to post the event to.

#### Parameters

- **event\_loop** –[in] the event loop to post to, must not be NULL
- **event\_base** –[in] the event base that identifies the event
- **event\_id** –[in] the event ID that identifies the event
- **event\_data** –[in] the data, specific to the event occurrence, that gets passed to the handler
- **event\_data\_size** –[in] the size of the event data
- **ticks\_to\_wait** –[in] number of ticks to block on a full event queue

#### Returns

- ESP\_OK: Success
- ESP\_ERR\_TIMEOUT: Time to wait for event queue to unblock expired, queue full when posting from ISR
- ESP\_ERR\_INVALID\_ARG: Invalid combination of event base and event ID
- Others: Fail

*esp\_err\_t* **esp\_event\_isr\_post** (*esp\_event\_base\_t* event\_base, *int32\_t* event\_id, const void \*event\_data, *size\_t* event\_data\_size,  *BaseType\_t* \*task\_unblocked)

Special variant of esp\_event\_post for posting events from interrupt handlers.

---

**Note:** this function is only available when CONFIG\_ESP\_EVENT\_POST\_FROM\_ISR is enabled

---

---

**Note:** when this function is called from an interrupt handler placed in IRAM, this function should be placed in IRAM as well by enabling CONFIG\_ESP\_EVENT\_POST\_FROM\_IRAM\_ISR

---

#### Parameters

- **event\_base** –[in] the event base that identifies the event
- **event\_id** –[in] the event ID that identifies the event
- **event\_data** –[in] the data, specific to the event occurrence, that gets passed to the handler
- **event\_data\_size** –[in] the size of the event data; max is 4 bytes
- **task\_unblocked** –[out] an optional parameter (can be NULL) which indicates that an event task with higher priority than currently running task has been unblocked by the posted event; a context switch should be requested before the interrupt is existed.

#### Returns

- ESP\_OK: Success
- ESP\_FAIL: Event queue for the default event loop full
- ESP\_ERR\_INVALID\_ARG: Invalid combination of event base and event ID, data size of more than 4 bytes
- Others: Fail

*esp\_err\_t* **esp\_event\_isr\_post\_to** (*esp\_event\_loop\_handle\_t* event\_loop, *esp\_event\_base\_t* event\_base, *int32\_t* event\_id, const void \*event\_data, *size\_t* event\_data\_size,  *BaseType\_t* \*task\_unblocked)

Special variant of `esp_event_post_to` for posting events from interrupt handlers.

---

**Note:** this function is only available when `CONFIG_ESP_EVENT_POST_FROM_ISR` is enabled

---



---

**Note:** when this function is called from an interrupt handler placed in IRAM, this function should be placed in IRAM as well by enabling `CONFIG_ESP_EVENT_POST_FROM_IRAM_ISR`

---

### Parameters

- **event\_loop** –[in] the event loop to post to, must not be NULL
- **event\_base** –[in] the event base that identifies the event
- **event\_id** –[in] the event ID that identifies the event
- **event\_data** –[in] the data, specific to the event occurrence, that gets passed to the handler
- **event\_data\_size** –[in] the size of the event data
- **task\_unblocked** –[out] an optional parameter (can be NULL) which indicates that an event task with higher priority than currently running task has been unblocked by the posted event; a context switch should be requested before the interrupt is existed.

### Returns

- `ESP_OK`: Success
- `ESP_FAIL`: Event queue for the loop full
- `ESP_ERR_INVALID_ARG`: Invalid combination of event base and event ID, data size of more than 4 bytes
- Others: Fail

*esp\_err\_t* `esp_event_dump` (FILE \*file)

Dumps statistics of all event loops.

Dumps event loop info in the format:

```

event loop
  handler
  handler
  ...
event loop
  handler
  handler
  ...

where:

event loop
  format: address,name rx:total_received dr:total_dropped
  where:
    address - memory address of the event loop
    name - name of the event loop, 'none' if no dedicated task
    total_received - number of successfully posted events
    total_dropped - number of events unsuccessfully posted due to queue_
↳being full

handler
  format: address ev:base,id inv:total_invoked run:total_runtime
  where:
    address - address of the handler function
    base,id - the event specified by event base and ID this handler_
↳executes

```

(continues on next page)



(continued from previous page)

```
total_invoked - number of times this handler has been invoked
total_runtime - total amount of time used for invoking this handler
```

---

**Note:** this function is a noop when CONFIG\_ESP\_EVENT\_LOOP\_PROFILING is disabled

---

**Parameters** `file` `-[in]` the file stream to output to

**Returns**

- ESP\_OK: Success
- ESP\_ERR\_NO\_MEM: Cannot allocate memory for event loops list
- Others: Fail

## Structures

struct `esp_event_loop_args_t`

Configuration for creating event loops.

### Public Members

`int32_t queue_size`

size of the event loop queue

`const char *task_name`

name of the event loop task; if NULL, a dedicated task is not created for event loop

`UBaseType_t task_priority`

priority of the event loop task, ignored if task name is NULL

`uint32_t task_stack_size`

stack size of the event loop task, ignored if task name is NULL

`BaseType_t task_core_id`

core to which the event loop task is pinned to, ignored if task name is NULL

## Header File

- [components/esp\\_event/include/esp\\_event\\_base.h](#)

## Macros

`ESP_EVENT_DECLARE_BASE` (id)

`ESP_EVENT_DEFINE_BASE` (id)

`ESP_EVENT_ANY_BASE`

register handler for any event base

`ESP_EVENT_ANY_ID`

register handler for any event id

## Type Definitions

typedef void \***esp\_event\_loop\_handle\_t**

a number that identifies an event with respect to a base

typedef void (\***esp\_event\_handler\_t**)(void \*event\_handler\_arg, esp\_event\_base\_t event\_base, int32\_t event\_id, void \*event\_data)

function called when an event is posted to the queue

typedef void \***esp\_event\_handler\_instance\_t**

context identifying an instance of a registered event handler

## Related Documents

### 2.9.10 FreeRTOS (Overview)

#### Overview

FreeRTOS is an open source real-time operating system kernel that acts as the operating system for ESP-IDF applications and is integrated into ESP-IDF as a component. The FreeRTOS component in ESP-IDF contains ports of the FreeRTOS kernel for all the CPU architectures used by ESP targets (i.e., Xtensa and RISC-V). Furthermore, ESP-IDF provides different implementations of FreeRTOS in order to support SMP (Symmetric Multiprocessing) on multi-core ESP targets. This document provides an overview of the FreeRTOS component, the FreeRTOS implementations offered by ESP-IDF, and the common aspects across all implementations.

#### Implementations

The [official FreeRTOS](#) (henceforth referred to as Vanilla FreeRTOS) is a single-core RTOS. In order to support the various multi-core ESP targets, ESP-IDF supports different FreeRTOS implementations, namely **ESP-IDF FreeRTOS** and **Amazon SMP FreeRTOS**.

**ESP-IDF FreeRTOS** ESP-IDF FreeRTOS is a FreeRTOS implementation based on Vanilla FreeRTOS v10.4.3, but contains significant modifications to support SMP. ESP-IDF FreeRTOS only supports two cores at most (i.e., dual core SMP), but is more optimized for this scenario by design. For more details regarding ESP-IDF FreeRTOS and its modifications, please refer to the [FreeRTOS \(ESP-IDF\)](#) document.

---

**Note:** ESP-IDF FreeRTOS is currently the default FreeRTOS implementation for ESP-IDF.

---

**Amazon SMP FreeRTOS** Amazon SMP FreeRTOS is an SMP implementation of FreeRTOS that is officially supported by Amazon. Amazon SMP FreeRTOS is able to support N-cores (i.e., more than two cores). Amazon SMP FreeRTOS can be enabled via the [CONFIG\\_FREERTOS\\_SMP](#) option. For more details regarding Amazon SMP FreeRTOS, please refer to the [official Amazon SMP FreeRTOS documentation](#).

<p><b>Warning:</b> The Amazon SMP FreeRTOS implementation (and its port in ESP-IDF) are currently in experimental/beta state. Therefore, significant behavioral changes and breaking API changes can occur.</p>
---

## Configuration

**Kernel Configuration** Vanilla FreeRTOS requires that ports and applications configure the kernel by adding various `#define config...` macros to `FreeRTOSConfig.h`. Vanilla FreeRTOS supports a list of kernel configuration options which allow various kernel behaviors and features to be enabled or disabled.

However, for all FreeRTOS ports in ESP-IDF, the `FreeRTOSConfig.h` file is considered private and must not be modified by users. A large number of kernel configuration options in `FreeRTOSConfig.h` are hard coded as they are either required or not supported in ESP-IDF. All kernel configuration options that are configurable by the user will be exposed via menuconfig under `Component Config/FreeRTOS/Kernel`.

For the full list of user configurable kernel options, see [Project Configuration](#). The list below highlights some commonly used kernel configuration options:

- `CONFIG_FREERTOS_UNICORE` will run FreeRTOS only on CPU0. Note that this is **not equivalent to running Vanilla FreeRTOS**. Furthermore, this option may affect behavior of components other than `freertos`. For more details regarding the effects of running FreeRTOS on a single core, refer to [ESP-IDF FreeRTOS Single Core](#) (if using ESP-IDF FreeRTOS) or the official Amazon SMP FreeRTOS documentation. Alternatively, users can also search for occurrences of `CONFIG_FREERTOS_UNICORE` in the ESP-IDF components.

---

**Note:** As ESP32-S2 is a single core SoC, the `CONFIG_FREERTOS_UNICORE` configuration is always set.

---

- `CONFIG_FREERTOS_ENABLE_BACKWARD_COMPATIBILITY` enables backward compatibility with some FreeRTOS macros/types/functions that were deprecated from v8.0 onwards.

**Port Configuration** All other FreeRTOS related configuration options that are not part of the kernel configuration are exposed via menuconfig under `Component Config/FreeRTOS/Port`. These options configure aspects such as:

- The FreeRTOS ports themselves (e.g., tick timer selection, ISR stack size)
- Additional features added to the FreeRTOS implementation or ports

## Using FreeRTOS

**Application Entry Point** Unlike Vanilla FreeRTOS, users of FreeRTOS in ESP-IDF **must never call** `vTaskStartScheduler()` and `vTaskEndScheduler()`. Instead, ESP-IDF will start FreeRTOS automatically. Users must define a `void app_main(void)` function which acts as the entry point for user's application and is automatically called on ESP-IDF startup.

- Typically, users would spawn the rest of their application's task from `app_main`.
- The `app_main` function is allowed to return at any point (i.e., before the application terminates).
- The `app_main` function is called from the `main` task.

**Background Tasks** During startup, ESP-IDF and FreeRTOS will automatically create multiple tasks that run in the background (listed in the the table below).

Table 9: List of Tasks Created During Startup

Task Name	Description	Stack Size	Affinity	Priority
Idle Tasks (IDLE <sub>x</sub> )	An idle task (IDLE <sub>x</sub> ) is created for (and pinned to) each CPU core, where <i>x</i> is the CPU core's number. The <i>x</i> is dropped when single-core configuration is enabled.	CON-CPU <sub>x</sub>		0
FreeRTOS Timer Task (Tmr Svc)	FreeRTOS will create the Timer Service/Daemon Task if any FreeRTOS Timer APIs are called by the application.	CON-CPU0	CON-	
Main Task (main)	Task that simply calls <code>app_main</code> . This task will self delete when <code>app_main</code> returns	CON-CON		1
IPC Tasks (ipc <sub>x</sub> )	When <code>CONFIG_FREERTOS_UNICORE</code> is false, an IPC task (ipc <sub>x</sub> ) is created for (and pinned to) each CPU. IPC tasks are used to implement the Inter-processor Call (IPC) feature.	CON-CPU <sub>x</sub>		2, 4
ESP Timer Task (esp_timer)	ESP-IDF will create the ESP Timer Task used to process ESP Timer callbacks.	CON-CPU0		2

**Note:** Note that if an application uses other ESP-IDF features (e.g., WiFi or Bluetooth), those features may create their own background tasks in addition to the tasks listed in the table above.

## FreeRTOS Additions

ESP-IDF provides some supplemental features to FreeRTOS such as Ring Buffers, ESP-IDF style Tick and Idle Hooks, and TLSP deletion callbacks. See *FreeRTOS (Supplemental Features)* for more details.

### 2.9.11 FreeRTOS (ESP-IDF)

#### Overview

The original FreeRTOS (hereinafter referred to as Vanilla FreeRTOS) is a small and efficient Real Time Operating System supported on many single-core MCUs and SoCs. However, to support numerous dual core ESP targets (such as the ESP32 and ESP32-S3), ESP-IDF provides a dual core SMP (Symmetric Multiprocessing) capable implementation of FreeRTOS, (hereinafter referred to as ESP-IDF FreeRTOS).

ESP-IDF FreeRTOS is based on Vanilla FreeRTOS v10.4.3, but contains significant modifications to both API and kernel behavior in order to support dual core SMP. This document describes the API and behavioral differences between Vanilla FreeRTOS and ESP-IDF FreeRTOS.

**Note:** This document assumes that the reader has a requisite understanding of Vanilla FreeRTOS (its features, behavior, and API usage). Refer to the [Vanilla FreeRTOS documentation](#) for more details.

**Note:** ESP-IDF FreeRTOS can be built for single core by enabling the `CONFIG_FREERTOS_UNICORE` configuration option. ESP targets that are single core will always have the `CONFIG_FREERTOS_UNICORE` option enabled. However, note that building with `CONFIG_FREERTOS_UNICORE` enabled does not equate to building with Vanilla

FreeRTOS (i.e., some of the behavioral and API changes of ESP-IDF will still be present). For more details, see [ESP-IDF FreeRTOS Single Core](#) for more details.

---

This document is split into the following parts.

### Contents

- *FreeRTOS (ESP-IDF)*
  - *Overview*
  - *Symmetric Multiprocessing*
  - *Tasks*
  - *SMP Scheduler*
  - *Critical Sections*
  - *Misc*
  - *API Reference*

## Symmetric Multiprocessing

**Basic Concepts** SMP (Symmetric Multiprocessing) is a computing architecture where two or more identical CPUs (cores) are connected to a single shared main memory and controlled by a single operating system. In general, an SMP system...

- has multiple cores running independently. Each core has its own register file, interrupts, and interrupt handling.
- presents an identical view of memory to each core. Thus a piece of code that accesses a particular memory address will have the same effect regardless of which core it runs on.

The main advantages of an SMP system compared to single core or Asymmetric Multiprocessing systems are that...

- the presence of multiple CPUs allows for multiple hardware threads, thus increases overall processing throughput.
- having symmetric memory means that threads can switch cores during execution. This in general can lead to better CPU utilization.

Although an SMP system allows threads to switch cores, there are scenarios where a thread must/should only run on a particular core. Therefore, threads in an SMP systems will also have a core affinity that specifies which particular core the thread is allowed to run on.

- A thread that is pinned to a particular core will only be able to run on that core
- A thread that is unpinned will be allowed to switch between cores during execution instead of being pinned to a particular core.

**SMP on an ESP Target** ESP targets (such as the ESP32, ESP32-S3) are dual core SMP SoCs. These targets have the following hardware features that make them SMP capable:

- Two identical cores known as CPU0 (i.e., Protocol CPU or PRO\_CPU) and CPU1 (i.e., Application CPU or APP\_CPU). This means that the execution of a piece of code is identical regardless of which core it runs on.
- Symmetric memory (with some small exceptions).
  - If multiple cores access the same memory address, their access will be serialized at the memory bus level.
  - True atomic access to the same memory address is achieved via an atomic compare-and-swap instruction provided by the ISA.
- Cross-core interrupts that allow one CPU to trigger and interrupt on another CPU. This allows cores to signal each other.

---

**Note:** The “PRO\_CPU” and “APP\_CPU” aliases for CPU0 and CPU1 exist in ESP-IDF as they reflect how typical IDF applications will utilize the two CPUs. Typically, the tasks responsible for handling wireless networking (e.g.,

WiFi or Bluetooth) will be pinned to CPU0 (thus the name PRO\_CPU), whereas the tasks handling the remainder of the application will be pinned to CPU1 (thus the name APP\_CPU).

---

## Tasks

**Creation** Vanilla FreeRTOS provides the following functions to create a task:

- `xTaskCreate()` creates a task. The task's memory is dynamically allocated
- `xTaskCreateStatic()` creates a task. The task's memory is statically allocated (i.e., provided by the user)

However, in an SMP system, tasks need to be assigned a particular affinity. Therefore, ESP-IDF provides a `PinnedToCore` version of Vanilla FreeRTOS' s task creation functions:

- `xTaskCreatePinnedToCore()` creates a task with a particular core affinity. The task's memory is dynamically allocated.
- `xTaskCreateStaticPinnedToCore()` creates a task with a particular core affinity. The task's memory is statically allocated (i.e., provided by the user)

The `PinnedToCore` versions of the task creation functions API differ from their vanilla counterparts by having an extra `xCoreID` parameter that is used to specify the created task's core affinity. The valid values for core affinity are:

- 0 which pins the created task to CPU0
- 1 which pins the created task to CPU1
- `tskNO_AFFINITY` which allows the task to be run on both CPUs

Note that ESP-IDF FreeRTOS still supports the vanilla versions of the task creation functions. However, they have been modified to simply call their `PinnedToCore` counterparts with `tskNO_AFFINITY`.

---

**Note:** ESP-IDF FreeRTOS also changes the units of `ulStackDepth` in the task creation functions. Task stack sizes in Vanilla FreeRTOS are specified in number of words, whereas in ESP-IDF FreeRTOS, the task stack sizes are specified in bytes.

---

**Execution** The anatomy of a task in ESP-IDF FreeRTOS is the same as Vanilla FreeRTOS. More specifically, ESP-IDF FreeRTOS tasks:

- Can only be in one of following states: Running, Ready, Blocked, or Suspended.
- Task functions are typically implemented as an infinite loop
- Task functions should never return

**Deletion** Task deletion in Vanilla FreeRTOS is called via `vTaskDelete()`. The function allows deletion of another task or the currently running task (if the provided task handle is `NULL`). The actual freeing of the task's memory is sometimes delegated to the idle task (if the task being deleted is the currently running task).

ESP-IDF FreeRTOS provides the same `vTaskDelete()` function. However, due to the dual core nature, there are some behavioral differences when calling `vTaskDelete()` in ESP-IDF FreeRTOS:

- When deleting a task that is pinned to the other core, that task's memory is always freed by the idle task of the other core (due to the need to clear FPU registers).
- When deleting a task that is currently running on the other core, a yield is triggered on the other core and the task's memory is freed by one of the idle tasks (depending on the task's core affinity)
- A deleted task's memory is freed immediately if...
  - The task is currently running on this core and is also pinned to this core
  - The task is not currently running and is not pinned to any core

Users should avoid calling `vTaskDelete()` on a task that is currently running on the other core. This is due to the fact that it is difficult to know what the task currently running on the other core is executing, thus can lead to unpredictable behavior such as...

- Deleting a task that is holding a mutex
- Deleting a task that has yet to free memory it previously allocated

Where possible, users should design their application such that `vTaskDelete()` is only ever called on tasks in a known state. For example:

- Tasks self deleting (via `vTaskDelete(NULL)`) when their execution is complete and have also cleaned up all resources used within the task.
- Tasks placing themselves in the suspend state (via `vTaskSuspend()`) before being deleted by another task.

## SMP Scheduler

The Vanilla FreeRTOS scheduler is best described as a **Fixed Priority Preemptive scheduler with Time Slicing** meaning that:

- Each task is given a constant priority upon creation. The scheduler executes highest priority ready state task
- The scheduler can switch execution to another task without the cooperation of the currently running task
- The scheduler will periodically switch execution between ready state tasks of the same priority (in a round robin fashion). Time slicing is governed by a tick interrupt.

The ESP-IDF FreeRTOS scheduler supports the same scheduling features (i.e., Fixed Priority, Preemption, and Time Slicing) albeit with some small behavioral differences.

**Fixed Priority** In Vanilla FreeRTOS, when scheduler selects a new task to run, it will always select the current highest priority ready state task. In ESP-IDF FreeRTOS, each core will independently schedule tasks to run. When a particular core selects a task, the core will select the highest priority ready state task that can be run by the core. A task can be run by the core if:

- The task has a compatible affinity (i.e., is either pinned to that core or is unpinned)
- The task is not currently being run by another core

However, users should not assume that the two highest priority ready state tasks are always run by the scheduler as a task's core affinity must also be accounted for. For example, given the following tasks:

- Task A of priority 10 pinned to CPU0
- Task B of priority 9 pinned to CPU0
- Task C of priority 8 pinned to CPU1

The resulting schedule will have Task A running on CPU0 and Task C running on CPU1. Task B is not run even though it is the second highest priority task.

**Preemption** In Vanilla FreeRTOS, the scheduler can preempt the currently running task if a higher priority task becomes ready to execute. Likewise in ESP-IDF FreeRTOS, each core can be individually preempted by the scheduler if the scheduler determines that a higher priority task can run on that core.

However, there are some instances where a higher priority task that becomes ready can be run on multiple cores. In this case, the scheduler will only preempt one core. The scheduler always gives preference to the current core when multiple cores can be preempted. In other words, if the higher priority ready task is unpinned and has a higher priority than the current priority of both cores, the scheduler will always choose to preempt the current core. For example, given the following tasks:

- Task A of priority 8 currently running on CPU0
- Task B of priority 9 currently running on CPU1
- Task C of priority 10 that is unpinned and was unblocked by Task B

The resulting schedule will have Task A running on CPU0 and Task C preempting Task B given that the scheduler always gives preference to the current core.

**Time Slicing** The Vanilla FreeRTOS scheduler implements time slicing meaning that if current highest ready priority contains multiple ready tasks, the scheduler will switch between those tasks periodically in a round robin fashion.

However, in ESP-IDF FreeRTOS, it is not possible to implement perfect Round Robin time slicing due to the fact that a particular task may not be able to run on a particular core due to the following reasons:

- The task is pinned to the another core.
- For unpinned tasks, the task is already being run by another core.

Therefore, when a core searches the ready state task list for a task to run, the core may need to skip over a few tasks in the same priority list or drop to a lower priority in order to find a ready state task that the core can run.

The ESP-IDF FreeRTOS scheduler implements a Best Effort Round Robin time slicing for ready state tasks of the same priority by ensuring that tasks that have been selected to run will be placed at the back of the list, thus giving unselected tasks a higher priority on the next scheduling iteration (i.e., the next tick interrupt or yield)

The following example demonstrates the Best Effort Round Robin time slicing in action. Assume that:

- There are four ready state tasks of the same priority AX, B0, C1, D1 where: - The priority is the current highest priority with ready state tasks - The first character represents the task's names (i.e., A, B, C, D) - And the second character represents the tasks core pinning (and X means unpinned)
- The task list is always searched from the head

-----

1. Starting state. None of the ready state tasks have been selected to run

Head [ AX , B0 , C1 , D0 ] Tail

-----

2. Core 0 has tick interrupt and searches for a task to run.

Task A is selected and is moved to the back of the list

Core0--|

Head [ AX , B0 , C1 , D0 ] Tail

0

Head [ B0 , C1 , D0 , AX ] Tail

-----

3. Core 1 has a tick interrupt and searches for a task to run.

Task B cannot be run due to incompatible affinity, so core 1 skips to Task C.

Task C is selected and is moved to the back of the list

Core1-----|

0

Head [ B0 , C1 , D0 , AX ] Tail

0 1

Head [ B0 , D0 , AX , C1 ] Tail

-----

4. Core 0 has another tick interrupt and searches for a task to run.

Task B is selected and moved to the back of the list

Core0--|

1

Head [ B0 , D0 , AX , C1 ] Tail

1 0

Head [ D0 , AX , C1 , B0 ] Tail

-----

(continues on next page)



```

-----
5. Core 1 has another tick and searches for a task to run.
   Task D cannot be run due to incompatible affinity, so core 1 skips to Task A
   Task A is selected and moved to the back of the list

```

```

Core1-----|           0
Head [ D0 , AX , C1 , B0 ] Tail

           0   1
Head [ D0 , C1 , B0 , AX ] Tail

```

The implications to users regarding the Best Effort Round Robin time slicing:

- Users cannot expect multiple ready state tasks of the same priority to run sequentially (as is the case in Vanilla FreeRTOS). As demonstrated in the example above, a core may need to skip over tasks.
- However, given enough ticks, a task will eventually be given some processing time.
- If a core cannot find a task runnable task at the highest ready state priority, it will drop to a lower priority to search for tasks.
- To achieve ideal round robin time slicing, users should ensure that all tasks of a particular priority are pinned to the same core.

**Tick Interrupts** Vanilla FreeRTOS requires that a periodic tick interrupt occurs. The tick interrupt is responsible for:

- Incrementing the scheduler's tick count
- Unblocking any blocked tasks that have timed out
- Checking if time slicing is required (i.e., triggering a context switch)
- Executing the application tick hook

In ESP-IDF FreeRTOS, each core will receive a periodic interrupt and independently run the tick interrupt. The tick interrupts on each core are of the same period but can be out of phase. However, the tick responsibilities listed above are not run by all cores:

- CPU0 will execute all of the tick interrupt responsibilities listed above
- CPU1 will only check for time slicing and execute the application tick hook

---

**Note:** CPU0 is solely responsible for keeping time in ESP-IDF FreeRTOS. Therefore anything that prevents CPU0 from incrementing the tick count (such as suspending the scheduler on CPU0) will cause the entire scheduler's time keeping to lag behind.

---

**Idle Tasks** Vanilla FreeRTOS will implicitly create an idle task of priority 0 when the scheduler is started. The idle task runs when no other task is ready to run, and it has the following responsibilities:

- Freeing the memory of deleted tasks
- Executing the application idle hook

In ESP-IDF FreeRTOS, a separate pinned idle task is created for each core. The idle tasks on each core have the same responsibilities as their vanilla counterparts.

**Scheduler Suspension** Vanilla FreeRTOS allows the scheduler to be suspended/resumed by calling `vTaskSuspendAll()` and `xTaskResumeAll()` respectively. While the scheduler is suspended:

- Task switching is disabled but interrupts are left enabled.
- Calling any blocking/yielding function is forbidden, and time slicing is disabled.
- The tick count is frozen (but the tick interrupt will still occur to execute the application tick hook)

On scheduler resumption, `xTaskResumeAll()` will catch up all of the lost ticks and unblock any timed out tasks.

In ESP-IDF FreeRTOS, suspending the scheduler across multiple cores is not possible. Therefore when `vTaskSuspendAll()` is called on a particular core (e.g., core A):

- Task switching is disabled only on core A but interrupts for core A are left enabled
- Calling any blocking/yielding function on core A is forbidden. Time slicing is disabled on core A.
- If an interrupt on core A unblocks any tasks, those tasks will go into core A's own pending ready task list
- If core A is CPU0, the tick count is frozen and a pended tick count is incremented instead. However, the tick interrupt will still occur in order to execute the application tick hook.

When `xTaskResumeAll()` is called on a particular core (e.g., core A):

- Any tasks added to core A's pending ready task list will be resumed
- If core A is CPU0, the pended tick count is unwound to catch up the lost ticks.

**Warning:** Given that scheduler suspension on ESP-IDF FreeRTOS will only suspend scheduling on a particular core, scheduler suspension is **NOT** a valid method ensuring mutual exclusion between tasks when accessing shared data. Users should use proper locking primitives such as mutexes or spinlocks if they require mutual exclusion.

**Disabling Interrupts** Vanilla FreeRTOS allows interrupts to be disabled and enabled by calling `taskDISABLE_INTERRUPTS` and `taskENABLE_INTERRUPTS` respectively.

ESP-IDF FreeRTOS provides the same API, however interrupts will only disabled or enabled on the current core.

**Warning:** Disabling interrupts is a valid method of achieve mutual exclusion in Vanilla FreeRTOS (and single core systems in general). However, in an SMP system, disabling interrupts is **NOT** a valid method ensuring mutual exclusion. Refer to Critical Sections for more details.

## Critical Sections

**API Changes** Vanilla FreeRTOS implements critical sections by disabling interrupts, This prevents preemptive context switches and the servicing of ISRs during a critical section. Thus a task/ISR that enters a critical section is guaranteed to be the sole entity to access a shared resource. Critical sections in Vanilla FreeRTOS have the following API:

- `taskENTER_CRITICAL()` enters a critical section by disabling interrupts
- `taskEXIT_CRITICAL()` exits a critical section by reenabling interrupts
- `taskENTER_CRITICAL_FROM_ISR()` enters a critical section from an ISR by disabling interrupt nesting
- `taskEXIT_CRITICAL_FROM_ISR()` exits a critical section from an ISR by reenabling interrupt nesting

However, in an SMP system, merely disabling interrupts does not constitute a critical section as the presence of other cores means that a shared resource can still be concurrently accessed. Therefore, critical sections in ESP-IDF FreeRTOS are implemented using spinlocks. To accommodate the spinlocks, the ESP-IDF FreeRTOS critical section APIs contain an additional spinlock parameter as shown below:

- Spinlocks are of `portMUX_TYPE` (**not to be confused to FreeRTOS mutexes**)
- `taskENTER_CRITICAL(&mux)` enters a critical from a task context
- `taskEXIT_CRITICAL(&mux)` exits a critical section from a task context
- `taskENTER_CRITICAL_ISR(&mux)` enters a critical section from an interrupt context
- `taskEXIT_CRITICAL_ISR(&mux)` exits a critical section from an interrupt context

---

**Note:** The critical section API can be called recursively (i.e., nested critical sections). Entering a critical section multiple times recursively is valid so long as the critical section is exited the same number of times it was entered. However, given that critical sections can target different spinlocks, users should take care to avoid dead locking when entering critical sections recursively.

---

**Implementation** In ESP-IDF FreeRTOS, the process of a particular core entering and exiting a critical section is as follows:

- For `taskENTER_CRITICAL(&mux)` (or `taskENTER_CRITICAL_ISR(&mux)`)
  1. The core disables its interrupts (or interrupt nesting) up to `configMAX_SYSCALL_INTERRUPT_PRIORITY`
  2. The core then spins on the spinlock using an atomic compare-and-set instruction until it acquires the lock. A lock is acquired when the core is able to set the lock's owner value to the core's ID.
  3. Once the spinlock is acquired, the function returns. The remainder of the critical section runs with interrupts (or interrupt nesting) disabled.
- For `taskEXIT_CRITICAL(&mux)` (or `taskEXIT_CRITICAL_ISR(&mux)`)
  1. The core releases the spinlock by clearing the spinlock's owner value
  2. The core re-enables interrupts (or interrupt nesting)

**Restrictions and Considerations** Given that interrupts (or interrupt nesting) are disabled during a critical section, there are multiple restrictions regarding what can be done within a critical sections. During a critical section, users should keep the following restrictions and considerations in mind:

- Critical sections should be as kept as short as possible
  - The longer the critical section lasts, the longer a pending interrupt can be delayed.
  - A typical critical section should only access a few data structures and/or hardware registers
  - If possible, defer as much processing and/or event handling to the outside of critical sections.
- FreeRTOS API should not be called from within a critical section
- Users should never call any blocking or yielding functions within a critical section

## Misc

**Floating Point Usage** Usually, when a context switch occurs:

- the current state of a CPU's registers are saved to the stack of task being switch out
- the previously saved state of the CPU's registers are loaded from the stack of the task being switched in

However, ESP-IDF FreeRTOS implements Lazy Context Switching for the FPU (Floating Point Unit) registers of a CPU. In other words, when a context switch occurs on a particular core (e.g., CPU0), the state of the core's FPU registers are not immediately saved to the stack of the task getting switched out (e.g., Task A). The FPU's registers are left untouched until:

- A different task (e.g., Task B) runs on the same core and uses the FPU. This will trigger an exception that will save the FPU registers to Task A's stack.
- Task A get's scheduled to the same core and continues execution. Saving and restoring the FPU's registers is not necessary in this case.

However, given that tasks can be unpinned thus can be scheduled on different cores (e.g., Task A switches to CPU1), it is infeasible to copy and restore the FPU's registers across cores. Therefore, when a task utilizes the FPU (by using a `float` type in its call flow), ESP-IDF FreeRTOS will automatically pin the task to the current core it is running on. This ensures that all tasks that uses the FPU are always pinned to a particular core.

Furthermore, ESP-IDF FreeRTOS by default does not support the usage of the FPU within an interrupt context given that the FPU's register state is tied to a particular task.

---

**Note:** ESP targets that contain an FPU do not support hardware acceleration for double precision floating point arithmetic (`double`). Instead `double` is implemented via software hence the behavioral restrictions regarding the `float` type do not apply to `double`. Note that due to the lack of hardware acceleration, `double` operations may consume significantly more CPU time in comparison to `float`.

---

**ESP-IDF FreeRTOS Single Core** Although ESP-IDF FreeRTOS is an SMP scheduler, some ESP targets are single core (such as the ESP32-S2 and ESP32-C3). When building ESP-IDF applications for these targets, ESP-IDF

FreeRTOS is still used but the number of cores will be set to 1 (i.e., the `CONFIG_FREERTOS_UNICORE` will always be enabled for single core targets).

For multicore targets (such as the ESP32 and ESP32-S3), `CONFIG_FREERTOS_UNICORE` can also be set. This will result in ESP-IDF FreeRTOS only running on CPU0, and all other cores will be inactive.

---

**Note:** Users should bear in mind that enabling `CONFIG_FREERTOS_UNICORE` is **NOT equivalent to running Vanilla FreeRTOS**. The additional API of ESP-IDF FreeRTOS can still be called, and the behavior changes of ESP-IDF FreeRTOS will incur a small amount of overhead even when compiled for only a single core.

---

## API Reference

This section contains documentation of FreeRTOS types, functions, and macros. It is automatically generated from FreeRTOS header files.

### Task API

#### Header File

- `components/freertos/FreeRTOS-Kernel/include/freertos/task.h`

#### Functions

BaseType\_t **xTaskCreatePinnedToCore** (TaskFunction\_t pvTaskCode, const char \*const pcName, const uint32\_t usStackDepth, void \*const pvParameters, UBaseType\_t uxPriority, *TaskHandle\_t* \*const pvCreatedTask, const BaseType\_t xCoreID)

Create a new task with a specified affinity.

This function is similar to `xTaskCreate`, but allows setting task affinity in SMP system.

#### Parameters

- **pvTaskCode** –Pointer to the task entry function. Tasks must be implemented to never return (i.e. continuous loop), or should be terminated using `vTaskDelete` function.
- **pcName** –A descriptive name for the task. This is mainly used to facilitate debugging. Max length defined by `configMAX_TASK_NAME_LEN` - default is 16.
- **usStackDepth** –The size of the task stack specified as the number of bytes. Note that this differs from vanilla FreeRTOS.
- **pvParameters** –Pointer that will be used as the parameter for the task being created.
- **uxPriority** –The priority at which the task should run. Systems that include MPU support can optionally create tasks in a privileged (system) mode by setting bit `portPRIVILEGE_BIT` of the priority parameter. For example, to create a privileged task at priority 2 the `uxPriority` parameter should be set to  $(2 | portPRIVILEGE_BIT)$ .
- **pvCreatedTask** –Used to pass back a handle by which the created task can be referenced.
- **xCoreID** –If the value is `tskNO_AFFINITY`, the created task is not pinned to any CPU, and the scheduler can run it on any core available. Values 0 or 1 indicate the index number of the CPU which the task should be pinned to. Specifying values larger than  $(portNUM_PROCESSORS - 1)$  will cause the function to fail.

**Returns** `pdPASS` if the task was successfully created and added to a ready list, otherwise an error code defined in the file `projdefs.h`

```
static inline BaseType_t xTaskCreate (TaskFunction_t pvTaskCode, const char *const pcName, const uint32_t usStackDepth, void *const pvParameters, UBaseType_t uxPriority, TaskHandle_t *const pxCreatedTask)
```

Create a new task and add it to the list of tasks that are ready to run.

Internally, within the FreeRTOS implementation, tasks use two blocks of memory. The first block is used to hold the task's data structures. The second block is used by the task as its stack. If a task is created using `xTaskCreate()` then both blocks of memory are automatically dynamically allocated inside the `xTaskCreate()` function. (see <https://www.FreeRTOS.org/a00111.html>). If a task is created using `xTaskCreateStatic()` then the application writer must provide the required memory. `xTaskCreateStatic()` therefore allows a task to be created without using any dynamic memory allocation.

See `xTaskCreateStatic()` for a version that does not use any dynamic memory allocation.

`xTaskCreate()` can only be used to create a task that has unrestricted access to the entire microcontroller memory map. Systems that include MPU support can alternatively create an MPU constrained task using `xTaskCreateRestricted()`.

Example usage:

```
// Task to be created.
void vTaskCode( void * pvParameters )
{
    for( ;; )
    {
        // Task code goes here.
    }
}

// Function that creates a task.
void vOtherFunction( void )
{
    static uint8_t ucParameterToPass;
    TaskHandle_t xHandle = NULL;

    // Create the task, storing the handle. Note that the passed parameter
    ↪ucParameterToPass
    // must exist for the lifetime of the task, so in this case is declared
    ↪static. If it was just an
    // an automatic stack variable it might no longer exist, or at least have
    ↪been corrupted, by the time
    // the new task attempts to access it.
    xTaskCreate( vTaskCode, "NAME", STACK_SIZE, &ucParameterToPass, tskIDLE_
    ↪PRIORITY, &xHandle );
    configASSERT( xHandle );

    // Use the handle to delete the task.
    if( xHandle != NULL )
    {
        vTaskDelete( xHandle );
    }
}
```

**Note:** If program uses thread local variables (ones specified with “`__thread`” keyword) then storage for them will be allocated on the task's stack.

### Parameters

- **pvTaskCode** –Pointer to the task entry function. Tasks must be implemented to never return (i.e. continuous loop), or should be terminated using `vTaskDelete` function.
- **pcName** –A descriptive name for the task. This is mainly used to facilitate debugging. Max length defined by `configMAX_TASK_NAME_LEN` - default is 16.
- **usStackDepth** –The size of the task stack specified as the number of bytes. Note that this differs from vanilla FreeRTOS.
- **pvParameters** –Pointer that will be used as the parameter for the task being created.

- **uxPriority** –The priority at which the task should run. Systems that include MPU support can optionally create tasks in a privileged (system) mode by setting bit portPRIVILEGE\_BIT of the priority parameter. For example, to create a privileged task at priority 2 the uxPriority parameter should be set to ( 2 | portPRIVILEGE\_BIT ).
- **pxCreatedTask** –Used to pass back a handle by which the created task can be referenced.

**Returns** pdPASS if the task was successfully created and added to a ready list, otherwise an error code defined in the file projdefs.h

*TaskHandle\_t* **xTaskCreateStaticPinnedToCore** (TaskFunction\_t pvTaskCode, const char \*const pcName, const uint32\_t ulStackDepth, void \*const pvParameters, UBaseType\_t uxPriority, StackType\_t \*const pxStackBuffer, StaticTask\_t \*const pxTaskBuffer, const BaseType\_t xCoreID)

Create a new task with a specified affinity.

This function is similar to xTaskCreateStatic, but allows specifying task affinity in an SMP system.

#### Parameters

- **pvTaskCode** –Pointer to the task entry function. Tasks must be implemented to never return (i.e. continuous loop), or should be terminated using vTaskDelete function.
- **pcName** –A descriptive name for the task. This is mainly used to facilitate debugging. The maximum length of the string is defined by configMAX\_TASK\_NAME\_LEN in FreeRTOSConfig.h.
- **ulStackDepth** –The size of the task stack specified as the number of bytes. Note that this differs from vanilla FreeRTOS.
- **pvParameters** –Pointer that will be used as the parameter for the task being created.
- **uxPriority** –The priority at which the task will run.
- **pxStackBuffer** –Must point to a StackType\_t array that has at least ulStackDepth indexes - the array will then be used as the task's stack, removing the need for the stack to be allocated dynamically.
- **pxTaskBuffer** –Must point to a variable of type StaticTask\_t, which will then be used to hold the task's data structures, removing the need for the memory to be allocated dynamically.
- **xCoreID** –If the value is tskNO\_AFFINITY, the created task is not pinned to any CPU, and the scheduler can run it on any core available. Values 0 or 1 indicate the index number of the CPU which the task should be pinned to. Specifying values larger than (portNUM\_PROCESSORS - 1) will cause the function to fail.

**Returns** If neither pxStackBuffer or pxTaskBuffer are NULL, then the task will be created and pdPASS is returned. If either pxStackBuffer or pxTaskBuffer are NULL then the task will not be created and errCOULD\_NOT\_ALLOCATE\_REQUIRED\_MEMORY is returned.

static inline *TaskHandle\_t* **xTaskCreateStatic** (TaskFunction\_t pvTaskCode, const char \*const pcName, const uint32\_t ulStackDepth, void \*const pvParameters, UBaseType\_t uxPriority, StackType\_t \*const puxStackBuffer, StaticTask\_t \*const pxTaskBuffer)

Create a new task and add it to the list of tasks that are ready to run.

Internally, within the FreeRTOS implementation, tasks use two blocks of memory. The first block is used to hold the task's data structures. The second block is used by the task as its stack. If a task is created using xTaskCreate() then both blocks of memory are automatically dynamically allocated inside the xTaskCreate() function. (see <http://www.freertos.org/a00111.html>). If a task is created using xTaskCreateStatic() then the application writer must provide the required memory. xTaskCreateStatic() therefore allows a task to be created without using any dynamic memory allocation.

Example usage:

```

// Dimensions the buffer that the task being created will use as its stack.
// NOTE: This is the number of bytes the stack will hold, not the number of
// words as found in vanilla FreeRTOS.
#define STACK_SIZE 200

// Structure that will hold the TCB of the task being created.
StaticTask_t xTaskBuffer;

// Buffer that the task being created will use as its stack. Note this is
// an array of StackType_t variables. The size of StackType_t is dependent on
// the RTOS port.
StackType_t xStack[ STACK_SIZE ];

// Function that implements the task being created.
void vTaskCode( void * pvParameters )
{
    // The parameter value is expected to be 1 as 1 is passed in the
    // pvParameters value in the call to xTaskCreateStatic().
    configASSERT( ( uint32_t ) pvParameters == 1UL );

    for( ;; )
    {
        // Task code goes here.
    }
}

// Function that creates a task.
void vOtherFunction( void )
{
    TaskHandle_t xHandle = NULL;

    // Create the task without using any dynamic memory allocation.
    xHandle = xTaskCreateStatic(
        vTaskCode,          // Function that implements the task.
        "NAME",            // Text name for the task.
        STACK_SIZE,        // Stack size in bytes, not words.
        ( void * ) 1,      // Parameter passed into the task.
        tskIDLE_PRIORITY, // Priority at which the task is created.
        xStack,            // Array to use as the task's stack.
        &xTaskBuffer );   // Variable to hold the task's data
        ↪ structure.

    // puxStackBuffer and pxTaskBuffer were not NULL, so the task will have
    // been created, and xHandle will be the task's handle. Use the handle
    // to suspend the task.
    vTaskSuspend( xHandle );
}

```

**Note:** If program uses thread local variables (ones specified with “\_\_thread” keyword) then storage for them will be allocated on the task’s stack.

### Parameters

- **pvTaskCode** –Pointer to the task entry function. Tasks must be implemented to never return (i.e. continuous loop), or should be terminated using vTaskDelete function.
- **pcName** –A descriptive name for the task. This is mainly used to facilitate debugging. The maximum length of the string is defined by configMAX\_TASK\_NAME\_LEN in FreeRTOSConfig.h.
- **ulStackDepth** –The size of the task stack specified as the number of bytes. Note that this differs from vanilla FreeRTOS.



- **pvParameters** –Pointer that will be used as the parameter for the task being created.
- **uxPriority** –The priority at which the task will run.
- **puxStackBuffer** –Must point to a StackType\_t array that has at least ulStackDepth indexes - the array will then be used as the task's stack, removing the need for the stack to be allocated dynamically.
- **pxTaskBuffer** –Must point to a variable of type StaticTask\_t, which will then be used to hold the task's data structures, removing the need for the memory to be allocated dynamically.

**Returns** If neither pxStackBuffer or pxTaskBuffer are NULL, then the task will be created and pdPASS is returned. If either pxStackBuffer or pxTaskBuffer are NULL then the task will not be created and errCOULD\_NOT\_ALLOCATE\_REQUIRED\_MEMORY is returned.

BaseType\_t **xTaskCreateRestricted** (const TaskParameters\_t \*const pxTaskDefinition, *TaskHandle\_t* \*pxCreatedTask)

Only available when configSUPPORT\_DYNAMIC\_ALLOCATION is set to 1.

xTaskCreateRestricted() should only be used in systems that include an MPU implementation.

Create a new task and add it to the list of tasks that are ready to run. The function parameters define the memory regions and associated access permissions allocated to the task.

See xTaskCreateRestrictedStatic() for a version that does not use any dynamic memory allocation.

return pdPASS if the task was successfully created and added to a ready list, otherwise an error code defined in the file projdefs.h

Example usage:

```
// Create an TaskParameters_t structure that defines the task to be created.
static const TaskParameters_t xCheckTaskParameters =
{
    vATask,          // pvTaskCode - the function that implements the task.
    "ATask",        // pcName - just a text name for the task to assist debugging.
    100,            // usStackDepth - the stack size DEFINED IN WORDS.
    NULL,           // pvParameters - passed into the task function as the function_
    ↪parameters.
    ( 1UL | portPRIVILEGE_BIT ), // uxPriority - task priority, set the_
    ↪portPRIVILEGE_BIT if the task should run in a privileged state.
    cStackBuffer, // puxStackBuffer - the buffer to be used as the task stack.

    // xRegions - Allocate up to three separate memory regions for access by
    // the task, with appropriate access permissions. Different processors have
    // different memory alignment requirements - refer to the FreeRTOS_
    ↪documentation
    // for full information.
    {
        // Base address          Length  Parameters
        { cReadWriteArray,      32,    portMPU_REGION_READ_WRITE },
        { cReadOnlyArray,       32,    portMPU_REGION_READ_ONLY },
        { cPrivilegedOnlyAccessArray, 128,   portMPU_REGION_PRIVILEGED_READ_
    ↪WRITE }
    }
};

int main( void )
{
    TaskHandle_t xHandle;

    // Create a task from the const structure defined above. The task handle
    // is requested (the second parameter is not NULL) but in this case just for
    // demonstration purposes as its not actually used.
```

(continues on next page)



(continued from previous page)

```
xTaskCreateRestricted( &xRegTest1Parameters, &xHandle );

// Start the scheduler.
vTaskStartScheduler();

// Will only get here if there was insufficient memory to create the idle
// and/or timer task.
for( ;; );
}
```

**Parameters**

- **pxTaskDefinition** –Pointer to a structure that contains a member for each of the normal xTaskCreate() parameters (see the xTaskCreate() API documentation) plus an optional stack buffer and the memory region definitions.
- **pxCreatedTask** –Used to pass back a handle by which the created task can be referenced.

void **vTaskAllocateMPURegions** (*TaskHandle\_t* xTask, const MemoryRegion\_t \*const pxRegions)

Only available when configSUPPORT\_STATIC\_ALLOCATION is set to 1.

xTaskCreateRestrictedStatic() should only be used in systems that include an MPU implementation.

Internally, within the FreeRTOS implementation, tasks use two blocks of memory. The first block is used to hold the task's data structures. The second block is used by the task as its stack. If a task is created using xTaskCreateRestricted() then the stack is provided by the application writer, and the memory used to hold the task's data structure is automatically dynamically allocated inside the xTaskCreateRestricted() function. If a task is created using xTaskCreateRestrictedStatic() then the application writer must provide the memory used to hold the task's data structures too. xTaskCreateRestrictedStatic() therefore allows a memory protected task to be created without using any dynamic memory allocation.

return pdPASS if the task was successfully created and added to a ready list, otherwise an error code defined in the file projdefs.h

Example usage:

```
// Create an TaskParameters_t structure that defines the task to be created.
// The StaticTask_t variable is only included in the structure when
// configSUPPORT_STATIC_ALLOCATION is set to 1. The PRIVILEGED_DATA macro can
// be used to force the variable into the RTOS kernel's privileged data area.
static PRIVILEGED_DATA StaticTask_t xTaskBuffer;
static const TaskParameters_t xCheckTaskParameters =
{
    vATask,          // pvTaskCode - the function that implements the task.
    "ATask",        // pcName - just a text name for the task to assist debugging.
    100,            // usStackDepth - the stack size DEFINED IN BYTES.
    NULL,           // pvParameters - passed into the task function as the function_
    ↪parameters.
    ( 1UL | portPRIVILEGE_BIT ), // uxPriority - task priority, set the_
    ↪portPRIVILEGE_BIT if the task should run in a privileged state.
    cStackBuffer, // puxStackBuffer - the buffer to be used as the task stack.

    // xRegions - Allocate up to three separate memory regions for access by
    // the task, with appropriate access permissions. Different processors have
    // different memory alignment requirements - refer to the FreeRTOS_
    ↪documentation
    // for full information.
    {
        // Base address                Length  Parameters
        { cReadWriteArray,             32,      portMPU_REGION_READ_WRITE },
    }
}
```

(continues on next page)

(continued from previous page)

```

        { cReadOnlyArray,          32,      portMPU_REGION_READ_ONLY },
        { cPrivilegedOnlyAccessArray, 128,  portMPU_REGION_PRIVILEGED_READ_
↪WRITE }
    }

    &xTaskBuffer; // Holds the task's data structure.
};

int main( void )
{
    TaskHandle_t xHandle;

    // Create a task from the const structure defined above. The task handle
    // is requested (the second parameter is not NULL) but in this case just for
    // demonstration purposes as its not actually used.
    xTaskCreateRestricted( &xRegTest1Parameters, &xHandle );

    // Start the scheduler.
    vTaskStartScheduler();

    // Will only get here if there was insufficient memory to create the idle
    // and/or timer task.
    for( ;; );
}

```

Memory regions are assigned to a restricted task when the task is created by a call to `xTaskCreateRestricted()`. These regions can be redefined using `vTaskAllocateMPURegions()`.

Example usage:

```

// Define an array of MemoryRegion_t structures that configures an MPU region
// allowing read/write access for 1024 bytes starting at the beginning of the
// ucOneKByte array. The other two of the maximum 3 definable regions are
// unused so set to zero.
static const MemoryRegion_t xAltRegions[ portNUM_CONFIGURABLE_REGIONS ] =
{
    // Base address      Length      Parameters
    { ucOneKByte,       1024,      portMPU_REGION_READ_WRITE },
    { 0,                0,         0 },
    { 0,                0,         0 }
};

void vATask( void *pvParameters )
{
    // This task was created such that it has access to certain regions of
    // memory as defined by the MPU configuration. At some point it is
    // desired that these MPU regions are replaced with that defined in the
    // xAltRegions const struct above. Use a call to vTaskAllocateMPURegions()
    // for this purpose. NULL is used as the task handle to indicate that this
    // function should modify the MPU regions of the calling task.
    vTaskAllocateMPURegions( NULL, xAltRegions );

    // Now the task can continue its function, but from this point on can only
    // access its stack and the ucOneKByte array (unless any other statically
    // defined or shared regions have been declared elsewhere).
}

```

### Parameters

- **pxTaskDefinition** –Pointer to a structure that contains a member for each of the normal `xTaskCreate()` parameters (see the `xTaskCreate()` API documentation)

plus an optional stack buffer and the memory region definitions. If `configSUPPORT_STATIC_ALLOCATION` is set to 1 the structure contains an additional member, which is used to point to a variable of type `StaticTask_t` - which is then used to hold the task's data structure.

- **pxCreatedTask** –Used to pass back a handle by which the created task can be referenced.
- **xTask** –The handle of the task being updated.
- **pxRegions** –A pointer to an `MemoryRegion_t` structure that contains the new memory region definitions.

void **vTaskDelete** (*TaskHandle\_t* xTaskToDelete)

`INCLUDE_vTaskDelete` must be defined as 1 for this function to be available. See the configuration section for more information.

Remove a task from the RTOS real time kernel's management. The task being deleted will be removed from all ready, blocked, suspended and event lists.

NOTE: The idle task is responsible for freeing the kernel allocated memory from tasks that have been deleted. It is therefore important that the idle task is not starved of microcontroller processing time if your application makes any calls to `vTaskDelete()`. Memory allocated by the task code is not automatically freed, and should be freed before the task is deleted.

See the demo application file `death.c` for sample code that utilises `vTaskDelete()`.

Example usage:

```
void vOtherFunction( void )
{
    TaskHandle_t xHandle;

    // Create the task, storing the handle.
    xTaskCreate( vTaskCode, "NAME", STACK_SIZE, NULL, tskIDLE_PRIORITY, &xHandle_
    ↪ );

    // Use the handle to delete the task.
    vTaskDelete( xHandle );
}
```

**Parameters** **xTaskToDelete** –The handle of the task to be deleted. Passing NULL will cause the calling task to be deleted.

void **vTaskDelay** (const `TickType_t` xTicksToDelay)

Delay a task for a given number of ticks. The actual time that the task remains blocked depends on the tick rate. The constant `portTICK_PERIOD_MS` can be used to calculate real time from the tick rate - with the resolution of one tick period.

`INCLUDE_vTaskDelay` must be defined as 1 for this function to be available. See the configuration section for more information.

`vTaskDelay()` specifies a time at which the task wishes to unblock relative to the time at which `vTaskDelay()` is called. For example, specifying a block period of 100 ticks will cause the task to unblock 100 ticks after `vTaskDelay()` is called. `vTaskDelay()` does not therefore provide a good method of controlling the frequency of a periodic task as the path taken through the code, as well as other task and interrupt activity, will effect the frequency at which `vTaskDelay()` gets called and therefore the time at which the task next executes. See `xTaskDelayUntil()` for an alternative API function designed to facilitate fixed frequency execution. It does this by specifying an absolute time (rather than a relative time) at which the calling task should unblock.

Example usage:

```

void vTaskFunction( void * pvParameters )
{
    // Block for 500ms.
    const TickType_t xDelay = 500 / portTICK_PERIOD_MS;

    for( ;; )
    {
        // Simply toggle the LED every 500ms, blocking between each toggle.
        vToggleLED();
        vTaskDelay( xDelay );
    }
}

```

**Parameters** **xTicksToDelay** –The amount of time, in tick periods, that the calling task should block.

BaseType\_t **xTaskDelayUntil** (TickType\_t \*const pxPreviousWakeTime, const TickType\_t xTimeIncrement)

INCLUDE\_xTaskDelayUntil must be defined as 1 for this function to be available. See the configuration section for more information.

Delay a task until a specified time. This function can be used by periodic tasks to ensure a constant execution frequency.

This function differs from vTaskDelay () in one important aspect: vTaskDelay () will cause a task to block for the specified number of ticks from the time vTaskDelay () is called. It is therefore difficult to use vTaskDelay () by itself to generate a fixed execution frequency as the time between a task starting to execute and that task calling vTaskDelay () may not be fixed [the task may take a different path though the code between calls, or may get interrupted or preempted a different number of times each time it executes].

Whereas vTaskDelay () specifies a wake time relative to the time at which the function is called, xTaskDelayUntil () specifies the absolute (exact) time at which it wishes to unblock.

The macro pdMS\_TO\_TICKS() can be used to calculate the number of ticks from a time specified in milliseconds with a resolution of one tick period.

Example usage:

```

// Perform an action every 10 ticks.
void vTaskFunction( void * pvParameters )
{
    TickType_t xLastWakeTime;
    const TickType_t xFrequency = 10;
    BaseType_t xWasDelayed;

    // Initialise the xLastWakeTime variable with the current time.
    xLastWakeTime = xTaskGetTickCount ();
    for( ;; )
    {
        // Wait for the next cycle.
        xWasDelayed = xTaskDelayUntil( &xLastWakeTime, xFrequency );

        // Perform action here. xWasDelayed value can be used to determine
        // whether a deadline was missed if the code here took too long.
    }
}

```

#### Parameters

- **pxPreviousWakeTime** –Pointer to a variable that holds the time at which the task was last unblocked. The variable must be initialised with the current time prior to its first

use (see the example below). Following this the variable is automatically updated within `xTaskDelayUntil()`.

- **xTimeIncrement** –The cycle time period. The task will be unblocked at time `*pxPreviousWakeTime + xTimeIncrement`. Calling `xTaskDelayUntil` with the same `xTimeIncrement` parameter value will cause the task to execute with a fixed interface period.

**Returns** Value which can be used to check whether the task was actually delayed. Will be `pdTRUE` if the task was delayed and `pdFALSE` otherwise. A task will not be delayed if the next expected wake time is in the past.

`BaseType_t xTaskAbortDelay (TaskHandle_t xTask)`

`INCLUDE_xTaskAbortDelay` must be defined as 1 in `FreeRTOSConfig.h` for this function to be available.

A task will enter the Blocked state when it is waiting for an event. The event it is waiting for can be a temporal event (waiting for a time), such as when `vTaskDelay()` is called, or an event on an object, such as when `xQueueReceive()` or `ulTaskNotifyTake()` is called. If the handle of a task that is in the Blocked state is used in a call to `xTaskAbortDelay()` then the task will leave the Blocked state, and return from whichever function call placed the task into the Blocked state.

There is no ‘FromISR’ version of this function as an interrupt would need to know which object a task was blocked on in order to know which actions to take. For example, if the task was blocked on a queue the interrupt handler would then need to know if the queue was locked.

**Parameters** `xTask` –The handle of the task to remove from the Blocked state.

**Returns** If the task referenced by `xTask` was not in the Blocked state then `pdFAIL` is returned. Otherwise `pdPASS` is returned.

`UBaseType_t uxTaskPriorityGet (const TaskHandle_t xTask)`

`INCLUDE_uxTaskPriorityGet` must be defined as 1 for this function to be available. See the configuration section for more information.

Obtain the priority of any task.

Example usage:

```
void vAFunction( void )
{
    TaskHandle_t xHandle;

    // Create a task, storing the handle.
    xTaskCreate( vTaskCode, "NAME", STACK_SIZE, NULL, tskIDLE_PRIORITY, &xHandle_
    ↪);

    // ...

    // Use the handle to obtain the priority of the created task.
    // It was created with tskIDLE_PRIORITY, but may have changed
    // it itself.
    if( uxTaskPriorityGet( xHandle ) != tskIDLE_PRIORITY )
    {
        // The task has changed it's priority.
    }

    // ...

    // Is our priority higher than the created task?
    if( uxTaskPriorityGet( xHandle ) < uxTaskPriorityGet( NULL ) )
    {
        // Our priority (obtained using NULL handle) is higher.
    }
}
```

**Parameters** **xTask** –Handle of the task to be queried. Passing a NULL handle results in the priority of the calling task being returned.

**Returns** The priority of xTask.

UBaseType\_t **uxTaskPriorityGetFromISR** (const *TaskHandle\_t* xTask)

A version of uxTaskPriorityGet() that can be used from an ISR.

*eTaskState* **eTaskGetState** (*TaskHandle\_t* xTask)

INCLUDE\_eTaskGetState must be defined as 1 for this function to be available. See the configuration section for more information.

Obtain the state of any task. States are encoded by the eTaskState enumerated type.

**Parameters** **xTask** –Handle of the task to be queried.

**Returns** The state of xTask at the time the function was called. Note the state of the task might change between the function being called, and the functions return value being tested by the calling task.

void **vTaskGetInfo** (*TaskHandle\_t* xTask, TaskStatus\_t \*pxTaskStatus, BaseType\_t xGetFreeStackSize, *eTaskState* eState)

configUSE\_TRACE\_FACILITY must be defined as 1 for this function to be available. See the configuration section for more information.

Populates a TaskStatus\_t structure with information about a task.

Example usage:

```
void vAFunction( void )
{
    TaskHandle_t xHandle;
    TaskStatus_t xTaskDetails;

    // Obtain the handle of a task from its name.
    xHandle = xTaskGetHandle( "Task_Name" );

    // Check the handle is not NULL.
    configASSERT( xHandle );

    // Use the handle to obtain further information about the task.
    vTaskGetInfo( xHandle,
                  &xTaskDetails,
                  pdTRUE, // Include the high water mark in xTaskDetails.
                  eInvalid ); // Include the task state in xTaskDetails.
}
```

### Parameters

- **xTask** –Handle of the task being queried. If xTask is NULL then information will be returned about the calling task.
- **pxTaskStatus** –A pointer to the TaskStatus\_t structure that will be filled with information about the task referenced by the handle passed using the xTask parameter.
- **xGetFreeStackSize** –The TaskStatus\_t structure contains a member to report the stack high water mark of the task being queried. Calculating the stack high water mark takes a relatively long time, and can make the system temporarily unresponsive - so the xGetFreeStackSize parameter is provided to allow the high water mark checking to be skipped. The high watermark value will only be written to the TaskStatus\_t structure if xGetFreeStackSize is not set to pdFALSE;
- **eState** –The TaskStatus\_t structure contains a member to report the state of the task being queried. Obtaining the task state is not as fast as a simple assignment - so the eState parameter is provided to allow the state information to be omitted from the TaskStatus\_t

structure. To obtain state information then set eState to eInvalid - otherwise the value passed in eState will be reported as the task state in the TaskStatus\_t structure.

void **vTaskPrioritySet** (*TaskHandle\_t* xTask, UBaseType\_t uxNewPriority)

INCLUDE\_vTaskPrioritySet must be defined as 1 for this function to be available. See the configuration section for more information.

Set the priority of any task.

A context switch will occur before the function returns if the priority being set is higher than the currently executing task.

Example usage:

```
void vAFunction( void )
{
    TaskHandle_t xHandle;

    // Create a task, storing the handle.
    xTaskCreate( vTaskCode, "NAME", STACK_SIZE, NULL, tskIDLE_PRIORITY, &xHandle_
    ↪);

    // ...

    // Use the handle to raise the priority of the created task.
    vTaskPrioritySet( xHandle, tskIDLE_PRIORITY + 1 );

    // ...

    // Use a NULL handle to raise our priority to the same value.
    vTaskPrioritySet( NULL, tskIDLE_PRIORITY + 1 );
}
```

#### Parameters

- **xTask** –Handle to the task for which the priority is being set. Passing a NULL handle results in the priority of the calling task being set.
- **uxNewPriority** –The priority to which the task will be set.

void **vTaskSuspend** (*TaskHandle\_t* xTaskToSuspend)

INCLUDE\_vTaskSuspend must be defined as 1 for this function to be available. See the configuration section for more information.

Suspend any task. When suspended a task will never get any microcontroller processing time, no matter what its priority.

Calls to vTaskSuspend are not accumulative - i.e. calling vTaskSuspend () twice on the same task still only requires one call to vTaskResume () to ready the suspended task.

Example usage:

```
void vAFunction( void )
{
    TaskHandle_t xHandle;

    // Create a task, storing the handle.
    xTaskCreate( vTaskCode, "NAME", STACK_SIZE, NULL, tskIDLE_PRIORITY, &xHandle_
    ↪);

    // ...
```

(continues on next page)

(continued from previous page)

```

// Use the handle to suspend the created task.
vTaskSuspend( xHandle );

// ...

// The created task will not run during this period, unless
// another task calls vTaskResume( xHandle ).

//...

// Suspend ourselves.
vTaskSuspend( NULL );

// We cannot get here unless another task calls vTaskResume
// with our handle as the parameter.
}

```

**Parameters** **xTaskToSuspend** –Handle to the task being suspended. Passing a NULL handle will cause the calling task to be suspended.

void **vTaskResume** (*TaskHandle\_t* xTaskToResume)

INCLUDE\_vTaskSuspend must be defined as 1 for this function to be available. See the configuration section for more information.

Resumes a suspended task.

A task that has been suspended by one or more calls to vTaskSuspend () will be made available for running again by a single call to vTaskResume ().

Example usage:

```

void vAFunction( void )
{
TaskHandle_t xHandle;

// Create a task, storing the handle.
xTaskCreate( vTaskCode, "NAME", STACK_SIZE, NULL, tskIDLE_PRIORITY, &xHandle_
→);

// ...

// Use the handle to suspend the created task.
vTaskSuspend( xHandle );

// ...

// The created task will not run during this period, unless
// another task calls vTaskResume( xHandle ).

//...

// Resume the suspended task ourselves.
vTaskResume( xHandle );

// The created task will once again get microcontroller processing
// time in accordance with its priority within the system.
}

```



**Parameters** **xTaskToResume** –Handle to the task being readied.

BaseType\_t **xTaskResumeFromISR** (*TaskHandle\_t* xTaskToResume)

INCLUDE\_xTaskResumeFromISR must be defined as 1 for this function to be available. See the configuration section for more information.

An implementation of vTaskResume() that can be called from within an ISR.

A task that has been suspended by one or more calls to vTaskSuspend () will be made available for running again by a single call to xTaskResumeFromISR ().

xTaskResumeFromISR() should not be used to synchronise a task with an interrupt if there is a chance that the interrupt could arrive prior to the task being suspended - as this can lead to interrupts being missed. Use of a semaphore as a synchronisation mechanism would avoid this eventuality.

**Parameters** **xTaskToResume** –Handle to the task being readied.

**Returns** pdTRUE if resuming the task should result in a context switch, otherwise pdFALSE. This is used by the ISR to determine if a context switch may be required following the ISR.

void **vTaskStartScheduler** (void)

Starts the real time kernel tick processing. After calling the kernel has control over which tasks are executed and when.

NOTE: In ESP-IDF the scheduler is started automatically during application startup, vTaskStartScheduler() should not be called from ESP-IDF applications.

See the demo application file main.c for an example of creating tasks and starting the kernel.

Example usage:

```
void vAFunction( void )
{
    // Create at least one task before starting the kernel.
    xTaskCreate( vTaskCode, "NAME", STACK_SIZE, NULL, tskIDLE_PRIORITY, NULL );

    // Start the real time kernel with preemption.
    vTaskStartScheduler ();

    // Will not get here unless a task calls vTaskEndScheduler ()
}
```

void **vTaskEndScheduler** (void)

NOTE: At the time of writing only the x86 real mode port, which runs on a PC in place of DOS, implements this function.

Stops the real time kernel tick. All created tasks will be automatically deleted and multitasking (either preemptive or cooperative) will stop. Execution then resumes from the point where vTaskStartScheduler () was called, as if vTaskStartScheduler () had just returned.

See the demo application file main.c in the demo/PC directory for an example that uses vTaskEndScheduler ().

vTaskEndScheduler () requires an exit function to be defined within the portable layer (see vPortEndScheduler () in port.c for the PC port). This performs hardware specific operations such as stopping the kernel tick.

vTaskEndScheduler () will cause all of the resources allocated by the kernel to be freed - but will not free resources allocated by application tasks.

Example usage:

```
void vTaskCode( void * pvParameters )
{
    for( ;; )
    {
        // Task code goes here.
    }
}
```

(continues on next page)

(continued from previous page)

```

        // At some point we want to end the real time kernel processing
        // so call ...
        vTaskEndScheduler ();
    }
}

void vAFunction( void )
{
    // Create at least one task before starting the kernel.
    xTaskCreate( vTaskCode, "NAME", STACK_SIZE, NULL, tskIDLE_PRIORITY, NULL );

    // Start the real time kernel with preemption.
    vTaskStartScheduler ();

    // Will only get here when the vTaskCode () task has called
    // vTaskEndScheduler (). When we get here we are back to single task
    // execution.
}

```

void **vTaskSuspendAll** (void)

Suspends the scheduler without disabling interrupts. Context switches will not occur while the scheduler is suspended.

After calling `vTaskSuspendAll ()` the calling task will continue to execute without risk of being swapped out until a call to `xTaskResumeAll ()` has been made.

API functions that have the potential to cause a context switch (for example, `vTaskDelayUntil()`, `xQueueSend()`, etc.) must not be called while the scheduler is suspended.

Example usage:

```

void vTask1( void * pvParameters )
{
    for( ;; )
    {
        // Task code goes here.

        // ...

        // At some point the task wants to perform a long operation during
        // which it does not want to get swapped out. It cannot use
        // taskENTER_CRITICAL ()/taskEXIT_CRITICAL () as the length of the
        // operation may cause interrupts to be missed - including the
        // ticks.

        // Prevent the real time kernel swapping out the task.
        vTaskSuspendAll ();

        // Perform the operation here. There is no need to use critical
        // sections as we have all the microcontroller processing time.
        // During this time interrupts will still operate and the kernel
        // tick count will be maintained.

        // ...

        // The operation is complete. Restart the kernel.
        xTaskResumeAll ();
    }
}

```

BaseType\_t **xTaskResumeAll** (void)

Resumes scheduler activity after it was suspended by a call to `vTaskSuspendAll()`.

`xTaskResumeAll()` only resumes the scheduler. It does not unsuspend tasks that were previously suspended by a call to `vTaskSuspend()`.

Example usage:

```
void vTask1( void * pvParameters )
{
    for( ;; )
    {
        // Task code goes here.

        // ...

        // At some point the task wants to perform a long operation during
        // which it does not want to get swapped out. It cannot use
        // taskENTER_CRITICAL ()/taskEXIT_CRITICAL () as the length of the
        // operation may cause interrupts to be missed - including the
        // ticks.

        // Prevent the real time kernel swapping out the task.
        vTaskSuspendAll ();

        // Perform the operation here. There is no need to use critical
        // sections as we have all the microcontroller processing time.
        // During this time interrupts will still operate and the real
        // time kernel tick count will be maintained.

        // ...

        // The operation is complete. Restart the kernel. We want to force
        // a context switch - but there is no point if resuming the scheduler
        // caused a context switch already.
        if( !xTaskResumeAll () )
        {
            taskYIELD ();
        }
    }
}
```

**Returns** If resuming the scheduler caused a context switch then `pdTRUE` is returned, otherwise `pdFALSE` is returned.

TickType\_t **xTaskGetTickCount** (void)

**Returns** The count of ticks since `vTaskStartScheduler` was called.

TickType\_t **xTaskGetTickCountFromISR** (void)

This is a version of `xTaskGetTickCount()` that is safe to be called from an ISR - provided that `TickType_t` is the natural word size of the microcontroller being used or interrupt nesting is either not supported or not being used.

**Returns** The count of ticks since `vTaskStartScheduler` was called.

UBaseType\_t **uxTaskGetNumberOfTasks** (void)

**Returns** The number of tasks that the real time kernel is currently managing. This includes all ready, blocked and suspended tasks. A task that has been deleted but not yet freed by the idle task will also be included in the count.

char \***pcTaskGetName** (*TaskHandle\_t* xTaskToQuery)

**Returns** The text (human readable) name of the task referenced by the handle xTaskToQuery. A task can query its own name by either passing in its own handle, or by setting xTaskToQuery to NULL.

*TaskHandle\_t* **xTaskGetHandle** (const char \*pcNameToQuery)

NOTE: This function takes a relatively long time to complete and should be used sparingly.

**Returns** The handle of the task that has the human readable name pcNameToQuery. NULL is returned if no matching name is found. INCLUDE\_xTaskGetHandle must be set to 1 in FreeRTOSConfig.h for pcTaskGetHandle() to be available.

UBaseType\_t **uxTaskGetStackHighWaterMark** (*TaskHandle\_t* xTask)

Returns the high water mark of the stack associated with xTask.

INCLUDE\_uxTaskGetStackHighWaterMark must be set to 1 in FreeRTOSConfig.h for this function to be available.

Returns the high water mark of the stack associated with xTask. That is, the minimum free stack space there has been (in bytes not words, unlike vanilla FreeRTOS) since the task started. The smaller the returned number the closer the task has come to overflowing its stack.

uxTaskGetStackHighWaterMark() and uxTaskGetStackHighWaterMark2() are the same except for their return type. Using configSTACK\_DEPTH\_TYPE allows the user to determine the return type. It gets around the problem of the value overflowing on 8-bit types without breaking backward compatibility for applications that expect an 8-bit return type.

**Parameters** **xTask** –Handle of the task associated with the stack to be checked. Set xTask to NULL to check the stack of the calling task.

**Returns** The smallest amount of free stack space there has been (in bytes not words, unlike vanilla FreeRTOS) since the task referenced by xTask was created.

configSTACK\_DEPTH\_TYPE **uxTaskGetStackHighWaterMark2** (*TaskHandle\_t* xTask)

Returns the start of the stack associated with xTask.

INCLUDE\_uxTaskGetStackHighWaterMark2 must be set to 1 in FreeRTOSConfig.h for this function to be available.

Returns the high water mark of the stack associated with xTask. That is, the minimum free stack space there has been (in words, so on a 32 bit machine a value of 1 means 4 bytes) since the task started. The smaller the returned number the closer the task has come to overflowing its stack.

uxTaskGetStackHighWaterMark() and uxTaskGetStackHighWaterMark2() are the same except for their return type. Using configSTACK\_DEPTH\_TYPE allows the user to determine the return type. It gets around the problem of the value overflowing on 8-bit types without breaking backward compatibility for applications that expect an 8-bit return type.

**Parameters** **xTask** –Handle of the task associated with the stack to be checked. Set xTask to NULL to check the stack of the calling task.

**Returns** The smallest amount of free stack space there has been (in words, so actual spaces on the stack rather than bytes) since the task referenced by xTask was created.

uint8\_t \***pxTaskGetStackStart** (*TaskHandle\_t* xTask)

Returns the start of the stack associated with xTask.

INCLUDE\_pxTaskGetStackStart must be set to 1 in FreeRTOSConfig.h for this function to be available.

Returns the lowest stack memory address, regardless of whether the stack grows up or down.

**Parameters** **xTask** –Handle of the task associated with the stack returned. Set xTask to NULL to return the stack of the calling task.

**Returns** A pointer to the start of the stack.

void **vTaskSetApplicationTaskTag** (*TaskHandle\_t* xTask, *TaskHookFunction\_t* pxHookFunction)

Sets pxHookFunction to be the task hook function used by the task xTask.

#### Parameters

- **xTask** –Handle of the task to set the hook function for Passing xTask as NULL has the effect of setting the calling tasks hook function.
- **pxHookFunction** –Pointer to the hook function.

*TaskHookFunction\_t* **xTaskGetApplicationTaskTag** (*TaskHandle\_t* xTask)

Returns the pxHookFunction value assigned to the task xTask. Do not call from an interrupt service routine - call xTaskGetApplicationTaskTagFromISR() instead.

*TaskHookFunction\_t* **xTaskGetApplicationTaskTagFromISR** (*TaskHandle\_t* xTask)

Returns the pxHookFunction value assigned to the task xTask. Can be called from an interrupt service routine.

void **vTaskSetThreadLocalStoragePointer** (*TaskHandle\_t* xTaskToSet, BaseType\_t xIndex, void \*pvValue)

Set local storage pointer specific to the given task.

Each task contains an array of pointers that is dimensioned by the configNUM\_THREAD\_LOCAL\_STORAGE\_POINTERS setting in FreeRTOSConfig.h. The kernel does not use the pointers itself, so the application writer can use the pointers for any purpose they wish.

#### Parameters

- **xTaskToSet** –Task to set thread local storage pointer for
- **xIndex** –The index of the pointer to set, from 0 to configNUM\_THREAD\_LOCAL\_STORAGE\_POINTERS - 1.
- **pvValue** –Pointer value to set.

void \***pvTaskGetThreadLocalStoragePointer** (*TaskHandle\_t* xTaskToQuery, BaseType\_t xIndex)

Get local storage pointer specific to the given task.

Each task contains an array of pointers that is dimensioned by the configNUM\_THREAD\_LOCAL\_STORAGE\_POINTERS setting in FreeRTOSConfig.h. The kernel does not use the pointers itself, so the application writer can use the pointers for any purpose they wish.

#### Parameters

- **xTaskToQuery** –Task to get thread local storage pointer for
- **xIndex** –The index of the pointer to get, from 0 to configNUM\_THREAD\_LOCAL\_STORAGE\_POINTERS - 1.

**Returns** Pointer value

void **vTaskSetThreadLocalStoragePointerAndDelCallback** (*TaskHandle\_t* xTaskToSet, BaseType\_t xIndex, void \*pvValue, *TlsDeleteCallbackFunction\_t* pvDelCallback)

Set local storage pointer and deletion callback.

Each task contains an array of pointers that is dimensioned by the configNUM\_THREAD\_LOCAL\_STORAGE\_POINTERS setting in FreeRTOSConfig.h. The kernel does not use the pointers itself, so the application writer can use the pointers for any purpose they wish.

Local storage pointers set for a task can reference dynamically allocated resources. This function is similar to vTaskSetThreadLocalStoragePointer, but provides a way to release these resources when the task gets deleted. For each pointer, a callback function can be set. This function will be called when task is deleted, with the local storage pointer index and value as arguments.

#### Parameters

- **xTaskToSet** –Task to set thread local storage pointer for
- **xIndex** –The index of the pointer to set, from 0 to configNUM\_THREAD\_LOCAL\_STORAGE\_POINTERS - 1.
- **pvValue** –Pointer value to set.

- **pvDelCallback** –Function to call to dispose of the local storage pointer when the task is deleted.

void **vApplicationGetIdleTaskMemory** (StaticTask\_t \*\*ppxIdleTaskTCBBuffer, StackType\_t \*\*ppxIdleTaskStackBuffer, uint32\_t \*pulIdleTaskStackSize)

This function is used to provide a statically allocated block of memory to FreeRTOS to hold the Idle Task TCB. This function is required when configSUPPORT\_STATIC\_ALLOCATION is set. For more information see this URI: [https://www.FreeRTOS.org/a00110.html#configSUPPORT\\_STATIC\\_ALLOCATION](https://www.FreeRTOS.org/a00110.html#configSUPPORT_STATIC_ALLOCATION)

#### Parameters

- **ppxIdleTaskTCBBuffer** –A handle to a statically allocated TCB buffer
- **ppxIdleTaskStackBuffer** –A handle to a statically allocated Stack buffer for this idle task
- **pulIdleTaskStackSize** –A pointer to the number of elements that will fit in the allocated stack buffer

BaseType\_t **xTaskCallApplicationTaskHook** (*TaskHandle\_t* xTask, void \*pvParameter)

Calls the hook function associated with xTask. Passing xTask as NULL has the effect of calling the Running tasks (the calling task) hook function.

#### Parameters

- **xTask** –Handle of the task to call the hook for.
- **pvParameter** –Parameter passed to the hook function for the task to interpret as it wants. The return value is the value returned by the task hook function registered by the user.

*TaskHandle\_t* **xTaskGetIdleTaskHandle** (void)

xTaskGetIdleTaskHandle() is only available if INCLUDE\_xTaskGetIdleTaskHandle is set to 1 in FreeRTOSConfig.h.

Simply returns the handle of the idle task. It is not valid to call xTaskGetIdleTaskHandle() before the scheduler has been started.

UBaseType\_t **uxTaskGetSystemState** (TaskStatus\_t \*const pxTaskStatusArray, const UBaseType\_t uxArraySize, uint32\_t \*const pulTotalRunTime)

configUSE\_TRACE\_FACILITY must be defined as 1 in FreeRTOSConfig.h for uxTaskGetSystemState() to be available.

uxTaskGetSystemState() populates an TaskStatus\_t structure for each task in the system. TaskStatus\_t structures contain, among other things, members for the task handle, task name, task priority, task state, and total amount of run time consumed by the task. See the TaskStatus\_t structure definition in this file for the full member list.

NOTE: This function is intended for debugging use only as its use results in the scheduler remaining suspended for an extended period.

Example usage:

```
// This example demonstrates how a human readable table of run time stats
// information is generated from raw data provided by uxTaskGetSystemState().
// The human readable table is written to pcWriteBuffer
void vTaskGetRunTimeStats( char *pcWriteBuffer )
{
    TaskStatus_t *pxTaskStatusArray;
    volatile UBaseType_t uxArraySize, x;
    uint32_t ulTotalRunTime, ulStatsAsPercentage;

    // Make sure the write buffer does not contain a string.
    *pcWriteBuffer = 0x00;

    // Take a snapshot of the number of tasks in case it changes while this
```

(continues on next page)

(continued from previous page)

```

// function is executing.
uxArraySize = uxTaskGetNumberOfTasks();

// Allocate a TaskStatus_t structure for each task. An array could be
// allocated statically at compile time.
pxTaskStatusArray = pvPortMalloc( uxArraySize * sizeof( TaskStatus_t ) );

if( pxTaskStatusArray != NULL )
{
    // Generate raw status information about each task.
    uxArraySize = uxTaskGetSystemState( pxTaskStatusArray, uxArraySize, &
↪ulTotalRunTime );

    // For percentage calculations.
    ulTotalRunTime /= 100UL;

    // Avoid divide by zero errors.
    if( ulTotalRunTime > 0 )
    {
        // For each populated position in the pxTaskStatusArray array,
        // format the raw data as human readable ASCII data
        for( x = 0; x < uxArraySize; x++ )
        {
            // What percentage of the total run time has the task used?
            // This will always be rounded down to the nearest integer.
            // ulTotalRunTimeDiv100 has already been divided by 100.
            ulStatsAsPercentage = pxTaskStatusArray[ x ].ulRunTimeCounter_
↪/ ulTotalRunTime;

            if( ulStatsAsPercentage > 0UL )
            {
                sprintf( pcWriteBuffer, "%s\t\t%lu\t\t%lu%%\r\n",
↪pxTaskStatusArray[ x ].pcTaskName, pxTaskStatusArray[ x ].ulRunTimeCounter,
↪ulStatsAsPercentage );
            }
            else
            {
                // If the percentage is zero here then the task has
                // consumed less than 1% of the total run time.
                sprintf( pcWriteBuffer, "%s\t\t%lu\t\t<1%%\r\n",
↪pxTaskStatusArray[ x ].pcTaskName, pxTaskStatusArray[ x ].ulRunTimeCounter );
            }

            pcWriteBuffer += strlen( ( char * ) pcWriteBuffer );
        }

        // The array is no longer needed, free the memory it consumes.
        vPortFree( pxTaskStatusArray );
    }
}

```

### Parameters

- **pxTaskStatusArray** –A pointer to an array of TaskStatus\_t structures. The array must contain at least one TaskStatus\_t structure for each task that is under the control of the RTOS. The number of tasks under the control of the RTOS can be determined using the uxTaskGetNumberOfTasks() API function.
- **uxArraySize** –The size of the array pointed to by the pxTaskStatusArray parameter. The size is specified as the number of indexes in the array, or the number of TaskStatus\_t structures contained in the array, not by the number of bytes in the array.
- **pulTotalRunTime** –If configGENERATE\_RUN\_TIME\_STATS is set to 1 in FreeR-



TOSConfig.h then `*pulTotalRunTime` is set by `uxTaskGetSystemState()` to the total run time (as defined by the run time stats clock, see <https://www.FreeRTOS.org/rtos-run-time-stats.html>) since the target booted. `pulTotalRunTime` can be set to NULL to omit the total run time information.

**Returns** The number of `TaskStatus_t` structures that were populated by `uxTaskGetSystemState()`. This should equal the number returned by the `uxTaskGetNumberOfTasks()` API function, but will be zero if the value passed in the `uxArraySize` parameter was too small.

void **vTaskList** (char \*pcWriteBuffer)

List all the current tasks.

`configUSE_TRACE_FACILITY` and `configUSE_STATS_FORMATTING_FUNCTIONS` must both be defined as 1 for this function to be available. See the configuration section of the FreeRTOS.org website for more information.

NOTE 1: This function will disable interrupts for its duration. It is not intended for normal application runtime use but as a debug aid.

Lists all the current tasks, along with their current state and stack usage high water mark.

Tasks are reported as blocked ( 'B' ), ready ( 'R' ), deleted ( 'D' ) or suspended ( 'S' ).

PLEASE NOTE:

This function is provided for convenience only, and is used by many of the demo applications. Do not consider it to be part of the scheduler.

`vTaskList()` calls `uxTaskGetSystemState()`, then formats part of the `uxTaskGetSystemState()` output into a human readable table that displays task names, states and stack usage.

`vTaskList()` has a dependency on the `sprintf()` C library function that might bloat the code size, use a lot of stack, and provide different results on different platforms. An alternative, tiny, third party, and limited functionality implementation of `sprintf()` is provided in many of the FreeRTOS/Demo sub-directories in a file called `printf-stdarg.c` (note `printf-stdarg.c` does not provide a full `snprintf()` implementation!).

It is recommended that production systems call `uxTaskGetSystemState()` directly to get access to raw stats data, rather than indirectly through a call to `vTaskList()`.

**Parameters** `pcWriteBuffer` –A buffer into which the above mentioned details will be written, in ASCII form. This buffer is assumed to be large enough to contain the generated report. Approximately 40 bytes per task should be sufficient.

void **vTaskGetRunTimeStats** (char \*pcWriteBuffer)

Get the state of running tasks as a string

`configGENERATE_RUN_TIME_STATS` and `configUSE_STATS_FORMATTING_FUNCTIONS` must both be defined as 1 for this function to be available. The application must also then provide definitions for `portCONFIGURE_TIMER_FOR_RUN_TIME_STATS()` and `portGET_RUN_TIME_COUNTER_VALUE()` to configure a peripheral timer/counter and return the timers current count value respectively. The counter should be at least 10 times the frequency of the tick count.

NOTE 1: This function will disable interrupts for its duration. It is not intended for normal application runtime use but as a debug aid.

Setting `configGENERATE_RUN_TIME_STATS` to 1 will result in a total accumulated execution time being stored for each task. The resolution of the accumulated time value depends on the frequency of the timer configured by the `portCONFIGURE_TIMER_FOR_RUN_TIME_STATS()` macro. Calling `vTaskGetRunTimeStats()` writes the total execution time of each task into a buffer, both as an absolute count value and as a percentage of the total system execution time.

NOTE 2:

This function is provided for convenience only, and is used by many of the demo applications. Do not consider it to be part of the scheduler.



`vTaskGetRunTimeStats()` calls `uxTaskGetSystemState()`, then formats part of the `uxTaskGetSystemState()` output into a human readable table that displays the amount of time each task has spent in the Running state in both absolute and percentage terms.

`vTaskGetRunTimeStats()` has a dependency on the `sprintf()` C library function that might bloat the code size, use a lot of stack, and provide different results on different platforms. An alternative, tiny, third party, and limited functionality implementation of `sprintf()` is provided in many of the FreeRTOS/Demo sub-directories in a file called `printf-stdarg.c` (note `printf-stdarg.c` does not provide a full `snprintf()` implementation!).

It is recommended that production systems call `uxTaskGetSystemState()` directly to get access to raw stats data, rather than indirectly through a call to `vTaskGetRunTimeStats()`.

**Parameters** `pcWriteBuffer` –A buffer into which the execution times will be written, in ASCII form. This buffer is assumed to be large enough to contain the generated report. Approximately 40 bytes per task should be sufficient.

`uint32_t ulTaskGetIdleRunTimeCounter` (void)

`configGENERATE_RUN_TIME_STATS` and `configUSE_STATS_FORMATTING_FUNCTIONS` must both be defined as 1 for this function to be available. The application must also then provide definitions for `portCONFIGURE_TIMER_FOR_RUN_TIME_STATS()` and `portGET_RUN_TIME_COUNTER_VALUE()` to configure a peripheral timer/counter and return the timers current count value respectively. The counter should be at least 10 times the frequency of the tick count.

Setting `configGENERATE_RUN_TIME_STATS` to 1 will result in a total accumulated execution time being stored for each task. The resolution of the accumulated time value depends on the frequency of the timer configured by the `portCONFIGURE_TIMER_FOR_RUN_TIME_STATS()` macro. While `uxTaskGetSystemState()` and `vTaskGetRunTimeStats()` writes the total execution time of each task into a buffer, `ulTaskGetIdleRunTimeCounter()` returns the total execution time of just the idle task.

**Returns** The total run time of the idle task. This is the amount of time the idle task has actually been executing. The unit of time is dependent on the frequency configured using the `portCONFIGURE_TIMER_FOR_RUN_TIME_STATS()` and `portGET_RUN_TIME_COUNTER_VALUE()` macros.

`BaseType_t xTaskGenericNotify` (*TaskHandle\_t* xTaskToNotify, `UBaseType_t` uxIndexToNotify, `uint32_t` ulValue, *eNotifyAction* eAction, `uint32_t` \*pulPreviousNotificationValue)

See <https://www.FreeRTOS.org/RTOS-task-notifications.html> for details.

`configUSE_TASK_NOTIFICATIONS` must be undefined or defined as 1 for these functions to be available.

Sends a direct to task notification to a task, with an optional value and action.

Each task has a private array of “notification values” (or ‘notifications’), each of which is a 32-bit unsigned integer (`uint32_t`). The constant `configTASK_NOTIFICATION_ARRAY_ENTRIES` sets the number of indexes in the array, and (for backward compatibility) defaults to 1 if left undefined. Prior to FreeRTOS V10.4.0 there was only one notification value per task.

Events can be sent to a task using an intermediary object. Examples of such objects are queues, semaphores, mutexes and event groups. Task notifications are a method of sending an event directly to a task without the need for such an intermediary object.

A notification sent to a task can optionally perform an action, such as update, overwrite or increment one of the task’s notification values. In that way task notifications can be used to send data to a task, or be used as light weight and fast binary or counting semaphores.

A task can use `xTaskNotifyWaitIndexed()` to [optionally] block to wait for a notification to be pending, or `ulTaskNotifyTakeIndexed()` to [optionally] block to wait for a notification value to have a non-zero value. The task does not consume any CPU time while it is in the Blocked state.

A notification sent to a task will remain pending until it is cleared by the task calling `xTaskNotifyWaitIndexed()` or `ulTaskNotifyTakeIndexed()` (or their un-indexed equivalents). If the task was already in the Blocked state to wait for a notification when the notification arrives then the task will automatically be removed from the Blocked state (unblocked) and the notification cleared.

**NOTE** Each notification within the array operates independently - a task can only block on one notification within the array at a time and will not be unblocked by a notification sent to any other array index.

Backward compatibility information: Prior to FreeRTOS V10.4.0 each task had a single “notification value”, and all task notification API functions operated on that value. Replacing the single notification value with an array of notification values necessitated a new set of API functions that could address specific notifications within the array. `xTaskNotify()` is the original API function, and remains backward compatible by always operating on the notification value at index 0 in the array. Calling `xTaskNotify()` is equivalent to calling `xTaskNotifyIndexed()` with the `uxIndexToNotify` parameter set to 0.

**eSetBits** - The target notification value is bitwise ORed with `ulValue`. `xTaskNotifyIndexed()` always returns `pdPASS` in this case.

**eIncrement** - The target notification value is incremented. `ulValue` is not used and `xTaskNotifyIndexed()` always returns `pdPASS` in this case.

**eSetValueWithOverwrite** - The target notification value is set to the value of `ulValue`, even if the task being notified had not yet processed the previous notification at the same array index (the task already had a notification pending at that index). `xTaskNotifyIndexed()` always returns `pdPASS` in this case.

**eSetValueWithoutOverwrite** - If the task being notified did not already have a notification pending at the same array index then the target notification value is set to `ulValue` and `xTaskNotifyIndexed()` will return `pdPASS`. If the task being notified already had a notification pending at the same array index then no action is performed and `pdFAIL` is returned.

**eNoAction** - The task receives a notification at the specified array index without the notification value at that index being updated. `ulValue` is not used and `xTaskNotifyIndexed()` always returns `pdPASS` in this case.

#### Parameters

- **xTaskToNotify** –The handle of the task being notified. The handle to a task can be returned from the `xTaskCreate()` API function used to create the task, and the handle of the currently running task can be obtained by calling `xTaskGetCurrentTaskHandle()`.
- **uxIndexToNotify** –The index within the target task’s array of notification values to which the notification is to be sent. `uxIndexToNotify` must be less than `configTASK_NOTIFICATION_ARRAY_ENTRIES`. `xTaskNotify()` does not have this parameter and always sends notifications to index 0.
- **ulValue** –Data that can be sent with the notification. How the data is used depends on the value of the `eAction` parameter.
- **eAction** –Specifies how the notification updates the task’s notification value, if at all. Valid values for `eAction` are as follows:
- **pulPreviousNotificationValue** – Can be used to pass out the subject task’s notification value before any bits are modified by the notify function.

**Returns** Dependent on the value of `eAction`. See the description of the `eAction` parameter.

```
BaseType_t xTaskGenericNotifyFromISR (TaskHandle_t xTaskToNotify, UBaseType_t
                                     uxIndexToNotify, uint32_t ulValue, eNotifyAction eAction,
                                     uint32_t *pulPreviousNotificationValue, BaseType_t
                                     *pxHigherPriorityTaskWoken)
```

See <https://www.FreeRTOS.org/RTOS-task-notifications.html> for details.

`configUSE_TASK_NOTIFICATIONS` must be undefined or defined as 1 for these functions to be available.

A version of `xTaskNotifyIndexed()` that can be used from an interrupt service routine (ISR).

Each task has a private array of “notification values” (or ‘notifications’), each of which is a 32-bit unsigned integer (`uint32_t`). The constant `configTASK_NOTIFICATION_ARRAY_ENTRIES` sets the number of indexes in the array, and (for backward compatibility) defaults to 1 if left undefined. Prior to FreeRTOS V10.4.0 there was only one notification value per task.

Events can be sent to a task using an intermediary object. Examples of such objects are queues, semaphores, mutexes and event groups. Task notifications are a method of sending an event directly to a task without the need for such an intermediary object.

A notification sent to a task can optionally perform an action, such as update, overwrite or increment one of the task's notification values. In that way task notifications can be used to send data to a task, or be used as light weight and fast binary or counting semaphores.

A task can use `xTaskNotifyWaitIndexed()` to [optionally] block to wait for a notification to be pending, or `ulTaskNotifyTakeIndexed()` to [optionally] block to wait for a notification value to have a non-zero value. The task does not consume any CPU time while it is in the Blocked state.

A notification sent to a task will remain pending until it is cleared by the task calling `xTaskNotifyWaitIndexed()` or `ulTaskNotifyTakeIndexed()` (or their un-indexed equivalents). If the task was already in the Blocked state to wait for a notification when the notification arrives then the task will automatically be removed from the Blocked state (unblocked) and the notification cleared.

**NOTE** Each notification within the array operates independently - a task can only block on one notification within the array at a time and will not be unblocked by a notification sent to any other array index.

Backward compatibility information: Prior to FreeRTOS V10.4.0 each task had a single "notification value", and all task notification API functions operated on that value. Replacing the single notification value with an array of notification values necessitated a new set of API functions that could address specific notifications within the array. `xTaskNotifyFromISR()` is the original API function, and remains backward compatible by always operating on the notification value at index 0 within the array. Calling `xTaskNotifyFromISR()` is equivalent to calling `xTaskNotifyIndexedFromISR()` with the `uxIndexToNotify` parameter set to 0.

**eSetBits** - The task's notification value is bitwise ORed with `ulValue`. `xTaskNotify()` always returns `pdPASS` in this case.

**eIncrement** - The task's notification value is incremented. `ulValue` is not used and `xTaskNotify()` always returns `pdPASS` in this case.

**eSetValueWithOverwrite** - The task's notification value is set to the value of `ulValue`, even if the task being notified had not yet processed the previous notification (the task already had a notification pending). `xTaskNotify()` always returns `pdPASS` in this case.

**eSetValueWithoutOverwrite** - If the task being notified did not already have a notification pending then the task's notification value is set to `ulValue` and `xTaskNotify()` will return `pdPASS`. If the task being notified already had a notification pending then no action is performed and `pdFAIL` is returned.

**eNoAction** - The task receives a notification without its notification value being updated. `ulValue` is not used and `xTaskNotify()` always returns `pdPASS` in this case.

#### Parameters

- **uxIndexToNotify** - The index within the target task's array of notification values to which the notification is to be sent. `uxIndexToNotify` must be less than `configTASK_NOTIFICATION_ARRAY_ENTRIES`. `xTaskNotifyFromISR()` does not have this parameter and always sends notifications to index 0.
- **xTaskToNotify** - The handle of the task being notified. The handle to a task can be returned from the `xTaskCreate()` API function used to create the task, and the handle of the currently running task can be obtained by calling `xTaskGetCurrentTaskHandle()`.
- **ulValue** - Data that can be sent with the notification. How the data is used depends on the value of the `eAction` parameter.
- **eAction** - Specifies how the notification updates the task's notification value, if at all. Valid values for `eAction` are as follows:
- **pdPreviousNotificationValue** - Can be used to pass out the subject task's notification value before any bits are modified by the notify function.
- **pdHigherPriorityTaskWoken** - `xTaskNotifyFromISR()` will set `*pdHigherPriorityTaskWoken` to `pdTRUE` if sending the notification caused the task to which the notification was sent to leave the Blocked state, and the unblocked task has a priority higher than the currently running task. If `xTaskNotifyFromISR()` sets this value to `pdTRUE` then a context switch should be requested before the interrupt is exited. How a context switch is requested from an ISR is dependent on the port - see the documentation page for the port in use.

**Returns** Dependent on the value of `eAction`. See the description of the `eAction` parameter.

BaseType\_t **xTaskGenericNotifyWait** (UBaseType\_t uxIndexToWaitOn, uint32\_t ulBitsToClearOnEntry, uint32\_t ulBitsToClearOnExit, uint32\_t \*pulNotificationValue, TickType\_t xTicksToWait)

Waits for a direct to task notification to be pending at a given index within an array of direct to task notifications.

See <https://www.FreeRTOS.org/RTOS-task-notifications.html> for details.

configUSE\_TASK\_NOTIFICATIONS must be undefined or defined as 1 for this function to be available.

Each task has a private array of “notification values” (or ‘notifications’), each of which is a 32-bit unsigned integer (uint32\_t). The constant configTASK\_NOTIFICATION\_ARRAY\_ENTRIES sets the number of indexes in the array, and (for backward compatibility) defaults to 1 if left undefined. Prior to FreeRTOS V10.4.0 there was only one notification value per task.

Events can be sent to a task using an intermediary object. Examples of such objects are queues, semaphores, mutexes and event groups. Task notifications are a method of sending an event directly to a task without the need for such an intermediary object.

A notification sent to a task can optionally perform an action, such as update, overwrite or increment one of the task’s notification values. In that way task notifications can be used to send data to a task, or be used as light weight and fast binary or counting semaphores.

A notification sent to a task will remain pending until it is cleared by the task calling xTaskNotifyWaitIndexed() or ulTaskNotifyTakeIndexed() (or their un-indexed equivalents). If the task was already in the Blocked state to wait for a notification when the notification arrives then the task will automatically be removed from the Blocked state (unblocked) and the notification cleared.

A task can use xTaskNotifyWaitIndexed() to [optionally] block to wait for a notification to be pending, or ulTaskNotifyTakeIndexed() to [optionally] block to wait for a notification value to have a non-zero value. The task does not consume any CPU time while it is in the Blocked state.

**NOTE** Each notification within the array operates independently - a task can only block on one notification within the array at a time and will not be unblocked by a notification sent to any other array index.

Backward compatibility information: Prior to FreeRTOS V10.4.0 each task had a single “notification value”, and all task notification API functions operated on that value. Replacing the single notification value with an array of notification values necessitated a new set of API functions that could address specific notifications within the array. xTaskNotifyWait() is the original API function, and remains backward compatible by always operating on the notification value at index 0 in the array. Calling xTaskNotifyWait() is equivalent to calling xTaskNotifyWaitIndexed() with the uxIndexToWaitOn parameter set to 0.

#### Parameters

- **uxIndexToWaitOn** –The index within the calling task’s array of notification values on which the calling task will wait for a notification to be received. uxIndexToWaitOn must be less than configTASK\_NOTIFICATION\_ARRAY\_ENTRIES. xTaskNotifyWait() does not have this parameter and always waits for notifications on index 0.
- **ulBitsToClearOnEntry** –Bits that are set in ulBitsToClearOnEntry value will be cleared in the calling task’s notification value before the task is marked as waiting for a new notification (provided a notification is not already pending). Optionally blocks if no notifications are pending. Setting ulBitsToClearOnEntry to ULONG\_MAX (if limits.h is included) or 0xffffffffUL (if limits.h is not included) will have the effect of resetting the task’s notification value to 0. Setting ulBitsToClearOnEntry to 0 will leave the task’s notification value unchanged.
- **ulBitsToClearOnExit** –If a notification is pending or received before the calling task exits the xTaskNotifyWait() function then the task’s notification value (see the xTaskNotify() API function) is passed out using the pulNotificationValue parameter. Then any bits that are set in ulBitsToClearOnExit will be cleared in the task’s notification value (note \*pulNotificationValue is set before any bits are cleared). Setting ulBitsToClearOnExit to ULONG\_MAX (if limits.h is included) or 0xffffffffUL (if limits.h is not included) will have the effect of resetting the task’s notification value to 0 before the function exits. Setting ulBitsToClearOnExit to 0 will leave the task’s notification value unchanged when the function exits (in which case the value passed out in pulNotificationValue will match the task’s notification value).

- **pulNotificationValue** –Used to pass the task’s notification value out of the function. Note the value passed out will not be effected by the clearing of any bits caused by `ulBitsToClearOnExit` being non-zero.
- **xTicksToWait** –The maximum amount of time that the task should wait in the Blocked state for a notification to be received, should a notification not already be pending when `xTaskNotifyWait()` was called. The task will not consume any processing time while it is in the Blocked state. This is specified in kernel ticks, the macro `pdMS_TO_TICKS( value_in_ms )` can be used to convert a time specified in milliseconds to a time specified in ticks.

**Returns** If a notification was received (including notifications that were already pending when `xTaskNotifyWait` was called) then `pdPASS` is returned. Otherwise `pdFAIL` is returned.

void **vTaskGenericNotifyGiveFromISR** (*TaskHandle\_t* xTaskToNotify, *UBaseType\_t* uxIndexToNotify, *BaseType\_t* \*pxHigherPriorityTaskWoken)

A version of `xTaskNotifyGiveIndexed()` that can be called from an interrupt service routine (ISR).

See <https://www.FreeRTOS.org/RTOS-task-notifications.html> for more details.

`configUSE_TASK_NOTIFICATIONS` must be undefined or defined as 1 for this macro to be available.

Each task has a private array of “notification values” (or ‘notifications’), each of which is a 32-bit unsigned integer (`uint32_t`). The constant `configTASK_NOTIFICATION_ARRAY_ENTRIES` sets the number of indexes in the array, and (for backward compatibility) defaults to 1 if left undefined. Prior to FreeRTOS V10.4.0 there was only one notification value per task.

Events can be sent to a task using an intermediary object. Examples of such objects are queues, semaphores, mutexes and event groups. Task notifications are a method of sending an event directly to a task without the need for such an intermediary object.

A notification sent to a task can optionally perform an action, such as update, overwrite or increment one of the task’s notification values. In that way task notifications can be used to send data to a task, or be used as light weight and fast binary or counting semaphores.

`vTaskNotifyGiveIndexedFromISR()` is intended for use when task notifications are used as light weight and faster binary or counting semaphore equivalents. Actual FreeRTOS semaphores are given from an ISR using the `xSemaphoreGiveFromISR()` API function, the equivalent action that instead uses a task notification is `vTaskNotifyGiveIndexedFromISR()`.

When task notifications are being used as a binary or counting semaphore equivalent then the task being notified should wait for the notification using the `ulTaskNotificationTakeIndexed()` API function rather than the `xTaskNotifyWaitIndexed()` API function.

**NOTE** Each notification within the array operates independently - a task can only block on one notification within the array at a time and will not be unblocked by a notification sent to any other array index.

Backward compatibility information: Prior to FreeRTOS V10.4.0 each task had a single “notification value”, and all task notification API functions operated on that value. Replacing the single notification value with an array of notification values necessitated a new set of API functions that could address specific notifications within the array. `xTaskNotifyFromISR()` is the original API function, and remains backward compatible by always operating on the notification value at index 0 within the array. Calling `xTaskNotifyGiveFromISR()` is equivalent to calling `xTaskNotifyGiveIndexedFromISR()` with the `uxIndexToNotify` parameter set to 0.

#### Parameters

- **xTaskToNotify** –The handle of the task being notified. The handle to a task can be returned from the `xTaskCreate()` API function used to create the task, and the handle of the currently running task can be obtained by calling `xTaskGetCurrentTaskHandle()`.
- **uxIndexToNotify** –The index within the target task’s array of notification values to which the notification is to be sent. `uxIndexToNotify` must be less than `configTASK_NOTIFICATION_ARRAY_ENTRIES`. `xTaskNotifyGiveFromISR()` does not have this parameter and always sends notifications to index 0.
- **pxHigherPriorityTaskWoken** –`vTaskNotifyGiveFromISR()` will set `*pxHigherPriorityTaskWoken` to `pdTRUE` if sending the notification caused the task to which the notification was sent to leave the Blocked state, and the unblocked task has a priority higher



than the currently running task. If `vTaskNotifyGiveFromISR()` sets this value to `pdTRUE` then a context switch should be requested before the interrupt is exited. How a context switch is requested from an ISR is dependent on the port - see the documentation page for the port in use.

`uint32_t ulTaskGenericNotifyTake` (`UBaseType_t uxIndexToWaitOn`, `BaseType_t xClearCountOnExit`, `TickType_t xTicksToWait`)

Waits for a direct to task notification on a particular index in the calling task's notification array in a manner similar to taking a counting semaphore.

See <https://www.FreeRTOS.org/RTOS-task-notifications.html> for details.

`configUSE_TASK_NOTIFICATIONS` must be undefined or defined as 1 for this function to be available.

Each task has a private array of "notification values" (or 'notifications'), each of which is a 32-bit unsigned integer (`uint32_t`). The constant `configTASK_NOTIFICATION_ARRAY_ENTRIES` sets the number of indexes in the array, and (for backward compatibility) defaults to 1 if left undefined. Prior to FreeRTOS V10.4.0 there was only one notification value per task.

Events can be sent to a task using an intermediary object. Examples of such objects are queues, semaphores, mutexes and event groups. Task notifications are a method of sending an event directly to a task without the need for such an intermediary object.

A notification sent to a task can optionally perform an action, such as update, overwrite or increment one of the task's notification values. In that way task notifications can be used to send data to a task, or be used as light weight and fast binary or counting semaphores.

`ulTaskNotifyTakeIndexed()` is intended for use when a task notification is used as a faster and lighter weight binary or counting semaphore alternative. Actual FreeRTOS semaphores are taken using the `xSemaphoreTake()` API function, the equivalent action that instead uses a task notification is `ulTaskNotifyTakeIndexed()`.

When a task is using its notification value as a binary or counting semaphore other tasks should send notifications to it using the `xTaskNotifyGiveIndexed()` macro, or `xTaskNotifyIndex()` function with the `eAction` parameter set to `eIncrement`.

`ulTaskNotifyTakeIndexed()` can either clear the task's notification value at the array index specified by the `uxIndexToWaitOn` parameter to zero on exit, in which case the notification value acts like a binary semaphore, or decrement the notification value on exit, in which case the notification value acts like a counting semaphore.

A task can use `ulTaskNotifyTakeIndexed()` to [optionally] block to wait for the task's notification value to be non-zero. The task does not consume any CPU time while it is in the Blocked state.

Where as `xTaskNotifyWaitIndexed()` will return when a notification is pending, `ulTaskNotifyTakeIndexed()` will return when the task's notification value is not zero.

**NOTE** Each notification within the array operates independently - a task can only block on one notification within the array at a time and will not be unblocked by a notification sent to any other array index.

Backward compatibility information: Prior to FreeRTOS V10.4.0 each task had a single "notification value", and all task notification API functions operated on that value. Replacing the single notification value with an array of notification values necessitated a new set of API functions that could address specific notifications within the array. `ulTaskNotifyTake()` is the original API function, and remains backward compatible by always operating on the notification value at index 0 in the array. Calling `ulTaskNotifyTake()` is equivalent to calling `ulTaskNotifyTakeIndexed()` with the `uxIndexToWaitOn` parameter set to 0.

#### Parameters

- **`uxIndexToWaitOn`** –The index within the calling task's array of notification values on which the calling task will wait for a notification to be non-zero. `uxIndexToWaitOn` must be less than `configTASK_NOTIFICATION_ARRAY_ENTRIES`. `xTaskNotifyTake()` does not have this parameter and always waits for notifications on index 0.
- **`xClearCountOnExit`** –if `xClearCountOnExit` is `pdFALSE` then the task's notification value is decremented when the function exits. In this way the notification value acts

like a counting semaphore. If `xClearCountOnExit` is not `pdFALSE` then the task's notification value is cleared to zero when the function exits. In this way the notification value acts like a binary semaphore.

- **xTicksToWait** –The maximum amount of time that the task should wait in the Blocked state for the task's notification value to be greater than zero, should the count not already be greater than zero when `ulTaskNotifyTake()` was called. The task will not consume any processing time while it is in the Blocked state. This is specified in kernel ticks, the macro `pdMS_TO_TICKS( value_in_ms )` can be used to convert a time specified in milliseconds to a time specified in ticks.

**Returns** The task's notification count before it is either cleared to zero or decremented (see the `xClearCountOnExit` parameter).

`BaseType_t xTaskGenericNotifyStateClear` (*TaskHandle\_t* xTask, `UBaseType_t` uxIndexToClear)

See <https://www.FreeRTOS.org/RTOS-task-notifications.html> for details.

`configUSE_TASK_NOTIFICATIONS` must be undefined or defined as 1 for these functions to be available.

Each task has a private array of “notification values” (or ‘notifications’), each of which is a 32-bit unsigned integer (`uint32_t`). The constant `configTASK_NOTIFICATION_ARRAY_ENTRIES` sets the number of indexes in the array, and (for backward compatibility) defaults to 1 if left undefined. Prior to FreeRTOS V10.4.0 there was only one notification value per task.

If a notification is sent to an index within the array of notifications then the notification at that index is said to be ‘pending’ until it is read or explicitly cleared by the receiving task. `xTaskNotifyStateClearIndexed()` is the function that clears a pending notification without reading the notification value. The notification value at the same array index is not altered. Set `xTask` to `NULL` to clear the notification state of the calling task.

Backward compatibility information: Prior to FreeRTOS V10.4.0 each task had a single “notification value”, and all task notification API functions operated on that value. Replacing the single notification value with an array of notification values necessitated a new set of API functions that could address specific notifications within the array. `xTaskNotifyStateClear()` is the original API function, and remains backward compatible by always operating on the notification value at index 0 within the array. Calling `xTaskNotifyStateClear()` is equivalent to calling `xTaskNotifyStateClearIndexed()` with the `uxIndexToNotify` parameter set to 0.

#### Parameters

- **xTask** –The handle of the RTOS task that will have a notification state cleared. Set `xTask` to `NULL` to clear a notification state in the calling task. To obtain a task's handle create the task using `xTaskCreate()` and make use of the `pxCreatedTask` parameter, or create the task using `xTaskCreateStatic()` and store the returned value, or use the task's name in a call to `xTaskGetHandle()`.
- **uxIndexToClear** –The index within the target task's array of notification values to act upon. For example, setting `uxIndexToClear` to 1 will clear the state of the notification at index 1 within the array. `uxIndexToClear` must be less than `configTASK_NOTIFICATION_ARRAY_ENTRIES`. `ulTaskNotifyStateClear()` does not have this parameter and always acts on the notification at index 0.

**Returns** `pdTRUE` if the task's notification state was set to `eNotWaitingNotification`, otherwise `pdFALSE`.

`uint32_t ulTaskGenericNotifyValueClear` (*TaskHandle\_t* xTask, `UBaseType_t` uxIndexToClear, `uint32_t` ulBitsToClear)

See <https://www.FreeRTOS.org/RTOS-task-notifications.html> for details.

`configUSE_TASK_NOTIFICATIONS` must be undefined or defined as 1 for these functions to be available.

Each task has a private array of “notification values” (or ‘notifications’), each of which is a 32-bit unsigned integer (`uint32_t`). The constant `configTASK_NOTIFICATION_ARRAY_ENTRIES` sets the number of indexes in the array, and (for backward compatibility) defaults to 1 if left undefined. Prior to FreeRTOS V10.4.0 there was only one notification value per task.

`ulTaskNotifyValueClearIndexed()` clears the bits specified by the `ulBitsToClear` bit mask in the notification value at array index `uxIndexToClear` of the task referenced by `xTask`.

Backward compatibility information: Prior to FreeRTOS V10.4.0 each task had a single “notification value”, and all task notification API functions operated on that value. Replacing the single notification value with an array of notification values necessitated a new set of API functions that could address specific notifications within the array. `ulTaskNotifyValueClear()` is the original API function, and remains backward compatible by always operating on the notification value at index 0 within the array. Calling `ulTaskNotifyValueClear()` is equivalent to calling `ulTaskNotifyValueClearIndexed()` with the `uxIndexToClear` parameter set to 0.

#### Parameters

- **xTask** –The handle of the RTOS task that will have bits in one of its notification values cleared. Set `xTask` to `NULL` to clear bits in a notification value of the calling task. To obtain a task’s handle create the task using `xTaskCreate()` and make use of the `pxCreatedTask` parameter, or create the task using `xTaskCreateStatic()` and store the returned value, or use the task’s name in a call to `xTaskGetHandle()`.
- **uxIndexToClear** –The index within the target task’s array of notification values in which to clear the bits. `uxIndexToClear` must be less than `configTASK_NOTIFICATION_ARRAY_ENTRIES`. `ulTaskNotifyValueClear()` does not have this parameter and always clears bits in the notification value at index 0.
- **ulBitsToClear** –Bit mask of the bits to clear in the notification value of `xTask`. Set a bit to 1 to clear the corresponding bits in the task’s notification value. Set `ulBitsToClear` to `0xffffffff` (UINT\_MAX on 32-bit architectures) to clear the notification value to 0. Set `ulBitsToClear` to 0 to query the task’s notification value without clearing any bits.

**Returns** The value of the target task’s notification value before the bits specified by `ulBitsToClear` were cleared.

void **vTaskSetTimeoutState** (Timeout\_t \*const pxTimeout)

BaseType\_t **xTaskCheckForTimeout** (Timeout\_t \*const pxTimeout, TickType\_t \*const pxTicksToWait)

Determines if `pxTicksToWait` ticks has passed since a time was captured using a call to `vTaskSetTimeoutState()`. The captured time includes the tick count and the number of times the tick count has overflowed.

#### Example Usage:

```
// Driver library function used to receive uxWantedBytes from an Rx buffer
// that is filled by a UART interrupt. If there are not enough bytes in the
// Rx buffer then the task enters the Blocked state until it is notified that
// more data has been placed into the buffer. If there is still not enough
// data then the task re-enters the Blocked state, and xTaskCheckForTimeout()
// is used to re-calculate the Block time to ensure the total amount of time
// spent in the Blocked state does not exceed MAX_TIME_TO_WAIT. This
// continues until either the buffer contains at least uxWantedBytes bytes,
// or the total amount of time spent in the Blocked state reaches
// MAX_TIME_TO_WAIT - at which point the task reads however many bytes are
// available up to a maximum of uxWantedBytes.
```

```
size_t xUART_Receive( uint8_t *pucBuffer, size_t uxWantedBytes )
{
    size_t uxReceived = 0;
    TickType_t xTicksToWait = MAX_TIME_TO_WAIT;
    Timeout_t xTimeout;

    // Initialize xTimeout. This records the time at which this function
    // was entered.
    vTaskSetTimeoutState( &xTimeout );

    // Loop until the buffer contains the wanted number of bytes, or a
    // timeout occurs.
    while( UART_bytes_in_rx_buffer( pxUARTInstance ) < uxWantedBytes )
    {
        // The buffer didn't contain enough data so this task is going to
        // enter the Blocked state. Adjusting xTicksToWait to account for
```

(continues on next page)



(continued from previous page)

```

// any time that has been spent in the Blocked state within this
// function so far to ensure the total amount of time spent in the
// Blocked state does not exceed MAX_TIME_TO_WAIT.
if( xTaskCheckForTimeOut( &xTimeOut, &xTicksToWait ) != pdFALSE )
{
    //Timed out before the wanted number of bytes were available,
    // exit the loop.
    break;
}

// Wait for a maximum of xTicksToWait ticks to be notified that the
// receive interrupt has placed more data into the buffer.
ulTaskNotifyTake( pdTRUE, xTicksToWait );
}

// Attempt to read uxWantedBytes from the receive buffer into pucBuffer.
// The actual number of bytes read (which might be less than
// uxWantedBytes) is returned.
uxReceived = UART_read_from_receive_buffer( pxUARTInstance,
                                             pucBuffer,
                                             uxWantedBytes );

return uxReceived;
}

```

**See also:**

<https://www.FreeRTOS.org/xTaskCheckForTimeOut.html>

**Parameters**

- **pxTimeOut** –The time status as captured previously using `vTaskSetTimeOutState`. If the timeout has not yet occurred, it is updated to reflect the current time status.
- **pxTicksToWait** –The number of ticks to check for timeout i.e. if `pxTicksToWait` ticks have passed since `pxTimeOut` was last updated (either by `vTaskSetTimeOutState()` or `xTaskCheckForTimeOut()`), the timeout has occurred. If the timeout has not occurred, `pxTicksToWait` is updated to reflect the number of remaining ticks.

**Returns** If timeout has occurred, `pdTRUE` is returned. Otherwise `pdFALSE` is returned and `pxTicksToWait` is updated to reflect the number of remaining ticks.

BaseType\_t **xTaskCatchUpTicks** (TickType\_t xTicksToCatchUp)

**Macros**

`tskKERNEL_VERSION_NUMBER`

`tskKERNEL_VERSION_MAJOR`

`tskKERNEL_VERSION_MINOR`

`tskKERNEL_VERSION_BUILD`

`tskMPU_REGION_READ_ONLY`

`tskMPU_REGION_READ_WRITE`

**tskMPU\_REGION\_EXECUTE\_NEVER**

**tskMPU\_REGION\_NORMAL\_MEMORY**

**tskMPU\_REGION\_DEVICE\_MEMORY**

**tskDEFAULT\_INDEX\_TO\_NOTIFY**

**tskNO\_AFFINITY**

**tskIDLE\_PRIORITY**

Defines the priority used by the idle task. This must not be modified.

**taskYIELD ()**

Macro for forcing a context switch.

**taskENTER\_CRITICAL ()**

Macro to mark the start of a critical code region. Preemptive context switches cannot occur when in a critical region.

---

**Note:** This may alter the stack (depending on the portable implementation) so must be used with care!

---

**taskENTER\_CRITICAL\_FROM\_ISR ()**

**taskENTER\_CRITICAL\_ISR ()**

**taskEXIT\_CRITICAL ()**

Macro to mark the end of a critical code region. Preemptive context switches cannot occur when in a critical region.

---

**Note:** This may alter the stack (depending on the portable implementation) so must be used with care!

---

**taskEXIT\_CRITICAL\_FROM\_ISR (x)**

**taskEXIT\_CRITICAL\_ISR ()**

**taskDISABLE\_INTERRUPTS ()**

Macro to disable all maskable interrupts.

**taskENABLE\_INTERRUPTS ()**

Macro to enable microcontroller interrupts.

**taskSCHEDULER\_SUSPENDED**

**taskSCHEDULER\_NOT\_STARTED**

**taskSCHEDULER\_RUNNING**

**vTaskDelayUntil** (pxPreviousWakeTime, xTimeIncrement)

**xTaskNotify** (xTaskToNotify, ulValue, eAction)

**xTaskNotifyIndexed** (xTaskToNotify, uxIndexToNotify, ulValue, eAction)

**xTaskNotifyAndQuery** (xTaskToNotify, ulValue, eAction, pulPreviousNotifyValue)

See <https://www.FreeRTOS.org/RTOS-task-notifications.html> for details.

xTaskNotifyAndQueryIndexed() performs the same operation as xTaskNotifyIndexed() with the addition that it also returns the subject task's prior notification value (the notification value at the time the function is called rather than when the function returns) in the additional pulPreviousNotifyValue parameter.

xTaskNotifyAndQuery() performs the same operation as xTaskNotify() with the addition that it also returns the subject task's prior notification value (the notification value as it was at the time the function is called, rather than when the function returns) in the additional pulPreviousNotifyValue parameter.

**xTaskNotifyAndQueryIndexed** (xTaskToNotify, uxIndexToNotify, ulValue, eAction, pulPreviousNotifyValue)

**xTaskNotifyFromISR** (xTaskToNotify, ulValue, eAction, pxHigherPriorityTaskWoken)

**xTaskNotifyIndexedFromISR** (xTaskToNotify, uxIndexToNotify, ulValue, eAction, pxHigherPriorityTaskWoken)

**xTaskNotifyAndQueryIndexedFromISR** (xTaskToNotify, uxIndexToNotify, ulValue, eAction, pulPreviousNotificationValue, pxHigherPriorityTaskWoken)

See <https://www.FreeRTOS.org/RTOS-task-notifications.html> for details.

xTaskNotifyAndQueryIndexedFromISR() performs the same operation as xTaskNotifyIndexedFromISR() with the addition that it also returns the subject task's prior notification value (the notification value at the time the function is called rather than at the time the function returns) in the additional pulPreviousNotifyValue parameter.

xTaskNotifyAndQueryFromISR() performs the same operation as xTaskNotifyFromISR() with the addition that it also returns the subject task's prior notification value (the notification value at the time the function is called rather than at the time the function returns) in the additional pulPreviousNotifyValue parameter.

**xTaskNotifyAndQueryFromISR** (xTaskToNotify, ulValue, eAction, pulPreviousNotificationValue, pxHigherPriorityTaskWoken)

**xTaskNotifyWait** (ulBitsToClearOnEntry, ulBitsToClearOnExit, pulNotificationValue, xTicksToWait)

**xTaskNotifyWaitIndexed** (uxIndexToWaitOn, ulBitsToClearOnEntry, ulBitsToClearOnExit, pulNotificationValue, xTicksToWait)

**xTaskNotifyGiveIndexed** (xTaskToNotify, uxIndexToNotify)

Sends a direct to task notification to a particular index in the target task's notification array in a manner similar to giving a counting semaphore.

See <https://www.FreeRTOS.org/RTOS-task-notifications.html> for more details.

configUSE\_TASK\_NOTIFICATIONS must be undefined or defined as 1 for these macros to be available.

Each task has a private array of "notification values" (or 'notifications'), each of which is a 32-bit unsigned integer (uint32\_t). The constant configTASK\_NOTIFICATION\_ARRAY\_ENTRIES sets the number of indexes in the array, and (for backward compatibility) defaults to 1 if left undefined. Prior to FreeRTOS V10.4.0 there was only one notification value per task.

Events can be sent to a task using an intermediary object. Examples of such objects are queues, semaphores, mutexes and event groups. Task notifications are a method of sending an event directly to a task without the need for such an intermediary object.

A notification sent to a task can optionally perform an action, such as update, overwrite or increment one of the task's notification values. In that way task notifications can be used to send data to a task, or be used as light weight and fast binary or counting semaphores.

xTaskNotifyGiveIndexed() is a helper macro intended for use when task notifications are used as light weight and faster binary or counting semaphore equivalents. Actual FreeRTOS semaphores are given using the

`xSemaphoreGive()` API function, the equivalent action that instead uses a task notification is `xTaskNotifyGiveIndexed()`.

When task notifications are being used as a binary or counting semaphore equivalent then the task being notified should wait for the notification using the `ulTaskNotificationTakeIndexed()` API function rather than the `xTaskNotifyWaitIndexed()` API function.

**NOTE** Each notification within the array operates independently - a task can only block on one notification within the array at a time and will not be unblocked by a notification sent to any other array index.

Backward compatibility information: Prior to FreeRTOS V10.4.0 each task had a single “notification value”, and all task notification API functions operated on that value. Replacing the single notification value with an array of notification values necessitated a new set of API functions that could address specific notifications within the array. `xTaskNotifyGive()` is the original API function, and remains backward compatible by always operating on the notification value at index 0 in the array. Calling `xTaskNotifyGive()` is equivalent to calling `xTaskNotifyGiveIndexed()` with the `uxIndexToNotify` parameter set to 0.

#### Parameters

- **`xTaskToNotify`** –The handle of the task being notified. The handle to a task can be returned from the `xTaskCreate()` API function used to create the task, and the handle of the currently running task can be obtained by calling `xTaskGetCurrentTaskHandle()`.
- **`uxIndexToNotify`** –The index within the target task’s array of notification values to which the notification is to be sent. `uxIndexToNotify` must be less than `configTASK_NOTIFICATION_ARRAY_ENTRIES`. `xTaskNotifyGive()` does not have this parameter and always sends notifications to index 0.

**Returns** `xTaskNotifyGive()` is a macro that calls `xTaskNotify()` with the `eAction` parameter set to `eIncrement` - so `pdPASS` is always returned.

**`xTaskNotifyGive`** (`xTaskToNotify`)

**`vTaskNotifyGiveFromISR`** (`xTaskToNotify`, `pxHigherPriorityTaskWoken`)

**`vTaskNotifyGiveIndexedFromISR`** (`xTaskToNotify`, `uxIndexToNotify`, `pxHigherPriorityTaskWoken`)

**`ulTaskNotifyTake`** (`xClearCountOnExit`, `xTicksToWait`)

**`ulTaskNotifyTakeIndexed`** (`uxIndexToWaitOn`, `xClearCountOnExit`, `xTicksToWait`)

**`xTaskNotifyStateClear`** (`xTask`)

**`xTaskNotifyStateClearIndexed`** (`xTask`, `uxIndexToClear`)

**`ulTaskNotifyValueClear`** (`xTask`, `ulBitsToClear`)

**`ulTaskNotifyValueClearIndexed`** (`xTask`, `uxIndexToClear`, `ulBitsToClear`)

#### Type Definitions

```
typedef struct tskTaskControlBlock *TaskHandle_t
```

```
typedef BaseType_t (*TaskHookFunction_t)(void*)
```

```
typedef void (*TlsDeleteCallbackFunction_t)(int, void*)
```

Prototype of local storage pointer deletion callback.

#### Enumerations

```
enum eTaskState
```

Task states returned by `eTaskGetState`.

*Values:*

enumerator **eRunning**

enumerator **eReady**

enumerator **eBlocked**

enumerator **eSuspended**

enumerator **eDeleted**

enumerator **eInvalid**

enum **eNotifyAction**

*Values:*

enumerator **eNoAction**

enumerator **eSetBits**

enumerator **eIncrement**

enumerator **eSetValueWithOverwrite**

enumerator **eSetValueWithoutOverwrite**

enum **eSleepModeStatus**

Possible return values for eTaskConfirmSleepModeStatus().

*Values:*

enumerator **eAbortSleep**

enumerator **eStandardSleep**

enumerator **eNoTasksWaitingTimeout**

## Queue API

### Header File

- [components/freertos/FreeRTOS-Kernel/include/freertos/queue.h](#)

### Functions

BaseType\_t **xQueueGenericSend** (*QueueHandle\_t* xQueue, const void \*const pvItemToQueue, TickType\_t xTicksToWait, const BaseType\_t xCopyPosition)

It is preferred that the macros xQueueSend(), xQueueSendToFront() and xQueueSendToBack() are used in place of calling this function directly.

Post an item on a queue. The item is queued by copy, not by reference. This function must not be called from an interrupt service routine. See `xQueueSendFromISR ()` for an alternative which may be used in an ISR.

Example usage:

```

struct AMessage
{
    char ucMessageID;
    char ucData[ 20 ];
} xMessage;

uint32_t ulVar = 10UL;

void vATask( void *pvParameters )
{
    QueueHandle_t xQueue1, xQueue2;
    struct AMessage *pxMessage;

    // Create a queue capable of containing 10 uint32_t values.
    xQueue1 = xQueueCreate( 10, sizeof( uint32_t ) );

    // Create a queue capable of containing 10 pointers to AMessage structures.
    // These should be passed by pointer as they contain a lot of data.
    xQueue2 = xQueueCreate( 10, sizeof( struct AMessage * ) );

    // ...

    if( xQueue1 != 0 )
    {
        // Send an uint32_t. Wait for 10 ticks for space to become
        // available if necessary.
        if( xQueueGenericSend( xQueue1, ( void * ) &ulVar, ( TickType_t ) 10, ←
        →queueSEND_TO_BACK ) != pdPASS )
        {
            // Failed to post the message, even after 10 ticks.
        }
    }

    if( xQueue2 != 0 )
    {
        // Send a pointer to a struct AMessage object. Don't block if the
        // queue is already full.
        pxMessage = &xMessage;
        xQueueGenericSend( xQueue2, ( void * ) &pxMessage, ( TickType_t ) 0, ←
        →queueSEND_TO_BACK );
    }

    // ... Rest of task code.
}

```

### Parameters

- **xQueue** –The handle to the queue on which the item is to be posted.
- **pvItemToQueue** –A pointer to the item that is to be placed on the queue. The size of the items the queue will hold was defined when the queue was created, so this many bytes will be copied from `pvItemToQueue` into the queue storage area.
- **xTicksToWait** –The maximum amount of time the task should block waiting for space to become available on the queue, should it already be full. The call will return immediately if this is set to 0 and the queue is full. The time is defined in tick periods so the constant `portTICK_PERIOD_MS` should be used to convert to real time if this is required.
- **xCopyPosition** –Can take the value `queueSEND_TO_BACK` to place the item at the

back of the queue, or `queueSEND_TO_FRONT` to place the item at the front of the queue (for high priority messages).

**Returns** `pdTRUE` if the item was successfully posted, otherwise `errQUEUE_FULL`.

`BaseType_t xQueuePeek ( QueueHandle_t xQueue, void *const pvBuffer, TickType_t xTicksToWait )`

Receive an item from a queue without removing the item from the queue. The item is received by copy so a buffer of adequate size must be provided. The number of bytes copied into the buffer was defined when the queue was created.

Successfully received items remain on the queue so will be returned again by the next call, or a call to `xQueueReceive()`.

This macro must not be used in an interrupt service routine. See `xQueuePeekFromISR()` for an alternative that can be called from an interrupt service routine.

Example usage:

```

struct AMessage
{
    char ucMessageID;
    char ucData[ 20 ];
} xMessage;

QueueHandle_t xQueue;

// Task to create a queue and post a value.
void vATask( void *pvParameters )
{
    struct AMessage *pxMessage;

    // Create a queue capable of containing 10 pointers to AMessage structures.
    // These should be passed by pointer as they contain a lot of data.
    xQueue = xQueueCreate( 10, sizeof( struct AMessage * ) );
    if( xQueue == 0 )
    {
        // Failed to create the queue.
    }

    // ...

    // Send a pointer to a struct AMessage object. Don't block if the
    // queue is already full.
    pxMessage = & xMessage;
    xQueueSend( xQueue, ( void * ) &pxMessage, ( TickType_t ) 0 );

    // ... Rest of task code.
}

// Task to peek the data from the queue.
void vADifferentTask( void *pvParameters )
{
    struct AMessage *pxRxdMessage;

    if( xQueue != 0 )
    {
        // Peek a message on the created queue. Block for 10 ticks if a
        // message is not immediately available.
        if( xQueuePeek( xQueue, &( pxRxdMessage ), ( TickType_t ) 10 ) )
        {
            // pxRxdMessage now points to the struct AMessage variable posted
            // by vATask, but the item still remains on the queue.
        }
    }
}

```

(continues on next page)

(continued from previous page)

```

}

// ... Rest of task code.
}

```

**Parameters**

- **xQueue** –The handle to the queue from which the item is to be received.
- **pvBuffer** –Pointer to the buffer into which the received item will be copied.
- **xTicksToWait** –The maximum amount of time the task should block waiting for an item to receive should the queue be empty at the time of the call. The time is defined in tick periods so the constant portTICK\_PERIOD\_MS should be used to convert to real time if this is required. xQueuePeek() will return immediately if xTicksToWait is 0 and the queue is empty.

**Returns** pdTRUE if an item was successfully received from the queue, otherwise pdFALSE.

BaseType\_t **xQueuePeekFromISR** (*QueueHandle\_t* xQueue, void \*const pvBuffer)

A version of xQueuePeek() that can be called from an interrupt service routine (ISR).

Receive an item from a queue without removing the item from the queue. The item is received by copy so a buffer of adequate size must be provided. The number of bytes copied into the buffer was defined when the queue was created.

Successfully received items remain on the queue so will be returned again by the next call, or a call to xQueueReceive().

**Parameters**

- **xQueue** –The handle to the queue from which the item is to be received.
- **pvBuffer** –Pointer to the buffer into which the received item will be copied.

**Returns** pdTRUE if an item was successfully received from the queue, otherwise pdFALSE.

BaseType\_t **xQueueReceive** (*QueueHandle\_t* xQueue, void \*const pvBuffer, TickType\_t xTicksToWait)

Receive an item from a queue. The item is received by copy so a buffer of adequate size must be provided. The number of bytes copied into the buffer was defined when the queue was created.

Successfully received items are removed from the queue.

This function must not be used in an interrupt service routine. See xQueueReceiveFromISR for an alternative that can.

Example usage:

```

struct AMessage
{
    char ucMessageID;
    char ucData[ 20 ];
} xMessage;

QueueHandle_t xQueue;

// Task to create a queue and post a value.
void vATask( void *pvParameters )
{
    struct AMessage *pxMessage;

    // Create a queue capable of containing 10 pointers to AMessage structures.
    // These should be passed by pointer as they contain a lot of data.
    xQueue = xQueueCreate( 10, sizeof( struct AMessage * ) );
    if( xQueue == 0 )
    {

```

(continues on next page)



```

    // Failed to create the queue.
}

// ...

// Send a pointer to a struct AMessage object. Don't block if the
// queue is already full.
pxMessage = & xMessage;
xQueueSend( xQueue, ( void * ) &pxMessage, ( TickType_t ) 0 );

// ... Rest of task code.
}

// Task to receive from the queue.
void vADifferentTask( void *pvParameters )
{
    struct AMessage *pxRxdMessage;

    if( xQueue != 0 )
    {
        // Receive a message on the created queue. Block for 10 ticks if a
        // message is not immediately available.
        if( xQueueReceive( xQueue, &( pxRxdMessage ), ( TickType_t ) 10 ) )
        {
            // pxRxdMessage now points to the struct AMessage variable posted
            // by vATask.
        }
    }

    // ... Rest of task code.
}

```

**Parameters**

- **xQueue** –The handle to the queue from which the item is to be received.
- **pvBuffer** –Pointer to the buffer into which the received item will be copied.
- **xTicksToWait** –The maximum amount of time the task should block waiting for an item to receive should the queue be empty at the time of the call. `xQueueReceive()` will return immediately if `xTicksToWait` is zero and the queue is empty. The time is defined in tick periods so the constant `portTICK_PERIOD_MS` should be used to convert to real time if this is required.

**Returns** `pdTRUE` if an item was successfully received from the queue, otherwise `pdFALSE`.

UBaseType\_t **uxQueueMessagesWaiting** (const *QueueHandle\_t* xQueue)

Return the number of messages stored in a queue.

**Parameters** **xQueue** –A handle to the queue being queried.

**Returns** The number of messages available in the queue.

UBaseType\_t **uxQueueSpacesAvailable** (const *QueueHandle\_t* xQueue)

Return the number of free spaces available in a queue. This is equal to the number of items that can be sent to the queue before the queue becomes full if no items are removed.

**Parameters** **xQueue** –A handle to the queue being queried.

**Returns** The number of spaces available in the queue.

void **vQueueDelete** (*QueueHandle\_t* xQueue)

Delete a queue - freeing all the memory allocated for storing of items placed on the queue.

**Parameters** **xQueue** –A handle to the queue to be deleted.

BaseType\_t **xQueueGenericSendFromISR** (*QueueHandle\_t* xQueue, const void \*const pvItemToQueue, BaseType\_t \*const pxHigherPriorityTaskWoken, const BaseType\_t xCopyPosition)

It is preferred that the macros `xQueueSendFromISR()`, `xQueueSendToFrontFromISR()` and `xQueueSendToBackFromISR()` be used in place of calling this function directly. `xQueueGiveFromISR()` is an equivalent for use by semaphores that don't actually copy any data.

Post an item on a queue. It is safe to use this function from within an interrupt service routine.

Items are queued by copy not reference so it is preferable to only queue small items, especially when called from an ISR. In most cases it would be preferable to store a pointer to the item being queued.

Example usage for buffered IO (where the ISR can obtain more than one value per call):

```
void vBufferISR( void )
{
    char cIn;
    BaseType_t xHigherPriorityTaskWokenByPost;

    // We have not woken a task at the start of the ISR.
    xHigherPriorityTaskWokenByPost = pdFALSE;

    // Loop until the buffer is empty.
    do
    {
        // Obtain a byte from the buffer.
        cIn = portINPUT_BYTE( RX_REGISTER_ADDRESS );

        // Post each byte.
        xQueueGenericSendFromISR( xRxQueue, &cIn, &xHigherPriorityTaskWokenByPost,
        ↪ queueSEND_TO_BACK );

    } while( portINPUT_BYTE( BUFFER_COUNT ) );

    // Now the buffer is empty we can switch context if necessary. Note that the
    // name of the yield function required is port specific.
    if( xHigherPriorityTaskWokenByPost )
    {
        taskYIELD_YIELD_FROM_ISR();
    }
}
```

### Parameters

- **xQueue** –The handle to the queue on which the item is to be posted.
- **pvItemToQueue** –A pointer to the item that is to be placed on the queue. The size of the items the queue will hold was defined when the queue was created, so this many bytes will be copied from `pvItemToQueue` into the queue storage area.
- **pxHigherPriorityTaskWoken** –[out] `xQueueGenericSendFromISR()` will set `*pxHigherPriorityTaskWoken` to `pdTRUE` if sending to the queue caused a task to unblock, and the unblocked task has a priority higher than the currently running task. If `xQueueGenericSendFromISR()` sets this value to `pdTRUE` then a context switch should be requested before the interrupt is exited.
- **xCopyPosition** –Can take the value `queueSEND_TO_BACK` to place the item at the back of the queue, or `queueSEND_TO_FRONT` to place the item at the front of the queue (for high priority messages).

**Returns** `pdTRUE` if the data was successfully sent to the queue, otherwise `errQUEUE_FULL`.

BaseType\_t **xQueueGiveFromISR** (*QueueHandle\_t* xQueue, BaseType\_t \*const pxHigherPriorityTaskWoken)

BaseType\_t **xQueueReceiveFromISR** (*QueueHandle\_t* xQueue, void \*const pvBuffer, BaseType\_t \*const pxHigherPriorityTaskWoken)

Receive an item from a queue. It is safe to use this function from within an interrupt service routine.

Example usage:

```
QueueHandle_t xQueue;

// Function to create a queue and post some values.
void vAFunction( void *pvParameters )
{
    char cValueToPost;
    const TickType_t xTicksToWait = ( TickType_t )0xff;

    // Create a queue capable of containing 10 characters.
    xQueue = xQueueCreate( 10, sizeof( char ) );
    if( xQueue == 0 )
    {
        // Failed to create the queue.
    }

    // ...

    // Post some characters that will be used within an ISR. If the queue
    // is full then this task will block for xTicksToWait ticks.
    cValueToPost = 'a';
    xQueueSend( xQueue, ( void * ) &cValueToPost, xTicksToWait );
    cValueToPost = 'b';
    xQueueSend( xQueue, ( void * ) &cValueToPost, xTicksToWait );

    // ... keep posting characters ... this task may block when the queue
    // becomes full.

    cValueToPost = 'c';
    xQueueSend( xQueue, ( void * ) &cValueToPost, xTicksToWait );
}

// ISR that outputs all the characters received on the queue.
void vISR_Routine( void )
{
    BaseType_t xTaskWokenByReceive = pdFALSE;
    char cRxdChar;

    while( xQueueReceiveFromISR( xQueue, ( void * ) &cRxdChar, &
    ↪xTaskWokenByReceive) )
    {
        // A character was received. Output the character now.
        vOutputCharacter( cRxdChar );

        // If removing the character from the queue woke the task that was
        // posting onto the queue cTaskWokenByReceive will have been set to
        // pdTRUE. No matter how many times this loop iterates only one
        // task will be woken.
    }

    if( cTaskWokenByPost != ( char ) pdFALSE;
    {
        taskYIELD ();
    }
}
```

**Parameters**

- **xQueue** –The handle to the queue from which the item is to be received.
- **pvBuffer** –Pointer to the buffer into which the received item will be copied.
- **pxHigherPriorityTaskWoken** –[out] A task may be blocked waiting for space to become available on the queue. If xQueueReceiveFromISR causes such a task to unblock \*pxTaskWoken will get set to pdTRUE, otherwise \*pxTaskWoken will remain unchanged.

**Returns** pdTRUE if an item was successfully received from the queue, otherwise pdFALSE.

BaseType\_t **xQueueIsQueueEmptyFromISR** (const *QueueHandle\_t* xQueue)

BaseType\_t **xQueueIsQueueFullFromISR** (const *QueueHandle\_t* xQueue)

UBaseType\_t **uxQueueMessagesWaitingFromISR** (const *QueueHandle\_t* xQueue)

void **vQueueAddToRegistry** (*QueueHandle\_t* xQueue, const char \*pcQueueName)

The registry is provided as a means for kernel aware debuggers to locate queues, semaphores and mutexes. Call vQueueAddToRegistry() add a queue, semaphore or mutex handle to the registry if you want the handle to be available to a kernel aware debugger. If you are not using a kernel aware debugger then this function can be ignored.

configQUEUE\_REGISTRY\_SIZE defines the maximum number of handles the registry can hold. configQUEUE\_REGISTRY\_SIZE must be greater than 0 within FreeRTOSConfig.h for the registry to be available. Its value does not effect the number of queues, semaphores and mutexes that can be created - just the number that the registry can hold.

**Parameters**

- **xQueue** –The handle of the queue being added to the registry. This is the handle returned by a call to xQueueCreate(). Semaphore and mutex handles can also be passed in here.
- **pcQueueName** –The name to be associated with the handle. This is the name that the kernel aware debugger will display. The queue registry only stores a pointer to the string - so the string must be persistent (global or preferably in ROM/Flash), not on the stack.

void **vQueueUnregisterQueue** (*QueueHandle\_t* xQueue)

The registry is provided as a means for kernel aware debuggers to locate queues, semaphores and mutexes. Call vQueueAddToRegistry() add a queue, semaphore or mutex handle to the registry if you want the handle to be available to a kernel aware debugger, and vQueueUnregisterQueue() to remove the queue, semaphore or mutex from the register. If you are not using a kernel aware debugger then this function can be ignored.

**Parameters** **xQueue** –The handle of the queue being removed from the registry.

const char \***pcQueueGetName** (*QueueHandle\_t* xQueue)

The queue registry is provided as a means for kernel aware debuggers to locate queues, semaphores and mutexes. Call pcQueueGetName() to look up and return the name of a queue in the queue registry from the queue's handle.

**Parameters** **xQueue** –The handle of the queue the name of which will be returned.

**Returns** If the queue is in the registry then a pointer to the name of the queue is returned. If the queue is not in the registry then NULL is returned.

*QueueHandle\_t* **xQueueGenericCreate** (const UBaseType\_t uxQueueLength, const UBaseType\_t uxItemSize, const uint8\_t ucQueueType)

Generic version of the function used to create a queue using dynamic memory allocation. This is called by other functions and macros that create other RTOS objects that use the queue structure as their base.

*QueueHandle\_t* **xQueueGenericCreateStatic** (const UBaseType\_t uxQueueLength, const UBaseType\_t uxItemSize, uint8\_t \*pucQueueStorage, StaticQueue\_t \*pxStaticQueue, const uint8\_t ucQueueType)

Generic version of the function used to create a queue using dynamic memory allocation. This is called by other functions and macros that create other RTOS objects that use the queue structure as their base.

**QueueSetHandle\_t xQueueCreateSet** (const UBaseType\_t uxEventQueueLength)

Queue sets provide a mechanism to allow a task to block (pend) on a read operation from multiple queues or semaphores simultaneously.

See FreeRTOS/Source/Demo/Common/Minimal/QueueSet.c for an example using this function.

A queue set must be explicitly created using a call to xQueueCreateSet() before it can be used. Once created, standard FreeRTOS queues and semaphores can be added to the set using calls to xQueueAddToSet(). xQueueSelectFromSet() is then used to determine which, if any, of the queues or semaphores contained in the set is in a state where a queue read or semaphore take operation would be successful.

Note 1: See the documentation on <https://www.FreeRTOS.org/RTOS-queue-sets.html> for reasons why queue sets are very rarely needed in practice as there are simpler methods of blocking on multiple objects.

Note 2: Blocking on a queue set that contains a mutex will not cause the mutex holder to inherit the priority of the blocked task.

Note 3: An additional 4 bytes of RAM is required for each space in a every queue added to a queue set. Therefore counting semaphores that have a high maximum count value should not be added to a queue set.

Note 4: A receive (in the case of a queue) or take (in the case of a semaphore) operation must not be performed on a member of a queue set unless a call to xQueueSelectFromSet() has first returned a handle to that set member.

**Parameters uxEventQueueLength** –Queue sets store events that occur on the queues and semaphores contained in the set. uxEventQueueLength specifies the maximum number of events that can be queued at once. To be absolutely certain that events are not lost uxEventQueueLength should be set to the total sum of the length of the queues added to the set, where binary semaphores and mutexes have a length of 1, and counting semaphores have a length set by their maximum count value. Examples:

- If a queue set is to hold a queue of length 5, another queue of length 12, and a binary semaphore, then uxEventQueueLength should be set to (5 + 12 + 1), or 18.
- If a queue set is to hold three binary semaphores then uxEventQueueLength should be set to (1 + 1 + 1), or 3.
- If a queue set is to hold a counting semaphore that has a maximum count of 5, and a counting semaphore that has a maximum count of 3, then uxEventQueueLength should be set to (5 + 3), or 8.

**Returns** If the queue set is created successfully then a handle to the created queue set is returned. Otherwise NULL is returned.

**BaseType\_t xQueueAddToSet** (*QueueSetMemberHandle\_t* xQueueOrSemaphore, *QueueSetHandle\_t* xQueueSet)

Adds a queue or semaphore to a queue set that was previously created by a call to xQueueCreateSet().

See FreeRTOS/Source/Demo/Common/Minimal/QueueSet.c for an example using this function.

Note 1: A receive (in the case of a queue) or take (in the case of a semaphore) operation must not be performed on a member of a queue set unless a call to xQueueSelectFromSet() has first returned a handle to that set member.

**Parameters**

- **xQueueOrSemaphore** –The handle of the queue or semaphore being added to the queue set (cast to an *QueueSetMemberHandle\_t* type).
- **xQueueSet** –The handle of the queue set to which the queue or semaphore is being added.

**Returns** If the queue or semaphore was successfully added to the queue set then pdPASS is returned. If the queue could not be successfully added to the queue set because it is already a member of a different queue set then pdFAIL is returned.

**BaseType\_t xQueueRemoveFromSet** (*QueueSetMemberHandle\_t* xQueueOrSemaphore, *QueueSetHandle\_t* xQueueSet)

Removes a queue or semaphore from a queue set. A queue or semaphore can only be removed from a set if the queue or semaphore is empty.

See FreeRTOS/Source/Demo/Common/Minimal/QueueSet.c for an example using this function.

#### Parameters

- **xQueueOrSemaphore** –The handle of the queue or semaphore being removed from the queue set (cast to an `QueueSetMemberHandle_t` type).
- **xQueueSet** –The handle of the queue set in which the queue or semaphore is included.

**Returns** If the queue or semaphore was successfully removed from the queue set then `pdPASS` is returned. If the queue was not in the queue set, or the queue (or semaphore) was not empty, then `pdFAIL` is returned.

*QueueSetMemberHandle\_t* **xQueueSelectFromSet** (*QueueSetHandle\_t* xQueueSet, const TickType\_t xTicksToWait)

`xQueueSelectFromSet()` selects from the members of a queue set a queue or semaphore that either contains data (in the case of a queue) or is available to take (in the case of a semaphore). `xQueueSelectFromSet()` effectively allows a task to block (pend) on a read operation on all the queues and semaphores in a queue set simultaneously.

See FreeRTOS/Source/Demo/Common/Minimal/QueueSet.c for an example using this function.

Note 1: See the documentation on <https://www.FreeRTOS.org/RTOS-queue-sets.html> for reasons why queue sets are very rarely needed in practice as there are simpler methods of blocking on multiple objects.

Note 2: Blocking on a queue set that contains a mutex will not cause the mutex holder to inherit the priority of the blocked task.

Note 3: A receive (in the case of a queue) or take (in the case of a semaphore) operation must not be performed on a member of a queue set unless a call to `xQueueSelectFromSet()` has first returned a handle to that set member.

#### Parameters

- **xQueueSet** –The queue set on which the task will (potentially) block.
- **xTicksToWait** –The maximum time, in ticks, that the calling task will remain in the Blocked state (with other tasks executing) to wait for a member of the queue set to be ready for a successful queue read or semaphore take operation.

**Returns** `xQueueSelectFromSet()` will return the handle of a queue (cast to a `QueueSetMemberHandle_t` type) contained in the queue set that contains data, or the handle of a semaphore (cast to a `QueueSetMemberHandle_t` type) contained in the queue set that is available, or `NULL` if no such queue or semaphore exists before the specified block time expires.

*QueueSetMemberHandle\_t* **xQueueSelectFromSetFromISR** (*QueueSetHandle\_t* xQueueSet)

A version of `xQueueSelectFromSet()` that can be used from an ISR.

## Macros

**xQueueCreate** (uxQueueLength, uxItemSize)

Creates a new queue instance, and returns a handle by which the new queue can be referenced.

Internally, within the FreeRTOS implementation, queues use two blocks of memory. The first block is used to hold the queue's data structures. The second block is used to hold items placed into the queue. If a queue is created using `xQueueCreate()` then both blocks of memory are automatically dynamically allocated inside the `xQueueCreate()` function. (see <https://www.FreeRTOS.org/a00111.html>). If a queue is created using `xQueueCreateStatic()` then the application writer must provide the memory that will get used by the queue. `xQueueCreateStatic()` therefore allows a queue to be created without using any dynamic memory allocation.

<https://www.FreeRTOS.org/Embedded-RTOS-Queues.html>

Example usage:

```
struct AMessage
{
    char ucMessageID;
```

(continues on next page)

(continued from previous page)

```

char ucData[ 20 ];
};

void vATask( void *pvParameters )
{
QueueHandle_t xQueue1, xQueue2;

// Create a queue capable of containing 10 uint32_t values.
xQueue1 = xQueueCreate( 10, sizeof( uint32_t ) );
if( xQueue1 == 0 )
{
// Queue was not created and must not be used.
}

// Create a queue capable of containing 10 pointers to AMessage structures.
// These should be passed by pointer as they contain a lot of data.
xQueue2 = xQueueCreate( 10, sizeof( struct AMessage * ) );
if( xQueue2 == 0 )
{
// Queue was not created and must not be used.
}

// ... Rest of task code.
}

```

**Parameters**

- **uxQueueLength** –The maximum number of items that the queue can contain.
- **uxItemSize** –The number of bytes each item in the queue will require. Items are queued by copy, not by reference, so this is the number of bytes that will be copied for each posted item. Each item on the queue must be the same size.

**Returns** If the queue is successfully create then a handle to the newly created queue is returned. If the queue cannot be created then 0 is returned.

**xQueueCreateStatic** (uxQueueLength, uxItemSize, pucQueueStorage, pxQueueBuffer)

Creates a new queue instance, and returns a handle by which the new queue can be referenced.

Internally, within the FreeRTOS implementation, queues use two blocks of memory. The first block is used to hold the queue's data structures. The second block is used to hold items placed into the queue. If a queue is created using `xQueueCreate()` then both blocks of memory are automatically dynamically allocated inside the `xQueueCreate()` function. (see <https://www.FreeRTOS.org/a00111.html>). If a queue is created using `xQueueCreateStatic()` then the application writer must provide the memory that will get used by the queue. `xQueueCreateStatic()` therefore allows a queue to be created without using any dynamic memory allocation.

<https://www.FreeRTOS.org/Embedded-RTOS-Queues.html>

Example usage:

```

struct AMessage
{
char ucMessageID;
char ucData[ 20 ];
};

#define QUEUE_LENGTH 10
#define ITEM_SIZE sizeof( uint32_t )

// xQueueBuffer will hold the queue structure.
StaticQueue_t xQueueBuffer;

```

(continues on next page)



(continued from previous page)

```

// ucQueueStorage will hold the items posted to the queue. Must be at least
// [(queue length) * (queue item size)] bytes long.
uint8_t ucQueueStorage[ QUEUE_LENGTH * ITEM_SIZE ];

void vATask( void *pvParameters )
{
QueueHandle_t xQueue1;

// Create a queue capable of containing 10 uint32_t values.
xQueue1 = xQueueCreate( QUEUE_LENGTH, // The number of items the queue can
→hold.
ITEM_SIZE // The size of each item in the queue
&( ucQueueStorage[ 0 ] ), // The buffer that will
→hold the items in the queue.
&xQueueBuffer ); // The buffer that will hold the
→queue structure.

// The queue is guaranteed to be created successfully as no dynamic memory
// allocation is used. Therefore xQueue1 is now a handle to a valid queue.

// ... Rest of task code.
}

```

**Parameters**

- **uxQueueLength** –The maximum number of items that the queue can contain.
- **uxItemSize** –The number of bytes each item in the queue will require. Items are queued by copy, not by reference, so this is the number of bytes that will be copied for each posted item. Each item on the queue must be the same size.
- **pucQueueStorage** –If uxItemSize is not zero then pucQueueStorageBuffer must point to a uint8\_t array that is at least large enough to hold the maximum number of items that can be in the queue at any one time - which is ( uxQueueLength \* uxItemsSize ) bytes. If uxItemSize is zero then pucQueueStorageBuffer can be NULL.
- **pxQueueBuffer** –Must point to a variable of type StaticQueue\_t, which will be used to hold the queue's data structure.

**Returns** If the queue is created then a handle to the created queue is returned. If pxQueueBuffer is NULL then NULL is returned.

**xQueueSendToFront** (xQueue, pvItemToQueue, xTicksToWait)

Post an item to the front of a queue. The item is queued by copy, not by reference. This function must not be called from an interrupt service routine. See xQueueSendFromISR () for an alternative which may be used in an ISR.

Example usage:

```

struct AMessage
{
char ucMessageID;
char ucData[ 20 ];
} xMessage;

uint32_t ulVar = 10UL;

void vATask( void *pvParameters )
{
QueueHandle_t xQueue1, xQueue2;
struct AMessage *pxMessage;

```

(continues on next page)



(continued from previous page)

```

// Create a queue capable of containing 10 uint32_t values.
xQueue1 = xQueueCreate( 10, sizeof( uint32_t ) );

// Create a queue capable of containing 10 pointers to AMessage structures.
// These should be passed by pointer as they contain a lot of data.
xQueue2 = xQueueCreate( 10, sizeof( struct AMessage * ) );

// ...

if( xQueue1 != 0 )
{
    // Send an uint32_t. Wait for 10 ticks for space to become
    // available if necessary.
    if( xQueueSendToFront( xQueue1, ( void * ) &ulVar, ( TickType_t ) 10 ) != pdPASS )
    {
        // Failed to post the message, even after 10 ticks.
    }
}

if( xQueue2 != 0 )
{
    // Send a pointer to a struct AMessage object. Don't block if the
    // queue is already full.
    pxMessage = &xMessage;
    xQueueSendToFront( xQueue2, ( void * ) &pxMessage, ( TickType_t ) 0 );
}

// ... Rest of task code.
}

```

**Parameters**

- **xQueue** –The handle to the queue on which the item is to be posted.
- **pvItemToQueue** –A pointer to the item that is to be placed on the queue. The size of the items the queue will hold was defined when the queue was created, so this many bytes will be copied from pvItemToQueue into the queue storage area.
- **xTicksToWait** –The maximum amount of time the task should block waiting for space to become available on the queue, should it already be full. The call will return immediately if this is set to 0 and the queue is full. The time is defined in tick periods so the constant portTICK\_PERIOD\_MS should be used to convert to real time if this is required.

**Returns** pdTRUE if the item was successfully posted, otherwise errQUEUE\_FULL.

**xQueueSendToBack** (xQueue, pvItemToQueue, xTicksToWait)

This is a macro that calls xQueueGenericSend().

Post an item to the back of a queue. The item is queued by copy, not by reference. This function must not be called from an interrupt service routine. See xQueueSendFromISR () for an alternative which may be used in an ISR.

Example usage:

```

struct AMessage
{
    char ucMessageID;
    char ucData[ 20 ];
} xMessage;

uint32_t ulVar = 10UL;

```

(continues on next page)

```

void vATask( void *pvParameters )
{
QueueHandle_t xQueue1, xQueue2;
struct AMessage *pxMessage;

// Create a queue capable of containing 10 uint32_t values.
xQueue1 = xQueueCreate( 10, sizeof( uint32_t ) );

// Create a queue capable of containing 10 pointers to AMessage structures.
// These should be passed by pointer as they contain a lot of data.
xQueue2 = xQueueCreate( 10, sizeof( struct AMessage * ) );

// ...

if( xQueue1 != 0 )
{
// Send an uint32_t. Wait for 10 ticks for space to become
// available if necessary.
if( xQueueSendToBack( xQueue1, ( void * ) &ulVar, ( TickType_t ) 10 ) !=
pdPASS )
{
// Failed to post the message, even after 10 ticks.
}
}

if( xQueue2 != 0 )
{
// Send a pointer to a struct AMessage object. Don't block if the
// queue is already full.
pxMessage = & xMessage;
xQueueSendToBack( xQueue2, ( void * ) &pxMessage, ( TickType_t ) 0 );
}

// ... Rest of task code.
}

```

### Parameters

- **xQueue** –The handle to the queue on which the item is to be posted.
- **pvItemToQueue** –A pointer to the item that is to be placed on the queue. The size of the items the queue will hold was defined when the queue was created, so this many bytes will be copied from pvItemToQueue into the queue storage area.
- **xTicksToWait** –The maximum amount of time the task should block waiting for space to become available on the queue, should it already be full. The call will return immediately if this is set to 0 and the queue is full. The time is defined in tick periods so the constant portTICK\_PERIOD\_MS should be used to convert to real time if this is required.

**Returns** pdTRUE if the item was successfully posted, otherwise errQUEUE\_FULL.

**xQueueSend** (xQueue, pvItemToQueue, xTicksToWait)

This is a macro that calls xQueueGenericSend(). It is included for backward compatibility with versions of FreeRTOS.org that did not include the xQueueSendToFront() and xQueueSendToBack() macros. It is equivalent to xQueueSendToBack().

Post an item on a queue. The item is queued by copy, not by reference. This function must not be called from an interrupt service routine. See xQueueSendFromISR () for an alternative which may be used in an ISR.

Example usage:

```

struct AMessage
{
    char ucMessageID;
    char ucData[ 20 ];
} xMessage;

uint32_t ulVar = 10UL;

void vATask( void *pvParameters )
{
    QueueHandle_t xQueue1, xQueue2;
    struct AMessage *pxMessage;

    // Create a queue capable of containing 10 uint32_t values.
    xQueue1 = xQueueCreate( 10, sizeof( uint32_t ) );

    // Create a queue capable of containing 10 pointers to AMessage structures.
    // These should be passed by pointer as they contain a lot of data.
    xQueue2 = xQueueCreate( 10, sizeof( struct AMessage * ) );

    // ...

    if( xQueue1 != 0 )
    {
        // Send an uint32_t. Wait for 10 ticks for space to become
        // available if necessary.
        if( xQueueSend( xQueue1, ( void * ) &ulVar, ( TickType_t ) 10 ) != pdPASS_
↪)
        {
            // Failed to post the message, even after 10 ticks.
        }
    }

    if( xQueue2 != 0 )
    {
        // Send a pointer to a struct AMessage object. Don't block if the
        // queue is already full.
        pxMessage = &xMessage;
        xQueueSend( xQueue2, ( void * ) &pxMessage, ( TickType_t ) 0 );
    }

    // ... Rest of task code.
}

```

**Parameters**

- **xQueue** –The handle to the queue on which the item is to be posted.
- **pvItemToQueue** –A pointer to the item that is to be placed on the queue. The size of the items the queue will hold was defined when the queue was created, so this many bytes will be copied from pvItemToQueue into the queue storage area.
- **xTicksToWait** –The maximum amount of time the task should block waiting for space to become available on the queue, should it already be full. The call will return immediately if this is set to 0 and the queue is full. The time is defined in tick periods so the constant portTICK\_PERIOD\_MS should be used to convert to real time if this is required.

**Returns** pdTRUE if the item was successfully posted, otherwise errQUEUE\_FULL.

**xQueueOverwrite** (xQueue, pvItemToQueue)

Only for use with queues that have a length of one - so the queue is either empty or full.

Post an item on a queue. If the queue is already full then overwrite the value held in the queue. The item is queued by copy, not by reference.

This function must not be called from an interrupt service routine. See `xQueueOverwriteFromISR()` for an alternative which may be used in an ISR.

Example usage:

```
void vFunction( void *pvParameters )
{
    QueueHandle_t xQueue;
    uint32_t ulVarToSend, ulValReceived;

    // Create a queue to hold one uint32_t value. It is strongly
    // recommended *not* to use xQueueOverwrite() on queues that can
    // contain more than one value, and doing so will trigger an assertion
    // if configASSERT() is defined.
    xQueue = xQueueCreate( 1, sizeof( uint32_t ) );

    // Write the value 10 to the queue using xQueueOverwrite().
    ulVarToSend = 10;
    xQueueOverwrite( xQueue, &ulVarToSend );

    // Peeking the queue should now return 10, but leave the value 10 in
    // the queue. A block time of zero is used as it is known that the
    // queue holds a value.
    ulValReceived = 0;
    xQueuePeek( xQueue, &ulValReceived, 0 );

    if( ulValReceived != 10 )
    {
        // Error unless the item was removed by a different task.
    }

    // The queue is still full. Use xQueueOverwrite() to overwrite the
    // value held in the queue with 100.
    ulVarToSend = 100;
    xQueueOverwrite( xQueue, &ulVarToSend );

    // This time read from the queue, leaving the queue empty once more.
    // A block time of 0 is used again.
    xQueueReceive( xQueue, &ulValReceived, 0 );

    // The value read should be the last value written, even though the
    // queue was already full when the value was written.
    if( ulValReceived != 100 )
    {
        // Error!
    }

    // ...
}
```

#### Parameters

- **xQueue** –The handle of the queue to which the data is being sent.
- **pvItemToQueue** –A pointer to the item that is to be placed on the queue. The size of the items the queue will hold was defined when the queue was created, so this many bytes will be copied from `pvItemToQueue` into the queue storage area.

**Returns** `xQueueOverwrite()` is a macro that calls `xQueueGenericSend()`, and therefore has the same return values as `xQueueSendToFront()`. However, `pdPASS` is the only value that can be returned because `xQueueOverwrite()` will write to the queue even when the queue is already full.

**xQueueSendToFrontFromISR** (xQueue, pvItemToQueue, pxHigherPriorityTaskWoken)

This is a macro that calls xQueueGenericSendFromISR().

Post an item to the front of a queue. It is safe to use this macro from within an interrupt service routine.

Items are queued by copy not reference so it is preferable to only queue small items, especially when called from an ISR. In most cases it would be preferable to store a pointer to the item being queued.

Example usage for buffered IO (where the ISR can obtain more than one value per call):

```
void vBufferISR( void )
{
    char cIn;
    BaseType_t xHigherPriorityTaskWoken;

    // We have not woken a task at the start of the ISR.
    xHigherPriorityTaskWoken = pdFALSE;

    // Loop until the buffer is empty.
    do
    {
        // Obtain a byte from the buffer.
        cIn = portINPUT_BYTE( RX_REGISTER_ADDRESS );

        // Post the byte.
        xQueueSendToFrontFromISR( xRxQueue, &cIn, &xHigherPriorityTaskWoken );
    } while( portINPUT_BYTE( BUFFER_COUNT ) );

    // Now the buffer is empty we can switch context if necessary.
    if( xHigherPriorityTaskWoken )
    {
        portYIELD_FROM_ISR ();
    }
}
```

**Parameters**

- **xQueue** –The handle to the queue on which the item is to be posted.
- **pvItemToQueue** –A pointer to the item that is to be placed on the queue. The size of the items the queue will hold was defined when the queue was created, so this many bytes will be copied from pvItemToQueue into the queue storage area.
- **pxHigherPriorityTaskWoken** –[out] xQueueSendToFrontFromISR() will set \*pxHigherPriorityTaskWoken to pdTRUE if sending to the queue caused a task to unblock, and the unblocked task has a priority higher than the currently running task. If xQueueSendFromFromISR() sets this value to pdTRUE then a context switch should be requested before the interrupt is exited.

**Returns** pdTRUE if the data was successfully sent to the queue, otherwise errQUEUE\_FULL.

**xQueueSendToBackFromISR** (xQueue, pvItemToQueue, pxHigherPriorityTaskWoken)

This is a macro that calls xQueueGenericSendFromISR().

Post an item to the back of a queue. It is safe to use this macro from within an interrupt service routine.

Items are queued by copy not reference so it is preferable to only queue small items, especially when called from an ISR. In most cases it would be preferable to store a pointer to the item being queued.

Example usage for buffered IO (where the ISR can obtain more than one value per call):

```

void vBufferISR( void )
{
char cIn;
BaseType_t xHigherPriorityTaskWoken;

// We have not woken a task at the start of the ISR.
xHigherPriorityTaskWoken = pdFALSE;

// Loop until the buffer is empty.
do
{
// Obtain a byte from the buffer.
cIn = portINPUT_BYTE( RX_REGISTER_ADDRESS );

// Post the byte.
xQueueSendToBackFromISR( xRxQueue, &cIn, &xHigherPriorityTaskWoken );
} while( portINPUT_BYTE( BUFFER_COUNT ) );

// Now the buffer is empty we can switch context if necessary.
if( xHigherPriorityTaskWoken )
{
portYIELD_FROM_ISR ();
}
}

```

### Parameters

- **xQueue** –The handle to the queue on which the item is to be posted.
- **pvItemToQueue** –A pointer to the item that is to be placed on the queue. The size of the items the queue will hold was defined when the queue was created, so this many bytes will be copied from pvItemToQueue into the queue storage area.
- **pxHigherPriorityTaskWoken** –[out] xQueueSendToBackFromISR() will set \*pxHigherPriorityTaskWoken to pdTRUE if sending to the queue caused a task to unblock, and the unblocked task has a priority higher than the currently running task. If xQueueSendToBackFromISR() sets this value to pdTRUE then a context switch should be requested before the interrupt is exited.

**Returns** pdTRUE if the data was successfully sent to the queue, otherwise errQUEUE\_FULL.

**xQueueOverwriteFromISR** (xQueue, pvItemToQueue, pxHigherPriorityTaskWoken)

A version of xQueueOverwrite() that can be used in an interrupt service routine (ISR).

Only for use with queues that can hold a single item - so the queue is either empty or full.

Post an item on a queue. If the queue is already full then overwrite the value held in the queue. The item is queued by copy, not by reference.

Example usage:

```

QueueHandle_t xQueue;

void vFunction( void *pvParameters )
{
// Create a queue to hold one uint32_t value. It is strongly
// recommended *not* to use xQueueOverwriteFromISR() on queues that can
// contain more than one value, and doing so will trigger an assertion
// if configASSERT() is defined.
xQueue = xQueueCreate( 1, sizeof( uint32_t ) );
}

```

(continues on next page)

(continued from previous page)

```

void vAnInterruptHandler( void )
{
// xHigherPriorityTaskWoken must be set to pdFALSE before it is used.
BaseType_t xHigherPriorityTaskWoken = pdFALSE;
uint32_t ulVarToSend, ulValReceived;

// Write the value 10 to the queue using xQueueOverwriteFromISR().
ulVarToSend = 10;
xQueueOverwriteFromISR( xQueue, &ulVarToSend, &xHigherPriorityTaskWoken );

// The queue is full, but calling xQueueOverwriteFromISR() again will still
// pass because the value held in the queue will be overwritten with the
// new value.
ulVarToSend = 100;
xQueueOverwriteFromISR( xQueue, &ulVarToSend, &xHigherPriorityTaskWoken );

// Reading from the queue will now return 100.

// ...

if( xHigherPriorityTaskWoken == pdTRUE )
{
// Writing to the queue caused a task to unblock and the unblocked task
// has a priority higher than or equal to the priority of the currently
// executing task (the task this interrupt interrupted). Perform a
↪context
// switch so this interrupt returns directly to the unblocked task.
portYIELD_FROM_ISR(); // or portEND_SWITCHING_ISR() depending on the port.
}
}

```

**Parameters**

- **xQueue** –The handle to the queue on which the item is to be posted.
- **pvItemToQueue** –A pointer to the item that is to be placed on the queue. The size of the items the queue will hold was defined when the queue was created, so this many bytes will be copied from pvItemToQueue into the queue storage area.
- **pxHigherPriorityTaskWoken** –[out] xQueueOverwriteFromISR() will set \*pxHigherPriorityTaskWoken to pdTRUE if sending to the queue caused a task to unblock, and the unblocked task has a priority higher than the currently running task. If xQueueOverwriteFromISR() sets this value to pdTRUE then a context switch should be requested before the interrupt is exited.

**Returns** xQueueOverwriteFromISR() is a macro that calls xQueueGenericSendFromISR(), and therefore has the same return values as xQueueSendToFrontFromISR(). However, pdPASS is the only value that can be returned because xQueueOverwriteFromISR() will write to the queue even when the queue is already full.

**xQueueSendFromISR** (xQueue, pvItemToQueue, pxHigherPriorityTaskWoken)

This is a macro that calls xQueueGenericSendFromISR(). It is included for backward compatibility with versions of FreeRTOS.org that did not include the xQueueSendToBackFromISR() and xQueueSendToFrontFromISR() macros.

Post an item to the back of a queue. It is safe to use this function from within an interrupt service routine.

Items are queued by copy not reference so it is preferable to only queue small items, especially when called from an ISR. In most cases it would be preferable to store a pointer to the item being queued.

Example usage for buffered IO (where the ISR can obtain more than one value per call):

```

void vBufferISR( void )
{
char cIn;
 BaseType_t xHigherPriorityTaskWoken;

// We have not woken a task at the start of the ISR.
xHigherPriorityTaskWoken = pdFALSE;

// Loop until the buffer is empty.
do
{
// Obtain a byte from the buffer.
cIn = portINPUT_BYTE( RX_REGISTER_ADDRESS );

// Post the byte.
xQueueSendFromISR( xRxQueue, &cIn, &xHigherPriorityTaskWoken );

} while( portINPUT_BYTE( BUFFER_COUNT ) );

// Now the buffer is empty we can switch context if necessary.
if( xHigherPriorityTaskWoken )
{
// Actual macro used here is port specific.
portYIELD_FROM_ISR ();
}
}

```

### Parameters

- **xQueue** –The handle to the queue on which the item is to be posted.
- **pvItemToQueue** –A pointer to the item that is to be placed on the queue. The size of the items the queue will hold was defined when the queue was created, so this many bytes will be copied from pvItemToQueue into the queue storage area.
- **pxHigherPriorityTaskWoken** –[out] xQueueSendFromISR() will set \*pxHigherPriorityTaskWoken to pdTRUE if sending to the queue caused a task to unblock, and the unblocked task has a priority higher than the currently running task. If xQueueSendFromISR() sets this value to pdTRUE then a context switch should be requested before the interrupt is exited.

**Returns** pdTRUE if the data was successfully sent to the queue, otherwise errQUEUE\_FULL.

**xQueueReset** (xQueue)

Reset a queue back to its original empty state. The return value is now obsolete and is always set to pdPASS.

### Type Definitions

typedef struct QueueDefinition \*QueueHandle\_t

typedef struct QueueDefinition \*QueueSetHandle\_t

Type by which queue sets are referenced. For example, a call to xQueueCreateSet() returns an xQueueSet variable that can then be used as a parameter to xQueueSelectFromSet(), xQueueAddToSet(), etc.

typedef struct QueueDefinition \*QueueSetMemberHandle\_t

Queue sets can contain both queues and semaphores, so the QueueSetMemberHandle\_t is defined as a type to be used where a parameter or return value can be either an QueueHandle\_t or an SemaphoreHandle\_t.

### Semaphore API



**Header File**

- components/freertos/FreeRTOS-Kernel/include/freertos/semphr.h

**Macros****semBINARY\_SEMAPHORE\_QUEUE\_LENGTH****semSEMAPHORE\_QUEUE\_ITEM\_LENGTH****semGIVE\_BLOCK\_TIME****vSemaphoreCreateBinary** (xSemaphore)**xSemaphoreCreateBinary** ()

Creates a new binary semaphore instance, and returns a handle by which the new semaphore can be referenced.

In many usage scenarios it is faster and more memory efficient to use a direct to task notification in place of a binary semaphore! <https://www.FreeRTOS.org/RTOS-task-notifications.html>

Internally, within the FreeRTOS implementation, binary semaphores use a block of memory, in which the semaphore structure is stored. If a binary semaphore is created using xSemaphoreCreateBinary() then the required memory is automatically dynamically allocated inside the xSemaphoreCreateBinary() function. (see <https://www.FreeRTOS.org/a00111.html>). If a binary semaphore is created using xSemaphoreCreateBinaryStatic() then the application writer must provide the memory. xSemaphoreCreateBinaryStatic() therefore allows a binary semaphore to be created without using any dynamic memory allocation.

The old vSemaphoreCreateBinary() macro is now deprecated in favour of this xSemaphoreCreateBinary() function. Note that binary semaphores created using the vSemaphoreCreateBinary() macro are created in a state such that the first call to ‘take’ the semaphore would pass, whereas binary semaphores created using xSemaphoreCreateBinary() are created in a state such that the the semaphore must first be ‘given’ before it can be ‘taken’ .

This type of semaphore can be used for pure synchronisation between tasks or between an interrupt and a task. The semaphore need not be given back once obtained, so one task/interrupt can continuously ‘give’ the semaphore while another continuously ‘takes’ the semaphore. For this reason this type of semaphore does not use a priority inheritance mechanism. For an alternative that does use priority inheritance see xSemaphoreCreateMutex().

Example usage:

```
SemaphoreHandle_t xSemaphore = NULL;

void vATask( void * pvParameters )
{
    // Semaphore cannot be used before a call to vSemaphoreCreateBinary().
    // This is a macro so pass the variable in directly.
    xSemaphore = xSemaphoreCreateBinary();

    if( xSemaphore != NULL )
    {
        // The semaphore was created successfully.
        // The semaphore can now be used.
    }
}
```

**Returns** Handle to the created semaphore, or NULL if the memory required to hold the semaphore’s data structures could not be allocated.

**xSemaphoreCreateBinaryStatic** (pxStaticSemaphore)

Creates a new binary semaphore instance, and returns a handle by which the new semaphore can be referenced.

NOTE: In many usage scenarios it is faster and more memory efficient to use a direct to task notification in place of a binary semaphore! <https://www.FreeRTOS.org/RTOS-task-notifications.html>

Internally, within the FreeRTOS implementation, binary semaphores use a block of memory, in which the semaphore structure is stored. If a binary semaphore is created using xSemaphoreCreateBinary() then the required memory is automatically dynamically allocated inside the xSemaphoreCreateBinary() function. (see <https://www.FreeRTOS.org/a00111.html>). If a binary semaphore is created using xSemaphoreCreateBinaryStatic() then the application writer must provide the memory. xSemaphoreCreateBinaryStatic() therefore allows a binary semaphore to be created without using any dynamic memory allocation.

This type of semaphore can be used for pure synchronisation between tasks or between an interrupt and a task. The semaphore need not be given back once obtained, so one task/interrupt can continuously ‘give’ the semaphore while another continuously ‘takes’ the semaphore. For this reason this type of semaphore does not use a priority inheritance mechanism. For an alternative that does use priority inheritance see xSemaphoreCreateMutex().

Example usage:

```
SemaphoreHandle_t xSemaphore = NULL;
StaticSemaphore_t xSemaphoreBuffer;

void vATask( void * pvParameters )
{
    // Semaphore cannot be used before a call to xSemaphoreCreateBinary() or
    // xSemaphoreCreateBinaryStatic().
    // The semaphore's data structures will be placed in the xSemaphoreBuffer
    // variable, the address of which is passed into the function. The
    // function's parameter is not NULL, so the function will not attempt any
    // dynamic memory allocation, and therefore the function will not return
    // return NULL.
    xSemaphore = xSemaphoreCreateBinaryStatic( &xSemaphoreBuffer );

    // Rest of task code goes here.
}
```

**Parameters**

- **pxStaticSemaphore** –Must point to a variable of type StaticSemaphore\_t, which will then be used to hold the semaphore’s data structure, removing the need for the memory to be allocated dynamically.

**Returns** If the semaphore is created then a handle to the created semaphore is returned. If pxSemaphoreBuffer is NULL then NULL is returned.

**xSemaphoreTake** (xSemaphore, xBlockTime)

*Macro* to obtain a semaphore. The semaphore must have previously been created with a call to xSemaphoreCreateBinary(), xSemaphoreCreateMutex() or xSemaphoreCreateCounting().

param xSemaphore A handle to the semaphore being taken - obtained when the semaphore was created.

param xBlockTime The time in ticks to wait for the semaphore to become available. The macro portTICK\_PERIOD\_MS can be used to convert this to a real time. A block time of zero can be used to poll the semaphore. A block time of portMAX\_DELAY can be used to block indefinitely (provided INCLUDE\_vTaskSuspend is set to 1 in FreeRTOSConfig.h).

Example usage:

```

SemaphoreHandle_t xSemaphore = NULL;

// A task that creates a semaphore.
void vATask( void * pvParameters )
{
    // Create the semaphore to guard a shared resource.
    vSemaphoreCreateBinary( xSemaphore );
}

// A task that uses the semaphore.
void vAnotherTask( void * pvParameters )
{
    // ... Do other things.

    if( xSemaphore != NULL )
    {
        // See if we can obtain the semaphore. If the semaphore is not available
        // wait 10 ticks to see if it becomes free.
        if( xSemaphoreTake( xSemaphore, ( TickType_t ) 10 ) == pdTRUE )
        {
            // We were able to obtain the semaphore and can now access the
            // shared resource.

            // ...

            // We have finished accessing the shared resource. Release the
            // semaphore.
            xSemaphoreGive( xSemaphore );
        }
        else
        {
            // We could not obtain the semaphore and can therefore not access
            // the shared resource safely.
        }
    }
}

```

**Returns** pdTRUE if the semaphore was obtained. pdFALSE if xBlockTime expired without the semaphore becoming available.

#### **xSemaphoreTakeRecursive** (xMutex, xBlockTime)

Macro to recursively obtain, or ‘take’, a mutex type semaphore. The mutex must have previously been created using a call to xSemaphoreCreateRecursiveMutex();

configUSE\_RECURSIVE\_MUTEXES must be set to 1 in FreeRTOSConfig.h for this macro to be available.

This macro must not be used on mutexes created using xSemaphoreCreateMutex().

A mutex used recursively can be ‘taken’ repeatedly by the owner. The mutex doesn’t become available again until the owner has called xSemaphoreGiveRecursive() for each successful ‘take’ request. For example, if a task successfully ‘takes’ the same mutex 5 times then the mutex will not be available to any other task until it has also ‘given’ the mutex back exactly five times.

Example usage:

```

SemaphoreHandle_t xMutex = NULL;

// A task that creates a mutex.
void vATask( void * pvParameters )
{

```

(continues on next page)

```

// Create the mutex to guard a shared resource.
xMutex = xSemaphoreCreateRecursiveMutex();
}

// A task that uses the mutex.
void vAnotherTask( void * pvParameters )
{
    // ... Do other things.

    if( xMutex != NULL )
    {
        // See if we can obtain the mutex.  If the mutex is not available
        // wait 10 ticks to see if it becomes free.
        if( xSemaphoreTakeRecursive( xSemaphore, ( TickType_t ) 10 ) == pdTRUE )
        {
            // We were able to obtain the mutex and can now access the
            // shared resource.

            // ...
            // For some reason due to the nature of the code further calls to
            // xSemaphoreTakeRecursive() are made on the same mutex.  In real
            // code these would not be just sequential calls as this would make
            // no sense.  Instead the calls are likely to be buried inside
            // a more complex call structure.
            xSemaphoreTakeRecursive( xMutex, ( TickType_t ) 10 );
            xSemaphoreTakeRecursive( xMutex, ( TickType_t ) 10 );

            // The mutex has now been 'taken' three times, so will not be
            // available to another task until it has also been given back
            // three times.  Again it is unlikely that real code would have
            // these calls sequentially, but instead buried in a more complex
            // call structure.  This is just for illustrative purposes.
            xSemaphoreGiveRecursive( xMutex );
            xSemaphoreGiveRecursive( xMutex );
            xSemaphoreGiveRecursive( xMutex );

            // Now the mutex can be taken by other tasks.
        }
        else
        {
            // We could not obtain the mutex and can therefore not access
            // the shared resource safely.
        }
    }
}

```

**Parameters**

- **xMutex** –A handle to the mutex being obtained. This is the handle returned by `xSemaphoreCreateRecursiveMutex()`;
- **xBlockTime** –The time in ticks to wait for the semaphore to become available. The macro `portTICK_PERIOD_MS` can be used to convert this to a real time. A block time of zero can be used to poll the semaphore. If the task already owns the semaphore then `xSemaphoreTakeRecursive()` will return immediately no matter what the value of `xBlockTime`.

**Returns** `pdTRUE` if the semaphore was obtained. `pdFALSE` if `xBlockTime` expired without the semaphore becoming available.

**xSemaphoreGive** (xSemaphore)

Macro to release a semaphore. The semaphore must have previously been created with a call to `xSemaphoreCreateBinary()`, `xSemaphoreCreateMutex()` or `xSemaphoreCreateCounting()`, and obtained us-

ing `sSemaphoreTake()`.

This macro must not be used from an ISR. See `xSemaphoreGiveFromISR()` for an alternative which can be used from an ISR.

This macro must also not be used on semaphores created using `xSemaphoreCreateRecursiveMutex()`.

Example usage:

```
SemaphoreHandle_t xSemaphore = NULL;

void vATask( void * pvParameters )
{
    // Create the semaphore to guard a shared resource.
    vSemaphoreCreateBinary( xSemaphore );

    if( xSemaphore != NULL )
    {
        if( xSemaphoreGive( xSemaphore ) != pdTRUE )
        {
            // We would expect this call to fail because we cannot give
            // a semaphore without first "taking" it!
        }

        // Obtain the semaphore - don't block if the semaphore is not
        // immediately available.
        if( xSemaphoreTake( xSemaphore, ( TickType_t ) 0 ) )
        {
            // We now have the semaphore and can access the shared resource.

            // ...

            // We have finished accessing the shared resource so can free the
            // semaphore.
            if( xSemaphoreGive( xSemaphore ) != pdTRUE )
            {
                // We would not expect this call to fail because we must have
                // obtained the semaphore to get here.
            }
        }
    }
}
```

#### Parameters

- **xSemaphore** – A handle to the semaphore being released. This is the handle returned when the semaphore was created.

**Returns** `pdTRUE` if the semaphore was released. `pdFALSE` if an error occurred. Semaphores are implemented using queues. An error can occur if there is no space on the queue to post a message - indicating that the semaphore was not first obtained correctly.

#### **xSemaphoreGiveRecursive** (xMutex)

Macro to recursively release, or ‘give’, a mutex type semaphore. The mutex must have previously been created using a call to `xSemaphoreCreateRecursiveMutex()`;

`configUSE_RECURSIVE_MUTEXES` must be set to 1 in `FreeRTOSConfig.h` for this macro to be available.

This macro must not be used on mutexes created using `xSemaphoreCreateMutex()`.

A mutex used recursively can be ‘taken’ repeatedly by the owner. The mutex doesn’t become available again until the owner has called `xSemaphoreGiveRecursive()` for each successful ‘take’ request. For example, if a task successfully ‘takes’ the same mutex 5 times then the mutex will not be available to any other task until it has also ‘given’ the mutex back exactly five times.

Example usage:

```

SemaphoreHandle_t xMutex = NULL;

// A task that creates a mutex.
void vATask( void * pvParameters )
{
    // Create the mutex to guard a shared resource.
    xMutex = xSemaphoreCreateRecursiveMutex();
}

// A task that uses the mutex.
void vAnotherTask( void * pvParameters )
{
    // ... Do other things.

    if( xMutex != NULL )
    {
        // See if we can obtain the mutex. If the mutex is not available
        // wait 10 ticks to see if it becomes free.
        if( xSemaphoreTakeRecursive( xMutex, ( TickType_t ) 10 ) == pdTRUE )
        {
            // We were able to obtain the mutex and can now access the
            // shared resource.

            // ...
            // For some reason due to the nature of the code further calls to
            // xSemaphoreTakeRecursive() are made on the same mutex. In real
            // code these would not be just sequential calls as this would make
            // no sense. Instead the calls are likely to be buried inside
            // a more complex call structure.
            xSemaphoreTakeRecursive( xMutex, ( TickType_t ) 10 );
            xSemaphoreTakeRecursive( xMutex, ( TickType_t ) 10 );

            // The mutex has now been 'taken' three times, so will not be
            // available to another task until it has also been given back
            // three times. Again it is unlikely that real code would have
            // these calls sequentially, it would be more likely that the calls
            // to xSemaphoreGiveRecursive() would be called as a call stack
            // unwound. This is just for demonstrative purposes.
            xSemaphoreGiveRecursive( xMutex );
            xSemaphoreGiveRecursive( xMutex );
            xSemaphoreGiveRecursive( xMutex );

            // Now the mutex can be taken by other tasks.
        }
        else
        {
            // We could not obtain the mutex and can therefore not access
            // the shared resource safely.
        }
    }
}

```

#### Parameters

- **xMutex** – A handle to the mutex being released, or ‘given’. This is the handle returned by `xSemaphoreCreateMutex()`;

**Returns** `pdTRUE` if the semaphore was given.

**xSemaphoreGiveFromISR** (`xSemaphore`, `pxHigherPriorityTaskWoken`)

*Macro* to release a semaphore. The semaphore must have previously been created with a call to `xSemaphoreCreateBinary()` or `xSemaphoreCreateCounting()`.

Mutex type semaphores (those created using a call to `xSemaphoreCreateMutex()`) must not be used with this macro.

This macro can be used from an ISR.

Example usage:

```
#define LONG_TIME 0xffff
#define TICKS_TO_WAIT 10
SemaphoreHandle_t xSemaphore = NULL;

// Repetitive task.
void vATask( void * pvParameters )
{
    for( ;; )
    {
        // We want this task to run every 10 ticks of a timer. The semaphore
        // was created before this task was started.

        // Block waiting for the semaphore to become available.
        if( xSemaphoreTake( xSemaphore, LONG_TIME ) == pdTRUE )
        {
            // It is time to execute.

            // ...

            // We have finished our task. Return to the top of the loop where
            // we will block on the semaphore until it is time to execute
            // again. Note when using the semaphore for synchronisation with an
            // ISR in this manner there is no need to 'give' the semaphore back.
        }
    }
}

// Timer ISR
void vTimerISR( void * pvParameters )
{
    static uint8_t ucLocalTickCount = 0;
    static BaseType_t xHigherPriorityTaskWoken;

    // A timer tick has occurred.

    // ... Do other time functions.

    // Is it time for vATask () to run?
    xHigherPriorityTaskWoken = pdFALSE;
    ucLocalTickCount++;
    if( ucLocalTickCount >= TICKS_TO_WAIT )
    {
        // Unblock the task by releasing the semaphore.
        xSemaphoreGiveFromISR( xSemaphore, &xHigherPriorityTaskWoken );

        // Reset the count so we release the semaphore again in 10 ticks time.
        ucLocalTickCount = 0;
    }

    if( xHigherPriorityTaskWoken != pdFALSE )
    {
        // We can force a context switch here. Context switching from an

```

(continues on next page)

(continued from previous page)

```

// ISR uses port specific syntax. Check the demo task for your port
// to find the syntax required.
}
}

```

**Parameters**

- **xSemaphore** –A handle to the semaphore being released. This is the handle returned when the semaphore was created.
- **pxHigherPriorityTaskWoken** –xSemaphoreGiveFromISR() will set \*pxHigherPriorityTaskWoken to pdTRUE if giving the semaphore caused a task to unblock, and the unblocked task has a priority higher than the currently running task. If xSemaphoreGiveFromISR() sets this value to pdTRUE then a context switch should be requested before the interrupt is exited.

**Returns** pdTRUE if the semaphore was successfully given, otherwise errQUEUE\_FULL.

**xSemaphoreTakeFromISR** (xSemaphore, pxHigherPriorityTaskWoken)

*Macro* to take a semaphore from an ISR. The semaphore must have previously been created with a call to xSemaphoreCreateBinary() or xSemaphoreCreateCounting().

Mutex type semaphores (those created using a call to xSemaphoreCreateMutex()) must not be used with this macro.

This macro can be used from an ISR, however taking a semaphore from an ISR is not a common operation. It is likely to only be useful when taking a counting semaphore when an interrupt is obtaining an object from a resource pool (when the semaphore count indicates the number of resources available).

**Parameters**

- **xSemaphore** –A handle to the semaphore being taken. This is the handle returned when the semaphore was created.
- **pxHigherPriorityTaskWoken** –[out] xSemaphoreTakeFromISR() will set \*pxHigherPriorityTaskWoken to pdTRUE if taking the semaphore caused a task to unblock, and the unblocked task has a priority higher than the currently running task. If xSemaphoreTakeFromISR() sets this value to pdTRUE then a context switch should be requested before the interrupt is exited.

**Returns** pdTRUE if the semaphore was successfully taken, otherwise pdFALSE

**xSemaphoreCreateMutex** ()

Creates a new mutex type semaphore instance, and returns a handle by which the new mutex can be referenced.

Internally, within the FreeRTOS implementation, mutex semaphores use a block of memory, in which the mutex structure is stored. If a mutex is created using xSemaphoreCreateMutex() then the required memory is automatically dynamically allocated inside the xSemaphoreCreateMutex() function. (see <https://www.FreeRTOS.org/a00111.html>). If a mutex is created using xSemaphoreCreateMutexStatic() then the application writer must provide the memory. xSemaphoreCreateMutexStatic() therefore allows a mutex to be created without using any dynamic memory allocation.

Mutexes created using this function can be accessed using the xSemaphoreTake() and xSemaphoreGive() macros. The xSemaphoreTakeRecursive() and xSemaphoreGiveRecursive() macros must not be used.

This type of semaphore uses a priority inheritance mechanism so a task ‘taking’ a semaphore MUST ALWAYS ‘give’ the semaphore back once the semaphore it is no longer required.

Mutex type semaphores cannot be used from within interrupt service routines.

See xSemaphoreCreateBinary() for an alternative implementation that can be used for pure synchronisation (where one task or interrupt always ‘gives’ the semaphore and another always ‘takes’ the semaphore) and from within interrupt service routines.

Example usage:



```

SemaphoreHandle_t xSemaphore;

void vATask( void * pvParameters )
{
    // Semaphore cannot be used before a call to xSemaphoreCreateMutex().
    // This is a macro so pass the variable in directly.
    xSemaphore = xSemaphoreCreateMutex();

    if( xSemaphore != NULL )
    {
        // The semaphore was created successfully.
        // The semaphore can now be used.
    }
}

```

**Returns** If the mutex was successfully created then a handle to the created semaphore is returned. If there was not enough heap to allocate the mutex data structures then NULL is returned.

#### **xSemaphoreCreateMutexStatic** (pxMutexBuffer)

Creates a new mutex type semaphore instance, and returns a handle by which the new mutex can be referenced.

Internally, within the FreeRTOS implementation, mutex semaphores use a block of memory, in which the mutex structure is stored. If a mutex is created using `xSemaphoreCreateMutex()` then the required memory is automatically dynamically allocated inside the `xSemaphoreCreateMutex()` function. (see <https://www.FreeRTOS.org/a00111.html>). If a mutex is created using `xSemaphoreCreateMutexStatic()` then the application writer must provide the memory. `xSemaphoreCreateMutexStatic()` therefore allows a mutex to be created without using any dynamic memory allocation.

Mutexes created using this function can be accessed using the `xSemaphoreTake()` and `xSemaphoreGive()` macros. The `xSemaphoreTakeRecursive()` and `xSemaphoreGiveRecursive()` macros must not be used.

This type of semaphore uses a priority inheritance mechanism so a task ‘taking’ a semaphore MUST ALWAYS ‘give’ the semaphore back once the semaphore it is no longer required.

Mutex type semaphores cannot be used from within interrupt service routines.

See `xSemaphoreCreateBinary()` for an alternative implementation that can be used for pure synchronisation (where one task or interrupt always ‘gives’ the semaphore and another always ‘takes’ the semaphore) and from within interrupt service routines.

Example usage:

```

SemaphoreHandle_t xSemaphore;
StaticSemaphore_t xMutexBuffer;

void vATask( void * pvParameters )
{
    // A mutex cannot be used before it has been created. xMutexBuffer is
    // into xSemaphoreCreateMutexStatic() so no dynamic memory allocation is
    // attempted.
    xSemaphore = xSemaphoreCreateMutexStatic( &xMutexBuffer );

    // As no dynamic memory allocation was performed, xSemaphore cannot be NULL,
    // so there is no need to check it.
}

```

#### **Parameters**

- **pxMutexBuffer** –Must point to a variable of type `StaticSemaphore_t`, which will be used to hold the mutex’s data structure, removing the need for the memory to be allocated dynamically.

**Returns** If the mutex was successfully created then a handle to the created mutex is returned. If pxMutexBuffer was NULL then NULL is returned.

#### **xSemaphoreCreateCounting** (uxMaxCount, uxInitialCount)

Creates a new recursive mutex type semaphore instance, and returns a handle by which the new recursive mutex can be referenced.

Internally, within the FreeRTOS implementation, recursive mutexes use a block of memory, in which the mutex structure is stored. If a recursive mutex is created using xSemaphoreCreateRecursiveMutex() then the required memory is automatically dynamically allocated inside the xSemaphoreCreateRecursiveMutex() function. (see <http://www.freertos.org/a00111.html>). If a recursive mutex is created using xSemaphoreCreateRecursiveMutexStatic() then the application writer must provide the memory that will get used by the mutex. xSemaphoreCreateRecursiveMutexStatic() therefore allows a recursive mutex to be created without using any dynamic memory allocation.

Mutexes created using this macro can be accessed using the xSemaphoreTakeRecursive() and xSemaphoreGiveRecursive() macros. The xSemaphoreTake() and xSemaphoreGive() macros must not be used.

A mutex used recursively can be ‘taken’ repeatedly by the owner. The mutex doesn’t become available again until the owner has called xSemaphoreGiveRecursive() for each successful ‘take’ request. For example, if a task successfully ‘takes’ the same mutex 5 times then the mutex will not be available to any other task until it has also ‘given’ the mutex back exactly five times.

This type of semaphore uses a priority inheritance mechanism so a task ‘taking’ a semaphore MUST ALWAYS ‘give’ the semaphore back once the semaphore it is no longer required.

Mutex type semaphores cannot be used from within interrupt service routines.

See vSemaphoreCreateBinary() for an alternative implementation that can be used for pure synchronisation (where one task or interrupt always ‘gives’ the semaphore and another always ‘takes’ the semaphore) and from within interrupt service routines.

Example usage:

```
SemaphoreHandle_t xSemaphore;

void vATask( void * pvParameters )
{
    // Semaphore cannot be used before a call to xSemaphoreCreateMutex().
    // This is a macro so pass the variable in directly.
    xSemaphore = xSemaphoreCreateRecursiveMutex();

    if( xSemaphore != NULL )
    {
        // The semaphore was created successfully.
        // The semaphore can now be used.
    }
}
```

Creates a new recursive mutex type semaphore instance, and returns a handle by which the new recursive mutex can be referenced.

Internally, within the FreeRTOS implementation, recursive mutexes use a block of memory, in which the mutex structure is stored. If a recursive mutex is created using xSemaphoreCreateRecursiveMutex() then the required memory is automatically dynamically allocated inside the xSemaphoreCreateRecursiveMutex() function. (see <https://www.FreeRTOS.org/a00111.html>). If a recursive mutex is created using xSemaphoreCreateRecursiveMutexStatic() then the application writer must provide the memory that will get used by the mutex. xSemaphoreCreateRecursiveMutexStatic() therefore allows a recursive mutex to be created without using any dynamic memory allocation.

Mutexes created using this macro can be accessed using the xSemaphoreTakeRecursive() and xSemaphoreGiveRecursive() macros. The xSemaphoreTake() and xSemaphoreGive() macros must not be used.

A mutex used recursively can be ‘taken’ repeatedly by the owner. The mutex doesn’t become available again until the owner has called `xSemaphoreGiveRecursive()` for each successful ‘take’ request. For example, if a task successfully ‘takes’ the same mutex 5 times then the mutex will not be available to any other task until it has also ‘given’ the mutex back exactly five times.

This type of semaphore uses a priority inheritance mechanism so a task ‘taking’ a semaphore **MUST ALWAYS** ‘give’ the semaphore back once the semaphore it is no longer required.

Mutex type semaphores cannot be used from within interrupt service routines.

See `xSemaphoreCreateBinary()` for an alternative implementation that can be used for pure synchronisation (where one task or interrupt always ‘gives’ the semaphore and another always ‘takes’ the semaphore) and from within interrupt service routines.

Example usage:

```
SemaphoreHandle_t xSemaphore;
StaticSemaphore_t xMutexBuffer;

void vATask( void * pvParameters )
{
    // A recursive semaphore cannot be used before it is created. Here a
    // recursive mutex is created using xSemaphoreCreateRecursiveMutexStatic().
    // The address of xMutexBuffer is passed into the function, and will hold
    // the mutexes data structures - so no dynamic memory allocation will be
    // attempted.
    xSemaphore = xSemaphoreCreateRecursiveMutexStatic( &xMutexBuffer );

    // As no dynamic memory allocation was performed, xSemaphore cannot be NULL,
    // so there is no need to check it.
}
```

Creates a new counting semaphore instance, and returns a handle by which the new counting semaphore can be referenced.

In many usage scenarios it is faster and more memory efficient to use a direct to task notification in place of a counting semaphore! <https://www.FreeRTOS.org/RTOS-task-notifications.html>

Internally, within the FreeRTOS implementation, counting semaphores use a block of memory, in which the counting semaphore structure is stored. If a counting semaphore is created using `xSemaphoreCreateCounting()` then the required memory is automatically dynamically allocated inside the `xSemaphoreCreateCounting()` function. (see <https://www.FreeRTOS.org/a00111.html>). If a counting semaphore is created using `xSemaphoreCreateCountingStatic()` then the application writer can instead optionally provide the memory that will get used by the counting semaphore. `xSemaphoreCreateCountingStatic()` therefore allows a counting semaphore to be created without using any dynamic memory allocation.

Counting semaphores are typically used for two things:

1) Counting events.

In this usage scenario an event handler will ‘give’ a semaphore each time an event occurs (incrementing the semaphore count value), and a handler task will ‘take’ a semaphore each time it processes an event (decrementing the semaphore count value). The count value is therefore the difference between the number of events that have occurred and the number that have been processed. In this case it is desirable for the initial count value to be zero.

2) Resource management.

In this usage scenario the count value indicates the number of resources available. To obtain control of a resource a task must first obtain a semaphore - decrementing the semaphore count value. When the count value reaches zero there are no free resources. When a task finishes with the resource it ‘gives’ the semaphore back - incrementing the semaphore count value. In this case it is desirable for the initial count value to be equal to the maximum count value, indicating that all resources are free.

Example usage:

```
SemaphoreHandle_t xSemaphore;

void vATask( void * pvParameters )
{
    SemaphoreHandle_t xSemaphore = NULL;

    // Semaphore cannot be used before a call to xSemaphoreCreateCounting().
    // The max value to which the semaphore can count should be 10, and the
    // initial value assigned to the count should be 0.
    xSemaphore = xSemaphoreCreateCounting( 10, 0 );

    if( xSemaphore != NULL )
    {
        // The semaphore was created successfully.
        // The semaphore can now be used.
    }
}
```

**Returns** xSemaphore Handle to the created mutex semaphore. Should be of type SemaphoreHandle\_t.

**Parameters**

- **pxStaticSemaphore** –Must point to a variable of type StaticSemaphore\_t, which will then be used to hold the recursive mutex’ s data structure, removing the need for the memory to be allocated dynamically.
- **uxMaxCount** –The maximum count value that can be reached. When the semaphore reaches this value it can no longer be ‘given’ .
- **uxInitialCount** –The count value assigned to the semaphore when it is created.

**Returns** If the recursive mutex was successfully created then a handle to the created recursive mutex is returned. If pxMutexBuffer was NULL then NULL is returned.

**Returns** Handle to the created semaphore. Null if the semaphore could not be created.

**xSemaphoreCreateCountingStatic** (uxMaxCount, uxInitialCount, pxSemaphoreBuffer)

Creates a new counting semaphore instance, and returns a handle by which the new counting semaphore can be referenced.

In many usage scenarios it is faster and more memory efficient to use a direct to task notification in place of a counting semaphore! <https://www.FreeRTOS.org/RTOS-task-notifications.html>

Internally, within the FreeRTOS implementation, counting semaphores use a block of memory, in which the counting semaphore structure is stored. If a counting semaphore is created using xSemaphoreCreateCounting() then the required memory is automatically dynamically allocated inside the xSemaphoreCreateCounting() function. (see <https://www.FreeRTOS.org/a00111.html>). If a counting semaphore is created using xSemaphoreCreateCountingStatic() then the application writer must provide the memory. xSemaphoreCreateCountingStatic() therefore allows a counting semaphore to be created without using any dynamic memory allocation.

Counting semaphores are typically used for two things:

1) Counting events.

In this usage scenario an event handler will ‘give’ a semaphore each time an event occurs (incrementing the semaphore count value), and a handler task will ‘take’ a semaphore each time it processes an event (decrementing the semaphore count value). The count value is therefore the difference between the number of events that have occurred and the number that have been processed. In this case it is desirable for the initial count value to be zero.

2) Resource management.

In this usage scenario the count value indicates the number of resources available. To obtain control of a resource a task must first obtain a semaphore - decrementing the semaphore count value. When the count value reaches zero there are no free resources. When a task finishes with the resource it 'gives' the semaphore back - incrementing the semaphore count value. In this case it is desirable for the initial count value to be equal to the maximum count value, indicating that all resources are free.

Example usage:

```
SemaphoreHandle_t xSemaphore;
StaticSemaphore_t xSemaphoreBuffer;

void vATask( void * pvParameters )
{
    SemaphoreHandle_t xSemaphore = NULL;

    // Counting semaphore cannot be used before they have been created. Create
    // a counting semaphore using xSemaphoreCreateCountingStatic(). The max
    // value to which the semaphore can count is 10, and the initial value
    // assigned to the count will be 0. The address of xSemaphoreBuffer is
    // passed in and will be used to hold the semaphore structure, so no dynamic
    // memory allocation will be used.
    xSemaphore = xSemaphoreCreateCounting( 10, 0, &xSemaphoreBuffer );

    // No memory allocation was attempted so xSemaphore cannot be NULL, so there
    // is no need to check its value.
}
```

#### Parameters

- **uxMaxCount** –The maximum count value that can be reached. When the semaphore reaches this value it can no longer be 'given'.
- **uxInitialCount** –The count value assigned to the semaphore when it is created.
- **pxSemaphoreBuffer** –Must point to a variable of type StaticSemaphore\_t, which will then be used to hold the semaphore's data structure, removing the need for the memory to be allocated dynamically.

**Returns** If the counting semaphore was successfully created then a handle to the created counting semaphore is returned. If pxSemaphoreBuffer was NULL then NULL is returned.

#### **vSemaphoreDelete** (xSemaphore)

Delete a semaphore. This function must be used with care. For example, do not delete a mutex type semaphore if the mutex is held by a task.

#### Parameters

- **xSemaphore** –A handle to the semaphore to be deleted.

#### **xSemaphoreGetMutexHolder** (xSemaphore)

If xMutex is indeed a mutex type semaphore, return the current mutex holder. If xMutex is not a mutex type semaphore, or the mutex is available (not held by a task), return NULL.

Note: This is a good way of determining if the calling task is the mutex holder, but not a good way of determining the identity of the mutex holder as the holder may change between the function exiting and the returned value being tested.

#### **xSemaphoreGetMutexHolderFromISR** (xSemaphore)

If xMutex is indeed a mutex type semaphore, return the current mutex holder. If xMutex is not a mutex type semaphore, or the mutex is available (not held by a task), return NULL.

#### **uxSemaphoreGetCount** (xSemaphore)

If the semaphore is a counting semaphore then uxSemaphoreGetCount() returns its current count value. If the semaphore is a binary semaphore then uxSemaphoreGetCount() returns 1 if the semaphore is available, and 0 if the semaphore is not available.

## Type Definitions

```
typedef QueueHandle_t SemaphoreHandle_t
```

## Timer API

### Header File

- [components/freertos/FreeRTOS-Kernel/include/freertos/timers.h](#)

### Functions

```
TimerHandle_t xTimerCreate (const char *const pcTimerName, const TickType_t xTimerPeriodInTicks, const
    UBaseType_t uxAutoReload, void *const pvTimerID,
    TimerCallbackFunction_t pxCallbackFunction)
```

```
TimerHandle_t xTimerCreate( const char * const pcTimerName, TickType_t xTimerPeriodInTicks, UBase-
Type_t uxAutoReload, void * pvTimerID, TimerCallbackFunction_t pxCallbackFunction );
```

Creates a new software timer instance, and returns a handle by which the created software timer can be referenced.

Internally, within the FreeRTOS implementation, software timers use a block of memory, in which the timer data structure is stored. If a software timer is created using `xTimerCreate()` then the required memory is automatically dynamically allocated inside the `xTimerCreate()` function. (see <https://www.FreeRTOS.org/a00111.html>). If a software timer is created using `xTimerCreateStatic()` then the application writer must provide the memory that will get used by the software timer. `xTimerCreateStatic()` therefore allows a software timer to be created without using any dynamic memory allocation.

Timers are created in the dormant state. The `xTimerStart()`, `xTimerReset()`, `xTimerStartFromISR()`, `xTimerResetFromISR()`, `xTimerChangePeriod()` and `xTimerChangePeriodFromISR()` API functions can all be used to transition a timer into the active state.

Example usage:

```
* #define NUM_TIMERS 5
*
* // An array to hold handles to the created timers.
* TimerHandle_t xTimers[ NUM_TIMERS ];
*
* // An array to hold a count of the number of times each timer expires.
* int32_t lExpireCounters[ NUM_TIMERS ] = { 0 };
*
* // Define a callback function that will be used by multiple timer instances.
* // The callback function does nothing but count the number of times the
* // associated timer expires, and stop the timer once the timer has expired
* // 10 times.
* void vTimerCallback( TimerHandle_t pxTimer )
* {
*     int32_t lArrayIndex;
*     const int32_t xMaxExpiryCountBeforeStopping = 10;
*
*     // Optionally do something if the pxTimer parameter is NULL.
*     configASSERT( pxTimer );
*
*     // Which timer expired?
*     lArrayIndex = ( int32_t ) pvTimerGetTimerID( pxTimer );
*
*     // Increment the number of times that pxTimer has expired.
*     lExpireCounters[ lArrayIndex ] += 1;
```

(continues on next page)

(continued from previous page)

```

*
* // If the timer has expired 10 times then stop it from running.
* if( lExpireCounters[ lArrayIndex ] == xMaxExpiryCountBeforeStopping )
* {
*     // Do not use a block time if calling a timer API function from a
*     // timer callback function, as doing so could cause a deadlock!
*     xTimerStop( pxTimer, 0 );
* }
* }
*
* void main( void )
* {
* int32_t x;
*
*     // Create then start some timers. Starting the timers before the
↳scheduler
*     // has been started means the timers will start running immediately that
*     // the scheduler starts.
*     for( x = 0; x < NUM_TIMERS; x++ )
*     {
*         xTimers[ x ] = xTimerCreate( "Timer", // Just a text name,
↳not used by the kernel.
*                                     ( 100 * x ), // The timer period
↳in ticks.
*                                     pdTRUE, // The timers will
↳auto-reload themselves when they expire.
*                                     ( void * ) x, // Assign each timer
↳a unique id equal to its array index.
*                                     vTimerCallback // Each timer calls
↳the same callback when it expires.
*                                     );
*
*         if( xTimers[ x ] == NULL )
*         {
*             // The timer was not created.
*         }
*         else
*         {
*             // Start the timer. No block time is specified, and even if one
↳was
*             // it would be ignored because the scheduler has not yet been
*             // started.
*             if( xTimerStart( xTimers[ x ], 0 ) != pdPASS )
*             {
*                 // The timer could not be set into the Active state.
*             }
*         }
*     }
*
*     // ...
*     // Create tasks here.
*     // ...
*
*     // Starting the scheduler will start the timers running as they have
↳already
*     // been set into the active state.
*     vTaskStartScheduler();
*
*     // Should not reach here.
*     for( ;; );
* }

```

(continues on next page)



```
*
```

### Parameters

- **pcTimerName** –A text name that is assigned to the timer. This is done purely to assist debugging. The kernel itself only ever references a timer by its handle, and never by its name.
- **xTimerPeriodInTicks** –The timer period. The time is defined in tick periods so the constant portTICK\_PERIOD\_MS can be used to convert a time that has been specified in milliseconds. For example, if the timer must expire after 100 ticks, then xTimerPeriodInTicks should be set to 100. Alternatively, if the timer must expire after 500ms, then xPeriod can be set to ( 500 / portTICK\_PERIOD\_MS ) provided configTICK\_RATE\_HZ is less than or equal to 1000. Time timer period must be greater than 0.
- **uxAutoReload** –If uxAutoReload is set to pdTRUE then the timer will expire repeatedly with a frequency set by the xTimerPeriodInTicks parameter. If uxAutoReload is set to pdFALSE then the timer will be a one-shot timer and enter the dormant state after it expires.
- **pvTimerID** –An identifier that is assigned to the timer being created. Typically this would be used in the timer callback function to identify which timer expired when the same callback function is assigned to more than one timer.
- **pxCallbackFunction** –The function to call when the timer expires. Callback functions must have the prototype defined by TimerCallbackFunction\_t, which is “void vCallbackFunction( TimerHandle\_t xTimer );” .

**Returns** If the timer is successfully created then a handle to the newly created timer is returned. If the timer cannot be created (because either there is insufficient FreeRTOS heap remaining to allocate the timer structures, or the timer period was set to 0) then NULL is returned.

*TimerHandle\_t* xTimerCreateStatic (const char \*const pcTimerName, const TickType\_t xTimerPeriodInTicks, const UBaseType\_t uxAutoReload, void \*const pvTimerID, *TimerCallbackFunction\_t* pxCallbackFunction, StaticTimer\_t \*pxTimerBuffer)

```
TimerHandle_t xTimerCreateStatic(const char * const pcTimerName, TickType_t xTimerPeriodInTicks,
UBaseType_t uxAutoReload, void * pvTimerID, TimerCallbackFunction_t pxCallbackFunction, StaticTimer_t *pxTimerBuffer );
```

Creates a new software timer instance, and returns a handle by which the created software timer can be referenced.

Internally, within the FreeRTOS implementation, software timers use a block of memory, in which the timer data structure is stored. If a software timer is created using xTimerCreate() then the required memory is automatically dynamically allocated inside the xTimerCreate() function. (see <https://www.FreeRTOS.org/a00111.html>). If a software timer is created using xTimerCreateStatic() then the application writer must provide the memory that will get used by the software timer. xTimerCreateStatic() therefore allows a software timer to be created without using any dynamic memory allocation.

Timers are created in the dormant state. The xTimerStart(), xTimerReset(), xTimerStartFromISR(), xTimerResetFromISR(), xTimerChangePeriod() and xTimerChangePeriodFromISR() API functions can all be used to transition a timer into the active state.

Example usage:

```
*
* // The buffer used to hold the software timer's data structure.
* static StaticTimer_t xTimerBuffer;
*
* // A variable that will be incremented by the software timer's callback
* // function.
* UBaseType_t uxVariableToIncrement = 0;
```

(continues on next page)



(continued from previous page)

```

*
* // A software timer callback function that increments a variable passed to
* // it when the software timer was created. After the 5th increment the
* // callback function stops the software timer.
* static void prvTimerCallback( TimerHandle_t xExpiredTimer )
* {
*     UBaseType_t *puxVariableToIncrement;
*     BaseType_t xReturned;
*
*     // Obtain the address of the variable to increment from the timer ID.
*     puxVariableToIncrement = ( UBaseType_t * ) pvTimerGetTimerID(
↳xExpiredTimer );
*
*     // Increment the variable to show the timer callback has executed.
*     ( *puxVariableToIncrement )++;
*
*     // If this callback has executed the required number of times, stop the
*     // timer.
*     if( *puxVariableToIncrement == 5 )
*     {
*         // This is called from a timer callback so must not block.
*         xTimerStop( xExpiredTimer, staticDONT_BLOCK );
*     }
* }
*
* void main( void )
* {
*     // Create the software time. xTimerCreateStatic() has an extra parameter
*     // than the normal xTimerCreate() API function. The parameter is a
↳pointer
*     // to the StaticTimer_t structure that will hold the software timer
*     // structure. If the parameter is passed as NULL then the structure
↳will be
*     // allocated dynamically, just as if xTimerCreate() had been called.
*     xTimer = xTimerCreateStatic( "T1", // Text name for the task.
↳ Helps debugging only. Not used by FreeRTOS.
*     xTimerPeriod, // The period of the
↳timer in ticks.
*     pdTRUE, // This is an auto-reload
↳timer.
*     ( void * ) &xVariableToIncrement, // A
↳variable incremented by the software timer's callback function
*     prvTimerCallback, // The function to
↳execute when the timer expires.
*     &xTimerBuffer ); // The buffer that will
↳hold the software timer structure.
*
*     // The scheduler has not started yet so a block time is not used.
*     xReturned = xTimerStart( xTimer, 0 );
*
*     // ...
*     // Create tasks here.
*     // ...
*
*     // Starting the scheduler will start the timers running as they have
↳already
*     // been set into the active state.
*     vTaskStartScheduler();
*
*     // Should not reach here.

```

(continues on next page)

```
*   for( ;; );
* }
*
```

### Parameters

- **pcTimerName** –A text name that is assigned to the timer. This is done purely to assist debugging. The kernel itself only ever references a timer by its handle, and never by its name.
- **xTimerPeriodInTicks** –The timer period. The time is defined in tick periods so the constant portTICK\_PERIOD\_MS can be used to convert a time that has been specified in milliseconds. For example, if the timer must expire after 100 ticks, then xTimerPeriodInTicks should be set to 100. Alternatively, if the timer must expire after 500ms, then xPeriod can be set to ( 500 / portTICK\_PERIOD\_MS ) provided configTICK\_RATE\_HZ is less than or equal to 1000. The timer period must be greater than 0.
- **uxAutoReload** –If uxAutoReload is set to pdTRUE then the timer will expire repeatedly with a frequency set by the xTimerPeriodInTicks parameter. If uxAutoReload is set to pdFALSE then the timer will be a one-shot timer and enter the dormant state after it expires.
- **pvTimerID** –An identifier that is assigned to the timer being created. Typically this would be used in the timer callback function to identify which timer expired when the same callback function is assigned to more than one timer.
- **pxCallbackFunction** –The function to call when the timer expires. Callback functions must have the prototype defined by TimerCallbackFunction\_t, which is “void vCallbackFunction( TimerHandle\_t xTimer );” .
- **pxTimerBuffer** –Must point to a variable of type StaticTimer\_t, which will be then be used to hold the software timer’s data structures, removing the need for the memory to be allocated dynamically.

**Returns** If the timer is created then a handle to the created timer is returned. If pxTimerBuffer was NULL then NULL is returned.

void \***pvTimerGetTimerID**( const *TimerHandle\_t* xTimer )

void \*pvTimerGetTimerID( TimerHandle\_t xTimer );

Returns the ID assigned to the timer.

IDs are assigned to timers using the pvTimerID parameter of the call to xTimerCreated() that was used to create the timer, and by calling the vTimerSetTimerID() API function.

If the same callback function is assigned to multiple timers then the timer ID can be used as time specific (timer local) storage.

Example usage:

See the xTimerCreate() API function example usage scenario.

**Parameters** **xTimer** –The timer being queried.

**Returns** The ID assigned to the timer being queried.

void **vTimerSetTimerID**( *TimerHandle\_t* xTimer, void \*pvNewID )

void vTimerSetTimerID( TimerHandle\_t xTimer, void \*pvNewID );

Sets the ID assigned to the timer.

IDs are assigned to timers using the pvTimerID parameter of the call to xTimerCreated() that was used to create the timer.

If the same callback function is assigned to multiple timers then the timer ID can be used as time specific (timer local) storage.

Example usage:

See the `xTimerCreate()` API function example usage scenario.

#### Parameters

- **xTimer** –The timer being updated.
- **pvNewID** –The ID to assign to the timer.

BaseType\_t **xTimerIsTimerActive** (*TimerHandle\_t* xTimer)

BaseType\_t xTimerIsTimerActive( TimerHandle\_t xTimer );

Queries a timer to see if it is active or dormant.

A timer will be dormant if: 1) It has been created but not started, or 2) It is an expired one-shot timer that has not been restarted.

Timers are created in the dormant state. The `xTimerStart()`, `xTimerReset()`, `xTimerStartFromISR()`, `xTimerResetFromISR()`, `xTimerChangePeriod()` and `xTimerChangePeriodFromISR()` API functions can all be used to transition a timer into the active state.

Example usage:

```
* // This function assumes xTimer has already been created.
* void vAFunction( TimerHandle_t xTimer )
* {
*     if( xTimerIsTimerActive( xTimer ) != pdFALSE ) // or more simply and
*     equivalently "if( xTimerIsTimerActive( xTimer ) )"
*     {
*         // xTimer is active, do something.
*     }
*     else
*     {
*         // xTimer is not active, do something else.
*     }
* }
*
```

**Parameters** **xTimer** –The timer being queried.

**Returns** `pdFALSE` will be returned if the timer is dormant. A value other than `pdFALSE` will be returned if the timer is active.

*TaskHandle\_t* **xTimerGetTimerDaemonTaskHandle** (void)

TaskHandle\_t xTimerGetTimerDaemonTaskHandle( void );

Simply returns the handle of the timer service/daemon task. It is not valid to call `xTimerGetTimerDaemonTaskHandle()` before the scheduler has been started.

BaseType\_t **xTimerPendFunctionCallFromISR** (*PendedFunction\_t* xFunctionToPend, void \*pvParameter1, uint32\_t ulParameter2, BaseType\_t \*pxHigherPriorityTaskWoken)

BaseType\_t xTimerPendFunctionCallFromISR( PendedFunction\_t xFunctionToPend, void \*pvParameter1, uint32\_t ulParameter2, BaseType\_t \*pxHigherPriorityTaskWoken );

Used from application interrupt service routines to defer the execution of a function to the RTOS daemon task (the timer service task, hence this function is implemented in `timers.c` and is prefixed with ‘Timer’).

Ideally an interrupt service routine (ISR) is kept as short as possible, but sometimes an ISR either has a lot of processing to do, or needs to perform processing that is not deterministic. In these cases `xTimerPendFunctionCallFromISR()` can be used to defer processing of a function to the RTOS daemon task.

A mechanism is provided that allows the interrupt to return directly to the task that will subsequently execute the pended callback function. This allows the callback function to execute contiguously in time with the interrupt - just as if the callback had executed in the interrupt itself.

## Example usage:

```

*
* // The callback function that will execute in the context of the daemon
* task.
* // Note callback functions must all use this same prototype.
* void vProcessInterface( void *pvParameter1, uint32_t ulParameter2 )
* {
*     BaseType_t xInterfaceToService;
*
*     // The interface that requires servicing is passed in the second
*     // parameter. The first parameter is not used in this case.
*     xInterfaceToService = ( BaseType_t ) ulParameter2;
*
*     // ...Perform the processing here...
* }
*
* // An ISR that receives data packets from multiple interfaces
* void vAnISR( void )
* {
*     BaseType_t xInterfaceToService, xHigherPriorityTaskWoken;
*
*     // Query the hardware to determine which interface needs processing.
*     xInterfaceToService = prvCheckInterfaces();
*
*     // The actual processing is to be deferred to a task. Request the
*     // vProcessInterface() callback function is executed, passing in the
*     // number of the interface that needs processing. The interface to
*     // service is passed in the second parameter. The first parameter is
*     // not used in this case.
*     xHigherPriorityTaskWoken = pdFALSE;
*     xTimerPendFunctionCallFromISR( vProcessInterface, NULL, ( uint32_t )
* xInterfaceToService, &xHigherPriorityTaskWoken );
*
*     // If xHigherPriorityTaskWoken is now set to pdTRUE then a context
*     // switch should be requested. The macro used is port specific and will
*     // be either portYIELD_FROM_ISR() or portEND_SWITCHING_ISR() - refer to
*     // the documentation page for the port being used.
*     portYIELD_FROM_ISR( xHigherPriorityTaskWoken );
* }
*

```

**Parameters**

- **xFunctionToPend** –The function to execute from the timer service/ daemon task. The function must conform to the PendedFunction\_t prototype.
- **pvParameter1** –The value of the callback function' s first parameter. The parameter has a void \* type to allow it to be used to pass any type. For example, unsigned longs can be cast to a void \*, or the void \* can be used to point to a structure.
- **ulParameter2** –The value of the callback function' s second parameter.
- **pxHigherPriorityTaskWoken** –As mentioned above, calling this function will result in a message being sent to the timer daemon task. If the priority of the timer daemon task (which is set using configTIMER\_TASK\_PRIORITY in FreeRTOSConfig.h) is higher than the priority of the currently running task (the task the interrupt interrupted) then \*pxHigherPriorityTaskWoken will be set to pdTRUE within xTimerPendFunctionCallFromISR(), indicating that a context switch should be requested before the interrupt exits. For that reason \*pxHigherPriorityTaskWoken must be initialised to pdFALSE. See the example code below.

**Returns** pdPASS is returned if the message was successfully sent to the timer daemon task, otherwise pdFALSE is returned.

BaseType\_t **xTimerPendFunctionCall** (*PendedFunction\_t* xFunctionToPend, void \*pvParameter1, uint32\_t ulParameter2, TickType\_t xTicksToWait)

BaseType\_t xTimerPendFunctionCall( PendedFunction\_t xFunctionToPend, void \*pvParameter1, uint32\_t ulParameter2, TickType\_t xTicksToWait );

Used to defer the execution of a function to the RTOS daemon task (the timer service task, hence this function is implemented in timers.c and is prefixed with 'Timer' ).

#### Parameters

- **xFunctionToPend** –The function to execute from the timer service/ daemon task. The function must conform to the PendedFunction\_t prototype.
- **pvParameter1** –The value of the callback function's first parameter. The parameter has a void \* type to allow it to be used to pass any type. For example, unsigned longs can be cast to a void \*, or the void \* can be used to point to a structure.
- **ulParameter2** –The value of the callback function's second parameter.
- **xTicksToWait** –Calling this function will result in a message being sent to the timer daemon task on a queue. xTicksToWait is the amount of time the calling task should remain in the Blocked state (so not using any processing time) for space to become available on the timer queue if the queue is found to be full.

**Returns** pdPASS is returned if the message was successfully sent to the timer daemon task, otherwise pdFALSE is returned.

const char \***pcTimerGetName** (*TimerHandle\_t* xTimer)  
const char \* const pcTimerGetName( TimerHandle\_t xTimer );

Returns the name that was assigned to a timer when the timer was created.

**Parameters** **xTimer** –The handle of the timer being queried.

**Returns** The name assigned to the timer specified by the xTimer parameter.

void **vTimerSetReloadMode** (*TimerHandle\_t* xTimer, const UBaseType\_t uxAutoReload)  
void vTimerSetReloadMode( TimerHandle\_t xTimer, const UBaseType\_t uxAutoReload );

Updates a timer to be either an auto-reload timer, in which case the timer automatically resets itself each time it expires, or a one-shot timer, in which case the timer will only expire once unless it is manually restarted.

#### Parameters

- **xTimer** –The handle of the timer being updated.
- **uxAutoReload** –If uxAutoReload is set to pdTRUE then the timer will expire repeatedly with a frequency set by the timer's period (see the xTimerPeriodInTicks parameter of the xTimerCreate() API function). If uxAutoReload is set to pdFALSE then the timer will be a one-shot timer and enter the dormant state after it expires.

UBaseType\_t **uxTimerGetReloadMode** (*TimerHandle\_t* xTimer)  
UBaseType\_t uxTimerGetReloadMode( TimerHandle\_t xTimer );

Queries a timer to determine if it is an auto-reload timer, in which case the timer automatically resets itself each time it expires, or a one-shot timer, in which case the timer will only expire once unless it is manually restarted.

**Parameters** **xTimer** –The handle of the timer being queried.

**Returns** If the timer is an auto-reload timer then pdTRUE is returned, otherwise pdFALSE is returned.

TickType\_t **xTimerGetPeriod** (*TimerHandle\_t* xTimer)  
TickType\_t xTimerGetPeriod( TimerHandle\_t xTimer );

Returns the period of a timer.

**Parameters** **xTimer** –The handle of the timer being queried.

**Returns** The period of the timer in ticks.

TickType\_t **xTimerGetExpiryTime** (*TimerHandle\_t* xTimer)

TickType\_t xTimerGetExpiryTime( TimerHandle\_t xTimer );

Returns the time in ticks at which the timer will expire. If this is less than the current tick count then the expiry time has overflowed from the current time.

**Parameters** **xTimer** –The handle of the timer being queried.

**Returns** If the timer is running then the time in ticks at which the timer will next expire is returned.

If the timer is not running then the return value is undefined.

void **vApplicationGetTimerTaskMemory** (StaticTask\_t \*\*ppxTimerTaskTCBBuffer, StackType\_t \*\*ppxTimerTaskStackBuffer, uint32\_t \*pulTimerTaskStackSize)

This function is used to provide a statically allocated block of memory to FreeRTOS to hold the Timer Task TCB. This function is required when configSUPPORT\_STATIC\_ALLOCATION is set. For more information see this URI: [https://www.FreeRTOS.org/a00110.html#configSUPPORT\\_STATIC\\_ALLOCATION](https://www.FreeRTOS.org/a00110.html#configSUPPORT_STATIC_ALLOCATION)

#### Parameters

- **ppxTimerTaskTCBBuffer** –A handle to a statically allocated TCB buffer
- **ppxTimerTaskStackBuffer** –A handle to a statically allocated Stack buffer for this idle task
- **pulTimerTaskStackSize** –A pointer to the number of elements that will fit in the allocated stack buffer

#### Macros

tmrCOMMAND\_EXECUTE\_CALLBACK\_FROM\_ISR

tmrCOMMAND\_EXECUTE\_CALLBACK

tmrCOMMAND\_START\_DONT\_TRACE

tmrCOMMAND\_START

tmrCOMMAND\_RESET

tmrCOMMAND\_STOP

tmrCOMMAND\_CHANGE\_PERIOD

tmrCOMMAND\_DELETE

tmrFIRST\_FROM\_ISR\_COMMAND

tmrCOMMAND\_START\_FROM\_ISR

tmrCOMMAND\_RESET\_FROM\_ISR

tmrCOMMAND\_STOP\_FROM\_ISR

tmrCOMMAND\_CHANGE\_PERIOD\_FROM\_ISR

**xTimerStart** (xTimer, xTicksToWait)

```
 BaseType_t xTimerStart( TimerHandle_t xTimer, TickType_t xTicksToWait );
```

Timer functionality is provided by a timer service/daemon task. Many of the public FreeRTOS timer API functions send commands to the timer service task through a queue called the timer command queue. The timer command queue is private to the kernel itself and is not directly accessible to application code. The length of the timer command queue is set by the configTIMER\_QUEUE\_LENGTH configuration constant.

xTimerStart() starts a timer that was previously created using the xTimerCreate() API function. If the timer had already been started and was already in the active state, then xTimerStart() has equivalent functionality to the xTimerReset() API function.

Starting a timer ensures the timer is in the active state. If the timer is not stopped, deleted, or reset in the mean time, the callback function associated with the timer will get called 'n' ticks after xTimerStart() was called, where 'n' is the timers defined period.

It is valid to call xTimerStart() before the scheduler has been started, but when this is done the timer will not actually start until the scheduler is started, and the timers expiry time will be relative to when the scheduler is started, not relative to when xTimerStart() was called.

The configUSE\_TIMERS configuration constant must be set to 1 for xTimerStart() to be available.

Example usage:

See the xTimerCreate() API function example usage scenario.

**Parameters**

- **xTimer** –The handle of the timer being started/restarted.
- **xTicksToWait** –Specifies the time, in ticks, that the calling task should be held in the Blocked state to wait for the start command to be successfully sent to the timer command queue, should the queue already be full when xTimerStart() was called. xTicksToWait is ignored if xTimerStart() is called before the scheduler is started.

**Returns** pdFAIL will be returned if the start command could not be sent to the timer command queue even after xTicksToWait ticks had passed. pdPASS will be returned if the command was successfully sent to the timer command queue. When the command is actually processed will depend on the priority of the timer service/daemon task relative to other tasks in the system, although the timers expiry time is relative to when xTimerStart() is actually called. The timer service/daemon task priority is set by the configTIMER\_TASK\_PRIORITY configuration constant.

**xTimerStop** (xTimer, xTicksToWait)

```
 BaseType_t xTimerStop( TimerHandle_t xTimer, TickType_t xTicksToWait );
```

Timer functionality is provided by a timer service/daemon task. Many of the public FreeRTOS timer API functions send commands to the timer service task through a queue called the timer command queue. The timer command queue is private to the kernel itself and is not directly accessible to application code. The length of the timer command queue is set by the configTIMER\_QUEUE\_LENGTH configuration constant.

xTimerStop() stops a timer that was previously started using either of the The xTimerStart(), xTimerReset(), xTimerStartFromISR(), xTimerResetFromISR(), xTimerChangePeriod() or xTimerChangePeriodFromISR() API functions.

Stopping a timer ensures the timer is not in the active state.

The configUSE\_TIMERS configuration constant must be set to 1 for xTimerStop() to be available.

Example usage:

See the xTimerCreate() API function example usage scenario.

**Parameters**

- **xTimer** –The handle of the timer being stopped.

- **xTicksToWait** – Specifies the time, in ticks, that the calling task should be held in the Blocked state to wait for the stop command to be successfully sent to the timer command queue, should the queue already be full when xTimerStop() was called. xTicksToWait is ignored if xTimerStop() is called before the scheduler is started.

**Returns** pdFAIL will be returned if the stop command could not be sent to the timer command queue even after xTicksToWait ticks had passed. pdPASS will be returned if the command was successfully sent to the timer command queue. When the command is actually processed will depend on the priority of the timer service/daemon task relative to other tasks in the system. The timer service/daemon task priority is set by the configTIMER\_TASK\_PRIORITY configuration constant.

**xTimerChangePeriod** (xTimer, xNewPeriod, xTicksToWait)

BaseType\_t xTimerChangePeriod( TimerHandle\_t xTimer, TickType\_t xNewPeriod, TickType\_t xTicksToWait );

Timer functionality is provided by a timer service/daemon task. Many of the public FreeRTOS timer API functions send commands to the timer service task through a queue called the timer command queue. The timer command queue is private to the kernel itself and is not directly accessible to application code. The length of the timer command queue is set by the configTIMER\_QUEUE\_LENGTH configuration constant.

xTimerChangePeriod() changes the period of a timer that was previously created using the xTimerCreate() API function.

xTimerChangePeriod() can be called to change the period of an active or dormant state timer.

The configUSE\_TIMERS configuration constant must be set to 1 for xTimerChangePeriod() to be available.

Example usage:

```
* // This function assumes xTimer has already been created.  If the timer
* // referenced by xTimer is already active when it is called, then the timer
* // is deleted.  If the timer referenced by xTimer is not active when it is
* // called, then the period of the timer is set to 500ms and the timer is
* // started.
* void vAFunction( TimerHandle_t xTimer )
* {
*     if( xTimerIsTimerActive( xTimer ) != pdFALSE ) // or more simply and
↳equivalently "if( xTimerIsTimerActive( xTimer ) )"
*     {
*         // xTimer is already active - delete it.
*         xTimerDelete( xTimer );
*     }
*     else
*     {
*         // xTimer is not active, change its period to 500ms.  This will also
*         // cause the timer to start.  Block for a maximum of 100 ticks if the
*         // change period command cannot immediately be sent to the timer
*         // command queue.
*         if( xTimerChangePeriod( xTimer, 500 / portTICK_PERIOD_MS, 100 ) ==
↳pdPASS )
*         {
*             // The command was successfully sent.
*         }
*         else
*         {
*             // The command could not be sent, even after waiting for 100
↳ticks
*             // to pass.  Take appropriate action here.
*         }
*     }
* }
* }
```



**Parameters**

- **xTimer** –The handle of the timer that is having its period changed.
- **xNewPeriod** –The new period for xTimer. Timer periods are specified in tick periods, so the constant portTICK\_PERIOD\_MS can be used to convert a time that has been specified in milliseconds. For example, if the timer must expire after 100 ticks, then xNewPeriod should be set to 100. Alternatively, if the timer must expire after 500ms, then xNewPeriod can be set to ( 500 / portTICK\_PERIOD\_MS ) provided configTICK\_RATE\_HZ is less than or equal to 1000.
- **xTicksToWait** –Specifies the time, in ticks, that the calling task should be held in the Blocked state to wait for the change period command to be successfully sent to the timer command queue, should the queue already be full when xTimerChangePeriod() was called. xTicksToWait is ignored if xTimerChangePeriod() is called before the scheduler is started.

**Returns** pdFAIL will be returned if the change period command could not be sent to the timer command queue even after xTicksToWait ticks had passed. pdPASS will be returned if the command was successfully sent to the timer command queue. When the command is actually processed will depend on the priority of the timer service/daemon task relative to other tasks in the system. The timer service/daemon task priority is set by the configTIMER\_TASK\_PRIORITY configuration constant.

**xTimerDelete** (xTimer, xTicksToWait)

BaseType\_t xTimerDelete( TimerHandle\_t xTimer, TickType\_t xTicksToWait );

Timer functionality is provided by a timer service/daemon task. Many of the public FreeRTOS timer API functions send commands to the timer service task through a queue called the timer command queue. The timer command queue is private to the kernel itself and is not directly accessible to application code. The length of the timer command queue is set by the configTIMER\_QUEUE\_LENGTH configuration constant.

xTimerDelete() deletes a timer that was previously created using the xTimerCreate() API function.

The configUSE\_TIMERS configuration constant must be set to 1 for xTimerDelete() to be available.

Example usage:

See the xTimerChangePeriod() API function example usage scenario.

**Parameters**

- **xTimer** –The handle of the timer being deleted.
- **xTicksToWait** –Specifies the time, in ticks, that the calling task should be held in the Blocked state to wait for the delete command to be successfully sent to the timer command queue, should the queue already be full when xTimerDelete() was called. xTicksToWait is ignored if xTimerDelete() is called before the scheduler is started.

**Returns** pdFAIL will be returned if the delete command could not be sent to the timer command queue even after xTicksToWait ticks had passed. pdPASS will be returned if the command was successfully sent to the timer command queue. When the command is actually processed will depend on the priority of the timer service/daemon task relative to other tasks in the system. The timer service/daemon task priority is set by the configTIMER\_TASK\_PRIORITY configuration constant.

**xTimerReset** (xTimer, xTicksToWait)

BaseType\_t xTimerReset( TimerHandle\_t xTimer, TickType\_t xTicksToWait );

Timer functionality is provided by a timer service/daemon task. Many of the public FreeRTOS timer API functions send commands to the timer service task through a queue called the timer command queue. The timer command queue is private to the kernel itself and is not directly accessible to application code. The length of the timer command queue is set by the configTIMER\_QUEUE\_LENGTH configuration constant.

xTimerReset() re-starts a timer that was previously created using the xTimerCreate() API function. If the timer had already been started and was already in the active state, then xTimerReset() will cause the timer to re-evaluate its expiry time so that it is relative to when xTimerReset() was called. If the timer was in the dormant state then xTimerReset() has equivalent functionality to the xTimerStart() API function.

Resetting a timer ensures the timer is in the active state. If the timer is not stopped, deleted, or reset in the mean time, the callback function associated with the timer will get called ‘n’ ticks after xTimerReset() was called, where ‘n’ is the timers defined period.

It is valid to call xTimerReset() before the scheduler has been started, but when this is done the timer will not actually start until the scheduler is started, and the timers expiry time will be relative to when the scheduler is started, not relative to when xTimerReset() was called.

The configUSE\_TIMERS configuration constant must be set to 1 for xTimerReset() to be available.

Example usage:

```
* // When a key is pressed, an LCD back-light is switched on. If 5 seconds
* pass
* // without a key being pressed, then the LCD back-light is switched off. In
* // this case, the timer is a one-shot timer.
*
* TimerHandle_t xBacklightTimer = NULL;
*
* // The callback function assigned to the one-shot timer. In this case the
* // parameter is not used.
* void vBacklightTimerCallback( TimerHandle_t pxTimer )
* {
*     // The timer expired, therefore 5 seconds must have passed since a key
*     // was pressed. Switch off the LCD back-light.
*     vSetBacklightState( BACKLIGHT_OFF );
* }
*
* // The key press event handler.
* void vKeyPressEventHandler( char cKey )
* {
*     // Ensure the LCD back-light is on, then reset the timer that is
*     // responsible for turning the back-light off after 5 seconds of
*     // key inactivity. Wait 10 ticks for the command to be successfully sent
*     // if it cannot be sent immediately.
*     vSetBacklightState( BACKLIGHT_ON );
*     if( xTimerReset( xBacklightTimer, 100 ) != pdPASS )
*     {
*         // The reset command was not executed successfully. Take appropriate
*         // action here.
*     }
*
*     // Perform the rest of the key processing here.
* }
*
* void main( void )
* {
*     int32_t x;
*
*     // Create then start the one-shot timer that is responsible for turning
*     // the back-light off if no keys are pressed within a 5 second period.
*     xBacklightTimer = xTimerCreate( "BacklightTimer",           // Just a
* text name, not used by the kernel.
*                                     ( 5000 / portTICK_PERIOD_MS), // The
* timer period in ticks.
*                                     pdFALSE,                       // The timer
* is a one-shot timer.
*                                     0,                             // The id is
* not used by the callback so can take any value.
*                                     vBacklightTimerCallback       // The
* callback function that switches the LCD back-light off.
*                                     );
```

(continues on next page)

(continued from previous page)

```

*
*   if( xBacklightTimer == NULL )
*   {
*       // The timer was not created.
*   }
*   else
*   {
*       // Start the timer. No block time is specified, and even if one was
*       // it would be ignored because the scheduler has not yet been
*       // started.
*       if( xTimerStart( xBacklightTimer, 0 ) != pdPASS )
*       {
*           // The timer could not be set into the Active state.
*       }
*   }
*
*   // ...
*   // Create tasks here.
*   // ...
*
*   // Starting the scheduler will start the timer running as it has already
*   // been set into the active state.
*   vTaskStartScheduler();
*
*   // Should not reach here.
*   for( ;; );
* }
*

```

**Parameters**

- **xTimer** –The handle of the timer being reset/started/restarted.
- **xTicksToWait** –Specifies the time, in ticks, that the calling task should be held in the Blocked state to wait for the reset command to be successfully sent to the timer command queue, should the queue already be full when xTimerReset() was called. xTicksToWait is ignored if xTimerReset() is called before the scheduler is started.

**Returns** pdFAIL will be returned if the reset command could not be sent to the timer command queue even after xTicksToWait ticks had passed. pdPASS will be returned if the command was successfully sent to the timer command queue. When the command is actually processed will depend on the priority of the timer service/daemon task relative to other tasks in the system, although the timers expiry time is relative to when xTimerStart() is actually called. The timer service/daemon task priority is set by the configTIMER\_TASK\_PRIORITY configuration constant.

**xTimerStartFromISR** (xTimer, pxHigherPriorityTaskWoken)

BaseType\_t xTimerStartFromISR( TimerHandle\_t xTimer, BaseType\_t \*pxHigherPriorityTaskWoken );

A version of xTimerStart() that can be called from an interrupt service routine.

**Example usage:**

```

* // This scenario assumes xBacklightTimer has already been created. When a
* // key is pressed, an LCD back-light is switched on. If 5 seconds pass
* // without a key being pressed, then the LCD back-light is switched off. In
* // this case, the timer is a one-shot timer, and unlike the example given for
* // the xTimerReset() function, the key press event handler is an interrupt
* // service routine.
*
* // The callback function assigned to the one-shot timer. In this case the

```

(continues on next page)

```

* // parameter is not used.
* void vBacklightTimerCallback( TimerHandle_t pxTimer )
* {
*     // The timer expired, therefore 5 seconds must have passed since a key
*     // was pressed. Switch off the LCD back-light.
*     vSetBacklightState( BACKLIGHT_OFF );
* }
*
* // The key press interrupt service routine.
* void vKeyPressEventInterruptHandler( void )
* {
*     BaseType_t xHigherPriorityTaskWoken = pdFALSE;
*
*     // Ensure the LCD back-light is on, then restart the timer that is
*     // responsible for turning the back-light off after 5 seconds of
*     // key inactivity. This is an interrupt service routine so can only
*     // call FreeRTOS API functions that end in "FromISR".
*     vSetBacklightState( BACKLIGHT_ON );
*
*     // xTimerStartFromISR() or xTimerResetFromISR() could be called here
*     // as both cause the timer to re-calculate its expiry time.
*     // xHigherPriorityTaskWoken was initialised to pdFALSE when it was
*     // declared (in this function).
*     if( xTimerStartFromISR( xBacklightTimer, &xHigherPriorityTaskWoken ) !=
↳pdPASS )
*     {
*         // The start command was not executed successfully. Take appropriate
*         // action here.
*     }
*
*     // Perform the rest of the key processing here.
*
*     // If xHigherPriorityTaskWoken equals pdTRUE, then a context switch
*     // should be performed. The syntax required to perform a context switch
*     // from inside an ISR varies from port to port, and from compiler to
*     // compiler. Inspect the demos for the port you are using to find the
*     // actual syntax required.
*     if( xHigherPriorityTaskWoken != pdFALSE )
*     {
*         // Call the interrupt safe yield function here (actual function
*         // depends on the FreeRTOS port being used).
*     }
* }
*

```

### Parameters

- **xTimer** –The handle of the timer being started/restarted.
- **pxHigherPriorityTaskWoken** –The timer service/daemon task spends most of its time in the Blocked state, waiting for messages to arrive on the timer command queue. Calling xTimerStartFromISR() writes a message to the timer command queue, so has the potential to transition the timer service/daemon task out of the Blocked state. If calling xTimerStartFromISR() causes the timer service/daemon task to leave the Blocked state, and the timer service/ daemon task has a priority equal to or greater than the currently executing task (the task that was interrupted), then \*pxHigherPriorityTaskWoken will get set to pdTRUE internally within the xTimerStartFromISR() function. If xTimerStartFromISR() sets this value to pdTRUE then a context switch should be performed before the interrupt exits.

**Returns** pdFAIL will be returned if the start command could not be sent to the timer command queue. pdPASS will be returned if the command was successfully sent to the timer command queue. When the command is actually processed will depend on the priority of the timer ser-

vice/daemon task relative to other tasks in the system, although the timers expiry time is relative to when `xTimerStartFromISR()` is actually called. The timer service/daemon task priority is set by the `configTIMER_TASK_PRIORITY` configuration constant.

#### **xTimerStopFromISR** (xTimer, pxHigherPriorityTaskWoken)

BaseType\_t xTimerStopFromISR( TimerHandle\_t xTimer, BaseType\_t \*pxHigherPriorityTaskWoken );

A version of `xTimerStop()` that can be called from an interrupt service routine.

Example usage:

```
* // This scenario assumes xTimer has already been created and started. When
* // an interrupt occurs, the timer should be simply stopped.
*
* // The interrupt service routine that stops the timer.
* void vAnExampleInterruptServiceRoutine( void )
* {
* BaseType_t xHigherPriorityTaskWoken = pdFALSE;
*
* // The interrupt has occurred - simply stop the timer.
* // xHigherPriorityTaskWoken was set to pdFALSE where it was defined
* // (within this function). As this is an interrupt service routine, only
* // FreeRTOS API functions that end in "FromISR" can be used.
* if( xTimerStopFromISR( xTimer, &xHigherPriorityTaskWoken ) != pdPASS )
* {
* // The stop command was not executed successfully. Take appropriate
* // action here.
* }
*
* // If xHigherPriorityTaskWoken equals pdTRUE, then a context switch
* // should be performed. The syntax required to perform a context switch
* // from inside an ISR varies from port to port, and from compiler to
* // compiler. Inspect the demos for the port you are using to find the
* // actual syntax required.
* if( xHigherPriorityTaskWoken != pdFALSE )
* {
* // Call the interrupt safe yield function here (actual function
* // depends on the FreeRTOS port being used).
* }
* }
*
```

#### Parameters

- **xTimer** –The handle of the timer being stopped.
- **pxHigherPriorityTaskWoken** –The timer service/daemon task spends most of its time in the Blocked state, waiting for messages to arrive on the timer command queue. Calling `xTimerStopFromISR()` writes a message to the timer command queue, so has the potential to transition the timer service/daemon task out of the Blocked state. If calling `xTimerStopFromISR()` causes the timer service/daemon task to leave the Blocked state, and the timer service/ daemon task has a priority equal to or greater than the currently executing task (the task that was interrupted), then `*pxHigherPriorityTaskWoken` will get set to `pdTRUE` internally within the `xTimerStopFromISR()` function. If `xTimerStopFromISR()` sets this value to `pdTRUE` then a context switch should be performed before the interrupt exits.

**Returns** `pdFAIL` will be returned if the stop command could not be sent to the timer command queue. `pdPASS` will be returned if the command was successfully sent to the timer command queue. When the command is actually processed will depend on the priority of the timer service/daemon task relative to other tasks in the system. The timer service/daemon task priority is set by the `configTIMER_TASK_PRIORITY` configuration constant.

**xTimerChangePeriodFromISR** (xTimer, xNewPeriod, pxHigherPriorityTaskWoken)

```
BaseType_t xTimerChangePeriodFromISR( TimerHandle_t xTimer, TickType_t xNewPeriod, BaseType_t
*pxHigherPriorityTaskWoken );
```

A version of xTimerChangePeriod() that can be called from an interrupt service routine.

Example usage:

```
* // This scenario assumes xTimer has already been created and started. When
* // an interrupt occurs, the period of xTimer should be changed to 500ms.
*
* // The interrupt service routine that changes the period of xTimer.
* void vAnExampleInterruptServiceRoutine( void )
* {
* BaseType_t xHigherPriorityTaskWoken = pdFALSE;
*
* // The interrupt has occurred - change the period of xTimer to 500ms.
* // xHigherPriorityTaskWoken was set to pdFALSE where it was defined
* // (within this function). As this is an interrupt service routine, only
* // FreeRTOS API functions that end in "FromISR" can be used.
* if( xTimerChangePeriodFromISR( xTimer, &xHigherPriorityTaskWoken ) !=
↳pdPASS )
* {
* // The command to change the timers period was not executed
* // successfully. Take appropriate action here.
* }
*
* // If xHigherPriorityTaskWoken equals pdTRUE, then a context switch
* // should be performed. The syntax required to perform a context switch
* // from inside an ISR varies from port to port, and from compiler to
* // compiler. Inspect the demos for the port you are using to find the
* // actual syntax required.
* if( xHigherPriorityTaskWoken != pdFALSE )
* {
* // Call the interrupt safe yield function here (actual function
* // depends on the FreeRTOS port being used).
* }
* }
*
```

**Parameters**

- **xTimer** –The handle of the timer that is having its period changed.
- **xNewPeriod** –The new period for xTimer. Timer periods are specified in tick periods, so the constant portTICK\_PERIOD\_MS can be used to convert a time that has been specified in milliseconds. For example, if the timer must expire after 100 ticks, then xNewPeriod should be set to 100. Alternatively, if the timer must expire after 500ms, then xNewPeriod can be set to ( 500 / portTICK\_PERIOD\_MS ) provided configTICK\_RATE\_HZ is less than or equal to 1000.
- **pxHigherPriorityTaskWoken** –The timer service/daemon task spends most of its time in the Blocked state, waiting for messages to arrive on the timer command queue. Calling xTimerChangePeriodFromISR() writes a message to the timer command queue, so has the potential to transition the timer service/ daemon task out of the Blocked state. If calling xTimerChangePeriodFromISR() causes the timer service/daemon task to leave the Blocked state, and the timer service/daemon task has a priority equal to or greater than the currently executing task (the task that was interrupted), then \*pxHigherPriorityTaskWoken will get set to pdTRUE internally within the xTimerChangePeriodFromISR() function. If xTimerChangePeriodFromISR() sets this value to pdTRUE then a context switch should be performed before the interrupt exits.

**Returns** pdFAIL will be returned if the command to change the timers period could not be sent to the timer command queue. pdPASS will be returned if the command was successfully sent

to the timer command queue. When the command is actually processed will depend on the priority of the timer service/daemon task relative to other tasks in the system. The timer service/daemon task priority is set by the configTIMER\_TASK\_PRIORITY configuration constant.

#### **xTimerResetFromISR** (xTimer, pxHigherPriorityTaskWoken)

BaseType\_t xTimerResetFromISR( TimerHandle\_t xTimer, BaseType\_t \*pxHigherPriorityTaskWoken );

A version of xTimerReset() that can be called from an interrupt service routine.

Example usage:

```
* // This scenario assumes xBacklightTimer has already been created. When a
* // key is pressed, an LCD back-light is switched on. If 5 seconds pass
* // without a key being pressed, then the LCD back-light is switched off. In
* // this case, the timer is a one-shot timer, and unlike the example given for
* // the xTimerReset() function, the key press event handler is an interrupt
* // service routine.
*
* // The callback function assigned to the one-shot timer. In this case the
* // parameter is not used.
* void vBacklightTimerCallback( TimerHandle_t pxTimer )
* {
*     // The timer expired, therefore 5 seconds must have passed since a key
*     // was pressed. Switch off the LCD back-light.
*     vSetBacklightState( BACKLIGHT_OFF );
* }
*
* // The key press interrupt service routine.
* void vKeyPressEventInterruptHandler( void )
* {
*     BaseType_t xHigherPriorityTaskWoken = pdFALSE;
*
*     // Ensure the LCD back-light is on, then reset the timer that is
*     // responsible for turning the back-light off after 5 seconds of
*     // key inactivity. This is an interrupt service routine so can only
*     // call FreeRTOS API functions that end in "FromISR".
*     vSetBacklightState( BACKLIGHT_ON );
*
*     // xTimerStartFromISR() or xTimerResetFromISR() could be called here
*     // as both cause the timer to re-calculate its expiry time.
*     // xHigherPriorityTaskWoken was initialised to pdFALSE when it was
*     // declared (in this function).
*     if( xTimerResetFromISR( xBacklightTimer, &xHigherPriorityTaskWoken ) !=
↳pdPASS )
*     {
*         // The reset command was not executed successfully. Take appropriate
*         // action here.
*     }
*
*     // Perform the rest of the key processing here.
*
*     // If xHigherPriorityTaskWoken equals pdTRUE, then a context switch
*     // should be performed. The syntax required to perform a context switch
*     // from inside an ISR varies from port to port, and from compiler to
*     // compiler. Inspect the demos for the port you are using to find the
*     // actual syntax required.
*     if( xHigherPriorityTaskWoken != pdFALSE )
*     {
*         // Call the interrupt safe yield function here (actual function
*         // depends on the FreeRTOS port being used).
```

(continues on next page)



```
*     }
* }
*
```

### Parameters

- **xTimer** –The handle of the timer that is to be started, reset, or restarted.
- **pxHigherPriorityTaskWoken** –The timer service/daemon task spends most of its time in the Blocked state, waiting for messages to arrive on the timer command queue. Calling xTimerResetFromISR() writes a message to the timer command queue, so has the potential to transition the timer service/daemon task out of the Blocked state. If calling xTimerResetFromISR() causes the timer service/daemon task to leave the Blocked state, and the timer service/ daemon task has a priority equal to or greater than the currently executing task (the task that was interrupted), then \*pxHigherPriorityTaskWoken will get set to pdTRUE internally within the xTimerResetFromISR() function. If xTimerResetFromISR() sets this value to pdTRUE then a context switch should be performed before the interrupt exits.

**Returns** pdFAIL will be returned if the reset command could not be sent to the timer command queue. pdPASS will be returned if the command was successfully sent to the timer command queue. When the command is actually processed will depend on the priority of the timer service/daemon task relative to other tasks in the system, although the timers expiry time is relative to when xTimerResetFromISR() is actually called. The timer service/daemon task priority is set by the configTIMER\_TASK\_PRIORITY configuration constant.

### Type Definitions

```
typedef struct tmrTimerControl *TimerHandle_t
```

```
typedef void (*TimerCallbackFunction_t)(TimerHandle_t xTimer)
```

```
typedef void (*PendedFunction_t)(void*, uint32_t)
```

### Event Group API

#### Header File

- components/freertos/FreeRTOS-Kernel/include/freertos/event\_groups.h

#### Functions

*EventGroupHandle\_t* **xEventGroupCreate** (void)

Create a new event group.

Internally, within the FreeRTOS implementation, event groups use a [small] block of memory, in which the event group's structure is stored. If an event groups is created using xEventGroupCreate() then the required memory is automatically dynamically allocated inside the xEventGroupCreate() function. (see <https://www.FreeRTOS.org/a00111.html>). If an event group is created using xEventGroupCreateStatic() then the application writer must instead provide the memory that will get used by the event group. xEventGroupCreateStatic() therefore allows an event group to be created without using any dynamic memory allocation.

Although event groups are not related to ticks, for internal implementation reasons the number of bits available for use in an event group is dependent on the configUSE\_16\_BIT\_TICKS setting in FreeRTOSConfig.h. If configUSE\_16\_BIT\_TICKS is 1 then each event group contains 8 usable bits (bit 0 to bit 7). If configUSE\_16\_BIT\_TICKS is set to 0 then each event group has 24 usable bits (bit 0 to bit 23). The EventBits\_t type is used to store event bits within an event group.



Example usage:

```
// Declare a variable to hold the created event group.
EventGroupHandle_t xCreatedEventGroup;

// Attempt to create the event group.
xCreatedEventGroup = xEventGroupCreate();

// Was the event group created successfully?
if( xCreatedEventGroup == NULL )
{
    // The event group was not created because there was insufficient
    // FreeRTOS heap available.
}
else
{
    // The event group was created.
}
```

**Returns** If the event group was created then a handle to the event group is returned. If there was insufficient FreeRTOS heap available to create the event group then NULL is returned. See <https://www.FreeRTOS.org/a00111.html>

*EventGroupHandle\_t* **xEventGroupCreateStatic** (StaticEventGroup\_t \*pxEventGroupBuffer)

Create a new event group.

Internally, within the FreeRTOS implementation, event groups use a [small] block of memory, in which the event group's structure is stored. If an event group is created using xEventGroupCreate() then the required memory is automatically dynamically allocated inside the xEventGroupCreate() function. (see <https://www.FreeRTOS.org/a00111.html>). If an event group is created using xEventGroupCreateStatic() then the application writer must instead provide the memory that will get used by the event group. xEventGroupCreateStatic() therefore allows an event group to be created without using any dynamic memory allocation.

Although event groups are not related to ticks, for internal implementation reasons the number of bits available for use in an event group is dependent on the configUSE\_16\_BIT\_TICKS setting in FreeRTOSConfig.h. If configUSE\_16\_BIT\_TICKS is 1 then each event group contains 8 usable bits (bit 0 to bit 7). If configUSE\_16\_BIT\_TICKS is set to 0 then each event group has 24 usable bits (bit 0 to bit 23). The EventBits\_t type is used to store event bits within an event group.

Example usage:

```
// StaticEventGroup_t is a publicly accessible structure that has the same
// size and alignment requirements as the real event group structure. It is
// provided as a mechanism for applications to know the size of the event
// group (which is dependent on the architecture and configuration file
// settings) without breaking the strict data hiding policy by exposing the
// real event group internals. This StaticEventGroup_t variable is passed
// into the xSemaphoreCreateEventGroupStatic() function and is used to store
// the event group's data structures
StaticEventGroup_t xEventGroupBuffer;

// Create the event group without dynamically allocating any memory.
xEventGroup = xEventGroupCreateStatic( &xEventGroupBuffer );
```

**Parameters** **pxEventGroupBuffer** –pxEventGroupBuffer must point to a variable of type StaticEventGroup\_t, which will be then be used to hold the event group's data structures, removing the need for the memory to be allocated dynamically.

**Returns** If the event group was created then a handle to the event group is returned. If pxEventGroupBuffer was NULL then NULL is returned.

*EventBits\_t* **xEventGroupWaitBits** (*EventGroupHandle\_t* xEventGroup, const *EventBits\_t* uxBitsToWaitFor, const *BaseType\_t* xClearOnExit, const *BaseType\_t* xWaitForAllBits, *TickType\_t* xTicksToWait)

[Potentially] block to wait for one or more bits to be set within a previously created event group.

This function cannot be called from an interrupt.

Example usage:

```
#define BIT_0 ( 1 << 0 )
#define BIT_4 ( 1 << 4 )

void aFunction( EventGroupHandle_t xEventGroup )
{
    EventBits_t uxBits;
    const TickType_t xTicksToWait = 100 / portTICK_PERIOD_MS;

    // Wait a maximum of 100ms for either bit 0 or bit 4 to be set within
    // the event group. Clear the bits before exiting.
    uxBits = xEventGroupWaitBits(
        xEventGroup,    // The event group being tested.
        BIT_0 | BIT_4, // The bits within the event group to wait
        pdTRUE,        // BIT_0 and BIT_4 should be cleared before
        pdFALSE,       // Don't wait for both bits, either bit will
        xTicksToWait ); // Wait a maximum of 100ms for either bit to

    if( ( uxBits & ( BIT_0 | BIT_4 ) ) == ( BIT_0 | BIT_4 ) )
    {
        // xEventGroupWaitBits() returned because both bits were set.
    }
    else if( ( uxBits & BIT_0 ) != 0 )
    {
        // xEventGroupWaitBits() returned because just BIT_0 was set.
    }
    else if( ( uxBits & BIT_4 ) != 0 )
    {
        // xEventGroupWaitBits() returned because just BIT_4 was set.
    }
    else
    {
        // xEventGroupWaitBits() returned because xTicksToWait ticks passed
        // without either BIT_0 or BIT_4 becoming set.
    }
}
```

### Parameters

- **xEventGroup** –The event group in which the bits are being tested. The event group must have previously been created using a call to `xEventGroupCreate()`.
- **uxBitsToWaitFor** –A bitwise value that indicates the bit or bits to test inside the event group. For example, to wait for bit 0 and/or bit 2 set `uxBitsToWaitFor` to `0x05`. To wait for bits 0 and/or bit 1 and/or bit 2 set `uxBitsToWaitFor` to `0x07`. Etc.
- **xClearOnExit** –If `xClearOnExit` is set to `pdTRUE` then any bits within `uxBitsToWaitFor` that are set within the event group will be cleared before `xEventGroupWaitBits()` returns if the wait condition was met (if the function returns for a reason other than a timeout). If `xClearOnExit` is set to `pdFALSE` then the bits set in the event group are not altered when the call to `xEventGroupWaitBits()` returns.

- **xWaitForAllBits** –If xWaitForAllBits is set to pdTRUE then xEventGroupWaitBits() will return when either all the bits in uxBitsToWaitFor are set or the specified block time expires. If xWaitForAllBits is set to pdFALSE then xEventGroupWaitBits() will return when any one of the bits set in uxBitsToWaitFor is set or the specified block time expires. The block time is specified by the xTicksToWait parameter.
- **xTicksToWait** –The maximum amount of time (specified in ‘ticks’ ) to wait for one/all (depending on the xWaitForAllBits value) of the bits specified by uxBitsToWaitFor to become set.

**Returns** The value of the event group at the time either the bits being waited for became set, or the block time expired. Test the return value to know which bits were set. If xEventGroupWaitBits() returned because its timeout expired then not all the bits being waited for will be set. If xEventGroupWaitBits() returned because the bits it was waiting for were set then the returned value is the event group value before any bits were automatically cleared in the case that xClearOnExit parameter was set to pdTRUE.

*EventBits\_t* **xEventGroupClearBits** (*EventGroupHandle\_t* xEventGroup, const *EventBits\_t* uxBitsToClear)

Clear bits within an event group. This function cannot be called from an interrupt.

Example usage:

```
#define BIT_0 ( 1 << 0 )
#define BIT_4 ( 1 << 4 )

void aFunction( EventGroupHandle_t xEventGroup )
{
    EventBits_t uxBits;

    // Clear bit 0 and bit 4 in xEventGroup.
    uxBits = xEventGroupClearBits(
        xEventGroup, // The event group being updated.
        BIT_0 | BIT_4 ); // The bits being cleared.

    if( ( uxBits & ( BIT_0 | BIT_4 ) ) == ( BIT_0 | BIT_4 ) )
    {
        // Both bit 0 and bit 4 were set before xEventGroupClearBits() was
        // called. Both will now be clear (not set).
    }
    else if( ( uxBits & BIT_0 ) != 0 )
    {
        // Bit 0 was set before xEventGroupClearBits() was called. It will
        // now be clear.
    }
    else if( ( uxBits & BIT_4 ) != 0 )
    {
        // Bit 4 was set before xEventGroupClearBits() was called. It will
        // now be clear.
    }
    else
    {
        // Neither bit 0 nor bit 4 were set in the first place.
    }
}
```

#### Parameters

- **xEventGroup** –The event group in which the bits are to be cleared.
- **uxBitsToClear** –A bitwise value that indicates the bit or bits to clear in the event group. For example, to clear bit 3 only, set uxBitsToClear to 0x08. To clear bit 3 and bit 0 set uxBitsToClear to 0x09.

**Returns** The value of the event group before the specified bits were cleared.

**EventBits\_t xEventGroupSetBits** (*EventGroupHandle\_t* xEventGroup, const *EventBits\_t* uxBitsToSet)

Set bits within an event group. This function cannot be called from an interrupt. xEventGroupSetBits-FromISR() is a version that can be called from an interrupt.

Setting bits in an event group will automatically unblock tasks that are blocked waiting for the bits.

Example usage:

```
#define BIT_0 ( 1 << 0 )
#define BIT_4 ( 1 << 4 )

void aFunction( EventGroupHandle_t xEventGroup )
{
    EventBits_t uxBits;

    // Set bit 0 and bit 4 in xEventGroup.
    uxBits = xEventGroupSetBits(
        xEventGroup,    // The event group being updated.
        BIT_0 | BIT_4 ); // The bits being set.

    if( ( uxBits & ( BIT_0 | BIT_4 ) ) == ( BIT_0 | BIT_4 ) )
    {
        // Both bit 0 and bit 4 remained set when the function returned.
    }
    else if( ( uxBits & BIT_0 ) != 0 )
    {
        // Bit 0 remained set when the function returned, but bit 4 was
        // cleared. It might be that bit 4 was cleared automatically as a
        // task that was waiting for bit 4 was removed from the Blocked
        // state.
    }
    else if( ( uxBits & BIT_4 ) != 0 )
    {
        // Bit 4 remained set when the function returned, but bit 0 was
        // cleared. It might be that bit 0 was cleared automatically as a
        // task that was waiting for bit 0 was removed from the Blocked
        // state.
    }
    else
    {
        // Neither bit 0 nor bit 4 remained set. It might be that a task
        // was waiting for both of the bits to be set, and the bits were
        // cleared as the task left the Blocked state.
    }
}
```

### Parameters

- **xEventGroup** –The event group in which the bits are to be set.
- **uxBitsToSet** –A bitwise value that indicates the bit or bits to set. For example, to set bit 3 only, set uxBitsToSet to 0x08. To set bit 3 and bit 0 set uxBitsToSet to 0x09.

**Returns** The value of the event group at the time the call to xEventGroupSetBits() returns. There are two reasons why the returned value might have the bits specified by the uxBitsToSet parameter cleared. First, if setting a bit results in a task that was waiting for the bit leaving the blocked state then it is possible the bit will be cleared automatically (see the xClearBitOnExit parameter of xEventGroupWaitBits()). Second, any unblocked (or otherwise Ready state) task that has a priority above that of the task that called xEventGroupSetBits() will execute and may change the event group value before the call to xEventGroupSetBits() returns.

**EventBits\_t xEventGroupSync** (*EventGroupHandle\_t* xEventGroup, const *EventBits\_t* uxBitsToSet, const *EventBits\_t* uxBitsToWaitFor, *TickType\_t* xTicksToWait)

Atomically set bits within an event group, then wait for a combination of bits to be set within the same event group. This functionality is typically used to synchronise multiple tasks, where each task has to wait for the other tasks to reach a synchronisation point before proceeding.

This function cannot be used from an interrupt.

The function will return before its block time expires if the bits specified by the `uxBitsToWait` parameter are set, or become set within that time. In this case all the bits specified by `uxBitsToWait` will be automatically cleared before the function returns.

Example usage:

```
// Bits used by the three tasks.
#define TASK_0_BIT      ( 1 << 0 )
#define TASK_1_BIT      ( 1 << 1 )
#define TASK_2_BIT      ( 1 << 2 )

#define ALL_SYNC_BITS ( TASK_0_BIT | TASK_1_BIT | TASK_2_BIT )

// Use an event group to synchronise three tasks. It is assumed this event
// group has already been created elsewhere.
EventGroupHandle_t xEventBits;

void vTask0( void *pvParameters )
{
    EventBits_t uxReturn;
    TickType_t xTicksToWait = 100 / portTICK_PERIOD_MS;

    for( ;; )
    {
        // Perform task functionality here.

        // Set bit 0 in the event flag to note this task has reached the
        // sync point. The other two tasks will set the other two bits defined
        // by ALL_SYNC_BITS. All three tasks have reached the synchronisation
        // point when all the ALL_SYNC_BITS are set. Wait a maximum of 100ms
        // for this to happen.
        uxReturn = xEventGroupSync( xEventBits, TASK_0_BIT, ALL_SYNC_BITS,
        ↪xTicksToWait );

        if( ( uxReturn & ALL_SYNC_BITS ) == ALL_SYNC_BITS )
        {
            // All three tasks reached the synchronisation point before the call
            // to xEventGroupSync() timed out.
        }
    }
}

void vTask1( void *pvParameters )
{
    for( ;; )
    {
        // Perform task functionality here.

        // Set bit 1 in the event flag to note this task has reached the
        // synchronisation point. The other two tasks will set the other two
        // bits defined by ALL_SYNC_BITS. All three tasks have reached the
        // synchronisation point when all the ALL_SYNC_BITS are set. Wait
        // indefinitely for this to happen.
        xEventGroupSync( xEventBits, TASK_1_BIT, ALL_SYNC_BITS, portMAX_DELAY );
    }
}
```

(continues on next page)

(continued from previous page)

```

// xEventGroupSync() was called with an indefinite block time, so
// this task will only reach here if the synchronisation was made by all
// three tasks, so there is no need to test the return value.
}
}

void vTask2( void *pvParameters )
{
    for( ;; )
    {
        // Perform task functionality here.

        // Set bit 2 in the event flag to note this task has reached the
        // synchronisation point. The other two tasks will set the other two
        // bits defined by ALL_SYNC_BITS. All three tasks have reached the
        // synchronisation point when all the ALL_SYNC_BITS are set. Wait
        // indefinitely for this to happen.
        xEventGroupSync( xEventBits, TASK_2_BIT, ALL_SYNC_BITS, portMAX_DELAY );

        // xEventGroupSync() was called with an indefinite block time, so
        // this task will only reach here if the synchronisation was made by all
        // three tasks, so there is no need to test the return value.
    }
}

```

**Parameters**

- **xEventGroup** –The event group in which the bits are being tested. The event group must have previously been created using a call to `xEventGroupCreate()`.
- **uxBitsToSet** –The bits to set in the event group before determining if, and possibly waiting for, all the bits specified by the `uxBitsToWait` parameter are set.
- **uxBitsToWaitFor** –A bitwise value that indicates the bit or bits to test inside the event group. For example, to wait for bit 0 and bit 2 set `uxBitsToWaitFor` to 0x05. To wait for bits 0 and bit 1 and bit 2 set `uxBitsToWaitFor` to 0x07. Etc.
- **xTicksToWait** –The maximum amount of time (specified in ‘ticks’) to wait for all of the bits specified by `uxBitsToWaitFor` to become set.

**Returns** The value of the event group at the time either the bits being waited for became set, or the block time expired. Test the return value to know which bits were set. If `xEventGroupSync()` returned because its timeout expired then not all the bits being waited for will be set. If `xEventGroupSync()` returned because all the bits it was waiting for were set then the returned value is the event group value before any bits were automatically cleared.

*EventBits\_t* **xEventGroupGetBitsFromISR** (*EventGroupHandle\_t* xEventGroup)

A version of `xEventGroupGetBits()` that can be called from an ISR.

**Parameters** **xEventGroup** –The event group being queried.

**Returns** The event group bits at the time `xEventGroupGetBitsFromISR()` was called.

**void vEventGroupDelete** (*EventGroupHandle\_t* xEventGroup)

Delete an event group that was previously created by a call to `xEventGroupCreate()`. Tasks that are blocked on the event group will be unblocked and obtain 0 as the event group’s value.

**Parameters** **xEventGroup** –The event group being deleted.

**Macros**

**xEventGroupClearBitsFromISR** (xEventGroup, uxBitsToClear)

A version of `xEventGroupClearBits()` that can be called from an interrupt.

Setting bits in an event group is not a deterministic operation because there are an unknown number of tasks that may be waiting for the bit or bits being set. FreeRTOS does not allow nondeterministic operations to be

performed while interrupts are disabled, so protects event groups that are accessed from tasks by suspending the scheduler rather than disabling interrupts. As a result event groups cannot be accessed directly from an interrupt service routine. Therefore `xEventGroupClearBitsFromISR()` sends a message to the timer task to have the clear operation performed in the context of the timer task.

Example usage:

```
#define BIT_0 ( 1 << 0 )
#define BIT_4 ( 1 << 4 )

// An event group which it is assumed has already been created by a call to
// xEventGroupCreate().
EventGroupHandle_t xEventGroup;

void anInterruptHandler( void )
{
    // Clear bit 0 and bit 4 in xEventGroup.
    xResult = xEventGroupClearBitsFromISR(
        xEventGroup,    // The event group being updated.
        BIT_0 | BIT_4 ); // The bits being set.

    if( xResult == pdPASS )
    {
        // The message was posted successfully.
    }
}
```

#### Parameters

- **xEventGroup** –The event group in which the bits are to be cleared.
- **uxBitsToClear** –A bitwise value that indicates the bit or bits to clear. For example, to clear bit 3 only, set `uxBitsToClear` to `0x08`. To clear bit 3 and bit 0 set `uxBitsToClear` to `0x09`.

**Returns** If the request to execute the function was posted successfully then `pdPASS` is returned, otherwise `pdFALSE` is returned. `pdFALSE` will be returned if the timer service queue was full.

**xEventGroupSetBitsFromISR** (`xEventGroup`, `uxBitsToSet`, `pxHigherPriorityTaskWoken`)

A version of `xEventGroupSetBits()` that can be called from an interrupt.

Setting bits in an event group is not a deterministic operation because there are an unknown number of tasks that may be waiting for the bit or bits being set. FreeRTOS does not allow nondeterministic operations to be performed in interrupts or from critical sections. Therefore `xEventGroupSetBitsFromISR()` sends a message to the timer task to have the set operation performed in the context of the timer task - where a scheduler lock is used in place of a critical section.

Example usage:

```
#define BIT_0 ( 1 << 0 )
#define BIT_4 ( 1 << 4 )

// An event group which it is assumed has already been created by a call to
// xEventGroupCreate().
EventGroupHandle_t xEventGroup;

void anInterruptHandler( void )
{
    BaseType_t xHigherPriorityTaskWoken, xResult;

    // xHigherPriorityTaskWoken must be initialised to pdFALSE.
```

(continues on next page)

(continued from previous page)

```

xHigherPriorityTaskWoken = pdFALSE;

// Set bit 0 and bit 4 in xEventGroup.
xResult = xEventGroupSetBitsFromISR(
    xEventGroup,    // The event group being updated.
    BIT_0 | BIT_4  // The bits being set.
    &xHigherPriorityTaskWoken );

// Was the message posted successfully?
if( xResult == pdPASS )
{
    // If xHigherPriorityTaskWoken is now set to pdTRUE then a context
    // switch should be requested. The macro used is port specific and
    // will be either portYIELD_FROM_ISR() or portEND_SWITCHING_ISR() -
    // refer to the documentation page for the port being used.
    portYIELD_FROM_ISR( xHigherPriorityTaskWoken );
}
}

```

**Parameters**

- **xEventGroup** –The event group in which the bits are to be set.
- **uxBitsToSet** –A bitwise value that indicates the bit or bits to set. For example, to set bit 3 only, set uxBitsToSet to 0x08. To set bit 3 and bit 0 set uxBitsToSet to 0x09.
- **pxHigherPriorityTaskWoken** –As mentioned above, calling this function will result in a message being sent to the timer daemon task. If the priority of the timer daemon task is higher than the priority of the currently running task (the task the interrupt interrupted) then \*pxHigherPriorityTaskWoken will be set to pdTRUE by xEventGroupSetBitsFromISR(), indicating that a context switch should be requested before the interrupt exits. For that reason \*pxHigherPriorityTaskWoken must be initialised to pdFALSE. See the example code below.

**Returns** If the request to execute the function was posted successfully then pdPASS is returned, otherwise pdFALSE is returned. pdFALSE will be returned if the timer service queue was full.

**xEventGroupGetBits** (xEventGroup)

Returns the current value of the bits in an event group. This function cannot be used from an interrupt.

**Parameters**

- **xEventGroup** –The event group being queried.

**Returns** The event group bits at the time xEventGroupGetBits() was called.

**Type Definitions**

```
typedef struct EventGroupDef_t *EventGroupHandle_t
```

```
typedef TickType_t EventBits_t
```

**Stream Buffer API****Header File**

- [components/freertos/FreeRTOS-Kernel/include/freertos/stream\\_buffer.h](#)

**Functions**



size\_t **xStreamBufferSend** (*StreamBufferHandle\_t* xStreamBuffer, const void \*pvTxData, size\_t xDataLengthBytes, TickType\_t xTicksToWait)

Sends bytes to a stream buffer. The bytes are copied into the stream buffer.

: Uniquely among FreeRTOS objects, the stream buffer implementation (so also the message buffer implementation, as message buffers are built on top of stream buffers) assumes there is only one task or interrupt that will write to the buffer (the writer), and only one task or interrupt that will read from the buffer (the reader). It is safe for the writer and reader to be different tasks or interrupts, but, unlike other FreeRTOS objects, it is not safe to have multiple different writers or multiple different readers. If there are to be multiple different writers then the application writer must place each call to a writing API function (such as xStreamBufferSend()) inside a critical section and set the send block time to 0. Likewise, if there are to be multiple different readers then the application writer must place each call to a reading API function (such as xStreamBufferReceive()) inside a critical section and set the receive block time to 0.

Use xStreamBufferSend() to write to a stream buffer from a task. Use xStreamBufferSendFromISR() to write to a stream buffer from an interrupt service routine (ISR).

Example use:

```
void vAFunction( StreamBufferHandle_t xStreamBuffer )
{
    size_t xBytesSent;
    uint8_t ucArrayToSend[] = { 0, 1, 2, 3 };
    char *pcStringToSend = "String to send";
    const TickType_t x100ms = pdMS_TO_TICKS( 100 );

    // Send an array to the stream buffer, blocking for a maximum of 100ms to
    // wait for enough space to be available in the stream buffer.
    xBytesSent = xStreamBufferSend( xStreamBuffer, ( void * ) ucArrayToSend,
    ↪ sizeof( ucArrayToSend ), x100ms );

    if( xBytesSent != sizeof( ucArrayToSend ) )
    {
        // The call to xStreamBufferSend() times out before there was enough
        // space in the buffer for the data to be written, but it did
        // successfully write xBytesSent bytes.
    }

    // Send the string to the stream buffer. Return immediately if there is not
    // enough space in the buffer.
    xBytesSent = xStreamBufferSend( xStreamBuffer, ( void * ) pcStringToSend,
    ↪ strlen( pcStringToSend ), 0 );

    if( xBytesSent != strlen( pcStringToSend ) )
    {
        // The entire string could not be added to the stream buffer because
        // there was not enough free space in the buffer, but xBytesSent bytes
        // were sent. Could try again to send the remaining bytes.
    }
}
```

### Parameters

- **xStreamBuffer** –The handle of the stream buffer to which a stream is being sent.
- **pvTxData** –A pointer to the buffer that holds the bytes to be copied into the stream buffer.
- **xDataLengthBytes** –The maximum number of bytes to copy from pvTxData into the stream buffer.
- **xTicksToWait** –The maximum amount of time the task should remain in the Blocked state to wait for enough space to become available in the stream buffer, should the stream buffer contain too little space to hold the another xDataLengthBytes bytes. The

block time is specified in tick periods, so the absolute time it represents is dependent on the tick frequency. The macro `pdMS_TO_TICKS()` can be used to convert a time specified in milliseconds into a time specified in ticks. Setting `xTicksToWait` to `portMAX_DELAY` will cause the task to wait indefinitely (without timing out), provided `INCLUDE_vTaskSuspend` is set to 1 in `FreeRTOSConfig.h`. If a task times out before it can write all `xDataLengthBytes` into the buffer it will still write as many bytes as possible. A task does not use any CPU time when it is in the blocked state.

**Returns** The number of bytes written to the stream buffer. If a task times out before it can write all `xDataLengthBytes` into the buffer it will still write as many bytes as possible.

`size_t xStreamBufferSendFromISR` (*StreamBufferHandle\_t* xStreamBuffer, const void \*pvTxData, size\_t xDataLengthBytes, BaseType\_t \*const pxHigherPriorityTaskWoken)

Interrupt safe version of the API function that sends a stream of bytes to the stream buffer.

: Uniquely among FreeRTOS objects, the stream buffer implementation (so also the message buffer implementation, as message buffers are built on top of stream buffers) assumes there is only one task or interrupt that will write to the buffer (the writer), and only one task or interrupt that will read from the buffer (the reader). It is safe for the writer and reader to be different tasks or interrupts, but, unlike other FreeRTOS objects, it is not safe to have multiple different writers or multiple different readers. If there are to be multiple different writers then the application writer must place each call to a writing API function (such as `xStreamBufferSend()`) inside a critical section and set the send block time to 0. Likewise, if there are to be multiple different readers then the application writer must place each call to a reading API function (such as `xStreamBufferReceive()`) inside a critical section and set the receive block time to 0.

Use `xStreamBufferSend()` to write to a stream buffer from a task. Use `xStreamBufferSendFromISR()` to write to a stream buffer from an interrupt service routine (ISR).

Example use:

```
// A stream buffer that has already been created.
StreamBufferHandle_t xStreamBuffer;

void vAnInterruptServiceRoutine( void )
{
    size_t xBytesSent;
    char *pcStringToSend = "String to send";
    BaseType_t xHigherPriorityTaskWoken = pdFALSE; // Initialised to pdFALSE.

    // Attempt to send the string to the stream buffer.
    xBytesSent = xStreamBufferSendFromISR( xStreamBuffer,
                                           ( void * ) pcStringToSend,
                                           strlen( pcStringToSend ),
                                           &xHigherPriorityTaskWoken );

    if( xBytesSent != strlen( pcStringToSend ) )
    {
        // There was not enough free space in the stream buffer for the entire
        // string to be written, ut xBytesSent bytes were written.
    }

    // If xHigherPriorityTaskWoken was set to pdTRUE inside
    // xStreamBufferSendFromISR() then a task that has a priority above the
    // priority of the currently executing task was unblocked and a context
    // switch should be performed to ensure the ISR returns to the unblocked
    // task. In most FreeRTOS ports this is done by simply passing
    // xHigherPriorityTaskWoken into taskYIELD_FROM_ISR(), which will test the
    // variables value, and perform the context switch if necessary. Check the
    // documentation for the port in use for port specific instructions.
    taskYIELD_FROM_ISR( xHigherPriorityTaskWoken );
}
```

**Parameters**

- **xStreamBuffer** –The handle of the stream buffer to which a stream is being sent.
- **pvTxData** –A pointer to the data that is to be copied into the stream buffer.
- **xDataLengthBytes** –The maximum number of bytes to copy from pvTxData into the stream buffer.
- **pxHigherPriorityTaskWoken** –It is possible that a stream buffer will have a task blocked on it waiting for data. Calling xStreamBufferSendFromISR() can make data available, and so cause a task that was waiting for data to leave the Blocked state. If calling xStreamBufferSendFromISR() causes a task to leave the Blocked state, and the unblocked task has a priority higher than the currently executing task (the task that was interrupted), then, internally, xStreamBufferSendFromISR() will set \*pxHigherPriorityTaskWoken to pdTRUE. If xStreamBufferSendFromISR() sets this value to pdTRUE, then normally a context switch should be performed before the interrupt is exited. This will ensure that the interrupt returns directly to the highest priority Ready state task. \*pxHigherPriorityTaskWoken should be set to pdFALSE before it is passed into the function. See the example code below for an example.

**Returns** The number of bytes actually written to the stream buffer, which will be less than xDataLengthBytes if the stream buffer didn't have enough free space for all the bytes to be written.

size\_t **xStreamBufferReceive** (*StreamBufferHandle\_t* xStreamBuffer, void \*pvRxData, size\_t xBufferLengthBytes, TickType\_t xTicksToWait)

Receives bytes from a stream buffer.

: Uniquely among FreeRTOS objects, the stream buffer implementation (so also the message buffer implementation, as message buffers are built on top of stream buffers) assumes there is only one task or interrupt that will write to the buffer (the writer), and only one task or interrupt that will read from the buffer (the reader). It is safe for the writer and reader to be different tasks or interrupts, but, unlike other FreeRTOS objects, it is not safe to have multiple different writers or multiple different readers. If there are to be multiple different writers then the application writer must place each call to a writing API function (such as xStreamBufferSend()) inside a critical section and set the send block time to 0. Likewise, if there are to be multiple different readers then the application writer must place each call to a reading API function (such as xStreamBufferReceive()) inside a critical section and set the receive block time to 0.

Use xStreamBufferReceive() to read from a stream buffer from a task. Use xStreamBufferReceiveFromISR() to read from a stream buffer from an interrupt service routine (ISR).

Example use:

```
void vAFunction( StreamBuffer_t xStreamBuffer )
{
    uint8_t ucRxData[ 20 ];
    size_t xReceivedBytes;
    const TickType_t xBlockTime = pdMS_TO_TICKS( 20 );

    // Receive up to another sizeof( ucRxData ) bytes from the stream buffer.
    // Wait in the Blocked state (so not using any CPU processing time) for a
    // maximum of 100ms for the full sizeof( ucRxData ) number of bytes to be
    // available.
    xReceivedBytes = xStreamBufferReceive( xStreamBuffer,
                                          ( void * ) ucRxData,
                                          sizeof( ucRxData ),
                                          xBlockTime );

    if( xReceivedBytes > 0 )
    {
        // A ucRxData contains another xRecievedBytes bytes of data, which can
        // be processed here....
    }
}
```

**Parameters**

- **xStreamBuffer** –The handle of the stream buffer from which bytes are to be received.
- **pvRxData** –A pointer to the buffer into which the received bytes will be copied.
- **xBufferLengthBytes** –The length of the buffer pointed to by the pvRxData parameter. This sets the maximum number of bytes to receive in one call. xStreamBufferReceive will return as many bytes as possible up to a maximum set by xBufferLengthBytes.
- **xTicksToWait** –The maximum amount of time the task should remain in the Blocked state to wait for data to become available if the stream buffer is empty. xStreamBufferReceive() will return immediately if xTicksToWait is zero. The block time is specified in tick periods, so the absolute time it represents is dependent on the tick frequency. The macro pdMS\_TO\_TICKS() can be used to convert a time specified in milliseconds into a time specified in ticks. Setting xTicksToWait to portMAX\_DELAY will cause the task to wait indefinitely (without timing out), provided INCLUDE\_vTaskSuspend is set to 1 in FreeRTOSConfig.h. A task does not use any CPU time when it is in the Blocked state.

**Returns** The number of bytes actually read from the stream buffer, which will be less than xBufferLengthBytes if the call to xStreamBufferReceive() timed out before xBufferLengthBytes were available.

```
size_t xStreamBufferReceiveFromISR (StreamBufferHandle_t xStreamBuffer, void *pvRxData, size_t
                                     xBufferLengthBytes, BaseType_t *const
                                     pxHigherPriorityTaskWoken)
```

An interrupt safe version of the API function that receives bytes from a stream buffer.

Use xStreamBufferReceive() to read bytes from a stream buffer from a task. Use xStreamBufferReceiveFromISR() to read bytes from a stream buffer from an interrupt service routine (ISR).

Example use:

```
// A stream buffer that has already been created.
StreamBuffer_t xStreamBuffer;

void vAnInterruptServiceRoutine( void )
{
    uint8_t ucRxData[ 20 ];
    size_t xReceivedBytes;
    BaseType_t xHigherPriorityTaskWoken = pdFALSE; // Initialised to pdFALSE.

    // Receive the next stream from the stream buffer.
    xReceivedBytes = xStreamBufferReceiveFromISR( xStreamBuffer,
                                                  ( void * ) ucRxData,
                                                  sizeof( ucRxData ),
                                                  &xHigherPriorityTaskWoken );

    if( xReceivedBytes > 0 )
    {
        // ucRxData contains xReceivedBytes read from the stream buffer.
        // Process the stream here....
    }

    // If xHigherPriorityTaskWoken was set to pdTRUE inside
    // xStreamBufferReceiveFromISR() then a task that has a priority above the
    // priority of the currently executing task was unblocked and a context
    // switch should be performed to ensure the ISR returns to the unblocked
    // task. In most FreeRTOS ports this is done by simply passing
    // xHigherPriorityTaskWoken into taskYIELD_FROM_ISR(), which will test the
    // variables value, and perform the context switch if necessary. Check the
    // documentation for the port in use for port specific instructions.
    taskYIELD_FROM_ISR( xHigherPriorityTaskWoken );
}
```

**Parameters**

- **xStreamBuffer** –The handle of the stream buffer from which a stream is being received.
- **pvRxData** –A pointer to the buffer into which the received bytes are copied.
- **xBufferLengthBytes** –The length of the buffer pointed to by the pvRxData parameter. This sets the maximum number of bytes to receive in one call. xStreamBufferReceive will return as many bytes as possible up to a maximum set by xBufferLengthBytes.
- **pxHigherPriorityTaskWoken** –It is possible that a stream buffer will have a task blocked on it waiting for space to become available. Calling xStreamBufferReceiveFromISR() can make space available, and so cause a task that is waiting for space to leave the Blocked state. If calling xStreamBufferReceiveFromISR() causes a task to leave the Blocked state, and the unblocked task has a priority higher than the currently executing task (the task that was interrupted), then, internally, xStreamBufferReceiveFromISR() will set \*pxHigherPriorityTaskWoken to pdTRUE. If xStreamBufferReceiveFromISR() sets this value to pdTRUE, then normally a context switch should be performed before the interrupt is exited. That will ensure the interrupt returns directly to the highest priority Ready state task. \*pxHigherPriorityTaskWoken should be set to pdFALSE before it is passed into the function. See the code example below for an example.

**Returns** The number of bytes read from the stream buffer, if any.

void **vStreamBufferDelete** (*StreamBufferHandle\_t* xStreamBuffer)

Deletes a stream buffer that was previously created using a call to xStreamBufferCreate() or xStreamBufferCreateStatic(). If the stream buffer was created using dynamic memory (that is, by xStreamBufferCreate()), then the allocated memory is freed.

A stream buffer handle must not be used after the stream buffer has been deleted.

**Parameters** **xStreamBuffer** –The handle of the stream buffer to be deleted.

BaseType\_t **xStreamBufferIsFull** (*StreamBufferHandle\_t* xStreamBuffer)

Queries a stream buffer to see if it is full. A stream buffer is full if it does not have any free space, and therefore cannot accept any more data.

**Parameters** **xStreamBuffer** –The handle of the stream buffer being queried.

**Returns** If the stream buffer is full then pdTRUE is returned. Otherwise pdFALSE is returned.

BaseType\_t **xStreamBufferIsEmpty** (*StreamBufferHandle\_t* xStreamBuffer)

Queries a stream buffer to see if it is empty. A stream buffer is empty if it does not contain any data.

**Parameters** **xStreamBuffer** –The handle of the stream buffer being queried.

**Returns** If the stream buffer is empty then pdTRUE is returned. Otherwise pdFALSE is returned.

BaseType\_t **xStreamBufferReset** (*StreamBufferHandle\_t* xStreamBuffer)

Resets a stream buffer to its initial, empty, state. Any data that was in the stream buffer is discarded. A stream buffer can only be reset if there are no tasks blocked waiting to either send to or receive from the stream buffer.

**Parameters** **xStreamBuffer** –The handle of the stream buffer being reset.

**Returns** If the stream buffer is reset then pdPASS is returned. If there was a task blocked waiting to send to or read from the stream buffer then the stream buffer is not reset and pdFAIL is returned.

size\_t **xStreamBufferSpacesAvailable** (*StreamBufferHandle\_t* xStreamBuffer)

Queries a stream buffer to see how much free space it contains, which is equal to the amount of data that can be sent to the stream buffer before it is full.

**Parameters** **xStreamBuffer** –The handle of the stream buffer being queried.

**Returns** The number of bytes that can be written to the stream buffer before the stream buffer would be full.

size\_t **xStreamBufferBytesAvailable** (*StreamBufferHandle\_t* xStreamBuffer)

Queries a stream buffer to see how much data it contains, which is equal to the number of bytes that can be read from the stream buffer before the stream buffer would be empty.

**Parameters** **xStreamBuffer** –The handle of the stream buffer being queried.

**Returns** The number of bytes that can be read from the stream buffer before the stream buffer would be empty.

BaseType\_t **xStreamBufferSetTriggerLevel** (*StreamBufferHandle\_t* xStreamBuffer, size\_t xTriggerLevel)

A stream buffer's trigger level is the number of bytes that must be in the stream buffer before a task that is blocked on the stream buffer to wait for data is moved out of the blocked state. For example, if a task is blocked on a read of an empty stream buffer that has a trigger level of 1 then the task will be unblocked when a single byte is written to the buffer or the task's block time expires. As another example, if a task is blocked on a read of an empty stream buffer that has a trigger level of 10 then the task will not be unblocked until the stream buffer contains at least 10 bytes or the task's block time expires. If a reading task's block time expires before the trigger level is reached then the task will still receive however many bytes are actually available. Setting a trigger level of 0 will result in a trigger level of 1 being used. It is not valid to specify a trigger level that is greater than the buffer size.

A trigger level is set when the stream buffer is created, and can be modified using xStreamBufferSetTriggerLevel().

#### Parameters

- **xStreamBuffer** –The handle of the stream buffer being updated.
- **xTriggerLevel** –The new trigger level for the stream buffer.

**Returns** If xTriggerLevel was less than or equal to the stream buffer's length then the trigger level will be updated and pdTRUE is returned. Otherwise pdFALSE is returned.

BaseType\_t **xStreamBufferSendCompletedFromISR** (*StreamBufferHandle\_t* xStreamBuffer, BaseType\_t \*pxHigherPriorityTaskWoken)

For advanced users only.

The sbSEND\_COMPLETED() macro is called from within the FreeRTOS APIs when data is sent to a message buffer or stream buffer. If there was a task that was blocked on the message or stream buffer waiting for data to arrive then the sbSEND\_COMPLETED() macro sends a notification to the task to remove it from the Blocked state. xStreamBufferSendCompletedFromISR() does the same thing. It is provided to enable application writers to implement their own version of sbSEND\_COMPLETED(), and MUST NOT BE USED AT ANY OTHER TIME.

See the example implemented in FreeRTOS/Demo/Minimal/MessageBufferAMP.c for additional information.

#### Parameters

- **xStreamBuffer** –The handle of the stream buffer to which data was written.
- **pxHigherPriorityTaskWoken** –\*pxHigherPriorityTaskWoken should be initialised to pdFALSE before it is passed into xStreamBufferSendCompletedFromISR(). If calling xStreamBufferSendCompletedFromISR() removes a task from the Blocked state, and the task has a priority above the priority of the currently running task, then \*pxHigherPriorityTaskWoken will get set to pdTRUE indicating that a context switch should be performed before exiting the ISR.

**Returns** If a task was removed from the Blocked state then pdTRUE is returned. Otherwise pdFALSE is returned.

BaseType\_t **xStreamBufferReceiveCompletedFromISR** (*StreamBufferHandle\_t* xStreamBuffer, BaseType\_t \*pxHigherPriorityTaskWoken)

For advanced users only.

The sbRECEIVE\_COMPLETED() macro is called from within the FreeRTOS APIs when data is read out of a message buffer or stream buffer. If there was a task that was blocked on the message or stream buffer waiting for data to arrive then the sbRECEIVE\_COMPLETED() macro sends a notification to the task to remove it from the Blocked state. xStreamBufferReceiveCompletedFromISR() does the same thing. It is provided to enable application writers to implement their own version of sbRECEIVE\_COMPLETED(), and MUST NOT BE USED AT ANY OTHER TIME.

See the example implemented in FreeRTOS/Demo/Minimal/MessageBufferAMP.c for additional information.

#### Parameters



- **xStreamBuffer** –The handle of the stream buffer from which data was read.
- **pxHigherPriorityTaskWoken** –\*pxHigherPriorityTaskWoken should be initialised to pdFALSE before it is passed into xStreamBufferReceiveCompletedFromISR(). If calling xStreamBufferReceiveCompletedFromISR() removes a task from the Blocked state, and the task has a priority above the priority of the currently running task, then \*pxHigherPriorityTaskWoken will get set to pdTRUE indicating that a context switch should be performed before exiting the ISR.

**Returns** If a task was removed from the Blocked state then pdTRUE is returned. Otherwise pdFALSE is returned.

## Macros

**xStreamBufferCreate** (xBufferSizeBytes, xTriggerLevelBytes)

Creates a new stream buffer using dynamically allocated memory. See xStreamBufferCreateStatic() for a version that uses statically allocated memory (memory that is allocated at compile time).

configSUPPORT\_DYNAMIC\_ALLOCATION must be set to 1 or left undefined in FreeRTOSConfig.h for xStreamBufferCreate() to be available.

Example use:

```
void vAFunction( void )
{
    StreamBufferHandle_t xStreamBuffer;
    const size_t xStreamBufferSizeBytes = 100, xTriggerLevel = 10;

    // Create a stream buffer that can hold 100 bytes. The memory used to hold
    // both the stream buffer structure and the data in the stream buffer is
    // allocated dynamically.
    xStreamBuffer = xStreamBufferCreate( xStreamBufferSizeBytes, xTriggerLevel );

    if( xStreamBuffer == NULL )
    {
        // There was not enough heap memory space available to create the
        // stream buffer.
    }
    else
    {
        // The stream buffer was created successfully and can now be used.
    }
}
```

## Parameters

- **xBufferSizeBytes** –The total number of bytes the stream buffer will be able to hold at any one time.
- **xTriggerLevelBytes** –The number of bytes that must be in the stream buffer before a task that is blocked on the stream buffer to wait for data is moved out of the blocked state. For example, if a task is blocked on a read of an empty stream buffer that has a trigger level of 1 then the task will be unblocked when a single byte is written to the buffer or the task's block time expires. As another example, if a task is blocked on a read of an empty stream buffer that has a trigger level of 10 then the task will not be unblocked until the stream buffer contains at least 10 bytes or the task's block time expires. If a reading task's block time expires before the trigger level is reached then the task will still receive however many bytes are actually available. Setting a trigger level of 0 will result in a trigger level of 1 being used. It is not valid to specify a trigger level that is greater than the buffer size.

**Returns** If NULL is returned, then the stream buffer cannot be created because there is insufficient heap memory available for FreeRTOS to allocate the stream buffer data structures and storage

area. A non-NULL value being returned indicates that the stream buffer has been created successfully - the returned value should be stored as the handle to the created stream buffer.

**xStreamBufferCreateStatic** (xBufferSizeBytes, xTriggerLevelBytes, pucStreamBufferStorageArea, pxStaticStreamBuffer)

Creates a new stream buffer using statically allocated memory. See xStreamBufferCreate() for a version that uses dynamically allocated memory.

configSUPPORT\_STATIC\_ALLOCATION must be set to 1 in FreeRTOSConfig.h for xStreamBufferCreateStatic() to be available.

Example use:

```
// Used to dimension the array used to hold the streams. The available space
// will actually be one less than this, so 999.
#define STORAGE_SIZE_BYTES 1000

// Defines the memory that will actually hold the streams within the stream
// buffer.
static uint8_t ucStorageBuffer[ STORAGE_SIZE_BYTES ];

// The variable used to hold the stream buffer structure.
StaticStreamBuffer_t xStreamBufferStruct;

void MyFunction( void )
{
    StreamBufferHandle_t xStreamBuffer;
    const size_t xTriggerLevel = 1;

    xStreamBuffer = xStreamBufferCreateStatic( sizeof( ucBufferStorage ),
                                              xTriggerLevel,
                                              ucBufferStorage,
                                              &xStreamBufferStruct );

    // As neither the pucStreamBufferStorageArea or pxStaticStreamBuffer
    // parameters were NULL, xStreamBuffer will not be NULL, and can be used to
    // reference the created stream buffer in other stream buffer API calls.

    // Other code that uses the stream buffer can go here.
}
```

### Parameters

- **xBufferSizeBytes** –The size, in bytes, of the buffer pointed to by the pucStreamBufferStorageArea parameter.
- **xTriggerLevelBytes** –The number of bytes that must be in the stream buffer before a task that is blocked on the stream buffer to wait for data is moved out of the blocked state. For example, if a task is blocked on a read of an empty stream buffer that has a trigger level of 1 then the task will be unblocked when a single byte is written to the buffer or the task's block time expires. As another example, if a task is blocked on a read of an empty stream buffer that has a trigger level of 10 then the task will not be unblocked until the stream buffer contains at least 10 bytes or the task's block time expires. If a reading task's block time expires before the trigger level is reached then the task will still receive however many bytes are actually available. Setting a trigger level of 0 will result in a trigger level of 1 being used. It is not valid to specify a trigger level that is greater than the buffer size.
- **pucStreamBufferStorageArea** –Must point to a uint8\_t array that is at least xBufferSizeBytes + 1 big. This is the array to which streams are copied when they are written to the stream buffer.
- **pxStaticStreamBuffer** –Must point to a variable of type StaticStreamBuffer\_t, which will be used to hold the stream buffer's data structure.



**Returns** If the stream buffer is created successfully then a handle to the created stream buffer is returned. If either `pucStreamBufferStorageArea` or `pxStaticstreamBuffer` are NULL then NULL is returned.

### Type Definitions

```
typedef struct StreamBufferDef_t *StreamBufferHandle_t
```

### Message Buffer API

#### Header File

- `components/freertos/FreeRTOS-Kernel/include/freertos/message_buffer.h`

#### Macros

**xMessageBufferCreate** (`xBufferSizeBytes`)

Creates a new message buffer using dynamically allocated memory. See `xMessageBufferCreateStatic()` for a version that uses statically allocated memory (memory that is allocated at compile time).

`configSUPPORT_DYNAMIC_ALLOCATION` must be set to 1 or left undefined in `FreeRTOSConfig.h` for `xMessageBufferCreate()` to be available.

Example use:

```
void vAFunction( void )
{
    MessageBufferHandle_t xMessageBuffer;
    const size_t xMessageBufferSizeBytes = 100;

    // Create a message buffer that can hold 100 bytes. The memory used to hold
    // both the message buffer structure and the messages themselves is allocated
    // dynamically. Each message added to the buffer consumes an additional 4
    // bytes which are used to hold the length of the message.
    xMessageBuffer = xMessageBufferCreate( xMessageBufferSizeBytes );

    if( xMessageBuffer == NULL )
    {
        // There was not enough heap memory space available to create the
        // message buffer.
    }
    else
    {
        // The message buffer was created successfully and can now be used.
    }
}
```

#### Parameters

- **xBufferSizeBytes** –The total number of bytes (not messages) the message buffer will be able to hold at any one time. When a message is written to the message buffer an additional `sizeof( size_t )` bytes are also written to store the message's length. `sizeof( size_t )` is typically 4 bytes on a 32-bit architecture, so on most 32-bit architectures a 10 byte message will take up 14 bytes of message buffer space.

**Returns** If NULL is returned, then the message buffer cannot be created because there is insufficient heap memory available for FreeRTOS to allocate the message buffer data structures and storage area. A non-NULL value being returned indicates that the message buffer has been created successfully - the returned value should be stored as the handle to the created message buffer.

**xMessageBufferCreateStatic** (xBufferSizeBytes, pucMessageBufferStorageArea, pxStaticMessageBuffer)

Creates a new message buffer using statically allocated memory. See xMessageBufferCreate() for a version that uses dynamically allocated memory.

Example use:

```
// Used to dimension the array used to hold the messages. The available space
// will actually be one less than this, so 999.
#define STORAGE_SIZE_BYTES 1000

// Defines the memory that will actually hold the messages within the message
// buffer.
static uint8_t ucStorageBuffer[ STORAGE_SIZE_BYTES ];

// The variable used to hold the message buffer structure.
StaticMessageBuffer_t xMessageBufferStruct;

void MyFunction( void )
{
    MessageBufferHandle_t xMessageBuffer;

    xMessageBuffer = xMessageBufferCreateStatic( sizeof( ucBufferStorage ),
                                                ucBufferStorage,
                                                &xMessageBufferStruct );

    // As neither the pucMessageBufferStorageArea or pxStaticMessageBuffer
    // parameters were NULL, xMessageBuffer will not be NULL, and can be used to
    // reference the created message buffer in other message buffer API calls.

    // Other code that uses the message buffer can go here.
}
```

### Parameters

- **xBufferSizeBytes** –The size, in bytes, of the buffer pointed to by the pucMessageBufferStorageArea parameter. When a message is written to the message buffer an additional sizeof( size\_t ) bytes are also written to store the message's length. sizeof( size\_t ) is typically 4 bytes on a 32-bit architecture, so on most 32-bit architecture a 10 byte message will take up 14 bytes of message buffer space. The maximum number of bytes that can be stored in the message buffer is actually (xBufferSizeBytes - 1).
- **pucMessageBufferStorageArea** –Must point to a uint8\_t array that is at least xBufferSizeBytes + 1 big. This is the array to which messages are copied when they are written to the message buffer.
- **pxStaticMessageBuffer** –Must point to a variable of type StaticMessageBuffer\_t, which will be used to hold the message buffer's data structure.

**Returns** If the message buffer is created successfully then a handle to the created message buffer is returned. If either pucMessageBufferStorageArea or pxStaticmessageBuffer are NULL then NULL is returned.

**xMessageBufferSend** (xMessageBuffer, pvTxData, xDataLengthBytes, xTicksToWait)

Sends a discrete message to the message buffer. The message can be any length that fits within the buffer's free space, and is copied into the buffer.

: Uniquely among FreeRTOS objects, the stream buffer implementation (so also the message buffer implementation, as message buffers are built on top of stream buffers) assumes there is only one task or interrupt that will write to the buffer (the writer), and only one task or interrupt that will read from the buffer (the reader). It is safe for the writer and reader to be different tasks or interrupts, but, unlike other FreeRTOS objects, it is not safe to have multiple different writers or multiple different readers. If there are to be multiple different writers then the application writer must place each call to a writing API function (such as xMessageBufferSend())

inside a critical section and set the send block time to 0. Likewise, if there are to be multiple different readers then the application writer must place each call to a reading API function (such as `xMessageBufferRead()`) inside a critical section and set the receive block time to 0.

Use `xMessageBufferSend()` to write to a message buffer from a task. Use `xMessageBufferSendFromISR()` to write to a message buffer from an interrupt service routine (ISR).

Example use:

```
void vAFunction( MessageBufferHandle_t xMessageBuffer )
{
    size_t xBytesSent;
    uint8_t ucArrayToSend[] = { 0, 1, 2, 3 };
    char *pcStringToSend = "String to send";
    const TickType_t x100ms = pdMS_TO_TICKS( 100 );

    // Send an array to the message buffer, blocking for a maximum of 100ms to
    // wait for enough space to be available in the message buffer.
    xBytesSent = xMessageBufferSend( xMessageBuffer, ( void * ) ucArrayToSend,
    ↪sizeof( ucArrayToSend ), x100ms );

    if( xBytesSent != sizeof( ucArrayToSend ) )
    {
        // The call to xMessageBufferSend() times out before there was enough
        // space in the buffer for the data to be written.
    }

    // Send the string to the message buffer. Return immediately if there is
    // not enough space in the buffer.
    xBytesSent = xMessageBufferSend( xMessageBuffer, ( void * ) pcStringToSend,
    ↪strlen( pcStringToSend ), 0 );

    if( xBytesSent != strlen( pcStringToSend ) )
    {
        // The string could not be added to the message buffer because there was
        // not enough free space in the buffer.
    }
}
```

### Parameters

- **xMessageBuffer** –The handle of the message buffer to which a message is being sent.
- **pvTxData** –A pointer to the message that is to be copied into the message buffer.
- **xDataLengthBytes** –The length of the message. That is, the number of bytes to copy from `pvTxData` into the message buffer. When a message is written to the message buffer an additional `sizeof( size_t )` bytes are also written to store the message's length. `sizeof( size_t )` is typically 4 bytes on a 32-bit architecture, so on most 32-bit architecture setting `xDataLengthBytes` to 20 will reduce the free space in the message buffer by 24 bytes (20 bytes of message data and 4 bytes to hold the message length).
- **xTicksToWait** –The maximum amount of time the calling task should remain in the Blocked state to wait for enough space to become available in the message buffer, should the message buffer have insufficient space when `xMessageBufferSend()` is called. The calling task will never block if `xTicksToWait` is zero. The block time is specified in tick periods, so the absolute time it represents is dependent on the tick frequency. The macro `pdMS_TO_TICKS()` can be used to convert a time specified in milliseconds into a time specified in ticks. Setting `xTicksToWait` to `portMAX_DELAY` will cause the task to wait indefinitely (without timing out), provided `INCLUDE_vTaskSuspend` is set to 1 in `FreeRTOSConfig.h`. Tasks do not use any CPU time when they are in the Blocked state.

**Returns** The number of bytes written to the message buffer. If the call to `xMessageBufferSend()` times out before there was enough space to write the message into the message buffer then zero is returned. If the call did not time out then `xDataLengthBytes` is returned.

**xMessageBufferSendFromISR** (xMessageBuffer, pvTxData, xDataLengthBytes, pxHigherPriorityTaskWoken)

Interrupt safe version of the API function that sends a discrete message to the message buffer. The message can be any length that fits within the buffer's free space, and is copied into the buffer.

: Uniquely among FreeRTOS objects, the stream buffer implementation (so also the message buffer implementation, as message buffers are built on top of stream buffers) assumes there is only one task or interrupt that will write to the buffer (the writer), and only one task or interrupt that will read from the buffer (the reader). It is safe for the writer and reader to be different tasks or interrupts, but, unlike other FreeRTOS objects, it is not safe to have multiple different writers or multiple different readers. If there are to be multiple different writers then the application writer must place each call to a writing API function (such as xMessageBufferSend()) inside a critical section and set the send block time to 0. Likewise, if there are to be multiple different readers then the application writer must place each call to a reading API function (such as xMessageBufferRead()) inside a critical section and set the receive block time to 0.

Use xMessageBufferSend() to write to a message buffer from a task. Use xMessageBufferSendFromISR() to write to a message buffer from an interrupt service routine (ISR).

Example use:

```
// A message buffer that has already been created.
MessageBufferHandle_t xMessageBuffer;

void vAnInterruptServiceRoutine( void )
{
    size_t xBytesSent;
    char *pcStringToSend = "String to send";
    BaseType_t xHigherPriorityTaskWoken = pdFALSE; // Initialised to pdFALSE.

    // Attempt to send the string to the message buffer.
    xBytesSent = xMessageBufferSendFromISR( xMessageBuffer,
                                           ( void * ) pcStringToSend,
                                           strlen( pcStringToSend ),
                                           &xHigherPriorityTaskWoken );

    if( xBytesSent != strlen( pcStringToSend ) )
    {
        // The string could not be added to the message buffer because there was
        // not enough free space in the buffer.
    }

    // If xHigherPriorityTaskWoken was set to pdTRUE inside
    // xMessageBufferSendFromISR() then a task that has a priority above the
    // priority of the currently executing task was unblocked and a context
    // switch should be performed to ensure the ISR returns to the unblocked
    // task. In most FreeRTOS ports this is done by simply passing
    // xHigherPriorityTaskWoken into portYIELD_FROM_ISR(), which will test the
    // variables value, and perform the context switch if necessary. Check the
    // documentation for the port in use for port specific instructions.
    portYIELD_FROM_ISR( xHigherPriorityTaskWoken );
}
```

#### Parameters

- **xMessageBuffer** –The handle of the message buffer to which a message is being sent.
- **pvTxData** –A pointer to the message that is to be copied into the message buffer.
- **xDataLengthBytes** –The length of the message. That is, the number of bytes to copy from pvTxData into the message buffer. When a message is written to the message buffer an additional sizeof( size\_t ) bytes are also written to store the message's length. sizeof( size\_t ) is typically 4 bytes on a 32-bit architecture, so on most 32-bit architecture setting xDataLengthBytes to 20 will reduce the free space in the message buffer by 24 bytes (20

bytes of message data and 4 bytes to hold the message length).

- **pxHigherPriorityTaskWoken** –It is possible that a message buffer will have a task blocked on it waiting for data. Calling `xMessageBufferSendFromISR()` can make data available, and so cause a task that was waiting for data to leave the Blocked state. If calling `xMessageBufferSendFromISR()` causes a task to leave the Blocked state, and the unblocked task has a priority higher than the currently executing task (the task that was interrupted), then, internally, `xMessageBufferSendFromISR()` will set `*pxHigherPriorityTaskWoken` to `pdTRUE`. If `xMessageBufferSendFromISR()` sets this value to `pdTRUE`, then normally a context switch should be performed before the interrupt is exited. This will ensure that the interrupt returns directly to the highest priority Ready state task. `*pxHigherPriorityTaskWoken` should be set to `pdFALSE` before it is passed into the function. See the code example below for an example.

**Returns** The number of bytes actually written to the message buffer. If the message buffer didn't have enough free space for the message to be stored then 0 is returned, otherwise `xDataLengthBytes` is returned.

**xMessageBufferReceive** (`xMessageBuffer`, `pvRxData`, `xBufferLengthBytes`, `xTicksToWait`)

Receives a discrete message from a message buffer. Messages can be of variable length and are copied out of the buffer.

: Uniquely among FreeRTOS objects, the stream buffer implementation (so also the message buffer implementation, as message buffers are built on top of stream buffers) assumes there is only one task or interrupt that will write to the buffer (the writer), and only one task or interrupt that will read from the buffer (the reader). It is safe for the writer and reader to be different tasks or interrupts, but, unlike other FreeRTOS objects, it is not safe to have multiple different writers or multiple different readers. If there are to be multiple different writers then the application writer must place each call to a writing API function (such as `xMessageBufferSend()`) inside a critical section and set the send block time to 0. Likewise, if there are to be multiple different readers then the application writer must place each call to a reading API function (such as `xMessageBufferRead()`) inside a critical section and set the receive block time to 0.

Use `xMessageBufferReceive()` to read from a message buffer from a task. Use `xMessageBufferReceiveFromISR()` to read from a message buffer from an interrupt service routine (ISR).

Example use:

```
void vAFunction( MessageBuffer_t xMessageBuffer )
{
    uint8_t ucRxData[ 20 ];
    size_t xReceivedBytes;
    const TickType_t xBlockTime = pdMS_TO_TICKS( 20 );

    // Receive the next message from the message buffer. Wait in the Blocked
    // state (so not using any CPU processing time) for a maximum of 100ms for
    // a message to become available.
    xReceivedBytes = xMessageBufferReceive( xMessageBuffer,
                                           ( void * ) ucRxData,
                                           sizeof( ucRxData ),
                                           xBlockTime );

    if( xReceivedBytes > 0 )
    {
        // A ucRxData contains a message that is xReceivedBytes long. Process
        // the message here....
    }
}
```

#### Parameters

- **xMessageBuffer** –The handle of the message buffer from which a message is being received.

- **pvRxData** –A pointer to the buffer into which the received message is to be copied.
- **xBufferLengthBytes** –The length of the buffer pointed to by the pvRxData parameter. This sets the maximum length of the message that can be received. If xBufferLengthBytes is too small to hold the next message then the message will be left in the message buffer and 0 will be returned.
- **xTicksToWait** –The maximum amount of time the task should remain in the Blocked state to wait for a message, should the message buffer be empty. xMessageBufferReceive() will return immediately if xTicksToWait is zero and the message buffer is empty. The block time is specified in tick periods, so the absolute time it represents is dependent on the tick frequency. The macro pdMS\_TO\_TICKS() can be used to convert a time specified in milliseconds into a time specified in ticks. Setting xTicksToWait to portMAX\_DELAY will cause the task to wait indefinitely (without timing out), provided INCLUDE\_vTaskSuspend is set to 1 in FreeRTOSConfig.h. Tasks do not use any CPU time when they are in the Blocked state.

**Returns** The length, in bytes, of the message read from the message buffer, if any. If xMessageBufferReceive() times out before a message became available then zero is returned. If the length of the message is greater than xBufferLengthBytes then the message will be left in the message buffer and zero is returned.

**xMessageBufferReceiveFromISR** (xMessageBuffer, pvRxData, xBufferLengthBytes, pxHigherPriorityTaskWoken)

An interrupt safe version of the API function that receives a discrete message from a message buffer. Messages can be of variable length and are copied out of the buffer.

: Uniquely among FreeRTOS objects, the stream buffer implementation (so also the message buffer implementation, as message buffers are built on top of stream buffers) assumes there is only one task or interrupt that will write to the buffer (the writer), and only one task or interrupt that will read from the buffer (the reader). It is safe for the writer and reader to be different tasks or interrupts, but, unlike other FreeRTOS objects, it is not safe to have multiple different writers or multiple different readers. If there are to be multiple different writers then the application writer must place each call to a writing API function (such as xMessageBufferSend()) inside a critical section and set the send block time to 0. Likewise, if there are to be multiple different readers then the application writer must place each call to a reading API function (such as xMessageBufferRead()) inside a critical section and set the receive block time to 0.

Use xMessageBufferReceive() to read from a message buffer from a task. Use xMessageBufferReceiveFromISR() to read from a message buffer from an interrupt service routine (ISR).

Example use:

```
// A message buffer that has already been created.
MessageBuffer_t xMessageBuffer;

void vAnInterruptServiceRoutine( void )
{
    uint8_t ucRxData[ 20 ];
    size_t xReceivedBytes;
    BaseType_t xHigherPriorityTaskWoken = pdFALSE; // Initialised to pdFALSE.

    // Receive the next message from the message buffer.
    xReceivedBytes = xMessageBufferReceiveFromISR( xMessageBuffer,
                                                    ( void * ) ucRxData,
                                                    sizeof( ucRxData ),
                                                    &xHigherPriorityTaskWoken );

    if( xReceivedBytes > 0 )
    {
        // A ucRxData contains a message that is xReceivedBytes long. Process
        // the message here....
    }
}
```

(continues on next page)

```

// If xHigherPriorityTaskWoken was set to pdTRUE inside
// xMessageBufferReceiveFromISR() then a task that has a priority above the
// priority of the currently executing task was unblocked and a context
// switch should be performed to ensure the ISR returns to the unblocked
// task. In most FreeRTOS ports this is done by simply passing
// xHigherPriorityTaskWoken into portYIELD_FROM_ISR(), which will test the
// variables value, and perform the context switch if necessary. Check the
// documentation for the port in use for port specific instructions.
portYIELD_FROM_ISR( xHigherPriorityTaskWoken );
}

```

**Parameters**

- **xMessageBuffer** –The handle of the message buffer from which a message is being received.
- **pvRxData** –A pointer to the buffer into which the received message is to be copied.
- **xBufferLengthBytes** –The length of the buffer pointed to by the pvRxData parameter. This sets the maximum length of the message that can be received. If xBufferLengthBytes is too small to hold the next message then the message will be left in the message buffer and 0 will be returned.
- **pxHigherPriorityTaskWoken** –It is possible that a message buffer will have a task blocked on it waiting for space to become available. Calling xMessageBufferReceiveFromISR() can make space available, and so cause a task that is waiting for space to leave the Blocked state. If calling xMessageBufferReceiveFromISR() causes a task to leave the Blocked state, and the unblocked task has a priority higher than the currently executing task (the task that was interrupted), then, internally, xMessageBufferReceiveFromISR() will set \*pxHigherPriorityTaskWoken to pdTRUE. If xMessageBufferReceiveFromISR() sets this value to pdTRUE, then normally a context switch should be performed before the interrupt is exited. That will ensure the interrupt returns directly to the highest priority Ready state task. \*pxHigherPriorityTaskWoken should be set to pdFALSE before it is passed into the function. See the code example below for an example.

**Returns** The length, in bytes, of the message read from the message buffer, if any.

**vMessageBufferDelete** (xMessageBuffer)

Deletes a message buffer that was previously created using a call to xMessageBufferCreate() or xMessageBufferCreateStatic(). If the message buffer was created using dynamic memory (that is, by xMessageBufferCreate()), then the allocated memory is freed.

A message buffer handle must not be used after the message buffer has been deleted.

**Parameters**

- **xMessageBuffer** –The handle of the message buffer to be deleted.

**xMessageBufferIsFull** (xMessageBuffer)

Tests to see if a message buffer is full. A message buffer is full if it cannot accept any more messages, of any size, until space is made available by a message being removed from the message buffer.

**Parameters**

- **xMessageBuffer** –The handle of the message buffer being queried.

**Returns** If the message buffer referenced by xMessageBuffer is full then pdTRUE is returned. Otherwise pdFALSE is returned.

**xMessageBufferIsEmpty** (xMessageBuffer)

Tests to see if a message buffer is empty (does not contain any messages).

**Parameters**

- **xMessageBuffer** –The handle of the message buffer being queried.

**Returns** If the message buffer referenced by xMessageBuffer is empty then pdTRUE is returned. Otherwise pdFALSE is returned.



**xMessageBufferReset** (xMessageBuffer)

Resets a message buffer to its initial empty state, discarding any message it contained.

A message buffer can only be reset if there are no tasks blocked on it.

**Parameters**

- **xMessageBuffer** –The handle of the message buffer being reset.

**Returns** If the message buffer was reset then pdPASS is returned. If the message buffer could not be reset because either there was a task blocked on the message queue to wait for space to become available, or to wait for a message to be available, then pdFAIL is returned.

**xMessageBufferSpaceAvailable** (xMessageBuffer)

Returns the number of bytes of free space in the message buffer.

**Parameters**

- **xMessageBuffer** –The handle of the message buffer being queried.

**Returns** The number of bytes that can be written to the message buffer before the message buffer would be full. When a message is written to the message buffer an additional sizeof( size\_t ) bytes are also written to store the message's length. sizeof( size\_t ) is typically 4 bytes on a 32-bit architecture, so if xMessageBufferSpacesAvailable() returns 10, then the size of the largest message that can be written to the message buffer is 6 bytes.

**xMessageBufferSpacesAvailable** (xMessageBuffer)**xMessageBufferNextLengthBytes** (xMessageBuffer)

Returns the length (in bytes) of the next message in a message buffer. Useful if xMessageBufferReceive() returned 0 because the size of the buffer passed into xMessageBufferReceive() was too small to hold the next message.

**Parameters**

- **xMessageBuffer** –The handle of the message buffer being queried.

**Returns** The length (in bytes) of the next message in the message buffer, or 0 if the message buffer is empty.

**xMessageBufferSendCompletedFromISR** (xMessageBuffer, pxHigherPriorityTaskWoken)

For advanced users only.

The sbSEND\_COMPLETED() macro is called from within the FreeRTOS APIs when data is sent to a message buffer or stream buffer. If there was a task that was blocked on the message or stream buffer waiting for data to arrive then the sbSEND\_COMPLETED() macro sends a notification to the task to remove it from the Blocked state. xMessageBufferSendCompletedFromISR() does the same thing. It is provided to enable application writers to implement their own version of sbSEND\_COMPLETED(), and MUST NOT BE USED AT ANY OTHER TIME.

See the example implemented in FreeRTOS/Demo/Minimal/MessageBufferAMP.c for additional information.

**Parameters**

- **xMessageBuffer** –The handle of the stream buffer to which data was written.
- **pxHigherPriorityTaskWoken** –\*pxHigherPriorityTaskWoken should be initialised to pdFALSE before it is passed into xMessageBufferSendCompletedFromISR(). If calling xMessageBufferSendCompletedFromISR() removes a task from the Blocked state, and the task has a priority above the priority of the currently running task, then \*pxHigherPriorityTaskWoken will get set to pdTRUE indicating that a context switch should be performed before exiting the ISR.

**Returns** If a task was removed from the Blocked state then pdTRUE is returned. Otherwise pdFALSE is returned.

**xMessageBufferReceiveCompletedFromISR** (xMessageBuffer, pxHigherPriorityTaskWoken)

For advanced users only.

The sbRECEIVE\_COMPLETED() macro is called from within the FreeRTOS APIs when data is read out of a message buffer or stream buffer. If there was a task that was blocked on the message or stream buffer waiting for data to arrive then the sbRECEIVE\_COMPLETED() macro sends a notification to the task to remove it



from the Blocked state. `xMessageBufferReceiveCompletedFromISR()` does the same thing. It is provided to enable application writers to implement their own version of `sbRECEIVE_COMPLETED()`, and **MUST NOT BE USED AT ANY OTHER TIME**.

See the example implemented in `FreeRTOS/Demo/Minimal/MessageBufferAMP.c` for additional information.

#### Parameters

- **xMessageBuffer** –The handle of the stream buffer from which data was read.
- **pxHigherPriorityTaskWoken** –\*pxHigherPriorityTaskWoken should be initialised to `pdFALSE` before it is passed into `xMessageBufferReceiveCompletedFromISR()`. If calling `xMessageBufferReceiveCompletedFromISR()` removes a task from the Blocked state, and the task has a priority above the priority of the currently running task, then \*pxHigherPriorityTaskWoken will get set to `pdTRUE` indicating that a context switch should be performed before exiting the ISR.

**Returns** If a task was removed from the Blocked state then `pdTRUE` is returned. Otherwise `pdFALSE` is returned.

#### Type Definitions

```
typedef void *MessageBufferHandle_t
```

Type by which message buffers are referenced. For example, a call to `xMessageBufferCreate()` returns an `MessageBufferHandle_t` variable that can then be used as a parameter to `xMessageBufferSend()`, `xMessageBufferReceive()`, etc.

### 2.9.12 FreeRTOS (Supplemental Features)

ESP-IDF provides multiple features to supplement the features offered by FreeRTOS. These supplemental features are available on all FreeRTOS implementations supported by ESP-IDF (i.e., ESP-IDF FreeRTOS and Amazon SMP FreeRTOS). This document describes these supplemental features and is split into the following sections:

#### Contents

- *FreeRTOS (Supplemental Features)*
  - *Overview*
  - *Ring Buffers*
  - *ESP-IDF Tick and Idle Hooks*
  - *TLSP Deletion Callbacks*
  - *Component Specific Properties*
  - *API Reference*

#### Overview

ESP-IDF adds various new features to supplement the capabilities of FreeRTOS as follows:

- **Ring buffers:** Ring buffers provide a FIFO buffer that can accept entries of arbitrary lengths.
- **ESP-IDF Tick and Idle Hooks:** ESP-IDF provides multiple custom tick interrupt hooks and idle task hooks that are more numerous and more flexible when compared to FreeRTOS tick and idle hooks.
- **Thread Local Storage Pointer (TLSP) Deletion Callbacks:** TLSP Deletion callbacks are run automatically when a task is deleted, thus allowing users to clean up their TLSPs automatically.
- **Component Specific Properties:** Currently added only one component specific property `ORIG_INCLUDE_PATH`.

## Ring Buffers

FreeRTOS provides stream buffers and message buffers as the primary mechanisms to send arbitrarily sized data between tasks and ISRs. However, FreeRTOS stream buffers and message buffers have the following limitations:

- Strictly single sender and single receiver
- Data is passed by copy
- Unable to reserve buffer space for a deferred send (i.e., send acquire)

Therefore, ESP-IDF provides a separate ring buffer implementation to address the issues above. ESP-IDF ring buffers are strictly FIFO buffers that supports arbitrarily sized items. Ring buffers are a more memory efficient alternative to FreeRTOS queues in situations where the size of items is variable. The capacity of a ring buffer is not measured by the number of items it can store, but rather by the amount of memory used for storing items. The ring buffer provides APIs to send an item, or to allocate space for an item in the ring buffer to be filled manually by the user. For efficiency reasons, **items are always retrieved from the ring buffer by reference**. As a result, all retrieved items *must also be returned* to the ring buffer by using `vRingbufferReturnItem()` or `vRingbufferReturnItemFromISR()`, in order for them to be removed from the ring buffer completely. The ring buffers are split into the three following types:

**No-Split buffers** will guarantee that an item is stored in contiguous memory and will not attempt to split an item under any circumstances. Use No-Split buffers when items must occupy contiguous memory. *Only this buffer type allows you to get the data item address and write to the item by yourself*. Refer the documentation of the functions `xRingbufferSendAcquire()` and `xRingbufferSendComplete()` for more details.

**Allow-Split buffers** will allow an item to be split in two parts when wrapping around the end of the buffer if there is enough space at the tail and the head of the buffer combined to store the item. Allow-Split buffers are more memory efficient than No-Split buffers but can return an item in two parts when retrieving.

**Byte buffers** do not store data as separate items. All data is stored as a sequence of bytes, and any number of bytes can be sent or retrieved each time. Use byte buffers when separate items do not need to be maintained (e.g. a byte stream).

---

**Note:** No-Split buffers and Allow-Split buffers will always store items at 32-bit aligned addresses. Therefore, when retrieving an item, the item pointer is guaranteed to be 32-bit aligned. This is useful especially when you need to send some data to the DMA.

---



---

**Note:** Each item stored in No-Split or Allow-Split buffers will **require an additional 8 bytes for a header**. Item sizes will also be rounded up to a 32-bit aligned size (multiple of 4 bytes), however the true item size is recorded within the header. The sizes of No-Split and Allow-Split buffers will also be rounded up when created.

---

**Usage** The following example demonstrates the usage of `xRingbufferCreate()` and `xRingbufferSend()` to create a ring buffer and then send an item to it.

```
#include "freertos/ringbuf.h"
static char tx_item[] = "test_item";

...

//Create ring buffer
RingbufHandle_t buf_handle;
buf_handle = xRingbufferCreate(1028, RINGBUF_TYPE_NOSPLIT);
if (buf_handle == NULL) {
    printf("Failed to create ring buffer\n");
}

//Send an item
UBaseType_t res = xRingbufferSend(buf_handle, tx_item, sizeof(tx_item), pdMS_
↵TO_TICKS(1000));
```

(continues on next page)

(continued from previous page)

```

if (res != pdTRUE) {
    printf("Failed to send item\n");
}

```

The following example demonstrates the usage of `xRingbufferSendAcquire()` and `xRingbufferSendComplete()` instead of `xRingbufferSend()` to acquire memory on the ring buffer (of type `RINGBUF_TYPE_NOSPLIT`) and then send an item to it. This adds one more step, but allows getting the address of the memory to write to, and writing to the memory yourself.

```

#include "freertos/ringbuf.h"
#include "soc/lldesc.h"

typedef struct {
    lldesc_t dma_desc;
    uint8_t buf[1];
} dma_item_t;

#define DMA_ITEM_SIZE(N) (sizeof(lldesc_t)+((N)+3)&(~3))

...

//Retrieve space for DMA descriptor and corresponding data buffer
//This has to be done with SendAcquire, or the address may be different when_
↪we copy
dma_item_t item;
UBaseType_t res = xRingbufferSendAcquire(buf_handle,
                                         &item, DMA_ITEM_SIZE(buffer_size), pdMS_TO_TICKS(1000));
if (res != pdTRUE) {
    printf("Failed to acquire memory for item\n");
}
item->dma_desc = (lldesc_t) {
    .size = buffer_size,
    .length = buffer_size,
    .eof = 0,
    .owner = 1,
    .buf = &item->buf,
};
//Actually send to the ring buffer for consumer to use
res = xRingbufferSendComplete(buf_handle, &item);
if (res != pdTRUE) {
    printf("Failed to send item\n");
}

```

The following example demonstrates retrieving and returning an item from a **No-Split ring buffer** using `xRingbufferReceive()` and `vRingbufferReturnItem()`

```

...

//Receive an item from no-split ring buffer
size_t item_size;
char *item = (char *)xRingbufferReceive(buf_handle, &item_size, pdMS_TO_
↪TICKS(1000));

//Check received item
if (item != NULL) {
    //Print item
    for (int i = 0; i < item_size; i++) {
        printf("%c", item[i]);
    }
    printf("\n");
    //Return Item

```

(continues on next page)

(continued from previous page)

```

    vRingbufferReturnItem(buf_handle, (void *)item);
} else {
    //Failed to receive item
    printf("Failed to receive item\n");
}

```

The following example demonstrates retrieving and returning an item from an **Allow-Split ring buffer** using `xRingbufferReceiveSplit()` and `vRingbufferReturnItem()`

```

...

//Receive an item from allow-split ring buffer
size_t item_size1, item_size2;
char *item1, *item2;
BaseType_t ret = xRingbufferReceiveSplit(buf_handle, (void **)&item1, (void_
↪ **)&item2, &item_size1, &item_size2, pdMS_TO_TICKS(1000));

//Check received item
if (ret == pdTRUE && item1 != NULL) {
    for (int i = 0; i < item_size1; i++) {
        printf("%c", item1[i]);
    }
    vRingbufferReturnItem(buf_handle, (void *)item1);
    //Check if item was split
    if (item2 != NULL) {
        for (int i = 0; i < item_size2; i++) {
            printf("%c", item2[i]);
        }
        vRingbufferReturnItem(buf_handle, (void *)item2);
    }
    printf("\n");
} else {
    //Failed to receive item
    printf("Failed to receive item\n");
}

```

The following example demonstrates retrieving and returning an item from a **byte buffer** using `xRingbufferReceiveUpTo()` and `vRingbufferReturnItem()`

```

...

//Receive data from byte buffer
size_t item_size;
char *item = (char *)xRingbufferReceiveUpTo(buf_handle, &item_size, pdMS_TO_
↪ TICKS(1000), sizeof(tx_item));

//Check received data
if (item != NULL) {
    //Print item
    for (int i = 0; i < item_size; i++) {
        printf("%c", item[i]);
    }
    printf("\n");
    //Return Item
    vRingbufferReturnItem(buf_handle, (void *)item);
} else {
    //Failed to receive item
    printf("Failed to receive item\n");
}

```

For ISR safe versions of the functions used above, call `xRingbufferSendFromISR()`, `xRingbufferReceiveFromISR()`, `xRingbufferReceiveSplitFromISR()`, `xRingbufferReceive-`

`UpToFromISR()`, and `vRingbufferReturnItemFromISR()`

**Note:** Two calls to `RingbufferReceive[UpTo][FromISR]()` are required if the bytes wraps around the end of the ring buffer.

**Sending to Ring Buffer** The following diagrams illustrate the differences between No-Split and Allow-Split buffers as compared to byte buffers with regard to sending items/data. The diagrams assume that three items of sizes **18, 3, and 27 bytes** are sent respectively to a **buffer of 128 bytes**.

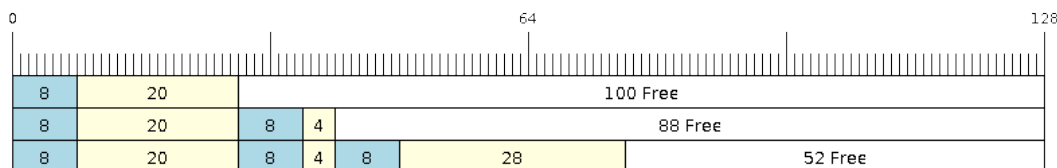

Fig. 37: Sending items to No-Split or Allow-Split ring buffers

For No-Split and Allow-Split buffers, a header of 8 bytes precedes every data item. Furthermore, the space occupied by each item is **rounded up to the nearest 32-bit aligned size** in order to maintain overall 32-bit alignment. However, the true size of the item is recorded inside the header which will be returned when the item is retrieved.

Referring to the diagram above, the 18, 3, and 27 byte items are **rounded up to 20, 4, and 28 bytes** respectively. An 8 byte header is then added in front of each item.

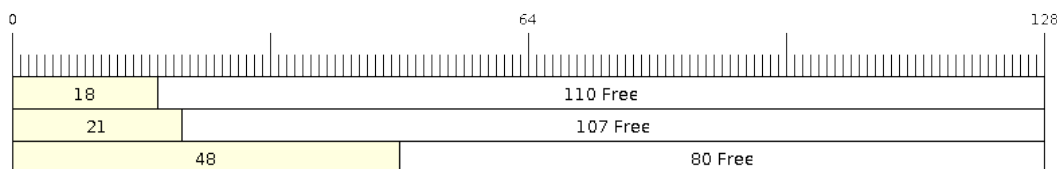

Fig. 38: Sending items to byte buffers

Byte buffers treat data as a sequence of bytes and does not incur any overhead (no headers). As a result, all data sent to a byte buffer is merged into a single item.

Referring to the diagram above, the 18, 3, and 27 byte items are sequentially written to the byte buffer and **merged into a single item of 48 bytes**.

**Using SendAcquire and SendComplete** Items in No-Split buffers are acquired (by `SendAcquire`) in strict FIFO order and must be sent to the buffer by `SendComplete` for the data to be accessible by the consumer. Multiple items can be sent or acquired without calling `SendComplete`, and the items do not necessarily need to be completed in the order they were acquired. However, the receiving of data items must occur in FIFO order, therefore not calling `SendComplete` for the earliest acquired item will prevent the subsequent items from being received.

The following diagrams illustrate what will happen when `SendAcquire` and `SendComplete` don't happen in the same order. At the beginning, there is already a data item of 16 bytes sent to the ring buffer. Then `SendAcquire` is called to acquire space of 20, 8, 24 bytes on the ring buffer.

After that, we fill (use) the buffers, and send them to the ring buffer by `SendComplete` in the order of 8, 24, 20. When 8 bytes and 24 bytes data are sent, the consumer still can only get the 16 bytes data item. Hence, if

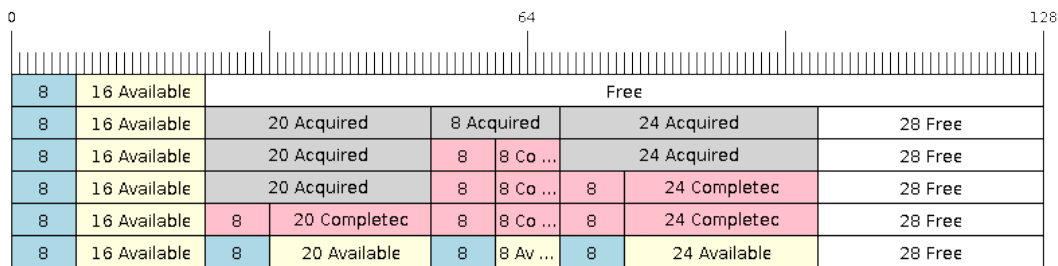

Fig. 39: SendAcquire/SendComplete items in No-Split ring buffers

SendComplete is not called for the 20 bytes, it will not be available, nor will the data items following the 20 bytes item.

When the 20 bytes item is finally completed, all the 3 data items can be received now, in the order of 20, 8, 24 bytes, right after the 16 bytes item existing in the buffer at the beginning.

Allow-Split buffers and byte buffers do not allow using SendAcquire or SendComplete since acquired buffers are required to be complete (not wrapped).

**Wrap around** The following diagrams illustrate the differences between No-Split, Allow-Split, and byte buffers when a sent item requires a wrap around. The diagrams assume a buffer of **128 bytes with 56 bytes of free space that wraps around** and a sent item of **28 bytes**.

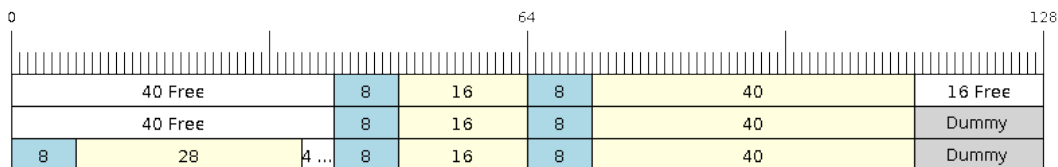

Fig. 40: Wrap around in No-Split buffers

No-Split buffers will **only store an item in continuous free space and will not split an item under any circumstances**. When the free space at the tail of the buffer is insufficient to completely store the item and its header, the free space at the tail will be **marked as dummy data**. The buffer will then wrap around and store the item in the free space at the head of the buffer.

Referring to the diagram above, the 16 bytes of free space at the tail of the buffer is insufficient to store the 28 byte item. Therefore, the 16 bytes is marked as dummy data and the item is written to the free space at the head of the buffer instead.

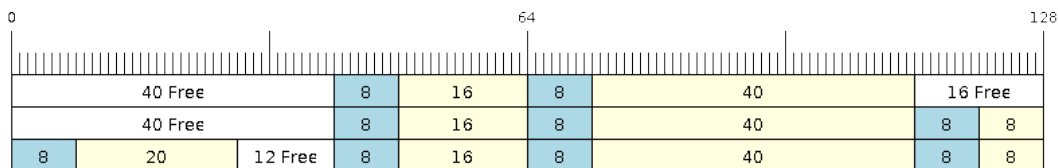

Fig. 41: Wrap around in Allow-Split buffers

Allow-Split buffers will attempt to **split the item into two parts** when the free space at the tail of the buffer is insufficient to store the item data and its header. Both parts of the split item will have their own headers (therefore incurring an extra 8 bytes of overhead).

Referring to the diagram above, the 16 bytes of free space at the tail of the buffer is insufficient to store the 28 byte item. Therefore, the item is split into two parts (8 and 20 bytes) and written as two parts to the buffer.

**Note:** Allow-Split buffers treat both parts of the split item as two separate items, therefore call `xRingbufferReceiveSplit()` instead of `xRingbufferReceive()` to receive both parts of a split item in a thread safe manner.

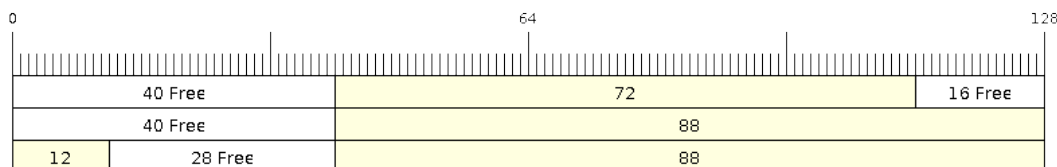

Fig. 42: Wrap around in byte buffers

Byte buffers will **store as much data as possible into the free space at the tail of buffer**. The remaining data will then be stored in the free space at the head of the buffer. No overhead is incurred when wrapping around in byte buffers.

Referring to the diagram above, the 16 bytes of free space at the tail of the buffer is insufficient to completely store the 28 bytes of data. Therefore, the 16 bytes of free space is filled with data, and the remaining 12 bytes are written to the free space at the head of the buffer. The buffer now contains data in two separate continuous parts, and each continuous part will be treated as a separate item by the byte buffer.

**Retrieving/Returning** The following diagrams illustrate the differences between No-Split and Allow-Split buffers as compared to byte buffers in retrieving and returning data.

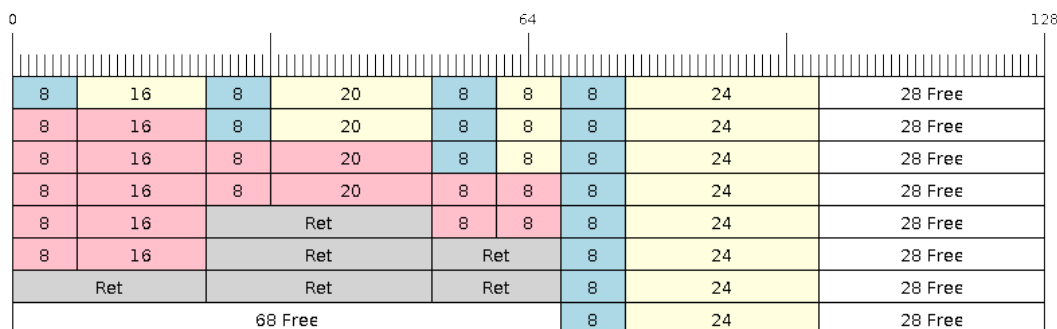

Fig. 43: Retrieving/Returning items in No-Split and Allow-Split ring buffers

Items in No-Split buffers and Allow-Split buffers are **retrieved in strict FIFO order** and **must be returned** for the occupied space to be freed. Multiple items can be retrieved before returning, and the items do not necessarily need to be returned in the order they were retrieved. However, the freeing of space must occur in FIFO order, therefore not returning the earliest retrieved item will prevent the space of subsequent items from being freed.

Referring to the diagram above, the **16, 20, and 8 byte items are retrieved in FIFO order**. However, the items are not returned in the order they were retrieved. First, the 20 byte item is returned followed by the 8 byte and the 16 byte items. The space is not freed until the first item, i.e., the 16 byte item is returned.

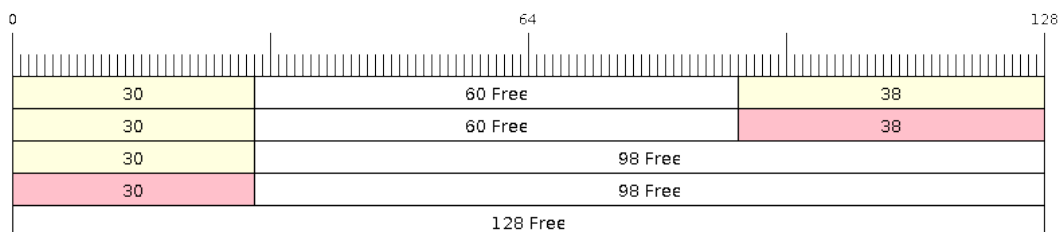

Fig. 44: Retrieving/Returning data in byte buffers

Byte buffers **do not allow multiple retrievals before returning** (every retrieval must be followed by a return before another retrieval is permitted). When using `xRingbufferReceive()` or `xRingbufferReceiveFromISR()`, all continuous stored data will be retrieved. `xRingbufferReceiveUpTo()` or `xRingbufferReceiveUpToFromISR()` can be used to restrict the maximum number of bytes retrieved. Since every retrieval must be followed by a return, the space will be freed as soon as the data is returned.

Referring to the diagram above, the 38 bytes of continuous stored data at the tail of the buffer is retrieved, returned, and freed. The next call to `xRingbufferReceive()` or `xRingbufferReceiveFromISR()` then wraps around and does the same to the 30 bytes of continuous stored data at the head of the buffer.

**Ring Buffers with Queue Sets** Ring buffers can be added to FreeRTOS queue sets using `xRingbufferAddToQueueSetRead()` such that every time a ring buffer receives an item or data, the queue set is notified. Once added to a queue set, every attempt to retrieve an item from a ring buffer should be preceded by a call to `xQueueSelectFromSet()`. To check whether the selected queue set member is the ring buffer, call `xRingbufferCanRead()`.

The following example demonstrates queue set usage with ring buffers.

```
#include "freertos/queue.h"
#include "freertos/ringbuf.h"

...

//Create ring buffer and queue set
RingbufHandle_t buf_handle = xRingbufferCreate(1028, RINGBUF_TYPE_NOSPLIT);
QueueSetHandle_t queue_set = xQueueCreateSet(3);

//Add ring buffer to queue set
if (xRingbufferAddToQueueSetRead(buf_handle, queue_set) != pdTRUE) {
    printf("Failed to add to queue set\n");
}

...

//Block on queue set
QueueSetMemberHandle_t member = xQueueSelectFromSet(queue_set, pdMS_TO_
↪TICKS(1000));

//Check if member is ring buffer
if (member != NULL && xRingbufferCanRead(buf_handle, member) == pdTRUE) {
    //Member is ring buffer, receive item from ring buffer
    size_t item_size;
    char *item = (char *)xRingbufferReceive(buf_handle, &item_size, 0);

    //Handle item
    ...
}
```

(continues on next page)



```

} else {
    ...
}

```

**Ring Buffers with Static Allocation** The `xRingbufferCreateStatic()` can be used to create ring buffers with specific memory requirements (such as a ring buffer being allocated in external RAM). All blocks of memory used by a ring buffer must be manually allocated beforehand then passed to the `xRingbufferCreateStatic()` to be initialized as a ring buffer. These blocks include the following:

- The ring buffer's data structure of type `StaticRingbuffer_t`
- The ring buffer's storage area of size `xBufferSize`. Note that `xBufferSize` must be 32-bit aligned for No-Split and Allow-Split buffers.

The manner in which these blocks are allocated will depend on the users requirements (e.g. all blocks being statically declared, or dynamically allocated with specific capabilities such as external RAM).

---

**Note:** When deleting a ring buffer created via `xRingbufferCreateStatic()`, the function `vRingbufferDelete()` will not free any of the memory blocks. This must be done manually by the user after `vRingbufferDelete()` is called.

---

The code snippet below demonstrates a ring buffer being allocated entirely in external RAM.

```

#include "freertos/ringbuf.h"
#include "freertos/semphr.h"
#include "esp_heap_caps.h"

#define BUFFER_SIZE      400          //32-bit aligned size
#define BUFFER_TYPE      RINGBUF_TYPE_NOSPLIT
...

//Allocate ring buffer data structure and storage area into external RAM
StaticRingbuffer_t *buffer_struct = (StaticRingbuffer_t *)heap_caps_
↳malloc(sizeof(StaticRingbuffer_t), MALLOC_CAP_SPIRAM);
uint8_t *buffer_storage = (uint8_t *)heap_caps_malloc(sizeof(uint8_t)*BUFFER_SIZE,↳
↳MALLOC_CAP_SPIRAM);

//Create a ring buffer with manually allocated memory
RingbufHandle_t handle = xRingbufferCreateStatic(BUFFER_SIZE, BUFFER_TYPE, buffer_
↳storage, buffer_struct);

...

//Delete the ring buffer after used
vRingbufferDelete(handle);

//Manually free all blocks of memory
free(buffer_struct);
free(buffer_storage);

```

**Priority Inversion** Ideally, ring buffers can be used with multiple tasks in an SMP fashion where the **highest priority task will always be serviced first**. However due to the usage of binary semaphores in the ring buffer's underlying implementation, priority inversion may occur under very specific circumstances.

The ring buffer governs sending by a binary semaphore which is given whenever space is freed on the ring buffer. The highest priority task waiting to send will repeatedly take the semaphore until sufficient free space becomes available or until it times out. Ideally this should prevent any lower priority tasks from being serviced as the semaphore should always be given to the highest priority task.

However, in between iterations of acquiring the semaphore, there is a **gap in the critical section** which may permit another task (on the other core or with an even higher priority) to free some space on the ring buffer and as a result give the semaphore. Therefore, the semaphore will be given before the highest priority task can re-acquire the semaphore. This will result in the **semaphore being acquired by the second-highest priority task** waiting to send, hence causing priority inversion.

This side effect will not affect ring buffer performance drastically given if the number of tasks using the ring buffer simultaneously is low, and the ring buffer is not operating near maximum capacity.

### ESP-IDF Tick and Idle Hooks

FreeRTOS allows applications to provide a tick hook and an idle hook at compile time:

- FreeRTOS tick hook can be enabled via the `CONFIG_FREERTOS_USE_TICK_HOOK` option. The application must provide the `void vApplicationTickHook( void )` callback.
- FreeRTOS idle hook can be enabled via the `CONFIG_FREERTOS_USE_IDLE_HOOK` option. The application must provide the `void vApplicationIdleHook( void )` callback.

However, the FreeRTOS tick hook and idle hook have the following drawbacks:

- The FreeRTOS hooks are registered at compile time
- Only one of each hook can be registered
- On multi-core targets, the FreeRTOS hooks are symmetric, meaning each CPU's tick interrupt and idle tasks ends up calling the same hook.

Therefore, ESP-IDF tick and idle hooks are provided to supplement the features of FreeRTOS tick and idle hooks. The ESP-IDF hooks have the following features:

- The hooks can be registered and deregistered at run-time
- Multiple hooks can be registered (with a maximum of 8 hooks of each type per CPU)
- On multi-core targets, the hooks can be asymmetric, meaning different hooks can be registered to each CPU

ESP-IDF hooks can be registered and deregistered using the following API:

- For tick hooks:
  - Register using `esp_register_freertos_tick_hook()` or `esp_register_freertos_tick_hook_for_cpu()`
  - Deregister using `esp_deregister_freertos_tick_hook()` or `esp_deregister_freertos_tick_hook_for_cpu()`
- For idle hooks:
  - Register using `esp_register_freertos_idle_hook()` or `esp_register_freertos_idle_hook_for_cpu()`
  - Deregister using `esp_deregister_freertos_idle_hook()` or `esp_deregister_freertos_idle_hook_for_cpu()`

---

**Note:** The tick interrupt stays active while the cache is disabled, therefore any tick hook (FreeRTOS or ESP-IDF) functions must be placed in internal RAM. Please refer to the [SPI flash API documentation](#) for more details.

---

### TLSP Deletion Callbacks

Vanilla FreeRTOS provides a Thread Local Storage Pointers (TLSP) feature. These are pointers stored directly in the Task Control Block (TCB) of a particular task. TLSPs allow each task to have its own unique set of pointers to data structures. Vanilla FreeRTOS expects users to...

- set a task's TLSPs by calling `vTaskSetThreadLocalStoragePointer()` after the task has been created.
- get a task's TLSPs by calling `pvTaskGetThreadLocalStoragePointer()` during the task's lifetime.
- free the memory pointed to by the TLSPs before the task is deleted.

However, there can be instances where users may want the freeing of TLSP memory to be automatic. Therefore, ESP-IDF provides the additional feature of TLSP deletion callbacks. These user provided deletion callbacks are called automatically when a task is deleted, thus allowing the TLSP memory to be cleaned up without needing to add the cleanup logic explicitly to the code of every task.

The TLSP deletion callbacks are set in a similar fashion to the TLSPs themselves.

- `vTaskSetThreadLocalStoragePointerAndDelCallback()` sets both a particular TLSP and its associated callback.
- Calling the Vanilla FreeRTOS function `vTaskSetThreadLocalStoragePointer()` will simply set the TLSP's associated Deletion Callback to `NULL` meaning that no callback will be called for that TLSP during task deletion.

When implementing TLSP callbacks, users should note the following:

- The callback **must never attempt to block or yield** and critical sections should be kept as short as possible
- The callback is called shortly before a deleted task's memory is freed. Thus, the callback can either be called from `vTaskDelete()` itself, or from the idle task.

### Component Specific Properties

Besides standard component variables that are available with basic cmake build properties, FreeRTOS component also provides arguments (only one so far) for simpler integration with other modules:

- `ORIG_INCLUDE_PATH` - contains an absolute path to freertos root include folder. Thus instead of `#include "freertos/FreeRTOS.h"` you can refer to headers directly: `#include "FreeRTOS.h"`.

## API Reference

### Ring Buffer API

#### Header File

- `components/esp_ringbuf/include/freertos/ringbuf.h`

#### Functions

`RingbufHandle_t xRingbufferCreate` (`size_t xBufferSize`, `RingbufferType_t xBufferType`)

Create a ring buffer.

---

**Note:** `xBufferSize` of no-split/allow-split buffers will be rounded up to the nearest 32-bit aligned size.

---

#### Parameters

- `xBufferSize` **–[in]** Size of the buffer in bytes. Note that items require space for a header in no-split/allow-split buffers
- `xBufferType` **–[in]** Type of ring buffer, see documentation.

**Returns** A handle to the created ring buffer, or `NULL` in case of error.

`RingbufHandle_t xRingbufferCreateNoSplit` (`size_t xItemSize`, `size_t xItemNum`)

Create a ring buffer of type `RINGBUF_TYPE_NOSPLIT` for a fixed `item_size`.

This API is similar to `xRingbufferCreate()`, but it will internally allocate additional space for the headers.

#### Parameters

- `xItemSize` **–[in]** Size of each item to be put into the ring buffer
- `xItemNum` **–[in]** Maximum number of items the buffer needs to hold simultaneously

**Returns** A `RingbufHandle_t` handle to the created ring buffer, or `NULL` in case of error.

*RingbufHandle\_t* **xRingbufferCreateStatic** (size\_t xBufferSize, *RingbufferType\_t* xBufferType, uint8\_t \*pucRingbufferStorage, *StaticRingbuffer\_t* \*pxStaticRingbuffer)

Create a ring buffer but manually provide the required memory.

---

**Note:** xBufferSize of no-split/allow-split buffers MUST be 32-bit aligned.

---

#### Parameters

- **xBufferSize** –[in] Size of the buffer in bytes.
- **xBufferType** –[in] Type of ring buffer, see documentation
- **pucRingbufferStorage** –[in] Pointer to the ring buffer's storage area. Storage area must have the same size as specified by xBufferSize
- **pxStaticRingbuffer** –[in] Pointed to a struct of type *StaticRingbuffer\_t* which will be used to hold the ring buffer's data structure

**Returns** A handle to the created ring buffer

BaseType\_t **xRingbufferSend** (*RingbufHandle\_t* xRingbuffer, const void \*pvItem, size\_t xItemSize, TickType\_t xTicksToWait)

Insert an item into the ring buffer.

Attempt to insert an item into the ring buffer. This function will block until enough free space is available or until it times out.

---

**Note:** For no-split/allow-split ring buffers, the actual size of memory that the item will occupy will be rounded up to the nearest 32-bit aligned size. This is done to ensure all items are always stored in 32-bit aligned fashion.

---

#### Parameters

- **xRingbuffer** –[in] Ring buffer to insert the item into
- **pvItem** –[in] Pointer to data to insert. NULL is allowed if xItemSize is 0.
- **xItemSize** –[in] Size of data to insert.
- **xTicksToWait** –[in] Ticks to wait for room in the ring buffer.

#### Returns

- pdTRUE if succeeded
- pdFALSE on time-out or when the data is larger than the maximum permissible size of the buffer

BaseType\_t **xRingbufferSendFromISR** (*RingbufHandle\_t* xRingbuffer, const void \*pvItem, size\_t xItemSize, BaseType\_t \*pxHigherPriorityTaskWoken)

Insert an item into the ring buffer in an ISR.

Attempt to insert an item into the ring buffer from an ISR. This function will return immediately if there is insufficient free space in the buffer.

---

**Note:** For no-split/allow-split ring buffers, the actual size of memory that the item will occupy will be rounded up to the nearest 32-bit aligned size. This is done to ensure all items are always stored in 32-bit aligned fashion.

---

#### Parameters

- **xRingbuffer** –[in] Ring buffer to insert the item into
- **pvItem** –[in] Pointer to data to insert. NULL is allowed if xItemSize is 0.
- **xItemSize** –[in] Size of data to insert.
- **pxHigherPriorityTaskWoken** –[out] Value pointed to will be set to pdTRUE if the function woke up a higher priority task.

#### Returns

- pdTRUE if succeeded

- pdFALSE when the ring buffer does not have space.

BaseType\_t **xRingbufferSendAcquire** (*RingbufHandle\_t* xRingbuffer, void \*\*ppvItem, size\_t xItemSize, TickType\_t xTicksToWait)

Acquire memory from the ring buffer to be written to by an external source and to be sent later.

Attempt to allocate buffer for an item to be sent into the ring buffer. This function will block until enough free space is available or until it times out.

The item, as well as the following items `SendAcquire` or `Send` after it, will not be able to be read from the ring buffer until this item is actually sent into the ring buffer.

---

**Note:** Only applicable for no-split ring buffers now, the actual size of memory that the item will occupy will be rounded up to the nearest 32-bit aligned size. This is done to ensure all items are always stored in 32-bit aligned fashion.

---

#### Parameters

- **xRingbuffer** –[in] Ring buffer to allocate the memory
- **ppvItem** –[out] Double pointer to memory acquired (set to NULL if no memory were retrieved)
- **xItemSize** –[in] Size of item to acquire.
- **xTicksToWait** –[in] Ticks to wait for room in the ring buffer.

#### Returns

- pdTRUE if succeeded
- pdFALSE on time-out or when the data is larger than the maximum permissible size of the buffer

BaseType\_t **xRingbufferSendComplete** (*RingbufHandle\_t* xRingbuffer, void \*pvItem)

Actually send an item into the ring buffer allocated before by `xRingbufferSendAcquire`.

---

**Note:** Only applicable for no-split ring buffers. Only call for items allocated by `xRingbufferSendAcquire`.

---

#### Parameters

- **xRingbuffer** –[in] Ring buffer to insert the item into
- **pvItem** –[in] Pointer to item in allocated memory to insert.

#### Returns

- pdTRUE if succeeded
- pdFALSE if fail for some reason.

void \***xRingbufferReceive** (*RingbufHandle\_t* xRingbuffer, size\_t \*pxItemSize, TickType\_t xTicksToWait)

Retrieve an item from the ring buffer.

Attempt to retrieve an item from the ring buffer. This function will block until an item is available or until it times out.

---

**Note:** A call to `vRingbufferReturnItem()` is required after this to free the item retrieved.

---

#### Parameters

- **xRingbuffer** –[in] Ring buffer to retrieve the item from
- **pxItemSize** –[out] Pointer to a variable to which the size of the retrieved item will be written.
- **xTicksToWait** –[in] Ticks to wait for items in the ring buffer.

#### Returns

- Pointer to the retrieved item on success; \*pxItemSize filled with the length of the item.
- NULL on timeout, \*pxItemSize is untouched in that case.

void \***xRingbufferReceiveFromISR** (*RingbufHandle\_t* xRingbuffer, size\_t \*pxItemSize)

Retrieve an item from the ring buffer in an ISR.

Attempt to retrieve an item from the ring buffer. This function returns immediately if there are no items available for retrieval

---

**Note:** A call to vRingbufferReturnItemFromISR() is required after this to free the item retrieved.

---

---

**Note:** Byte buffers do not allow multiple retrievals before returning an item

---

---

**Note:** Two calls to RingbufferReceiveFromISR() are required if the bytes wrap around the end of the ring buffer.

---

#### Parameters

- **xRingbuffer** –[in] Ring buffer to retrieve the item from
- **pxItemSize** –[out] Pointer to a variable to which the size of the retrieved item will be written.

#### Returns

- Pointer to the retrieved item on success; \*pxItemSize filled with the length of the item.
- NULL when the ring buffer is empty, \*pxItemSize is untouched in that case.

BaseType\_t **xRingbufferReceiveSplit** (*RingbufHandle\_t* xRingbuffer, void \*\*ppvHeadItem, void \*\*ppvTailItem, size\_t \*pxHeadItemSize, size\_t \*pxTailItemSize, TickType\_t xTicksToWait)

Retrieve a split item from an allow-split ring buffer.

Attempt to retrieve a split item from an allow-split ring buffer. If the item is not split, only a single item is retrieved. If the item is split, both parts will be retrieved. This function will block until an item is available or until it times out.

---

**Note:** Call(s) to vRingbufferReturnItem() is required after this to free up the item(s) retrieved.

---

---

**Note:** This function should only be called on allow-split buffers

---

#### Parameters

- **xRingbuffer** –[in] Ring buffer to retrieve the item from
- **ppvHeadItem** –[out] Double pointer to first part (set to NULL if no items were retrieved)
- **ppvTailItem** –[out] Double pointer to second part (set to NULL if item is not split)
- **pxHeadItemSize** –[out] Pointer to size of first part (unmodified if no items were retrieved)
- **pxTailItemSize** –[out] Pointer to size of second part (unmodified if item is not split)
- **xTicksToWait** –[in] Ticks to wait for items in the ring buffer.

#### Returns

- pdTRUE if an item (split or unsplit) was retrieved
- pdFALSE when no item was retrieved

BaseType\_t **xRingbufferReceiveSplitFromISR** (*RingbufHandle\_t* xRingbuffer, void \*\*ppvHeadItem, void \*\*ppvTailItem, size\_t \*pxHeadItemSize, size\_t \*pxTailItemSize)

Retrieve a split item from an allow-split ring buffer in an ISR.

Attempt to retrieve a split item from an allow-split ring buffer. If the item is not split, only a single item is retrieved. If the item is split, both parts will be retrieved. This function returns immediately if there are no items available for retrieval

---

**Note:** Calls to `vRingbufferReturnItemFromISR()` is required after this to free up the item(s) retrieved.

---

---

**Note:** This function should only be called on allow-split buffers

---

#### Parameters

- **xRingbuffer** –[in] Ring buffer to retrieve the item from
- **ppvHeadItem** –[out] Double pointer to first part (set to NULL if no items were retrieved)
- **ppvTailItem** –[out] Double pointer to second part (set to NULL if item is not split)
- **pxHeadItemSize** –[out] Pointer to size of first part (unmodified if no items were retrieved)
- **pxTailItemSize** –[out] Pointer to size of second part (unmodified if item is not split)

#### Returns

- pdTRUE if an item (split or unsplit) was retrieved
- pdFALSE when no item was retrieved

void \***xRingbufferReceiveUpTo** (*RingbufHandle\_t* xRingbuffer, size\_t \*pxItemSize, TickType\_t xTicksToWait, size\_t xMaxSize)

Retrieve bytes from a byte buffer, specifying the maximum amount of bytes to retrieve.

Attempt to retrieve data from a byte buffer whilst specifying a maximum number of bytes to retrieve. This function will block until there is data available for retrieval or until it times out.

---

**Note:** A call to `vRingbufferReturnItem()` is required after this to free up the data retrieved.

---

---

**Note:** This function should only be called on byte buffers

---

---

**Note:** Byte buffers do not allow multiple retrievals before returning an item

---

---

**Note:** Two calls to `RingbufferReceiveUpTo()` are required if the bytes wrap around the end of the ring buffer.

---

#### Parameters

- **xRingbuffer** –[in] Ring buffer to retrieve the item from
- **pxItemSize** –[out] Pointer to a variable to which the size of the retrieved item will be written.
- **xTicksToWait** –[in] Ticks to wait for items in the ring buffer.
- **xMaxSize** –[in] Maximum number of bytes to return.

#### Returns

- Pointer to the retrieved item on success; \*pxItemSize filled with the length of the item.
- NULL on timeout, \*pxItemSize is untouched in that case.

void **\*xRingbufferReceiveUpToFromISR** (*RingbufHandle\_t* xRingbuffer, size\_t \*pxItemSize, size\_t xMaxSize)

Retrieve bytes from a byte buffer, specifying the maximum amount of bytes to retrieve. Call this from an ISR.

Attempt to retrieve bytes from a byte buffer whilst specifying a maximum number of bytes to retrieve. This function will return immediately if there is no data available for retrieval.

---

**Note:** A call to `vRingbufferReturnItemFromISR()` is required after this to free up the data received.

---

---

**Note:** This function should only be called on byte buffers

---

---

**Note:** Byte buffers do not allow multiple retrievals before returning an item

---

#### Parameters

- **xRingbuffer** –[in] Ring buffer to retrieve the item from
- **pxItemSize** –[out] Pointer to a variable to which the size of the retrieved item will be written.
- **xMaxSize** –[in] Maximum number of bytes to return.

#### Returns

- Pointer to the retrieved item on success; \*pxItemSize filled with the length of the item.
- NULL when the ring buffer is empty, \*pxItemSize is untouched in that case.

void **vRingbufferReturnItem** (*RingbufHandle\_t* xRingbuffer, void \*pvItem)

Return a previously-retrieved item to the ring buffer.

---

**Note:** If a split item is retrieved, both parts should be returned by calling this function twice

---

#### Parameters

- **xRingbuffer** –[in] Ring buffer the item was retrieved from
- **pvItem** –[in] Item that was received earlier

void **vRingbufferReturnItemFromISR** (*RingbufHandle\_t* xRingbuffer, void \*pvItem, BaseType\_t \*pxHigherPriorityTaskWoken)

Return a previously-retrieved item to the ring buffer from an ISR.

---

**Note:** If a split item is retrieved, both parts should be returned by calling this function twice

---

#### Parameters

- **xRingbuffer** –[in] Ring buffer the item was retrieved from
- **pvItem** –[in] Item that was received earlier
- **pxHigherPriorityTaskWoken** –[out] Value pointed to will be set to `pdTRUE` if the function woke up a higher priority task.

void **vRingbufferDelete** (*RingbufHandle\_t* xRingbuffer)

Delete a ring buffer.

---

**Note:** This function will not deallocate any memory if the ring buffer was created using `xRingbufferCreateStatic()`. Deallocation must be done manually by the user.

---



**Parameters** **xRingbuffer** –[in] Ring buffer to delete

size\_t **xRingbufferGetMaxItemSize** (*RingbufHandle\_t* xRingbuffer)

Get maximum size of an item that can be placed in the ring buffer.

This function returns the maximum size an item can have if it was placed in an empty ring buffer.

---

**Note:** The max item size for a no-split buffer is limited to  $((\text{buffer\_size}/2) - \text{header\_size})$ . This limit is imposed so that an item of max item size can always be sent to an empty no-split buffer regardless of the internal positions of the buffer's read/write/free pointers.

---

**Parameters** **xRingbuffer** –[in] Ring buffer to query

**Returns** Maximum size, in bytes, of an item that can be placed in a ring buffer.

size\_t **xRingbufferGetCurFreeSize** (*RingbufHandle\_t* xRingbuffer)

Get current free size available for an item/data in the buffer.

This gives the real time free space available for an item/data in the ring buffer. This represents the maximum size an item/data can have if it was currently sent to the ring buffer.

---

**Note:** An empty no-split buffer has a max current free size for an item that is limited to  $((\text{buffer\_size}/2) - \text{header\_size})$ . See API reference for `xRingbufferGetMaxItemSize()`.

---

**Warning:** This API is not thread safe. So, if multiple threads are accessing the same ring buffer, it is the application's responsibility to ensure atomic access to this API and the subsequent Send

**Parameters** **xRingbuffer** –[in] Ring buffer to query

**Returns** Current free size, in bytes, available for an entry

BaseType\_t **xRingbufferAddToQueueSetRead** (*RingbufHandle\_t* xRingbuffer, *QueueSetHandle\_t* xQueueSet)

Add the ring buffer's read semaphore to a queue set.

The ring buffer's read semaphore indicates that data has been written to the ring buffer. This function adds the ring buffer's read semaphore to a queue set.

**Parameters**

- **xRingbuffer** –[in] Ring buffer to add to the queue set
- **xQueueSet** –[in] Queue set to add the ring buffer's read semaphore to

**Returns**

- pdTRUE on success, pdFALSE otherwise

BaseType\_t **xRingbufferCanRead** (*RingbufHandle\_t* xRingbuffer, *QueueSetMemberHandle\_t* xMember)

Check if the selected queue set member is the ring buffer's read semaphore.

This API checks if queue set member returned from `xQueueSelectFromSet()` is the read semaphore of this ring buffer. If so, this indicates the ring buffer has items waiting to be retrieved.

**Parameters**

- **xRingbuffer** –[in] Ring buffer which should be checked
- **xMember** –[in] Member returned from `xQueueSelectFromSet`

**Returns**

- pdTRUE when semaphore belongs to ring buffer
- pdFALSE otherwise.

BaseType\_t **xRingbufferRemoveFromQueueSetRead** (*RingbufHandle\_t* xRingbuffer, *QueueSetHandle\_t* xQueueSet)

Remove the ring buffer's read semaphore from a queue set.

This specifically removes a ring buffer's read semaphore from a queue set. The read semaphore is used to indicate when data has been written to the ring buffer

#### Parameters

- **xRingbuffer** –[in] Ring buffer to remove from the queue set
- **xQueueSet** –[in] Queue set to remove the ring buffer's read semaphore from

#### Returns

- pdTRUE on success
- pdFALSE otherwise

void **vRingbufferGetInfo** (*RingbufHandle\_t* xRingbuffer, BaseType\_t \*uxFree, BaseType\_t \*uxRead, BaseType\_t \*uxWrite, BaseType\_t \*uxAcquire, BaseType\_t \*uxItemsWaiting)

Get information about ring buffer status.

Get information of a ring buffer's current status such as free/read/write/acquire pointer positions, and number of items waiting to be retrieved. Arguments can be set to NULL if they are not required.

#### Parameters

- **xRingbuffer** –[in] Ring buffer to remove from the queue set
- **uxFree** –[out] Pointer use to store free pointer position
- **uxRead** –[out] Pointer use to store read pointer position
- **uxWrite** –[out] Pointer use to store write pointer position
- **uxAcquire** –[out] Pointer use to store acquire pointer position
- **uxItemsWaiting** –[out] Pointer use to store number of items (bytes for byte buffer) waiting to be retrieved

void **xRingbufferPrintInfo** (*RingbufHandle\_t* xRingbuffer)

Debugging function to print the internal pointers in the ring buffer.

**Parameters** **xRingbuffer** –Ring buffer to show

## Structures

struct **xSTATIC\_RINGBUFFER**

Struct that is equivalent in size to the ring buffer's data structure.

The contents of this struct are not meant to be used directly. This structure is meant to be used when creating a statically allocated ring buffer where this struct is of the exact size required to store a ring buffer's control data structure.

## Type Definitions

typedef void \***RingbufHandle\_t**

Type by which ring buffers are referenced. For example, a call to xRingbufferCreate() returns a RingbufHandle\_t variable that can then be used as a parameter to xRingbufferSend(), xRingbufferReceive(), etc.

typedef struct *xSTATIC\_RINGBUFFER* **StaticRingbuffer\_t**

Struct that is equivalent in size to the ring buffer's data structure.

The contents of this struct are not meant to be used directly. This structure is meant to be used when creating a statically allocated ring buffer where this struct is of the exact size required to store a ring buffer's control data structure.

## Enumerations

enum **RingbufferType\_t**

*Values:*

enumerator **RINGBUF\_TYPE\_NOSPLIT**

No-split buffers will only store an item in contiguous memory and will never split an item. Each item requires an 8 byte overhead for a header and will always internally occupy a 32-bit aligned size of space.

enumerator **RINGBUF\_TYPE\_ALLOWSPLIT**

Allow-split buffers will split an item into two parts if necessary in order to store it. Each item requires an 8 byte overhead for a header, splitting incurs an extra header. Each item will always internally occupy a 32-bit aligned size of space.

enumerator **RINGBUF\_TYPE\_BYTEBUF**

Byte buffers store data as a sequence of bytes and do not maintain separate items, therefore byte buffers have no overhead. All data is stored as a sequence of byte and any number of bytes can be sent or retrieved each time.

enumerator **RINGBUF\_TYPE\_MAX**

## Hooks API

### Header File

- [components/esp\\_system/include/esp\\_freertos\\_hooks.h](#)

### Functions

*esp\_err\_t* **esp\_register\_freertos\_idle\_hook\_for\_cpu** (*esp\_freertos\_idle\_cb\_t* new\_idle\_cb, UBaseType\_t cpuid)

Register a callback to be called from the specified core's idle hook. The callback should return true if it should be called by the idle hook once per interrupt (or FreeRTOS tick), and return false if it should be called repeatedly as fast as possible by the idle hook.

**Warning:** Idle callbacks MUST NOT, UNDER ANY CIRCUMSTANCES, CALL A FUNCTION THAT MIGHT BLOCK.

#### Parameters

- **new\_idle\_cb** –[in] Callback to be called
- **cpuid** –[in] id of the core

#### Returns

- **ESP\_OK**: Callback registered to the specified core's idle hook
- **ESP\_ERR\_NO\_MEM**: No more space on the specified core's idle hook to register callback
- **ESP\_ERR\_INVALID\_ARG**: cpuid is invalid

*esp\_err\_t* **esp\_register\_freertos\_idle\_hook** (*esp\_freertos\_idle\_cb\_t* new\_idle\_cb)

Register a callback to the idle hook of the core that calls this function. The callback should return true if it should be called by the idle hook once per interrupt (or FreeRTOS tick), and return false if it should be called repeatedly as fast as possible by the idle hook.

**Warning:** Idle callbacks MUST NOT, UNDER ANY CIRCUMSTANCES, CALL A FUNCTION THAT MIGHT BLOCK.

**Parameters** `new_idle_cb` –[in] Callback to be called

**Returns**

- `ESP_OK`: Callback registered to the calling core's idle hook
- `ESP_ERR_NO_MEM`: No more space on the calling core's idle hook to register callback

`esp_err_t esp_register_freertos_tick_hook_for_cpu(esp_freertos_tick_cb_t new_tick_cb, UBaseType_t cpuid)`

Register a callback to be called from the specified core's tick hook.

**Parameters**

- `new_tick_cb` –[in] Callback to be called
- `cpuid` –[in] id of the core

**Returns**

- `ESP_OK`: Callback registered to specified core's tick hook
- `ESP_ERR_NO_MEM`: No more space on the specified core's tick hook to register the callback
- `ESP_ERR_INVALID_ARG`: `cpuid` is invalid

`esp_err_t esp_register_freertos_tick_hook(esp_freertos_tick_cb_t new_tick_cb)`

Register a callback to be called from the calling core's tick hook.

**Parameters** `new_tick_cb` –[in] Callback to be called

**Returns**

- `ESP_OK`: Callback registered to the calling core's tick hook
- `ESP_ERR_NO_MEM`: No more space on the calling core's tick hook to register the callback

`void esp_deregister_freertos_idle_hook_for_cpu(esp_freertos_idle_cb_t old_idle_cb, UBaseType_t cpuid)`

Unregister an idle callback from the idle hook of the specified core.

**Parameters**

- `old_idle_cb` –[in] Callback to be unregistered
- `cpuid` –[in] id of the core

`void esp_deregister_freertos_idle_hook(esp_freertos_idle_cb_t old_idle_cb)`

Unregister an idle callback. If the idle callback is registered to the idle hooks of both cores, the idle hook will be unregistered from both cores.

**Parameters** `old_idle_cb` –[in] Callback to be unregistered

`void esp_deregister_freertos_tick_hook_for_cpu(esp_freertos_tick_cb_t old_tick_cb, UBaseType_t cpuid)`

Unregister a tick callback from the tick hook of the specified core.

**Parameters**

- `old_tick_cb` –[in] Callback to be unregistered
- `cpuid` –[in] id of the core

`void esp_deregister_freertos_tick_hook(esp_freertos_tick_cb_t old_tick_cb)`

Unregister a tick callback. If the tick callback is registered to the tick hooks of both cores, the tick hook will be unregistered from both cores.

**Parameters** `old_tick_cb` –[in] Callback to be unregistered

## Type Definitions

```
typedef bool (*esp_freertos_idle_cb_t)(void)
```

```
typedef void (*esp_freertos_tick_cb_t)(void)
```

## 2.9.13 Heap Memory Allocation

### Stack and Heap

ESP-IDF applications use the common computer architecture patterns of *stack* (dynamic memory allocated by program control flow) and *heap* (dynamic memory allocated by function calls), as well as statically allocated memory (allocated at compile time).

Because ESP-IDF is a multi-threaded RTOS environment, each RTOS task has its own stack. By default, each of these stacks is allocated from the heap when the task is created. (See `xTaskCreateStatic()` for the alternative where stacks are statically allocated.)

Because ESP32-S2 uses multiple types of RAM, it also contains multiple heaps with different capabilities. A capabilities-based memory allocator allows apps to make heap allocations for different purposes.

For most purposes, the standard libc `malloc()` and `free()` functions can be used for heap allocation without any special consideration.

However, in order to fully make use of all of the memory types and their characteristics, ESP-IDF also has a capabilities-based heap memory allocator. If you want to have memory with certain properties (for example, *DMA-Capable Memory* or executable-memory), you can create an OR-mask of the required capabilities and pass that to `heap_caps_malloc()`.

### Memory Capabilities

The ESP32-S2 contains multiple types of RAM:

- DRAM (Data RAM) is memory used to hold data. This is the most common kind of memory accessed as heap.
- IRAM (Instruction RAM) usually holds executable data only. If accessed as generic memory, all accesses must be *32-bit aligned*.
- D/IRAM is RAM which can be used as either Instruction or Data RAM.

For more details on these internal memory types, see *Memory Types*.

It's also possible to connect external SPI RAM to the ESP32-S2 - *external RAM* can be integrated into the ESP32-S2's memory map using the flash cache, and accessed similarly to DRAM.

DRAM uses capability `MALLOC_CAP_8BIT` (accessible in single byte reads and writes). To test the free DRAM heap size at runtime, call `cpp:func:heap_caps_get_free_size(MALLOC_CAP_8BIT)`.

When calling `malloc()`, the ESP-IDF `malloc()` implementation internally calls `cpp:func:heap_caps_malloc_default(size)`. This will allocate memory with capability `MALLOC_CAP_DEFAULT`, which is byte-addressable.

Because `malloc` uses the capabilities-based allocation system, memory allocated using `heap_caps_malloc()` can be freed by calling the standard `free()` function.

### Available Heap

**DRAM** At startup, the DRAM heap contains all data memory which is not statically allocated by the app. Reducing statically allocated buffers will increase the amount of available free heap.

To find the amount of statically allocated memory, use the `idf.py size` command.

**Note:** At runtime, the available heap DRAM may be less than calculated at compile time, because at startup some memory is allocated from the heap before the FreeRTOS scheduler is started (including memory for the stacks of initial FreeRTOS tasks).

---

**IRAM** At startup, the IRAM heap contains all instruction memory which is not used by the app executable code. The `idf.py size` command can be used to find the amount of IRAM used by the app.

**D/IRAM** Some memory in the ESP32-S2 is available as either DRAM or IRAM. If memory is allocated from a D/IRAM region, the free heap size for both types of memory will decrease.

**Heap Sizes** At startup, all ESP-IDF apps log a summary of all heap addresses (and sizes) at level Info:

```
I (252) heap_init: Initializing. RAM available for dynamic allocation:
I (259) heap_init: At 3FFAE6E0 len 00001920 (6 KiB): DRAM
I (265) heap_init: At 3FFB2EC8 len 0002D138 (180 KiB): DRAM
I (272) heap_init: At 3FFE0440 len 00003AE0 (14 KiB): D/IRAM
I (278) heap_init: At 3FFE4350 len 0001BCB0 (111 KiB): D/IRAM
I (284) heap_init: At 4008944C len 00016BB4 (90 KiB): IRAM
```

**Finding available heap** See [Heap Information](#).

### Special Capabilities

**DMA-Capable Memory** Use the `MALLOC_CAP_DMA` flag to allocate memory which is suitable for use with hardware DMA engines (for example SPI and I2S). This capability flag excludes any external PSRAM.

**32-Bit Accessible Memory** If a certain memory structure is only addressed in 32-bit units, for example an array of ints or pointers, it can be useful to allocate it with the `MALLOC_CAP_32BIT` flag. This also allows the allocator to give out IRAM memory; something which it can't do for a normal `malloc()` call. This can help to use all the available memory in the ESP32-S2.

Memory allocated with `MALLOC_CAP_32BIT` can *only* be accessed via 32-bit reads and writes, any other type of access will generate a fatal `LoadStoreError` exception.

**External SPI Memory** When [external RAM](#) is enabled, external SPI RAM under 4MiB in size can be allocated using standard `malloc` calls, or via `heap_caps_malloc(MALLOC_CAP_SPIRAM)`, depending on configuration. See [Configuring External RAM](#) for more details.

### Thread Safety

Heap functions are thread safe, meaning they can be called from different tasks simultaneously without any limitations.

It is technically possible to call `malloc`, `free`, and related functions from interrupt handler (ISR) context (see [Calling heap related functions from ISR](#)). However this is not recommended, as heap function calls may delay other interrupts. It is strongly recommended to refactor applications so that any buffers used by an ISR are pre-allocated outside of the ISR. Support for calling heap functions from ISRs may be removed in a future update.

## Calling heap related functions from ISR

The following functions from the heap component can be called from interrupt handler (ISR):

- [heap\\_caps\\_malloc\(\)](#)
- [heap\\_caps\\_malloc\\_default\(\)](#)
- [heap\\_caps\\_realloc\\_default\(\)](#)
- [heap\\_caps\\_malloc\\_prefer\(\)](#)
- [heap\\_caps\\_realloc\\_prefer\(\)](#)
- [heap\\_caps\\_calloc\\_prefer\(\)](#)
- [heap\\_caps\\_free\(\)](#)
- [heap\\_caps\\_realloc\(\)](#)
- [heap\\_caps\\_calloc\(\)](#)
- [heap\\_caps\\_aligned\\_alloc\(\)](#)
- [heap\\_caps\\_aligned\\_free\(\)](#)

Note however this practice is strongly discouraged.

## Heap Tracing & Debugging

The following features are documented on the [Heap Memory Debugging](#) page:

- [Heap Information](#) (free space, etc.)
- [Heap Corruption Detection](#)
- [Heap Tracing](#) (memory leak detection, monitoring, etc.)

## Implementation Notes

Knowledge about the regions of memory in the chip comes from the “soc” component, which contains memory layout information for the chip, and the different capabilities of each region. Each region’s capabilities are prioritised, so that (for example) dedicated DRAM and IRAM regions will be used for allocations ahead of the more versatile D/IRAM regions.

Each contiguous region of memory contains its own memory heap. The heaps are created using the [multi\\_heap](#) functionality. `multi_heap` allows any contiguous region of memory to be used as a heap.

The heap capabilities allocator uses knowledge of the memory regions to initialize each individual heap. Allocation functions in the heap capabilities API will find the most appropriate heap for the allocation (based on desired capabilities, available space, and preferences for each region’s use) and then calling [multi\\_heap\\_malloc\(\)](#) for the heap situated in that particular region.

Calling `free()` involves finding the particular heap corresponding to the freed address, and then calling [multi\\_heap\\_free\(\)](#) on that particular `multi_heap` instance.

## API Reference - Heap Allocation

### Header File

- `components/heap/include/esp_heap_caps.h`

### Functions

[esp\\_err\\_t heap\\_caps\\_register\\_failed\\_alloc\\_callback\(esp\\_alloc\\_failed\\_hook\\_t callback\)](#)

registers a callback function to be invoked if a memory allocation operation fails

**Parameters** `callback` – caller defined callback to be invoked

**Returns** `ESP_OK` if callback was registered.

void \***heap\_caps\_malloc** (size\_t size, uint32\_t caps)

Allocate a chunk of memory which has the given capabilities.

Equivalent semantics to libc malloc(), for capability-aware memory.

**Parameters**

- **size** –Size, in bytes, of the amount of memory to allocate
- **caps** –Bitwise OR of MALLOC\_CAP\_\* flags indicating the type of memory to be returned

**Returns** A pointer to the memory allocated on success, NULL on failure

void **heap\_caps\_free** (void \*ptr)

Free memory previously allocated via heap\_caps\_malloc() or heap\_caps\_realloc().

Equivalent semantics to libc free(), for capability-aware memory.

In IDF, free(p) is equivalent to heap\_caps\_free(p).

**Parameters ptr** –Pointer to memory previously returned from heap\_caps\_malloc() or heap\_caps\_realloc(). Can be NULL.

void \***heap\_caps\_realloc** (void \*ptr, size\_t size, uint32\_t caps)

Reallocate memory previously allocated via heap\_caps\_malloc() or heap\_caps\_realloc().

Equivalent semantics to libc realloc(), for capability-aware memory.

In IDF, realloc(p, s) is equivalent to heap\_caps\_realloc(p, s, MALLOC\_CAP\_8BIT).

‘caps’ parameter can be different to the capabilities that any original ‘ptr’ was allocated with. In this way, realloc can be used to “move” a buffer if necessary to ensure it meets a new set of capabilities.

**Parameters**

- **ptr** –Pointer to previously allocated memory, or NULL for a new allocation.
- **size** –Size of the new buffer requested, or 0 to free the buffer.
- **caps** –Bitwise OR of MALLOC\_CAP\_\* flags indicating the type of memory desired for the new allocation.

**Returns** Pointer to a new buffer of size ‘size’ with capabilities ‘caps’, or NULL if allocation failed.

void \***heap\_caps\_aligned\_alloc** (size\_t alignment, size\_t size, uint32\_t caps)

Allocate an aligned chunk of memory which has the given capabilities.

Equivalent semantics to libc aligned\_alloc(), for capability-aware memory.

**Parameters**

- **alignment** –How the pointer received needs to be aligned must be a power of two
- **size** –Size, in bytes, of the amount of memory to allocate
- **caps** –Bitwise OR of MALLOC\_CAP\_\* flags indicating the type of memory to be returned

**Returns** A pointer to the memory allocated on success, NULL on failure

void **heap\_caps\_aligned\_free** (void \*ptr)

Used to deallocate memory previously allocated with heap\_caps\_aligned\_alloc.

---

**Note:** This function is deprecated, please consider using heap\_caps\_free() instead

---

**Parameters ptr** –Pointer to the memory allocated

void \***heap\_caps\_aligned\_calloc** (size\_t alignment, size\_t n, size\_t size, uint32\_t caps)

Allocate an aligned chunk of memory which has the given capabilities. The initialized value in the memory is set to zero.

**Parameters**



- **alignment** –How the pointer received needs to be aligned must be a power of two
- **n** –Number of continuing chunks of memory to allocate
- **size** –Size, in bytes, of a chunk of memory to allocate
- **caps** –Bitwise OR of `MALLOC_CAP_*` flags indicating the type of memory to be returned

**Returns** A pointer to the memory allocated on success, NULL on failure

void \***heap\_caps\_malloc** (size\_t n, size\_t size, uint32\_t caps)

Allocate a chunk of memory which has the given capabilities. The initialized value in the memory is set to zero.

Equivalent semantics to `libc calloc()`, for capability-aware memory.

In IDF, `calloc(p)` is equivalent to `heap_caps_malloc(p, MALLOC_CAP_8BIT)`.

**Parameters**

- **n** –Number of continuing chunks of memory to allocate
- **size** –Size, in bytes, of a chunk of memory to allocate
- **caps** –Bitwise OR of `MALLOC_CAP_*` flags indicating the type of memory to be returned

**Returns** A pointer to the memory allocated on success, NULL on failure

size\_t **heap\_caps\_get\_total\_size** (uint32\_t caps)

Get the total size of all the regions that have the given capabilities.

This function takes all regions capable of having the given capabilities allocated in them and adds up the total space they have.

**Parameters** **caps** –Bitwise OR of `MALLOC_CAP_*` flags indicating the type of memory

**Returns** total size in bytes

size\_t **heap\_caps\_get\_free\_size** (uint32\_t caps)

Get the total free size of all the regions that have the given capabilities.

This function takes all regions capable of having the given capabilities allocated in them and adds up the free space they have.

---

**Note:** Note that because of heap fragmentation it is probably not possible to allocate a single block of memory of this size. Use `heap_caps_get_largest_free_block()` for this purpose.

---

**Parameters** **caps** –Bitwise OR of `MALLOC_CAP_*` flags indicating the type of memory

**Returns** Amount of free bytes in the regions

size\_t **heap\_caps\_get\_minimum\_free\_size** (uint32\_t caps)

Get the total minimum free memory of all regions with the given capabilities.

This adds all the low watermarks of the regions capable of delivering the memory with the given capabilities.

---

**Note:** Note the result may be less than the global all-time minimum available heap of this kind, as “low watermarks” are tracked per-region. Individual regions’ heaps may have reached their “low watermarks” at different points in time. However, this result still gives a “worst case” indication for all-time minimum free heap.

---

**Parameters** **caps** –Bitwise OR of `MALLOC_CAP_*` flags indicating the type of memory

**Returns** Amount of free bytes in the regions

size\_t **heap\_caps\_get\_largest\_free\_block** (uint32\_t caps)

Get the largest free block of memory able to be allocated with the given capabilities.

Returns the largest value of `s` for which `heap_caps_malloc(s, caps)` will succeed.

**Parameters** **caps** –Bitwise OR of MALLOC\_CAP\_\* flags indicating the type of memory

**Returns** Size of the largest free block in bytes.

void **heap\_caps\_get\_info** (*multi\_heap\_info\_t* \*info, uint32\_t caps)

Get heap info for all regions with the given capabilities.

Calls multi\_heap\_info() on all heaps which share the given capabilities. The information returned is an aggregate across all matching heaps. The meanings of fields are the same as defined for *multi\_heap\_info\_t*, except that `minimum_free_bytes` has the same caveats described in `heap_caps_get_minimum_free_size()`.

**Parameters**

- **info** –Pointer to a structure which will be filled with relevant heap metadata.
- **caps** –Bitwise OR of MALLOC\_CAP\_\* flags indicating the type of memory

void **heap\_caps\_print\_heap\_info** (uint32\_t caps)

Print a summary of all memory with the given capabilities.

Calls multi\_heap\_info on all heaps which share the given capabilities, and prints a two-line summary for each, then a total summary.

**Parameters** **caps** –Bitwise OR of MALLOC\_CAP\_\* flags indicating the type of memory

bool **heap\_caps\_check\_integrity\_all** (bool print\_errors)

Check integrity of all heap memory in the system.

Calls multi\_heap\_check on all heaps. Optionally print errors if heaps are corrupt.

Calling this function is equivalent to calling heap\_caps\_check\_integrity with the caps argument set to MALLOC\_CAP\_INVALID.

**Parameters** **print\_errors** –Print specific errors if heap corruption is found.

**Returns** True if all heaps are valid, False if at least one heap is corrupt.

bool **heap\_caps\_check\_integrity** (uint32\_t caps, bool print\_errors)

Check integrity of all heaps with the given capabilities.

Calls multi\_heap\_check on all heaps which share the given capabilities. Optionally print errors if the heaps are corrupt.

See also heap\_caps\_check\_integrity\_all to check all heap memory in the system and heap\_caps\_check\_integrity\_addr to check memory around a single address.

**Parameters**

- **caps** –Bitwise OR of MALLOC\_CAP\_\* flags indicating the type of memory
- **print\_errors** –Print specific errors if heap corruption is found.

**Returns** True if all heaps are valid, False if at least one heap is corrupt.

bool **heap\_caps\_check\_integrity\_addr** (intptr\_t addr, bool print\_errors)

Check integrity of heap memory around a given address.

This function can be used to check the integrity of a single region of heap memory, which contains the given address.

This can be useful if debugging heap integrity for corruption at a known address, as it has a lower overhead than checking all heap regions. Note that if the corrupt address moves around between runs (due to timing or other factors) then this approach won't work, and you should call heap\_caps\_check\_integrity or heap\_caps\_check\_integrity\_all instead.

---

**Note:** The entire heap region around the address is checked, not only the adjacent heap blocks.

---

**Parameters**

- **addr** –Address in memory. Check for corruption in region containing this address.
- **print\_errors** –Print specific errors if heap corruption is found.

**Returns** True if the heap containing the specified address is valid, False if at least one heap is corrupt or the address doesn't belong to a heap region.

void **heap\_caps\_malloc\_extmem\_enable** (size\_t limit)

Enable malloc() in external memory and set limit below which malloc() attempts are placed in internal memory.

When external memory is in use, the allocation strategy is to initially try to satisfy smaller allocation requests with internal memory and larger requests with external memory. This sets the limit between the two, as well as generally enabling allocation in external memory.

**Parameters** **limit** –Limit, in bytes.

void \***heap\_caps\_malloc\_prefer** (size\_t size, size\_t num, ...)

Allocate a chunk of memory as preference in decreasing order.

**Attention** The variable parameters are bitwise OR of MALLOC\_CAP\_\* flags indicating the type of memory. This API prefers to allocate memory with the first parameter. If failed, allocate memory with the next parameter. It will try in this order until allocating a chunk of memory successfully or fail to allocate memories with any of the parameters.

**Parameters**

- **size** –Size, in bytes, of the amount of memory to allocate
- **num** –Number of variable parameters

**Returns** A pointer to the memory allocated on success, NULL on failure

void \***heap\_caps\_realloc\_prefer** (void \*ptr, size\_t size, size\_t num, ...)

Reallocate a chunk of memory as preference in decreasing order.

**Parameters**

- **ptr** –Pointer to previously allocated memory, or NULL for a new allocation.
- **size** –Size of the new buffer requested, or 0 to free the buffer.
- **num** –Number of variable parameters

**Returns** Pointer to a new buffer of size 'size', or NULL if allocation failed.

void \***heap\_caps\_calloc\_prefer** (size\_t n, size\_t size, size\_t num, ...)

Allocate a chunk of memory as preference in decreasing order.

**Parameters**

- **n** –Number of continuing chunks of memory to allocate
- **size** –Size, in bytes, of a chunk of memory to allocate
- **num** –Number of variable parameters

**Returns** A pointer to the memory allocated on success, NULL on failure

void **heap\_caps\_dump** (uint32\_t caps)

Dump the full structure of all heaps with matching capabilities.

Prints a large amount of output to serial (because of locking limitations, the output bypasses stdout/stderr). For each (variable sized) block in each matching heap, the following output is printed on a single line:

- Block address (the data buffer returned by malloc is 4 bytes after this if heap debugging is set to Basic, or 8 bytes otherwise).
- Data size (the data size may be larger than the size requested by malloc, either due to heap fragmentation or because of heap debugging level).
- Address of next block in the heap.
- If the block is free, the address of the next free block is also printed.

**Parameters** **caps** –Bitwise OR of MALLOC\_CAP\_\* flags indicating the type of memory

void **heap\_caps\_dump\_all** (void)

Dump the full structure of all heaps.

Covers all registered heaps. Prints a large amount of output to serial.

Output is the same as for heap\_caps\_dump.

size\_t **heap\_caps\_get\_allocated\_size** (void \*ptr)

Return the size that a particular pointer was allocated with.

---

**Note:** The app will crash with an assertion failure if the pointer is not valid.

---

**Parameters** **ptr** –Pointer to currently allocated heap memory. Must be a pointer value previously returned by heap\_caps\_malloc, malloc, calloc, etc. and not yet freed.

**Returns** Size of the memory allocated at this block.

## Macros

### **MALLOC\_CAP\_EXEC**

Flags to indicate the capabilities of the various memory systems.

Memory must be able to run executable code

### **MALLOC\_CAP\_32BIT**

Memory must allow for aligned 32-bit data accesses.

### **MALLOC\_CAP\_8BIT**

Memory must allow for 8/16/...-bit data accesses.

### **MALLOC\_CAP\_DMA**

Memory must be able to accessed by DMA.

### **MALLOC\_CAP\_PID2**

Memory must be mapped to PID2 memory space (PIDs are not currently used)

### **MALLOC\_CAP\_PID3**

Memory must be mapped to PID3 memory space (PIDs are not currently used)

### **MALLOC\_CAP\_PID4**

Memory must be mapped to PID4 memory space (PIDs are not currently used)

### **MALLOC\_CAP\_PID5**

Memory must be mapped to PID5 memory space (PIDs are not currently used)

### **MALLOC\_CAP\_PID6**

Memory must be mapped to PID6 memory space (PIDs are not currently used)

### **MALLOC\_CAP\_PID7**

Memory must be mapped to PID7 memory space (PIDs are not currently used)

### **MALLOC\_CAP\_SPIRAM**

Memory must be in SPI RAM.

**MALLOC\_CAP\_INTERNAL**

Memory must be internal; specifically it should not disappear when flash/spiram cache is switched off.

**MALLOC\_CAP\_DEFAULT**

Memory can be returned in a non-capability-specific memory allocation (e.g. malloc(), calloc()) call.

**MALLOC\_CAP\_IRAM\_8BIT**

Memory must be in IRAM and allow unaligned access.

**MALLOC\_CAP\_RETENTION**

Memory must be able to be accessed by retention DMA.

**MALLOC\_CAP\_RTCRAM**

Memory must be in RTC fast memory.

**MALLOC\_CAP\_INVALID**

Memory can't be used / list end marker.

## Type Definitions

```
typedef void (*esp_alloc_failed_hook_t)(size_t size, uint32_t caps, const char *function_name)
```

callback called when an allocation operation fails, if registered

**Param size** in bytes of failed allocation

**Param caps** capabilities requested of failed allocation

**Param function\_name** function which generated the failure

## API Reference - Initialisation

### Header File

- [components/heap/include/esp\\_heap\\_caps\\_init.h](#)

### Functions

```
void heap_caps_init (void)
```

Initialize the capability-aware heap allocator.

This is called once in the IDF startup code. Do not call it at other times.

```
void heap_caps_enable_nonos_stack_heaps (void)
```

Enable heap(s) in memory regions where the startup stacks are located.

On startup, the pro/app CPUs have a certain memory region they use as stack, so we cannot do allocations in the regions these stack frames are. When FreeRTOS is completely started, they do not use that memory anymore and heap(s) there can be enabled.

```
esp_err_t heap_caps_add_region (intptr_t start, intptr_t end)
```

Add a region of memory to the collection of heaps at runtime.

Most memory regions are defined in `soc_memory_layout.c` for the SoC, and are registered via `heap_caps_init()`. Some regions can't be used immediately and are later enabled via `heap_caps_enable_nonos_stack_heaps()`.

Call this function to add a region of memory to the heap at some later time.

This function does not consider any of the “reserved” regions or other data in `soc_memory_layout`, caller needs to consider this themselves.

All memory within the region specified by start & end parameters must be otherwise unused.

The capabilities of the newly registered memory will be determined by the start address, as looked up in the regions specified in soc\_memory\_layout.c.

Use heap\_caps\_add\_region\_with\_caps() to register a region with custom capabilities.

**Note:** Please refer to following example for memory regions allowed for addition to heap based on an existing region (address range for demonstration purpose only):

```
Existing region: 0x1000 <-> 0x3000
New region:      0x1000 <-> 0x3000 (Allowed)
New region:      0x1000 <-> 0x2000 (Allowed)
New region:      0x0000 <-> 0x1000 (Allowed)
New region:      0x3000 <-> 0x4000 (Allowed)
New region:      0x0000 <-> 0x2000 (NOT Allowed)
New region:      0x0000 <-> 0x4000 (NOT Allowed)
New region:      0x1000 <-> 0x4000 (NOT Allowed)
New region:      0x2000 <-> 0x4000 (NOT Allowed)
```

### Parameters

- **start** –Start address of new region.
- **end** –End address of new region.

**Returns** ESP\_OK on success, ESP\_ERR\_INVALID\_ARG if a parameter is invalid, ESP\_ERR\_NOT\_FOUND if the specified start address doesn't reside in a known region, or any error returned by heap\_caps\_add\_region\_with\_caps().

*esp\_err\_t* heap\_caps\_add\_region\_with\_caps (const uint32\_t caps[], intptr\_t start, intptr\_t end)

Add a region of memory to the collection of heaps at runtime, with custom capabilities.

Similar to heap\_caps\_add\_region(), only custom memory capabilities are specified by the caller.

**Note:** Please refer to following example for memory regions allowed for addition to heap based on an existing region (address range for demonstration purpose only):

```
Existing region: 0x1000 <-> 0x3000
New region:      0x1000 <-> 0x3000 (Allowed)
New region:      0x1000 <-> 0x2000 (Allowed)
New region:      0x0000 <-> 0x1000 (Allowed)
New region:      0x3000 <-> 0x4000 (Allowed)
New region:      0x0000 <-> 0x2000 (NOT Allowed)
New region:      0x0000 <-> 0x4000 (NOT Allowed)
New region:      0x1000 <-> 0x4000 (NOT Allowed)
New region:      0x2000 <-> 0x4000 (NOT Allowed)
```

### Parameters

- **caps** –Ordered array of capability masks for the new region, in order of priority. Must have length SOC\_MEMORY\_TYPE\_NO\_PRIOS. Does not need to remain valid after the call returns.
- **start** –Start address of new region.
- **end** –End address of new region.

### Returns

- ESP\_OK on success
- ESP\_ERR\_INVALID\_ARG if a parameter is invalid
- ESP\_ERR\_NO\_MEM if no memory to register new heap.
- ESP\_ERR\_INVALID\_SIZE if the memory region is too small to fit a heap
- ESP\_FAIL if region overlaps the start and/or end of an existing region

## API Reference - Multi Heap API

(Note: The multi heap API is used internally by the heap capabilities allocator. Most IDF programs will never need to call this API directly.)

### Header File

- [components/heap/include/multi\\_heap.h](#)

### Functions

void **\*multi\_heap\_aligned\_alloc** (*multi\_heap\_handle\_t* heap, size\_t size, size\_t alignment)

allocate a chunk of memory with specific alignment

#### Parameters

- **heap** –Handle to a registered heap.
- **size** –size in bytes of memory chunk
- **alignment** –how the memory must be aligned

**Returns** pointer to the memory allocated, NULL on failure

void **\*multi\_heap\_malloc** (*multi\_heap\_handle\_t* heap, size\_t size)

malloc() a buffer in a given heap

Semantics are the same as standard malloc(), only the returned buffer will be allocated in the specified heap.

#### Parameters

- **heap** –Handle to a registered heap.
- **size** –Size of desired buffer.

**Returns** Pointer to new memory, or NULL if allocation fails.

void **multi\_heap\_aligned\_free** (*multi\_heap\_handle\_t* heap, void \*p)

free() a buffer aligned in a given heap.

---

**Note:** This function is deprecated, consider using multi\_heap\_free() instead

---

#### Parameters

- **heap** –Handle to a registered heap.
- **p** –NULL, or a pointer previously returned from multi\_heap\_aligned\_alloc() for the same heap.

void **multi\_heap\_free** (*multi\_heap\_handle\_t* heap, void \*p)

free() a buffer in a given heap.

Semantics are the same as standard free(), only the argument ‘p’ must be NULL or have been allocated in the specified heap.

#### Parameters

- **heap** –Handle to a registered heap.
- **p** –NULL, or a pointer previously returned from multi\_heap\_malloc() or multi\_heap\_realloc() for the same heap.

void **\*multi\_heap\_realloc** (*multi\_heap\_handle\_t* heap, void \*p, size\_t size)

realloc() a buffer in a given heap.

Semantics are the same as standard realloc(), only the argument ‘p’ must be NULL or have been allocated in the specified heap.

#### Parameters

- **heap** –Handle to a registered heap.
- **p** –NULL, or a pointer previously returned from multi\_heap\_malloc() or multi\_heap\_realloc() for the same heap.

- **size** –Desired new size for buffer.

**Returns** New buffer of ‘size’ containing contents of ‘p’ , or NULL if reallocation failed.

size\_t **multi\_heap\_get\_allocated\_size** (*multi\_heap\_handle\_t* heap, void \*p)

Return the size that a particular pointer was allocated with.

**Parameters**

- **heap** –Handle to a registered heap.
- **p** –Pointer, must have been previously returned from multi\_heap\_malloc() or multi\_heap\_realloc() for the same heap.

**Returns** Size of the memory allocated at this block. May be more than the original size argument, due to padding and minimum block sizes.

*multi\_heap\_handle\_t* **multi\_heap\_register** (void \*start, size\_t size)

Register a new heap for use.

This function initialises a heap at the specified address, and returns a handle for future heap operations.

There is no equivalent function for deregistering a heap - if all blocks in the heap are free, you can immediately start using the memory for other purposes.

**Parameters**

- **start** –Start address of the memory to use for a new heap.
- **size** –Size (in bytes) of the new heap.

**Returns** Handle of a new heap ready for use, or NULL if the heap region was too small to be initialised.

void **multi\_heap\_set\_lock** (*multi\_heap\_handle\_t* heap, void \*lock)

Associate a private lock pointer with a heap.

The lock argument is supplied to the MULTI\_HEAP\_LOCK() and MULTI\_HEAP\_UNLOCK() macros, defined in multi\_heap\_platform.h.

The lock in question must be recursive.

When the heap is first registered, the associated lock is NULL.

**Parameters**

- **heap** –Handle to a registered heap.
- **lock** –Optional pointer to a locking structure to associate with this heap.

void **multi\_heap\_dump** (*multi\_heap\_handle\_t* heap)

Dump heap information to stdout.

For debugging purposes, this function dumps information about every block in the heap to stdout.

**Parameters** **heap** –Handle to a registered heap.

bool **multi\_heap\_check** (*multi\_heap\_handle\_t* heap, bool print\_errors)

Check heap integrity.

Walks the heap and checks all heap data structures are valid. If any errors are detected, an error-specific message can be optionally printed to stderr. Print behaviour can be overridden at compile time by defining MULTI\_CHECK\_FAIL\_PRINTF in multi\_heap\_platform.h.

---

**Note:** This function is not thread-safe as it sets a global variable with the value of print\_errors.

---

**Parameters**

- **heap** –Handle to a registered heap.
- **print\_errors** –If true, errors will be printed to stderr.

**Returns** true if heap is valid, false otherwise.



`size_t multi_heap_free_size (multi_heap_handle_t heap)`

Return free heap size.

Returns the number of bytes available in the heap.

Equivalent to the `total_free_bytes` member returned by `multi_heap_get_heap_info()`.

Note that the heap may be fragmented, so the actual maximum size for a single `malloc()` may be lower. To know this size, see the `largest_free_block` member returned by `multi_heap_get_heap_info()`.

**Parameters** `heap` –Handle to a registered heap.

**Returns** Number of free bytes.

`size_t multi_heap_minimum_free_size (multi_heap_handle_t heap)`

Return the lifetime minimum free heap size.

Equivalent to the `minimum_free_bytes` member returned by `multi_heap_get_info()`.

Returns the lifetime “low watermark” of possible values returned from `multi_free_heap_size()`, for the specified heap.

**Parameters** `heap` –Handle to a registered heap.

**Returns** Number of free bytes.

`void multi_heap_get_info (multi_heap_handle_t heap, multi_heap_info_t *info)`

Return metadata about a given heap.

Fills a `multi_heap_info_t` structure with information about the specified heap.

**Parameters**

- `heap` –Handle to a registered heap.
- `info` –Pointer to a structure to fill with heap metadata.

## Structures

`struct multi_heap_info_t`

Structure to access heap metadata via `multi_heap_get_info`.

### Public Members

`size_t total_free_bytes`

Total free bytes in the heap. Equivalent to `multi_free_heap_size()`.

`size_t total_allocated_bytes`

Total bytes allocated to data in the heap.

`size_t largest_free_block`

Size of the largest free block in the heap. This is the largest `malloc`-able size.

`size_t minimum_free_bytes`

Lifetime minimum free heap size. Equivalent to `multi_minimum_free_heap_size()`.

`size_t allocated_blocks`

Number of (variable size) blocks allocated in the heap.

`size_t free_blocks`

Number of (variable size) free blocks in the heap.

size\_t **total\_blocks**

Total number of (variable size) blocks in the heap.

### Type Definitions

```
typedef struct multi_heap_info *multi_heap_handle_t
```

Opaque handle to a registered heap.

## 2.9.14 Heap Memory Debugging

### Overview

ESP-IDF integrates tools for requesting *heap information*, *detecting heap corruption*, and *tracing memory leaks*. These can help track down memory-related bugs.

For general information about the heap memory allocator, see the *Heap Memory Allocation* page.

### Heap Information

To obtain information about the state of the heap:

- `xPortGetFreeHeapSize()` is a FreeRTOS function which returns the number of free bytes in the (data memory) heap. This is equivalent to calling `heap_caps_get_free_size(MALLOC_CAP_8BIT)`.
- `heap_caps_get_free_size()` can also be used to return the current free memory for different memory capabilities.
- `heap_caps_get_largest_free_block()` can be used to return the largest free block in the heap. This is the largest single allocation which is currently possible. Tracking this value and comparing to total free heap allows you to detect heap fragmentation.
- `xPortGetMinimumEverFreeHeapSize()` and the related `heap_caps_get_minimum_free_size()` can be used to track the heap “low watermark” since boot.
- `heap_caps_get_info()` returns a `multi_heap_info_t` structure which contains the information from the above functions, plus some additional heap-specific data (number of allocations, etc.).
- `heap_caps_print_heap_info()` prints a summary to stdout of the information returned by `heap_caps_get_info()`.
- `heap_caps_dump()` and `heap_caps_dump_all()` will output detailed information about the structure of each block in the heap. Note that this can be large amount of output.

### Heap Corruption Detection

Heap corruption detection allows you to detect various types of heap memory errors:

- Out of bounds writes & buffer overflow.
- Writes to freed memory.
- Reads from freed or uninitialized memory,

**Assertions** The heap implementation (`multi_heap.c`, etc.) includes a lot of assertions which will fail if the heap memory is corrupted. To detect heap corruption most effectively, ensure that assertions are enabled in the project configuration menu under `Compiler options` -> `CONFIG_COMPILER_OPTIMIZATION_ASSERTION_LEVEL`.

If a heap integrity assertion fails, a line will be printed like `CORRUPT HEAP: multi_heap.c:225 detected at 0x3ffbb71c`. The memory address which is printed is the address of the heap structure which has corrupt content.

It's also possible to manually check heap integrity by calling `heap_caps_check_integrity_all()` or related functions. This function checks all of requested heap memory for integrity, and can be used even if assertions are disabled. If the integrity check prints an error, it will also contain the address(es) of corrupt heap structures.

**Memory Allocation Failed Hook** Users can use `heap_caps_register_failed_alloc_callback()` to register a callback that will be invoked every time an allocation operation fails.

Additionally, users can enable the generation of a system abort if an allocation operation fails by following the steps below: - In the project configuration menu, navigate to Component config -> Heap Memory Debugging and select Abort if memory allocation fails option (see [CONFIG\\_HEAP\\_ABORT\\_WHEN\\_ALLOCATION\\_FAILS](#)).

The example below shows how to register an allocation failure callback:

```
#include "esp_heap_caps.h"

void heap_caps_alloc_failed_hook(size_t requested_size, uint32_t caps, const char_
↳*function_name)
{
    printf("%s was called but failed to allocate %d bytes with 0x%X capabilities. \n
↳", function_name, requested_size, caps);
}

void app_main()
{
    ...
    esp_err_t error = heap_caps_register_failed_alloc_callback(heap_caps_alloc_
↳failed_hook);
    ...
    void *ptr = heap_caps_malloc(allocation_size, MALLOC_CAP_DEFAULT);
    ...
}
```

**Finding Heap Corruption** Memory corruption can be one of the hardest classes of bugs to find and fix, as one area of memory can be corrupted from a totally different place. Some tips:

- A crash with a `CORRUPT HEAP`: message will usually include a stack trace, but this stack trace is rarely useful. The crash is the symptom of memory corruption when the system realises the heap is corrupt, but usually the corruption happened elsewhere and earlier in time.
- Increasing the Heap memory debugging [Configuration](#) level to “Light impact” or “Comprehensive” can give you a more accurate message with the first corrupt memory address.
- Adding regular calls to `heap_caps_check_integrity_all()` or `heap_caps_check_integrity_addr()` in your code will help you pin down the exact time that the corruption happened. You can move these checks around to “close in on” the section of code that corrupted the heap.
- Based on the memory address which is being corrupted, you can use [JTAG debugging](#) to set a watchpoint on this address and have the CPU halt when it is written to.
- If you don’ t have JTAG, but you do know roughly when the corruption happens, then you can set a watchpoint in software just beforehand via `esp_cpu_set_watchpoint()`. A fatal exception will occur when the watchpoint triggers. The following is an example of how to use the function - `esp_cpu_set_watchpoint(0, (void *)addr, 4, ESP_WATCHPOINT_STORE)`. Note that watchpoints are per-CPU and are set on the current running CPU only, so if you don’ t know which CPU is corrupting memory then you will need to call this function on both CPUs.
- For buffer overflows, [heap tracing](#) in `HEAP_TRACE_ALL` mode lets you see which callers are allocating which addresses from the heap. See [Heap Tracing To Find Heap Corruption](#) for more details. If you can find the function which allocates memory with an address immediately before the address which is corrupted, this will probably be the function which overflows the buffer.
- Calling `heap_caps_dump()` or `heap_caps_dump_all()` can give an indication of what heap blocks are surrounding the corrupted region and may have overflowed/underflowed/etc.

**Configuration** Temporarily increasing the heap corruption detection level can give more detailed information about heap corruption errors.

In the project configuration menu, under `Component config` there is a menu `Heap memory debugging`. The setting `CONFIG_HEAP_CORRUPTION_DETECTION` can be set to one of three levels:

**Basic (no poisoning)** This is the default level. No special heap corruption features are enabled, but provided assertions are enabled (the default configuration) then a heap corruption error will be printed if any of the heap's internal data structures appear overwritten or corrupted. This usually indicates a buffer overrun or out of bounds write.

If assertions are enabled, an assertion will also trigger if a double-free occurs (the same memory is freed twice).

Calling `heap_caps_check_integrity()` in Basic mode will check the integrity of all heap structures, and print errors if any appear to be corrupted.

**Light Impact** At this level, heap memory is additionally “poisoned” with head and tail “canary bytes” before and after each block which is allocated. If an application writes outside the bounds of allocated buffers, the canary bytes will be corrupted and the integrity check will fail.

The head canary word is 0xABBA1234 (3412BAAB in byte order), and the tail canary word is 0xBAAD5678 (7856ADBA in byte order).

“Basic” heap corruption checks can also detect most out of bounds writes, but this setting is more precise as even a single byte overrun can be detected. With Basic heap checks, the number of overrun bytes before a failure is detected will depend on the properties of the heap.

Enabling “Light Impact” checking increases memory usage, each individual allocation will use 9 to 12 additional bytes of memory (depending on alignment).

Each time `free()` is called in Light Impact mode, the head and tail canary bytes of the buffer being freed are checked against the expected values.

When `heap_caps_check_integrity()` is called, all allocated blocks of heap memory have their canary bytes checked against the expected values.

In both cases, the check is that the first 4 bytes of an allocated block (before the buffer returned to the user) should be the word 0xABBA1234. Then the last 4 bytes of the allocated block (after the buffer returned to the user) should be the word 0xBAAD5678.

Different values usually indicate buffer underrun or overrun, respectively.

**Comprehensive** This level incorporates the “light impact” detection features plus additional checks for uninitialised-access and use-after-free bugs. In this mode, all freshly allocated memory is filled with the pattern 0xCE, and all freed memory is filled with the pattern 0xFE.

Enabling “Comprehensive” detection has a substantial runtime performance impact (as all memory needs to be set to the allocation patterns each time a malloc/free completes, and the memory also needs to be checked each time.) However, it allows easier detection of memory corruption bugs which are much more subtle to find otherwise. It is recommended to only enable this mode when debugging, not in production.

**Crashes in Comprehensive Mode** If an application crashes reading/writing an address related to 0xCECECECE in Comprehensive mode, this indicates it has read uninitialized memory. The application should be changed to either use `calloc()` (which zeroes memory), or initialize the memory before using it. The value 0xCECECECE may also be seen in stack-allocated automatic variables, because in IDF most task stacks are originally allocated from the heap and in C stack memory is uninitialized by default.

If an application crashes and the exception register dump indicates that some addresses or values were 0xFEFEFEFE, this indicates it is reading heap memory after it has been freed (a “use after free bug”.) The application should be changed to not access heap memory after it has been freed.

If a call to `malloc()` or `realloc()` causes a crash because it expected to find the pattern 0xFEFEFEFE in free memory and a different pattern was found, then this indicates the app has a use-after-free bug where it is writing to memory which has already been freed.

**Manual Heap Checks in Comprehensive Mode** Calls to `heap_caps_check_integrity()` may print errors relating to 0xFEFEFEFE, 0xABBA1234 or 0xBAAD5678. In each case the checker is expecting to find a given pattern, and will error out if this is not found:

- For free heap blocks, the checker expects to find all bytes set to 0xFE. Any other values indicate a use-after-free bug where free memory has been incorrectly overwritten.
- For allocated heap blocks, the behaviour is the same as for *Light Impact* mode. The canary bytes 0xABBA1234 and 0xBAAD5678 are checked at the head and tail of each allocated buffer, and any variation indicates a buffer overrun/underrun.

### Heap Task Tracking

Heap Task Tracking can be used to get per task info for heap memory allocation. Application has to specify the heap capabilities for which the heap allocation is to be tracked.

Example code is provided in [system/heap\\_task\\_tracking](#)

### Heap Tracing

Heap Tracing allows tracing of code which allocates/frees memory. Two tracing modes are supported:

- Standalone. In this mode trace data are kept on-board, so the size of gathered information is limited by the buffer assigned for that purposes. Analysis is done by the on-board code. There are a couple of APIs available for accessing and dumping collected info.
- Host-based. This mode does not have the limitation of the standalone mode, because trace data are sent to the host over JTAG connection using `app_trace` library. Later on they can be analysed using special tools.

Heap tracing can perform two functions:

- Leak checking: find memory which is allocated and never freed.
- Heap use analysis: show all functions that are allocating/freeing memory while the trace is running.

**How To Diagnose Memory Leaks** If you suspect a memory leak, the first step is to figure out which part of the program is leaking memory. Use the `xPortGetFreeHeapSize()`, `heap_caps_get_free_size()`, or [related functions](#) to track memory use over the life of the application. Try to narrow the leak down to a single function or sequence of functions where free memory always decreases and never recovers.

**Standalone Mode** Once you've identified the code which you think is leaking:

- In the project configuration menu, navigate to Component settings -> Heap Memory Debugging -> Heap tracing and select Standalone option (see [CONFIG\\_HEAP\\_TRACING\\_DEST](#)).
- Call the function `heap_trace_init_standalone()` early in the program, to register a buffer which can be used to record the memory trace.
- Call the function `heap_trace_start()` to begin recording all mallocs/frees in the system. Call this immediately before the piece of code which you suspect is leaking memory.
- Call the function `heap_trace_stop()` to stop the trace once the suspect piece of code has finished executing.
- Call the function `heap_trace_dump()` to dump the results of the heap trace.

An example:

```
#include "esp_heap_trace.h"

#define NUM_RECORDS 100
static heap_trace_record_t trace_record[NUM_RECORDS]; // This buffer must be in
↳ internal RAM

...

```

(continues on next page)

(continued from previous page)

```

void app_main()
{
    ...
    ESP_ERROR_CHECK( heap_trace_init_standalone(trace_record, NUM_RECORDS) );
    ...
}

void some_function()
{
    ESP_ERROR_CHECK( heap_trace_start(HEAP_TRACE_LEAKS) );

    do_something_you_suspect_is_leaking();

    ESP_ERROR_CHECK( heap_trace_stop() );
    heap_trace_dump();
    ...
}

```

The output from the heap trace will look something like this:

```

2 allocations trace (100 entry buffer)
32 bytes (@ 0x3ffaf214) allocated CPU 0 ccount 0x2e9b7384 caller_
↪0x400d276d:0x400d27c1
0x400d276d: leak_some_memory at /path/to/idf/examples/get-started/blink/main/.
↪blink.c:27

0x400d27c1: blink_task at /path/to/idf/examples/get-started/blink/main/./blink.c:52

8 bytes (@ 0x3ffaf804) allocated CPU 0 ccount 0x2e9b79c0 caller_
↪0x400d2776:0x400d27c1
0x400d2776: leak_some_memory at /path/to/idf/examples/get-started/blink/main/.
↪blink.c:29

0x400d27c1: blink_task at /path/to/idf/examples/get-started/blink/main/./blink.c:52

40 bytes 'leaked' in trace (2 allocations)
total allocations 2 total frees 0

```

(Above example output is using *IDF Monitor* to automatically decode PC addresses to their source files & line number.)

The first line indicates how many allocation entries are in the buffer, compared to its total size.

In `HEAP_TRACE_LEAKS` mode, for each traced memory allocation which has not already been freed a line is printed with:

- `XX bytes` is the number of bytes allocated
- `@ 0x...` is the heap address returned from `malloc/calloc`.
- `CPU x` is the CPU (0 or 1) running when the allocation was made.
- `ccount 0x...` is the `CCOUNT` (CPU cycle count) register value when the allocation was made. Is different for CPU 0 vs CPU 1.
- `caller 0x...` gives the call stack of the call to `malloc()/free()`, as a list of PC addresses. These can be decoded to source files and line numbers, as shown above.

The depth of the call stack recorded for each trace entry can be configured in the project configuration menu, under `Heap Memory Debugging -> Enable heap tracing -> Heap tracing stack depth`. Up to 10 stack frames can be recorded for each allocation (the default is 2). Each additional stack frame increases the memory usage of each `heap_trace_record_t` record by eight bytes.

Finally, the total number of ‘leaked’ bytes (bytes allocated but not freed while trace was running) is printed, and the total number of allocations this represents.

A warning will be printed if the trace buffer was not large enough to hold all the allocations which happened. If you see this warning, consider either shortening the tracing period or increasing the number of records in the trace buffer.

**Host-Based Mode** Once you've identified the code which you think is leaking:

- In the project configuration menu, navigate to Component settings -> Heap Memory Debugging -> *CONFIG\_HEAP\_TRACING\_DEST* and select Host-Based.
- In the project configuration menu, navigate to Component settings -> Application Level Tracing -> *CONFIG\_APPTRACE\_DESTINATION1* and select Trace memory.
- In the project configuration menu, navigate to Component settings -> Application Level Tracing -> FreeRTOS SystemView Tracing and enable *CONFIG\_APPTRACE\_SV\_ENABLE*.
- Call the function *heap\_trace\_init\_tohost()* early in the program, to initialize JTAG heap tracing module.
- Call the function *heap\_trace\_start()* to begin recording all mallocs/frees in the system. Call this immediately before the piece of code which you suspect is leaking memory. In host-based mode, the argument to this function is ignored, and the heap tracing module behaves like *HEAP\_TRACE\_ALL* was passed: all allocations and deallocations are sent to the host.
- Call the function *heap\_trace\_stop()* to stop the trace once the suspect piece of code has finished executing.

An example:

```
#include "esp_heap_trace.h"

...

void app_main()
{
    ...
    ESP_ERROR_CHECK( heap_trace_init_tohost() );
    ...
}

void some_function()
{
    ESP_ERROR_CHECK( heap_trace_start(HEAP_TRACE_LEAKS) );

    do_something_you_suspect_is_leaking();

    ESP_ERROR_CHECK( heap_trace_stop() );
    ...
}
```

To gather and analyse heap trace do the following on the host:

1. Build the program and download it to the target as described in *Getting Started Guide*.
2. Run OpenOCD (see *JTAG Debugging*).

**Note:** In order to use this feature you need OpenOCD version *v0.10.0-esp32-20181105* or later.

3. You can use GDB to start and/or stop tracing automatically. To do this you need to prepare special gdbinit file:

```
target remote :3333

mon reset halt
flushregs

tb heap_trace_start
commands
```

(continues on next page)



(continued from previous page)

```

mon esp sysview start file:///tmp/heap.svdat
c
end

tb heap_trace_stop
commands
mon esp sysview stop
end

c

```

Using this file GDB will connect to the target, reset it, and start tracing when program hits breakpoint at `heap_trace_start()`. Trace data will be saved to `/tmp/heap_log.svdat`. Tracing will be stopped when program hits breakpoint at `heap_trace_stop()`.

4. Run GDB using the following command `xtensa-esp32s2-elf-gdb -x gdbinit </path/to/program/elf>`
5. Quit GDB when program stops at `heap_trace_stop()`. Trace data are saved in `/tmp/heap.svdat`
6. Run processing script `$IDF_PATH/tools/esp_app_trace/sysviewtrace_proc.py -p -b </path/to/program/elf> /tmp/heap_log.svdat`

The output from the heap trace will look something like this:

```

Parse trace from '/tmp/heap.svdat'...
Stop parsing trace. (Timeout 0.000000 sec while reading 1 bytes!)
Process events from '['/tmp/heap.svdat']'...
[0.002244575] HEAP: Allocated 1 bytes @ 0x3ffaffd8 from task "alloc" on core 0 by:
/home/user/projects/esp/esp-idf/examples/system/sysview_tracing_heap_log/main/
↪sysview_heap_log.c:47
/home/user/projects/esp/esp-idf/components/freertos/port.c:355 (discriminator 1)

[0.002258425] HEAP: Allocated 2 bytes @ 0x3ffaffe0 from task "alloc" on core 0 by:
/home/user/projects/esp/esp-idf/examples/system/sysview_tracing_heap_log/main/
↪sysview_heap_log.c:48
/home/user/projects/esp/esp-idf/components/freertos/port.c:355 (discriminator 1)

[0.002563725] HEAP: Freed bytes @ 0x3ffaffe0 from task "free" on core 0 by:
/home/user/projects/esp/esp-idf/examples/system/sysview_tracing_heap_log/main/
↪sysview_heap_log.c:31 (discriminator 9)
/home/user/projects/esp/esp-idf/components/freertos/port.c:355 (discriminator 1)

[0.002782950] HEAP: Freed bytes @ 0x3ffb40b8 from task "main" on core 0 by:
/home/user/projects/esp/esp-idf/components/freertos/tasks.c:4590
/home/user/projects/esp/esp-idf/components/freertos/tasks.c:4590

[0.002798700] HEAP: Freed bytes @ 0x3ffb50bc from task "main" on core 0 by:
/home/user/projects/esp/esp-idf/components/freertos/tasks.c:4590
/home/user/projects/esp/esp-idf/components/freertos/tasks.c:4590

[0.102436025] HEAP: Allocated 2 bytes @ 0x3ffaffe0 from task "alloc" on core 0 by:
/home/user/projects/esp/esp-idf/examples/system/sysview_tracing_heap_log/main/
↪sysview_heap_log.c:47
/home/user/projects/esp/esp-idf/components/freertos/port.c:355 (discriminator 1)

[0.102449800] HEAP: Allocated 4 bytes @ 0x3ffaffe8 from task "alloc" on core 0 by:
/home/user/projects/esp/esp-idf/examples/system/sysview_tracing_heap_log/main/
↪sysview_heap_log.c:48
/home/user/projects/esp/esp-idf/components/freertos/port.c:355 (discriminator 1)

[0.102666150] HEAP: Freed bytes @ 0x3ffaffe8 from task "free" on core 0 by:
/home/user/projects/esp/esp-idf/examples/system/sysview_tracing_heap_log/main/
↪sysview_heap_log.c:31 (discriminator 9)

```

(continues on next page)



(continued from previous page)

```
/home/user/projects/esp/esp-idf/components/freertos/port.c:355 (discriminator 1)

[0.202436200] HEAP: Allocated 3 bytes @ 0x3ffaaffe8 from task "alloc" on core 0 by:
/home/user/projects/esp/esp-idf/examples/system/sysview_tracing_heap_log/main/
↪sysview_heap_log.c:47
/home/user/projects/esp/esp-idf/components/freertos/port.c:355 (discriminator 1)

[0.202451725] HEAP: Allocated 6 bytes @ 0x3ffaaff0 from task "alloc" on core 0 by:
/home/user/projects/esp/esp-idf/examples/system/sysview_tracing_heap_log/main/
↪sysview_heap_log.c:48
/home/user/projects/esp/esp-idf/components/freertos/port.c:355 (discriminator 1)

[0.202667075] HEAP: Freed bytes @ 0x3ffaaff0 from task "free" on core 0 by:
/home/user/projects/esp/esp-idf/examples/system/sysview_tracing_heap_log/main/
↪sysview_heap_log.c:31 (discriminator 9)
/home/user/projects/esp/esp-idf/components/freertos/port.c:355 (discriminator 1)

[0.302436000] HEAP: Allocated 4 bytes @ 0x3ffaaff0 from task "alloc" on core 0 by:
/home/user/projects/esp/esp-idf/examples/system/sysview_tracing_heap_log/main/
↪sysview_heap_log.c:47
/home/user/projects/esp/esp-idf/components/freertos/port.c:355 (discriminator 1)

[0.302451475] HEAP: Allocated 8 bytes @ 0x3ffb40b8 from task "alloc" on core 0 by:
/home/user/projects/esp/esp-idf/examples/system/sysview_tracing_heap_log/main/
↪sysview_heap_log.c:48
/home/user/projects/esp/esp-idf/components/freertos/port.c:355 (discriminator 1)

[0.302667500] HEAP: Freed bytes @ 0x3ffb40b8 from task "free" on core 0 by:
/home/user/projects/esp/esp-idf/examples/system/sysview_tracing_heap_log/main/
↪sysview_heap_log.c:31 (discriminator 9)
/home/user/projects/esp/esp-idf/components/freertos/port.c:355 (discriminator 1)

Processing completed.
Processed 1019 events
===== HEAP TRACE REPORT =====
Processed 14 heap events.
[0.002244575] HEAP: Allocated 1 bytes @ 0x3ffaafd8 from task "alloc" on core 0 by:
/home/user/projects/esp/esp-idf/examples/system/sysview_tracing_heap_log/main/
↪sysview_heap_log.c:47
/home/user/projects/esp/esp-idf/components/freertos/port.c:355 (discriminator 1)

[0.102436025] HEAP: Allocated 2 bytes @ 0x3ffaaffe0 from task "alloc" on core 0 by:
/home/user/projects/esp/esp-idf/examples/system/sysview_tracing_heap_log/main/
↪sysview_heap_log.c:47
/home/user/projects/esp/esp-idf/components/freertos/port.c:355 (discriminator 1)

[0.202436200] HEAP: Allocated 3 bytes @ 0x3ffaaffe8 from task "alloc" on core 0 by:
/home/user/projects/esp/esp-idf/examples/system/sysview_tracing_heap_log/main/
↪sysview_heap_log.c:47
/home/user/projects/esp/esp-idf/components/freertos/port.c:355 (discriminator 1)

[0.302436000] HEAP: Allocated 4 bytes @ 0x3ffaaff0 from task "alloc" on core 0 by:
/home/user/projects/esp/esp-idf/examples/system/sysview_tracing_heap_log/main/
↪sysview_heap_log.c:47
/home/user/projects/esp/esp-idf/components/freertos/port.c:355 (discriminator 1)

Found 10 leaked bytes in 4 blocks.
```

**Heap Tracing To Find Heap Corruption** Heap tracing can also be used to help track down heap corruption. When a region in heap is corrupted, it may be from some other part of the program which allocated memory at a

nearby address.

If you have some idea at what time the corruption occurred, enabling heap tracing in `HEAP_TRACE_ALL` mode allows you to record all the functions which allocated memory, and the addresses of the allocations.

Using heap tracing in this way is very similar to memory leak detection as described above. For memory which is allocated and not freed, the output is the same. However, records will also be shown for memory which has been freed.

**Performance Impact** Enabling heap tracing in menuconfig increases the code size of your program, and has a very small negative impact on performance of heap allocation/free operations even when heap tracing is not running.

When heap tracing is running, heap allocation/free operations are substantially slower than when heap tracing is stopped. Increasing the depth of stack frames recorded for each allocation (see above) will also increase this performance impact.

**False-Positive Memory Leaks** Not everything printed by `heap_trace_dump()` is necessarily a memory leak. Among things which may show up here, but are not memory leaks:

- Any memory which is allocated after `heap_trace_start()` but then freed after `heap_trace_stop()` will appear in the leak dump.
- Allocations may be made by other tasks in the system. Depending on the timing of these tasks, it's quite possible this memory is freed after `heap_trace_stop()` is called.
- The first time a task uses `stdio` - for example, when it calls `printf()` - a lock (RTOS mutex semaphore) is allocated by the libc. This allocation lasts until the task is deleted.
- Certain uses of `printf()`, such as printing floating point numbers, will allocate some memory from the heap on demand. These allocations last until the task is deleted.
- The Bluetooth, Wi-Fi, and TCP/IP libraries will allocate heap memory buffers to handle incoming or outgoing data. These memory buffers are usually short-lived, but some may be shown in the heap leak trace if the data was received/transmitted by the lower levels of the network while the leak trace was running.
- TCP connections will continue to use some memory after they are closed, because of the `TIME_WAIT` state. After the `TIME_WAIT` period has completed, this memory will be freed.

One way to differentiate between “real” and “false positive” memory leaks is to call the suspect code multiple times while tracing is running, and look for patterns (multiple matching allocations) in the heap trace output.

## API Reference - Heap Tracing

### Header File

- [components/heap/include/esp\\_heap\\_trace.h](#)

### Functions

`esp_err_t heap_trace_init_standalone(heap_trace_record_t *record_buffer, size_t num_records)`

Initialise heap tracing in standalone mode.

This function must be called before any other heap tracing functions.

To disable heap tracing and allow the buffer to be freed, stop tracing and then call `heap_trace_init_standalone(NULL, 0)`;

#### Parameters

- **record\_buffer** – Provide a buffer to use for heap trace data. Must remain valid any time heap tracing is enabled, meaning it must be allocated from internal memory not in PSRAM.
- **num\_records** – Size of the heap trace buffer, as number of record structures.

#### Returns

- `ESP_ERR_NOT_SUPPORTED` Project was compiled without heap tracing enabled in menuconfig.

- ESP\_ERR\_INVALID\_STATE Heap tracing is currently in progress.
- ESP\_OK Heap tracing initialised successfully.

*esp\_err\_t* **heap\_trace\_init\_tohost** (void)

Initialise heap tracing in host-based mode.

This function must be called before any other heap tracing functions.

**Returns**

- ESP\_ERR\_INVALID\_STATE Heap tracing is currently in progress.
- ESP\_OK Heap tracing initialised successfully.

*esp\_err\_t* **heap\_trace\_start** (*heap\_trace\_mode\_t* mode)

Start heap tracing. All heap allocations & frees will be traced, until `heap_trace_stop()` is called.

---

**Note:** `heap_trace_init_standalone()` must be called to provide a valid buffer, before this function is called.

---

---

**Note:** Calling this function while heap tracing is running will reset the heap trace state and continue tracing.

---

**Parameters mode** –Mode for tracing.

- HEAP\_TRACE\_ALL means all heap allocations and frees are traced.
- HEAP\_TRACE\_LEAKS means only suspected memory leaks are traced. (When memory is freed, the record is removed from the trace buffer.)

**Returns**

- ESP\_ERR\_NOT\_SUPPORTED Project was compiled without heap tracing enabled in `menuconfig`.
- ESP\_ERR\_INVALID\_STATE A non-zero-length buffer has not been set via `heap_trace_init_standalone()`.
- ESP\_OK Tracing is started.

*esp\_err\_t* **heap\_trace\_stop** (void)

Stop heap tracing.

**Returns**

- ESP\_ERR\_NOT\_SUPPORTED Project was compiled without heap tracing enabled in `menuconfig`.
- ESP\_ERR\_INVALID\_STATE Heap tracing was not in progress.
- ESP\_OK Heap tracing stopped..

*esp\_err\_t* **heap\_trace\_resume** (void)

Resume heap tracing which was previously stopped.

Unlike `heap_trace_start()`, this function does not clear the buffer of any pre-existing trace records.

The heap trace mode is the same as when `heap_trace_start()` was last called (or `HEAP_TRACE_ALL` if `heap_trace_start()` was never called).

**Returns**

- ESP\_ERR\_NOT\_SUPPORTED Project was compiled without heap tracing enabled in `menuconfig`.
- ESP\_ERR\_INVALID\_STATE Heap tracing was already started.
- ESP\_OK Heap tracing resumed.

*size\_t* **heap\_trace\_get\_count** (void)

Return number of records in the heap trace buffer.

It is safe to call this function while heap tracing is running.

*esp\_err\_t* **heap\_trace\_get** (size\_t index, *heap\_trace\_record\_t* \*record)

Return a raw record from the heap trace buffer.

---

**Note:** It is safe to call this function while heap tracing is running, however in HEAP\_TRACE\_LEAK mode record indexing may skip entries unless heap tracing is stopped first.

---

#### Parameters

- **index** –Index (zero-based) of the record to return.
- **record** –[out] Record where the heap trace record will be copied.

#### Returns

- ESP\_ERR\_NOT\_SUPPORTED Project was compiled without heap tracing enabled in menuconfig.
- ESP\_ERR\_INVALID\_STATE Heap tracing was not initialised.
- ESP\_ERR\_INVALID\_ARG Index is out of bounds for current heap trace record count.
- ESP\_OK Record returned successfully.

void **heap\_trace\_dump** (void)

Dump heap trace record data to stdout.

---

**Note:** It is safe to call this function while heap tracing is running, however in HEAP\_TRACE\_LEAK mode the dump may skip entries unless heap tracing is stopped first.

---

## Structures

struct **heap\_trace\_record\_t**

Trace record data type. Stores information about an allocated region of memory.

### Public Members

uint32\_t **ccount**

CCOUNT of the CPU when the allocation was made. LSB (bit value 1) is the CPU number (0 or 1).

void \***address**

Address which was allocated.

size\_t **size**

Size of the allocation.

void \***allocated\_by**[CONFIG\_HEAP\_TRACING\_STACK\_DEPTH]

Call stack of the caller which allocated the memory.

void \***freed\_by**[CONFIG\_HEAP\_TRACING\_STACK\_DEPTH]

Call stack of the caller which freed the memory (all zero if not freed.)

## Macros

**CONFIG\_HEAP\_TRACING\_STACK\_DEPTH**

## Enumerations

enum `heap_trace_mode_t`

Values:

enumerator `HEAP_TRACE_ALL`

enumerator `HEAP_TRACE_LEAKS`

### 2.9.15 High Resolution Timer (ESP Timer)

#### Overview

Although FreeRTOS provides software timers, these timers have a few limitations:

- Maximum resolution is equal to RTOS tick period
- Timer callbacks are dispatched from a low-priority task

Hardware timers are free from both of the limitations, but often they are less convenient to use. For example, application components may need timer events to fire at certain times in the future, but the hardware timer only contains one “compare” value used for interrupt generation. This means that some facility needs to be built on top of the hardware timer to manage the list of pending events can dispatch the callbacks for these events as corresponding hardware interrupts happen.

An interrupt level of the handler depends on the `CONFIG_ESP_TIMER_INTERRUPT_LEVEL` option. It allows to set this: 1, 2 or 3 level (by default 1). Raising the level, the interrupt handler can reduce the timer processing delay.

`esp_timer` set of APIs provides one-shot and periodic timers, microsecond time resolution, and 64-bit range.

Internally, `esp_timer` uses a 64-bit hardware timer, where the implementation depends on the target. `SYSTIMER` is used for ESP32-S2.

Timer callbacks can be dispatched by two methods:

- `ESP_TIMER_TASK`
- `ESP_TIMER_ISR`. Available only if `CONFIG_ESP_TIMER_SUPPORTS_ISR_DISPATCH_METHOD` is enabled (by default disabled).

`ESP_TIMER_TASK`. Timer callbacks are dispatched from a high-priority `esp_timer` task. Because all the callbacks are dispatched from the same task, it is recommended to only do the minimal possible amount of work from the callback itself, posting an event to a lower priority task using a queue instead.

If other tasks with priority higher than `esp_timer` are running, callback dispatching will be delayed until `esp_timer` task has a chance to run. For example, this will happen if an SPI Flash operation is in progress.

`ESP_TIMER_ISR`. Timer callbacks are dispatched directly from the timer interrupt handler. This method is useful for some simple callbacks which aim for lower latency.

Creating and starting a timer, and dispatching the callback takes some time. Therefore, there is a lower limit to the timeout value of one-shot `esp_timer`. If `esp_timer_start_once()` is called with a timeout value less than 20us, the callback will be dispatched only after approximately 20us.

Periodic `esp_timer` also imposes a 50us restriction on the minimal timer period. Periodic software timers with period of less than 50us are not practical since they would consume most of the CPU time. Consider using dedicated hardware peripherals or DMA features if you find that a timer with small period is required.

#### Using `esp_timer` APIs

Single timer is represented by `esp_timer_handle_t` type. Timer has a callback function associated with it. This callback function is called from the `esp_timer` task each time the timer elapses.

- To create a timer, call `esp_timer_create()`.

- To delete the timer when it is no longer needed, call `esp_timer_delete()`.

The timer can be started in one-shot mode or in periodic mode.

- To start the timer in one-shot mode, call `esp_timer_start_once()`, passing the time interval after which the callback should be called. When the callback gets called, the timer is considered to be stopped.
- To start the timer in periodic mode, call `esp_timer_start_periodic()`, passing the period with which the callback should be called. The timer keeps running until `esp_timer_stop()` is called.

Note that the timer must not be running when `esp_timer_start_once()` or `esp_timer_start_periodic()` is called. To restart a running timer, call `esp_timer_stop()` first, then call one of the start functions.

## Callback functions

---

**Note:** Keep the callback functions as short as possible otherwise it will affect all timers.

---

Timer callbacks which are processed by `ESP_TIMER_ISR` method should not call the context switch call - `portYIELD_FROM_ISR()`, instead of this you should use the `esp_timer_isr_dispatch_need_yield()` function. The context switch will be done after all ISR dispatch timers have been processed, if required by the system.

## esp\_timer during the light sleep

During light sleep, the `esp_timer` counter stops and no callback functions are called. Instead, the time is counted by the RTC counter. Upon waking up, the system gets the difference between the counters and calls a function that advances the `esp_timer` counter. Since the counter has been advanced, the system starts calling callbacks that were not called during sleep. The number of callbacks depends on the duration of the sleep and the period of the timers. It can lead to overflow of some queues. This only applies to periodic timers, one-shot timers will be called once.

This behavior can be changed by calling `esp_timer_stop()` before sleeping. In some cases, this can be inconvenient, and instead of the stop function, you can use the `skip_unhandled_events` option during `esp_timer_create()`. When the `skip_unhandled_events` is true, if a periodic timer expires one or more times during light sleep then only one callback is called on wake.

Using the `skip_unhandled_events` option with *automatic light sleep* (see [Power Management APIs](#)) helps to reduce the consumption of the system when it is in light sleep. The duration of light sleep is also determined by `esp_timers`. Timers with `skip_unhandled_events` option will not wake up the system.

## Handling callbacks

`esp_timer` is designed to achieve a high-resolution low latency timer and the ability to handle delayed events. If the timer is late then the callback will be called as soon as possible, it will not be lost. In the worst case, when the timer has not been processed for more than one period (for periodic timers), in this case the callbacks will be called one after the other without waiting for the set period. This can be bad for some applications, and the `skip_unhandled_events` option was introduced to eliminate this behavior. If `skip_unhandled_events` is set then a periodic timer that has expired multiple times without being able to call the callback will still result in only one callback event once processing is possible.

## Obtaining Current Time

`esp_timer` also provides a convenience function to obtain the time passed since start-up, with microsecond precision: `esp_timer_get_time()`. This function returns the number of microseconds since `esp_timer` was initialized, which usually happens shortly before `app_main` function is called.

Unlike `gettimeofday` function, values returned by `esp_timer_get_time()`:

- Start from zero after the chip wakes up from deep sleep
- Do not have timezone or DST adjustments applied

### Application Example

The following example illustrates usage of `esp_timer` APIs: [system/esp\\_timer](#).

### API Reference

#### Header File

- [components/esp\\_timer/include/esp\\_timer.h](#)

#### Functions

*esp\_err\_t* **esp\_timer\_early\_init** (void)

Minimal initialization of `esp_timer`.

This function can be called very early in startup process, after this call only `esp_timer_get_time` function can be used.

---

**Note:** This function is called from startup code. Applications do not need to call this function before using other `esp_timer` APIs.

---

#### Returns

- `ESP_OK` on success

*esp\_err\_t* **esp\_timer\_init** (void)

Initialize `esp_timer` library.

---

**Note:** This function is called from startup code. Applications do not need to call this function before using other `esp_timer` APIs. Before calling this function, `esp_timer_early_init` must be called by the startup code.

---

#### Returns

- `ESP_OK` on success
- `ESP_ERR_NO_MEM` if allocation has failed
- `ESP_ERR_INVALID_STATE` if already initialized
- other errors from interrupt allocator

*esp\_err\_t* **esp\_timer\_deinit** (void)

De-initialize `esp_timer` library.

---

**Note:** Normally this function should not be called from applications

---

#### Returns

- `ESP_OK` on success
- `ESP_ERR_INVALID_STATE` if not yet initialized

*esp\_err\_t* **esp\_timer\_create** (const *esp\_timer\_create\_args\_t* \*create\_args, *esp\_timer\_handle\_t* \*out\_handle)

Create an esp\_timer instance.

---

**Note:** When done using the timer, delete it with esp\_timer\_delete function.

---

#### Parameters

- **create\_args** –Pointer to a structure with timer creation arguments. Not saved by the library, can be allocated on the stack.
- **out\_handle** –[out] Output, pointer to esp\_timer\_handle\_t variable which will hold the created timer handle.

#### Returns

- ESP\_OK on success
- ESP\_ERR\_INVALID\_ARG if some of the create\_args are not valid
- ESP\_ERR\_INVALID\_STATE if esp\_timer library is not initialized yet
- ESP\_ERR\_NO\_MEM if memory allocation fails

*esp\_err\_t* **esp\_timer\_start\_once** (*esp\_timer\_handle\_t* timer, uint64\_t timeout\_us)

Start one-shot timer.

Timer should not be running when this function is called.

#### Parameters

- **timer** –timer handle created using esp\_timer\_create
- **timeout\_us** –timer timeout, in microseconds relative to the current moment

#### Returns

- ESP\_OK on success
- ESP\_ERR\_INVALID\_ARG if the handle is invalid
- ESP\_ERR\_INVALID\_STATE if the timer is already running

*esp\_err\_t* **esp\_timer\_start\_periodic** (*esp\_timer\_handle\_t* timer, uint64\_t period)

Start a periodic timer.

Timer should not be running when this function is called. This function will start the timer which will trigger every ‘period’ microseconds.

#### Parameters

- **timer** –timer handle created using esp\_timer\_create
- **period** –timer period, in microseconds

#### Returns

- ESP\_OK on success
- ESP\_ERR\_INVALID\_ARG if the handle is invalid
- ESP\_ERR\_INVALID\_STATE if the timer is already running

*esp\_err\_t* **esp\_timer\_restart** (*esp\_timer\_handle\_t* timer, uint64\_t timeout\_us)

Restart a currently running timer.

If the given timer is a one-shot timer, the timer is restarted immediately and will timeout once in timeout\_us microseconds. If the given timer is a periodic timer, the timer is restarted immediately with a new period of timeout\_us microseconds.

#### Parameters

- **timer** –timer Handle created using esp\_timer\_create
- **timeout\_us** –Timeout, in microseconds relative to the current time. In case of a periodic timer, also represents the new period.

#### Returns

- ESP\_OK on success
- ESP\_ERR\_INVALID\_ARG if the handle is invalid
- ESP\_ERR\_INVALID\_STATE if the timer is not running



*esp\_err\_t* **esp\_timer\_stop** (*esp\_timer\_handle\_t* timer)

Stop the timer.

This function stops the timer previously started using `esp_timer_start_once` or `esp_timer_start_periodic`.

**Parameters** **timer** –timer handle created using `esp_timer_create`

**Returns**

- ESP\_OK on success
- ESP\_ERR\_INVALID\_STATE if the timer is not running

*esp\_err\_t* **esp\_timer\_delete** (*esp\_timer\_handle\_t* timer)

Delete an `esp_timer` instance.

The timer must be stopped before deleting. A one-shot timer which has expired does not need to be stopped.

**Parameters** **timer** –timer handle allocated using `esp_timer_create`

**Returns**

- ESP\_OK on success
- ESP\_ERR\_INVALID\_STATE if the timer is running

*int64\_t* **esp\_timer\_get\_time** (void)

Get time in microseconds since boot.

**Returns** number of microseconds since underlying timer has been started

*int64\_t* **esp\_timer\_get\_next\_alarm** (void)

Get the timestamp when the next timeout is expected to occur.

**Returns** Timestamp of the nearest timer event, in microseconds. The timebase is the same as for the values returned by `esp_timer_get_time`.

*int64\_t* **esp\_timer\_get\_next\_alarm\_for\_wake\_up** (void)

Get the timestamp when the next timeout is expected to occur skipping those which have `skip_unhandled_events` flag.

**Returns** Timestamp of the nearest timer event, in microseconds. The timebase is the same as for the values returned by `esp_timer_get_time`.

*esp\_err\_t* **esp\_timer\_get\_period** (*esp\_timer\_handle\_t* timer, *uint64\_t* \*period)

Get the period of a timer.

This function fetches the timeout period of a timer.

---

**Note:** The timeout period is the time interval with which a timer restarts after expiry. For one-shot timers, the period is 0 as there is no periodicity associated with such timers.

---

**Parameters**

- **timer** –timer handle allocated using `esp_timer_create`
- **period** –memory to store the timer period value in microseconds

**Returns**

- ESP\_OK on success
- ESP\_ERR\_INVALID\_ARG if the arguments are invalid

*esp\_err\_t* **esp\_timer\_get\_expiry\_time** (*esp\_timer\_handle\_t* timer, *uint64\_t* \*expiry)

Get the expiry time of a one-shot timer.

This function fetches the expiry time of a one-shot timer.

---

**Note:** This API returns a valid expiry time only for a one-shot timer. It returns an error if the timer handle passed to the function is for a periodic timer.

---

**Parameters**

- **timer** –timer handle allocated using `esp_timer_create`
- **expiry** –memory to store the timeout value in microseconds

**Returns**

- `ESP_OK` on success
- `ESP_ERR_INVALID_ARG` if the arguments are invalid
- `ESP_ERR_NOT_SUPPORTED` if the timer type is periodic

*esp\_err\_t* **esp\_timer\_dump** (FILE \*stream)

Dump the list of timers to a stream.

If `CONFIG_ESP_TIMER_PROFILING` option is enabled, this prints the list of all the existing timers. Otherwise, only the list active timers is printed.

The format is:

name period alarm times\_armed times\_triggered total\_callback\_run\_time

where:

name —timer name (if `CONFIG_ESP_TIMER_PROFILING` is defined), or timer pointer period —period of timer, in microseconds, or 0 for one-shot timer alarm - time of the next alarm, in microseconds since boot, or 0 if the timer is not started

The following fields are printed if `CONFIG_ESP_TIMER_PROFILING` is defined:

times\_armed —number of times the timer was armed via `esp_timer_start_X` times\_triggered - number of times the callback was called total\_callback\_run\_time - total time taken by callback to execute, across all calls

**Parameters** **stream** –stream (such as stdout) to dump the information to

**Returns**

- `ESP_OK` on success
- `ESP_ERR_NO_MEM` if can not allocate temporary buffer for the output

void **esp\_timer\_isr\_dispatch\_need\_yield** (void)

Requests a context switch from a timer callback function.

This only works for a timer that has an ISR dispatch method. The context switch will be called after all ISR dispatch timers have been processed.

bool **esp\_timer\_is\_active** (*esp\_timer\_handle\_t* timer)

Returns status of a timer, active or not.

This function is used to identify if the timer is still active or not.

**Parameters** **timer** –timer handle created using `esp_timer_create`

**Returns**

- 1 if timer is still active
- 0 if timer is not active.

**Structures**

struct **esp\_timer\_create\_args\_t**

Timer configuration passed to `esp_timer_create`.

**Public Members**

*esp\_timer\_cb\_t* **callback**

Function to call when timer expires.

void **\*arg**

Argument to pass to the callback.

*esp\_timer\_dispatch\_t* **dispatch\_method**

Call the callback from task or from ISR.

const char **\*name**

Timer name, used in `esp_timer_dump` function.

bool **skip\_unhandled\_events**

Skip unhandled events for periodic timers.

### Type Definitions

typedef struct esp\_timer **\*esp\_timer\_handle\_t**

Opaque type representing a single `esp_timer`.

typedef void (**\*esp\_timer\_cb\_t**)(void \*arg)

Timer callback function type.

**Param arg** pointer to opaque user-specific data

### Enumerations

enum **esp\_timer\_dispatch\_t**

Method for dispatching timer callback.

*Values:*

enumerator **ESP\_TIMER\_TASK**

Callback is called from timer task.

enumerator **ESP\_TIMER\_MAX**

Count of the methods for dispatching timer callback.

## 2.9.16 Internal and Unstable APIs

This section is listing some APIs that are internal or likely to be changed or removed in the next releases of ESP-IDF.

### API Reference

#### Header File

- [components/esp\\_rom/include/esp\\_rom\\_sys.h](#)

#### Functions

void **esp\_rom\_software\_reset\_system** (void)

Software Reset digital core include RTC.

It is not recommended to use this function in esp-idf, use `esp_restart()` instead.

int **esp\_rom\_printf** (const char \*fmt, ...)

Print formatted string to console device.

---

**Note:** float and long long data are not supported!

---

**Parameters**

- **fmt** –Format string
- **...** –Additional arguments, depending on the format string

**Returns** int: Total number of characters written on success; A negative number on failure.

void **esp\_rom\_delay\_us** (uint32\_t us)

Pauses execution for us microseconds.

**Parameters** **us** –Number of microseconds to pause

void **esp\_rom\_install\_channel\_putc** (int channel, void (\*putc)(char c))

esp\_rom\_printf can print message to different channels simultaneously. This function can help install the low level putc function for esp\_rom\_printf.

**Parameters**

- **channel** –Channel number (starting from 1)
- **putc** –Function pointer to the putc implementation. Set NULL can disconnect esp\_rom\_printf with putc.

void **esp\_rom\_install\_uart\_printf** (void)

Install UART1 as the default console channel, equivalent to esp\_rom\_install\_channel\_putc(1, esp\_rom\_uart\_putc)

soc\_reset\_reason\_t **esp\_rom\_get\_reset\_reason** (int cpu\_no)

Get reset reason of CPU.

**Parameters** **cpu\_no** –CPU number

**Returns** Reset reason code (see in soc/reset\_reasons.h)

void **esp\_rom\_route\_intr\_matrix** (int cpu\_core, uint32\_t periph\_intr\_id, uint32\_t cpu\_intr\_num)

Route peripheral interrupt sources to CPU's interrupt port by matrix.

Usually there're 4 steps to use an interrupt:

- Route peripheral interrupt source to CPU. e.g. `esp_rom_route_intr_matrix(0, ETS_WIFI_MAC_INTR_SOURCE, ETS_WMAC_INUM)`
- Set interrupt handler for CPU
- Enable CPU interrupt
- Enable peripheral interrupt

**Parameters**

- **cpu\_core** –The CPU number, which the peripheral interrupt will inform to
- **periph\_intr\_id** –The peripheral interrupt source number
- **cpu\_intr\_num** –The CPU interrupt number

uint32\_t **esp\_rom\_get\_cpu\_ticks\_per\_us** (void)

Get the real CPU ticks per us.

**Returns** CPU ticks per us

## 2.9.17 Interrupt allocation

## Overview

The ESP32-S2 has one core, with 32 interrupts. Each interrupt has a certain priority level, most (but not all) interrupts are connected to the interrupt mux.

Because there are more interrupt sources than interrupts, sometimes it makes sense to share an interrupt in multiple drivers. The `esp_intr_alloc()` abstraction exists to hide all these implementation details.

A driver can allocate an interrupt for a certain peripheral by calling `esp_intr_alloc()` (or `esp_intr_alloc_intrstatus()`). It can use the flags passed to this function to set the type of interrupt allocated, specifying a particular level or trigger method. The interrupt allocation code will then find an applicable interrupt, use the interrupt mux to hook it up to the peripheral, and install the given interrupt handler and ISR to it.

This code presents two different types of interrupts, handled differently: shared interrupts and non-shared interrupts. The simplest ones are non-shared interrupts: a separate interrupt is allocated per `esp_intr_alloc()` call and this interrupt is solely used for the peripheral attached to it, with only one ISR that will get called. On the other hand, shared interrupts can have multiple peripherals triggering them, with multiple ISRs being called when one of the peripherals attached signals an interrupt. Thus, ISRs that are intended for shared interrupts should check the interrupt status of the peripheral they service in order to check if any action is required.

Non-shared interrupts can be either level- or edge-triggered. Shared interrupts can only be level interrupts due to the chance of missed interrupts when edge interrupts are used.

For example, let's say DevA and DevB share an interrupt. DevB signals an interrupt, so INT line goes high. The ISR handler calls code for DevA but does nothing. Then, ISR handler calls code for DevB, but while doing that, DevA signals an interrupt. DevB's ISR is done, it clears interrupt status for DevB and exits interrupt code. Now, an interrupt for DevA is still pending, but because the INT line never went low, as DevA kept it high even when the interrupt for DevB was cleared, the interrupt is never serviced.

## IRAM-Safe Interrupt Handlers

The `ESP_INTR_FLAG_IRAM` flag registers an interrupt handler that always runs from IRAM (and reads all its data from DRAM), and therefore does not need to be disabled during flash erase and write operations.

This is useful for interrupts which need a guaranteed minimum execution latency, as flash write and erase operations can be slow (erases can take tens or hundreds of milliseconds to complete).

It can also be useful to keep an interrupt handler in IRAM if it is called very frequently, to avoid flash cache misses.

Refer to the [SPI flash API documentation](#) for more details.

## Multiple Handlers Sharing A Source

Several handlers can be assigned to a same source, given that all handlers are allocated using the `ESP_INTR_FLAG_SHARED` flag. They will all be allocated to the interrupt, which the source is attached to, and called sequentially when the source is active. The handlers can be disabled and freed individually. The source is attached to the interrupt (enabled), if one or more handlers are enabled, otherwise detached. A handler will never be called when disabled, while **its source may still be triggered** if any one of its handler enabled.

Sources attached to non-shared interrupt do not support this feature.

Though the framework support this feature, you have to use it *very carefully*. There usually exist two ways to stop an interrupt from being triggered: *disable the source* or *mask peripheral interrupt status*. IDF only handles enabling and disabling of the source itself, leaving status and mask bits to be handled by users. **Status bits shall either be masked before the handler responsible for it is disabled, either be masked and then properly handled in another enabled interrupt.** Please note that leaving some status bits unhandled without masking them, while disabling the handlers for them, will cause the interrupt(s) to be triggered indefinitely, resulting therefore in a system crash.

## API Reference

### Header File

- `components/esp_hw_support/include/esp_intr_alloc.h`

### Functions

`esp_err_t esp_intr_mark_shared` (int intno, int cpu, bool is\_in\_iram)

Mark an interrupt as a shared interrupt.

This will mark a certain interrupt on the specified CPU as an interrupt that can be used to hook shared interrupt handlers to.

#### Parameters

- **intno** –The number of the interrupt (0-31)
- **cpu** –CPU on which the interrupt should be marked as shared (0 or 1)
- **is\_in\_iram** –Shared interrupt is for handlers that reside in IRAM and the int can be left enabled while the flash cache is disabled.

**Returns** ESP\_ERR\_INVALID\_ARG if cpu or intno is invalid ESP\_OK otherwise

`esp_err_t esp_intr_reserve` (int intno, int cpu)

Reserve an interrupt to be used outside of this framework.

This will mark a certain interrupt on the specified CPU as reserved, not to be allocated for any reason.

#### Parameters

- **intno** –The number of the interrupt (0-31)
- **cpu** –CPU on which the interrupt should be marked as shared (0 or 1)

**Returns** ESP\_ERR\_INVALID\_ARG if cpu or intno is invalid ESP\_OK otherwise

`esp_err_t esp_intr_alloc` (int source, int flags, `intr_handler_t` handler, void \*arg, `intr_handle_t` \*ret\_handle)

Allocate an interrupt with the given parameters.

This finds an interrupt that matches the restrictions as given in the flags parameter, maps the given interrupt source to it and hooks up the given interrupt handler (with optional argument) as well. If needed, it can return a handle for the interrupt as well.

The interrupt will always be allocated on the core that runs this function.

If ESP\_INTR\_FLAG\_IRAM flag is used, and handler address is not in IRAM or RTC\_FAST\_MEM, then ESP\_ERR\_INVALID\_ARG is returned.

#### Parameters

- **source** –The interrupt source. One of the ETS\_\*\_INTR\_SOURCE interrupt mux sources, as defined in soc/soc.h, or one of the internal ETS\_INTERNAL\_\*\_INTR\_SOURCE sources as defined in this header.
- **flags** –An ORred mask of the ESP\_INTR\_FLAG\_\* defines. These restrict the choice of interrupts that this routine can choose from. If this value is 0, it will default to allocating a non-shared interrupt of level 1, 2 or 3. If this is ESP\_INTR\_FLAG\_SHARED, it will allocate a shared interrupt of level 1. Setting ESP\_INTR\_FLAG\_INTRDISABLED will return from this function with the interrupt disabled.
- **handler** –The interrupt handler. Must be NULL when an interrupt of level >3 is requested, because these types of interrupts aren't C-callable.
- **arg** –Optional argument for passed to the interrupt handler
- **ret\_handle** –Pointer to an `intr_handle_t` to store a handle that can later be used to request details or free the interrupt. Can be NULL if no handle is required.

**Returns** ESP\_ERR\_INVALID\_ARG if the combination of arguments is invalid.  
ESP\_ERR\_NOT\_FOUND No free interrupt found with the specified flags  
ESP\_OK otherwise

`esp_err_t esp_intr_alloc_intrstatus` (int source, int flags, uint32\_t intrstatusreg, uint32\_t intrstatusmask, `intr_handler_t` handler, void \*arg, `intr_handle_t` \*ret\_handle)

Allocate an interrupt with the given parameters.

This essentially does the same as `esp_intr_alloc`, but allows specifying a register and mask combo. For shared interrupts, the handler is only called if a read from the specified register, ANDed with the mask, returns non-zero. By passing an interrupt status register address and a fitting mask, this can be used to accelerate interrupt handling in the case a shared interrupt is triggered; by checking the interrupt statuses first, the code can decide which ISRs can be skipped

#### Parameters

- **source** –The interrupt source. One of the `ETS_*_INTR_SOURCE` interrupt mux sources, as defined in `soc/soc.h`, or one of the internal `ETS_INTERNAL_*_INTR_SOURCE` sources as defined in this header.
- **flags** –An ORred mask of the `ESP_INTR_FLAG_*` defines. These restrict the choice of interrupts that this routine can choose from. If this value is 0, it will default to allocating a non-shared interrupt of level 1, 2 or 3. If this is `ESP_INTR_FLAG_SHARED`, it will allocate a shared interrupt of level 1. Setting `ESP_INTR_FLAG_INTRDISABLED` will return from this function with the interrupt disabled.
- **intrstatusreg** –The address of an interrupt status register
- **intrstatusmask** –A mask. If a read of address `intrstatusreg` has any of the bits that are 1 in the mask set, the ISR will be called. If not, it will be skipped.
- **handler** –The interrupt handler. Must be NULL when an interrupt of level >3 is requested, because these types of interrupts aren't C-callable.
- **arg** –Optional argument for passed to the interrupt handler
- **ret\_handle** –Pointer to an `intr_handle_t` to store a handle that can later be used to request details or free the interrupt. Can be NULL if no handle is required.

**Returns** `ESP_ERR_INVALID_ARG` if the combination of arguments is invalid.  
`ESP_ERR_NOT_FOUND` No free interrupt found with the specified flags  
`ESP_OK` otherwise

`esp_err_t esp_intr_free` (*intr\_handle\_t* handle)

Disable and free an interrupt.

Use an interrupt handle to disable the interrupt and release the resources associated with it. If the current core is not the core that registered this interrupt, this routine will be assigned to the core that allocated this interrupt, blocking and waiting until the resource is successfully released.

---

**Note:** When the handler shares its source with other handlers, the interrupt status bits it's responsible for should be managed properly before freeing it. see `esp_intr_disable` for more details. Please do not call this function in `esp_ipc_call_blocking`.

---

**Parameters** **handle** –The handle, as obtained by `esp_intr_alloc` or `esp_intr_alloc_intrstatus`

**Returns** `ESP_ERR_INVALID_ARG` the handle is NULL  
`ESP_FAIL` failed to release this handle  
`ESP_OK` otherwise

int `esp_intr_get_cpu` (*intr\_handle\_t* handle)

Get CPU number an interrupt is tied to.

**Parameters** **handle** –The handle, as obtained by `esp_intr_alloc` or `esp_intr_alloc_intrstatus`

**Returns** The core number where the interrupt is allocated

int `esp_intr_get_intno` (*intr\_handle\_t* handle)

Get the allocated interrupt for a certain handle.

**Parameters** **handle** –The handle, as obtained by `esp_intr_alloc` or `esp_intr_alloc_intrstatus`

**Returns** The interrupt number

`esp_err_t esp_intr_disable` (*intr\_handle\_t* handle)

Disable the interrupt associated with the handle.

**Note:**

- a. For local interrupts (ESP\_INTERNAL\_\* sources), this function has to be called on the CPU the interrupt is allocated on. Other interrupts have no such restriction.
  - b. When several handlers sharing a same interrupt source, interrupt status bits, which are handled in the handler to be disabled, should be masked before the disabling, or handled in other enabled interrupts properly. Miss of interrupt status handling will cause infinite interrupt calls and finally system crash.
- 

**Parameters** **handle** –The handle, as obtained by `esp_intr_alloc` or `esp_intr_alloc_intrstatus`

**Returns** ESP\_ERR\_INVALID\_ARG if the combination of arguments is invalid. ESP\_OK otherwise

*esp\_err\_t* **esp\_intr\_enable** (*intr\_handle\_t* handle)

Enable the interrupt associated with the handle.

---

**Note:** For local interrupts (ESP\_INTERNAL\_\* sources), this function has to be called on the CPU the interrupt is allocated on. Other interrupts have no such restriction.

---

**Parameters** **handle** –The handle, as obtained by `esp_intr_alloc` or `esp_intr_alloc_intrstatus`

**Returns** ESP\_ERR\_INVALID\_ARG if the combination of arguments is invalid. ESP\_OK otherwise

*esp\_err\_t* **esp\_intr\_set\_in\_iram** (*intr\_handle\_t* handle, bool is\_in\_iram)

Set the “in IRAM” status of the handler.

---

**Note:** Does not work on shared interrupts.

---

**Parameters**

- **handle** –The handle, as obtained by `esp_intr_alloc` or `esp_intr_alloc_intrstatus`
- **is\_in\_iram** –Whether the handler associated with this handle resides in IRAM. Handlers residing in IRAM can be called when cache is disabled.

**Returns** ESP\_ERR\_INVALID\_ARG if the combination of arguments is invalid. ESP\_OK otherwise

void **esp\_intr\_noniram\_disable** (void)

Disable interrupts that aren't specifically marked as running from IRAM.

void **esp\_intr\_noniram\_enable** (void)

Re-enable interrupts disabled by `esp_intr_noniram_disable`.

void **esp\_intr\_enable\_source** (int inum)

enable the interrupt source based on its number

**Parameters** **inum** –interrupt number from 0 to 31

void **esp\_intr\_disable\_source** (int inum)

disable the interrupt source based on its number

**Parameters** **inum** –interrupt number from 0 to 31

static inline int **esp\_intr\_flags\_to\_level** (int flags)

Get the lowest interrupt level from the flags.

**Parameters** **flags** –The same flags that pass to `esp_intr_alloc_intrstatus` API



**Macros****ESP\_INTR\_FLAG\_LEVEL1**

Interrupt allocation flags.

These flags can be used to specify which interrupt qualities the code calling `esp_intr_alloc*` needs. Accept a Level 1 interrupt vector (lowest priority)

**ESP\_INTR\_FLAG\_LEVEL2**

Accept a Level 2 interrupt vector.

**ESP\_INTR\_FLAG\_LEVEL3**

Accept a Level 3 interrupt vector.

**ESP\_INTR\_FLAG\_LEVEL4**

Accept a Level 4 interrupt vector.

**ESP\_INTR\_FLAG\_LEVEL5**

Accept a Level 5 interrupt vector.

**ESP\_INTR\_FLAG\_LEVEL6**

Accept a Level 6 interrupt vector.

**ESP\_INTR\_FLAG\_NMI**

Accept a Level 7 interrupt vector (highest priority)

**ESP\_INTR\_FLAG\_SHARED**

Interrupt can be shared between ISRs.

**ESP\_INTR\_FLAG\_EDGE**

Edge-triggered interrupt.

**ESP\_INTR\_FLAG\_IRAM**

ISR can be called if cache is disabled.

**ESP\_INTR\_FLAG\_INTRDISABLED**

Return with this interrupt disabled.

**ESP\_INTR\_FLAG\_LOWMED**

Low and medium prio interrupts. These can be handled in C.

**ESP\_INTR\_FLAG\_HIGH**

High level interrupts. Need to be handled in assembly.

**ESP\_INTR\_FLAG\_LEVELMASK**

Mask for all level flags.

**ETS\_INTERNAL\_TIMER0\_INTR\_SOURCE**

Platform timer 0 interrupt source.

The `esp_intr_alloc*` functions can allocate an int for all `ETS_*_INTR_SOURCE` interrupt sources that are routed through the interrupt mux. Apart from these sources, each core also has some internal sources that do

not pass through the interrupt mux. To allocate an interrupt for these sources, pass these pseudo-sources to the functions.

**ETS\_INTERNAL\_TIMER1\_INTR\_SOURCE**

Platform timer 1 interrupt source.

**ETS\_INTERNAL\_TIMER2\_INTR\_SOURCE**

Platform timer 2 interrupt source.

**ETS\_INTERNAL\_SW0\_INTR\_SOURCE**

Software int source 1.

**ETS\_INTERNAL\_SW1\_INTR\_SOURCE**

Software int source 2.

**ETS\_INTERNAL\_PROFILING\_INTR\_SOURCE**

Int source for profiling.

**ETS\_INTERNAL\_UNUSED\_INTR\_SOURCE**

Interrupt is not assigned to any source.

**ETS\_INTERNAL\_INTR\_SOURCE\_OFF**

Provides SystemView with positive IRQ IDs, otherwise scheduler events are not shown properly

**ESP\_INTR\_ENABLE** (inum)

Enable interrupt by interrupt number

**ESP\_INTR\_DISABLE** (inum)

Disable interrupt by interrupt number

## Type Definitions

```
typedef void (*intr_handler_t)(void *arg)
```

Function prototype for interrupt handler function

```
typedef struct intr_handle_data_t intr_handle_data_t
```

Interrupt handler associated data structure

```
typedef intr_handle_data_t *intr_handle_t
```

Handle to an interrupt handler

## 2.9.18 Logging library

### Overview

The logging library provides two ways for setting log verbosity:

- **At compile time:** in menuconfig, set the verbosity level using the option [CONFIG\\_LOG\\_DEFAULT\\_LEVEL](#).
- Optionally, also in menuconfig, set the maximum verbosity level using the option [CONFIG\\_LOG\\_MAXIMUM\\_LEVEL](#). By default this is the same as the default level, but it can be set higher in order to compile more optional logs into the firmware.
- **At runtime:** all logs for verbosity levels lower than [CONFIG\\_LOG\\_DEFAULT\\_LEVEL](#) are enabled by default. The function [esp\\_log\\_level\\_set\(\)](#) can be used to set a logging level on a per module basis. Modules are identified by their tags, which are human-readable ASCII zero-terminated strings.

There are the following verbosity levels:

- Error (lowest)
- Warning
- Info
- Debug
- Verbose (highest)

---

**Note:** The function `esp_log_level_set()` cannot set logging levels higher than specified by `CONFIG_LOG_MAXIMUM_LEVEL`. To increase log level for a specific file above this maximum at compile time, use the macro `LOG_LOCAL_LEVEL` (see the details below).

---

### How to use this library

In each C file that uses logging functionality, define the TAG variable as shown below:

```
static const char* TAG = "MyModule";
```

Then use one of logging macros to produce output, e.g:

```
ESP_LOGW(TAG, "Baud rate error %.1f%%. Requested: %d baud, actual: %d baud", error_↵  
↵* 100, baud_req, baud_real);
```

Several macros are available for different verbosity levels:

- `ESP_LOGE` - error (lowest)
- `ESP_LOGW` - warning
- `ESP_LOGI` - info
- `ESP_LOGD` - debug
- `ESP_LOGV` - verbose (highest)

Additionally, there are `ESP_EARLY_LOGx` versions for each of these macros, e.g. `ESP_EARLY_LOGE`. These versions have to be used explicitly in the early startup code only, before heap allocator and syscalls have been initialized. Normal `ESP_LOGx` macros can also be used while compiling the bootloader, but they will fall back to the same implementation as `ESP_EARLY_LOGx` macros.

There are also `ESP_DRAM_LOGx` versions for each of these macros, e.g. `ESP_DRAM_LOGE`. These versions are used in some places where logging may occur with interrupts disabled or with flash cache inaccessible. Use of this macros should be as sparing as possible, as logging in these types of code should be avoided for performance reasons.

---

**Note:** Inside critical sections interrupts are disabled so it's only possible to use `ESP_DRAM_LOGx` (preferred) or `ESP_EARLY_LOGx`. Even though it's possible to log in these situations, it's better if your program can be structured not to require it.

---

To override default verbosity level at file or component scope, define the `LOG_LOCAL_LEVEL` macro.

At file scope, define it before including `esp_log.h`, e.g.:

```
#define LOG_LOCAL_LEVEL ESP_LOG_VERBOSE  
#include "esp_log.h"
```

At component scope, define it in the component makefile:

```
target_compile_definitions(${COMPONENT_LIB} PUBLIC "-DLOG_LOCAL_LEVEL=ESP_LOG_↵  
↵VERBOSE")
```

To configure logging output per module at runtime, add calls to the function `esp_log_level_set()` as follows:

```
esp_log_level_set("*", ESP_LOG_ERROR); // set all components to ERROR level
esp_log_level_set("wifi", ESP_LOG_WARN); // enable WARN logs from WiFi stack
esp_log_level_set("dhcpc", ESP_LOG_INFO); // enable INFO logs from DHCP client
```

---

**Note:** The “DRAM” and “EARLY” log macro variants documented above do not support per module setting of log verbosity. These macros will always log at the “default” verbosity level, which can only be changed at runtime by calling `esp_log_level("*", level)`.

---

**Logging to Host via JTAG** By default, the logging library uses the `vprintf`-like function to write formatted output to the dedicated UART. By calling a simple API, all log output may be routed to JTAG instead, making logging several times faster. For details, please refer to Section [Logging to Host](#).

### Application Example

The logging library is commonly used by most esp-idf components and examples. For demonstration of log functionality, check ESP-IDF’s [examples](#) directory. The most relevant examples that deal with logging are the following:

- [system/ota](#)
- [storage/sd\\_card](#)
- [protocols/https\\_request](#)

### API Reference

#### Header File

- [components/log/include/esp\\_log.h](#)

#### Functions

void **esp\_log\_level\_set** (const char \*tag, [esp\\_log\\_level\\_t](#) level)

Set log level for given tag.

If logging for given component has already been enabled, changes previous setting.

---

**Note:** Note that this function can not raise log level above the level set using `CONFIG_LOG_MAXIMUM_LEVEL` setting in `menuconfig`. To raise log level above the default one for a given file, define `LOG_LOCAL_LEVEL` to one of the `ESP_LOG_*` values, before including `esp_log.h` in this file.

---

#### Parameters

- **tag** –Tag of the log entries to enable. Must be a non-NULL zero terminated string. Value “\*” resets log level for all tags to the given value.
- **level** –Selects log level to enable. Only logs at this and lower verbosity levels will be shown.

[esp\\_log\\_level\\_t](#) **esp\_log\_level\_get** (const char \*tag)

Get log level for a given tag, can be used to avoid expensive log statements.

**Parameters** **tag** –Tag of the log to query current level. Must be a non-NULL zero terminated string.

**Returns** The current log level for the given tag

*vprintf\_like\_t* **esp\_log\_set\_vprintf** (*vprintf\_like\_t* func)

Set function used to output log entries.

By default, log output goes to UART0. This function can be used to redirect log output to some other destination, such as file or network. Returns the original log handler, which may be necessary to return output to the previous destination.

---

**Note:** Please note that function callback here must be re-entrant as it can be invoked in parallel from multiple thread context.

---

**Parameters** **func** –new Function used for output. Must have same signature as vprintf.

**Returns** func old Function used for output.

uint32\_t **esp\_log\_timestamp** (void)

Function which returns timestamp to be used in log output.

This function is used in expansion of ESP\_LOGx macros. In the 2nd stage bootloader, and at early application startup stage this function uses CPU cycle counter as time source. Later when FreeRTOS scheduler start running, it switches to FreeRTOS tick count.

For now, we ignore millisecond counter overflow.

**Returns** timestamp, in milliseconds

char \***esp\_log\_system\_timestamp** (void)

Function which returns system timestamp to be used in log output.

This function is used in expansion of ESP\_LOGx macros to print the system time as “HH:MM:SS.sss” . The system time is initialized to 0 on startup, this can be set to the correct time with an SNTP sync, or manually with standard POSIX time functions.

Currently, this will not get used in logging from binary blobs (i.e. Wi-Fi & Bluetooth libraries), these will still print the RTOS tick time.

**Returns** timestamp, in “HH:MM:SS.sss”

uint32\_t **esp\_log\_early\_timestamp** (void)

Function which returns timestamp to be used in log output.

This function uses HW cycle counter and does not depend on OS, so it can be safely used after application crash.

**Returns** timestamp, in milliseconds

void **esp\_log\_write** (*esp\_log\_level\_t* level, const char \*tag, const char \*format, ...)

Write message into the log.

This function is not intended to be used directly. Instead, use one of ESP\_LOGE, ESP\_LOGW, ESP\_LOGI, ESP\_LOGD, ESP\_LOGV macros.

This function or these macros should not be used from an interrupt.

void **esp\_log\_writev** (*esp\_log\_level\_t* level, const char \*tag, const char \*format, va\_list args)

Write message into the log, va\_list variant.

This function is provided to ease integration toward other logging framework, so that esp\_log can be used as a log sink.

**See also:**

esp\_log\_write()

**Macros****ESP\_LOG\_BUFFER\_HEX\_LEVEL** (tag, buffer, buff\_len, level)

Log a buffer of hex bytes at specified level, separated into 16 bytes each line.

**Parameters**

- **tag** –description tag
- **buffer** –Pointer to the buffer array
- **buff\_len** –length of buffer in bytes
- **level** –level of the log

**ESP\_LOG\_BUFFER\_CHAR\_LEVEL** (tag, buffer, buff\_len, level)

Log a buffer of characters at specified level, separated into 16 bytes each line. Buffer should contain only printable characters.

**Parameters**

- **tag** –description tag
- **buffer** –Pointer to the buffer array
- **buff\_len** –length of buffer in bytes
- **level** –level of the log

**ESP\_LOG\_BUFFER\_HEXDUMP** (tag, buffer, buff\_len, level)

Dump a buffer to the log at specified level.

The dump log shows just like the one below:

```

W (195) log_example: 0x3ffb4280  45 53 50 33 32 20 69 73  20 67 72 65 61 74_
↪2c 20 |ESP32 is great, |
W (195) log_example: 0x3ffb4290  77 6f 72 6b 69 6e 67 20  61 6c 6f 6e 67 20_
↪77 69 |working along wi|
W (205) log_example: 0x3ffb42a0  74 68 20 74 68 65 20 49  44 46 2e 00      _
↪      |th the IDF..|

```

It is highly recommended to use terminals with over 102 text width.

**Parameters**

- **tag** –description tag
- **buffer** –Pointer to the buffer array
- **buff\_len** –length of buffer in bytes
- **level** –level of the log

**ESP\_LOG\_BUFFER\_HEX** (tag, buffer, buff\_len)

Log a buffer of hex bytes at Info level.

**See also:**

esp\_log\_buffer\_hex\_level

**Parameters**

- **tag** –description tag
- **buffer** –Pointer to the buffer array
- **buff\_len** –length of buffer in bytes

**ESP\_LOG\_BUFFER\_CHAR** (tag, buffer, buff\_len)

Log a buffer of characters at Info level. Buffer should contain only printable characters.

**See also:**

esp\_log\_buffer\_char\_level

**Parameters**

- **tag** –description tag

- **buffer** –Pointer to the buffer array
- **buff\_len** –length of buffer in bytes

**ESP\_EARLY\_LOGE** (tag, format, ...)

macro to output logs in startup code, before heap allocator and syscalls have been initialized. Log at ESP\_LOG\_ERROR level.

**See also:**

`printf`, `ESP_LOGE`, `ESP_DRAM_LOGE` In the future, we want to switch to C++20. We also want to become compatible with clang. Hence, we provide two versions of the following macros which are using variadic arguments. The first one is using the GNU extension `##_VA_ARGS__`. The second one is using the C++20 feature `VA_OPT(,)`. This allows users to compile their code with standard C++20 enabled instead of the GNU extension. Below C++20, we haven't found any good alternative to using `##_VA_ARGS__`.

**ESP\_EARLY\_LOGW** (tag, format, ...)

macro to output logs in startup code at ESP\_LOG\_WARN level.

**See also:**

`ESP_EARLY_LOGE`, `ESP_LOGE`, `printf`

**ESP\_EARLY\_LOGI** (tag, format, ...)

macro to output logs in startup code at ESP\_LOG\_INFO level.

**See also:**

`ESP_EARLY_LOGE`, `ESP_LOGE`, `printf`

**ESP\_EARLY\_LOGD** (tag, format, ...)

macro to output logs in startup code at ESP\_LOG\_DEBUG level.

**See also:**

`ESP_EARLY_LOGE`, `ESP_LOGE`, `printf`

**ESP\_EARLY\_LOGV** (tag, format, ...)

macro to output logs in startup code at ESP\_LOG\_VERBOSE level.

**See also:**

`ESP_EARLY_LOGE`, `ESP_LOGE`, `printf`

**\_ESP\_LOG\_EARLY\_ENABLED** (log\_level)

**ESP\_LOG\_EARLY\_IMPL** (tag, format, log\_level, log\_tag\_letter, ...)

**ESP\_LOGE** (tag, format, ...)

**ESP\_LOGW** (tag, format, ...)

**ESP\_LOGI** (tag, format, ...)

**ESP\_LOGD** (tag, format, ...)

**ESP\_LOGV** (tag, format, ...)

**ESP\_LOG\_LEVEL** (level, tag, format, ...)

runtime macro to output logs at a specified level.

**See also:**

`printf`

**Parameters**

- **tag** –tag of the log, which can be used to change the log level by `esp_log_level_set` at runtime.
- **level** –level of the output log.
- **format** –format of the output log. See `printf`
- **...** –variables to be replaced into the log. See `printf`

**ESP\_LOG\_LEVEL\_LOCAL** (level, tag, format, ...)

runtime macro to output logs at a specified level. Also check the level with `LOG_LOCAL_LEVEL`.

**See also:**

`printf`, `ESP_LOG_LEVEL`

**ESP\_DRAM\_LOGE** (tag, format, ...)

Macro to output logs when the cache is disabled. Log at `ESP_LOG_ERROR` level.

Similar to

Usage: `ESP_DRAM_LOGE(DRAM_STR("my_tag"), "format", or ESP_DRAM_LOGE(TAG, "format", ...)`, where `TAG` is a `char*` that points to a str in the DRAM.

**See also:**

`ESP_EARLY_LOGE`, the log level cannot be changed per-tag, however `esp_log_level_set("...", level)` will set the default level which controls these log lines also.

**See also:**

`esp_rom_printf`, `ESP_LOGE`

---

**Note:** Unlike normal logging macros, it's possible to use this macro when interrupts are disabled or inside an ISR.

---

---

**Note:** Placing log strings in DRAM reduces available DRAM, so only use when absolutely essential.

---

**ESP\_DRAM\_LOGW** (tag, format, ...)

macro to output logs when the cache is disabled at `ESP_LOG_WARN` level.

**See also:**

`ESP_DRAM_LOGW`, `ESP_LOGW`, `esp_rom_printf`



**ESP\_DRAM\_LOGI** (tag, format, ...)

macro to output logs when the cache is disabled at ESP\_LOG\_INFO level.

**See also:**

ESP\_DRAM\_LOGI,ESP\_LOGI, esp\_rom\_printf

**ESP\_DRAM\_LOGD** (tag, format, ...)

macro to output logs when the cache is disabled at ESP\_LOG\_DEBUG level.

**See also:**

ESP\_DRAM\_LOGD,ESP\_LOGD, esp\_rom\_printf

**ESP\_DRAM\_LOGV** (tag, format, ...)

macro to output logs when the cache is disabled at ESP\_LOG\_VERBOSE level.

**See also:**

ESP\_DRAM\_LOGV,ESP\_LOGV, esp\_rom\_printf

## Type Definitions

typedef int (**\*vprintf\_like\_t**)(const char\*, va\_list)

## Enumerations

enum **esp\_log\_level\_t**

Log level.

*Values:*

enumerator **ESP\_LOG\_NONE**

No log output

enumerator **ESP\_LOG\_ERROR**

Critical errors, software module can not recover on its own

enumerator **ESP\_LOG\_WARN**

Error conditions from which recovery measures have been taken

enumerator **ESP\_LOG\_INFO**

Information messages which describe normal flow of events

enumerator **ESP\_LOG\_DEBUG**

Extra information which is not necessary for normal use (values, pointers, sizes, etc).

enumerator **ESP\_LOG\_VERBOSE**

Bigger chunks of debugging information, or frequent messages which can potentially flood the output.

## 2.9.19 Miscellaneous System APIs

## Software Reset

To perform software reset of the chip, the `esp_restart()` function is provided. When the function is called, execution of the program stops, both CPUs are reset, and the application is loaded by the bootloader and starts execution again.

Additionally, the `esp_register_shutdown_handler()` function can register a routine that will be automatically called before a restart (that is triggered by `esp_restart()`) occurs. This is similar to the functionality of `atexit` POSIX function.

## Reset Reason

ESP-IDF applications can be started or restarted due to a variety of reasons. To get the last reset reason, call `esp_reset_reason()` function. See description of `esp_reset_reason_t` for the list of possible reset reasons.

## Heap Memory

Two heap-memory-related functions are provided:

- `esp_get_free_heap_size()` returns the current size of free heap memory.
- `esp_get_minimum_free_heap_size()` returns the minimum size of free heap memory that has ever been available (i.e., the smallest size of free heap memory in the applications lifetime).

Note that ESP-IDF supports multiple heaps with different capabilities. The functions mentioned in this section return the size of heap memory that can be allocated using the `malloc` family of functions. For further information about heap memory, see [Heap Memory Allocation](#).

## MAC Address

These APIs allow querying and customizing MAC addresses for different supported network interfaces (e.g., Wi-Fi, Bluetooth, Ethernet).

To fetch the MAC address for a specific network interface (e.g., Wi-Fi, Bluetooth, Ethernet), call the function `esp_read_mac()`.

In ESP-IDF, the MAC addresses for the various network interfaces are calculated from a single *base MAC address*. By default, the Espressif base MAC address is used. This base MAC address is pre-programmed into the ESP32-S2 eFuse in the factory during production.

Interface	MAC Address (2 universally administered, default)	MAC Address (1 universally administered)
Wi-Fi Station	<code>base_mac</code>	<code>base_mac</code>
Wi-Fi SoftAP	<code>base_mac</code> , +1 to the last octet	<i>Local MAC</i> (derived from Wi-Fi Station MAC)
Ethernet	<i>Local MAC</i> (derived from Wi-Fi SoftAP MAC)	<i>Local MAC</i> (derived from <code>base_mac</code> with +1 to last octet. Not recommended.)

---

**Note:** The [configuration](#) configures the number of universally administered MAC addresses that are provided by Espressif.

---

---

**Note:** Although ESP32-S2 has no integrated Ethernet MAC, it is still possible to calculate an Ethernet MAC address. However, this MAC address can only be used with an external ethernet interface such as an SPI-Ethernet device. See [Ethernet](#).

---

**Custom Base MAC** The default base MAC is pre-programmed by Espressif in eFuse BLK1. To set a custom base MAC instead, call the function `esp_base_mac_addr_set()` before initializing any network interfaces or calling the `esp_read_mac()` function. The custom MAC address can be stored in any supported storage device (e.g., flash, NVS).

The custom base MAC addresses should be allocated such that derived MAC addresses will not overlap. Based on the table above, users can configure the option `CONFIG_ESP32S2_UNIVERSAL_MAC_ADDRESSES` to set the number of valid universal MAC addresses that can be derived from the custom base MAC.

---

**Note:** It is also possible to call the function `esp_netif_set_mac()` to set the specific MAC used by a network interface after network initialization. But it is recommended to use the base MAC approach documented here to avoid the possibility of the original MAC address briefly appearing on the network before being changed.

---

**Custom MAC Address in eFuse** When reading custom MAC addresses from eFuse, ESP-IDF provides a helper function `esp_efuse_mac_get_custom()`. This loads the MAC address from eFuse BLK3. This function assumes that the custom base MAC address is stored in the following format:

Field	# of bits	Range of bits
MAC address	48	200:248

---

**Note:** The eFuse BLK3 uses RS-coding during a burn operation, which means that all eFuse fields in this block must be burnt at the same time.

---

Once MAC address has been obtained using `esp_efuse_mac_get_custom()`, call `esp_base_mac_addr_set()` to set this MAC address as base MAC address.

**Local vs Universal MAC Addresses** ESP32-S2 comes pre-programmed with enough valid Espressif universally administered MAC addresses for all internal interfaces. The table above shows how to calculate and derive the MAC address for a specific interface according to the base MAC address.

When using a custom MAC address scheme, it is possible that not all interfaces can be assigned with a universally administered MAC address. In these cases, a locally administered MAC address is assigned. Note that these addresses are intended for use on a single local network only.

See [this article](#) for the definition of locally and universally administered MAC addresses.

Function `esp_derive_local_mac()` is called internally to derive a local MAC address from a universal MAC address. The process is as follows:

1. The U/L bit (bit value 0x2) is set in the first octet of the universal MAC address, creating a local MAC address.
2. If this bit is already set in the supplied universal MAC address (i.e., the supplied “universal” MAC address was in fact already a local MAC address), then the first octet of the local MAC address is XORed with 0x4.

## Chip Version

`esp_chip_info()` function fills `esp_chip_info_t` structure with information about the chip. This includes the chip revision, number of CPU cores, and a bit mask of features enabled in the chip.

## SDK Version

`esp_get_idf_version()` returns a string describing the ESP-IDF version which is used to compile the application. This is the same value as the one available through `IDF_VER` variable of the build system. The version string generally has the format of `git describe` output.

To get the version at build time, additional version macros are provided. They can be used to enable or disable parts of the program depending on the ESP-IDF version.

- `ESP_IDF_VERSION_MAJOR`, `ESP_IDF_VERSION_MINOR`, `ESP_IDF_VERSION_PATCH` are defined to integers representing major, minor, and patch version.
- `ESP_IDF_VERSION_VAL` and `ESP_IDF_VERSION` can be used when implementing version checks:

```
#include "esp_idf_version.h"

#if ESP_IDF_VERSION >= ESP_IDF_VERSION_VAL(4, 0, 0)
    // enable functionality present in ESP-IDF v4.0
#endif
```

## App Version

The application version is stored in `esp_app_desc_t` structure. It is located in DROM sector and has a fixed offset from the beginning of the binary file. The structure is located after `esp_image_header_t` and `esp_image_segment_header_t` structures. The type of the field version is string and it has a maximum length of 32 chars.

To set the version in your project manually, you need to set the `PROJECT_VER` variable in the `CMakeLists.txt` of your project. In application `CMakeLists.txt`, put `set(PROJECT_VER "0.1.0.1")` before including `project.cmake`.

If the `CONFIG_APP_PROJECT_VER_FROM_CONFIG` option is set, the value of `CONFIG_APP_PROJECT_VER` will be used. Otherwise, if the `PROJECT_VER` variable is not set in the project, it will be retrieved either from the `$(PROJECT_PATH)/version.txt` file (if present) or using git command `git describe`. If neither is available, `PROJECT_VER` will be set to "1". Application can make use of this by calling `esp_app_get_description()` or `esp_ota_get_partition_description()` functions.

## API Reference

### Header File

- `components/esp_system/include/esp_system.h`

### Functions

`esp_err_t esp_register_shutdown_handler(shutdown_handler_t handle)`

Register shutdown handler.

This function allows you to register a handler that gets invoked before the application is restarted using `esp_restart` function.

**Parameters** `handle` –function to execute on restart

**Returns**

- `ESP_OK` on success
- `ESP_ERR_INVALID_STATE` if the handler has already been registered
- `ESP_ERR_NO_MEM` if no more shutdown handler slots are available

`esp_err_t esp_unregister_shutdown_handler(shutdown_handler_t handle)`

Unregister shutdown handler.

This function allows you to unregister a handler which was previously registered using `esp_register_shutdown_handler` function.

- `ESP_OK` on success
- `ESP_ERR_INVALID_STATE` if the given handler hasn't been registered before

void **esp\_restart** (void)

Restart PRO and APP CPUs.

This function can be called both from PRO and APP CPUs. After successful restart, CPU reset reason will be SW\_CPU\_RESET. Peripherals (except for Wi-Fi, BT, UART0, SPI1, and legacy timers) are not reset. This function does not return.

*esp\_reset\_reason\_t* **esp\_reset\_reason** (void)

Get reason of last reset.

**Returns** See description of *esp\_reset\_reason\_t* for explanation of each value.

uint32\_t **esp\_get\_free\_heap\_size** (void)

Get the size of available heap.

---

**Note:** Note that the returned value may be larger than the maximum contiguous block which can be allocated.

---

**Returns** Available heap size, in bytes.

uint32\_t **esp\_get\_free\_internal\_heap\_size** (void)

Get the size of available internal heap.

---

**Note:** Note that the returned value may be larger than the maximum contiguous block which can be allocated.

---

**Returns** Available internal heap size, in bytes.

uint32\_t **esp\_get\_minimum\_free\_heap\_size** (void)

Get the minimum heap that has ever been available.

**Returns** Minimum free heap ever available

void **esp\_system\_abort** (const char \*details)

Trigger a software abort.

**Parameters** **details** –Details that will be displayed during panic handling.

## Type Definitions

typedef void (\***shutdown\_handler\_t**)(void)

Shutdown handler type

## Enumerations

enum **esp\_reset\_reason\_t**

Reset reasons.

*Values:*

enumerator **ESP\_RST\_UNKNOWN**

Reset reason can not be determined.

enumerator **ESP\_RST\_POWERON**

Reset due to power-on event.

enumerator **ESP\_RST\_EXT**

Reset by external pin (not applicable for ESP32)

enumerator **ESP\_RST\_SW**

Software reset via esp\_restart.

enumerator **ESP\_RST\_PANIC**

Software reset due to exception/panic.

enumerator **ESP\_RST\_INT\_WDT**

Reset (software or hardware) due to interrupt watchdog.

enumerator **ESP\_RST\_TASK\_WDT**

Reset due to task watchdog.

enumerator **ESP\_RST\_WDT**

Reset due to other watchdogs.

enumerator **ESP\_RST\_DEEPSLEEP**

Reset after exiting deep sleep mode.

enumerator **ESP\_RST\_BROWNOUT**

Brownout reset (software or hardware)

enumerator **ESP\_RST\_SDIO**

Reset over SDIO.

### Header File

- [components/esp\\_common/include/esp\\_idf\\_version.h](#)

### Functions

const char \***esp\_get\_idf\_version** (void)

Return full IDF version string, same as ‘git describe’ output.

---

**Note:** If you are printing the ESP-IDF version in a log file or other information, this function provides more information than using the numerical version macros. For example, numerical version macros don't differentiate between development, pre-release and release versions, but the output of this function does.

---

**Returns** constant string from IDF\_VER

### Macros

**ESP\_IDF\_VERSION\_MAJOR**

Major version number (X.x.x)

**ESP\_IDF\_VERSION\_MINOR**

Minor version number (x.X.x)

**ESP\_IDF\_VERSION\_PATCH**

Patch version number (x.x.X)

**ESP\_IDF\_VERSION\_VAL** (major, minor, patch)

Macro to convert IDF version number into an integer

To be used in comparisons, such as `ESP_IDF_VERSION >= ESP_IDF_VERSION_VAL(4, 0, 0)`

**ESP\_IDF\_VERSION**

Current IDF version, as an integer

To be used in comparisons, such as `ESP_IDF_VERSION >= ESP_IDF_VERSION_VAL(4, 0, 0)`

**Header File**

- [components/esp\\_hw\\_support/include/esp\\_mac.h](#)

**Functions***esp\_err\_t* **esp\_base\_mac\_addr\_set** (const uint8\_t \*mac)

Set base MAC address with the MAC address which is stored in BLK3 of EFUSE or external storage e.g. flash and EEPROM.

Base MAC address is used to generate the MAC addresses used by network interfaces.

If using a custom base MAC address, call this API before initializing any network interfaces. Refer to the ESP-IDF Programming Guide for details about how the Base MAC is used.

---

**Note:** Base MAC must be a unicast MAC (least significant bit of first byte must be zero).

---

---

**Note:** If not using a valid OUI, set the “locally administered” bit (bit value 0x02 in the first byte) to avoid collisions.

---

**Parameters** **mac** –base MAC address, length: 6 bytes/8 bytes. length: 6 bytes for MAC-48 8 bytes for EUI-64(used for IEEE 802.15.4)

**Returns** ESP\_OK on success ESP\_ERR\_INVALID\_ARG If mac is NULL or is not a unicast MAC

*esp\_err\_t* **esp\_base\_mac\_addr\_get** (uint8\_t \*mac)

Return base MAC address which is set using `esp_base_mac_addr_set`.

---

**Note:** If no custom Base MAC has been set, this returns the pre-programmed Espressif base MAC address.

---

**Parameters** **mac** –base MAC address, length: 6 bytes/8 bytes. length: 6 bytes for MAC-48 8 bytes for EUI-64(used for IEEE 802.15.4)

**Returns** ESP\_OK on success ESP\_ERR\_INVALID\_ARG **mac** is NULL  
ESP\_ERR\_INVALID\_MAC base MAC address has not been set

*esp\_err\_t* **esp\_efuse\_mac\_get\_custom** (uint8\_t \*mac)

Return base MAC address which was previously written to BLK3 of EFUSE.

Base MAC address is used to generate the MAC addresses used by the networking interfaces. This API returns the custom base MAC address which was previously written to EFUSE BLK3 in a specified format.

Writing this EFUSE allows setting of a different (non-Espressif) base MAC address. It is also possible to store a custom base MAC address elsewhere, see `esp_base_mac_addr_set()` for details.

---

**Note:** This function is currently only supported on ESP32.

---

**Parameters** `mac` –base MAC address, length: 6 bytes/8 bytes. length: 6 bytes for MAC-48 8 bytes for EUI-64(used for IEEE 802.15.4)

**Returns** `ESP_OK` on success `ESP_ERR_INVALID_ARG` `mac` is `NULL` `ESP_ERR_INVALID_MAC` `CUSTOM_MAC` address has not been set, all zeros (for esp32-xx) `ESP_ERR_INVALID_VERSION` An invalid MAC version field was read from BLK3 of EFUSE (for esp32) `ESP_ERR_INVALID_CRC` An invalid MAC CRC was read from BLK3 of EFUSE (for esp32)

*esp\_err\_t* `esp_efuse_mac_get_default` (`uint8_t *mac`)

Return base MAC address which is factory-programmed by Espressif in EFUSE.

**Parameters** `mac` –base MAC address, length: 6 bytes/8 bytes. length: 6 bytes for MAC-48 8 bytes for EUI-64(used for IEEE 802.15.4)

**Returns** `ESP_OK` on success `ESP_ERR_INVALID_ARG` `mac` is `NULL`

*esp\_err\_t* `esp_read_mac` (`uint8_t *mac`, `esp_mac_type_t` `type`)

Read base MAC address and set MAC address of the interface.

This function first get base MAC address using `esp_base_mac_addr_get()`. Then calculates the MAC address of the specific interface requested, refer to ESP-IDF Programming Guide for the algorithm.

**Parameters**

- `mac` –base MAC address, length: 6 bytes/8 bytes. length: 6 bytes for MAC-48 8 bytes for EUI-64(used for IEEE 802.15.4)
- `type` –Type of MAC address to return

**Returns** `ESP_OK` on success

*esp\_err\_t* `esp_derive_local_mac` (`uint8_t *local_mac`, `const uint8_t *universal_mac`)

Derive local MAC address from universal MAC address.

This function copies a universal MAC address and then sets the “locally administered” bit (bit 0x2) in the first octet, creating a locally administered MAC address.

If the universal MAC address argument is already a locally administered MAC address, then the first octet is XORed with 0x4 in order to create a different locally administered MAC address.

**Parameters**

- `local_mac` –base MAC address, length: 6 bytes/8 bytes. length: 6 bytes for MAC-48 8 bytes for EUI-64(used for IEEE 802.15.4)
- `universal_mac` –Source universal MAC address, length: 6 bytes.

**Returns** `ESP_OK` on success

## Macros

`MAC2STR` (a)

`MACSTR`

## Enumerations

enum `esp_mac_type_t`

Values:



enumerator **ESP\_MAC\_WIFI\_STA**

enumerator **ESP\_MAC\_WIFI\_SOFTAP**

enumerator **ESP\_MAC\_BT**

enumerator **ESP\_MAC\_ETH**

enumerator **ESP\_MAC\_IEEE802154**

### Header File

- [components/esp\\_hw\\_support/include/esp\\_chip\\_info.h](#)

### Functions

void **esp\_chip\_info** (*esp\_chip\_info\_t* \*out\_info)

Fill an *esp\_chip\_info\_t* structure with information about the chip.

**Parameters** *out\_info* –[out] structure to be filled

### Structures

struct **esp\_chip\_info\_t**

The structure represents information about the chip.

### Public Members

*esp\_chip\_model\_t* **model**

chip model, one of *esp\_chip\_model\_t*

uint32\_t **features**

bit mask of *CHIP\_FEATURE\_x* feature flags

uint16\_t **revision**

chip revision number (in format MXX; where M - wafer major version, XX - wafer minor version)

uint8\_t **cores**

number of CPU cores

### Macros

**CHIP\_FEATURE\_EMB\_FLASH**

Chip has embedded flash memory.

**CHIP\_FEATURE\_WIFI\_BGN**

Chip has 2.4GHz WiFi.

**CHIP\_FEATURE\_BLE**

Chip has Bluetooth LE.

#### **CHIP\_FEATURE\_BT**

Chip has Bluetooth Classic.

#### **CHIP\_FEATURE\_IEEE802154**

Chip has IEEE 802.15.4.

#### **CHIP\_FEATURE\_EMB\_PSRAM**

Chip has embedded psram.

### **Enumerations**

enum **esp\_chip\_model\_t**

Chip models.

*Values:*

enumerator **CHIP\_ESP32**

ESP32.

enumerator **CHIP\_ESP32S2**

ESP32-S2.

enumerator **CHIP\_ESP32S3**

ESP32-S3.

enumerator **CHIP\_ESP32C3**

ESP32-C3.

enumerator **CHIP\_ESP32H2**

ESP32-H2.

enumerator **CHIP\_ESP32C2**

ESP32-C2.

### **Header File**

- [components/esp\\_hw\\_support/include/esp\\_cpu.h](#)

### **Functions**

void **esp\_cpu\_stall** (int core\_id)

Stall a CPU core.

**Parameters** **core\_id** –The core' s ID

void **esp\_cpu\_unstall** (int core\_id)

Resume a previously stalled CPU core.

**Parameters** **core\_id** –The core' s ID

void **esp\_cpu\_reset** (int core\_id)

Reset a CPU core.

**Parameters** **core\_id** –The core' s ID

void **esp\_cpu\_wait\_for\_intr** (void)

Wait for Interrupt.

This function causes the current CPU core to execute its Wait For Interrupt (WFI or equivalent) instruction. After executing this function, the CPU core will stop execution until an interrupt occurs.

int **esp\_cpu\_get\_core\_id** (void)

Get the current core' s ID.

This function will return the ID of the current CPU (i.e., the CPU that calls this function).

**Returns** The current core' s ID [0..SOC\_CPU\_CORES\_NUM - 1]

void **\*esp\_cpu\_get\_sp** (void)

Read the current stack pointer address.

**Returns** Stack pointer address

*esp\_cpu\_cycle\_count\_t* **esp\_cpu\_get\_cycle\_count** (void)

Get the current CPU core' s cycle count.

Each CPU core maintains an internal counter (i.e., cycle count) that increments every CPU clock cycle.

**Returns** Current CPU' s cycle count, 0 if not supported.

void **esp\_cpu\_set\_cycle\_count** (*esp\_cpu\_cycle\_count\_t* cycle\_count)

Set the current CPU core' s cycle count.

Set the given value into the internal counter that increments every CPU clock cycle.

**Parameters** **cycle\_count** –CPU cycle count

void **\*esp\_cpu\_pc\_to\_addr** (uint32\_t pc)

Convert a program counter (PC) value to address.

If the architecture does not store the true virtual address in the CPU' s PC or return addresses, this function will convert the PC value to a virtual address. Otherwise, the PC is just returned

**Parameters** **pc** –PC value

**Returns** Virtual address

void **esp\_cpu\_intr\_get\_desc** (int core\_id, int intr\_num, *esp\_cpu\_intr\_desc\_t* \*intr\_desc\_ret)

Get a CPU interrupt' s descriptor.

Each CPU interrupt has a descriptor describing the interrupt' s capabilities and restrictions. This function gets the descriptor of a particular interrupt on a particular CPU.

**Parameters**

- **core\_id** –[in] The core' s ID
- **intr\_num** –[in] Interrupt number
- **intr\_desc\_ret** –[out] The interrupt' s descriptor

void **esp\_cpu\_intr\_set\_ivt\_addr** (const void \*ivt\_addr)

Set the base address of the current CPU' s Interrupt Vector Table (IVT)

**Parameters** **ivt\_addr** –Interrupt Vector Table' s base address

bool **esp\_cpu\_intr\_has\_handler** (int intr\_num)

Check if a particular interrupt already has a handler function.

Check if a particular interrupt on the current CPU already has a handler function assigned.

---

**Note:** This function simply checks if the IVT of the current CPU already has a handler assigned.

---

**Parameters** **intr\_num** –Interrupt number (from 0 to 31)

**Returns** True if the interrupt has a handler function, false otherwise.

void **esp\_cpu\_intr\_set\_handler** (int intr\_num, *esp\_cpu\_intr\_handler\_t* handler, void \*handler\_arg)

Set the handler function of a particular interrupt.

Assign a handler function (i.e., ISR) to a particular interrupt on the current CPU.

---

**Note:** This function simply sets the handler function (in the IVT) and does not actually enable the interrupt.

---

**Parameters**

- **intr\_num** –Interrupt number (from 0 to 31)
- **handler** –Handler function
- **handler\_arg** –Argument passed to the handler function

void \***esp\_cpu\_intr\_get\_handler\_arg** (int intr\_num)

Get a handler function's argument of.

Get the argument of a previously assigned handler function on the current CPU.

**Parameters** **intr\_num** –Interrupt number (from 0 to 31)

**Returns** The the argument passed to the handler function

void **esp\_cpu\_intr\_enable** (uint32\_t intr\_mask)

Enable particular interrupts on the current CPU.

**Parameters** **intr\_mask** –Bit mask of the interrupts to enable

void **esp\_cpu\_intr\_disable** (uint32\_t intr\_mask)

Disable particular interrupts on the current CPU.

**Parameters** **intr\_mask** –Bit mask of the interrupts to disable

uint32\_t **esp\_cpu\_intr\_get\_enabled\_mask** (void)

Get the enabled interrupts on the current CPU.

**Returns** Bit mask of the enabled interrupts

void **esp\_cpu\_intr\_edge\_ack** (int intr\_num)

Acknowledge an edge interrupt.

**Parameters** **intr\_num** –Interrupt number (from 0 to 31)

void **esp\_cpu\_configure\_region\_protection** (void)

Configure the CPU to disable access to invalid memory regions.

*esp\_err\_t* **esp\_cpu\_set\_breakpoint** (int bp\_num, const void \*bp\_addr)

Set and enable a hardware breakpoint on the current CPU.

---

**Note:** This function is meant to be called by the panic handler to set a breakpoint for an attached debugger during a panic.

---

---

**Note:** Overwrites previously set breakpoint with same breakpoint number.

---

**Parameters**

- **bp\_num** –Hardware breakpoint number [0..SOC\_CPU\_BREAKPOINTS\_NUM - 1]
- **bp\_addr** –Address to set a breakpoint on

**Returns** ESP\_OK if breakpoint is set. Failure otherwise

*esp\_err\_t* **esp\_cpu\_clear\_breakpoint** (int bp\_num)

Clear a hardware breakpoint on the current CPU.

---

**Note:** Clears a breakpoint regardless of whether it was previously set

---

**Parameters** **bp\_num** –Hardware breakpoint number [0..SOC\_CPU\_BREAKPOINTS\_NUM - 1]

**Returns** ESP\_OK if breakpoint is cleared. Failure otherwise

*esp\_err\_t* **esp\_cpu\_set\_watchpoint** (int wp\_num, const void \*wp\_addr, size\_t size, *esp\_cpu\_watchpoint\_trigger\_t* trigger)

Set and enable a hardware watchpoint on the current CPU.

Set and enable a hardware watchpoint on the current CPU, specifying the memory range and trigger operation. Watchpoints will break/panic the CPU when the CPU accesses (according to the trigger type) on a certain memory range.

---

**Note:** Overwrites previously set watchpoint with same watchpoint number. On RISC-V chips, this API uses method0(Exact matching) and method1(NAPOT matching) according to the riscv-debug-spec-0.13 specification for address matching. If the watch region size is 1byte, it uses exact matching (method 0). If the watch region size is larger than 1byte, it uses NAPOT matching (method 1). This mode requires the watching region start address to be aligned to the watching region size.

---

**Parameters**

- **wp\_num** –Hardware watchpoint number [0..SOC\_CPU\_WATCHPOINTS\_NUM - 1]
- **wp\_addr** –Watchpoint’s base address, must be naturally aligned to the size of the region
- **size** –Size of the region to watch. Must be one of  $2^n$  and in the range of [1 .. SOC\_CPU\_WATCHPOINT\_MAX\_REGION\_SIZE]
- **trigger** –Trigger type

**Returns** ESP\_ERR\_INVALID\_ARG on invalid arg, ESP\_OK otherwise

*esp\_err\_t* **esp\_cpu\_clear\_watchpoint** (int wp\_num)

Clear a hardware watchpoint on the current CPU.

---

**Note:** Clears a watchpoint regardless of whether it was previously set

---

**Parameters** **wp\_num** –Hardware watchpoint number [0..SOC\_CPU\_WATCHPOINTS\_NUM - 1]

**Returns** ESP\_OK if watchpoint was cleared. Failure otherwise.

bool **esp\_cpu\_dbgr\_is\_attached** (void)

Check if the current CPU has a debugger attached.

**Returns** True if debugger is attached, false otherwise

void **esp\_cpu\_dbgr\_break** (void)

Trigger a call to the current CPU’s attached debugger.

intptr\_t **esp\_cpu\_get\_call\_addr** (intptr\_t return\_address)

Given the return address, calculate the address of the preceding call instruction This is typically used to answer the question “where was the function called from?” .

**Parameters** **return\_address** –The value of the return address register. Typically set to the value of `__builtin_return_address(0)`.

**Returns** Address of the call instruction preceding the return address.

bool **esp\_cpu\_compare\_and\_set** (volatile uint32\_t \*addr, uint32\_t compare\_value, uint32\_t new\_value)  
Atomic compare-and-set operation.

#### Parameters

- **addr** –Address of atomic variable
- **compare\_value** –Value to compare the atomic variable to
- **new\_value** –New value to set the atomic variable to

**Returns** Whether the atomic variable was set or not

### Structures

struct **esp\_cpu\_intr\_desc\_t**

CPU interrupt descriptor.

Each particular CPU interrupt has an associated descriptor describing that particular interrupt's characteristics. Call `esp_cpu_intr_get_desc()` to get the descriptors of a particular interrupt.

#### Public Members

int **priority**

Priority of the interrupt if it has a fixed priority, (-1) if the priority is configurable.

*esp\_cpu\_intr\_type\_t* **type**

Whether the interrupt is an edge or level type interrupt, `ESP_CPU_INTR_TYPE_NA` if the type is configurable.

uint32\_t **flags**

Flags indicating extra details.

### Macros

**ESP\_CPU\_INTR\_DESC\_FLAG\_SPECIAL**

Interrupt descriptor flags of *esp\_cpu\_intr\_desc\_t*.

The interrupt is a special interrupt (e.g., a CPU timer interrupt)

**ESP\_CPU\_INTR\_DESC\_FLAG\_RESVD**

The interrupt is reserved for internal use

### Type Definitions

typedef uint32\_t **esp\_cpu\_cycle\_count\_t**

CPU cycle count type.

This data type represents the CPU's clock cycle count

typedef void (\***esp\_cpu\_intr\_handler\_t**)(void \*arg)

CPU interrupt handler type.

### Enumerations

enum **esp\_cpu\_intr\_type\_t**

CPU interrupt type.

*Values:*

enumerator **ESP\_CPU\_INTR\_TYPE\_LEVEL**

enumerator **ESP\_CPU\_INTR\_TYPE\_EDGE**

enumerator **ESP\_CPU\_INTR\_TYPE\_NA**

enum **esp\_cpu\_watchpoint\_trigger\_t**

CPU watchpoint trigger type.

*Values:*

enumerator **ESP\_CPU\_WATCHPOINT\_LOAD**

enumerator **ESP\_CPU\_WATCHPOINT\_STORE**

enumerator **ESP\_CPU\_WATCHPOINT\_ACCESS**

### Header File

- [components/esp\\_app\\_format/include/esp\\_app\\_desc.h](#)

### Functions

const *esp\_app\_desc\_t* \***esp\_app\_get\_description** (void)

Return esp\_app\_desc structure. This structure includes app version.

Return description for running app.

**Returns** Pointer to esp\_app\_desc structure.

int **esp\_app\_get\_elf\_sha256** (char \*dst, size\_t size)

Fill the provided buffer with SHA256 of the ELF file, formatted as hexadecimal, null-terminated. If the buffer size is not sufficient to fit the entire SHA256 in hex plus a null terminator, the largest possible number of bytes will be written followed by a null.

#### Parameters

- **dst** –Destination buffer
- **size** –Size of the buffer

**Returns** Number of bytes written to dst (including null terminator)

### Structures

struct **esp\_app\_desc\_t**

Description about application.

### Public Members

uint32\_t **magic\_word**

Magic word ESP\_APP\_DESC\_MAGIC\_WORD

uint32\_t **secure\_version**

Secure version

uint32\_t **reserv1**[2]  
reserv1

char **version**[32]  
Application version

char **project\_name**[32]  
Project name

char **time**[16]  
Compile time

char **date**[16]  
Compile date

char **idf\_ver**[32]  
Version IDF

uint8\_t **app\_elf\_sha256**[32]  
sha256 of elf file

uint32\_t **reserv2**[20]  
reserv2

## Macros

### ESP\_APP\_DESC\_MAGIC\_WORD

The magic word for the esp\_app\_desc structure that is in DROM.

## 2.9.20 Over The Air Updates (OTA)

### OTA Process Overview

The OTA update mechanism allows a device to update itself based on data received while the normal firmware is running (for example, over Wi-Fi or Bluetooth.)

OTA requires configuring the *Partition Table* of the device with at least two “OTA app slot” partitions (i.e. *ota\_0* and *ota\_1*) and an “OTA Data Partition” .

The OTA operation functions write a new app firmware image to whichever OTA app slot that is currently not selected for booting. Once the image is verified, the OTA Data partition is updated to specify that this image should be used for the next boot.

### OTA Data Partition

An OTA data partition (type `data`, subtype `ota`) must be included in the *Partition Table* of any project which uses the OTA functions.



For factory boot settings, the OTA data partition should contain no data (all bytes erased to 0xFF). In this case the esp-idf software bootloader will boot the factory app if it is present in the partition table. If no factory app is included in the partition table, the first available OTA slot (usually `ota_0`) is booted.

After the first OTA update, the OTA data partition is updated to specify which OTA app slot partition should be booted next.

The OTA data partition is two flash sectors (0x2000 bytes) in size, to prevent problems if there is a power failure while it is being written. Sectors are independently erased and written with matching data, and if they disagree a counter field is used to determine which sector was written more recently.

### App rollback

The main purpose of the application rollback is to keep the device working after the update. This feature allows you to roll back to the previous working application in case a new application has critical errors. When the rollback process is enabled and an OTA update provides a new version of the app, one of three things can happen:

- The application works fine, `esp_ota_mark_app_valid_cancel_rollback()` marks the running application with the state `ESP_OTA_IMG_VALID`. There are no restrictions on booting this application.
- The application has critical errors and further work is not possible, a rollback to the previous application is required, `esp_ota_mark_app_invalid_rollback_and_reboot()` marks the running application with the state `ESP_OTA_IMG_INVALID` and reset. This application will not be selected by the bootloader for boot and will boot the previously working application.
- If the `CONFIG_BOOTLOADER_APP_ROLLBACK_ENABLE` option is set, and a reset occurs without calling either function then the application is rolled back.

**Note:** The state is not written to the binary image of the application but rather to the `otadata` partition. The partition contains a `ota_seq` counter which is a pointer to the slot (`ota_0`, `ota_1`, ...) from which the application will be selected for boot.

**App OTA State** States control the process of selecting a boot app:

States	Restriction of selecting a boot app in bootloader
<code>ESP_OTA_IMG_VALID</code>	None restriction. Will be selected.
<code>ESP_OTA_IMG_UNDEFINED</code>	None restriction. Will be selected.
<code>ESP_OTA_IMG_INVALID</code>	Will not be selected.
<code>ESP_OTA_IMG_ABORTED</code>	Will not be selected.
<code>ESP_OTA_IMG_NEW</code>	If <code>CONFIG_BOOTLOADER_APP_ROLLBACK_ENABLE</code> option is set it will be selected only once. In bootloader the state immediately changes to <code>ESP_OTA_IMG_PENDING_VERIFY</code> .
<code>ESP_OTA_IMG_PENDING_VERIFY</code>	If <code>CONFIG_BOOTLOADER_APP_ROLLBACK_ENABLE</code> option is set it will not be selected, and the state will change to <code>ESP_OTA_IMG_ABORTED</code> .

If `CONFIG_BOOTLOADER_APP_ROLLBACK_ENABLE` option is not enabled (by default), then the use of the following functions `esp_ota_mark_app_valid_cancel_rollback()` and `esp_ota_mark_app_invalid_rollback_and_reboot()` are optional, and `ESP_OTA_IMG_NEW` and `ESP_OTA_IMG_PENDING_VERIFY` states are not used.

An option in Kconfig `CONFIG_BOOTLOADER_APP_ROLLBACK_ENABLE` allows you to track the first boot of a new application. In this case, the application must confirm its operability by calling `esp_ota_mark_app_valid_cancel_rollback()` function, otherwise the application will be rolled back upon reboot. It allows you to control the operability of the application during the boot phase. Thus, a new application has only one attempt to boot successfully.

**Rollback Process** The description of the rollback process when `CONFIG_BOOTLOADER_APP_ROLLBACK_ENABLE` option is enabled:

- The new application is successfully downloaded and `esp_ota_set_boot_partition()` function makes this partition bootable and sets the state `ESP_OTA_IMG_NEW`. This state means that the application is new and should be monitored for its first boot.
- Reboot `esp_restart()`.
- The bootloader checks for the `ESP_OTA_IMG_PENDING_VERIFY` state if it is set, then it will be written to `ESP_OTA_IMG_ABORTED`.
- The bootloader selects a new application to boot so that the state is not set as `ESP_OTA_IMG_INVALID` or `ESP_OTA_IMG_ABORTED`.
- The bootloader checks the selected application for `ESP_OTA_IMG_NEW` state if it is set, then it will be written to `ESP_OTA_IMG_PENDING_VERIFY`. This state means that the application requires confirmation of its operability, if this does not happen and a reboot occurs, this state will be overwritten to `ESP_OTA_IMG_ABORTED` (see above) and this application will no longer be able to start, i.e. there will be a rollback to the previous working application.
- A new application has started and should make a self-test.
- If the self-test has completed successfully, then you must call the function `esp_ota_mark_app_valid_cancel_rollback()` because the application is awaiting confirmation of operability (`ESP_OTA_IMG_PENDING_VERIFY` state).
- If the self-test fails then call `esp_ota_mark_app_invalid_rollback_and_reboot()` function to roll back to the previous working application, while the invalid application is set `ESP_OTA_IMG_INVALID` state.
- If the application has not been confirmed, the state remains `ESP_OTA_IMG_PENDING_VERIFY`, and the next boot it will be changed to `ESP_OTA_IMG_ABORTED`. That will prevent re-boot of this application. There will be a rollback to the previous working application.

**Unexpected Reset** If a power loss or an unexpected crash occurs at the time of the first boot of a new application, it will roll back the application.

Recommendation: Perform the self-test procedure as quickly as possible, to prevent rollback due to power loss.

Only OTA partitions can be rolled back. Factory partition is not rolled back.

**Booting invalid/aborted apps** Booting an application which was previously set to `ESP_OTA_IMG_INVALID` or `ESP_OTA_IMG_ABORTED` is possible:

- Get the last invalid application partition `esp_ota_get_last_invalid_partition()`.
- Pass the received partition to `esp_ota_set_boot_partition()`, this will update the otadata.
- Restart `esp_restart()`. The bootloader will boot the specified application.

To determine if self-tests should be run during startup of an application, call the `esp_ota_get_state_partition()` function. If result is `ESP_OTA_IMG_PENDING_VERIFY` then self-testing and subsequent confirmation of operability is required.

**Where the states are set** A brief description of where the states are set:

- `ESP_OTA_IMG_VALID` state is set by `esp_ota_mark_app_valid_cancel_rollback()` function.
- `ESP_OTA_IMG_UNDEFINED` state is set by `esp_ota_set_boot_partition()` function if `CONFIG_BOOTLOADER_APP_ROLLBACK_ENABLE` option is not enabled.
- `ESP_OTA_IMG_NEW` state is set by `esp_ota_set_boot_partition()` function if `CONFIG_BOOTLOADER_APP_ROLLBACK_ENABLE` option is enabled.
- `ESP_OTA_IMG_INVALID` state is set by `esp_ota_mark_app_invalid_rollback_and_reboot()` function.
- `ESP_OTA_IMG_ABORTED` state is set if there was no confirmation of the application operability and occurs reboots (if `CONFIG_BOOTLOADER_APP_ROLLBACK_ENABLE` option is enabled).
- `ESP_OTA_IMG_PENDING_VERIFY` state is set in a bootloader if `CONFIG_BOOTLOADER_APP_ROLLBACK_ENABLE` option is enabled and selected app has `ESP_OTA_IMG_NEW` state.

## Anti-rollback

Anti-rollback prevents rollback to application with security version lower than one programmed in eFuse of chip.

This function works if set `CONFIG_BOOTLOADER_APP_ANTI_ROLLBACK` option. In the bootloader, when selecting a bootable application, an additional security version check is added which is on the chip and in the application image. The version in the bootable firmware must be greater than or equal to the version in the chip.

`CONFIG_BOOTLOADER_APP_ANTI_ROLLBACK` and `CONFIG_BOOTLOADER_APP_ROLLBACK_ENABLE` options are used together. In this case, rollback is possible only on the security version which is equal or higher than the version in the chip.

### A typical anti-rollback scheme is

- New firmware released with the elimination of vulnerabilities with the previous version of security.
- After the developer makes sure that this firmware is working. He can increase the security version and release a new firmware.
- Download new application.
- To make it bootable, run the function `esp_ota_set_boot_partition()`. If the security version of the new application is smaller than the version in the chip, the new application will be erased. Update to new firmware is not possible.
- Reboot.
- In the bootloader, an application with a security version greater than or equal to the version in the chip will be selected. If otadata is in the initial state, and one firmware was loaded via a serial channel, whose secure version is higher than the chip, then the secure version of efuse will be immediately updated in the bootloader.
- New application booted. Then the application should perform diagnostics of the operation and if it is completed successfully, you should call `esp_ota_mark_app_valid_cancel_rollback()` function to mark the running application with the `ESP_OTA_IMG_VALID` state and update the secure version on chip. Note that if was called `esp_ota_mark_app_invalid_rollback_and_reboot()` function a rollback may not happen as the device may not have any bootable apps. It will then return `ESP_ERR_OTA_ROLLBACK_FAILED` error and stay in the `ESP_OTA_IMG_PENDING_VERIFY` state.
- The next update of app is possible if a running app is in the `ESP_OTA_IMG_VALID` state.

Recommendation:

If you want to avoid the download/erase overhead in case of the app from the server has security version lower than the running app, you have to get `new_app_info.secure_version` from the first package of an image and compare it with the secure version of efuse. Use `esp_efuse_check_secure_version(new_app_info.secure_version)` function if it is true then continue downloading otherwise abort.

```

....
bool image_header_was_checked = false;
while (1) {
    int data_read = esp_http_client_read(client, ota_write_data, BUFSIZE);
    ...
    if (data_read > 0) {
        if (image_header_was_checked == false) {
            esp_app_desc_t new_app_info;
            if (data_read > sizeof(esp_image_header_t) + sizeof(esp_image_segment_
↪header_t) + sizeof(esp_app_desc_t)) {
                // check current version with downloading
                if (esp_efuse_check_secure_version(new_app_info.secure_version) ==
↪false) {
                    ESP_LOGE(TAG, "This a new app can not be downloaded due to a
↪secure version is lower than stored in efuse.");
                    http_cleanup(client);
                    task_fatal_error();
                }

                image_header_was_checked = true;
            }
        }
    }
}

```

(continues on next page)

(continued from previous page)

```

        esp_ota_begin(update_partition, OTA_SIZE_UNKNOWN, &update_handle);
    }
}
esp_ota_write( update_handle, (const void *)ota_write_data, data_read);
}
}
...

```

**Restrictions:**

- The number of bits in the `secure_version` field is limited to 16 bits. This means that only 16 times you can do an anti-rollback. You can reduce the length of this efuse field using [CONFIG\\_BOOTLOADER\\_APP\\_SEC\\_VER\\_SIZE\\_EFUSE\\_FIELD](#) option.
- Factory and Test partitions are not supported in anti rollback scheme and hence partition table should not have partition with SubType set to `factory` or `test`.

`security_version`:

- In application image it is stored in `esp_app_desc` structure. The number is set [CONFIG\\_BOOTLOADER\\_APP\\_SECURE\\_VERSION](#).

**Secure OTA Updates Without Secure boot**

The verification of signed OTA updates can be performed even without enabling hardware secure boot. This can be achieved by setting [CONFIG\\_SECURE\\_SIGNED\\_APPS\\_NO\\_SECURE\\_BOOT](#) and [CONFIG\\_SECURE\\_SIGNED\\_ON\\_UPDATE\\_NO\\_SECURE\\_BOOT](#)

**OTA Tool (otatool.py)**

The component `app_update` provides a tool [otatool.py](#) for performing OTA partition-related operations on a target device. The following operations can be performed using the tool:

- read contents of otadata partition (`read_otadata`)
- erase otadata partition, effectively resetting device to factory app (`erase_otadata`)
- switch OTA partitions (`switch_ota_partition`)
- erasing OTA partition (`erase_ota_partition`)
- write to OTA partition (`write_ota_partition`)
- read contents of OTA partition (`read_ota_partition`)

The tool can either be imported and used from another Python script or invoked from shell script for users wanting to perform operation programmatically. This is facilitated by the tool's Python API and command-line interface, respectively.

**Python API** Before anything else, make sure that the `otatool` module is imported.

```

import sys
import os

idf_path = os.environ["IDF_PATH"] # get value of IDF_PATH from environment
otatool_dir = os.path.join(idf_path, "components", "app_update") # otatool.py_
↳ lives in $IDF_PATH/components/app_update

sys.path.append(otatool_dir) # this enables Python to find otatool module
from otatool import * # import all names inside otatool module

```

The starting point for using the tool's Python API to do is create a `OtatoolTarget` object:

```
# Create a partool.py target device connected on serial port /dev/ttyUSB1
target = OtatoolTarget("/dev/ttyUSB1")
```

The created object can now be used to perform operations on the target device:

```
# Erase otadata, resetting the device to factory app
target.erase_otadata()

# Erase contents of OTA app slot 0
target.erase_ota_partition(0)

# Switch boot partition to that of app slot 1
target.switch_ota_partition(1)

# Read OTA partition 'ota_3' and save contents to a file named 'ota_3.bin'
target.read_ota_partition("ota_3", "ota_3.bin")
```

The OTA partition to operate on is specified using either the app slot number or the partition name.

More information on the Python API is available in the docstrings for the tool.

**Command-line Interface** The command-line interface of *otatool.py* has the following structure:

```
otatool.py [command-args] [subcommand] [subcommand-args]

- command-args - these are arguments that are needed for executing the main_
  ↳command (partool.py), mostly pertaining to the target device
- subcommand - this is the operation to be performed
- subcommand-args - these are arguments that are specific to the chosen operation
```

```
# Erase otadata, resetting the device to factory app
otatool.py --port "/dev/ttyUSB1" erase_otadata

# Erase contents of OTA app slot 0
otatool.py --port "/dev/ttyUSB1" erase_ota_partition --slot 0

# Switch boot partition to that of app slot 1
otatool.py --port "/dev/ttyUSB1" switch_ota_partition --slot 1

# Read OTA partition 'ota_3' and save contents to a file named 'ota_3.bin'
otatool.py --port "/dev/ttyUSB1" read_ota_partition --name=ota_3 --output=ota_3.bin
```

More information can be obtained by specifying *-help* as argument:

```
# Display possible subcommands and show main command argument descriptions
otatool.py --help

# Show descriptions for specific subcommand arguments
otatool.py [subcommand] --help
```

### See also

- [Partition Table documentation](#)
- [Lower-Level SPI Flash/Partition API](#)
- [ESP HTTPS OTA](#)

### Application Example

End-to-end example of OTA firmware update workflow: [system/ota](#).

## API Reference

### Header File

- `components/app_update/include/esp_ota_ops.h`

### Functions

const *esp\_app\_desc\_t* \***esp\_ota\_get\_app\_description** (void)

Return `esp_app_desc` structure. This structure includes app version.

Return description for running app.

---

**Note:** This API is present for backward compatibility reasons. Alternative function with the same functionality is `esp_app_get_description`

---

**Returns** Pointer to `esp_app_desc` structure.

int **esp\_ota\_get\_app\_elf\_sha256** (char \*dst, size\_t size)

Fill the provided buffer with SHA256 of the ELF file, formatted as hexadecimal, null-terminated. If the buffer size is not sufficient to fit the entire SHA256 in hex plus a null terminator, the largest possible number of bytes will be written followed by a null.

---

**Note:** This API is present for backward compatibility reasons. Alternative function with the same functionality is `esp_app_get_elf_sha256`

---

#### Parameters

- **dst** –Destination buffer
- **size** –Size of the buffer

**Returns** Number of bytes written to `dst` (including null terminator)

*esp\_err\_t* **esp\_ota\_begin** (const *esp\_partition\_t* \*partition, size\_t image\_size, *esp\_ota\_handle\_t* \*out\_handle)

Commence an OTA update writing to the specified partition.

The specified partition is erased to the specified image size.

If image size is not yet known, pass `OTA_SIZE_UNKNOWN` which will cause the entire partition to be erased.

On success, this function allocates memory that remains in use until `esp_ota_end()` is called with the returned handle.

Note: If the rollback option is enabled and the running application has the `ESP_OTA_IMG_PENDING_VERIFY` state then it will lead to the `ESP_ERR_OTA_ROLLBACK_INVALID_STATE` error. Confirm the running app before to run download a new app, use `esp_ota_mark_app_valid_cancel_rollback()` function for it (this should be done as early as possible when you first download a new application).

#### Parameters

- **partition** –Pointer to info for partition which will receive the OTA update. Required.
- **image\_size** –Size of new OTA app image. Partition will be erased in order to receive this size of image. If 0 or `OTA_SIZE_UNKNOWN`, the entire partition is erased.
- **out\_handle** –On success, returns a handle which should be used for subsequent `esp_ota_write()` and `esp_ota_end()` calls.

#### Returns

- `ESP_OK`: OTA operation commenced successfully.
- `ESP_ERR_INVALID_ARG`: `partition` or `out_handle` arguments were `NULL`, or `partition` doesn't point to an OTA app partition.

- `ESP_ERR_NO_MEM`: Cannot allocate memory for OTA operation.
- `ESP_ERR_OTA_PARTITION_CONFLICT`: Partition holds the currently running firmware, cannot update in place.
- `ESP_ERR_NOT_FOUND`: Partition argument not found in partition table.
- `ESP_ERR_OTA_SELECT_INFO_INVALID`: The OTA data partition contains invalid data.
- `ESP_ERR_INVALID_SIZE`: Partition doesn't fit in configured flash size.
- `ESP_ERR_FLASH_OP_TIMEOUT` or `ESP_ERR_FLASH_OP_FAIL`: Flash write failed.
- `ESP_ERR_OTA_ROLLBACK_INVALID_STATE`: If the running app has not confirmed state. Before performing an update, the application must be valid.

*esp\_err\_t* `esp_ota_write` (*esp\_ota\_handle\_t* handle, const void \*data, size\_t size)

Write OTA update data to partition.

This function can be called multiple times as data is received during the OTA operation. Data is written sequentially to the partition.

#### Parameters

- **handle** –Handle obtained from `esp_ota_begin`
- **data** –Data buffer to write
- **size** –Size of data buffer in bytes.

#### Returns

- `ESP_OK`: Data was written to flash successfully, or size = 0
- `ESP_ERR_INVALID_ARG`: handle is invalid.
- `ESP_ERR_OTA_VALIDATE_FAILED`: First byte of image contains invalid app image magic byte.
- `ESP_ERR_FLASH_OP_TIMEOUT` or `ESP_ERR_FLASH_OP_FAIL`: Flash write failed.
- `ESP_ERR_OTA_SELECT_INFO_INVALID`: OTA data partition has invalid contents

*esp\_err\_t* `esp_ota_write_with_offset` (*esp\_ota\_handle\_t* handle, const void \*data, size\_t size, uint32\_t offset)

Write OTA update data to partition at an offset.

This function can write data in non-contiguous manner. If flash encryption is enabled, data should be 16 bytes aligned.

---

**Note:** While performing OTA, if the packets arrive out of order, `esp_ota_write_with_offset()` can be used to write data in non-contiguous manner. Use of `esp_ota_write_with_offset()` in combination with `esp_ota_write()` is not recommended.

---

#### Parameters

- **handle** –Handle obtained from `esp_ota_begin`
- **data** –Data buffer to write
- **size** –Size of data buffer in bytes
- **offset** –Offset in flash partition

#### Returns

- `ESP_OK`: Data was written to flash successfully.
- `ESP_ERR_INVALID_ARG`: handle is invalid.
- `ESP_ERR_OTA_VALIDATE_FAILED`: First byte of image contains invalid app image magic byte.
- `ESP_ERR_FLASH_OP_TIMEOUT` or `ESP_ERR_FLASH_OP_FAIL`: Flash write failed.
- `ESP_ERR_OTA_SELECT_INFO_INVALID`: OTA data partition has invalid contents

*esp\_err\_t* `esp_ota_end` (*esp\_ota\_handle\_t* handle)

Finish OTA update and validate newly written app image.



---

**Note:** After calling `esp_ota_end()`, the handle is no longer valid and any memory associated with it is freed (regardless of result).

---

**Parameters** `handle` –Handle obtained from `esp_ota_begin()`.

**Returns**

- `ESP_OK`: Newly written OTA app image is valid.
- `ESP_ERR_NOT_FOUND`: OTA handle was not found.
- `ESP_ERR_INVALID_ARG`: Handle was never written to.
- `ESP_ERR_OTA_VALIDATE_FAILED`: OTA image is invalid (either not a valid app image, or - if secure boot is enabled - signature failed to verify.)
- `ESP_ERR_INVALID_STATE`: If flash encryption is enabled, this result indicates an internal error writing the final encrypted bytes to flash.

*esp\_err\_t* `esp_ota_abort` (*esp\_ota\_handle\_t* handle)

Abort OTA update, free the handle and memory associated with it.

**Parameters** `handle` –obtained from `esp_ota_begin()`.

**Returns**

- `ESP_OK`: Handle and its associated memory is freed successfully.
- `ESP_ERR_NOT_FOUND`: OTA handle was not found.

*esp\_err\_t* `esp_ota_set_boot_partition` (const *esp\_partition\_t* \*partition)

Configure OTA data for a new boot partition.

---

**Note:** If this function returns `ESP_OK`, calling `esp_restart()` will boot the newly configured app partition.

---

**Parameters** `partition` –Pointer to info for partition containing app image to boot.

**Returns**

- `ESP_OK`: OTA data updated, next reboot will use specified partition.
- `ESP_ERR_INVALID_ARG`: partition argument was NULL or didn't point to a valid OTA partition of type "app".
- `ESP_ERR_OTA_VALIDATE_FAILED`: Partition contained invalid app image. Also returned if secure boot is enabled and signature validation failed.
- `ESP_ERR_NOT_FOUND`: OTA data partition not found.
- `ESP_ERR_FLASH_OP_TIMEOUT` or `ESP_ERR_FLASH_OP_FAIL`: Flash erase or write failed.

const *esp\_partition\_t* \*`esp_ota_get_boot_partition` (void)

Get partition info of currently configured boot app.

If `esp_ota_set_boot_partition()` has been called, the partition which was set by that function will be returned.

If `esp_ota_set_boot_partition()` has not been called, the result is usually the same as `esp_ota_get_running_partition()`. The two results are not equal if the configured boot partition does not contain a valid app (meaning that the running partition will be an app that the bootloader chose via fallback).

If the OTA data partition is not present or not valid then the result is the first app partition found in the partition table. In priority order, this means: the factory app, the first OTA app slot, or the test app partition.

Note that there is no guarantee the returned partition is a valid app. Use `esp_image_verify(ESP_IMAGE_VERIFY, ...)` to verify if the returned partition contains a bootable image.

**Returns** Pointer to info for partition structure, or NULL if partition table is invalid or a flash read operation failed. Any returned pointer is valid for the lifetime of the application.



const *esp\_partition\_t* \***esp\_ota\_get\_running\_partition** (void)

Get partition info of currently running app.

This function is different to `esp_ota_get_boot_partition()` in that it ignores any change of selected boot partition caused by `esp_ota_set_boot_partition()`. Only the app whose code is currently running will have its partition information returned.

The partition returned by this function may also differ from `esp_ota_get_boot_partition()` if the configured boot partition is somehow invalid, and the bootloader fell back to a different app partition at boot.

**Returns** Pointer to info for partition structure, or NULL if no partition is found or flash read operation failed. Returned pointer is valid for the lifetime of the application.

const *esp\_partition\_t* \***esp\_ota\_get\_next\_update\_partition** (const *esp\_partition\_t* \*start\_from)

Return the next OTA app partition which should be written with a new firmware.

Call this function to find an OTA app partition which can be passed to `esp_ota_begin()`.

Finds next partition round-robin, starting from the current running partition.

**Parameters** **start\_from** –If set, treat this partition info as describing the current running partition. Can be NULL, in which case `esp_ota_get_running_partition()` is used to find the currently running partition. The result of this function is never the same as this argument.

**Returns** Pointer to info for partition which should be updated next. NULL result indicates invalid OTA data partition, or that no eligible OTA app slot partition was found.

*esp\_err\_t* **esp\_ota\_get\_partition\_description** (const *esp\_partition\_t* \*partition, *esp\_app\_desc\_t* \*app\_desc)

Returns `esp_app_desc` structure for app partition. This structure includes app version.

Returns a description for the requested app partition.

**Parameters**

- **partition** –[in] Pointer to app partition. (only app partition)
- **app\_desc** –[out] Structure of info about app.

**Returns**

- ESP\_OK Successful.
- ESP\_ERR\_NOT\_FOUND `app_desc` structure is not found. Magic word is incorrect.
- ESP\_ERR\_NOT\_SUPPORTED Partition is not application.
- ESP\_ERR\_INVALID\_ARG Arguments is NULL or if `partition`'s offset exceeds partition size.
- ESP\_ERR\_INVALID\_SIZE Read would go out of bounds of the partition.
- or one of error codes from lower-level flash driver.

uint8\_t **esp\_ota\_get\_app\_partition\_count** (void)

Returns number of ota partitions provided in partition table.

**Returns**

- Number of OTA partitions

*esp\_err\_t* **esp\_ota\_mark\_app\_valid\_cancel\_rollback** (void)

This function is called to indicate that the running app is working well.

**Returns**

- ESP\_OK: if successful.

*esp\_err\_t* **esp\_ota\_mark\_app\_invalid\_rollback\_and\_reboot** (void)

This function is called to roll back to the previously workable app with reboot.

If rollback is successful then device will reset else API will return with error code. Checks applications on a flash drive that can be booted in case of rollback. If the flash does not have at least one app (except the running app) then rollback is not possible.

**Returns**

- ESP\_FAIL: if not successful.

- `ESP_ERR_OTA_ROLLBACK_FAILED`: The rollback is not possible due to flash does not have any apps.

const *esp\_partition\_t* \*`esp_ota_get_last_invalid_partition` (void)

Returns last partition with invalid state (`ESP_OTA_IMG_INVALID` or `ESP_OTA_IMG_ABORTED`).

**Returns** partition.

*esp\_err\_t* `esp_ota_get_state_partition` (const *esp\_partition\_t* \*partition, *esp\_ota\_img\_states\_t* \*ota\_state)

Returns state for given partition.

**Parameters**

- **partition** –[in] Pointer to partition.
- **ota\_state** –[out] state of partition (if this partition has a record in otadata).

**Returns**

- `ESP_OK`: Successful.
- `ESP_ERR_INVALID_ARG`: partition or ota\_state arguments were NULL.
- `ESP_ERR_NOT_SUPPORTED`: partition is not ota.
- `ESP_ERR_NOT_FOUND`: Partition table does not have otadata or state was not found for given partition.

*esp\_err\_t* `esp_ota_erase_last_boot_app_partition` (void)

Erase previous boot app partition and corresponding otadata select for this partition.

When current app is marked to as valid then you can erase previous app partition.

**Returns**

- `ESP_OK`: Successful, otherwise `ESP_ERR`.

bool `esp_ota_check_rollback_is_possible` (void)

Checks applications on the slots which can be booted in case of rollback.

These applications should be valid (marked in otadata as not `UNDEFINED`, `INVALID` or `ABORTED` and crc is good) and be able booted, and `secure_version` of app  $\geq$  `secure_version` of efuse (if anti-rollback is enabled).

**Returns**

- True: Returns true if the slots have at least one app (except the running app).
- False: The rollback is not possible.

*esp\_err\_t* `esp_ota_revoke_secure_boot_public_key` (*esp\_ota\_secure\_boot\_public\_key\_index\_t* index)

Revokes the signature digest denoted by the given index. This should be called in the application only after the rollback logic otherwise the device may end up in unrecoverable state.

Relevant for Secure boot v2 on ESP32-S2, ESP32-S3, ESP32-C3, ESP32-C6, ESP32-H2 where up to 3 key digests can be stored (Key #N-1, Key #N, Key #N+1). When a key used to sign an app is invalidated, an OTA update is to be sent with an app signed with at least one of the other two keys which has not been revoked already. After successfully booting the OTA app should call this function to revoke Key #N-1.

**Parameters** **index** -- The index of the signature block to be revoked

**Returns**

- `ESP_OK`: If revocation is successful.
- `ESP_ERR_INVALID_ARG`: If the index of the public key to be revoked is incorrect.
- `ESP_FAIL`: If secure boot v2 has not been enabled.

## Macros

### `OTA_SIZE_UNKNOWN`

Used for `esp_ota_begin()` if new image size is unknown

**OTA\_WITH\_SEQUENTIAL\_WRITES**

Used for `esp_ota_begin()` if new image size is unknown and erase can be done in incremental manner (assuming write operation is in continuous sequence)

**ESP\_ERR\_OTA\_BASE**

Base error code for `ota_ops` api

**ESP\_ERR\_OTA\_PARTITION\_CONFLICT**

Error if request was to write or erase the current running partition

**ESP\_ERR\_OTA\_SELECT\_INFO\_INVALID**

Error if OTA data partition contains invalid content

**ESP\_ERR\_OTA\_VALIDATE\_FAILED**

Error if OTA app image is invalid

**ESP\_ERR\_OTA\_SMALL\_SEC\_VER**

Error if the firmware has a secure version less than the running firmware.

**ESP\_ERR\_OTA\_ROLLBACK\_FAILED**

Error if flash does not have valid firmware in passive partition and hence rollback is not possible

**ESP\_ERR\_OTA\_ROLLBACK\_INVALID\_STATE**

Error if current active firmware is still marked in pending validation state (`ESP_OTA_IMG_PENDING_VERIFY`), essentially first boot of firmware image post upgrade and hence firmware upgrade is not possible

**Type Definitions**

```
typedef uint32_t esp_ota_handle_t
```

Opaque handle for an application OTA update.

`esp_ota_begin()` returns a handle which is then used for subsequent calls to `esp_ota_write()` and `esp_ota_end()`.

**Enumerations**

```
enum esp_ota_secure_boot_public_key_index_t
```

Secure Boot V2 public key indexes.

*Values:*

```
enumerator SECURE_BOOT_PUBLIC_KEY_INDEX_0
```

Points to the 0th index of the Secure Boot v2 public key

```
enumerator SECURE_BOOT_PUBLIC_KEY_INDEX_1
```

Points to the 1st index of the Secure Boot v2 public key

```
enumerator SECURE_BOOT_PUBLIC_KEY_INDEX_2
```

Points to the 2nd index of the Secure Boot v2 public key

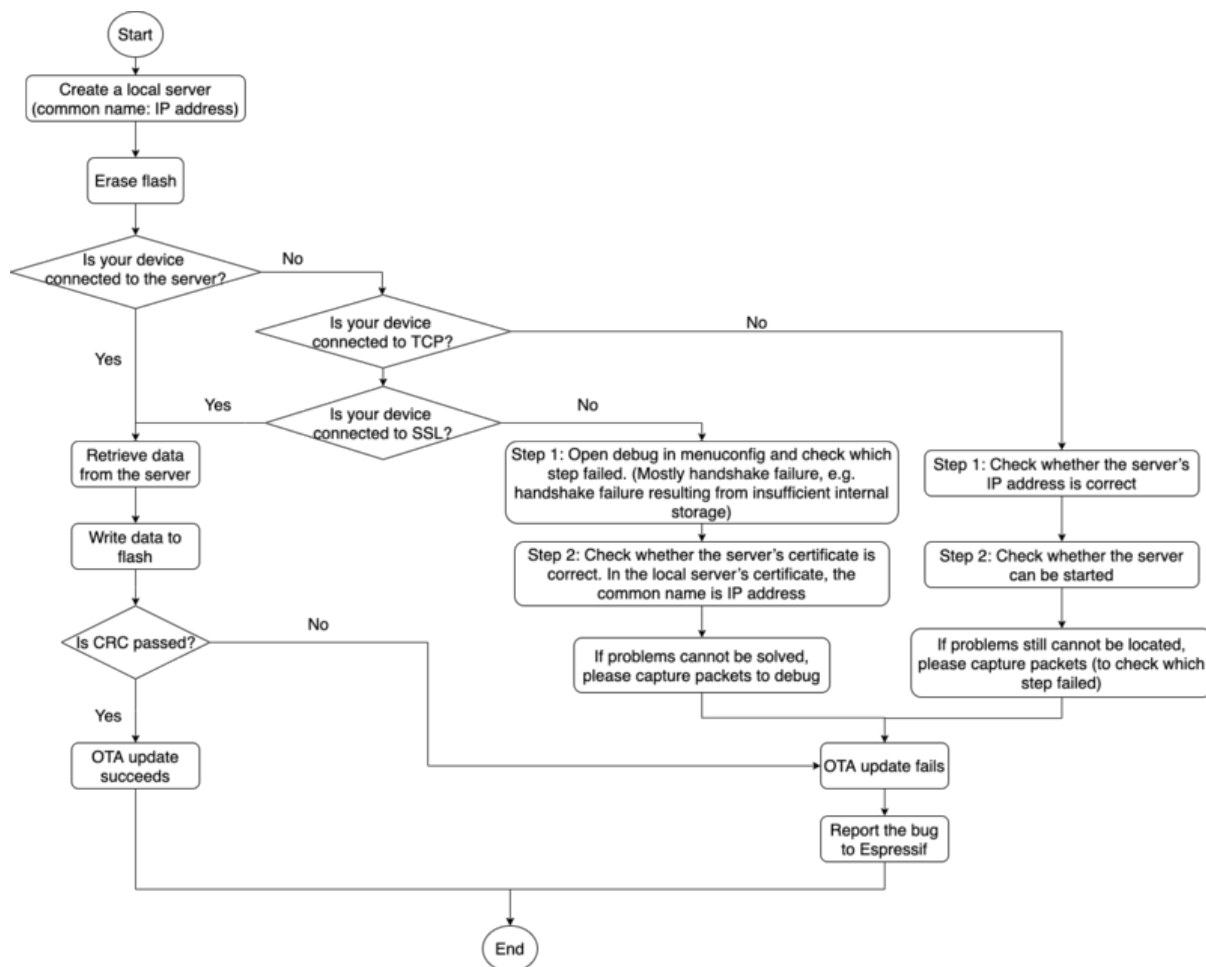

Fig. 45: How to Debug When OTA Fails (click to enlarge)

## Debugging OTA Failure

### 2.9.21 Performance Monitor

The Performance Monitor component provides APIs to use ESP32-S2 internal performance counters to profile functions and applications.

#### Application Example

An example which combines performance monitor is provided in `examples/system/perfmon` directory. This example initializes the performance monitor structure and execute them with printing the statistics.

#### High level API Reference

##### Header Files

- [perfmon/include/perfmon.h](#)

##### API Reference

##### Header File

- [components/perfmon/include/xtensa\\_perfmon\\_access.h](#)

##### Functions

*esp\_err\_t* **xtensa\_perfmon\_init** (int id, uint16\_t select, uint16\_t mask, int kernelcnt, int tracelevel)

Init Performance Monitor.

Initialize performance monitor register with define values

##### Parameters

- **id** –[in] performance counter number
- **select** –[in] select value from PMCTRLx register
- **mask** –[in] mask value from PMCTRLx register
- **kernelcnt** –[in] kernelcnt value from PMCTRLx register
- **tracelevel** –[in] tracelevel value from PMCTRLx register

##### Returns

- ESP\_OK on success
- ESP\_ERR\_INVALID\_ARG if one of the arguments is not correct

*esp\_err\_t* **xtensa\_perfmon\_reset** (int id)

Reset PM counter.

Reset PM counter. Writes 0 to the PMx register.

**Parameters** **id** –[in] performance counter number

##### Returns

- ESP\_OK on success
- ESP\_ERR\_INVALID\_ARG if id out of range

void **xtensa\_perfmon\_start** (void)

Start PM counters.

Start all PM counters synchronously. Write 1 to the PGM register

void **xtensa\_perfmon\_stop** (void)

Stop PM counters.

Stop all PM counters synchronously. Write 0 to the PGM register

uint32\_t **xtensa\_perfmon\_value** (int id)

Read PM counter.

Read value of defined PM counter.

**Parameters** **id** –[in] performance counter number

**Returns**

- Performance counter value

*esp\_err\_t* **xtensa\_perfmon\_overflow** (int id)

Read PM overflow state.

Read overflow value of defined PM counter.

**Parameters** **id** –[in] performance counter number

**Returns**

- ESP\_OK if there is no overflow (overflow = 0)
- ESP\_FAIL if overflow occur (overflow = 1)

void **xtensa\_perfmon\_dump** (void)

Dump PM values.

Dump all PM register to the console.

## Header File

- [components/perfmon/include/xtensa\\_perfmon\\_apis.h](#)

## Functions

*esp\_err\_t* **xtensa\_perfmon\_exec** (const *xtensa\_perfmon\_config\_t* \*config)

Execute PM.

Execute performance counter for dedicated function with defined parameters

**Parameters** **config** –[in] pointer to the configuration structure

**Returns**

- ESP\_OK if no errors
- ESP\_ERR\_INVALID\_ARG if one of the required parameters not defined
- ESP\_FAIL - counter overflow

void **xtensa\_perfmon\_view\_cb** (void \*params, uint32\_t select, uint32\_t mask, uint32\_t value)

Dump PM results.

Callback to dump perfmon result to a FILE\* stream specified in *perfmon\_config\_t::callback\_params*. If *callback\_params* is set to NULL, will print to stdout

**Parameters**

- **params** –[in] used parameters passed from configuration (*callback\_params*). This parameter expected as FILE\* handle, where data will be stored. If this parameter NULL, then data will be stored to the stdout.
- **select** –[in] select value for current counter
- **mask** –[in] mask value for current counter
- **value** –[in] counter value for current counter

## Structures

struct **xtensa\_perfmon\_config**

Performance monitor configuration structure.

Structure to configure performance counter to measure dedicated function

## Public Members

int **repeat\_count**

how much times function will be called before the callback will be repeated

float **max\_deviation**

Difference between min and max counter number 0..1, 0 - no difference, 1 - not used

void **\*call\_params**

This pointer will be passed to the call\_function as a parameter

void (**\*call\_function**)(void \*params)

pointer to the function that have to be called

void (**\*callback**)(void \*params, uint32\_t select, uint32\_t mask, uint32\_t value)

pointer to the function that will be called with result parameters

void **\*callback\_params**

parameter that will be passed to the callback

int **tracelevel**

trace level for all counters. In case of negative value, the filter will be ignored. If it's  $\geq 0$ , then the perfmon will count only when interrupt level  $>$  tracelevel. It's useful to monitor interrupts.

uint32\_t **counters\_size**

amount of counter in the list

const uint32\_t **\*select\_mask**

list of the select/mask parameters

## Type Definitions

typedef struct *xtensa\_perfmon\_config* **xtensa\_perfmon\_config\_t**

Performance monitor configuration structure.

Structure to configure performance counter to measure dedicated function

## 2.9.22 Power Management

### Overview

Power management algorithm included in ESP-IDF can adjust the advanced peripheral bus (APB) frequency, CPU frequency, and put the chip into light sleep mode to run an application at smallest possible power consumption, given the requirements of application components.

Application components can express their requirements by creating and acquiring power management locks.

For example:

- Driver for a peripheral clocked from APB can request the APB frequency to be set to 80 MHz while the peripheral is used.

- RTOS can request the CPU to run at the highest configured frequency while there are tasks ready to run.
- A peripheral driver may need interrupts to be enabled, which means it will have to request disabling light sleep.

Since requesting higher APB or CPU frequencies or disabling light sleep causes higher current consumption, please keep the usage of power management locks by components to a minimum.

### Configuration

Power management can be enabled at compile time, using the option `CONFIG_PM_ENABLE`.

Enabling power management features comes at the cost of increased interrupt latency. Extra latency depends on a number of factors, such as the CPU frequency, single/dual core mode, whether or not frequency switch needs to be done. Minimum extra latency is 0.2 us (when the CPU frequency is 240 MHz and frequency scaling is not enabled). Maximum extra latency is 40 us (when frequency scaling is enabled, and a switch from 40 MHz to 80 MHz is performed on interrupt entry).

Dynamic frequency scaling (DFS) and automatic light sleep can be enabled in an application by calling the function `esp_pm_configure()`. Its argument is a structure defining the frequency scaling settings, `esp_pm_config_esp32s2_t`. In this structure, three fields need to be initialized:

- `max_freq_mhz`: Maximum CPU frequency in MHz, i.e., the frequency used when the `ESP_PM_CPU_FREQ_MAX` lock is acquired. This field will usually be set to the default CPU frequency.
- `min_freq_mhz`: Minimum CPU frequency in MHz, i.e., the frequency used when only the `ESP_PM_APB_FREQ_MAX` lock is acquired. This field can be set to the XTAL frequency value, or the XTAL frequency divided by an integer. Note that 10 MHz is the lowest frequency at which the default `REF_TICK` clock of 1 MHz can be generated.
- `light_sleep_enable`: Whether the system should automatically enter light sleep when no locks are acquired (`true/false`).

Alternatively, if you enable the option `CONFIG_PM_DFS_INIT_AUTO` in menuconfig, the maximum CPU frequency will be determined by the `CONFIG_ESP_DEFAULT_CPU_FREQ_MHZ` setting, and the minimum CPU frequency will be locked to the XTAL frequency.

---

**Note:** Automatic light sleep is based on FreeRTOS Tickless Idle functionality. If automatic light sleep is requested while the option `CONFIG_FREERTOS_USE_TICKLESS_IDLE` is not enabled in menuconfig, `esp_pm_configure()` will return the error `ESP_ERR_NOT_SUPPORTED`.

---

---

**Note:** In light sleep, peripherals are clock gated, and interrupts (from GPIOs and internal peripherals) will not be generated. A wakeup source described in the *Sleep Modes* documentation can be used to trigger wakeup from the light sleep state.

---

For example, the EXT0 and EXT1 wakeup sources can be used to wake up the chip via a GPIO.

### Power Management Locks

Applications have the ability to acquire/release locks in order to control the power management algorithm. When an application acquires a lock, the power management algorithm operation is restricted in a way described below. When the lock is released, such restrictions are removed.

Power management locks have acquire/release counters. If the lock has been acquired a number of times, it needs to be released the same number of times to remove associated restrictions.

ESP32-S2 supports three types of locks described in the table below.



Lock	Description
ESP_PM_CPU_FREQ_MAX	Requests CPU frequency to be at the maximum value set with <code>esp_pm_configure()</code> . For ESP32-S2, this value can be set to 80 MHz, 160 MHz, or 240 MHz.
ESP_PM_APB_FREQ_MAX	Requests the APB frequency to be at the maximum supported value. For ESP32-S2, this is 80 MHz.
ESP_PM_NO_LIGHT_SLEEP	Disables automatic switching to light sleep.

### ESP32-S2 Power Management Algorithm

The table below shows how CPU and APB frequencies will be switched if dynamic frequency scaling is enabled. You can specify the maximum CPU frequency with either `esp_pm_configure()` or `CONFIG_ESP_DEFAULT_CPU_FREQ_MHZ`.

Max CPU Frequency Set	Lock Acquisition	CPU and APB Frequencies
240	ESP_PM_CPU_FREQ_MAX acquired	CPU: 240 MHz APB: 80 Mhz
	ESP_PM_APB_FREQ_MAX acquired, ESP_PM_CPU_FREQ_MAX not acquired	CPU: 80 MHz APB: 80 Mhz
	None	Min values for both frequencies set with <code>esp_pm_configure()</code>
160	ESP_PM_CPU_FREQ_MAX acquired	CPU: 160 MHz APB: 80 Mhz
	ESP_PM_APB_FREQ_MAX acquired, ESP_PM_CPU_FREQ_MAX not acquired	CPU: 80 MHz APB: 80 Mhz
	None	Min values for both frequencies set with <code>esp_pm_configure()</code>
80	Any of ESP_PM_CPU_FREQ_MAX or ESP_PM_APB_FREQ_MAX acquired	CPU: 80 MHz APB: 80 Mhz
	None	Min values for both frequencies set with <code>esp_pm_configure()</code>

If none of the locks are acquired, and light sleep is enabled in a call to `esp_pm_configure()`, the system will go into light sleep mode. The duration of light sleep will be determined by:

- FreeRTOS tasks blocked with finite timeouts
- Timers registered with *High resolution timer* APIs

Light sleep duration will be chosen to wake up the chip before the nearest event (task being unblocked, or timer elapses).

To skip unnecessary wake-up, you can consider initializing an `esp_timer` with the `skip_unhandled_events` option as true. Timers with this flag will not wake up the system and it helps to reduce consumption.

## Dynamic Frequency Scaling and Peripheral Drivers

When DFS is enabled, the APB frequency can be changed multiple times within a single RTOS tick. The APB frequency change does not affect the operation of some peripherals, while other peripherals may have issues. For example, Timer Group peripheral timers will keep counting, however, the speed at which they count will change proportionally to the APB frequency.

Peripheral clock sources such as `REF_TICK`, `XTAL`, `RC_FAST` (i.e. `RTC_8M`), their frequencies will not be influenced by APB frequency. And therefore, to ensure the peripheral behaves consistently during DFS, it is recommended to select one of these clocks as the peripheral clock source. For more specific guidelines, please refer to the “Power Management” section of each peripheral’s “API Reference > Peripherals API” page.

Currently, the following peripheral drivers are aware of DFS and will use the `ESP_PM_APB_FREQ_MAX` lock for the duration of the transaction:

- SPI master
- I2C
- I2S (If the APLL clock is used, then it will use the `ESP_PM_NO_LIGHT_SLEEP` lock)
- SDMMC

The following drivers will hold the `ESP_PM_APB_FREQ_MAX` lock while the driver is enabled:

- **SPI slave:** between calls to `spi_slave_initialize()` and `spi_slave_free()`.
- **GPTimer:** between calls to `gptimer_enable()` and `gptimer_disable()`.
- **Ethernet:** between calls to `esp_eth_driver_install()` and `esp_eth_driver_uninstall()`.
- **WiFi:** between calls to `esp_wifi_start()` and `esp_wifi_stop()`. If modem sleep is enabled, the lock will be released for the periods of time when radio is disabled.
- **TWAI:** between calls to `twai_driver_install()` and `twai_driver_uninstall()`.

The following peripheral drivers are not aware of DFS yet. Applications need to acquire/release locks themselves, when necessary:

- PCNT
- Sigma-delta
- The legacy timer group driver

## API Reference

### Header File

- `components/esp_pm/include/esp_pm.h`

### Functions

`esp_err_t esp_pm_configure` (const void \*config)

Set implementation-specific power management configuration.

**Parameters** `config` –pointer to implementation-specific configuration structure (e.g. `esp_pm_config_esp32`)

#### Returns

- `ESP_OK` on success
- `ESP_ERR_INVALID_ARG` if the configuration values are not correct
- `ESP_ERR_NOT_SUPPORTED` if certain combination of values is not supported, or if `CONFIG_PM_ENABLE` is not enabled in `sdkconfig`

*esp\_err\_t* **esp\_pm\_get\_configuration** (void \*config)

Get implementation-specific power management configuration.

**Parameters** **config** –pointer to implementation-specific configuration structure (e.g. `esp_pm_config_esp32`)

**Returns**

- ESP\_OK on success
- ESP\_ERR\_INVALID\_ARG if the pointer is null

*esp\_err\_t* **esp\_pm\_lock\_create** (*esp\_pm\_lock\_type\_t* lock\_type, int arg, const char \*name, *esp\_pm\_lock\_handle\_t* \*out\_handle)

Initialize a lock handle for certain power management parameter.

When lock is created, initially it is not taken. Call `esp_pm_lock_acquire` to take the lock.

This function must not be called from an ISR.

**Parameters**

- **lock\_type** –Power management constraint which the lock should control
- **arg** –argument, value depends on `lock_type`, see `esp_pm_lock_type_t`
- **name** –arbitrary string identifying the lock (e.g. “wifi” or “spi” ). Used by the `esp_pm_dump_locks` function to list existing locks. May be set to NULL. If not set to NULL, must point to a string which is valid for the lifetime of the lock.
- **out\_handle** –[out] handle returned from this function. Use this handle when calling `esp_pm_lock_delete`, `esp_pm_lock_acquire`, `esp_pm_lock_release`. Must not be NULL.

**Returns**

- ESP\_OK on success
- ESP\_ERR\_NO\_MEM if the lock structure can not be allocated
- ESP\_ERR\_INVALID\_ARG if `out_handle` is NULL or type argument is not valid
- ESP\_ERR\_NOT\_SUPPORTED if `CONFIG_PM_ENABLE` is not enabled in `sdkconfig`

*esp\_err\_t* **esp\_pm\_lock\_acquire** (*esp\_pm\_lock\_handle\_t* handle)

Take a power management lock.

Once the lock is taken, power management algorithm will not switch to the mode specified in a call to `esp_pm_lock_create`, or any of the lower power modes (higher numeric values of ‘mode’ ).

The lock is recursive, in the sense that if `esp_pm_lock_acquire` is called a number of times, `esp_pm_lock_release` has to be called the same number of times in order to release the lock.

This function may be called from an ISR.

This function is not thread-safe w.r.t. calls to other `esp_pm_lock_*` functions for the same handle.

**Parameters** **handle** –handle obtained from `esp_pm_lock_create` function

**Returns**

- ESP\_OK on success
- ESP\_ERR\_INVALID\_ARG if the handle is invalid
- ESP\_ERR\_NOT\_SUPPORTED if `CONFIG_PM_ENABLE` is not enabled in `sdkconfig`

*esp\_err\_t* **esp\_pm\_lock\_release** (*esp\_pm\_lock\_handle\_t* handle)

Release the lock taken using `esp_pm_lock_acquire`.

Call to this functions removes power management restrictions placed when taking the lock.

Locks are recursive, so if `esp_pm_lock_acquire` is called a number of times, `esp_pm_lock_release` has to be called the same number of times in order to actually release the lock.

This function may be called from an ISR.

This function is not thread-safe w.r.t. calls to other `esp_pm_lock_*` functions for the same handle.

**Parameters** **handle** –handle obtained from `esp_pm_lock_create` function

**Returns**

- ESP\_OK on success
- ESP\_ERR\_INVALID\_ARG if the handle is invalid

- ESP\_ERR\_INVALID\_STATE if lock is not acquired
- ESP\_ERR\_NOT\_SUPPORTED if CONFIG\_PM\_ENABLE is not enabled in sdkconfig

*esp\_err\_t* **esp\_pm\_lock\_delete** (*esp\_pm\_lock\_handle\_t* handle)

Delete a lock created using esp\_pm\_lock.

The lock must be released before calling this function.

This function must not be called from an ISR.

**Parameters** *handle* –handle obtained from esp\_pm\_lock\_create function

**Returns**

- ESP\_OK on success
- ESP\_ERR\_INVALID\_ARG if the handle argument is NULL
- ESP\_ERR\_INVALID\_STATE if the lock is still acquired
- ESP\_ERR\_NOT\_SUPPORTED if CONFIG\_PM\_ENABLE is not enabled in sdkconfig

*esp\_err\_t* **esp\_pm\_dump\_locks** (FILE \*stream)

Dump the list of all locks to stderr

This function dumps debugging information about locks created using esp\_pm\_lock\_create to an output stream.

This function must not be called from an ISR. If esp\_pm\_lock\_acquire/release are called while this function is running, inconsistent results may be reported.

**Parameters** *stream* –stream to print information to; use stdout or stderr to print to the console; use fopen/open\_memstream to print to a string buffer.

**Returns**

- ESP\_OK on success
- ESP\_ERR\_NOT\_SUPPORTED if CONFIG\_PM\_ENABLE is not enabled in sdkconfig

## Type Definitions

typedef struct esp\_pm\_lock \***esp\_pm\_lock\_handle\_t**

Opaque handle to the power management lock.

## Enumerations

enum **esp\_pm\_lock\_type\_t**

Power management constraints.

*Values:*

enumerator **ESP\_PM\_CPU\_FREQ\_MAX**

Require CPU frequency to be at the maximum value set via esp\_pm\_configure. Argument is unused and should be set to 0.

enumerator **ESP\_PM\_APB\_FREQ\_MAX**

Require APB frequency to be at the maximum value supported by the chip. Argument is unused and should be set to 0.

enumerator **ESP\_PM\_NO\_LIGHT\_SLEEP**

Prevent the system from going into light sleep. Argument is unused and should be set to 0.

## Header File

- components/esp\_pm/include/esp32s2/pm.h

## Structures

struct **esp\_pm\_config\_esp32s2\_t**

Power management config for ESP32.

Pass a pointer to this structure as an argument to `esp_pm_configure` function.

### Public Members

int **max\_freq\_mhz**

Maximum CPU frequency, in MHz

int **min\_freq\_mhz**

Minimum CPU frequency to use when no locks are taken, in MHz

bool **light\_sleep\_enable**

Enter light sleep when no locks are taken

## 2.9.23 POSIX Threads Support

### Overview

ESP-IDF is based on FreeRTOS but offers a range of POSIX-compatible APIs that allow easy porting of third party code. This includes support for common parts of the POSIX Threads “`pthread`” API.

POSIX Threads are implemented in ESP-IDF as wrappers around equivalent FreeRTOS features. The runtime memory or performance overhead of using the `pthread` API is quite low, but not every feature available in either `pthread` or FreeRTOS is available via the ESP-IDF `pthread` support.

`pthread` can be used in ESP-IDF by including standard `pthread.h` header, which is included in the toolchain `libc`. An additional ESP-IDF specific header, `esp_pthread.h`, provides additional non-POSIX APIs for using some ESP-IDF features with `pthread`.

C++ Standard Library implementations for `std::thread`, `std::mutex`, `std::condition_variable`, etc. are implemented using `pthread` (via GCC `libstdc++`). Therefore, restrictions mentioned here also apply to the equivalent C++ standard library functionality.

### RTOS Integration

Unlike many operating systems using POSIX Threads, ESP-IDF is a real-time operating system with a real-time scheduler. This means that a thread will only stop running if a higher priority task is ready to run, the thread blocks on an OS synchronization structure like a mutex, or the thread calls any of the functions `sleep`, `vTaskDelay()`, or `usleep`.

---

**Note:** If calling a standard `libc` or C++ sleep function, such as `usleep` defined in `unistd.h`, then the task will only block and yield the CPU if the sleep time is longer than *one FreeRTOS tick period*. If the time is shorter, the thread will busy-wait instead of yielding to another RTOS task.

---

By default, all POSIX Threads have the same RTOS priority, but it is possible to change this by calling a *custom API*.

## Standard features

The following standard APIs are implemented in ESP-IDF.

Refer to standard POSIX Threads documentation, or `pthread.h`, for details about the standard arguments and behaviour of each function. Differences or limitations compared to the standard APIs are noted below.

## Thread APIs

- `pthread_create()` - The `attr` argument is supported for setting stack size and detach state only. Other attribute fields are ignored. - Unlike FreeRTOS task functions, the `start_routine` function is allowed to return. A “detached” type thread is automatically deleted if the function returns. The default “joinable” type thread will be suspended until `pthread_join()` is called on it.
- `pthread_join()`
- `pthread_detach()`
- `pthread_exit()`
- `sched_yield()`
- `pthread_self()` - An assert will fail if this function is called from a FreeRTOS task which is not a pthread.
- `pthread_equal()`

## Thread Attributes

- `pthread_attr_init()`
- `pthread_attr_destroy()` - This function doesn't need to free any resources and instead resets the `attr` structure to defaults (implementation is same as `pthread_attr_init()`).
- `pthread_attr_getstacksize()` / `pthread_attr_setstacksize()`
- `pthread_attr_getdetachstate()` / `pthread_attr_setdetachstate()`

## Once

- `pthread_once()`

Static initializer constant `PTHREAD_ONCE_INIT` is supported.

---

**Note:** This function can be called from tasks created using either pthread or FreeRTOS APIs

---

**Mutexes** POSIX Mutexes are implemented as FreeRTOS Mutex Semaphores (normal type for “fast” or “error check” mutexes, and Recursive type for “recursive” mutexes). This means that they have the same priority inheritance behaviour as mutexes created with `xSemaphoreCreateMutex()`.

- `pthread_mutex_init()`
- `pthread_mutex_destroy()`
- `pthread_mutex_lock()`
- `pthread_mutex_timedlock()`
- `pthread_mutex_trylock()`
- `pthread_mutex_unlock()`
- `pthread_mutexattr_init()`
- `pthread_mutexattr_destroy()`
- `pthread_mutexattr_gettype()` / `pthread_mutexattr_settype()`

Static initializer constant `PTHREAD_MUTEX_INITIALIZER` is supported, but the non-standard static initializer constants for other mutex types are not supported.

---

**Note:** These functions can be called from tasks created using either pthread or FreeRTOS APIs

---

### Condition Variables

- `pthread_cond_init()` - The `attr` argument is not implemented and is ignored.
- `pthread_cond_destroy()`
- `pthread_cond_signal()`
- `pthread_cond_broadcast()`
- `pthread_cond_wait()`
- `pthread_cond_timedwait()`

Static initializer constant `PTHREAD_COND_INITIALIZER` is supported.

- The resolution of `pthread_cond_timedwait()` timeouts is the RTOS tick period (see [CONFIG\\_FREERTOS\\_HZ](#)). Timeouts may be delayed up to one tick period after the requested timeout.

---

**Note:** These functions can be called from tasks created using either `pthread` or FreeRTOS APIs

---

### Read/Write Locks

- `pthread_rwlock_init()` - The `attr` argument is not implemented and is ignored.
- `pthread_rwlock_destroy()`
- `pthread_rwlock_rdlock()`
- `pthread_rwlock_wrlock()`
- `pthread_rwlock_unlock()`

Static initializer constant `PTHREAD_RWLOCK_INITIALIZER` is supported.

---

**Note:** These functions can be called from tasks created using either `pthread` or FreeRTOS APIs

---

### Thread-Specific Data

- `pthread_key_create()` - The `destr_function` argument is supported and will be called if a thread function exits normally, calls `pthread_exit()`, or if the underlying task is deleted directly using the FreeRTOS function `vTaskDelete()`.
- `pthread_key_delete()`
- `pthread_setspecific()` / `pthread_getspecific()`

---

**Note:** These functions can be called from tasks created using either `pthread` or FreeRTOS APIs

---

---

**Note:** There are other options for thread local storage in ESP-IDF, including options with higher performance. See [Thread Local Storage](#).

---

### Not Implemented

The `pthread.h` header is a standard header and includes additional APIs and features which are not implemented in ESP-IDF. These include:

- `pthread_cancel()` returns `ENOSYS` if called.
- `pthread_condattr_init()` returns `ENOSYS` if called.

Other POSIX Threads functions (not listed here) are not implemented and will produce either a compiler or a linker error if referenced from an ESP-IDF application. If you identify a useful API that you would like to see implemented in ESP-IDF, please open a *feature request on GitHub* <<https://github.com/espressif/esp-idf/issues>> with the details.

## ESP-IDF Extensions

The API `esp_thread_set_cfg()` defined in the `esp_threads.h` header offers custom extensions to control how subsequent calls to `pthread_create()` will behave. Currently, the following configuration can be set:

- Default stack size of new threads, if not specified when calling `pthread_create()` (overrides `CONFIG_PTHREAD_TASK_STACK_SIZE_DEFAULT`).
- RTOS priority of new threads (overrides `CONFIG_PTHREAD_TASK_PRIO_DEFAULT`).
- FreeRTOS task name for new threads (overrides `CONFIG_PTHREAD_TASK_NAME_DEFAULT`)

This configuration is scoped to the calling thread (or FreeRTOS task), meaning that `esp_thread_set_cfg()` can be called independently in different threads or tasks. If the `inherit_cfg` flag is set in the current configuration then any new thread created will inherit the creator's configuration (if that thread calls `pthread_create()` recursively), otherwise the new thread will have the default configuration.

## Examples

- [system/pthread](#) demonstrates using the pthreads API to create threads
- [cxx/pthread](#) demonstrates using C++ Standard Library functions with threads

## API Reference

### Header File

- [components/pthread/include/esp\\_thread.h](#)

### Functions

`esp_thread_cfg_t esp_thread_get_default_config` (void)

Creates a default pthread configuration based on the values set via menuconfig.

**Returns** A default configuration structure.

`esp_err_t esp_thread_set_cfg` (const `esp_thread_cfg_t` \*cfg)

Configure parameters for creating pthread.

This API allows you to configure how the subsequent `pthread_create()` call will behave. This call can be used to setup configuration parameters like stack size, priority, configuration inheritance etc.

If the 'inherit' flag in the configuration structure is enabled, then the same configuration is also inherited in the thread subtree.

---

**Note:** Passing non-NULL attributes to `pthread_create()` will override the `stack_size` parameter set using this API

---

**Parameters** `cfg` –The pthread config parameters

#### Returns

- `ESP_OK` if configuration was successfully set
- `ESP_ERR_NO_MEM` if out of memory
- `ESP_ERR_INVALID_ARG` if `stack_size` is less than `PTHREAD_STACK_MIN`

`esp_err_t esp_thread_get_cfg` (`esp_thread_cfg_t` \*p)

Get current pthread creation configuration.

This will retrieve the current configuration that will be used for creating threads.



**Parameters** **p** –Pointer to the pthread config structure that will be updated with the currently configured parameters

**Returns**

- ESP\_OK if the configuration was available
- ESP\_ERR\_NOT\_FOUND if a configuration wasn't previously set

*esp\_err\_t* **esp\_thread\_init** (void)

Initialize pthread library.

## Structures

struct **esp\_thread\_cfg\_t**

pthread configuration structure that influences pthread creation

### Public Members

size\_t **stack\_size**

The stack size of the pthread.

size\_t **prio**

The thread's priority.

bool **inherit\_cfg**

Inherit this configuration further.

const char \***thread\_name**

The thread name.

int **pin\_to\_core**

The core id to pin the thread to. Has the same value range as xCoreId argument of xTaskCreatePinnedToCore.

## Macros

**PTHREAD\_STACK\_MIN**

### 2.9.24 Random Number Generation

ESP32-S2 contains a hardware random number generator, values from it can be obtained using the APIs *esp\_random()* and *esp\_fill\_random()*.

The hardware RNG produces true random numbers under any of the following conditions:

- RF subsystem is enabled (i.e. Wi-Fi is enabled).
- An internal entropy source has been enabled by calling *bootloader\_random\_enable()* and not yet disabled by calling *bootloader\_random\_disable()*.
- While the ESP-IDF *Second stage bootloader* is running. This is because the default ESP-IDF bootloader implementation calls *bootloader\_random\_enable()* when the bootloader starts, and *bootloader\_random\_disable()* before executing the app.

When any of these conditions are true, samples of physical noise are continuously mixed into the internal hardware RNG state to provide entropy. Consult the *ESP32-S2 Technical Reference Manual > Random Number Generator (RNG)* [PDF] chapter for more details.

If none of the above conditions are true, the output of the RNG should be considered pseudo-random only.

## Startup

During startup, ESP-IDF bootloader temporarily enables a non-RF entropy source (internal reference voltage noise) that provides entropy for any first boot key generation. However, after the app starts executing then normally only pseudo-random numbers are available until Wi-Fi is initialized.

To re-enable the entropy source temporarily during app startup, or for an application that does not use Wi-Fi, call the function `bootloader_random_enable()` to re-enable the internal entropy source. The function `bootloader_random_disable()` must be called to disable the entropy source again before using ADC, Wi-Fi.

---

**Note:** The entropy source enabled during the boot process by the ESP-IDF Second Stage Bootloader will seed the internal RNG state with some entropy. However, the internal hardware RNG state is not large enough to provide a continuous stream of true random numbers. This is why a continuous entropy source must be enabled whenever true random numbers are required.

---

---

**Note:** If an application requires a source of true random numbers but it is not possible to permanently enable a hardware entropy source, consider using a strong software DRBG implementation such as the mbedTLS CTR-DRBG or HMAC-DRBG, with an initial seed of entropy from hardware RNG true random numbers.

---

## Secondary Entropy

ESP32-S2 RNG contains a secondary entropy source, based on sampling an asynchronous 8MHz internal oscillator (see the Technical Reference Manual for details). This entropy source is always enabled in ESP-IDF and continuously mixed into the RNG state by hardware. In testing, this secondary entropy source was sufficient to pass the [Dieharder](#) random number test suite without the main entropy source enabled (test input was created by concatenating short samples from a continuously resetting ESP32-S2). However, it is currently only guaranteed that true random numbers will be produced when the main entropy source is also enabled as described above.

## API Reference

### Header File

- `components/esp_hw_support/include/esp_random.h`

### Functions

`uint32_t esp_random (void)`

Get one random 32-bit word from hardware RNG.

If Wi-Fi or Bluetooth are enabled, this function returns true random numbers. In other situations, if true random numbers are required then consult the ESP-IDF Programming Guide “Random Number Generation” section for necessary prerequisites.

This function automatically busy-waits to ensure enough external entropy has been introduced into the hardware RNG state, before returning a new random number. This delay is very short (always less than 100 CPU cycles).

**Returns** Random value between 0 and `UINT32_MAX`

`void esp_fill_random (void *buf, size_t len)`

Fill a buffer with random bytes from hardware RNG.

---

**Note:** This function is implemented via calls to `esp_random()`, so the same constraints apply.

---

### Parameters

- `buf` –Pointer to buffer to fill with random numbers.

- **len** –Length of buffer in bytes

### Header File

- [components/bootloader\\_support/include/bootloader\\_random.h](#)

### Functions

void **bootloader\_random\_enable** (void)

Enable an entropy source for RNG if RF subsystem is disabled.

The exact internal entropy source mechanism depends on the chip in use but all SoCs use the SAR ADC to continuously mix random bits (an internal noise reading) into the HWRNG. Consult the SoC Technical Reference Manual for more information.

Can also be called from app code, if true random numbers are required without initialized RF subsystem. This might be the case in early startup code of the application when the RF subsystem has not started yet or if the RF subsystem should not be enabled for power saving.

Consult ESP-IDF Programming Guide “Random Number Generation” section for details.

**Warning:** This function is not safe to use if any other subsystem is accessing the RF subsystem or the ADC at the same time!

void **bootloader\_random\_disable** (void)

Disable entropy source for RNG.

Disables internal entropy source. Must be called after `bootloader_random_enable()` and before RF subsystem features, ADC, or I2S (ESP32 only) are initialized.

Consult the ESP-IDF Programming Guide “Random Number Generation” section for details.

void **bootloader\_fill\_random** (void \*buffer, size\_t length)

Fill buffer with ‘length’ random bytes.

---

**Note:** If this function is being called from app code only, and never from the bootloader, then it’s better to call `esp_fill_random()`.

---

#### Parameters

- **buffer** –Pointer to buffer
- **length** –This many bytes of random data will be copied to buffer

### getrandom

A compatible version of the Linux `getrandom()` function is also provided for ease of porting:

```
#include <sys/random.h>

ssize_t getrandom(void *buf, size_t buflen, unsigned int flags);
```

This function is implemented by calling `esp_fill_random()` internally.

The `flags` argument is ignored, this function is always non-blocking but the strength of any random numbers is dependent on the same conditions described above.

Return value is -1 (with `errno` set to `EFAULT`) if the `buf` argument is `NULL`, and equal to `buflen` otherwise.

## 2.9.25 Sleep Modes

### Overview

ESP32-S2 contains the following power saving modes: Light-sleep, and Deep-sleep.

In Light-sleep mode, the digital peripherals, most of the RAM, and CPUs are clock-gated and their supply voltage is reduced. Upon exit from Light-sleep, the digital peripherals, RAM, and CPUs resume operation and their internal states are preserved.

In Deep-sleep mode, the CPUs, most of the RAM, and all digital peripherals that are clocked from APB\_CLK are powered off. The only parts of the chip that remain powered on are:

- RTC controller
- ULP coprocessor
- RTC fast memory
- RTC slow memory

There are several wakeup sources in Deep-sleep and Light-sleep modes. These sources can also be combined so that the chip will wake up when any of the sources are triggered. Wakeup sources can be enabled using `esp_sleep_enable_X_wakeup` APIs and can be disabled using `esp_sleep_disable_wakeup_source()` API. Next section describes these APIs in detail. Wakeup sources can be configured at any moment before entering Light-sleep or Deep-sleep mode.

Additionally, the application can force specific powerdown modes for RTC peripherals and RTC memories using `esp_sleep_pd_config()` API.

Once wakeup sources are configured, the application can enter sleep mode using `esp_light_sleep_start()` or `esp_deep_sleep_start()` APIs. At this point, the hardware will be configured according to the requested wakeup sources, and the RTC controller will either power down or power off the CPUs and digital peripherals.

### Wi-Fi and Sleep Modes

In Deep-sleep and Light-sleep modes, the wireless peripherals are powered down. Before entering Deep-sleep or Light-sleep modes, applications must disable Wi-Fi using the appropriate calls (`esp_wifi_stop()`). Wi-Fi connections will not be maintained in Deep-sleep or Light-sleep mode, even if these functions are not called.

If Wi-Fi connections need to be maintained, enable Wi-Fi Modem-sleep mode and automatic Light-sleep feature (see [Power Management APIs](#)). This will allow the system to wake up from sleep automatically when required by the Wi-Fi driver, thereby maintaining a connection to the AP.

### Wakeup Sources

**Timer** The RTC controller has a built-in timer which can be used to wake up the chip after a predefined amount of time. Time is specified at microsecond precision, but the actual resolution depends on the clock source selected for RTC SLOW\_CLK.

For details on RTC clock options, see *ESP32-S2 Technical Reference Manual > ULP Coprocessor* [PDF].

RTC peripherals or RTC memories don't need to be powered on during sleep in this wakeup mode.

`esp_sleep_enable_timer_wakeup()` function can be used to enable sleep wakeup using a timer.

**Touchpad** The RTC IO module contains the logic to trigger wakeup when a touch sensor interrupt occurs. To wakeup from a touch sensor interrupt, users need to configure the touch pad interrupt before the chip enters Deep-sleep or Light-sleep modes.

`esp_sleep_enable_touchpad_wakeup()` function can be used to enable this wakeup source.

**External Wakeup (ext0)** The RTC IO module contains the logic to trigger wakeup when one of RTC GPIOs is set to a predefined logic level. RTC IO is part of the RTC peripherals power domain, so RTC peripherals will be kept powered on during Deep-sleep if this wakeup source is requested.

The RTC IO module is enabled in this mode, so internal pullup or pulldown resistors can also be used. They need to be configured by the application using `rtc_gpio_pullup_en()` and `rtc_gpio_pulldown_en()` functions before calling `esp_deep_sleep_start()`.

`esp_sleep_enable_ext0_wakeup()` function can be used to enable this wakeup source.

**Warning:** After waking up from sleep, the IO pad used for wakeup will be configured as RTC IO. Therefore, before using this pad as digital GPIO, users need to reconfigure it using `rtc_gpio_deinit()` function.

**External Wakeup (ext1)** The RTC controller contains the logic to trigger wakeup using multiple RTC GPIOs. One of the following two logic functions can be used to trigger wakeup:

- wake up if any of the selected pins is high (ESP\_EXT1\_WAKEUP\_ANY\_HIGH)
- wake up if any of the selected pins is low (ESP\_EXT1\_WAKEUP\_ANY\_LOW)

This wakeup source is implemented by the RTC controller. As such, RTC peripherals and RTC memories can be powered down in this mode. However, if RTC peripherals are powered down, internal pullup and pulldown resistors will be disabled. To use internal pullup or pulldown resistors, request the RTC peripherals power domain to be kept on during sleep, and configure pullup/pulldown resistors using `rtc_gpio_` functions before entering sleep:

```
esp_sleep_pd_config(ESP_PD_DOMAIN_RTC_PERIPH, ESP_PD_OPTION_ON);
rtc_gpio_pullup_dis(gpio_num);
rtc_gpio_pulldown_en(gpio_num);
```

**Warning:**

- To use the EXT1 wakeup, the IO pad(s) are configured as RTC IO. Thus if these pads want to be used as digital GPIOs after waking up from sleep, `rtc_gpio_deinit()` needs to be called first.
- If the RTC peripherals are configured to be powered down (which is by default), the wakeup IOs will be set to holding state before entering sleep. Therefore, after waking up from Light-sleep, please call `rtc_gpio_hold_dis` to disable the hold function to perform any pin re-configuration. For Deep-sleep wakeup, this is already being handled at the application startup stage.

`esp_sleep_enable_ext1_wakeup()` function can be used to enable this wakeup source.

**ULP Coprocessor Wakeup** ULP coprocessor can run while the chip is in sleep mode, and may be used to poll sensors, monitor ADC or touch sensor values, and wake up the chip when a specific event is detected. ULP coprocessor is part of the RTC peripherals power domain, and it runs the program stored in RTC slow memory. RTC slow memory will be powered on during sleep if this wakeup mode is requested. RTC peripherals will be automatically powered on before ULP coprocessor starts running the program; once the program stops running, RTC peripherals are automatically powered down again.

`esp_sleep_enable_ulp_wakeup()` function can be used to enable this wakeup source.

**GPIO Wakeup (Light-sleep Only)** In addition to EXT0 and EXT1 wakeup sources described above, one more method of wakeup from external inputs is available in Light-sleep mode. With this wakeup source, each pin can be individually configured to trigger wakeup on high or low level using `gpio_wakeup_enable()` function. Unlike EXT0 and EXT1 wakeup sources, which can only be used with RTC IOs, this wakeup source can be used with any IO (RTC or digital).

`esp_sleep_enable_gpio_wakeup()` function can be used to enable this wakeup source.

**Warning:** Before entering Light-sleep mode, check if any GPIO pin to be driven is part of the VDD\_SPI power domain. If so, this power domain must be configured to remain ON during sleep.

For example, on ESP32-WROOM-32 board, GPIO16 and GPIO17 are linked to VDD\_SPI power domain. If they are configured to remain high during Light-sleep, the power domain should be configured to remain powered ON. This can be done with `esp_sleep_pd_config()`:

```
esp_sleep_pd_config(ESP_PD_DOMAIN_VDDSDIO, ESP_PD_OPTION_ON);
```

**UART Wakeup (Light-sleep Only)** When ESP32-S2 receives UART input from external devices, it is often necessary to wake up the chip when input data is available. The UART peripheral contains a feature which allows waking up the chip from Light-sleep when a certain number of positive edges on RX pin are seen. This number of positive edges can be set using `uart_set_wakeup_threshold()` function. Note that the character which triggers wakeup (and any characters before it) will not be received by the UART after wakeup. This means that the external device typically needs to send an extra character to the ESP32-S2 to trigger wakeup before sending the data.

`esp_sleep_enable_uart_wakeup()` function can be used to enable this wakeup source.

After waking-up from UART, you should send some extra data through the UART port in Active mode, so that the internal wakeup indication signal can be cleared. Otherwise, the next UART wake-up would trigger with two less rising edges than the configured threshold value.

### Power-down of RTC Peripherals and Memories

By default, `esp_deep_sleep_start()` and `esp_light_sleep_start()` functions will power down all RTC power domains which are not needed by the enabled wakeup sources. To override this behaviour, `esp_sleep_pd_config()` function is provided.

If some variables in the program are placed into RTC slow memory (for example, using `RTC_DATA_ATTR` attribute), RTC slow memory will be kept powered on by default. This can be overridden using `esp_sleep_pd_config()` function, if desired.

### Power-down of Flash

By default, to avoid potential issues, `esp_light_sleep_start()` function will **not** power down flash. To be more specific, it takes time to power down the flash and during this period the system may be woken up, which then actually powers up the flash before this flash could be powered down completely. As a result, there is a chance that the flash may not work properly.

So, in theory, it's ok if you only wake up the system after the flash is completely powered down. However, in reality, the flash power-down period can be hard to predict (for example, this period can be much longer when you add filter capacitors to the flash's power supply circuit) and uncontrollable (for example, the asynchronous wake-up signals make the actual sleep time uncontrollable).

**Warning:** If a filter capacitor is added to your flash power supply circuit, please do everything possible to avoid powering down flash.

Therefore, it's recommended not to power down flash when using ESP-IDF. For power-sensitive applications, it's recommended to use Kconfig option `CONFIG_ESP_SLEEP_FLASH_LEAKAGE_WORKAROUND` to reduce the power consumption of the flash during light sleep, instead of powering down the flash.

It is worth mentioning that PSRAM has a similar Kconfig option `CONFIG_ESP_SLEEP_PSRAM_LEAKAGE_WORKAROUND`.

However, for those who have fully understood the risk and are still willing to power down the flash to further reduce the power consumption, please check the following mechanisms:

- Setting Kconfig option `CONFIG_ESP_SLEEP_POWER_DOWN_FLASH` only powers down the flash when the RTC timer is the only wake-up source **and** the sleep time is longer than the flash power-down period.
- Calling `esp_sleep_pd_config(ESP_PD_DOMAIN_VDDSDIO, ESP_PD_OPTION_OFF)` powers down flash when the RTC timer is not enabled as a wakeup source **or** the sleep time is longer than the flash power-down period.

---

**Note:**

- ESP-IDF does not provide any mechanism that can power down the flash in all conditions when light sleep.
  - `esp_deep_sleep_start()` function will force power down flash regardless of user configuration.
- 

### Entering Light-sleep

`esp_light_sleep_start()` function can be used to enter Light-sleep once wakeup sources are configured. It is also possible to enter Light-sleep with no wakeup sources configured. In this case, the chip will be in Light-sleep mode indefinitely until external reset is applied.

### Entering Deep-sleep

`esp_deep_sleep_start()` function can be used to enter Deep-sleep once wakeup sources are configured. It is also possible to enter Deep-sleep with no wakeup sources configured. In this case, the chip will be in Deep-sleep mode indefinitely until external reset is applied.

### Configuring IOs

Some ESP32-S2 IOs have internal pullups or pulldowns, which are enabled by default. If an external circuit drives this pin in Deep-sleep mode, current consumption may increase due to current flowing through these pullups and pulldowns.

To isolate a pin to prevent extra current draw, call `rtc_gpio_isolate()` function.

For example, on ESP32-WROVER module, GPIO12 is pulled up externally, and it also has an internal pulldown in the ESP32 chip. This means that in Deep-sleep, some current will flow through these external and internal resistors, increasing Deep-sleep current above the minimal possible value.

Add the following code before `esp_deep_sleep_start()` to remove such extra current:

```
rtc_gpio_isolate(GPIO_NUM_12);
```

### UART Output Handling

Before entering sleep mode, `esp_deep_sleep_start()` will flush the contents of UART FIFOs.

When entering Light-sleep mode using `esp_light_sleep_start()`, UART FIFOs will not be flushed. Instead, UART output will be suspended, and remaining characters in the FIFO will be sent out after wakeup from Light-sleep.

### Checking Sleep Wakeup Cause

`esp_sleep_get_wakeup_cause()` function can be used to check which wakeup source has triggered wakeup from sleep mode.

For touchpad, it is possible to identify which touch pin has caused wakeup using `esp_sleep_get_touchpad_wakeup_status()` functions.

For ext1 wakeup sources, it is possible to identify which touch pin has caused wakeup using `esp_sleep_get_ext1_wakeup_status()` functions.

### Disable Sleep Wakeup Source

Previously configured wakeup sources can be disabled later using `esp_sleep_disable_wakeup_source()` API. This function deactivates trigger for the given wakeup source. Additionally, it can disable all triggers if the argument is `ESP_SLEEP_WAKEUP_ALL`.

### Application Example

- `protocols/sntp`: the implementation of basic functionality of Deep-sleep, where ESP module is periodically waken up to retrieve time from NTP server.
- `wifi/power_save`: the implementation of Wi-Fi Modem-sleep example.
- `system/deep_sleep`: the usage of various Deep-sleep wakeup triggers and ULP coprocessor programming.

## API Reference

### Header File

- `components/esp_hw_support/include/esp_sleep.h`

### Functions

`esp_err_t esp_sleep_disable_wakeup_source(esp_sleep_source_t source)`

Disable wakeup source.

This function is used to deactivate wake up trigger for source defined as parameter of the function.

See docs/sleep-modes.rst for details.

---

**Note:** This function does not modify wake up configuration in RTC. It will be performed in `esp_deep_sleep_start/esp_light_sleep_start` function.

---

**Parameters** `source` -- number of source to disable of type `esp_sleep_source_t`

#### Returns

- `ESP_OK` on success
- `ESP_ERR_INVALID_STATE` if trigger was not active



*esp\_err\_t* **esp\_sleep\_enable\_ulp\_wakeup** (void)

Enable wakeup by ULP coprocessor.

---

**Note:** On ESP32, ULP wakeup source cannot be used when RTC\_PERIPH power domain is forced, to be powered on (ESP\_PD\_OPTION\_ON) or when ext0 wakeup source is used.

---

**Returns**

- ESP\_OK on success
- ESP\_ERR\_NOT\_SUPPORTED if additional current by touch (CONFIG\_RTC\_EXT\_CRYST\_ADDIT\_CURRENT) is enabled.
- ESP\_ERR\_INVALID\_STATE if ULP co-processor is not enabled or if wakeup triggers conflict

*esp\_err\_t* **esp\_sleep\_enable\_timer\_wakeup** (uint64\_t time\_in\_us)

Enable wakeup by timer.

**Parameters** *time\_in\_us* –time before wakeup, in microseconds

**Returns**

- ESP\_OK on success
- ESP\_ERR\_INVALID\_ARG if value is out of range (TBD)

*esp\_err\_t* **esp\_sleep\_enable\_touchpad\_wakeup** (void)

Enable wakeup by touch sensor.

---

**Note:** On ESP32, touch wakeup source can not be used when RTC\_PERIPH power domain is forced to be powered on (ESP\_PD\_OPTION\_ON) or when ext0 wakeup source is used.

---

---

**Note:** The FSM mode of the touch button should be configured as the timer trigger mode.

---

**Returns**

- ESP\_OK on success
- ESP\_ERR\_NOT\_SUPPORTED if additional current by touch (CONFIG\_RTC\_EXT\_CRYST\_ADDIT\_CURRENT) is enabled.
- ESP\_ERR\_INVALID\_STATE if wakeup triggers conflict

*touch\_pad\_t* **esp\_sleep\_get\_touchpad\_wakeup\_status** (void)

Get the touch pad which caused wakeup.

If wakeup was caused by another source, this function will return TOUCH\_PAD\_MAX;

**Returns** touch pad which caused wakeup

bool **esp\_sleep\_is\_valid\_wakeup\_gpio** (*gpio\_num\_t* gpio\_num)

Returns true if a GPIO number is valid for use as wakeup source.

---

**Note:** For SoCs with RTC IO capability, this can be any valid RTC IO input pin.

---

**Parameters** *gpio\_num* –Number of the GPIO to test for wakeup source capability

**Returns** True if this GPIO number will be accepted as a sleep wakeup source.

*esp\_err\_t* **esp\_sleep\_enable\_ext0\_wakeup** (*gpio\_num\_t* gpio\_num, int level)

Enable wakeup using a pin.

This function uses external wakeup feature of RTC\_IO peripheral. It will work only if RTC peripherals are kept on during sleep.

This feature can monitor any pin which is an RTC IO. Once the pin transitions into the state given by level argument, the chip will be woken up.

---

**Note:** This function does not modify pin configuration. The pin is configured in `esp_deep_sleep_start/esp_light_sleep_start`, immediately before entering sleep mode.

---

---

**Note:** ESP32: ext0 wakeup source can not be used together with touch or ULP wakeup sources.

---

#### Parameters

- **gpio\_num** –GPIO number used as wakeup source. Only GPIOs with the RTC functionality can be used. For different SoCs, the related GPIOs are:
  - ESP32: 0, 2, 4, 12-15, 25-27, 32-39
  - ESP32-S2: 0-21
  - ESP32-S3: 0-21
- **level** –input level which will trigger wakeup (0=low, 1=high)

#### Returns

- ESP\_OK on success
- ESP\_ERR\_INVALID\_ARG if the selected GPIO is not an RTC GPIO, or the mode is invalid
- ESP\_ERR\_INVALID\_STATE if wakeup triggers conflict

*esp\_err\_t* **esp\_sleep\_enable\_ext1\_wakeup** (uint64\_t mask, *esp\_sleep\_ext1\_wakeup\_mode\_t* mode)

Enable wakeup using multiple pins.

This function uses external wakeup feature of RTC controller. It will work even if RTC peripherals are shut down during sleep.

This feature can monitor any number of pins which are in RTC IOs. Once any of the selected pins goes into the state given by mode argument, the chip will be woken up.

---

**Note:** This function does not modify pin configuration. The pins are configured in `esp_deep_sleep_start/esp_light_sleep_start`, immediately before entering sleep mode.

---

---

**Note:** Internal pullups and pulldowns don't work when RTC peripherals are shut down. In this case, external resistors need to be added. Alternatively, RTC peripherals (and pullups/pulldowns) may be kept enabled using `esp_sleep_pd_config` function.

---

#### Parameters

- **mask** –bit mask of GPIO numbers which will cause wakeup. Only GPIOs which have RTC functionality can be used in this bit map. For different SoCs, the related GPIOs are:
  - ESP32: 0, 2, 4, 12-15, 25-27, 32-39
  - ESP32-S2: 0-21
  - ESP32-S3: 0-21
  - ESP32-C6: 0-7
  - ESP32-H2: 7-14
- **mode** –select logic function used to determine wakeup condition:
  - ESP\_EXT1\_WAKEUP\_ALL\_LOW: wake up when all selected GPIOs are low
  - ESP\_EXT1\_WAKEUP\_ANY\_HIGH: wake up when any of the selected GPIOs is high

**Returns**

- ESP\_OK on success
- ESP\_ERR\_INVALID\_ARG if any of the selected GPIOs is not an RTC GPIO, or mode is invalid

*esp\_err\_t* **esp\_sleep\_enable\_gpio\_wakeup** (void)

Enable wakeup from light sleep using GPIOs.

Each GPIO supports wakeup function, which can be triggered on either low level or high level. Unlike EXT0 and EXT1 wakeup sources, this method can be used both for all IOs: RTC IOs and digital IOs. It can only be used to wakeup from light sleep though.

To enable wakeup, first call `gpio_wakeup_enable`, specifying `gpio` number and wakeup level, for each GPIO which is used for wakeup. Then call this function to enable wakeup feature.

---

**Note:** On ESP32, GPIO wakeup source can not be used together with touch or ULP wakeup sources.

---

**Returns**

- ESP\_OK on success
- ESP\_ERR\_INVALID\_STATE if wakeup triggers conflict

*esp\_err\_t* **esp\_sleep\_enable\_uart\_wakeup** (int `uart_num`)

Enable wakeup from light sleep using UART.

Use `uart_set_wakeup_threshold` function to configure UART wakeup threshold.

Wakeup from light sleep takes some time, so not every character sent to the UART can be received by the application.

---

**Note:** ESP32 does not support wakeup from UART2.

---

**Parameters** `uart_num` –UART port to wake up from

**Returns**

- ESP\_OK on success
- ESP\_ERR\_INVALID\_ARG if wakeup from given UART is not supported

*esp\_err\_t* **esp\_sleep\_enable\_bt\_wakeup** (void)

Enable wakeup by bluetooth.

**Returns**

- ESP\_OK on success
- ESP\_ERR\_NOT\_SUPPORTED if wakeup from bluetooth is not supported

*esp\_err\_t* **esp\_sleep\_disable\_bt\_wakeup** (void)

Disable wakeup by bluetooth.

**Returns**

- ESP\_OK on success
- ESP\_ERR\_NOT\_SUPPORTED if wakeup from bluetooth is not supported

*esp\_err\_t* **esp\_sleep\_enable\_wifi\_wakeup** (void)

Enable wakeup by WiFi MAC.

**Returns**

- ESP\_OK on success

*esp\_err\_t* **esp\_sleep\_disable\_wifi\_wakeup** (void)

Disable wakeup by WiFi MAC.

**Returns**

- ESP\_OK on success

uint64\_t **esp\_sleep\_get\_ext1\_wakeup\_status** (void)

Get the bit mask of GPIOs which caused wakeup (ext1)

If wakeup was caused by another source, this function will return 0.

**Returns** bit mask, if GPIO n caused wakeup, BIT(n) will be set

*esp\_err\_t* **esp\_sleep\_pd\_config** (*esp\_sleep\_pd\_domain\_t* domain, *esp\_sleep\_pd\_option\_t* option)

Set power down mode for an RTC power domain in sleep mode.

If not set using this API, all power domains default to ESP\_PD\_OPTION\_AUTO.

**Parameters**

- **domain** –power domain to configure
- **option** –power down option (ESP\_PD\_OPTION\_OFF, ESP\_PD\_OPTION\_ON, or ESP\_PD\_OPTION\_AUTO)

**Returns**

- ESP\_OK on success
- ESP\_ERR\_INVALID\_ARG if either of the arguments is out of range

void **esp\_deep\_sleep\_start** (void)

Enter deep sleep with the configured wakeup options.

This function does not return.

*esp\_err\_t* **esp\_light\_sleep\_start** (void)

Enter light sleep with the configured wakeup options.

**Returns**

- ESP\_OK on success (returned after wakeup)
- ESP\_ERR\_SLEEP\_REJECT sleep request is rejected (wakeup source set before the sleep request)
- ESP\_ERR\_SLEEP\_TOO\_SHORT\_SLEEP\_DURATION after deducting the sleep flow overhead, the final sleep duration is too short to cover the minimum sleep duration of the chip, when rtc timer wakeup source enabled

void **esp\_deep\_sleep** (uint64\_t time\_in\_us)

Enter deep-sleep mode.

The device will automatically wake up after the deep-sleep time. Upon waking up, the device calls deep sleep wake stub, and then proceeds to load application.

Call to this function is equivalent to a call to esp\_deep\_sleep\_enable\_timer\_wakeup followed by a call to esp\_deep\_sleep\_start.

esp\_deep\_sleep does not shut down WiFi, BT, and higher level protocol connections gracefully. Make sure relevant WiFi and BT stack functions are called to close any connections and deinitialize the peripherals. These include:

- esp\_bluedroid\_disable
- esp\_bt\_controller\_disable
- esp\_wifi\_stop

This function does not return.

---

**Note:** The device will wake up immediately if the deep-sleep time is set to 0

---

**Parameters** **time\_in\_us** –deep-sleep time, unit: microsecond

*esp\_sleep\_wakeup\_cause\_t* **esp\_sleep\_get\_wakeup\_cause** (void)

Get the wakeup source which caused wakeup from sleep.

**Returns** cause of wake up from last sleep (deep sleep or light sleep)

void **esp\_wake\_deep\_sleep** (void)

Default stub to run on wake from deep sleep.

Allows for executing code immediately on wake from sleep, before the software bootloader or ESP-IDF app has started up.

This function is weak-linked, so you can implement your own version to run code immediately when the chip wakes from sleep.

See docs/deep-sleep-stub.rst for details.

void **esp\_set\_deep\_sleep\_wake\_stub** (*esp\_deep\_sleep\_wake\_stub\_fn\_t* new\_stub)

Install a new stub at runtime to run on wake from deep sleep.

If implementing `esp_wake_deep_sleep()` then it is not necessary to call this function.

However, it is possible to call this function to substitute a different deep sleep stub. Any function used as a deep sleep stub must be marked `RTC_IRAM_ATTR`, and must obey the same rules given for `esp_wake_deep_sleep()`.

*esp\_deep\_sleep\_wake\_stub\_fn\_t* **esp\_get\_deep\_sleep\_wake\_stub** (void)

Get current wake from deep sleep stub.

**Returns** Return current wake from deep sleep stub, or NULL if no stub is installed.

void **esp\_default\_wake\_deep\_sleep** (void)

The default esp-idf-provided `esp_wake_deep_sleep()` stub.

See docs/deep-sleep-stub.rst for details.

void **esp\_deep\_sleep\_disable\_rom\_logging** (void)

Disable logging from the ROM code after deep sleep.

Using LSB of `RTC_STORE4`.

void **esp\_sleep\_config\_gpio\_isolate** (void)

Configure to isolate all GPIO pins in sleep state.

void **esp\_sleep\_enable\_gpio\_switch** (bool enable)

Enable or disable GPIO pins status switching between slept status and waked status.

**Parameters** `enable` –decide whether to switch status or not

## Type Definitions

```
typedef esp_sleep_source_t esp_sleep_wakeup_cause_t
```

```
typedef void (*esp_deep_sleep_wake_stub_fn_t)(void)
```

Function type for stub to run on wake from sleep.

## Enumerations

```
enum esp_sleep_ext1_wakeup_mode_t
```

Logic function used for EXT1 wakeup mode.

*Values:*

enumerator **ESP\_EXT1\_WAKEUP\_ANY\_LOW**

Wake the chip when any of the selected GPIOs go low.

enumerator **ESP\_EXT1\_WAKEUP\_ANY\_HIGH**

Wake the chip when any of the selected GPIOs go high.

enumerator **ESP\_EXT1\_WAKEUP\_ALL\_LOW**

enum **esp\_sleep\_pd\_domain\_t**

Power domains which can be powered down in sleep mode.

*Values:*

enumerator **ESP\_PD\_DOMAIN\_RTC\_PERIPH**

RTC IO, sensors and ULP co-processor.

enumerator **ESP\_PD\_DOMAIN\_RTC\_SLOW\_MEM**

RTC slow memory.

enumerator **ESP\_PD\_DOMAIN\_RTC\_FAST\_MEM**

RTC fast memory.

enumerator **ESP\_PD\_DOMAIN\_XTAL**

XTAL oscillator.

enumerator **ESP\_PD\_DOMAIN\_RTC8M**

Internal 8M oscillator.

enumerator **ESP\_PD\_DOMAIN\_VDDSDIO**

VDD\_SDIO.

enumerator **ESP\_PD\_DOMAIN\_MAX**

Number of domains.

enum **esp\_sleep\_pd\_option\_t**

Power down options.

*Values:*

enumerator **ESP\_PD\_OPTION\_OFF**

Power down the power domain in sleep mode.

enumerator **ESP\_PD\_OPTION\_ON**

Keep power domain enabled during sleep mode.

enumerator **ESP\_PD\_OPTION\_AUTO**

Keep power domain enabled in sleep mode, if it is needed by one of the wakeup options. Otherwise power it down.

enum **esp\_sleep\_source\_t**

Sleep wakeup cause.

*Values:*

enumerator **ESP\_SLEEP\_WAKEUP\_UNDEFINED**

In case of deep sleep, reset was not caused by exit from deep sleep.

enumerator **ESP\_SLEEP\_WAKEUP\_ALL**

Not a wakeup cause, used to disable all wakeup sources with `esp_sleep_disable_wakeup_source`.

enumerator **ESP\_SLEEP\_WAKEUP\_EXT0**

Wakeup caused by external signal using `RTC_IO`.

enumerator **ESP\_SLEEP\_WAKEUP\_EXT1**

Wakeup caused by external signal using `RTC_CNTL`.

enumerator **ESP\_SLEEP\_WAKEUP\_TIMER**

Wakeup caused by timer.

enumerator **ESP\_SLEEP\_WAKEUP\_TOUCHPAD**

Wakeup caused by touchpad.

enumerator **ESP\_SLEEP\_WAKEUP\_ULP**

Wakeup caused by ULP program.

enumerator **ESP\_SLEEP\_WAKEUP\_GPIO**

Wakeup caused by GPIO (light sleep only on ESP32, S2 and S3)

enumerator **ESP\_SLEEP\_WAKEUP\_UART**

Wakeup caused by UART (light sleep only)

enumerator **ESP\_SLEEP\_WAKEUP\_WIFI**

Wakeup caused by WIFI (light sleep only)

enumerator **ESP\_SLEEP\_WAKEUP\_COCPU**

Wakeup caused by COCPU int.

enumerator **ESP\_SLEEP\_WAKEUP\_COCPU\_TRAP\_TRIG**

Wakeup caused by COCPU crash.

enumerator **ESP\_SLEEP\_WAKEUP\_BT**

Wakeup caused by BT (light sleep only)

enum [**anonymous**]

*Values:*

enumerator **ESP\_ERR\_SLEEP\_REJECT**

enumerator **ESP\_ERR\_SLEEP\_TOO\_SHORT\_SLEEP\_DURATION**

## 2.9.26 SoC Capabilities

This section lists definitions of the ESP32-S2's SoC hardware capabilities. These definitions are commonly used in IDF to control which hardware dependent features are supported and thus compiled into the binary.

---

**Note:** These defines are currently not considered to be part of the public API, and may be changed at any time.

---

### API Reference

#### Header File

- [components/soc/esp32s2/include/soc/soc\\_caps.h](#)

#### Macros

SOC\_ADC\_SUPPORTED

SOC\_DAC\_SUPPORTED

SOC\_TWAI\_SUPPORTED

SOC\_CP\_DMA\_SUPPORTED

SOC\_DEDICATED\_GPIO\_SUPPORTED

SOC\_SUPPORTS\_SECURE\_DL\_MODE

SOC\_RISCV\_COPROC\_SUPPORTED

SOC\_USB\_OTG\_SUPPORTED

SOC\_PCNT\_SUPPORTED

SOC\_WIFI\_SUPPORTED

SOC\_ULP\_SUPPORTED

SOC\_CCOMP\_TIMER\_SUPPORTED

SOC\_ASYNC\_MEMCPY\_SUPPORTED

SOC\_EFUSE\_KEY\_PURPOSE\_FIELD

SOC\_TEMP\_SENSOR\_SUPPORTED

SOC\_CACHE\_SUPPORT\_WRAP



**SOC\_RTC\_FAST\_MEM\_SUPPORTED**

**SOC\_RTC\_SLOW\_MEM\_SUPPORTED**

**SOC\_RTC\_MEM\_SUPPORTED**

**SOC\_PSRAM\_DMA\_CAPABLE**

**SOC\_XT\_WDT\_SUPPORTED**

**SOC\_I2S\_SUPPORTED**

**SOC\_RMT\_SUPPORTED**

**SOC\_SDM\_SUPPORTED**

**SOC\_SYSTIMER\_SUPPORTED**

**SOC\_SUPPORT\_COEXISTENCE**

**SOC\_AES\_SUPPORTED**

**SOC\_MPI\_SUPPORTED**

**SOC\_SHA\_SUPPORTED**

**SOC\_HMAC\_SUPPORTED**

**SOC\_DIG\_SIGN\_SUPPORTED**

**SOC\_FLASH\_ENC\_SUPPORTED**

**SOC\_SECURE\_BOOT\_SUPPORTED**

**SOC\_MEMPROT\_SUPPORTED**

**SOC\_TOUCH\_SENSOR\_SUPPORTED**

**SOC\_XTAL\_SUPPORT\_40M**

**SOC\_ADC\_RTC\_CTRL\_SUPPORTED**

< SAR ADC Module

**SOC\_ADC\_DIG\_CTRL\_SUPPORTED**

**SOC\_ADC\_ARBITER\_SUPPORTED**

**SOC\_ADC\_FILTER\_SUPPORTED**

**SOC\_ADC\_MONITOR\_SUPPORTED**

**SOC\_ADC\_DMA\_SUPPORTED**

**SOC\_ADC\_DIG\_SUPPORTED\_UNIT** (UNIT)

**SOC\_ADC\_PERIPH\_NUM**

**SOC\_ADC\_CHANNEL\_NUM** (UNIT)

**SOC\_ADC\_MAX\_CHANNEL\_NUM**

**SOC\_ADC\_ATTEN\_NUM**

Digital

**SOC\_ADC\_DIGI\_CONTROLLER\_NUM**

**SOC\_ADC\_PATT\_LEN\_MAX**

Two pattern table, each contains 16 items. Each item takes 1 byte

**SOC\_ADC\_DIGI\_MIN\_BITWIDTH**

**SOC\_ADC\_DIGI\_MAX\_BITWIDTH**

**SOC\_ADC\_DIGI\_RESULT\_BYTES**

**SOC\_ADC\_DIGI\_DATA\_BYTES\_PER\_CONV**

$F_{\text{sample}} = F_{\text{digi\_con}} / 2 / \text{interval}$ .  $F_{\text{digi\_con}} = 5\text{M}$  for now.  $30 \leq \text{interval} \leq 4095$

**SOC\_ADC\_SAMPLE\_FREQ\_THRES\_HIGH**

**SOC\_ADC\_SAMPLE\_FREQ\_THRES\_LOW**

RTC

**SOC\_ADC\_RTC\_MIN\_BITWIDTH**

**SOC\_ADC\_RTC\_MAX\_BITWIDTH**

**SOC\_RTC\_SLOW\_CLOCK\_SUPPORT\_8MD256**

Calibration

**SOC\_ADC\_CALIBRATION\_V1\_SUPPORTED**

support HW offset calibration version 1

**SOC\_BROWNOUT\_RESET\_SUPPORTED**

**SOC\_MMU\_LINEAR\_ADDRESS\_REGION\_NUM**

**SOC\_CP\_DMA\_MAX\_BUFFER\_SIZE**

Maximum size of the buffer that can be attached to descriptor

**SOC\_CPU\_CORES\_NUM**

**SOC\_CPU\_INTR\_NUM**

**SOC\_CPU\_BREAKPOINTS\_NUM**

**SOC\_CPU\_WATCHPOINTS\_NUM**

**SOC\_CPU\_WATCHPOINT\_MAX\_REGION\_SIZE**

**SOC\_DAC\_PERIPH\_NUM**

**SOC\_DAC\_RESOLUTION**

**SOC\_GPIO\_PORT**

**SOC\_GPIO\_PIN\_COUNT**

**SOC\_GPIO\_SUPPORT\_RTC\_INDEPENDENT**

**SOC\_GPIO\_SUPPORT\_FORCE\_HOLD**

**SOC\_GPIO\_VALID\_GPIO\_MASK**

**SOC\_GPIO\_VALID\_OUTPUT\_GPIO\_MASK**

**SOC\_GPIO\_VALID\_DIGITAL\_IO\_PAD\_MASK**

**SOC\_DEDIC\_GPIO\_OUT\_CHANNELS\_NUM**

8 outward channels on each CPU core

**SOC\_DEDIC\_GPIO\_IN\_CHANNELS\_NUM**

8 inward channels on each CPU core

**SOC\_DEDIC\_GPIO\_ALLOW\_REG\_ACCESS**

Allow access dedicated GPIO channel by register

**SOC\_DEDIC\_GPIO\_HAS\_INTERRUPT**

Dedicated GPIO has its own interrupt source

**SOC\_DEDIC\_GPIO\_OUT\_AUTO\_ENABLE**

Dedicated GPIO output attribution is enabled automatically

**SOC\_I2C\_NUM**

**SOC\_I2C\_FIFO\_LEN**

I2C hardware FIFO depth

**SOC\_I2C\_SUPPORT\_SLAVE**

**SOC\_I2C\_SUPPORT\_HW\_CLR\_BUS**

**SOC\_I2C\_SUPPORT\_REF\_TICK**

**SOC\_I2C\_SUPPORT\_APB**

**SOC\_CLK\_APLL\_SUPPORTED**

**SOC\_APLL\_MULTIPLIER\_OUT\_MIN\_HZ**

**SOC\_APLL\_MULTIPLIER\_OUT\_MAX\_HZ**

**SOC\_APLL\_MIN\_HZ**

**SOC\_APLL\_MAX\_HZ**

**SOC\_I2S\_NUM**

**SOC\_I2S\_HW\_VERSION\_1**

**SOC\_I2S\_SUPPORTS\_APLL**

**SOC\_I2S\_SUPPORTS\_DMA\_EQUAL**

**SOC\_I2S\_SUPPORTS\_LCD\_CAMERA**

**SOC\_I2S\_APLL\_MIN\_FREQ**

**SOC\_I2S\_APLL\_MAX\_FREQ**

**SOC\_I2S\_APLL\_MIN\_RATE**

**SOC\_I2S\_LCD\_I80\_VARIANT**

**SOC\_LCD\_I80\_SUPPORTED**

Intel 8080 LCD is supported

**SOC\_LCD\_I80\_BUSES**

Only I2S0 has LCD mode

**SOC\_LCD\_I80\_BUS\_WIDTH**

Intel 8080 bus width

**SOC\_LEDC\_HAS\_TIMER\_SPECIFIC\_MUX**

**SOC\_LEDC\_SUPPORT\_APB\_CLOCK**

**SOC\_LEDC\_SUPPORT\_REF\_TICK**

**SOC\_LEDC\_SUPPORT\_XTAL\_CLOCK**

**SOC\_LEDC\_CHANNEL\_NUM**

**SOC\_LEDC\_TIMER\_BIT\_WIDE\_NUM**

**SOC\_LEDC\_SUPPORT\_FADE\_STOP**

**SOC\_MPU\_CONFIGURABLE\_REGIONS\_SUPPORTED**

**SOC\_MPU\_MIN\_REGION\_SIZE**

**SOC\_MPU\_REGIONS\_MAX\_NUM**

**SOC\_MPU\_REGION\_RO\_SUPPORTED**

**SOC\_MPU\_REGION\_WO\_SUPPORTED**

**SOC\_PCNT\_GROUPS**

**SOC\_PCNT\_UNITS\_PER\_GROUP**

**SOC\_PCNT\_CHANNELS\_PER\_UNIT**

**SOC\_PCNT\_THRES\_POINT\_PER\_UNIT**

**SOC\_RMT\_GROUPS**

One RMT group

**SOC\_RMT\_TX\_CANDIDATES\_PER\_GROUP**

Number of channels that capable of Transmit in each group

**SOC\_RMT\_RX\_CANDIDATES\_PER\_GROUP**

Number of channels that capable of Receive in each group

**SOC\_RMT\_CHANNELS\_PER\_GROUP**

Total 4 channels

**SOC\_RMT\_MEM\_WORDS\_PER\_CHANNEL**

Each channel owns 64 words memory (1 word = 4 Bytes)

**SOC\_RMT\_SUPPORT\_RX\_DEMODULATION**

Support signal demodulation on RX path (i.e. remove carrier)

**SOC\_RMT\_SUPPORT\_TX\_ASYNC\_STOP**

Support stop transmission asynchronously

**SOC\_RMT\_SUPPORT\_TX\_LOOP\_COUNT**

Support transmitting specified number of cycles in loop mode

**SOC\_RMT\_SUPPORT\_TX\_SYNCHRO**

Support coordinate a group of TX channels to start simultaneously

**SOC\_RMT\_SUPPORT\_TX\_CARRIER\_DATA\_ONLY**

TX carrier can be modulated to data phase only

**SOC\_RMT\_SUPPORT\_REF\_TICK**

Support set REF\_TICK as the RMT clock source

**SOC\_RMT\_SUPPORT\_APB**

Support set APB as the RMT clock source

**SOC\_RMT\_CHANNEL\_CLK\_INDEPENDENT**

Can select different source clock for each channel

**SOC\_RTCIO\_PIN\_COUNT**

**SOC\_RTCIO\_INPUT\_OUTPUT\_SUPPORTED**

**SOC\_RTCIO\_HOLD\_SUPPORTED**

**SOC\_RTCIO\_WAKE\_SUPPORTED**

**SOC\_SDM\_GROUPS**

**SOC\_SDM\_CHANNELS\_PER\_GROUP**

**SOC\_SPI\_HD\_BOTH\_INOUT\_SUPPORTED**

**SOC\_SPI\_PERIPH\_NUM**

**SOC\_SPI\_DMA\_CHAN\_NUM**

`SOC_SPI_PERIPH_CS_NUM` (i)

`SOC_SPI_MAX_CS_NUM`

`SOC_SPI_MAXIMUM_BUFFER_SIZE`

`SOC_SPI_MAX_PRE_DIVIDER`

`SOC_SPI_SUPPORT_DDRCLK`

`SOC_SPI_SLAVE_SUPPORT_SEG_TRANS`

`SOC_SPI_SUPPORT_CD_SIG`

`SOC_SPI_SUPPORT_CONTINUOUS_TRANS`

`SOC_SPI_SUPPORT_SLAVE_HD_VER2`

The SPI Slave half duplex mode has been updated greatly in ESP32-S2.

`SOC_SPI_PERIPH_SUPPORT_MULTILINE_MODE` (host\_id)

`SOC_SPI_PERIPH_SUPPORT_CONTROL_DUMMY_OUT`

`SOC_MEMSPI_IS_INDEPENDENT`

`SOC_SPI_SUPPORT_OCT`

`SOC_MEMSPI_SRC_FREQ_80M_SUPPORTED`

`SOC_MEMSPI_SRC_FREQ_40M_SUPPORTED`

`SOC_MEMSPI_SRC_FREQ_26M_SUPPORTED`

`SOC_MEMSPI_SRC_FREQ_20M_SUPPORTED`

`SOC_SYSTIMER_COUNTER_NUM`

`SOC_SYSTIMER_ALARM_NUM`

`SOC_SYSTIMER_BIT_WIDTH_LO`

`SOC_SYSTIMER_BIT_WIDTH_HI`

`SOC_TIMER_GROUPS`

`SOC_TIMER_GROUP_TIMERS_PER_GROUP`

**SOC\_TIMER\_GROUP\_COUNTER\_BIT\_WIDTH**

**SOC\_TIMER\_GROUP\_SUPPORT\_XTAL**

**SOC\_TIMER\_GROUP\_SUPPORT\_APB**

**SOC\_TIMER\_GROUP\_TOTAL\_TIMERS**

**SOC\_TOUCH\_VERSION\_2**

Hardware version of touch sensor

**SOC\_TOUCH\_SENSOR\_NUM**

15 Touch channels

**SOC\_TOUCH\_PROXIMITY\_CHANNEL\_NUM**

**SOC\_TOUCH\_PAD\_THRESHOLD\_MAX**

If set touch threshold max value, The touch sensor can't be in touched status

**SOC\_TOUCH\_PAD\_MEASURE\_WAIT\_MAX**

The timer frequency is 8Mhz, the max value is 0xff

**SOC\_TWAI\_BRP\_MIN**

**SOC\_TWAI\_BRP\_MAX**

**SOC\_TWAI\_SUPPORTS\_RX\_STATUS**

**SOC\_UART\_NUM**

**SOC\_UART\_SUPPORT\_WAKEUP\_INT**

Support UART wakeup interrupt

**SOC\_UART\_SUPPORT\_APB\_CLK**

Support APB as the clock source

**SOC\_UART\_SUPPORT\_REF\_TICK**

Support REF\_TICK as the clock source

**SOC\_UART\_FIFO\_LEN**

The UART hardware FIFO length

**SOC\_UART\_BITRATE\_MAX**

Max bit rate supported by UART

**SOC\_SPIRAM\_SUPPORTED**



SOC\_USB\_OTG\_PERIPH\_NUM

SOC\_SHA\_DMA\_MAX\_BUFFER\_SIZE

SOC\_SHA\_SUPPORT\_DMA

SOC\_SHA\_SUPPORT\_RESUME

SOC\_SHA\_CRYPTODMA

SOC\_SHA\_SUPPORT\_SHA1

SOC\_SHA\_SUPPORT\_SHA224

SOC\_SHA\_SUPPORT\_SHA256

SOC\_SHA\_SUPPORT\_SHA384

SOC\_SHA\_SUPPORT\_SHA512

SOC\_SHA\_SUPPORT\_SHA512\_224

SOC\_SHA\_SUPPORT\_SHA512\_256

SOC\_SHA\_SUPPORT\_SHA512\_T

SOC\_RSA\_MAX\_BIT\_LEN

SOC\_AES\_SUPPORT\_DMA

SOC\_AES\_SUPPORT\_GCM

SOC\_EFUSE\_DIS\_DOWNLOAD\_DCACHE

SOC\_EFUSE\_HARD\_DIS\_JTAG

SOC\_EFUSE\_SOFT\_DIS\_JTAG

SOC\_EFUSE\_DIS\_BOOT\_REMAP

SOC\_EFUSE\_DIS\_LEGACY\_SPI\_BOOT

SOC\_SECURE\_BOOT\_V2\_RSA

SOC\_EFUSE\_SECURE\_BOOT\_KEY\_DIGESTS

SOC\_EFUSE\_REVOKE\_BOOT\_KEY\_DIGESTS

SOC\_SUPPORT\_SECURE\_BOOT\_REVOKE\_KEY

SOC\_FLASH\_ENCRYPTED\_XTS\_AES\_BLOCK\_MAX

SOC\_FLASH\_ENCRYPTION\_XTS\_AES

SOC\_FLASH\_ENCRYPTION\_XTS\_AES\_OPTIONS

SOC\_FLASH\_ENCRYPTION\_XTS\_AES\_128

SOC\_FLASH\_ENCRYPTION\_XTS\_AES\_256

SOC\_MEMPROT\_CPU\_PREFETCH\_PAD\_SIZE

SOC\_MEMPROT\_MEM\_ALIGN\_SIZE

SOC\_AES\_CRYPTO\_DMA

SOC\_AES\_SUPPORT\_AES\_128

SOC\_AES\_SUPPORT\_AES\_192

SOC\_AES\_SUPPORT\_AES\_256

SOC\_PHY\_DIG\_REGS\_MEM\_SIZE

SOC\_WIFI\_LIGHT\_SLEEP\_CLK\_WIDTH

SOC\_SPI\_MEM\_SUPPORT\_AUTO\_WAIT\_IDLE

SOC\_SPI\_MEM\_SUPPORT\_AUTO\_SUSPEND

SOC\_SPI\_MEM\_SUPPORT\_SW\_SUSPEND

SOC\_SPI\_MEM\_SUPPORT\_CONFIG\_GPIO\_BY\_EFUSE

SOC\_PM\_SUPPORT\_EXT\_WAKEUP

SOC\_PM\_SUPPORT\_WIFI\_WAKEUP

SOC\_PM\_SUPPORT\_TOUCH\_SENSOR\_WAKEUP

Supports waking up from touch pad trigger

**SOC\_PM\_SUPPORT\_WIFI\_PD**

**SOC\_PM\_SUPPORT\_RTC\_PERIPH\_PD**

**SOC\_PM\_SUPPORT\_RTC\_FAST\_MEM\_PD**

**SOC\_PM\_SUPPORT\_RTC\_SLOW\_MEM\_PD**

**SOC\_COEX\_HW\_PTI**

**SOC\_TEMPERATURE\_SENSOR\_SUPPORT\_FAST\_RC**

**SOC\_WIFI\_HW\_TSF**

Support hardware TSF

**SOC\_WIFI\_FTM\_SUPPORT**

Support FTM

**SOC\_WIFI\_GCMP\_SUPPORT**

GCMP is not supported(GCMP128 and GCMP256)

**SOC\_WIFI\_WAPI\_SUPPORT**

Support WAPI

**SOC\_WIFI\_CSI\_SUPPORT**

Support CSI

**SOC\_WIFI\_MESH\_SUPPORT**

Support WIFI MESH

## 2.9.27 System Time

### Overview

ESP32-S2 uses two hardware timers for the purpose of keeping system time. System time can be kept by using either one or both of the hardware timers depending on the application's purpose and accuracy requirements for system time. The two hardware timers are:

- **RTC timer:** This timer allows time keeping in various sleep modes, and can also persist time keeping across any resets (with the exception of power-on resets which reset the RTC timer). The frequency deviation depends on the *RTC Timer Clock Sources* and affects the accuracy only in sleep modes, in which case the time will be measured at 6.6667  $\mu$ s resolution.
- **High-resolution timer:** This timer is not available in sleep modes and will not persist over a reset, but has greater accuracy. The timer uses the APB\_CLK clock source (typically 80 MHz), which has a frequency deviation of less than  $\pm 10$  ppm. Time will be measured at 1  $\mu$ s resolution.

The possible combinations of hardware timers used to keep system time are listed below:

- RTC and high-resolution timer (default)

- RTC
- High-resolution timer
- None

It is recommended that users stick to the default option as it provides the highest accuracy. However, users can also select a different setting via the `CONFIG_NEWLIB_TIME_SYSCALL` configuration option.

### RTC Timer Clock Sources

The RTC timer has the following clock sources:

- **Internal 90 kHz RC oscillator (default):** Features the lowest Deep-sleep current consumption and no dependence on any external components. However, the frequency stability of this clock source is affected by temperature fluctuations, so time may drift in both Deep-sleep and Light-sleep modes.
- **External 32 kHz crystal:** Requires a 32 kHz crystal to be connected to the XTAL\_32K\_P and XTAL\_32K\_N pins. This source provides a better frequency stability at the expense of a slightly higher (by 1  $\mu$ A) Deep-sleep current consumption.
- **External 32 kHz oscillator at XTAL\_32K\_P pin:** Allows using 32 kHz clock generated by an external circuit. The external clock signal must be connected to the XTAL\_32K\_P pin. The amplitude should be less than 1.2 V for sine wave signal and less than 1 V for square wave signal. Common mode voltage should be in the range of  $0.1 < V_{cm} < 0.5 \times V_{amp}$ , where  $V_{amp}$  stands for signal amplitude. In this case, the XTAL\_32K\_P pin cannot be used as a GPIO pin.
- **Internal 8.5 MHz oscillator, divided by 256 (~33 kHz):** Provides better frequency stability than the Internal 90 kHz RC oscillator at the expense of a higher (by 5  $\mu$ A) Deep-sleep current consumption. It also does not require external components.

The choice depends on your requirements for system time accuracy and power consumption in sleep modes. To modify the RTC clock source, set `CONFIG_RTC_CLK_SRC` in project configuration.

More details about the wiring requirements for the external crystal or external oscillator, please refer to [ESP32-S2 Hardware Design Guidelines](#).

### Get Current Time

To get the current time, use the POSIX function `gettimeofday()`. Additionally, you can use the following standard C library functions to obtain time and manipulate it:

```
gettimeofday
time
asctime
clock
ctime
difftime
gmtime
localtime
mktime
strftime
adjtime*
```

To stop smooth time adjustment and update the current time immediately, use the POSIX function `settimeofday()`.

If you need to obtain time with one second resolution, use the following code snippet:

```
time_t now;
char strftime_buf[64];
struct tm timeinfo;
```

(continues on next page)

(continued from previous page)

```
time(&now);
// Set timezone to China Standard Time
setenv("TZ", "CST-8", 1);
tzset();

localtime_r(&now, &timeinfo);
strftime(strftime_buf, sizeof(strftime_buf), "%c", &timeinfo);
ESP_LOGI(TAG, "The current date/time in Shanghai is: %s", strftime_buf);
```

If you need to obtain time with one microsecond resolution, use the code snippet below:

```
struct timeval tv_now;
gettimeofday(&tv_now, NULL);
int64_t time_us = (int64_t)tv_now.tv_sec * 1000000L + (int64_t)tv_now.tv_usec;
```

## SNTP Time Synchronization

To set the current time, you can use the POSIX functions `settimeofday()` and `adjtime()`. They are used internally in the lwIP SNTP library to set current time when a response from the NTP server is received. These functions can also be used separately from the lwIP SNTP library.

The function to use inside the lwIP SNTP library depends on the sync mode for system time. Use the function `sntp_set_sync_mode()` to set one of the following sync modes:

- `SNTP_SYNC_MODE_IMMED` (default): Updates system time immediately upon receiving a response from the SNTP server after using `settimeofday()`.
- `SNTP_SYNC_MODE_SMOOTH`: Updates time smoothly by gradually reducing time error using the function `adjtime()`. If the difference between the SNTP response time and system time is more than 35 minutes, update system time immediately by using `settimeofday()`.

The lwIP SNTP library has API functions for setting a callback function for a certain event. You might need the following functions:

- `sntp_set_time_sync_notification_cb()`: Can be used to set a callback function that will notify of the time synchronization process.
- `sntp_get_sync_status()` and `sntp_set_sync_status()`: Can be used to get/set time synchronization status.

To start synchronization via SNTP, just call the following three functions:

```
esp_sntp_setoperatingmode(ESP_SNTP_OPMODE_POLL);
esp_sntp_setservername(0, "pool.ntp.org");
esp_sntp_init();
```

An application with this initialization code will periodically synchronize the time. The time synchronization period is determined by `CONFIG_LWIP_SNTP_UPDATE_DELAY` (the default value is one hour). To modify the variable, set `CONFIG_LWIP_SNTP_UPDATE_DELAY` in project configuration.

A code example that demonstrates the implementation of time synchronization based on the lwIP SNTP library is provided in the `protocols/sntp` directory.

## Timezones

To set the local timezone, use the following POSIX functions:

1. Call `setenv()` to set the TZ environment variable to the correct value based on the device location. The format of the time string is the same as described in the [GNU libc documentation](#) (although the implementation is different).
2. Call `tzset()` to update C library runtime data for the new timezone.

Once these steps are completed, call the standard C library function `localtime()`, and it will return the correct local time taking into account the timezone offset and daylight saving time.

### Year 2036 and 2038 Overflow Issues

**SNTP/NTP 2036 Overflow** SNTP/NTP timestamps are represented as 64-bit unsigned fixed point numbers, where the first 32 bits represent the integer part, and the last 32 bits represent the fractional part. The 64-bit unsigned fixed point number represents the number of seconds since 00:00 on 1st of January 1900, thus SNTP/NTP times will overflow in the year 2036.

To address this issue, lifetime of the SNTP/NTP timestamps has been extended by convention by using the MSB (bit 0 by convention) of the integer part to indicate time ranges between years 1968 to 2104 (see [RFC2030](#) for more details). This convention is implemented in lwIP library SNTP module. Therefore SNTP-related functions in ESP-IDF are future-proof until year 2104.

**Unix Time 2038 Overflow** Unix time (type `time_t`) was previously represented as a 32-bit signed integer, leading to an overflow in year 2038 (i.e., [Y2K38 issue](#)). To address the Y2K38 issue, ESP-IDF uses a 64-bit signed integer to represent `time_t` starting from release v5.0, thus deferring `time_t` overflow for another 292 billion years.

## API Reference

### Header File

- [components/lwip/include/apps/esp\\_sntp.h](#)

### Functions

void **sntp\_sync\_time** (struct `timeval *tv`)

This function updates the system time.

This is a weak-linked function. It is possible to replace all SNTP update functionality by placing a `sntp_sync_time()` function in the app firmware source. If the default implementation is used, calling `sntp_set_sync_mode()` allows the time synchronization mode to be changed to instant or smooth. If a callback function is registered via `sntp_set_time_sync_notification_cb()`, it will be called following time synchronization.

**Parameters** `tv` –Time received from SNTP server.

void **sntp\_set\_sync\_mode** (`sntp_sync_mode_t sync_mode`)

Set the sync mode.

Modes allowed: `SNTP_SYNC_MODE_IMMED` and `SNTP_SYNC_MODE_SMOOTH`.

**Parameters** `sync_mode` –Sync mode.

`sntp_sync_mode_t` **sntp\_get\_sync\_mode** (void)

Get set sync mode.

**Returns** `SNTP_SYNC_MODE_IMMED`: Update time immediately.  
`SNTP_SYNC_MODE_SMOOTH`: Smooth time updating.

`sntp_sync_status_t` **sntp\_get\_sync\_status** (void)

Get status of time sync.

After the update is completed, the status will be returned as `SNTP_SYNC_STATUS_COMPLETED`. After that, the status will be reset to `SNTP_SYNC_STATUS_RESET`. If the update operation is not completed yet, the status will be `SNTP_SYNC_STATUS_RESET`. If a smooth mode was chosen and the synchronization is still continuing (adjtime works), then it will be `SNTP_SYNC_STATUS_IN_PROGRESS`.

**Returns** `SNTP_SYNC_STATUS_RESET`: Reset status. `SNTP_SYNC_STATUS_COMPLETED`: Time is synchronized. `SNTP_SYNC_STATUS_IN_PROGRESS`: Smooth time sync in progress.

void **sntp\_set\_sync\_status** (*sntp\_sync\_status\_t* sync\_status)

Set status of time sync.

**Parameters** **sync\_status** –status of time sync (see *sntp\_sync\_status\_t*)

void **sntp\_set\_time\_sync\_notification\_cb** (*sntp\_sync\_time\_cb\_t* callback)

Set a callback function for time synchronization notification.

**Parameters** **callback** –a callback function

void **sntp\_set\_sync\_interval** (uint32\_t interval\_ms)

Set the sync interval of SNTP operation.

Note: SNTPv4 RFC 4330 enforces a minimum sync interval of 15 seconds. This sync interval will be used in the next attempt update time through SNTP. To apply the new sync interval call the *sntp\_restart()* function, otherwise, it will be applied after the last interval expired.

**Parameters** **interval\_ms** –The sync interval in ms. It cannot be lower than 15 seconds, otherwise 15 seconds will be set.

uint32\_t **sntp\_get\_sync\_interval** (void)

Get the sync interval of SNTP operation.

**Returns** the sync interval

bool **sntp\_restart** (void)

Restart SNTP.

**Returns** True - Restart False - SNTP was not initialized yet

void **esp\_sntp\_setoperatingmode** (*esp\_sntp\_operatingmode\_t* operating\_mode)

Sets SNTP operating mode. The mode has to be set before init.

**Parameters** **operating\_mode** –Desired operating mode

void **esp\_sntp\_init** (void)

Init and start SNTP service.

void **esp\_sntp\_stop** (void)

Stops SNTP service.

void **esp\_sntp\_setserver** (u8\_t idx, const ip\_addr\_t \*addr)

Sets SNTP server address.

**Parameters**

- **idx** –Index of the server
- **addr** –IP address of the server

void **esp\_sntp\_setservername** (u8\_t idx, const char \*server)

Sets SNTP hostname.

**Parameters**

- **idx** –Index of the server
- **server** –Name of the server

const char \***esp\_sntp\_getservername** (u8\_t idx)

Gets SNTP server name.

**Parameters** **idx** –Index of the server

**Returns** Name of the server

const ip\_addr\_t \***esp\_sntp\_getserver** (u8\_t idx)

Get SNTP server IP.

**Parameters** **idx** –Index of the server

**Returns** IP address of the server

bool **esp\_sntp\_enabled** (void)

Checks if sntp is enabled.

**Returns** true if sntp module is enabled

### Macros

**esp\_sntp\_sync\_time**

Aliases for esp\_sntp prefixed API (inherently thread safe)

**esp\_sntp\_set\_sync\_mode**

**esp\_sntp\_get\_sync\_mode**

**esp\_sntp\_get\_sync\_status**

**esp\_sntp\_set\_sync\_status**

**esp\_sntp\_set\_time\_sync\_notification\_cb**

**esp\_sntp\_set\_sync\_interval**

**esp\_sntp\_get\_sync\_interval**

**esp\_sntp\_restart**

### Type Definitions

typedef void (\***sntp\_sync\_time\_cb\_t**)(struct timeval \*tv)

SNTP callback function for notifying about time sync event.

**Param tv** Time received from SNTP server.

### Enumerations

enum **sntp\_sync\_mode\_t**

SNTP time update mode.

*Values:*

enumerator **SNTP\_SYNC\_MODE\_IMMED**

Update system time immediately when receiving a response from the SNTP server.

enumerator **SNTP\_SYNC\_MODE\_SMOOTH**

Smooth time updating. Time error is gradually reduced using adjtime function. If the difference between SNTP response time and system time is large (more than 35 minutes) then update immediately.

enum **sntp\_sync\_status\_t**

SNTP sync status.

*Values:*



enumerator **SNTP\_SYNC\_STATUS\_RESET**

enumerator **SNTP\_SYNC\_STATUS\_COMPLETED**

enumerator **SNTP\_SYNC\_STATUS\_IN\_PROGRESS**

enum **esp\_sntp\_operatingmode\_t**

SNTP operating modes per lwip SNTP module.

*Values:*

enumerator **ESP\_SNTP\_OPMODE\_POLL**

enumerator **ESP\_SNTP\_OPMODE\_LISTENONLY**

## 2.9.28 The Async memcpy API

### Overview

ESP32-S2 has a DMA engine which can help to offload internal memory copy operations from the CPU in a asynchronous way.

The async memcpy API wraps all DMA configurations and operations, the signature of `esp_async_memcpy()` is almost the same to the standard libc one.

Thanks to the benefit of the DMA, we don't have to wait for each memory copy to be done before we issue another memcpy request. By the way, it's still possible to know when memcpy is finished by listening in the memcpy callback function.

---

**Note:** Memory copy from/to external PSRAM is not supported on ESP32-S2, `esp_async_memcpy()` will abort returning an error if buffer address is not in SRAM.

---

### Configure and Install driver

`esp_async_memcpy_install()` is used to install the driver with user's configuration. Please note that async memcpy has to be called with the handle returned from `esp_async_memcpy_install()`.

Driver configuration is described in `async_memcpy_config_t`:

- `backlog`: This is used to configure the maximum number of DMA operations being processed at the same time.
- `sram_trans_align`: Declare SRAM alignment for both data address and copy size, set to zero if the data has no restriction in alignment. If set to a quadruple value (i.e. 4X), the driver will enable the burst mode internally, which is helpful for some performance related application.
- `psram_trans_align`: Declare PSRAM alignment for both data address and copy size. User has to give it a valid value (only 16, 32, 64 are supported) if the destination of memcpy is located in PSRAM. The default alignment (i.e. 16) will be applied if it's set to zero. Internally, the driver configures the size of block used by DMA to access PSRAM, according to the alignment.
- `flags`: This is used to enable some special driver features.

`ASYNC_MEMCPY_DEFAULT_CONFIG` provides a default configuration, which specifies the backlog to 8.

```

async_memcpy_config_t config = ASYNC_MEMCPY_DEFAULT_CONFIG();
// update the maximum data stream supported by underlying DMA engine
config.backlog = 16;
async_memcpy_t driver = NULL;
ESP_ERROR_CHECK(esp_async_memcpy_install(&config, &driver)); // install driver,
↳return driver handle

```

### Send memory copy request

`esp_async_memcpy()` is the API to send memory copy request to DMA engine. It must be called after driver is installed successfully. This API is thread safe, so it can be called from different tasks.

Different from the libc version of `memcpy`, user should also pass a callback to `esp_async_memcpy()`, if it's necessary to be notified when the memory copy is done. The callback is executed in the ISR context, make sure you won't violate the restriction applied to ISR handler.

Besides that, the callback function should reside in IRAM space by applying `IRAM_ATTR` attribute. The prototype of the callback function is `async_memcpy_isr_cb_t`, please note that, the callback function should return true if it wakes up a high priority task by some API like `xSemaphoreGiveFromISR()`.

```

SemaphoreHandle_t semphr; //already initialized in somewhere

// Callback implementation, running in ISR context
static IRAM_ATTR bool my_async_memcpy_cb(async_memcpy_t mcp_hdl, async_memcpy_
↳event_t *event, void *cb_args)
{
    SemaphoreHandle_t sem = (SemaphoreHandle_t)cb_args;
    BaseType_t high_task_wakeup = pdFALSE;
    SemaphoreGiveInISR(semphr, &high_task_wakeup); // high_task_wakeup set to pdTRUE
↳if some high priority task unblocked
    return high_task_wakeup == pdTRUE;
}

// Called from user's context
ESP_ERROR_CHECK(esp_async_memcpy(driver_handle, to, from, copy_len, my_async_
↳memcpy_cb, my_semaphore));
//Do something else here
SemaphoreTake(my_semaphore, ...); //wait until the buffer copy is done

```

### Uninstall driver (optional)

`esp_async_memcpy_uninstall()` is used to uninstall asynchronous memcpy driver. It's not necessary to uninstall the driver after each memcpy operation. If you know your application won't use this driver anymore, then this API can recycle the memory for you.

## API Reference

### Header File

- `components/esp_hw_support/include/esp_async_memcpy.h`

### Functions

`esp_err_t esp_async_memcpy_install` (const `async_memcpy_config_t` \*config, `async_memcpy_t` \*asmcp)

Install async memcpy driver.

#### Parameters

- **config** –[in] Configuration of async memcpy

- **asmcp** –[out] Handle of async memcopy that returned from this API. If driver installation is failed, asmcp would be assigned to NULL.

**Returns**

- ESP\_OK: Install async memcopy driver successfully
- ESP\_ERR\_INVALID\_ARG: Install async memcopy driver failed because of invalid argument
- ESP\_ERR\_NO\_MEM: Install async memcopy driver failed because out of memory
- ESP\_FAIL: Install async memcopy driver failed because of other error

*esp\_err\_t* **esp\_async\_memcopy\_uninstall** (*async\_memcopy\_t* asmcp)

Uninstall async memcopy driver.

**Parameters** **asmcp** –[in] Handle of async memcopy driver that returned from esp\_async\_memcopy\_install

**Returns**

- ESP\_OK: Uninstall async memcopy driver successfully
- ESP\_ERR\_INVALID\_ARG: Uninstall async memcopy driver failed because of invalid argument
- ESP\_FAIL: Uninstall async memcopy driver failed because of other error

*esp\_err\_t* **esp\_async\_memcopy** (*async\_memcopy\_t* asmcp, void \*dst, void \*src, size\_t n, *async\_memcopy\_isr\_cb\_t* cb\_isr, void \*cb\_args)

Send an asynchronous memory copy request.

---

**Note:** The callback function is invoked in interrupt context, never do blocking jobs in the callback.

---

**Parameters**

- **asmcp** –[in] Handle of async memcopy driver that returned from esp\_async\_memcopy\_install
- **dst** –[in] Destination address (copy to)
- **src** –[in] Source address (copy from)
- **n** –[in] Number of bytes to copy
- **cb\_isr** –[in] Callback function, which got invoked in interrupt context. Set to NULL can bypass the callback.
- **cb\_args** –[in] User defined argument to be passed to the callback function

**Returns**

- ESP\_OK: Send memory copy request successfully
- ESP\_ERR\_INVALID\_ARG: Send memory copy request failed because of invalid argument
- ESP\_FAIL: Send memory copy request failed because of other error

**Structures**

struct **async\_memcopy\_event\_t**

Type of async memcopy event object.

**Public Members**

void \***data**

Event data

struct **async\_memcopy\_config\_t**

Type of async memcopy configuration.

## Public Members

uint32\_t **backlog**

Maximum number of streams that can be handled simultaneously

size\_t **sram\_trans\_align**

DMA transfer alignment (both in size and address) for SRAM memory

size\_t **psram\_trans\_align**

DMA transfer alignment (both in size and address) for PSRAM memory

uint32\_t **flags**

Extra flags to control async memcopy feature

## Macros

**ASYNC\_MEMCPY\_DEFAULT\_CONFIG** ()

Default configuration for async memcopy.

## Type Definitions

typedef struct async\_memcopy\_context\_t \***async\_memcopy\_t**

Type of async memcopy handle.

typedef bool (\***async\_memcopy\_isr\_cb\_t**)(*async\_memcopy\_t* mcp\_hdl, *async\_memcopy\_event\_t* \*event, void \*cb\_args)

Type of async memcopy interrupt callback function.

---

**Note:** User can call OS primitives (semaphore, mutex, etc) in the callback function. Keep in mind, if any OS primitive wakes high priority task up, the callback should return true.

---

**Param mcp\_hdl** Handle of async memcopy

**Param event** Event object, which contains related data, reserved for future

**Param cb\_args** User defined arguments, passed from esp\_async\_memcopy function

**Return** Whether a high priority task is woken up by the callback function

## 2.9.29 ULP Coprocessor programming

The Ultra Low Power (ULP) coprocessor is a simple finite state machine (FSM) which is designed to perform measurements using the ADC, temperature sensor, and external I2C sensors, while the main processors are in deep sleep mode. The ULP coprocessor can access the RTC\_SLOW\_MEM memory region, and registers in the RTC\_CNTL, RTC\_IO, and SARADC peripherals. The ULP coprocessor uses fixed-width 32-bit instructions, 32-bit memory addressing, and has 4 general-purpose 16-bit registers. This coprocessor is referred to as *ULP FSM* in ESP-IDF.

ESP32-S2 provides a second type of ULP coprocessor which is based on a RISC-V instruction set architecture. For details regarding *ULP RISC-V* refer [ULP-RISC-V Coprocessor](#).

## Installing the Toolchain

The ULP FSM coprocessor code is written in assembly and compiled using the [binutils-esp32ulp toolchain](#).

If you have already set up ESP-IDF with CMake build system according to the [Getting Started Guide](#), then the ULP FSM toolchain will already be installed.

## Programming ULP FSM

The ULP FSM can be programmed using the supported instruction set. Alternatively, the ULP FSM coprocessor can also be programmed using C Macros on the main CPU. These two methods are described in the following section:

**ESP32-S2 ULP coprocessor instruction set** This document provides details about the instructions used by ESP32-S2 ULP FSM coprocessor assembler.

ULP FSM coprocessor has 4 16-bit general purpose registers, labeled R0, R1, R2, R3. It also has an 8-bit counter register (stage\_cnt) which can be used to implement loops. Stage count register is accessed using special instructions.

ULP coprocessor can access 8k bytes of RTC\_SLOW\_MEM memory region. Memory is addressed in 32-bit word units. It can also access peripheral registers in RTC\_CNTL, RTC\_IO, and SENS peripherals.

All instructions are 32-bit. Jump instructions, ALU instructions, peripheral register and memory access instructions are executed in 1 cycle. Instructions which work with peripherals (TSENS, ADC, I2C) take variable number of cycles, depending on peripheral operation.

The instruction syntax is case insensitive. Upper and lower case letters can be used and intermixed arbitrarily. This is true both for register names and instruction names.

**Note about addressing** ESP32-S2 ULP FSM coprocessor's *JUMP*, *ST*, *LD* family of instructions expect the address argument to be expressed in the following way depending on the type of address argument used:

- When the address argument is presented as a label then the instruction expects the address to be expressed as 32-bit words.

Consider the following example program:

```
entry:
    NOP
    NOP
    NOP
    NOP
loop:
    MOVE R1, loop
    JUMP R1
```

When this program is assembled and linked, address of label `loop` will be equal to 16 (expressed in bytes). However *JUMP* instruction expects the address stored in register R1 to be expressed in 32-bit words. To account for this common use case, the assembler will convert the address of label `loop` from bytes to words, when generating the *MOVE* instruction. Hence, the code generated code will be equivalent to:

```
0000  NOP
0004  NOP
0008  NOP
000c  NOP
0010  MOVE R1, 4
0014  JUMP R1
```

- The other case is when the argument of *MOVE* instruction is not a label but a constant. In this case assembler will **use the value as is**, without any conversion:

```
.set      val, 0x10
MOVE     R1, val
```

In this case, value loaded into R1 will be 0x10.

However, when an immediate value is used as an offset in LD and ST instructions, the assembler considers the address argument in bytes and converts it to 32-bit words before executing the instruction:

```
ST R1, R2, 4 // offset = 4 bytes; Mem[R2 + 4 / 4] = R1
```

In this case, the value in R1 is stored at the memory location pointed by [R2 + offset / 4]

Consider the following code:

```
.global array
array: .long 0
       .long 0
       .long 0
       .long 0

MOVE R1, array
MOVE R2, 0x1234
ST R2, R1, 0 // write value of R2 into the first array element,
              // i.e. array[0]

ST R2, R1, 4 // write value of R2 into the second array element
              // (4 byte offset), i.e. array[1]

ADD R1, R1, 2 // this increments address by 2 words (8 bytes)
ST R2, R1, 0 // write value of R2 into the third array element,
              // i.e. array[2]
```

**Note about instruction execution time** ULP coprocessor is clocked from RTC\_FAST\_CLK, which is normally derived from the internal 8MHz oscillator. Applications which need to know exact ULP clock frequency can calibrate it against the main XTAL clock:

```
#include "soc/rtc.h"

// calibrate 8M/256 clock against XTAL, get 8M/256 clock period
uint32_t rtc_8md256_period = rtc_clk_cal(RTC_CAL_8MD256, 100);
uint32_t rtc_fast_freq_hz = 1000000ULL * (1 << RTC_CLK_CAL_FRACT) * 256 / rtc_
↪8md256_period;
```

ULP coprocessor needs certain number of clock cycles to fetch each instruction, plus certain number of cycles to execute it, depending on the instruction. See description of each instruction below for details on the execution time.

Instruction fetch time is:

- 2 clock cycles —for instructions following ALU and branch instructions.
- 4 clock cycles —in other cases.

Note that when accessing RTC memories and RTC registers, ULP coprocessor has lower priority than the main CPUs. This means that ULP coprocessor execution may be suspended while the main CPUs access same memory region as the ULP.

The detailed description of all instructions is presented below:

**Difference between ESP32 ULP and ESP32-S2 ULP Instruction sets** Compared to the ESP32 ULP FSM coprocessor, the ESP32-S2 ULP FSM coprocessor has an extended instruction set. The ESP32-S2 ULP FSM is not binary compatible with ESP32 ULP FSM, but a ESP32 ULP FSM assembled program is expected to work on the ESP32-S2 ULP FSM after rebuilding. The list of the new instructions that was added to the ESP32-S2 ULP FSM is: LDL, LDH, STL, STH, ST32, STO, STI, STI32.

## NOP - no operation

### Syntax NOP

**Operands** None**Cycles** 2 cycle to execute, 4 cycles to fetch next instruction**Description** No operation is performed. Only the PC is incremented.**Example:**

```
1:    NOP
```

**ADD - Add to register****Syntax** `ADD Rdst, Rsrc1, Rsrc2``ADD Rdst, Rsrc1, imm`**Operands**

- *Rdst* - Register R[0..3]
- *Rsrc1* - Register R[0..3]
- *Rsrc2* - Register R[0..3]
- *Imm* - 16-bit signed value

**Cycles** 2 cycles to execute, 4 cycles to fetch next instruction**Description** The instruction adds source register to another source register or to a 16-bit signed value and stores the result in the destination register.**Examples:**

```
1:    ADD R1, R2, R3           // R1 = R2 + R3
2:    Add R1, R2, 0x1234      // R1 = R2 + 0x1234
3:    .set value1, 0x03       // constant value1=0x03
    Add R1, R2, value1       // R1 = R2 + value1
4:    .global label          // declaration of variable label
    add R1, R2, label        // R1 = R2 + label
    ...
    label: nop               // definition of variable label
```

**SUB - Subtract from register****Syntax** `SUB Rdst, Rsrc1, Rsrc2``SUB Rdst, Rsrc1, imm`**Operands**

- *Rdst* - Register R[0..3]
- *Rsrc1* - Register R[0..3]
- *Rsrc2* - Register R[0..3]
- *Imm* - 16-bit signed value

**Cycles** 2 cycles to execute, 4 cycles to fetch next instruction**Description** The instruction subtracts the source register from another source register or subtracts a 16-bit signed value from a source register, and stores the result to the destination register.**Examples:**

```
1:    SUB R1, R2, R3           // R1 = R2 - R3
2:    sub R1, R2, 0x1234      // R1 = R2 - 0x1234
3:    .set value1, 0x03       // constant value1=0x03
    SUB R1, R2, value1       // R1 = R2 - value1
4:    .global label          // declaration of variable label
    SUB R1, R2, label        // R1 = R2 - label
    ....
    label: nop               // definition of variable label
```

**AND - Bitwise logical AND of two operands**

**Syntax** `AND Rdst, Rsrc1, Rsrc2`  
`AND Rdst, Rsrc1, imm`

**Operands**

- *Rdst* - Register R[0..3]
- *Rsrc1* - Register R[0..3]
- *Rsrc2* - Register R[0..3]
- *Imm* - 16-bit signed value

**Cycles** 2 cycles to execute, 4 cycles to fetch next instruction

**Description** The instruction does a bitwise logical AND of a source register and another source register or a 16-bit signed value and stores the result to the destination register.

**Examples:**

```
1:      AND R1, R2, R3           // R1 = R2 & R3
2:      AND R1, R2, 0x1234      // R1 = R2 & 0x1234
3:      .set value1, 0x03       // constant value1=0x03
      AND R1, R2, value1       // R1 = R2 & value1
4:      .global label          // declaration of variable label
      AND R1, R2, label        // R1 = R2 & label
      ...
label:  nop                    // definition of variable label
```

**OR - Bitwise logical OR of two operands**

**Syntax** `OR Rdst, Rsrc1, Rsrc2`  
`OR Rdst, Rsrc1, imm`

**Operands**

- *Rdst* - Register R[0..3]
- *Rsrc1* - Register R[0..3]
- *Rsrc2* - Register R[0..3]
- *Imm* - 16-bit signed value

**Cycles** 2 cycles to execute, 4 cycles to fetch next instruction

**Description** The instruction does a bitwise logical OR of a source register and another source register or a 16-bit signed value and stores the result to the destination register.

**Examples:**

```
1:      OR R1, R2, R3           // R1 = R2 || R3
2:      OR R1, R2, 0x1234      // R1 = R2 || 0x1234
3:      .set value1, 0x03       // constant value1=0x03
      OR R1, R2, value1        // R1 = R2 || value1
4:      .global label          // declaration of variable label
      OR R1, R2, label        // R1 = R2 || label
      ...
label:  nop                    // definition of variable label
```

**LSH - Logical Shift Left**

**Syntax** `LSH Rdst, Rsrc1, Rsrc2`  
`LSH Rdst, Rsrc1, imm`

**Operands**

- *Rdst* - Register R[0..3]



- *Rsrc1* - Register R[0..3]
- *Rsrc2* - Register R[0..3]
- *Imm* - 16-bit signed value

**Cycles** 2 cycles to execute, 4 cycles to fetch next instruction

**Description** The instruction does a logical shift to left of the source register by the number of bits from another source register or a 16-bit signed value and stores the result to the destination register.

---

**Note:** Shift operations which are greater than 15 bits will have an undefined result.

---

**Examples:**

```

1:      LSH R1, R2, R3           // R1 = R2 << R3
2:      LSH R1, R2, 0x03        // R1 = R2 << 0x03
3:      .set value1, 0x03       // constant value1=0x03
      LSH R1, R2, value1        // R1 = R2 << value1
4:      .global label           // declaration of variable label
      LSH R1, R2, label         // R1 = R2 << label
      ...
label:  nop                     // definition of variable label

```

### RSH - Logical Shift Right

**Syntax** **RSH** *Rdst, Rsrc1, Rsrc2*

**RSH** *Rdst, Rsrc1, imm*

**Operands** *Rdst* - Register R[0..3] *Rsrc1* - Register R[0..3] *Rsrc2* - Register R[0..3] *Imm* - 16-bit signed value

**Cycles** 2 cycles to execute, 4 cycles to fetch next instruction

**Description** The instruction does a logical shift to right of a source register by the number of bits from another source register or a 16-bit signed value and stores the result to the destination register.

---

**Note:** Shift operations which are greater than 15 bits will have an undefined result.

---

**Examples:**

```

1:      RSH R1, R2, R3           // R1 = R2 >> R3
2:      RSH R1, R2, 0x03        // R1 = R2 >> 0x03
3:      .set value1, 0x03       // constant value1=0x03
      RSH R1, R2, value1        // R1 = R2 >> value1
4:      .global label           // declaration of variable label
      RSH R1, R2, label         // R1 = R2 >> label
label:  nop                     // definition of variable label

```

### MOVE –Move to register

**Syntax** **MOVE** *Rdst, Rsrc*

**MOVE** *Rdst, imm*

**Operands**

- *Rdst* –Register R[0..3]
- *Rsrc* –Register R[0..3]
- *Imm* –16-bit signed value

**Cycles** 2 cycles to execute, 4 cycles to fetch next instruction

**Description** The instruction moves the value from the source register or a 16-bit signed value to the destination register.

**Note:** Note that when a label is used as an immediate, the address of the label will be converted from bytes to words. This is because LD, ST, and JUMP instructions expect the address register value to be expressed in words rather than bytes. See the section [Note about addressing](#) for more details.

**Examples:**

```
1:      MOVE      R1, R2           // R1 = R2
2:      MOVE      R1, 0x03        // R1 = 0x03
3:      .set      value1, 0x03    // constant value1=0x03
      MOVE      R1, value1        // R1 = value1
4:      .global   label          // declaration of label
      MOVE      R1, label         // R1 = address_of(label) / 4
      ...
label:  nop                       // definition of label
```

### ST –Store data to the memory

**Syntax** ST *Rsrc, Rdst, offset*

**Operands**

- *Rsrc* –Register R[0..3], holds the 16-bit value to store
- *Rdst* –Register R[0..3], address of the destination, in 32-bit words
- *Offset* –13-bit signed value, offset in bytes

**Cycles** 4 cycles to execute, 4 cycles to fetch next instruction

**Description** The instruction stores the 16-bit value of *Rsrc* to the lower half-word of memory with address *Rdst*+*offset*. The upper half-word is written with the current program counter (PC) (expressed in words, shifted left by 5 bits) OR'ed with *Rdst* (0..3):

```
Mem[Rdst + offset / 4]{31:0} = {PC[10:0], 3'b0, Rdst, Rsrc[15:0]}
```

The application can use the higher 16 bits to determine which instruction in the ULP program has written any particular word into memory.

**Note:** Note that the offset specified in bytes is converted to a 32-bit word offset before execution. See the section [Note about addressing](#) for more details.

**Examples:**

```
1:      ST   R1, R2, 0x12        // MEM[R2 + 0x12 / 4] = R1
2:      .data
Addr1:  .word 123                // Data section definition
      .set  offs, 0x00          // Define label Addr1 16 bit
      .text
      MOVE R1, 1                 // Define constant offs
      MOVE R2, Addr1            // Text section definition
      ST   R1, R2, offs         // R1 = 1
      // R2 = Addr1
      // MEM[R2 + 0 / 4] = R1
      // MEM[Addr1 + 0] will be 32'h600001
```

### STL –Store data to the lower 16 bits of 32-bit memory

**Syntax** STL *Rsrc, Rdst, offset, Label*

**Operands**

- *Rsrc* –Register R[0..3], holds the 16-bit value to store
- *Rdst* –Register R[0..3], address of the destination, in 32-bit words
- *Offset* –11-bit signed value, offset in bytes
- *Label* –2-bit user defined unsigned value

**Cycles** 4 cycles to execute, 4 cycles to fetch next instruction

**Description** The instruction stores the 16-bit value of *Rsrc* to the lower half-word of the memory with address [*Rdst* + *offset* / 4]:

```
Mem[Rdst + offset / 4]{15:0} = {Rsrc[15:0]}
Mem[Rdst + offset / 4]{15:0} = {Label[1:0],Rsrc[13:0]}
```

The ST and the STL commands can be used interchangeably and have been provided to maintain backward compatibility with previous versions of the ULP core.

**Note:** Note that the offset specified in bytes is converted to a 32-bit word offset before execution. See the section [Note about addressing](#) for more details.

### Examples:

```
1:      STL  R1, R2, 0x12           // MEM[R2 + 0x12 / 4] = R1

2:      .data                      // Data section definition
  Addr1: .word    123              // Define label Addr1 16 bit
        .set     offs, 0x00       // Define constant offs
        .text    // Text section definition
        MOVE    R1, 1             // R1 = 1
        MOVE    R2, Addr1        // R2 = Addr1
        STL     R1, R2, offs      // MEM[R2 + 0 / 4] = R1
                                           // MEM[Addr1 + 0] will be 32'hxxxx0001

3:      MOVE    R1, 1             // R1 = 1
        STL     R1, R2, 0x12, 1  // MEM[R2 + 0x12 / 4] = 0xxxxx4001
```

### STH –Store data to the higher 16 bits of 32-bit memory

**Syntax** **STH** *Rsrc*, *Rdst*, *offset*, *Label*

#### Operands

- *Rsrc* –Register R[0..3], holds the 16-bit value to store
- *Rdst* –Register R[0..3], address of the destination, in 32-bit words
- *Offset* –11-bit signed value, offset in bytes
- *Label* –2-bit user defined unsigned value

**Cycles** 4 cycles to execute, 4 cycles to fetch next instruction

**Description** The instruction stores the 16-bit value of *Rsrc* to the upper half-word of memory with address [*Rdst* + *offset* / 4]:

```
Mem[Rdst + offset / 4]{31:16} = {Rsrc[15:0]}
Mem[Rdst + offset / 4]{31:16} = {Label[1:0],Rsrc[13:0]}
```

**Note:** Note that the offset specified in bytes is converted to a 32-bit word offset before execution. See the section [Note about addressing](#) for more details.

### Examples:

```
1:      STH  R1, R2, 0x12           // MEM[R2 + 0x12 / 4][31:16] = R1

2:      .data                      // Data section definition
  Addr1: .word    123              // Define label Addr1 16 bit
```

(continues on next page)

(continued from previous page)

```

.set      offs, 0x00      // Define constant offs
.text
MOVE     R1, 1           // R1 = 1
MOVE     R2, Addr1       // R2 = Addr1
STH      R1, R2, offs    // MEM[R2 + 0 / 4] = R1
                                     // MEM[Addr1 + 0] will be 32'h0001xxxx
3:
MOVE     R1, 1           // R1 = 1
STH      R1, R2, 0x12, 1 // MEM[R2 + 0x12 / 4] 0x4001xxxx

```

**ST32 –Store 32-bits data to the 32-bits memory****Syntax** ST32 *Rsrc, Rdst, offset, Label***Operands**

- *Rsrc* –Register R[0..3], holds the 16-bit value to store
- *Rdst* –Register R[0..3], address of the destination, in 32-bit words
- *Offset* –11-bit signed value, offset in bytes
- *Label* –2-bit user defined unsigned value

**Cycles** 4 cycles to execute, 4 cycles to fetch next instruction**Description** The instruction stores 11 bits of the PC value, label value and the 16-bit value of Rsrc to the 32-bit memory with address [Rdst + offset / 4]:

```
Mem[Rdst + offset / 4]{31:0} = {PC[10:0], 0[2:0], Label[1:0], Rsrc[15:0]}
```

**Note:** Note that the offset specified in bytes is converted to a 32-bit word offset before execution. See the section [Note about addressing](#) for more details.**Examples:**

```

1:      ST32  R1, R2, 0x12, 0      // MEM[R2 + 0x12 / 4] [31:0] = {PC[10:0],
↪0[2:0], Label[1:0], Rsrc[15:0]}

2:      .data                      // Data section definition
Addr1:  .word    123                // Define label Addr1 16 bit
        .set     offs, 0x00         // Define constant offs
        .text
MOVE    R1, 1                       // R1 = 1
MOVE    R2, Addr1                    // R2 = Addr1
ST32    R1, R2, offs, 1             // MEM[R2 + 0] = {PC[10:0], 0[2:0],
↪Label[1:0], Rsrc[15:0]}
                                     // MEM[Addr1 + 0] will be 32'h00010001

```

**STO –Set offset value for auto increment operation****Syntax** STO *offset***Operands**

- *Offset* –11-bit signed value, offset in bytes

**Cycles** 4 cycles to execute, 4 cycles to fetch next instruction**Description** The instruction sets the 16-bit value to the offset register:

```
offset = value / 4
```

**Note:** Note that the offset specified in bytes is converted to a 32-bit word offset before execution. See the section [Note about addressing](#) for more details.

**Examples:**

```

1:      STO   0x12           // Offset = 0x12 / 4

2:      .data                // Data section definition
Addr1:  .word   123          // Define label Addr1 16 bit
        .set    offs, 0x00  // Define constant offs
        .text                // Text section definition
        STO    offs        // Offset = 0x00

```

**STI –Store data to the 32-bits memory with auto increment of predefined offset address****Syntax** STI *Rsrc, Rdst, Label***Operands**

- *Rsrc* –Register R[0..3], holds the 16-bit value to store
- *Rdst* –Register R[0..3], address of the destination, in 32-bit words
- *Label* –2-bit user defined unsigned value

**Cycles** 4 cycles to execute, 4 cycles to fetch next instruction**Description** The instruction stores the 16-bit value of *Rsrc* to the lower and upper half-word of memory with address  $[Rdst + offset / 4]$ . The offset value is auto incremented when the STI instruction is called twice. Make sure to execute the STO instruction to set the offset value before executing the STI instruction:

```

Mem[Rdst + offset / 4]{15:0/31:16} = {Rsrc[15:0]}
Mem[Rdst + offset / 4]{15:0/31:16} = {Label[1:0],Rsrc[13:0]}

```

**Examples:**

```

1:      STO   4              // Set offset to 4
        STI   R1, R2        // MEM[R2 + 4 / 4][15:0] = R1
        STI   R1, R2        // MEM[R2 + 4 / 4][31:16] = R1
                                // offset += (1 * 4) //offset is incremented by 1
↪1 word
        STI   R1, R2        // MEM[R2 + 8 / 4][15:0] = R1
        STI   R1, R2        // MEM[R2 + 8 / 4][31:16] = R1

```

**STI32 –Store 32-bits data to the 32-bits memory with auto increment of address offset****Syntax** STI32 *Rsrc, Rdst, Label***Operands**

- *Rsrc* –Register R[0..3], holds the 16-bit value to store
- *Rdst* –Register R[0..3], address of the destination, in 32-bit words
- *Label* –2-bit user defined unsigned value

**Cycles** 4 cycles to execute, 4 cycles to fetch next instruction**Description** The instruction stores 11 bits of the PC value, label value and the 16-bit value of *Rsrc* to the 32-bit memory with address  $[Rdst + offset / 4]$ . The offset value is auto incremented each time the STI32 instruction is called. Make sure to execute the STO instruction to set the offset value before executing the STI32 instruction:

```

Mem[Rdst + offset / 4]{31:0} = {PC[10:0],0[2:0],Label[1:0],Rsrc[15:0]}

```

**Examples:**

```

1:      STO   0x12
        STI32 R1, R2, 0     // MEM[R2 + 0x12 / 4][31:0] = {PC[10:0],0[2:0],
↪Label[1:0],Rsrc[15:0]}
                                // offset += (1 * 4) //offset is incremented by 1
↪word
        STI32 R1, R2, 0     // MEM[R2 + 0x16 / 4][31:0] = {PC[10:0],0[2:0],
↪Label[1:0],Rsrc[15:0]}

```

**LD –Load data from the memory****Syntax** LD *Rdst, Rsrc, offset***Operands**

- *Rdst* –Register R[0..3], destination
- *Rsrc* –Register R[0..3], holds address of destination, in 32-bit words
- *Offset* –13-bit signed value, offset in bytes

**Cycles** 4 cycles to execute, 4 cycles to fetch next instruction**Description** The instruction loads the lower 16-bit half-word from memory with address [*Rsrc* + *offset* / 4] into the destination register *Rdst*:

```
Rdst[15:0] = Mem[Rsrc + offset / 4][15:0]
```

**Note:** Note that the offset specified in bytes is converted to a 32-bit word offset before execution. See the section [Note about addressing](#) for more details.**Examples:**

```
1:      LD   R1, R2, 0x12           // R1 = MEM[R2 + 0x12 / 4]
2:      .data                               // Data section definition
Addr1:  .word 123                       // Define label Addr1 16 bit
        .set  offs, 0x00                // Define constant offs
        .text                               // Text section definition
        MOVE R1, 1                       // R1 = 1
        MOVE R2, Addr1                   // R2 = Addr1 / 4 (address of label is_
↳converted into words)
        LD   R1, R2, offs                // R1 = MEM[R2 + 0]
                                           // R1 will be 123
```

**LDL –Load data from the lower half-word of the 32-bit memory****Syntax** LDL *Rdst, Rsrc, offset***Operands**

- *Rdst* –Register R[0..3], destination
- *Rsrc* –Register R[0..3], holds address of destination, in 32-bit words
- *Offset* –13-bit signed value, offset in bytes

**Cycles** 4 cycles to execute, 4 cycles to fetch next instruction**Description** The instruction loads the lower 16-bit half-word from memory with address [*Rsrc* + *offset* / 4] into the destination register *Rdst*:

```
Rdst[15:0] = Mem[Rsrc + offset / 4][15:0]
```

The LD and the LDL commands can be used interchangeably and have been provided to maintain backward compatibility with previous versions of the ULP core.

**Note:** Note that the offset specified in bytes is converted to a 32-bit word offset before execution. See the section [Note about addressing](#) for more details.**Examples:**

```
1:      LDL  R1, R2, 0x12           // R1 = MEM[R2 + 0x12 / 4]
2:      .data                               // Data section definition
Addr1:  .word 123                       // Define label Addr1 16 bit
        .set  offs, 0x00                // Define constant offs
        .text                               // Text section definition
        MOVE R1, 1                       // R1 = 1
```

(continues on next page)

(continued from previous page)

```

MOVE    R2, Addr1          // R2 = Addr1 / 4 (address of label is_
↳converted into words)
LDL     R1, R2, offs       // R1 = MEM[R2 + 0]
                                     // R1 will be 123

```

**LDH –Load data from upper half-word of the 32-bit memory****Syntax** LDH *Rdst, Rsrc, offset***Operands**

- *Rdst* –Register R[0..3], destination
- *Rsrc* –Register R[0..3], holds address of destination, in 32-bit words
- *Offset* –13-bit signed value, offset in bytes

**Cycles** 4 cycles to execute, 4 cycles to fetch next instruction**Description** The instruction loads the upper 16-bit half-word from memory with address [*Rsrc* + *offset* / 4] into the destination register *Rdst*:

```
Rdst[15:0] = Mem[Rsrc + offset / 4][15:0]
```

**Note:** Note that the offset specified in bytes is converted to a 32-bit word offset before execution. See the section [Note about addressing](#) for more details.**Examples:**

```

1:      LDH   R1, R2, 0x12          // R1 = MEM[R2 + 0x12 / 4]
2:      .data
Addr1:  .word 0x12345678          // Data section definition
        .set  offs, 0x00         // Define label Addr1 16 bit
        .text                          // Define constant offs
        .text                          // Text section definition
        MOVE  R1, 1                // R1 = 1
        MOVE  R2, Addr1            // R2 = Addr1 / 4 (address of label is_
↳converted into words)
        LDH   R1, R2, offs        // R1 = MEM[R2 + 0]
                                     // R1 will be 0x1234

```

**JUMP –Jump to an absolute address****Syntax** JUMP *Rdst***JUMP** *ImmAddr***JUMP** *Rdst, Condition***JUMP** *ImmAddr, Condition***Operands**

- *Rdst* –Register R[0..3] containing address to jump to (expressed in 32-bit words)
- *ImmAddr* –13 bits address (expressed in bytes), aligned to 4 bytes
- **Condition:**
  - EQ –jump if last ALU operation result was zero
  - OV –jump if last ALU has set overflow flag

**Cycles** 2 cycles to execute, 2 cycles to fetch next instruction**Description** The instruction makes jump to the specified address. Jump can be either unconditional or based on an ALU flag.**Examples:**

```

1:      JUMP   R1                  // Jump to address in R1 (address in R1 is in_
↳32-bit words)

```

(continues on next page)

(continued from previous page)

```

2:      JUMP      0x120, EQ    // Jump to address 0x120 (in bytes) if ALU_
↳result is zero

3:      JUMP      label      // Jump to label
      ...
label:  nop            // Definition of label

4:      .global   label      // Declaration of global label

      MOVE      R1, label    // R1 = label (value loaded into R1 is in words)
      JUMP      R1          // Jump to label
      ...
label:  nop            // Definition of label

```

**JUMPR –Jump to a relative offset (condition based on R0)****Syntax** `JUMPR Step, Threshold, Condition`**Operands**

- *Step* –relative shift from current position, in bytes
- *Threshold* –threshold value for branch condition
- **Condition:**
  - *EQ* (equal) –jump if value in R0 == threshold
  - *LT* (less than) –jump if value in R0 < threshold
  - *LE* (less or equal) –jump if value in R0 <= threshold
  - *GT* (greater than) –jump if value in R0 > threshold
  - *GE* (greater or equal) –jump if value in R0 >= threshold

**Cycles**Conditions *EQ*, *GT* and *LT*: 2 cycles to execute, 2 cycles to fetch next instructionConditions *LE* and *GE* are implemented in the assembler using two **JUMPR** instructions:

```

// JUMPR target, threshold, LE is implemented as:

      JUMPR target, threshold, EQ
      JUMPR target, threshold, LT

// JUMPR target, threshold, GE is implemented as:

      JUMPR target, threshold, EQ
      JUMPR target, threshold, GT

```

Therefore the execution time will depend on the branches taken: either 2 cycles to execute + 2 cycles to fetch, or 4 cycles to execute + 4 cycles to fetch.

**Description** The instruction makes a jump to a relative address if condition is true. Condition is the result of comparison of R0 register value and the threshold value.**Examples:**

```

1:pos:  JUMPR      16, 20, GE    // Jump to address (position + 16 bytes) if_
↳value in R0 >= 20

2:      // Down counting loop using R0 register
      MOVE      R0, 16        // load 16 into R0
label:  SUB       R0, R0, 1     // R0--
      NOP              // do something
      JUMPR     label, 1, GE   // jump to label if R0 >= 1

```



**JUMPS –Jump to a relative address (condition based on stage count)****Syntax** `JUMPS Step, Threshold, Condition`**Operands**

- *Step* –relative shift from current position, in bytes
- *Threshold* –threshold value for branch condition
- **Condition:**
  - *EQ* (equal) –jump if value in stage\_cnt == threshold
  - *LT* (less than) –jump if value in stage\_cnt < threshold
  - *LE* (less or equal) - jump if value in stage\_cnt <= threshold
  - *GT* (greater than) –jump if value in stage\_cnt > threshold
  - *GE* (greater or equal) —jump if value in stage\_cnt >= threshold

**Cycles**

2 cycles to execute, 2 cycles to fetch next instruction

**Description** The instruction makes a jump to a relative address if condition is true. Condition is the result of comparison of count register value and threshold value.**Examples:**

```

1:pos:    JUMPS    16, 20, EQ    // Jump to (position + 16 bytes) if stage_cnt_
↳ == 20

2:        // Up counting loop using stage count register
          STAGE_RST           // set stage_cnt to 0
label:    STAGE_INC 1          // stage_cnt++
          NOP                 // do something
          JUMPS    label, 16, LT // jump to label if stage_cnt < 16

```

**STAGE\_RST –Reset stage count register****Syntax** `STAGE_RST`**Operands** No operands**Description** The instruction sets the stage count register to 0**Cycles** 2 cycles to execute, 4 cycles to fetch next instruction**Examples:**

```

1:        STAGE_RST           // Reset stage count register

```

**STAGE\_INC –Increment stage count register****Syntax** `STAGE_INC Value`**Operands**

- *Value* –8 bits value

**Cycles** 2 cycles to execute, 4 cycles to fetch next instruction**Description** The instruction increments the stage count register by the given value.**Examples:**

```

1:        STAGE_INC    10          // stage_cnt += 10

2:        // Up counting loop example:
          STAGE_RST           // set stage_cnt to 0
label:    STAGE_INC 1          // stage_cnt++
          NOP                 // do something
          JUMPS    label, 16, LT // jump to label if stage_cnt < 16

```

**STAGE\_DEC –Decrement stage count register****Syntax** STAGE\_DEC *Value***Operands**

- *Value* –8 bits value

**Cycles** 2 cycles to execute, 4 cycles to fetch next instruction**Description** The instruction decrements the stage count register by the given value.**Examples:**

```

1:      STAGE_DEC      10          // stage_cnt -= 10;

2:      // Down counting loop example
      STAGE_RST          // set stage_cnt to 0
      STAGE_INC  16      // increment stage_cnt to 16
label:  STAGE_DEC  1      // stage_cnt--;
      NOP                // do something
      JUMPS      label, 0, GT // jump to label if stage_cnt > 0

```

**HALT –End the program****Syntax** HALT**Operands** No operands**Cycles** 2 cycles to execute**Description** The instruction halts the ULP coprocessor and restarts the ULP wakeup timer, if it is enabled.**Examples:**

```

1:      HALT          // Halt the coprocessor

```

**WAKE –Wake up the chip****Syntax** WAKE**Operands** No operands**Cycles** 2 cycles to execute, 4 cycles to fetch next instruction**Description** The instruction sends an interrupt from the ULP coprocessor to the RTC controller.

- If the SoC is in deep sleep mode, and ULP wakeup is enabled, this causes the SoC to wake up.
- If the SoC is not in deep sleep mode, and ULP interrupt bit (RTC\_CNTL\_ULP\_CP\_INT\_ENA) is set in RTC\_CNTL\_INT\_ENA\_REG register, RTC interrupt will be triggered.

Note that before using WAKE instruction, ULP program may needs to wait until RTC controller is ready to wake up the main CPU. This is indicated using RTC\_CNTL\_RDY\_FOR\_WAKEUP bit of RTC\_CNTL\_LOW\_POWER\_ST\_REG register. If WAKE instruction is executed while RTC\_CNTL\_RDY\_FOR\_WAKEUP is zero, it has no effect (wake up does not occur).

**Examples:**

```

1: is_rdy_for_wakeup:          // Read RTC_CNTL_RDY_FOR_WAKEUP bit
      READ_RTC_FIELD(RTC_CNTL_LOW_POWER_ST_REG, RTC_CNTL_RDY_FOR_WAKEUP)
      AND r0, r0, 1
      JUMP is_rdy_for_wakeup, eq // Retry until the bit is set
      WAKE                // Trigger wake up
      REG_WR 0x006, 24, 24, 0 // Stop ULP timer (clear RTC_CNTL_ULP_CP_
↪SLP_TIMER_EN)
      HALT                // Stop the ULP program
      // After these instructions, SoC will wake up,
      // and ULP will not run again until started by the main program.

```

**WAIT –wait some number of cycles****Syntax** WAIT *Cycles*

**Operands**

- *Cycles* –number of cycles for wait

**Cycles** 2 + *Cycles* cycles to execute, 4 cycles to fetch next instruction

**Description** The instruction delays for given number of cycles.

**Examples:**

```
1:      WAIT      10          // Do nothing for 10 cycles
2:      .set    wait_cnt, 10  // Set a constant
        WAIT    wait_cnt     // wait for 10 cycles
```

**TSENS –do measurement with temperature sensor****Syntax**

- **TSENS** *Rdst, Wait\_Delay*

**Operands**

- *Rdst* –Destination Register R[0..3], result will be stored to this register
- *Wait\_Delay* –number of cycles used to perform the measurement

**Cycles** 2 + *Wait\_Delay* + 3 \* TSENS\_CLK to execute, 4 cycles to fetch next instruction

**Description** The instruction performs measurement using TSENS and stores the result into a general purpose register.

**Examples:**

```
1:      TSENS    R1, 1000    // Measure temperature sensor for 1000 cycles,
                          // and store result to R1
```

**ADC –do measurement with ADC****Syntax**

- **ADC** *Rdst, Sar\_sel, Mux*
- **ADC** *Rdst, Sar\_sel, Mux, 0* —deprecated form

**Operands**

- *Rdst* –Destination Register R[0..3], result will be stored to this register
- *Sar\_sel* –Select ADC: 0 = SARADC1, 1 = SARADC2
- *Mux* - selected PAD, SARADC Pad[Mux-1] is enabled. If the user passes Mux value 1, then ADC pad 0 gets used.

**Cycles** 23 + max(1, SAR\_AMP\_WAIT1) + max(1, SAR\_AMP\_WAIT2) + max(1, SAR\_AMP\_WAIT3) + SARx\_SAMPLE\_CYCLE + SARx\_SAMPLE\_BIT cycles to execute, 4 cycles to fetch next instruction

**Description** The instruction makes measurements from ADC.

**Examples:**

```
.. only:: esp32
```

```
1: ADC R1, 0, 1 // Measure value using ADC1 channel 0 and store result into R1
```

```
1: ADC R1, 0, 1 // Measure value using ADC1 pad 2 and store result into R1
```

**REG\_RD –read from peripheral register**

**Syntax** **REG\_RD** *Addr, High, Low*

**Operands**

- *Addr* –Register address, in 32-bit words
- *High* –Register end bit number
- *Low* –Register start bit number

**Cycles** 4 cycles to execute, 4 cycles to fetch next instruction

**Description** The instruction reads up to 16 bits from a peripheral register into a general purpose register:  $R0 = \text{REG}[\text{Addr}] [\text{High}:\text{Low}]$ .

This instruction can access registers in RTC\_CNTL, RTC\_IO, SENS, and RTC\_I2C peripherals. Address of the register, as seen from the ULP, can be calculated from the address of the same register on the PeriBUS1 as follows:

```
addr_ulp = (addr_peribus1 - DR_REG_RTCCNTL_BASE) / 4
```

**Examples:**

```
1:          REG_RD          0x120, 7, 4          // load 4 bits: R0 = {12'b0, REG[0x120][7:4]}
```

### REG\_WR –write to peripheral register

**Syntax** REG\_WR *Addr, High, Low, Data*

**Operands**

- *Addr* –Register address, in 32-bit words.
- *High* –Register end bit number
- *Low* –Register start bit number
- *Data* –Value to write, 8 bits

**Cycles** 8 cycles to execute, 4 cycles to fetch next instruction

**Description** The instruction writes up to 8 bits from an immediate data value into a peripheral register:  $\text{REG}[\text{Addr}] [\text{High}:\text{Low}] = \text{data}$ .

This instruction can access registers in RTC\_CNTL, RTC\_IO, SENS, and RTC\_I2C peripherals. Address of the register, as seen from the ULP, can be calculated from the address of the same register on the PeriBUS1 as follows:

```
addr_ulp = (addr_peribus1 - DR_REG_RTCCNTL_BASE) / 4
```

**Examples:**

```
1:          REG_WR          0x120, 7, 0, 0x10    // set 8 bits: REG[0x120][7:0] = 0x10
```

**Convenience macros for peripheral registers access** ULP source files are passed through C preprocessor before the assembler. This allows certain macros to be used to facilitate access to peripheral registers.

Some existing macros are defined in `soc/soc_ulp.h` header file. These macros allow access to the fields of peripheral registers by their names. Peripheral registers names which can be used with these macros are the ones defined in `soc/rtc_cntl_reg.h`, `soc/rtc_io_reg.h`, `soc/sens_reg.h`, and `soc/rtc_i2c_reg.h`.

**READ\_RTC\_REG(*rtc\_reg, low\_bit, bit\_width*)** Read up to 16 bits from `rtc_reg[low_bit + bit_width - 1 : low_bit]` into R0. For example:

```
#include "soc/soc_ulp.h"
#include "soc/rtc_cntl_reg.h"

/* Read 16 lower bits of RTC_CNTL_TIME0_REG into R0 */
READ_RTC_REG(RTC_CNTL_TIME0_REG, 0, 16)
```

**READ\_RTC\_FIELD(*rtc\_reg, field*)** Read from a field in `rtc_reg` into R0, up to 16 bits. For example:

```
#include "soc/soc_ulp.h"
#include "soc/sens_reg.h"

/* Read 8-bit SENS_TSENS_OUT field of SENS_SAR_SLAVE_ADDR3_REG into R0 */
READ_RTC_FIELD(SENS_SAR_SLAVE_ADDR3_REG, SENS_TSENS_OUT)
```

**WRITE\_RTC\_REG(*rtc\_reg, low\_bit, bit\_width, value*)** Write immediate value into `rtc_reg[low_bit + bit_width - 1 : low_bit]`, `bit_width <= 8`. For example:

```
#include "soc/soc_ulp.h"
#include "soc/rtc_io_reg.h"

/* Set BIT(2) of RTC_GPIO_OUT_DATA_W1TS field in RTC_GPIO_OUT_W1TS_REG */
WRITE_RTC_REG(RTC_GPIO_OUT_W1TS_REG, RTC_GPIO_OUT_DATA_W1TS_S + 2, 1, 1)
```

**WRITE\_RTC\_FIELD(*rtc\_reg*, *field*, *value*)** Write immediate value into a field in *rtc\_reg*, up to 8 bits. For example:

```
#include "soc/soc_ulp.h"
#include "soc/rtc_cntl_reg.h"

/* Set RTC_CNTL_ULP_CP_SLP_TIMER_EN field of RTC_CNTL_STATE0_REG to 0 */
WRITE_RTC_FIELD(RTC_CNTL_STATE0_REG, RTC_CNTL_ULP_CP_SLP_TIMER_EN, 0)
```

**Programming ULP FSM coprocessor using C macros (legacy)** In addition to the existing binutils port for the ESP32-S2 ULP coprocessor, it is possible to generate programs for the ULP FSM coprocessor by embedding assembly-like macros into an ESP32-S2 application. Here is an example how this can be done:

```
const ulp_insn_t program[] = {
    I_MOVI(R3, 16),          // R3 <- 16
    I_LD(R0, R3, 0),        // R0 <- RTC_SLOW_MEM[R3 + 0]
    I_LD(R1, R3, 1),        // R1 <- RTC_SLOW_MEM[R3 + 1]
    I_ADDR(R2, R0, R1),     // R2 <- R0 + R1
    I_ST(R2, R3, 2),        // R2 -> RTC_SLOW_MEM[R2 + 2]
    I_HALT()
};
size_t load_addr = 0;
size_t size = sizeof(program)/sizeof(ulp_insn_t);
ulp_process_macros_and_load(load_addr, program, &size);
ulp_run(load_addr);
```

The program array is an array of `ulp_insn_t`, i.e. ULP coprocessor instructions. Each `I_XXX` preprocessor define translates into a single 32-bit instruction. Arguments of these preprocessor defines can be register numbers (R0—R3) and literal constants. See the API reference section at the end of this guide for descriptions of instructions and arguments they take.

**Note:** Because some of the instruction macros expand to inline function calls, defining such array in global scope will cause the compiler to produce an “initializer element is not constant” error. To fix this error, move the definition of instructions array into local scope.

**Note:** Load, store and move instructions use **addresses expressed in 32-bit words**. Address 0 corresponds to the first word of `RTC_SLOW_MEM`. This is different to how address arguments are handled in assembly code of the same instructions. See the section [Note about addressing](#) for more details for reference.

To generate branch instructions, special `M_` preprocessor defines are used. `M_LABEL` define can be used to define a branch target. Label identifier is a 16-bit integer. `M_Bxxx` defines can be used to generate branch instructions with target set to a particular label.

Implementation note: these `M_` preprocessor defines will be translated into two `ulp_insn_t` values: one is a token value which contains label number, and the other is the actual instruction. `ulp_process_macros_and_load` function resolves the label number to the address, modifies the branch instruction to use the correct address, and removes the the extra `ulp_insn_t` token which contains the label number.

Here is an example of using labels and branches:

```

const ulp_insn_t program[] = {
    I_MOVI(R0, 34),          // R0 <- 34
    M_LABEL(1),            // label_1
    I_MOVI(R1, 32),        // R1 <- 32
    I_LD(R1, R1, 0),       // R1 <- RTC_SLOW_MEM[R1]
    I_MOVI(R2, 33),        // R2 <- 33
    I_LD(R2, R2, 0),       // R2 <- RTC_SLOW_MEM[R2]
    I_SUBR(R3, R1, R2),    // R3 <- R1 - R2
    I_ST(R3, R0, 0),       // R3 -> RTC_SLOW_MEM[R0 + 0]
    I_ADDI(R0, R0, 1),     // R0++
    M_BL(1, 64),          // if (R0 < 64) goto label_1
    I_HALT(),
};
RTC_SLOW_MEM[32] = 42;
RTC_SLOW_MEM[33] = 18;
size_t load_addr = 0;
size_t size = sizeof(program)/sizeof(ulp_insn_t);
ulp_process_macros_and_load(load_addr, program, &size);
ulp_run(load_addr);

```

## API Reference

### Header File

- [components/ulp/ulp\\_fsm/include/esp32s2/ulp.h](#)

### Functions

static inline uint32\_t **SOC\_REG\_TO\_ULP\_PERIPH\_SEL** (uint32\_t reg)

Map SoC peripheral register to `periph_sel` field of `RD_REG` and `WR_REG` instructions.

**Parameters** `reg` –peripheral register in `RTC_CNTL_`, `RTC_IO_`, `SENS_`, `RTC_I2C` peripherals.

**Returns** `periph_sel` value for the peripheral to which this register belongs.

### Unions

union **ulp\_insn**

*#include <ulp.h>* Instruction format structure.

All ULP instructions are 32 bit long. This union contains field layouts used by all of the supported instructions. This union also includes a special “macro” instruction layout. This is not a real instruction which can be executed by the CPU. It acts as a token which is removed from the program by the `ulp_process_macros_and_load` function.

These structures are not intended to be used directly. Preprocessor definitions provided below fill the fields of these structure with the right arguments.

### Public Members

uint32\_t **cycles**

Number of cycles to sleep

TBD, cycles used for measurement

uint32\_t **unused**

Unused

**uint32\_t opcode**

Opcode (OPCODE\_DELAY)  
Opcode (OPCODE\_ST)  
Opcode (OPCODE\_LD)  
Opcode (OPCODE\_HALT)  
Opcode (OPCODE\_BRANCH)  
Opcode (OPCODE\_ALU)  
Opcode (OPCODE\_WR\_REG)  
Opcode (OPCODE\_RD\_REG)  
Opcode (OPCODE\_ADC)  
Opcode (OPCODE\_TSENS)  
Opcode (OPCODE\_I2C)  
Opcode (OPCODE\_END)  
Opcode (OPCODE\_MACRO)

**struct *ulp\_insn*::[anonymous] delay**

Format of DELAY instruction

**uint32\_t dreg**

Register which contains data to store  
Register where the data should be loaded to  
Register which contains target PC, expressed in words (used if .reg == 1)  
Destination register  
Register where to store ADC result  
Register where to store temperature measurement result

**uint32\_t sreg**

Register which contains address in RTC memory (expressed in words)  
Register with operand A

**uint32\_t label**

Data label, 2-bit user defined unsigned value  
Label number

**uint32\_t upper**

0: write the low half-word; 1: write the high half-word

**uint32\_t wr\_way**

0: write the full-word; 1: with the label; 3: without the label

**uint32\_t unused1**

Unused

**uint32\_t offset**

Offset to add to sreg

Absolute value of target PC offset w.r.t. current PC, expressed in words

**uint32\_t unused2**

Unused

**uint32\_t sub\_opcode**

Sub opcode (SUB\_OPCODE\_ST)

Sub opcode (SUB\_OPCODE\_BX)

Sub opcode (SUB\_OPCODE\_B)

Sub opcode (SUB\_OPCODE\_ALU\_REG)

Sub opcode (SUB\_OPCODE\_ALU\_IMM)

Sub opcode (SUB\_OPCODE\_ALU\_CNT)

Sub opcode (SUB\_OPCODE\_WAKEUP)

SUB\_OPCODE\_MACRO\_LABEL or SUB\_OPCODE\_MACRO\_BRANCH

struct *ulp\_insn*::[anonymous] **st**

Format of ST instruction

**uint32\_t rd\_upper**

0: read the high half-word; 1: read the low half-word

struct *ulp\_insn*::[anonymous] **ld**

Format of LD instruction

struct *ulp\_insn*::[anonymous] **halt**

Format of HALT instruction

**uint32\_t addr**

Target PC, expressed in words (used if .reg == 0)

Address within either RTC\_CNTL, RTC\_IO, or SARADC

**uint32\_t reg**

Target PC in register (1) or immediate (0)

**uint32\_t type**

Jump condition (BX\_JUMP\_TYPE\_XXX)

struct *ulp\_insn*::[anonymous] **bx**

Format of BRANCH instruction (absolute address)

**uint32\_t imm**

Immediate value to compare against

Immediate value of operand B

Immediate value



uint32\_t **cmp**

Comparison to perform: B\_CMP\_L or B\_CMP\_GE

uint32\_t **sign**

Sign of target PC offset: 0: positive, 1: negative

struct *ulp\_insn*::[anonymous] **b**

Format of BRANCH instruction (relative address)

uint32\_t **treg**

Register with operand B

uint32\_t **sel**

Operation to perform, one of ALU\_SEL\_XXX

struct *ulp\_insn*::[anonymous] **alu\_reg**

Format of ALU instruction (both sources are registers)

struct *ulp\_insn*::[anonymous] **alu\_imm**

Format of ALU instruction (one source is an immediate)

uint32\_t **unused3**

Unused

struct *ulp\_insn*::[anonymous] **alu\_cnt**

Format of ALU instruction with stage count register and an immediate

uint32\_t **periph\_sel**

Select peripheral: RTC\_CNTL (0), RTC\_IO(1), SARADC(2)

uint32\_t **data**

8 bits of data to write

Data to read or write

uint32\_t **low**

Low bit

uint32\_t **high**

High bit

struct *ulp\_insn*::[anonymous] **wr\_reg**

Format of WR\_REG instruction

struct *ulp\_insn*::[anonymous] **rd\_reg**

Format of RD\_REG instruction

uint32\_t **mux**

Select SARADC pad (mux + 1)

uint32\_t **sar\_sel**

Select SARADC0 (0) or SARADC1 (1)

struct *ulp\_insn*::[anonymous] **adc**

Format of ADC instruction

uint32\_t **wait\_delay**

Cycles to wait after measurement is done

uint32\_t **reserved**

Reserved, set to 0

struct *ulp\_insn*::[anonymous] **tsens**

Format of TSENS instruction

uint32\_t **i2c\_addr**

I2C slave address

uint32\_t **low\_bits**

TBD

uint32\_t **high\_bits**

TBD

uint32\_t **i2c\_sel**

TBD, select reg\_i2c\_slave\_address[7:0]

uint32\_t **rw**

Write (1) or read (0)

struct *ulp\_insn*::[anonymous] **i2c**

Format of I2C instruction

uint32\_t **wakeup**

Set to 1 to wake up chip

struct *ulp\_insn*::[anonymous] **end**

Format of END instruction with wakeup

struct *ulp\_insn*::[anonymous] **macro**

Format of tokens used by LABEL and BRANCH macros

## Macros

### R0

general purpose register 0

### R1

general purpose register 1

**R2**

general purpose register 2

**R3**

general purpose register 3

**OPCODE\_WR\_REG**

Instruction: write peripheral register (RTC\_CNTL/RTC\_IO/SARADC) (not implemented yet)

**OPCODE\_RD\_REG**

Instruction: read peripheral register (RTC\_CNTL/RTC\_IO/SARADC) (not implemented yet)

**RD\_REG\_PERIPH\_RTC\_CNTL**

Identifier of RTC\_CNTL peripheral for RD\_REG and WR\_REG instructions

**RD\_REG\_PERIPH\_RTC\_IO**

Identifier of RTC\_IO peripheral for RD\_REG and WR\_REG instructions

**RD\_REG\_PERIPH\_SENS**

Identifier of SARADC peripheral for RD\_REG and WR\_REG instructions

**RD\_REG\_PERIPH\_RTC\_I2C**

Identifier of RTC\_I2C peripheral for RD\_REG and WR\_REG instructions

**OPCODE\_I2C**

Instruction: read/write I2C (not implemented yet)

**OPCODE\_DELAY**

Instruction: delay (nop) for a given number of cycles

**OPCODE\_ADC**

Instruction: SAR ADC measurement (not implemented yet)

**OPCODE\_ST**

Instruction: store indirect to RTC memory

**SUB\_OPCODE\_ST\_AUTO**

Automatic Storage Mode - Access continuous addresses. Use SUB\_OPCODE\_ST\_OFFSET to configure the initial address before using this instruction.

**SUB\_OPCODE\_ST\_OFFSET**

Automatic Storage Mode - Configure the initial address.

**SUB\_OPCODE\_ST**

Manual Storage Mode. Store 32 bits, 16 MSBs contain PC, 16 LSBs contain value from source register

**OPCODE\_ALU**

Arithmetic instructions

**SUB\_OPCODE\_ALU\_REG**

Arithmetic instruction, both source values are in register

**SUB\_OPCODE\_ALU\_IMM**

Arithmetic instruction, one source value is an immediate

**SUB\_OPCODE\_ALU\_CNT**

Arithmetic instruction between counter register and an immediate (not implemented yet)

**ALU\_SEL\_ADD**

Addition

**ALU\_SEL\_SUB**

Subtraction

**ALU\_SEL\_AND**

Logical AND

**ALU\_SEL\_OR**

Logical OR

**ALU\_SEL\_MOV**

Copy value (immediate to destination register or source register to destination register)

**ALU\_SEL\_LSH**

Shift left by given number of bits

**ALU\_SEL\_RSH**

Shift right by given number of bits

**ALU\_SEL\_STAGE\_INC**

Increment stage count register

**ALU\_SEL\_STAGE\_DEC**

Decrement stage count register

**ALU\_SEL\_STAGE\_RST**

Reset stage count register

**OPCODE\_BRANCH**

Branch instructions

**SUB\_OPCODE\_B**

Branch to a relative offset

**SUB\_OPCODE\_BX**

Branch to absolute PC (immediate or in register)

**SUB\_OPCODE\_BS**

Branch to a relative offset by comparing the stage\_cnt register

**BX\_JUMP\_TYPE\_DIRECT**

Unconditional jump

**BX\_JUMP\_TYPE\_ZERO**

Branch if last ALU result is zero

**BX\_JUMP\_TYPE\_OVF**

Branch if last ALU operation caused and overflow

**B\_CMP\_L**

Branch if R0 is less than an immediate

**B\_CMP\_G**

Branch if R0 is greater than an immediate

**B\_CMP\_E**

Branch if R0 is equal to an immediate

**BS\_CMP\_L**

Branch if stage\_cnt is less than an immediate

**BS\_CMP\_GE**

Branch if stage\_cnt is greater than or equal to an immediate

**BS\_CMP\_LE**

Branch if stage\_cnt is less than or equal to an immediate

**OPCODE\_END**

Stop executing the program

**SUB\_OPCODE\_END**

Stop executing the program and optionally wake up the chip

**SUB\_OPCODE\_SLEEP**

Stop executing the program and run it again after selected interval

**OPCODE\_TSENS**

Instruction: temperature sensor measurement (not implemented yet)

**OPCODE\_HALT**

Halt the coprocessor

**OPCODE\_LD**

Indirect load lower 16 bits from RTC memory

**OPCODE\_MACRO**

Not a real opcode. Used to identify labels and branches in the program

**SUB\_OPCODE\_MACRO\_LABEL**

Label macro

**SUB\_OPCODE\_MACRO\_BRANCH**

Branch macro

**SUB\_OPCODE\_MACRO\_LABELPC**

Label pointer macro

**I\_DELAY** (cycles\_)

Delay (nop) for a given number of cycles

**I\_HALT** ()

Halt the coprocessor.

This instruction halts the coprocessor, but keeps ULP timer active. As such, ULP program will be restarted again by timer. To stop the program and prevent the timer from restarting the program, use I\_END(0) instruction.

**I\_WR\_REG** (reg, low\_bit, high\_bit, val)

Write literal value to a peripheral register

reg[high\_bit : low\_bit] = val This instruction can access RTC\_CNTL\_, RTC\_IO\_, SENS\_, and RTC\_I2C peripheral registers.

**I\_RD\_REG** (reg, low\_bit, high\_bit)

Read from peripheral register into R0

R0 = reg[high\_bit : low\_bit] This instruction can access RTC\_CNTL\_, RTC\_IO\_, SENS\_, and RTC\_I2C peripheral registers.

**I\_WR\_REG\_BIT** (reg, shift, val)

Set or clear a bit in the peripheral register.

Sets bit (1 << shift) of register reg to value val. This instruction can access RTC\_CNTL\_, RTC\_IO\_, SENS\_, and RTC\_I2C peripheral registers.

**I\_WAKE** ()

Wake the SoC from deep sleep.

This instruction initiates wake up from deep sleep. Use esp\_deep\_sleep\_enable\_ulp\_wakeup to enable deep sleep wakeup triggered by the ULP before going into deep sleep. Note that ULP program will still keep running until the I\_HALT instruction, and it will still be restarted by timer at regular intervals, even when the SoC is woken up.

To stop the ULP program, use I\_HALT instruction.

To disable the timer which start ULP program, use I\_END() instruction. I\_END instruction clears the RTC\_CNTL\_ULP\_CP\_SLP\_TIMER\_EN\_S bit of RTC\_CNTL\_ULP\_CP\_TIMER\_REG register, which controls the ULP timer.

**I\_END** ()

Stop ULP program timer.

This is a convenience macro which disables the ULP program timer. Once this instruction is used, ULP program will not be restarted anymore until ulp\_run function is called.

ULP program will continue running after this instruction. To stop the currently running program, use I\_HALT().











**I\_BXZR** (reg\_pc)

Branch to absolute PC if ALU result is zero, address in register.

reg\_pc is the register which contains address to jump to. Address is expressed in 32-bit words.

**I\_BXZI** (imm\_pc)

Branch to absolute PC if ALU result is zero, immediate address.

Address imm\_pc is expressed in 32-bit words.

**I\_BXFR** (reg\_pc)

Branch to absolute PC if ALU overflow, address in register

reg\_pc is the register which contains address to jump to. Address is expressed in 32-bit words.

**I\_BXFI** (imm\_pc)

Branch to absolute PC if ALU overflow, immediate address

Address imm\_pc is expressed in 32-bit words.

**I\_BSLE** (pc\_offset, imm\_value)

Branch relative if stage\_cnt is less than or equal to the immediate value.

pc\_offset is expressed in words, and can be from -127 to 127 imm\_value is a 16-bit value to compare R0 against

**I\_BSGE** (pc\_offset, imm\_value)

Branch relative if stage\_cnt register is greater than or equal to the immediate value.

pc\_offset is expressed in words, and can be from -127 to 127 imm\_value is a 16-bit value to compare R0 against

**I\_BSL** (pc\_offset, imm\_value)

Branch relative if stage\_cnt register is less than the immediate value.

pc\_offset is expressed in words, and can be from -127 to 127 imm\_value is a 16-bit value to compare R0 against

**I\_ADDR** (reg\_dest, reg\_src1, reg\_src2)

Addition:  $dest = src1 + src2$

**I\_SUBR** (reg\_dest, reg\_src1, reg\_src2)

Subtraction:  $dest = src1 - src2$

**I\_ANDR** (reg\_dest, reg\_src1, reg\_src2)

Logical AND:  $dest = src1 \& src2$

**I\_ORR** (reg\_dest, reg\_src1, reg\_src2)

Logical OR:  $dest = src1 | src2$

**I\_MOVR** (reg\_dest, reg\_src)

Copy:  $dest = src$

**I\_LSHR** (reg\_dest, reg\_src, reg\_shift)

Logical shift left:  $dest = src \ll shift$

**I\_RSHR** (reg\_dest, reg\_src, reg\_shift)

Logical shift right:  $dest = src \gg shift$

**I\_ADDI** (reg\_dest, reg\_src, imm\_)

Add register and an immediate value:  $dest = src1 + imm$

**I\_SUBI** (reg\_dest, reg\_src, imm\_)

Subtract register and an immediate value:  $dest = src - imm$

**I\_ANDI** (reg\_dest, reg\_src, imm\_)

Logical AND register and an immediate value: dest = src & imm

**I\_ORI** (reg\_dest, reg\_src, imm\_)

Logical OR register and an immediate value: dest = src | imm

**I\_MOVI** (reg\_dest, imm\_)

Copy an immediate value into register: dest = imm

**I\_LSHI** (reg\_dest, reg\_src, imm\_)

Logical shift left register value by an immediate: dest = src << imm

**I\_RSHI** (reg\_dest, reg\_src, imm\_)

Logical shift right register value by an immediate: dest = val >> imm

**I\_STAGE\_INC** (reg\_dest, reg\_src, imm\_)

Increment stage\_cnt register by an immediate: stage\_cnt = stage\_cnt + imm

**I\_STAGE\_DEC** (reg\_dest, reg\_src, imm\_)

Decrement stage\_cnt register by an immediate: stage\_cnt = stage\_cnt - imm

**I\_STAGE\_RST** (reg\_dest, reg\_src, imm\_)

Reset stage\_cnt register by an immediate: stage\_cnt = 0

**M\_LABEL** (label\_num)

Define a label with number label\_num.

This is a macro which doesn't generate a real instruction. The token generated by this macro is removed by ulp\_process\_macros\_and\_load function. Label defined using this macro can be used in branch macros defined below.

**M\_BRANCH** (label\_num)

Token macro used by M\_B and M\_BX macros. Not to be used directly.

**M\_BL** (label\_num, imm\_value)

Macro: branch to label label\_num if R0 is less than immediate value.

This macro generates two ulp\_insn\_t values separated by a comma, and should be used when defining contents of ulp\_insn\_t arrays. First value is not a real instruction; it is a token which is removed by ulp\_process\_macros\_and\_load function.

**M\_BG** (label\_num, imm\_value)

Macro: branch to label label\_num if R0 is greater than immediate value

This macro generates two ulp\_insn\_t values separated by a comma, and should be used when defining contents of ulp\_insn\_t arrays. First value is not a real instruction; it is a token which is removed by ulp\_process\_macros\_and\_load function.

**M\_BE** (label\_num, imm\_value)

Macro: branch to label label\_num if R0 equal to the immediate value

This macro generates two ulp\_insn\_t values separated by a comma, and should be used when defining contents of ulp\_insn\_t arrays. First value is not a real instruction; it is a token which is removed by ulp\_process\_macros\_and\_load function.

**M\_BX** (label\_num)

Macro: unconditional branch to label

This macro generates two ulp\_insn\_t values separated by a comma, and should be used when defining contents of ulp\_insn\_t arrays. First value is not a real instruction; it is a token which is removed by ulp\_process\_macros\_and\_load function.

**M\_BXZ** (label\_num)

Macro: branch to label if ALU result is zero

This macro generates two `ulp_insn_t` values separated by a comma, and should be used when defining contents of `ulp_insn_t` arrays. First value is not a real instruction; it is a token which is removed by `ulp_process_macros_and_load` function.

**M\_BXF** (label\_num)

Macro: branch to label if ALU overflow

This macro generates two `ulp_insn_t` values separated by a comma, and should be used when defining contents of `ulp_insn_t` arrays. First value is not a real instruction; it is a token which is removed by `ulp_process_macros_and_load` function.

## Compiling the ULP Code

To compile the ULP FSM code as part of the component, the following steps must be taken:

1. The ULP FSM code, written in assembly, must be added to one or more files with `.S` extension. These files must be placed into a separate directory inside the component directory, for instance, `ulp/`.

---

**Note:** When registering the component (via `idf_component_register`), this directory should not be added to the `SRC_DIRS` argument. The logic behind this is that the ESP-IDF build system will compile files found in `SRC_DIRS` based on their extensions. For `.S` files, `xtensa-esp32s2-elf-as` assembler is used. This is not desirable for ULP FSM assembly files, so the easiest way to achieve the distinction is by placing ULP FSM assembly files into a separate directory. The ULP FSM assembly source files should also **not** be added to `SRCS` for the same reason. See the step below for how to properly add ULP FSM assembly source files.

---

2. Call `ulp_embed_binary` from the component `CMakeLists.txt` after registration. For example:

```
...
idf_component_register()

set(ulp_app_name ulp_${COMPONENT_NAME})
set(ulp_s_sources ulp/ulp_assembly_source_file.S)
set(ulp_exp_dep_srcs "ulp_c_source_file.c")

ulp_embed_binary(${ulp_app_name} "${ulp_s_sources}" "${ulp_exp_dep_srcs}")
```

The first argument to `ulp_embed_binary` specifies the ULP FSM binary name. The name specified here will also be used by other generated artifacts such as the ELF file, map file, header file and linker export file. The second argument specifies the ULP FSM assembly source files. Finally, the third argument specifies the list of component source files which include the header file to be generated. This list is needed to build the dependencies correctly and ensure that the generated header file will be created before any of these files are compiled. See the section below for the concept of generated header files for ULP applications.

3. Build the application as usual (e.g. `idf.py app`).  
Inside, the build system will take the following steps to build ULP FSM program:
  1. **Run each assembly file (foo.S) through the C preprocessor.** This step generates the preprocessed assembly files (`foo.ulp.S`) in the component build directory. This step also generates dependency files (`foo.ulp.d`).
  2. **Run preprocessed assembly sources through the assembler.** This produces object (`foo.ulp.o`) and listing (`foo.ulp.lst`) files. Listing files are generated for debugging purposes and are not used at later stages of the build process.
  3. **Run the linker script template through the C preprocessor.** The template is located in `components/ulp/ld` directory.
  4. **Link the object files into an output ELF file (`ulp_app_name.elf`).** The Map file (`ulp_app_name.map`) generated at this stage may be useful for debugging purposes.

5. **Dump the contents of the ELF file into a binary** (`ulp_app_name.bin`) which can then be embedded into the application.
6. **Generate a list of global symbols** (`ulp_app_name.sym`) in the ELF file using `esp32ulp-elf-nm`.
7. **Create an LD export script and a header file** (`ulp_app_name.ld` and `ulp_app_name.h`) containing the symbols from `ulp_app_name.sym`. This is done using the `esp32ulp_mapgen.py` utility.
8. **Add the generated binary to the list of binary files** to be embedded into the application.

### Accessing the ULP FSM Program Variables

Global symbols defined in the ULP FSM program may be used inside the main program.

For example, the ULP FSM program may define a variable `measurement_count` which will define the number of ADC measurements the program needs to make before waking up the chip from deep sleep:

```

                                .global measurement_count
measurement_count:              .long 0

                                // later, use measurement_count
                                move r3, measurement_count
                                ld r3, r3, 0

```

The main program needs to initialize this variable before the ULP program is started. The build system makes this possible by generating the `_${ULP_APP_NAME}.h` and `_${ULP_APP_NAME}.ld` files which define the global symbols present in the ULP program. Each global symbol defined in the ULP program is included in these files and are prefixed with `ulp_`.

The header file contains the declaration of the symbol:

```
extern uint32_t ulp_measurement_count;
```

Note that all symbols (variables, arrays, functions) are declared as `uint32_t`. For functions and arrays, take the address of the symbol and cast it to the appropriate type.

The generated linker script file defines the locations of symbols in `RTC_SLOW_MEM`:

```
PROVIDE ( ulp_measurement_count = 0x50000060 );
```

To access the ULP program variables from the main program, the generated header file should be included using an `include` statement. This will allow the ULP program variables to be accessed as regular variables:

```

#include "ulp_app_name.h"

// later
void init_ulp_vars() {
    ulp_measurement_count = 64;
}

```

### Starting the ULP FSM Program

To run a ULP FSM program, the main application needs to load the ULP program into RTC memory using the `ulp_load_binary()` function, and then start it using the `ulp_run()` function.

Note that the `Enable Ultra Low Power (ULP) Coprocessor` option must be enabled in `menuconfig` to work with ULP. To select the type of ULP to be used, the `ULP Co-processor type` option must be set. To reserve memory for the ULP, the `RTC slow memory reserved for coprocessor` option must be set to a value big enough to store ULP code and data. If the application components contain multiple ULP programs, then the size of the RTC memory must be sufficient to hold the largest one.

Each ULP program is embedded into the ESP-IDF application as a binary blob. The application can reference this blob and load it in the following way (suppose `ULP_APP_NAME` was defined to `ulp_app_name`):

```
extern const uint8_t bin_start[] asm("_binary_ulp_app_name_bin_start");
extern const uint8_t bin_end[]   asm("_binary_ulp_app_name_bin_end");

void start_ulp_program() {
    ESP_ERROR_CHECK(ulp_load_binary(
        0 // load address, set to 0 when using default linker scripts
        bin_start,
        (bin_end - bin_start) / sizeof(uint32_t) );
}
```

Once the program is loaded into RTC memory, the application can start it by passing the address of the entry point to the `ulp_run` function:

```
ESP_ERROR_CHECK(ulp_run(&ulp_entry - RTC_SLOW_MEM) );
```

Declaration of the entry point symbol comes from the generated header file mentioned above, `_${ULP_APP_NAME}.h`. In the assembly source of the ULP FSM application, this symbol must be marked as `.global`:

```
.global entry
entry:
    // code starts here
```

### ESP32-S2 ULP program flow

ESP32-S2 ULP coprocessor is started by a timer. The timer is started once `ulp_run()` is called. The timer counts a number of `RTC_SLOW_CLK` ticks (by default, produced by an internal 90 kHz RC oscillator). The number of ticks is set using `RTC_CNTL_ULP_CP_TIMER_1_REG` register.

The application can set ULP timer period values by `ulp_set_wakeup_period()` function.

Once the timer counts the number of ticks set in the selected `RTC_CNTL_ULP_CP_TIMER_1_REG` register, ULP coprocessor powers up and starts running the program from the entry point set in the call to `ulp_run()`.

The program runs until it encounters a `halt` instruction or an illegal instruction. Once the program halts, ULP coprocessor powers down, and the timer is started again.

To disable the timer (effectively preventing the ULP program from running again), clear the `RTC_CNTL_ULP_CP_SLP_TIMER_EN` bit in the `RTC_CNTL_ULP_CP_TIMER_REG` register. This can be done both from ULP code and from the main program.

### Application Examples

- ULP FSM Coprocessor counts pulses on an IO while main CPU is in deep sleep: [system/ulp\\_fsm/ulp](#).

### API Reference

#### Header File

- [components/ulp/ulp\\_fsm/include/ulp\\_fsm\\_common.h](#)

#### Functions

*esp\_err\_t* **ulp\_process\_macros\_and\_load** (uint32\_t load\_addr, const *ulp\_insn\_t* \*program, size\_t \*psize)

Resolve all macro references in a program and load it into RTC memory.

**Parameters**

- **load\_addr** –address where the program should be loaded, expressed in 32-bit words
- **program** –ulp\_insn\_t array with the program
- **psize** –size of the program, expressed in 32-bit words

**Returns**

- ESP\_OK on success
- ESP\_ERR\_NO\_MEM if auxiliary temporary structure can not be allocated
- one of ESP\_ERR\_ULP\_XXX if program is not valid or can not be loaded

*esp\_err\_t* **ulp\_load\_binary** (uint32\_t load\_addr, const uint8\_t \*program\_binary, size\_t program\_size)

Load ULP program binary into RTC memory.

ULP program binary should have the following format (all values little-endian):

- MAGIC, (value 0x00706c75, 4 bytes)
- TEXT\_OFFSET, offset of .text section from binary start (2 bytes)
- TEXT\_SIZE, size of .text section (2 bytes)
- DATA\_SIZE, size of .data section (2 bytes)
- BSS\_SIZE, size of .bss section (2 bytes)
- (TEXT\_OFFSET - 12) bytes of arbitrary data (will not be loaded into RTC memory)
- .text section
- .data section

Linker script in components/ulp/ld/esp32.ulp.ld produces ELF files which correspond to this format. This linker script produces binaries with load\_addr == 0.

**Parameters**

- **load\_addr** –address where the program should be loaded, expressed in 32-bit words
- **program\_binary** –pointer to program binary
- **program\_size** –size of the program binary

**Returns**

- ESP\_OK on success
- ESP\_ERR\_INVALID\_ARG if load\_addr is out of range
- ESP\_ERR\_INVALID\_SIZE if program\_size doesn't match (TEXT\_OFFSET + TEXT\_SIZE + DATA\_SIZE)
- ESP\_ERR\_NOT\_SUPPORTED if the magic number is incorrect

*esp\_err\_t* **ulp\_run** (uint32\_t entry\_point)

Run the program loaded into RTC memory.

**Parameters** **entry\_point** –entry point, expressed in 32-bit words

**Returns** ESP\_OK on success

## Macros

### ESP\_ERR\_ULP\_BASE

Offset for ULP-related error codes

### ESP\_ERR\_ULP\_SIZE\_TOO\_BIG

Program doesn't fit into RTC memory reserved for the ULP

### ESP\_ERR\_ULP\_INVALID\_LOAD\_ADDR

Load address is outside of RTC memory reserved for the ULP

### ESP\_ERR\_ULP\_DUPLICATE\_LABEL

More than one label with the same number was defined



**ESP\_ERR\_ULP\_UNDEFINED\_LABEL**

Branch instructions references an undefined label

**ESP\_ERR\_ULP\_BRANCH\_OUT\_OF\_RANGE**

Branch target is out of range of B instruction (try replacing with BX)

**Type Definitions**

```
typedef union ulp_insn ulp_insn_t
```

**Header File**

- [components/ulp/ulp\\_common/include/ulp\\_common.h](#)

**Functions**

*esp\_err\_t* **ulp\_set\_wakeup\_period** (size\_t period\_index, uint32\_t period\_us)

Set one of ULP wakeup period values.

ULP coprocessor starts running the program when the wakeup timer counts up to a given value (called period). There are 5 period values which can be programmed into SENS\_ULP\_CP\_SLEEP\_CYCx\_REG registers, x = 0..4 for ESP32, and one period value which can be programmed into RTC\_CNTL\_ULP\_CP\_TIMER\_1\_REG register for ESP32-S2/S3. By default, for ESP32, wakeup timer will use the period set into SENS\_ULP\_CP\_SLEEP\_CYC0\_REG, i.e. period number 0. ULP program code can use SLEEP instruction to select which of the SENS\_ULP\_CP\_SLEEP\_CYCx\_REG should be used for subsequent wakeups.

However, please note that SLEEP instruction issued (from ULP program) while the system is in deep sleep mode does not have effect, and sleep cycle count 0 is used.

For ESP32-S2/S3 the SLEEP instruction not exist. Instead a WAKE instruction will be used.

---

**Note:** The ULP FSM requires two clock cycles to wakeup before being able to run the program. Then additional 16 cycles are reserved after wakeup waiting until the 8M clock is stable. The FSM also requires two more clock cycles to go to sleep after the program execution is halted. The minimum wakeup period that may be set up for the ULP is equal to the total number of cycles spent on the above internal tasks. For a default configuration of the ULP running at 150kHz it makes about 133us.

---

**Parameters**

- **period\_index** –wakeup period setting number (0 - 4)
- **period\_us** –wakeup period, us

**Returns**

- ESP\_OK on success
- ESP\_ERR\_INVALID\_ARG if period\_index is out of range

void **ulp\_timer\_stop** (void)

Stop the ULP timer.

---

**Note:** This will stop the ULP from waking up if halted, but will not abort any program currently executing on the ULP.

---

void **ulp\_timer\_resume** (void)

Resume the ULP timer.

---

**Note:** This will resume an already configured timer, but does no other configuration

---

### Header File

- `components/ulp/ulp_common/include/esp32s2/ulp_common_defs.h`

### Macros

#### **RTC\_SLOW\_MEM**

RTC slow memory, 8k size

## 2.9.30 ULP RISC-V Coprocessor programming

The ULP RISC-V coprocessor is a variant of the ULP present in ESP32-S2. Similar to ULP FSM, the ULP RISC-V coprocessor can perform tasks such as sensor readings while the main CPU stays in low power modes. The main difference between ULP FSM and ULP RISC-V is that the latter can be programmed in C using standard GNU tools. The ULP RISC-V coprocessor can access the `RTC_SLOW_MEM` memory region, and registers in `RTC_CNTL`, `RTC_IO`, and `SARADC` peripherals. The RISC-V processor is a 32-bit fixed point machine. Its instruction set is based on RV32IMC which includes hardware multiplication and division, and compressed code.

### Installing the ULP RISC-V Toolchain

The ULP RISC-V coprocessor code is written in C (assembly is also possible) and compiled using the RISC-V toolchain based on GCC.

If you have already set up ESP-IDF with CMake build system according to the [Getting Started Guide](#), then the toolchain should already be installed.

---

**Note:** In earlier versions of ESP-IDF, RISC-V toolchain had a different prefix: *riscv-none-embed-gcc*.

---

### Compiling the ULP RISC-V Code

To compile the ULP RISC-V code as part of the component, the following steps must be taken:

1. The ULP RISC-V code, written in C or assembly (must use the `.S` extension), must be placed in a separate directory inside the component directory, for instance, `ulp/`.

---

**Note:** When registering the component (via `idf_component_register`), this directory should not be added to the `SRC_DIRS` argument as it is currently done for the ULP FSM. See the step below for how to properly add ULP source files.

---

2. Call `ulp_embed_binary` from the component `CMakeLists.txt` after registration. For example:

```
...
idf_component_register()

set(ulp_app_name ulp_${COMPONENT_NAME})
set(ulp_sources "ulp/ulp_c_source_file.c" "ulp/ulp_assembly_source_file.S")
set(ulp_exp_dep_srcs "ulp_c_source_file.c")

ulp_embed_binary(${ulp_app_name} "${ulp_sources}" "${ulp_exp_dep_srcs}")
```

The first argument to `ulp_embed_binary` specifies the ULP binary name. The name specified here will also be used by other generated artifacts such as the ELF file, map file, header file and linker export file. The second argument specifies the ULP source files. Finally, the third argument specifies the list

of component source files which include the header file to be generated. This list is needed to build the dependencies correctly and ensure that the generated header file will be created before any of these files are compiled. See the section below for the concept of generated header files for ULP applications.

3. Build the application as usual (e.g. *idf.py app*).

Inside, the build system will take the following steps to build ULP program:

1. **Run each source file through the C compiler and assembler.** This step generates the object files (.obj.c or .obj.S depending of source file processed) in the component build directory.
2. **Run the linker script template through the C preprocessor.** The template is located in components/ulp/ld directory.
3. **Link the object files into an output ELF file** (ulp\_app\_name.elf). The Map file (ulp\_app\_name.map) generated at this stage may be useful for debugging purposes.
4. **Dump the contents of the ELF file into a binary** (ulp\_app\_name.bin) which can then be embedded into the application.
5. **Generate a list of global symbols** (ulp\_app\_name.sym) in the ELF file using riscv32-esp-elf-nm.
6. **Create an LD export script and a header file** (ulp\_app\_name.ld and ulp\_app\_name.h) containing the symbols from ulp\_app\_name.sym. This is done using the esp32ulp\_mapgen.py utility.
7. **Add the generated binary to the list of binary files** to be embedded into the application.

### Accessing the ULP RISC-V Program Variables

Global symbols defined in the ULP RISC-V program may be used inside the main program.

For example, the ULP RISC-V program may define a variable `measurement_count` which will define the number of ADC measurements the program needs to make before waking up the chip from deep sleep.

```
volatile int measurement_count;

int some_function()
{
    //read the measurement count for use it later.
    int temp = measurement_count;

    ...do something.
}
```

The main program can access the global ULP RISC-V program variables as the build system makes this possible by generating the `_${ULP_APP_NAME}.h` and `_${ULP_APP_NAME}.ld` files which define the global symbols present in the ULP RISC-V program. Each global symbol defined in the ULP RISC-V program is included in these files and are prefixed with `ulp_`.

The header file contains the declaration of the symbol:

```
extern uint32_t ulp_measurement_count;
```

Note that all symbols (variables, arrays, functions) are declared as `uint32_t`. For functions and arrays, take the address of the symbol and cast it to the appropriate type.

The generated linker script file defines the locations of symbols in `RTC_SLOW_MEM`:

```
PROVIDE ( ulp_measurement_count = 0x50000060 );
```

To access the ULP RISC-V program variables from the main program, the generated header file should be included using an `include` statement. This will allow the ULP RISC-V program variables to be accessed as regular variables.

```
#include "ulp_app_name.h"

void init_ulp_vars() {
```

(continues on next page)

(continued from previous page)

```

    ulp_measurement_count = 64;
}

```

### Starting the ULP RISC-V Program

To run a ULP RISC-V program, the main application needs to load the ULP program into RTC memory using the `ulp_riscv_load_binary()` function, and then start it using the `ulp_riscv_run()` function.

Note that `CONFIG_ULP_COPROC_ENABLED` and `CONFIG_ULP_COPROC_TYPE_RISCV` options must be enabled in menuconfig to work with ULP RISC-V. To reserve memory for the ULP, the RTC slow memory reserved for coprocessor option must be set to a value big enough to store ULP RISC-V code and data. If the application components contain multiple ULP programs, then the size of the RTC memory must be sufficient to hold the largest one.

Each ULP RISC-V program is embedded into the ESP-IDF application as a binary blob. The application can reference this blob and load it in the following way (suppose `ULP_APP_NAME` was defined to `ulp_app_name`):

```

extern const uint8_t bin_start[] asm("_binary_ulp_app_name_bin_start");
extern const uint8_t bin_end[]   asm("_binary_ulp_app_name_bin_end");

void start_ulp_program() {
    ESP_ERROR_CHECK(ulp_riscv_load_binary(bin_start,
                                         (bin_end - bin_start)));
}

```

Once the program is loaded into RTC memory, the application can start it by calling the `ulp_riscv_run()` function:

```
ESP_ERROR_CHECK(ulp_riscv_run());
```

### ULP RISC-V Program Flow

The ULP RISC-V coprocessor is started by a timer. The timer is started once `ulp_riscv_run()` is called. The timer counts the number of `RTC_SLOW_CLK` ticks (by default, produced by an internal 90kHz RC oscillator). The number of ticks is set using `RTC_CNTL_ULP_CP_TIMER_1_REG` register. When starting the ULP, `RTC_CNTL_ULP_CP_TIMER_1_REG` will be used to set the number of timer ticks.

The application can set ULP timer period values (`RTC_CNTL_ULP_CP_TIMER_1_REG`) using the `ulp_set_wakeup_period()` function.

Once the timer counts the number of ticks set in the `RTC_CNTL_ULP_CP_TIMER_1_REG` register, the ULP RISC-V coprocessor will power up and start running the program from the entry point set in the call to `ulp_riscv_run()`.

The program runs until the field `RTC_CNTL_COCPU_DONE` in register `RTC_CNTL_COCPU_CTRL_REG` gets written or when a trap occurs due to illegal processor state. Once the program halts, the ULP RISC-V coprocessor will power down, and the timer will be started again.

To disable the timer (effectively preventing the ULP program from running again), please clear the `RTC_CNTL_ULP_CP_SLP_TIMER_EN` bit in the `RTC_CNTL_ULP_CP_TIMER_REG` register. This can be done both from the ULP code and from the main program.

### Debugging Your ULP RISC-V Program

When programming the ULP RISC-V it can sometimes be challenging to figure out why the program is not behaving as expected. Due to the simplicity of the core many of the standard methods of debugging, e.g. JTAG or `printf`, are simply not available.

Keeping this in mind, here are some ways that may help you debug you ULP RISC-V program:

- Share program state through shared variables: as described in [Accessing the ULP RISC-V Program Variables](#), both the main CPU and the ULP core can easily access global variables in RTC memory. Writing state information to such a variable from the ULP and reading it from the main CPU can help you discern what is happening on the ULP core. The downside of this approach is that it requires the main CPU to be awake, which will not always be the case. Keeping the main CPU awake might even, in some cases, mask problems, as some issues may only occur when certain power domains are powered down.
- Printing using the bit-banged UART driver: the ULP RISC-V component comes with a low-speed bit-banged UART TX driver that can be used for printing information independently of the main CPU state. See [system/ulp\\_riscv/uart\\_print](#) for an example of how to use this driver.
- Trap signal: the ULP RISC-V has a hardware trap that will trigger under certain conditions, e.g. illegal instruction. This will cause the main CPU to be woken up with the wake-up cause [ESP\\_SLEEP\\_WAKEUP\\_COCPU\\_TRAP\\_TRIG](#).

### Application Examples

- ULP RISC-V Coprocessor polls GPIO while main CPU is in deep sleep: [system/ulp\\_riscv/gpio](#).
- ULP RISC-V Coprocessor uses bit-banged UART tx to print: [system/ulp\\_riscv/uart\\_print](#).
- ULP RISC-V Coprocessor reads external temperature sensor while main CPU is in deep sleep: [system/ulp\\_riscv/ds18b20\\_onewire](#).

### API Reference

#### Header File

- [components/ulp/ulp\\_riscv/include/ulp\\_riscv.h](#)

#### Functions

*esp\_err\_t* **ulp\_riscv\_config\_and\_run** (*ulp\_riscv\_cfg\_t* \*cfg)

Configure the ULP and run the program loaded into RTC memory.

**Parameters** *cfg* –pointer to the config struct

**Returns** ESP\_OK on success

*esp\_err\_t* **ulp\_riscv\_run** (void)

Configure the ULP with default settings and run the program loaded into RTC memory.

**Returns** ESP\_OK on success

*esp\_err\_t* **ulp\_riscv\_load\_binary** (const uint8\_t \*program\_binary, size\_t program\_size\_bytes)

Load ULP-RISC-V program binary into RTC memory.

Different than ULP FSM, the binary program has no special format, it is the ELF file generated by RISC-V toolchain converted to binary format using objcopy.

Linker script in components/ulp/ld/ulp\_riscv.ld produces ELF files which correspond to this format. This linker script produces binaries with load\_addr == 0.

**Parameters**

- **program\_binary** –pointer to program binary
- **program\_size\_bytes** –size of the program binary

**Returns**

- ESP\_OK on success
- ESP\_ERR\_INVALID\_SIZE if program\_size\_bytes is more than 8KiB

void **ulp\_riscv\_timer\_stop** (void)

Stop the ULP timer.

---

**Note:** This will stop the ULP from waking up if halted, but will not abort any program currently executing on the ULP.

---

void **ulp\_riscv\_timer\_resume** (void)

Resumes the ULP timer.

---

**Note:** This will resume an already configured timer, but does no other configuration

---

void **ulp\_riscv\_halt** (void)

Halts the program currently running on the ULP-RISC-V.

---

**Note:** Program will restart at the next ULP timer trigger if timer is still running. If you want to stop the ULP from waking up then call `ulp_riscv_timer_stop()` first.

---

## Structures

struct **ulp\_riscv\_cfg\_t**

ULP riscv init parameters.

## Public Members

*ulp\_riscv\_wakeup\_source\_t* **wakeup\_source**

ULP wakeup source

## Macros

**ULP\_RISCV\_DEFAULT\_CONFIG** ()

## Enumerations

enum **ulp\_riscv\_wakeup\_source\_t**

*Values:*

enumerator **ULP\_RISCV\_WAKEUP\_SOURCE\_TIMER**

enumerator **ULP\_RISCV\_WAKEUP\_SOURCE\_GPIO**

## 2.9.31 Watchdogs

### Overview

The ESP-IDF has support for multiple types of watchdogs, with the two main ones being: The Interrupt Watchdog Timer and the Task Watchdog Timer (TWDT). The Interrupt Watchdog Timer and the TWDT can both be enabled using [Project Configuration Menu](#), however the TWDT can also be enabled during runtime. The Interrupt Watchdog is responsible for detecting instances where FreeRTOS task switching is blocked for a prolonged period of time. The TWDT is responsible for detecting instances of tasks running without yielding for a prolonged period.

ESP-IDF has support for the following types of watchdog timers:

- Interrupt Watchdog Timer (IWDT)
- Task Watchdog Timer (TWDT)
- Crystal 32K Watchdog Timer (XTWDT)

The various watchdog timers can be enabled using the *Project Configuration Menu*. However, the TWDT can also be enabled during runtime.

### Interrupt Watchdog Timer (IWDT)

The purpose of the IWDT is to ensure that interrupt service routines (ISRs) are not blocked from running for a prolonged period of time (i.e., the IWDT timeout period). Blocking ISRs from running in a timely manner is undesirable as it can increase ISR latency, and also prevents task switching (as task switching is executed from an ISR). The things that can block ISRs from running include:

- Disabling interrupts
- Critical Sections (also disables interrupts)
- Other same/higher priority ISRs (will block same/lower priority ISRs from running it completes execution)

The IWDT utilizes the watchdog timer in Timer Group 1 as its underlying hardware timer and leverages the FreeRTOS tick interrupt on each CPU to feed the watchdog timer. If the tick interrupt on a particular CPU is not run at within the IWDT timeout period, it is indicative that something is blocking ISRs from being run on that CPU (see the list of reasons above).

When the IWDT times out, the default action is to invoke the panic handler and display the panic reason as `Interrupt wdt timeout on CPU0` or `Interrupt wdt timeout on CPU1` (as applicable). Depending on the panic handler's configured behavior (see *CONFIG\_ESP\_SYSTEM\_PANIC*), users can then debug the source of the IWDT timeout (via the backtrace, OpenOCD, gdbstub etc) or simply reset the chip (which may be preferred in a production environment).

If for whatever reason the panic handler is unable to run after an IWDT timeout, the IWDT has a secondary timeout that will hard-reset the chip (i.e., a system reset).

### Configuration

- The IWDT is enabled by default via the *CONFIG\_ESP\_INT\_WDT* option.
- The IWDT's timeout is configured by setting the *CONFIG\_ESP\_INT\_WDT\_TIMEOUT\_MS* option.
  - Note that the default timeout is higher if PSRAM support is enabled, as a critical section or interrupt routine that accesses a large amount of PSRAM will take longer to complete in some circumstances.
  - The timeout should always be at least twice longer than the period between FreeRTOS ticks (see *CONFIG\_FREERTOS\_HZ*).

**Tuning** If you find the IWDT timeout is triggered because an interrupt or critical section is running longer than the timeout period, consider rewriting the code:

- Critical sections should be made as short as possible. Any non-critical code/computation should be placed outside the critical section.
- Interrupt handlers should also perform the minimum possible amount of computation. Users can consider deferring any computation to a task by having the ISR push data to a task using queues.

Neither critical sections or interrupt handlers should ever block waiting for another event to occur. If changing the code to reduce the processing time is not possible or desirable, it's possible to increase the *CONFIG\_ESP\_INT\_WDT\_TIMEOUT\_MS* setting instead.

### Task Watchdog Timer (TWDT)

The Task Watchdog Timer (TWDT) is used to monitor particular tasks, ensuring that they are able to execute within a given timeout period. The TWDT primarily watches the Idle task, however any task can subscribe to be watched by the TWDT. By watching the Idle task, the TWDT can detect instances of tasks running for a prolonged period of



time without yielding. This can be an indicator of poorly written code that spinloops on a peripheral, or a task that is stuck in an infinite loop.

The TWDT is built around the Hardware Watchdog Timer in Timer Group 0. When a timeout occurs, an interrupt is triggered. Users can define the function `esp_task_wdt_isr_user_handler` in the user code, in order to receive the timeout event and extend the default behavior.

**Usage** The following functions can be used to watch tasks using the TWDT:

- `esp_task_wdt_init()` to initialize the TWDT and subscribe the idle tasks.
- `esp_task_wdt_add()` subscribes other tasks to the TWDT.
- Once subscribed, `esp_task_wdt_reset()` should be called from the task to feed the TWDT.
- `esp_task_wdt_delete()` unsubscribes a previously subscribed task
- `esp_task_wdt_deinit()` unsubscribes the idle tasks and deinitializes the TWDT

In the case where applications need to watch at a more granular level (i.e., ensure that a particular functions/stub/code-path is called), the TWDT allows subscription of “users” .

- `esp_task_wdt_add_user()` to subscribe an arbitrary user of the TWDT. This function will return a user handle to the added user.
- `esp_task_wdt_reset_user()` must be called using the user handle in order to prevent a TWDT timeout.
- `esp_task_wdt_delete_user()` unsubscribes an arbitrary user of the TWDT.

**Configuration** The default timeout period for the TWDT is set using config item `CONFIG_ESP_TASK_WDT_TIMEOUT_S`. This should be set to at least as long as you expect any single task will need to monopolize the CPU (for example, if you expect the app will do a long intensive calculation and should not yield to other tasks). It is also possible to change this timeout at runtime by calling `esp_task_wdt_init()`.

---

**Note:** Erasing large flash areas can be time consuming and can cause a task to run continuously, thus triggering a TWDT timeout. The following two methods can be used to avoid this:

- Increase `CONFIG_ESP_TASK_WDT_TIMEOUT_S` in menuconfig for a larger watchdog timeout period.
- You can also call `esp_task_wdt_init()` to increase the watchdog timeout period before erasing a large flash area.

For more information, you can refer to *SPI Flash*.

---

The following config options control TWDT configuration. They are all enabled by default:

- `CONFIG_ESP_TASK_WDT_EN` - enables TWDT feature. If this option is disabled, TWDT cannot be used, even if initialized at runtime.
- `CONFIG_ESP_TASK_WDT_INIT` - the TWDT is initialized automatically during startup. If this option is disabled, it is still possible to initialize the Task WDT at runtime by calling `esp_task_wdt_init()`.
- `CONFIG_ESP_TASK_WDT_CHECK_IDLE_TASK_CPU0` - Idle task is subscribed to the TWDT during startup. If this option is disabled, it is still possible to subscribe the idle task by calling `esp_task_wdt_init()` again.

### XTAL32K Watchdog Timer (XTWDT)

One of the optional clock inputs to the ESP32-S2 is an external 32 KHz crystal or oscillator (XTAL32K) that is used as a clock source (`XTAL32K_CLK`) to various subsystems (such as the RTC).

The XTWDT is a dedicated watchdog timer used to ensure that the XTAL32K is functioning correctly. When `XTAL32K_CLK` works as the clock source of `RTC_SLOW_CLK` and stops oscillating, the XTWDT will detect this and generate an interrupt. It also provides functionality for automatically switching over to the internal, but less accurate oscillator as the `RTC_SLOW_CLK` source.



Since the switch to the backup clock is done in hardware it can also happen during deep sleep. This means that even if XTAL32K\_CLK stops functioning while the chip in deep sleep, waiting for a timer to expire, it will still be able to wake-up as planned.

If the XTAL32K\_CLK starts functioning normally again, you can call `esp_xt_wdt_restore_clk` to switch back to this clock source and re-enable the watchdog timer.

### Configuration

- When the external 32KHz crystal or oscillator is selected (`CONFIG_RTC_CLK_SRC`) the XTWDT can be enabled via the `CONFIG_ESP_XT_WDT` configuration option.
- The timeout is configured by setting the `CONFIG_ESP_XT_WDT_TIMEOUT` option.
- The automatic backup clock functionality is enabled via the ref:`CONFIG_ESP_XT_WDT_BACKUP_CLK_ENABLE` configuration option.

### JTAG & Watchdogs

While debugging using OpenOCD, the CPUs will be halted every time a breakpoint is reached. However if the watchdog timers continue to run when a breakpoint is encountered, they will eventually trigger a reset making it very difficult to debug code. Therefore OpenOCD will disable the hardware timers of both the interrupt and task watchdogs at every breakpoint. Moreover, OpenOCD will not reenable them upon leaving the breakpoint. This means that interrupt watchdog and task watchdog functionality will essentially be disabled. No warnings or panics from either watchdogs will be generated when the ESP32-S2 is connected to OpenOCD via JTAG.

### API Reference

**Task Watchdog** A full example using the Task Watchdog is available in esp-idf: [system/task\\_watchdog](#)

### Header File

- `components/esp_system/include/esp_task_wdt.h`

### Functions

`esp_err_t esp_task_wdt_init` (const `esp_task_wdt_config_t` \*config)

Initialize the Task Watchdog Timer (TWDT)

This function configures and initializes the TWDT. This function will subscribe the idle tasks if configured to do so. For other tasks, users can subscribe them using `esp_task_wdt_add()` or `esp_task_wdt_add_user()`. This function won't start the timer if no task have been registered yet.

---

**Note:** `esp_task_wdt_init()` must only be called after the scheduler is started. Moreover, it must not be called by multiple tasks simultaneously.

---

**Parameters** `config` –[in] Configuration structure

#### Returns

- `ESP_OK`: Initialization was successful
- `ESP_ERR_INVALID_STATE`: Already initialized
- Other: Failed to initialize TWDT

`esp_err_t esp_task_wdt_reconfigure` (const `esp_task_wdt_config_t` \*config)

Reconfigure the Task Watchdog Timer (TWDT)

The function reconfigures the running TWDT. It must already be initialized when this function is called.

---

**Note:** `esp_task_wdt_reconfigure()` must not be called by multiple tasks simultaneously.

---

**Parameters** `config` –[in] Configuration structure

**Returns**

- `ESP_OK`: Reconfiguring was successful
- `ESP_ERR_INVALID_STATE`: TWDT not initialized yet
- Other: Failed to initialize TWDT

*esp\_err\_t* `esp_task_wdt_deinit` (void)

Deinitialize the Task Watchdog Timer (TWDT)

This function will deinitialize the TWDT, and unsubscribe any idle tasks. Calling this function whilst other tasks are still subscribed to the TWDT, or when the TWDT is already deinitialized, will result in an error code being returned.

---

**Note:** `esp_task_wdt_deinit()` must not be called by multiple tasks simultaneously.

---

**Returns**

- `ESP_OK`: TWDT successfully deinitialized
- Other: Failed to deinitialize TWDT

*esp\_err\_t* `esp_task_wdt_add` (*TaskHandle\_t* task\_handle)

Subscribe a task to the Task Watchdog Timer (TWDT)

This function subscribes a task to the TWDT. Each subscribed task must periodically call `esp_task_wdt_reset()` to prevent the TWDT from elapsing its timeout period. Failure to do so will result in a TWDT timeout.

**Parameters** `task_handle` –Handle of the task. Input NULL to subscribe the current running task to the TWDT

**Returns**

- `ESP_OK`: Successfully subscribed the task to the TWDT
- Other: Failed to subscribe task

*esp\_err\_t* `esp_task_wdt_add_user` (const char \*user\_name, *esp\_task\_wdt\_user\_handle\_t* \*user\_handle\_ret)

Subscribe a user to the Task Watchdog Timer (TWDT)

This function subscribes a user to the TWDT. A user of the TWDT is usually a function that needs to run periodically. Each subscribed user must periodically call `esp_task_wdt_reset_user()` to prevent the TWDT from elapsing its timeout period. Failure to do so will result in a TWDT timeout.

**Parameters**

- `user_name` –[in] String to identify the user
- `user_handle_ret` –[out] Handle of the user

**Returns**

- `ESP_OK`: Successfully subscribed the user to the TWDT
- Other: Failed to subscribe user

*esp\_err\_t* `esp_task_wdt_reset` (void)

Reset the Task Watchdog Timer (TWDT) on behalf of the currently running task.

This function will reset the TWDT on behalf of the currently running task. Each subscribed task must periodically call this function to prevent the TWDT from timing out. If one or more subscribed tasks fail to reset the TWDT on their own behalf, a TWDT timeout will occur.

**Returns**

- `ESP_OK`: Successfully reset the TWDT on behalf of the currently running task
- Other: Failed to reset

*esp\_err\_t* **esp\_task\_wdt\_reset\_user** (*esp\_task\_wdt\_user\_handle\_t* user\_handle)

Reset the Task Watchdog Timer (TWDT) on behalf of a user.

This function will reset the TWDT on behalf of a user. Each subscribed user must periodically call this function to prevent the TWDT from timing out. If one or more subscribed users fail to reset the TWDT on their own behalf, a TWDT timeout will occur.

**Parameters** **user\_handle** –[in] User handle

- ESP\_OK: Successfully reset the TWDT on behalf of the user
- Other: Failed to reset

*esp\_err\_t* **esp\_task\_wdt\_delete** (*TaskHandle\_t* task\_handle)

Unsubscribes a task from the Task Watchdog Timer (TWDT)

This function will unsubscribe a task from the TWDT. After being unsubscribed, the task should no longer call `esp_task_wdt_reset()`.

**Parameters** **task\_handle** –[in] Handle of the task. Input NULL to unsubscribe the current running task.

**Returns**

- ESP\_OK: Successfully unsubscribed the task from the TWDT
- Other: Failed to unsubscribe task

*esp\_err\_t* **esp\_task\_wdt\_delete\_user** (*esp\_task\_wdt\_user\_handle\_t* user\_handle)

Unsubscribes a user from the Task Watchdog Timer (TWDT)

This function will unsubscribe a user from the TWDT. After being unsubscribed, the user should no longer call `esp_task_wdt_reset_user()`.

**Parameters** **user\_handle** –[in] User handle

**Returns**

- ESP\_OK: Successfully unsubscribed the user from the TWDT
- Other: Failed to unsubscribe user

*esp\_err\_t* **esp\_task\_wdt\_status** (*TaskHandle\_t* task\_handle)

Query whether a task is subscribed to the Task Watchdog Timer (TWDT)

This function will query whether a task is currently subscribed to the TWDT, or whether the TWDT is initialized.

**Parameters** **task\_handle** –[in] Handle of the task. Input NULL to query the current running task.

**Returns** :

- ESP\_OK: The task is currently subscribed to the TWDT
- ESP\_ERR\_NOT\_FOUND: The task is not subscribed
- ESP\_ERR\_INVALID\_STATE: TWDT was never initialized

void **esp\_task\_wdt\_isr\_user\_handler** (void)

User ISR callback placeholder.

This function is called by `task_wdt_isr` function (ISR for when TWDT times out). It can be defined in user code to handle TWDT events.

---

**Note:** It has the same limitations as the interrupt function. Do not use ESP\_LOGx functions inside.

---

## Structures

struct **esp\_task\_wdt\_config\_t**

Task Watchdog Timer (TWDT) configuration structure.

### Public Members

`uint32_t timeout_ms`

TWDT timeout duration in milliseconds

`uint32_t idle_core_mask`

Mask of the cores who's idle task should be subscribed on initialization

`bool trigger_panic`

Trigger panic when timeout occurs

### Type Definitions

```
typedef struct esp_task_wdt_user_handle_s *esp_task_wdt_user_handle_t
```

Task Watchdog Timer (TWDT) user handle.

Code examples for this API section are provided in the [system](#) directory of ESP-IDF examples.



## Chapter 3

# Hardware Reference

### 3.1 Chip Series Comparison

The comparison below covers key features of chips supported by ESP-IDF. For the full list of features please refer to respective datasheets in Section [Related Documents](#).

Table 1: Chip Series Comparison

Feature	ESP32 Series	ESP32-S2 Series	ESP32-C3 Series	ESP32-S3 Series
Launch year	2016	2020	2020	2020
Variants	See <a href="#">ESP32 Datasheet (PDF)</a>	See <a href="#">ESP32-S2 Datasheet (PDF)</a>	See <a href="#">ESP32-C3 Datasheet (PDF)</a>	See <a href="#">ESP32-S3 Datasheet (PDF)</a>
Core	Xtensa® dual-/single core 32-bit LX6	Xtensa® single-core 32-bit LX7	32-bit single-core RISC-V	Xtensa® dual-core 32-bit LX7
Wi-Fi protocols	802.11 b/g/n, 2.4 GHz	802.11 b/g/n, 2.4 GHz	802.11 b/g/n, 2.4 GHz	802.11 b/g/n, 2.4 GHz
Bluetooth®	Bluetooth v4.2 BR/EDR and Bluetooth Low Energy	×	Bluetooth 5.0	Bluetooth 5.0
Typical frequency	240 MHz (160 MHz for ESP32-S0WD)	240 MHz	160 MHz	240 MHz
SRAM	520 KB	320 KB	400 KB	512 KB
ROM	448 KB for booting and core functions	128 KB for booting and core functions	384 KB for booting and core functions	384 KB for booting and core functions
Embedded flash	2 MB, 4 MB, or none, depending on variants	2 MB, 4 MB, or none, depending on variants	4 MB or none, depending on variants	8 MB or none, depending on variants
External flash	Up to 16 MB device, address 11 MB + 248 KB each time	Up to 1 GB device, address 11.5 MB each time	Up to 16 MB device, address 8 MB each time	Up to 1 GB device, address 32 MB each time
External RAM	Up to 8 MB device, address 4 MB each time	Up to 1 GB device, address 11.5 MB each time	×	Up to 1 GB device, address 32 MB each time

continues on next page

Table 1 – continued from previous page

Feature	ESP32 Series	ESP32-S2 Series	ESP32-C3 Series	ESP32-S3 Series
Cache	✓ Two-way set associative	✓ Four-way set associative, independent instruction cache and data cache	✓ Eight-way set associative, 32-bit data/instruction bus width	✓ Four-way or eight-way set associative for instruction cache; four-way set associative for data cache, 32-bit data/instruction bus width
<b>Peripherals</b>				
ADC	Two 12-bit, 18 channels	Two 12-bit, 20 channels	Two 12-bit SAR ADCs, at most 6 channels	Two 12-bit SAR ADCs, 20 channels
DAC	Two 8-bit channels	Two 8-bit channels	×	×
Timers	Four 64-bit general-purpose timers, and three watchdog timers	Four 64-bit general-purpose timers, and three watchdog timers	Two 54-bit general-purpose timers, and three watchdog timers	Four 54-bit general-purpose timers, and three watchdog timers
Temperature sensor	×	1	1	1
Touch sensor	10	14	×	14
Hall sensor	1	×	×	×
GPIO	34	43	22	45
SPI	4	4	3	4
LCD interface	1	1	×	1
UART	3	2 <sup>1</sup>	2 <sup>1</sup>	3
I2C	2	2	1	2
I2S	2, can be configured to operate with 8/16/32/40/48-bit resolution as an input or output channel.	1, can be configured to operate with 8/16/24/32/48/64-bit resolution as an input or output channel.	1, can be configured to operate with 8/16/24/32-bit resolution as an input or output channel.	2, can be configured to operate with 8/16/24/32-bit resolution as an input or output channel.
Camera interface	1	1	×	1
DMA	Dedicated DMA to UART, SPI, I2S, SDIO slave, SD/MMC host, EMAC, BT, and Wi-Fi	Dedicated DMA to UART, SPI, AES, SHA, I2S, and ADC Controller	General-purpose, 3 TX channels, 3 RX channels	General-purpose, 5 TX channels, 5 RX channels
RMT	8 channels	4 channels <sup>1</sup> , can be configured to TX/RX channels	4 channels <sup>2</sup> , 2 TX channels, 2 RX channels	8 channels <sup>2</sup> , 4 TX channels, 4 RX channels
Pulse counter	8 channels	4 channels <sup>1</sup>	×	4 channels <sup>1</sup>
LED PWM	16 channels	8 channels <sup>1</sup>	6 channels <sup>2</sup>	8 channels <sup>1</sup>
MCPWM	2, six PWM outputs	×	×	2, six PWM outputs
USB OTG	×	1	×	1

continues on next page

Table 1 – continued from previous page

Feature	ESP32 Series	ESP32-S2 Series	ESP32-C3 Series	ESP32-S3 Series
TWAI® controller (compatible with ISO 11898-1)	1	1	1	1
SD/SDIO/MMC host controller		×	×	1
SDIO slave controller	1	×	×	×
Ethernet MAC	1	×	×	×
ULP	ULP FSM	PicoRV32 core with 8 KB SRAM, ULP FSM	×	PicoRV32 core with 8 KB SRAM, ULP FSM
Debug Assist	×	×	1	×
<b>Security</b>				
Secure boot	✓	✓ Faster and safer, compared with ESP32	✓ Faster and safer, compared with ESP32	✓ Faster and safer, compared with ESP32
Flash encryption	✓	✓ Support for PSRAM encryption. Safer, compared with ESP32	✓ Safer, compared with ESP32	✓ Support for PSRAM encryption. Safer, compared with ESP32
OTP	1024-bit	4096-bit	4096-bit	4096-bit
AES	✓ AES-128, AES-192, AES-256 (FIPS PUB 197)	✓ AES-128, AES-192, AES-256 (FIPS PUB 197); DMA support	✓ AES-128, AES-256 (FIPS PUB 197); DMA support	✓ AES-128, AES-256 (FIPS PUB 197); DMA support
HASH	SHA-1, SHA-256, SHA-384, SHA-512 (FIPS PUB 180-4)	SHA-1, SHA-224, SHA-256, SHA-384, SHA-512, SHA-512/224, SHA-512/256, SHA-512/t (FIPS PUB 180-4); DMA support	SHA-1, SHA-224, SHA-256 (FIPS PUB 180-4); DMA support	SHA-1, SHA-224, SHA-256, SHA-384, SHA-512, SHA-512/224, SHA-512/256, SHA-512/t (FIPS PUB 180-4); DMA support
RSA	Up to 4096 bits	Up to 4096 bits	Up to 3072 bits	Up to 4096 bits
RNG	✓	✓	✓	✓
HMAC	×	✓	✓	✓
Digital signature	×	✓	✓	✓
XTS	×	✓ XTS-AES-128, XTS-AES-256	✓ XTS-AES-128	✓ XTS-AES-128, XTS-AES-256
<b>Other</b>				
Deep-sleep (ULP sensor-monitored pattern)	100 μA (when ADC work with a duty cycle of 1%)	22 μA (when touch sensors work with a duty cycle of 1%)	No such pattern	TBD
Size	QFN48 5*5, 6*6, depending on variants	QFN56 7*7	QFN32 5*5	QFN56 7*7

- **Note 1:** Reduced chip area compared with ESP32
- **Note 2:** Reduced chip area compared with ESP32 and ESP32-S2



- **Note 3:** Die size: ESP32-C3 < ESP32-S2 < ESP32-S3 < ESP32

### 3.1.1 Related Documents

- [ESP32 Datasheet \(PDF\)](#)
- [ESP32-PICO Datasheets \(PDF\)](#)
  - [ESP32-PICO-D4](#)
  - [ESP32-PICO-V3](#)
  - [ESP32-PICO-V3-02](#)
- [ESP32-S2 Datasheet \(PDF\)](#)
- [ESP32-C3 Datasheet \(PDF\)](#)
- [ESP32-S3 Datasheet \(PDF\)](#)
- [ESP Product Selector](#)

# Chapter 4

## API Guides

### 4.1 Application Level Tracing library

#### 4.1.1 Overview

ESP-IDF provides a useful feature for program behavior analysis: application level tracing. It is implemented in the corresponding library and can be enabled in menuconfig. This feature allows to transfer arbitrary data between host and ESP32-S2 via JTAG, UART, or USB interfaces with small overhead on program execution. It is possible to use JTAG and UART interfaces simultaneously. The UART interface is mostly used for connection with SEGGER SystemView tool (see [SystemView](#)).

Developers can use this library to send application-specific state of execution to the host and receive commands or other types of information from the opposite direction at runtime. The main use cases of this library are:

1. Collecting application-specific data. See [Application Specific Tracing](#).
2. Lightweight logging to the host. See [Logging to Host](#).
3. System behavior analysis. See [System Behavior Analysis with SEGGER SystemView](#).
4. Source code coverage. See [Gcov \(Source Code Coverage\)](#).

Tracing components used when working over JTAG interface are shown in the figure below.

#### 4.1.2 Modes of Operation

The library supports two modes of operation:

**Post-mortem mode:** This is the default mode. The mode does not need interaction with the host side. In this mode, tracing module does not check whether the host has read all the data from *HW UP BUFFER*, but directly overwrites old data with the new ones. This mode is useful when only the latest trace data is interesting to the user, e.g., for analyzing program's behavior just before the crash. The host can read the data later on upon user request, e.g., via special OpenOCD command in case of working via JTAG interface.

**Streaming mode:** Tracing module enters this mode when the host connects to ESP32-S2. In this mode, before writing new data to *HW UP BUFFER*, the tracing module checks that whether there is enough space in it and if necessary, waits for the host to read data and free enough memory. Maximum waiting time is controlled via timeout values passed by users to corresponding API routines. So when application tries to write data to the trace buffer using the finite value of the maximum waiting time, it is possible that this data will be dropped. This is especially true for tracing from time critical code (ISRs, OS scheduler code, etc.) where infinite timeouts can lead to system malfunction. In order to avoid loss of such critical data, developers can enable additional data buffering via menuconfig option



Fig. 1: Tracing Components Used When Working Over JTAG

`CONFIG_APTRACE_PENDING_DATA_SIZE_MAX`. This macro specifies the size of data which can be buffered in above conditions. The option can also help to overcome situation when data transfer to the host is temporarily slowed down, e.g., due to USB bus congestions. But it will not help when the average bitrate of the trace data stream exceeds the hardware interface capabilities.

### 4.1.3 Configuration Options and Dependencies

Using of this feature depends on two components:

1. **Host side:** Application tracing is done over JTAG, so it needs OpenOCD to be set up and running on host machine. For instructions on how to set it up, please see [JTAG Debugging](#) for details.
2. **Target side:** Application tracing functionality can be enabled in menuconfig. Please go to `Component config > Application Level Tracing` menu, which allows selecting destination for the trace data (hardware interface for transport: JTAG or/and UART). Choosing any of the destinations automatically enables the `CONFIG_APTRACE_ENABLE` option. For UART interfaces, users have to define baud rate, TX and RX pins numbers, and additional UART-related parameters.

---

**Note:** In order to achieve higher data rates and minimize the number of dropped packets, it is recommended to optimize the setting of JTAG clock frequency, so that it is at maximum and still provides stable operation of JTAG. See [Optimize JTAG speed](#).

---

There are two additional menuconfig options not mentioned above:

1. *Threshold for flushing last trace data to host on panic* (`CONFIG_APTRACE_POSTMORTEM_FLUSH_THRESH`). This option is necessary due to the nature of working over JTAG. In this mode, trace data is exposed to the host in 16 KB blocks. In post-mortem mode, when one block is filled, it is exposed to the host and the previous one becomes unavailable. In other words, the trace data is overwritten in 16 KB granularity. On panic, the latest data from the current input block is exposed to the host and the host can read them for post-analysis. System panic may occur when a very small amount of data are not exposed to the host yet. In this case, the previous 16 KB of collected data will be lost and the host will see the latest, but very small piece of the trace.

It can be insufficient to diagnose the problem. This menuconfig option allows avoiding such situations. It controls the threshold for flushing data in case of apanic. For example, users can decide that it needs no less than 512 bytes of the recent trace data, so if there is less than 512 bytes of pending data at the moment of panic, they will not be flushed and will not overwrite the previous 16 KB. The option is only meaningful in post-mortem mode and when working over JTAG.

2. *Timeout for flushing last trace data to host on panic* (`CONFIG_APPTRACE_ONPANIC_HOST_FLUSH_TMO`). The option is only meaningful in streaming mode and it controls the maximum time that the tracing module will wait for the host to read the last data in case of panic.
3. *UART RX/TX ring buffer size* (`CONFIG_APPTRACE_UART_TX_BUFF_SIZE`). The size of the buffer depends on the amount of data transferred through the UART.
4. *UART TX message size* (`CONFIG_APPTRACE_UART_TX_MSG_SIZE`). The maximum size of the single message to transfer.

#### 4.1.4 How to Use This Library

This library provides APIs for transferring arbitrary data between the host and ESP32-S2. When enabled in menuconfig, the target application tracing module is initialized automatically at the system startup, so all what the user needs to do is to call corresponding APIs to send, receive or flush the data.

##### Application Specific Tracing

In general, users should decide what type of data should be transferred in every direction and how these data must be interpreted (processed). The following steps must be performed to transfer data between the target and the host:

1. On the target side, users should implement algorithms for writing trace data to the host. Piece of code below shows an example on how to do this.

```
#include "esp_app_trace.h"
...
char buf[] = "Hello World!";
esp_err_t res = esp_apprace_write(ESP_APPTRACE_DEST_TRAX, buf,
↳strlen(buf), ESP_APPTRACE_TMO_INFINITE);
if (res != ESP_OK) {
    ESP_LOGE(TAG, "Failed to write data to host!");
    return res;
}
```

`esp_apprace_write()` function uses `memcpy` to copy user data to the internal buffer. In some cases, it can be more optimal to use `esp_apprace_buffer_get()` and `esp_apprace_buffer_put()` functions. They allow developers to allocate buffer and fill it themselves. The following piece of code shows how to do this.

```
#include "esp_app_trace.h"
...
int number = 10;
char *ptr = (char *)esp_apprace_buffer_get(ESP_APPTRACE_DEST_TRAX, 32,
↳100/*tmo in us*/);
if (ptr == NULL) {
    ESP_LOGE(TAG, "Failed to get buffer!");
    return ESP_FAIL;
}
sprintf(ptr, "Here is the number %d", number);
esp_err_t res = esp_apprace_buffer_put(ESP_APPTRACE_DEST_TRAX, ptr,
↳100/*tmo in us*/);
if (res != ESP_OK) {
    /* in case of error host tracing tool (e.g., OpenOCD) will report
↳incomplete user buffer */
    ESP_LOGE(TAG, "Failed to put buffer!");
    return res;
}
```

Also according to his needs, the user may want to receive data from the host. Piece of code below shows an example on how to do this.

```
#include "esp_app_trace.h"
...
char buf[32];
char down_buf[32];
size_t sz = sizeof(buf);

/* config down buffer */
esp_apptrace_down_buffer_config(down_buf, sizeof(down_buf));
/* check for incoming data and read them if any */
esp_err_t res = esp_apptrace_read(ESP_APPTRACE_DEST_TRAX, buf, &sz, 0/
↳*do not wait*/);
if (res != ESP_OK) {
    ESP_LOGE(TAG, "Failed to read data from host!");
    return res;
}
if (sz > 0) {
    /* we have data, process them */
    ...
}
```

esp\_apptrace\_read() function uses memcpy to copy host data to user buffer. In some cases it can be more optimal to use esp\_apptrace\_down\_buffer\_get() and esp\_apptrace\_down\_buffer\_put() functions. They allow developers to occupy chunk of read buffer and process it in-place. The following piece of code shows how to do this.

```
#include "esp_app_trace.h"
...
char down_buf[32];
uint32_t *number;
size_t sz = 32;

/* config down buffer */
esp_apptrace_down_buffer_config(down_buf, sizeof(down_buf));
char *ptr = (char *)esp_apptrace_down_buffer_get(ESP_APPTRACE_DEST_
↳TRAX, &sz, 100/*tmo in us*/);
if (ptr == NULL) {
    ESP_LOGE(TAG, "Failed to get buffer!");
    return ESP_FAIL;
}
if (sz > 4) {
    number = (uint32_t *)ptr;
    printf("Here is the number %d", *number);
} else {
    printf("No data");
}
esp_err_t res = esp_apptrace_down_buffer_put(ESP_APPTRACE_DEST_TRAX,
↳ptr, 100/*tmo in us*/);
if (res != ESP_OK) {
    /* in case of error host tracing tool (e.g., OpenOCD) will report
↳incomplete user buffer */
    ESP_LOGE(TAG, "Failed to put buffer!");
    return res;
}
```

2. The next step is to build the program image and download it to the target as described in the [Getting Started Guide](#).
3. Run OpenOCD (see [JTAG Debugging](#)).
4. Connect to OpenOCD telnet server. It can be done using the following command in terminal telnet <oocd\_host> 4444. If telnet session is opened on the same machine which runs OpenOCD, you can use localhost as <oocd\_host> in the command above.

5. Start trace data collection using special OpenOCD command. This command will transfer tracing data and redirect them to the specified file or socket (currently only files are supported as trace data destination). For description of the corresponding commands, see [OpenOCD Application Level Tracing Commands](#).
6. The final step is to process received data. Since the format of data is defined by users, the processing stage is out of the scope of this document. Good starting points for data processor are python scripts in `$IDF_PATH/tools/esp_app_trace`: `apptrace_proc.py` (used for feature tests) and `logtrace_proc.py` (see more details in section [Logging to Host](#)).

**OpenOCD Application Level Tracing Commands** *HW UP BUFFER* is shared between user data blocks and the filling of the allocated memory is performed on behalf of the API caller (in task or ISR context). In multithreading environment, it can happen that the task/ISR which fills the buffer is preempted by another high priority task/ISR. So it is possible that the user data preparation process is not completed at the moment when that chunk is read by the host. To handle such conditions, the tracing module prepends all user data chunks with header which contains the allocated user buffer size (2 bytes) and the length of the actually written data (2 bytes). So the total length of the header is 4 bytes. OpenOCD command which reads trace data reports error when it reads incomplete user data chunk, but in any case, it puts the contents of the whole user chunk (including unfilled area) to the output file.

Below is the description of available OpenOCD application tracing commands.

---

**Note:** Currently, OpenOCD does not provide commands to send arbitrary user data to the target.

---

Command usage:

```
esp apptrace [start <options>] | [stop] | [status] | [dump <cores_num> <outfile>]
```

Sub-commands:

**start** Start tracing (continuous streaming).  
**stop** Stop tracing.  
**status** Get tracing status.  
**dump** Dump all data from (post-mortem dump).

Start command syntax:

```
start <outfile> [poll_period [trace_size [stop_tmo [wait4halt  
[skip_size]]]]]
```

**outfile** Path to file to save data from both CPUs. This argument should have the following format: `file://path/to/file`.

**poll\_period** Data polling period (in ms) for available trace data. If greater than 0, then command runs in non-blocking mode. By default, 1 ms.

**trace\_size** Maximum size of data to collect (in bytes). Tracing is stopped after specified amount of data is received. By default, -1 (trace size stop trigger is disabled).

**stop\_tmo** Idle timeout (in sec). Tracing is stopped if there is no data for specified period of time. By default, -1 (disable this stop trigger). Optionally set it to value longer than longest pause between tracing commands from target.

**wait4halt** If 0, start tracing immediately, otherwise command waits for the target to be halted (after reset, by breakpoint etc.) and then automatically resumes it and starts tracing. By default, 0.

**skip\_size** Number of bytes to skip at the start. By default, 0.

---

**Note:** If `poll_period` is 0, OpenOCD telnet command line will not be available until tracing is stopped. You must stop it manually by resetting the board or pressing Ctrl+C in OpenOCD window (not one with the telnet session). Another option is to set `trace_size` and wait until this size of data is collected. At this point, tracing stops automatically.

---

Command usage examples:

1. Collect 2048 bytes of tracing data to the file `trace.log`. The file will be saved in the `openocd-esp32` directory.

```
esp apptrace start file://trace.log 1 2048 5 0 0
```

The tracing data will be retrieved and saved in non-blocking mode. This process will stop automatically after 2048 bytes are collected, or if no data are available for more than 5 seconds.

---

**Note:** Tracing data is buffered before it is made available to OpenOCD. If you see “Data timeout!” message, then it is likely that the target is not sending enough data to empty the buffer to OpenOCD before the timeout. Either increase the timeout or use the function `esp_apptrace_flush()` to flush the data on specific intervals.

---

2. Retrieve tracing data indefinitely in non-blocking mode.

```
esp apptrace start file://trace.log 1 -1 -1 0 0
```

There is no limitation on the size of collected data and there is no data timeout set. This process may be stopped by issuing `esp apptrace stop` command on OpenOCD telnet prompt, or by pressing Ctrl+C in OpenOCD window.

3. Retrieve tracing data and save them indefinitely.

```
esp apptrace start file://trace.log 0 -1 -1 0 0
```

OpenOCD telnet command line prompt will not be available until tracing is stopped. To stop tracing, press Ctrl+C in the OpenOCD window.

4. Wait for the target to be halted. Then resume the target’s operation and start data retrieval. Stop after collecting 2048 bytes of data:

```
esp apptrace start file://trace.log 0 2048 -1 1 0
```

To configure tracing immediately after reset, use the OpenOCD `reset halt` command.

## Logging to Host

ESP-IDF implements a useful feature: logging to the host via application level tracing library. This is a kind of semihosting when all `ESP_LOGx` calls send strings to be printed to the host instead of UART. This can be useful because “printing to host” eliminates some steps performed when logging to UART. Most part of the work is done on the host.

By default, ESP-IDF’s logging library uses `vprintf`-like function to write formatted output to dedicated UART. In general, it involves the following steps:

1. Format string is parsed to obtain type of each argument.
2. According to its type, every argument is converted to string representation.
3. Format string combined with converted arguments is sent to UART.

Though the implementation of the `vprintf`-like function can be optimized to a certain level, all steps above have to be performed in any case and every step takes some time (especially item 3). So it frequently occurs that with additional log added to the program to identify the problem, the program behavior is changed and the problem cannot be reproduced. And in the worst cases, the program cannot work normally at all and ends up with an error or even hangs.

Possible ways to overcome this problem are to use higher UART bitrates (or another faster interface) and/or to move string formatting procedure to the host.

The application level tracing feature can be used to transfer log information to the host using `esp_apptrace_vprintf` function. This function does not perform full parsing of the format string and arguments. Instead, it just calculates the number of arguments passed and sends them along with the format string address to the host. On the host, log data is processed and printed out by a special Python script.

**Limitations** Current implementation of logging over JTAG has some limitations:

1. No support for tracing from `ESP_EARLY_LOGx` macros.
2. No support for `printf` arguments whose size exceeds 4 bytes (e.g., `double` and `uint64_t`).
3. Only strings from the `.rodata` section are supported as format strings and arguments.
4. The maximum number of `printf` arguments is 256.

**How To Use It** In order to use logging via trace module, users need to perform the following steps:

1. On the target side, the special `vprintf`-like function `esp_apptrace_vprintf` needs to be installed. It sends log data to the host. Example code is provided in `system/app_trace_to_host`.
2. Follow instructions in items 2-5 in *Application Specific Tracing*.
3. To print out collected log records, run the following command in terminal: `$IDF_PATH/tools/esp_app_trace/logtrace_proc.py /path/to/trace/file /path/to/program/elf/file`.

**Log Trace Processor Command Options** Command usage:

```
logtrace_proc.py [-h] [--no-errors] <trace_file> <elf_file>
```

Positional arguments:

**trace\_file** Path to log trace file.

**elf\_file** Path to program ELF file.

Optional arguments:

**-h, --help** Show this help message and exit.

**--no-errors, -n** Do not print errors.

### System Behavior Analysis with SEGGER SystemView

Another useful ESP-IDF feature built on top of application tracing library is the system level tracing which produces traces compatible with SEGGER SystemView tool (see [SystemView](#)). SEGGER SystemView is a real-time recording and visualization tool that allows to analyze runtime behavior of an application. It is possible to view events in real-time through the UART interface.

**How To Use It** Support for this feature is enabled by Component `config>Application Level Tracing>FreeRTOS SystemView Tracing (CONFIG_APPTRACE_SV_ENABLE)` menuconfig option. There are several other options enabled under the same menu:

1. SystemView destination. Select the destination interface: JTAG or UART. In case of UART, it will be possible to connect SystemView application to the ESP32-S2 directly and receive data in real-time.
2. ESP32-S2 timer to use as SystemView timestamp source: (`CONFIG_APPTRACE_SV_TS_SOURCE`) selects the source of timestamps for SystemView events. In the single core mode, timestamps are generated using ESP32-S2 internal cycle counter running at maximum 240 Mhz (~4 ns granularity). In the dual-core mode, external timer working at 40 Mhz is used, so the timestamp granularity is 25 ns.
3. Individually enabled or disabled collection of SystemView events (`CONFIG_APPTRACE_SV_EVT_XXX`):
  - Trace Buffer Overflow Event
  - ISR Enter Event
  - ISR Exit Event
  - ISR Exit to Scheduler Event
  - Task Start Execution Event
  - Task Stop Execution Event
  - Task Start Ready State Event
  - Task Stop Ready State Event
  - Task Create Event
  - Task Terminate Event
  - System Idle Event
  - Timer Enter Event
  - Timer Exit Event



ESP-IDF has all the code required to produce SystemView compatible traces, so users can just configure necessary project options (see above), build, download the image to target, and use OpenOCD to collect data as described in the previous sections.

4. Select Pro or App CPU in menuconfig options `Component config>Application Level Tracing >FreeRTOS SystemView Tracing` to trace over the UART interface in real-time.

### OpenOCD SystemView Tracing Command Options

 Command usage:

```
esp sysview [start <options>] | [stop] | [status]
```

Sub-commands:

**start** Start tracing (continuous streaming).

**stop** Stop tracing.

**status** Get tracing status.

Start command syntax:

```
start <outfile1> [outfile2] [poll_period [trace_size [stop_tmo]]]
```

**outfile1** Path to file to save data from PRO CPU. This argument should have the following format: `file://path/to/file`.

**outfile2** Path to file to save data from APP CPU. This argument should have the following format: `file://path/to/file`.

**poll\_period** Data polling period (in ms) for available trace data. If greater than 0, then command runs in non-blocking mode. By default, 1 ms.

**trace\_size** Maximum size of data to collect (in bytes). Tracing is stopped after specified amount of data is received. By default, -1 (trace size stop trigger is disabled).

**stop\_tmo** Idle timeout (in sec). Tracing is stopped if there is no data for specified period of time. By default, -1 (disable this stop trigger).

---

**Note:** If `poll_period` is 0, OpenOCD telnet command line will not be available until tracing is stopped. You must stop it manually by resetting the board or pressing Ctrl+C in the OpenOCD window (not the one with the telnet session). Another option is to set `trace_size` and wait until this size of data is collected. At this point, tracing stops automatically.

---

Command usage examples:

1. Collect SystemView tracing data to files `pro-cpu.SVdat` and `app-cpu.SVdat`. The files will be saved in `openocd-esp32` directory.

```
esp sysview start file://pro-cpu.SVdat file://app-cpu.SVdat
```

The tracing data will be retrieved and saved in non-blocking mode. To stop this process, enter `esp sysview stop` command on OpenOCD telnet prompt, optionally pressing Ctrl+C in the OpenOCD window.

2. Retrieve tracing data and save them indefinitely.

```
esp sysview start file://pro-cpu.SVdat file://app-cpu.SVdat 0 -1 -1
```

OpenOCD telnet command line prompt will not be available until tracing is stopped. To stop tracing, press Ctrl+C in the OpenOCD window.

**Data Visualization** After trace data are collected, users can use a special tool to visualize the results and inspect behavior of the program.

It is uneasy and awkward to analyze data for every core in separate instance of the tool. Fortunately, there is an Eclipse plugin called *Impulse* which can load several trace files, thus making it possible to inspect events from both cores in one view. Also, this plugin has no limitation of 1,000,000 events as compared to the free version of SystemView.

Good instructions on how to install, configure, and visualize data in Impulse from one core can be found [here](#).

**Note:** ESP-IDF uses its own mapping for SystemView FreeRTOS events IDs, so users need to replace the original file mapping `$SYSVIEW_INSTALL_DIR/Description/SYSVIEW_FreeRTOS.txt` with `$IDF_PATH/tools/esp_app_trace/SYSVIEW_FreeRTOS.txt`. Also, contents of that IDF-specific file should be used when configuring SystemView serializer using the above link.

---

## Gcov (Source Code Coverage)

**Basics of Gcov and Gcovr** Source code coverage is data indicating the count and frequency of every program execution path that has been taken within a program's runtime. **Gcov** is a GCC tool that, when used in concert with the compiler, can generate log files indicating the execution count of each line of a source file. The **Gcovr** tool is a utility for managing Gcov and generating summarized code coverage results.

Generally, using Gcov to compile and run programs on the host will undergo these steps:

1. Compile the source code using GCC with the `--coverage` option enabled. This will cause the compiler to generate a `.gcno` notes files during compilation. The notes files contain information to reconstruct execution path block graphs and map each block to source code line numbers. Each source file compiled with the `--coverage` option should have their own `.gcno` file of the same name (e.g., a `main.c` will generate a `main.gcno` when compiled).
2. Execute the program. During execution, the program should generate `.gcda` data files. These data files contain the counts of the number of times an execution path was taken. The program will generate a `.gcda` file for each source file compiled with the `--coverage` option (e.g., `main.c` will generate a `main.gcda`).
3. Gcov or Gcovr can be used to generate a code coverage based on the `.gcno`, `.gcda`, and source files. Gcov will generate a text-based coverage report for each source file in the form of a `.gcov` file, whilst Gcovr will generate a coverage report in HTML format.

**Gcov and Gcovr in ESP-IDF** Using Gcov in ESP-IDF is complicated due to the fact that the program is running remotely from the host (i.e., on the target). The code coverage data (i.e., the `.gcda` files) is initially stored on the target itself. OpenOCD is then used to dump the code coverage data from the target to the host via JTAG during runtime. Using Gcov in ESP-IDF can be split into the following steps.

1. [Setting Up a Project for Gcov](#)
2. [Dumping Code Coverage Data](#)
3. [Generating Coverage Report](#)

## Setting Up a Project for Gcov

**Compiler Option** In order to obtain code coverage data in a project, one or more source files within the project must be compiled with the `--coverage` option. In ESP-IDF, this can be achieved at the component level or the individual source file level:

- To cause all source files in a component to be compiled with the `--coverage` option, you can add `target_compile_options(${COMPONENT_LIB} PRIVATE --coverage)` to the `CMakeLists.txt` file of the component.
- To cause a select number of source files (e.g., `source1.c` and `source2.c`) in the same component to be compiled with the `--coverage` option, you can add `set_source_files_properties(source1.c source2.c PROPERTIES COMPILE_FLAGS --coverage)` to the `CMakeLists.txt` file of the component.

When a source file is compiled with the `--coverage` option (e.g., `gcov_example.c`), the compiler will generate the `gcov_example.gcno` file in the project's build directory.

**Project Configuration** Before building a project with source code coverage, make sure that the following project configuration options are enabled by running `idf.py menuconfig`.

- Enable the application tracing module by selecting Trace Memory for the `CONFIG_APPTRACE_DESTINATION1` option.
- Enable Gcov to the host via the `CONFIG_APPTRACE_GCOV_ENABLE`.

**Dumping Code Coverage Data** Once a project has been compiled with the `--coverage` option and flashed onto the target, code coverage data will be stored internally on the target (i.e., in trace memory) whilst the application runs. The process of transferring code coverage data from the target to the host is known as dumping.

The dumping of coverage data is done via OpenOCD (see *JTAG Debugging* on how to setup and run OpenOCD). A dump is triggered by issuing commands to OpenOCD, therefore a telnet session to OpenOCD must be opened to issue such commands (run `telnet localhost 4444`). Note that GDB could be used instead of telnet to issue commands to OpenOCD, however all commands issued from GDB will need to be prefixed as `mon <occd_command>`.

When the target dumps code coverage data, the `.gcda` files are stored in the project's build directory. For example, if `gcov_example_main.c` of the main component is compiled with the `--coverage` option, then dumping the code coverage data would generate a `gcov_example_main.gcda` in `build/esp-idf/main/CMakeFiles/___idf_main.dir/gcov_example_main.c.gcda`. Note that the `.gcno` files produced during compilation are also placed in the same directory.

The dumping of code coverage data can be done multiple times throughout an application's lifetime. Each dump will simply update the `.gcda` file with the newest code coverage information. Code coverage data is accumulative, thus the newest data will contain the total execution count of each code path over the application's entire lifetime.

ESP-IDF supports two methods of dumping code coverage data from the target to the host:

- Instant Run-Time Dumpgit
- Hard-coded Dump

**Instant Run-Time Dump** An Instant Run-Time Dump is triggered by calling the `ESP32-S2 gcov` OpenOCD command (via a telnet session). Once called, OpenOCD will immediately preempt the ESP32-S2's current state and execute a built-in ESP-IDF Gcov debug stub function. The debug stub function will handle the dumping of data to the host. Upon completion, the ESP32-S2 will resume its current state.

**Hard-coded Dump** A Hard-coded Dump is triggered by the application itself by calling `esp_gcov_dump()` from somewhere within the application. When called, the application will halt and wait for OpenOCD to connect and retrieve the code coverage data. Once `esp_gcov_dump()` is called, the host must execute the `esp gcov dump` OpenOCD command (via a telnet session). The `esp gcov dump` command will cause OpenOCD to connect to the ESP32-S2, retrieve the code coverage data, then disconnect from the ESP32-S2, thus allowing the application to resume. Hard-coded Dumps can also be triggered multiple times throughout an application's lifetime.

Hard-coded dumps are useful if code coverage data is required at certain points of an application's lifetime by placing `esp_gcov_dump()` where necessary (e.g., after application initialization, during each iteration of an application's main loop).

GDB can be used to set a breakpoint on `esp_gcov_dump()`, then call `mon esp gcov dump` automatically via the use a `gdbinit` script (see Using GDB from *Command Line*).

The following GDB script will add a breakpoint at `esp_gcov_dump()`, then call the `mon esp gcov dump` OpenOCD command.

```
b esp_gcov_dump
commands
mon esp gcov dump
end
```

---

**Note:** Note that all OpenOCD commands should be invoked in GDB as: `mon <occd_command>`.

---

**Generating Coverage Report** Once the code coverage data has been dumped, the `.gcno`, `.gda` and the source files can be used to generate a code coverage report. A code coverage report is simply a report indicating the number of times each line in a source file has been executed.

Both `Gcov` and `Gcovr` can be used to generate code coverage reports. `Gcov` is provided along with the Xtensa toolchain, whilst `Gcovr` may need to be installed separately. For details on how to use `Gcov` or `Gcovr`, refer to [Gcov documentation](#) and [Gcovr documentation](#).

**Adding Gcovr Build Target to Project** To make report generation more convenient, users can define additional build targets in their projects such that the report generation can be done with a single build command.

Add the following lines to the `CMakeLists.txt` file of your project.

```
include($ENV{IDF_PATH}/tools/cmake/gcov.cmake)
idf_create_coverage_report(${CMAKE_CURRENT_BINARY_DIR}/coverage_report)
idf_clean_coverage_report(${CMAKE_CURRENT_BINARY_DIR}/coverage_report)
```

The following commands can now be used:

- `cmake --build build/ --target gcovr-report` will generate an HTML coverage report in `$(BUILD_DIR_BASE)/coverage_report/html` directory.
- `cmake --build build/ --target cov-data-clean` will remove all coverage data files.

## 4.2 Application Startup Flow

This note explains various steps which happen before `app_main` function of an ESP-IDF application is called.

The high level view of startup process is as follows:

1. *First stage bootloader* in ROM loads second-stage bootloader image to RAM (IRAM & DRAM) from flash offset `0x1000`.
2. *Second stage bootloader* loads partition table and main app image from flash. Main app incorporates both RAM segments and read-only segments mapped via flash cache.
3. *Application startup* executes. At this point the second CPU and RTOS scheduler are started.

This process is explained in detail in the following sections.

### 4.2.1 First stage bootloader

After SoC reset, the CPU will start running immediately to perform initialization. The reset vector code is located in the mask ROM of the ESP32-S2 chip and cannot be modified.

Startup code called from the reset vector determines the boot mode by checking `GPIO_STRAP_REG` register for bootstrap pin states. Depending on the reset reason, the following takes place:

1. **Reset from deep sleep:** if the value in `RTC_CNTL_STORE6_REG` is non-zero, and CRC value of RTC memory in `RTC_CNTL_STORE7_REG` is valid, use `RTC_CNTL_STORE6_REG` as an entry point address and jump immediately to it. If `RTC_CNTL_STORE6_REG` is zero, or `RTC_CNTL_STORE7_REG` contains invalid CRC, or once the code called via `RTC_CNTL_STORE6_REG` returns, proceed with boot as if it was a power-on reset. **Note:** to run customized code at this point, a deep sleep stub mechanism is provided. Please see [deep sleep](#) documentation for this.
2. **For power-on reset, software SOC reset, and watchdog SOC reset:** check the `GPIO_STRAP_REG` register if a custom boot mode (such as UART Download Mode) is requested. If this is the case, this custom loader mode is executed from ROM. Otherwise, proceed with boot as if it was due to software CPU reset. Consult ESP32-S2 datasheet for a description of SoC boot modes and how to execute them.

3. For software CPU reset and watchdog CPU reset: configure SPI flash based on EFUSE values, and attempt to load the code from flash. This step is described in more detail in the next paragraphs.

---

**Note:** During normal boot modes the RTC watchdog is enabled when this happens, so if the process is interrupted or stalled then the watchdog will reset the SOC automatically and repeat the boot process. This may cause the SoC to strap into a new boot mode, if the strapping GPIOs have changed.

---

Second stage bootloader binary image is loaded from flash starting at address 0x1000. The 4 kB sector of flash before this address is unused.

## 4.2.2 Second stage bootloader

In ESP-IDF, the binary image which resides at offset 0x1000 in flash is the second stage bootloader. Second stage bootloader source code is available in [components/bootloader](#) directory of ESP-IDF. Second stage bootloader is used in ESP-IDF to add flexibility to flash layout (using partition tables), and allow for various flows associated with flash encryption, secure boot, and over-the-air updates (OTA) to take place.

When the first stage bootloader is finished checking and loading the second stage bootloader, it jumps to the second stage bootloader entry point found in the binary image header.

Second stage bootloader reads the partition table found by default at offset 0x8000 (*configurable value*). See [partition tables](#) documentation for more information. The bootloader finds factory and OTA app partitions. If OTA app partitions are found in the partition table, the bootloader consults the `otadata` partition to determine which one should be booted. See [Over The Air Updates \(OTA\)](#) for more information.

For a full description of the configuration options available for the ESP-IDF bootloader, see [Bootloader](#).

For the selected partition, second stage bootloader reads the binary image from flash one segment at a time:

- For segments with load addresses in internal *IRAM (Instruction RAM)* or *DRAM (Data RAM)*, the contents are copied from flash to the load address.
- For segments which have load addresses in *DRROM (data stored in flash)* or *IROM (code executed from flash)* regions, the flash MMU is configured to provide the correct mapping from the flash to the load address.

Once all segments are processed - meaning code is loaded and flash MMU is set up, second stage bootloader verifies the integrity of the application and then jumps to the application entry point found in the binary image header.

## 4.2.3 Application startup

Application startup covers everything that happens after the app starts executing and before the `app_main` function starts running inside the main task. This is split into three stages:

- Port initialization of hardware and basic C runtime environment.
- System initialization of software services and FreeRTOS.
- Running the main task and calling `app_main`.

---

**Note:** Understanding all stages of ESP-IDF app initialization is often not necessary. To understand initialization from the application developer's perspective only, skip forward to [Running the main task](#).

---

### Port Initialization

ESP-IDF application entry point is `call_start_cpu0` function found in [components/esp\\_system/port/cpu\\_start.c](#). This function is executed by the second stage bootloader, and never returns.

This port-layer initialization function initializes the basic C Runtime Environment ( “CRT” ) and performs initial configuration of the SoC's internal hardware:

- Reconfigure CPU exceptions for the app (allowing app interrupt handlers to run, and causing *Fatal Errors* to be handled using the options configured for the app rather than the simpler error handler provided by ROM).
- If the option `CONFIG_BOOTLOADER_WDT_ENABLE` is not set then the RTC watchdog timer is disabled.
- Initialize internal memory (data & bss).
- Finish configuring the MMU cache.
- Enable PSRAM if configured.
- Set the CPU clocks to the frequencies configured for the project.
- Initialize memory protection if configured.

Once `call_start_cpu0` completes running, it calls the “system layer” initialization function `start_cpu0` found in [components/esp\\_system/startup.c](#).

### System Initialization

The main system initialization function is `start_cpu0`. By default, this function is weak-linked to the function `start_cpu0_default`. This means that it’s possible to override this function to add some additional initialization steps.

The primary system initialization stage includes:

- Log information about this application (project name, *App Version*, etc.) if default log level enables this.
- Initialize the heap allocator (before this point all allocations must be static or on the stack).
- Initialize newlib component syscalls and time functions.
- Configure the brownout detector.
- Setup libc stdin, stdout, and stderr according to the [serial console configuration](#).
- Perform any security-related checks, including burning efuses that should be burned for this configuration (including [permanently limiting ROM download modes](#)).
- Initialize SPI flash API support.
- Call global C++ constructors and any C functions marked with `__attribute__((constructor))`.

Secondary system initialization allows individual components to be initialized. If a component has an initialization function annotated with the `ESP_SYSTEM_INIT_FN` macro, it will be called as part of secondary initialization. Component initialization functions have priorities assigned to them to ensure the desired initialization order. The priorities are documented in [esp\\_system/system\\_init\\_fn.txt](#) and `ESP_SYSTEM_INIT_FN` definition in source code are checked against this file.

### Running the main task

After all other components are initialized, the main task is created and the FreeRTOS scheduler starts running.

After doing some more initialization tasks (that require the scheduler to have started), the main task runs the application-provided function `app_main` in the firmware.

The main task that runs `app_main` has a fixed RTOS priority (one higher than the minimum) and a [configurable stack size](#).

Unlike normal FreeRTOS tasks (or embedded C main functions), the `app_main` task is allowed to return. If this happens, The task is cleaned up and the system will continue running with other RTOS tasks scheduled normally. Therefore, it is possible to implement `app_main` as either a function that creates other application tasks and then returns, or as a main application task itself.

## 4.3 Bootloader

The ESP-IDF Software Bootloader performs the following functions:

1. Minimal initial configuration of internal modules;



2. Initialize *Flash Encryption* and/or *Secure* features, if configured;
3. Select the application partition to boot, based on the partition table and `ota_data` (if any);
4. Load this image to RAM (IRAM & DRAM) and transfer management to the image that was just loaded.

Bootloader is located at the address 0x1000 in the flash.

For a full description of the startup process including the the ESP-IDF bootloader, see [Application Startup Flow](#).

### 4.3.1 Bootloader compatibility

It is recommended to update to newer *versions of ESP-IDF*: when they are released. The OTA (over the air) update process can flash new apps in the field but cannot flash a new bootloader. For this reason, the bootloader supports booting apps built from newer versions of ESP-IDF.

The bootloader does not support booting apps from older versions of ESP-IDF. When updating ESP-IDF manually on an existing product that might need to downgrade the app to an older version, keep using the older ESP-IDF bootloader binary as well.

---

**Note:** If testing an OTA update for an existing product in production, always test it using the same ESP-IDF bootloader binary that is deployed in production.

---

### SPI Flash Configuration

Each ESP-IDF application or bootloader .bin file contains a header with `CONFIG_ESPTOOLPY_FLASHMODE`, `CONFIG_ESPTOOLPY_FLASHFREQ`, `CONFIG_ESPTOOLPY_FLASHSIZE` embedded in it. These are used to configure the SPI flash during boot.

The *First stage bootloader* in ROM reads the *Second stage bootloader* header information from flash and uses this information to load the rest of the *Second stage bootloader* from flash. However, at this time the system clock speed is lower than configured and not all flash modes are supported. When the *Second stage bootloader* then runs, it will reconfigure the flash using values read from the currently selected app binary's header (and NOT from the *Second stage bootloader* header). This allows an OTA update to change the SPI flash settings in use.

### 4.3.2 Log Level

The default bootloader log level is “Info” . By setting the `CONFIG_BOOTLOADER_LOG_LEVEL` option, it's possible to increase or decrease this level. This log level is separate from the log level used in the app (see [Logging library](#)).

Reducing bootloader log verbosity can improve the overall project boot time by a small amount.

### 4.3.3 Factory reset

Sometimes it is desirable to have a way for the device to fall back to a known-good state, in case of some problem with an update.

To roll back to the original “factory” device configuration and clear any user settings, configure the config item `CONFIG_BOOTLOADER_FACTORY_RESET` in the bootloader.

The factory reset mechanism allows the device to be factory reset in two ways:

- Clear one or more data partitions. The `CONFIG_BOOTLOADER_DATA_FACTORY_RESET` option allows users to specify which data partitions will be erased when the factory reset is executed. Users can specify the names of partitions as a comma-delimited list with optional spaces for readability. (Like this: `nvs, phy_init, nvs_custom`). Make sure that the names of partitions specified in the option are the same as those found in the partition table. Partitions of type “app” cannot be specified here.

- Boot from “factory” app partition. Enabling the [CONFIG\\_BOOTLOADER\\_OTA\\_DATA\\_ERASE](#) option will cause the device to boot from the default “factory” app partition after a factory reset (or if there is no factory app partition in the partition table then the default ota app partition is selected instead). This reset process involves erasing the OTA data partition which holds the currently selected OTA partition slot. The “factory” app partition slot (if it exists) is never updated via OTA, so resetting to this allows reverting to a “known good” firmware application.

Either or both of these configuration options can be enabled independently.

In addition, the following configuration options control the reset condition:

- [CONFIG\\_BOOTLOADER\\_NUM\\_PIN\\_FACTORY\\_RESET](#)- The input GPIO number used to trigger a factory reset. This GPIO must be pulled low or high (configurable) on reset to trigger this.
- [CONFIG\\_BOOTLOADER\\_HOLD\\_TIME\\_GPIO](#)- this is hold time of GPIO for reset/test mode (by default 5 seconds). The GPIO must be held continuously for this period of time after reset before a factory reset or test partition boot (as applicable) is performed.
- [CONFIG\\_BOOTLOADER\\_FACTORY\\_RESET\\_PIN\\_LEVEL](#) - configure whether a factory reset should trigger on a high or low level of the GPIO. If the GPIO has an internal pullup then this is enabled before the pin is sampled, consult the ESP32-S2 datasheet for details on pin internal pullups.

### 4.3.4 Boot from Test Firmware

It's possible to write a special firmware app for testing in production, and boot this firmware when needed. The project partition table will need a dedicated app partition entry for this testing app, type `app` and subtype `test` (see [Partition Tables](#)).

Implementing a dedicated test app firmware requires creating a totally separate ESP-IDF project for the test app (each project in ESP-IDF only builds one app). The test app can be developed and tested independently of the main project, and then integrated at production testing time as a pre-compiled `.bin` file which is flashed to the address of the main project's test app partition.

To support this functionality in the main project's bootloader, set the configuration item [CONFIG\\_BOOTLOADER\\_APP\\_TEST](#) and configure the following two items:

- [CONFIG\\_BOOTLOADER\\_NUM\\_PIN\\_APP\\_TEST](#) - GPIO number to boot TEST partition. The selected GPIO will be configured as an input with internal pull-up enabled. To trigger a test app, this GPIO must be pulled low on reset.  
Once the GPIO input is released (allowing it to be pulled up) and the device has been reboot, the normally configured application will boot (factory or any OTA app partition slot).
- [CONFIG\\_BOOTLOADER\\_HOLD\\_TIME\\_GPIO](#) - this is hold time of GPIO for reset/test mode (by default 5 seconds). The GPIO must be held low continuously for this period of time after reset before a factory reset or test partition boot (as applicable) is performed.

### 4.3.5 Rollback

Rollback and anti-rollback features must be configured in the bootloader as well.

Consult the [App rollback](#) and [Anti-rollback](#) sections in the [OTA API reference document](#).

### 4.3.6 Watchdog

By default, the hardware RTC Watchdog timer remains running while the bootloader is running and will automatically reset the chip if no app has successfully started after 9 seconds.

- The timeout period can be adjusted by setting [CONFIG\\_BOOTLOADER\\_WDT\\_TIME\\_MS](#) and recompiling the bootloader.



- The app's behaviour can be adjusted so the RTC Watchdog remains enabled after app startup. The Watchdog would need to be explicitly reset (i.e., fed) by the app to avoid a reset. To do this, set the `CONFIG_BOOTLOADER_WDT_DISABLE_IN_USER_CODE` option, modify the app as needed, and then recompile the app.
- The RTC Watchdog can be disabled in the bootloader by disabling the `CONFIG_BOOTLOADER_WDT_ENABLE` setting and recompiling the bootloader. This is not recommended.

### 4.3.7 Bootloader Size

When enabling additional bootloader functions, including *Flash Encryption* or Secure Boot, and especially if setting a high `CONFIG_BOOTLOADER_LOG_LEVEL` level, then it is important to monitor the bootloader .bin file's size.

When using the default `CONFIG_PARTITION_TABLE_OFFSET` value 0x8000, the size limit is 0x7000 (28672) bytes.

If the bootloader binary is too large, then the bootloader build will fail with an error “Bootloader binary size [...] is too large for partition table offset”. If the bootloader binary is flashed anyhow then the ESP32-S2 will fail to boot - errors will be logged about either invalid partition table or invalid bootloader checksum.

Options to work around this are:

- Set `bootloader_compiler_optimization` back to “Size” if it has been changed from this default value.
- Reduce `bootloader_log_level`. Setting log level to Warning, Error or None all significantly reduce the final binary size (but may make it harder to debug).
- Set `CONFIG_PARTITION_TABLE_OFFSET` to a higher value than 0x8000, to place the partition table later in the flash. This increases the space available for the bootloader. If the *partition table* CSV file contains explicit partition offsets, they will need changing so no partition has an offset lower than `CONFIG_PARTITION_TABLE_OFFSET + 0x1000`. (This includes the default partition CSV files supplied with ESP-IDF.)

When Secure Boot V2 is enabled, there is also an absolute binary size limit of 64KB (0x10000 bytes) (excluding the 4 KB signature), because the bootloader is first loaded into a fixed size buffer for verification.

### 4.3.8 Fast boot from Deep Sleep

The bootloader has the `CONFIG_BOOTLOADER_SKIP_VALIDATE_IN_DEEP_SLEEP` option which allows the wake-up time from deep sleep to be reduced (useful for reducing power consumption). This option is available when `CONFIG_SECURE_BOOT` option is disabled. Reduction of time is achieved due to the lack of image verification. During the first boot, the bootloader stores the address of the application being launched in the RTC FAST memory. And during the awakening, this address is used for booting without any checks, thus fast loading is achieved.

### 4.3.9 Custom bootloader

The current bootloader implementation allows a project to extend it or modify it. There are two ways of doing it: by implementing hooks or by overriding it. Both ways are presented in `custom_bootloader` folder in ESP-IDF examples:

- `bootloader_hooks` which presents how to connect some hooks to the bootloader initialization
- `bootloader_override` which presents how to override the bootloader implementation

In the bootloader space, you cannot use the drivers and functions from other components. If necessary, then the required functionality should be placed in the project's `bootloader_components` directory (note that this will increase its size).

If the bootloader grows too large then it can collide with the partition table, which is flashed at offset 0x8000 by default. Increase the *partition table offset* value to place the partition table later in the flash. This increases the space available for the bootloader.

## 4.4 Build System

This document explains the implementation of the ESP-IDF build system and the concept of “components” . Read this document if you want to know how to organize and build a new ESP-IDF project or component.

### 4.4.1 Overview

An ESP-IDF project can be seen as an amalgamation of a number of components. For example, for a webserver that shows the current humidity, there could be:

- The ESP-IDF base libraries (libc, ROM bindings, etc)
- The Wi-Fi drivers
- A TCP/IP stack
- The FreeRTOS operating system
- A webserver
- A driver for the humidity sensor
- Main code tying it all together

ESP-IDF makes these components explicit and configurable. To do that, when a project is compiled, the build system will look up all the components in the ESP-IDF directories, the project directories and (optionally) in additional custom component directories. It then allows the user to configure the ESP-IDF project using a text-based menu system to customize each component. After the components in the project are configured, the build system will compile the project.

### Concepts

- A “project” is a directory that contains all the files and configuration to build a single “app” (executable), as well as additional supporting elements such as a partition table, data/filesystem partitions, and a bootloader.
- “Project configuration” is held in a single file called `sdkconfig` in the root directory of the project. This configuration file is modified via `idf.py menuconfig` to customise the configuration of the project. A single project contains exactly one project configuration.
- An “app” is an executable which is built by ESP-IDF. A single project will usually build two apps - a “project app” (the main executable, ie your custom firmware) and a “bootloader app” (the initial bootloader program which launches the project app).
- “components” are modular pieces of standalone code which are compiled into static libraries (.a files) and linked into an app. Some are provided by ESP-IDF itself, others may be sourced from other places.
- “Target” is the hardware for which an application is built. A full list of supported targets in your version of ESP-IDF can be seen by running `idf.py -list-targets`.

Some things are not part of the project:

- “ESP-IDF” is not part of the project. Instead it is standalone, and linked to the project via the `IDF_PATH` environment variable which holds the path of the `esp-idf` directory. This allows the IDF framework to be decoupled from your project.
- The toolchain for compilation is not part of the project. The toolchain should be installed in the system command line `PATH`.

### 4.4.2 Using the Build System

#### `idf.py`

The `idf.py` command-line tool provides a front-end for easily managing your project builds. It manages the following tools:

- [CMake](#), which configures the project to be built
- [Ninja](#) which builds the project

- [esptool.py](#) for flashing the target.

You can read more about configuring the build system using `idf.py` [here](#).

### Using CMake Directly

`idf.py` is a wrapper around `CMake` for convenience. However, you can also invoke `CMake` directly if you prefer.

When `idf.py` does something, it prints each command that it runs for easy reference. For example, the `idf.py build` command is the same as running these commands in a bash shell (or similar commands for Windows Command Prompt):

```
mkdir -p build
cd build
cmake .. -G Ninja # or 'Unix Makefiles'
ninja
```

In the above list, the `cmake` command configures the project and generates build files for use with the final build tool. In this case the final build tool is `Ninja`: running `ninja` actually builds the project.

It's not necessary to run `cmake` more than once. After the first build, you only need to run `ninja` each time. `ninja` will automatically re-invoke `cmake` if the project needs reconfiguration.

If using `CMake` with `ninja` or `make`, there are also targets for more of the `idf.py` sub-commands - for example running `make menuconfig` or `ninja menuconfig` in the build directory will work the same as `idf.py menuconfig`.

---

**Note:** If you're already familiar with `CMake`, you may find the ESP-IDF `CMake`-based build system unusual because it wraps a lot of `CMake`'s functionality to reduce boilerplate. See [writing pure CMake components](#) for some information about writing more “`CMake` style” components.

---

**Flashing with `ninja` or `make`** It's possible to build and flash directly from `ninja` or `make` by running a target like:

```
ninja flash
```

Or:

```
make app-flash
```

Available targets are: `flash`, `app-flash` (app only), `bootloader-flash` (bootloader only).

When flashing this way, optionally set the `ESPPORT` and `ESPBAUD` environment variables to specify the serial port and baud rate. You can set environment variables in your operating system or IDE project. Alternatively, set them directly on the command line:

```
ESPPORT=/dev/ttyUSB0 ninja flash
```

---

**Note:** Providing environment variables at the start of the command like this is Bash shell Syntax. It will work on Linux and macOS. It won't work when using Windows Command Prompt, but it will work when using Bash-like shells on Windows.

---

Or:

```
make -j3 app-flash ESPPORT=COM4 ESPBAUD=2000000
```

---

**Note:** Providing variables at the end of the command line is `make` syntax, and works for `make` on all platforms.

---

## Using CMake in an IDE

You can also use an IDE with CMake integration. The IDE will want to know the path to the project's `CMakeLists.txt` file. IDEs with CMake integration often provide their own build tools (CMake calls these “generators”) to build the source files as part of the IDE.

When adding custom non-build steps like “flash” to the IDE, it is recommended to execute `idf.py` for these “special” commands.

For more detailed information about integrating ESP-IDF with CMake into an IDE, see [Build System Metadata](#).

## Setting up the Python Interpreter

ESP-IDF works well with Python version 3.7+.

`idf.py` and other Python scripts will run with the default Python interpreter, i.e. `python`. You can switch to a different one like `python3 $IDF_PATH/tools/idf.py . . .`, or you can set up a shell alias or another script to simplify the command.

If using CMake directly, running `cmake -D PYTHON=python3 . . .` will cause CMake to override the default Python interpreter.

If using an IDE with CMake, setting the `PYTHON` value as a CMake cache override in the IDE UI will override the default Python interpreter.

To manage the Python version more generally via the command line, check out the tools [pyenv](#) or [virtualenv](#). These let you change the default Python version.

**Possible issues** The user of `idf.py` may sometimes experience `ImportError` described below.

```
Traceback (most recent call last):
  File "/Users/user_name/e/esp-idf/tools/kconfig_new/configgen.py", line 27, in
↳<module>
    import kconfiglib
ImportError: bad magic number in 'kconfiglib': b'\x03\xf3\r\n'
```

The exception is often caused by `.pyc` files generated by different Python versions. To solve the issue run the following command:

```
idf.py python-clean
```

## 4.4.3 Example Project

An example project directory tree might look like this:

```
- myProject/
  - CMakeLists.txt
  - sdkconfig
  - components/
    - component1/
      - CMakeLists.txt
      - Kconfig
      - src1.c
    - component2/
      - CMakeLists.txt
      - Kconfig
      - src1.c
      - include/
        - component2.h
  - main/
    - CMakeLists.txt
    - src1.c
    - src2.c
  - build/
```

This example “myProject” contains the following elements:

- A top-level project CMakeLists.txt file. This is the primary file which CMake uses to learn how to build the project; and may set project-wide CMake variables. It includes the file `/tools/cmake/project.cmake` which implements the rest of the build system. Finally, it sets the project name and defines the project.
- “sdkconfig” project configuration file. This file is created/updated when `idf.py menuconfig` runs, and holds configuration for all of the components in the project (including ESP-IDF itself). The “sdkconfig” file may or may not be added to the source control system of the project.
- Optional “components” directory contains components that are part of the project. A project does not have to contain custom components of this kind, but it can be useful for structuring reusable code or including third party components that aren’t part of ESP-IDF. Alternatively, `EXTRA_COMPONENT_DIRS` can be set in the top-level CMakeLists.txt to look for components in other places.
- “main” directory is a special component that contains source code for the project itself. “main” is a default name, the CMake variable `COMPONENT_DIRS` includes this component but you can modify this variable. See the [renaming main](#) section for more info. If you have a lot of source files in your project, we recommend grouping most into components instead of putting them all in “main”.
- “build” directory is where build output is created. This directory is created by `idf.py` if it doesn’t already exist. CMake configures the project and generates interim build files in this directory. Then, after the main build process is run, this directory will also contain interim object files and libraries as well as final binary output files. This directory is usually not added to source control or distributed with the project source code.

Component directories each contain a component `CMakeLists.txt` file. This file contains variable definitions to control the build process of the component, and its integration into the overall project. See [Component CMakeLists Files](#) for more details.

Each component may also include a `Kconfig` file defining the [component configuration](#) options that can be set via `menuconfig`. Some components may also include `Kconfig.projbuild` and `project_include.cmake` files, which are special files for [overriding parts of the project](#).

#### 4.4.4 Project CMakeLists File

Each project has a single top-level `CMakeLists.txt` file that contains build settings for the entire project. By default, the project CMakeLists can be quite minimal.

##### Minimal Example CMakeLists

Minimal project:

```
cmake_minimum_required(VERSION 3.16)
include($ENV{IDF_PATH}/tools/cmake/project.cmake)
project(myProject)
```

##### Mandatory Parts

The inclusion of these three lines, in the order shown above, is necessary for every project:

- `cmake_minimum_required(VERSION 3.16)` tells CMake the minimum version that is required to build the project. ESP-IDF is designed to work with CMake 3.16 or newer. This line must be the first line in the CMakeLists.txt file.
- `include($ENV{IDF_PATH}/tools/cmake/project.cmake)` pulls in the rest of the CMake functionality to configure the project, discover all the components, etc.
- `project(myProject)` creates the project itself, and specifies the project name. The project name is used for the final binary output files of the app - ie `myProject.elf`, `myProject.bin`. Only one project can be defined per CMakeLists file.

## Optional Project Variables

These variables all have default values that can be overridden for custom behaviour. Look in [/tools/cmake/project.cmake](#) for all of the implementation details.

- `COMPONENT_DIRS`: Directories to search for components. Defaults to `IDF_PATH/components`, `PROJECT_DIR/components`, and `EXTRA_COMPONENT_DIRS`. Override this variable if you don't want to search for components in these places.
- `EXTRA_COMPONENT_DIRS`: Optional list of additional directories to search for components. Paths can be relative to the project directory, or absolute.
- `COMPONENTS`: A list of component names to build into the project. Defaults to all components found in the `COMPONENT_DIRS` directories. Use this variable to “trim down” the project for faster build times. Note that any component which “requires” another component via the `REQUIRES` or `PRIV_REQUIRES` arguments on component registration will automatically have it added to this list, so the `COMPONENTS` list can be very short.

Any paths in these variables can be absolute paths, or set relative to the project directory.

To set these variables, use the `cmake set command` ie `set(VARIABLE "VALUE")`. The `set()` commands should be placed after the `cmake_minimum(...)` line but before the `include(...)` line.

## Renaming main component

The build system provides special treatment to the `main` component. It is a component that gets automatically added to the build provided that it is in the expected location, `PROJECT_DIR/main`. All other components in the build are also added as its dependencies, saving the user from hunting down dependencies and providing a build that works right out of the box. Renaming the `main` component causes the loss of these behind-the-scenes heavy lifting, requiring the user to specify the location of the newly renamed component and manually specifying its dependencies. Specifically, the steps to renaming `main` are as follows:

1. Rename `main` directory.
2. Set `EXTRA_COMPONENT_DIRS` in the project `CMakeLists.txt` to include the renamed `main` directory.
3. Specify the dependencies in the renamed component's `CMakeLists.txt` file via `REQUIRES` or `PRIV_REQUIRES` arguments *on component registration*.

## Overriding default build specifications

The build sets some global build specifications (compile flags, definitions, etc.) that gets used in compiling all sources from all components.

For example, one of the default build specifications set is the compile option `-Wextra`. Suppose a user wants to use override this with `-Wno-extra`, it should be done after `project()`:

```
cmake_minimum_required(VERSION 3.16)
include($ENV{IDF_PATH}/tools/cmake/project.cmake)
project(myProject)

idf_build_set_property(COMPILE_OPTIONS "-Wno-error" APPEND)
```

This ensures that the compile options set by the user won't be overridden by the default build specifications, since the latter are set inside `project()`.

## 4.4.5 Component CMakeLists Files

Each project contains one or more components. Components can be part of ESP-IDF, part of the project's own components directory, or added from custom component directories (*see above*).

A component is any directory in the `COMPONENT_DIRS` list which contains a `CMakeLists.txt` file.

## Searching for Components

The list of directories in `COMPONENT_DIRS` is searched for the project's components. Directories in this list can either be components themselves (ie they contain a `CMakeLists.txt` file), or they can be top-level directories whose sub-directories are components.

When CMake runs to configure the project, it logs the components included in the build. This list can be useful for debugging the inclusion/exclusion of certain components.

## Multiple components with the same name

When ESP-IDF is collecting all the components to compile, it will do this in the order specified by `COMPONENT_DIRS`; by default, this means ESP-IDF's internal components first (`IDF_PATH/components`), then any components in directories specified in `EXTRA_COMPONENT_DIRS`, and finally the project's components (`PROJECT_DIR/components`). If two or more of these directories contain component sub-directories with the same name, the component in the last place searched is used. This allows, for example, overriding ESP-IDF components with a modified version by copying that component from the ESP-IDF components directory to the project components directory and then modifying it there. If used in this way, the ESP-IDF directory itself can remain untouched.

---

**Note:** If a component is overridden in an existing project by moving it to a new location, the project will not automatically see the new component path. Run `idf.py reconfigure` (or delete the project build folder) and then build again.

---

## Minimal Component CMakeLists

The minimal component `CMakeLists.txt` file simply registers the component to the build system using `idf_component_register`:

```
idf_component_register(SRCS "foo.c" "bar.c"
                      INCLUDE_DIRS "include"
                      REQUIRES mbedtls)
```

- `SRCS` is a list of source files (`*.c`, `*.cpp`, `*.cc`, `*.S`). These source files will be compiled into the component library.
- `INCLUDE_DIRS` is a list of directories to add to the global include search path for any component which requires this component, and also the main source files.
- `REQUIRES` is not actually required, but it is very often required to declare what other components this component will use. See [component requirements](#).

A library with the name of the component will be built and linked into the final app.

Directories are usually specified relative to the `CMakeLists.txt` file itself, although they can be absolute.

There are other arguments that can be passed to `idf_component_register`. These arguments are discussed [here](#).

See [example component requirements](#) and [example component CMakeLists](#) for more complete component `CMakeLists.txt` examples.

## Preset Component Variables

The following component-specific variables are available for use inside component `CMakeLists`, but should not be modified:

- `COMPONENT_DIR`: The component directory. Evaluates to the absolute path of the directory containing `CMakeLists.txt`. The component path cannot contain spaces. This is the same as the `CMAKE_CURRENT_SOURCE_DIR` variable.



- `COMPONENT_NAME`: Name of the component. Same as the name of the component directory.
- `COMPONENT_ALIAS`: Alias of the library created internally by the build system for the component.
- `COMPONENT_LIB`: Name of the library created internally by the build system for the component.

The following variables are set at the project level, but available for use in component CMakeLists:

- `CONFIG_*`: Each value in the project configuration has a corresponding variable available in cmake. All names begin with `CONFIG_`. [More information here](#).
- `ESP_PLATFORM`: Set to 1 when the CMake file is processed within ESP-IDF build system.

### Build/Project Variables

The following are some project/build variables that are available as build properties and whose values can be queried using `idf_build_get_property` from the component CMakeLists.txt:

- `PROJECT_NAME`: Name of the project, as set in project CMakeLists.txt file.
- `PROJECT_DIR`: Absolute path of the project directory containing the project CMakeLists. Same as the `CMAKE_SOURCE_DIR` variable.
- `COMPONENTS`: Names of all components that are included in this build, formatted as a semicolon-delimited CMake list.
- `IDF_VER`: Git version of ESP-IDF (produced by `git describe`)
- `IDF_VERSION_MAJOR`, `IDF_VERSION_MINOR`, `IDF_VERSION_PATCH`: Components of ESP-IDF version, to be used in conditional expressions. Note that this information is less precise than that provided by `IDF_VER` variable. `v4.0-dev-*`, `v4.0-beta1`, `v4.0-rc1` and `v4.0` will all have the same values of `IDF_VERSION_*` variables, but different `IDF_VER` values.
- `IDF_TARGET`: Name of the target for which the project is being built.
- `PROJECT_VER`: Project version.
  - If `CONFIG_APP_PROJECT_VER_FROM_CONFIG` option is set, the value of `CONFIG_APP_PROJECT_VER` will be used.
  - Else, if `PROJECT_VER` variable is set in project CMakeLists.txt file, its value will be used.
  - Else, if the `PROJECT_DIR/version.txt` exists, its contents will be used as `PROJECT_VER`.
  - Else, if the project is located inside a Git repository, the output of `git describe` will be used.
  - Otherwise, `PROJECT_VER` will be “1” .
- `EXTRA_PARTITION_SUBTYPES`: CMake list of extra partition subtypes. Each subtype description is a comma separated string with `type_name`, `subtype_name`, `numeric_value` format. Components may add new subtypes by appending them to this list.

Other build properties are listed [here](#).

### Controlling Component Compilation

To pass compiler options when compiling source files belonging to a particular component, use the `target_compile_options` function:

```
target_compile_options(${COMPONENT_LIB} PRIVATE -Wno-unused-variable)
```

To apply the compilation flags to a single source file, use the CMake `set_source_files_properties` command:

```
set_source_files_properties(mysrc.c
    PROPERTIES COMPILE_FLAGS
    -Wno-unused-variable
)
```

This can be useful if there is upstream code that emits warnings.

When using these commands, place them after the call to `idf_component_register` in the component CMakeLists file.



## 4.4.6 Component Configuration

Each component can also have a `Kconfig` file, alongside `CMakeLists.txt`. This contains configuration settings to add to the configuration menu for this component.

These settings are found under the “Component Settings” menu when `menuconfig` is run.

To create a component `Kconfig` file, it is easiest to start with one of the `Kconfig` files distributed with ESP-IDF.

For an example, see [Adding conditional configuration](#).

## 4.4.7 Preprocessor Definitions

The ESP-IDF build system adds the following C preprocessor definitions on the command line:

- `ESP_PLATFORM`: Can be used to detect that build happens within ESP-IDF.
- `IDF_VER`: Defined to a git version string. E.g. `v2.0` for a tagged release or `v1.0-275-g0efaa4f` for an arbitrary commit.

## 4.4.8 Component Requirements

When compiling each component, the ESP-IDF build system recursively evaluates its dependencies. This means each component needs to declare the components that it depends on (“requires”).

### When writing a component

```
idf_component_register(...  
    REQUIRES mbedtls  
    PRIV_REQUIRES console spiffs)
```

- `REQUIRES` should be set to all components whose header files are `#included` from the *public* header files of this component.
- `PRIV_REQUIRES` should be set to all components whose header files are `#included` from *any source files* in this component, unless already listed in `REQUIRES`. Also any component which is required to be linked in order for this component to function correctly.
- The values of `REQUIRES` and `PRIV_REQUIRES` should not depend on any configuration choices (`CONFIG_XXX` macros). This is because requirements are expanded before configuration is loaded. Other component variables (like include paths or source files) can depend on configuration choices.
- Not setting either or both `REQUIRES` variables is fine. If the component has no requirements except for the *Common component requirements* needed for RTOS, libc, etc.

If a component only supports some target chips (values of `IDF_TARGET`) then it can specify `REQUIRED_IDF_TARGETS` in the `idf_component_register` call to express these requirements. In this case the build system will generate an error if the component is included into the build, but does not support the selected target.

---

**Note:** In CMake terms, `REQUIRES` & `PRIV_REQUIRES` are approximate wrappers around the CMake functions `target_link_libraries(... PUBLIC ...)` and `target_link_libraries(... PRIVATE ...)`.

---

### Example of component requirements

Imagine there is a `car` component, which uses the `engine` component, which uses the `spark_plug` component:

```
- autoProject/
  - CMakeLists.txt
  - components/ - car/ - CMakeLists.txt
    - car.c
    - car.h
  - engine/ - CMakeLists.txt
    - engine.c
    - include/ - engine.h
  - spark_plug/ - CMakeLists.txt
    - spark_plug.c
    - spark_plug.h
```

**Car component** The `car.h` header file is the public interface for the `car` component. This header includes `engine.h` directly because it uses some declarations from this header:

```
/* car.h */
#include "engine.h"

#ifdef ENGINE_IS_HYBRID
#define CAR_MODEL "Hybrid"
#endif
```

And `car.c` includes `car.h` as well:

```
/* car.c */
#include "car.h"
```

This means the `car/CMakeLists.txt` file needs to declare that `car` requires `engine`:

```
idf_component_register(SRCS "car.c"
                      INCLUDE_DIRS "."
                      REQUIRES engine)
```

- `SRCS` gives the list of source files in the `car` component.
- `INCLUDE_DIRS` gives the list of public include directories for this component. Because the public interface is `car.h`, the directory containing `car.h` is listed here.
- `REQUIRES` gives the list of components required by the public interface of this component. Because `car.h` is a public header and includes a header from `engine`, we include `engine` here. This makes sure that any other component which includes `car.h` will be able to recursively include the required `engine.h` also.

**Engine component** The `engine` component also has a public header file `include/engine.h`, but this header is simpler:

```
/* engine.h */
#define ENGINE_IS_HYBRID

void engine_start(void);
```

The implementation is in `engine.c`:

```
/* engine.c */
#include "engine.h"
#include "spark_plug.h"

...
```

In this component, `engine` depends on `spark_plug` but this is a private dependency. `spark_plug.h` is needed to compile `engine.c`, but not needed to include `engine.h`.

This means that the `engine/CMakeLists.txt` file can use `PRIV_REQUIRES`:

```
idf_component_register(SRCS "engine.c"
                      INCLUDE_DIRS "include"
                      PRIV_REQUIRES spark_plug)
```

As a result, source files in the `car` component don't need the `spark_plug` include directories added to their compiler search path. This can speed up compilation, and stops compiler command lines from becoming longer than necessary.

**Spark Plug Component** The `spark_plug` component doesn't depend on anything else. It has a public header file `spark_plug.h`, but this doesn't include headers from any other components.

This means that the `spark_plug/CMakeLists.txt` file doesn't need any `REQUIRES` or `PRIV_REQUIRES` clauses:

```
idf_component_register(SRCS "spark_plug.c"
                      INCLUDE_DIRS ".")
```

### Source File Include Directories

Each component's source file is compiled with these include path directories, as specified in the passed arguments to `idf_component_register`:

```
idf_component_register(..
                      INCLUDE_DIRS "include"
                      PRIV_INCLUDE_DIRS "other")
```

- The current component's `INCLUDE_DIRS` and `PRIV_INCLUDE_DIRS`.
- The `INCLUDE_DIRS` belonging to all other components listed in the `REQUIRES` and `PRIV_REQUIRES` parameters (ie all the current component's public and private dependencies).
- Recursively, all of the `INCLUDE_DIRS` of those components `REQUIRES` lists (ie all public dependencies of this component's dependencies, recursively expanded).

### Main component requirements

The component named `main` is special because it automatically requires all other components in the build. So it's not necessary to pass `REQUIRES` or `PRIV_REQUIRES` to this component. See [renaming main](#) for a description of what needs to be changed if no longer using the `main` component.

### Common component requirements

To avoid duplication, every component automatically requires some “common” IDF components even if they are not mentioned explicitly. Headers from these components can always be included.

The list of common components is: `cxx`, `newlib`, `freertos`, `esp_hw_support`, `heap`, `log`, `soc`, `hal`, `esp_rom`, `esp_common`, `esp_system`, `xtensa/riscv`.

### Including components in the build

- By default, every component is included in the build.
- If you set the `COMPONENTS` variable to a minimal list of components used directly by your project, then the build will expand to also include required components. The full list of components will be:
  - Components mentioned explicitly in `COMPONENTS`.
  - Those components' requirements (evaluated recursively).
  - The “common” components that every component depends on.
- Setting `COMPONENTS` to the minimal list of required components can significantly reduce compile times.

## Circular Dependencies

It's possible for a project to contain Component A that requires (REQUIRES or PRIV\_REQUIRES) Component B, and Component B that requires Component A. This is known as a dependency cycle or a circular dependency.

CMake will usually handle circular dependencies automatically by repeating the component library names twice on the linker command line. However this strategy doesn't always work, and it's possible the build will fail with a linker error about "Undefined reference to ...", referencing a symbol defined by one of the components inside the circular dependency. This is particularly likely if there is a large circular dependency, i.e. A->B->C->D->A.

The best solution is to restructure the components to remove the circular dependency. In most cases, a software architecture without circular dependencies has desirable properties of modularity and clean layering and will be more maintainable in the long term. However, removing circular dependencies is not always possible.

To bypass a linker error caused by a circular dependency, the simplest workaround is to increase the CMake `LINK_INTERFACE_MULTIPLICITY` property of one of the component libraries. This causes CMake to repeat this library and its dependencies more than two times on the linker command line.

For example:

```
set_property(TARGET ${COMPONENT_LIB} APPEND PROPERTY LINK_INTERFACE_MULTIPLICITY 3)
```

- This line should be placed after `idf_component_register` in the component CMakeLists.txt file.
- If possible, place this line in the component that creates the circular dependency by depending on a lot of other components. However, the line can be placed inside any component that is part of the cycle. Choosing the component that owns the source file shown in the linker error message, or the component that defines the symbol(s) mentioned in the linker error message, is a good place to start.
- Usually increasing the value to 3 (default is 2) is enough, but if this doesn't work then try increasing the number further.
- Adding this option will make the linker command line longer, and the linking stage slower.

**Advanced Workaround: Undefined Symbols** If only one or two symbols is causing a circular dependency, and all other dependencies are linear, then there is an alternative method to avoid linker errors: Specify the specific symbols required for the "reverse" dependency as undefined symbols at link time.

For example, if component A depends on component B but component B also needs to reference `reverse_ops` from component A (but nothing else), then you can add a line like the following to the component B CMakeLists.txt to resolve the cycle at link time:

```
# This symbol is provided by 'Component A' at link time
target_link_libraries(${COMPONENT_LIB} INTERFACE "-u reverse_ops")
```

- The `-u` argument means that the linker will always include this symbol in the link, regardless of dependency ordering.
- This line should be placed after `idf_component_register` in the component CMakeLists.txt file.
- If 'Component B' doesn't need to access any headers of 'Component A', only link to a few symbol(s), then this line can be used instead of any REQUIRES from B to A. This further simplifies the component structure in the build system.

See the [target\\_link\\_libraries](#) documentation for more information about this CMake function.

## Requirements in the build system implementation

- Very early in the CMake configuration process, the script `expand_requirements.cmake` is run. This script does a partial evaluation of all component CMakeLists.txt files and builds a graph of component requirements (this *graph may have cycles*). The graph is used to generate a file `component_depends.cmake` in the build directory.
- The main CMake process then includes this file and uses it to determine the list of components to include in the build (internal `BUILD_COMPONENTS` variable). The `BUILD_COMPONENTS` variable is sorted so dependencies are listed first, however as the component dependency graph has cycles this cannot be guaranteed

for all components. The order should be deterministic given the same set of components and component dependencies.

- The value of `BUILD_COMPONENTS` is logged by CMake as “Component names: “
- Configuration is then evaluated for the components included in the build.
- Each component is included in the build normally and the `CMakeLists.txt` file is evaluated again to add the component libraries to the build.

**Component Dependency Order** The order of components in the `BUILD_COMPONENTS` variable determines other orderings during the build:

- Order that `project_include.cmake` files are included into the project.
- Order that the list of header paths is generated for compilation (via `-I` argument). (Note that for a given component’s source files, only that component’s dependency’s header paths are passed to the compiler.)

**Adding Link-Time Dependencies** The ESP-IDF CMake helper function `idf_component_add_link_dependency` adds a link-only dependency between one component and another. In almost all cases, it is better to use the `PRIV_REQUIRES` feature in `idf_component_register` to create a dependency. However, in some cases, it’s necessary to add the link-time dependency of another component to this component, i.e., the reverse order to `PRIV_REQUIRES` (for example: [Overriding Default Chip Drivers](#)).

To make another component depend on this component at link time:

```
idf_component_add_link_dependency (FROM other_component)
```

Place this line after the line with `idf_component_register`.

It’s also possible to specify both components by name:

```
idf_component_add_link_dependency (FROM other_component TO that_component)
```

## 4.4.9 Overriding Parts of the Project

### `project_include.cmake`

For components that have build requirements which must be evaluated before any component `CMakeLists` files are evaluated, you can create a file called `project_include.cmake` in the component directory. This CMake file is included when `project.cmake` is evaluating the entire project.

`project_include.cmake` files are used inside ESP-IDF, for defining project-wide build features such as `esptool.py` command line arguments and the bootloader “special app”.

Unlike component `CMakeLists.txt` files, when including a `project_include.cmake` file the current source directory (`CMAKE_CURRENT_SOURCE_DIR` and working directory) is the project directory. Use the variable `COMPONENT_DIR` for the absolute directory of the component.

Note that `project_include.cmake` isn’t necessary for the most common component uses - such as adding include directories to the project, or `LDFLAGS` to the final linking step. These values can be customised via the `CMakeLists.txt` file itself. See [Optional Project Variables](#) for details.

`project_include.cmake` files are included in the order given in `BUILD_COMPONENTS` variable (as logged by CMake). This means that a component’s `project_include.cmake` file will be included after it’s all dependencies’ `project_include.cmake` files, unless both components are part of a dependency cycle. This is important if a `project_include.cmake` file relies on variables set by another component. See also [above](#).

Take great care when setting variables or targets in a `project_include.cmake` file. As the values are included into the top-level project CMake pass, they can influence or break functionality across all components!

### KConfig.projbuild

This is an equivalent to `project_include.cmake` for *Component Configuration* KConfig files. If you want to include configuration options at the top-level of `menuconfig`, rather than inside the “Component Configuration” sub-menu, then these can be defined in the `KConfig.projbuild` file alongside the `CMakeLists.txt` file.

Take care when adding configuration values in this file, as they will be included across the entire project configuration. Where possible, it’s generally better to create a KConfig file for *Component Configuration*.

`project_include.cmake` files are used inside ESP-IDF, for defining project-wide build features such as `esptool.py` command line arguments and the `bootloader` “special app”.

#### 4.4.10 Configuration-Only Components

Special components which contain no source files, only `Kconfig.projbuild` and `KConfig`, can have a one-line `CMakeLists.txt` file which calls the function `idf_component_register()` with no arguments specified. This function will include the component in the project build, but no library will be built *and* no header files will be added to any include paths.

#### 4.4.11 Debugging CMake

For full details about [CMake](#) and CMake commands, see the [CMake v3.16 documentation](#).

Some tips for debugging the ESP-IDF CMake-based build system:

- When CMake runs, it prints quite a lot of diagnostic information including lists of components and component paths.
- Running `cmake -DDEBUG=1` will produce more verbose diagnostic output from the IDF build system.
- Running `cmake` with the `--trace` or `--trace-expand` options will give a lot of information about control flow. See the [cmake command line documentation](#).

When included from a project CMakeLists file, the `project.cmake` file defines some utility modules and global variables and then sets `IDF_PATH` if it was not set in the system environment.

It also defines an overridden custom version of the built-in [CMake](#) `project` function. This function is overridden to add all of the ESP-IDF specific project functionality.

#### Warning On Undefined Variables

By default, `idf.py` passes the `--warn-uninitialized` flag to [CMake](#) so it will print a warning if an undefined variable is referenced in the build. This can be very useful to find buggy CMake files.

If you don’t want this behaviour, it can be disabled by passing `--no-warnings` to `idf.py`.

Browse the [/tools/cmake/project.cmake](#) file and supporting functions in [/tools/cmake/](#) for more details.

#### 4.4.12 Example Component CMakeLists

Because the build environment tries to set reasonable defaults that will work most of the time, component `CMakeLists.txt` can be very small or even empty (see [Minimal Component CMakeLists](#)). However, overriding [pre-set\\_component\\_variables](#) is usually required for some functionality.

Here are some more advanced examples of component CMakeLists files.

### Adding conditional configuration

The configuration system can be used to conditionally compile some files depending on the options selected in the project configuration.

Kconfig:

```
config FOO_ENABLE_BAR
    bool "Enable the BAR feature."
    help
        This enables the BAR feature of the FOO component.
```

CMakeLists.txt:

```
set(srcs "foo.c" "more_foo.c")

if(CONFIG_FOO_ENABLE_BAR)
    list(APPEND srcs "bar.c")
endif()

idf_component_register(SRCS "${srcs}"
    ...)
```

This example makes use of the CMake [if](#) function and [list APPEND](#) function.

This can also be used to select or stub out an implementation, as such:

Kconfig:

```
config ENABLE_LCD_OUTPUT
    bool "Enable LCD output."
    help
        Select this if your board has a LCD.

config ENABLE_LCD_CONSOLE
    bool "Output console text to LCD"
    depends on ENABLE_LCD_OUTPUT
    help
        Select this to output debugging output to the lcd

config ENABLE_LCD_PLOT
    bool "Output temperature plots to LCD"
    depends on ENABLE_LCD_OUTPUT
    help
        Select this to output temperature plots
```

CMakeLists.txt:

```
if(CONFIG_ENABLE_LCD_OUTPUT)
    set(srcs lcd-real.c lcd-spi.c)
else()
    set(srcs lcd-dummy.c)
endif()

# We need font if either console or plot is enabled
if(CONFIG_ENABLE_LCD_CONSOLE OR CONFIG_ENABLE_LCD_PLOT)
    list(APPEND srcs "font.c")
endif()

idf_component_register(SRCS "${srcs}"
    ...)
```

### Conditions which depend on the target

The current target is available to CMake files via `IDF_TARGET` variable.

In addition to that, if target `xyz` is used (`IDF_TARGET=xyz`), then Kconfig variable `CONFIG_IDF_TARGET_XYZ` will be set.

Note that component dependencies may depend on `IDF_TARGET` variable, but not on Kconfig variables. Also one can not use Kconfig variables in `include` statements in CMake files, but `IDF_TARGET` can be used in such context.

### Source Code Generation

Some components will have a situation where a source file isn't supplied with the component itself but has to be generated from another file. Say our component has a header file that consists of the converted binary data of a BMP file, converted using a hypothetical tool called `bmp2h`. The header file is then included in as C source file called `graphics_lib.c`:

```
add_custom_command(OUTPUT logo.h
    COMMAND bmp2h -i ${COMPONENT_DIR}/logo.bmp -o log.h
    DEPENDS ${COMPONENT_DIR}/logo.bmp
    VERBATIM)

add_custom_target(logo DEPENDS logo.h)
add_dependencies(${COMPONENT_LIB} logo)

set_property(DIRECTORY "${COMPONENT_DIR}" APPEND PROPERTY
    ADDITIONAL_CLEAN_FILES logo.h)
```

This answer is adapted from the [CMake FAQ](#) entry, which contains some other examples that will also work with ESP-IDF builds.

In this example, `logo.h` will be generated in the current directory (the build directory) while `logo.bmp` comes with the component and resides under the component path. Because `logo.h` is a generated file, it should be cleaned when the project is cleaned. For this reason it is added to the [ADDITIONAL\\_CLEAN\\_FILES](#) property.

---

**Note:** If generating files as part of the project `CMakeLists.txt` file, not a component `CMakeLists.txt`, then use build property `PROJECT_DIR` instead of `${COMPONENT_DIR}` and `PROJECT_NAME` instead of `COMPONENT_LIB`.)

---

If a source file from another component included `logo.h`, then `add_dependencies` would need to be called to add a dependency between the two components, to ensure that the component source files were always compiled in the correct order.

### Embedding Binary Data

Sometimes you have a file with some binary or text data that you'd like to make available to your component - but you don't want to reformat the file as C source.

You can specify argument `EMBED_FILES` in the component registration, giving space-delimited names of the files to embed:

```
idf_component_register(...
    EMBED_FILES server_root_cert.der)
```

Or if the file is a string, you can use the variable `EMBED_TXTFILES`. This will embed the contents of the text file as a null-terminated string:

```
idf_component_register(...
    EMBED_TXTFILES server_root_cert.pem)
```



The file's contents will be added to the .rodata section in flash, and are available via symbol names as follows:

```
extern const uint8_t server_root_cert_pem_start[] asm("_binary_server_root_cert_
↪pem_start");
extern const uint8_t server_root_cert_pem_end[] asm("_binary_server_root_cert_
↪pem_end");
```

The names are generated from the full name of the file, as given in `MBED_FILES`. Characters `/`, `.`, etc. are replaced with underscores. The `_binary` prefix in the symbol name is added by objcopy and is the same for both text and binary files.

To embed a file into a project, rather than a component, you can call the function `target_add_binary_data` like this:

```
target_add_binary_data(myproject.elf "main/data.bin" TEXT)
```

Place this line after the `project()` line in your project `CMakeLists.txt` file. Replace `myproject.elf` with your project name. The final argument can be `TEXT` to embed a null-terminated string, or `BINARY` to embed the content as-is.

For an example of using this technique, see the “main” component of the `file_serving` example [protocols/http\\_server/file\\_serving/main/CMakeLists.txt](https://github.com/espressif/esp-idf/blob/master/examples/protocols/http_server/file_serving/main/CMakeLists.txt) - two files are loaded at build time and linked into the firmware.

It is also possible embed a generated file:

```
add_custom_command(OUTPUT my_processed_file.bin
                    COMMAND my_process_file_cmd my_unprocessed_file.bin)
target_add_binary_data(my_target "my_processed_file.bin" BINARY)
```

In the example above, `my_processed_file.bin` is generated from `my_unprocessed_file.bin` through some command `my_process_file_cmd`, then embedded into the target.

To specify a dependence on a target, use the `DEPENDS` argument:

```
add_custom_target(my_process COMMAND ...)
target_add_binary_data(my_target "my_embed_file.bin" BINARY DEPENDS my_process)
```

The `DEPENDS` argument to `target_add_binary_data` ensures that the target executes first.

## Code and Data Placements

ESP-IDF has a feature called linker script generation that enables components to define where its code and data will be placed in memory through linker fragment files. These files are processed by the build system, and is used to augment the linker script used for linking app binary. See [Linker Script Generation](#) for a quick start guide as well as a detailed discussion of the mechanism.

## Fully Overriding The Component Build Process

Obviously, there are cases where all these recipes are insufficient for a certain component, for example when the component is basically a wrapper around another third-party component not originally intended to be compiled under this build system. In that case, it's possible to forego the ESP-IDF build system entirely by using a CMake feature called `ExternalProject`. Example component `CMakeLists`:

```
# External build process for quirc, runs in source dir and
# produces libquirc.a
externalproject_add(quirc_build
    PREFIX ${COMPONENT_DIR}
    SOURCE_DIR ${COMPONENT_DIR}/quirc
    CONFIGURE_COMMAND ""
    BUILD_IN_SOURCE 1
```

(continues on next page)

```

BUILD_COMMAND make CC=${CMAKE_C_COMPILER} libquirc.a
INSTALL_COMMAND ""
)

# Add libquirc.a to the build process
add_library(quirc STATIC IMPORTED GLOBAL)
add_dependencies(quirc quirc_build)

set_target_properties(quirc PROPERTIES IMPORTED_LOCATION
    ${COMPONENT_DIR}/quirc/libquirc.a)
set_target_properties(quirc PROPERTIES INTERFACE_INCLUDE_DIRECTORIES
    ${COMPONENT_DIR}/quirc/lib)

set_directory_properties( PROPERTIES ADDITIONAL_CLEAN_FILES
    "${COMPONENT_DIR}/quirc/libquirc.a")

```

(The above CMakeLists.txt can be used to create a component named `quirc` that builds the `quirc` project using its own Makefile.)

- `externalproject_add` defines an external build system.
  - `SOURCE_DIR`, `CONFIGURE_COMMAND`, `BUILD_COMMAND` and `INSTALL_COMMAND` should always be set. `CONFIGURE_COMMAND` can be set to an empty string if the build system has no “configure” step. `INSTALL_COMMAND` will generally be empty for ESP-IDF builds.
  - Setting `BUILD_IN_SOURCE` means the build directory is the same as the source directory. Otherwise you can set `BUILD_DIR`.
  - Consult the [ExternalProject](#) documentation for more details about `externalproject_add()`
- The second set of commands adds a library target, which points to the “imported” library file built by the external system. Some properties need to be set in order to add include directories and tell CMake where this file is.
- Finally, the generated library is added to `ADDITIONAL_CLEAN_FILES`. This means `make clean` will delete this library. (Note that the other object files from the build won’t be deleted.)

**ExternalProject dependencies, clean builds** CMake has some unusual behaviour around external project builds:

- `ADDITIONAL_CLEAN_FILES` only works when “make” or “ninja” is used as the build system. If an IDE build system is used, it won’t delete these files when cleaning.
- However, the [ExternalProject](#) `configure` & `build` commands will *always* be re-run after a clean is run.
- Therefore, there are two alternative recommended ways to configure the external build command:
  1. Have the external `BUILD_COMMAND` run a full clean compile of all sources. The build command will be run if any of the dependencies passed to `externalproject_add` with `DEPENDS` have changed, or if this is a clean build (ie any of `idf.py clean`, `ninja clean`, or `make clean` was run.)
  2. Have the external `BUILD_COMMAND` be an incremental build command. Pass the parameter `BUILD_ALWAYS 1` to `externalproject_add`. This means the external project will be built each time a build is run, regardless of dependencies. This is only recommended if the external project has correct incremental build behaviour, and doesn’t take too long to run.

The best of these approaches for building an external project will depend on the project itself, its build system, and whether you anticipate needing to frequently recompile the project.

#### 4.4.13 Custom sdkconfig defaults

For example projects or other projects where you don’t want to specify a full `sdkconfig` configuration, but you do want to override some key values from the ESP-IDF defaults, it is possible to create a file `sdkconfig.defaults` in the project directory. This file will be used when creating a new config from scratch, or when any new config value hasn’t yet been set in the `sdkconfig` file.

To override the name of this file or to specify multiple files, set the `SDKCONFIG_DEFAULTS` environment variable or set `SDKCONFIG_DEFAULTS` in top-level `CMakeLists.txt`. File names that are not specified as full paths are resolved relative to current project’s directory.

When specifying multiple files, use a semicolon as the list separator. Files listed first will be applied first. If a particular key is defined in multiple files, the definition in the latter file will override definitions from former files.

Some of the IDF examples include a `sdkconfig.ci` file. This is part of the continuous integration (CI) test framework and is ignored by the normal build process.

### Target-dependent `sdkconfig` defaults

In addition to `sdkconfig.defaults` file, build system will also load defaults from `sdkconfig.defaults.TARGET_NAME` file, where `TARGET_NAME` is the value of `IDF_TARGET`. For example, for `esp32` target, default settings will be taken from `sdkconfig.defaults` first, and then from `sdkconfig.defaults.esp32`.

If `SDKCONFIG_DEFAULTS` is used to override the name of defaults file/files, the name of target-specific defaults file will be derived from `SDKCONFIG_DEFAULTS` value/values using the rule above. When there are multiple files in `SDKCONFIG_DEFAULTS`, target-specific file will be applied right after the file bringing it in, before all latter files in `SDKCONFIG_DEFAULTS`

For example, if `SDKCONFIG_DEFAULTS="sdkconfig.defaults; sdkconfig_devkit1"`, and there is a file `sdkconfig.defaults.esp32` in the same folder, then the files will be applied in the following order: (1) `sdkconfig.defaults` (2) `sdkconfig.defaults.esp32` (3) `sdkconfig_devkit1`.

#### 4.4.14 Flash arguments

There are some scenarios that we want to flash the target board without IDF. For this case we want to save the built binaries, `esptool.py` and `esptool write_flash` arguments. It's simple to write a script to save binaries and `esptool.py`.

After running a project build, the build directory contains binary output files (`.bin` files) for the project and also the following flashing data files:

- `flash_project_args` contains arguments to flash the entire project (app, bootloader, partition table, PHY data if this is configured).
- `flash_app_args` contains arguments to flash only the app.
- `flash_bootloader_args` contains arguments to flash only the bootloader.

You can pass any of these flasher argument files to `esptool.py` as follows:

```
python esptool.py --chip esp32 write_flash @build/flash_project_args
```

Alternatively, it is possible to manually copy the parameters from the argument file and pass them on the command line.

The build directory also contains a generated file `flasher_args.json` which contains project flash information, in JSON format. This file is used by `idf.py` and can also be used by other tools which need information about the project build.

#### 4.4.15 Building the Bootloader

The bootloader is a special “subproject” inside `/components/bootloader/subproject`. It has its own project `CMakeLists.txt` file and builds separate `.ELF` and `.BIN` files to the main project. However it shares its configuration and build directory with the main project.

The subproject is inserted as an external project from the top-level project, by the file `/components/bootloader/project_include.cmake`. The main build process runs CMake for the subproject, which includes discovering components (a subset of the main components) and generating a bootloader-specific config (derived from the main `sdkconfig`).

#### 4.4.16 Writing Pure CMake Components

The ESP-IDF build system “wraps” CMake with the concept of “components”, and helper functions to automatically integrate these components into a project build.

However, underneath the concept of “components” is a full CMake build system. It is also possible to make a component which is pure CMake.

Here is an example minimal “pure CMake” component CMakeLists file for a component named `json`:

```
add_library(json STATIC
  cJSON/cJSON.c
  cJSON/cJSON_Utils.c)

target_include_directories(json PUBLIC cJSON)
```

- This is actually an equivalent declaration to the IDF `json` component [/components/json/CMakeLists.txt](#).
- This file is quite simple as there are not a lot of source files. For components with a large number of files, the globbing behaviour of ESP-IDF’s component logic can make the component CMakeLists style simpler.)
- Any time a component adds a library target with the component name, the ESP-IDF build system will automatically add this to the build, expose public include directories, etc. If a component wants to add a library target with a different name, dependencies will need to be added manually via CMake commands.

#### 4.4.17 Using Third-Party CMake Projects with Components

CMake is used for a lot of open-source C and C++ projects —code that users can tap into for their applications. One of the benefits of having a CMake build system is the ability to import these third-party projects, sometimes even without modification! This allows for users to be able to get functionality that may not yet be provided by a component, or use another library for the same functionality.

Importing a library might look like this for a hypothetical library `foo` to be used in the `main` component:

```
# Register the component
idf_component_register(...)

# Set values of hypothetical variables that control the build of `foo`
set(FOO_BUILD_STATIC OFF)
set(FOO_BUILD_TESTS OFF)

# Create and import the library targets
add_subdirectory(foo)

# Publicly link `foo` to `main` component
target_link_libraries(main PUBLIC foo)
```

For an actual example, take a look at [build\\_system/cmake/import\\_lib](#). Take note that what needs to be done in order to import the library may vary. It is recommended to read up on the library’s documentation for instructions on how to import it from other projects. Studying the library’s CMakeLists.txt and build structure can also be helpful.

It is also possible to wrap a third-party library to be used as a component in this manner. For example, the `mbedtls` component is a wrapper for Espressif’s fork of `mbedtls`. See its [component CMakeLists.txt](#).

The CMake variable `ESP_PLATFORM` is set to 1 whenever the ESP-IDF build system is being used. Tests such as `if (ESP_PLATFORM)` can be used in generic CMake code if special IDF-specific logic is required.

#### Using ESP-IDF components from external libraries

The above example assumes that the external library `foo` (or `tinymce` in the case of the `import_lib` example) doesn’t need to use any ESP-IDF APIs apart from common APIs such as `libc`, `libstdc++`, etc. If the external library needs to use APIs provided by other ESP-IDF components, this needs to be specified in the external CMakeLists.txt file by adding a dependency on the library target `idf::<componentname>`.

For example, in the `foo/CMakeLists.txt` file:

```
add_library(foo bar.c fizz.cpp buzz.cpp)

if(ESP_PLATFORM)
    # On ESP-IDF, bar.c needs to include esp_flash.h from the spi_flash component
    target_link_libraries(foo PRIVATE idf::spi_flash)
endif()
```

### 4.4.18 Using Prebuilt Libraries with Components

Another possibility is that you have a prebuilt static library (`.a` file), built by some other build process.

The ESP-IDF build system provides a utility function `add_prebuilt_library` for users to be able to easily import and use prebuilt libraries:

```
add_prebuilt_library(target_name lib_path [REQUIRES req1 req2 ...] [PRIV_REQUIRES_
↳req1 req2 ...])
```

where:

- `target_name`- name that can be used to reference the imported library, such as when linking to other targets
- `lib_path`- path to prebuilt library; may be an absolute or relative path to the component directory

Optional arguments `REQUIRES` and `PRIV_REQUIRES` specify dependency on other components. These have the same meaning as the arguments for `idf_component_register`.

Take note that the prebuilt library must have been compiled for the same target as the consuming project. Configuration relevant to the prebuilt library must also match. If not paid attention to, these two factors may contribute to subtle bugs in the app.

For an example, take a look at [build\\_system/cmake/import\\_prebuilt](#).

### 4.4.19 Using ESP-IDF in Custom CMake Projects

ESP-IDF provides a template CMake project for easily creating an application. However, in some instances the user might already have an existing CMake project or may want to create a custom one. In these cases it is desirable to be able to consume IDF components as libraries to be linked to the user's targets (libraries/ executables).

It is possible to do so by using the *build system APIs provided* by `tools/cmake/idf.cmake`. For example:

```
cmake_minimum_required(VERSION 3.16)
project(my_custom_app C)

# Include CMake file that provides ESP-IDF CMake build system APIs.
include($ENV{IDF_PATH}/tools/cmake/idf.cmake)

# Include ESP-IDF components in the build, may be thought as an equivalent of
# add_subdirectory() but with some additional processing and magic for ESP-IDF.
↳build
# specific build processes.
idf_build_process(esp32)

# Create the project executable and plainly link the newlib component to it using
# its alias, idf::newlib.
add_executable(${CMAKE_PROJECT_NAME}.elf main.c)
target_link_libraries(${CMAKE_PROJECT_NAME}.elf idf::newlib)

# Let the build system know what the project executable is to attach more targets,
↳dependencies, etc.
idf_build_executable(${CMAKE_PROJECT_NAME}.elf)
```

The example in [build\\_system/cmake/idf\\_as\\_lib](#) demonstrates the creation of an application equivalent to [hello world application](#) using a custom CMake project.

## 4.4.20 ESP-IDF CMake Build System API

### idf-build-commands

```
idf_build_get_property(var property [GENERATOR_EXPRESSION])
```

Retrieve a *build property* *property* and store it in *var* accessible from the current scope. Specifying *GENERATOR\_EXPRESSION* will retrieve the generator expression string for that property, instead of the actual value, which can be used with CMake commands that support generator expressions.

```
idf_build_set_property(property val [APPEND])
```

Set a *build property* *property* with value *val*. Specifying *APPEND* will append the specified value to the current value of the property. If the property does not previously exist or it is currently empty, the specified value becomes the first element/member instead.

```
idf_build_component(component_dir)
```

Present a directory *component\_dir* that contains a component to the build system. Relative paths are converted to absolute paths with respect to current directory. All calls to this command must be performed before *idf\_build\_process*.

This command does not guarantee that the component will be processed during build (see the *COMPONENTS* argument description for *idf\_build\_process*)

```
idf_build_process(target
    [PROJECT_DIR project_dir]
    [PROJECT_VER project_ver]
    [PROJECT_NAME project_name]
    [SDKCONFIG sdkconfig]
    [SDKCONFIG_DEFAULTS sdkconfig_defaults]
    [BUILD_DIR build_dir]
    [COMPONENTS component1 component2 ...])
```

Performs the bulk of the behind-the-scenes magic for including ESP-IDF components such as component configuration, libraries creation, dependency expansion and resolution. Among these functions, perhaps the most important from a user's perspective is the libraries creation by calling each component's *idf\_component\_register*. This command creates the libraries for each component, which are accessible using aliases in the form *idf::component\_name*. These aliases can be used to link the components to the user's own targets, either libraries or executables.

The call requires the target chip to be specified with *target* argument. Optional arguments for the call include:

- **PROJECT\_DIR** - directory of the project; defaults to **CMAKE\_SOURCE\_DIR**
- **PROJECT\_NAME** - name of the project; defaults to **CMAKE\_PROJECT\_NAME**
- **PROJECT\_VER** - version/revision of the project; defaults to "1"
- **SDKCONFIG** - output path of generated *sdkconfig* file; defaults to **PROJECT\_DIR/sdkconfig** or **CMAKE\_SOURCE\_DIR/sdkconfig** depending if **PROJECT\_DIR** is set
- **SDKCONFIG\_DEFAULTS** - list of files containing default config to use in the build (list must contain full paths); defaults to empty. For each value *filename* in the list, the config from file *filename.target*, if it exists, is also loaded.
- **BUILD\_DIR** - directory to place ESP-IDF build-related artifacts, such as generated binaries, text files, components; defaults to **CMAKE\_BINARY\_DIR**
- **COMPONENTS** - select components to process among the components known by the build system (added via *idf\_build\_component*). This argument is used to trim the build. Other components are automatically added if they are required in the dependency chain, i.e. the public and private requirements of the components in this list are automatically added, and in turn the public and private requirements of those requirements, so on and so forth. If not specified, all components known to the build system are processed.



```
idf_build_executable(executable)
```

Specify the executable *executable* for ESP-IDF build. This attaches additional targets such as dependencies related to flashing, generating additional binary files, etc. Should be called after `idf_build_process`.

```
idf_build_get_config(var config [GENERATOR_EXPRESSION])
```

Get the value of the specified config. Much like build properties, specifying *GENERATOR\_EXPRESSION* will retrieve the generator expression string for that config, instead of the actual value, which can be used with CMake commands that support generator expressions. Actual config values are only known after call to `idf_build_process`, however.

### idf-build-properties

These are properties that describe the build. Values of build properties can be retrieved by using the build command `idf_build_get_property`. For example, to get the Python interpreter used for the build:

```
idf_build_get_property(python PYTHON)
message(STATUS "The Python interpreter is: ${python}")
```

- `BUILD_DIR` - build directory; set from `idf_build_process BUILD_DIR` argument
- `BUILD_COMPONENTS` - list of components included in the build; set by `idf_build_process`
- `BUILD_COMPONENT_ALIASES` - list of library alias of components included in the build; set by `idf_build_process`
- `C_COMPILE_OPTIONS` - compile options applied to all components' C source files
- `COMPILE_OPTIONS` - compile options applied to all components' source files, regardless of it being C or C++
- `COMPILE_DEFINITIONS` - compile definitions applied to all component source files
- `CXX_COMPILE_OPTIONS` - compile options applied to all components' C++ source files
- `EXECUTABLE` - project executable; set by call to `idf_build_executable`
- `EXECUTABLE_NAME` - name of project executable without extension; set by call to `idf_build_executable`
- `EXECUTABLE_DIR` - path containing the output executable
- `IDF_COMPONENT_MANAGER` - the component manager is enabled by default, but if this property is set to 0 it was disabled by the `IDF_COMPONENT_MANAGER` environment variable
- `IDF_PATH` - ESP-IDF path; set from `IDF_PATH` environment variable, if not, inferred from the location of `idf.cmake`
- `IDF_TARGET` - target chip for the build; set from the required target argument for `idf_build_process`
- `IDF_VER` - ESP-IDF version; set from either a version file or the Git revision of the `IDF_PATH` repository
- `INCLUDE_DIRECTORIES` - include directories for all component source files
- `KCONFIGS` - list of Kconfig files found in components in build; set by `idf_build_process`
- `KCONFIG_PROJBUILDS` - list of Kconfig.projbuild files found in components in build; set by `idf_build_process`
- `PROJECT_NAME` - name of the project; set from `idf_build_process PROJECT_NAME` argument
- `PROJECT_DIR` - directory of the project; set from `idf_build_process PROJECT_DIR` argument
- `PROJECT_VER` - version of the project; set from `idf_build_process PROJECT_VER` argument
- `PYTHON` - Python interpreter used for the build; set from `PYTHON` environment variable if available, if not "python" is used
- `SDKCONFIG` - full path to output config file; set from `idf_build_process SDKCONFIG` argument
- `SDKCONFIG_DEFAULTS` - list of files containing default config to use in the build; set from `idf_build_process SDKCONFIG_DEFAULTS` argument
- `SDKCONFIG_HEADER` - full path to C/C++ header file containing component configuration; set by `idf_build_process`
- `SDKCONFIG_CMAKE` - full path to CMake file containing component configuration; set by `idf_build_process`
- `SDKCONFIG_JSON` - full path to JSON file containing component configuration; set by `idf_build_process`

- `SDKCONFIG_JSON_MENUS` - full path to JSON file containing config menus; set by `idf_build_process`

### idf-component-commands

```
idf_component_get_property(var component property [GENERATOR_EXPRESSION])
```

Retrieve a specified *component*'s *component property*, *property* and store it in *var* accessible from the current scope. Specifying *GENERATOR\_EXPRESSION* will retrieve the generator expression string for that property, instead of the actual value, which can be used with CMake commands that support generator expressions.

```
idf_component_set_property(component property val [APPEND])
```

Set a specified *component*'s *component property*, *property* with value *val*. Specifying *APPEND* will append the specified value to the current value of the property. If the property does not previously exist or it is currently empty, the specified value becomes the first element/member instead.

```
idf_component_register([[SRCS src1 src2 ...] | [[SRC_DIRS dir1 dir2 ...] [EXCLUDE_
→SRCS src1 src2 ...]]
                        [INCLUDE_DIRS dir1 dir2 ...]
                        [PRIV_INCLUDE_DIRS dir1 dir2 ...]
                        [REQUIRES component1 component2 ...]
                        [PRIV_REQUIRES component1 component2 ...]
                        [LDFRAGMENTS ldfragment1 ldfragment2 ...]
                        [REQUIRED_IDF_TARGETS target1 target2 ...]
                        [EMBED_FILES file1 file2 ...]
                        [EMBED_TXTFILES file1 file2 ...]
                        [KCONFIG kconfig]
                        [KCONFIG_PROJBUILD kconfig_projbuild]
                        [WHOLE_ARCHIVE])
```

Register a component to the build system. Much like the `project()` CMake command, this should be called from the component's `CMakeLists.txt` directly (not through a function or macro) and is recommended to be called before any other command. Here are some guidelines on what commands can **not** be called before `idf_component_register`:

- commands that are not valid in CMake script mode
- custom commands defined in `project_include.cmake`
- build system API commands except `idf_build_get_property`; although consider whether the property may not have been set yet

Commands that set and operate on variables are generally okay to call before `idf_component_register`.

The arguments for `idf_component_register` include:

- `SRCS` - component source files used for creating a static library for the component; if not specified, component is treated as a config-only component and an interface library is created instead.
- `SRC_DIRS`, `EXCLUDE_SRCS` - used to glob source files (`.c`, `.cpp`, `.S`) by specifying directories, instead of specifying source files manually via `SRCS`. Note that this is subject to the *limitations of globbing in CMake*. Source files specified in `EXCLUDE_SRCS` are removed from the globbed files.
- `INCLUDE_DIRS` - paths, relative to the component directory, which will be added to the include search path for all other components which require the current component
- `PRIV_INCLUDE_DIRS` - directory paths, must be relative to the component directory, which will be added to the include search path for this component's source files only
- `REQUIRES` - public component requirements for the component
- `PRIV_REQUIRES` - private component requirements for the component; ignored on config-only components
- `LDFRAGMENTS` - component linker fragment files
- `REQUIRED_IDF_TARGETS` - specify the only target the component supports
- `KCONFIG` - override the default Kconfig file
- `KCONFIG_PROJBUILD` - override the default Kconfig.projbuild file



- `WHOLE_ARCHIVE` - if specified, the component library is surrounded by `-Wl,--whole-archive`, `-Wl,--no-whole-archive` when linked. This has the same effect as setting `WHOLE_ARCHIVE` component property.

The following are used for *embedding data into the component*, and is considered as source files when determining if a component is config-only. This means that even if the component does not specify source files, a static library is still created internally for the component if it specifies either:

- `EMBED_FILES` - binary files to be embedded in the component
- `EMBED_TXTFILES` - text files to be embedded in the component

### idf-component-properties

These are properties that describe a component. Values of component properties can be retrieved by using the build command `idf_component_get_property`. For example, to get the directory of the `freertos` component:

```
idf_component_get_property(dir freertos COMPONENT_DIR)
message(STATUS "The 'freertos' component directory is: ${dir}")
```

- `COMPONENT_ALIAS` - alias for `COMPONENT_LIB` used for linking the component to external targets; set by `idf_build_component` and alias library itself is created by `idf_component_register`
- `COMPONENT_DIR` - component directory; set by `idf_build_component`
- `COMPONENT_OVERRIDEN_DIR` - contains the directory of the original component if *this component overrides another component*
- `COMPONENT_LIB` - name for created component static/interface library; set by `idf_build_component` and library itself is created by `idf_component_register`
- `COMPONENT_NAME` - name of the component; set by `idf_build_component` based on the component directory name
- `COMPONENT_TYPE` - type of the component, whether `LIBRARY` or `CONFIG_ONLY`. A component is of type `LIBRARY` if it specifies source files or embeds a file
- `EMBED_FILES` - list of files to embed in component; set from `idf_component_register` `EMBED_FILES` argument
- `EMBED_TXTFILES` - list of text files to embed in component; set from `idf_component_register` `EMBED_TXTFILES` argument
- `INCLUDE_DIRS` - list of component include directories; set from `idf_component_register` `INCLUDE_DIRS` argument
- `KCONFIG` - component Kconfig file; set by `idf_build_component`
- `KCONFIG_PROJBUILD` - component Kconfig.projbuild; set by `idf_build_component`
- `LDFRAGMENTS` - list of component linker fragment files; set from `idf_component_register` `LDFRAGMENTS` argument
- `MANAGED_PRIV_REQUIRES` - list of private component dependencies added by the IDF component manager from dependencies in `idf_component.yml` manifest file
- `MANAGED_REQUIRES` - list of public component dependencies added by the IDF component manager from dependencies in `idf_component.yml` manifest file
- `PRIV_INCLUDE_DIRS` - list of component private include directories; set from `idf_component_register` `PRIV_INCLUDE_DIRS` on components of type `LIBRARY`
- `PRIV_REQUIRES` - list of private component dependencies; set from value of `idf_component_register` `PRIV_REQUIRES` argument and dependencies in `idf_component.yml` manifest file
- `REQUIRED_IDF_TARGETS` - list of targets the component supports; set from `idf_component_register` `EMBED_TXTFILES` argument
- `REQUIRES` - list of public component dependencies; set from value of `idf_component_register` `REQUIRES` argument and dependencies in `idf_component.yml` manifest file
- `SRCS` - list of component source files; set from `SRCS` or `SRC_DIRS/EXCLUDE_SRCS` argument of `idf_component_register`
- `WHOLE_ARCHIVE` - if this property is set to `TRUE` (or any boolean “true” CMake value: `1`, `ON`, `YES`, `Y`), the component library is surrounded by `-Wl,--whole-archive`, `-Wl,--no-whole-archive` when linked. This can be used to force the linker to include every object file into the executable, even if the object file doesn't resolve any references from the rest of the application. This is commonly used when a component

contains plugins or modules which rely on link-time registration. This property is `FALSE` by default. It can be set to `TRUE` from the component `CMakeLists.txt` file.

### 4.4.21 File Globbing & Incremental Builds

The preferred way to include source files in an ESP-IDF component is to list them manually via `SRCS` argument to `idf_component_register`:

```
idf_component_register(SRCS library/a.c library/b.c platform/platform.c
                      ...)
```

This preference reflects the [CMake best practice](#) of manually listing source files. This could, however, be inconvenient when there are lots of source files to add to the build. The ESP-IDF build system provides an alternative way for specifying source files using `SRC_DIRS`:

```
idf_component_register(SRC_DIRS library platform
                      ...)
```

This uses globbing behind the scenes to find source files in the specified directories. Be aware, however, that if a new source file is added and this method is used, then CMake won't know to automatically re-run and this file won't be added to the build.

The trade-off is acceptable when you're adding the file yourself, because you can trigger a clean build or run `idf.py reconfigure` to manually re-run CMake. However, the problem gets harder when you share your project with others who may check out a new version using a source control tool like Git...

For components which are part of ESP-IDF, we use a third party Git CMake integration module ([/tools/cmake/third\\_party/GetGitRevisionDescription.cmake](#)) which automatically re-runs CMake any time the repository commit changes. This means if you check out a new ESP-IDF version, CMake will automatically re-run.

For project components (not part of ESP-IDF), there are a few different options:

- If keeping your project file in Git, ESP-IDF will automatically track the Git revision and re-run CMake if the revision changes.
- If some components are kept in a third git repository (not the project repository or ESP-IDF repository), you can add a call to the `git_describe` function in a component `CMakeLists` file in order to automatically trigger re-runs of CMake when the Git revision changes.
- If not using Git, remember to manually run `idf.py reconfigure` whenever a source file may change.
- To avoid this problem entirely, use `SRCS` argument to `idf_component_register` to list all source files in project components.

The best option will depend on your particular project and its users.

### 4.4.22 Build System Metadata

For integration into IDEs and other build systems, when CMake runs the build process generates a number of metadata files in the `build/` directory. To regenerate these files, run `cmake` or `idf.py reconfigure` (or any other `idf.py build` command).

- `compile_commands.json` is a standard format JSON file which describes every source file which is compiled in the project. A CMake feature generates this file, and many IDEs know how to parse it.
- `project_description.json` contains some general information about the ESP-IDF project, configured paths, etc.
- `flasher_args.json` contains `esptool.py` arguments to flash the project's binary files. There are also `flash_*_args` files which can be used directly with `esptool.py`. See [Flash arguments](#).
- `CMakeCache.txt` is the CMake cache file which contains other information about the CMake process, toolchain, etc.
- `config/sdkconfig.json` is a JSON-formatted version of the project configuration values.

- `config/kconfig_menus.json` is a JSON-formatted version of the menus shown in `menuconfig`, for use in external IDE UIs.

### JSON Configuration Server

A tool called `confserver.py` is provided to allow IDEs to easily integrate with the configuration system logic. `confserver.py` is designed to run in the background and interact with a calling process by reading and writing JSON over process stdin & stdout.

You can run `confserver.py` from a project via `idf.py confserver` or `ninja confserver`, or a similar target triggered from a different build generator.

For more information about `confserver.py`, see [tools/kconfig\\_new/README.md](tools/kconfig_new/README.md).

## 4.4.23 Build System Internals

### Build Scripts

The listfiles for the ESP-IDF build system reside in `/tools/cmake`. The modules which implement core build system functionality are as follows:

- `build.cmake` - Build related commands i.e. build initialization, retrieving/setting build properties, build processing.
- `component.cmake` - Component related commands i.e. adding components, retrieving/setting component properties, registering components.
- `kconfig.cmake` - Generation of configuration files (`sdkconfig`, `sdkconfig.h`, `sdkconfig.cmake`, etc.) from Kconfig files.
- `ldgen.cmake` - Generation of final linker script from linker fragment files.
- `target.cmake` - Setting build target and toolchain file.
- `utilities.cmake` - Miscellaneous helper commands.

Aside from these files, there are two other important CMake scripts in `/tools/cmake`:

- `idf.cmake` - Sets up the build and includes the core modules listed above. Included in CMake projects in order to access ESP-IDF build system functionality.
- `project.cmake` - Includes `idf.cmake` and provides a custom `project()` command that takes care of all the heavy lifting of building an executable. Included in the top-level `CMakeLists.txt` of standard ESP-IDF projects.

The rest of the files in `/tools/cmake` are support or third-party scripts used in the build process.

### Build Process

This section describes the standard ESP-IDF application build process. The build process can be broken down roughly into four phases:



Fig. 2: ESP-IDF Build System Process

**Initialization** This phase sets up necessary parameters for the build.

- **Upon inclusion of `idf.cmake` in `project.cmake`, the following steps are performed:**
  - Set `IDF_PATH` from environment variable or inferred from path to `project.cmake` included in the top-level `CMakeLists.txt`.
  - Add `/tools/cmake` to `CMAKE_MODULE_PATH` and include core modules plus the various helper/third-party scripts.
  - Set build tools/executables such as default Python interpreter.
  - Get ESP-IDF git revision and store as `IDF_VER`.
  - Set global build specifications i.e. compile options, compile definitions, include directories for all components in the build.
  - Add components in `components` to the build.
- **The initial part of the custom `project()` command performs the following steps:**
  - Set `IDF_TARGET` from environment variable or CMake cache and the corresponding `CMAKE_TOOLCHAIN_FILE` to be used.
  - Add components in `EXTRA_COMPONENT_DIRS` to the build.
  - Prepare arguments for calling command `idf_build_process()` from variables such as `COMPONENTS/EXCLUDE_COMPONENTS`, `SDKCONFIG`, `SDKCONFIG_DEFAULTS`.

The call to `idf_build_process()` command marks the end of this phase.

### Enumeration

This phase builds a final list of components to be processed in the build, and is performed in the first half of `idf_build_process()`.

- Retrieve each component's public and private requirements. A child process is created which executes each component's `CMakeLists.txt` in script mode. The values of `idf_component_register` `REQUIRES` and `PRIV_REQUIRES` argument is returned to the parent build process. This is called early expansion. The variable `CMAKE_BUILD_EARLY_EXPANSION` is defined during this step.
- Recursively include components based on public and private requirements.

### Processing

This phase processes the components in the build, and is the second half of `idf_build_process()`.

- Load project configuration from `sdkconfig` file and generate an `sdkconfig.cmake` and `sdkconfig.h` header. These define configuration variables/macros that are accessible from the build scripts and C/C++ source/header files, respectively.
- Include each component's `project_include.cmake`.
- Add each component as a subdirectory, processing its `CMakeLists.txt`. The component `CMakeLists.txt` calls the registration command, `idf_component_register` which adds source files, include directories, creates component library, links dependencies, etc.

### Finalization

This phase is everything after `idf_build_process()`.

- Create executable and link the component libraries to it.
- Generate project metadata files such as `project_description.json` and display relevant information about the project built.

Browse </tools/cmake/project.cmake> for more details.

## 4.4.24 Migrating from ESP-IDF GNU Make System

Some aspects of the CMake-based ESP-IDF build system are very similar to the older GNU Make-based system. The developer needs to provide values the include directories, source files etc. There is a syntactical difference, however,

as the developer needs to pass these as arguments to the registration command, `idf_component_register`.

### Automatic Conversion Tool

An automatic project conversion tool is available in `tools/cmake/convert_to_cmake.py` in ESP-IDF v4.x releases. The script was removed in v5.0 because of its `make` build system dependency.

### No Longer Available in CMake

Some features are significantly different or removed in the CMake-based system. The following variables no longer exist in the CMake-based build system:

- `COMPONENT_BUILD_DIR`: Use `CMAKE_CURRENT_BINARY_DIR` instead.
- `COMPONENT_LIBRARY`: Defaulted to `$(COMPONENT_NAME).a`, but the library name could be overridden by the component. The name of the component library can no longer be overridden by the component.
- `CC`, `LD`, `AR`, `OBJCOPY`: Full paths to each tool from the `gcc xtensa` cross-toolchain. Use `CMAKE_C_COMPILER`, `CMAKE_C_LINK_EXECUTABLE`, `CMAKE_OBJCOPY`, etc instead. [Full list here](#).
- `HOSTCC`, `HOSTLD`, `HOSTAR`: Full names of each tool from the host native toolchain. These are no longer provided, external projects should detect any required host toolchain manually.
- `COMPONENT_ADD_LDFLAGS`: Used to override linker flags. Use the CMake [target\\_link\\_libraries](#) command instead.
- `COMPONENT_ADD_LINKER_DEPS`: List of files that linking should depend on. [target\\_link\\_libraries](#) will usually infer these dependencies automatically. For linker scripts, use the provided custom CMake function `target_linker_scripts`.
- `COMPONENT_SUBMODULES`: No longer used, the build system will automatically enumerate all submodules in the ESP-IDF repository.
- `COMPONENT_EXTRA_INCLUDES`: Used to be an alternative to `COMPONENT_PRIV_INCLUDEDIRS` for absolute paths. Use `COMPONENT_PRIV_INCLUDE_DIRS` argument to `idf_component_register` for all cases now (can be relative or absolute).
- `COMPONENT_OBJS`: Previously, component sources could be specified as a list of object files. Now they can be specified as a list of source files via `SRC` argument to `idf_component_register`.
- `COMPONENT_OBJEXCLUDE`: Has been replaced with `EXCLUDE_SRCS` argument to `idf_component_register`. Specify source files (as absolute paths or relative to component directory), instead.
- `COMPONENT_EXTRA_CLEAN`: Set property `ADDITIONAL_CLEAN_FILES` instead but note [CMake has some restrictions around this functionality](#).
- `COMPONENT_OWNBUILDTARGET` & `COMPONENT_OWNCLEANTARGET`: Use CMake [ExternalProject](#) instead. See [Fully Overriding The Component Build Process](#) for full details.
- `COMPONENT_CONFIG_ONLY`: Call `idf_component_register` without any arguments instead. See [Configuration-Only Components](#).
- `CFLAGS`, `CPPFLAGS`, `CXXFLAGS`: Use equivalent CMake commands instead. See [Controlling Component Compilation](#).

### No Default Values

Unlike in the legacy Make-based build system, the following have no default values:

- Source directories (`COMPONENT_SRCDIRS` variable in Make, `SRC_DIRS` argument to `idf_component_register` in CMake)
- Include directories (`COMPONENT_ADD_INCLUDEDIRS` variable in Make, `INCLUDE_DIRS` argument to `idf_component_register` in CMake)

### No Longer Necessary

- In the legacy Make-based build system, it is required to also set `COMPONENT_SRCDIRS` if `COMPONENT_SRCS` is set. In CMake, the equivalent is not necessary i.e. specifying `SRC_DIRS` to

`idf_component_register` if `SRCS` is also specified (in fact, `SRCS` is ignored if `SRC_DIRS` is specified).

### Flashing from make

`make flash` and similar targets still work to build and flash. However, project `sdkconfig` no longer specifies serial port and baud rate. Environment variables can be used to override these. See [Flashing with ninja or make](#) for more details.

## 4.5 Core Dump

### 4.5.1 Overview

ESP-IDF provides support to generate core dumps on unrecoverable software errors. This useful technique allows post-mortem analysis of software state at the moment of failure. Upon the crash system enters panic state, prints some information and halts or reboots depending configuration. User can choose to generate core dump in order to analyse the reason of failure on PC later on. Core dump contains snapshots of all tasks in the system at the moment of failure. Snapshots include tasks control blocks (TCB) and stacks. So it is possible to find out what task, at what instruction (line of code) and what callstack of that task lead to the crash. It is also possible dumping variables content on demand if previously attributed accordingly. ESP-IDF provides special script `espcoredump.py` to help users to retrieve and analyse core dumps. This tool provides two commands for core dumps analysis:

- `info_corefile` - prints crashed task's registers, callstack, list of available tasks in the system, memory regions and contents of memory stored in core dump (TCBs and stacks)
- `dbg_corefile` - creates core dump ELF file and runs GDB debug session with this file. User can examine memory, variables and tasks states manually. Note that since not all memory is saved in core dump only values of variables allocated on stack will be meaningful

For more information about core dump internals see the - [Core dump internals](#)

### 4.5.2 Configurations

There are a number of core dump related configuration options which user can choose in project configuration menu (`idf.py menuconfig`).

#### Core dump data destination (Components -> Core dump -> Data destination)

- Save core dump to Flash (Flash)
- Print core dump to UART (UART)
- Disable core dump generation (None)

#### Core dump data format (Components -> Core dump -> Core dump data format)

- ELF format (Executable and Linkable Format file for core dump)
- Binary format (Basic binary format for core dump)

The ELF format contains extended features and allow to save more information about broken tasks and crashed software but it requires more space in the flash memory. This format of core dump is recommended for new software designs and is flexible enough to extend saved information for future revisions.

The Binary format is kept for compatibility reasons, it uses less space in the memory to keep data and provides better performance.

#### Core dump data integrity check (Components -> Core dump -> Core dump data integrity check)

- Use CRC32 for core dump integrity verification

**Maximum number of tasks snapshots in core dump (Components -> Core dump -> Maximum number of tasks)**

**Delay before core dump is printed to UART (Components -> Core dump -> Delay before print to UART)**

The value is in ms.

**Handling of UART core dumps in IDF Monitor (Components -> Core dump -> Delay before print to UART)**

The value is base64 encoded.

- Decode and show summary (info\_corefile)
- Don't decode

**Reserved stack size (Components -> Core dump -> Reserved stack size)**

Size of the memory to be reserved for core dump stack. If 0 core dump process will run on the stack of crashed task/ISR, otherwise special stack will be allocated. To ensure that core dump itself will not overflow task/ISR stack set this to the value above 800.

### 4.5.3 Save core dump to flash

When this option is selected core dumps are saved to special partition on flash. When using default partition table files which are provided with ESP-IDF it automatically allocates necessary space on flash. But if user wants to use its own layout file together with core dump feature it should define separate partition for core dump as it is shown below:

```
# Name, Type, SubType, Offset, Size
# Note: if you have increased the bootloader size, make sure to update the offsets.
↳to avoid overlap
nvs, data, nvs, 0x9000, 0x6000
phy_init, data, phy, 0xf000, 0x1000
factory, app, factory, 0x10000, 1M
coredump, data, coredump,, 64K
```

There are no special requirements for partition name. It can be chosen according to the user application needs, but partition type should be 'data' and sub-type should be 'coredump'. Also when choosing partition size note that core dump data structure introduces constant overhead of 20 bytes and per-task overhead of 12 bytes. This overhead does not include size of TCB and stack for every task. So partition size should be at least 20 + max tasks number x (12 + TCB size + max task stack size) bytes.

The example of generic command to analyze core dump from flash is:

```
espcoredump.py -p </path/to/serial/port> info_corefile </path/to/program/elf/file>
```

or

```
espcoredump.py -p </path/to/serial/port> dbg_corefile </path/to/program/elf/file>
```

### 4.5.4 Print core dump to UART

When this option is selected base64-encoded core dumps are printed on UART upon system panic. In this case user should save core dump text body to some file manually and then run the following command:

```
espcoredump.py --chip esp32s2 info_corefile -t b64 -c </path/to/saved/base64/text>
↳</path/to/program/elf/file>
```

or

```
espcoredump.py --chip esp32s2 dbg_corefile -t b64 -c </path/to/saved/base64/text>
↳</path/to/program/elf/file>
```

Base64-encoded body of core dump will be between the following header and footer:



```
===== CORE DUMP START =====  
<body of base64-encoded core dump, save it to file on disk>  
===== CORE DUMP END =====
```

The `CORE DUMP START` and `CORE DUMP END` lines must not be included in core dump text file.

### 4.5.5 ROM Functions in Backtraces

It is possible situation that at the moment of crash some tasks or/and crashed task itself have one or more ROM functions in their callstacks. Since ROM is not part of the program ELF it will be impossible for GDB to parse such callstacks, because it tries to analyse functions' prologues to accomplish that. In that case callstack printing will be broken with error message at the first ROM function. To overcome this issue, you can use the [ROM ELF](#) provided by Espressif. You can find the esp32s2' s corresponding ROM ELF file from the list of released archives. The ROM ELF file can then be passed to `espcoredump.py`. More details about ROM ELFs can be found [here](#).

### 4.5.6 Dumping variables on demand

Sometimes you want to read the last value of a variable to understand the root cause of a crash. Core dump supports retrieving variable data over GDB by attributing special notations declared variables.

#### Supported notations and RAM regions

- `COREDUMP_DRAM_ATTR` places variable into DRAM area which will be included into dump.
- `COREDUMP_RTC_ATTR` places variable into RTC area which will be included into dump.
- `COREDUMP_RTC_FAST_ATTR` places variable into RTC\_FAST area which will be included into dump.

#### Example

1. In *Project Configuration Menu*, enable *COREDUMP TO FLASH*, then save and exit.
2. In your project, create a global variable in DRAM area as such as:

```
// uint8_t global_var;  
COREDUMP_DRAM_ATTR uint8_t global_var;
```

3. In main application, set the variable to any value and `assert(0)` to cause a crash.

```
global_var = 25;  
assert(0);
```

4. Build, flash and run the application on a target device and wait for the dumping information.
5. Run the command below to start core dumping in GDB, where `PORT` is the device USB port:

```
espcoredump.py -p PORT dbg_corefile <path/to/elf>
```

6. In GDB shell, type `p global_var` to get the variable content:

```
(gdb) p global_var  
$1 = 25 '\031'
```

### 4.5.7 Running `espcoredump.py`

Generic command syntax: `espcoredump.py [options] command [args]`



### Script Options

- chip** {*auto,esp32,esp32s2,esp32s3,esp32c2,esp32c3*} Target chip type. Default value is “auto”
- port** *PORT*, **-p** *PORT* Serial port device. Either “chip” or “port” need to be specified to determine the port when you have multi-target connected at the same time.
- baud** *BAUD*, **-b** *BAUD* Serial port baud rate used when flashing/reading
- gdb-timeout-sec** *GDB\_TIMEOUT\_SEC* Overwrite the default internal delay for gdb responses

**Commands** **dbg\_corefile** Starts GDB debugging session with specified corefile

**info\_corefile** Print core dump info from file

### Command Arguments

- debug** *DEBUG*, **-d** *DEBUG* Log level (0..3)
- gdb** *GDB*, **-g** *GDB* Path to gdb
- core** *CORE*, **-c** *CORE* Path to core dump file (if skipped core dump will be read from flash)
- core-format** {*b64,elf,raw*}, **-t** {*b64,elf,raw*} File specified with “-c” is an ELF ( “elf” ), raw (raw) or base64-encoded (b64) binary
- off** *OFF*, **-o** *OFF* Offset of core dump partition in flash (type “idf.py partition-table” to see).
- save-core** *SAVE\_CORE*, **-s** *SAVE\_CORE* Save core to file. Otherwise temporary core file will be deleted. Does not work with “-c”
- rom-elf** *ROM\_ELF*, **-r** *ROM\_ELF* Path to ROM ELF file. Will use “<target>\_rom.elf” if not specified
- print-mem**, **-m** Print memory dump. Only valid when info\_corefile.
- <prog>** Path to program ELF file.

### Related Documents

**Anatomy of core dump image** Core dump component can be configured to use old legacy binary format or the new ELF one. The ELF format is recommended for new designs. It provides more information about the CPU and memory state of a program at the moment when panic handler is entered. The memory state embeds a snapshot of all tasks mapped in the memory space of the program. The CPU state contains register values when the core dump has been generated. Core dump file uses a subset of the ELF structures to register these information. Loadable ELF segments are used for the memory state of the process while ELF notes (ELF.PT\_NOTE) are used for process metadata (pid, registers, signal, ...). Especially, the CPU status is stored in a note with a special name and type (CORE, NT\_PRSTATUS type).

Here is an overview of core dump layout:

Note: The format of image file showed on the above pictures represents current version of image and can be changed in future releases.

**Overview of implementation** The figure below describes some basic aspects related to implementation of core dump:

Note: The diagram above hide some details and represents current implementation of the core dump and can be changed later.

## 4.6 Deep Sleep Wake Stubs

ESP32-S2 supports running a “deep sleep wake stub” when coming out of deep sleep. This function runs immediately as soon as the chip wakes up - before any normal initialisation, bootloader, or ESP-IDF code has run. After the wake stub runs, the SoC can go back to sleep or continue to start ESP-IDF normally.

Deep sleep wake stub code is loaded into “RTC Fast Memory” and any data which it uses must also be loaded into RTC memory. RTC memory regions hold their contents during deep sleep.

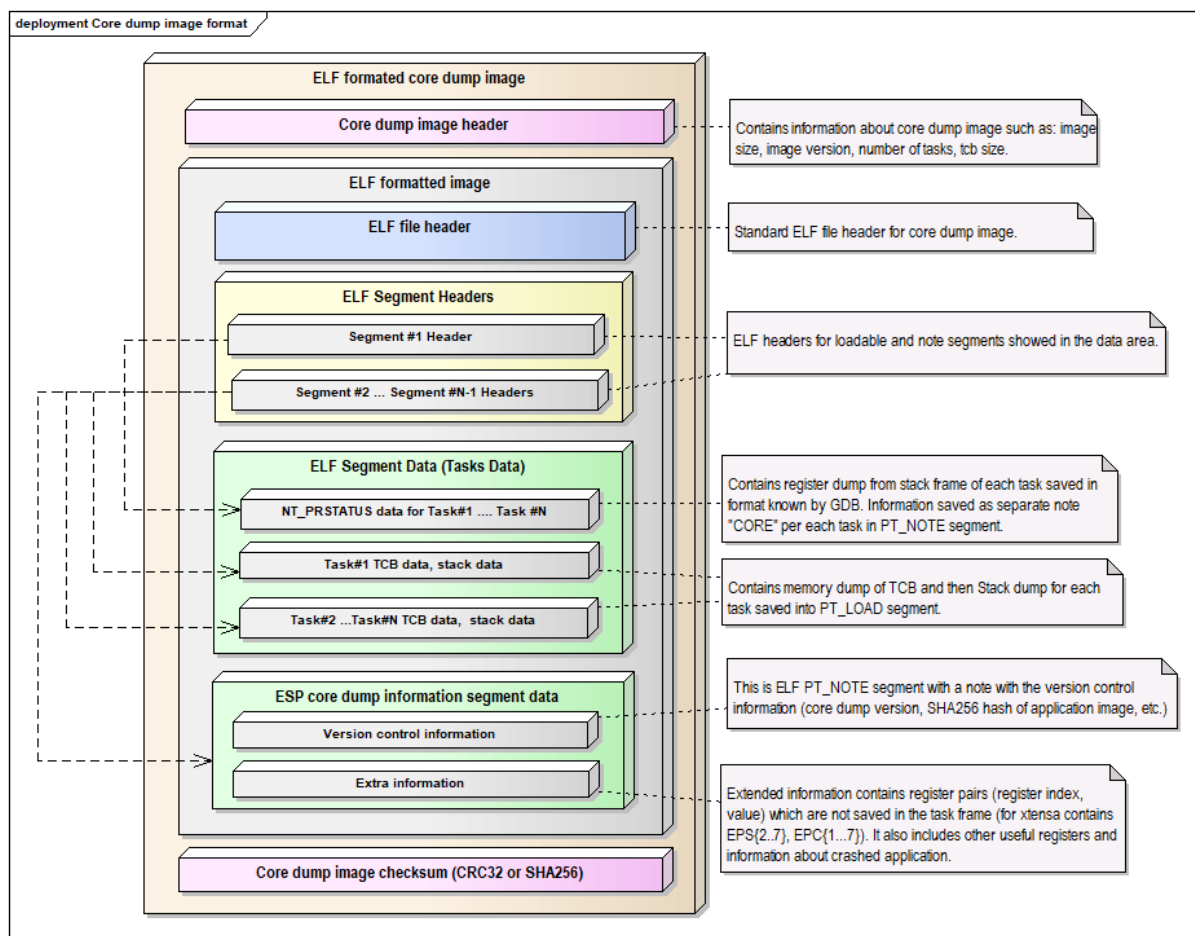

Fig. 3: Core dump ELF image format

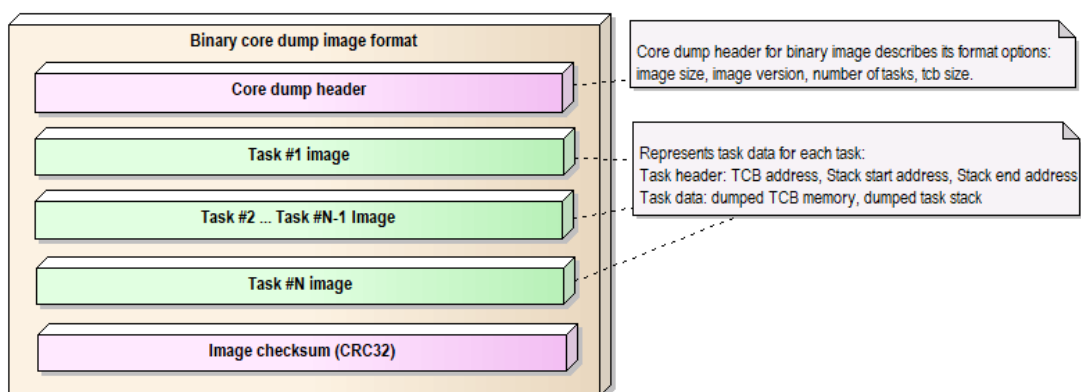

Fig. 4: Core dump binary image format

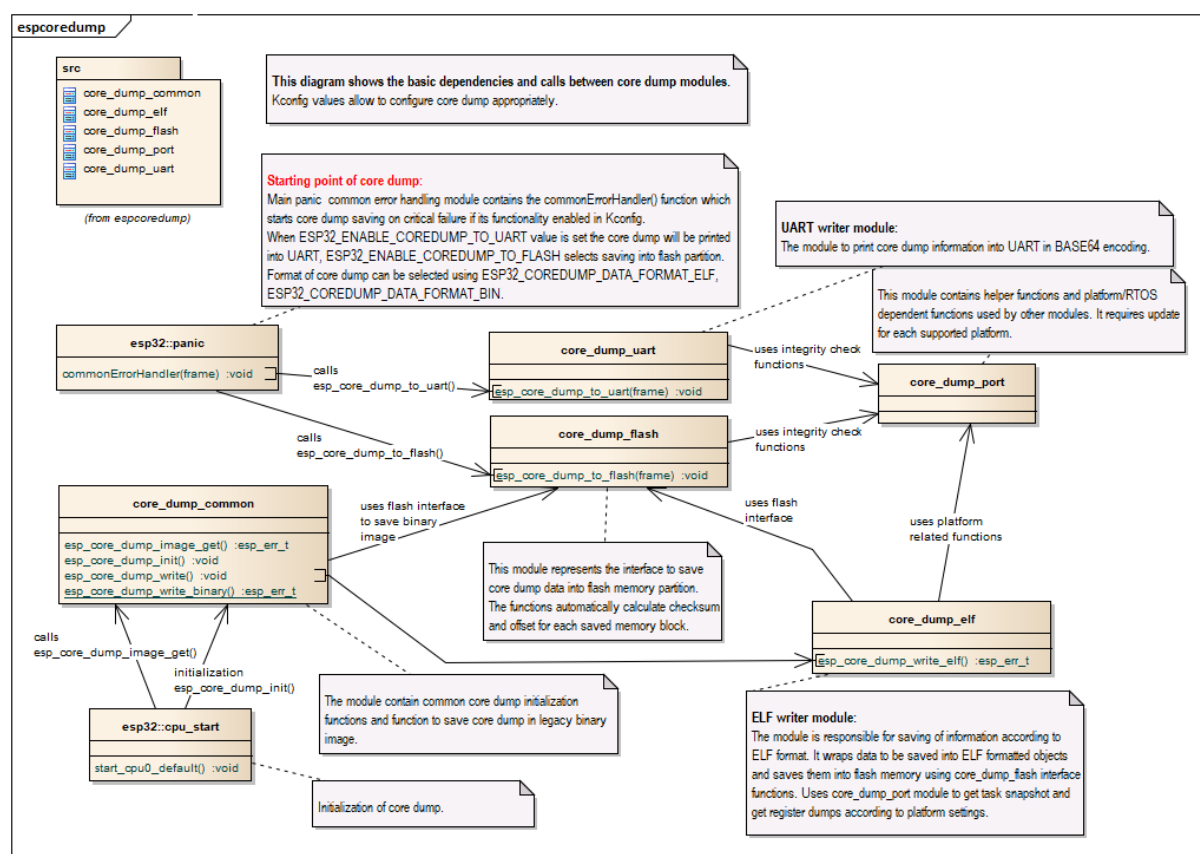

Fig. 5: Core dump implementation overview

## 4.6.1 Rules for Wake Stubs

Wake stub code must be carefully written:

- As the SoC has freshly woken from sleep, most of the peripherals are in reset states. The SPI flash is unmapped.
- The wake stub code can only call functions implemented in ROM or loaded into RTC Fast Memory (see below.)
- The wake stub code can only access data loaded in RTC memory. All other RAM will be uninitialised and have random contents. The wake stub can use other RAM for temporary storage, but the contents will be overwritten when the SoC goes back to sleep or starts ESP-IDF.
- RTC memory must include any read-only data (.rodata) used by the stub.
- Data in RTC memory is initialised whenever the SoC restarts, except when waking from deep sleep. When waking from deep sleep, the values which were present before going to sleep are kept.
- Wake stub code is a part of the main esp-idf app. During normal running of esp-idf, functions can call the wake stub functions or access RTC memory. It is as if these were regular parts of the app.

## 4.6.2 Implementing A Stub

The wake stub in esp-idf is called `esp_wake_deep_sleep()`. This function runs whenever the SoC wakes from deep sleep. There is a default version of this function provided in esp-idf, but the default function is weak-linked so if your app contains a function named `esp_wake_deep_sleep()` then this will override the default.

If supplying a custom wake stub, the first thing it does should be to call `esp_default_wake_deep_sleep()`.

It is not necessary to implement `esp_wake_deep_sleep()` in your app in order to use deep sleep. It is only necessary if you want to have special behaviour immediately on wake.

If you want to swap between different deep sleep stubs at runtime, it is also possible to do this by calling the `esp_set_deep_sleep_wake_stub()` function. This is not necessary if you only use the default `esp_wake_deep_sleep()` function.

All of these functions are declared in the `esp_sleep.h` header under `components/esp32s2`.

### 4.6.3 Loading Code Into RTC Memory

Wake stub code must be resident in RTC Fast Memory. This can be done in one of two ways.

The first way is to use the `RTC_IRAM_ATTR` attribute to place a function into RTC memory:

```
void RTC_IRAM_ATTR esp_wake_deep_sleep(void) {
    esp_default_wake_deep_sleep();
    // Add additional functionality here
}
```

The second way is to place the function into any source file whose name starts with `rtc_wake_stub`. Files names `rtc_wake_stub*` have their contents automatically put into RTC memory by the linker.

The first way is simpler for very short and simple code, or for source files where you want to mix “normal” and “RTC” code. The second way is simpler when you want to write longer pieces of code for RTC memory.

### 4.6.4 Loading Data Into RTC Memory

Data used by stub code must be resident in RTC memory.

The data can be placed in RTC Fast memory or in RTC Slow memory which is also used by the ULP.

Specifying this data can be done in one of two ways:

The first way is to use the `RTC_DATA_ATTR` and `RTC_RODATA_ATTR` to specify any data (writeable or read-only, respectively) which should be loaded into RTC memory:

```
RTC_DATA_ATTR int wake_count;

void RTC_IRAM_ATTR esp_wake_deep_sleep(void) {
    esp_default_wake_deep_sleep();
    static RTC_RODATA_ATTR const char fmt_str[] = "Wake count %d\n";
    esp_rom_printf(fmt_str, wake_count++);
}
```

The RTC memory area where this data will be placed can be configured via menuconfig option named `CONFIG_ESP32S2_RTCDATA_IN_FAST_MEM`. This option allows to keep slow memory area for ULP programs and once it is enabled the data marked with `RTC_DATA_ATTR` and `RTC_RODATA_ATTR` are placed in the RTC fast memory segment otherwise it goes to RTC slow memory (default option). This option depends on the `CONFIG_FREERTOS_UNICORE` because RTC fast memory can be accessed only by `PRO_CPU`.

The attributes `RTC_FAST_ATTR` and `RTC_SLOW_ATTR` can be used to specify data that will be force placed into `RTC_FAST` and `RTC_SLOW` memory respectively. Any access to data marked with `RTC_FAST_ATTR` is allowed by `PRO_CPU` only and it is responsibility of user to make sure about it.

Unfortunately, any string constants used in this way must be declared as arrays and marked with `RTC_RODATA_ATTR`, as shown in the example above.

The second way is to place the data into any source file whose name starts with `rtc_wake_stub`.

For example, the equivalent example in `rtc_wake_stub_counter.c`:

```
int wake_count;

void RTC_IRAM_ATTR esp_wake_deep_sleep(void) {
    esp_default_wake_deep_sleep();
    esp_rom_printf("Wake count %d\n", wake_count++);
}
```

The second way is a better option if you need to use strings, or write other more complex code.

To reduce wake-up time use the `CONFIG_BOOTLOADER_SKIP_VALIDATE_IN_DEEP_SLEEP` Kconfig option, see more information in [Fast boot from Deep Sleep](#).

### 4.6.5 CRC Check For Wake Stubs

During deep sleep, all RTC Fast memory areas will be validated with CRC. When ESP32-S2 wakes up from deep sleep, the RTC fast memory will be validated with CRC again. If the validation passes, the wake stubs code will be executed. Otherwise, the normal initialization, bootloader and esp-idf codes will be executed.

---

**Note:** When the `CONFIG_ESP_SYSTEM_ALLOW_RTC_FAST_MEM_AS_HEAP` option is enabled, all the RTC fast memory except the wake stubs area is added to the heap.

---

### 4.6.6 Example

ESP-IDF provides an example to show how to implement the Deep-sleep wake stub.

- [system/deep\\_sleep\\_wake\\_stub](#)

## 4.7 Device Firmware Upgrade via USB

Typically, the firmware of the ESP32-S2 is flashed via the chip's serial port. However, flashing via the serial port requires a USB to serial converter chip (e.g., CP210x or FTDI) to be connected to the ESP32-S2 (see [Establish Serial Connection with ESP32-S2](#) for more details). The ESP32-S2 contains a USB OTG peripheral making it possible to connect the ESP32-S2 to the host directly via USB (thus not requiring a USB to serial converter chip).

Device Firmware Upgrade (DFU) is a mechanism for upgrading the firmware of the ESP32-S2 directly via the Universal Serial Bus (USB).

- [Software](#) of the Getting Started Guide introduces the software requirements of DFU.
- Section [Building the DFU Image](#) describes how to build firmware for DFU with ESP-IDF.
- Section [Flashing the DFU Image](#) deals with flashing the firmware.

### 4.7.1 USB Connection

The necessary connections for the ESP32-S2's internal USB PHY (transceiver) are shown in the following table:

GPIO	USB
20	D+ (green)
19	D- (white)
GND	GND (black)
+5V	+5V (red)

**Warning:** Some cables are wired up with non-standard colors and some drivers are able to work with swapped D+ and D- connections. Please try to swap the cables connecting to D+ and D- if your device is not detected.

**Note:** The ESP32-S2 chip needs to be in bootloader mode before it can be detected as a DFU device and flash. This can be achieved by pulling GPIO0 down (e.g., pressing the BOOT button), pulling RESET down for a moment, and releasing GPIO0.

---

## 4.8 Building the DFU Image

The command below will create a DFU image named `dfu.bin` that is placed in the project's `build` directory:

```
idf.py dfu
```

**Note:** Do not forget to set the target chip by `idf.py set-target` before running `idf.py dfu`. Otherwise, you might create an image for a different chip or receive an error message like `unknown target 'dfu'`.

---

## 4.9 Flashing the DFU Image

The command below will download the DFU image into the ESP32-S2:

```
idf.py dfu-flash
```

The command relies on `dfu-util`. Please see [Software](#) for installing `dfu-util`. `dfu-util` needs additional setup for [USB Drivers \(Windows only\)](#) or setting up an [Udev Rule \(Linux only\)](#). macOS users should be able to use `dfu-util` without further setup.

If there are more boards with the same chip connected then `idf.py dfu-list` can be used to list the available devices, for example:

```
Found Runtime: [303a:0002] ver=0723, devnum=4, cfg=1, intf=2, path="1-10", alt=0, ␣  
↳name="UNKNOWN", serial="0"  
Found Runtime: [303a:0002] ver=0723, devnum=6, cfg=1, intf=2, path="1-2", alt=0, ␣  
↳name="UNKNOWN", serial="0"
```

Consequently, the desired device can be selected for flashing by the `--path` argument. For example, the devices listed above can be flashed individually by the following commands:

```
idf.py dfu-flash --path 1-10  
idf.py dfu-flash --path 1-2
```

**Note:** The vendor and product identifiers are set based on the selected chip target by the `idf.py set-target` command and they are not selectable during the `idf.py dfu-flash` call.

---

See [Common Errors and Known Issues](#) and their solutions.

### 4.9.1 Udev Rule (Linux only)

Udev is a device manager for the Linux kernel. It allows us to run `dfu-util` (and `idf.py dfu-flash`) without `sudo` for gaining access to the chip.

Create file `/etc/udev/rules.d/40-dfuse.rules` with the following content:

```
SUBSYSTEMS=="usb", ATTRS{idVendor}=="303a", ATTRS{idProduct}=="00??", GROUP=  
↳"plugdev", MODE="0666"
```

---

**Note:** Please check the output of the command `groups`. The user has to be a member of the *GROUP* specified above. You may use some other existing groups for this purpose (e.g., *uucp* on some systems instead of *plugdev*) or create a new group for this purpose.

---

Restart your computer so the previous setting could take into affect or run `sudo udevadm trigger` to force manually udev to trigger your new rule.

## 4.9.2 USB Drivers (Windows only)

`dfu-util` uses *libusb* to access the device. You have to register on Windows the device with the *WinUSB* driver.

Please see the [libusb wiki](#) for more details.

The drivers can be installed by the [Zadig tool](#). Please make sure that the device is in download mode before you run the tool and that it detects the ESP32-S2 device before you install the drivers. The Zadig tool might detect several USB interfaces of ESP32-S2. Please install the WinUSB driver only for the interface where there is no driver installed (probably it is Interface 2) and do not re-install the driver for the other interface.

**Warning:** The manual installation of the driver in Device Manager of Windows is not recommended because the flashing might not work properly.

## 4.9.3 Common Errors and Known Issues

- `dfu-util: command not found` might indicate that the tool hasn't been installed or is not available from the terminal. An easy way of checking the tool is running `dfu-util --version`. Please see [Software](#) for installing `dfu-util`.
- The reason for No DFU capable USB device available could be that the USB driver wasn't properly installed on Windows (see [USB Drivers \(Windows only\)](#)), udev rule was not setup on Linux (see [Udev Rule \(Linux only\)](#)) or the device isn't in bootloader mode.
- Flashing with `dfu-util` on Windows fails on the first attempt with error `Lost device after RESET?`. Please retry the flashing and it should succeed the next time.

## 4.10 Error Handling

### 4.10.1 Overview

Identifying and handling run-time errors is important for developing robust applications. There can be multiple kinds of run-time errors:

- Recoverable errors:
  - Errors indicated by functions through return values (error codes)
  - C++ exceptions, thrown using `throw` keyword
- Unrecoverable (fatal) errors:
  - Failed assertions (using `assert` macro and equivalent methods, see [Assertions](#)) and `abort()` calls.
  - CPU exceptions: access to protected regions of memory, illegal instruction, etc.
  - System level checks: watchdog timeout, cache access error, stack overflow, stack smashing, heap corruption, etc.

This guide explains ESP-IDF error handling mechanisms related to recoverable errors, and provides some common error handling patterns.



For instructions on diagnosing unrecoverable errors, see *Fatal Errors*.

## 4.10.2 Error codes

The majority of ESP-IDF-specific functions use `esp_err_t` type to return error codes. `esp_err_t` is a signed integer type. Success (no error) is indicated with `ESP_OK` code, which is defined as zero.

Various ESP-IDF header files define possible error codes using preprocessor defines. Usually these defines start with `ESP_ERR_` prefix. Common error codes for generic failures (out of memory, timeout, invalid argument, etc.) are defined in `esp_err.h` file. Various components in ESP-IDF may define additional error codes for specific situations.

For the complete list of error codes, see *Error Code Reference*.

## 4.10.3 Converting error codes to error messages

For each error code defined in ESP-IDF components, `esp_err_t` value can be converted to an error code name using `esp_err_to_name()` or `esp_err_to_name_r()` functions. For example, passing `0x101` to `esp_err_to_name()` will return “ESP\_ERR\_NO\_MEM” string. Such strings can be used in log output to make it easier to understand which error has happened.

Additionally, `esp_err_to_name_r()` function will attempt to interpret the error code as a **standard POSIX error code**, if no matching `ESP_ERR_` value is found. This is done using `strerror_r` function. POSIX error codes (such as `ENOENT`, `ENOMEM`) are defined in `errno.h` and are typically obtained from `errno` variable. In ESP-IDF this variable is thread-local: multiple FreeRTOS tasks have their own copies of `errno`. Functions which set `errno` only modify its value for the task they run in.

This feature is enabled by default, but can be disabled to reduce application binary size. See *CONFIG\_ESP\_ERR\_TO\_NAME\_LOOKUP*. When this feature is disabled, `esp_err_to_name()` and `esp_err_to_name_r()` are still defined and can be called. In this case, `esp_err_to_name()` will return `UNKNOWN_ERROR`, and `esp_err_to_name_r()` will return `Unknown error 0xXXXX(YYYY)`, where `0xXXXX` and `YYYY` are the hexadecimal and decimal representations of the error code, respectively.

## 4.10.4 ESP\_ERROR\_CHECK macro

`ESP_ERROR_CHECK` macro serves similar purpose as `assert`, except that it checks `esp_err_t` value rather than a `bool` condition. If the argument of `ESP_ERROR_CHECK` is not equal `ESP_OK`, then an error message is printed on the console, and `abort()` is called.

Error message will typically look like this:

```
ESP_ERROR_CHECK failed: esp_err_t 0x107 (ESP_ERR_TIMEOUT) at 0x400d1fdf
file: "/Users/user/esp/example/main/main.c" line 20
func: app_main
expression: sdmmc_card_init(host, &card)

Backtrace: 0x40086e7c:0x3ffb4ff0 0x40087328:0x3ffb5010 0x400d1fdf:0x3ffb5030_
↳0x400d0816:0x3ffb5050
```

**Note:** If *IDF monitor* is used, addresses in the backtrace will be converted to file names and line numbers.

- The first line mentions the error code as a hexadecimal value, and the identifier used for this error in source code. The latter depends on *CONFIG\_ESP\_ERR\_TO\_NAME\_LOOKUP* option being set. Address in the program where error has occurred is printed as well.
- Subsequent lines show the location in the program where `ESP_ERROR_CHECK` macro was called, and the expression which was passed to the macro as an argument.



- Finally, backtrace is printed. This is part of panic handler output common to all fatal errors. See [Fatal Errors](#) for more information about the backtrace.

#### 4.10.5 ESP\_ERROR\_CHECK\_WITHOUT\_ABORT macro

`ESP_ERROR_CHECK_WITHOUT_ABORT` macro serves similar purpose as `ESP_ERROR_CHECK`, except that it won't call `abort()`.

#### 4.10.6 ESP\_RETURN\_ON\_ERROR macro

`ESP_RETURN_ON_ERROR` macro checks the error code, if the error code is not equal `ESP_OK`, it prints the message and returns.

#### 4.10.7 ESP\_GOTO\_ON\_ERROR macro

`ESP_GOTO_ON_ERROR` macro checks the error code, if the error code is not equal `ESP_OK`, it prints the message, sets the local variable `ret` to the code, and then exits by jumping to `goto_tag`.

#### 4.10.8 ESP\_RETURN\_ON\_FALSE macro

`ESP_RETURN_ON_FALSE` macro checks the condition, if the condition is not equal `true`, it prints the message and returns with the supplied `err_code`.

#### 4.10.9 ESP\_GOTO\_ON\_FALSE macro

`ESP_GOTO_ON_FALSE` macro checks the condition, if the condition is not equal `true`, it prints the message, sets the local variable `ret` to the supplied `err_code`, and then exits by jumping to `goto_tag`.

#### 4.10.10 CHECK MACROS Examples

Some examples:

```
static const char* TAG = "Test";

esp_err_t test_func(void)
{
    esp_err_t ret = ESP_OK;

    ESP_ERROR_CHECK(x); // err message_
    ↪printed if `x` is not `ESP_OK`, and then `abort()`.
    ESP_ERROR_CHECK_WITHOUT_ABORT(x); // err message_
    ↪printed if `x` is not `ESP_OK`, without `abort()`.
    ESP_RETURN_ON_ERROR(x, TAG, "fail reason 1"); // err message_
    ↪printed if `x` is not `ESP_OK`, and then function returns with code `x`.
    ESP_GOTO_ON_ERROR(x, err, TAG, "fail reason 2"); // err message_
    ↪printed if `x` is not `ESP_OK`, `ret` is set to `x`, and then jumps to `err`.
    ESP_RETURN_ON_FALSE(a, err_code, TAG, "fail reason 3"); // err message_
    ↪printed if `a` is not `true`, and then function returns with code `err_code`.
    ESP_GOTO_ON_FALSE(a, err_code, err, TAG, "fail reason 4"); // err message_
    ↪printed if `a` is not `true`, `ret` is set to `err_code`, and then jumps to_
    ↪`err`.

err:
    // clean up
```

(continues on next page)

```

return ret;
}

```

**Note:** If the option `CONFIG_COMPILER_OPTIMIZATION_CHECKS_SILENT` in Kconfig is enabled, the err message will be discarded, while the other action works as is.

The `ESP_RETURN_XX` and `ESP_GOTO_XX` macros can't be called from ISR. While there are `XX_ISR` versions for each of them, e.g., `ESP_RETURN_ON_ERROR_ISR`, these macros could be used in ISR.

### 4.10.11 Error handling patterns

1. Attempt to recover. Depending on the situation, we may try the following methods:
  - retry the call after some time;
  - attempt to de-initialize the driver and re-initialize it again;
  - fix the error condition using an out-of-band mechanism (e.g reset an external peripheral which is not responding).

Example:

```

esp_err_t err;
do {
    err = sdio_slave_send_queue(addr, len, arg, timeout);
    // keep retrying while the sending queue is full
} while (err == ESP_ERR_TIMEOUT);
if (err != ESP_OK) {
    // handle other errors
}

```

2. Propagate the error to the caller. In some middleware components this means that a function must exit with the same error code, making sure any resource allocations are rolled back.

Example:

```

sdmmc_card_t* card = calloc(1, sizeof(sdmmc_card_t));
if (card == NULL) {
    return ESP_ERR_NO_MEM;
}
esp_err_t err = sdmmc_card_init(host, &card);
if (err != ESP_OK) {
    // Clean up
    free(card);
    // Propagate the error to the upper layer (e.g. to notify the user).
    // Alternatively, application can define and return custom error code.
    return err;
}

```

3. Convert into unrecoverable error, for example using `ESP_ERROR_CHECK`. See [ESP\\_ERROR\\_CHECK macro](#) section for details.

Terminating the application in case of an error is usually undesirable behavior for middleware components, but is sometimes acceptable at application level.

Many ESP-IDF examples use `ESP_ERROR_CHECK` to handle errors from various APIs. This is not the best practice for applications, and is done to make example code more concise.

Example:

```

ESP_ERROR_CHECK(spi_bus_initialize(host, bus_config, dma_chan));

```

## 4.10.12 C++ Exceptions

Support for C++ Exceptions in ESP-IDF is disabled by default, but can be enabled using [CONFIG\\_COMPILER\\_CXX\\_EXCEPTIONS](#) option.

Enabling exception handling normally increases application binary size by a few KB. Additionally it may be necessary to reserve some amount of RAM for exception emergency pool. Memory from this pool will be used if it is not possible to allocate exception object from the heap. Amount of memory in the emergency pool can be set using [CONFIG\\_COMPILER\\_CXX\\_EXCEPTIONS\\_EMG\\_POOL\\_SIZE](#) variable.

If an exception is thrown, but there is no `catch` block, the program will be terminated by `abort` function, and backtrace will be printed. See [Fatal Errors](#) for more information about backtraces.

See [cxx/exceptions](#) for an example of C++ exception handling.

## 4.11 ESP-WIFI-MESH

This guide provides information regarding the ESP-WIFI-MESH protocol. Please see the [ESP-WIFI-MESH API Reference](#) for more information about API usage.

### 4.11.1 Overview

ESP-WIFI-MESH is a networking protocol built atop the Wi-Fi protocol. ESP-WIFI-MESH allows numerous devices (henceforth referred to as nodes) spread over a large physical area (both indoors and outdoors) to be interconnected under a single WLAN (Wireless Local-Area Network). ESP-WIFI-MESH is self-organizing and self-healing meaning the network can be built and maintained autonomously.

The ESP-WIFI-MESH guide is split into the following sections:

1. [Introduction](#)
2. [ESP-WIFI-MESH Concepts](#)
3. [Building a Network](#)
4. [Managing a Network](#)
5. [Data Transmission](#)
6. [Channel Switching](#)
7. [Performance](#)
8. [Further Notes](#)

### 4.11.2 Introduction

A traditional infrastructure Wi-Fi network is a point-to-multipoint network where a single central node known as the access point (AP) is directly connected to all other nodes known as stations. The AP is responsible for arbitrating and forwarding transmissions between the stations. Some APs also relay transmissions to/from an external IP network via a router. Traditional infrastructure Wi-Fi networks suffer the disadvantage of limited coverage area due to the requirement that every station must be in range to directly connect with the AP. Furthermore, traditional Wi-Fi networks are susceptible to overloading as the maximum number of stations permitted in the network is limited by the capacity of the AP.

ESP-WIFI-MESH differs from traditional infrastructure Wi-Fi networks in that nodes are not required to connect to a central node. Instead, nodes are permitted to connect with neighboring nodes. Nodes are mutually responsible for relaying each others transmissions. This allows an ESP-WIFI-MESH network to have much greater coverage area as nodes can still achieve interconnectivity without needing to be in range of the central node. Likewise, ESP-WIFI-MESH is also less susceptible to overloading as the number of nodes permitted on the network is no longer limited by a single central node.

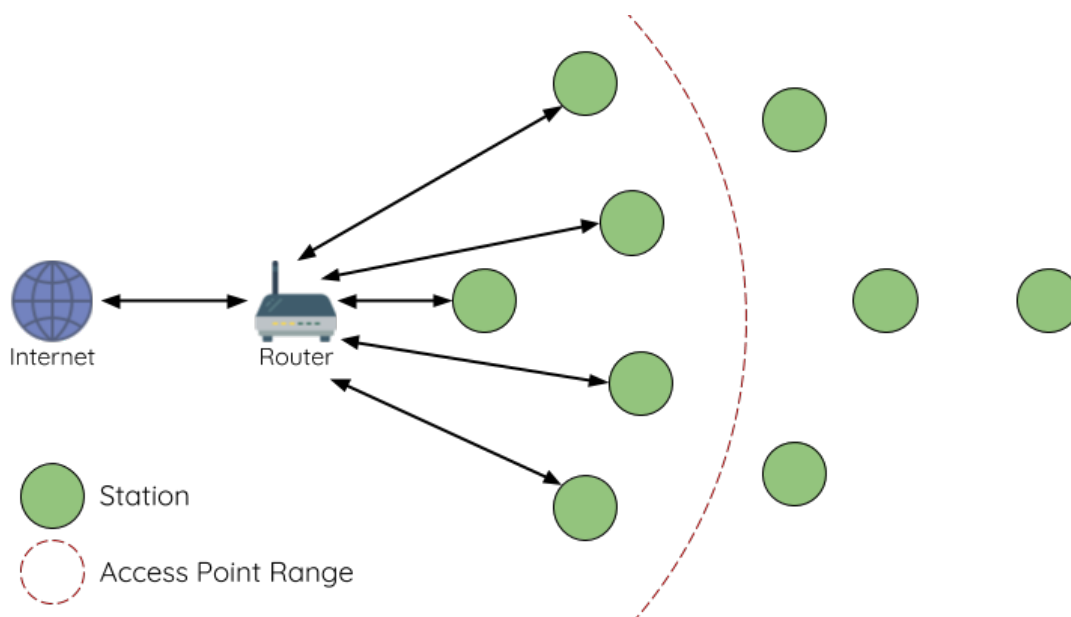

Fig. 6: Traditional Wi-Fi Network Architecture

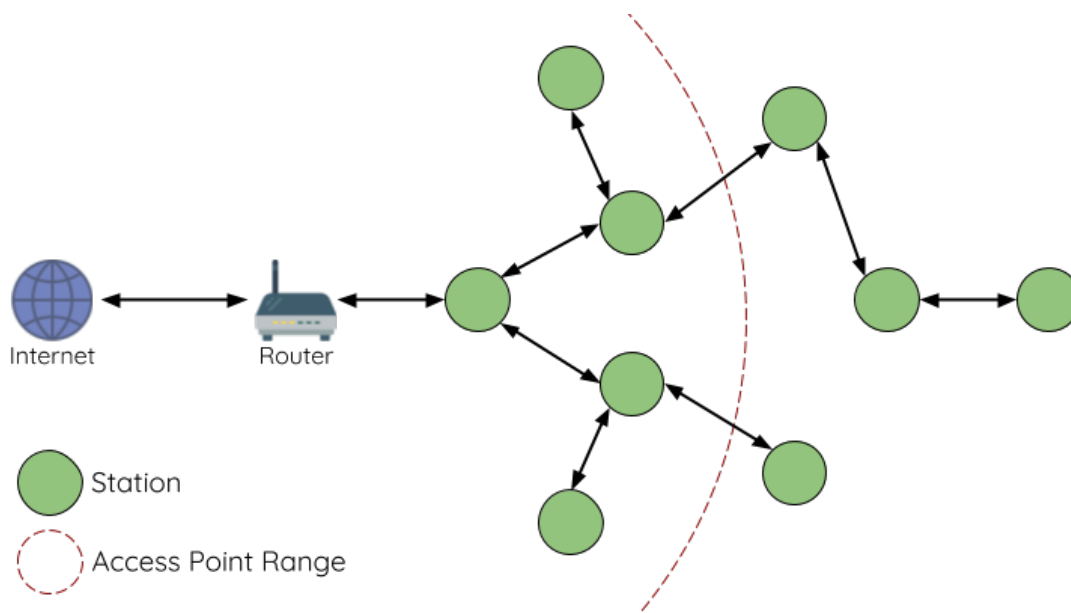

Fig. 7: ESP-WIFI-MESH Network Architecture

### 4.11.3 ESP-WIFI-MESH Concepts

#### Terminology

Term	Description
Node	Any device that <b>is</b> or <b>can be</b> part of an ESP-WIFI-MESH network
Root Node	The top node in the network
Child Node	A node X is a child node when it is connected to another node Y where the connection makes node X more distant from the root node than node Y (in terms of number of connections).
Parent Node	The converse notion of a child node
Descendant Node	Any node reachable by repeated proceeding from parent to child
Sibling Nodes	Nodes that share the same parent node
Connection	A traditional Wi-Fi association between an AP and a station. A node in ESP-WIFI-MESH will use its station interface to associate with the softAP interface of another node, thus forming a connection. The connection process includes the authentication and association processes in Wi-Fi.
Upstream Connection	The connection from a node to its parent node
Downstream Connection	The connection from a node to one of its child nodes
Wireless Hop	The portion of the path between source and destination nodes that corresponds to a single wireless connection. A data packet that traverses a single connection is known as <b>single-hop</b> whereas traversing multiple connections is known as <b>multi-hop</b> .
Subnetwork	A subnetwork is subdivision of an ESP-WIFI-MESH network which consists of a node and all of its descendant nodes. Therefore the subnetwork of the root node consists of all nodes in an ESP-WIFI-MESH network.
MAC Address	Media Access Control Address used to uniquely identify each node or router within an ESP-WIFI-MESH network.
DS	Distribution System (External IP Network)

#### Tree Topology

ESP-WIFI-MESH is built atop the infrastructure Wi-Fi protocol and can be thought of as a networking protocol that combines many individual Wi-Fi networks into a single WLAN. In Wi-Fi, stations are limited to a single connection with an AP (upstream connection) at any time, whilst an AP can be simultaneously connected to multiple stations (downstream connections). However ESP-WIFI-MESH allows nodes to simultaneously act as a station and an AP. Therefore a node in ESP-WIFI-MESH can have **multiple downstream connections using its softAP interface**, whilst simultaneously having **a single upstream connection using its station interface**. This naturally results in a tree network topology with a parent-child hierarchy consisting of multiple layers.

ESP-WIFI-MESH is a multiple hop (multi-hop) network meaning nodes can transmit packets to other nodes in the network through one or more wireless hops. Therefore, nodes in ESP-WIFI-MESH not only transmit their own packets, but simultaneously serve as relays for other nodes. Provided that a path exists between any two nodes on the physical layer (via one or more wireless hops), any pair of nodes within an ESP-WIFI-MESH network can communicate.

---

**Note:** The size (total number of nodes) in an ESP-WIFI-MESH network is dependent on the maximum number of layers permitted in the network, and the maximum number of downstream connections each node can have. Both of these variables can be configured to limit the size of the network.

---

#### Node Types

**Root Node:** The root node is the top node in the network and serves as the only interface between the ESP-WIFI-MESH network and an external IP network. The root node is connected to a conventional Wi-Fi router and relays packets to/from the external IP network to nodes within the ESP-WIFI-MESH network. **There can only be one**

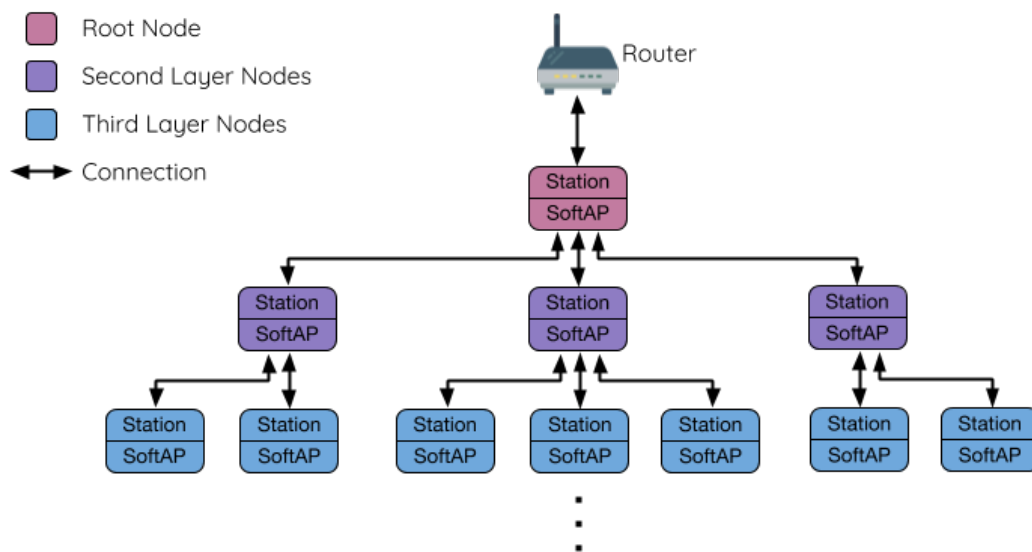

Fig. 8: ESP-WIFI-MESH Tree Topology

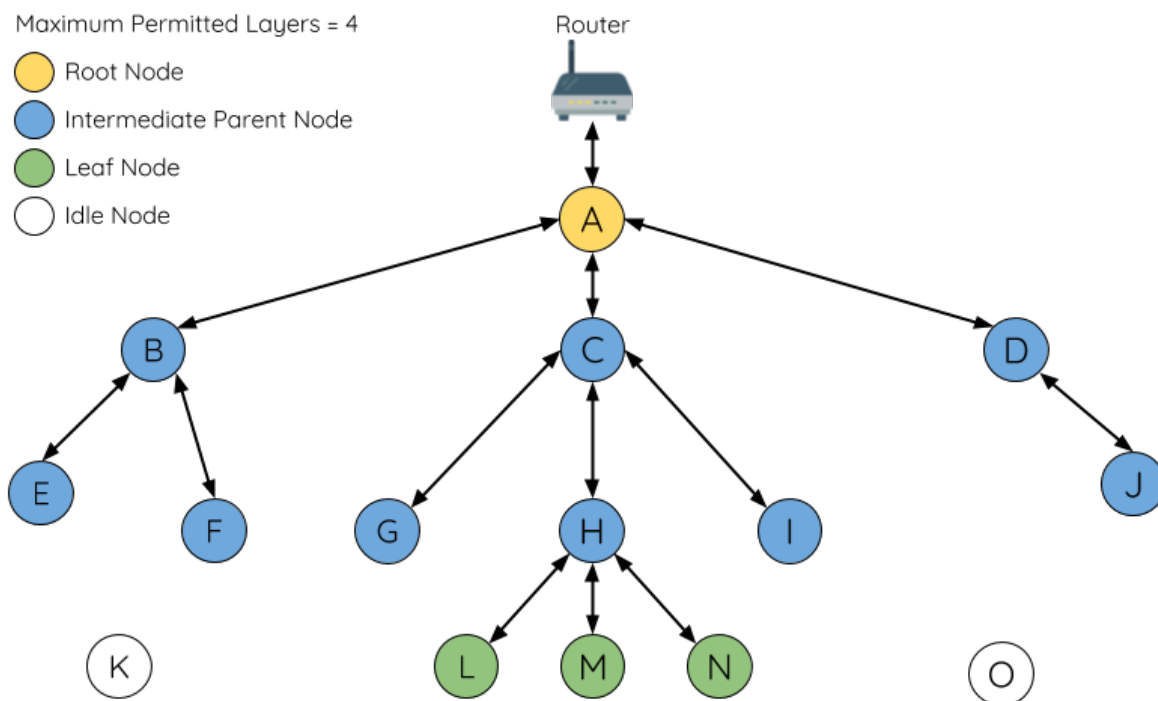

Fig. 9: ESP-WIFI-MESH Node Types

**root node within an ESP-WIFI-MESH network** and the root node's upstream connection may only be with the router. Referring to the diagram above, node A is the root node of the network.

**Leaf Nodes:** A leaf node is a node that is not permitted to have any child nodes (no downstream connections). Therefore a leaf node can only transmit or receive its own packets, but cannot forward the packets of other nodes. If a node is situated on the network's maximum permitted layer, it will be assigned as a leaf node. This prevents the node from forming any downstream connections thus ensuring the network does not add an extra layer. Some nodes without a softAP interface (station only) will also be assigned as leaf nodes due to the requirement of a softAP interface for any downstream connections. Referring to the diagram above, nodes L/M/N are situated on the network's maximum permitted layer hence have been assigned as leaf nodes.

**Intermediate Parent Nodes:** Connected nodes that are neither the root node or a leaf node are intermediate parent nodes. An intermediate parent node must have a single upstream connection (a single parent node), but can have zero to multiple downstream connections (zero to multiple child nodes). Therefore an intermediate parent node can transmit and receive packets, but also forward packets sent from its upstream and downstream connections. Referring to the diagram above, nodes B to J are intermediate parent nodes. **Intermediate parent nodes without downstream connections such as nodes E/F/G/I/J are not equivalent to leaf nodes** as they are still permitted to form downstream connections in the future.

**Idle Nodes:** Nodes that have yet to join the network are assigned as idle nodes. Idle nodes will attempt to form an upstream connection with an intermediate parent node or attempt to become the root node under the correct circumstances (see [Automatic Root Node Selection](#)). Referring to the diagram above, nodes K and O are idle nodes.

### Beacon Frames & RSSI Thresholding

Every node in ESP-WIFI-MESH that is able to form downstream connections (i.e. has a softAP interface) will periodically transmit Wi-Fi beacon frames. A node uses beacon frames to allow other nodes to detect its presence and know of its status. Idle nodes will listen for beacon frames to generate a list of potential parent nodes, one of which the idle node will form an upstream connection with. ESP-WIFI-MESH uses the Vendor Information Element to store metadata such as:

- Node Type (Root, Intermediate Parent, Leaf, Idle)
- Current layer of Node
- Maximum number of layers permitted in the network
- Current number of child nodes
- Maximum number of downstream connections to accept

The signal strength of a potential upstream connection is represented by RSSI (Received Signal Strength Indication) of the beacon frames of the potential parent node. To prevent nodes from forming a weak upstream connection, ESP-WIFI-MESH implements an RSSI threshold mechanism for beacon frames. If a node detects a beacon frame with an RSSI below a preconfigured threshold, the transmitting node will be disregarded when forming an upstream connection.

**Panel A** of the illustration above demonstrates how the RSSI threshold affects the number of parent node candidates an idle node has.

**Panel B** of the illustration above demonstrates how an RF shielding object can lower the RSSI of a potential parent node. Due to the RF shielding object, the area in which the RSSI of node X is above the threshold is significantly reduced. This causes the idle node to disregard node X even though node X is physically adjacent. The idle node will instead form an upstream connection with the physically distant node Y due to a stronger RSSI.

---

**Note:** Nodes technically still receive all beacon frames on the MAC layer. The RSSI threshold is an ESP-WIFI-MESH feature that simply filters out all received beacon frames that are below the preconfigured threshold.

---

### Preferred Parent Node

When an idle node has multiple parent nodes candidates (potential parent nodes), the idle node will form an upstream connection with the **preferred parent node**. The preferred parent node is determined based on the following criteria:

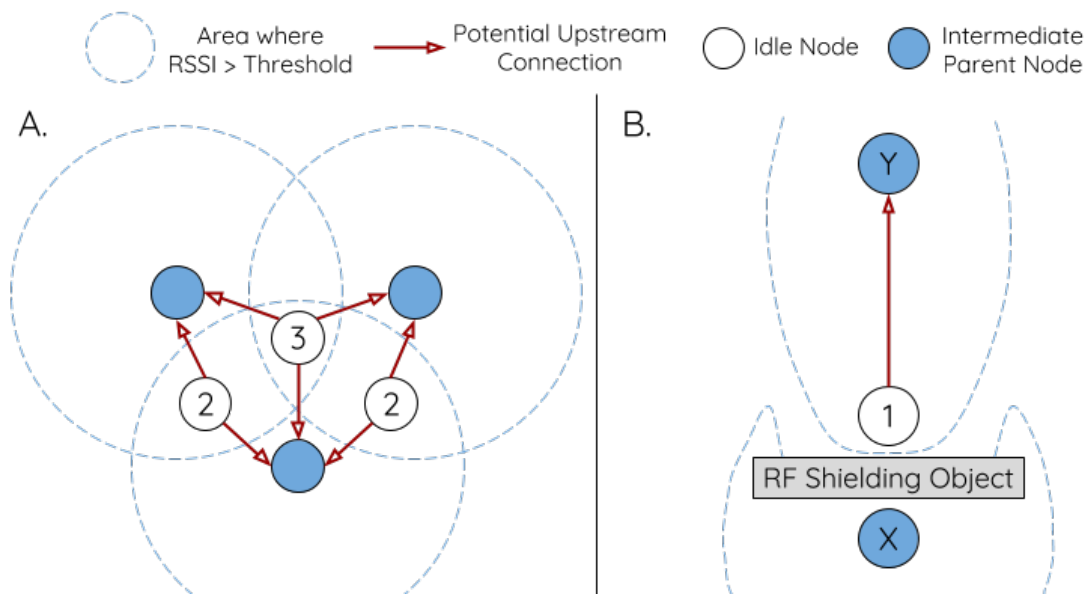

Fig. 10: Effects of RSSI Thresholding

- Which layer the parent node candidate is situated on
- The number of downstream connections (child nodes) the parent node candidate currently has

The selection of the preferred parent node will always prioritize the parent node candidate on the shallowest layer of the network (including the root node). This helps minimize the total number of layers in an ESP-WIFI-MESH network when upstream connections are formed. For example, given a second layer node and a third layer node, the second layer node will always be preferred.

If there are multiple parent node candidates within the same layer, the parent node candidate with the least child nodes will be preferred. This criteria has the effect of balancing the number of downstream connections amongst nodes of the same layer.

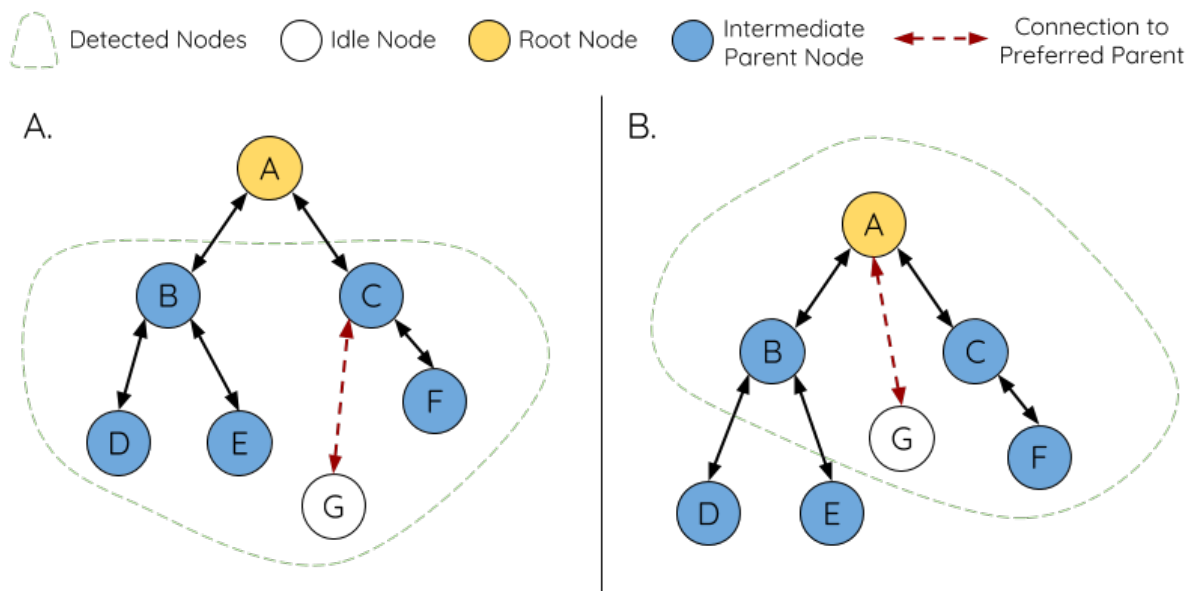

Fig. 11: Preferred Parent Node Selection

**Panel A** of the illustration above demonstrates an example of how the idle node G selects a preferred parent node given the five parent node candidates B/C/D/E/F. Nodes on the shallowest layer are preferred, hence nodes B/C are prioritized since they are second layer nodes whereas nodes D/E/F are on the third layer. Node C is selected as the



preferred parent node due it having fewer downstream connections (fewer child nodes) compared to node B.

**Panel B** of the illustration above demonstrates the case where the root node is within range of the idle node G. In other words, the root node's beacon frames are above the RSSI threshold when received by node G. The root node is always the shallowest node in an ESP-WIFI-MESH network hence is always the preferred parent node given multiple parent node candidates.

**Note:** Users may also define their own algorithm for selecting a preferred parent node, or force a node to only connect with a specific parent node (see the [Mesh Manual Networking Example](#)).

## Routing Tables

Each node within an ESP-WIFI-MESH network will maintain its individual routing table used to correctly route ESP-WIFI-MESH packets (see [ESP-WIFI-MESH Packet](#)) to the correct destination node. The routing table of a particular node will **consist of the MAC addresses of all nodes within the particular node's subnetwork** (including the MAC address of the particular node itself). Each routing table is internally partitioned into multiple subtables with each subtable corresponding to the subnetwork of each child node.

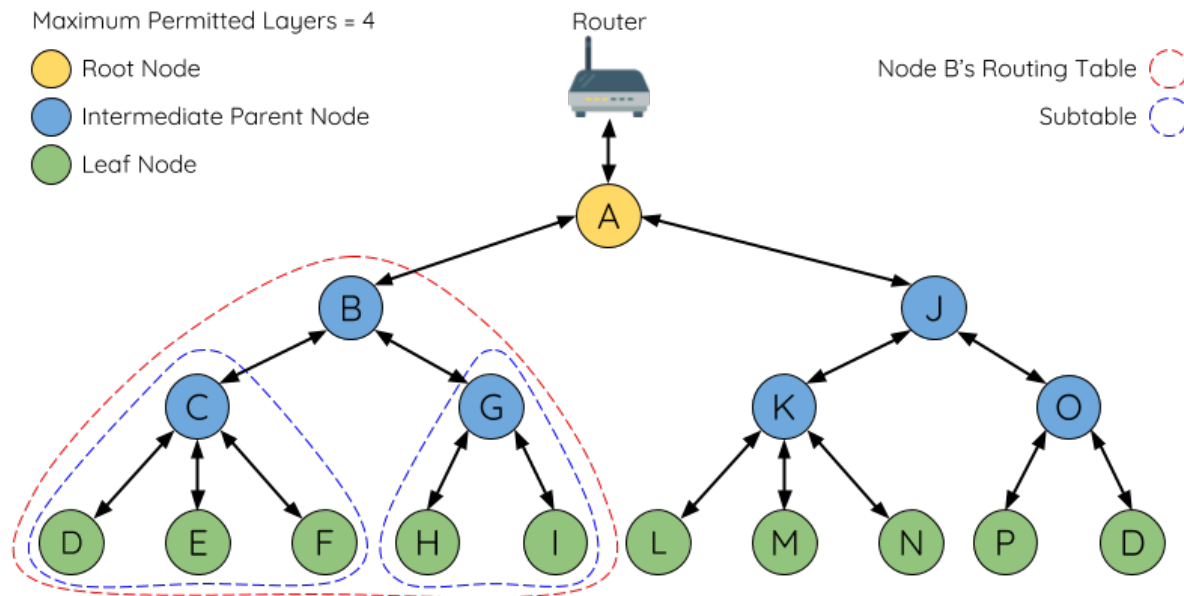

Fig. 12: ESP-WIFI-MESH Routing Tables Example

Using the diagram above as an example, the routing table of node B would consist of the MAC addresses of nodes B to I (i.e. equivalent to the subnetwork of node B). Node B's routing table is internally partitioned into two subtables containing of nodes C to F and nodes G to I (i.e. equivalent to the subnetworks of nodes C and G respectively).

**ESP-WIFI-MESH utilizes routing tables to determine whether an ESP-WIFI-MESH packet should be forwarded upstream or downstream based on the following rules.**

1. If the packet's destination MAC address is within the current node's routing table and is not the current node, select the subtable that contains the destination MAC address and forward the data packet downstream to the child node corresponding to the subtable.
2. If the destination MAC address is not within the current node's routing table, forward the data packet upstream to the current node's parent node. Doing so repeatedly will result in the packet arriving at the root node where the routing table should contain all nodes within the network.

**Note:** Users can call `esp_mesh_get_routing_table()` to obtain a node's routing table, or `esp_mesh_get_routing_table_size()` to obtain the size of a node's routing table.

`esp_mesh_get_subnet_nodes_list()` can be used to obtain the corresponding subtable of a specific child node. Likewise `esp_mesh_get_subnet_nodes_num()` can be used to obtain the size of the subtable.

#### 4.11.4 Building a Network

##### General Process

**Warning:** Before the ESP-WIFI-MESH network building process can begin, certain parts of the configuration must be uniform across each node in the network (see `mesh_cfg_t`). Each node must be configured with **the same Mesh Network ID, router configuration, and softAP configuration.**

An ESP-WIFI-MESH network building process involves selecting a root node, then forming downstream connections layer by layer until all nodes have joined the network. The exact layout of the network can be dependent on factors such as root node selection, parent node selection, and asynchronous power-on reset. However, the ESP-WIFI-MESH network building process can be generalized into the following steps:

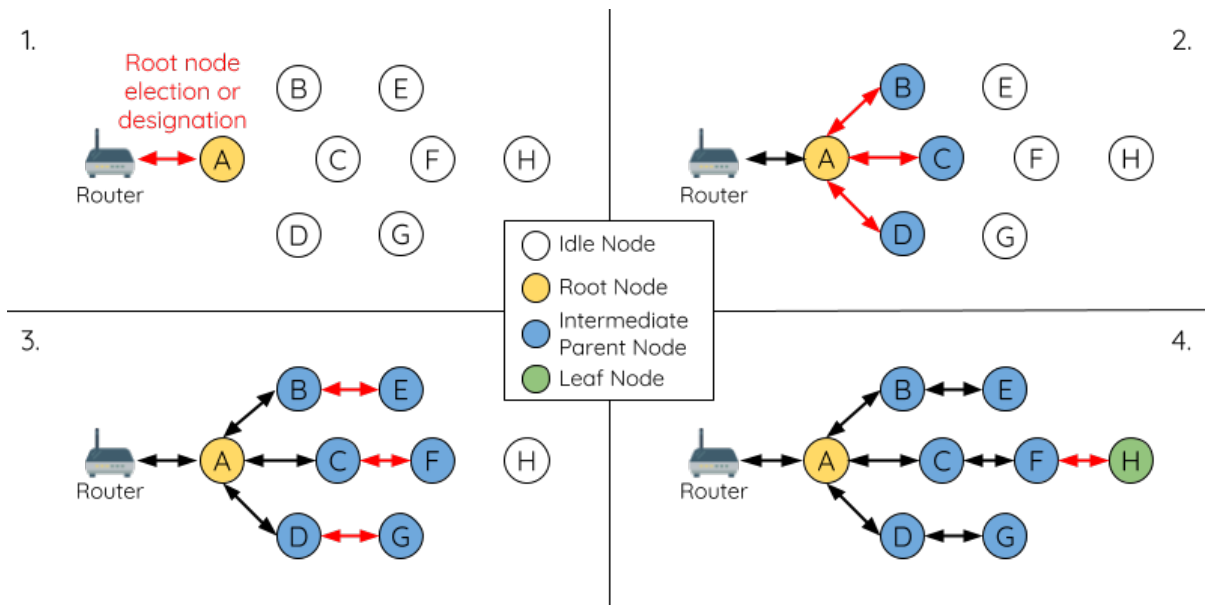

Fig. 13: ESP-WIFI-MESH Network Building Process

**1. Root Node Selection** The root node can be designated during configuration (see section on *User Designated Root Node*), or dynamically elected based on the signal strength between each node and the router (see *Automatic Root Node Selection*). Once selected, the root node will connect with the router and begin allowing downstream connections to form. Referring to the figure above, node A is selected to be the root node hence node A forms an upstream connection with the router.

**2. Second Layer Formation** Once the root node has connected to the router, idle nodes in range of the root node will begin connecting with the root node thereby forming the second layer of the network. Once connected, the second layer nodes become intermediate parent nodes (assuming maximum permitted layers > 2) hence the next layer to form. Referring to the figure above, nodes B to D are in range of the root node. Therefore nodes B to D form upstream connections with the root node and become intermediate parent nodes.

**3. Formation of remaining layers** The remaining idle nodes will connect with intermediate parent nodes within range thereby forming a new layer in the network. Once connected, the idles nodes become intermediate parent node or leaf nodes depending on the networks maximum permitted layers. This step is repeated until there are no more idle nodes within the network or until the maximum permitted layer of the network has been reached. Referring to the figure above, nodes E/F/G connect with nodes B/C/D respectively and become intermediate parent nodes themselves.

**4. Limiting Tree Depth** To prevent the network from exceeding the maximum permitted number of layers, nodes on the maximum layer will automatically become leaf nodes once connected. This prevents any other idle node from connecting with the leaf node thereby prevent a new layer form forming. However if an idle node has no other potential parent node, it will remain idle indefinitely. Referring to the figure above, the network’ s number of maximum permitted layers is set to four. Therefore when node H connects, it becomes a leaf node to prevent any downstream connections from forming.

**Automatic Root Node Selection**

The automatic selection of a root node involves an election process amongst all idle nodes based on their signal strengths with the router. Each idle node will transmit their MAC addresses and router RSSI values via Wi-Fi beacon frames. **The MAC address is used to uniquely identify each node in the network** whilst the **router RSSI** is used to indicate a node’ s signal strength with reference to the router.

Each node will then simultaneously scan for the beacon frames from other idle nodes. If a node detects a beacon frame with a stronger router RSSI, the node will begin transmitting the contents of that beacon frame (i.e. voting for the node with the stronger router RSSI). The process of transmission and scanning will repeat for a preconfigured minimum number of iterations (10 iterations by default) and result in the beacon frame with the strongest router RSSI being propagated throughout the network.

After all iterations, each node will individually check for its **vote percentage** (number of votes/number of nodes participating in election) to determine if it should become the root node. **If a node has a vote percentage larger than a preconfigured threshold (90% by default), the node will become a root node.**

The following diagram demonstrates how an ESP-WIFI-MESH network is built when the root node is automatically selected.

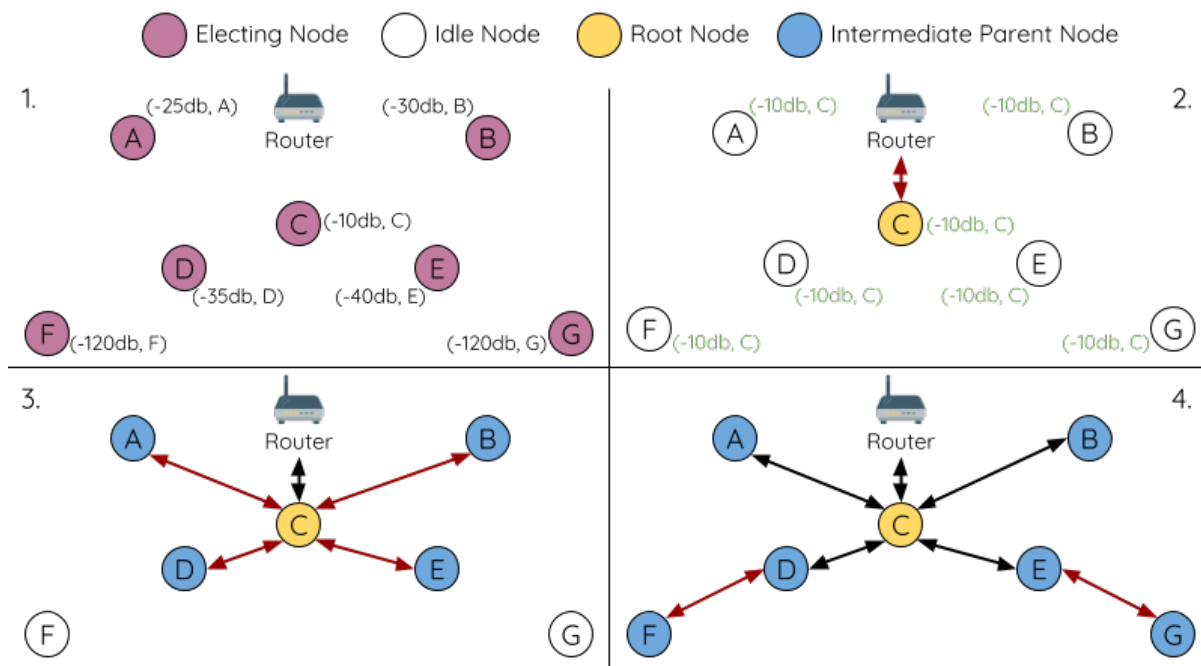

Fig. 14: Root Node Election Example

1. On power-on reset, each node begins transmitting beacon frames consisting of their own MAC addresses and their router RSSIs.
2. Over multiple iterations of transmission and scanning, the beacon frame with the strongest router RSSI is propagated throughout the network. Node C has the strongest router RSSI (-10 dB) hence its beacon frame is propagated throughout the network. All nodes participating in the election vote for node C thus giving node C a vote percentage of 100%. Therefore node C becomes a root node and connects with the router.
3. Once Node C has connected with the router, nodes A/B/D/E connect with node C as it is the preferred parent node (i.e. the shallowest node). Nodes A/B/D/E form the second layer of the network.
4. Node F and G connect with nodes D and E respectively and the network building process is complete.

**Note:** The minimum number of iterations for the election process can be configured using `esp_mesh_set_attempts()`. Users should adjust the number of iterations based on the number of nodes within the network (i.e. the larger the network the larger number of scan iterations required).

**Warning:** **Vote percentage threshold** can also be configured using `esp_mesh_set_vote_percentage()`. Setting a low vote percentage threshold **can result in two or more nodes becoming root nodes** within the same ESP-WIFI-MESH network leading to the building of multiple networks. If such is the case, ESP-WIFI-MESH has internal mechanisms to autonomously resolve the **root node conflict**. The networks of the multiple root nodes will be combined into a single network with a single root node. However, root node conflicts where two or more root nodes have the same router SSID but different router BSSID are not handled.

### User Designated Root Node

The root node can also be designated by user which will entail the designated root node to directly connect with the router and forgo the election process. When a root node is designated, all other nodes within the network must also forgo the election process to prevent the occurrence of a root node conflict. The following diagram demonstrates how an ESP-WIFI-MESH network is built when the root node is designated by the user.

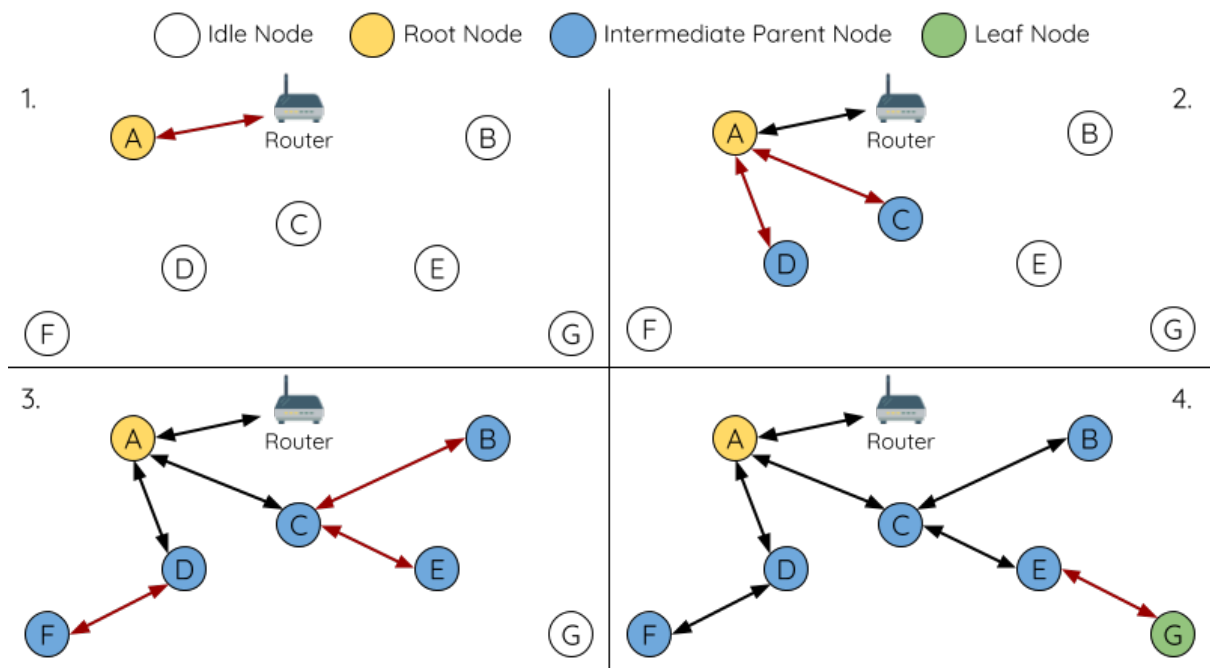

Fig. 15: Root Node Designation Example (Root Node = A, Max Layers = 4)

1. Node A is designated the root node by the user therefore directly connects with the router. All other nodes forgo the election process.
2. Nodes C/D connect with node A as their preferred parent node. Both nodes form the second layer of the network.
3. Likewise, nodes B/E connect with node C, and node F connects with node D. Nodes B/E/F form the third layer of the network.
4. Node G connects with node E, forming the fourth layer of the network. However the maximum permitted number of layers in this network is configured as four, therefore node G becomes a leaf node to prevent any new layers from forming.

---

**Note:** When designating a root node, the root node should call `esp_mesh_set_parent()` in order to directly connect with the router. Likewise, all other nodes should call `esp_mesh_fix_root()` to forgo the election process.

---

### Parent Node Selection

By default, ESP-WIFI-MESH is self organizing meaning that each node will autonomously select which potential parent node to form an upstream connection with. The autonomously selected parent node is known as the preferred parent node. The criteria used for selecting the preferred parent node is designed to reduce the number of layers in the ESP-WIFI-MESH network and to balance the number of downstream connections between potential parent nodes (see section on [Preferred Parent Node](#)).

However ESP-WIFI-MESH also allows users to disable self-organizing behavior which will allow users to define their own criteria for parent node selection, or to configure nodes to have designated parent nodes (see the [Mesh Manual Networking Example](#)).

### Asynchronous Power-on Reset

ESP-WIFI-MESH network building can be affected by the order in which nodes power-on. If certain nodes within the network power-on asynchronously (i.e. separated by several minutes), **the final structure of the network could differ from the ideal case where all nodes are powered on synchronously**. Nodes that are delayed in powering on will adhere to the following rules:

**Rule 1:** If a root node already exists in the network, the delayed node will not attempt to elect a new root node, even if it has a stronger RSSI with the router. The delayed node will instead join the network like any other idle node by connecting with a preferred parent node. If the delayed node is the designated root node, all other nodes in the network will remain idle until the delayed node powers-on.

**Rule 2:** If a delayed node forms an upstream connection and becomes an intermediate parent node, it may also become the new preferred parent of other nodes (i.e. being a shallower node). This will cause the other nodes to switch their upstream connections to connect with the delayed node (see [Parent Node Switching](#)).

**Rule 3:** If an idle node has a designated parent node which is delayed in powering-on, the idle node will not attempt to form any upstream connections in the absence of its designated parent node. The idle node will remain idle indefinitely until its designated parent node powers-on.

The following example demonstrates the effects of asynchronous power-on with regards to network building.

1. Nodes A/C/D/F/G/H are powered-on synchronously and begin the root node election process by broadcasting their MAC addresses and router RSSIs. Node A is elected as the root node as it has the strongest RSSI.
2. Once node A becomes the root node, the remaining nodes begin forming upstream connections layer by layer with their preferred parent nodes. The result is a network with five layers.
3. Node B/E are delayed in powering-on but neither attempt to become the root node even though they have stronger router RSSIs (-20 dB and -10 dB) compared to node A. Instead both delayed nodes form upstream connections with their preferred parent nodes A and C respectively. Both nodes B/E become intermediate parent nodes after connecting.



Fig. 16: Network Building with Asynchronous Power On Example

4. Nodes D/G switch their upstream connections as node B is the new preferred parent node due to it being on a shallower layer (second layer node). Due to the switch, the resultant network has three layers instead of the original five layers.

**Synchronous Power-On:** Had all nodes powered-on synchronously, node E would have become the root node as it has the strongest router RSSI (-10 dB). This would result in a significantly different network layout compared to the network formed under the conditions of asynchronous power-on. **However the synchronous power-on network layout can still be reached if the user manually switches the root node** (see `esp_mesh_waive_root()`).

---

**Note:** Differences in parent node selection caused by asynchronous power-on are autonomously corrected for to some extent in ESP-WIFI-MESH (see *Parent Node Switching*)

---

### Loop-back Avoidance, Detection, and Handling

A loop-back is the situation where a particular node forms an upstream connection with one of its descendant nodes (a node within the particular node's subnetwork). This results in a circular connection path thereby breaking the tree topology. ESP-WIFI-MESH prevents loop-back during parent selection by excluding nodes already present in the selecting node's routing table (see *Routing Tables*) thus prevents a particular node from attempting to connect to any node within its subnetwork.

In the event that a loop-back occurs, ESP-WIFI-MESH utilizes a path verification mechanism and energy transfer mechanism to detect the loop-back occurrence. The parent node of the upstream connection that caused the loop-back will then inform the child node of the loop-back and initiate a disconnection.

## 4.11.5 Managing a Network

**ESP-WIFI-MESH is a self healing network meaning it can detect and correct for failures in network routing.** Failures occur when a parent node with one or more child nodes breaks down, or when the connection between a parent node and its child nodes becomes unstable. Child nodes in ESP-WIFI-MESH will autonomously select a new parent node and form an upstream connection with it to maintain network interconnectivity. ESP-WIFI-MESH can handle both Root Node Failures and Intermediate Parent Node Failures.

### Root Node Failure

If the root node breaks down, the nodes connected with it (second layer nodes) will promptly detect the failure of the root node. The second layer nodes will initially attempt to reconnect with the root node. However after multiple failed attempts, the second layer nodes will initialize a new round of root node election. **The second layer node with the strongest router RSSI will be elected as the new root node** whilst the remaining second layer nodes will form an upstream connection with the new root node (or a neighboring parent node if not in range).

If the root node and multiple downstream layers simultaneously break down (e.g. root node, second layer, and third layer), the shallowest layer that is still functioning will initialize the root node election. The following example illustrates an example of self healing from a root node break down.

1. Node C is the root node of the network. Nodes A/B/D/E are second layer nodes connected to node C.
2. Node C breaks down. After multiple failed attempts to reconnect, the second layer nodes begin the election process by broadcasting their router RSSIs. Node B has the strongest router RSSI.
3. Node B is elected as the root node and begins accepting downstream connections. The remaining second layer nodes A/D/E form upstream connections with node B thus the network is healed and can continue operating normally.

---

**Note:** If a designated root node breaks down, the remaining nodes **will not autonomously attempt to elect a new root node** as an election process will never be attempted whilst a designated root node is used.

---



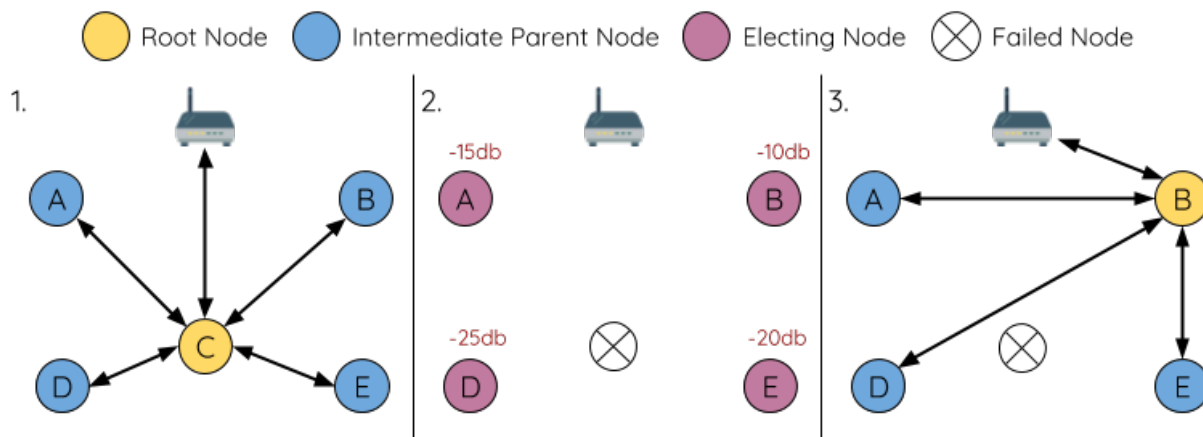

Fig. 17: Self Healing From Root Node Failure

**Intermediate Parent Node Failure**

If an intermediate parent node breaks down, the disconnected child nodes will initially attempt to reconnect with the parent node. After multiple failed attempts to reconnect, each child node will begin to scan for potential parent nodes (see *Beacon Frames & RSSI Thresholding*).

If other potential parent nodes are available, each child node will individually select a new preferred parent node (see *Preferred Parent Node*) and form an upstream connection with it. If there are no other potential parent nodes for a particular child node, it will remain idle indefinitely.

The following diagram illustrates an example of self healing from an Intermediate Parent Node break down.

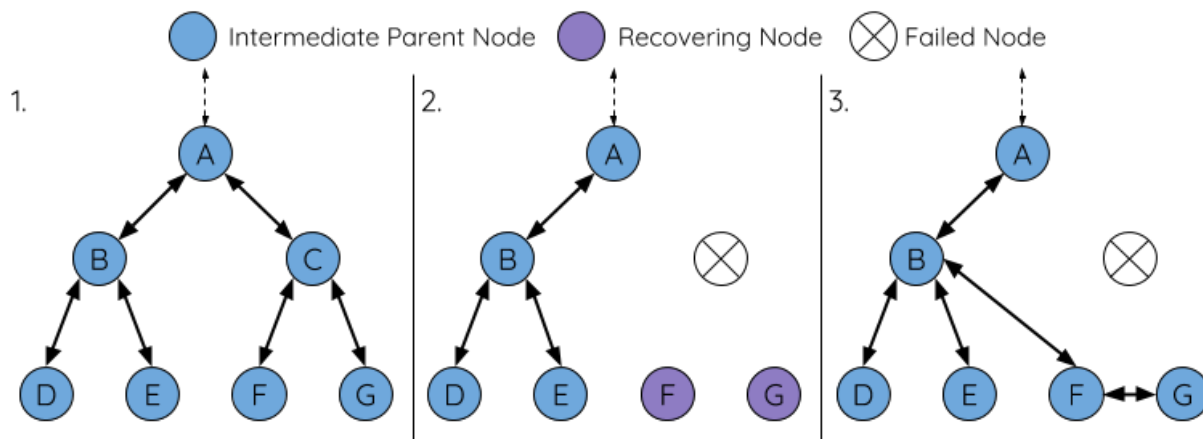

Fig. 18: Self Healing From Intermediate Parent Node Failure

1. The following branch of the network consists of nodes A to G.
2. Node C breaks down. Nodes F/G detect the break down and attempt to reconnect with node C. After multiple failed attempts to reconnect, nodes F/G begin to select a new preferred parent node.
3. Node G is out of range from any other parent node hence remains idle for the time being. Node F is in range of nodes B/E, however node B is selected as it is the shallower node. Node F becomes an intermediate parent node after connecting with Node B thus node G can connect with node F. The network is healed, however the network routing as been affected and an extra layer has been added.

**Note:** If a child node has a designated parent node that breaks down, the child node will make no attempt to connect with a new parent node. The child node will remain idle indefinitely.



## Root Node Switching

ESP-WIFI-MESH does not automatically switch the root node unless the root node breaks down. Even if the root node's router RSSI degrades to the point of disconnection, the root node will remain unchanged. Root node switching is the act of explicitly starting a new election such that a node with a stronger router RSSI will be elected as the new root node. This can be a useful method of adapting to degrading root node performance.

To trigger a root node switch, the current root node must explicitly call `esp_mesh_waive_root()` to trigger a new election. The current root node will signal all nodes within the network to begin transmitting and scanning for beacon frames (see [Automatic Root Node Selection](#)) **whilst remaining connected to the network (i.e. not idle)**. If another node receives more votes than the current root node, a root node switch will be initiated. **The root node will remain unchanged otherwise.**

A newly elected root node sends a **switch request** to the current root node which in turn will respond with an acknowledgment signifying both nodes are ready to switch. Once the acknowledgment is received, the newly elected root node will disconnect from its parent and promptly form an upstream connection with the router thereby becoming the new root node of the network. The previous root node will disconnect from the router **whilst maintaining all of its downstream connections** and enter the idle state. The previous root node will then begin scanning for potential parent nodes and selecting a preferred parent.

The following diagram illustrates an example of a root node switch.

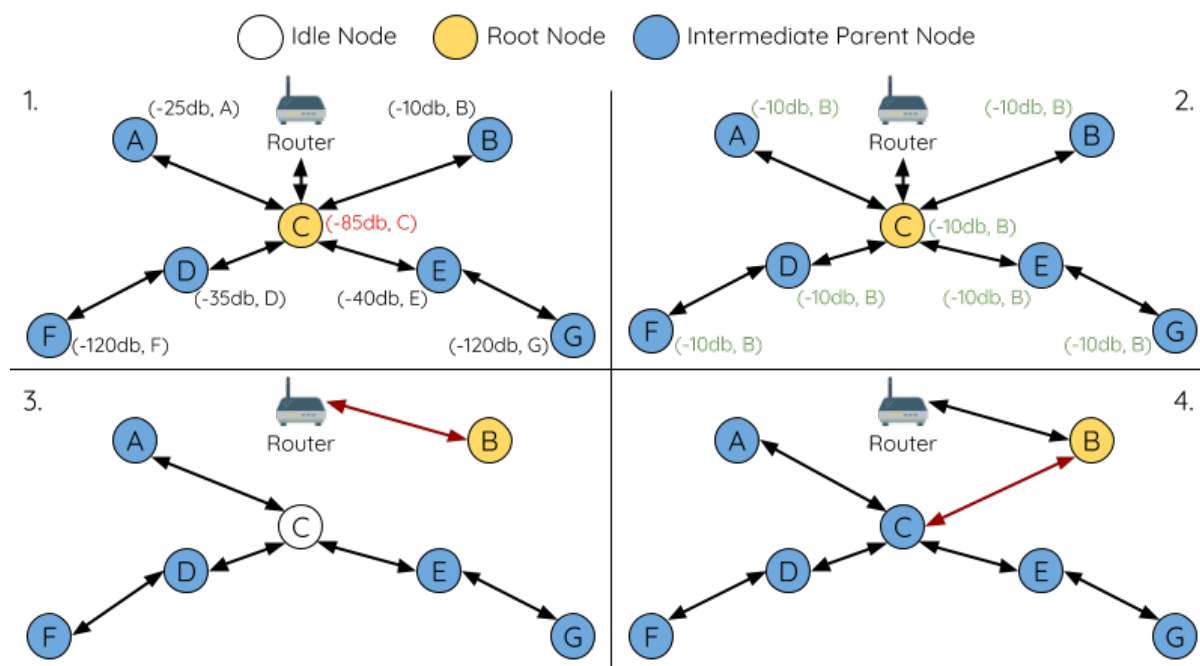

Fig. 19: Root Node Switch Example

**1.** Node C is the current root node but has degraded signal strength with the router (-85db). The node C triggers a new election and all nodes begin transmitting and scanning for beacon frames **whilst still being connected**.

**2.** After multiple rounds of transmission and scanning, node B is elected as the new root node. Node B sends node C a **switch request** and node C responds with an acknowledgment.

**3.** Node B disconnects from its parent and connects with the router becoming the network's new root node. Node C disconnects from the router, enters the idle state, and begins scanning for and selecting a new preferred parent node. **Node C maintains all its downstream connections throughout this process.**

**4.** Node C selects node B as its preferred parent node, forms an upstream connection, and becomes a second layer node. The network layout is similar after the switch as node C still maintains the same subnetwork. However, each node in node C's subnetwork has been placed one layer deeper as a result of the switch. *Parent Node Switching* may adjust the network layout afterwards if any nodes have a new preferred parent node as a result of the root node switch.

---

**Note:** Root node switching must require an election hence is only supported when using a self-organized ESP-WIFI-MESH network. In other words, root node switching cannot occur if a designated root node is used.

---

### Parent Node Switching

Parent Node Switching entails a child node switching its upstream connection to another parent node of a shallower layer. **Parent Node Switching occurs autonomously** meaning that a child node will change its upstream connection automatically if a potential parent node of a shallower layer becomes available (i.e. due to a *Asynchronous Power-on Reset*).

All potential parent nodes periodically transmit beacon frames (see *Beacon Frames & RSSI Thresholding*) allowing for a child node to scan for the availability of a shallower parent node. Due to parent node switching, a self-organized ESP-WIFI-MESH network can dynamically adjust its network layout to ensure each connection has a good RSSI and that the number of layers in the network is minimized.

## 4.11.6 Data Transmission

### ESP-WIFI-MESH Packet

ESP-WIFI-MESH network data transmissions use ESP-WIFI-MESH packets. ESP-WIFI-MESH packets are **entirely contained within the frame body of a Wi-Fi data frame**. A multi-hop data transmission in an ESP-WIFI-MESH network will involve a single ESP-WIFI-MESH packet being carried over each wireless hop by a different Wi-Fi data frame.

The following diagram shows the structure of an ESP-WIFI-MESH packet and its relation with a Wi-Fi data frame.

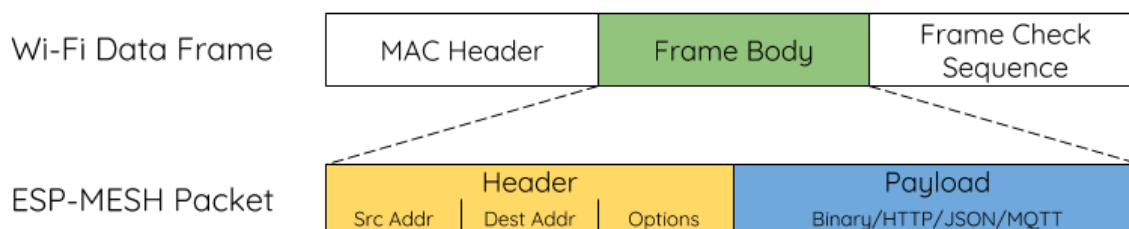

Fig. 20: ESP-WIFI-MESH Packet

**The header** of an ESP-WIFI-MESH packet contains the MAC addresses of the source and destination nodes. The options field contains information pertaining to the special types of ESP-WIFI-MESH packets such as a group transmission or a packet originating from the external IP network (see *MESH\_OPT\_SEND\_GROUP* and *MESH\_OPT\_RECV\_DS\_ADDR*).

**The payload** of an ESP-WIFI-MESH packet contains the actual application data. This data can be raw binary data, or encoded under an application layer protocol such as HTTP, MQTT, and JSON (see *mesh\_proto\_t*).

---

**Note:** When sending an ESP-WIFI-MESH packet to the external IP network, the destination address field of the header will contain the IP address and port of the target server rather than the MAC address of a node (see *mesh\_addr\_t*). Furthermore the root node will handle the formation of the outgoing TCP/IP packet.

---

### Group Control & Multicasting

Multicasting is a feature that allows a single ESP-WIFI-MESH packet to be transmitted simultaneously to multiple nodes within the network. Multicasting in ESP-WIFI-MESH can be achieved by either specifying a list

of target nodes, or specifying a preconfigured group of nodes. Both methods of multicasting are called via `esp_mesh_send()`.

To multicast by specifying a list of target nodes, users must first set the ESP-WIFI-MESH packet's destination address to the **Multicast-Group Address** (01:00:5E:xx:xx:xx). This signifies that the ESP-WIFI-MESH packet is a multicast packet with a group of addresses, and that the address should be obtained from the header options. Users must then list the MAC addresses of the target nodes as options (see `mesh_opt_t` and `MESH_OPT_SEND_GROUP`). This method of multicasting requires no prior setup but can incur a large amount of overhead data as each target node's MAC address must be listed in the options field of the header.

Multicasting by group allows a ESP-WIFI-MESH packet to be transmitted to a preconfigured group of nodes. Each grouping is identified by a unique ID, and a node can be placed into a group via `esp_mesh_set_group_id()`. Multicasting to a group involves setting the destination address of the ESP-WIFI-MESH packet to the target group ID. Furthermore, the `MESH_DATA_GROUP` flag must set. Using groups to multicast incurs less overhead, but requires nodes to be previously added into groups.

---

**Note:** During a multicast, all nodes within the network still receive the ESP-WIFI-MESH packet on the MAC layer. However, nodes not included in the MAC address list or the target group will simply filter out the packet.

---

## Broadcasting

Broadcasting is a feature that allows a single ESP-WIFI-MESH packet to be transmitted simultaneously to all nodes within the network. Each node essentially forwards a broadcast packet to all of its upstream and downstream connections such that the packet propagates throughout the network as quickly as possible. However, ESP-WIFI-MESH utilizes the following methods to avoid wasting bandwidth during a broadcast.

1. When an intermediate parent node receives a broadcast packet from its parent, it will forward the packet to each of its child nodes whilst storing a copy of the packet for itself.
2. When an intermediate parent node is the source node of the broadcast, it will transmit the broadcast packet upstream to its parent node and downstream to each of its child nodes.
3. When an intermediate parent node receives a broadcast packet from one of its child nodes, it will forward the packet to its parent node and each of its remaining child nodes whilst storing a copy of the packet for itself.
4. When a leaf node is the source node of a broadcast, it will directly transmit the packet to its parent node.
5. When the root node is the source node of a broadcast, the root node will transmit the packet to all of its child nodes.
6. When the root node receives a broadcast packet from one of its child nodes, it will forward the packet to each of its remaining child nodes whilst storing a copy of the packet for itself.
7. When a node receives a broadcast packet with a source address matching its own MAC address, the node will discard the broadcast packet.
8. When an intermediate parent node receives a broadcast packet from its parent node which was originally transmitted from one of its child nodes, it will discard the broadcast packet

## Upstream Flow Control

ESP-WIFI-MESH relies on parent nodes to control the upstream data flow of their immediate child nodes. To prevent a parent node's message buffer from overflowing due to an overload of upstream transmissions, a parent node will allocate a quota for upstream transmissions known as a **receiving window** for each of its child nodes. **Each child node must apply for a receiving window before it is permitted to transmit upstream.** The size of a receiving window can be dynamically adjusted. An upstream transmission from a child node to the parent node consists of the following steps:

1. Before each transmission, the child node sends a window request to its parent node. The window request consists of a sequence number which corresponds to the child node's data packet that is pending transmission.

2. The parent node receives the window request and compares the sequence number with the sequence number of the previous packet sent by the child node. The comparison is used to calculate the size of the receiving window which is transmitted back to the child node.

3. The child node transmits the data packet in accordance with the window size specified by the parent node. If the child node depletes its receiving window, it must obtain another receiving windows by sending a request before it is permitted to continue transmitting.

**Note:** ESP-WIFI-MESH does not support any downstream flow control.

**Warning:** Due to *Parent Node Switching*, packet loss may occur during upstream transmissions.

Due to the fact that the root node acts as the sole interface to an external IP network, it is critical that downstream nodes are aware of the root node's connection status with the external IP network. Failing to do so can lead to nodes attempting to pass data upstream to the root node whilst it is disconnected from the IP network. This results in unnecessary transmissions and packet loss. ESP-WIFI-MESH address this issue by providing a mechanism to stabilize the throughput of outgoing data based on the connection status between the root node and the external IP network. The root node can broadcast its external IP network connection status to all other nodes by calling `esp_mesh_post_toDS_state()`.

### Bi-Directional Data Stream

The following diagram illustrates the various network layers involved in an ESP-WIFI-MESH Bidirectional Data Stream.

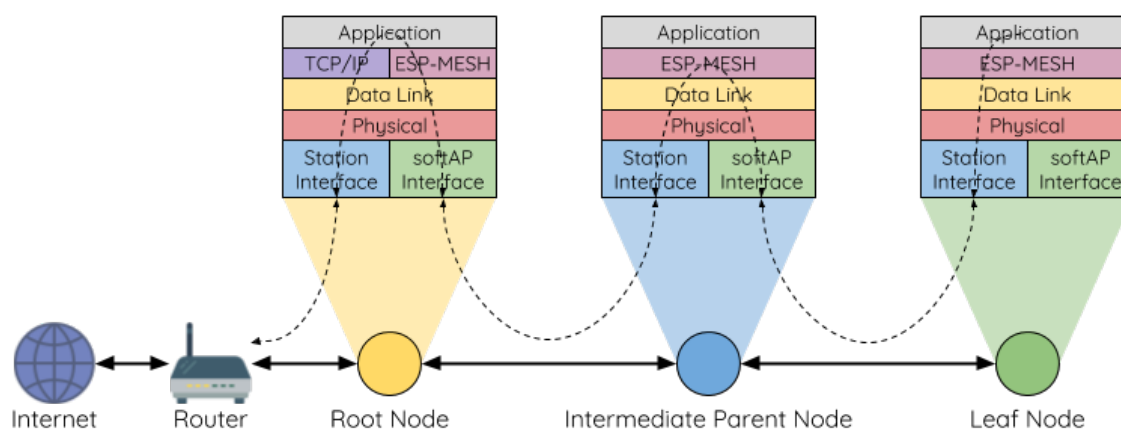

Fig. 21: ESP-WIFI-MESH Bidirectional Data Stream

Due to the use of *Routing Tables*, **ESP-WIFI-MESH is able to handle pack forwarding entirely on the mesh layer**. A TCP/IP layer is only required on the root node when it transmits/receives a packet to/from an external IP network.

### 4.11.7 Channel Switching

#### Background

In traditional Wi-Fi networks, **channels** are predetermined frequency ranges. In an infrastructure basic service set (BSS), the serving AP and its connected stations must be on the same operating channels (1 to 14) in which beacons are transmitted. Physically adjacent BSS (Basic Service Sets) operating on the same channel can lead to interference and degraded performance.

In order to allow a BSS adapt to changing physical layer conditions and maintain performance, Wi-Fi contains mechanisms for **network channel switching**. A network channel switch is an attempt to move a BSS to a new operating channel whilst minimizing disruption to the BSS during this process. However it should be recognized that a channel switch may be unsuccessful in moving all stations to the new operating channel.

In an infrastructure Wi-Fi network, network channel switches are triggered by the AP with the aim of having the AP and all connected stations synchronously switch to a new channel. Network channel switching is implemented by embedding a **Channel Switch Announcement (CSA)** element within the AP's periodically transmitted beacon frames. The CSA element is used to advertise to all connected stations regarding an upcoming network channel switch and will be included in multiple beacon frames up until the switch occurs.

A CSA element contains information regarding the **New Channel Number** and a **Channel Switch Count** which indicates the number of beacon frame intervals (TBTTs) remaining until the network channel switch occurs. Therefore, the Channel Switch Count is decremented every beacon frame and allows connected stations to synchronize their channel switch with the AP.

### ESP-WIFI-MESH Network Channel Switching

ESP-WIFI-MESH Network Channel Switching also utilize beacon frames that contain a CSA element. However, being a multi-hop network makes the switching process in ESP-WIFI-MESH is more complex due to the fact that a beacon frame might not be able to reach all nodes within the network (i.e. in a single hop). Therefore, an ESP-WIFI-MESH network relies on nodes to forward the CSA element so that it is propagated throughout the network.

When an intermediate parent node with one or more child nodes receives a beacon frame containing a CSA, the node will forward the CSA element by including the element in its next transmitted beacon frame (i.e. with the same **New Channel Number** and **Channel Switch Count**). Given that all nodes within an ESP-WIFI-MESH network receive the same CSA, the nodes can synchronize their channel switches using the Channel Switch Count, albeit with a short delay due to CSA element forwarding.

An ESP-WIFI-MESH network channel switch can be triggered by either the router or the root node.

**Root Node Triggered** A root node triggered channel switch can only occur when the ESP-WIFI-MESH network is not connected to a router. By calling `esp_mesh_switch_channel()`, the root node will set an initial Channel Switch Count value and begin including a CSA element in its beacon frames. Each CSA element is then received by second layer nodes, and forwarded downstream in their own beacon frames.

**Router Triggered** When an ESP-WIFI-MESH network is connected to a router, the entire network must use the same channel as the router. Therefore, **the root node will not be permitted to trigger a channel switch when it is connected to a router.**

When the root node receives beacon frame containing a CSA element from the router, **the root node will set Channel Switch Count value in the CSA element to a custom value before forwarding it downstream via beacon frames.** It will also decrement the Channel Switch Count of subsequent CSA elements relative to the custom value. This custom value can be based on factors such as the number of network layers, the current number of nodes etc.

The setting the Channel Switch Count value to a custom value is due to the fact that the ESP-WIFI-MESH network and its router may have a different and varying beacon intervals. Therefore, the Channel Switch Count value provided by the router is irrelevant to an ESP-WIFI-MESH network. By using a custom value, nodes within the ESP-WIFI-MESH network are able to switch channels synchronously relative to the ESP-WIFI-MESH network's beacon interval. However, this will also result in the ESP-WIFI-MESH network's channel switch being unsynchronized with the channel switch of the router and its connected stations.

### Impact of Network Channel Switching

- **Due to the ESP-WIFI-MESH network channel switch being unsynchronized with the router's channel switch, there will be a delay in the network's channel switch.**
  - The ESP-WIFI-MESH network's channel switch time is dependent on the ESP-WIFI-MESH network's beacon interval and the root node's custom Channel Switch Count value.

- The channel discrepancy prevents any data exchange between the root node and the router during that ESP-WIFI-MESH network’s switch.
- In the ESP-WIFI-MESH network, the root node and intermediate parent nodes will request their connected child nodes to stop transmissions until the channel switch takes place by setting the **Channel Switch Mode** field in the CSA element to 1.
- Frequent router triggered network channel switches can degrade the ESP-WIFI-MESH network’s performance. Note that this can be caused by the ESP-WIFI-MESH network itself (e.g. due to wireless medium contention with ESP-WIFI-MESH network). If this is the case, users should disable the automatic channel switching on the router and use a specified channel instead.
- **When there is a temporary channel discrepancy, the root node remains technically connected to the router.**
  - Disconnection occurs after the root node fails to receive any beacon frames or probe responses from the router over a fixed number of router beacon intervals.
  - Upon disconnection, the root node will automatically re-scan all channels for the presence of a router.
- **If the root node is unable to receive any of the router’s CSA beacon frames (e.g. due to short switch time given by the**
  - After the router switches channels, the root node will no longer be able to receive the router’s beacon frames and probe responses and result in a disconnection after a fixed number of beacon intervals.
  - The root node will re-scan all channels for the router after disconnection.
  - The root node will maintain downstream connections throughout this process.

---

**Note:** Although ESP-WIFI-MESH network channel switching aims to move all nodes within the network to a new operating channel, it should be recognized that a channel switch might not successfully move all nodes (e.g. due to reasons such as node failures).

---

### Channel and Router Switching Configuration

ESP-WIFI-MESH allows for autonomous channel switching to be enabled/disabled via configuration. Likewise, autonomous router switching (i.e. when a root node autonomously connects to another router) can also be enabled/disabled by configuration. Autonomous channel switching and router switching is dependent on the following configuration parameters and run-time conditions.

**Allow Channel Switch:** This parameter is set via the `allow_channel_switch` field of the `mesh_cfg_t` structure and permits an ESP-WIFI-MESH network to dynamically switch channels when set.

**Preset Channel:** An ESP-WIFI-MESH network can have a preset channel by setting the `channel` field of the `mesh_cfg_t` structure to the desired channel number. If this field is unset, the `allow_channel_switch` parameter is overridden such that channel switches are always permitted.

**Allow Router Switch:** This parameter is set via the `allow_router_switch` field of the `mesh_router_t` and permits an ESP-WIFI-MESH to dynamically switch to a different router when set.

**Preset Router BSSID:** An ESP-WIFI-MESH network can have a preset router by setting the `bssid` field of the `mesh_router_t` structure to the BSSID of the desired router. If this field is unset, the `allow_router_switch` parameter is overridden such that router switches are always permitted.

**Root Node Present:** The presence of a root node will can also affect whether or a channel or router switch is permitted.

The following table illustrates how the different combinations of parameters/conditions affect whether channel switching and/or router switching is permitted. Note that X represents a “don’t care” for the parameter.



Preset Channel	Allow Channel Switch	Preset Router BSSID	Allow Router Switch	Root Node Present	Permitted Switches?
N	X	N	X	X	Channel and Router
N	X	Y	N	X	Channel Only
N	X	Y	Y	X	Channel and Router
Y	Y	N	X	X	Channel and Router
Y	N	N	X	N	Router Only
Y	N	N	X	Y	Channel and Router
Y	Y	Y	N	X	Channel Only
Y	N	Y	N	N	N
Y	N	Y	N	Y	Channel Only
Y	Y	Y	Y	X	Channel and Router
Y	N	Y	Y	N	Router Only
Y	N	Y	Y	Y	Channel and Router

### 4.11.8 Performance

The performance of an ESP-WIFI-MESH network can be evaluated based on multiple metrics such as the following:

**Network Building Time:** The amount of time taken to build an ESP-WIFI-MESH network from scratch.

**Healing Time:** The amount of time taken for the network to detect a node break down and carry out appropriate actions to heal the network (such as generating a new root node or forming new connections).

**Per-hop latency:** The latency of data transmission over one wireless hop. In other words, the time taken to transmit a data packet from a parent node to a child node or vice versa.

**Network Node Capacity:** The total number of nodes the ESP-WIFI-MESH network can simultaneously support. This number is determined by the maximum number of downstream connections a node can accept and the maximum number of layers permissible in the network.

The following table lists the common performance figures of an ESP-WIFI-MESH network:

- Network Building Time: < 60 seconds
- **Healing time:**
  - Root node break down: < 10 seconds
  - Child node break down: < 5 seconds
- Per-hop latency: 10 to 30 milliseconds

**Note:** The following test conditions were used to generate the performance figures above.

- Number of test devices: **100**
- Maximum Downstream Connections to Accept: **6**
- Maximum Permissible Layers: **6**

**Note:** Throughput depends on packet error rate and hop count.

**Note:** The throughput of root node's access to the external IP network is directly affected by the number of nodes in the ESP-WIFI-MESH network and the bandwidth of the router.

**Note:** The performance figures can vary greatly between installations based on network configuration and operating environment.

---

### 4.11.9 Further Notes

- Data transmission uses Wi-Fi WPA2-PSK encryption
- Mesh networking IE uses AES encryption

Router and internet icon made by [Smashicons](http://Smashicons.com) from [www.flaticon.com](http://www.flaticon.com)

## 4.12 Event Handling

Several ESP-IDF components use *events* to inform application about state changes, such as connection or disconnection. This document gives an overview of these event mechanisms.

### 4.12.1 Wi-Fi, Ethernet, and IP Events

Before the introduction of *esp\_event library*, events from Wi-Fi driver, Ethernet driver, and TCP/IP stack were dispatched using the so-called *legacy event loop*. The following sections explain each of the methods.

#### esp\_event Library Event Loop

esp\_event library is designed to supersede the legacy event loop for the purposes of event handling in ESP-IDF. In the legacy event loop, all possible event types and event data structures had to be defined in `system_event_id_t` enumeration and `system_event_info_t` union, which made it impossible to send custom events to the event loop, and use the event loop for other kinds of events (e.g. Mesh). Legacy event loop also supported only one event handler function, therefore application components could not handle some of Wi-Fi or IP events themselves, and required application to forward these events from its event handler function.

See *esp\_event library API reference* for general information on using this library. Wi-Fi, Ethernet, and IP events are sent to the *default event loop* provided by this library.

#### Legacy Event Loop

This event loop implementation is started using `esp_event_loop_init()` function. Application typically supplies an *event handler*, a function with the following signature:

```
esp_err_t event_handler(void *ctx, system_event_t *event)
{
}
```

Both the pointer to event handler function, and an arbitrary context pointer are passed to `esp_event_loop_init()`.

When Wi-Fi, Ethernet, or IP stack generate an event, this event is sent to a high-priority *event* task via a queue. Application-provided event handler function is called in the context of this task. Event task stack size and event queue size can be adjusted using `CONFIG_ESP_SYSTEM_EVENT_TASK_STACK_SIZE` and `CONFIG_ESP_SYSTEM_EVENT_QUEUE_SIZE` options, respectively.

Event handler receives a pointer to the event structure (`system_event_t`) which describes current event. This structure follows a *tagged union* pattern: `event_id` member indicates the type of event, and `event_info` member is a union of description structures. Application event handler will typically use `switch(event->event_id)` to handle different kinds of events.



If application event handler needs to relay the event to some other task, it is important to note that event pointer passed to the event handler is a pointer to temporary structure. To pass the event to another task, application has to make a copy of the entire structure.

### Event IDs and Corresponding Data Structures

Event ID (legacy event ID)	Event data structure
<b>Wi-Fi</b>	
WIFI_EVENT_WIFI_READY (SYSTEM_EVENT_WIFI_READY)	n/a
WIFI_EVENT_SCAN_DONE (SYSTEM_EVENT_SCAN_DONE)	<a href="#">wifi_event_sta_scan_done_t</a>
WIFI_EVENT_STA_START (SYSTEM_EVENT_STA_START)	n/a
WIFI_EVENT_STA_STOP (SYSTEM_EVENT_STA_STOP)	n/a
WIFI_EVENT_STA_CONNECTED (SYSTEM_EVENT_STA_CONNECTED)	<a href="#">wifi_event_sta_connected_t</a>
WIFI_EVENT_STA_DISCONNECTED (SYSTEM_EVENT_STA_DISCONNECTED)	<a href="#">wifi_event_sta_disconnected_t</a>
WIFI_EVENT_STA_AUTHMODE_CHANGE (SYSTEM_EVENT_STA_AUTHMODE_CHANGE)	<a href="#">wifi_event_sta_authmode_change_t</a>
WIFI_EVENT_STA_WPS_ER_SUCCESS (SYSTEM_EVENT_STA_WPS_ER_SUCCESS)	n/a
WIFI_EVENT_STA_WPS_ER_FAILED (SYSTEM_EVENT_STA_WPS_ER_FAILED)	<a href="#">wifi_event_sta_wps_fail_reason_t</a>
WIFI_EVENT_STA_WPS_ER_TIMEOUT (SYSTEM_EVENT_STA_WPS_ER_TIMEOUT)	n/a
WIFI_EVENT_STA_WPS_ER_PIN (SYSTEM_EVENT_STA_WPS_ER_PIN)	<a href="#">wifi_event_sta_wps_er_pin_t</a>
WIFI_EVENT_AP_START (SYSTEM_EVENT_AP_START)	n/a
WIFI_EVENT_AP_STOP (SYSTEM_EVENT_AP_STOP)	n/a
WIFI_EVENT_AP_STACONNECTED (SYSTEM_EVENT_AP_STACONNECTED)	<a href="#">wifi_event_ap_staconnected_t</a>
WIFI_EVENT_AP_STADISCONNECTED (SYSTEM_EVENT_AP_STADISCONNECTED)	<a href="#">wifi_event_ap_stadisconnected_t</a>
WIFI_EVENT_AP_PROBEREQRCVD (SYSTEM_EVENT_AP_PROBEREQRCVD)	<a href="#">wifi_event_ap_probe_req_rx_t</a>
<b>Ethernet</b>	
ETHERNET_EVENT_START (SYSTEM_EVENT_ETH_START)	n/a
ETHERNET_EVENT_STOP (SYSTEM_EVENT_ETH_STOP)	n/a
ETHERNET_EVENT_CONNECTED (SYSTEM_EVENT_ETH_CONNECTED)	n/a
ETHERNET_EVENT_DISCONNECTED (SYSTEM_EVENT_ETH_DISCONNECTED)	n/a
<b>IP</b>	
IP_EVENT_STA_GOT_IP (SYSTEM_EVENT_STA_GOT_IP)	<a href="#">ip_event_got_ip_t</a>
IP_EVENT_STA_LOST_IP (SYSTEM_EVENT_STA_LOST_IP)	n/a
IP_EVENT_AP_STAIPASSIGNED (SYSTEM_EVENT_AP_STAIPASSIGNED)	n/a
IP_EVENT_GOT_IP6 (SYSTEM_EVENT_GOT_IP6)	<a href="#">ip_event_got_ip6_t</a>
IP_EVENT_ETH_GOT_IP (SYSTEM_EVENT_ETH_GOT_IP)	<a href="#">ip_event_got_ip_t</a>
IP_EVENT_ETH_LOST_IP (SYSTEM_EVENT_ETH_LOST_IP)	n/a

#### 4.12.2 Mesh Events

ESP-WIFI-MESH uses a system similar to the [Legacy Event Loop](#) to deliver events to the application. See [System Events](#) for details.

### 4.12.3 Bluetooth Events

Various modules of the Bluetooth stack deliver events to applications via dedicated callback functions. Callback functions receive the event type (enumerated value) and event data (union of structures for each event type). The following list gives the registration API name, event enumeration type, and event parameters type.

- BLE GAP: `esp_ble_gap_register_callback()`, `esp_gap_ble_cb_event_t`, `esp_ble_gap_cb_param_t`.
- BT GAP: `esp_bt_gap_register_callback()`, `esp_bt_gap_cb_event_t`, `esp_bt_gap_cb_param_t`.
- GATT: `esp_ble_gattc_register_callback()`, `esp_ble_gattc_cb_event_t`, `esp_ble_gattc_cb_param_t`.
- GATTS: `esp_ble_gatts_register_callback()`, `esp_ble_gatts_cb_event_t`, `esp_ble_gatts_cb_param_t`.
- SPP: `esp_spp_register_callback()`, `esp_spp_cb_event_t`, `esp_spp_cb_param_t`.
- Blufi: `esp_blufi_register_callbacks()`, `esp_blufi_cb_event_t`, `esp_blufi_cb_param_t`.
- A2DP: `esp_a2d_register_callback()`, `esp_a2d_cb_event_t`, `esp_a2d_cb_param_t`.
- AVRC: `esp_avrc_ct_register_callback()`, `esp_avrc_ct_cb_event_t`, `esp_avrc_ct_cb_param_t`.
- HFP Client: `esp_hf_client_register_callback()`, `esp_hf_client_cb_event_t`, `esp_hf_client_cb_param_t`.
- HFP AG: `esp_bt_hf_register_callback()`, `esp_hf_cb_event_t`, `esp_hf_cb_param_t`.

## 4.13 Fatal Errors

### 4.13.1 Overview

In certain situations, execution of the program can not be continued in a well defined way. In ESP-IDF, these situations include:

- CPU Exceptions: Illegal Instruction, Load/Store Alignment Error, Load/Store Prohibited error, Double Exception.
- System level checks and safeguards:
  - *Interrupt watchdog* timeout
  - *Task watchdog* timeout (only fatal if `CONFIG_ESP_TASK_WDT_PANIC` is set)
  - Cache access error
  - Memory protection fault
  - Brownout detection event
  - Stack overflow
  - Stack smashing protection check
  - Heap integrity check
  - Undefined behavior sanitizer (UBSAN) checks
- Failed assertions, via `assert`, `configASSERT` and similar macros.

This guide explains the procedure used in ESP-IDF for handling these errors, and provides suggestions on troubleshooting the errors.

### 4.13.2 Panic Handler

Every error cause listed in the *Overview* will be handled by the *panic handler*.

The panic handler will start by printing the cause of the error to the console. For CPU exceptions, the message will be similar to

```
Guru Meditation Error: Core 0 panic'ed (IllegalInstruction). Exception was
↳unhandled.
```

For some of the system level checks (interrupt watchdog, cache access error), the message will be similar to

```
Guru Meditation Error: Core 0 panic'ed (Cache disabled but cached memory
↳region accessed). Exception was unhandled.
```

In all cases, the error cause will be printed in parentheses. See [Guru Meditation Errors](#) for a list of possible error causes.

Subsequent behavior of the panic handler can be set using `CONFIG_ESP_SYSTEM_PANIC` configuration choice. The available options are:

- Print registers and reboot (`CONFIG_ESP_SYSTEM_PANIC_PRINT_REBOOT`) —default option.  
This will print register values at the point of the exception, print the backtrace, and restart the chip.
- Print registers and halt (`CONFIG_ESP_SYSTEM_PANIC_PRINT_HALT`)  
Similar to the above option, but halt instead of rebooting. External reset is required to restart the program.
- Silent reboot (`CONFIG_ESP_SYSTEM_PANIC_SILENT_REBOOT`)  
Don't print registers or backtrace, restart the chip immediately.
- Invoke GDB Stub (`CONFIG_ESP_SYSTEM_PANIC_GDBSTUB`)  
Start GDB server which can communicate with GDB over console UART port. This option will only provide read-only debugging or post-mortem debugging. See [GDB Stub](#) for more details.
- Invoke dynamic GDB Stub (`ESP_SYSTEM_GDBSTUB_RUNTIME`)  
Start GDB server which can communicate with GDB over console UART port. This option allows the user to debug a program at run time and set break points, alter the execution, etc. See [GDB Stub](#) for more details.

The behavior of the panic handler is affected by two other configuration options.

- If `CONFIG_ESP_DEBUG_OCDAWARE` is enabled (which is the default), the panic handler will detect whether a JTAG debugger is connected. If it is, execution will be halted and control will be passed to the debugger. In this case, registers and backtrace are not dumped to the console, and GDBStub / Core Dump functions are not used.
- If the [Core Dump](#) feature is enabled, then the system state (task stacks and registers) will be dumped to either Flash or UART, for later analysis.
- If `CONFIG_ESP_PANIC_HANDLER_IRAM` is disabled (disabled by default), the panic handler code is placed in flash memory, not IRAM. This means that if ESP-IDF crashes while flash cache is disabled, the panic handler will automatically re-enable flash cache before running GDB Stub or Core Dump. This adds some minor risk, if the flash cache status is also corrupted during the crash.  
If this option is enabled, the panic handler code (including required UART functions) is placed in IRAM, and hence will decrease the usable memory space in SRAM. But this may be necessary to debug some complex issues with crashes while flash cache is disabled (for example, when writing to SPI flash) or when flash cache is corrupted when an exception is triggered.

The following diagram illustrates the panic handler behavior:

### 4.13.3 Register Dump and Backtrace

Unless the `CONFIG_ESP_SYSTEM_PANIC_SILENT_REBOOT` option is enabled, the panic handler prints some of the CPU registers, and the backtrace, to the console

```
Core 0 register dump:
PC      : 0x400e14ed  PS      : 0x00060030  A0      : 0x800d0805  A1      :
↳0x3ffb5030
A2      : 0x00000000  A3      : 0x00000001  A4      : 0x00000001  A5      :
↳0x3ffb50dc
A6      : 0x00000000  A7      : 0x00000001  A8      : 0x00000000  A9      :
↳0x3ffb5000
A10     : 0x00000000  A11     : 0x3ffb2bac  A12     : 0x40082d1c  A13     :
↳0x06ff1ff8
```

(continues on next page)

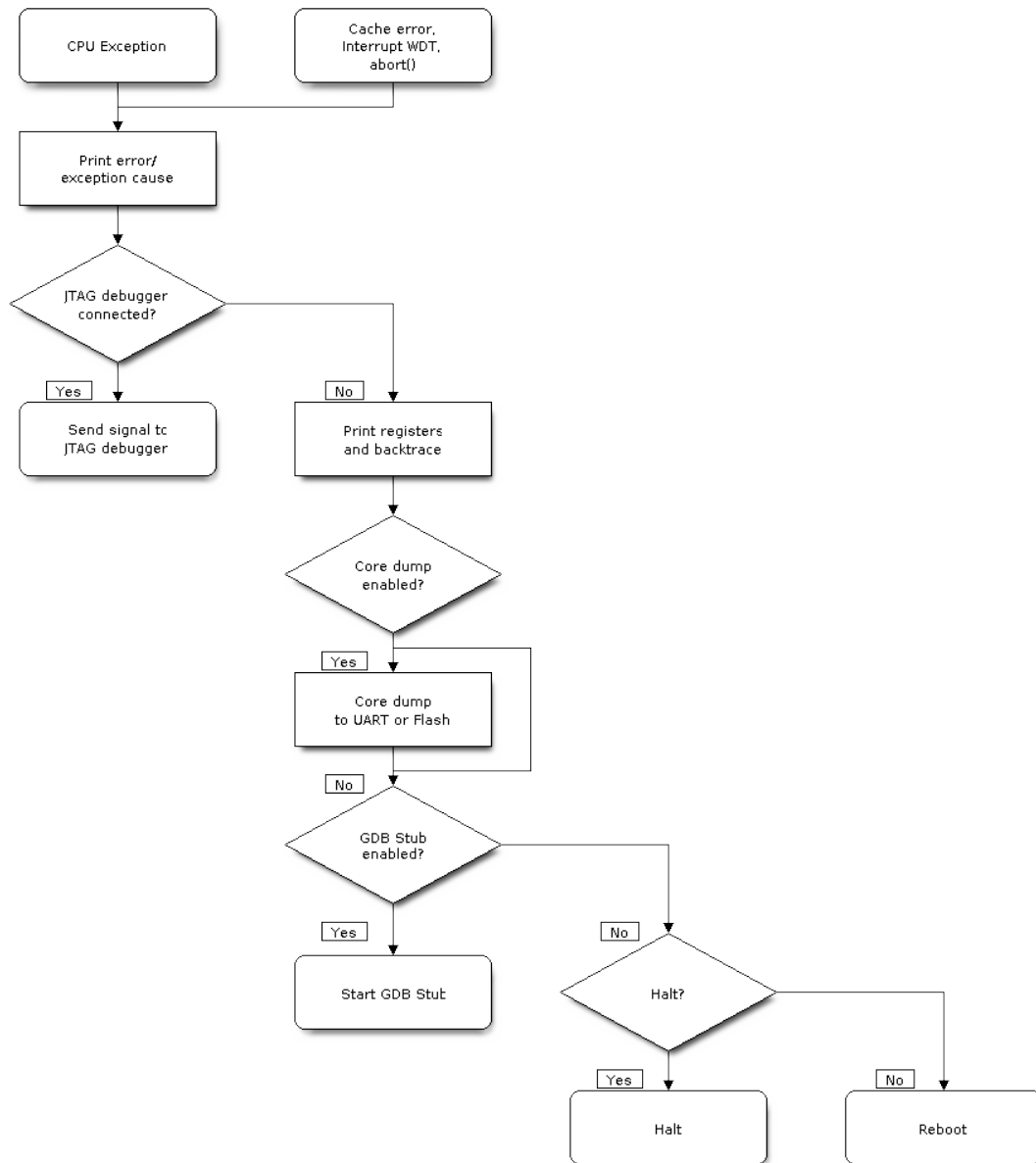

Fig. 22: Panic Handler Flowchart (click to enlarge)

(continued from previous page)

```

A14      : 0x3ffb7078  A15      : 0x00000000  SAR       : 0x00000014  EXCCAUSE:↵
↵0x0000001d
EXCVADDR: 0x00000000  LBEG     : 0x4000c46c  LEND      : 0x4000c477  LCOUNT  :↵
↵0xffffffff

Backtrace: 0x400e14ed:0x3ffb5030 0x400d0802:0x3ffb5050

```

The register values printed are the register values in the exception frame, i.e., values at the moment when the CPU exception or another fatal error has occurred.

A Register dump is not printed if the panic handler has been executed as a result of an `abort()` call.

In some cases, such as interrupt watchdog timeout, the panic handler may print additional CPU registers (EPC1-EPC4) and the registers/backtrace of the code running on the other CPU.

The backtrace line contains PC:SP pairs, where PC is the Program Counter and SP is Stack Pointer, for each stack frame of the current task. If a fatal error happens inside an ISR, the backtrace may include PC:SP pairs both from the task which was interrupted, and from the ISR.

If *IDF Monitor* is used, Program Counter values will be converted to code locations (function name, file name, and line number), and the output will be annotated with additional lines:

```

Core 0 register dump:
PC       : 0x400e14ed  PS       : 0x00060030  A0       : 0x800d0805  A1       :↵
↵0x3ffb5030
0x400e14ed: app_main at /Users/user/esp/example/main/main.cpp:36

A2       : 0x00000000  A3       : 0x00000001  A4       : 0x00000001  A5       :↵
↵0x3ffb50dc
A6       : 0x00000000  A7       : 0x00000001  A8       : 0x00000000  A9       :↵
↵0x3ffb5000
A10      : 0x00000000  A11      : 0x3ffb2bac  A12      : 0x40082d1c  A13      :↵
↵0x06ff1ff8
0x40082d1c: _calloc_r at /Users/user/esp/esp-idf/components/newlib/syscalls.c:51

A14      : 0x3ffb7078  A15      : 0x00000000  SAR       : 0x00000014  EXCCAUSE:↵
↵0x0000001d
EXCVADDR: 0x00000000  LBEG     : 0x4000c46c  LEND      : 0x4000c477  LCOUNT  :↵
↵0xffffffff

Backtrace: 0x400e14ed:0x3ffb5030 0x400d0802:0x3ffb5050
0x400e14ed: app_main at /Users/user/esp/example/main/main.cpp:36

0x400d0802: main_task at /Users/user/esp/esp-idf/components/esp32s2/cpu_start.c:470

```

To find the location where a fatal error has happened, look at the lines which follow the “Backtrace” line. Fatal error location is the top line, and subsequent lines show the call stack.

#### 4.13.4 GDB Stub

If the `CONFIG_ESP_SYSTEM_PANIC_GDBSTUB` option is enabled, the panic handler will not reset the chip when a fatal error happens. Instead, it will start a GDB remote protocol server, commonly referred to as GDB Stub. When this happens, a GDB instance running on the host computer can be instructed to connect to the ESP32-S2 UART port.

If *IDF Monitor* is used, GDB is started automatically when a GDB Stub prompt is detected on the UART. The output looks like this:

```

Entering gdb stub now.
$T0b#e6GNU gdb (crosstool-NG crosstool-ng-1.22.0-80-gff1f415) 7.10
Copyright (C) 2015 Free Software Foundation, Inc.

```

(continues on next page)

(continued from previous page)

```

License GPLv3+: GNU GPL version 3 or later <http://gnu.org/licenses/gpl.html>
This is free software: you are free to change and redistribute it.
There is NO WARRANTY, to the extent permitted by law.  Type "show copying"
and "show warranty" for details.
This GDB was configured as "--host=x86_64-build_apple-darwin16.3.0 --target=xtensa-
↳esp32s2-elf".
Type "show configuration" for configuration details.
For bug reporting instructions, please see:
<http://www.gnu.org/software/gdb/bugs/>.
Find the GDB manual and other documentation resources online at:
<http://www.gnu.org/software/gdb/documentation/>.
For help, type "help".
Type "apropos word" to search for commands related to "word"...
Reading symbols from /Users/user/esp/example/build/example.elf...done.
Remote debugging using /dev/cu.usbserial-31301
0x400e1b41 in app_main ()
    at /Users/user/esp/example/main/main.cpp:36
36      *((int*) 0) = 0;
(gdb)

```

The GDB prompt can be used to inspect CPU registers, local and static variables, and arbitrary locations in memory. It is not possible to set breakpoints, change the PC, or continue execution. To reset the program, exit GDB and perform an external reset: Ctrl-T Ctrl-R in IDF Monitor, or using the external reset button on the development board.

### 4.13.5 RTC Watchdog Timeout

The RTC watchdog is used in the startup code to keep track of execution time and it also helps to prevent a lock-up caused by an unstable power source. It is enabled by default (see [CONFIG\\_BOOTLOADER\\_WDT\\_ENABLE](#)). If the execution time is exceeded, the RTC watchdog will restart the system. In this case, the ROM bootloader will print a message with the RTC Watchdog Timeout reason for the reboot.

```
rst:0x10 (RTCWDT_RTC_RST)
```

The RTC watchdog covers the execution time from the first stage bootloader (ROM bootloader) to application startup. It is initially set in the ROM bootloader, then configured in the bootloader with the [CONFIG\\_BOOTLOADER\\_WDT\\_TIME\\_MS](#) option (9000 ms by default). During the application initialization stage, it is reconfigured because the source of the slow clock may have changed, and finally disabled right before the `app_main()` call. There is an option [CONFIG\\_BOOTLOADER\\_WDT\\_DISABLE\\_IN\\_USER\\_CODE](#) which prevents the RTC watchdog from being disabled before `app_main`. Instead, the RTC watchdog remains active and must be fed periodically in your application's code.

### 4.13.6 Guru Meditation Errors

This section explains the meaning of different error causes, printed in parens after the Guru Meditation Error: Core panic'ed message.

---

**Note:** See the [Guru Meditation Wikipedia article](#) for historical origins of “Guru Meditation” .

---

#### IllegalInstruction

This CPU exception indicates that the instruction which was executed was not a valid instruction. Most common reasons for this error include:

- FreeRTOS task function has returned. In FreeRTOS, if a task function needs to terminate, it should call `vTaskDelete()` and delete itself, instead of returning.

- Failure to read next instruction from SPI flash. This usually happens if:
  - Application has reconfigured the SPI flash pins as some other function (GPIO, UART, etc.). Consult the Hardware Design Guidelines and the datasheet for the chip or module for details about the SPI flash pins.
  - Some external device has accidentally been connected to the SPI flash pins, and has interfered with communication between ESP32-S2 and SPI flash.
- In C++ code, exiting from a non-void function without returning a value is considered to be an undefined behavior. When optimizations are enabled, the compiler will often omit the epilogue in such functions. This most often results in an `IllegalInstruction` exception. By default, ESP-IDF build system enables `-Werror=return-type` which means that missing return statements are treated as compile time errors. However if the application project disables compiler warnings, this issue might go undetected and the `IllegalInstruction` exception will occur at run time.

### **InstrFetchProhibited**

This CPU exception indicates that the CPU could not read an instruction because the address of the instruction does not belong to a valid region in instruction RAM or ROM.

Usually, this means an attempt to call a function pointer, which does not point to valid code. `PC` (Program Counter) register can be used as an indicator: it will be zero or will contain a garbage value (not `0x4xxxxxxxx`).

### **LoadProhibited, StoreProhibited**

These CPU exceptions happen when an application attempts to read from or write to an invalid memory location. The address which has been written/read is found in the `EXCVADDR` register in the register dump. If this address is zero, it usually means that the application has attempted to dereference a `NULL` pointer. If this address is close to zero, it usually means that the application has attempted to access a member of a structure, but the pointer to the structure is `NULL`. If this address is something else (garbage value, not in `0x3fxxxxxxx - 0x6xxxxxxx` range), it likely means that the pointer used to access the data is either not initialized or has been corrupted.

### **IntegerDivideByZero**

Application has attempted to do an integer division by zero.

### **LoadStoreAlignment**

Application has attempted to read or write a memory location, and the address alignment does not match the load/store size. For example, a 32-bit read can only be done from a 4-byte aligned address, and a 16-bit write can only be done to a 2-byte aligned address.

### **LoadStoreError**

This exception may happen in the following cases:

- If the application has attempted to do an 8- or 16- bit read to, or write from, a memory region which only supports 32-bit reads/writes. For example, dereferencing a `char*` pointer to instruction memory (IRAM, IROM) will result in such an error.
- If the application has attempted to write to a read-only memory region, such as IROM or DROM.

### **Unhandled debug exception**

This will usually be followed by a message like:

```
Debug exception reason: Stack canary watchpoint triggered (task_name)
```

This error indicates that the application has written past the end of the stack of the task with name `task_name`. Note that not every stack overflow is guaranteed to trigger this error. It is possible that the task writes to memory beyond the stack canary location, in which case the watchpoint will not be triggered.

### Interrupt wdt timeout on CPU0 / CPU1

Indicates that an interrupt watchdog timeout has occurred. See [Watchdogs](#) for more information.

### Cache disabled but cached memory region accessed

In some situations, ESP-IDF will temporarily disable access to external SPI Flash and SPI RAM via caches. For example, this happens when `spi_flash` APIs are used to read/write/erase/mmap regions of SPI Flash. In these situations, tasks are suspended, and interrupt handlers not registered with `ESP_INTR_FLAG_IRAM` are disabled. Make sure that any interrupt handlers registered with this flag have all the code and data in IRAM/DRAM. Refer to the [SPI flash API documentation](#) for more details.

### Memory protection fault

ESP32-S2 Permission Control feature is used in ESP-IDF to prevent the following types of memory access:

- writing to instruction RAM after the program is loaded
- executing code from data RAM (areas used for heap and static `.data` and `.bss`)

Such operations are not necessary for most programs. Prohibiting such operations typically makes software vulnerabilities harder to exploit. Applications which rely on dynamic loading or self-modifying code may disable this protection using `CONFIG_ESP_SYSTEM_MEMPROT_FEATURE` Kconfig option.

When the fault occurs, the panic handler reports the address of the fault and the type of memory access that caused it.

## 4.13.7 Other Fatal Errors

### Brownout

ESP32-S2 has a built-in brownout detector, which is enabled by default. The brownout detector can trigger a system reset if the supply voltage goes below a safe level. The brownout detector can be configured using `CONFIG_ESP_BROWNOUT_DET` and `CONFIG_ESP_BROWNOUT_DET_LVL_SEL` options.

When the brownout detector triggers, the following message is printed:

```
Brownout detector was triggered
```

The chip is reset after the message is printed.

Note that if the supply voltage is dropping at a fast rate, only part of the message may be seen on the console.

### Corrupt Heap

ESP-IDF's heap implementation contains a number of run-time checks of the heap structure. Additional checks ("Heap Poisoning") can be enabled in menuconfig. If one of the checks fails, a message similar to the following will be printed:

```
CORRUPT HEAP: Bad tail at 0x3ffe270a. Expected 0xbaad5678 got 0xbaac5678
assertion "head != NULL" failed: file "/Users/user/esp/esp-idf/components/heap/
↳multi_heap_poisoning.c", line 201, function: multi_heap_free
abort() was called at PC 0x400dca43 on core 0
```

Consult [Heap Memory Debugging](#) documentation for further information.



## Stack Smashing

Stack smashing protection (based on GCC `-fstack-protector*` flags) can be enabled in ESP-IDF using `CONFIG_COMPILER_STACK_CHECK_MODE` option. If stack smashing is detected, message similar to the following will be printed:

```
Stack smashing protect failure!

abort() was called at PC 0x400d2138 on core 0

Backtrace: 0x4008e6c0:0x3ffc1780 0x4008e8b7:0x3ffc17a0 0x400d2138:0x3ffc17c0_
↳0x400e79d5:0x3ffc17e0 0x400e79a7:0x3ffc1840 0x400e79df:0x3ffc18a0_
↳0x400e2235:0x3ffc18c0 0x400e1916:0x3ffc18f0 0x400e19cd:0x3ffc1910_
↳0x400e1a11:0x3ffc1930 0x400e1bb2:0x3ffc1950 0x400d2c44:0x3ffc1a80
0
```

The backtrace should point to the function where stack smashing has occurred. Check the function code for unbounded access to local arrays.

## Undefined behavior sanitizer (UBSAN) checks

Undefined behavior sanitizer (UBSAN) is a compiler feature which adds run-time checks for potentially incorrect operations, such as:

- overflows (multiplication overflow, signed integer overflow)
- shift base or exponent errors (e.g. shift by more than 32 bits)
- integer conversion errors

See [GCC documentation](#) of `-fsanitize=undefined` option for the complete list of supported checks.

**Enabling UBSAN** UBSAN is disabled by default. It can be enabled at file, component, or project level by adding the `-fsanitize=undefined` compiler option in the build system.

When enabling UBSAN for code which uses the SOC hardware register header files (`soc/xxx_reg.h`), it is recommended to disable shift-base sanitizer using `-fno-sanitize=shift-base` option. This is due to the fact that ESP-IDF register header files currently contain patterns which cause false positives for this specific sanitizer option.

To enable UBSAN at project level, add the following code at the end of the project's `CMakeLists.txt` file:

```
idf_build_set_property(COMPILER_OPTIONS "-fsanitize=undefined" "-fno-sanitize=shift-
↳base" APPEND)
```

Alternatively, pass these options through the `EXTRA_CFLAGS` and `EXTRA_CXXFLAGS` environment variables.

Enabling UBSAN results in significant increase of code and data size. Most applications, except for the trivial ones, will not fit into the available RAM of the microcontroller when UBSAN is enabled for the whole application. Therefore it is recommended that UBSAN is instead enabled for specific components under test.

To enable UBSAN for a specific component (`component_name`) from the project's `CMakeLists.txt` file, add the following code at the end of the file:

```
idf_component_get_property(lib component_name COMPONENT_LIB)
target_compile_options(${lib} PRIVATE "-fsanitize=undefined" "-fno-sanitize=shift-
↳base")
```

---

**Note:** See the build system documentation for more information about [build properties](#) and [component properties](#).

---

To enable UBSAN for a specific component (`component_name`) from `CMakeLists.txt` of the same component, add the following at the end of the file:

```
target_compile_options(${COMPONENT_LIB} PRIVATE "-fsanitize=undefined" "-fno-
↳sanitize=shift-base")
```

**UBSAN output** When UBSAN detects an error, a message and the backtrace are printed, for example:

```
Undefined behavior of type out_of_bounds

Backtrace:0x4008b383:0x3ffcd8b0 0x4008c791:0x3ffcd8d0 0x4008c587:0x3ffcd8f0_
↳0x4008c6be:0x3ffcd950 0x400db74f:0x3ffcd970 0x400db99c:0x3ffcd9a0
```

When using *IDF Monitor*, the backtrace will be decoded to function names and source code locations, pointing to the location where the issue has happened (here it is `main.c:128`):

```
0x4008b383: panic_abort at /path/to/esp-idf/components/esp_system/panic.c:367

0x4008c791: esp_system_abort at /path/to/esp-idf/components/esp_system/system_api.
↳c:106

0x4008c587: __ubsan_default_handler at /path/to/esp-idf/components/esp_system/
↳ubsan.c:152

0x4008c6be: __ubsan_handle_out_of_bounds at /path/to/esp-idf/components/esp_system/
↳ubsan.c:223

0x400db74f: test_ub at main.c:128

0x400db99c: app_main at main.c:56 (discriminator 1)
```

The types of errors reported by UBSAN can be as follows:

Name	Meaning
<code>type_mismatch</code> , <code>type_mismatch_v1</code>	Incorrect pointer value: null, unaligned, not compatible with the given type.
<code>add_overflow</code> , <code>sub_overflow</code> , <code>mul_overflow</code> , <code>negate_overflow</code>	Integer overflow during addition, subtraction, multiplication, negation.
<code>divrem_overflow</code>	Integer division by 0 or <code>INT_MIN</code> .
<code>shift_out_of_bounds</code>	Overflow in left or right shift operators.
<code>out_of_bounds</code>	Access outside of bounds of an array.
<code>unreachable</code>	Unreachable code executed.
<code>missing_return</code>	Non-void function has reached its end without returning a value (C++ only).
<code>vla_bound_not_positive</code>	Size of variable length array is not positive.
<code>load_invalid_value</code>	Value of <code>bool</code> or <code>enum</code> (C++ only) variable is invalid (out of bounds).
<code>nonnull_arg</code>	Null argument passed to a function which is declared with a <code>nonnull</code> attribute.
<code>nonnull_return</code>	Null value returned from a function which is declared with <code>returns_nonnull</code> attribute.
<code>builtin_unreachable</code>	<code>__builtin_unreachable</code> function called.
<code>pointer_overflow</code>	Overflow in pointer arithmetic.

## 4.14 Flash Encryption

This is a quick start guide to ESP32-S2's flash encryption feature. Using application code as an example, it demonstrates how to test and verify flash encryption operations during development and production.

### 4.14.1 Introduction

Flash encryption is intended for encrypting the contents of the ESP32-S2's off-chip flash memory. Once this feature is enabled, firmware is flashed as plaintext, and then the data is encrypted in place on the first boot. As a result, physical readout of flash will not be sufficient to recover most flash contents.

With flash encryption enabled, the following types of data are encrypted by default:

- Firmware bootloader
- Partition Table
- All “app” type partitions

Other types of data can be encrypted conditionally:

- Any partition marked with the `encrypted` flag in the partition table. For details, see [Encrypted Partition Flag](#).
- Secure Boot bootloader digest if Secure Boot is enabled (see below).

---

**Important:** For production use, flash encryption should be enabled in the “Release” mode only.

---

---

**Important:** Enabling flash encryption limits the options for further updates of ESP32-S2. Before using this feature, read the document and make sure to understand the implications.

---

### 4.14.2 Relevant eFuses

The flash encryption operation is controlled by various eFuses available on ESP32-S2. The list of eFuses and their descriptions is given in the table below. The names in eFuse column are also used by `es-efuse.py` tool. For usage in the eFuse API, modify the name by adding `ESP_EFUSE_`, for example: `esp_efuse_read_field_bit(ESP_EFUSE_DISABLE_DL_ENCRYPT)`.

Table 1: eFuses Used in Flash Encryption

eFuse	Description	Bit Depth
BLOCK_KEYN	AES key storage. N is between 0 and 5.	One 256 bit key block for XTS_AES_128, Two 256 bit key blocks for XTS_AES_256 (512 bit total)
KEY_PURPOSE_N	Controls the purpose of eFuse block BLOCK_KEYN, where N is between 0 and 5. Possible values: 2 for XTS_AES_256_KEY_1, 3 for XTS_AES_256_KEY_2, and 4 for XTS_AES_128_KEY. Final AES key is derived based on the value of one or two of these purpose eFuses. For a detailed description of the possible combinations, see <i>ESP32-S2 Technical Reference Manual &gt; External Memory Encryption and Decryption (XTS_AES)</i> [PDF].	4
DIS_DOWNLOAD_MANUAL_ENCRYPT	Bitset, disables flash encryption when in download boot-modes.	1
SPI_BOOT_CRYPT_CNT	Enables encryption and decryption, when an SPI boot mode is set. Feature is enabled if 1 or 3 bits are set in the eFuse, disabled otherwise.	3

**Note:**

- R/W access control is available for all the eFuse bits listed in the table above.
- The default value of these bits is 0 after manufacturing.

Read and write access to eFuse bits is controlled by appropriate fields in the registers WR\_DIS and RD\_DIS. For more information on ESP32-S2 eFuses, see *eFuse manager*. To change protection bits of eFuse field using `espefuse.py`, use these two commands: `read_protect_efuse` and `write_protect_efuse`. Example `espefuse.py write_protect_efuse DISABLE_DL_ENCRYPT`.

### 4.14.3 Flash Encryption Process

Assuming that the eFuse values are in their default states and the firmware bootloader is compiled to support flash encryption, the flash encryption process executes as shown below:

1. On the first power-on reset, all data in flash is un-encrypted (plaintext). The ROM bootloader loads the firmware bootloader.
2. Firmware bootloader reads the SPI\_BOOT\_CRYPT\_CNT eFuse value (0b000). Since the value is 0 (even number of bits set), it configures and enables the flash encryption block. For more information on the flash encryption block, see *ESP32-S2 Technical Reference Manual > eFuse Controller (eFuse) > Auto Encryption Block* [PDF].
3. Firmware bootloader uses RNG (random) module to generate an 256 bit or 512 bit key, depending on the value of *Size of generated AES-XTS key*, and then writes it into respectively one or two BLOCK\_KEYN eFuses. The software also updates the KEY\_PURPOSE\_N for the blocks where the keys were stored. The key cannot be accessed via software as the write and read protection bits for one or two BLOCK\_KEYN eFuses are set. KEY\_PURPOSE\_N field is write-protected as well. The flash encryption operations happen entirely by hardware, and the key cannot be accessed via software.

- Flash encryption block encrypts the flash contents - the firmware bootloader, applications and partitions marked as `encrypted`. Encrypting in-place can take time, up to a minute for large partitions.
- Firmware bootloader sets the first available bit in `SPI_BOOT_CRYPT_CNT` (0b001) to mark the flash contents as encrypted. Odd number of bits is set.
- For *Development Mode*, the firmware bootloader allows the UART bootloader to re-flash encrypted binaries. Also, the `SPI_BOOT_CRYPT_CNT` eFuse bits are NOT write-protected. In addition, the firmware bootloader by default sets the following eFuse bits:

- `DIS_BOOT_REMAP`
- `DIS_DOWNLOAD_ICACHE`
- `DIS_DOWNLOAD_DCACHE`
- `HARD_DIS_JTAG`
- `DIS_LEGACY_SPI_BOOT`

- For *Release Mode*, the firmware bootloader sets all the eFuse bits set under development mode as well as `DIS_DOWNLOAD_MANUAL_ENCRYPT`. It also write-protects the `SPI_BOOT_CRYPT_CNT` eFuse bits. To modify this behavior, see *Enabling UART Bootloader Encryption/Decryption*.
- The device is then rebooted to start executing the encrypted image. The firmware bootloader calls the flash decryption block to decrypt the flash contents and then loads the decrypted contents into IRAM.

During the development stage, there is a frequent need to program different plaintext flash images and test the flash encryption process. This requires that Firmware Download mode is able to load new plaintext images as many times as it might be needed. However, during manufacturing or production stages, Firmware Download mode should not be allowed to access flash contents for security reasons.

Hence, two different flash encryption configurations were created: for development and for production. For details on these configurations, see Section *Flash Encryption Configuration*.

#### 4.14.4 Flash Encryption Configuration

The following flash encryption modes are available:

- Development Mode* - recommended for use only during development. In this mode, it is still possible to flash new plaintext firmware to the device, and the bootloader will transparently encrypt this firmware using the key stored in hardware. This allows, indirectly, to read out the plaintext of the firmware in flash.
- Release Mode* - recommended for manufacturing and production. In this mode, flashing plaintext firmware to the device without knowing the encryption key is no longer possible.

This section provides information on the mentioned flash encryption modes and step by step instructions on how to use them.

##### Development Mode

During development, you can encrypt flash using either an ESP32-S2 generated key or external host-generated key.

**Using ESP32-S2 Generated Key** Development mode allows you to download multiple plaintext images using Firmware Download mode.

To test flash encryption process, take the following steps:

- Ensure that you have an ESP32-S2 device with default flash encryption eFuse settings as shown in *Relevant eFuses*.

See how to check *ESP32-S2 Flash Encryption Status*.

- In *Project Configuration Menu*, do the following:

- Enable flash encryption on boot*.

- *Select encryption mode* (**Development mode** by default).
- *Select UART ROM download mode* (**enabled** by default).
- *Set Size of generated AES-XTS key*.
- *Select the appropriate bootloader log verbosity*.
- Save the configuration and exit.

Enabling flash encryption will increase the size of bootloader, which might require updating partition table offset. See [Bootloader Size](#).

3. Run the command given below to build and flash the complete images.

```
idf.py flash monitor
```

**Note:** This command does not include any user files which should be written to the partitions on the flash memory. Please write them manually before running this command otherwise the files should be encrypted separately before writing.

This command will write to flash memory unencrypted images: the firmware bootloader, the partition table and applications. Once the flashing is complete, ESP32-S2 will reset. On the next boot, the firmware bootloader encrypts: the firmware bootloader, application partitions and partitions marked as encrypted then resets. Encrypting in-place can take time, up to a minute for large partitions. After that, the application is decrypted at runtime and executed.

A sample output of the first ESP32-S2 boot after enabling flash encryption is given below:

```
ESP-ROM:esp32s2-rc4-20191025
Build:Oct 25 2019
rst:0x1 (POWERON),boot:0x8 (SPI_FAST_FLASH_BOOT)
SPIWP:0xee
mode:DIO, clock div:1
load:0x3ffe6260,len:0x78
load:0x3ffe62d8,len:0x231c
load:0x4004c000,len:0x9d8
load:0x40050000,len:0x3cf8
entry 0x4004c1ec
I (48) boot: ESP-IDF qa-test-v4.3-20201113-777-gd8e1 2nd stage bootloader
I (48) boot: compile time 11:24:04
I (48) boot: chip revision: 0
I (52) boot.esp32s2: SPI Speed      : 80MHz
I (57) boot.esp32s2: SPI Mode      : DIO
I (62) boot.esp32s2: SPI Flash Size : 2MB
I (66) boot: Enabling RNG early entropy source...
I (72) boot: Partition Table:
I (75) boot: ## Label                Usage            Type ST Offset   Length
I (83) boot:  0 nvs                   WiFi data        01 02 0000a000 00006000
I (90) boot:  1 storage                Unknown data     01 ff 00010000 00001000
I (98) boot:  2 factory                factory app      00 00 00020000 00100000
I (105) boot: End of partition table
I (109) esp_image: segment 0: paddr=0x00020020 vaddr=0x3f000020 size=0x0618c ( ↵
↵24972) map
I (124) esp_image: segment 1: paddr=0x000261b4 vaddr=0x3ffbcae0 size=0x02624 ( ↵
↵9764) load
I (129) esp_image: segment 2: paddr=0x000287e0 vaddr=0x40022000 size=0x00404 ( ↵
↵1028) load
0x40022000: _WindowOverflow4 at /home/marius/esp-idf/components/freertos/port/
↵xtensa/xtensa_vectors.S:1730
I (136) esp_image: segment 3: paddr=0x00028bec vaddr=0x40022404 size=0x0742c ( ↵
↵29740) load
0x40022404: _coredump_iram_end at ????
```

(continues on next page)

(continued from previous page)

```

I (153) esp_image: segment 4: paddr=0x00030020 vaddr=0x40080020 size=0x1457c (
↳83324) map
0x40080020: _stext at ???

I (171) esp_image: segment 5: paddr=0x000445a4 vaddr=0x40029830 size=0x032ac (
↳12972) load
0x40029830: gpspi_flash_ll_set_miso_bitlen at /home/marius/esp-idf/examples/
↳security/flash_encryption/build/../../../../../components/hal/esp32s2/include/hal/
↳gpspi_flash_ll.h:261
(inlined by) spi_flash_hal_gpspi_common_command at /home/marius/esp-idf/components/
↳hal/spi_flash_hal_common.inc:161

I (181) boot: Loaded app from partition at offset 0x20000
I (181) boot: Checking flash encryption...
I (181) efuse: Batch mode of writing fields is enabled
I (188) flash_encrypt: Generating new flash encryption key...
W (199) flash_encrypt: Not disabling UART bootloader encryption
I (201) flash_encrypt: Disable UART bootloader cache...
I (207) flash_encrypt: Disable JTAG...
I (212) efuse: Batch mode of writing fields is disabled
I (217) esp_image: segment 0: paddr=0x00001020 vaddr=0x3ffe6260 size=0x00078 (
↳120)
I (226) esp_image: segment 1: paddr=0x000010a0 vaddr=0x3ffe62d8 size=0x0231c (
↳8988)
I (236) esp_image: segment 2: paddr=0x000033c4 vaddr=0x4004c000 size=0x009d8 (
↳2520)
I (243) esp_image: segment 3: paddr=0x00003da4 vaddr=0x40050000 size=0x03cf8 (
↳15608)
I (651) flash_encrypt: bootloader encrypted successfully
I (704) flash_encrypt: partition table encrypted and loaded successfully
I (704) flash_encrypt: Encrypting partition 1 at offset 0x10000 (length 0x1000)...
I (765) flash_encrypt: Done encrypting
I (766) esp_image: segment 0: paddr=0x00020020 vaddr=0x3f000020 size=0x0618c (
↳24972) map
I (773) esp_image: segment 1: paddr=0x000261b4 vaddr=0x3ffbcae0 size=0x02624 (
↳9764)
I (778) esp_image: segment 2: paddr=0x000287e0 vaddr=0x40022000 size=0x00404 (
↳1028)
0x40022000: _WindowOverflow4 at /home/marius/esp-idf/components/freertos/port/
↳xtensa/xtensa_vectors.S:1730

I (785) esp_image: segment 3: paddr=0x00028bec vaddr=0x40022404 size=0x0742c (
↳29740)
0x40022404: _coredump_iram_end at ???

I (799) esp_image: segment 4: paddr=0x00030020 vaddr=0x40080020 size=0x1457c (
↳83324) map
0x40080020: _stext at ???

I (820) esp_image: segment 5: paddr=0x000445a4 vaddr=0x40029830 size=0x032ac (
↳12972)
0x40029830: gpspi_flash_ll_set_miso_bitlen at /home/marius/esp-idf/examples/
↳security/flash_encryption/build/../../../../../components/hal/esp32s2/include/hal/
↳gpspi_flash_ll.h:261
(inlined by) spi_flash_hal_gpspi_common_command at /home/marius/esp-idf/components/
↳hal/spi_flash_hal_common.inc:161

I (823) flash_encrypt: Encrypting partition 2 at offset 0x20000 (length 0x100000)..
↳.
I (13869) flash_encrypt: Done encrypting
I (13870) flash_encrypt: Flash encryption completed

```

(continues on next page)

(continued from previous page)

```
I (13870) boot: Resetting with flash encryption enabled...
```

A sample output of subsequent ESP32-S2 boots just mentions that flash encryption is already enabled:

```
ESP-ROM:esp32s2-rc4-20191025
Build:Oct 25 2019
rst:0x3 (RTC_SW_SYS_RST),boot:0x8 (SPI_FAST_FLASH_BOOT)
Saved PC:0x40051242
SPIWP:0xee
mode:DIO, clock div:1
load:0x3ffe6260,len:0x78
load:0x3ffe62d8,len:0x231c
load:0x4004c000,len:0x9d8
load:0x40050000,len:0x3cf8
entry 0x4004c1ec
I (56) boot: ESP-IDF qa-test-v4.3-20201113-777-gd8e1 2nd stage bootloader
I (56) boot: compile time 11:24:04
I (56) boot: chip revision: 0
I (60) boot.esp32s2: SPI Speed      : 80MHz
I (65) boot.esp32s2: SPI Mode      : DIO
I (69) boot.esp32s2: SPI Flash Size : 2MB
I (74) boot: Enabling RNG early entropy source...
I (80) boot: Partition Table:
I (83) boot: ## Label                Usage                Type ST Offset   Length
I (90) boot:  0 nvs                   WiFi data            01 02 0000a000 00006000
I (98) boot:  1 storage                Unknown data         01 ff 00010000 00001000
I (105) boot:  2 factory                factory app          00 00 00020000 00100000
I (113) boot: End of partition table
I (117) esp_image: segment 0: paddr=0x00020020 vaddr=0x3f000020 size=0x0618c ( ↵
↪24972) map
I (132) esp_image: segment 1: paddr=0x000261b4 vaddr=0x3ffbcae0 size=0x02624 ( ↵
↪9764) load
I (137) esp_image: segment 2: paddr=0x000287e0 vaddr=0x40022000 size=0x00404 ( ↵
↪1028) load
0x40022000: _WindowOverflow4 at /home/marius/esp-idf/components/freertos/port/
↪xtensa/xtensa_vectors.S:1730
I (144) esp_image: segment 3: paddr=0x00028bec vaddr=0x40022404 size=0x0742c ( ↵
↪29740) load
0x40022404: _coredump_iram_end at ???
I (161) esp_image: segment 4: paddr=0x00030020 vaddr=0x40080020 size=0x1457c ( ↵
↪83324) map
0x40080020: _stext at ???
I (180) esp_image: segment 5: paddr=0x000445a4 vaddr=0x40029830 size=0x032ac ( ↵
↪12972) load
0x40029830: gpspi_flash_ll_set_miso_bitlen at /home/marius/esp-idf/examples/
↪security/flash_encryption/build/../../../../components/hal/esp32s2/include/hal/
↪gpspi_flash_ll.h:261
(inlined by) spi_flash_hal_gpspi_common_command at /home/marius/esp-idf/components/
↪hal/spi_flash_hal_common.inc:161
I (190) boot: Loaded app from partition at offset 0x20000
I (191) boot: Checking flash encryption...
I (191) flash_encrypt: flash encryption is enabled (1 plaintext flashes left)
I (199) boot: Disabling RNG early entropy source...
I (216) cache: Instruction cache      : size 8KB, 4Ways, cache line size 32Byte
I (216) cpu_start: Pro cpu up.
I (268) cpu_start: Pro cpu start user code
I (268) cpu_start: cpu freq: 160000000
```

(continues on next page)



(continued from previous page)

```

I (268) cpu_start: Application information:
I (271) cpu_start: Project name:      flash_encryption
I (277) cpu_start: App version:      qa-test-v4.3-20201113-777-gd8e1
I (284) cpu_start: Compile time:     Dec 21 2020 11:24:00
I (290) cpu_start: ELF file SHA256:  30fd1b899312fef7...
I (296) cpu_start: ESP-IDF:         qa-test-v4.3-20201113-777-gd8e1
I (303) heap_init: Initializing. RAM available for dynamic allocation:
I (310) heap_init: At 3FF9E000 len 00002000 (8 KiB): RTCRAM
I (316) heap_init: At 3FFBF898 len 0003C768 (241 KiB): DRAM
I (323) heap_init: At 3FFFC000 len 00003A10 (14 KiB): DRAM
W (329) flash_encrypt: Flash encryption mode is DEVELOPMENT (not secure)
I (336) spi_flash: detected chip: generic
I (341) spi_flash: flash io: dio
W (345) spi_flash: Detected size(4096k) larger than the size in the binary image_
↳header(2048k). Using the size in the binary image header.
I (358) cpu_start: Starting scheduler on PRO CPU.

```

```

Example to check Flash Encryption status
This is esp32s2 chip with 1 CPU core(s), WiFi, silicon revision 0, 2MB external_
↳flash
FLASH_CRYPT_CNT eFuse value is 1
Flash encryption feature is enabled in DEVELOPMENT mode

```

At this stage, if you need to update and re-flash binaries, see [Re-flashing Updated Partitions](#).

**Using Host Generated Key** It is possible to pre-generate a flash encryption key on the host computer and burn it into the eFuse. This allows you to pre-encrypt data on the host and flash already encrypted data without needing a plaintext flash update. This feature can be used in both [Development Mode](#) and [Release Mode](#). Without a pre-generated key, data is flashed in plaintext and then ESP32-S2 encrypts the data in-place.

---

**Note:** This option is not recommended for production, unless a separate key is generated for each individual device.

---

To use a host generated key, take the following steps:

1. Ensure that you have an ESP32-S2 device with default flash encryption eFuse settings as shown in [Relevant eFuses](#).

See how to check [ESP32-S2 Flash Encryption Status](#).

2. Generate a random key by running:

If *Size of generated AES-XTS key* is AES-128 (256-bit key):

```
espsecure.py generate_flash_encryption_key my_flash_encryption_key.bin
```

else if *Size of generated AES-XTS key* is AES-256 (512-bit key):

```
espsecure.py generate_flash_encryption_key --keylen 512 my_flash_
↳encryption_key.bin
```

3. **Before the first encrypted boot**, burn the key into your device's eFuse using the command below. This action can be done **only once**.

```
espefuse.py --port PORT burn_key BLOCK my_flash_encryption_key.bin_
↳KEYPURPOSE
```

where BLOCK is a free keyblock between BLOCK\_KEY0 and BLOCK\_KEY5. And KEYPURPOSE is either AES\_256\_KEY\_1, XTS\_AES\_256\_KEY\_2, XTS\_AES\_128\_KEY. See [ESP32-S2 Technical Reference Manual](#) for a description of the key purposes.

For AES-128 (256-bit key) - XTS\_AES\_128\_KEY:

```
espefuse.py --port PORT burn_key BLOCK my_flash_encryption_key.bin XTS_
↳AES_128_KEY
```

For AES-256 (512-bit key) - XTS\_AES\_256\_KEY\_1 and XTS\_AES\_256\_KEY\_2. espefuse.py supports burning both these two key purposes together with a 512 bit key to two separate key blocks via the virtual key purpose XTS\_AES\_256\_KEY. When this is used espefuse.py will burn the first 256 bit of the key to the specified BLOCK and burn the corresponding block key purpose to XTS\_AES\_256\_KEY\_1. The last 256 bit of the key will be burned to the first free key block after BLOCK and the corresponding block key purpose to XTS\_AES\_256\_KEY\_2

```
espefuse.py --port PORT burn_key BLOCK my_flash_encryption_key.bin XTS_
↳AES_256_KEY
```

If you wish to specify exactly which two blocks are used then it is possible to divide key into two 256 bit keys, and manually burn each half with XTS\_AES\_256\_KEY\_1 and XTS\_AES\_256\_KEY\_2 as key purposes:

```
split -b 32 my_flash_encryption_key.bin my_flash_encryption_key.bin.
espefuse.py --port PORT burn_key BLOCK my_flash_encryption_key.bin.aa_
↳XTS_AES_256_KEY_1
espefuse.py --port PORT burn_key BLOCK+1 my_flash_encryption_key.bin.ab_
↳XTS_AES_256_KEY_2
```

If the key is not burned and the device is started after enabling flash encryption, the ESP32-S2 will generate a random key that software cannot access or modify.

4. In *Project Configuration Menu*, do the following:
  - *Enable flash encryption on boot*
  - *Select encryption mode (Development mode by default)*
  - *Select the appropriate bootloader log verbosity*
  - Save the configuration and exit.

Enabling flash encryption will increase the size of bootloader, which might require updating partition table offset. See *Bootloader Size*.

5. Run the command given below to build and flash the complete images.

```
idf.py flash monitor
```

**Note:** This command does not include any user files which should be written to the partitions on the flash memory. Please write them manually before running this command otherwise the files should be encrypted separately before writing.

This command will write to flash memory unencrypted images: the firmware bootloader, the partition table and applications. Once the flashing is complete, ESP32-S2 will reset. On the next boot, the firmware bootloader encrypts: the firmware bootloader, application partitions and partitions marked as encrypted then resets. Encrypting in-place can take time, up to a minute for large partitions. After that, the application is decrypted at runtime and executed.

If using Development Mode, then the easiest way to update and re-flash binaries is *Re-flashing Updated Partitions*.

If using Release Mode, then it is possible to pre-encrypt the binaries on the host and then flash them as ciphertext. See *Manually Encrypting Files*.

**Re-flashing Updated Partitions** If you update your application code (done in plaintext) and want to re-flash it, you will need to encrypt it before flashing. To encrypt the application and flash it in one step, run:

```
idf.py encrypted-app-flash monitor
```

If all partitions needs to be updated in encrypted format, run:

```
idf.py encrypted-flash monitor
```

## Release Mode

In Release mode, UART bootloader cannot perform flash encryption operations. New plaintext images can ONLY be downloaded using the over-the-air (OTA) scheme which will encrypt the plaintext image before writing to flash.

To use this mode, take the following steps:

1. Ensure that you have an ESP32-S2 device with default flash encryption eFuse settings as shown in [Relevant eFuses](#).

See how to check [ESP32-S2 Flash Encryption Status](#).

2. In [Project Configuration Menu](#), do the following:

- [Enable flash encryption on boot](#)
- [Select Release mode](#) (Note that once Release mode is selected, the EFUSE\_DIS\_DOWNLOAD\_MANUAL\_ENCRYPT eFuse bit will be burned to disable flash encryption hardware in ROM Download Mode.)
- [Select UART ROM download mode \(Permanently switch to Secure mode \(recommended\)\)](#). This is the default option, and is recommended. It is also possible to change this configuration setting to permanently disable UART ROM download mode, if this mode is not needed.
- [Select the appropriate bootloader log verbosity](#)
- Save the configuration and exit.

Enabling flash encryption will increase the size of bootloader, which might require updating partition table offset. See [Bootloader Size](#).

3. Run the command given below to build and flash the complete images.

```
idf.py flash monitor
```

---

**Note:** This command does not include any user files which should be written to the partitions on the flash memory. Please write them manually before running this command otherwise the files should be encrypted separately before writing.

---

This command will write to flash memory unencrypted images: the firmware bootloader, the partition table and applications. Once the flashing is complete, ESP32-S2 will reset. On the next boot, the firmware bootloader encrypts: the firmware bootloader, application partitions and partitions marked as encrypted then resets. Encrypting in-place can take time, up to a minute for large partitions. After that, the application is decrypted at runtime and executed.

Once the flash encryption is enabled in Release mode, the bootloader will write-protect the SPI\_BOOT\_CRYPT\_CNT eFuse.

For subsequent plaintext field updates, use [OTA scheme](#).

---

**Note:** If you have pre-generated the flash encryption key and stored a copy, and the UART download mode is not permanently disabled via [CONFIG\\_SECURE\\_UART\\_ROM\\_DL\\_MODE](#), then it is possible to update the flash locally by pre-encrypting the files and then flashing the ciphertext. See [Manually Encrypting Files](#).

---

## Best Practices

When using Flash Encryption in production:

- Do not reuse the same flash encryption key between multiple devices. This means that an attacker who copies encrypted data from one device cannot transfer it to a second device.
- The UART ROM Download Mode should be disabled entirely if it is not needed, or permanently set to “Secure Download Mode” otherwise. Secure Download Mode permanently limits the available commands to updating SPI config, changing baud rate, basic flash write, and returning a summary of the currently enabled security features with the `get_security_info` command. The default behaviour is to set Secure Download Mode on first boot in Release mode. To disable Download Mode entirely, select `CONFIG_SECURE_UART_ROM_DL_MODE` to “Permanently disable ROM Download Mode (recommended)” or call `esp_efuse_disable_rom_download_mode()` at runtime.
- Enable `Secure Boot` as an extra layer of protection, and to prevent an attacker from selectively corrupting any part of the flash before boot.

### 4.14.5 Possible Failures

Once flash encryption is enabled, the `SPI_BOOT_CRYPT_CNT` eFuse value will have an odd number of bits set. It means that all the partitions marked with the encryption flag are expected to contain encrypted ciphertext. Below are the three typical failure cases if the ESP32-S2 is erroneously loaded with plaintext data:

1. If the bootloader partition is re-flashed with a **plaintext firmware bootloader image**, the ROM bootloader will fail to load the firmware bootloader resulting in the following failure:

```
rst:0x3 (SW_RESET),boot:0x13 (SPI_FAST_FLASH_BOOT)
invalid header: 0xb414f76b
invalid header: 0xb414f76b
invalid header: 0xb414f76b
invalid header: 0xb414f76b
invalid header: 0xb414f76b
invalid header: 0xb414f76b
invalid header: 0xb414f76b
```

---

**Note:** The value of invalid header will be different for every application.

---



---

**Note:** This error also appears if the flash contents are erased or corrupted.

---

2. If the firmware bootloader is encrypted, but the partition table is re-flashed with a **plaintext partition table image**, the bootloader will fail to read the partition table resulting in the following failure:

```
rst:0x3 (SW_RESET),boot:0x13 (SPI_FAST_FLASH_BOOT)
configsip: 0, SPIWP:0xee
clk_drv:0x00,q_drv:0x00,d_drv:0x00,cs0_drv:0x00,hd_drv:0x00,wp_drv:0x00
mode:DIO, clock div:2
load:0x3fff0018,len:4
load:0x3fff001c,len:10464
ho 0 tail 12 room 4
load:0x40078000,len:19168
load:0x40080400,len:6664
entry 0x40080764
I (60) boot: ESP-IDF v4.0-dev-763-g2c55fae6c-dirty 2nd stage bootloader
I (60) boot: compile time 19:15:54
I (62) boot: Enabling RNG early entropy source...
I (67) boot: SPI Speed      : 40MHz
I (72) boot: SPI Mode      : DIO
I (76) boot: SPI Flash Size : 4MB
E (80) flash_parts: partition 0 invalid magic number 0x94f6
```

(continues on next page)

(continued from previous page)

```
E (86) boot: Failed to verify partition table
E (91) boot: load partition table error!
```

- If the bootloader and partition table are encrypted, but the application is re-flashed with a **plaintext application image**, the bootloader will fail to load the application resulting in the following failure:

```
rst:0x3 (SW_RESET),boot:0x13 (SPI_FAST_FLASH_BOOT)
configsip: 0, SPIWP:0xee
clk_drv:0x00,q_drv:0x00,d_drv:0x00,cs0_drv:0x00,hd_drv:0x00,wp_drv:0x00
mode:DIO, clock div:2
load:0x3fff0018,len:4
load:0x3fff001c,len:8452
load:0x40078000,len:13616
load:0x40080400,len:6664
entry 0x40080764
I (56) boot: ESP-IDF v4.0-dev-850-gc4447462d-dirty 2nd stage bootloader
I (56) boot: compile time 15:37:14
I (58) boot: Enabling RNG early entropy source...
I (64) boot: SPI Speed      : 40MHz
I (68) boot: SPI Mode      : DIO
I (72) boot: SPI Flash Size : 4MB
I (76) boot: Partition Table:
I (79) boot: ## Label                Usage                Type ST Offset   Length
I (87) boot:  0 nvs                   WiFi data            01 02 0000a000 00006000
I (94) boot:  1 phy_init              RF data              01 01 00010000 00001000
I (102) boot:  2 factory                factory app          00 00 00020000 00100000
I (109) boot: End of partition table
E (113) esp_image: image at 0x20000 has invalid magic byte
W (120) esp_image: image at 0x20000 has invalid SPI mode 108
W (126) esp_image: image at 0x20000 has invalid SPI size 11
E (132) boot: Factory app partition is not bootable
E (138) boot: No bootable app partitions in the partition table
```

#### 4.14.6 ESP32-S2 Flash Encryption Status

- Ensure that you have an ESP32-S2 device with default flash encryption eFuse settings as shown in [Relevant eFuses](#).

To check if flash encryption on your ESP32-S2 device is enabled, do one of the following:

- flash the application example [security/flash\\_encryption](#) onto your device. This application prints the `SPI_BOOT_CRYPT_CNT` eFuse value and if flash encryption is enabled or disabled.
- [Find the serial port name](#) under which your ESP32-S2 device is connected, replace `PORT` with your port name in the following command, and run it:

```
espefuse.py -p PORT summary
```

#### 4.14.7 Reading and Writing Data in Encrypted Flash

ESP32-S2 application code can check if flash encryption is currently enabled by calling `esp_flash_encryption_enabled()`. Also, a device can identify the flash encryption mode by calling `esp_get_flash_encryption_mode()`.

Once flash encryption is enabled, be more careful with accessing flash contents from code.

## Scope of Flash Encryption

Whenever the `SPI_BOOT_CRYPT_CNT` eFuse is set to a value with an odd number of bits, all flash content accessed via the MMU's flash cache is transparently decrypted. It includes:

- Executable application code in flash (IROM).
- All read-only data stored in flash (DROM).
- Any data accessed via `spi_flash_mmap()`.
- The firmware bootloader image when it is read by the ROM bootloader.

---

**Important:** The MMU flash cache unconditionally decrypts all existing data. Data which is stored unencrypted in flash memory will also be “transparently decrypted” via the flash cache and will appear to software as random garbage.

---

## Reading from Encrypted Flash

To read data without using a flash cache MMU mapping, you can use the partition read function `esp_partition_read()`. This function will only decrypt data when it is read from an encrypted partition. Data read from unencrypted partitions will not be decrypted. In this way, software can access encrypted and non-encrypted flash in the same way.

You can also use the following SPI flash API functions:

- `esp_flash_read()` to read raw (encrypted) data which will not be decrypted
- `esp_flash_read_decrypted()` to read and decrypt data

Data stored using the Non-Volatile Storage (NVS) API is always stored and read decrypted from the perspective of flash encryption. It is up to the library to provide encryption feature if required. Refer to [NVS Encryption](#) for more details.

## Writing to Encrypted Flash

It is recommended to use the partition write function `esp_partition_write()`. This function will only encrypt data when it is written to an encrypted partition. Data written to unencrypted partitions will not be encrypted. In this way, software can access encrypted and non-encrypted flash in the same way.

You can also pre-encrypt and write data using the function `esp_flash_write_encrypted()`

Also, the following ROM function exist but not supported in esp-idf applications:

- `esp_rom_spiflash_write_encrypted` pre-encrypts and writes data to flash
- `SPIWrite` writes unencrypted data to flash

Since data is encrypted in blocks, the minimum write size for encrypted data is 16 bytes and the alignment is also 16 bytes.

### 4.14.8 Updating Encrypted Flash

#### OTA Updates

OTA updates to encrypted partitions will automatically write encrypted data if the function `esp_partition_write()` is used.

Before building the application image for OTA updating of an already encrypted device, enable the option [Enable flash encryption on boot](#) in project configuration menu.

For general information about ESP-IDF OTA updates, please refer to [OTA](#)

## Updating Encrypted Flash via Serial

Flashing an encrypted device via serial bootloader requires that the serial bootloader download interface has not been permanently disabled via eFuse.

In Development Mode, the recommended method is *Re-flashing Updated Partitions*.

In Release Mode, if a copy of the same key stored in eFuse is available on the host then it's possible to pre-encrypt files on the host and then flash them. See *Manually Encrypting Files*.

### 4.14.9 Disabling Flash Encryption

If flash encryption was enabled accidentally, flashing of plaintext data will soft-brick the ESP32-S2. The device will reboot continuously, printing the error `flash read err, 1000` or `invalid header: 0xFFFFFFFF`.

For flash encryption in Development mode, encryption can be disabled by burning the `SPI_BOOT_CRYPT_CNT` eFuse. It can only be done one time per chip by taking the following steps:

1. In *Project Configuration Menu*, disable *Enable flash encryption on boot*, then save and exit.
2. Open project configuration menu again and **double-check** that you have disabled this option! If this option is left enabled, the bootloader will immediately re-enable encryption when it boots.
3. With flash encryption disabled, build and flash the new bootloader and application by running `idf.py flash`.
4. Use `espefuse.py` (in `components/esptool_py/esptool`) to disable the `SPI_BOOT_CRYPT_CNT` by running:

```
espefuse.py burn_efuse SPI_BOOT_CRYPT_CNT
```

Reset the ESP32-S2. Flash encryption will be disabled, and the bootloader will boot as usual.

### 4.14.10 Key Points About Flash Encryption

- Flash memory contents is encrypted using XTS-AES-128 or XTS-AES-256. The flash encryption key is 256 bits and 512 bits respectively and stored in one or two `BLOCK_KEYN` eFuses internal to the chip and, by default, is protected from software access.
- Flash access is transparent via the flash cache mapping feature of ESP32-S2 - any flash regions which are mapped to the address space will be transparently decrypted when read. Some data partitions might need to remain unencrypted for ease of access or might require the use of flash-friendly update algorithms which are ineffective if the data is encrypted. NVS partitions for non-volatile storage cannot be encrypted since the NVS library is not directly compatible with flash encryption. For details, refer to *NVS Encryption*.
- If flash encryption might be used in future, the programmer must keep it in mind and take certain precautions when writing code that *uses encrypted flash*.
- If secure boot is enabled, re-flashing the bootloader of an encrypted device requires a “Re-flashable” secure boot digest (see *Flash Encryption and Secure Boot*).

Enabling flash encryption will increase the size of bootloader, which might require updating partition table offset. See *Bootloader Size*.

---

**Important:** Do not interrupt power to the ESP32-S2 while the first boot encryption pass is running. If power is interrupted, the flash contents will be corrupted and will require flashing with unencrypted data again. In this case, re-flashing will not count towards the flashing limit.

---



### 4.14.11 Limitations of Flash Encryption

Flash encryption protects firmware against unauthorised readout and modification. It is important to understand the limitations of the flash encryption feature:

- Flash encryption is only as strong as the key. For this reason, we recommend keys are generated on the device during first boot (default behaviour). If generating keys off-device, ensure proper procedure is followed and don't share the same key between all production devices.
- Not all data is stored encrypted. If storing data on flash, check if the method you are using (library, API, etc.) supports flash encryption.
- Flash encryption does not prevent an attacker from understanding the high-level layout of the flash. This is because the same AES key is used for every pair of adjacent 16 byte AES blocks. When these adjacent 16 byte blocks contain identical content (such as empty or padding areas), these blocks will encrypt to produce matching pairs of encrypted blocks. This may allow an attacker to make high-level comparisons between encrypted devices (i.e. to tell if two devices are probably running the same firmware version).
- Flash encryption alone may not prevent an attacker from modifying the firmware of the device. To prevent unauthorised firmware from running on the device, use flash encryption in combination with *Secure Boot*.

### 4.14.12 Flash Encryption and Secure Boot

It is recommended to use flash encryption in combination with Secure Boot. However, if Secure Boot is enabled, additional restrictions apply to device re-flashing:

- *OTA Updates* are not restricted, provided that the new app is signed correctly with the Secure Boot signing key.

### 4.14.13 Advanced Features

The following section covers advanced features of flash encryption.

#### Encrypted Partition Flag

Some partitions are encrypted by default. Other partitions can be marked in the partition table description as requiring encryption by adding the flag `encrypted` to the partitions' flag field. As a result, data in these marked partitions will be treated as encrypted in the same manner as an app partition.

```
# Name, Type, SubType, Offset, Size, Flags
nvs, data, nvs, 0x9000, 0x6000
phy_init, data, phy, 0xf000, 0x1000
factory, app, factory, 0x10000, 1M
secret_data, 0x40, 0x01, 0x20000, 256K, encrypted
```

For details on partition table description, see *partition table*.

Further information about encryption of partitions:

- Default partition tables do not include any encrypted data partitions.
- With flash encryption enabled, the `app` partition is always treated as encrypted and does not require marking.
- If flash encryption is not enabled, the flag "encrypted" has no effect.
- You can also consider protecting `phy_init` data from physical access, readout, or modification, by marking the optional `phy` partition with the flag `encrypted`.
- The `nvs` partition cannot be encrypted, because the NVS library is not directly compatible with flash encryption.



## Enabling UART Bootloader Encryption/Decryption

On the first boot, the flash encryption process burns by default the following eFuses:

- `DIS_DOWNLOAD_MANUAL_ENCRYPT` which disables flash encryption operation when running in UART bootloader boot mode.
- `DIS_DOWNLOAD_ICACHE` and `DIS_DOWNLOAD_DCACHE` which disables the entire MMU flash cache when running in UART bootloader mode.
- `HARD_DIS_JTAG` which disables JTAG.
- `DIS_DIRECT_BOOT` (old name `DIS_LEGACY_SPI_BOOT`) which disables direct boot mode

However, before the first boot you can choose to keep any of these features enabled by burning only selected eFuses and write-protect the rest of eFuses with unset value 0. For example:

```
espefuse.py --port PORT burn_efuse DIS_DOWNLOAD_MANUAL_ENCRYPT
espefuse.py --port PORT write_protect_efuse DIS_DOWNLOAD_MANUAL_ENCRYPT
```

---

**Note:** Set all appropriate bits before write-protecting!

Write protection of all the three eFuses is controlled by one bit. It means that write-protecting one eFuse bit will inevitably write-protect all unset eFuse bits.

---

Write protecting these eFuses to keep them unset is not currently very useful, as `esptool.py` does not support reading encrypted flash.

## JTAG Debugging

By default, when Flash Encryption is enabled (in either Development or Release mode) then JTAG debugging is disabled via eFuse. The bootloader does this on first boot, at the same time it enables flash encryption.

See [JTAG with Flash Encryption or Secure Boot](#) for more information about using JTAG Debugging with Flash Encryption.

## Manually Encrypting Files

Manually encrypting or decrypting files requires the flash encryption key to be pre-burned in eFuse (see [Using Host Generated Key](#)) and a copy to be kept on the host. If the flash encryption is configured in Development Mode then it's not necessary to keep a copy of the key or follow these steps, the simpler [Re-flashing Updated Partitions](#) steps can be used.

The key file should be a single raw binary file (example: `key.bin`).

For example, these are the steps to encrypt the file `build/my-app.bin` to flash at offset `0x10000`. Run `espsecure.py` as follows:

```
espsecure.py encrypt_flash_data --aes_xts --keyfile /path/to/key.bin --address_
↪0x10000 --output my-app-ciphertext.bin build/my-app.bin
```

The file `my-app-ciphertext.bin` can then be flashed to offset `0x10000` using `esptool.py`. To see all of the command line options recommended for `esptool.py`, see the output printed when `idf.py build` succeeds.

---

**Note:** If the flashed ciphertext file is not recognized by the ESP32-S2 when it boots, check that the keys match and that the command line arguments match exactly, including the correct offset.

---

The command `espsecure.py decrypt_flash_data` can be used with the same options (and different input/output files), to decrypt ciphertext flash contents or a previously encrypted file.

#### 4.14.14 External RAM

When Flash Encryption is enabled any data read from and written to external SPI RAM through the cache will also be encrypted/decrypted. This happens the same way and with the same key as for Flash Encryption. If Flash Encryption is enabled then encryption for external SPI RAM is also always enabled, it is not possible to separately control this functionality.

#### 4.14.15 Technical Details

The following sections provide some reference information about the operation of flash encryption.

##### Flash Encryption Algorithm

- ESP32-S2 use the XTS-AES block cipher mode with 256 bit or 512 bit key size for flash encryption.
- XTS-AES is a block cipher mode specifically designed for disc encryption and addresses the weaknesses other potential modes (e.g. AES-CTR) have for this use case. A detailed description of the XTS-AES algorithm can be found in [IEEE Std 1619-2007](#).
- The flash encryption key is stored in one or two `BLOCK_KEYN` eFuses and, by default, is protected from further writes or software readout.
- To see the full flash encryption algorithm implemented in Python, refer to the `_flash_encryption_operation()` function in the `espsecure.py` source code.

### 4.15 Hardware Abstraction

ESP-IDF provides a group of APIs for hardware abstraction. These APIs allow you to control peripherals at different levels of abstraction, giving you more flexibility compared to using only the ESP-IDF drivers to interact with hardware. ESP-IDF Hardware abstraction is likely to be useful for writing high-performance bare-metal drivers, or for attempting to port an ESP chip to another platform.

This guide is split into the following sections:

1. [Architecture](#)
2. [LL \(Low Level\) Layer](#)
3. [HAL \(Hardware Abstraction Layer\)](#)

**Warning:** Hardware abstraction API (excluding the driver and `xxx_types.h`) should be considered an experimental feature, thus cannot be considered public API. The hardware abstraction API does not adhere to the API name changing restrictions of ESP-IDF's versioning scheme. In other words, it is possible that Hardware Abstraction API may change in between non-major release versions.

---

**Note:** Although this document mainly focuses on hardware abstraction of peripherals, e.g., UART, SPI, I2C, certain layers of hardware abstraction extend to other aspects of hardware as well, e.g., some of the CPU's features are partially abstracted.

---

#### 4.15.1 Architecture

Hardware abstraction in ESP-IDF is comprised of the following layers, ordered from low level of abstraction that is closer to hardware, to high level of abstraction that is further away from hardware.

- Low Level (LL) Layer

- Hardware Abstraction Layer (HAL)
- Driver Layers

The LL Layer, and HAL are entirely contained within the `hal` component. Each layer is dependent on the layer below it, i.e. driver depends on HAL, HAL depends on LL, LL depends on the register header files.

For a particular peripheral `xxx`, its hardware abstraction generally consists of the header files described in the table below. Files that are **Target Specific** have a separate implementation for each target, i.e., a separate copy for each chip. However, the `#include` directive is still target-independent, i.e., is the same for different targets, as the build system automatically includes the correct version of the header and source files.

Table 2: Hardware Abstraction Header Files

Include Directive	Target Specific	Description
<code>#include 'soc/xxx_caps.h'</code>	Y	This header contains a list of C macros specifying the various capabilities of the ESP32-S2's peripheral <code>xxx</code> . Hardware capabilities of a peripheral include things such as the number of channels, DMA support, hardware FIFO/buffer lengths, etc.
<code>#include "soc/xxx_struct.h"</code> <code>#include "soc/xxx_reg.h"</code>	Y	The two headers contain a representation of a peripheral's registers in C structure and C macro format respectively, allowing you to operate a peripheral at the register level via either of these two header files.
<code>#include "soc/xxx_pins.h"</code>	Y	If certain signals of a peripheral are mapped to a particular pin of the ESP32-S2, their mappings are defined in this header as C macros.
<code>#include "soc/xxx_periph.h"</code>	N	This header is mainly used as a convenience header file to automatically include <code>xxx_caps.h</code> , <code>xxx_struct.h</code> , and <code>xxx_reg.h</code> .
<code>#include "hal/xxx_types.h"</code>	N	This header contains type definitions and macros that are shared among the LL, HAL, and driver layers. Moreover, it is considered public API thus can be included by the application level. The shared types and definitions usually related to non-implementation specific concepts such as the following: <ul style="list-style-type: none"> <li>• Protocol-related types/macros such as frames, modes, common bus speeds, etc.</li> <li>• Features/characteristics of an <code>xxx</code> peripheral that are likely to be present on any implementation (implementation-independent) such as channels, operating modes, signal amplification or attenuation intensities, etc.</li> </ul>
<code>#include "hal/xxx_ll.h"</code>	Y	This header contains the Low Level (LL) Layer of hardware abstraction. LL Layer API are primarily used to abstract away register operations into readable functions.
<code>#include "hal/xxx_hal.h"</code>	Y	The Hardware Abstraction Layer (HAL) is used to abstract away peripheral operation steps into functions (e.g., reading a buffer, starting a transmission, handling an event, etc). The HAL is built on top of the LL Layer.
<code>#include "driver/xxx.h"</code>	N	The driver layer is the highest level of ESP-IDF's hardware abstraction. Driver layer API are meant to be called from ESP-IDF applications, and internally utilize OS primitives. Thus, driver layer API are event-driven, and can be used in a multi-threaded environment.

### 4.15.2 LL (Low Level) Layer

The primary purpose of the LL Layer is to abstract away register field access into more easily understandable functions. LL functions essentially translate various in/out arguments into the register fields of a peripheral in the form of `get/set` functions. All the necessary bit shifting, masking, offsetting, and endianness of the register fields should be handled by the LL functions.

```

//Inside xxx_ll.h

static inline void xxx_ll_set_baud_rate(xxx_dev_t *hw,
                                       xxx_ll_clk_src_t clock_source,
                                       uint32_t baud_rate) {
    uint32_t src_clk_freq = (source_clk == XXX_SCLK_APB) ? APB_CLK_FREQ : REF_CLK_
↪FREQ;
    uint32_t clock_divider = src_clk_freq / baud;
    // Set clock select field
    hw->clk_div_reg.divider = clock_divider >> 4;
    // Set clock divider field
    hw->config.clk_sel = (source_clk == XXX_SCLK_APB) ? 0 : 1;
}

static inline uint32_t xxx_ll_get_rx_byte_count(xxx_dev_t *hw) {
    return hw->status_reg.rx_cnt;
}

```

The code snippet above illustrates typical LL functions for a peripheral `xxx`. LL functions typically have the following characteristics:

- All LL functions are defined as `static inline` so that there is minimal overhead when calling these functions due to compiler optimization. These functions are not guaranteed to be inlined by the compiler, so any LL function that is called when the cache is disabled (e.g., from an IRAM ISR context) should be marked with `__attribute__((always_inline))`.
- The first argument should be a pointer to a `xxx_dev_t` type. The `xxx_dev_t` type is a structure representing the peripheral's registers, thus the first argument is always a pointer to the starting address of the peripheral's registers. Note that in some cases where the peripheral has multiple channels with identical register layouts, `xxx_dev_t *hw` may point to the registers of a particular channel instead.
- LL functions should be short, and in most cases are deterministic. In other words, in the worst case, runtime of the LL function can be determined at compile time. Thus, any loops in LL functions should be finite bounded; however, there are currently a few exceptions to this rule.
- LL functions are not thread-safe, it is the responsibility of the upper layers (driver layer) to ensure that registers or register fields are not accessed concurrently.

### 4.15.3 HAL (Hardware Abstraction Layer)

The HAL layer models the operational process of a peripheral as a set of general steps, where each step has an associated function. For each step, the details of a peripheral's register implementation (i.e., which registers need to be set/read) are hidden (abstracted away) by the HAL. By modeling peripheral operation as a set of functional steps, any minor hardware implementation differences of the peripheral between different targets or chip versions can be abstracted away by the HAL (i.e., handled transparently). In other words, the HAL API for a particular peripheral remains mostly the same across multiple targets/chip versions.

The following HAL function examples are selected from the Watchdog Timer HAL as each function maps to one of the steps in a WDT's operation life cycle, thus illustrating how a HAL abstracts a peripheral's operation into functional steps.

```

// Initialize one of the WDTs
void wdt_hal_init(wdt_hal_context_t *hal, wdt_inst_t wdt_inst, uint32_t prescaler,
↪bool enable_intr);

// Configure a particular timeout stage of the WDT
void wdt_hal_config_stage(wdt_hal_context_t *hal, wdt_stage_t stage, uint32_t
↪timeout, wdt_stage_action_t behavior);

// Start the WDT
void wdt_hal_enable(wdt_hal_context_t *hal);

```

(continues on next page)

(continued from previous page)

```

// Feed (i.e., reset) the WDT
void wdt_hal_feed(wdt_hal_context_t *hal);

// Handle a WDT timeout
void wdt_hal_handle_intr(wdt_hal_context_t *hal);

// Stop the WDT
void wdt_hal_disable(wdt_hal_context_t *hal);

// De-initialize the WDT
void wdt_hal_deinit(wdt_hal_context_t *hal);

```

HAL functions generally have the following characteristics:

- The first argument to a HAL function has the `xxx_hal_context_t *` type. The HAL context type is used to store information about a particular instance of the peripheral (i.e., the context instance). A HAL context is initialized by the `xxx_hal_init()` function and can store information such as the following:
  - The channel number of this instance
  - Pointer to the peripheral's (or channel's) registers (i.e., a `xxx_dev_t *` type)
  - Information about an ongoing transaction (e.g., pointer to DMA descriptor list in use)
  - Some configuration values for the instance (e.g., channel configurations)
  - Variables to maintain state information regarding the instance (e.g., a flag to indicate if the instance is waiting for transaction to complete)
- HAL functions should not contain any OS primitives such as queues, semaphores, mutexes, etc. All synchronization/concurrency should be handled at higher layers (e.g., the driver).
- Some peripherals may have steps that cannot be further abstracted by the HAL, thus end up being a direct wrapper (or macro) for an LL function.
- Some HAL functions may be placed in IRAM thus may carry an `IRAM_ATTR` or be placed in a separate `xxx_hal_iram.c` source file.

## 4.16 High-Level Interrupts

The Xtensa architecture has support for 32 interrupts, divided over 7 levels (levels 1 to 7, with 7 being an NMI), plus an assortment of exceptions. On the ESP32-S2, the interrupt mux allows most interrupt sources to be routed to these interrupts using the *interrupt allocator*. Normally, interrupts will be written in C, but ESP-IDF allows high-level interrupts to be written in assembly as well, resulting in very low interrupt latencies.

### 4.16.1 Interrupt Levels

Level	Symbol	Remark
1	N/A	Exception and level 0 interrupts. Handled by ESP-IDF
2-3	N/A	Medium level interrupts. Handled by ESP-IDF
4	<code>xt_highint4</code>	Normally used by ESP-IDF debug logic
5	<code>xt_highint5</code>	Free to use
NMI	<code>xt_nmi</code>	Free to use
dbg	<code>xt_debugexception</code>	Debug exception. Called on e.g. a BREAK instruction.

Using these symbols is done by creating an assembly file (suffix `.S`) and defining the named symbols, like this:

```

.section .iram1,"ax"
.global xt_highint5
.type xt_highint5,@function
.align 4
xt_highint5:

```

(continues on next page)

```

... your code here
rsr      a0, EXCSAVE_5
rfi      5

```

For a real-life example, see the [esp\\_system/port/soc/esp32s2/highint\\_hdl.S](#) file; the panic handler interrupt is implemented there.

## 4.16.2 Notes

- Do not call C code from a high-level interrupt; as these interrupts are run from a critical section, this can cause the target to crash. Note that although the panic handler interrupt does call normal C code, this exception is allowed due to the fact that this handler never returns (i.e., the application will not continue to run after the panic handler). so breaking C code execution flow is not a problem.
- Make sure your assembly code gets linked in. Indeed, as the free-to-use symbols are declared as weak, the linker may discard the file containing the symbol. This will happen if the only symbol defined, or used, from the user file is the `xt_*` free-to-use symbol. To avoid this, in the assembly file containing the `xt_*` symbol, define another symbol, like:

```

.global ld_include_my_isr_file
ld_include_my_isr_file:

Here it is called ``ld_include_my_isr_file`` but can have any name, as long as
→it is not defined anywhere else in the project.

Then, in the component ``CMakeLists.txt``, add this name as an unresolved
→symbol to the ld command line arguments::

    target_link_libraries(${COMPONENT_TARGET} "-u ld_include_my_isr_file")

This should cause the linker to always include the file defining ``ld_include_
→my_isr_file``, causing the ISR to always be linked in.

```

- High-level interrupts can be routed and handled using [esp\\_intr\\_alloc\(\)](#) and associated functions. The handler and handler arguments to [esp\\_intr\\_alloc\(\)](#) must be NULL, however.
- In theory, medium priority interrupts could also be handled in this way. ESP-IDF does not support this yet.

## 4.17 JTAG Debugging

This document provides a guide to installing OpenOCD for ESP32-S2 and debugging using GDB. The document is structured as follows:

**Introduction** Introduction to the purpose of this guide.

**How it Works?** Description how ESP32-S2, JTAG interface, OpenOCD and GDB are interconnected and working together to enable debugging of ESP32-S2.

**Selecting JTAG Adapter** What are the criteria and options to select JTAG adapter hardware.

**Setup of OpenOCD** Procedure to install OpenOCD and verify that it is installed.

**Configuring ESP32-S2 Target** Configuration of OpenOCD software and setting up of JTAG adapter hardware, which together make up the debugging target.

**Launching Debugger** Steps to start up a debug session with GDB from [Eclipse](#) and from [Command Line](#).

**Debugging Examples** If you are not familiar with GDB, check this section for debugging examples provided from [Eclipse](#) as well as from [Command Line](#).

**Building OpenOCD from Sources** Procedure to build OpenOCD from sources for [Windows](#), [Linux](#) and [macOS](#) operating systems.

**Tips and Quirks** This section provides collection of tips and quirks related to JTAG debugging of ESP32-S2 with OpenOCD and GDB.

### 4.17.1 Introduction

Espressif has ported OpenOCD to support the ESP32-S2 processor and the multi-core FreeRTOS (which is the foundation of most ESP32-S2 apps). Additionally, some extra tools have been written to provide extra features that OpenOCD does not support natively.

This document provides a guide to installing OpenOCD for ESP32-S2 and debugging using GDB under Linux, Windows and macOS. Except for OS specific installation procedures, the s/w user interface and use procedures are the same across all supported operating systems.

**Note:** Screenshots presented in this document have been made for Eclipse Neon 3 running on Ubuntu 16.04 LTS. There may be some small differences in what a particular user interface looks like, depending on whether you are using Windows, macOS or Linux and / or a different release of Eclipse.

### 4.17.2 How it Works?

The key software and hardware components that perform debugging of ESP32-S2 with OpenOCD over JTAG (Joint Test Action Group) interface is presented in the diagram below under the “Debugging With JTAG” label. These components include xtensa-esp32s2-elf-gdb debugger, OpenOCD on chip debugger, and the JTAG adapter connected to ESP32-S2 target.

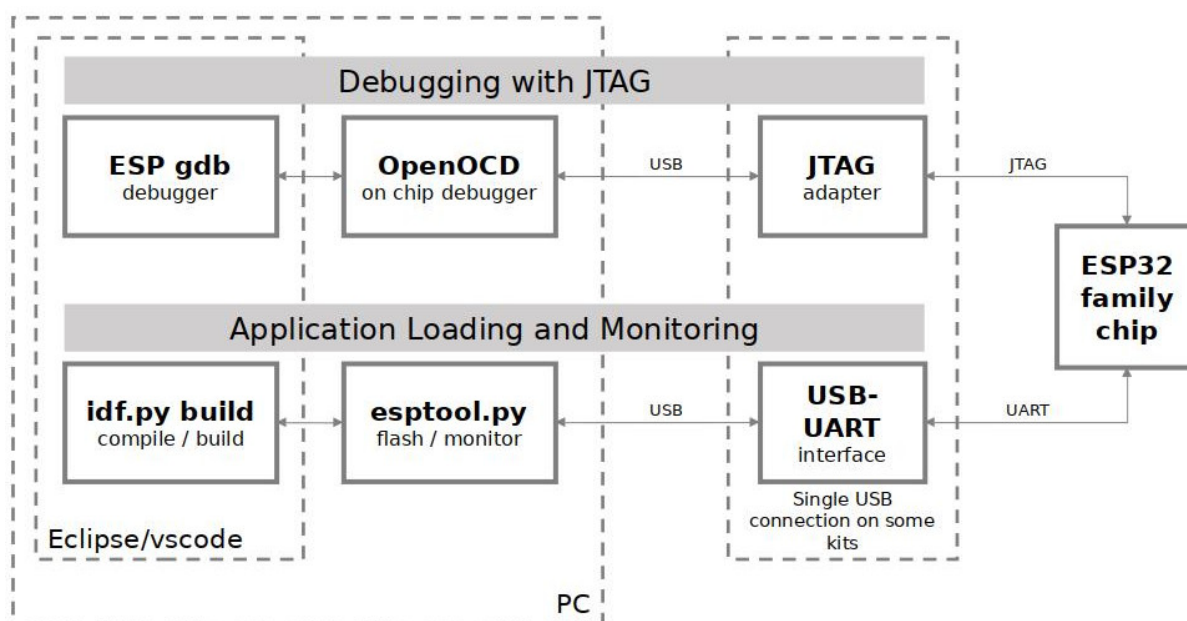

Fig. 23: JTAG debugging - overview diagram

Likewise, the “Application Loading and Monitoring” label indicates the key software and hardware components that allow an application to be compiled, built, and flashed to ESP32-S2, as well as to provide means to monitor diagnostic messages from ESP32-S2.

“Debugging With JTAG” and “Application Loading and Monitoring” is integrated under the Eclipse IDE in order to provide a quick and easy transition between writing/compiling/loading/debugging code. The Eclipse IDE (and the integrated debugging software) is available for Windows, Linux and macOS platforms. Depending on user preferences, both the debugger and `idf.py build` can also be used directly from terminal/command line, instead of Eclipse.

If the *ESP32-S2-Kaluga-1* is used, then connection from PC to ESP32-S2 is done effectively with a single USB cable. This is made possible by the FT2232H chip, which provides two USB channels, one for JTAG and the other for UART connection.



### 4.17.3 Selecting JTAG Adapter

The quickest and most convenient way to start with JTAG debugging is by using *ESP32-S2-Kaluga-1*. Each version of this development board has JTAG interface already built in. No need for an external JTAG adapter and extra wiring / cable to connect JTAG to ESP32-S2. ESP32-S2-Kaluga-1 is using FT2232H JTAG interface operating at 20 MHz clock speed, which is difficult to achieve with an external adapter.

If you decide to use separate JTAG adapter, look for one that is compatible with both the voltage levels on the ESP32-S2 as well as with the OpenOCD software. The JTAG port on the ESP32-S2 is an industry-standard JTAG port which lacks (and does not need) the TRST pin. The JTAG I/O pins all are powered from the VDD\_3P3\_RTC pin (which normally would be powered by a 3.3 V rail) so the JTAG adapter needs to be able to work with JTAG pins in that voltage range.

On the software side, OpenOCD supports a fair amount of JTAG adapters. See <https://openocd.org/doc/html/Debug-Adapter-Hardware.html> for an (unfortunately slightly incomplete) list of the adapters OpenOCD works with. This page lists SWD-compatible adapters as well; take note that the ESP32-S2 does not support SWD. JTAG adapters that are hardcoded to a specific product line, e.g. ST-LINK debugging adapters for STM32 families, will not work.

The minimal signalling to get a working JTAG connection are TDI, TDO, TCK, TMS and GND. Some JTAG debuggers also need a connection from the ESP32-S2 power line to a line called e.g. Vtar to set the working voltage. SRST can optionally be connected to the CH\_PD of the ESP32-S2, although for now, support in OpenOCD for that line is pretty minimal.

*ESP-Prog* is an example for using an external board for debugging by connecting it to the JTAG pins of ESP32-S2.

### 4.17.4 Setup of OpenOCD

If you have already set up ESP-IDF with CMake build system according to the *Getting Started Guide*, then OpenOCD is already installed. After *setting up the environment* in your terminal, you should be able to run OpenOCD. Check this by executing the following command:

```
openocd --version
```

The output should be as follows (although the version may be more recent than listed here):

```
Open On-Chip Debugger v0.10.0-esp32-20190708 (2019-07-08-11:04)
Licensed under GNU GPL v2
For bug reports, read
  https://openocd.org/doc/doxygen/bugs.html
```

You may also verify that OpenOCD knows where its configuration scripts are located by printing the value of OPENOCD\_SCRIPTS environment variable, by typing `echo $OPENOCD_SCRIPTS` (for Linux and macOS) or `echo %OPENOCD_SCRIPTS%` (for Windows). If a valid path is printed, then OpenOCD is set up correctly.

If any of these steps do not work, please go back to the *setting up the tools* section of the Getting Started Guide.

---

**Note:** It is also possible to build OpenOCD from source. Please refer to *Building OpenOCD from Sources* section for details.

---

### 4.17.5 Configuring ESP32-S2 Target

Once OpenOCD is installed, you can proceed to configuring the ESP32-S2 target (i.e ESP32-S2 board with JTAG interface). Configuring the target is split into the following three steps:

- *Configure and connect JTAG interface*
- *Run OpenOCD*
- *Upload application for debugging*



## Configure and connect JTAG interface

This step depends on the JTAG and ESP32-S2 board you are using (see the two cases described below).

### Configure ESP32-S2-Kaluga-1 JTAG Interface

All versions of ESP32-S2-Kaluga-1 boards have built-in JTAG functionality. Putting it to work requires setting jumpers or DIP switches to enable JTAG functionality, and configuring USB drivers. Please refer to step by step instructions below.

### Configure Hardware

- Out of the box, ESP32-S2-Kaluga-1 doesn't need any additional hardware configuration for JTAG debugging. However if you are experiencing issues, check that the "JTAG" DIP switches (SW5 in the schematic) labelled TCK, TDO, TDI, TMS are in "ON" position.
- Verify if ESP32-S2 pins used for JTAG communication are not connected to some other h/w that may disturb JTAG operation:

Table 3: ESP32-S2 pins and JTAG signals

ESP32-S2 Pin	JTAG Signal
MTDO / GPIO40	TDO
MTDI / GPIO41	TDI
MTCK / GPIO39	TCK
MTMS / GPIO42	TMS

**Configure USB Drivers** Install and configure USB drivers, so OpenOCD is able to communicate with JTAG interface on ESP32-S2-Kaluga-1 board as well as with UART interface used to upload application for flash. Follow steps below specific to your operating system.

---

**Note:** ESP32-S2-Kaluga-1 uses an FT2232 adapter. The following instructions can also be used for other FT2232 based JTAG adapters.

---

### Windows

1. Using standard USB A / micro USB B cable connect ESP32-S2-Kaluga-1 to the computer. Switch the ESP32-S2-Kaluga-1 on.
2. Wait until USB ports of ESP32-S2-Kaluga-1 are recognized by Windows and drivers are installed. If they do not install automatically, then download them from <https://ftdichip.com/drivers/d2xx-drivers/> and install manually.
3. Download Zadig tool (Zadig\_X.X.exe) from <https://zadig.akeo.ie/> and run it.
4. In Zadig tool go to "Options" and check "List All Devices" .
5. Check the list of devices that should contain two ESP32-S2-Kaluga-1 specific USB entries: "Dual RS232-HS (Interface 0)" and "Dual RS232-HS (Interface 1)" . The driver name would be "FTDIBUS (vxxxx)" and USB ID: 0403 6010.
6. The first device (Dual RS232-HS (Interface 0)) is connected to the JTAG port of the ESP32-S2. Original "FTDIBUS (vxxxx)" driver of this device should be replaced with "WinUSB (v6xxxxx)" . To do so, select "Dual RS232-HS (Interface 0) and reinstall attached driver to the "WinUSB (v6xxxxx)" , see picture above.

---

**Note:** Do not change the second device "Dual RS232-HS (Interface 1)" . It is routed to ESP32-S2's serial port (UART) used for upload of application to ESP32-S2's flash.

---

Now ESP32-S2-Kaluga-1's JTAG interface should be available to the OpenOCD. To carry on with debugging environment setup, proceed to section [Run OpenOCD](#).

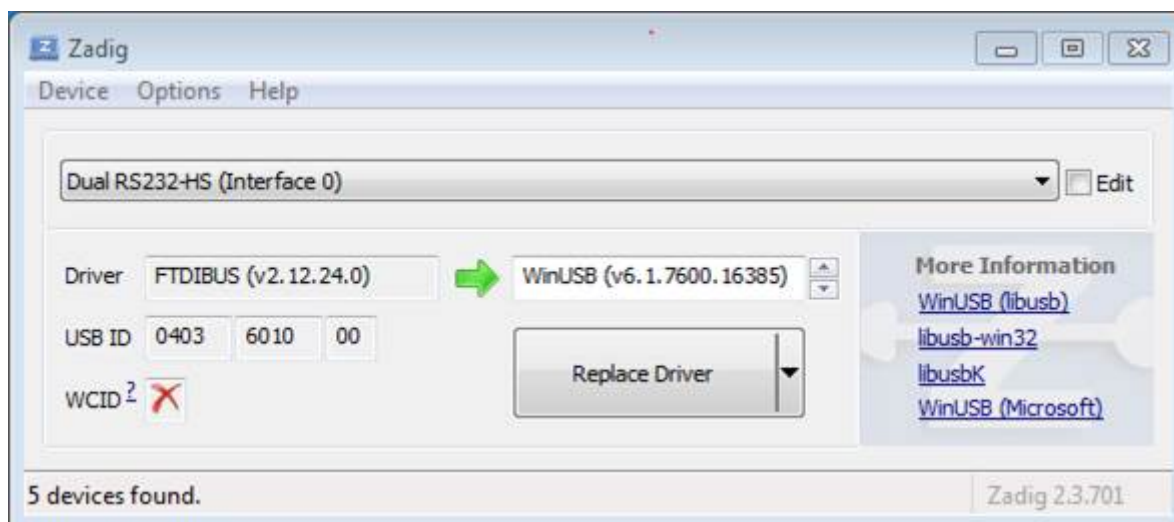

Fig. 24: Configuration of JTAG USB driver in Zadig tool

## Linux

1. Using standard USB A / micro USB B cable connect ESP32-S2-Kaluga-1 board to the computer. Power on the board.
2. Open a terminal, enter `ls -l /dev/ttyUSB*` command and check, if board' s USB ports are recognized by the OS. You are looking for similar result:

```
user-name@computer-name:~/esp$ ls -l /dev/ttyUSB*
crw-rw---- 1 root dialout 188, 0 Jul 10 19:04 /dev/ttyUSB0
crw-rw---- 1 root dialout 188, 1 Jul 10 19:04 /dev/ttyUSB1
```

3. Following section “Permissions delegation” in [OpenOCD' s README](#), set up the access permissions to both USB ports.
4. Log off and login, then cycle the power to the board to make the changes effective. In terminal enter again `ls -l /dev/ttyUSB*` command to verify, if group-owner has changed from dialout to plugdev:

```
user-name@computer-name:~/esp$ ls -l /dev/ttyUSB*
crw-rw-r-- 1 root plugdev 188, 0 Jul 10 19:07 /dev/ttyUSB0
crw-rw-r-- 1 root plugdev 188, 1 Jul 10 19:07 /dev/ttyUSB1
```

If you see similar result and you are a member of `plugdev` group, then the set up is complete.

The `/dev/ttyUSBn` interface with lower number is used for JTAG communication. The other interface is routed to ESP32-S2' s serial port (UART) used for upload of application to ESP32-S2' s flash.

Now ESP32-S2-Kaluga-1' s JTAG interface should be available to the OpenOCD. To carry on with debugging environment setup, proceed to section [Run OpenOCD](#).

**MacOS** On macOS, using FT2232 for JTAG and serial port at the same time needs some additional steps. When the OS loads FTDI serial port driver, it does so for both channels of FT2232 chip. However only one of these channels is used as a serial port, while the other is used as JTAG. If the OS has loaded FTDI serial port driver for the channel used for JTAG, OpenOCD will not be able to connect to the chip. There are two ways around this:

1. Manually unload the FTDI serial port driver before starting OpenOCD, start OpenOCD, then load the serial port driver.
2. Modify FTDI driver configuration so that it doesn' t load itself for channel B of FT2232 chip, which is the channel used for JTAG on ESP32-S2-Kaluga-1.

## Manually unloading the driver

1. Install FTDI driver from <https://ftdichip.com/drivers/vcp-drivers/>

2. Connect USB cable to the ESP32-S2-Kaluga-1.
3. Unload the serial port driver:

```
sudo kextunload -b com.FTDI.driver.FTDIUSBSerialDriver
```

In some cases you may need to unload Apple's FTDI driver as well:

- macOS < 10.15:

```
sudo kextunload -b com.apple.driver.AppleUSBFTDI
```

- macOS 10.15:

```
sudo kextunload -b com.apple.DriverKit-AppleUSBFTDI
```

**Warning:** Attempting to use serial over the wrong channel with the FTDI driver will cause a kernel panic. The ESP-WROVER-KIT uses channel A for JTAG and channel B for serial.

4. Run OpenOCD:

```
openocd -f board/esp32s2-kaluga-1.cfg
```

5. In another terminal window, load FTDI serial port driver again:

```
sudo kextload -b com.FTDI.driver.FTDIUSBSerialDriver
```

---

**Note:** If you need to restart OpenOCD, there is no need to unload FTDI driver again — just stop OpenOCD and start it again. The driver only needs to be unloaded if ESP32-S2-Kaluga-1 was reconnected or power was toggled.

---

This procedure can be wrapped into a shell script, if desired.

**Modifying FTDI driver** In a nutshell, this approach requires modification to FTDI driver configuration file, which prevents the driver from being loaded for channel B of FT2232H.

---

**Note:** Other boards may use channel A for JTAG, so use this option with caution.

---

**Warning:** This approach also needs signature verification of drivers to be disabled, so may not be acceptable for all users.

1. Open FTDI driver configuration file using a text editor (note sudo):

```
sudo nano /Library/Extensions/FTDIUSBSerialDriver.kext/Contents/Info.plist
```

2. Find and delete the following lines:

```
<key>FT2232H_B</key>
<dict>
  <key>CFBundleIdentifier</key>
  <string>com.FTDI.driver.FTDIUSBSerialDriver</string>
  <key>IOClass</key>
  <string>FTDIUSBSerialDriver</string>
  <key>IOProviderClass</key>
  <string>IOUSBInterface</string>
  <key>bConfigurationValue</key>
  <integer>1</integer>
  <key>bInterfaceNumber</key>
  <integer>1</integer>
  <key>bcdDevice</key>
```

(continues on next page)

(continued from previous page)

```

<integer>1792</integer>
<key>idProduct</key>
<integer>24592</integer>
<key>idVendor</key>
<integer>1027</integer>
</dict>

```

3. Save and close the file
4. Disable driver signature verification:
  1. Open Apple logo menu, choose “Restart…”
  2. When you hear the chime after reboot, press CMD+R immediately
  3. Once Recovery mode starts up, open Terminal
  4. Run the command:

```
csrutil enable --without kext
```

5. Restart again

After these steps, serial port and JTAG can be used at the same time.

To carry on with debugging environment setup, proceed to section [Run OpenOCD](#).

### Configure Other JTAG Interfaces

For guidance about which JTAG interface to select when using OpenOCD with ESP32-S2, refer to the section [Selecting JTAG Adapter](#). Then follow the configuration steps below to get it working.

### Configure Hardware

1. Identify all pins/signals on JTAG interface and ESP32-S2 board that should be connected to establish communication.

Table 4: ESP32-S2 pins and JTAG signals

ESP32-S2 Pin	JTAG Signal
MTDO / GPIO40	TDO
MTDI / GPIO41	TDI
MTCK / GPIO39	TCK
MTMS / GPIO42	TMS

2. Verify if ESP32-S2 pins used for JTAG communication are not connected to some other hardware that may disturb JTAG operation.
3. Connect identified pin/signals of ESP32-S2 and JTAG interface.

**Configure Drivers** You may need to install driver software to make JTAG work with computer. Refer to documentation of your JTAG adapter for related details.

**Connect** Connect JTAG interface to the computer. Power on ESP32-S2 and JTAG interface boards. Check if the JTAG interface is visible on the computer.

To carry on with debugging environment setup, proceed to section [Run OpenOCD](#).

### Run OpenOCD

Once target is configured and connected to computer, you are ready to launch OpenOCD.

Open a terminal and set it up for using the ESP-IDF as described in the [setting up the environment](#) section of the Getting Started Guide. Then run OpenOCD (this command works on Windows, Linux, and macOS):

```
openocd -f board/esp32s2-kaluga-1.cfg
```

**Note:** The files provided after `-f` above are specific for ESP32-S2-Kaluga-1 board. You may need to provide different files depending on the hardware that is used. For guidance see [Configuration of OpenOCD for specific target](#).

For example, `board/esp32c3-ftdi.cfg` can be used for a custom board with an FT2232H or FT232H chip used for JTAG connection, or with ESP-Prog.

You should now see similar output (this log is for ESP32-S2-Kaluga-1 board):

```
user-name@computer-name:~/esp/esp-idf$ openocd -f board/esp32s2-kaluga-1.cfg
Open On-Chip Debugger v0.10.0-esp32-20200420 (2020-04-20-16:15)
Licensed under GNU GPL v2
For bug reports, read
    https://openocd.org/doc/doxygen/bugs.html
none separate
adapter speed: 20000 kHz
force hard breakpoints
Info : ftdi: if you experience problems at higher adapter clocks, try the command
↪ "ftdi_tdo_sample_edge falling"
Info : clock speed 20000 kHz
Info : JTAG tap: esp32s2.cpu0 tap/device found: 0x120034e5 (mfg: 0x272 (Tensilica),
↪ part: 0x2003, ver: 0x1)
Info : esp32s2: Debug controller was reset (pwrstat=0x5F, after clear 0x0F).
Info : esp32s2: Core was reset (pwrstat=0x5F, after clear 0x0F).
```

- If there is an error indicating permission problems, please see section on “Permissions delegation” in the OpenOCD README file located in the `~/esp/openocd-esp32` directory.
- In case there is an error in finding the configuration files, e.g. `Can't find board/esp32s2-kaluga-1.cfg`, check if the `OPENOCD_SCRIPTS` environment variable is set correctly. This variable is used by OpenOCD to look for the files specified after the `-f` option. See [Setup of OpenOCD](#) section for details. Also check if the file is indeed under the provided path.
- If you see JTAG errors (e.g., `...all ones` or `...all zeroes`), please check your JTAG connections, whether other signals are connected to JTAG besides ESP32-S2's pins, and see if everything is powered on correctly.

### Upload application for debugging

Build and upload your application to ESP32-S2 as usual, see [Step 5. First Steps on ESP-IDF](#).

Another option is to write application image to flash using OpenOCD via JTAG with commands like this:

```
openocd -f board/esp32s2-kaluga-1.cfg -c "program_esp filename.bin 0x10000 verify_
↪exit"
```

OpenOCD flashing command `program_esp` has the following format:

```
program_esp <image_file> <offset> [verify] [reset] [exit]
```

- `image_file` - Path to program image file.
- `offset` - Offset in flash bank to write image.
- `verify` - Optional. Verify flash contents after writing.
- `reset` - Optional. Reset target after programing.
- `exit` - Optional. Finally exit OpenOCD.

You are now ready to start application debugging. Follow the steps described in the section below.

### 4.17.6 Launching Debugger

The toolchain for ESP32-S2 features GNU Debugger, in short GDB. It is available with other toolchain programs under filename: xtensa-esp32s2-elf-gdb. GDB can be called and operated directly from command line in a terminal. Another option is to call it from within IDE (like Eclipse, Visual Studio Code, etc.) and operate indirectly with help of GUI instead of typing commands in a terminal.

Both options of using debugger are discussed under links below.

- [Eclipse](#)
- [Command Line](#)

It is recommended to first check if debugger works from [Command Line](#) and then move to using [Eclipse](#).

### 4.17.7 Debugging Examples

This section is intended for users not familiar with GDB. It presents example debugging session from [Eclipse](#) using simple application available under [get-started/blink](#) and covers the following debugging actions:

1. [Navigating through the code, call stack and threads](#)
2. [Setting and clearing breakpoints](#)
3. [Halting the target manually](#)
4. [Stepping through the code](#)
5. [Checking and setting memory](#)
6. [Watching and setting program variables](#)
7. [Setting conditional breakpoints](#)

Similar debugging actions are provided using GDB from [Command Line](#).

Before proceeding to examples, set up your ESP32-S2 target and load it with [get-started/blink](#).

### 4.17.8 Building OpenOCD from Sources

Please refer to separate documents listed below, that describe build process.

#### Building OpenOCD from Sources for Windows

---

**Note:** This document outlines how to build a binary of OpenOCD from its source files instead of downloading the pre-built binary. For a quick setup, users can download a pre-built binary of OpenOCD from [Espressif GitHub](#) instead of compiling it themselves (see [Setup of OpenOCD](#) for more details).

---

---

**Note:** All code snippets in this document are assumed to be running in an MSYS2 shell with the MINGW32 subsystem.

---

**Install Dependencies** Install packages that are required to compile OpenOCD:

```
pacman -S --noconfirm --needed autoconf automake git make \  
mingw-w64-i686-gcc \  
mingw-w64-i686-toolchain \  
mingw-w64-i686-libtool \  
mingw-w64-i686-pkg-config \  
mingw-w64-cross-winthreads-git \  
p7zip
```

**Download Sources of OpenOCD** The sources for the ESP32-S2-enabled variant of OpenOCD are available from Espressif's GitHub under <https://github.com/espressif/openocd-esp32>. These source files can be pulled via Git using the following commands:

```
cd ~/esp
git clone --recursive https://github.com/espressif/openocd-esp32.git
```

The clone of sources should be now saved in `~/esp/openocd-esp32` directory.

**Downloading libusb** The libusb library is also required when building OpenOCD. The following commands will download a particular release of libusb and uncompress it to the current directory.

```
wget https://github.com/libusb/libusb/releases/download/v1.0.22/libusb-1.0.22.7z
7z x -olibusb ./libusb-1.0.22.7z
```

We now need to export the following variables such that the libusb library gets linked into the OpenOCD build.

```
export CPPFLAGS="$CPPFLAGS -I${PWD}/libusb/include/libusb-1.0"
export LDFLAGS="$LDFLAGS -L${PWD}/libusb/MinGW32/.libs/dll"
```

**Build OpenOCD** The following commands will configure OpenOCD then build it.

```
cd ~/esp/openocd-esp32
export CPPFLAGS="$CPPFLAGS -D__USE_MINGW_ANSI_STDIO=1 -Wno-error"; export CFLAGS="
↳$CFLAGS -Wno-error"
./bootstrap
./configure --disable-doxygen-pdf --enable-ftdi --enable-jlink --enable-ulink --
↳build=i686-w64-mingw32 --host=i686-w64-mingw32
make
cp ../libusb/MinGW32/dll/libusb-1.0.dll ./src
cp /opt/i686-w64-mingw32/bin/libwinpthread-1.dll ./src
```

Once the build is completed, the OpenOCD binary will be placed in `~/esp/openocd-esp32/src/`.

You can then optionally call `make install`. This will copy the OpenOCD binary to a user specified location.

- This location can be specified when OpenOCD is configured, or by setting `export DESTDIR="/custom/install/dir"` before calling `make install`.
- If you have an existing OpenOCD (from e.g. another development platform), you may want to skip this call as your existing OpenOCD may get overwritten.

---

**Note:**

- Should an error occur, resolve it and try again until the command `make` works.
- If there is a submodule problem from OpenOCD, please `cd` to the `openocd-esp32` directory and input `git submodule update --init`.
- If the `./configure` is successfully run, information of enabled JTAG will be printed under OpenOCD configuration summary.
- If the information of your device is not shown in the log, use `./configure` to enable it as described in `../openocd-esp32/doc/INSTALL.txt`.
- For details concerning compiling OpenOCD, please refer to `openocd-esp32/README.Windows`.
- Don't forget to copy `libusb-1.0.dll` and `libwinpthread-1.dll` into `OOCD_INSTALLDIR/bin` from `~/esp/openocd-esp32/src`.

---

Once `make` process is successfully completed, the executable of OpenOCD will be saved in `~/esp/openocd-esp32/src` directory.



**Full Listing** For greater convenience, all of commands called throughout the OpenOCD build process have been listed in the code snippet below. Users can copy this code snippet into a shell script then execute it:

```
pacman -S --noconfirm --needed autoconf automake git make mingw-w64-i686-gcc mingw-
↳w64-i686-toolchain mingw-w64-i686-libtool mingw-w64-i686-pkg-config mingw-w64-
↳cross-winpthread-git p7zip
cd ~/esp
git clone --recursive https://github.com/espressif/openocd-esp32.git

wget https://github.com/libusb/libusb/releases/download/v1.0.22/libusb-1.0.22.7z
7z x -olibusb ./libusb-1.0.22.7z
export CPPFLAGS="$CPPFLAGS -I${PWD}/libusb/include/libusb-1.0"; export LDFLAGS="
↳$LDFLAGS -L${PWD}/libusb/MinGW32/.libs/dll"

export CPPFLAGS="$CPPFLAGS -D__USE_MINGW_ANSI_STDIO=1 -Wno-error"; export CFLAGS="
↳$CFLAGS -Wno-error"
cd ~/esp/openocd-esp32
./bootstrap
./configure --disable-doxygen-pdf --enable-ftdi --enable-jlink --enable-ulink --
↳build=i686-w64-mingw32 --host=i686-w64-mingw32
make
cp ../libusb/MinGW32/dll/libusb-1.0.dll ./src
cp /opt/i686-w64-mingw32/bin/libwinpthread-1.dll ./src

# # optional
# export DESTDIR="$PWD"
# make install
# cp ./src/libusb-1.0.dll $DESTDIR/mingw32/bin
# cp ./src/libwinpthread-1.dll $DESTDIR/mingw32/bin
```

**Next Steps** To carry on with debugging environment setup, proceed to section *Configuring ESP32-S2 Target*.

### Building OpenOCD from Sources for Linux

The following instructions are alternative to downloading binary OpenOCD from [Espressif GitHub](#). To quickly setup the binary OpenOCD, instead of compiling it yourself, backup and proceed to section *Setup of OpenOCD*.

**Download Sources of OpenOCD** The sources for the ESP32-S2-enabled variant of OpenOCD are available from Espressif GitHub under <https://github.com/espressif/openocd-esp32>. To download the sources, use the following commands:

```
cd ~/esp
git clone --recursive https://github.com/espressif/openocd-esp32.git
```

The clone of sources should be now saved in ~/esp/openocd-esp32 directory.

**Install Dependencies** Install packages that are required to compile OpenOCD.

**Note:** Install the following packages one by one, check if installation was successful and then proceed to the next package. Resolve reported problems before moving to the next step.

```
sudo apt-get install make
sudo apt-get install libtool
sudo apt-get install pkg-config
```

(continues on next page)



(continued from previous page)

```
sudo apt-get install autoconf
sudo apt-get install automake
sudo apt-get install texinfo
sudo apt-get install libusb-1.0
```

---

**Note:**

- Version of pkg-config should be 0.2.3 or above.
  - Version of autoconf should be 2.6.4 or above.
  - Version of automake should be 1.9 or above.
  - When using USB-Blaster, ASIX Presto, OpenJTAG and FT2232 as adapters, drivers libFTDI and FTD2XX need to be downloaded and installed.
  - When using CMSIS-DAP, HIDAPI is needed.
- 

**Build OpenOCD** Proceed with configuring and building OpenOCD:

```
cd ~/esp/openocd-esp32
./bootstrap
./configure
make
```

Optionally you can add `sudo make install` step at the end. Skip it, if you have an existing OpenOCD (from e.g. another development platform), as it may get overwritten.

---

**Note:**

- Should an error occur, resolve it and try again until the command `make` works.
  - If there is a submodule problem from OpenOCD, please `cd` to the `openocd-esp32` directory and input `git submodule update --init`.
  - If the `./configure` is successfully run, information of enabled JTAG will be printed under OpenOCD configuration summary.
  - If the information of your device is not shown in the log, use `./configure` to enable it as described in `../openocd-esp32/doc/INSTALL.txt`.
  - For details concerning compiling OpenOCD, please refer to `openocd-esp32/README`.
- 

Once `make` process is successfully completed, the executable of OpenOCD will be saved in `~/openocd-esp32/bin` directory.

**Next Steps** To carry on with debugging environment setup, proceed to section [Configuring ESP32-S2 Target](#).

### Building OpenOCD from Sources for MacOS

The following instructions are alternative to downloading binary OpenOCD from [Espressif GitHub](#). To quickly setup the binary OpenOCD, instead of compiling it yourself, backup and proceed to section [Setup of OpenOCD](#).

**Download Sources of OpenOCD** The sources for the ESP32-S2-enabled variant of OpenOCD are available from Espressif GitHub under <https://github.com/espressif/openocd-esp32>. To download the sources, use the following commands:

```
cd ~/esp
git clone --recursive https://github.com/espressif/openocd-esp32.git
```

The clone of sources should be now saved in `~/esp/openocd-esp32` directory.

**Install Dependencies** Install packages that are required to compile OpenOCD using Homebrew:

```
brew install automake libtool libusb wget gcc@4.9 pkg-config
```

**Build OpenOCD** Proceed with configuring and building OpenOCD:

```
cd ~/esp/openocd-esp32
./bootstrap
./configure
make
```

Optionally you can add `sudo make install` step at the end. Skip it, if you have an existing OpenOCD (from e.g. another development platform), as it may get overwritten.

---

**Note:**

- Should an error occur, resolve it and try again until the command `make` works.
- If there is a submodule problem from OpenOCD, please `cd` to the `openocd-esp32` directory and input `git submodule update --init`.
- If the `./configure` is successfully run, information of enabled JTAG will be printed under OpenOCD configuration summary.
- If the information of your device is not shown in the log, use `./configure` to enable it as described in `../openocd-esp32/doc/INSTALL.txt`.
- For details concerning compiling OpenOCD, please refer to `openocd-esp32/README.OSX`.

---

Once `make` process is successfully completed, the executable of OpenOCD will be saved in `~/esp/openocd-esp32/src/openocd` directory.

**Next Steps** To carry on with debugging environment setup, proceed to section [Configuring ESP32-S2 Target](#).

The examples of invoking OpenOCD in this document assume using pre-built binary distribution described in section [Setup of OpenOCD](#).

To use binaries build locally from sources, change the path to OpenOCD executable to `src/openocd` and set the `OPENOCD_SCRIPTS` environment variable so that OpenOCD can find the configuration files. For Linux and macOS:

```
cd ~/esp/openocd-esp32
export OPENOCD_SCRIPTS=$PWD/tcl
```

For Windows:

```
cd %USERPROFILE%\esp\openocd-esp32
set "OPENOCD_SCRIPTS=%CD%\tcl"
```

Example of invoking OpenOCD build locally from sources, for Linux and macOS:

```
src/openocd -f board/esp32s2-kaluga-1.cfg
```

and Windows:

```
src\openocd -f board/esp32s2-kaluga-1.cfg
```

### 4.17.9 Tips and Quirks

This section provides collection of links to all tips and quirks referred to from various parts of this guide.

#### Tips and Quirks

This section provides collection of all tips and quirks referred to from various parts of this guide.

**Breakpoints and watchpoints available** ESP32-S2 debugger supports 2 hardware implemented breakpoints and 64 software ones. Hardware breakpoints are implemented by ESP32-S2 chip's logic and can be set anywhere in the code: either in flash or IRAM program's regions. Additionally there are 2 types of software breakpoints implemented by OpenOCD: flash (up to 32) and IRAM (up to 32) breakpoints. Currently GDB can not set software breakpoints in flash. So until this limitation is removed those breakpoints have to be emulated by OpenOCD as hardware ones (see *below* for details). ESP32-S2 also supports 2 watchpoints, so 2 variables can be watched for change or read by the GDB command `watch myVariable`. Note that menuconfig option `CONFIG_FREERTOS_WATCHPOINT_END_OF_STACK` uses the last watchpoint and will not provide expected results, if you also try to use it within OpenOCD / GDB. See menuconfig's help for detailed description.

**What else should I know about breakpoints?** Emulating part of hardware breakpoints using software flash ones means that the GDB command `hb myFunction` which is invoked for function in flash will use pure hardware breakpoint if it is available otherwise one of the 32 software flash breakpoints is used. The same rule applies to `b myFunction`-like commands. In this case GDB will decide what type of breakpoint to set itself. If `myFunction` is resided in writable region (IRAM) software IRAM breakpoint will be used otherwise hardware or software flash breakpoint is used as it is done for `hb` command.

**Flash Mappings vs SW Flash Breakpoints** In order to set/clear software breakpoints in flash, OpenOCD needs to know their flash addresses. To accomplish conversion from the ESP32-S2 address space to the flash one, OpenOCD uses mappings of program's code regions resided in flash. Those mappings are kept in the image header which is prepended to program binary data (code and data segments) and is specific to every application image written to the flash. So to support software flash breakpoints OpenOCD should know where application image under debugging is resided in the flash. By default OpenOCD reads partition table at 0x8000 and uses mappings from the first found application image, but there can be the cases when it will not work, e.g. partition table is not at standard flash location or even there can be multiple images: one factory and two OTA and you may want to debug any of them. To cover all possible debugging scenarios OpenOCD supports special command which can be used to set arbitrary location of application image to debug. The command has the following format:

```
esp appimage_offset <offset>
```

Offset should be in hex format. To reset to the default behaviour you can specify `-1` as offset.

---

**Note:** Since GDB requests memory map from OpenOCD only once when connecting to it, this command should be specified in one of the TCL configuration files, or passed to OpenOCD via its command line. In the latter case command line should look like below:

```
openocd -f board/esp32s2-kaluga-1.cfg -c "init; halt; esp appimage_offset 0x210000"
```

Another option is to execute that command via OpenOCD telnet session and then connect GDB, but it seems to be less handy.

---

**Why stepping with “next” does not bypass subroutine calls?** When stepping through the code with `next` command, GDB is internally setting a breakpoint ahead in the code to bypass the subroutine calls. If all 2 breakpoints are already set, this functionality will not work. If this is the case, delete breakpoints to have one “spare”. With

all breakpoints already used, stepping through the code with `next` command will work as like with `step` command and debugger will step inside subroutine calls.

**Support options for OpenOCD at compile time** ESP-IDF has some support options for OpenOCD debugging which can be set at compile time:

- `CONFIG_ESP_DEBUG_OCDAWARE` is enabled by default. If a panic or unhandled exception is thrown and a JTAG debugger is connected (ie OpenOCD is running), ESP-IDF will break into the debugger.
- `CONFIG_FREERTOS_WATCHPOINT_END_OF_STACK` (disabled by default) sets watchpoint index 1 (the second of two) at the end of any task stack. This is the most accurate way to debug task stack overflows. Click the link for more details.

Please see the [project configuration menu](#) menu for more details on setting compile-time options.

**FreeRTOS support** OpenOCD has explicit support for the ESP-IDF FreeRTOS. GDB can see FreeRTOS tasks as threads. Viewing them all can be done using the GDB `i threads` command, changing to a certain task is done with `thread n`, with `n` being the number of the thread. FreeRTOS detection can be disabled in target's configuration. For more details see [Configuration of OpenOCD for specific target](#).

**Optimize JTAG speed** In order to achieve higher data rates and minimize number of dropped packets it is recommended to optimize setting of JTAG clock frequency, so it is at maximum and still provides stable operation of JTAG. To do so use the following tips.

1. The upper limit of JTAG clock frequency is 20 MHz if CPU runs at 80 MHz, or 26 MHz if CPU runs at 160 MHz or 240 MHz.
2. Depending on particular JTAG adapter and the length of connecting cables, you may need to reduce JTAG frequency below 20 / 26 MHz.
3. In particular reduce frequency, if you get DSR/DIR errors (and they do not relate to OpenOCD trying to read from a memory range without physical memory being present there).
4. ESP-WROVER-KIT operates stable at 20 / 26 MHz.

**What is the meaning of debugger's startup commands?** On startup, debugger is issuing sequence of commands to reset the chip and halt it at specific line of code. This sequence (shown below) is user defined to pick up at most convenient / appropriate line and start debugging.

- `set remote hardware-watchpoint-limit 2` —Restrict GDB to using available hardware watchpoints supported by the chip, 2 for ESP32-S2. For more information see <https://sourceware.org/gdb/onlinedocs/gdb/Remote-Configuration.html>.
- `mon reset halt` —reset the chip and keep the CPUs halted
- `flushregs` —monitor (`mon`) command can not inform GDB that the target state has changed. GDB will assume that whatever stack the target had before `mon reset halt` will still be valid. In fact, after reset the target state will change, and executing `flushregs` is a way to force GDB to get new state from the target.
- `thb app_main` —insert a temporary hardware breakpoint at `app_main`, put here another function name if required
- `c` —resume the program. It will then stop at breakpoint inserted at `app_main`.

**Configuration of OpenOCD for specific target** There are several kinds of OpenOCD configuration files (\*.cfg). All configuration files are located in subdirectories of `share/openocd/scripts` directory of OpenOCD distribution (or `tcl/scripts` directory of the source repository). For the purposes of this guide, the most important ones are `board`, `interface` and `target`.

- `interface` configuration files describe the JTAG adapter. Examples of JTAG adapters are ESP-Prog and J-Link.
- `target` configuration files describe specific chips, or in some cases, modules.
- `board` configuration files are provided for development boards with a built-in JTAG adapter. Such files include an `interface` configuration file to choose the adapter, and `target` configuration file to choose the chip/module.

The following configuration files are available for ESP32-S2:

Table 5: OpenOCD configuration files for ESP32-S2

Name	Description
board/esp32s2-kaluga-1.cfg	Board configuration file for ESP32-S2-Kaluga-1, includes target and adapter configuration.
target/esp32s2.cfg	ESP32-S2 target configuration file. Can be used together with one of the interface/ configuration files.
interface/ftdi/esp32s2_kaluga_v1.cfg	JTAG adapter configuration file for ESP32-S2-Kaluga-1 board.
interface/ftdi/esp32_devkitj_v1.cfg	JTAG adapter configuration file for ESP-Prog boards.

If you are using one of the boards which have a pre-defined configuration file, you only need to pass one `-f` argument to OpenOCD, specifying that file.

If you are using a board not listed here, you need to specify both the interface configuration file and target configuration file.

**Custom configuration files** OpenOCD configuration files are written in TCL, and include a variety of choices for customization and scripting. This can be useful for non-standard debugging situations. Please refer to [OpenOCD Manual](#) for the TCL scripting reference.

**OpenOCD configuration variables** The following variables can be optionally set before including the ESP-specific target configuration file. This can be done either in a custom configuration file, or from the command line.

The syntax for setting a variable in TCL is:

```
set VARIABLE_NAME value
```

To set a variable from the command line (replace the name of .cfg file with the correct file for your board):

```
openocd -c 'set VARIABLE_NAME value' -f board/esp-xxxxx-kit.cfg
```

It is important to set the variable before including the ESP-specific configuration file, otherwise the variable will not have effect. You can set multiple variables by repeating the `-c` option.

Table 6: Common ESP-related OpenOCD variables

Variable	Description
ESP_RTOS	Set to <code>none</code> to disable RTOS support. In this case, thread list will not be available in GDB. Can be useful when debugging FreeRTOS itself, and stepping through the scheduler code.
ESP_FLASH_SIZE	Set to <code>0</code> to disable Flash breakpoints support.
ESP_SEMIHOST_BASED	Set to the path (on the host) which will be the default directory for semihosting functions.

**How debugger resets ESP32-S2?** The board can be reset by entering `mon reset` or `mon reset halt` into GDB.

**Do not use JTAG pins for something else** Operation of JTAG may be disturbed, if some other h/w is connected to JTAG pins besides ESP32-S2 module and JTAG adapter. ESP32-S2 JTAG is using the following pins:

Table 7: ESP32-S2 pins and JTAG signals

ESP32-S2 Pin	JTAG Signal
MTDO / GPIO40	TDO
MTDI / GPIO41	TDI
MTCK / GPIO39	TCK
MTMS / GPIO42	TMS

JTAG communication will likely fail, if configuration of JTAG pins is changed by user application. If OpenOCD initializes correctly (detects the two Tensilica cores), but loses sync and spews out a lot of DTR/DIR errors when the program is ran, it is likely that the application reconfigures the JTAG pins to something else, or the user forgot to connect Vtar to a JTAG adapter that needed it.

Below is an excerpt from series of errors reported by GDB after the application stepped into the code that reconfigured MTDO pin to be an input:

```
cpu0: xtensa_resume (line 431): DSR (FFFFFFFF) indicates target still busy!
cpu0: xtensa_resume (line 431): DSR (FFFFFFFF) indicates DIR instruction generated.
↳an exception!
cpu0: xtensa_resume (line 431): DSR (FFFFFFFF) indicates DIR instruction generated.
↳an overrun!
cpu1: xtensa_resume (line 431): DSR (FFFFFFFF) indicates target still busy!
cpu1: xtensa_resume (line 431): DSR (FFFFFFFF) indicates DIR instruction generated.
↳an exception!
cpu1: xtensa_resume (line 431): DSR (FFFFFFFF) indicates DIR instruction generated.
↳an overrun!
```

**JTAG with Flash Encryption or Secure Boot** By default, enabling Flash Encryption and/or Secure Boot will disable JTAG debugging. On first boot, the bootloader will burn an eFuse bit to permanently disable JTAG at the same time it enables the other features.

The project configuration option `CONFIG_SECURE_BOOT_ALLOW_JTAG` will keep JTAG enabled at this time, removing all physical security but allowing debugging. (Although the name suggests Secure Boot, this option can be applied even when only Flash Encryption is enabled).

However, OpenOCD may attempt to automatically read and write the flash in order to set *software breakpoints*. This has two problems:

- Software breakpoints are incompatible with Flash Encryption, OpenOCD currently has no support for encrypting or decrypting flash contents.
- If Secure Boot is enabled, setting a software breakpoint will change the digest of a signed app and make the signature invalid. This means if a software breakpoint is set and then a reset occurs, the signature verification will fail on boot.

To disable software breakpoints while using JTAG, add an extra argument `-c 'set ESP_FLASH_SIZE 0'` to the start of the OpenOCD command line, see *OpenOCD configuration variables*.

**Note:** For the same reason, the ESP-IDF app may fail bootloader verification of app signatures, when this option is enabled and a software breakpoint is set.

**Reporting issues with OpenOCD / GDB** In case you encounter a problem with OpenOCD or GDB programs itself and do not find a solution searching available resources on the web, open an issue in the OpenOCD issue tracker under <https://github.com/espressif/openocd-esp32/issues>.

1. In issue report provide details of your configuration:
  - a. JTAG adapter type, and the chip/module being debugged.
  - b. Release of ESP-IDF used to compile and load application that is being debugged.
  - c. Details of OS used for debugging.

- d. Is OS running natively on a PC or on a virtual machine?
2. Create a simple example that is representative to observed issue. Describe steps how to reproduce it. In such an example debugging should not be affected by non-deterministic behaviour introduced by the Wi-Fi stack, so problems will likely be easier to reproduce, if encountered once.
3. Prepare logs from debugging session by adding additional parameters to start up commands.  
OpenOCD:

```
openocd -l openocd_log.txt -d3 -f board/esp32s2-kaluga-1.cfg
```

Logging to a file this way will prevent information displayed on the terminal. This may be a good thing taken amount of information provided, when increased debug level `-d3` is set. If you still like to see the log on the screen, then use another command instead:

```
openocd -d3 -f board/esp32s2-kaluga-1.cfg 2>&1 | tee openocd.log
```

Debugger:

```
xtensa-esp32s2-elf-gdb -ex "set remotelogfile gdb_log.txt" <all other options>
```

Optionally add command `remotelogfile gdb_log.txt` to the `gdbinit` file.

4. Attach both `openocd_log.txt` and `gdb_log.txt` files to your issue report.

## 4.17.10 Related Documents

### Using Debugger

This section covers configuration and running debugger using several methods:

- from [Eclipse](#)
- from [Command Line](#)
- using [idf.py debug targets](#)

### Eclipse

---

**Note:** It is recommended to first check if debugger works using [idf.py debug targets](#) or from [Command Line](#) and then move to using Eclipse.

---

Debugging functionality is provided out of box in standard Eclipse installation. Another option is to use pluggins like “GDB Hardware Debugging” plugin. We have found this plugin quite convenient and decided to use throughout this guide.

To begin with, install “GDB Hardware Debugging” plugin by opening Eclipse and going to *Help > Install New Software*.

Once installation is complete, configure debugging session following steps below. Please note that some of configuration parameters are generic and some are project specific. This will be shown below by configuring debugging for “blink” example project. If not done already, add this project to Eclipse workspace following guidance in [Eclipse Plugin](#). The source of `get-started/blink` application is available in [examples](#) directory of ESP-IDF repository.

1. In Eclipse go to *Run > Debug Configuration*. A new window will open. In the window’s left pane double click “GDB Hardware Debugging” (or select “GDB Hardware Debugging” and press the “New” button) to create a new configuration.
2. In a form that will show up on the right, enter the “Name:” of this configuration, e.g. “Blink checking” .
3. On the “Main” tab below, under “Project:” , press “Browse” button and select the “blink” project.
4. In next line “C/C++ Application:” press “Browse” button and select “blink.elf” file. If “blink.elf” is not there, then likely this project has not been build yet. See [Eclipse Plugin](#) how to do it.
5. Finally, under “Build (if required) before launching” click “Disable auto build” .  
A sample window with settings entered in points 1 - 5 is shown below.
6. Click “Debugger” tab. In field “GDB Command” enter `xtensa-esp32s2-elf-gdb` to invoke debugger.



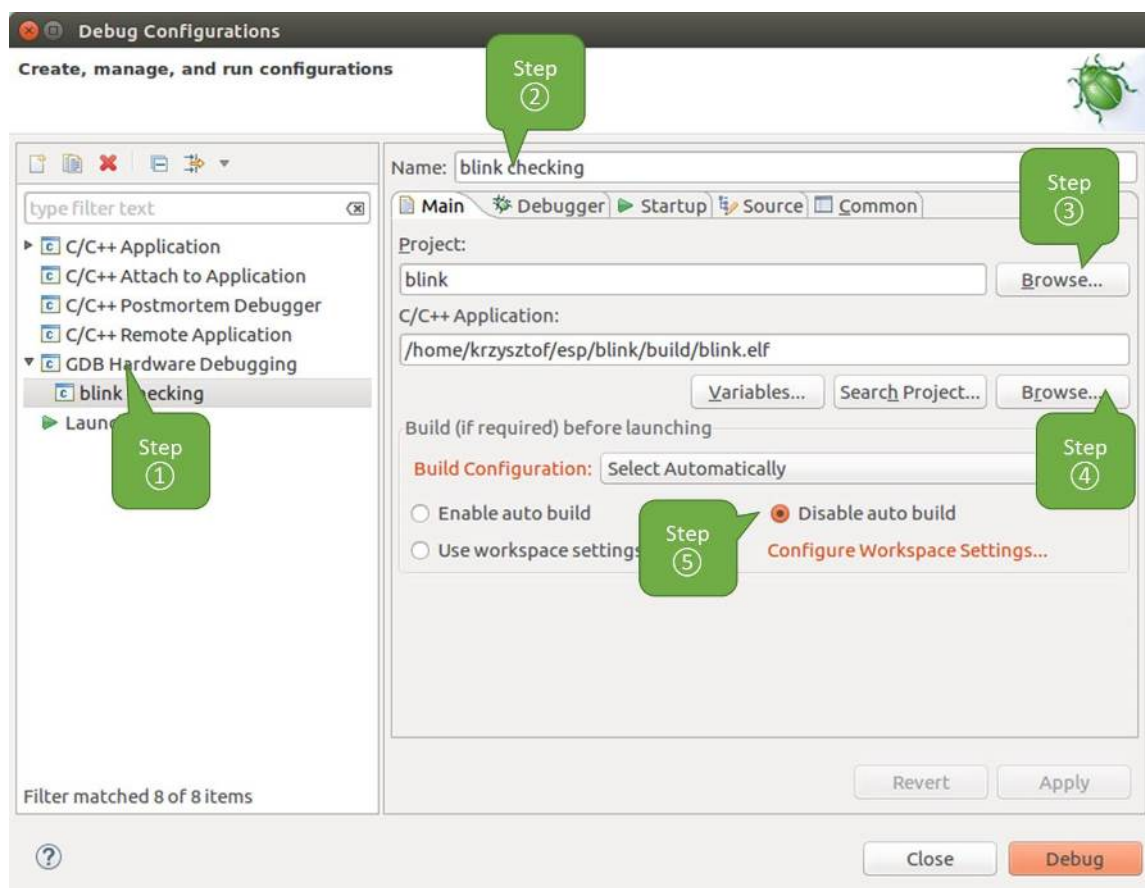

Fig. 25: Configuration of GDB Hardware Debugging - Main tab



- Change default configuration of “Remote host” by entering 3333 under the “Port number” . Configuration entered in points 6 and 7 is shown on the following picture.

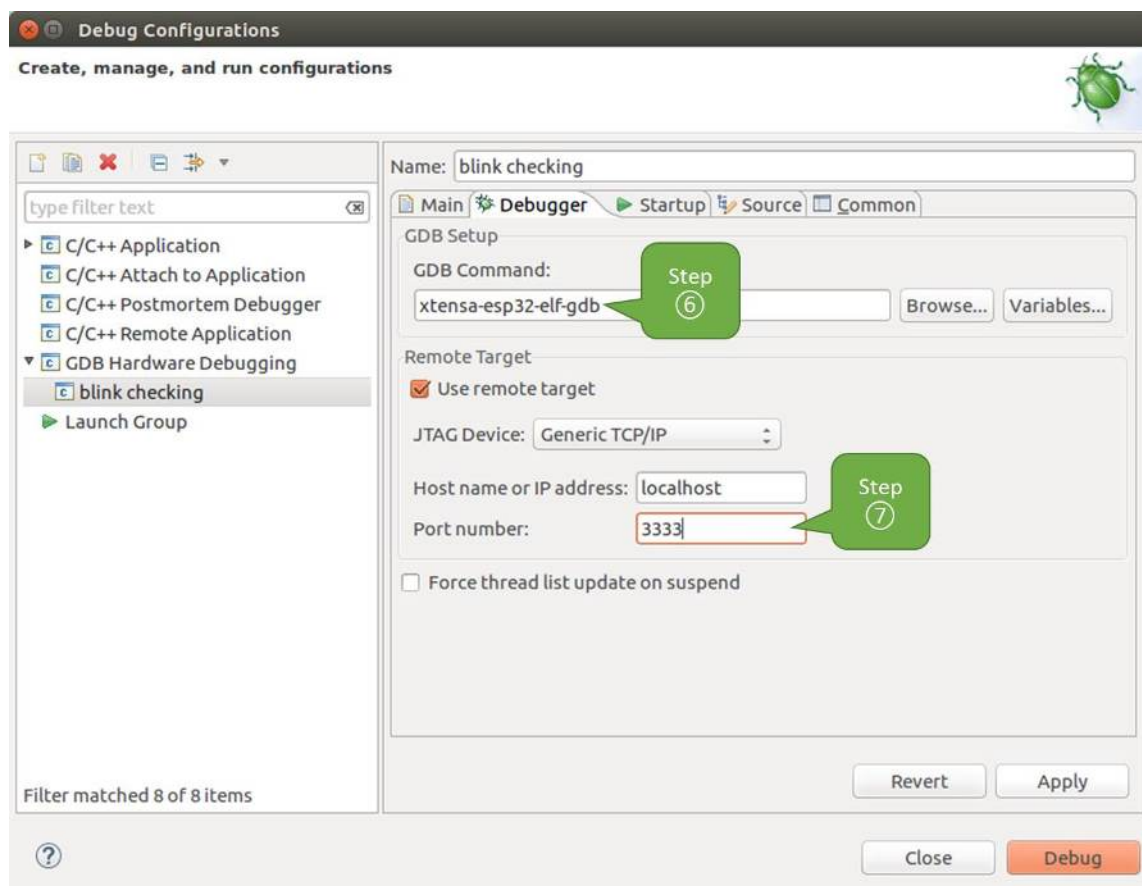

Fig. 26: Configuration of GDB Hardware Debugging - Debugger tab

- The last tab to that requires changing of default configuration is “Startup” . Under “Initialization Commands” uncheck “Reset and Delay (seconds)” and “Halt” . Then, in entry field below, enter the following lines:

```
mon reset halt
flushregs
set remote hardware-watchpoint-limit 2
```

**Note:** If you want to update image in the flash automatically before starting new debug session add the following lines of commands at the beginning of “Initialization Commands” textbox:

```
mon reset halt
mon program_esp ${workspace_loc:blink/build/blink.bin} 0x10000 verify
```

For description of `program_esp` command see [Upload application for debugging](#).

- Under “Load Image and Symbols” uncheck “Load image” option.
- Further down on the same tab, establish an initial breakpoint to halt CPUs after they are reset by debugger. The plugin will set this breakpoint at the beginning of the function entered under “Set break point at:” . Check out this option and enter `app_main` in provided field.
- Check out “Resume” option. This will make the program to resume after `mon reset halt` is invoked per point 8. The program will then stop at breakpoint inserted at `app_main`. Configuration described in points 8 - 11 is shown below.  
If the “Startup” sequence looks convoluted and respective “Initialization Commands” are not clear to you, check [What is the meaning of debugger’s startup commands?](#) for additional explanation.
- If you previously completed [Configuring ESP32-S2 Target](#) steps described above, so the target is running and ready to talk to debugger, go right to debugging by pressing “Debug” button. Otherwise press “Apply” to

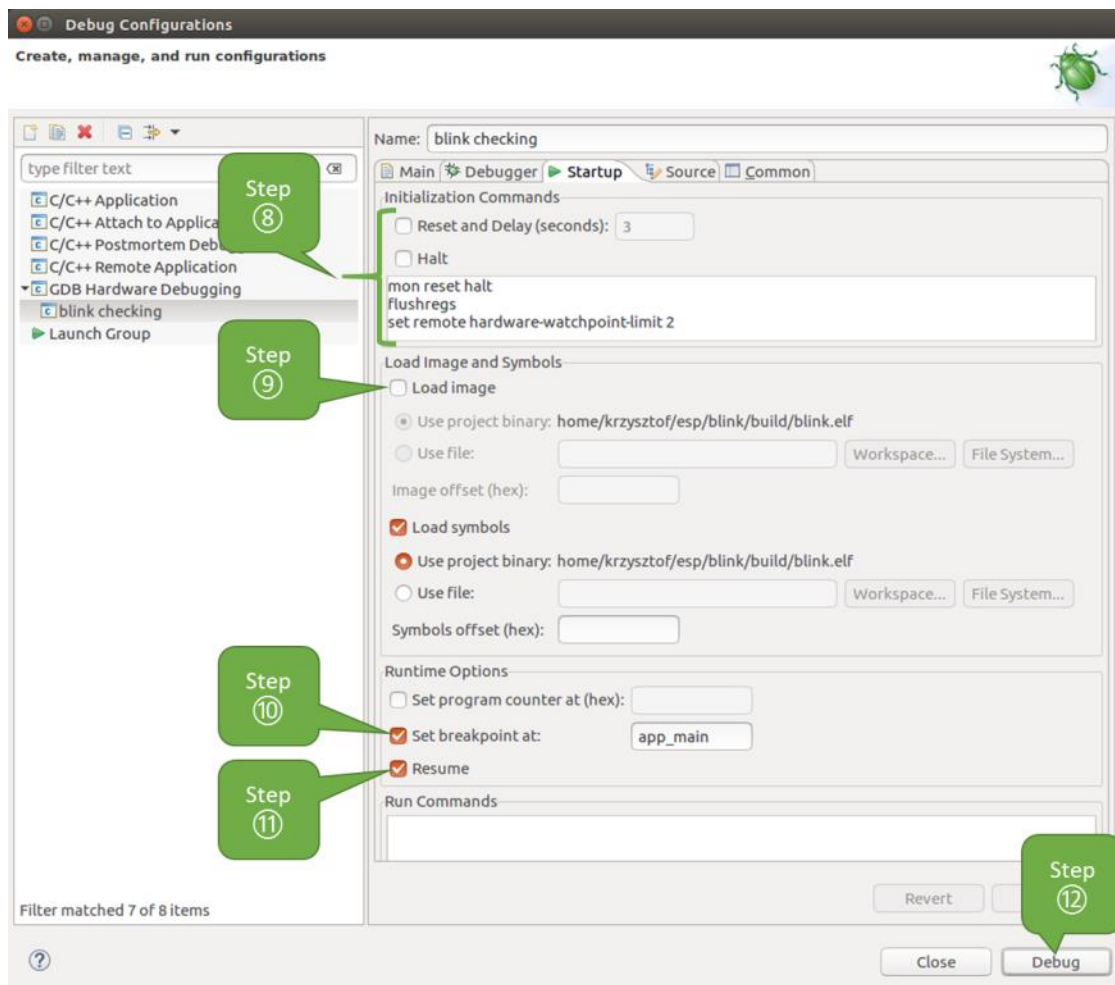

Fig. 27: Configuration of GDB Hardware Debugging - Startup tab

save changes, go back to *Configuring ESP32-S2 Target* and return here to start debugging.

Once all 1 - 12 configuration steps are satisfied, the new Eclipse perspective called “Debug” will open as shown on example picture below.

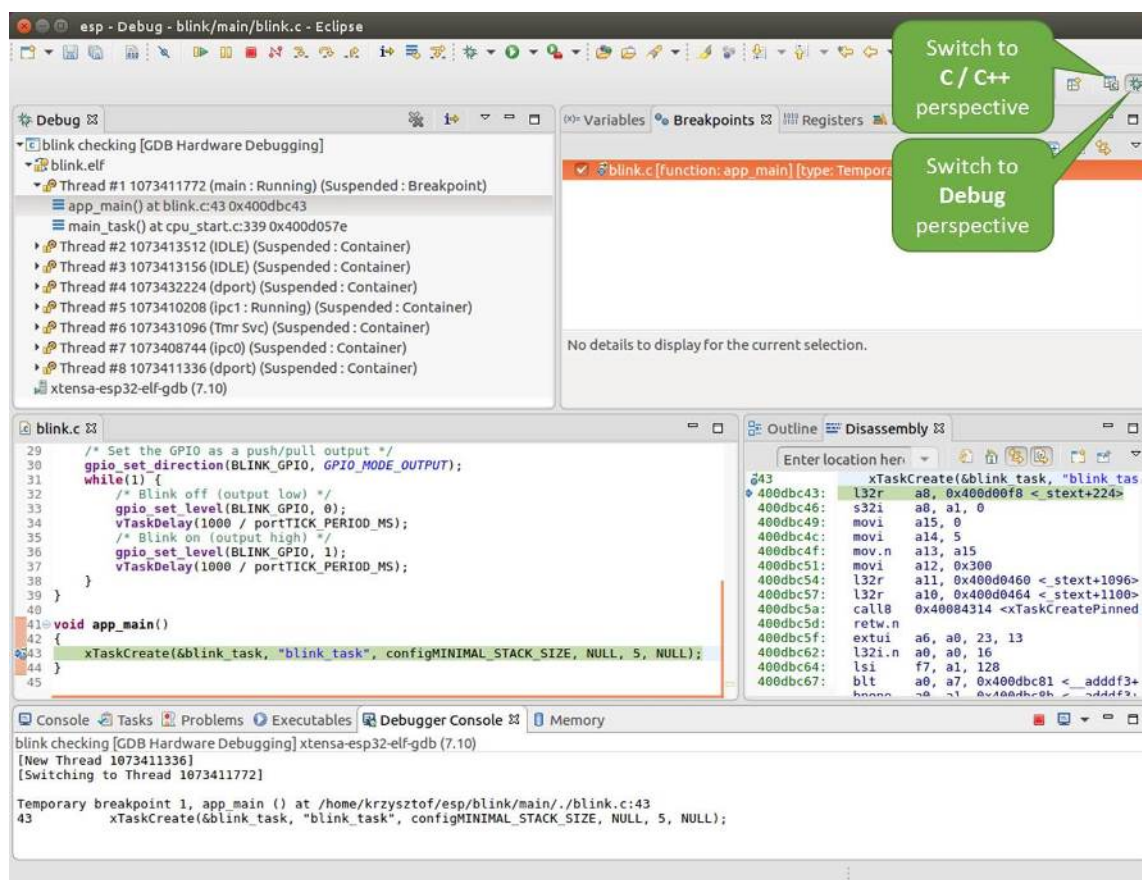

Fig. 28: Debug Perspective in Eclipse

If you are not quite sure how to use GDB, check *Eclipse* example debugging session in section *Debugging Examples*.

### Command Line

1. Begin with completing steps described under *Configuring ESP32-S2 Target*. This is prerequisite to start a debugging session.
2. Open a new terminal session and go to directory that contains project for debugging, e.g.

```
cd ~/esp/blink
```

3. When launching a debugger, you will need to provide couple of configuration parameters and commands. Instead of entering them one by one in command line, create a configuration file and name it `gdbinit`:

```
target remote :3333
set remote hardware-watchpoint-limit 2
mon reset halt
flushregs
thb app_main
c
```

Save this file in current directory.

For more details what's inside `gdbinit` file, see *What is the meaning of debugger's startup commands?*

4. Now you are ready to launch GDB. Type the following in terminal:

```
xtensa-esp32s2-elf-gdb -x gdbinit build/blink.elf
```

5. If previous steps have been done correctly, you will see a similar log concluded with (gdb) prompt:

```
user-name@computer-name:~/esp/blink$ xtensa-esp32s2-elf-gdb -x gdbinit build/
↳blink.elf
GNU gdb (crosstool-NG crosstool-ng-1.22.0-61-gab8375a) 7.10
Copyright (C) 2015 Free Software Foundation, Inc.
License GPLv3+: GNU GPL version 3 or later <http://gnu.org/licenses/gpl.html>
This is free software: you are free to change and redistribute it.
There is NO WARRANTY, to the extent permitted by law. Type "show copying"
and "show warranty" for details.
This GDB was configured as "--host=x86_64-build_pc-linux-gnu --target=xtensa-
↳esp32s2-elf".
Type "show configuration" for configuration details.
For bug reporting instructions, please see:
<http://www.gnu.org/software/gdb/bugs/>.
Find the GDB manual and other documentation resources online at:
<http://www.gnu.org/software/gdb/documentation/>.
For help, type "help".
Type "apropos word" to search for commands related to "word"...
Reading symbols from build/blink.elf...done.
0x400d10d8 in esp_vApplicationIdleHook () at /home/user-name/esp/esp-idf/
↳components/esp32s2/./freertos_hooks.c:52
52     asm("waiti 0");
JTAG tap: esp32s2.cpu0 tap/device found: 0x120034e5 (mfg: 0x272 (Tensilica),
↳part: 0x2003, ver: 0x1)
JTAG tap: esp32s2.slave tap/device found: 0x120034e5 (mfg: 0x272 (Tensilica),
↳part: 0x2003, ver: 0x1)
esp32s2: Debug controller was reset (pwrstat=0x5F, after clear 0x0F).
esp32s2: Core was reset (pwrstat=0x5F, after clear 0x0F).
Target halted. PRO_CPU: PC=0x5000004B (active) APP_CPU: PC=0x00000000
esp32s2: target state: halted
esp32s2: Core was reset (pwrstat=0x1F, after clear 0x0F).
Target halted. PRO_CPU: PC=0x40000400 (active) APP_CPU: PC=0x40000400
esp32s2: target state: halted
Hardware assisted breakpoint 1 at 0x400db717: file /home/user-name/esp/blink/
↳main/./blink.c, line 43.
0x0: 0x00000000
Target halted. PRO_CPU: PC=0x400DB717 (active) APP_CPU: PC=0x400D10D8
[New Thread 1073428656]
[New Thread 1073413708]
[New Thread 1073431316]
[New Thread 1073410672]
[New Thread 1073408876]
[New Thread 1073432196]
[New Thread 1073411552]
[Switching to Thread 1073411996]

Temporary breakpoint 1, app_main () at /home/user-name/esp/blink/main/./blink.
↳c:43
43     xTaskCreate(&blink_task, "blink_task", 512, NULL, 5, NULL);
(gdb)
```

Note the third line from bottom that shows debugger halting at breakpoint established in `gdbinit` file at function `app_main()`. Since the processor is halted, the LED should not be blinking. If this is what you see as well, you are ready to start debugging.

If you are not quite sure how to use GDB, check [Command Line](#) example debugging session in section [Debugging Examples](#).

**idf.py debug targets** It is also possible to execute the described debugging tools conveniently from `idf.py`. These commands are supported:

1. `idf.py openocd`  
Runs OpenOCD in a console with configuration defined in the environment or via command line. It uses default script directory defined as `OPENOCD_SCRIPTS` environmental variable, which is automatically added from an Export script (`export.sh` or `export.bat`). It is possible to override the script location using command line argument `--openocd-scripts`.  
As for the JTAG configuration of the current board, please use the environmental variable `OPENOCD_COMMANDS` or `--openocd-commands` command line argument. If none of the above is defined, OpenOCD is started with `-f board/esp32s2-kaluga-1.cfg` board definition.
2. `idf.py gdb`  
Starts the `gdb` the same way as the *Command Line*, but generates the initial `gdb` scripts referring to the current project `elf` file.
3. `idf.py gdbtui`  
The same as 2, but starts the `gdb` with `tui` argument allowing very simple source code view.
4. `idf.py gdbgui`  
Starts `gdbgui` debugger frontend enabling out-of-the-box debugging in a browser window. Please run the install script with the `"--enable-gdbgui"` argument in order to make this option supported, e.g. `install.sh --enable-gdbgui`.  
It is possible to combine these debugging actions on a single command line allowing convenient setup of blocking and non-blocking actions in one step. `idf.py` implements a simple logic to move the background actions (such as `openocd`) to the beginning and the interactive ones (such as `gdb`, `monitor`) to the end of the action list. An example of a very useful combination is:

```
idf.py openocd gdbgui monitor
```

The above command runs OpenOCD in the background, starts `gdbgui` to open a browser window with active debugger frontend and opens a serial monitor in the active console.

## Debugging Examples

This section describes debugging with GDB from *Eclipse* as well as from *Command Line*.

**Eclipse** Verify if your target is ready and loaded with `get-started/blink` example. Configure and start debugger following steps in section *Eclipse*. Pick up where target was left by debugger, i.e. having the application halted at breakpoint established at `app_main()`.

### Examples in this section

1. *Navigating through the code, call stack and threads*
2. *Setting and clearing breakpoints*
3. *Halting the target manually*
4. *Stepping through the code*
5. *Checking and setting memory*
6. *Watching and setting program variables*
7. *Setting conditional breakpoints*

**Navigating through the code, call stack and threads** When the target is halted, debugger shows the list of threads in “Debug” window. The line of code where program halted is highlighted in another window below, as shown on the following picture. The LED stops blinking.

Specific thread where the program halted is expanded showing the call stack. It represents function calls that lead up to the highlighted line of code, where the target halted. The first line of call stack under Thread #1 contains the last called function `app_main()`, that in turn was called from function `main_task()` shown in a line below. Each





Fig. 29: Debug Perspective in Eclipse

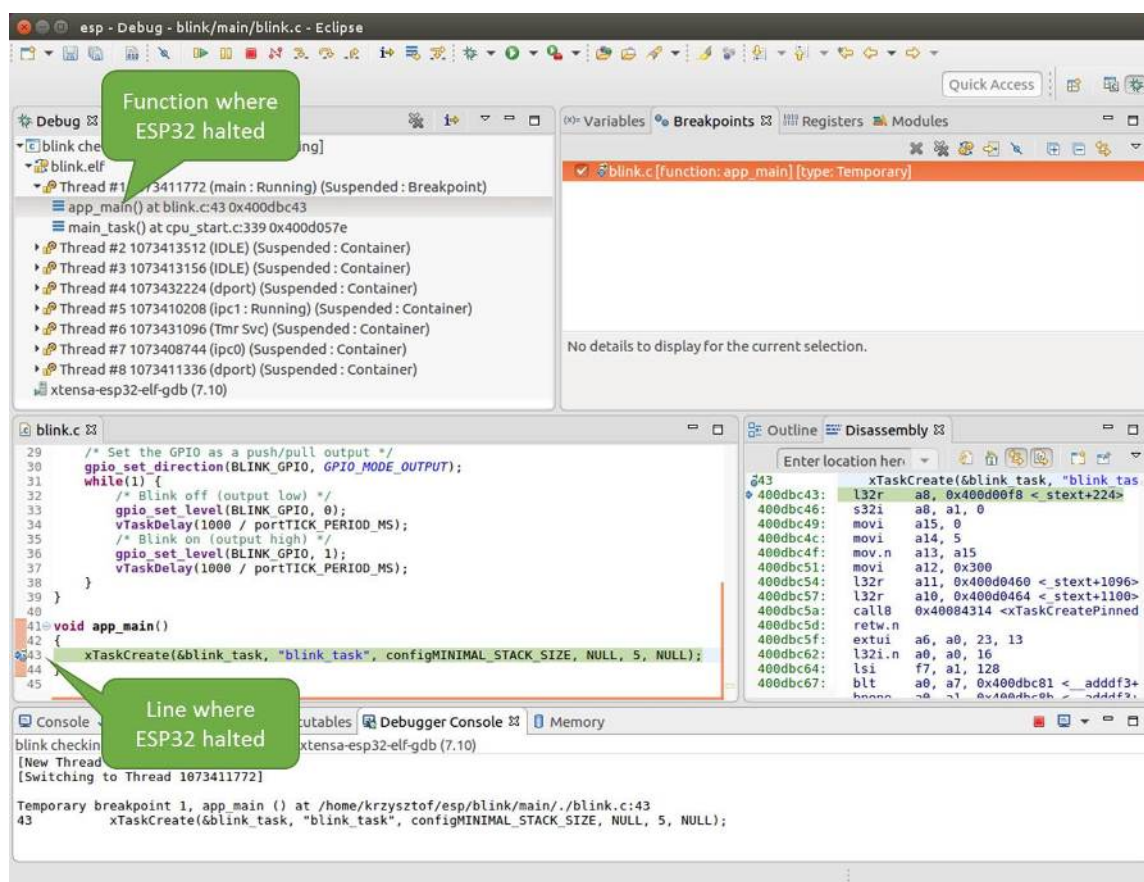

Fig. 30: Target halted during debugging

line of the stack also contains the file name and line number where the function was called. By clicking / highlighting the stack entries, in window below, you will see contents of this file.

By expanding threads you can navigate throughout the application. Expand Thread #5 that contains much longer call stack. You will see there, besides function calls, numbers like `0x4000000c`. They represent addresses of binary code not provided in source form.

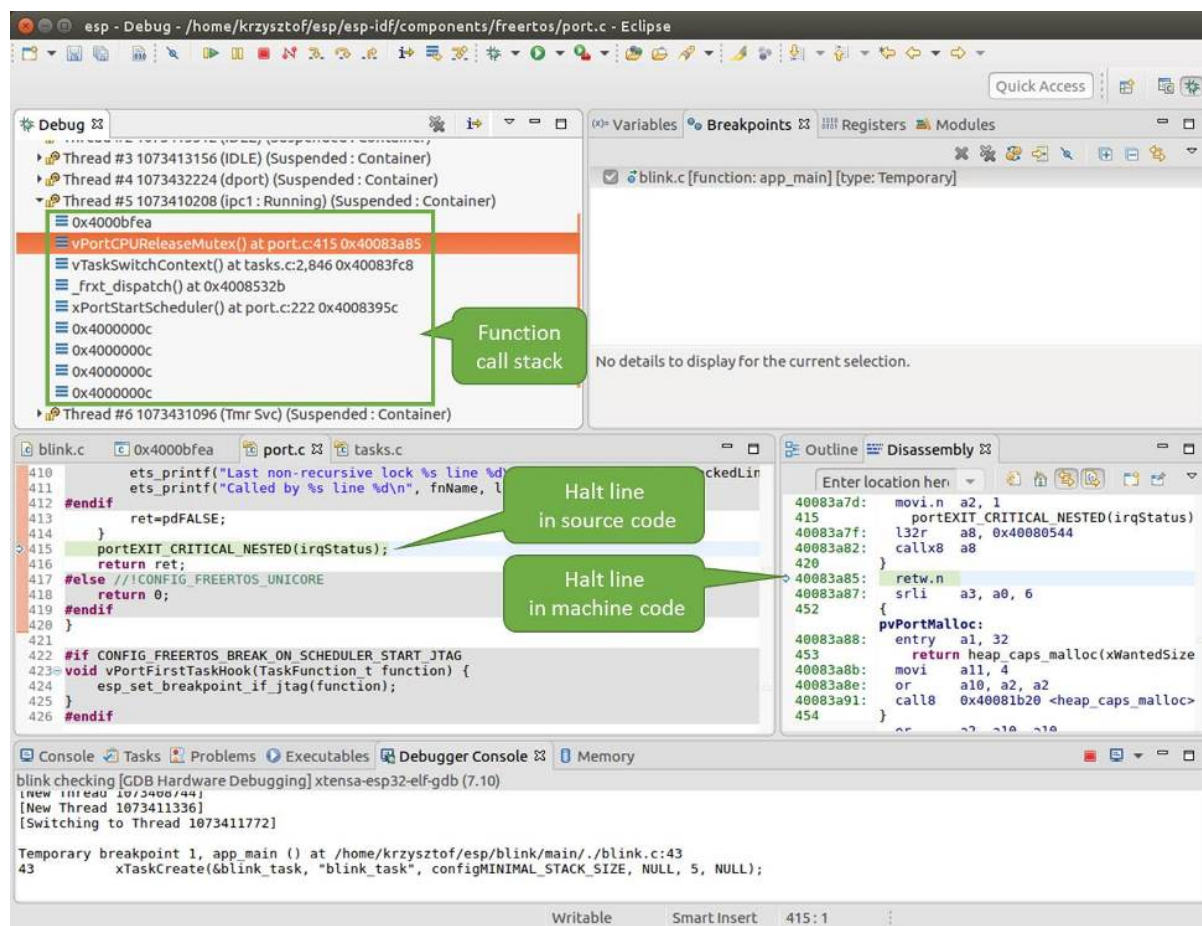

Fig. 31: Navigate through the call stack

In another window on right, you can see the disassembled machine code no matter if your project provides it in source or only the binary form.

Go back to the `app_main()` in Thread #1 to familiar code of `blink.c` file that will be examined in more details in the following examples. Debugger makes it easy to navigate through the code of entire application. This comes handy when stepping through the code and working with breakpoints and will be discussed below.

**Setting and clearing breakpoints** When debugging, we would like to be able to stop the application at critical lines of code and then examine the state of specific variables, memory and registers / peripherals. To do so we are using breakpoints. They provide a convenient way to quickly get to and halt the application at specific line.

Let's establish two breakpoints when the state of LED changes. Basing on code listing above, this happens at lines 33 and 36. To do so, hold the "Control" on the keyboard and double click on number 33 in file `blink.c` file. A dialog will open where you can confirm your selection by pressing "OK" button. If you do not like to see the dialog just double click the line number. Set another breakpoint in line 36.

Information how many breakpoints are set and where is shown in window "Breakpoints" on top right. Click "Show Breakpoints Supported by Selected Target" to refresh this list. Besides the two just set breakpoints the list may contain temporary breakpoint at function `app_main()` established at debugger start. As maximum two breakpoints are allowed (see [Breakpoints and watchpoints available](#)), you need to delete it, or debugging will fail.



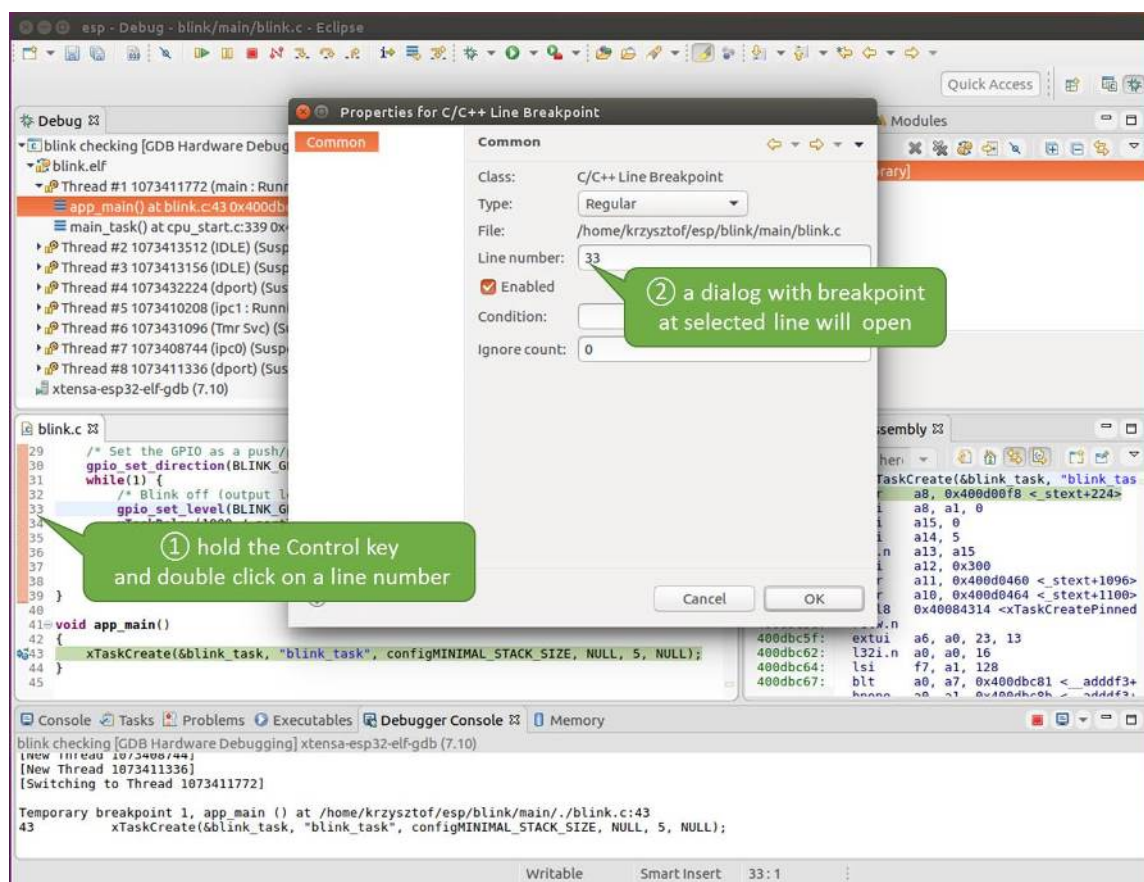

Fig. 32: Setting a breakpoint



Fig. 33: Three breakpoints are set / maximum two are allowed

If you now click “Resume” (click `blink_task()` under “Tread #8”, if “Resume” button is grayed out), the processor will run and halt at a breakpoint. Clicking “Resume” another time will make it run again, halt on second breakpoint, and so on.

You will be also able to see that LED is changing the state after each click to “Resume” program execution.

Read more about breakpoints under [Breakpoints and watchpoints available](#) and [What else should I know about breakpoints?](#)

**Halting the target manually** When debugging, you may resume application and enter code waiting for some event or staying in infinite loop without any break points defined. In such case, to go back to debugging mode, you can break program execution manually by pressing “Suspend” button.

To check it, delete all breakpoints and click “Resume”. Then click “Suspend”. Application will be halted at some random point and LED will stop blinking. Debugger will expand tread and highlight the line of code where application halted.

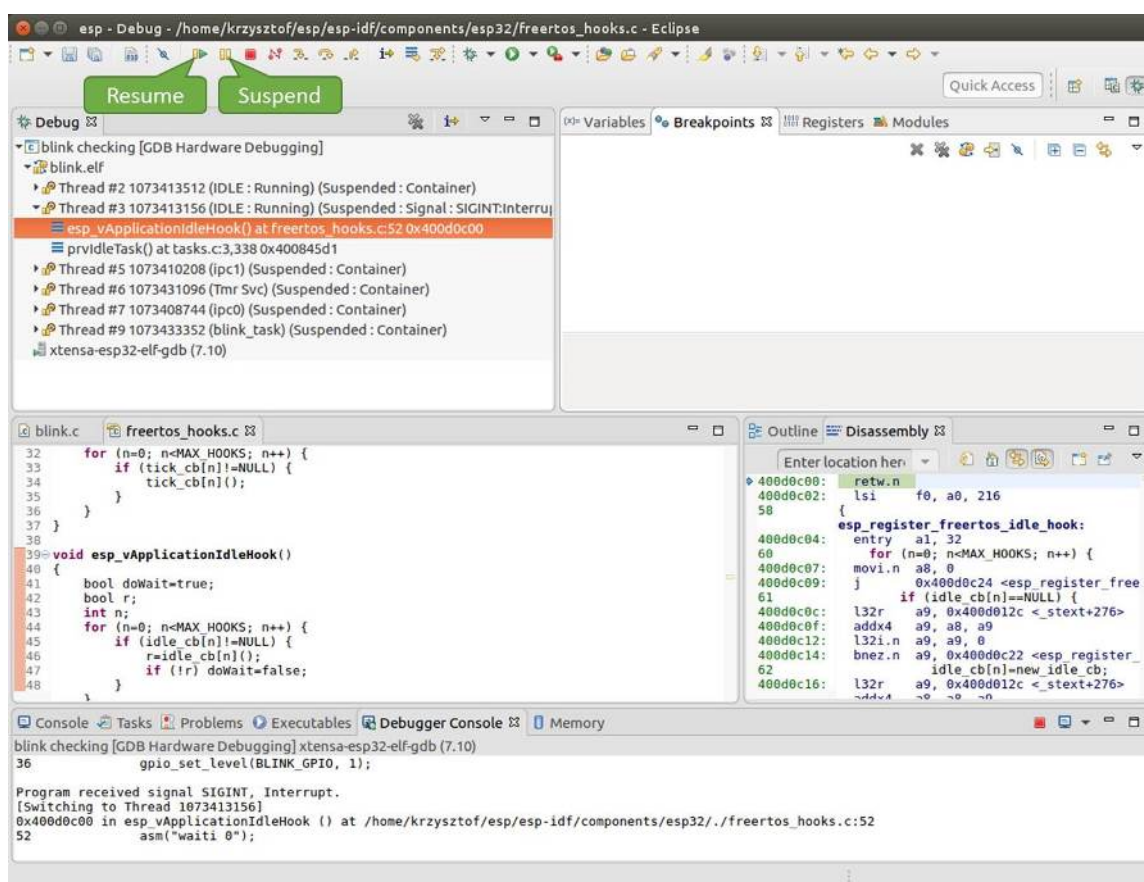

Fig. 34: Target halted manually

In particular case above, the application has been halted in line 52 of code in file `freertos_hooks.c`. Now you can resume it again by pressing “Resume” button or do some debugging as discussed below.

**Stepping through the code** It is also possible to step through the code using “Step Into (F5)” and “Step Over (F6)” commands. The difference is that “Step Into (F5)” is entering inside subroutines calls, while “Step Over (F6)” steps over the call, treating it as a single source line.

Before being able to demonstrate this functionality, using information discussed in previous paragraph, make sure that you have only one breakpoint defined at line 36 of `blink.c`.

Resume program by entering pressing F8 and let it halt. Now press “Step Over (F6)”, one by one couple of times, to see how debugger is stepping one program line at a time.



Fig. 35: Stepping through the code with “Step Over (F6)”



If you press “Step Into (F5)” instead, then debugger will step inside subroutine calls.

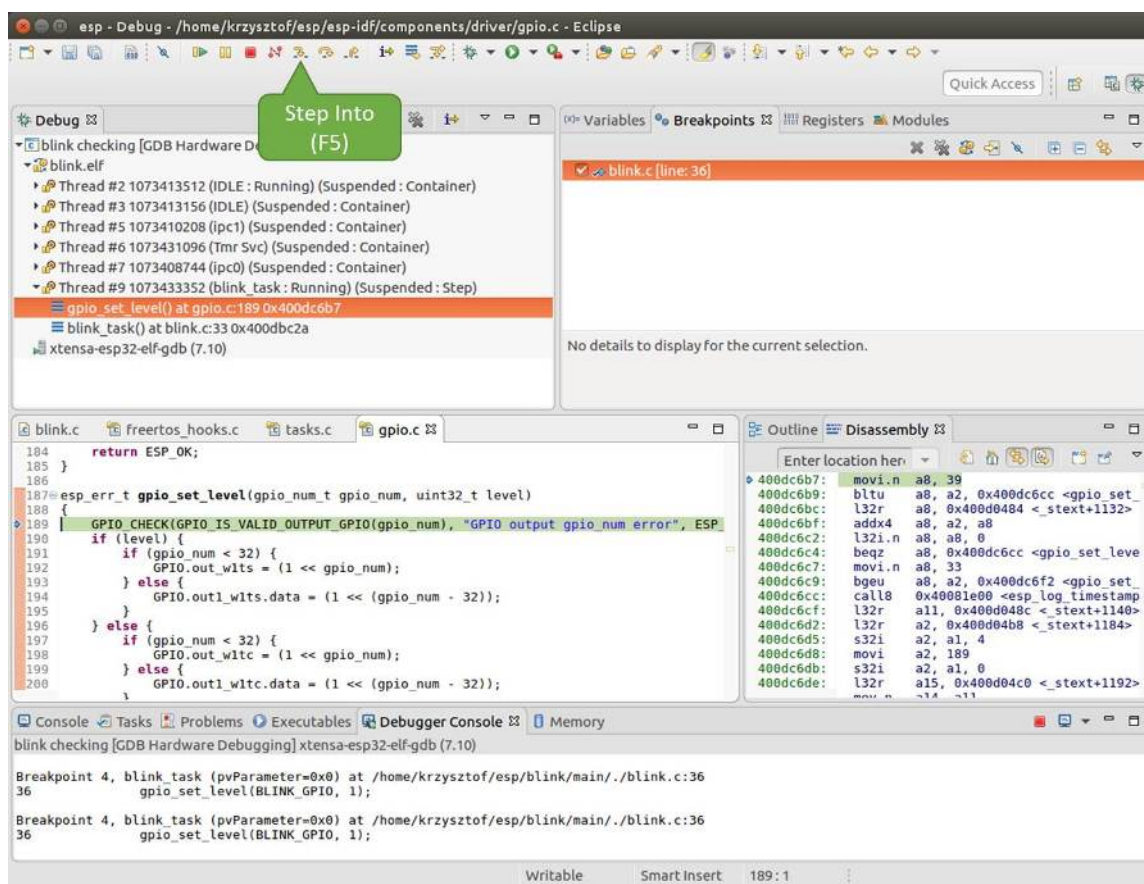

Fig. 36: Stepping through the code with “Step Into (F5)”

In this particular case debugger stepped inside `gpio_set_level(BLINK_GPIO, 0)` and effectively moved to `gpio.c` driver code.

See *Why stepping with “next” does not bypass subroutine calls?* for potential limitation of using `next` command.

**Checking and setting memory** To display or set contents of memory use “Memory” tab at the bottom of “Debug” perspective.

With the “Memory” tab, we will read from and write to the memory location `0x3FF44004` labeled as `GPIO_OUT_REG` used to set and clear individual GPIO’s.

For more information, see *ESP32-S2 Technical Reference Manual > IO MUX and GPIO Matrix (GPIO, IO\_MUX)* [PDF].

Being in the same `blink.c` project as before, set two breakpoints right after `gpio_set_level` instruction. Click “Memory” tab and then “Add Memory Monitor” button. Enter `0x3FF44004` in provided dialog.

Now resume program by pressing F8 and observe “Monitor” tab.

You should see one bit being flipped over at memory location `0x3FF44004` (and LED changing the state) each time F8 is pressed.

To set memory use the same “Monitor” tab and the same memory location. Type in alternate bit pattern as previously observed. Immediately after pressing enter you will see LED changing the state.

**Watching and setting program variables** A common debugging tasks is checking the value of a program variable as the program runs. To be able to demonstrate this functionality, update file `blink.c` by adding a declaration of

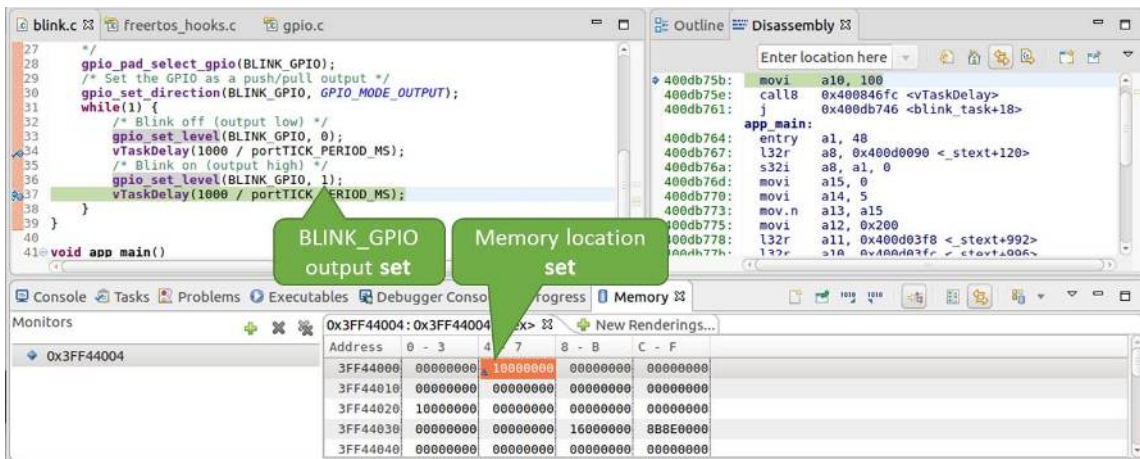

Fig. 37: Observing memory location 0x3FF44004 changing one bit to “ON”

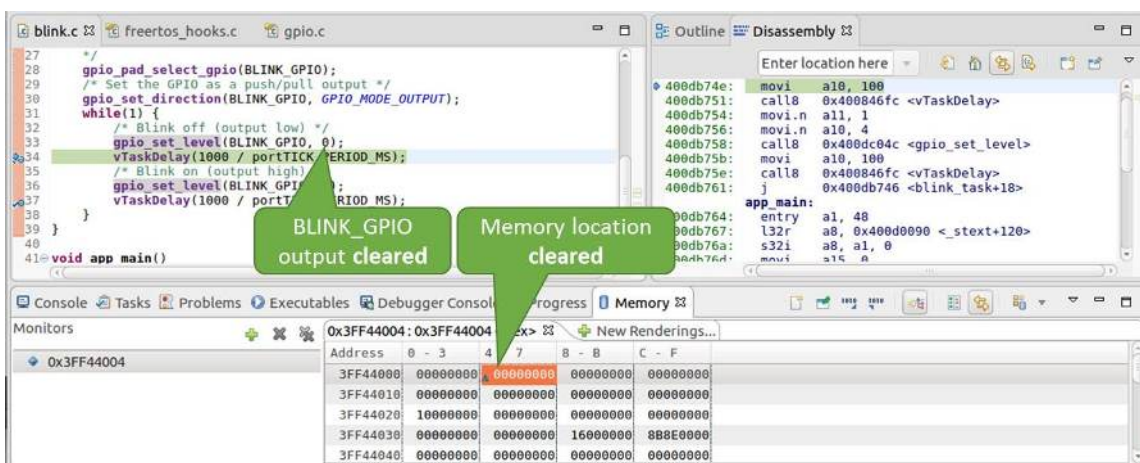

Fig. 38: Observing memory location 0x3FF44004 changing one bit to “OFF”

a global variable `int i` above definition of function `blink_task`. Then add `i++` inside `while(1)` of this function to get `i` incremented on each blink.

Exit debugger, so it is not confused with new code, build and flash the code to the ESP and restart debugger. There is no need to restart OpenOCD.

Once application is halted, enter a breakpoint in the line where you put `i++`.

In next step, in the window with “Breakpoints”, click the “Expressions” tab. If this tab is not visible, then add it by going to the top menu `Window > Show View > Expressions`. Then click “Add new expression” and enter `i`.

Resume program execution by pressing `F8`. Each time the program is halted you will see `i` value being incremented.

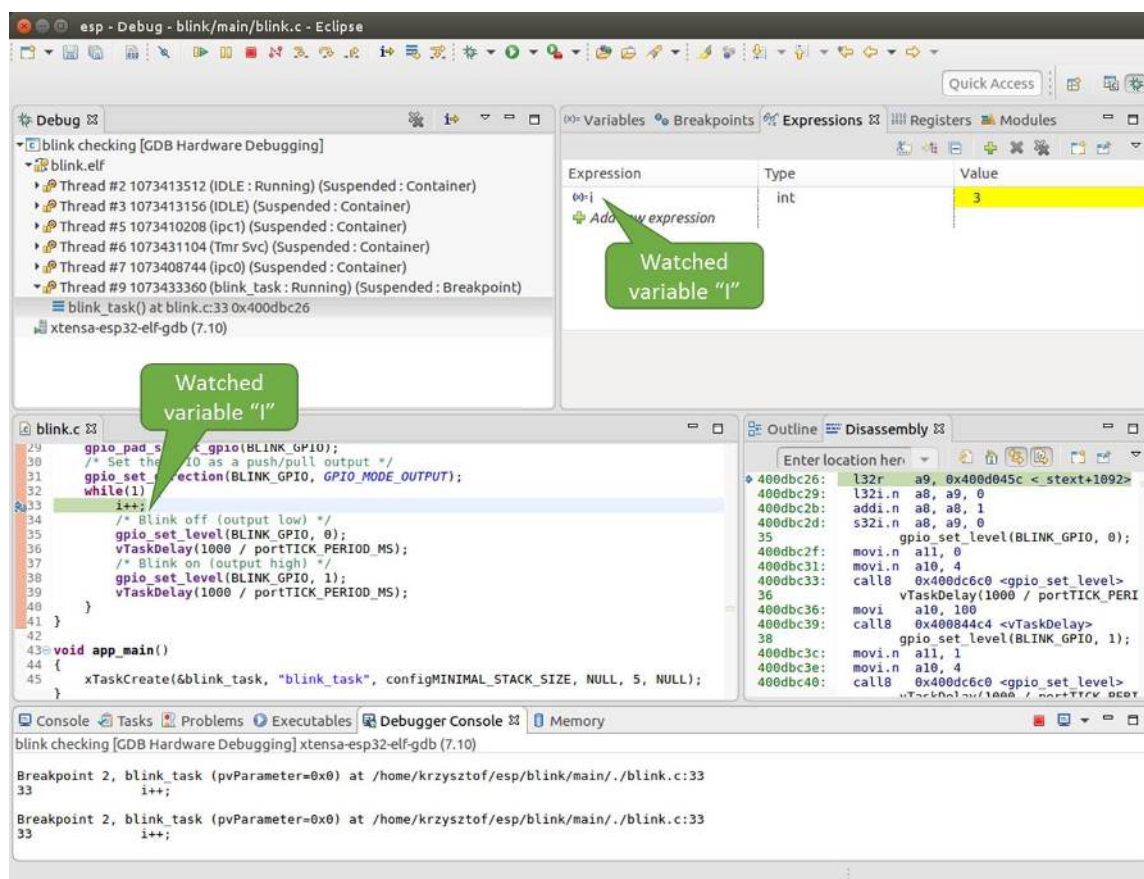

Fig. 39: Watching program variable “i”

To modify `i` enter a new number in “Value” column. After pressing “Resume (`F8`)” the program will keep incrementing `i` starting from the new entered number.

**Setting conditional breakpoints** Here comes more interesting part. You may set a breakpoint to halt the program execution, if certain condition is satisfied. Right click on the breakpoint to open a context menu and select “Breakpoint Properties”. Change the selection under “Type:” to “Hardware” and enter a “Condition:” like `i == 2`.

If current value of `i` is less than 2 (change it if required) and program is resumed, it will blink LED in a loop until condition `i == 2` gets true and then finally halt.

**Command Line** Verify if your target is ready and loaded with [get-started/blink](#) example. Configure and start debugger following steps in section [Command Line](#). Pick up where target was left by debugger, i.e. having the application halted at breakpoint established at `app_main()`:

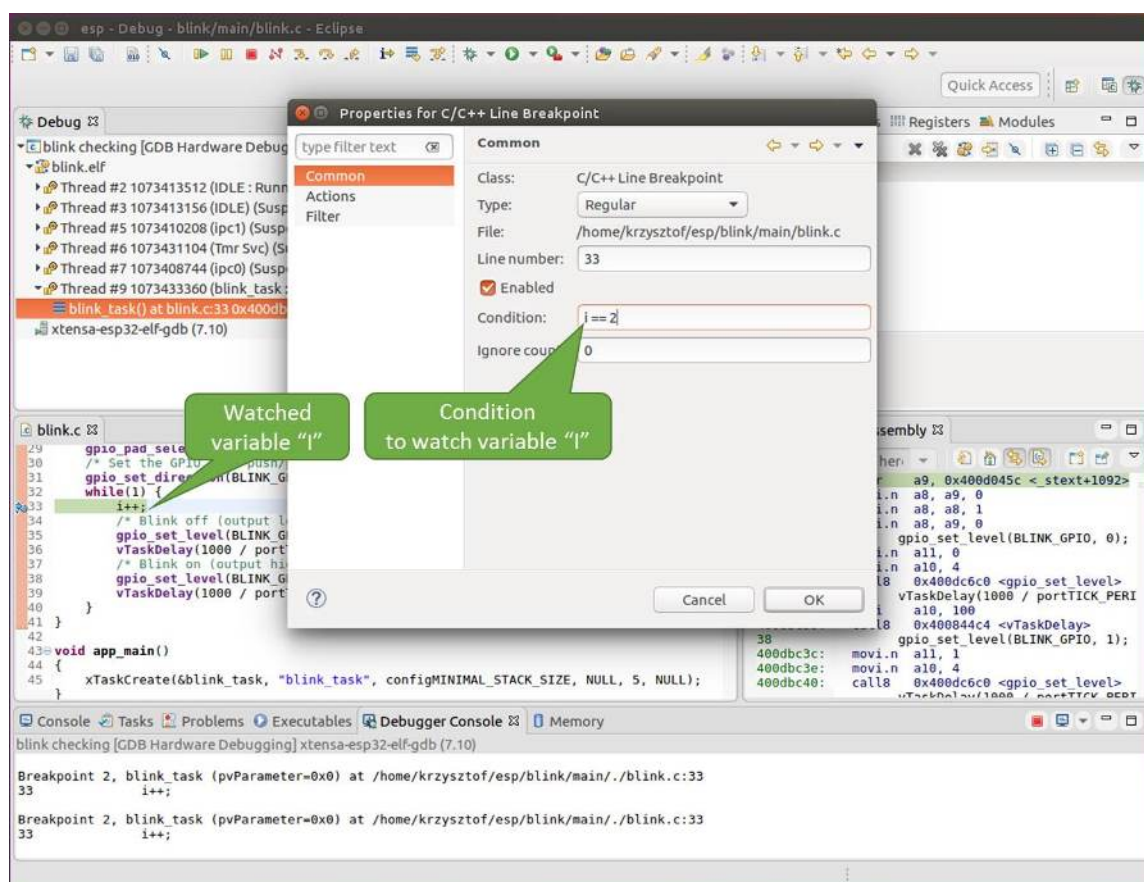

Fig. 40: Setting a conditional breakpoint



```
Temporary breakpoint 1, app_main () at /home/user-name/esp/blink/main/./blink.c:43
43     xTaskCreate(&blink_task, "blink_task", configMINIMAL_STACK_SIZE, NULL, 5, &
↳NULL);
(gdb)
```

### Examples in this section

1. *Navigating through the code, call stack and threads*
2. *Setting and clearing breakpoints*
3. *Halting and resuming the application*
4. *Stepping through the code*
5. *Checking and setting memory*
6. *Watching and setting program variables*
7. *Setting conditional breakpoints*

**Navigating through the code, call stack and threads** When you see the (gdb) prompt, the application is halted. LED should not be blinking.

To find out where exactly the code is halted, enter `l` or `list`, and debugger will show couple of lines of code around the halt point (line 43 of code in file `blink.c`)

```
(gdb) l
38     }
39 }
40
41 void app_main()
42 {
43     xTaskCreate(&blink_task, "blink_task", configMINIMAL_STACK_SIZE, NULL, 5, &
↳NULL);
44 }
(gdb)
```

Check how code listing works by entering, e.g. `l 30, 40` to see particular range of lines of code.

You can use `bt` or `backtrace` to see what function calls lead up to this code:

```
(gdb) bt
#0 app_main () at /home/user-name/esp/blink/main/./blink.c:43
#1 0x400d057e in main_task (args=0x0) at /home/user-name/esp/esp-idf/components/
↳esp32s2/./cpu_start.c:339
(gdb)
```

Line #0 of output provides the last function call before the application halted, i.e. `app_main ()` we have listed previously. The `app_main ()` was in turn called by function `main_task` from line 339 of code located in file `cpu_start.c`.

To get to the context of `main_task` in file `cpu_start.c`, enter `frame N`, where `N = 1`, because the `main_task` is listed under #1):

```
(gdb) frame 1
#1 0x400d057e in main_task (args=0x0) at /home/user-name/esp/esp-idf/components/
↳esp32s2/./cpu_start.c:339
339     app_main();
(gdb)
```

Enter `l` and this will reveal the piece of code that called `app_main ()` (in line 339):

```
(gdb) l
334     ;
335 }
```

(continues on next page)

(continued from previous page)

```

336 #endif
337     //Enable allocation in region where the startup stacks were located.
338     heap_caps_enable_nonos_stack_heaps();
339     app_main();
340     vTaskDelete(NULL);
341 }
342
(gdb)

```

By listing some lines before, you will see the function name `main_task` we have been looking for:

```

(gdb) l 326, 341
326 static void main_task(void* args)
327 {
328     // Now that the application is about to start, disable boot watchdogs
329     REG_CLR_BIT(TIMG_WDTCONFIG0_REG(0), TIMG_WDT_FLASHBOOT_MOD_EN_S);
330     REG_CLR_BIT(RTC_CNTL_WDTCONFIG0_REG, RTC_CNTL_WDT_FLASHBOOT_MOD_EN);
331 #if !CONFIG_FREERTOS_UNICORE
332     // Wait for FreeRTOS initialization to finish on APP CPU, before replacing
↳ its startup stack
333     while (port_xSchedulerRunning[1] == 0) {
334         ;
335     }
336 #endif
337     //Enable allocation in region where the startup stacks were located.
338     heap_caps_enable_nonos_stack_heaps();
339     app_main();
340     vTaskDelete(NULL);
341 }
(gdb)

```

To see the other code, enter `i threads`. This will show the list of threads running on target:

```

(gdb) i threads
Id   Target Id           Frame
  8   Thread 1073411336 (dport) 0x400d0848 in dport_access_init_core (arg=
↳ <optimized out>)
    at /home/user-name/esp/esp-idf/components/esp32s2/./dport_access.c:170
  7   Thread 1073408744 (ipc0) xQueueGenericReceive (xQueue=0x3ffae694,
↳ pvBuffer=0x0, xTicksToWait=1644638200,
    xJustPeeking=0) at /home/user-name/esp/esp-idf/components/freertos/./queue.
↳ c:1452
  6   Thread 1073431096 (Tmr Svc) prvTimerTask (pvParameters=0x0)
    at /home/user-name/esp/esp-idf/components/freertos/./timers.c:445
  5   Thread 1073410208 (ipc1 : Running) 0x4000bfea in ?? ()
  4   Thread 1073432224 (dport) dport_access_init_core (arg=0x0)
    at /home/user-name/esp/esp-idf/components/esp32s2/./dport_access.c:150
  3   Thread 1073413156 (IDLE) prvIdleTask (pvParameters=0x0)
    at /home/user-name/esp/esp-idf/components/freertos/./tasks.c:3282
  2   Thread 1073413512 (IDLE) prvIdleTask (pvParameters=0x0)
    at /home/user-name/esp/esp-idf/components/freertos/./tasks.c:3282
* 1   Thread 1073411772 (main : Running) app_main () at /home/user-name/esp/blink/
↳ main/./blink.c:43
(gdb)

```

The thread list shows the last function calls per each thread together with the name of C source file if available.

You can navigate to specific thread by entering `thread N`, where `N` is the thread Id. To see how it works go to thread thread 5:

```
(gdb) thread 5
```

(continues on next page)

(continued from previous page)

```
[Switching to thread 5 (Thread 1073410208)]
#0 0x4000bfea in ?? ()
(gdb)
```

Then check the backtrace:

```
(gdb) bt
#0 0x4000bfea in ?? ()
#1 0x40083a85 in vPortCPUReleaseMutex (mux=<optimized out>) at /home/user-name/
↳esp/esp-idf/components/freertos/./port.c:415
#2 0x40083fc8 in vTaskSwitchContext () at /home/user-name/esp/esp-idf/components/
↳freertos/./tasks.c:2846
#3 0x4008532b in _frxt_dispatch ()
#4 0x4008395c in xPortStartScheduler () at /home/user-name/esp/esp-idf/components/
↳freertos/./port.c:222
#5 0x4000000c in ?? ()
#6 0x4000000c in ?? ()
#7 0x4000000c in ?? ()
#8 0x4000000c in ?? ()
(gdb)
```

As you see, the backtrace may contain several entries. This will let you check what exact sequence of function calls lead to the code where the target halted. Question marks ?? instead of a function name indicate that application is available only in binary format, without any source file in C language. The value like 0x4000bfea is the memory address of the function call.

Using `bt`, `i threads`, `thread N` and `list` commands we are now able to navigate through the code of entire application. This comes handy when stepping through the code and working with breakpoints and will be discussed below.

**Setting and clearing breakpoints** When debugging, we would like to be able to stop the application at critical lines of code and then examine the state of specific variables, memory and registers / peripherals. To do so we are using breakpoints. They provide a convenient way to quickly get to and halt the application at specific line.

Let's establish two breakpoints when the state of LED changes. Basing on code listing above this happens at lines 33 and 36. Breakpoints may be established using command `break M` where `M` is the code line number:

```
(gdb) break 33
Breakpoint 2 at 0x400db6f6: file /home/user-name/esp/blink/main/./blink.c, line 33.
(gdb) break 36
Breakpoint 3 at 0x400db704: file /home/user-name/esp/blink/main/./blink.c, line 36.
```

If you now enter `c`, the processor will run and halt at a breakpoint. Entering `c` another time will make it run again, halt on second breakpoint, and so on:

```
(gdb) c
Continuing.
Target halted. PRO_CPU: PC=0x400DB6F6 (active) APP_CPU: PC=0x400D10D8

Breakpoint 2, blink_task (pvParameter=0x0) at /home/user-name/esp/blink/main/./
↳blink.c:33
33         gpio_set_level(BLINK_GPIO, 0);
(gdb) c
Continuing.
Target halted. PRO_CPU: PC=0x400DB6F8 (active) APP_CPU: PC=0x400D10D8
Target halted. PRO_CPU: PC=0x400DB704 (active) APP_CPU: PC=0x400D10D8

Breakpoint 3, blink_task (pvParameter=0x0) at /home/user-name/esp/blink/main/./
↳blink.c:36
36         gpio_set_level(BLINK_GPIO, 1);
```

(continues on next page)

```
(gdb)
```

You will be also able to see that LED is changing the state only if you resume program execution by entering `c`.

To examine how many breakpoints are set and where, use command `info break`:

```
(gdb) info break
Num      Type           Disp Enb Address      What
2        breakpoint     keep y   0x400db6f6 in blink_task at /home/user-name/esp/
↳blink/main/./blink.c:33
    breakpoint already hit 1 time
3        breakpoint     keep y   0x400db704 in blink_task at /home/user-name/esp/
↳blink/main/./blink.c:36
    breakpoint already hit 1 time
(gdb)
```

Please note that breakpoint numbers (listed under `Num`) start with 2. This is because first breakpoint has been already established at function `app_main()` by running command `thb app_main` on debugger launch. As it was a temporary breakpoint, it has been automatically deleted and now is not listed anymore.

To remove breakpoints enter `delete N` command (in short `d N`), where `N` is the breakpoint number:

```
(gdb) delete 1
No breakpoint number 1.
(gdb) delete 2
(gdb)
```

Read more about breakpoints under *Breakpoints and watchpoints available* and *What else should I know about breakpoints?*

**Halting and resuming the application** When debugging, you may resume application and enter code waiting for some event or staying in infinite loop without any break points defined. In such case, to go back to debugging mode, you can break program execution manually by entering `Ctrl+C`.

To check it delete all breakpoints and enter `c` to resume application. Then enter `Ctrl+C`. Application will be halted at some random point and LED will stop blinking. Debugger will print the following:

```
(gdb) c
Continuing.
^CTarget halted. PRO_CPU: PC=0x400D0C00          APP_CPU: PC=0x400D0C00 (active)
[New Thread 1073433352]

Program received signal SIGINT, Interrupt.
[Switching to Thread 1073413512]
0x400d0c00 in esp_vApplicationIdleHook () at /home/user-name/esp/esp-idf/
↳components/esp32s2/./freertos_hooks.c:52
52          asm("waiti 0");
(gdb)
```

In particular case above, the application has been halted in line 52 of code in file `freertos_hooks.c`. Now you can resume it again by enter `c` or do some debugging as discussed below.

---

**Note:** In MSYS2 shell `Ctrl+C` does not halt the target but exists debugger. To resolve this issue consider debugging with *Eclipse* or check a workaround under [http://www.mingw.org/wiki/Workaround\\_for\\_GDB\\_Ctrl\\_C\\_Interrupt](http://www.mingw.org/wiki/Workaround_for_GDB_Ctrl_C_Interrupt).

---

**Stepping through the code** It is also possible to step through the code using `step` and `next` commands (in short `s` and `n`). The difference is that `step` is entering inside subroutines calls, while `next` steps over the call, treating it as a single source line.

To demonstrate this functionality, using command `break` and `delete` discussed in previous paragraph, make sure that you have only one breakpoint defined at line 36 of `blink.c`:

```
(gdb) info break
Num      Type           Disp Enb Address      What
3        breakpoint      keep y  0x400db704  in blink_task at /home/user-name/esp/
↳blink/main/./blink.c:36
breakpoint already hit 1 time
(gdb)
```

Resume program by entering `c` and let it halt:

```
(gdb) c
Continuing.
Target halted. PRO_CPU: PC=0x400DB754 (active)    APP_CPU: PC=0x400D1128

Breakpoint 3, blink_task (pvParameter=0x0) at /home/user-name/esp/blink/main/./
↳blink.c:36
36          gpio_set_level(BLINK_GPIO, 1);
(gdb)
```

Then enter `n` couple of times to see how debugger is stepping one program line at a time:

```
(gdb) n
Target halted. PRO_CPU: PC=0x400DB756 (active)    APP_CPU: PC=0x400D1128
Target halted. PRO_CPU: PC=0x400DB758 (active)    APP_CPU: PC=0x400D1128
Target halted. PRO_CPU: PC=0x400DC04C (active)    APP_CPU: PC=0x400D1128
Target halted. PRO_CPU: PC=0x400DB75B (active)    APP_CPU: PC=0x400D1128
37          vTaskDelay(1000 / portTICK_PERIOD_MS);
(gdb) n
Target halted. PRO_CPU: PC=0x400DB75E (active)    APP_CPU: PC=0x400D1128
Target halted. PRO_CPU: PC=0x400846FC (active)    APP_CPU: PC=0x400D1128
Target halted. PRO_CPU: PC=0x400DB761 (active)    APP_CPU: PC=0x400D1128
Target halted. PRO_CPU: PC=0x400DB746 (active)    APP_CPU: PC=0x400D1128
33          gpio_set_level(BLINK_GPIO, 0);
(gdb)
```

If you enter `s` instead, then debugger will step inside subroutine calls:

```
(gdb) s
Target halted. PRO_CPU: PC=0x400DB748 (active)    APP_CPU: PC=0x400D1128
Target halted. PRO_CPU: PC=0x400DB74B (active)    APP_CPU: PC=0x400D1128
Target halted. PRO_CPU: PC=0x400DC04C (active)    APP_CPU: PC=0x400D1128
Target halted. PRO_CPU: PC=0x400DC04F (active)    APP_CPU: PC=0x400D1128
gpio_set_level (gpio_num=GPIO_NUM_4, level=0) at /home/user-name/esp/esp-idf/
↳components/driver/./gpio.c:183
183      GPIO_CHECK(GPIO_IS_VALID_OUTPUT_GPIO(gpio_num), "GPIO output gpio_num error
↳", ESP_ERR_INVALID_ARG);
(gdb)
```

In this particular case debugger stepped inside `gpio_set_level(BLINK_GPIO, 0)` and effectively moved to `gpio.c` driver code.

See [Why stepping with “next” does not bypass subroutine calls?](#) for potential limitation of using `next` command.

**Checking and setting memory** Displaying the contents of memory is done with command `x`. With additional parameters you may vary the format and count of memory locations displayed. Run `help x` to see more details. Companion command to `x` is `set` that let you write values to the memory.

We will demonstrate how `x` and `set` work by reading from and writing to the memory location `0x3FF44004` labeled as `GPIO_OUT_REG` used to set and clear individual GPIO's.

For more information, see *ESP32-S2 Technical Reference Manual > IO MUX and GPIO Matrix (GPIO, IO\_MUX)* [PDF].

Being in the same `blink.c` project as before, set two breakpoints right after `gpio_set_level` instruction. Enter two times `c` to get to the break point followed by `x /1wx 0x3FF44004` to display contents of `GPIO_OUT_REG` memory location:

```
(gdb) c
Continuing.
Target halted. PRO_CPU: PC=0x400DB75E (active)   APP_CPU: PC=0x400D1128
Target halted. PRO_CPU: PC=0x400DB74E (active)   APP_CPU: PC=0x400D1128

Breakpoint 2, blink_task (pvParameter=0x0) at /home/user-name/esp/blink/main/./
↳blink.c:34
34         vTaskDelay(1000 / portTICK_PERIOD_MS);
(gdb) x /1wx 0x3FF44004
0x3ff44004: 0x00000000
(gdb) c
Continuing.
Target halted. PRO_CPU: PC=0x400DB751 (active)   APP_CPU: PC=0x400D1128
Target halted. PRO_CPU: PC=0x400DB75B (active)   APP_CPU: PC=0x400D1128

Breakpoint 3, blink_task (pvParameter=0x0) at /home/user-name/esp/blink/main/./
↳blink.c:37
37         vTaskDelay(1000 / portTICK_PERIOD_MS);
(gdb) x /1wx 0x3FF44004
0x3ff44004: 0x00000010
(gdb)
```

If you are blinking LED connected to GPIO4, then you should see fourth bit being flipped each time the LED changes the state:

```
0x3ff44004: 0x00000000
...
0x3ff44004: 0x00000010
```

Now, when the LED is off, that corresponds to `0x3ff44004: 0x00000000` being displayed, try using `set` command to set this bit by writing `0x00000010` to the same memory location:

```
(gdb) x /1wx 0x3FF44004
0x3ff44004: 0x00000000
(gdb) set {unsigned int}0x3FF44004=0x000010
```

You should see the LED to turn on immediately after entering `set {unsigned int}0x3FF44004=0x000010` command.

**Watching and setting program variables** A common debugging task is checking the value of a program variable as the program runs. To be able to demonstrate this functionality, update file `blink.c` by adding a declaration of a global variable `int i` above definition of function `blink_task`. Then add `i++` inside `while(1)` of this function to get `i` incremented on each blink.

Exit debugger, so it is not confused with new code, build and flash the code to the ESP and restart debugger. There is no need to restart OpenOCD.

Once application is halted, enter the command `watch i`:

```
(gdb) watch i
Hardware watchpoint 2: i
(gdb)
```

This will insert so called “watchpoint” in each place of code where variable `i` is being modified. Now enter `continue` to resume the application and observe it being halted:

```
(gdb) c
Continuing.
Target halted. PRO_CPU: PC=0x400DB751 (active)   APP_CPU: PC=0x400D0811
[New Thread 1073432196]

Program received signal SIGTRAP, Trace/breakpoint trap.
[Switching to Thread 1073432196]
0x400db751 in blink_task (pvParameter=0x0) at /home/user-name/esp/blink/main/.
↳blink.c:33
33         i++;
(gdb)
```

Resume application couple more times so `i` gets incremented. Now you can enter `print i` (in short `p i`) to check the current value of `i`:

```
(gdb) p i
$1 = 3
(gdb)
```

To modify the value of `i` use `set` command as below (you can then print it out to check if it has been indeed changed):

```
(gdb) set var i = 0
(gdb) p i
$3 = 0
(gdb)
```

You may have up to two watchpoints, see [Breakpoints and watchpoints available](#).

**Setting conditional breakpoints** Here comes more interesting part. You may set a breakpoint to halt the program execution, if certain condition is satisfied. Delete existing breakpoints and try this:

```
(gdb) break blink.c:34 if (i == 2)
Breakpoint 3 at 0x400db753: file /home/user-name/esp/blink/main/.blink.c, line 34.
(gdb)
```

Above command sets conditional breakpoint to halt program execution in line 34 of `blink.c` if `i == 2`.

If current value of `i` is less than 2 and program is resumed, it will blink LED in a loop until condition `i == 2` gets true and then finally halt:

```
(gdb) set var i = 0
(gdb) c
Continuing.
Target halted. PRO_CPU: PC=0x400DB755 (active)   APP_CPU: PC=0x400D112C
Target halted. PRO_CPU: PC=0x400DB753 (active)   APP_CPU: PC=0x400D112C
Target halted. PRO_CPU: PC=0x400DB755 (active)   APP_CPU: PC=0x400D112C
Target halted. PRO_CPU: PC=0x400DB753 (active)   APP_CPU: PC=0x400D112C

Breakpoint 3, blink_task (pvParameter=0x0) at /home/user-name/esp/blink/main/.
↳blink.c:34
34         gpio_set_level(BLINK_GPIO, 0);
(gdb)
```

**Obtaining help on commands** Commands presented so far should provide a very basic and intended to let you quickly get started with JTAG debugging. Check help what are the other commands at your disposal. To obtain help on syntax and functionality of a particular command, being at `(gdb)` prompt type `help` and command name:

```
(gdb) help next
Step program, proceeding through subroutine calls.
Usage: next [N]
Unlike "step", if the current source line calls a subroutine,
this command does not enter the subroutine, but instead steps over
the call, in effect treating it as a single source line.
(gdb)
```

By typing just `help`, you will get top level list of command classes, to aid you drilling down to more details. Optionally refer to available GDB cheat sheets, for instance <https://darkdust.net/files/GDB%20Cheat%20Sheet.pdf>. Good to have as a reference (even if not all commands are applicable in an embedded environment).

**Ending debugger session** To quit debugger enter `q`:

```
(gdb) q
A debugging session is active.

    Inferior 1 [Remote target] will be detached.

Quit anyway? (y or n) y
Detaching from program: /home/user-name/esp/blink/build/blink.elf, Remote target
Ending remote debugging.
user-name@computer-name:~/esp/blink$
```

- [Using Debugger](#)
- [Debugging Examples](#)
- [Tips and Quirks](#)
- [Application Level Tracing library](#)
- [Introduction to ESP-Prog Board](#)

## 4.18 Linker Script Generation

### 4.18.1 Overview

There are several *memory regions* where code and data can be placed. Code and read-only data are placed by default in flash, writable data in RAM, etc. However, it is sometimes necessary to change these default placements.

For example, it may be necessary to place:

- critical code in RAM for performance reasons.
- executable code in IRAM so that it can be ran while cache is disabled.
- code in RTC memory for use in a wake stub.
- code in RTC memory for use by the ULP coprocessor.

With the linker script generation mechanism, it is possible to specify these placements at the component level within ESP-IDF. The component presents information on how it would like to place its symbols, objects or the entire archive. During build, the information presented by the components are collected, parsed and processed; and the placement rules generated is used to link the app.

### 4.18.2 Quick Start

This section presents a guide for quickly placing code/data to RAM and RTC memory - placements ESP-IDF provides out-of-the-box.



For this guide, suppose we have the following:

```

components
├── my_component
│   ├── CMakeLists.txt
│   ├── Kconfig
│   ├── src/
│   │   ├── my_src1.c
│   │   ├── my_src2.c
│   │   └── my_src3.c
│   └── my_linker_fragment_file.lf

```

- a component named `my_component` that is archived as library `libmy_component.a` during build
- three source files archived under the library, `my_src1.c`, `my_src2.c` and `my_src3.c` which are compiled as `my_src1.o`, `my_src2.o` and `my_src3.o`, respectively
- under `my_src1.o`, the function `my_function1` is defined; under `my_src2.o`, the function `my_function2` is defined
- there is bool-type config `PERFORMANCE_MODE` (y/n) and int type config `PERFORMANCE_LEVEL` (with range 0-3) in `my_component`'s `Kconfig`

### Creating and Specifying a Linker Fragment File

Before anything else, a linker fragment file needs to be created. A linker fragment file is simply a text file with a `.lf` extension upon which the desired placements will be written. After creating the file, it is then necessary to present it to the build system. The instructions for the build systems supported by ESP-IDF are as follows:

In the component's `CMakeLists.txt` file, specify argument `LDFRAGMENTS` in the `idf_component_register` call. The value of `LDFRAGMENTS` can either be an absolute path or a relative path from the component directory to the created linker fragment file.

```

# file paths relative to CMakeLists.txt
idf_component_register(...)
    LDFRAGMENTS "path/to/linker_fragment_file.lf" "path/to/
↳another_linker_fragment_file.lf"
    ...
)

```

### Specifying placements

It is possible to specify placements at the following levels of granularity:

- object file (`.obj` or `.o` files)
- symbol (function/variable)
- archive (`.a` files)

**Placing object files** Suppose the entirety of `my_src1.o` is performance-critical, so it is desirable to place it in RAM. On the other hand, the entirety of `my_src2.o` contains symbols needed coming out of deep sleep, so it needs to be put under RTC memory.

In the linker fragment file, we can write:

```

[mapping:my_component]
archive: libmy_component.a
entries:
    my_src1 (noflash)      # places all my_src1 code/read-only data under IRAM/DRAM
    my_src2 (rtc)         # places all my_src2 code/ data and read-only data under_
↳RTC fast memory/RTC slow memory

```

What happens to `my_src3.o`? Since it is not specified, default placements are used for `my_src3.o`. More on default placements [here](#).

**Placing symbols** Continuing our example, suppose that among functions defined under `object1.o`, only `my_function1` is performance-critical; and under `object2.o`, only `my_function2` needs to execute after the chip comes out of deep sleep. This could be accomplished by writing:

```
[mapping:my_component]
archive: libmy_component.a
entries:
    my_src1:my_function1 (noflash)
    my_src2:my_function2 (rtc)
```

The default placements are used for the rest of the functions in `my_src1.o` and `my_src2.o` and the entire `object3.o`. Something similar can be achieved for placing data by writing the variable name instead of the function name, like so:

```
my_src1:my_variable (noflash)
```

**Warning:** There are *limitations* in placing code/data at symbol granularity. In order to ensure proper placements, an alternative would be to group relevant code and data into source files, and *use object-granularity placements*.

**Placing entire archive** In this example, suppose that the entire component archive needs to be placed in RAM. This can be written as:

```
[mapping:my_component]
archive: libmy_component.a
entries:
    * (noflash)
```

Similarly, this places the entire component in RTC memory:

```
[mapping:my_component]
archive: libmy_component.a
entries:
    * (rtc)
```

**Configuration-dependent placements** Suppose that the entire component library should only have special placement when a certain condition is true; for example, when `CONFIG_PERFORMANCE_MODE == y`. This could be written as:

```
[mapping:my_component]
archive: libmy_component.a
entries:
    if PERFORMANCE_MODE = y:
        * (noflash)
    else:
        * (default)
```

For a more complex config-dependent placement, suppose the following requirements: when `CONFIG_PERFORMANCE_LEVEL == 1`, only `object1.o` is put in RAM; when `CONFIG_PERFORMANCE_LEVEL == 2`, `object1.o` and `object2.o`; and when `CONFIG_PERFORMANCE_LEVEL == 3` all object files under the archive are to be put into RAM. When these three are false however, put entire library in RTC memory. This scenario is a bit contrived, but, it can be written as:

```
[mapping:my_component]
archive: libmy_component.a
entries:
    if PERFORMANCE_LEVEL = 1:
```

(continues on next page)

(continued from previous page)

```

my_src1 (noflash)
elif PERFORMANCE_LEVEL = 2:
    my_src1 (noflash)
    my_src2 (noflash)
elif PERFORMANCE_LEVEL = 3:
    my_src1 (noflash)
    my_src2 (noflash)
    my_src3 (noflash)
else:
    * (rtc)

```

Nesting condition-checking is also possible. The following is equivalent to the snippet above:

```

[mapping:my_component]
archive: libmy_component.a
entries:
    if PERFORMANCE_LEVEL <= 3 && PERFORMANCE_LEVEL > 0:
        if PERFORMANCE_LEVEL >= 1:
            object1 (noflash)
            if PERFORMANCE_LEVEL >= 2:
                object2 (noflash)
                if PERFORMANCE_LEVEL >= 3:
                    object2 (noflash)
        else:
            * (rtc)

```

### The ‘default’ placements

Up until this point, the term ‘default placements’ has been mentioned as fallback placements when the placement rules `rtc` and `noflash` are not specified. It is important to note that the tokens `noflash` or `rtc` are not merely keywords, but are actually entities called fragments, specifically *schemes*.

In the same manner as `rtc` and `noflash` are schemes, there exists a `default` scheme which defines what the default placement rules should be. As the name suggests, it is where code and data are usually placed, i.e. code/constants is placed in flash, variables placed in RAM, etc. More on the default scheme [here](#).

---

**Note:** For an example of an ESP-IDF component using the linker script generation mechanism, see [freertos/CMakeLists.txt](#). `freertos` uses this to place its object files to the instruction RAM for performance reasons.

---

This marks the end of the quick start guide. The following text discusses the internals of the mechanism in a little bit more detail. The following sections should be helpful in creating custom placements or modifying default behavior.

### 4.18.3 Linker Script Generation Internals

Linking is the last step in the process of turning C/C++ source files into an executable. It is performed by the toolchain’s linker, and accepts linker scripts which specify code/data placements, among other things. With the linker script generation mechanism, this process is no different, except that the linker script passed to the linker is dynamically generated from: (1) the collected *linker fragment files* and (2) *linker script template*.

---

**Note:** The tool that implements the linker script generation mechanism lives under `tools/ldgen`.

---

## Linker Fragment Files

As mentioned in the quick start guide, fragment files are simple text files with the `.lf` extension containing the desired placements. This is a simplified description of what fragment files contain, however. What fragment files actually contain are ‘fragments’. Fragments are entities which contain pieces of information which, when put together, form placement rules that tell where to place sections of object files in the output binary. There are three types of fragments: *sections*, *scheme* and *mapping*.

**Grammar** The three fragment types share a common grammar:

```
[type:name]
key: value
key:
  value
  value
  value
  ...
```

- **type**: Corresponds to the fragment type, can either be *sections*, *scheme* or *mapping*.
- **name**: The name of the fragment, should be unique for the specified fragment type.
- **key, value**: Contents of the fragment; each fragment type may support different keys and different grammars for the key values.
  - For *sections* and *scheme*, the only supported key is *entries*
  - For *mappings*, both *archive* and *entries* are supported.

---

**Note:** In cases where multiple fragments of the same type and name are encountered, an exception is thrown.

---

---

**Note:** The only valid characters for fragment names and keys are alphanumeric characters and underscore.

---

## Condition Checking

Condition checking enable the linker script generation to be configuration-aware. Depending on whether expressions involving configuration values are true or not, a particular set of values for a key can be used. The evaluation uses `eval_string` from `kconfiglib` package and adheres to its required syntax and limitations. Supported operators are as follows:

- **comparison**
  - `LessThan <`
  - `LessThanOrEqualTo <=`
  - `MoreThan >`
  - `MoreThanOrEqualTo >=`
  - `Equal =`
  - `NotEqual !=`
- **logical**
  - `Or ||`
  - `And &&`
  - `Negation !`
- **grouping**
  - `Parenthesis ()`

Condition checking behaves as you would expect an `if...elseif/elif...else` block in other languages. Condition-checking is possible for both key values and entire fragments. The two sample fragments below are equivalent:

```
# Value for keys is dependent on config
[type:name]
key_1:
```

(continues on next page)

(continued from previous page)

```

    if CONDITION = y:
        value_1
    else:
        value_2
key_2:
    if CONDITION = y:
        value_a
    else:
        value_b

```

```

# Entire fragment definition is dependent on config
if CONDITION = y:
    [type:name]
    key_1:
        value_1
    key_2:
        value_a
else:
    [type:name]
    key_1:
        value_2
    key_2:
        value_b

```

**Comments**

Comment in linker fragment files begin with #. Like in other languages, comment are used to provide helpful descriptions and documentation and are ignored during processing.

**Types Sections**

Sections fragments defines a list of object file sections that the GCC compiler emits. It may be a default section (e.g. `.text`, `.data`) or it may be user defined section through the `__attribute__` keyword.

The use of an optional '+' indicates the inclusion of the section in the list, as well as sections that start with it. This is the preferred method over listing both explicitly.

```

[sections:name]
entries:
    .section+
    .section
    ...

```

**Example:**

```

# Non-preferred
[sections:text]
entries:
    .text
    .text.*
    .literal
    .literal.*

# Preferred, equivalent to the one above
[sections:text]
entries:
    .text+           # means .text and .text.*
    .literal+       # means .literal and .literal.*

```

**Scheme**

Scheme fragments define what `target` a sections fragment is assigned to.

```
[scheme:name]
entries:
  sections -> target
  sections -> target
  ...
```

**Example:**

```
[scheme:noflash]
entries:
  text -> iram0_text      # the entries under the sections fragment named_
↔text will go to iram0_text
  rodata -> dram0_data   # the entries under the sections fragment named_
↔rodata will go to dram0_data
```

**The default scheme**

There exists a special scheme with the name `default`. This scheme is special because catch-all placement rules are generated from its entries. This means that, if one of its entries is `text -> flash_text`, the placement rule will be generated for the target `flash_text`.

```
*(.literal .literal.* .text .text.*)
```

These catch-all rules then effectively serve as fallback rules for those whose mappings were not specified.

The `default` scheme is defined in [esp\\_system/app.lf](#). The `noflash` and `rtc` scheme fragments which are built-in schemes referenced in the quick start guide are also defined in this file.

**Mapping**

Mapping fragments define what scheme fragment to use for mappable entities, i.e. object files, function names, variable names, archives.

```
[mapping:name]
archive: archive          # output archive file name, as built (i.e. libxxx.
↔a)
entries:
  object:symbol (scheme)  # symbol granularity
  object (scheme)        # object granularity
  * (scheme)              # archive granularity
```

There are three levels of placement granularity:

- **symbol:** The object file name and symbol name are specified. The symbol name can be a function name or a variable name.
- **object:** Only the object file name is specified.
- **archive:** `*` is specified, which is a short-hand for all the object files under the archive.

To know what an entry means, let us expand a sample object-granularity placement:

```
object (scheme)
```

Then expanding the scheme fragment from its entries definitions, we have:

```
object (sections -> target,
  sections -> target,
  ...)
```

Expanding the sections fragment with its entries definition:

```
object (.section,      # given this object file
  .section,          # put its sections listed here at this
  ... -> target,     # target
```

(continues on next page)

```
.section,
.section,      # same should be done for these sections
... -> target,

...           # and so on
```

Example:

```
[mapping:map]
archive: libfreertos.a
entries:
    * (noflash)
```

Aside from the entity and scheme, flags can also be specified in an entry. The following flags are supported (note: <> = argument name, [] = optional):

1. ALIGN(<alignment>[, pre, post])  
Align the placement by the amount specified in `alignment`. Generates
2. SORT([<sort\_by\_first>, <sort\_by\_second>])  
Emits `SORT_BY_NAME`, `SORT_BY_ALIGNMENT`, `SORT_BY_INIT_PRIORITY` or `SORT` in the input section description.  
Possible values for `sort_by_first` and `sort_by_second` are: `name`, `alignment`, `init_priority`.  
If both `sort_by_first` and `sort_by_second` are not specified, the input sections are sorted by name. If both are specified, then the nested sorting follows the same rules discussed in <https://sourceware.org/binutils/docs/ld/Input-Section-Wildcards.html>.
3. KEEP()  
Prevent the linker from discarding the placement by surrounding the input section description with `KEEP` command. See <https://sourceware.org/binutils/docs/ld/Input-Section-Keep.html> for more details.

#### 4.SURROUND(<name>)

Generate symbols before and after the placement. The generated symbols follow the naming `_<name>_start` and `_<name>_end`. For example, if `name == sym1`,

When adding flags, the specific `section -> target` in the scheme needs to be specified. For multiple `section -> target`, use a comma as a separator. For example,

```
# Notes:
# A. semicolon after entity-scheme
# B. comma before section2 -> target2
# C. section1 -> target1 and section2 -> target2 should be defined in entries of _
↪scheme1
entity1 (scheme1);
    section1 -> target1 KEEP() ALIGN(4, pre, post),
    section2 -> target2 SURROUND(sym) ALIGN(4, post) SORT()
```

Putting it all together, the following mapping fragment, for example,

```
[mapping:name]
archive: lib1.a
entries:
    obj1 (noflash);
    rodata -> dram0_data KEEP() SORT() ALIGN(8) SURROUND(my_sym)
```

generates an output on the linker script:

```

. = ALIGN(8)
_my_sym_start = ABSOLUTE(.)
KEEP(lib1.a:obj1.*( SORT(.rodata) SORT(.rodata.*) ))
_my_sym_end = ABSOLUTE(.)

```

Note that `ALIGN` and `SURROUND`, as mentioned in the flag descriptions, are order sensitive. Therefore, if for the same mapping fragment these two are switched, the following is generated instead:

```

_my_sym_start = ABSOLUTE(.)
. = ALIGN(8)
KEEP(lib1.a:obj1.*( SORT(.rodata) SORT(.rodata.*) ))
_my_sym_end = ABSOLUTE(.)

```

**On Symbol-Granularity Placements** Symbol granularity placements is possible due to compiler flags `-ffunction-sections` and `-ffdata-sections`. ESP-IDF compiles with these flags by default. If the user opts to remove these flags, then the symbol-granularity placements will not work. Furthermore, even with the presence of these flags, there are still other limitations to keep in mind due to the dependence on the compiler's emitted output sections.

For example, with `-ffunction-sections`, separate sections are emitted for each function; with section names predictably constructed i.e. `.text.{func_name}` and `.literal.{func_name}`. This is not the case for string literals within the function, as they go to pooled or generated section names.

With `-ffdata-sections`, for global scope data the compiler predictably emits either `.data.{var_name}`, `.rodata.{var_name}` or `.bss.{var_name}`; and so Type I mapping entry works for these. However, this is not the case for static data declared in function scope, as the generated section name is a result of mangling the variable name with some other information.

### Linker Script Template

The linker script template is the skeleton in which the generated placement rules are put into. It is an otherwise ordinary linker script, with a specific marker syntax that indicates where the generated placement rules are placed.

To reference the placement rules collected under a `target` token, the following syntax is used:

```
mapping[target]
```

Example:

The example below is an excerpt from a possible linker script template. It defines an output section `.iram0.text`, and inside is a marker referencing the target `iram0_text`.

```

.iram0.text :
{
    /* Code marked as running out of IRAM */
    _iram_text_start = ABSOLUTE(.);

    /* Marker referencing iram0_text */
    mapping[iram0_text]

    _iram_text_end = ABSOLUTE(.);
} > iram0_0_seg

```

Suppose the generator collected the fragment definitions below:

```

[sections:text]
.text+
.literal+

```

(continues on next page)



```
[sections:iram]
    .iram1+

[scheme:default]
entries:
    text -> flash_text
    iram -> iram0_text

[scheme:noflash]
entries:
    text -> iram0_text

[mapping:freertos]
archive: libfreertos.a
entries:
    * (noflash)
```

Then the corresponding excerpt from the generated linker script will be as follows:

```
.iram0.text :
{
    /* Code marked as running out of IRAM */
    _iram_text_start = ABSOLUTE(.);

    /* Placement rules generated from the processed fragments, placed where the
    ↪marker was in the template */
    *(.iram1 .iram1.*)
    *libfreertos.a:(.literal .text .literal.* .text.*)

    _iram_text_end = ABSOLUTE(.);
} > iram0_0_seg
```

```
*libfreertos.a:(.literal .text .literal.* .text.*)
```

Rule generated from the entry `* (noflash)` of the `freertos` mapping fragment. All `text` sections of all object files under the archive `libfreertos.a` will be collected under the target `iram0_text` (as per the `noflash` scheme) and placed wherever in the template `iram0_text` is referenced by a marker.

```
*(.iram1 .iram1.*)
```

Rule generated from the default scheme entry `iram -> iram0_text`. Since the default scheme specifies an `iram -> iram0_text` entry, it too is placed wherever `iram0_text` is referenced by a marker. Since it is a rule generated from the default scheme, it comes first among all other rules collected under the same target name.

The linker script template currently used is [esp\\_system/ld/esp32s2/sections.ld.in](#); the generated output script `sections.ld` is put under its build directory.

### Migrate to ESP-IDF v5.0 Linker Script Fragment Files Grammar

The old grammar supported in ESP-IDF v3.x would be dropped in ESP-IDF v5.0. Here are a few notes on how to migrate properly:

1. Now indentation is enforced and improperly indented fragment files would generate a runtime parse exception. This was not enforced in the old version but previous documentation and examples demonstrate properly indented grammar.
2. Migrate the old condition entry to the `if...elif...else` structure for conditionals. You can refer to the [earlier chapter](#) for detailed grammar.
3. mapping fragments now requires a name like other fragment types.

## 4.19 lwIP

ESP-IDF uses the open source [lwIP lightweight TCP/IP stack](#). The ESP-IDF version of lwIP ([esp-lwip](#)) has some modifications and additions compared to the upstream project.

### 4.19.1 Supported APIs

ESP-IDF supports the following lwIP TCP/IP stack functions:

- [BSD Sockets API](#)
- [Netconn API](#) is enabled but not officially supported for ESP-IDF applications

#### Adapted APIs

**Warning:** When using any lwIP API (other than [BSD Sockets API](#)), please make sure that it is thread safe. To check if a given API call is safe, enable [CONFIG\\_LWIP\\_CHECK\\_THREAD\\_SAFETY](#) and run the application. This way lwIP asserts the TCP/IP core functionality to be correctly accessed; the execution aborts if it is not locked properly or accessed from the correct task ([lwIP FreeRTOS Task](#)). The general recommendation is to use [ESP-NETIF](#) component to interact with lwIP.

Some common lwIP “app” APIs are supported indirectly by ESP-IDF:

- DHCP Server & Client are supported indirectly via the [ESP-NETIF](#) functionality
- Domain Name System (DNS) is supported in lwIP; DNS servers could be assigned automatically when acquiring a DHCP address, or manually configured using the [ESP-NETIF](#) API.

---

**Note:** DNS server configuration in lwIP is global, not interface-specific. If you are using multiple network interfaces with distinct DNS servers, exercise caution to prevent inadvertent overwrites of one interface’s DNS settings when acquiring a DHCP lease from another interface.

---

- Simple Network Time Protocol (SNTP) is supported via the [lwip/include/apps/sntp/sntp.h](#) [lwip/lwip/src/include/lwip/apps/sntp.h](#) functions (see also [SNTP Time Synchronization](#))
- ICMP Ping is supported using a variation on the lwIP ping API. See [ICMP Echo](#).
- NetBIOS lookup is available using the standard lwIP API. [protocols/http\\_server/restful\\_server](#) has an option to demonstrate using NetBIOS to look up a host on the LAN.
- mDNS uses a different implementation to the lwIP default mDNS (see [mDNS Service](#)), but lwIP can look up mDNS hosts using standard APIs such as `gethostbyname()` and the convention `hostname.local`, provided the [CONFIG\\_LWIP\\_DNS\\_SUPPORT\\_MDNS\\_QUERIES](#) setting is enabled.

### 4.19.2 BSD Sockets API

The BSD Sockets API is a common cross-platform TCP/IP sockets API that originated in the Berkeley Standard Distribution of UNIX but is now standardized in a section of the POSIX specification. BSD Sockets are sometimes called POSIX Sockets or Berkeley Sockets.

As implemented in ESP-IDF, lwIP supports all of the common usages of the BSD Sockets API.

#### References

A wide range of BSD Sockets reference material is available, including:

- [Single UNIX Specification BSD Sockets page](#)
- [Berkeley Sockets Wikipedia page](#)

## Examples

A number of ESP-IDF examples show how to use the BSD Sockets APIs:

- [protocols/sockets/tcp\\_server](#)
- [protocols/sockets/tcp\\_client](#)
- [protocols/sockets/udp\\_server](#)
- [protocols/sockets/udp\\_client](#)
- [protocols/sockets/udp\\_multicast](#)
- [protocols/http\\_request](#) (Note: this is a simplified example of using a TCP socket to send an HTTP request. The *ESP HTTP Client* is a much better option for sending HTTP requests.)

## Supported functions

The following BSD socket API functions are supported. For full details see [lwip/lwip/src/include/lwip/sockets.h](#).

- `socket()`
- `bind()`
- `accept()`
- `shutdown()`
- `getpeername()`
- `getsockopt()` & `setsockopt()` (see [Socket Options](#))
- `close()` (via [Virtual filesystem component](#))
- `read()`, `readv()`, `write()`, `writew()` (via [Virtual filesystem component](#))
- `recv()`, `recvmsg()`, `recvfrom()`
- `send()`, `sendmsg()`, `sendto()`
- `select()` (via [Virtual filesystem component](#))
- `poll()` (Note: on ESP-IDF, `poll()` is implemented by calling `select` internally, so using `select()` directly is recommended if a choice of methods is available.)
- `fcntl()` (see [fcntl](#))

Non-standard functions:

- `ioctl()` (see [ioctls](#))

---

**Note:** Some lwIP application sample code uses prefixed versions of BSD APIs, for example `lwip_socket()` instead of the standard `socket()`. Both forms can be used with ESP-IDF, but using standard names is recommended.

---

## Socket Error Handling

BSD Socket error handling code is very important for robust socket applications. Normally the socket error handling involves the following aspects:

- Detecting the error.
- Getting the error reason code.
- Handle the error according to the reason code.

In lwIP, we have two different scenarios of handling socket errors:

- Socket API returns an error. For more information, see [Socket API Errors](#).
- `select(int maxfdp1, fd_set *readset, fd_set *writeset, fd_set *exceptset, struct timeval *timeout)` has exception descriptor indicating that the socket has an error. For more information, see [select\(\) Errors](#).

## Socket API Errors

### The error detection

- We can know that the socket API fails according to its return value.

#### Get the error reason code

- When socket API fails, the return value doesn't contain the failure reason and the application can get the error reason code by accessing `errno`. Different values indicate different meanings. For more information, see [<Socket Error Reason Code>](#).

Example:

```
int err;
int sockfd;

if (sockfd = socket(AF_INET, SOCK_STREAM, 0) < 0) {
    // the error code is obtained from errno
    err = errno;
    return err;
}
```

### select() Errors

#### The error detection

- Socket error when `select()` has exception descriptor

#### Get the error reason code

- If the `select` indicates that the socket fails, we can't get the error reason code by accessing `errno`, instead we should call `getsockopt()` to get the failure reason code. Because `select()` has exception descriptor, the error code will not be given to `errno`.

---

**Note:** `getsockopt` function prototype `int getsockopt(int s, int level, int optname, void *optval, socklen_t *optlen)`. Its function is to get the current value of the option of any type, any state socket, and store the result in `optval`. For example, when you get the error code on a socket, you can get it by `getsockopt(sockfd, SOL_SOCKET, SO_ERROR, &err, &optlen)`.

---

Example:

```
int err;

if (select(sockfd + 1, NULL, NULL, &exfds, &tval) <= 0) {
    err = errno;
    return err;
} else {
    if (FD_ISSET(sockfd, &exfds)) {
        // select() exception set using getsockopt()
        int optlen = sizeof(int);
        getsockopt(sockfd, SOL_SOCKET, SO_ERROR, &err, &optlen);
        return err;
    }
}
```

**Socket Error Reason Code** Below is a list of common error codes. For more detailed list of standard POSIX/C error codes, please see [newlib errno.h](#) and the platform-specific extensions [newlib/platform\\_include/errno.h](#)

Error code	Description
ECONNREFUSED	Connection refused
EADDRINUSE	Address already in use
ECONNABORTED	Software caused connection abort
ENETUNREACH	Network is unreachable
ENETDOWN	Network interface is not configured
ETIMEDOUT	Connection timed out
EHOSTDOWN	Host is down
EHOSTUNREACH	Host is unreachable
EINPROGRESS	Connection already in progress
EALREADY	Socket already connected
EDESTADDRREQ	Destination address required
EPROTONOSUPPORT	Unknown protocol

### Socket Options

The `getsockopt()` and `setsockopt()` functions allow getting/setting per-socket options.

Not all standard socket options are supported by lwIP in ESP-IDF. The following socket options are supported:

**Common options** Used with level argument `SOL_SOCKET`.

- `SO_REUSEADDR` (available if `CONFIG_LWIP_SO_REUSE` is set, behavior can be customized by setting `CONFIG_LWIP_SO_REUSE_RXTOALL`)
- `SO_KEEPALIVE`
- `SO_BROADCAST`
- `SO_ACCEPTCONN`
- `SO_RCVBUF` (available if `CONFIG_LWIP_SO_RCVBUF` is set)
- `SO_SNDTIMEO` / `SO_RCVTIMEO`
- `SO_ERROR` (this option is only used with `select()`, see *Socket Error Handling*)
- `SO_TYPE`
- `SO_NO_CHECK` (for UDP sockets only)

**IP options** Used with level argument `IPPROTO_IP`.

- `IP_TOS`
- `IP_TTL`
- `IP_PKTINFO` (available if `CONFIG_LWIP_NETBUF_RECVINFO` is set)

For multicast UDP sockets:

- `IP_MULTICAST_IF`
- `IP_MULTICAST_LOOP`
- `IP_MULTICAST_TTL`
- `IP_ADD_MEMBERSHIP`
- `IP_DROP_MEMBERSHIP`

**TCP options** TCP sockets only. Used with level argument `IPPROTO_TCP`.

- `TCP_NODELAY`

Options relating to TCP keepalive probes:

- `TCP_KEEPALIVE` (int value, TCP keepalive period in milliseconds)
- `TCP_KEEPIDLE` (same as `TCP_KEEPALIVE`, but the value is in seconds)
- `TCP_KEEPINTVL` (int value, interval between keepalive probes in seconds)
- `TCP_KEEPCNT` (int value, number of keepalive probes before timing out)

**IPv6 options** IPv6 sockets only. Used with level argument `IPPROTO_IPV6`

- `IPV6_CHECKSUM`
- `IPV6_V6ONLY`

For multicast IPv6 UDP sockets:

- `IPV6_JOIN_GROUP / IPV6_ADD_MEMBERSHIP`
- `IPV6_LEAVE_GROUP / IPV6_DROP_MEMBERSHIP`
- `IPV6_MULTICAST_IF`
- `IPV6_MULTICAST_HOPS`
- `IPV6_MULTICAST_LOOP`

## **fcntl**

The `fcntl()` function is a standard API for manipulating options related to a file descriptor. In ESP-IDF, the *Virtual filesystem component* layer is used to implement this function.

When the file descriptor is a socket, only the following `fcntl()` values are supported:

- `O_NONBLOCK` to set/clear non-blocking I/O mode. Also supports `O_NDELAY`, which is identical to `O_NONBLOCK`.
- `O_RDONLY`, `O_WRONLY`, `O_RDWR` flags for different read/write modes. These can read via `F_GETFL` only, they cannot be set using `F_SETFL`. A TCP socket will return a different mode depending on whether the connection has been closed at either end or is still open at both ends. UDP sockets always return `O_RDWR`.

## **ioctl**

The `ioctl()` function provides a semi-standard way to access some internal features of the TCP/IP stack. In ESP-IDF, the *Virtual filesystem component* layer is used to implement this function.

When the file descriptor is a socket, only the following `ioctl()` values are supported:

- `FIONREAD` returns the number of bytes of pending data already received in the socket's network buffer.
- `FIONBIO` is an alternative way to set/clear non-blocking I/O status for a socket, equivalent to `fcntl(fd, F_SETFL, O_NONBLOCK, ...)`.

### **4.19.3 Netconn API**

lwIP supports two lower level APIs as well as the BSD Sockets API: the Netconn API and the Raw API.

The lwIP Raw API is designed for single threaded devices and is not supported in ESP-IDF.

The Netconn API is used to implement the BSD Sockets API inside lwIP, and it can also be called directly from ESP-IDF apps. This API has lower resource usage than the BSD Sockets API, in particular it can send and receive data without needing to first copy it into internal lwIP buffers.

---

**Important:** Espressif does not test the Netconn API in ESP-IDF. As such, this functionality is *enabled but not supported*. Some functionality may only work correctly when used from the BSD Sockets API.

---

For more information about the Netconn API, consult [lwip/lwip/src/include/lwip/api.h](#) and [this wiki page which is part of the unofficial lwIP Application Developers Manual](#).

### **4.19.4 lwIP FreeRTOS Task**

lwIP creates a dedicated TCP/IP FreeRTOS task to handle socket API requests from other tasks.

A number of configuration items are available to modify the task and the queues ( “mailboxes” ) used to send data to/from the TCP/IP task:

- [CONFIG\\_LWIP\\_TCPIP\\_RECVMBOX\\_SIZE](#)
- [CONFIG\\_LWIP\\_TCPIP\\_TASK\\_STACK\\_SIZE](#)
- [CONFIG\\_LWIP\\_TCPIP\\_TASK\\_AFFINITY](#)

### 4.19.5 IPv6 Support

Both IPv4 and IPv6 are supported as dual stack and enabled by default (IPv6 may be disabled if it's not needed, see [Minimum RAM usage](#)). IPv6 support is limited to *Stateless Autoconfiguration* only, *Stateful configuration* is not supported in ESP-IDF (not in upstream lwip). IPv6 Address configuration is defined by means of these protocols or services:

- **SLAAC** IPv6 Stateless Address Autoconfiguration (RFC-2462)
- **DHCPv6** Dynamic Host Configuration Protocol for IPv6 (RFC-8415)

None of these two types of address configuration is enabled by default, so the device uses only Link Local addresses or statically defined addresses.

#### Stateless Autoconfiguration Process

To enable address autoconfiguration using Router Advertisement protocol please enable:

- [CONFIG\\_LWIP\\_IPV6\\_AUTOCONFIG](#)

This configuration option enables IPv6 autoconfiguration for all network interfaces (in contrast to the upstream lwIP, where the autoconfiguration needs to be explicitly enabled for each netif with `netif->ip6_autoconfig_enabled=1`

#### DHCPv6

DHCPv6 in lwIP is very simple and support only stateless configuration. It could be enabled using:

- [CONFIG\\_LWIP\\_IPV6\\_DHCP6](#)

Since the DHCPv6 works only in its stateless configuration, the [Stateless Autoconfiguration Process](#) has to be enabled, too, by means of [CONFIG\\_LWIP\\_IPV6\\_AUTOCONFIG](#). Moreover, the DHCPv6 needs to be explicitly enabled from the application code using

```
dhcp6_enable_stateless(netif);
```

#### DNS servers in IPv6 autoconfiguration

In order to autoconfigure DNS server(s), especially in IPv6 only networks, we have these two options

- Recursive domain name system –this belongs to the Neighbor Discovery Protocol (NDP), uses [Stateless Autoconfiguration Process](#). Number of servers must be set [CONFIG\\_LWIP\\_IPV6\\_RDNSS\\_MAX\\_DNS\\_SERVERS](#), this is option is disabled (set to 0) by default.
- DHCPv6 stateless configuration –uses [DHCPv6](#) to configure DNS servers. Note that the this configuration assumes IPv6 Router Advertisement Flags (RFC-5175) to be set to
  - Managed Address Configuration Flag = 0
  - Other Configuration Flag = 1

### 4.19.6 esp-lwip custom modifications

#### Additions

The following code is added which is not present in the upstream lwIP release:

**Thread-safe sockets** It is possible to `close()` a socket from a different thread to the one that created it. The `close()` call will block until any function calls currently using that socket from other tasks have returned.

It is, however, not possible to delete a task while it is actively waiting on `select()` or `poll()` APIs. It is always necessary that these APIs exit before destroying the task, as this might corrupt internal structures and cause subsequent crashes of the lwIP. (These APIs allocate globally referenced callback pointers on stack, so that when the task gets destroyed before unrolling the stack, the lwIP would still hold pointers to the deleted stack)

**On demand timers** lwIP IGMP and MLD6 features both initialize a timer in order to trigger timeout events at certain times.

The default lwIP implementation is to have these timers enabled all the time, even if no timeout events are active. This increases CPU usage and power consumption when using automatic light sleep mode. `esp-lwip` default behaviour is to set each timer “on demand” so it is only enabled when an event is pending.

To return to the default lwIP behaviour (always-on timers), disable `CONFIG_LWIP_TIMERS_ONDEMAND`.

**Lwip timers API** When users are not using WiFi, these APIs provide users with the ability to turn off LwIP timer to reduce power consumption.

The following API functions are supported. For full details see [lwip/lwip/src/include/lwip/timeouts.h](http://lwip/lwip/src/include/lwip/timeouts.h).

- `sys_timeouts_init()`
- `sys_timeouts_deinit()`

### Additional Socket Options

- Some standard IPV4 and IPV6 multicast socket options are implemented (see *Socket Options*).
- Possible to set IPV6-only UDP and TCP sockets with `IPV6_V6ONLY` socket option (normal lwIP is TCP only).

### IP layer features

- IPV4 source based routing implementation is different.
- IPV4 mapped IPV6 addresses are supported.

**Customized lwIP hooks** The original lwIP supports implementing custom compile-time modifications via `LWIP_HOOK_FILENAME`. This file is already used by the IDF port layer, but IDF users could still include and implement any custom additions via a header file defined by the macro `ESP_IDF_LWIP_HOOK_FILENAME`. Here is an example of adding a custom hook file to the build process (the hook is called `my_hook.h` and located in the project's `main` folder):

```
idf_component_get_property(lwip lwip COMPONENT_LIB)
target_compile_options(${lwip} PRIVATE "-I${PROJECT_DIR}/main")
target_compile_definitions(${lwip} PRIVATE "-DESP_IDF_LWIP_HOOK_FILENAME=\"my_hook.
↪h\"")
```

**Customized lwIP Options From ESP-IDF Build System** The most common lwIP options are configurable through the component configuration menu. However, certain definitions need to be injected from the command line. The CMake function `target_compile_definitions()` can be employed to define macros, as illustrated below:

```
idf_component_get_property(lwip lwip COMPONENT_LIB)
target_compile_definitions(${lwip} PRIVATE "-DETHARP_SUPPORT_VLAN=1")
```



This approach may not work for function-like macros, as there is no guarantee that the definition will be accepted by all compilers, although it is supported in GCC. To address this limitation, the `add_definitions()` function can be utilized to define the macro for the entire project, for example: `add_definitions("-DFALLBACK_DNS_SERVER_ADDRESS(addr)=\"IP_ADDR4((addr), 8, 8, 8)\")`.

Alternatively, you can define your function-like macro in a header file which will be pre-included as an lwIP hook file, see [Customized lwIP hooks](#).

### Limitations

ESP-IDF additions to lwIP still suffer from the global DNS limitation, described in [Adapted APIs](#). To address this limitation from application code, the `FALLBACK_DNS_SERVER_ADDRESS()` macro can be utilized to define a global DNS fallback server accessible from all interfaces. Alternatively, you have the option to maintain per-interface DNS servers and reconfigure them whenever the default interface changes.

Calling `send()` or `sendto()` repeatedly on a UDP socket may eventually fail with `errno` equal to `ENOMEM`. This is a limitation of buffer sizes in the lower layer network interface drivers. If all driver transmit buffers are full then UDP transmission will fail. Applications sending a high volume of UDP datagrams who don't wish for any to be dropped by the sender should check for this error code and re-send the datagram after a short delay.

Increasing the number of TX buffers in the [Wi-Fi](#) project configuration may also help.

## 4.19.7 Performance Optimization

TCP/IP performance is a complex subject, and performance can be optimized towards multiple goals. The default settings of ESP-IDF are tuned for a compromise between throughput, latency, and moderate memory usage.

### Maximum throughput

Espressif tests ESP-IDF TCP/IP throughput using the [wifi/iperf](#) example in an RF sealed enclosure.

The [wifi/iperf/sdkconfig.defaults](#) file for the iperf example contains settings known to maximize TCP/IP throughput, usually at the expense of higher RAM usage. To get maximum TCP/IP throughput in an application at the expense of other factors then suggest applying settings from this file into the project `sdkconfig`.

---

**Important:** Suggest applying changes a few at a time and checking the performance each time with a particular application workload.

---

- If a lot of tasks are competing for CPU time on the system, consider that the lwIP task has configurable CPU affinity (`CONFIG_LWIP_TCPIP_TASK_AFFINITY`) and runs at fixed priority `ESP_TASK_TCPIP_PRIO` (18). Configure competing tasks to be pinned to a different core, or to run at a lower priority. See also [Built-In Task Priorities](#).
- If using `select()` function with socket arguments only, disabling `CONFIG_VFS_SUPPORT_SELECT` will make `select()` calls faster.
- If there is enough free IRAM, select `CONFIG_LWIP_IRAM_OPTIMIZATION` to improve TX/RX throughput

If using a Wi-Fi network interface, please also refer to [Wi-Fi Buffer Usage](#).

### Minimum latency

Except for increasing buffer sizes, most changes which increase throughput will also decrease latency by reducing the amount of CPU time spent in lwIP functions.

- For TCP sockets, lwIP supports setting the standard `TCP_NODELAY` flag to disable Nagle's algorithm.

## Minimum RAM usage

Most lwIP RAM usage is on-demand, as RAM is allocated from the heap as needed. Therefore, changing lwIP settings to reduce RAM usage may not change RAM usage at idle but can change it at peak.

- Reducing `CONFIG_LWIP_MAX_SOCKETS` reduces the maximum number of sockets in the system. This will also cause TCP sockets in the `WAIT_CLOSE` state to be closed and recycled more rapidly (if needed to open a new socket), further reducing peak RAM usage.
- Reducing `CONFIG_LWIP_TCPIP_RECVMBOX_SIZE`, `CONFIG_LWIP_TCP_RECVMBOX_SIZE` and `CONFIG_LWIP_UDP_RECVMBOX_SIZE` reduce memory usage at the expense of throughput, depending on usage.
- Reducing `CONFIG_LWIP_TCP_MSL`, `CONFIG_LWIP_TCP_FIN_WAIT_TIMEOUT` reduces the maximum segment lifetime in the system. This will also cause TCP sockets in the `TIME_WAIT`, `FIN_WAIT_2` state to be closed and recycled more rapidly
- Disable `CONFIG_LWIP_IPV6` can save about 39 KB for firmware size and 2KB RAM when system power up and 7KB RAM when TCPIP stack running. If there is no requirement for supporting IPV6 then it can be disabled to save flash and RAM footprint.

If using Wi-Fi, please also refer to [Wi-Fi Buffer Usage](#).

**Peak Buffer Usage** The peak heap memory that lwIP consumes is the **theoretically-maximum memory** that the lwIP driver consumes. Generally, the peak heap memory that lwIP consumes depends on:

- the memory required to create a UDP connection: `lwip_udp_conn`
- the memory required to create a TCP connection: `lwip_tcp_conn`
- the number of UDP connections that the application has: `lwip_udp_con_num`
- the number of TCP connections that the application has: `lwip_tcp_con_num`
- the TCP TX window size: `lwip_tcp_tx_win_size`
- the TCP RX window size: `lwip_tcp_rx_win_size`

**So, the peak heap memory that the LwIP consumes can be calculated with the following formula:**

$$\text{lwip\_dynamic\_peek\_memory} = (\text{lwip\_udp\_con\_num} * \text{lwip\_udp\_conn}) + (\text{lwip\_tcp\_con\_num} * (\text{lwip\_tcp\_tx\_win\_size} + \text{lwip\_tcp\_rx\_win\_size} + \text{lwip\_tcp\_conn}))$$

Some TCP-based applications need only one TCP connection. However, they may choose to close this TCP connection and create a new one when an error (such as a sending failure) occurs. This may result in multiple TCP connections existing in the system simultaneously, because it may take a long time for a TCP connection to close, according to the TCP state machine (refer to RFC793).

## 4.20 Memory Types

ESP32-S2 chip has multiple memory types and flexible memory mapping features. This section describes how ESP-IDF uses these features by default.

ESP-IDF distinguishes between instruction memory bus (IRAM, IROM, RTC FAST memory) and data memory bus (DRAM, DROM). Instruction memory is executable, and can only be read or written via 4-byte aligned words. Data memory is not executable and can be accessed via individual byte operations. For more information about the different memory buses consult the *ESP32-S2 Technical Reference Manual > System and Memory* [PDF].

### 4.20.1 DRAM (Data RAM)

Non-constant static data (`.data`) and zero-initialized data (`.bss`) is placed by the linker into Internal SRAM as data memory. The remaining space in this region is used for the runtime heap.

By applying the `EXT_RAM_BSS_ATTR` macro, zero-initialized data can also be placed into external RAM. To use this macro, the `CONFIG_SPIRAM_ALLOW_BSS_SEG_EXTERNAL_MEMORY` needs to be enabled. See *Allow .bss Segment to be Placed in External Memory*.

**Note:** The maximum statically allocated DRAM size is reduced by the *IRAM (Instruction RAM)* size of the compiled application. The available heap memory at runtime is reduced by the total static IRAM and DRAM usage of the application.

---

Constant data may also be placed into DRAM, for example if it is used in a non-flash-safe ISR (see explanation under *How to place code in IRAM*).

### “noinit” DRAM

The macro `__NOINIT_ATTR` can be used as attribute to place data into `.noinit` section. The values placed into this section will not be initialized at startup and should keep its value after software restart.

Example:

```
__NOINIT_ATTR uint32_t noinit_data;
```

## 4.20.2 IRAM (Instruction RAM)

ESP-IDF allocates part of the Internal SRAM region for instruction RAM. The region is defined in *ESP32-S2 Technical Reference Manual > System and Memory > Internal Memory* [PDF]. Except for the first block (up to 32 KB) which is used for MMU cache, the rest of this memory range is used to store parts of application which need to run from RAM.

**Note:** Any internal SRAM which is not used for Instruction RAM will be made available as *DRAM (Data RAM)* for static data and dynamic allocation (heap).

---

### When to place code in IRAM

Cases when parts of the application should be placed into IRAM:

- Interrupt handlers must be placed into IRAM if `ESP_INTR_FLAG_IRAM` is used when registering the interrupt handler. For more information, see *IRAM-Safe Interrupt Handlers*.
- Some timing critical code may be placed into IRAM to reduce the penalty associated with loading the code from flash. ESP32-S2 reads code and data from flash via the MMU cache. In some cases, placing a function into IRAM may reduce delays caused by a cache miss and significantly improve that function's performance.

### How to place code in IRAM

Some code is automatically placed into the IRAM region using the linker script.

If some specific application code needs to be placed into IRAM, it can be done by using the *Linker Script Generation* feature and adding a linker script fragment file to your component that targets at the entire source files or functions with the `noflash` placement. See the *Linker Script Generation* docs for more information.

Alternatively, it's possible to specify IRAM placement in the source code using the `IRAM_ATTR` macro:

```
#include "esp_attr.h"

void IRAM_ATTR gpio_isr_handler(void* arg)
{
    // ...
}
```

There are some possible issues with placement in IRAM, that may cause problems with IRAM-safe interrupt handlers:

- Strings or constants inside an `IRAM_ATTR` function may not be placed in RAM automatically. It's possible to use `DRAM_ATTR` attributes to mark these, or using the linker script method will cause these to be automatically placed correctly.

```
void IRAM_ATTR gpio_isr_handler(void* arg)
{
    const static DRAM_ATTR uint8_t INDEX_DATA[] = { 45, 33, 12, 0 };
    const static char *MSG = DRAM_STR("I am a string stored in RAM");
}
```

Note that knowing which data should be marked with `DRAM_ATTR` can be hard, the compiler will sometimes recognize that a variable or expression is constant (even if it is not marked `const`) and optimize it into flash, unless it is marked with `DRAM_ATTR`.

- GCC optimizations that automatically generate jump tables or switch/case lookup tables place these tables in flash. IDF by default builds all files with `-fno-jump-tables -fno-tree-switch-conversion` flags to avoid this.

Jump table optimizations can be re-enabled for individual source files that don't need to be placed in IRAM. For instructions on how to add the `-fno-jump-tables -fno-tree-switch-conversion` options when compiling individual source files, see [Controlling Component Compilation](#).

### 4.20.3 IROM (code executed from flash)

If a function is not explicitly placed into *IRAM (Instruction RAM)* or RTC memory, it is placed into flash. As IRAM is limited, most of an application's binary code must be placed into IROM instead.

During *Application Startup Flow*, the bootloader (which runs from IRAM) configures the MMU flash cache to map the app's instruction code region to the instruction space. Flash accessed via the MMU is cached using some internal SRAM and accessing cached flash data is as fast as accessing other types of internal memory.

### 4.20.4 DROM (data stored in flash)

By default, constant data is placed by the linker into a region mapped to the MMU flash cache. This is the same as the *IROM (code executed from flash)* section, but is for read-only data not executable code.

The only constant data not placed into this memory type by default are literal constants which are embedded by the compiler into application code. These are placed as the surrounding function's executable instructions.

The `DRAM_ATTR` attribute can be used to force constants from DROM into the *DRAM (Data RAM)* section (see above).

### 4.20.5 RTC Slow memory

Global and static variables used by code which runs from RTC memory must be placed into RTC Slow memory. For example *deep sleep* variables can be placed here instead of RTC FAST memory, or code and variables accessed by the *ULP Coprocessor programming*.

The attribute macro named `RTC_NOINIT_ATTR` can be used to place data into this type of memory. The values placed into this section keep their value after waking from deep sleep.

Example:

```
RTC_NOINIT_ATTR uint32_t rtc_noinit_data;
```

### 4.20.6 RTC FAST memory

The same region of RTC FAST memory can be accessed as both instruction and data memory. Code which has to run after wake-up from deep sleep mode has to be placed into RTC memory. Please check detailed description in [deep sleep](#) documentation.

Remaining RTC FAST memory is added to the heap unless the option `CONFIG_ESP_SYSTEM_ALLOW_RTC_FAST_MEM_AS_HEAP` is disabled. This memory can be used interchangeably with [DRAM \(Data RAM\)](#), but is slightly slower to access.

### 4.20.7 DMA Capable Requirement

Most peripheral DMA controllers (e.g. SPI, sdmmc, etc.) have requirements that sending/receiving buffers should be placed in DRAM and word-aligned. We suggest to place DMA buffers in static variables rather than in the stack. Use macro `DMA_ATTR` to declare global/local static variables like:

```
DMA_ATTR uint8_t buffer[]="I want to send something";

void app_main()
{
    // initialization code...
    spi_transaction_t temp = {
        .tx_buffer = buffer,
        .length = 8 * sizeof(buffer),
    };
    spi_device_transmit(spi, &temp);
    // other stuff
}
```

Or:

```
void app_main()
{
    DMA_ATTR static uint8_t buffer[] = "I want to send something";
    // initialization code...
    spi_transaction_t temp = {
        .tx_buffer = buffer,
        .length = 8 * sizeof(buffer),
    };
    spi_device_transmit(spi, &temp);
    // other stuff
}
```

It is also possible to allocate DMA-capable memory buffers dynamically by using the `MALLOC_CAP_DMA` capabilities flag.

### 4.20.8 DMA Buffer in the stack

Placing DMA buffers in the stack is possible but discouraged. If doing so, pay attention to the following:

- Placing DRAM buffers on the stack is not recommended if the stack may be in PSRAM. If the stack of a task is placed in the PSRAM, several steps have to be taken as described in [Support for External RAM](#).
- Use macro `WORD_ALIGNED_ATTR` in functions before variables to place them in proper positions like:

```
void app_main()
{
    uint8_t stuff;
    WORD_ALIGNED_ATTR uint8_t buffer[] = "I want to send something"; //or_
    ↪the buffer will be placed right after stuff. (continues on next page)
```

(continued from previous page)

```
// initialization code...
spi_transaction_t temp = {
    .tx_buffer = buffer,
    .length = 8 * sizeof(buffer),
};
spi_device_transmit(spi, &temp);
// other stuff
}
```

## 4.21 OpenThread

**OpenThread** is an IP stack running on the 802.15.4 MAC layer which features mesh network and low power consumption.

### 4.21.1 Modes of the OpenThread stack

OpenThread can run under the following modes on Espressif chips:

#### Standalone Node

The full OpenThread stack and the application layer run on the same chip. This mode is available on chips with 15.4 radio such as ESP32-H2 and ESP32-C6.

#### Radio Co-Processor (RCP)

The chip is connected to another host running the OpenThread IP stack. It sends and receives 15.4 packets on behalf of the host. This mode is available on chips with 15.4 radio such as ESP32-H2 and ESP32-C6. The underlying transport between the chip and the host can be SPI or UART. For the sake of latency, we recommend using SPI as the underlying transport.

#### OpenThread Host

For chips without a 15.4 radio, it can be connected to an RCP and run OpenThread under host mode. This mode enables OpenThread on Wi-Fi chips such as ESP32, ESP32-S2, ESP32-S3, and ESP32-C3. The following diagram shows how devices work under different modes:

### 4.21.2 How to Write an OpenThread Application

The OpenThread `openthread/ot_cli` example is a good place to start at. It demonstrates basic OpenThread initialization and simple socket-based server and client.

#### Before OpenThread Initialization

- s1.1: The main task calls `esp_vfs_eventfd_register()` to initialize the eventfd virtual file system. The eventfd file system is used for task notification in the OpenThread driver.
- s1.2: The main task calls `nvs_flash_init()` to initialize the NVS where the Thread network data is stored.
- s1.3: **Optional.** The main task calls `esp_netif_init()` only when it wants to create the network interface for Thread.

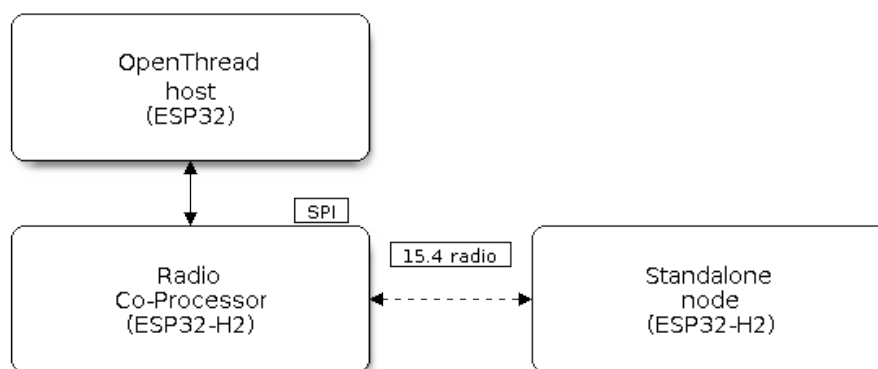

Fig. 41: OpenThread device modes

- s1.4: The main task calls `esp_event_loop_create()` to create the system Event task and initialize an application event's callback function.

### OpenThread Stack Initialization

- s2.1: Call `esp_openthread_init()` to initialize the OpenThread stack.

### OpenThread Network Interface Initialization

The whole stage is **optional** and only required if the application wants to create the network interface for Thread.

- s3.1: Call `esp_netif_new()` with `ESP_NETIF_DEFAULT_OPENTHREAD` to create the interface.
- s3.2: Call `esp_openthread_netif_glue_init()` to create the OpenThread interface handlers.
- s3.3: Call `esp_netif_attach()` to attach the handlers to the interface.

### The OpenThread Main Loop

- s4.3: Call `esp_openthread_launch_mainloop()` to launch the OpenThread main loop. Note that this is a busy loop and does not return until the OpenThread stack is terminated.

### Calling OpenThread APIs

The OpenThread APIs are not thread-safe. When calling OpenThread APIs from other tasks, make sure to hold the lock with `esp_openthread_lock_acquire()` and release the lock with `esp_openthread_lock_release()` afterwards.

### Deinitialization

The following steps are required to deinitialize the OpenThread stack:

- Call `esp_netif_destroy()` and `esp_openthread_netif_glue_deinit()` to deinitialize the OpenThread network interface if you have created one.
- Call `esp_openthread_deinit()` to deinitialize the OpenThread stack.

### 4.21.3 The OpenThread Border Router

The OpenThread border router connects the Thread network with other IP networks. It provides IPv6 connectivity, service registration, and commission functionality.

To launch an OpenThread border router on an ESP chip, you need to connect an RCP to a Wi-Fi capable chip such as ESP32.

Calling `esp_openthread_border_router_init()` during the initialization launches all the border routing functionalities.

You may refer to the [openthread/ot\\_br](#) example and the README for further border router details.

## 4.22 Partition Tables

### 4.22.1 Overview

A single ESP32-S2's flash can contain multiple apps, as well as many different kinds of data (calibration data, filesystems, parameter storage, etc). For this reason a partition table is flashed to (*default offset*) 0x8000 in the flash.

Partition table length is 0xC00 bytes (maximum 95 partition table entries). An MD5 checksum, which is used for checking the integrity of the partition table, is appended after the table data.

Each entry in the partition table has a name (label), type (app, data, or something else), subtype and the offset in flash where the partition is loaded.

The simplest way to use the partition table is to open the project configuration menu (`idf.py menuconfig`) and choose one of the simple predefined partition tables under `CONFIG_PARTITION_TABLE_TYPE`:

- “Single factory app, no OTA”
- “Factory app, two OTA definitions”

In both cases the factory app is flashed at offset 0x10000. If you execute `idf.py partition-table` then it will print a summary of the partition table.

### 4.22.2 Built-in Partition Tables

Here is the summary printed for the “Single factory app, no OTA” configuration:

```
# ESP-IDF Partition Table
# Name, Type, SubType, Offset, Size, Flags
nvs, data, nvs, 0x9000, 0x6000,
phy_init, data, phy, 0xf000, 0x1000,
factory, app, factory, 0x10000, 1M,
```

- At a 0x10000 (64 KB) offset in the flash is the app labelled “factory”. The bootloader will run this app by default.
- There are also two data regions defined in the partition table for storing NVS library partition and PHY init data.

Here is the summary printed for the “Factory app, two OTA definitions” configuration:

```
# ESP-IDF Partition Table
# Name, Type, SubType, Offset, Size, Flags
nvs, data, nvs, 0x9000, 0x4000,
otadata, data, ota, 0xd000, 0x2000,
phy_init, data, phy, 0xf000, 0x1000,
```

(continues on next page)



(continued from previous page)

```
factory, app, factory, 0x10000, 1M,
ota_0, app, ota_0, 0x110000, 1M,
ota_1, app, ota_1, 0x210000, 1M,
```

- There are now three app partition definitions. The type of the factory app (at 0x10000) and the next two “OTA” apps are all set to “app”, but their subtypes are different.
- There is also a new “otadata” slot, which holds the data for OTA updates. The bootloader consults this data in order to know which app to execute. If “ota data” is empty, it will execute the factory app.

### 4.22.3 Creating Custom Tables

If you choose “Custom partition table CSV” in menuconfig then you can also enter the name of a CSV file (in the project directory) to use for your partition table. The CSV file can describe any number of definitions for the table you need.

The CSV format is the same format as printed in the summaries shown above. However, not all fields are required in the CSV. For example, here is the “input” CSV for the OTA partition table:

```
# Name, Type, SubType, Offset, Size, Flags
nvs, data, nvs, 0x9000, 0x4000
otadata, data, ota, 0xd000, 0x2000
phy_init, data, phy, 0xf000, 0x1000
factory, app, factory, 0x10000, 1M
ota_0, app, ota_0, , 1M
ota_1, app, ota_1, , 1M
nvs_key, data, nvs_keys, , 0x1000
```

- Whitespace between fields is ignored, and so is any line starting with # (comments).
- Each non-comment line in the CSV file is a partition definition.
- The “Offset” field for each partition is empty. The `gen_esp32part.py` tool fills in each blank offset, starting after the partition table and making sure each partition is aligned correctly.

#### Name field

Name field can be any meaningful name. It is not significant to the ESP32-S2. Names longer than 16 characters will be truncated.

#### Type field

Partition type field can be specified as `app` (0x00) or `data` (0x01). Or it can be a number 0-254 (or as hex 0x00-0xFE). Types 0x00-0x3F are reserved for ESP-IDF core functions.

If your app needs to store data in a format not already supported by ESP-IDF, then please add a custom partition type value in the range 0x40-0xFE.

See [esp\\_partition\\_type\\_t](#) for the enum definitions for `app` and `data` partitions.

If writing in C++ then specifying a application-defined partition type requires casting an integer to [esp\\_partition\\_type\\_t](#) in order to use it with the [partition API](#). For example:

```
static const esp_partition_type_t APP_PARTITION_TYPE_A = (esp_partition_type_t)0x40;
```

The ESP-IDF bootloader ignores any partition types other than `app` (0x00) and `data` (0x01).

## SubType

The 8-bit subtype field is specific to a given partition type. ESP-IDF currently only specifies the meaning of the subtype field for `app` and `data` partition types.

See enum `esp_partition_subtype_t` for the full list of subtypes defined by ESP-IDF, including the following:

- When type is `app`, the subtype field can be specified as `factory` (0x00), `ota_0` (0x10) ... `ota_15` (0x1F) or `test` (0x20).
  - `factory` (0x00) is the default `app` partition. The bootloader will execute the factory app unless there it sees a partition of type `data/ota`, in which case it reads this partition to determine which OTA image to boot.
    - \* OTA never updates the factory partition.
    - \* If you want to conserve flash usage in an OTA project, you can remove the factory partition and use `ota_0` instead.
  - `ota_0` (0x10) ... `ota_15` (0x1F) are the OTA app slots. When *OTA* is in use, the OTA data partition configures which app slot the bootloader should boot. When using OTA, an application should have at least two OTA application slots (`ota_0` & `ota_1`). Refer to the *OTA documentation* for more details.
  - `test` (0x20) is a reserved subtype for factory test procedures. It will be used as the fallback boot partition if no other valid app partition is found. It is also possible to configure the bootloader to read a GPIO input during each boot, and boot this partition if the GPIO is held low, see *Boot from Test Firmware*.
- When type is `data`, the subtype field can be specified as `ota` (0x00), `phy` (0x01), `nvs` (0x02), `nvs_keys` (0x04), or a range of other component-specific subtypes (see *subtype enum*).
  - `ota` (0) is the *OTA data partition* which stores information about the currently selected OTA app slot. This partition should be 0x2000 bytes in size. Refer to the *OTA documentation* for more details.
  - `phy` (1) is for storing PHY initialisation data. This allows PHY to be configured per-device, instead of in firmware.
    - \* In the default configuration, the phy partition is not used and PHY initialisation data is compiled into the app itself. As such, this partition can be removed from the partition table to save space.
    - \* To load PHY data from this partition, open the project configuration menu (`idf.py menuconfig`) and enable `CONFIG_ESP_PHY_INIT_DATA_IN_PARTITION` option. You will also need to flash your devices with phy init data as the esp-idf build system does not do this automatically.
  - `nvs` (2) is for the *Non-Volatile Storage (NVS) API*.
    - \* NVS is used to store per-device PHY calibration data (different to initialisation data).
    - \* NVS is used to store WiFi data if the `esp_wifi_set_storage(WIFI_STORAGE_FLASH)` initialisation function is used.
    - \* The NVS API can also be used for other application data.
    - \* It is strongly recommended that you include an NVS partition of at least 0x3000 bytes in your project.
    - \* If using NVS API to store a lot of data, increase the NVS partition size from the default 0x6000 bytes.
  - `nvs_keys` (4) is for the NVS key partition. See *Non-Volatile Storage (NVS) API* for more details.
    - \* It is used to store NVS encryption keys when *NVS Encryption* feature is enabled.
    - \* The size of this partition should be 4096 bytes (minimum partition size).
  - There are other predefined data subtypes for data storage supported by ESP-IDF. These include *FAT filesystem* (`ESP_PARTITION_SUBTYPE_DATA_FAT`), *SPIFFS* (`ESP_PARTITION_SUBTYPE_DATA_SPIFFS`), etc.

Other subtypes of `data` type are reserved for future ESP-IDF uses.

- If the partition type is any application-defined value (range 0x40-0xFE), then `subtype` field can be any value chosen by the application (range 0x00-0xFE).

Note that when writing in C++, an application-defined subtype value requires casting to type `esp_partition_subtype_t` in order to use it with the *partition API*.

## Extra Partition SubTypes

A component can define a new partition subtype by setting the `EXTRA_PARTITION_SUBTYPES` property. This property is a CMake list, each entry of which is a comma separated string with `<type>`, `<subtype>`, `<value>` format. The build system uses this property to add extra subtypes and creates fields named `ESP_PARTITION_SUBTYPE_<type>_<subtype>` in `esp_partition_type_t`. The

project can use this subtype to define partitions in the partitions table CSV file and use the new fields in `esp_partition_type_t`.

### Offset & Size

Partitions with blank offsets in the CSV file will start after the previous partition, or after the partition table in the case of the first partition.

Partitions of type `app` have to be placed at offsets aligned to 0x10000 (64K). If you leave the offset field blank, `gen_esp32part.py` will automatically align the partition. If you specify an unaligned offset for an `app` partition, the tool will return an error.

Sizes and offsets can be specified as decimal numbers, hex numbers with the prefix 0x, or size multipliers K or M (1024 and 1024\*1024 bytes).

If you want the partitions in the partition table to work relative to any placement (*CONFIG\_PARTITION\_TABLE\_OFFSET*) of the table itself, leave the offset field (in CSV file) for all partitions blank. Similarly, if changing the partition table offset then be aware that all blank partition offsets may change to match, and that any fixed offsets may now collide with the partition table (causing an error).

### Flags

Only one flag is currently supported, `encrypted`. If this field is set to `encrypted`, this partition will be encrypted if *Flash Encryption* is enabled.

---

**Note:** `app` type partitions will always be encrypted, regardless of whether this flag is set or not.

---

## 4.22.4 Generating Binary Partition Table

The partition table which is flashed to the ESP32-S2 is in a binary format, not CSV. The tool `partition_table/gen_esp32part.py` is used to convert between CSV and binary formats.

If you configure the partition table CSV name in the project configuration (`idf.py menuconfig`) and then build the project or run `idf.py partition-table`, this conversion is done as part of the build process.

To convert CSV to Binary manually:

```
python gen_esp32part.py input_partitions.csv binary_partitions.bin
```

To convert binary format back to CSV manually:

```
python gen_esp32part.py binary_partitions.bin input_partitions.csv
```

To display the contents of a binary partition table on stdout (this is how the summaries displayed when running `idf.py partition-table` are generated:

```
python gen_esp32part.py binary_partitions.bin
```

## 4.22.5 Partition Size Checks

The ESP-IDF build system will automatically check if generated binaries fit in the available partition space, and will fail with an error if a binary is too large.

Currently these checks are performed for the following binaries:

- Bootloader binary must fit in space before partition table (see *Bootloader Size*).

- App binary should fit in at least one partition of type “app”. If the app binary doesn’t fit in any app partition, the build will fail. If it only fits in some of the app partitions, a warning is printed about this.

---

**Note:** Although the build process will fail if the size check returns an error, the binary files are still generated and can be flashed (although they may not work if they are too large for the available space.)

---

### MD5 checksum

The binary format of the partition table contains an MD5 checksum computed based on the partition table. This checksum is used for checking the integrity of the partition table during the boot.

The MD5 checksum generation can be disabled by the `--disable-md5sum` option of `gen_esp32part.py` or by the `CONFIG_PARTITION_TABLE_MD5` option.

### 4.22.6 Flashing the partition table

- `idf.py partition-table-flash`: will flash the partition table with `esptool.py`.
- `idf.py flash`: Will flash everything including the partition table.

A manual flashing command is also printed as part of `idf.py partition-table` output.

---

**Note:** Note that updating the partition table doesn’t erase data that may have been stored according to the old partition table. You can use `idf.py erase-flash` (or `esptool.py erase_flash`) to erase the entire flash contents.

---

### 4.22.7 Partition Tool (`parttool.py`)

The component `partition_table` provides a tool `parttool.py` for performing partition-related operations on a target device. The following operations can be performed using the tool:

- reading a partition and saving the contents to a file (`read_partition`)
- writing the contents of a file to a partition (`write_partition`)
- erasing a partition (`erase_partition`)
- retrieving info such as name, offset, size and flag ( “encrypted” ) of a given partition (`get_partition_info`)

The tool can either be imported and used from another Python script or invoked from shell script for users wanting to perform operation programmatically. This is facilitated by the tool’s Python API and command-line interface, respectively.

#### Python API

Before anything else, make sure that the `parttool` module is imported.

```
import sys
import os

idf_path = os.environ["IDF_PATH"] # get value of IDF_PATH from environment
parttool_dir = os.path.join(idf_path, "components", "partition_table") # parttool.
↳py lives in $IDF_PATH/components/partition_table

sys.path.append(parttool_dir) # this enables Python to find parttool module
from parttool import * # import all names inside parttool module
```

The starting point for using the tool’s Python API to do is create a `ParttoolTarget` object:

```
# Create a partool.py target device connected on serial port /dev/ttyUSB1
target = ParttoolTarget("/dev/ttyUSB1")
```

The created object can now be used to perform operations on the target device:

```
# Erase partition with name 'storage'
target.erase_partition(PartitionName("storage"))

# Read partition with type 'data' and subtype 'spiffs' and save to file 'spiffs.bin'
↪
target.read_partition(PartitionType("data", "spiffs"), "spiffs.bin")

# Write to partition 'factory' the contents of a file named 'factory.bin'
target.write_partition(PartitionName("factory"), "factory.bin")

# Print the size of default boot partition
storage = target.get_partition_info(PARTITION_BOOT_DEFAULT)
print(storage.size)
```

The partition to operate on is specified using *PartitionName* or *PartitionType* or `PARTITION_BOOT_DEFAULT`. As the name implies, these can be used to refer to partitions of a particular name, type-subtype combination, or the default boot partition.

More information on the Python API is available in the docstrings for the tool.

### Command-line Interface

The command-line interface of *partool.py* has the following structure:

```
partool.py [command-args] [subcommand] [subcommand-args]

- command-args - These are arguments that are needed for executing the main_
↪command (partool.py), mostly pertaining to the target device
- subcommand - This is the operation to be performed
- subcommand-args - These are arguments that are specific to the chosen operation
```

```
# Erase partition with name 'storage'
partool.py --port "/dev/ttyUSB1" erase_partition --partition-name=storage

# Read partition with type 'data' and subtype 'spiffs' and save to file 'spiffs.bin'
↪
partool.py --port "/dev/ttyUSB1" read_partition --partition-type=data --partition-
↪subtype=spiffs --output "spiffs.bin"

# Write to partition 'factory' the contents of a file named 'factory.bin'
partool.py --port "/dev/ttyUSB1" write_partition --partition-name=factory --input
↪"factory.bin"

# Print the size of default boot partition
partool.py --port "/dev/ttyUSB1" get_partition_info --partition-boot-default --
↪info size
```

More information can be obtained by specifying *-help* as argument:

```
# Display possible subcommands and show main command argument descriptions
partool.py --help

# Show descriptions for specific subcommand arguments
partool.py [subcommand] --help
```

## 4.23 Performance

ESP-IDF ships with default settings that are designed for a trade-off between performance, resource usage, and available functionality.

These guides describe how to optimize a firmware application for a particular aspect of performance. Usually this involves some trade-off in terms of limiting available functions, or swapping one aspect of performance (such as execution speed) for another (such as RAM usage).

### 4.23.1 How to Optimize Performance

1. Decide what the performance-critical aspects of your application are (for example: a particular response time to a certain network operation, a particular startup time limit, particular peripheral data throughput, etc.).
2. Find a way to measure this performance (some methods are outlined in the guides below).
3. Modify the code and project configuration and compare the new measurement to the old measurement.
4. Repeat step 3 until the performance meets the requirements set out in step 1.

### 4.23.2 Guides

#### Maximizing Execution Speed

**Overview** Optimizing execution speed is a key element of software performance. Code that executes faster can also have other positive effects, like reducing overall power consumption. However, improving execution speed may have trade-offs with other aspects of performance such as [Minimizing Binary Size](#).

**Choose What To Optimize** If a function in the application firmware is executed once per week in the background, it may not matter if that function takes 10 ms or 100 ms to execute. If a function is executed constantly at 10 Hz, it matters greatly if it takes 10 ms or 100 ms to execute.

Most application firmwares will only have a small set of functions which require optimal performance. Perhaps those functions are executed very often, or have to meet some application requirements for latency or throughput. Optimization efforts should be targeted at these particular functions.

**Measuring Performance** The first step to improving something is to measure it.

**Basic Performance Measurements** If measuring performance relative to an external interaction with the world, you may be able to measure this directly (for example see the examples [wifi/iperf](#) and [ethernet/iperf](#) for measuring general network performance, or you can use an oscilloscope or logic analyzer to measure timing of an interaction with a device peripheral.)

Otherwise, one way to measure performance is to augment the code to take timing measurements:

```
#include "esp_timer.h"

void measure_important_function(void) {
    const unsigned MEASUREMENTS = 5000;
    uint64_t start = esp_timer_get_time();

    for (int retries = 0; retries < MEASUREMENTS; retries++) {
        important_function(); // This is the thing you need to measure
    }

    uint64_t end = esp_timer_get_time();

    printf("%u iterations took %llu milliseconds (%llu microseconds per_
↵invocation)\n",
```

(continues on next page)

(continued from previous page)

```

    MEASUREMENTS, (end - start)/1000, (end - start)/MEASUREMENTS);
}

```

Executing the target multiple times can help average out factors like RTOS context switches, overhead of measurements, etc.

- Using `esp_timer_get_time()` generates “wall clock” timestamps with microsecond precision, but has moderate overhead each time the timing functions are called.
- It’s also possible to use the standard Unix `gettimeofday()` and `utime()` functions, although the overhead is slightly higher.
- Otherwise, including `hal/cpu_hal.h` and calling the HAL function `cpu_hal_get_cycle_count()` will return the number of CPU cycles executed. This function has lower overhead than the others. It is good for measuring very short execution times with high precision.
- If making “microbenchmarks” (i.e. benchmarking only a very small routine of code that runs in less than 1-2 milliseconds) then flash cache performance can sometimes cause big variations in timing measurements depending on the binary. This happens because binary layout can cause different patterns of cache misses in a particular sequence of execution. If the test code is larger then this effect usually averages out. Executing a small function multiple times when benchmarking can help reduce the impact of flash cache misses. Alternatively, move this code to IRAM (see [Targeted Optimizations](#)).

**External Tracing** The [Application Level Tracing library](#) allows measuring code execution with minimal impact on the code itself.

**Tasks** If the option `CONFIG_FREERTOS_GENERATE_RUN_TIME_STATS` is enabled then the FreeRTOS API `vTaskGetRunTimeStats()` can be used to retrieve runtime information about the processor time used by each FreeRTOS task.

[SEGGER SystemView](#) is an excellent tool for visualizing task execution and looking for performance issues or improvements in the system as a whole.

**Improving Overall Speed** The following optimizations will improve the execution of nearly all code - including boot times, throughput, latency, etc:

- Set `CONFIG_ESPTOOLPY_FLASHMODE` to QIO or QOUT mode (Quad I/O). Both will almost double the speed at which code is loaded or executed from flash compared to the default DIO mode. QIO is slightly faster than QOUT if both are supported. Note that both the flash chip model and the electrical connections between the ESP32-S2 and the flash chip must support quad I/O modes or the SoC will not work correctly.
- Set `CONFIG_COMPILER_OPTIMIZATION` to “Optimize for performance (-O2)”. This may slightly increase binary size compared to the default setting, but will almost certainly increase performance of some code. Note that if your code contains C or C++ Undefined Behaviour then increasing the compiler optimization level may expose bugs that otherwise are not seen.
- Avoid using floating point arithmetic (`float`). On ESP32-S2 these calculations are emulated in software and are very slow. If possible then use fixed point representations, a different method of integer representation, or convert part of the calculation to be integer only before switching to floating point.
- Avoid using double precision floating point arithmetic (`double`). These calculations are emulated in software and are very slow. If possible then use an integer-based representation, or single-precision floating point.

**Reduce Logging Overhead** Although standard output is buffered, it’s possible for an application to be limited by the rate at which it can print data to log output once buffers are full. This is particularly relevant for startup time if a lot of output is logged, but can happen at other times as well. There are multiple ways to solve this problem:



- Reduce the volume of log output by lowering the app `CONFIG_LOG_DEFAULT_LEVEL` (the equivalent boot-loader setting is `CONFIG_BOOTLOADER_LOG_LEVEL`). This also reduces the binary size, and saves some CPU time spent on string formatting.
- Increase the speed of logging output by increasing the `CONFIG_ESP_CONSOLE_UART_BAUDRATE`. (Unless using internal USB-CDC for serial console, in which case the serial throughput doesn't depend on the configured baud rate.)

**Not Recommended** The following options will also increase execution speed, but are not recommended as they also reduce the debuggability of the firmware application and may increase the severity of any bugs.

- Set `CONFIG_COMPILER_OPTIMIZATION_ASSERTION_LEVEL` to disabled. This also reduces firmware binary size by a small amount. However, it may increase the severity of bugs in the firmware including security-related bugs. If necessary to do this to optimize a particular function, consider adding `#define NDEBUG` in the top of that single source file instead.

**Targeted Optimizations** The following changes will increase the speed of a chosen part of the firmware application:

- Move frequently executed code to IRAM. By default, all code in the app is executed from flash cache. This means that it's possible for the CPU to have to wait on a "cache miss" while the next instructions are loaded from flash. Functions which are copied into IRAM are loaded once at boot time, and then will always execute at full speed.  
IRAM is a limited resource, and using more IRAM may reduce available DRAM, so a strategic approach is needed when moving code to IRAM. See *IRAM (Instruction RAM)* for more information.
- Jump table optimizations can be re-enabled for individual source files that don't need to be placed in IRAM. For hot paths in large switch cases this will improve performance. For instructions on how to add the `-fjump-tables -free-switch-conversion` options when compiling individual source files, see *Controlling Component Compilation*

**Improving Startup Time** In addition to the overall performance improvements shown above, the following options can be tweaked to specifically reduce startup time:

- Minimizing the `CONFIG_LOG_DEFAULT_LEVEL` and `CONFIG_BOOTLOADER_LOG_LEVEL` has a large impact on startup time. To enable more logging after the app starts up, set the `CONFIG_LOG_MAXIMUM_LEVEL` as well and then call `esp_log_level_set()` to restore higher level logs. The `system/startup_time` main function shows how to do this.
- If using deep sleep, setting `CONFIG_BOOTLOADER_SKIP_VALIDATE_IN_DEEP_SLEEP` allows a faster wake from sleep. Note that if using Secure Boot this represents a security compromise, as Secure Boot validation will not be performed on wake.
- Setting `CONFIG_BOOTLOADER_SKIP_VALIDATE_ON_POWER_ON` will skip verifying the binary on every boot from power-on reset. How much time this saves depends on the binary size and the flash settings. Note that this setting carries some risk if the flash becomes corrupt unexpectedly. Read the help text of the *config item* for an explanation and recommendations if using this option.
- It's possible to save a small amount of time during boot by disabling RTC slow clock calibration. To do so, set `CONFIG_RTC_CLK_CAL_CYCLES` to 0. Any part of the firmware that uses RTC slow clock as a timing source will be less accurate as a result.

The example project `system/startup_time` is pre-configured to optimize startup time. The file `system/startup_time/sdkconfig.defaults` contain all of these settings. You can append these to the end of your project's own `sdkconfig` file to merge the settings, but please read the documentation for each setting first.

**Task Priorities** As ESP-IDF FreeRTOS is a real-time operating system, it's necessary to ensure that high throughput or low latency tasks are granted a high priority in order to run immediately. Priority is set when calling



`xTaskCreate()` or `xTaskCreatePinnedToCore()` and can be changed at runtime by calling `vTaskPrioritySet()`.

It's also necessary to ensure that tasks yield CPU (by calling `vTaskDelay()`, `sleep()`, or by blocking on semaphores, queues, task notifications, etc) in order to not starve lower priority tasks and cause problems for the overall system. The *Task Watchdog Timer (TWDT)* provides a mechanism to automatically detect if task starvation happens, however note that a Task WDT timeout does not always indicate a problem (sometimes the correct operation of the firmware requires some long-running computation). In these cases tweaking the Task WDT timeout or even disabling the Task WDT may be necessary.

**Built-In Task Priorities** ESP-IDF starts a number of system tasks at fixed priority levels. Some are automatically started during the boot process, some are started only if the application firmware initializes a particular feature. To optimize performance, structure application task priorities so that they are not delayed by system tasks, while also not starving system tasks and impacting other functions of the system.

This may require splitting up a particular task. For example, perform a time-critical operation in a high priority task or an interrupt handler and do the non-time-critical part in a lower priority task.

Header `components/esp_system/include/esp_task.h` contains macros for the priority levels used for built-in ESP-IDF tasks system.

Common priorities are:

- *Main task that executes `app_main` function* has minimum priority (1).
- *High Resolution Timer (ESP Timer)* system task to manage timer events and execute callbacks has high priority (22, `ESP_TASK_TIMER_PRIO`)
- FreeRTOS Timer Task to handle FreeRTOS timer callbacks is created when the scheduler initializes and has minimum task priority (1, *configurable*).
- *Event Handling* system task to manage the default system event loop and execute callbacks has high priority (20, `ESP_TASK_EVENT_PRIO`). This configuration is only used if the application calls `esp_event_loop_create_default()`, it's possible to call `esp_event_loop_create()` with a custom task configuration instead.
- *lwIP TCP/IP* task has high priority (18, `ESP_TASK_TCPIP_PRIO`).
- *Wi-Fi Driver* task has high priority (23).
- Wi-Fi wpa\_supplicant component may create dedicated tasks while the Wi-Fi Protected Setup (WPS), WPA2 EAP-TLS, Device Provisioning Protocol (DPP) or BSS Transition Management (BTM) features are in use. These tasks all have low priority (2).
- The Ethernet driver creates a task for the MAC to receive Ethernet frames. If using the default config `ETH_MAC_DEFAULT_CONFIG` then the priority is medium-high (15). This setting can be changed by passing a custom `eth_mac_config_t` struct when initializing the Ethernet MAC.
- If using the *MQTT* component, it creates a task with default priority 5 (*configurable*, depends on `CONFIG_MQTT_USE_CUSTOM_CONFIG` (also configurable runtime by `task_prio` field in the `esp_mqtt_client_config_t`))
- To see what is the task priority for mDNS service, please check [Performance Optimization](#).

**Choosing application task priorities** In general, it's not recommended to set task priorities higher than the built-in Wi-Fi operations as starving them of CPU may make the system unstable. For very short timing-critical operations that don't use the network, use an ISR or a very restricted task (very short bursts of runtime only) at highest priority (24). Choosing priority 19 will allow lower layer Wi-Fi functionality to run without delays, but still preempts the lwIP TCP/IP stack and other less time-critical internal functionality - this is the best option for time-critical tasks that don't perform network operations. Any task that does TCP/IP network operations should run at lower priority than the lwIP TCP/IP task (18) to avoid priority inversion issues.

---

**Note:** Task execution is always completely suspended when writing to the built-in SPI flash chip. Only *IRAM-Safe Interrupt Handlers* will continue executing.

---

**Improving Interrupt Performance** ESP-IDF supports dynamic *Interrupt allocation* with interrupt preemption. Each interrupt in the system has a priority, and higher priority interrupts will preempt lower priority ones.

Interrupt handlers will execute in preference to any task (provided the task is not inside a critical section). For this reason, it's important to minimize the amount of time spent executing in an interrupt handler.

To obtain the best performance for a particular interrupt handler:

- Assign more important interrupts a higher priority using a flag such as `ESP_INTR_FLAG_LEVEL2` or `ESP_INTR_FLAG_LEVEL3` when calling `esp_intr_alloc()`.
- If you're sure the entire interrupt handler can run from IRAM (see *IRAM-Safe Interrupt Handlers*) then set the `ESP_INTR_FLAG_IRAM` flag when calling `esp_intr_alloc()` to assign the interrupt. This prevents it being temporarily disabled if the application firmware writes to the internal SPI flash.
- Even if the interrupt handler is not IRAM safe, if it is going to be executed frequently then consider moving the handler function to IRAM anyhow. This minimizes the chance of a flash cache miss when the interrupt code is executed (see *Targeted Optimizations*). It's possible to do this without adding the `ESP_INTR_FLAG_IRAM` flag to mark the interrupt as IRAM-safe, if only part of the handler is guaranteed to be in IRAM.

### Improving Network Speed

- For Wi-Fi, see *How to Improve Wi-Fi Performance* and *Wi-Fi Buffer Usage*
- For lwIP TCP/IP (Wi-Fi and Ethernet), see *Performance Optimization*
- The `wifi/iperf` example contains a configuration that is heavily optimized for Wi-Fi TCP/IP throughput. Append the contents of the files `wifi/iperf/sdkconfig.defaults`, `wifi/iperf/sdkconfig.defaults.esp32s2` and `wifi/iperf/sdkconfig.ci.99` to your project `sdkconfig` file in order to add all of these options. Note that some of these options may have trade-offs in terms of reduced debuggability, increased firmware size, increased memory usage, or reduced performance of other features. To get the best result, read the documentation pages linked above and use this information to determine exactly which options are best suited for your app.

### Minimizing Binary Size

The ESP-IDF build system compiles all source files in the project and ESP-IDF, but only functions and variables that are actually referenced by the program are linked into the final binary. In some cases, it is necessary to reduce the total size of the firmware binary (for example, in order to fit it into the available flash partition size).

The first step to reducing the total firmware binary size is measuring what is causing the size to increase.

**Measuring Static Sizes** To optimize both firmware binary size and memory usage it's necessary to measure statically allocated RAM ( "data" , "bss" ), code ( "text" ) and read-only data ( "rodata" ) in your project.

Using the `idf.py` sub-commands `size`, `size-components` and `size-files` provides a summary of memory used by the project:

#### Size Summary (idf.py size)

```
$ idf.py size
[...]
Total sizes:
DRAM .data size: 11584 bytes
DRAM .bss size: 19624 bytes
Used static DRAM: 0 bytes ( 0 available, nan% used)
Used static IRAM: 0 bytes ( 0 available, nan% used)
Used stat D/IRAM: 136276 bytes ( 519084 available, 20.8% used)
Flash code: 630508 bytes
Flash rodata: 177048 bytes
Total image size:~ 924208 bytes (.bin may be padded larger)
```

This output breaks down the size of all static memory regions in the firmware binary:

- DRAM `.data` size is statically allocated RAM that is assigned to non-zero values at startup. This uses RAM (DRAM) at runtime and also uses space in the binary file.
- DRAM `.bss` size is statically allocated RAM that is assigned zero at startup. This uses RAM (DRAM) at runtime but doesn't use any space in the binary file.
- Used static DRAM, Used static IRAM - these options are kept for compatibility with ESP32 target, and currently read 0.
- Used static D/IRAM - This is total internal RAM usage, the sum of static DRAM `.data` + `.bss`, and also static *IRAM (Instruction RAM)* used by the application for executable code. The available size is the estimated amount of DRAM which will be available as heap memory at runtime (due to metadata overhead and implementation constraints, and heap allocations done by ESP-IDF during startup, the actual free heap at startup will be lower than this).
- Flash code is the total size of executable code executed from flash cache (*IROM*). This uses space in the binary file.
- Flash rodata is the total size of read-only data loaded from flash cache (*DROM*). This uses space in the binary file.
- Total image size is the estimated total binary file size, which is the total of all the used memory types except for `.bss`.

**Component Usage Summary (`idf.py size-components`)** The summary output provided by `idf.py size` does not give enough detail to find the main contributor to excessive binary size. To analyze in more detail, use `idf.py size-components`

```
$ idf.py size-components
[...]
  Total sizes:
  DRAM .data size: 14956 bytes
  DRAM .bss size: 15808 bytes
  Used static DRAM: 30764 bytes ( 149972 available, 17.0% used)
  Used static IRAM: 83918 bytes ( 47154 available, 64.0% used)
    Flash code: 559943 bytes
    Flash rodata: 176736 bytes
  Total image size:~ 835553 bytes (.bin may be padded larger)
  Per-archive contributions to ELF file:
      Archive File DRAM .data & .bss & other  IRAM  D/IRAM Flash code &
  ↪rodata  Total
      libnet80211.a      1267  6044  0  5490  0  107445  ↪
  ↪18484  138730
      liblwip.a         21  3838  0  0  0  97465  ↪
  ↪16116  117440
      libmbedtls.a     60  524  0  0  0  27655  ↪
  ↪69907  98146
      libmbedcrypto.a  64  81  0  30  0  76645  ↪
  ↪11661  88481
      libpp.a          2427  1292  0  20851  0  37208  ↪
  ↪4708  66486
      libc.a           4  0  0  0  0  57056  ↪
  ↪6455  63515
      libphy.a         1439  715  0  7798  0  33074  ↪
  ↪ 0  43026
      libwpa_supplicant.a  12  848  0  0  0  35505  ↪
  ↪1446  37811
      libfreertos.a   3104  740  0  15711  0  367  ↪
  ↪4228  24150
      libnvs_flash.a  0  24  0  0  0  14347  ↪
  ↪2924  17295
      libspi_flash.a  1562  294  0  8851  0  1840  ↪
  ↪1913  14460
```

(continues on next page)

(continued from previous page)

	libesp_system.a	245	206	0	3078	0	5990	└
↔3817	13336							
	libesp-tls.a	0	4	0	0	0	5637	└
↔3524	9165							
[... removed some lines here ...]								
	libesp_rom.a	0	0	0	112	0	0	└
↔ 0	112							
	libcxx.a	0	0	0	0	0	47	└
↔ 0	47							
	(exe)	0	0	0	3	0	3	└
↔ 12	18							
	libesp_pm.a	0	0	0	0	0	8	└
↔ 0	8							
	libesp_eth.a	0	0	0	0	0	0	└
↔ 0	0							
	libmesh.a	0	0	0	0	0	0	└
↔ 0	0							

The first lines of output from `idf.py size-components` are the same as `idf.py size`. After this a table is printed of “per-archive contributions to ELF file”. This means how much each static library archive has contributed to the final binary size.

Generally, one static library archive is built per component, although some are binary libraries included by a particular component (for example, `libnet80211.a` is included by `esp_wifi` component). There are also toolchain libraries such as `libc.a` and `libgcc.a` listed here, these provide Standard C/C++ Library and toolchain built-in functionality.

If your project is simple and only has a “main” component, then all of the project’s code will be shown under `libmain.a`. If your project includes its own components (see [Build System](#)), then they will each be shown on a separate line.

The table is sorted in descending order of the total contribution to the binary size.

The columns are as follows:

- DRAM `.data` & `.bss` & `other-.data` and `.bss` are the same as for the totals shown above (static variables, these both reduce total available RAM at runtime but `.bss` doesn’t contribute to the binary file size). “other” is a column for any custom section types that also contribute to RAM size (usually this value is 0).
- IRAM - is the same as for the totals shown above (code linked to execute from IRAM, uses space in the binary file and also reduces DRAM available as heap at runtime).
- Flash code & `rodata` - these are the same as the totals above, IROM and DROM space accessed from flash cache that contribute to the binary size.

**Source File Usage Summary (`idf.py size-files`)** For even more detail, run `idf.py size-files` to get a summary of the contribution each object file has made to the final binary size. Each object file corresponds to a single source file.

```
$ idf.py size-files
[...]
Total sizes:
  DRAM .data size: 14956 bytes
  DRAM .bss size: 15808 bytes
  Used static DRAM: 30764 bytes ( 149972 available, 17.0% used)
  Used static IRAM: 83918 bytes ( 47154 available, 64.0% used)
  Flash code: 559943 bytes
  Flash rodata: 176736 bytes
Total image size:~ 835553 bytes (.bin may be padded larger)
Per-file contributions to ELF file:
  Object File DRAM .data & .bss & other IRAM D/IRAM Flash code &
↔rodata Total
```

(continues on next page)

(continued from previous page)

	x509_crt_bundle.S.o	0	0	0	0	0	0	└
↔64212	64212							
	wl_cnx.o	2	3183	0	221	0	13119	└
↔3286	19811							
	phy_chip_v7.o	721	614	0	1642	0	16820	└
↔0	19797							
	ieee80211_ioctl.o	740	96	0	437	0	15325	└
↔2627	19225							
	pp.o	1142	45	0	8871	0	5030	└
↔537	15625							
	ieee80211_output.o	2	20	0	2118	0	11617	└
↔914	14671							
	ieee80211_sta.o	1	41	0	1498	0	10858	└
↔2218	14616							
	lib_a-vfprintf.o	0	0	0	0	0	13829	└
↔752	14581							
	lib_a-svfprintf.o	0	0	0	0	0	13251	└
↔752	14003							
	ssl_tls.c.o	60	0	0	0	0	12769	└
↔463	13292							
	sockets.c.o	0	648	0	0	0	11096	└
↔1030	12774							
	nd6.c.o	8	932	0	0	0	11515	└
↔314	12769							
	phy_chip_v7_cal.o	477	53	0	3499	0	8561	└
↔0	12590							
	pm.o	32	364	0	2673	0	7788	└
↔782	11639							
	ieee80211_scan.o	18	288	0	0	0	8889	└
↔1921	11116							
	lib_a-svfprintf.o	0	0	0	0	0	9654	└
↔1206	10860							
	lib_a-svfprintf.o	0	0	0	0	0	10069	└
↔734	10803							
	ieee80211_ht.o	0	4	0	1186	0	8628	└
↔898	10716							
	phy_chip_v7_ana.o	241	48	0	2657	0	7677	└
↔0	10623							
	bignum.c.o	0	4	0	0	0	9652	└
↔752	10408							
	tcp_in.c.o	0	52	0	0	0	8750	└
↔1282	10084							
	trc.o	664	88	0	1726	0	6245	└
↔1108	9831							
	tasks.c.o	8	704	0	7594	0	0	└
↔1475	9781							
	eep_curves.c.o	28	0	0	0	0	7384	└
↔2325	9737							
	eep.c.o	0	64	0	0	0	8864	└
↔286	9214							
	ieee80211_hostap.o	1	41	0	0	0	8578	└
↔585	9205							
	wdev.o	121	125	0	4499	0	3684	└
↔580	9009							
	tcp_out.c.o	0	0	0	0	0	5686	└
↔2161	7847							
	tcp.c.o	2	26	0	0	0	6161	└
↔1617	7806							
	ieee80211_input.o	0	0	0	0	0	6797	└
↔973	7770							
	wpa.c.o	0	656	0	0	0	6828	└
↔55	7539							

(continues on next page)

```
[... additional lines removed ...]
```

After the summary of total sizes, a table of “Per-file contributions to ELF file” is printed.

The columns are the same as shown above for `idy.py size-components`, but this time the granularity is the contribution of each individual object file to the binary size.

For example, we can see that the file `x509_crt_bundle.S.o` contributed 64212 bytes to the total firmware size, all as `.rodata` in flash. Therefore we can guess that this application is using the *ESP x509 Certificate Bundle* feature and not using this feature would save at least this many bytes from the firmware size.

Some of the object files are linked from binary libraries and therefore you won’t find a corresponding source file. To locate which component a source file belongs to, it’s generally possible to search in the ESP-IDF source tree or look in the *Linker Map File* for the full path.

**Comparing Two Binaries** If making some changes that affect binary size, it’s possible to use an ESP-IDF tool to break down the exact differences in size.

This operation isn’t part of `idf.py`, it’s necessary to run the `idf-size.py` Python tool directly.

To do so, first locate the linker map file in the build directory. It will have the name `PROJECTNAME.map`. The `idf-size.py` tool performs its analysis based on the output of the linker map file.

To compare with another binary, you will also need its corresponding `.map` file saved from the build directory.

For example, to compare two builds: one with the default `CONFIG_COMPILER_OPTIMIZATION` setting “Debug (-Og)” configuration and one with “Optimize for size (-Os)” :

```
$ $IDF_PATH/tools/idf_size.py --diff build_Og/https_request.map build_Os/https_
↪request.map
<CURRENT> MAP file: build_Os/https_request.map
<REFERENCE> MAP file: build_Og/https_request.map
Difference is counted as <CURRENT> - <REFERENCE>, i.e. a positive number means
↪that <CURRENT> is larger.
Total sizes of <CURRENT>:
↪<REFERENCE>      Difference
DRAM .data size:  14516 bytes
↪14956            -440
DRAM .bss size:   15792 bytes
↪15808           -16
Used static DRAM: 30308 bytes ( 150428 available, 16.8% used)
↪30764           -456 ( +456 available, +0 total)
Used static IRAM: 78498 bytes ( 52574 available, 59.9% used)
↪83918           -5420 ( +5420 available, +0 total)
Flash code:      509183 bytes
↪559943         -50760
Flash rodata:    170592 bytes
↪176736         -6144
Total image size:~ 772789 bytes (.bin may be padded larger)
↪835553         -62764
```

We can see from the “Difference” column that changing this one setting caused the whole binary to be over 60 KB smaller and over 5 KB more RAM is available.

It’s also possible to use the “diff” mode to output a table of component-level (static library archive) differences:

```
$IDF_PATH/tools/idf_size.py --archives --diff build_Og/https_request.map build_
↪Oshttps_request.map
```

Also at the individual source file level:

```
$IDF_PATH/tools/idf_size.py --files --diff build_Og/https_request.map build_
↪Oshttps_request.map
```

Other options (like writing the output to a file) are available, pass `--help` to see the full list.

**Showing Size When Linker Fails** If too much static memory is used, then the linker will fail with an error such as DRAM segment data does not fit, region ``iram0_0_seg'` overflowed by 44 bytes, or similar.

In these cases, `idf.py size` will not succeed either. However it is possible to run `idf_size.py` manually in order to view the *partial static memory usage* (the memory usage will miss the variables which could not be linked, so there still appears to be some free space.)

The map file argument is `<projectname>.map` in the build directory

```
$IDF_PATH/tools/idf_size.py build/project_name.map
```

It is also possible to view the equivalent of `size-components` or `size-files` output:

```
$IDF_PATH/tools/idf_size.py --archives build/project_name.map
$IDF_PATH/tools/idf_size.py --files build/project_name.map
```

**Linker Map File** *This is an advanced analysis method, but it can be very useful. Feel free to skip ahead to [:ref:reducing-overall-size](#) and possibly come back to this later.*

The `idf.py size` analysis tools all work by parsing the GNU binutils “linker map file”, which is a summary of everything the linker did when it created (“linked”) the final firmware binary file

Linker map files themselves are plain text files, so it’s possible to read them and find out exactly what the linker did. However, they are also very complex and long - often 100,000 or more lines!

The map file itself is broken into parts and each part has a heading. The parts are:

- **Archive member included to satisfy reference by file (symbol)**. This shows you: for each object file included in the link, what symbol (function or variable) was the linker searching for when it included that object file. If you’re wondering why some object file in particular was included in the binary, this part may give a clue. This part can be used in conjunction with the Cross Reference Table at the end of the file. Note that not every object file shown in this list ends up included in the final binary, some end up in the Discarded input sections list instead.
- **Allocating common symbols** - This is a list of (some) global variables along with their sizes. Common symbols have a particular meaning in ELF binary files, but ESP-IDF doesn’t make much use of them.
- **Discarded input sections** - These sections were read by the linker as part of an object file to be linked into the final binary, but then nothing else referred to them so they were discarded from the final binary. For ESP-IDF this list can be very long, as we compile each function and static variable to a unique section in order to minimize the final binary size (specifically ESP-IDF uses compiler options `-ffunction-sections` `-fdata-sections` and linker option `--gc-sections`). Items mentioned in this list *do not* contribute to the final binary.
- **Memory Configuration, Linker script and memory map** These two parts go together. Some of the output comes directly from the linker command line and the Linker Script, both provided by the [Build System](#). The linker script is partially generated from the ESP-IDF project using the [Linker Script Generation](#) feature.  
As the output of the Linker script and memory map part of the map unfolds, you can see each symbol (function or static variable) linked into the final binary along with its address (as a 16 digit hex number), its length (also in hex), and the library and object file it was linked from (which can be used to determine the component and the source file).  
Following all of the output sections that take up space in the final `.bin` file, the memory map also includes some sections in the ELF file that are only used for debugging (ELF sections `.debug_*`, etc.). These don’t contribute to the final binary size. You’ll notice the address of these symbols is a very low number (starting from `0x0000000000000000` and counting up).
- **Cross Reference Table**. This table shows for each symbol (function or static variable), the list of object file(s) that referred to it. If you’re wondering why a particular thing is included in the binary, this will help determine what included it.



---

**Note:** Unfortunately, the Cross Reference Table doesn't only include symbols that made it into the final binary. It also includes symbols in discarded sections. Therefore, just because something is shown here doesn't mean that it was included in the final binary - this needs to be checked separately.

---

---

**Note:** Linker map files are generated by the GNU binutils linker "ld", not ESP-IDF. You can find additional information online about the linker map file format. This quick summary is written from the perspective of ESP-IDF build system in particular.

---

**Reducing Overall Size** The following configuration options will reduce the final binary size of almost any ESP-IDF project:

- Set `CONFIG_COMPILER_OPTIMIZATION` to "Optimize for size (-Os)". In some cases, "Optimize for performance (-O2)" will also reduce the binary size compared to the default. Note that if your code contains C or C++ Undefined Behaviour then increasing the compiler optimization level may expose bugs that otherwise don't happen.
- Reduce the compiled-in log output by lowering the app `CONFIG_LOG_DEFAULT_LEVEL`. If the `CONFIG_LOG_MAXIMUM_LEVEL` is changed from the default then this setting controls the binary size instead. Reducing compiled-in logging reduces the number of strings in the binary, and also the code size of the calls to logging functions.
- Set the `CONFIG_COMPILER_OPTIMIZATION_ASSERTION_LEVEL` to "Silent". This avoids compiling in a dedicated assertion string and source file name for each assert that may fail. It's still possible to find the failed assert in the code by looking at the memory address where the assertion failed.
- Besides the `CONFIG_COMPILER_OPTIMIZATION_ASSERTION_LEVEL`, you can disable or silent the assertion for HAL component separately by setting `CONFIG_HAL_DEFAULT_ASSERTION_LEVEL`. It is to notice that ESP-IDF lowers HAL assertion level in bootloader to be silent even if `CONFIG_HAL_DEFAULT_ASSERTION_LEVEL` is set to full-assertion level. This is to reduce the bootloader size.
- Set `CONFIG_COMPILER_OPTIMIZATION_CHECKS_SILENT`. This removes specific error messages for particular internal ESP-IDF error check macros. This may make it harder to debug some error conditions by reading the log output.
- Don't enable `CONFIG_COMPILER_CXX_EXCEPTIONS`, `CONFIG_COMPILER_CXX_RTTI`, or set the `CONFIG_COMPILER_STACK_CHECK_MODE` to Overall. All of these options are already disabled by default, but they have a large impact on binary size.
- Disabling `CONFIG_ESP_ERR_TO_NAME_LOOKUP` will remove the lookup table to translate user-friendly names for error values (see [Error Handling](#)) in error logs, etc. This saves some binary size, but error values will be printed as integers only.
- Setting `CONFIG_ESP_SYSTEM_PANIC` to "Silent reboot" will save a small amount of binary size, however this is *only* recommended if no one will use UART output to debug the device.
- If the application binary uses only one of the security versions of the protocomm component, then the support for others can be disabled to save some code size. The support can be disabled through `CONFIG_ESP_PROTOCOMM_SUPPORT_SECURITY_VERSION_0`, `CONFIG_ESP_PROTOCOMM_SUPPORT_SECURITY_VERSION_1` or `CONFIG_ESP_PROTOCOMM_SUPPORT_SECURITY_VERSION_2` respectively.

---

**Note:** In addition to the many configuration items shown here, there are a number of configuration options where changing the option from the default will increase binary size. These are not noted here. Where the increase is significant, this is usually noted in the configuration item help text.

---

**Targeted Optimizations** The following binary size optimizations apply to a particular component or a function:

## Wi-Fi



- Disabling `CONFIG_ESP32_WIFI_ENABLE_WPA3_SAE` will save some Wi-Fi binary size if WPA3 support is not needed. (Note that WPA3 is mandatory for new Wi-Fi device certifications.)
- Disabling `CONFIG_ESP_WIFI_SOFTAP_SUPPORT` will save some Wi-Fi binary size if soft-AP support is not needed.
- Disabling `CONFIG_ESP_WIFI_ENTERPRISE_SUPPORT` will save some Wi-Fi binary size if enterprise support is not needed.

### lwIP IPv6

- Setting `CONFIG_LWIP_IPV6` to false will reduce the size of the lwIP TCP/IP stack, at the cost of only supporting IPv4.

---

**Note:** IPv6 is required by some components such as `coap` and `ASIO port`, These components will not be available if IPV6 is disabled.

---

**Newlib nano formatting** By default, ESP-IDF uses newlib “full” formatting for I/O (`printf`, `scanf`, etc.)

Enabling the config option `CONFIG_NEWLIB_NANO_FORMAT` will switch newlib to the “nano” formatting mode. This both smaller in code size and a large part of the implementation is compiled into the ESP32-S2 ROM, so it doesn't need to be included in the binary at all.

The exact difference in binary size depends on which features the firmware uses, but 25 KB ~ 50 KB is typical.

Enabling Nano formatting also reduces the stack usage of each function that calls `printf()` or another string formatting function, see [Reducing Stack Sizes](#).

“Nano” formatting doesn't support 64-bit integers, or C99 formatting features. For a full list of restrictions, search for `--enable-newlib-nano-formatted-io` in the [Newlib README file](#).

**MBEDTLS features** Under *Component Config* -> *MBEDTLS* there are multiple mbedTLS features which are enabled by default but can be disabled if not needed to save code size.

These include:

- `CONFIG_MBEDTLS_HAVE_TIME`
- `CONFIG_MBEDTLS_ECDSA_DETERMINISTIC`
- `CONFIG_MBEDTLS_SHA512_C`
- `CONFIG_MBEDTLS_CLIENT_SSL_SESSION_TICKETS`
- `CONFIG_MBEDTLS_SERVER_SSL_SESSION_TICKETS`
- `CONFIG_MBEDTLS_SSL_CONTEXT_SERIALIZATION`
- `CONFIG_MBEDTLS_SSL_ALPN`
- `CONFIG_MBEDTLS_SSL_RENEGOTIATION`
- `CONFIG_MBEDTLS_CCM_C`
- `CONFIG_MBEDTLS_GCM_C`
- `CONFIG_MBEDTLS_ECP_C` (Alternatively: Leave this option enabled but disable some of the elliptic curves listed in the sub-menu.)
- `CONFIG_MBEDTLS_ECP_NIST_OPTIM`
- `CONFIG_MBEDTLS_ECP_FIXED_POINT_OPTIM`
- Change `CONFIG_MBEDTLS_TLS_MODE` if both server & client functionalities are not needed
- Consider disabling some ciphersuites listed in the “TLS Key Exchange Methods” sub-menu (i.e. `CONFIG_MBEDTLS_KEY_EXCHANGE_RSA`)

The help text for each option has some more information.

---

**Important:** It is **strongly not recommended to disable all these mbedTLS options**. Only disable options where you understand the functionality and are certain that it is not needed in the application. In particular:

- Ensure that any TLS server(s) the device connects to can still be used. If the server is controlled by a third party or a cloud service, recommend ensuring that the firmware supports at least two of the supported cipher suites in case one is disabled in a future update.
- Ensure that any TLS client(s) that connect to the device can still connect with supported/recommended cipher suites. Note that future versions of client operating systems may remove support for some features, so it is recommended to enable multiple supported cipher suites or algorithms for redundancy.

If depending on third party clients or servers, always pay attention to announcements about future changes to supported TLS features. If not, the ESP32-S2 device may become inaccessible if support changes.

---

**Note:** Not every combination of mbedTLS compile-time config is tested in ESP-IDF. If you find a combination that fails to compile or function as expected, please report the details on GitHub.

---

**VFS** *Virtual filesystem* feature in ESP-IDF allows multiple filesystem drivers and file-like peripheral drivers to be accessed using standard I/O functions (`open`, `read`, `write`, etc.) and C library functions (`fopen`, `fread`, `fwrite`, etc.). When filesystem or file-like peripheral driver functionality is not used in the application this feature can be fully or partially disabled. VFS component provides the following configuration options:

- `CONFIG_VFS_SUPPORT_TERMIOS` — can be disabled if the application doesn't use `termios` family of functions. Currently, these functions are implemented only for UART VFS driver. Most applications can disable this option. Disabling this option reduces the code size by about 1.8 kB.
- `CONFIG_VFS_SUPPORT_SELECT` — can be disabled if the application doesn't use `select` function with file descriptors. Currently, only the UART and eventfd VFS drivers implement `select` support. Note that when this option is disabled, `select` can still be used for socket file descriptors. Disabling this option reduces the code size by about 2.7 kB.
- `CONFIG_VFS_SUPPORT_DIR` — can be disabled if the application doesn't use directory related functions, such as `readdir` (see the description of this option for the complete list). Applications which only open, read and write specific files and don't need to enumerate or create directories can disable this option, reducing the code size by 0.5 kB or more, depending on the filesystem drivers in use.
- `CONFIG_VFS_SUPPORT_IO` — can be disabled if the application doesn't use filesystems or file-like peripheral drivers. This disables all VFS functionality, including the three options mentioned above. When this option is disabled, `console` can't be used. Note that the application can still use standard I/O functions with socket file descriptors when this option is disabled. Compared to the default configuration, disabling this option reduces code size by about 9.4 kB.

**Bootloader Size** This document deals with the size of an ESP-IDF app binary only, and not the ESP-IDF *Second stage bootloader*.

For a discussion of ESP-IDF bootloader binary size, see *Bootloader Size*.

**IRAM Binary Size** If the IRAM section of a binary is too large, this issue can be resolved by reducing IRAM memory usage. See *Optimizing IRAM Usage*.

### Minimizing RAM Usage

In some cases, a firmware application's available RAM may run low or run out entirely. In these cases, it's necessary to tune the memory usage of the firmware application.

In general, firmware should aim to leave some “headroom” of free internal RAM in order to deal with extraordinary situations or changes in RAM usage in future updates.

**Background** Before optimizing ESP-IDF RAM usage, it's necessary to understand the basics of ESP32-S2 memory types, the difference between static and dynamic memory usage in C, and the way ESP-IDF uses stack and heap. This information can all be found in *Heap Memory Allocation*.

**Measuring Static Memory Usage** The *idf.py* tool can be used to generate reports about the static memory usage of an application. Refer to *the Binary Size chapter for more information*.

**Measuring Dynamic Memory Usage** ESP-IDF contains a range of heap APIs for measuring free heap at runtime. See *Heap Memory Debugging*.

---

**Note:** In embedded systems, heap fragmentation can be a significant issue alongside total RAM usage. The heap measurement APIs provide ways to measure the “largest free block” . Monitoring this value along with the total number of free bytes can give a quick indication of whether heap fragmentation is becoming an issue.

---

### Reducing Static Memory Usage

- Reducing the static memory usage of the application increases the amount of RAM available for heap at runtime, and vice versa.
- Generally speaking, minimizing static memory usage requires monitoring the `.data` and `.bss` sizes. For tools to do this, see *Measuring Static Sizes*.
- Internal ESP-IDF functions do not make heavy use of static RAM allocation in C. In many instances (including: Wi-Fi library) “static” buffers are still allocated from heap, but the allocation is done once when the feature is initialized and will be freed if the feature is deinitialized. This is done in order to maximize the amount of free memory at different points in the application life-cycle.

To minimize static memory use:

- Declare structures, buffers, or other variables `const` whenever possible. Constant data can be stored in flash not RAM. This may require changing functions in the firmware to take `const *` arguments instead of mutable pointer arguments. These changes can also reduce the stack usage of some functions.
- If *Coredump* component is enabled, `ESP_COREDUMP_LOG` macros will use ~5KB internal memory to place strings into DRAM. By disabling `CONFIG_ESP_COREDUMP_LOGS` option, these logs are disabled and the memory is reclaimed.

**Reducing Stack Sizes** In FreeRTOS, task stacks are usually allocated from the heap. The stack size for each task is fixed (passed as an argument to `xTaskCreate()`). Each task can use up to its allocated stack size, but using more than this will cause an otherwise valid program to crash with a stack overflow or heap corruption.

Therefore, determining the optimum sizes of each task stack can substantially reduce RAM usage.

To determine optimum task stack sizes:

- Combine tasks. The best task stack size is 0 bytes, achieved by combining a task with another existing task. Anywhere that the firmware can be structured to perform multiple functions sequentially in a single task will increase free memory. In some cases, using a “worker task” pattern where jobs are serialized into a FreeRTOS queue (or similar) and then processed by generic worker tasks may help.
- Consolidate task functions. String formatting functions (like `printf`) are particularly heavy users of stack, so any task which doesn't ever call these can usually have its stack size reduced.
- Enabling *Newlib nano formatting* will reduce the stack usage of any task that calls `printf()` or other C string formatting functions.
- Avoid allocating large variables on the stack. In C, any large struct or array allocated as an “automatic” variable (i.e. default scope of a C declaration) will use space on the stack. Minimize the sizes of these, allocate them statically and/or see if you can save memory by allocating them from the heap only when they are needed.
- Avoid deep recursive function calls. Individual recursive function calls don't always add a lot of stack usage each time they are called, but if each function includes large stack-based variables then the overhead can get quite high.
- At runtime, call the function `uxTaskGetStackHighWaterMark()` with the handle of any task where you think there is unused stack memory. This function returns the minimum lifetime free stack memory in bytes. The easiest time to call this is from the task itself: call `uxTaskGetStackHighWaterMark(NULL)` to get the current task's high water mark after the time that the task has achieved its peak

stack usage (i.e. if there is a main loop, execute the main loop a number of times with all possible states and then call `uxTaskGetStackHighWaterMark()`). Often, it's possible to subtract almost the entire value returned here from the total stack size of a task, but allow some safety margin to account for unexpected small increases in stack usage at runtime.

- Call `uxTaskGetSystemState()` at runtime to get a summary of all tasks in the system. This includes their individual stack “high watermark” values.
- When debugger watchpoints are not being used, set the `CONFIG_FREERTOS_WATCHPOINT_END_OF_STACK` option to trigger an immediate panic if a task writes the word at the end of its assigned stack. This is slightly more reliable than the default `CONFIG_FREERTOS_CHECK_STACKOVERFLOW` option of “Check using canary bytes”, because the panic happens immediately, not on the next RTOS context switch. Neither option is perfect, it's possible in some cases for stack pointer to skip the watchpoint or canary bytes and corrupt another region of RAM, instead.

**Internal Stack Sizes** ESP-IDF allocates a number of internal tasks for housekeeping purposes or operating system functions. Some are created during the startup process, and some are created at runtime when particular features are initialized.

The default stack sizes for these tasks are usually set conservatively high, to allow all common usage patterns. Many of the stack sizes are configurable, and it may be possible to reduce them to match the real runtime stack usage of the task.

---

**Important:** If internal task stack sizes are set too small, ESP-IDF will crash unpredictably. Even if the root cause is task stack overflow, this is not always clear when debugging. It is recommended that internal stack sizes are only reduced carefully (if at all), with close attention to “high water mark” free space under load. If reporting an issue that occurs when internal task stack sizes have been reduced, please always include this information and the specific configuration that is being used.

---

- *Main task that executes `app_main` function* has stack size `CONFIG_ESP_MAIN_TASK_STACK_SIZE`.
- *High Resolution Timer (ESP Timer) system task* which executes callbacks has stack size `CONFIG_ESP_TIMER_TASK_STACK_SIZE`.
- *FreeRTOS Timer Task* to handle FreeRTOS timer callbacks has stack size `CONFIG_FREERTOS_TIMER_TASK_STACK_DEPTH`.
- *Event Handling system task* to execute callbacks for the default system event loop has stack size `CONFIG_ESP_SYSTEM_EVENT_TASK_STACK_SIZE`.
- *lwIP TCP/IP task* has stack size `CONFIG_LWIP_TCPIP_TASK_STACK_SIZE`
- The Ethernet driver creates a task for the MAC to receive Ethernet frames. If using the default config `ETH_MAC_DEFAULT_CONFIG` then the task stack size is 4 KB. This setting can be changed by passing a custom `eth_mac_config_t` struct when initializing the Ethernet MAC.
- FreeRTOS idle task stack size is configured by `CONFIG_FREERTOS_IDLE_TASK_STACKSIZE`.
- If using the `MQTT` component, it creates a task with stack size configured by `CONFIG_MQTT_TASK_STACK_SIZE`. MQTT stack size can also be configured using `task_stack` field of `esp_mqtt_client_config_t`.
- To see how to optimize RAM usage when using mDNS, please check [Performance Optimization](#).

---

**Note:** Aside from built-in system features such as esp-timer, if an ESP-IDF feature is not initialized by the firmware then no associated task is created. In those cases, the stack usage is zero and the stack size configuration for the task is not relevant.

---

**Reducing Heap Usage** For functions that assist in analyzing heap usage at runtime, see [Heap Memory Debugging](#).

Normally, optimizing heap usage consists of analyzing the usage and removing calls to `malloc()` that aren't being used, reducing the corresponding sizes, or freeing previously allocated buffers earlier.

There are some ESP-IDF configuration options that can reduce heap usage at runtime:

- lwIP documentation has a section to configure *Minimum RAM usage*.
- *Wi-Fi Buffer Usage* describes options to either reduce numbers of “static” buffers or reduce the maximum number of “dynamic” buffers in use, in order to minimize memory usage at possible cost of performance. Note that “static” Wi-Fi buffers are still allocated from heap when Wi-Fi is initialized and will be freed if Wi-Fi is deinitialized.
- Several Mbed TLS configuration options can be used to reduce heap memory usage. See the *Mbed TLS* docs for details.

---

**Note:** There are other configuration options that will increase heap usage at runtime if changed from the defaults. These are not listed here, but the help text for the configuration item will mention if there is some memory impact.

---

**Optimizing IRAM Usage** The available DRAM at runtime (for heap usage) is also reduced by the static IRAM usage. Therefore, one way to increase available DRAM is to reduce IRAM usage.

If the app allocates more static IRAM than is available then the app will fail to build and linker errors such as section ``.iram0.text'` will not fit in region ``.iram0_0_seg'`, IRAM0 segment data does not fit and region ``.iram0_0_seg'` overflowed by 84 bytes will be seen. If this happens, it is necessary to find ways to reduce static IRAM usage in order to link the application.

To analyze the IRAM usage in the firmware binary, use *Measuring Static Sizes*. If the firmware failed to link, steps to analyze are shown at *Showing Size When Linker Fails*.

The following options will reduce IRAM usage of some ESP-IDF features:

- Enable `CONFIG_FREERTOS_PLACE_FUNCTIONS_INTO_FLASH`. Provided these functions are not (incorrectly) used from ISRs, this option is safe to enable in all configurations.
- Enable `CONFIG_FREERTOS_PLACE_SNAPSHOT_FUNS_INTO_FLASH`. Enabling this option will place snapshot-related functions, such as `vTaskGetSnapshot` or `uxTaskGetSnapshotAll`, in flash.
- Enable `CONFIG_RINGBUF_PLACE_FUNCTIONS_INTO_FLASH`. Provided these functions are not (incorrectly) used from ISRs, this option is safe to enable in all configurations.
- Enable `CONFIG_RINGBUF_PLACE_ISR_FUNCTIONS_INTO_FLASH`. This option is not safe to use if the ISR ringbuf functions are used from an IRAM interrupt context, e.g. if `CONFIG_UART_ISR_IN_IRAM` is enabled. For the IDF drivers where this is the case you will get an error at run-time when installing the driver in question.
- Disable Wi-Fi options `CONFIG_ESP32_WIFI_IRAM_OPT` and/or `CONFIG_ESP32_WIFI_RX_IRAM_OPT`. Disabling these options will free available IRAM at the cost of Wi-Fi performance.
- Disabling `CONFIG_ESP_EVENT_POST_FROM_IRAM_ISR` prevents posting `esp_event` events from *IRAM-Safe Interrupt Handlers* but will save some IRAM.
- Disabling `CONFIG_SPI_MASTER_ISR_IN_IRAM` prevents `spi_master` interrupts from being serviced while writing to flash, and may otherwise reduce `spi_master` performance, but will save some IRAM.
- Setting `CONFIG_HAL_DEFAULT_ASSERTION_LEVEL` to disable assertion for HAL component will save some IRAM especially for HAL code who calls `HAL_ASSERT` a lot and resides in IRAM.

---

**Note:** Moving frequently-called functions from IRAM to flash may increase their execution time.

---

---

**Note:** Other configuration options exist that will increase IRAM usage by moving some functionality into IRAM, usually for performance, but the default option is not to do this. These are not listed here. The IRAM size impact of enabling these options is usually noted in the configuration item help text.

---

## 4.24 RF calibration

ESP32-S2 supports three RF calibration methods during RF initialization:

1. Partial calibration
2. Full calibration
3. No calibration

### 4.24.1 Partial calibration

During RF initialization, the partial calibration method is used by default for RF calibration. It is done based on the full calibration data which is stored in the NVS. To use this method, please go to `menuconfig` and enable `CONFIG_ESP_PHY_CALIBRATION_AND_DATA_STORAGE`.

### 4.24.2 Full calibration

Full calibration is triggered in the following conditions:

1. NVS does not exist.
2. The NVS partition to store calibration data is erased.
3. Hardware MAC address is changed.
4. PHY library version is changed.
5. The RF calibration data loaded from the NVS partition is broken.

It takes about 100ms more than partial calibration. If boot duration is not critical, it is suggested to use the full calibration method. To switch to the full calibration method, go to `menuconfig` and disable `CONFIG_ESP_PHY_CALIBRATION_AND_DATA_STORAGE`. If you use the default method of RF calibration, there are two ways to add the function of triggering full calibration as a last-resort remedy.

1. Erase the NVS partition if you don't mind all of the data stored in the NVS partition is erased. That is indeed the easiest way.
2. Call API `esp_phy_erase_cal_data_in_nvs()` before initializing WiFi and BT/BLE based on some conditions (e.g. an option provided in some diagnostic mode). In this case, only phy namespace of the NVS partition is erased.

### 4.24.3 No calibration

No calibration method is only used when the device wakes up from deep sleep.

### 4.24.4 PHY initialization data

The PHY initialization data is used for RF calibration. There are two ways to get the PHY initialization data.

One is the default initialization data which is located in the header file `components/esp_phy/esp32s2/include/phy_init_data.h`.

It is embedded into the application binary after compiling and then stored into read-only memory (DROM). To use the default initialization data, please go to `menuconfig` and disable `CONFIG_ESP_PHY_INIT_DATA_IN_PARTITION`.

Another is the initialization data which is stored in a partition. When using a custom partition table, make sure that PHY data partition is included (type: `data`, subtype: `phy`). With default partition table, this is done automatically. If initialization data is stored in a partition, it has to be flashed there, otherwise runtime error will occur. To switch to the initialization data stored in a partition, go to `menuconfig` and enable `CONFIG_ESP_PHY_INIT_DATA_IN_PARTITION`.



## 4.24.5 API Reference

### Header File

- `components/esp_phy/include/esp_phy_init.h`

### Functions

`const esp_phy_init_data_t *esp_phy_get_init_data (void)`

Get PHY init data.

If “Use a partition to store PHY init data” option is set in menuconfig, This function will load PHY init data from a partition. Otherwise, PHY init data will be compiled into the application itself, and this function will return a pointer to PHY init data located in read-only memory (DROM).

If “Use a partition to store PHY init data” option is enabled, this function may return NULL if the data loaded from flash is not valid.

---

**Note:** Call `esp_phy_release_init_data` to release the pointer obtained using this function after the call to `esp_wifi_init`.

---

**Returns** pointer to PHY init data structure

`void esp_phy_release_init_data (const esp_phy_init_data_t *data)`

Release PHY init data.

**Parameters** `data` –pointer to PHY init data structure obtained from `esp_phy_get_init_data` function

`esp_err_t esp_phy_load_cal_data_from_nvs (esp_phy_calibration_data_t *out_cal_data)`

Function called by `esp_phy_load_cal_and_init` to load PHY calibration data.

This is a convenience function which can be used to load PHY calibration data from NVS. Data can be stored to NVS using `esp_phy_store_cal_data_to_nvs` function.

If calibration data is not present in the NVS, or data is not valid (was obtained for a chip with a different MAC address, or obtained for a different version of software), this function will return an error.

**Parameters** `out_cal_data` –pointer to calibration data structure to be filled with loaded data.

**Returns** ESP\_OK on success

`esp_err_t esp_phy_store_cal_data_to_nvs (const esp_phy_calibration_data_t *cal_data)`

Function called by `esp_phy_load_cal_and_init` to store PHY calibration data.

This is a convenience function which can be used to store PHY calibration data to the NVS. Calibration data is returned by `esp_phy_load_cal_and_init` function. Data saved using this function to the NVS can later be loaded using `esp_phy_store_cal_data_to_nvs` function.

**Parameters** `cal_data` –pointer to calibration data which has to be saved.

**Returns** ESP\_OK on success

`esp_err_t esp_phy_erase_cal_data_in_nvs (void)`

Erase PHY calibration data which is stored in the NVS.

This is a function which can be used to trigger full calibration as a last-resort remedy if partial calibration is used. It can be called in the application based on some conditions (e.g. an option provided in some diagnostic mode).

**Returns** ESP\_OK on success

**Returns** others on fail. Please refer to NVS API return value error number.

bool **esp\_phy\_is\_initialized** (void)

Get phy initialize status.

**Returns** return true if phy is already initialized.

void **esp\_phy\_enable** (void)

Enable PHY and RF module.

PHY and RF module should be enabled in order to use WiFi or BT. Now PHY and RF enabling job is done automatically when start WiFi or BT. Users should not call this API in their application.

void **esp\_phy\_disable** (void)

Disable PHY and RF module.

PHY module should be disabled in order to shutdown WiFi or BT. Now PHY and RF disabling job is done automatically when stop WiFi or BT. Users should not call this API in their application.

void **esp\_phy\_load\_cal\_and\_init** (void)

Load calibration data from NVS and initialize PHY and RF module.

void **esp\_phy\_modem\_init** (void)

Initialize backup memory for Phy power up/down.

void **esp\_phy\_modem\_deinit** (void)

Deinitialize backup memory for Phy power up/down Set phy\_init\_flag if all modems deinit on ESP32C3.

void **esp\_phy\_common\_clock\_enable** (void)

Enable WiFi/BT common clock.

void **esp\_phy\_common\_clock\_disable** (void)

Disable WiFi/BT common clock.

int64\_t **esp\_phy\_rf\_get\_on\_ts** (void)

Get the time stamp when PHY/RF was switched on.

**Returns** return 0 if PHY/RF is never switched on. Otherwise return time in microsecond since boot when phy/rf was last switched on

*esp\_err\_t* **esp\_phy\_update\_country\_info** (const char \*country)

Update the corresponding PHY init type according to the country code of Wi-Fi.

**Parameters** **country** –country code

**Returns** ESP\_OK on success.

**Returns** esp\_err\_t code describing the error on fail

char \***get\_phy\_version\_str** (void)

Get PHY lib version.

**Returns** PHY lib version.

void **phy\_init\_param\_set** (uint8\_t param)

Set PHY init parameters.

**Parameters** **param** –is 1 means combo module

void **phy\_wifi\_enable\_set** (uint8\_t enable)

Wi-Fi RX enable.

**Parameters** **enable** –Whether to enable phy for wifi

## Structures

struct **esp\_phy\_init\_data\_t**

Structure holding PHY init parameters.



### Public Members

uint8\_t **params**[128]  
opaque PHY initialization parameters

struct **esp\_phy\_calibration\_data\_t**  
Opaque PHY calibration data.

### Public Members

uint8\_t **version**[4]  
PHY version

uint8\_t **mac**[6]  
The MAC address of the station

uint8\_t **opaque**[1894]  
calibration data

### Enumerations

enum **esp\_phy\_calibration\_mode\_t**  
PHY calibration mode.

*Values:*

enumerator **PHY\_RF\_CAL\_PARTIAL**  
Do part of RF calibration. This should be used after power-on reset.

enumerator **PHY\_RF\_CAL\_NONE**  
Don't do any RF calibration. This mode is only suggested to be used after deep sleep reset.

enumerator **PHY\_RF\_CAL\_FULL**  
Do full RF calibration. Produces best results, but also consumes a lot of time and current. Suggested to be used once.

## 4.25 Secure Boot V2

---

**Important:** This document is about Secure Boot V2, supported on the following chips: ESP32 (ECO3 onwards), ESP32-S2, ESP32-S3, ESP32-C3 (ECO3 onwards), and ESP32-C2. Except for ESP32, it is the only supported Secure Boot scheme.

Secure Boot V2 uses RSA-PSS based app and bootloader verification. This document can also be used as a reference for signing apps using the RSA-PSS scheme without signing the bootloader.

---

### 4.25.1 Background

Secure Boot protects a device from running any unauthorized (i.e., unsigned) code by checking that each piece of software that is being booted is signed. On an ESP32-S2, these pieces of software include the second stage bootloader and each application binary. Note that the first stage bootloader does not require signing as it is ROM code thus cannot be changed.

A new RSA based Secure Boot verification scheme (Secure Boot V2) has been introduced on the ESP32 (ECO3 onwards), ESP32-S2, ESP32-S3 and ESP32-C3 (ECO3 onwards).

The Secure Boot process on the ESP32-S2 involves the following steps:

1. When the first stage bootloader loads the second stage bootloader, the second stage bootloader's RSA-PSS signature is verified. If the verification is successful, the second stage bootloader is executed.
2. When the second stage bootloader loads a particular application image, the application's RSA-PSS signature is verified. If the verification is successful, the application image is executed.

### 4.25.2 Advantages

- The RSA-PSS public key is stored on the device. The corresponding RSA-PSS private key is kept at a secret place and is never accessed by the device.
- Up to three public keys can be generated and stored in the chip during manufacturing.
- ESP32-S2 provides the facility to permanently revoke individual public keys. This can be configured conservatively or aggressively.
- Conservatively - The old key is revoked after the bootloader and application have successfully migrated to a new key. Aggressively - The key is revoked as soon as verification with this key fails.
- Same image format and signature verification method is applied for applications and software bootloader.
- No secrets are stored on the device. Therefore, it is immune to passive side-channel attacks (timing or power analysis, etc.)

### 4.25.3 Secure Boot V2 Process

This is an overview of the Secure Boot V2 Process. Instructions how to enable Secure Boot are supplied in section [How To Enable Secure Boot V2](#).

Secure Boot V2 verifies the bootloader image and application binary images using a dedicated *signature block*. Each image has a separately generated signature block which is appended to the end of the image.

Up to 3 signature blocks can be appended to the bootloader or application image in ESP32-S2.

Each signature block contains a signature of the preceding image as well as the corresponding RSA-3072 public key. For more details about the format, refer to [Signature Block Format](#). A digest of the RSA-3072 public key is stored in the eFuse.

The application image is not only verified on every boot but also on each over the air (OTA) update. If the currently selected OTA app image cannot be verified, the bootloader will fall back and look for another correctly signed application image.

The Secure Boot V2 process follows these steps:

1. On startup, the ROM code checks the Secure Boot V2 bit in the eFuse. If Secure Boot is disabled, a normal boot will be executed. If Secure Boot is enabled, the boot will proceed according to the following steps.
2. The ROM code verifies the bootloader's signature block ([Verifying a Signature Block](#)). If this fails, the boot process will be aborted.
3. The ROM code verifies the bootloader image using the raw image data, its corresponding signature block(s), and the eFuse ([Verifying an Image](#)). If this fails, the boot process will be aborted.
4. The ROM code executes the bootloader.
5. The bootloader verifies the application image's signature block ([Verifying a Signature Block](#)). If this fails, the boot process will be aborted.

6. The bootloader verifies the application image using the raw image data, its corresponding signature blocks and the eFuse (*Verifying an Image*). If this fails, the boot process will be aborted. If the verification fails but another application image is found, the bootloader will then try to verify that other image using steps 5 to 7. This repeats until a valid image is found or no other images are found.
7. The bootloader executes the verified application image.

#### 4.25.4 Signature Block Format

The signature block starts on a 4KB aligned boundary and has a flash sector of its own. The signature is calculated over all bytes in the image including the padding bytes (*Secure Padding*).

The content of each signature block is shown in the following table:

Table 8: Content of a Signature Block

Offset	Size (bytes)	Description
0	1	Magic byte
1	1	Version number byte (currently 0x02), 0x01 is for Secure Boot V1.
2	2	Padding bytes, Reserved. Should be zero.
4	32	SHA-256 hash of only the image content, not including the signature block.
36	384	RSA Public Modulus used for signature verification. (value 'n' in RFC8017).
420	4	RSA Public Exponent used for signature verification (value 'e' in RFC8017).
424	384	Pre-calculated R, derived from 'n'.
808	4	Pre-calculated M', derived from 'n'
812	384	RSA-PSS Signature result (section 8.1.1 of RFC8017) of image content, computed using following PSS parameters: SHA256 hash, MFG1 function, salt length 32 bytes, default trailer field (0xBC).
1196	4	CRC32 of the preceding 1196 bytes.
1200	16	Zero padding to length 1216 bytes.

---

**Note:** R and M' are used for hardware-assisted Montgomery Multiplication.

---

The remainder of the signature sector is erased flash (0xFF) which allows writing other signature blocks after previous signature block.

#### 4.25.5 Secure Padding

In Secure Boot V2 scheme, the application image is padded to the flash MMU page size boundary to ensure that only verified contents are mapped in the internal address space. This is known as secure padding. Signature of the image is calculated after padding and then signature block (4KB) gets appended to the image.

- Default flash MMU page size is 64KB
- Secure padding is applied through the option `--secure-pad-v2` in the `elf2image` conversion using `esptool.py`

Following table explains the Secure Boot V2 signed image with secure padding and signature block appended:

Table 9: Contents of a signed application

Offset	Size (KB)	Description
0	580	Unsigned application size (as an example)
580	60	Secure padding (aligned to next 64KB boundary)
640	4	Signature block

**Note:** Please note that the application image always starts on the next flash MMU page size boundary (default 64KB) and hence the space left over after the signature block shown above can be utilized to store any other data partitions (e.g., `nvs`).

#### 4.25.6 Verifying a Signature Block

A signature block is “valid” if the first byte is 0xe7 and a valid CRC32 is stored at offset 1196. Otherwise it’s invalid.

#### 4.25.7 Verifying an Image

An image is “verified” if the public key stored in any signature block is valid for this device, and if the stored signature is valid for the image data read from flash.

1. Compare the SHA-256 hash digest of the public key embedded in the bootloader’s signature block with the digest(s) saved in the eFuses. If public key’s hash doesn’t match any of the hashes from the eFuses, the verification fails.
2. Generate the application image digest and match it with the image digest in the signature block. If the digests don’t match, the verification fails.
3. Use the public key to verify the signature of the bootloader image, using RSA-PSS (section 8.1.2 of RFC8017) with the image digest calculated in step (2) for comparison.

#### 4.25.8 Bootloader Size

Enabling Secure boot and/or flash encryption will increase the size of bootloader, which might require updating partition table offset. See [Bootloader Size](#).

In the case when `CONFIG_SECURE_BOOT_BUILD_SIGNED_BINARIES` is disabled, the bootloader is sector padded (4KB) using the `--pad-to-size` option in `elf2image` command of `esptool`.

#### 4.25.9 eFuse usage

- `SECURE_BOOT_EN` - Enables Secure Boot protection on boot.
- `KEY_PURPOSE_X` - Set the purpose of the key block on ESP32-S2 by programming `SECURE_BOOT_DIGESTX` ( $X = 0, 1, 2$ ) into `KEY_PURPOSE_X` ( $X = 0, 1, 2, 3, 4, 5$ ). Example: If `KEY_PURPOSE_2` is set to `SECURE_BOOT_DIGEST1`, then `BLOCK_KEY2` will have the Secure Boot V2 public key digest. The write-protection bit must be set (this field does not have a read-protection bit).
- `BLOCK_KEYX` - The block contains the data corresponding to its purpose programmed in `KEY_PURPOSE_X`. Stores the SHA-256 digest of the public key. SHA-256 hash of public key modulus, exponent, pre-calculated R & M’ values (represented as 776 bytes –offsets 36 to 812 - as per the [Signature Block Format](#)) is written to an eFuse key block. The write-protection bit must be set, but the read-protection bit must not.
- `KEY_REVOKEX` - The revocation bits corresponding to each of the 3 key block. Ex. Setting `KEY_REVOKE2` revokes the key block whose key purpose is `SECURE_BOOT_DIGEST2`.

- `SECURE_BOOT_AGGRESSIVE_REVOKE` - Enables aggressive revocation of keys. The key is revoked as soon as verification with this key fails.

To ensure no trusted keys can be added later by an attacker, each unused key digest slot should be revoked (`KEY_REVOKEY`). It will be checked during app startup in `esp_secure_boot_init_checks()` and fixed unless `CONFIG_SECURE_BOOT_ALLOW_UNUSED_DIGEST_SLOTS` is enabled.

The key(s) must be readable in order to give software access to it. If the key(s) is read-protected then the software reads the key(s) as all zeros and the signature verification process will fail, and the boot process will be aborted.

#### 4.25.10 How To Enable Secure Boot V2

1. Open the *Project Configuration Menu*, in “Security features” set “Enable hardware Secure Boot in bootloader” to enable Secure Boot.
2. The “Secure Boot V2” option will be selected and the “App Signing Scheme” would be set to RSA by default.
3. Specify the path to Secure Boot signing key, relative to the project directory.
4. Select the desired UART ROM download mode in “UART ROM download mode”. By default, it is set to “Permanently switch to Secure mode” which is generally recommended. For production devices, the most secure option is to set it to “Permanently disabled”.
5. Set other menuconfig options (as desired). Then exit menuconfig and save your configuration.
6. The first time you run `idf.py build`, if the signing key is not found then an error message will be printed with a command to generate a signing key via `espsecure.py generate_signing_key`.

---

**Important:** A signing key generated this way will use the best random number source available to the OS and its Python installation (`/dev/urandom` on OSX/Linux and `CryptGenRandom()` on Windows). If this random number source is weak, then the private key will be weak.

---

---

**Important:** For production environments, we recommend generating the key pair using openssl or another industry standard encryption program. See *Generating Secure Boot Signing Key* for more details.

---

7. Run `idf.py bootloader` to build a Secure Boot enabled bootloader. The build output will include a prompt for a flashing command, using `esptool.py write_flash`.
8. When you’re ready to flash the bootloader, run the specified command (you have to enter it yourself, this step is not performed by the build system) and then wait for flashing to complete.
9. Run `idf.py flash` to build and flash the partition table and the just-built app image. The app image will be signed using the signing key you generated in step 6.

---

**Note:** `idf.py flash` doesn’t flash the bootloader if Secure Boot is enabled.

---

10. Reset the ESP32-S2 and it will boot the software bootloader you flashed. The software bootloader will enable Secure Boot on the chip, and then it verifies the app image signature and boots the app. You should watch the serial console output from the ESP32-S2 to verify that Secure Boot is enabled and no errors have occurred due to the build configuration.

---

**Note:** Secure boot won’t be enabled until after a valid partition table and app image have been flashed. This is to prevent accidents before the system is fully configured.

---

---

**Note:** If the ESP32-S2 is reset or powered down during the first boot, it will start the process again on the next boot.

---

11. On subsequent boots, the Secure Boot hardware will verify the software bootloader has not changed and the software bootloader will verify the signed app image (using the validated public key portion of its appended signature block).

### 4.25.11 Restrictions after Secure Boot is enabled

- Any updated bootloader or app will need to be signed with a key matching the digest already stored in eFuse.
- After Secure Boot is enabled, no further eFuses can be read protected. (If *Flash Encryption* is enabled then the bootloader will ensure that any flash encryption key generated on first boot will already be read protected.) If `CONFIG_SECURE_BOOT_INSECURE` is enabled then this behavior can be disabled, but this is not recommended.

### 4.25.12 Generating Secure Boot Signing Key

The build system will prompt you with a command to generate a new signing key via `espsecure.py generate_signing_key`.

The `--version 2` parameter will generate the RSA 3072 private key for Secure Boot V2.

The strength of the signing key is proportional to (a) the random number source of the system, and (b) the correctness of the algorithm used. For production devices, we recommend generating signing keys from a system with a quality entropy source, and using the best available RSA-PSS key generation utilities.

For example, to generate a signing key using the `openssl` command line:

```
` openssl genrsa -out my_secure_boot_signing_key.pem 3072 `
```

Remember that the strength of the Secure Boot system depends on keeping the signing key private.

### 4.25.13 Remote Signing of Images

#### Signing using `espsecure.py`

For production builds, it can be good practice to use a remote signing server rather than have the signing key on the build machine (which is the default `esp-idf` Secure Boot configuration). The `espsecure.py` command line program can be used to sign app images & partition table data for Secure Boot, on a remote system.

To use remote signing, disable the option `CONFIG_SECURE_BOOT_BUILD_SIGNED_BINARIES` and build the firmware. The private signing key does not need to be present on the build system.

After the app image and partition table are built, the build system will print signing steps using `espsecure.py`:

```
espsecure.py sign_data BINARY_FILE --version 2 --keyfile PRIVATE_SIGNING_KEY
```

The above command appends the image signature to the existing binary. You can use the `-output` argument to write the signed binary to a separate file:

```
espsecure.py sign_data --version 2 --keyfile PRIVATE_SIGNING_KEY --output SIGNED_
↪BINARY_FILE BINARY_FILE
```

#### Signing using Pre-calculated Signatures

If you have valid pre-calculated signatures generated for an image and their corresponding public keys, you can use these signatures to generate a signature sector and append it to the image. Note that the pre-calculated signature should be calculated over all bytes in the image including the secure-padding bytes.

In such cases, the firmware image should be built by disabling the option `CONFIG_SECURE_BOOT_BUILD_SIGNED_BINARIES`. This image will be secure-padded and to generate a signed binary use the following command:

```
espsecure.py sign_data --version 2 --pub-key PUBLIC_SIGNING_KEY --signature_  
↪SIGNATURE_FILE --output SIGNED_BINARY_FILE BINARY_FILE
```

The above command verifies the signature, generates a signature block (refer to [Signature Block Format](#)) and appends it to the binary file.

### Signing using an External Hardware Security Module (HSM)

For security reasons, you might also use an external Hardware Security Module (HSM) to store your private signing key, which cannot be accessed directly but has an interface to generate the signature of a binary file and its corresponding public key.

In such cases, disable the option `CONFIG_SECURE_BOOT_BUILD_SIGNED_BINARIES` and build the firmware. This secure-padded image then can be used to supply the external HSM for generating a signature. Refer to [Signing using an External HSM](#) to generate a signed image.

---

**Note:** For all the above three remote signing workflows, the signed binary is written to the filename provided to the `--output` argument and the option `--append_signatures` allows us to append multiple signatures (up to 3) the image.

---

## 4.25.14 Secure Boot Best Practices

- Generate the signing key on a system with a quality source of entropy.
- Keep the signing key private at all times. A leak of this key will compromise the Secure Boot system.
- Do not allow any third party to observe any aspects of the key generation or signing process using `espsecure.py`. Both processes are vulnerable to timing or other side-channel attacks.
- Enable all Secure Boot options in the Secure Boot Configuration. These include flash encryption, disabling of JTAG, disabling BASIC ROM interpreter, and disabling the UART bootloader encrypted flash access.
- Use Secure Boot in combination with [flash encryption](#) to prevent local readout of the flash contents.

## 4.25.15 Key Management

- Between 1 and 3 RSA-3072 public key pairs (Keys #0, #1, #2) should be computed independently and stored separately.
- The KEY\_DIGEST eFuses should be write protected after being programmed.
- The unused KEY\_DIGEST slots must have their corresponding KEY\_REVOKE eFuse burned to permanently disable them. This must happen before the device leaves the factory.
- The eFuses can either be written by the software bootloader during during first boot after enabling “Secure Boot V2” from menuconfig or can be done using `espefuse.py` which communicates with the serial bootloader program in ROM.
- The KEY\_DIGESTs should be numbered sequentially beginning at key digest #0. (i.e., if key digest #1 is used, key digest #0 should be used. If key digest #2 is used, key digest #0 & #1 must be used.)
- The software bootloader (non OTA upgradeable) is signed using at least one, possibly all three, private keys and flashed in the factory.
- Apps should only be signed with a single private key (the others being stored securely elsewhere), however they may be signed with multiple private keys if some are being revoked (see Key Revocation, below).

## 4.25.16 Multiple Keys

- The bootloader should be signed with all the private key(s) that are needed for the life of the device, before it is flashed.
- The build system can sign with at most one private key, user has to run manual commands to append more signatures if necessary.



- **You can use the append functionality of `espsecure.py`, this command would also printed at the end of the Secure B**  
`espsecure.py sign_data -k secure_boot_signing_key2.pem -v 2 --append_signatures -o signed_bootloader.bin build/bootloader/bootloader.bin`
- While signing with multiple private keys, it is recommended that the private keys be signed independently, if possible on different servers and stored separately.
- **You can check the signatures attached to a binary using -** `espsecure.py signature_info_v2 datafile.bin`

### 4.25.17 Key Revocation

- Keys are processed in a linear order. (key #0, key #1, key #2).
- Applications should be signed with only one key at a time, to minimize the exposure of unused private keys.
- The bootloader can be signed with multiple keys from the factory.

#### Conservative approach:

Assuming a trusted private key (N-1) has been compromised, to update to new key pair (N).

1. Server sends an OTA update with an application signed with the new private key (#N).
  2. The new OTA update is written to an unused OTA app partition.
  3. The new application's signature block is validated. The public keys are checked against the digests programmed in the eFuse & the application is verified using the verified public key.
  4. The active partition is set to the new OTA application's partition.
  5. Device resets, loads the bootloader (verified with key #N-1 and #N) which then boots new app (verified with key #N).
  6. The new app verifies bootloader and application with key #N (as a final check) and then runs code to revoke key #N-1 (sets KEY\_REVOKE eFuse bit).
  7. The API `esp_ota_revoke_secure_boot_public_key()` can be used to revoke the key #N-1.
- A similar approach can also be used to physically re-flash with a new key. For physical re-flashing, the bootloader content can also be changed at the same time.

#### Aggressive approach:

ROM code has an additional feature of revoking a public key digest if the signature verification fails.

To enable this feature, you need to burn `SECURE_BOOT_AGGRESSIVE_REVOKE` efuse or enable `CONFIG_SECURE_BOOT_ENABLE_AGGRESSIVE_KEY_REVOKE`

Key revocation is not applicable unless secure boot is successfully enabled. Also, a key is not revoked in case of invalid signature block or invalid image digest, it is only revoked in case the signature verification fails, i.e. revoke key only if failure in step 3 of *Verifying an Image*

Once a key is revoked, it can never be used for verifying a signature of an image. This feature provides strong resistance against physical attacks on the device. However, this could also brick the device permanently if all the keys are revoked because of signature verification failure.

### 4.25.18 Technical Details

The following sections contain low-level reference descriptions of various Secure Boot elements:

#### Manual Commands

Secure boot is integrated into the `esp-idf` build system, so `idf.py build` will sign an app image and `idf.py bootloader` will produce a signed bootloader if secure signed binaries on build is enabled.

However, it is possible to use the `espsecure.py` tool to make standalone signatures and digests.

To sign a binary image:



```
espsecure.py sign_data --version 2 --keyfile ./my_signing_key.pem --output ./image_  
→signed.bin image-unsigned.bin
```

Keyfile is the PEM file containing an RSA-3072 private signing key.

### 4.25.19 Secure Boot & Flash Encryption

If Secure Boot is used without *Flash Encryption*, it is possible to launch “time-of-check to time-of-use” attack, where flash contents are swapped after the image is verified and running. Therefore, it is recommended to use both the features together.

### 4.25.20 Signed App Verification Without Hardware Secure Boot

The Secure Boot V2 signature of apps can be checked on OTA update, without enabling the hardware Secure Boot option. This option uses the same app signature scheme as Secure Boot V2, but unlike hardware Secure Boot it does not prevent an attacker who can write to flash from bypassing the signature protection.

This may be desirable in cases where the delay of Secure Boot verification on startup is unacceptable, and/or where the threat model does not include physical access or attackers writing to bootloader or app partitions in flash.

In this mode, the public key which is present in the signature block of the currently running app will be used to verify the signature of a newly updated app. (The signature on the running app isn't verified during the update process, it's assumed to be valid.) In this way the system creates a chain of trust from the running app to the newly updated app.

For this reason, it's essential that the initial app flashed to the device is also signed. A check is run on app startup and the app will abort if no signatures are found. This is to try and prevent a situation where no update is possible. The app should have only one valid signature block in the first position. Note again that, unlike hardware Secure Boot V2, the signature of the running app isn't verified on boot. The system only verifies a signature block in the first position and ignores any other appended signatures.

Although multiple trusted keys are supported when using hardware Secure Boot, only the first public key in the signature block is used to verify updates if signature checking without Secure Boot is configured. If multiple trusted public keys are required, it's necessary to enable the full Secure Boot feature instead.

---

**Note:** In general, it's recommended to use full hardware Secure Boot unless certain that this option is sufficient for application security needs.

---

#### How To Enable Signed App Verification

1. Open *Project Configuration Menu* -> Security features
2. Ensure *App Signing Scheme* is *RSA*
3. Enable *CONFIG\_SECURE\_SIGNED\_APPS\_NO\_SECURE\_BOOT*
4. By default, “Sign binaries during build” will be enabled on selecting “Require signed app images” option, which will sign binary files as a part of build process. The file named in “Secure boot private signing key” will be used to sign the image.
5. If you disable “Sign binaries during build” option then all app binaries must be manually signed by following instructions in *Remote Signing of Images*.

**Warning:** It is very important that all apps flashed have been signed, either during the build or after the build.

## 4.25.21 Advanced Features

### JTAG Debugging

By default, when Secure Boot is enabled then JTAG debugging is disabled via eFuse. The bootloader does this on first boot, at the same time it enables Secure Boot.

See [JTAG with Flash Encryption or Secure Boot](#) for more information about using JTAG Debugging with either Secure Boot or signed app verification enabled.

## 4.26 Support for External RAM

### 4.26.1 Introduction

ESP32-S2 has a few hundred kilobytes of internal RAM, residing on the same die as the rest of the chip components. It can be insufficient for some purposes, ESP32-S2 has the ability to use up to 10.5 MB of virtual addresses for external SPI RAM memory. The external memory is incorporated in the memory map and, with certain restrictions, is usable in the same way as internal data RAM.

### 4.26.2 Hardware

ESP32-S2 supports SPI PSRAM (Pseudostatic RAM) connected in parallel with the SPI flash chip. While ESP32-S2 is capable of supporting several types of RAM chips, ESP-IDF currently only supports Espressif branded PSRAM chips (e.g., ESP-PSRAM32, ESP-PSRAM64, etc).

---

**Note:** Some PSRAM chips are 1.8 V devices and some are 3.3 V. The working voltage of the PSRAM chip must match the working voltage of the flash component. Consult the datasheet for your PSRAM chip and ESP32-S2 device to find out the working voltages. For a 1.8 V PSRAM chip, make sure to either set the MTDI pin to a high signal level on bootup, or program ESP32-S2 eFuses to always use the VDD\_SIO level of 1.8 V. Not doing this can damage the PSRAM and/or flash chip.

---

---

**Note:** Espressif produces both modules and system-in-package chips that integrate compatible PSRAM and flash and are ready to mount on a product PCB. Consult the Espressif website for more information. If you're using a custom PSRAM chip, ESP-IDF SDK might not be compatible with it.

---

For specific details about connecting the SoC or module pins to an external PSRAM chip, consult the SoC or module datasheet.

### 4.26.3 Configuring External RAM

ESP-IDF fully supports the use of external RAM in applications. Once the external RAM is initialized at startup, ESP-IDF can be configured to integrate the external RAM in several ways:

- [Integrate RAM into the ESP32-S2 Memory Map](#)
- [Add External RAM to the Capability Allocator](#)
- [Provide External RAM via malloc\(\)](#) (default)
- [Allow .bss Segment to be Placed in External Memory](#)

### Integrate RAM into the ESP32-S2 Memory Map

Select this option by choosing “Integrate RAM into memory map” from [CONFIG\\_SPIRAM\\_USE](#).

This is the most basic option for external SPI RAM integration. Most likely, you will need another, more advanced option.

During the ESP-IDF startup, external RAM is mapped into the data address space, starting at address 0x3F500000 (byte-accessible). The length of this region is the same as the SPI RAM size (up to the limit of 10.5 MB).

Applications can manually place data in external memory by creating pointers to this region. So if an application uses external memory, it is responsible for all management of the external SPI RAM: coordinating buffer usage, preventing corruption, etc.

### Add External RAM to the Capability Allocator

Select this option by choosing “Make RAM allocatable using `heap_caps_malloc(..., MALLOC_CAP_SPIRAM)`” from [CONFIG\\_SPIRAM\\_USE](#).

When enabled, memory is mapped to address 0x3F500000 and also added to the *capabilities-based heap memory allocator* using `MALLOC_CAP_SPIRAM`.

To allocate memory from external RAM, a program should call `heap_caps_malloc(size, MALLOC_CAP_SPIRAM)`. After use, this memory can be freed by calling the normal `free()` function.

### Provide External RAM via `malloc()`

Select this option by choosing “Make RAM allocatable using `malloc()` as well” from [CONFIG\\_SPIRAM\\_USE](#). This is the default option.

In this case, memory is added to the capability allocator as described for the previous option. However, it is also added to the pool of RAM that can be returned by the standard `malloc()` function.

This allows any application to use the external RAM without having to rewrite the code to use `heap_caps_malloc(..., MALLOC_CAP_SPIRAM)`.

An additional configuration item, [CONFIG\\_SPIRAM\\_MALLOC\\_ALWAYSINTERNAL](#), can be used to set the size threshold when a single allocation should prefer external memory:

- When allocating a size less than the threshold, the allocator will try internal memory first.
- When allocating a size equal to or larger than the threshold, the allocator will try external memory first.

If a suitable block of preferred internal/external memory is not available, the allocator will try the other type of memory.

Because some buffers can only be allocated in internal memory, a second configuration item [CONFIG\\_SPIRAM\\_MALLOC\\_RESERVE\\_INTERNAL](#) defines a pool of internal memory which is reserved for *only* explicitly internal allocations (such as memory for DMA use). Regular `malloc()` will not allocate from this pool. The [MALLOC\\_CAP\\_DMA](#) and `MALLOC_CAP_INTERNAL` flags can be used to allocate memory from this pool.

### Allow .bss Segment to be Placed in External Memory

Enable this option by checking [CONFIG\\_SPIRAM\\_ALLOW\\_BSS\\_SEG\\_EXTERNAL\\_MEMORY](#). This configuration setting is independent of the other three.

If enabled, the region of the data virtual address space where the PSRAM is mapped to will be used to store zero-initialized data (BSS segment) from the lwIP, net80211, libpp, wpa\_supplicant and bluedroid ESP-IDF libraries.

Additional data can be moved from the internal BSS segment to external RAM by applying the macro `EXT_RAM_BSS_ATTR` to any static declaration (which is not initialized to a non-zero value).

It is also possible to place the BSS section of a component or a library to external RAM using linker fragment scheme `extram_bss`.

This option reduces the internal static memory used by the BSS segment.

Remaining external RAM can also be added to the capability heap allocator using the method shown above.

#### 4.26.4 Restrictions

External RAM use has the following restrictions:

- When flash cache is disabled (for example, if the flash is being written to), the external RAM also becomes inaccessible; any reads from or writes to it will lead to an illegal cache access exception. This is also the reason why ESP-IDF does not by default allocate any task stacks in external RAM (see below).
  - External RAM cannot be used as a place to store DMA transaction descriptors or as a buffer for a DMA transfer to read from or write into. Therefore when External RAM is enabled, any buffer that will be used in combination with DMA must be allocated using `heap_caps_malloc(size, MALLOC_CAP_DMA | MALLOC_CAP_INTERNAL)` and can be freed using a standard `free()` call.

Note, although ESP32-S2 has hardware support for DMA to/from external RAM, this is not yet supported in ESP-IDF.

- External RAM uses the same cache region as the external flash. This means that frequently accessed variables in external RAM can be read and modified almost as quickly as in internal ram. However, when accessing large chunks of data (>32 KB), the cache can be insufficient, and speeds will fall back to the access speed of the external RAM. Moreover, accessing large chunks of data can “push out” cached flash, possibly making the execution of code slower afterwards.
- In general, external RAM will not be used as task stack memory. `xTaskCreate()` and similar functions will always allocate internal memory for stack and task TCBs.

The option `CONFIG_SPIRAM_ALLOW_STACK_EXTERNAL_MEMORY` can be used to allow placing task stacks into external memory. In these cases `xTaskCreateStatic()` must be used to specify a task stack buffer allocated from external memory, otherwise task stacks will still be allocated from internal memory.

#### 4.26.5 Failure to initialize

By default, failure to initialize external RAM will cause the ESP-IDF startup to abort. This can be disabled by enabling the config item `CONFIG_SPIRAM_IGNORE_NOTFOUND`.

If `CONFIG_SPIRAM_ALLOW_BSS_SEG_EXTERNAL_MEMORY` is enabled, the option to ignore failure is not available as the linker will have assigned symbols to external memory addresses at link time.

#### 4.26.6 Encryption

It is possible to enable automatic encryption for data stored in external RAM. When this is enabled any data read and written through the cache will automatically be encrypted/decrypted by the external memory encryption hardware.

This feature is enabled whenever flash encryption is enabled. For more information on how to enable and how it works see [Flash Encryption](#).

### 4.27 Thread Local Storage

#### 4.27.1 Overview

Thread-local storage (TLS) is a mechanism by which variables are allocated such that there is one instance of the variable per extant thread. ESP-IDF provides three ways to make use of such variables:

- [FreeRTOS Native API](#): ESP-IDF FreeRTOS native API.

- *Pthread API*: ESP-IDF's pthread API.
- *C11 Standard*: C11 standard introduces special keyword to declare variables as thread local.

### 4.27.2 FreeRTOS Native API

The ESP-IDF FreeRTOS provides the following API to manage thread local variables:

- `vTaskSetThreadLocalStoragePointer()`
- `pvTaskGetThreadLocalStoragePointer()`
- `vTaskSetThreadLocalStoragePointerAndDelCallback()`

In this case maximum number of variables that can be allocated is limited by `CONFIG_FREERTOS_THREAD_LOCAL_STORAGE_POINTERS` configuration value. Variables are kept in the task control block (TCB) and accessed by their index. Note that index 0 is reserved for ESP-IDF internal uses.

Using that API user can allocate thread local variables of an arbitrary size and assign them to any number of tasks. Different tasks can have different sets of TLS variables.

If size of the variable is more than 4 bytes then user is responsible for allocating/deallocating memory for it. Variable's deallocation is initiated by FreeRTOS when task is deleted, but user must provide function (callback) to do proper cleanup.

### 4.27.3 Pthread API

The ESP-IDF provides the following *pthread API* to manage thread local variables:

- `pthread_key_create()`
- `pthread_key_delete()`
- `pthread_getspecific()`
- `pthread_setspecific()`

This API has all benefits of the one above, but eliminates some its limits. The number of variables is limited only by size of available memory on the heap. Due to the dynamic nature this API introduces additional performance overhead compared to the native one.

### 4.27.4 C11 Standard

The ESP-IDF FreeRTOS supports thread local variables according to C11 standard (ones specified with `__thread` keyword). For details on this GCC feature please see <https://gcc.gnu.org/onlinedocs/gcc-5.5.0/gcc/Thread-Local.html#Thread-Local>. Storage for that kind of variables is allocated on the task's stack. Note that area for all such variables in the program will be allocated on the stack of every task in the system even if that task does not use such variables at all. For example ESP-IDF system tasks (like `ipc`, `timer` tasks etc.) will also have that extra stack space allocated. So this feature should be used with care. There is a tradeoff: C11 thread local variables are quite handy to use in programming and can be accessed using minimal CPU instructions, but this benefit goes with the cost of additional stack usage for all tasks in the system. Due to static nature of variables allocation all tasks in the system have the same sets of C11 thread local variables.

## 4.28 Tools

### 4.28.1 IDF Frontend - `idf.py`

The `idf.py` command-line tool provides a front-end for easily managing your project builds, deployment and debugging, and more. It manages several tools, for example:

- `CMake`, which configures the project to be built.

- [Ninja](#), which builds the project.
- [esptool.py](#), which flashes the target.

The [Step 5. First Steps on ESP-IDF](#) contains a brief introduction on how to set up `idf.py` to configure, build, and flash projects.

---

**Important:** `idf.py` should be run in an ESP-IDF project directory, i.e., a directory containing a `CMakeLists.txt` file. Older style projects that contain a `Makefile` will not work with `idf.py`.

---

## Commands

### Start a New Project: `create-project`

```
idf.py create-project <project name>
```

This command creates a new ESP-IDF project. Additionally, the folder where the project will be created in can be specified by the `--path` option.

### Create a New Component: `create-component`

```
idf.py create-component <component name>
```

This command creates a new component, which will have a minimum set of files necessary for building. The `-C` option can be used to specify the directory the component will be created in. For more information about components see the [Component CMakeLists Files](#).

**Select the Target Chip: `set-target`** ESP-IDF supports multiple targets (chips). A full list of supported targets in your version of ESP-IDF can be seen by running `idf.py --list-targets`.

```
idf.py set-target <target>
```

This command sets the current project target.

---

**Important:** `idf.py set-target` will clear the build directory and re-generate the `sdkconfig` file from scratch. The old `sdkconfig` file will be saved as `sdkconfig.old`.

---

**Note:** The behavior of the `idf.py set-target` command is equivalent to:

1. clearing the build directory (`idf.py fullclean`)
  2. removing the `sdkconfig` file (`mv sdkconfig sdkconfig.old`)
  3. configuring the project with the new target (`idf.py -DIDF_TARGET=esp32 reconfigure`)
- 

It is also possible to pass the desired `IDF_TARGET` as an environment variable (e.g., `export IDF_TARGET=esp32s2`) or as a CMake variable (e.g., `-DIDF_TARGET=esp32s2` argument to CMake or `idf.py`). Setting the environment variable is a convenient method if you mostly work with one type of the chip.

To specify the default value of `IDF_TARGET` for a given project, please add the `CONFIG_IDF_TARGET` option to the project's `sdkconfig.defaults` file, e.g., `CONFIG_IDF_TARGET="esp32s2"`. This value of the option will be used if `IDF_TARGET` is not specified by other methods, such as using an environment variable, a CMake variable, or the `idf.py set-target` command.

If the target has not been set by any of these methods, the build system will default to `esp32` target.

**Start the Graphical Configuration Tool: menuconfig**

```
idf.py menuconfig
```

**Build the Project: build**

```
idf.py build
```

This command builds the project found in the current directory. This can involve multiple steps:

- Create the build directory if needed. The sub-directory `build` is used to hold build output, although this can be changed with the `-B` option.
- Run [CMake](#) as necessary to configure the project and generate build files for the main build tool.
- Run the main build tool ([Ninja](#) or *GNU Make*). By default, the build tool is automatically detected but it can be explicitly set by passing the `-G` option to `idf.py`.

Building is incremental, so if no source files or configuration has changed since the last build, nothing will be done.

Additionally, the command can be run with `app`, `bootloader` and `partition-table` arguments to build only the app, bootloader or partition table as applicable.

**Remove the Build Output: clean**

```
idf.py clean
```

This command removes the project build output files from the build directory, and the project will be fully rebuilt on next build. Using this command does not remove the CMake configuration output inside the build folder.

**Delete the Entire Build Contents: fullclean**

```
idf.py fullclean
```

This command deletes the entire “build” directory contents, which includes all CMake configuration output. The next time the project is built, CMake will configure it from scratch. Note that this option recursively deletes **all** files in the build directory, so use with care. Project configuration is not deleted.

**Flash the Project: flash**

```
idf.py flash
```

This command automatically builds the project if necessary, and then flash it to the target. You can use `-p` and `-b` options to set serial port name and flasher baud rate, respectively.

---

**Note:** The environment variables `ESPPORT` and `ESPBAUD` can be used to set default values for the `-p` and `-b` options, respectively. Providing these options on the command line overrides the default.

---

Similarly to the `build` command, the command can be run with `app`, `bootloader` and `partition-table` arguments to flash only the app, bootloader or partition table as applicable.

**Hints on How to Resolve Errors**

`idf.py` will try to suggest hints on how to resolve errors. It works with a database of hints stored in [tools/idf\\_py\\_actions/hints.yml](#) and the hints will be printed if a match is found for the given error. The `menuconfig`, `gdb` and `openocd` targets are not supported at the moment by automatic hints on resolving errors.

The `--no-hints` argument of `idf.py` can be used to turn the hints off in case they are not desired.



## Important Notes

Multiple `idf.py` commands can be combined into one. For example, `idf.py -p COM4 clean flash monitor` will clean the source tree, then build the project and flash it to the target before running the serial monitor.

The order of multiple `idf.py` commands on the same invocation is not important, as they will automatically be executed in the correct order for everything to take effect (e.g., building before flashing, erasing before flashing).

For commands that are not known to `idf.py`, an attempt to execute them as a build system target will be made.

The command `idf.py` supports [shell autocompletion](#) for bash, zsh and fish shells.

In order to make [shell autocompletion](#) supported, please make sure you have at least Python 3.5 and [click 7.1](#) or newer (*Software*).

To enable autocompletion for `idf.py`, use the `export` command (*Step 4. Set up the environment variables*). Autocompletion is initiated by pressing the TAB key. Type `idf.py -` and press the TAB key to autocomplete options.

The autocomplete support for PowerShell is planned in the future.

## Advanced Commands

### Open the Documentation: `docs`

```
idf.py docs
```

This command opens the documentation for the projects target and ESP-IDF version in the browser.

### Show Size: `size`

```
idf.py size
```

This command prints app size information including the occupied RAM and flash and section (i.e., .bss) sizes.

```
idf.py size
```

Similarly, this command prints the same information for each component used in the project.

```
idf.py size-files
```

This command prints size information per source file in the project.

If you define variable `-DOUTPUT_JSON=1` when running CMake (or `idf.py`), the output will be formatted as JSON not as human readable text. See `idf.py-size` for more information.

### Reconfigure the Project: `reconfigure`

```
idf.py reconfigure
```

This command forces CMake to be rerun regardless of whether it is necessary. It's unnecessary during normal usage, but can be useful after adding/removing files from the source tree, or when modifying CMake cache variables. For example, `idf.py -DNAME='VALUE' reconfigure` can be used to set variable NAME in CMake cache to value VALUE.

### Clean the Python Byte Code: `python-clean`

```
idf.py python-clean
```

This command deletes generated python byte code from the ESP-IDF directory. The byte code may cause issues when switching between ESP-IDF and Python versions. It is advised to run this target after switching versions of Python.



### Generate a UF2 binary: `uf2`

```
idf.py uf2
```

This command will generate a UF2 (USB Flashing Format) binary `uf2.bin` in the build directory. This file includes all the necessary binaries (bootloader, app, and partition table) for flashing the target.

This UF2 file can be copied to a USB mass storage device exposed by another ESP running the [ESP USB Bridge](#) project. The bridge MCU will use it to flash the target MCU. This is as simple copying (or “drag-and-dropping”) the file to the exposed disk accessed by a file explorer in your machine.

To generate a UF2 binary for the application only (not including the bootloader and partition table), use the `uf2-app` command.

```
idf.py uf2-app
```

### Global Options

To list all available root level options, run `idf.py --help`. To list options that are specific for a subcommand, run `idf.py <command> --help`, e.g., `idf.py monitor --help`. Here is a list of some useful options:

- `-C <dir>` allows overriding the project directory from the default current working directory.
- `-B <dir>` allows overriding the build directory from the default `build` subdirectory of the project directory.
- `--ccache` enables [CCache](#) when compiling source files if the [CCache](#) tool is installed. This can dramatically reduce the build time.

---

**Important:** Note that some older versions of [CCache](#) may exhibit bugs on some platforms, so if files are not rebuilt as expected, try disabling [CCache](#) and rebuilding the project. To enable [CCache](#) by default, set the `IDF_CCACHE_ENABLE` environment variable to a non-zero value.

---

- `-v` flag causes both `idf.py` and the build system to produce verbose build output. This can be useful for debugging build problems.
- `--cmake-warn-uninitialized` (or `-w`) causes CMake to print uninitialized variable warnings found in the project directory only. This only controls CMake variable warnings inside CMake itself, not other types of build warnings. This option can also be set permanently by setting the `IDF_CMAKE_WARN_UNINITIALIZED` environment variable to a non-zero value.
- `--no-hints` flag disables hints on resolving errors and disable capturing output.

## 4.28.2 IDF Docker Image

IDF Docker image (`espressif/idf`) is intended for building applications and libraries with specific versions of ESP-IDF, when doing automated builds.

The image contains:

- Common utilities such as `git`, `wget`, `curl`, `zip`.
- Python 3.7 or newer.
- A copy of a specific version of ESP-IDF (see below for information about versions). `IDF_PATH` environment variable is set, and points to ESP-IDF location in the container.
- All the build tools required for the specific version of ESP-IDF: CMake, ninja, cross-compiler toolchains, etc.
- All Python packages required by ESP-IDF are installed in a virtual environment.

The image entrypoint sets up `PATH` environment variable to point to the correct version of tools, and activates the Python virtual environment. As a result, the environment is ready to use the ESP-IDF build system.

The image can also be used as a base for custom images, if additional utilities are required.

## Tags

Multiple tags of this image are maintained:

- `latest`: tracks master branch of ESP-IDF
- `vX.Y`: corresponds to ESP-IDF release `vX.Y`
- `release-vX.Y`: tracks `release/vX.Y` branch of ESP-IDF

---

**Note:** Versions of ESP-IDF released before this feature was introduced do not have corresponding Docker image versions. You can check the up-to-date list of available tags at <https://hub.docker.com/r/espressif/idf/tags>.

---

## Usage

**Setting up Docker** Before using the `espressif/idf` Docker image locally, make sure you have Docker installed. Follow the instructions at <https://docs.docker.com/install/>, if it is not installed yet.

If using the image in CI environment, consult the documentation of your CI service on how to specify the image used for the build process.

**Building a project with CMake** In the project directory, run:

```
docker run --rm -v $PWD:/project -w /project espressif/idf idf.py build
```

The above command explained:

- `docker run`: runs a Docker image. It is a shorter form of the command `docker container run`.
- `--rm`: removes the container when the build is finished
- `-v $PWD:/project`: mounts the current directory on the host (`$PWD`) as `/project` directory in the container
- `espressif/idf`: uses Docker image `espressif/idf` with tag `latest` (implicitly added by Docker when no tag is specified)
- `idf.py build`: runs this command inside the container

---

**Note:** When the mounted directory, `/project`, contains a git repository owned by a different user (UID) than the one running the Docker container, git commands executed within `/project` might fail, displaying an error message `fatal: detected dubious ownership in repository at '/project'`. To resolve this issue, you can designate the `/project` directory as safe by setting the `IDF_GIT_SAFE_DIR` environment variable during the Docker container startup. For instance, you can achieve this by including `-e IDF_GIT_SAFE_DIR='/project'` as a parameter. Additionally, multiple directories can be specified by using a `:` separator. To entirely disable this git security check, `*` can be used.

---

To build with a specific docker image tag, specify it as `espressif/idf:TAG`, for example:

```
docker run --rm -v $PWD:/project -w /project espressif/idf:release-v4.4 idf.py ↵
↳ build
```

You can check the up-to-date list of available tags at <https://hub.docker.com/r/espressif/idf/tags>.

**Using the image interactively** It is also possible to do builds interactively, to debug build issues or test the automated build scripts. Start the container with `-i -t` flags:

```
docker run --rm -v $PWD:/project -w /project -it espressif/idf
```

Then inside the container, use `idf.py` as usual:

```
idf.py menuconfig
idf.py build
```

**Note:** Commands which communicate with the development board, such as `idf.py flash` and `idf.py monitor` will not work in the container unless the serial port is passed through into the container. However currently this is not possible with Docker for Windows (<https://github.com/docker/for-win/issues/1018>) and Docker for Mac (<https://github.com/docker/for-mac/issues/900>).

---

### Building custom images

The Dockerfile in ESP-IDF repository provides several build arguments which can be used to customize the Docker image:

- `IDF_CLONE_URL`: URL of the repository to clone ESP-IDF from. Can be set to a custom URL when working with a fork of ESP-IDF. Default is `https://github.com/espressif/esp-idf.git`.
- `IDF_CLONE_BRANCH_OR_TAG`: Name of a git branch or tag use when cloning ESP-IDF. This value is passed to `git clone` command using the `--branch` argument. Default is `master`.
- `IDF_CHECKOUT_REF`: If this argument is set to a non-empty value, `git checkout $IDF_CHECKOUT_REF` command will be performed after cloning. This argument can be set to the SHA of the specific commit to check out, for example if some specific commit on a release branch is desired.
- `IDF_CLONE_SHALLOW`: If this argument is set to a non-empty value, `--depth=1 --shallow-submodules` arguments will be used when performing `git clone`. This significantly reduces the amount of data downloaded and the size of the resulting Docker image. However, if switching to a different branch in such a “shallow” repository is necessary, an additional `git fetch origin <branch>` command must be executed first.
- `IDF_INSTALL_TARGETS`: Comma-separated list of IDF targets to install toolchains for, or `all` to install toolchains for all targets. Selecting specific targets reduces the amount of data downloaded and the size of the resulting Docker image. Default is `all`.

To use these arguments, pass them via the `--build-arg` command line option. For example, the following command will build a Docker image with a shallow clone of ESP-IDF v4.4.1 and tools for ESP32-C3, only:

```
docker build -t idf-custom:v4.4.1-esp32c3 \
  --build-arg IDF_CLONE_BRANCH_OR_TAG=v4.4.1 \
  --build-arg IDF_CLONE_SHALLOW=1 \
  --build-arg IDF_INSTALL_TARGETS=esp32c3 \
  tools/docker
```

## 4.28.3 IDF Windows Installer

### Command-line parameters

Windows Installer `esp-idf-tools-setup` provides the following command-line parameters:

- `/CONFIG=[PATH]` - Path to `ini` configuration file to override default configuration of the installer. Default: `config.ini`.
- `/GITCLEAN=[yes|no]` - Perform `git clean` and remove untracked directories in Offline mode installation. Default: `yes`.
- `/GITRECURSIVE=[yes|no]` - Clone recursively all git repository submodules. Default: `yes`
- `/GITREPO=[URL|PATH]` - URL of repository to clone ESP-IDF. Default: <https://github.com/espressif/esp-idf.git>
- `/GITRESET=[yes|no]` - Enable/Disable `git reset` of repository during installation. Default: `yes`.
- `/HELP` - Display command line options provided by Inno Setup installer.
- `/IDFDIR=[PATH]` - Path to directory where it will be installed. Default: `{userdesktop}\esp-idf}`
- `/IDFVERSION=[v4.3|v4.1|master]` - Use specific IDF version. E.g. `v4.1`, `v4.2`, `master`. Default: empty, pick the first version in the list.

- /IDFVERSIONSURL=[URL] - Use URL to download list of IDF versions. Default: [https://dl.espressif.com/dl/esp-idf/idf\\_versions.txt](https://dl.espressif.com/dl/esp-idf/idf_versions.txt)
- /LOG=[PATH] - Store installation log file in specific directory. Default: empty.
- /OFFLINE=[yes|no] - Execute installation of Python packages by PIP in offline mode. The same result can be achieved by setting the environment variable PIP\_NO\_INDEX. Default: no.
- /USEEMBEDDEDPYTHON=[yes|no] - Use Embedded Python version for the installation. Set to no to allow Python selection screen in the installer. Default: yes.
- /PYTHONNOUSERSITE=[yes|no] - Set PYTHONNOUSERSITE variable before launching any Python command to avoid loading Python packages from AppDataRoaming. Default: yes.
- /PYTHONWHEELSURL=[URL] - Specify URLs to PyPi repositories for resolving binary Python Wheel dependencies. The same result can be achieved by setting the environment variable PIP\_EXTRA\_INDEX\_URL. Default: <https://dl.espressif.com/pypi>
- /SKIPSYSTEMCHECK=[yes|no] - Skip System Check page. Default: no.
- /VERYSILENT /SUPPRESSMSGBOXES /SP- /NOCANCEL - Perform silent installation.

### Unattended installation

The unattended installation of IDF can be achieved by following command-line parameters:

```
esp-idf-tools-setup-x.x.exe /VERYSILENT /SUPPRESSMSGBOXES /SP- /NOCANCEL
```

The installer detaches its process from the command-line. Waiting for installation to finish could be achieved by following PowerShell script:

```
esp-idf-tools-setup-x.x.exe /VERYSILENT /SUPPRESSMSGBOXES /SP- /NOCANCEL
$InstallerProcess = Get-Process esp-idf-tools-setup
Wait-Process -Id $InstallerProcess.id
```

### Custom Python and custom location of Python wheels

The IDF installer is using by default embedded Python with reference to Python Wheel mirror.

Following parameters allows to select custom Python and custom location of Python wheels:

```
esp-idf-tools-setup-x.x.exe /USEEMBEDDEDPYTHON=no /PYTHONWHEELSURL=https://pypi.
↳org/simple/
```

## 4.28.4 IDF Component Manager

The IDF Component manager is a tool that downloads dependencies for any ESP-IDF CMake project. The download happens automatically during a run of CMake. It can source components either from [the component registry](#) or from a git repository.

A list of components can be found on <https://components.espressif.com/>

### Using with a project

Dependencies for each component in the project are defined in a separate manifest file named `idf_component.yml` placed in the root of the component. The manifest file template can be created for a component by running `idf.py create-manifest --component=my_component`. When a new manifest is added to one of the components in the project it's necessary to reconfigure it manually by running `idf.py reconfigure`. Then build will track changes in `idf_component.yml` manifests and automatically triggers CMake when necessary.

There is an example application: `example:build_system/cmake/component_manager` that uses components installed by the component manager.

It's not necessary to have a manifest for components that don't need any managed dependencies.

When CMake configures the project (e.g. `idf.py reconfigure`) component manager does a few things:

- Processes `idf_component.yml` manifests for every component in the project and recursively solves dependencies
- Creates a `dependencies.lock` file in the root of the project with a full list of dependencies
- Downloads all dependencies to the `managed_components` directory

The lock-file `dependencies.lock` and content of `managed_components` directory is not supposed to be modified by a user. When the component manager runs it always make sure they are up to date. If these files were accidentally modified it's possible to re-run the component manager by triggering CMake with `idf.py reconfigure`

### Defining dependencies in the manifest

```
dependencies:
  # Required IDF version
  idf: ">=4.1"
  # Defining a dependency from the registry:
  # https://components.espressif.com/component/example/cmp
  example/cmp: ">=1.0.0"

  # # Other ways to define dependencies
  #
  # # For components maintained by Espressif only name can be used.
  # # Same as `espressif/cmp`
  # component: "~1.0.0"
  #
  # # Or in a longer form with extra parameters
  # component2:
  #   version: ">=2.0.0"
  #
  # # For transient dependencies `public` flag can be set.
  # # `public` flag doesn't affect the `main` component.
  # # All dependencies of `main` are public by default.
  # public: true
  #
  # # For components hosted on non-default registry:
  # service_url: "https://componentregistry.company.com"
  #
  # # For components in git repository:
  # test_component:
  #   path: test_component
  #   git: ssh://git@gitlab.com/user/components.git
  #
  # # For test projects during component development
  # # components can be used from a local directory
  # # with relative or absolute path
  # some_local_component:
  #   path: ../../projects/component
```

### Disabling the Component Manager

The component manager can be explicitly disabled by setting `IDF_COMPONENT_MANAGER` environment variable to 0.

#### 4.28.5 IDF Clang Tidy

The IDF Clang Tidy is a tool that uses `clang-tidy` to run static analysis on your current app.

**Warning:** This functionality and the toolchain it relies on are still under development. There may be breaking changes before a final release.

### Prerequisites

If you have never run this tool before, take the following steps to get this tool prepared.

1. Run the export scripts (`export.sh / export.bat / ...`) to set up the environment variables.
2. Run `pip install --upgrade pyclang` to install this plugin. The extra commands would be activated in `idf.py` automatically.
3. Run `idf_tools.py install xtensa-clang` to install the clang-tidy required binaries

---

**Note:** This toolchain is still under development. After the final release, you don't have to install them manually.

---

4. Get file from the [llvm repository](#) and add the folder of this script to the `$PATH`. Or you could pass an optional argument `--run-clang-tidy-py` later when you call `idf.py clang-check`. Please don't forget to make the script executable.

---

**Note:** This file would be bundled in future toolchain releases. This is a temporary workaround.

---

5. Run the export scripts (`export.sh / export.bat / ...`) again to refresh the environment variables.

### Extra Commands

**clang-check** Run `idf.py clang-check` to re-generate the compilation database and run `clang-tidy` under your current project folder. The output would be written to `<project_dir>/warnings.txt`.

Run `idf.py clang-check --help` to see the full documentation.

### clang-html-report

1. Run `pip install codereport` to install the additional dependency.
2. Run `idf.py clang-html-report` to generate an HTML report in folder `<project_dir>/html_report` according to the `warnings.txt`. Please open the `<project_dir>/html_report/index.html` in your browser to check the report.

### Bug Report

This tool is hosted in [espressif/clang-tidy-runner](#). If you faced any bugs or have any feature request, please report them via [github issues](#).

## 4.28.6 Downloadable Tools

ESP-IDF build process relies on a number of tools: cross-compiler toolchains, CMake build system, and others.

Installing the tools using an OS-specific package manager (like `apt`, `yum`, `brew`, etc.) is the preferred method when the required version of the tool is available. This recommendation is reflected in the Getting Started guide. For example, on Linux and macOS it is recommended to install CMake using an OS package manager.

However, some of the tools are IDF-specific and are not available in OS package repositories. Furthermore, different versions of ESP-IDF require different versions of the tools to operate correctly. To solve these two problems, ESP-IDF provides a set of scripts for downloading and installing the correct versions of tools, and exposing them in the environment.

The rest of the document refers to these downloadable tools simply as “tools”. Other kinds of tools used in ESP-IDF are:

- Python scripts bundled with ESP-IDF (such as `idf.py`)
- Python packages installed from PyPI.

The following sections explain the installation method, and provide the list of tools installed on each platform.

---

**Note:** This document is provided for advanced users who need to customize their installation, users who wish to understand the installation process, and ESP-IDF developers.

If you are looking for instructions on how to install the tools, see the [Getting Started Guide](#).

---

### Tools metadata file

The list of tools and tool versions required for each platform is located in [tools/tools.json](#). The schema of this file is defined by [tools/tools\\_schema.json](#).

This file is used by [tools/idf\\_tools.py](#) script when installing the tools or setting up the environment variables.

### Tools installation directory

`IDF_TOOLS_PATH` environment variable specifies the location where the tools are to be downloaded and installed. If not set, `IDF_TOOLS_PATH` defaults to `HOME/.espressif` on Linux and macOS, and `%USER_PROFILE%\espressif` on Windows.

Inside `IDF_TOOLS_PATH`, the scripts performing tools installation create the following directories and files:

- `dist` —where the archives of the tools are downloaded.
- `tools` —where the tools are extracted. The tools are extracted into subdirectories: `tools/TOOL_NAME/VERSION/`. This arrangement allows different versions of tools to be installed side by side.
- `idf-env.json` —user install options (targets, features) are stored in this file. Targets are selected chip targets for which tools are installed and kept up-to-date. Features determine the Python package set which should be installed. These options will be discussed later.
- `python_env` —not tools related; virtual Python environments are installed in the sub-directories. Note that the Python environment directory can be placed elsewhere by setting the `IDF_PYTHON_ENV_PATH` environment variable.
- `espidf.constraints.*.txt` —one constraint file for each ESP-IDF release containing Python package version requirements.

### GitHub Assets Mirror

Most of the tools downloaded by the tools installer are GitHub Release Assets, which are files attached to a software release on GitHub.

If GitHub downloads are inaccessible or slow to access, it’s possible to configure a GitHub assets mirror.

To use Espressif’s download server, set the environment variable `IDF_GITHUB_ASSETS` to `dl.espressif.com/github_assets`. When the install process is downloading a tool from `github.com`, the URL will be rewritten to use this server instead.

Any mirror server can be used provided the URL matches the `github.com` download URL format: the install process will replace `https://github.com` with `https://{IDF_GITHUB_ASSETS}` for any GitHub asset URL that it downloads.

---

**Note:** The Espressif download server doesn’t currently mirror everything from GitHub, it only mirrors files attached as Assets to some releases as well as source archives for some releases.

---



**idf\_tools.py script**

`tools/idf_tools.py` script bundled with ESP-IDF performs several functions:

- `install`: Download the tool into `${IDF_TOOLS_PATH}/dist` directory, extract it into `${IDF_TOOLS_PATH}/tools/TOOL_NAME/VERSION`. `install` command accepts the list of tools to install, in `TOOL_NAME` or `TOOL_NAME@VERSION` format. If `all` is given, all the tools (required and optional ones) are installed. If no argument or `required` is given, only the required tools are installed.
- `download`: Similar to `install` but doesn't extract the tools. An optional `--platform` argument may be used to download the tools for the specific platform.
- `export`: Lists the environment variables which need to be set to use the installed tools. For most of the tools, setting `PATH` environment variable is sufficient, but some tools require extra environment variables.

The environment variables can be listed in either of `shell` or `key-value` formats, set by `--format` parameter:

- `export` optional parameters:
  - \* `--unset` Creates statement that unset some global variables, so the environment gets to the state it was before calling `export.{sh/fish}`.
  - \* `--add_paths_extras` Adds extra ESP-IDF-related paths of `$PATH` to `${IDF_TOOLS_PATH}/esp-idf.json`, which is used to remove global variables when the active ESP-IDF environment is deactivated. Example: While processing `export.{sh/fish}` script, new paths are added to global variable `$PATH`. This option is used to save these new paths to the `${IDF_TOOLS_PATH}/esp-idf.json`.
- `shell` produces output suitable for evaluation in the shell. For example,

```
export PATH="/home/user/.espressif/tools/tool/v1.0.0/bin:$PATH"
```

on Linux and macOS, and

```
set "PATH=C:\Users\user\.espressif\tools\v1.0.0\bin;%PATH%"
```

on Windows.

**Note:** Exporting environment variables in Powershell format is not supported at the moment. `key-value` format may be used instead.

The output of this command may be used to update the environment variables, if the shell supports this. For example:

```
eval $(${IDF_PATH}/tools/idf_tools.py export)
```

- `key-value` produces output in `VARIABLE=VALUE` format, suitable for parsing by other scripts:

```
PATH=/home/user/.espressif/tools/tool/v1.0.0:$PATH
```

Note that the script consuming this output has to perform expansion of `$VAR` or `%VAR%` patterns found in the output.

- `list`: Lists the known versions of the tools, and indicates which ones are installed.
- `check`: For each tool, checks whether the tool is available in the system path and in `IDF_TOOLS_PATH`.
- `install-python-env`: Create a Python virtual environment in the `${IDF_TOOLS_PATH}/python_env` directory (or directly in the directory set by the `IDF_PYTHON_ENV_PATH` environment variable) and install there the required Python packages. An optional `--features` argument allows one to specify a comma-separated list of features to be added or removed. Feature that begins with `-` will be removed and features with `+` or without any sign will be added. Example syntax for removing feature `XY` is `--features=-XY` and for adding `--features=+XY` or `--features=XY`. If both removing and adding options are provided with the same feature, no operation is performed. For each feature a requirements file must exist. For example, feature `XY` is a valid feature if `${IDF_PATH}/tools/requirements/requirements.XY.txt` is an existing file with a list of Python packages to be installed. There is one mandatory `core` feature ensuring core functionality of ESP-IDF (`build`, `flash`, `monitor`, `debug in console`). There can be an arbitrary number of optional features. The selected list of features is stored in `idf-env.json`. The requirement files contain a list of the desired Python packages to be installed and `espidf.constraints.*.txt` downloaded from <https://dl.espressif.com> and stored in `${IDF_TOOLS_PATH}`



the package version requirements for a given ESP-IDF version. Although it is not recommended, the download and use of constraint files can be disabled with the `--no-constraints` argument or setting the `IDF_PYTHON_CHECK_CONSTRAINTS` environment variable to `no`.

- `check-python-dependencies`: Checks if all required Python packages are installed. Packages from `${IDF_PATH}/tools/requirements/requirements.*.txt` files selected by the feature list of `idf-env.json` are checked with the package versions specified in the `espidf.constraints.*.txt` file. The constraint file is downloaded with `install-python-env` command. The use of constraints files can be disabled similarly to the `install-python-env` command.
- `uninstall`: Print and remove tools, that are currently not used by active ESP-IDF version.
  - `--dry-run` Print installed unused tools.
  - `--remove-archives` Additionally remove all older versions of previously downloaded installation packages.

## Install scripts

Shell-specific user-facing scripts are provided in the root of ESP-IDF repository to facilitate tools installation. These are:

- `install.bat` for Windows Command Prompt
- `install.ps1` for Powershell
- `install.sh` for Bash
- `install.fish` for Fish

Aside from downloading and installing the tools into `IDF_TOOLS_PATH`, these scripts prepare a Python virtual environment, and install the required packages into that environment.

These scripts accept optionally a comma separated list of chip targets and `--enable-*` arguments for enabling features. These arguments are passed to the `idf_tools.py` script which stores them in `idf-env.json`. Therefore, chip targets and features can be enabled incrementally.

Running the scripts without any optional arguments will install tools for all chip targets (by running `idf_tools.py install --targets=all`) and Python packages for core ESP-IDF functionality (by running `idf_tools.py install-python-env --features=core`).

Or for example, `install.sh esp32` will install tools only for ESP32. See the [Getting Started Guide](#) for more examples.

`install.sh --enable-XY` will enable feature XY (by running `idf_tools.py install-python-env --features=core,XY`).

## Export scripts

Since the installed tools are not permanently added into the user or system `PATH` environment variable, an extra step is required to use them in the command line. The following scripts modify the environment variables in the current shell to make the correct versions of the tools available:

- `export.bat` for Windows Command Prompt
- `export.ps1` for Powershell
- `export.sh` for Bash
- `export.fish` for Fish

---

**Note:** To modify the shell environment in Bash, `export.sh` must be “sourced”: `. ./export.sh` (note the leading dot and space).

`export.sh` may be used with shells other than Bash (such as `zsh`). However in this case the `IDF_PATH` environment variable must be set before running the script. When used in Bash, the script will guess the `IDF_PATH` value from its own location.

---

In addition to calling `idf_tools.py`, these scripts list the directories which have been added to the `PATH`.

## Other installation methods

Depending on the environment, more user-friendly wrappers for `idf_tools.py` are provided:

- [IDF Tools installer for Windows](#) can download and install the tools. Internally the installer uses `idf_tools.py`.
- [Eclipse Plugin](#) includes a menu item to set up the tools. Internally the plugin calls `idf_tools.py`.
- [VSCode Extension](#) for ESP-IDF includes an onboarding flow. This flow helps setting up the tools. Although the extension does not rely on `idf_tools.py`, the same installation method is used.

## Custom installation

Although the methods above are recommended for ESP-IDF users, they are not a must for building ESP-IDF applications. ESP-IDF build system expects that all the necessary tools are installed somewhere, and made available in the `PATH`.

## Uninstall ESP-IDF

Uninstalling ESP-IDF requires removing both the tools and the environment variables that have been configured during the installation.

- Windows users using the [Windows ESP-IDF Tools Installer](#) can simply run the uninstall wizard to remove ESP-IDF.
- To remove an installation performed by running the supported [install scripts](#), simply delete the [tools installation directory](#) including the downloaded and installed tools. Any environment variables set by the [export scripts](#) are not permanent and will not be present after opening a new environment.
- When dealing with a custom installation, in addition to deleting the tools as mentioned above, you may also need to manually revert any changes to environment variables or system paths that were made to accommodate the ESP-IDF tools (e.g., `IDF_PYTHON_ENV_PATH` or `IDF_TOOLS_PATH`). If you manually copied any tools, you would need to track and delete those files manually.
- If you installed any plugins like the [ESP-IDF Eclipse Plugin](#) or [VSCode ESP-IDF Extension](#), you should follow the specific uninstallation instructions described in the documentation of those components.

---

**Note:** Uninstalling the ESP-IDF tools does not remove any project files or your code. Be mindful of what you are deleting to avoid losing any work. If you are unsure about a step, refer back to the installation instructions.

These instructions assume that the tools were installed following the procedures in this provided document. If you've used a custom installation method, you might need to adapt these instructions accordingly.

---

## List of IDF Tools

**xtensa-esp-elf-gdb** GDB for Xtensa

License: [GPL-3.0-or-later](#)

More info: <https://github.com/espressif/binutils-gdb>

Platform	Required	Download
linux-amd64	required	<a href="https://github.com/espressif/binutils-gdb/releases/download/esp-gdb-v12.1_20231023/xtensa-esp-elf-gdb-12.1_20231023-x86_64-linux-gnu.tar.gz">https://github.com/espressif/binutils-gdb/releases/download/esp-gdb-v12.1_20231023/xtensa-esp-elf-gdb-12.1_20231023-x86_64-linux-gnu.tar.gz</a> SHA256: d0743ec43cd92c35452a9097f7863281de4e72f04120d63cfbcf9d591a373529
linux-arm64	required	<a href="https://github.com/espressif/binutils-gdb/releases/download/esp-gdb-v12.1_20231023/xtensa-esp-elf-gdb-12.1_20231023-aarch64-linux-gnu.tar.gz">https://github.com/espressif/binutils-gdb/releases/download/esp-gdb-v12.1_20231023/xtensa-esp-elf-gdb-12.1_20231023-aarch64-linux-gnu.tar.gz</a> SHA256: bc1fac0366c6a08e26c45896ca21c8c90efc2cdd431b8ba084e8772e15502d0e
linux-armel	required	<a href="https://github.com/espressif/binutils-gdb/releases/download/esp-gdb-v12.1_20231023/xtensa-esp-elf-gdb-12.1_20231023-arm-linux-gnueabi.tar.gz">https://github.com/espressif/binutils-gdb/releases/download/esp-gdb-v12.1_20231023/xtensa-esp-elf-gdb-12.1_20231023-arm-linux-gnueabi.tar.gz</a> SHA256: 25efc51d52b71f097ccec763c5c885c8f5026b432fec4b5badd6a5f36fe34d04
linux-armhf	required	<a href="https://github.com/espressif/binutils-gdb/releases/download/esp-gdb-v12.1_20231023/xtensa-esp-elf-gdb-12.1_20231023-arm-linux-gnueabihf.tar.gz">https://github.com/espressif/binutils-gdb/releases/download/esp-gdb-v12.1_20231023/xtensa-esp-elf-gdb-12.1_20231023-arm-linux-gnueabihf.tar.gz</a> SHA256: 0f9ff39fdec4d8c9c1ef33149a3fcd2cf1bae121529c507817c994d5ac38ca4
linux-i686	required	<a href="https://github.com/espressif/binutils-gdb/releases/download/esp-gdb-v12.1_20231023/xtensa-esp-elf-gdb-12.1_20231023-i586-linux-gnu.tar.gz">https://github.com/espressif/binutils-gdb/releases/download/esp-gdb-v12.1_20231023/xtensa-esp-elf-gdb-12.1_20231023-i586-linux-gnu.tar.gz</a> SHA256: e0af0b3b4a6b29a843cd5f47e331a966d9258f7d825b4656c6251490f71b05b2
macos	required	<a href="https://github.com/espressif/binutils-gdb/releases/download/esp-gdb-v12.1_20231023/xtensa-esp-elf-gdb-12.1_20231023-x86_64-apple-darwin14.tar.gz">https://github.com/espressif/binutils-gdb/releases/download/esp-gdb-v12.1_20231023/xtensa-esp-elf-gdb-12.1_20231023-x86_64-apple-darwin14.tar.gz</a> SHA256: bd146fd99a52b2d71c7ce0f62b9e18f3423d6cae7b2b2c954046b0dd7a23142f
macos-arm64	required	<a href="https://github.com/espressif/binutils-gdb/releases/download/esp-gdb-v12.1_20231023/xtensa-esp-elf-gdb-12.1_20231023-aarch64-apple-darwin21.1.tar.gz">https://github.com/espressif/binutils-gdb/releases/download/esp-gdb-v12.1_20231023/xtensa-esp-elf-gdb-12.1_20231023-aarch64-apple-darwin21.1.tar.gz</a> SHA256: 5edc76565bf9d2fadf24e443ddf3df7567354f336a65d4af5b2ee805cdfcec24
win32	required	<a href="https://github.com/espressif/binutils-gdb/releases/download/esp-gdb-v12.1_20231023/xtensa-esp-elf-gdb-12.1_20231023-i686-w64-mingw32.zip">https://github.com/espressif/binutils-gdb/releases/download/esp-gdb-v12.1_20231023/xtensa-esp-elf-gdb-12.1_20231023-i686-w64-mingw32.zip</a> SHA256: ea4f3ee6b95ad1ad2e07108a21a50037a3e64a420cdeb34b2ba95d612faed898
win64	required	<a href="https://github.com/espressif/binutils-gdb/releases/download/esp-gdb-v12.1_20231023/xtensa-esp-elf-gdb-12.1_20231023-x86_64-w64-mingw32.zip">https://github.com/espressif/binutils-gdb/releases/download/esp-gdb-v12.1_20231023/xtensa-esp-elf-gdb-12.1_20231023-x86_64-w64-mingw32.zip</a> SHA256: 13bb97f39173948d1cfb6e651d9b335ea9d52f1fdd0dda1eda3a2d23d8c63644

**riscv32-esp-elf-gdb** GDB for RISC-V

License: [GPL-3.0-or-later](#)

More info: <https://github.com/espressif/binutils-gdb>

Platform	Required	Download
linux-amd64	required	<a href="https://github.com/espressif/binutils-gdb/releases/download/esp-gdb-v12.1_20231023/riscv32-esp-elf-gdb-12.1_20231023-x86_64-linux-gnu.tar.gz">https://github.com/espressif/binutils-gdb/releases/download/esp-gdb-v12.1_20231023/riscv32-esp-elf-gdb-12.1_20231023-x86_64-linux-gnu.tar.gz</a> SHA256: 2c78b806be176b1e449e07ff83429d38dfc39a13f89a127ac1ffa6c1230537a0
linux-arm64	required	<a href="https://github.com/espressif/binutils-gdb/releases/download/esp-gdb-v12.1_20231023/riscv32-esp-elf-gdb-12.1_20231023-aarch64-linux-gnu.tar.gz">https://github.com/espressif/binutils-gdb/releases/download/esp-gdb-v12.1_20231023/riscv32-esp-elf-gdb-12.1_20231023-aarch64-linux-gnu.tar.gz</a> SHA256: 33f80117c8777aaff9179e27953e41764c5c46b3c576dc96a37ecc7a368807ec
linux-armel	required	<a href="https://github.com/espressif/binutils-gdb/releases/download/esp-gdb-v12.1_20231023/riscv32-esp-elf-gdb-12.1_20231023-arm-linux-gnueabi.tar.gz">https://github.com/espressif/binutils-gdb/releases/download/esp-gdb-v12.1_20231023/riscv32-esp-elf-gdb-12.1_20231023-arm-linux-gnueabi.tar.gz</a> SHA256: 292e6ec0a9381c1480bbadf5caae25e86428b68fb5d030c9be7deda5e7f070e0
linux-armhf	required	<a href="https://github.com/espressif/binutils-gdb/releases/download/esp-gdb-v12.1_20231023/riscv32-esp-elf-gdb-12.1_20231023-arm-linux-gnueabihf.tar.gz">https://github.com/espressif/binutils-gdb/releases/download/esp-gdb-v12.1_20231023/riscv32-esp-elf-gdb-12.1_20231023-arm-linux-gnueabihf.tar.gz</a> SHA256: 3b803ab1ae619d62a885afd31c2798de77368d59b888c27ec6e525709e782ef5
linux-i686	required	<a href="https://github.com/espressif/binutils-gdb/releases/download/esp-gdb-v12.1_20231023/riscv32-esp-elf-gdb-12.1_20231023-i586-linux-gnu.tar.gz">https://github.com/espressif/binutils-gdb/releases/download/esp-gdb-v12.1_20231023/riscv32-esp-elf-gdb-12.1_20231023-i586-linux-gnu.tar.gz</a> SHA256: 68a25fbcfc6371ec4dbe503ec92211977eb2006f0c29e67dbce6b93c70c6b7ec
macos	required	<a href="https://github.com/espressif/binutils-gdb/releases/download/esp-gdb-v12.1_20231023/riscv32-esp-elf-gdb-12.1_20231023-x86_64-apple-darwin14.tar.gz">https://github.com/espressif/binutils-gdb/releases/download/esp-gdb-v12.1_20231023/riscv32-esp-elf-gdb-12.1_20231023-x86_64-apple-darwin14.tar.gz</a> SHA256: 322c722e6c12225ed8cd97f95a0375105756dc5113d369958ce0858ad1a90257
macos-arm64	required	<a href="https://github.com/espressif/binutils-gdb/releases/download/esp-gdb-v12.1_20231023/riscv32-esp-elf-gdb-12.1_20231023-aarch64-apple-darwin21.1.tar.gz">https://github.com/espressif/binutils-gdb/releases/download/esp-gdb-v12.1_20231023/riscv32-esp-elf-gdb-12.1_20231023-aarch64-apple-darwin21.1.tar.gz</a> SHA256: c2224b3a8d02451c530cf004c29653292d963a1b4021b4b472b862b6dbe97e0b
win32	required	<a href="https://github.com/espressif/binutils-gdb/releases/download/esp-gdb-v12.1_20231023/riscv32-esp-elf-gdb-12.1_20231023-i686-w64-mingw32.zip">https://github.com/espressif/binutils-gdb/releases/download/esp-gdb-v12.1_20231023/riscv32-esp-elf-gdb-12.1_20231023-i686-w64-mingw32.zip</a> SHA256: 4b42149a99dd87ee7e6dde25c99bad966c7f964253fa8f771593d7cef69f5602
win64	required	<a href="https://github.com/espressif/binutils-gdb/releases/download/esp-gdb-v12.1_20231023/riscv32-esp-elf-gdb-12.1_20231023-x86_64-w64-mingw32.zip">https://github.com/espressif/binutils-gdb/releases/download/esp-gdb-v12.1_20231023/riscv32-esp-elf-gdb-12.1_20231023-x86_64-w64-mingw32.zip</a> SHA256: 728231546ad5006d34463f972658b2a89e52f660a42abab08a29bedd4a8046ad

**xtensa-esp32-elf** Toolchain for Xtensa (ESP32) based on GCC

License: [GPL-3.0-with-GCC-exception](#)

More info: <https://github.com/espressif/crosstool-NG>

Platform	Required	Download
linux-amd64	required	<a href="https://github.com/espressif/crosstool-NG/releases/download/esp-2022r1/xtensa-esp32-elf-gcc11_2_0-esp-2022r1-linux-amd64.tar.xz">https://github.com/espressif/crosstool-NG/releases/download/esp-2022r1/xtensa-esp32-elf-gcc11_2_0-esp-2022r1-linux-amd64.tar.xz</a> SHA256: 698d8407e18275d18feb7d1afdb68800b97904fbc39080422fb8609afa49df30
linux-arm64	required	<a href="https://github.com/espressif/crosstool-NG/releases/download/esp-2022r1/xtensa-esp32-elf-gcc11_2_0-esp-2022r1-linux-arm64.tar.xz">https://github.com/espressif/crosstool-NG/releases/download/esp-2022r1/xtensa-esp32-elf-gcc11_2_0-esp-2022r1-linux-arm64.tar.xz</a> SHA256: 48ed01abff1e89e6fe1c3ebe4e00df6a0a67e53ae24979970464a4a3b64aa622
linux-armel	required	<a href="https://github.com/espressif/crosstool-NG/releases/download/esp-2022r1/xtensa-esp32-elf-gcc11_2_0-esp-2022r1-linux-armel.tar.xz">https://github.com/espressif/crosstool-NG/releases/download/esp-2022r1/xtensa-esp32-elf-gcc11_2_0-esp-2022r1-linux-armel.tar.xz</a> SHA256: 0e6131a9ab4e3da0a153ee75097012823ccf21f90c69368c3bf53c8a086736f8
linux-armhf	required	<a href="https://github.com/espressif/crosstool-NG/releases/download/esp-2022r1/xtensa-esp32-elf-gcc11_2_0-esp-2022r1-linux-armhf.tar.xz">https://github.com/espressif/crosstool-NG/releases/download/esp-2022r1/xtensa-esp32-elf-gcc11_2_0-esp-2022r1-linux-armhf.tar.xz</a> SHA256: 74173665e228d8b1c988de0d743607a2f661e2bd24619c246e25dba7a01f46bd
linux-i686	required	<a href="https://github.com/espressif/crosstool-NG/releases/download/esp-2022r1/xtensa-esp32-elf-gcc11_2_0-esp-2022r1-linux-i686.tar.xz">https://github.com/espressif/crosstool-NG/releases/download/esp-2022r1/xtensa-esp32-elf-gcc11_2_0-esp-2022r1-linux-i686.tar.xz</a> SHA256: d06511bb18057d72b555d6c5b62b0686f19e9f8c7d7eae218b712eed0907dbb2
macos	required	<a href="https://github.com/espressif/crosstool-NG/releases/download/esp-2022r1/xtensa-esp32-elf-gcc11_2_0-esp-2022r1-macos.tar.xz">https://github.com/espressif/crosstool-NG/releases/download/esp-2022r1/xtensa-esp32-elf-gcc11_2_0-esp-2022r1-macos.tar.xz</a> SHA256: 1c9d873c56469e3abec1e4214b7200d36804a605d4f0991e539b1577415409bf
macos-arm64	required	<a href="https://github.com/espressif/crosstool-NG/releases/download/esp-2022r1/xtensa-esp32-elf-gcc11_2_0-esp-2022r1-macos-arm64.tar.xz">https://github.com/espressif/crosstool-NG/releases/download/esp-2022r1/xtensa-esp32-elf-gcc11_2_0-esp-2022r1-macos-arm64.tar.xz</a> SHA256: 297249b0dc5307fd496c4d85d960b69824996c0c450a8c92f8414a5fd32a7c3b
win32	required	<a href="https://github.com/espressif/crosstool-NG/releases/download/esp-2022r1/xtensa-esp32-elf-gcc11_2_0-esp-2022r1-win32.zip">https://github.com/espressif/crosstool-NG/releases/download/esp-2022r1/xtensa-esp32-elf-gcc11_2_0-esp-2022r1-win32.zip</a> SHA256: 858ee049d6d8de730ed3e30285c4adc1a9cdf077b591ed0b6f2bfa5e3564f53
win64	required	<a href="https://github.com/espressif/crosstool-NG/releases/download/esp-2022r1/xtensa-esp32-elf-gcc11_2_0-esp-2022r1-win64.zip">https://github.com/espressif/crosstool-NG/releases/download/esp-2022r1/xtensa-esp32-elf-gcc11_2_0-esp-2022r1-win64.zip</a> SHA256: f469aff6a71113e3a145466d814184339e02248b158357766970646f5d2a3da7

**xtensa-esp32s2-elf** Toolchain for Xtensa (ESP32-S2) based on GCC

License: [GPL-3.0-with-GCC-exception](https://www.gnu.org/licenses/gpl-3.0.html)

More info: <https://github.com/espressif/crosstool-NG>

Platform	Required	Download
linux-amd64	required	<a href="https://github.com/espressif/crosstool-NG/releases/download/esp-2022r1/xtensa-esp32s2-elf-gcc11_2_0-esp-2022r1-linux-amd64.tar.xz">https://github.com/espressif/crosstool-NG/releases/download/esp-2022r1/xtensa-esp32s2-elf-gcc11_2_0-esp-2022r1-linux-amd64.tar.xz</a> SHA256: 56e5913b6662b8eec7d6b46780e668bc7e7cebef239e326a74f764c92a3cc841
linux-arm64	required	<a href="https://github.com/espressif/crosstool-NG/releases/download/esp-2022r1/xtensa-esp32s2-elf-gcc11_2_0-esp-2022r1-linux-arm64.tar.xz">https://github.com/espressif/crosstool-NG/releases/download/esp-2022r1/xtensa-esp32s2-elf-gcc11_2_0-esp-2022r1-linux-arm64.tar.xz</a> SHA256: 2f0ccc9d40279d6407ed9547250fb0434f16060faa94460c52b74614a38a1e21
linux-armel	required	<a href="https://github.com/espressif/crosstool-NG/releases/download/esp-2022r1/xtensa-esp32s2-elf-gcc11_2_0-esp-2022r1-linux-armel.tar.xz">https://github.com/espressif/crosstool-NG/releases/download/esp-2022r1/xtensa-esp32s2-elf-gcc11_2_0-esp-2022r1-linux-armel.tar.xz</a> SHA256: f71974c4aaf3f637f6adaa28bbdbf3a911db3385e0ab1544844513ec65185cc5
linux-armhf	required	<a href="https://github.com/espressif/crosstool-NG/releases/download/esp-2022r1/xtensa-esp32s2-elf-gcc11_2_0-esp-2022r1-linux-armhf.tar.xz">https://github.com/espressif/crosstool-NG/releases/download/esp-2022r1/xtensa-esp32s2-elf-gcc11_2_0-esp-2022r1-linux-armhf.tar.xz</a> SHA256: 73e3be22c993f1112fcb1f7631d82552a6b759f82f12cfb78e669c7303d92b25
linux-i686	required	<a href="https://github.com/espressif/crosstool-NG/releases/download/esp-2022r1/xtensa-esp32s2-elf-gcc11_2_0-esp-2022r1-linux-i686.tar.xz">https://github.com/espressif/crosstool-NG/releases/download/esp-2022r1/xtensa-esp32s2-elf-gcc11_2_0-esp-2022r1-linux-i686.tar.xz</a> SHA256: 504efe97ce24561537bd442494b1046fc8fb9cc43a1c06ef1afa4652b7517201
macos	required	<a href="https://github.com/espressif/crosstool-NG/releases/download/esp-2022r1/xtensa-esp32s2-elf-gcc11_2_0-esp-2022r1-macos.tar.xz">https://github.com/espressif/crosstool-NG/releases/download/esp-2022r1/xtensa-esp32s2-elf-gcc11_2_0-esp-2022r1-macos.tar.xz</a> SHA256: f53da9423490001727c5b6c3b8e1602b887783f0ed68e5defbb3c7712ada9631
macos-arm64	required	<a href="https://github.com/espressif/crosstool-NG/releases/download/esp-2022r1/xtensa-esp32s2-elf-gcc11_2_0-esp-2022r1-macos-arm64.tar.xz">https://github.com/espressif/crosstool-NG/releases/download/esp-2022r1/xtensa-esp32s2-elf-gcc11_2_0-esp-2022r1-macos-arm64.tar.xz</a> SHA256: 3592e0fbd2ca438c7360d93fd62ef0e05ead2fc8144eff344bbe1971d333287
win32	required	<a href="https://github.com/espressif/crosstool-NG/releases/download/esp-2022r1/xtensa-esp32s2-elf-gcc11_2_0-esp-2022r1-win32.zip">https://github.com/espressif/crosstool-NG/releases/download/esp-2022r1/xtensa-esp32s2-elf-gcc11_2_0-esp-2022r1-win32.zip</a> SHA256: 96b873210438713a84ea6e39e591cddbefe453cb431d8392ac3fa2e68a48bc97
win64	required	<a href="https://github.com/espressif/crosstool-NG/releases/download/esp-2022r1/xtensa-esp32s2-elf-gcc11_2_0-esp-2022r1-win64.zip">https://github.com/espressif/crosstool-NG/releases/download/esp-2022r1/xtensa-esp32s2-elf-gcc11_2_0-esp-2022r1-win64.zip</a> SHA256: 9ab0387e08047916bbf7ff0d2eb974c710bcf2e042cb04037b4dd93c9186f676

**xtensa-esp32s3-elf** Toolchain for Xtensa (ESP32-S3) based on GCC

License: [GPL-3.0-with-GCC-exception](#)

More info: <https://github.com/espressif/crosstool-NG>

Platform	Required	Download
linux-amd64	required	<a href="https://github.com/espressif/crosstool-NG/releases/download/esp-2022r1/xtensa-esp32s3-elf-gcc11_2_0-esp-2022r1-linux-amd64.tar.xz">https://github.com/espressif/crosstool-NG/releases/download/esp-2022r1/xtensa-esp32s3-elf-gcc11_2_0-esp-2022r1-linux-amd64.tar.xz</a> SHA256: 5058b2e724166c34ca09ec2d5377350252de8bce5039b06c00352f9a8151f76e
linux-arm64	required	<a href="https://github.com/espressif/crosstool-NG/releases/download/esp-2022r1/xtensa-esp32s3-elf-gcc11_2_0-esp-2022r1-linux-arm64.tar.xz">https://github.com/espressif/crosstool-NG/releases/download/esp-2022r1/xtensa-esp32s3-elf-gcc11_2_0-esp-2022r1-linux-arm64.tar.xz</a> SHA256: d2c6fb98a5018139a9f5af6eb808e968f1381a5b34547a185f4dec142b0fa44e
linux-armel	required	<a href="https://github.com/espressif/crosstool-NG/releases/download/esp-2022r1/xtensa-esp32s3-elf-gcc11_2_0-esp-2022r1-linux-armel.tar.xz">https://github.com/espressif/crosstool-NG/releases/download/esp-2022r1/xtensa-esp32s3-elf-gcc11_2_0-esp-2022r1-linux-armel.tar.xz</a> SHA256: 9944e67d95a5de9875670c5cd5cb0bb282ebac235a38b5fd6d53069813fead9e
linux-armhf	required	<a href="https://github.com/espressif/crosstool-NG/releases/download/esp-2022r1/xtensa-esp32s3-elf-gcc11_2_0-esp-2022r1-linux-armhf.tar.xz">https://github.com/espressif/crosstool-NG/releases/download/esp-2022r1/xtensa-esp32s3-elf-gcc11_2_0-esp-2022r1-linux-armhf.tar.xz</a> SHA256: c0a8836dd709605f8d68ea1fd6e8ae79b3fa76274bfffdd8e79eeadc8f1f3ce1
linux-i686	required	<a href="https://github.com/espressif/crosstool-NG/releases/download/esp-2022r1/xtensa-esp32s3-elf-gcc11_2_0-esp-2022r1-linux-i686.tar.xz">https://github.com/espressif/crosstool-NG/releases/download/esp-2022r1/xtensa-esp32s3-elf-gcc11_2_0-esp-2022r1-linux-i686.tar.xz</a> SHA256: 0feccf884e36b6e93c27c793729199b18df22a409557b16c90b2883a6748e041
macos	required	<a href="https://github.com/espressif/crosstool-NG/releases/download/esp-2022r1/xtensa-esp32s3-elf-gcc11_2_0-esp-2022r1-macos.tar.xz">https://github.com/espressif/crosstool-NG/releases/download/esp-2022r1/xtensa-esp32s3-elf-gcc11_2_0-esp-2022r1-macos.tar.xz</a> SHA256: 2b46730adc6afd8115e0be9365050a87f9523617e5e58ee35cb85ff1ddf2756c
macos-arm64	required	<a href="https://github.com/espressif/crosstool-NG/releases/download/esp-2022r1/xtensa-esp32s3-elf-gcc11_2_0-esp-2022r1-macos-arm64.tar.xz">https://github.com/espressif/crosstool-NG/releases/download/esp-2022r1/xtensa-esp32s3-elf-gcc11_2_0-esp-2022r1-macos-arm64.tar.xz</a> SHA256: bb449ac62b9917638b35234c98ce03ddf1cac75c2d80fbd67c46ecec08369838
win32	required	<a href="https://github.com/espressif/crosstool-NG/releases/download/esp-2022r1/xtensa-esp32s3-elf-gcc11_2_0-esp-2022r1-win32.zip">https://github.com/espressif/crosstool-NG/releases/download/esp-2022r1/xtensa-esp32s3-elf-gcc11_2_0-esp-2022r1-win32.zip</a> SHA256: 0c9ec6d296b66523e3990b195b6597dfc4030f2335bf904b614f990ad6dabbde
win64	required	<a href="https://github.com/espressif/crosstool-NG/releases/download/esp-2022r1/xtensa-esp32s3-elf-gcc11_2_0-esp-2022r1-win64.zip">https://github.com/espressif/crosstool-NG/releases/download/esp-2022r1/xtensa-esp32s3-elf-gcc11_2_0-esp-2022r1-win64.zip</a> SHA256: 7213a0bf22607e9c70febaabef37822c2ae5e071ac53d6467e6031b02bb0b2bf

**xtensa-clang** LLVM for Xtensa (ESP32, ESP32-S2) based on clang

License: [Apache-2.0](#)

More info: <https://github.com/espressif/llvm-project>

Platform	Required	Download
linux-amd64	optional	<a href="https://github.com/espressif/llvm-project/releases/download/esp-14.0.0-20220415/xtensa-esp32-elf-llvm14_0_0-esp-14.0.0-20220415-linux-amd64.tar.xz">https://github.com/espressif/llvm-project/releases/download/esp-14.0.0-20220415/xtensa-esp32-elf-llvm14_0_0-esp-14.0.0-20220415-linux-amd64.tar.xz</a> SHA256: b0148627912dacf4a4cab4596ba9467cb8dd771522ca27b9526bc57b88ff366f
macos	optional	<a href="https://github.com/espressif/llvm-project/releases/download/esp-14.0.0-20220415/xtensa-esp32-elf-llvm14_0_0-esp-14.0.0-20220415-macos.tar.xz">https://github.com/espressif/llvm-project/releases/download/esp-14.0.0-20220415/xtensa-esp32-elf-llvm14_0_0-esp-14.0.0-20220415-macos.tar.xz</a> SHA256: 1a78c598825ef168c0c5668aff7848825a7b9d014bffd1f2f2484ceea9df3841
macos-arm64	optional	<a href="https://github.com/espressif/llvm-project/releases/download/esp-14.0.0-20220415/xtensa-esp32-elf-llvm14_0_0-esp-14.0.0-20220415-macos.tar.xz">https://github.com/espressif/llvm-project/releases/download/esp-14.0.0-20220415/xtensa-esp32-elf-llvm14_0_0-esp-14.0.0-20220415-macos.tar.xz</a> SHA256: 1a78c598825ef168c0c5668aff7848825a7b9d014bffd1f2f2484ceea9df3841
win64	optional	<a href="https://github.com/espressif/llvm-project/releases/download/esp-14.0.0-20220415/xtensa-esp32-elf-llvm14_0_0-esp-14.0.0-20220415-win64.zip">https://github.com/espressif/llvm-project/releases/download/esp-14.0.0-20220415/xtensa-esp32-elf-llvm14_0_0-esp-14.0.0-20220415-win64.zip</a> SHA256: 793e7bd9c40fcb9a4fababaaccf3e4c5b8d9554d406af1b1fbee51806bf8c5dd

**riscv32-esp-elf** Toolchain for 32-bit RISC-V based on GCC

License: [GPL-3.0-with-GCC-exception](#)

More info: <https://github.com/espressif/crosstool-NG>



Platform	Required	Download
linux-amd64	required	<a href="https://github.com/espressif/crosstool-NG/releases/download/esp-2022r1/riscv32-esp-elf-gcc11_2_0-esp-2022r1-linux-amd64.tar.xz">https://github.com/espressif/crosstool-NG/releases/download/esp-2022r1/riscv32-esp-elf-gcc11_2_0-esp-2022r1-linux-amd64.tar.xz</a> SHA256: 52710f804df4a033a2b621cc16cfa21023b42052819a51e35a2a164140bbf665
linux-arm64	required	<a href="https://github.com/espressif/crosstool-NG/releases/download/esp-2022r1/riscv32-esp-elf-gcc11_2_0-esp-2022r1-linux-arm64.tar.xz">https://github.com/espressif/crosstool-NG/releases/download/esp-2022r1/riscv32-esp-elf-gcc11_2_0-esp-2022r1-linux-arm64.tar.xz</a> SHA256: 812a18f2ecdc3f72c1d098c4e8baa968841099ce9d9ecf95baea85ff71e11013
linux-armel	required	<a href="https://github.com/espressif/crosstool-NG/releases/download/esp-2022r1/riscv32-esp-elf-gcc11_2_0-esp-2022r1-linux-armel.tar.xz">https://github.com/espressif/crosstool-NG/releases/download/esp-2022r1/riscv32-esp-elf-gcc11_2_0-esp-2022r1-linux-armel.tar.xz</a> SHA256: bc6e3ff8323d1f8b137374788b5615152281aab9e7561c55ab1504145677b6c7
linux-armhf	required	<a href="https://github.com/espressif/crosstool-NG/releases/download/esp-2022r1/riscv32-esp-elf-gcc11_2_0-esp-2022r1-linux-armhf.tar.xz">https://github.com/espressif/crosstool-NG/releases/download/esp-2022r1/riscv32-esp-elf-gcc11_2_0-esp-2022r1-linux-armhf.tar.xz</a> SHA256: 63f85a089fcd06939ed5e7e72ee5cdca590aa470075e409c0a4c59ef1cab3a7b
linux-i686	required	<a href="https://github.com/espressif/crosstool-NG/releases/download/esp-2022r1/riscv32-esp-elf-gcc11_2_0-esp-2022r1-linux-i686.tar.xz">https://github.com/espressif/crosstool-NG/releases/download/esp-2022r1/riscv32-esp-elf-gcc11_2_0-esp-2022r1-linux-i686.tar.xz</a> SHA256: 39d7295c30a23b5ea91baf61c207718ce86d4b1589014b030e121300370f696d
macos	required	<a href="https://github.com/espressif/crosstool-NG/releases/download/esp-2022r1/riscv32-esp-elf-gcc11_2_0-esp-2022r1-macos.tar.xz">https://github.com/espressif/crosstool-NG/releases/download/esp-2022r1/riscv32-esp-elf-gcc11_2_0-esp-2022r1-macos.tar.xz</a> SHA256: d3a6f42b02a5f1485ba3fa92b8a9d9f307f643420e22b3765e88bbe4570aee01
macos-arm64	required	<a href="https://github.com/espressif/crosstool-NG/releases/download/esp-2022r1/riscv32-esp-elf-gcc11_2_0-esp-2022r1-macos-arm64.tar.xz">https://github.com/espressif/crosstool-NG/releases/download/esp-2022r1/riscv32-esp-elf-gcc11_2_0-esp-2022r1-macos-arm64.tar.xz</a> SHA256: 23d9a715d932a3af57fd7393b0789f88d0f70fedaf5b803deb9ab81dee271bd6
win32	required	<a href="https://github.com/espressif/crosstool-NG/releases/download/esp-2022r1/riscv32-esp-elf-gcc11_2_0-esp-2022r1-win32.zip">https://github.com/espressif/crosstool-NG/releases/download/esp-2022r1/riscv32-esp-elf-gcc11_2_0-esp-2022r1-win32.zip</a> SHA256: 3e677ef068d7f154d33b0d3788b5f985c5066d110028eac44e0f76b3bda4429b
win64	required	<a href="https://github.com/espressif/crosstool-NG/releases/download/esp-2022r1/riscv32-esp-elf-gcc11_2_0-esp-2022r1-win64.zip">https://github.com/espressif/crosstool-NG/releases/download/esp-2022r1/riscv32-esp-elf-gcc11_2_0-esp-2022r1-win64.zip</a> SHA256: 324a5c679fef75313766cc48d3433c48bf23985a11b5070c5d19144538c6357b

**esp32ulp-elf** Toolchain for ESP32 ULP coprocessor

License: [GPL-3.0-or-later](https://www.gnu.org/licenses/gpl-3.0-or-later.html)

More info: <https://github.com/espressif/binutils-gdb>



Platform	Required	Download
linux-amd64	required	<a href="https://github.com/espressif/binutils-gdb/releases/download/esp32ulp-elf-v2.35_20220830/esp32ulp-elf-2.35_20220830-linux-amd64.tar.gz">https://github.com/espressif/binutils-gdb/releases/download/esp32ulp-elf-v2.35_20220830/esp32ulp-elf-2.35_20220830-linux-amd64.tar.gz</a> SHA256: b1f7801c3a16162e72393ebb772c0cbfe4d22d907be7c2c2dac168736e9195fd
linux-arm64	required	<a href="https://github.com/espressif/binutils-gdb/releases/download/esp32ulp-elf-v2.35_20220830/esp32ulp-elf-2.35_20220830-linux-arm64.tar.gz">https://github.com/espressif/binutils-gdb/releases/download/esp32ulp-elf-v2.35_20220830/esp32ulp-elf-2.35_20220830-linux-arm64.tar.gz</a> SHA256: d6671b31bab31b9b13aea25bb7d60f15484cb8bf961ddbf67a62867e5563eae5
linux-armel	required	<a href="https://github.com/espressif/binutils-gdb/releases/download/esp32ulp-elf-v2.35_20220830/esp32ulp-elf-2.35_20220830-linux-armel.tar.gz">https://github.com/espressif/binutils-gdb/releases/download/esp32ulp-elf-v2.35_20220830/esp32ulp-elf-2.35_20220830-linux-armel.tar.gz</a> SHA256: e107e7a9cd50d630b034f435a16a52db5a57388dc639a99c4c393c5e429711e9
linux-armhf	required	<a href="https://github.com/espressif/binutils-gdb/releases/download/esp32ulp-elf-v2.35_20220830/esp32ulp-elf-2.35_20220830-linux-armhf.tar.gz">https://github.com/espressif/binutils-gdb/releases/download/esp32ulp-elf-v2.35_20220830/esp32ulp-elf-2.35_20220830-linux-armhf.tar.gz</a> SHA256: 6c6dd25477b2e758d4669da3774bf664d1f012442c880f17dfdf0339e9c3dae9
linux-i686	required	<a href="https://github.com/espressif/binutils-gdb/releases/download/esp32ulp-elf-v2.35_20220830/esp32ulp-elf-2.35_20220830-linux-i686.tar.gz">https://github.com/espressif/binutils-gdb/releases/download/esp32ulp-elf-v2.35_20220830/esp32ulp-elf-2.35_20220830-linux-i686.tar.gz</a> SHA256: beb9b6737c975369b6959007739c88f44eb5afbb220f40737071540b2c1a9064
macos	required	<a href="https://github.com/espressif/binutils-gdb/releases/download/esp32ulp-elf-v2.35_20220830/esp32ulp-elf-2.35_20220830-macos.tar.gz">https://github.com/espressif/binutils-gdb/releases/download/esp32ulp-elf-v2.35_20220830/esp32ulp-elf-2.35_20220830-macos.tar.gz</a> SHA256: 5a952087b621ced16af1e375feac1371a61cb51ab7e7b44cbefb5afda2d573de
macos-arm64	required	<a href="https://github.com/espressif/binutils-gdb/releases/download/esp32ulp-elf-v2.35_20220830/esp32ulp-elf-2.35_20220830-macos-arm64.tar.gz">https://github.com/espressif/binutils-gdb/releases/download/esp32ulp-elf-v2.35_20220830/esp32ulp-elf-2.35_20220830-macos-arm64.tar.gz</a> SHA256: 73bda8476ef92d4f4abee96519abbba40e5ee32f368427469447b83cc7bb9b42
win32	required	<a href="https://github.com/espressif/binutils-gdb/releases/download/esp32ulp-elf-v2.35_20220830/esp32ulp-elf-2.35_20220830-win32.zip">https://github.com/espressif/binutils-gdb/releases/download/esp32ulp-elf-v2.35_20220830/esp32ulp-elf-2.35_20220830-win32.zip</a> SHA256: 77344715ea7d7a7a9fd0b27653f880efaf3bcc1ac843f61492d8a0365d91f731
win64	required	<a href="https://github.com/espressif/binutils-gdb/releases/download/esp32ulp-elf-v2.35_20220830/esp32ulp-elf-2.35_20220830-win64.zip">https://github.com/espressif/binutils-gdb/releases/download/esp32ulp-elf-v2.35_20220830/esp32ulp-elf-2.35_20220830-win64.zip</a> SHA256: 525e5b4c8299869a3fd5b51baad76612c5c104bd96952ae6460ad7e5b5a4e21

**cmake** CMake build system

On Linux and macOS, it is recommended to install CMake using the OS-specific package manager (like apt, yum, brew, etc.). However, for convenience it is possible to install CMake using idf\_tools.py along with the other tools.

License: [BSD-3-Clause](#)

More info: <https://github.com/Kitware/CMake>

Platform	Required	Download
linux-amd64	optional	<a href="https://github.com/Kitware/CMake/releases/download/v3.30.2/cmake-3.30.2-linux-x86_64.tar.gz">https://github.com/Kitware/CMake/releases/download/v3.30.2/cmake-3.30.2-linux-x86_64.tar.gz</a> SHA256: cdd7fb352605cee3ae53b0e18b5929b642900e33d6b0173e19f6d4f2067ebf16
linux-arm64	optional	<a href="https://github.com/Kitware/CMake/releases/download/v3.30.2/cmake-3.30.2-linux-aarch64.tar.gz">https://github.com/Kitware/CMake/releases/download/v3.30.2/cmake-3.30.2-linux-aarch64.tar.gz</a> SHA256: d18f50f01b001303d21f53c6c16ff12ee3aa45df5da1899c2fe95be7426aa026
linux-armel	optional	<a href="https://dl.espressif.com/dl/cmake/cmake-3.30.2-Linux-armv7l.tar.gz">https://dl.espressif.com/dl/cmake/cmake-3.30.2-Linux-armv7l.tar.gz</a> SHA256: 446650c69ea74817a770f96446c162bb7ad24ffecaacb35fcd4845ec7d3c9099
linux-armhf	optional	<a href="https://dl.espressif.com/dl/cmake/cmake-3.30.2-Linux-armv7l.tar.gz">https://dl.espressif.com/dl/cmake/cmake-3.30.2-Linux-armv7l.tar.gz</a> SHA256: 446650c69ea74817a770f96446c162bb7ad24ffecaacb35fcd4845ec7d3c9099
macos	optional	<a href="https://github.com/Kitware/CMake/releases/download/v3.30.2/cmake-3.30.2-macos-universal.tar.gz">https://github.com/Kitware/CMake/releases/download/v3.30.2/cmake-3.30.2-macos-universal.tar.gz</a> SHA256: c6fdda745f9ce69bca048e91955c7d043ba905d6388a62e0ff52b681ac17183c
macos-arm64	optional	<a href="https://github.com/Kitware/CMake/releases/download/v3.30.2/cmake-3.30.2-macos-universal.tar.gz">https://github.com/Kitware/CMake/releases/download/v3.30.2/cmake-3.30.2-macos-universal.tar.gz</a> SHA256: c6fdda745f9ce69bca048e91955c7d043ba905d6388a62e0ff52b681ac17183c
win32	required	<a href="https://github.com/Kitware/CMake/releases/download/v3.30.2/cmake-3.30.2-windows-x86_64.zip">https://github.com/Kitware/CMake/releases/download/v3.30.2/cmake-3.30.2-windows-x86_64.zip</a> SHA256: 48bf4b3dc2d668c578e0884cac7878e146b036ca6b5ce4f8b5572f861b004c25
win64	required	<a href="https://github.com/Kitware/CMake/releases/download/v3.30.2/cmake-3.30.2-windows-x86_64.zip">https://github.com/Kitware/CMake/releases/download/v3.30.2/cmake-3.30.2-windows-x86_64.zip</a> SHA256: 48bf4b3dc2d668c578e0884cac7878e146b036ca6b5ce4f8b5572f861b004c25

**openocd-esp32** OpenOCD for ESP32

License: GPL-2.0-only

More info: <https://github.com/espressif/openocd-esp32>

Platform	Required	Download
linux-amd64	required	<a href="https://github.com/espressif/openocd-esp32/releases/download/v0.12.0-esp32-20240821/openocd-esp32-linux-amd64-0.12.0-esp32-20240821.tar.gz">https://github.com/espressif/openocd-esp32/releases/download/v0.12.0-esp32-20240821/openocd-esp32-linux-amd64-0.12.0-esp32-20240821.tar.gz</a> SHA256: f8c68541fa38307bc0c0763b7e1e3fe4e943d5d45da07d817a73b492e103b652
linux-arm64	required	<a href="https://github.com/espressif/openocd-esp32/releases/download/v0.12.0-esp32-20240821/openocd-esp32-linux-arm64-0.12.0-esp32-20240821.tar.gz">https://github.com/espressif/openocd-esp32/releases/download/v0.12.0-esp32-20240821/openocd-esp32-linux-arm64-0.12.0-esp32-20240821.tar.gz</a> SHA256: 4d6e263d84e447354dc685848557d6c284dda7fe007ee451f729a7edfa7baad7
linux-armel	required	<a href="https://github.com/espressif/openocd-esp32/releases/download/v0.12.0-esp32-20240821/openocd-esp32-linux-armel-0.12.0-esp32-20240821.tar.gz">https://github.com/espressif/openocd-esp32/releases/download/v0.12.0-esp32-20240821/openocd-esp32-linux-armel-0.12.0-esp32-20240821.tar.gz</a> SHA256: 9d45679f2c4cf450d5e2350047cf57bb76dde2487d30cebce0a72c9173b5c45b
linux-armhf	required	<a href="https://github.com/espressif/openocd-esp32/releases/download/v0.12.0-esp32-20240821/openocd-esp32-linux-armhf-0.12.0-esp32-20240821.tar.gz">https://github.com/espressif/openocd-esp32/releases/download/v0.12.0-esp32-20240821/openocd-esp32-linux-armhf-0.12.0-esp32-20240821.tar.gz</a> SHA256: 7f56d6a0c73e3988891a0781adee4973e6b9ea4bb4584cacb88384cb3db59050
macos	required	<a href="https://github.com/espressif/openocd-esp32/releases/download/v0.12.0-esp32-20240821/openocd-esp32-macos-0.12.0-esp32-20240821.tar.gz">https://github.com/espressif/openocd-esp32/releases/download/v0.12.0-esp32-20240821/openocd-esp32-macos-0.12.0-esp32-20240821.tar.gz</a> SHA256: 565c8fabcb5f19a6e7a0864a294d74b307eccc30b9291d16d3fc90e273f0330cb4
macos-arm64	required	<a href="https://github.com/espressif/openocd-esp32/releases/download/v0.12.0-esp32-20240821/openocd-esp32-macos-arm64-0.12.0-esp32-20240821.tar.gz">https://github.com/espressif/openocd-esp32/releases/download/v0.12.0-esp32-20240821/openocd-esp32-macos-arm64-0.12.0-esp32-20240821.tar.gz</a> SHA256: 68c5c7cf3d15b9810939a5edabc6ff2c9f4fc32262de91fc292a180bc5cc0637
win32	required	<a href="https://github.com/espressif/openocd-esp32/releases/download/v0.12.0-esp32-20240821/openocd-esp32-win32-0.12.0-esp32-20240821.zip">https://github.com/espressif/openocd-esp32/releases/download/v0.12.0-esp32-20240821/openocd-esp32-win32-0.12.0-esp32-20240821.zip</a> SHA256: 463fc2903ddaf03f86ff50836c5c63cc696550b0446140159eddf2e85570c5d
win64	required	<a href="https://github.com/espressif/openocd-esp32/releases/download/v0.12.0-esp32-20240821/openocd-esp32-win64-0.12.0-esp32-20240821.zip">https://github.com/espressif/openocd-esp32/releases/download/v0.12.0-esp32-20240821/openocd-esp32-win64-0.12.0-esp32-20240821.zip</a> SHA256: 550f57369f1f1f6cc600b5dffa3378fd6164d8ea8db7c567cf41091771f090cb

**ninja** Ninja build system

On Linux and macOS, it is recommended to install ninja using the OS-specific package manager (like apt, yum, brew, etc.). However, for convenience it is possible to install ninja using idf\_tools.py along with the other tools.

License: [Apache-2.0](#)

More info: <https://github.com/ninja-build/ninja>

Platform	Required	Download
linux-amd64	optional	<a href="https://github.com/ninja-build/ninja/releases/download/v1.12.1/ninja-linux.zip">https://github.com/ninja-build/ninja/releases/download/v1.12.1/ninja-linux.zip</a> SHA256: 6f98805688d19672bd699fbbfa2c2cf0fc054ac3df1f0e6a47664d963d530255
macos	optional	<a href="https://github.com/ninja-build/ninja/releases/download/v1.12.1/ninja-mac.zip">https://github.com/ninja-build/ninja/releases/download/v1.12.1/ninja-mac.zip</a> SHA256: 89a287444b5b3e98f88a945afa50ce937b8ffd1dcc59c555ad9b1baf855298c9
macos-arm64	optional	<a href="https://github.com/ninja-build/ninja/releases/download/v1.12.1/ninja-mac.zip">https://github.com/ninja-build/ninja/releases/download/v1.12.1/ninja-mac.zip</a> SHA256: 89a287444b5b3e98f88a945afa50ce937b8ffd1dcc59c555ad9b1baf855298c9
win64	required	<a href="https://github.com/ninja-build/ninja/releases/download/v1.12.1/ninja-win.zip">https://github.com/ninja-build/ninja/releases/download/v1.12.1/ninja-win.zip</a> SHA256: f550fec705b6d6ff58f2db3c374c2277a37691678d6aba463adcbb129108467a

**idf-exe** IDF wrapper tool for Windows

License: [Apache-2.0](#)

More info: [https://github.com/espressif/idf\\_py\\_exe\\_tool](https://github.com/espressif/idf_py_exe_tool)

Platform	Required	Download
win32	required	<a href="https://github.com/espressif/idf_py_exe_tool/releases/download/v1.0.3/idf-exe-v1.0.3.zip">https://github.com/espressif/idf_py_exe_tool/releases/download/v1.0.3/idf-exe-v1.0.3.zip</a> SHA256: 7c81ef534c562354a5402ab6b90a6eb1cc8473a9f4a7b7a7f93ebbd23b4a2755
win64	required	<a href="https://github.com/espressif/idf_py_exe_tool/releases/download/v1.0.3/idf-exe-v1.0.3.zip">https://github.com/espressif/idf_py_exe_tool/releases/download/v1.0.3/idf-exe-v1.0.3.zip</a> SHA256: 7c81ef534c562354a5402ab6b90a6eb1cc8473a9f4a7b7a7f93ebbd23b4a2755

**ccache** Ccache (compiler cache)

License: [GPL-3.0-or-later](#)

More info: <https://github.com/ccache/ccache>

Platform	Required	Download
win64	required	<a href="https://github.com/ccache/ccache/releases/download/v4.10.2/ccache-4.10.2-windows-x86_64.zip">https://github.com/ccache/ccache/releases/download/v4.10.2/ccache-4.10.2-windows-x86_64.zip</a> SHA256: 6252f081876a9a9f700fae13a5aec5d0d486b28261d7f1f72ac11c7ad9df4da9

**dfu-util** dfu-util (Device Firmware Upgrade Utilities)

License: [GPL-2.0-only](#)

More info: <http://dfu-util.sourceforge.net/>

Platform	Required	Download
win64	required	<a href="https://dl.espressif.com/dl/dfu-util-0.9-win64.zip">https://dl.espressif.com/dl/dfu-util-0.9-win64.zip</a> SHA256: 5816d7ec68ef3ac07b5ac9fb9837c57d2efe45b6a80a2f2bbe6b40b1c15c470e

**esp-rom-elfs** ESP ROM ELF'sLicense: [Apache-2.0](#)More info: <https://github.com/espressif/esp-rom-elfs>

Platform	Required	Download
any	required	<a href="https://github.com/espressif/esp-rom-elfs/releases/download/20220823/esp-rom-elfs-20220823.tar.gz">https://github.com/espressif/esp-rom-elfs/releases/download/20220823/esp-rom-elfs-20220823.tar.gz</a> SHA256: add4bedbdd950c8409ff45bbf5610316e7d14c4635ea6906f057f2183ab3e3e9

## 4.29 Unit Testing in ESP32-S2

ESP-IDF provides the following methods to test software.

- Target based tests using a central unit test application which runs on the esp32s2. These tests use the [Unity](#) unit test framework. They can be integrated into an ESP-IDF component by placing them in the component's `test` subdirectory. This document mainly introduces this target based tests.
- Linux-host based unit tests in which all the hardware are abstracted via mocks. Linux-host based tests are still under development and only a small fraction of IDF components support them, currently. They are covered here: [Unit Testing on Linux](#).

### 4.29.1 Normal Test Cases

Unit tests are located in the `test` subdirectory of a component. Tests are written in C, and a single C source file can contain multiple test cases. Test files start with the word “test” .

Each test file should include the `unity.h` header and the header for the C module to be tested.

Tests are added in a function in the C file as follows:

```
TEST_CASE("test name", "[module name]")
{
    // Add test here
}
```

- The first argument is a descriptive name for the test.
- The second argument is an identifier in square brackets. Identifiers are used to group related test, or tests with specific properties.

---

**Note:** There is no need to add a main function with `UNITY_BEGIN()` and `UNITY_END()` in each test case. `unity_platform.c` will run `UNITY_BEGIN()` autonomously, and run the test cases, then call `UNITY_END()`.

---

The `test` subdirectory should contain a *component CMakeLists.txt*, since they are themselves components (i.e., a test component). ESP-IDF uses the Unity test framework located in the `unity` component. Thus, each test component should specify the `unity` component as a component requirement using the `REQUIRES` argument. Normally, components *should list their sources manually*; for component tests however, this requirement is relaxed and the use of the `SRC_DIRS` argument in `idf_component_register` is advised.

Overall, the minimal `test` subdirectory `CMakeLists.txt` file should contain the following:

```
idf_component_register(SRC_DIRS "."
                      INCLUDE_DIRS "."
                      REQUIRES unity)
```

See <http://www.throwtheswitch.org/unity> for more information about writing tests in Unity.

### 4.29.2 Multi-device Test Cases

The normal test cases will be executed on one DUT (Device Under Test). However, components that require some form of communication (e.g., GPIO, SPI) require another device to communicate with, thus cannot be tested through normal test cases. Multi-device test cases involve writing multiple test functions, and running them on multiple DUTs.

The following is an example of a multi-device test case:

```
void gpio_master_test()
{
    gpio_config_t slave_config = {
        .pin_bit_mask = 1 << MASTER_GPIO_PIN,
        .mode = GPIO_MODE_INPUT,
    };
    gpio_config(&slave_config);
    unity_wait_for_signal("output high level");
    TEST_ASSERT(gpio_get_level(MASTER_GPIO_PIN) == 1);
}

void gpio_slave_test()
{
    gpio_config_t master_config = {
        .pin_bit_mask = 1 << SLAVE_GPIO_PIN,
        .mode = GPIO_MODE_OUTPUT,
    };
    gpio_config(&master_config);
    gpio_set_level(SLAVE_GPIO_PIN, 1);
    unity_send_signal("output high level");
}

TEST_CASE_MULTIPLE_DEVICES("gpio multiple devices test example", "[driver]", gpio_
↵master_test, gpio_slave_test);
```

The macro `TEST_CASE_MULTIPLE_DEVICES` is used to declare a multi-device test case.

- The first argument is test case name.
- The second argument is test case description.
- From the third argument, up to 5 test functions can be defined, each function will be the entry point of tests running on each DUT.

Running test cases from different DUTs could require synchronizing between DUTs. We provide `unity_wait_for_signal` and `unity_send_signal` to support synchronizing with UART. As the scenario in the above example, the slave should get GPIO level after master set level. DUT UART console will prompt and user interaction is required:

DUT1 (master) console:

```
Waiting for signal: [output high level]!
Please press "Enter" key to once any board send this signal.
```

DUT2 (slave) console:

```
Send signal: [output high level]!
```

Once the signal is sent from DUT2, you need to press “Enter” on DUT1, then DUT1 unblocks from `unity_wait_for_signal` and starts to change GPIO level.

### 4.29.3 Multi-stage Test Cases

The normal test cases are expected to finish without reset (or only need to check if reset happens). Sometimes we expect to run some specific tests after certain kinds of reset. For example, we want to test if the reset reason is correct after a wake up from deep sleep. We need to create a deep-sleep reset first and then check the reset reason. To support this, we can define multi-stage test cases, to group a set of test functions:

```
static void trigger_deepsleep(void)
{
    esp_sleep_enable_timer_wakeup(2000);
    esp_deep_sleep_start();
}

void check_deepsleep_reset_reason()
{
    soc_reset_reason_t reason = esp_rom_get_reset_reason(0);
    TEST_ASSERT(reason == RESET_REASON_CORE_DEEP_SLEEP);
}

TEST_CASE_MULTIPLE_STAGES("reset reason check for deepsleep", "[esp32s2]", trigger_
↪deepsleep, check_deepsleep_reset_reason);
```

Multi-stage test cases present a group of test functions to users. It needs user interactions (select cases and select different stages) to run the case.

### 4.29.4 Tests For Different Targets

Some tests (especially those related to hardware) cannot run on all targets. Below is a guide how to make your unit tests run on only specified targets.

1. Wrap your test code by `!(TEMPORARY_)DISABLED_FOR_TARGETS()` macros and place them either in the original test file, or separate the code into files grouped by functions, but make sure all these files will be processed by the compiler. E.g.:

```
#if !TEMPORARY_DISABLED_FOR_TARGETS(ESP32, ESP8266)
TEST_CASE("a test that is not ready for esp32 and esp8266 yet", "[ ]")
{
}
#endif //!TEMPORARY_DISABLED_FOR_TARGETS(ESP32, ESP8266)
```

Once you need one of the tests to be compiled on a specified target, just modify the targets in the disabled list. It's more encouraged to use some general conception that can be described in `soc_caps.h` to control the disabling of tests. If this is done but some of the tests are not ready yet, use both of them (and remove `!(TEMPORARY_)DISABLED_FOR_TARGETS()` later). E.g.:

```
#if SOC_SDIO_SLAVE_SUPPORTED
#if !TEMPORARY_DISABLED_FOR_TARGETS(ESP64)
TEST_CASE("a sdio slave tests that is not ready for esp64 yet", "[sdio_slave]")
{
    //available for esp32 now, and will be available for esp64 in the future
}
#endif //!TEMPORARY_DISABLED_FOR_TARGETS(ESP64)
#endif //SOC_SDIO_SLAVE_SUPPORTED
```

2. For test code that you are 100% for sure that will not be supported (e.g. no peripheral at all), use `DISABLED_FOR_TARGETS`; for test code that should be disabled temporarily, or due to lack of runners, etc., use `TEMPORARY_DISABLED_FOR_TARGETS`.

Some old ways of disabling unit tests for targets, that have obvious disadvantages, are deprecated:

- DON'T put the test code under `test/target` folder and use `CMakeLists.txt` to choose one of the target folder. This is prevented because test code is more likely to be reused than the implementations. If you put

something into `test/esp32` just to avoid building it on `esp32s2`, it's hard to make the code tidy if you want to enable the test again on `esp32s3`.

- DON'T use `CONFIG_IDF_TARGET_XXX` macros to disable the test items any more. This makes it harder to track disabled tests and enable them again. Also, a black-list style `#if !disabled` is preferred to white-list style `#if CONFIG_IDF_TARGET_XXX`, since you will not silently disable cases when new targets are added in the future. But for test implementations, it's allowed to use `#if CONFIG_IDF_TARGET_XXX` to pick one of the implementation code.
  - Test item: some items that will be performed on some targets, but skipped on other targets. E.g. There are three test items SD 1-bit, SD 4-bit and SDSPI. For ESP32-S2, which doesn't have SD host, among the tests only SDSPI is enabled on ESP32-S2.
  - Test implementation: some code will always happen, but in different ways. E.g. There is no SDIO PKT\_LEN register on ESP8266. If you want to get the length from the slave as a step in the test process, you can have different implementation code protected by `#if CONFIG_IDF_TARGET_` reading in different ways. But please avoid using `#else` macro. When new target is added, the test case will fail at building stage, so that the maintainer will be aware of this, and choose one of the implementations explicitly.

### 4.29.5 Building Unit Test App

Follow the setup instructions in the top-level `esp-idf` README. Make sure that `IDF_PATH` environment variable is set to point to the path of `esp-idf` top-level directory.

Change into `tools/unit-test-app` directory to configure and build it:

- `idf.py menuconfig` - configure unit test app.
- `idf.py -T all build` - build unit test app with tests for each component having tests in the `test` subdirectory.
- `idf.py -T "xxx yyy" build` - build unit test app with tests for some space-separated specific components (For instance: `idf.py -T heap build` - build unit tests only for `heap` component directory).
- `idf.py -T all -E "xxx yyy" build` - build unit test app with all unit tests, except for unit tests of some components (For instance: `idf.py -T all -E "ulp mbedtls" build` - build all unit tests excludes `ulp` and `mbedtls` components).

---

**Note:** Due to inherent limitations of Windows command prompt, following syntax has to be used in order to build `unit-test-app` with multiple components: `idf.py -T xxx -T yyy build` or with escaped quotes: `idf.py -T \"xxx yyy\" build` in PowerShell or `idf.py -T ^"ssd1306 hts221\" build` in Windows command prompt.

---

When the build finishes, it will print instructions for flashing the chip. You can simply run `idf.py flash` to flash all build output.

You can also run `idf.py -T all flash` or `idf.py -T xxx flash` to build and flash. Everything needed will be rebuilt automatically before flashing.

Use `menuconfig` to set the serial port for flashing. For more information, see <tools/unit-test-app/README.md>.

### 4.29.6 Running Unit Tests

After flashing reset the ESP32-S2 and it will boot the unit test app.

When unit test app is idle, press “Enter” will make it print test menu with all available tests:

```
Here's the test menu, pick your combo:
(1)  "esp_ota_begin() verifies arguments" [ota]
(2)  "esp_ota_get_next_update_partition logic" [ota]
(3)  "Verify bootloader image in flash" [bootloader_support]
(4)  "Verify unit test app image" [bootloader_support]
(5)  "can use new and delete" [cxx]
```

(continues on next page)



(continued from previous page)

```

(6)    "can call virtual functions" [cxx]
(7)    "can use static initializers for non-POD types" [cxx]
(8)    "can use std::vector" [cxx]
(9)    "static initialization guards work as expected" [cxx]
(10)   "global initializers run in the correct order" [cxx]
(11)   "before scheduler has started, static initializers work correctly" [cxx]
(12)   "adc2 work with wifi" [adc]
(13)   "gpio master/slave test example" [ignore][misc][test_env=UT_T2_1][multi_
→device]
      (1)    "gpio_master_test"
      (2)    "gpio_slave_test"
(14)   "SPI Master clockdiv calculation routines" [spi]
(15)   "SPI Master test" [spi][ignore]
(16)   "SPI Master test, interaction of multiple devs" [spi][ignore]
(17)   "SPI Master no response when switch from host1 (SPI2) to host2 (SPI3)"_
→[spi]
(18)   "SPI Master DMA test, TX and RX in different regions" [spi]
(19)   "SPI Master DMA test: length, start, not aligned" [spi]
(20)   "reset reason check for deepsleep" [esp32s2][test_env=UT_T2_1][multi_stage]
      (1)    "trigger_deepsleep"
      (2)    "check_deepsleep_reset_reason"

```

The normal case will print the case name and description. Master-slave cases will also print the sub-menu (the registered test function names).

Test cases can be run by inputting one of the following:

- Test case name in quotation marks to run a single test case
- Test case index to run a single test case
- Module name in square brackets to run all test cases for a specific module
- An asterisk to run all test cases

[multi\_device] and [multi\_stage] tags tell the test runner whether a test case is a multiple devices or multiple stages of test case. These tags are automatically added by `TEST_CASE_MULTIPLE_STAGES` and `TEST_CASE_MULTIPLE_DEVICES` macros.

After you select a multi-device test case, it will print sub-menu:

```

Running gpio master/slave test example...
gpio master/slave test example
      (1)    "gpio_master_test"
      (2)    "gpio_slave_test"

```

You need to input a number to select the test running on the DUT.

Similar to multi-device test cases, multi-stage test cases will also print sub-menu:

```

Running reset reason check for deepsleep...
reset reason check for deepsleep
      (1)    "trigger_deepsleep"
      (2)    "check_deepsleep_reset_reason"

```

First time you execute this case, input 1 to run first stage (trigger deepsleep). After DUT is rebooted and able to run test cases, select this case again and input 2 to run the second stage. The case only passes if the last stage passes and all previous stages trigger reset.

### 4.29.7 Timing Code with Cache Compensated Timer

Instructions and data stored in external memory (e.g. SPI Flash and SPI RAM) are accessed through the CPU's unified instruction and data cache. When code or data is in cache, access is very fast (i.e., a cache hit).



However, if the instruction or data is not in cache, it needs to be fetched from external memory (i.e., a cache miss). Access to external memory is significantly slower, as the CPU must execute stall cycles whilst waiting for the instruction or data to be retrieved from external memory. This can cause the overall code execution speed to vary depending on the number of cache hits or misses.

Code and data placements can vary between builds, and some arrangements may be more favorable with regards to cache access (i.e., minimizing cache misses). This can technically affect execution speed, however these factors are usually irrelevant as their effect ‘average out’ over the device’s operation.

The effect of the cache on execution speed, however, can be relevant in benchmarking scenarios (especially micro benchmarks). There might be some variability in measured time between runs and between different builds. A technique for eliminating for some of the variability is to place code and data in instruction or data RAM (IRAM/DRAM), respectively. The CPU can access IRAM and DRAM directly, eliminating the cache out of the equation. However, this might not always be viable as the size of IRAM and DRAM is limited.

The cache compensated timer is an alternative to placing the code/data to be benchmarked in IRAM/DRAM. This timer uses the processor’s internal event counters in order to determine the amount of time spent on waiting for code/data in case of a cache miss, then subtract that from the recorded wall time.

```
// Start the timer
ccomp_timer_start();

// Function to time
func_code_to_time();

// Stop the timer, and return the elapsed time in microseconds relative to
// ccomp_timer_start
int64_t t = ccomp_timer_stop();
```

One limitation of the cache compensated timer is that the task that benchmarked functions should be pinned to a core. This is due to each core having its own event counters that are independent of each other. For example, if `ccomp_timer_start` gets called on one core, put to sleep by the scheduler, wakes up, and gets rescheduled on the other core, then the corresponding `ccomp_timer_stop` will be invalid.

## 4.29.8 Mocks

---

**Note:** Currently, mocking is only possible with some selected components when running on the Linux host. In the future, we plan to make essential components in IDF mockable. This will also include mocking when running on the ESP32-S2.

---

One of the biggest problems regarding unit testing of embedded systems are the strong hardware dependencies. Running unit tests directly on the ESP32-S2 can be especially difficult for higher layer components for the following reasons:

- Decreased test reliability due to lower layer components and/or hardware setup.
- Increased difficulty in testing edge cases due to limitations of lower layer components and/or hardware setup
- Increased difficulty in identifying the root cause due to the large number of dependencies influencing the behavior

When testing a particular component, (i.e., the component under test), software mocking allows the dependencies of the component under test to be substituted (i.e., mocked) entirely in software. To allow software mocking, ESP-IDF integrates the **CMock** mocking framework as a component. With the addition of some CMake functions in the ESP-IDF’s build system, it is possible to conveniently mock the entirety (or a part of) an IDF component.

Ideally, all components that the component under test is dependent on should be mocked, thus allowing the test environment complete control over all interactions with the component under test. However, if mocking all dependent components becomes too complex or too tedious (e.g. because you need to mock too many function calls) you have the following options:

- Include more “real” IDF code in the tests. This may work but increases the dependency on the “real” code’s behavior. Furthermore, once a test fails, you may not know if the failure is in your actual code under tests or the “real” IDF code.
- Re-evaluate the design of the code under test and attempt to reduce its dependencies by dividing the code under test into more manageable components. This may seem burdensome but it is common knowledge that unit tests often expose software design weaknesses. Fixing design weaknesses will not only help with unit testing in the short term, but will help future code maintenance as well.

Refer to [cmock/CMock/docs/CMock\\_Summary.md](#) for more details on how CMock works and how to create and use mocks.

## Requirements

The Linux target is the only target where mocking currently works. The following requirements are necessary to generate the mocks:

- Installed ESP-IDF including all ESP-IDF requirements
- System package requirements (`libbsd`, `libbsd-dev`)
- A recent enough Linux or macOS version and GCC compiler
- All components the application depends on must be either supported on the Linux target (Linux/POSIX simulator) or mock-able

An application that runs on the Linux target has to set the `COMPONENTS` variable to `main` in the `CMakeLists.txt` of the application’s root directory:

```
set(COMPONENTS main)
```

This prevents the automatic inclusion of all components from ESP-IDF to the build process which is otherwise done for convenience.

## Mock a Component

To create a mock version of a component, called a *component mock*, the component needs to be overwritten in a particular way. Overriding a component entails creating a component with the exact same name as the original component, then let the build system discover it later than the original component (see [Multiple components with the same name](#) for more details).

In the component mock, the following parts are specified:

- The headers providing the functions to generate mocks for
- Include paths of the aforementioned headers
- Dependencies of the mock component (this is necessary e.g. if the headers include files from other components)

All these parts have to be specified using the IDF build system function `idf_component_mock`. You can use the IDF build system function `idf_component_get_property` with the tag `COMPONENT_OVERRIDEN_DIR` to access the component directory of the original component and then register the mock component parts using `idf_component_mock`:

```
idf_component_get_property(original_component_dir <original-component-name>_  
↪COMPONENT_OVERRIDEN_DIR)  
...  
idf_component_mock(INCLUDE_DIRS "${original_component_dir}/include"  
    REQUIRES freertos  
    MOCK_HEADER_FILES ${original_component_dir}/include/header_containing_  
↪functions_to_mock.h)
```

The component mock also requires a separate mock directory containing a `mock_config.yaml` file that configures CMock. A simple `mock_config.yaml` could look like this:

```
:cmock:  
  :plugins:  
    - expect  
    - expect_any_args
```

For more details about the CMock configuration yaml file, have a look at [cmock/CMock/docs/CMock\\_Summary.md](#).

Note that the component mock does not have to mock the original component in its entirety. As long as the test project's dependencies and dependencies of other code to the original components are satisfied by the component mock, partial mocking is adequate. In fact, most of the component mocks in IDF in `tools/mocks` are only partially mocking the original component.

Examples of component mocks can be found under [tools/mocks](#) in the IDF directory. General information on how to *override an IDF component* can be found in [Multiple components with the same name](#).

### Adjustments in Unit Test

The unit test needs to inform the cmake build system to mock dependent components (i.e., it needs to override the original component with the mock component). This is done by either placing the component mock into the project's `components` directory or adding the mock component's directory using the following line in the project's root `CMakeLists.txt`:

```
list(APPEND EXTRA_COMPONENT_DIRS "<mock_component_dir>")
```

Both methods will override existing components in ESP-IDF with the component mock. The latter is particularly convenient if you use component mocks that are already supplied by IDF.

Users should refer to the `esp_event` host-based unit test and its [esp\\_event/host\\_test/esp\\_event\\_unit\\_test/CMakeLists.txt](#) as an example of a component mock.

## 4.30 Unit Testing on Linux

---

**Note:** Host testing with IDF is experimental for now. We try our best to keep interfaces stable but can't guarantee it for now. Feedback via [github](#) or the forum on [esp32.com](#) is highly welcome, though and may influence the future design of the host-based tests.

---

This article provides an overview of unit tests with IDF on Linux. For using unit tests on the target, please refer to [target based unit testing](#).

### 4.30.1 Embedded Software Tests

Embedded software tests are challenging due to the following factors:

- Difficulties running tests efficiently.
- Lack of many operating system abstractions when interfacing with hardware, making it difficult to isolate code under test.

To solve these two problems, Linux host-based tests with [CMock](#) are introduced. Linux host-based tests are more efficient than unit tests on the target since they:

- Compile the necessary code only
- Don't need time to upload to a target
- Run much faster on a host-computer, compared to an ESP

Using the [CMock](#) framework also solves the problem of hardware dependencies. Through mocking, hardware details are emulated and specified at run time, but only if necessary.

Of course, using code on the host and using mocks does not fully represent the target device. Thus, two kinds of tests are recommended:

1. Unit tests which test program logic on a Linux machine, isolated through mocks.
2. System/Integration tests which test the interaction of components and the whole system. They run on the target, where irrelevant components and code may as well be emulated via mocks.

This documentation is about the first kind of tests. Refer to *target based unit testing* for more information on target tests (the second kind of tests).

### 4.30.2 IDF Unit Tests on Linux Host

The current focus of the Linux host tests is on creating isolated unit tests of components, while mocking the component's dependencies with CMock.

A complete implementation of IDF to run on Linux does not exist currently.

There are currently two examples for running IDF-built code on Linux host:

- An example [hello-world application](#)
- A [unit test for NVS](#).

Inside the component which should be tested, there is a separate directory `host_test`, besides the “traditional” test directory or the `test_apps` directory. It has one or more subdirectories:

```
- host_test/
    - fixtures/
        contains test fixtures (structs/functions to do test case set-up
        ↪and tear-down).
        If there are no fixtures, this can be omitted.
    - <test_name>/
        IDF applications which run the tests
    - <test_name2>/
        Further tests are possible.
```

The IDF applications inside `host_test` set the mocking configuration as described in the *IDF unit test documentation*.

The [NVS page unit test](#) provides some illustration of how to control the mocks.

#### Requirements

- Installed ESP-IDF including all ESP-IDF requirements
- System package requirements (`libbsd`, `libbsd-dev`)
- A recent enough Linux or macOS version and GCC compiler
- All components the application depends on must be either supported on the Linux target (Linux/POSIX simulator) or mock-able

An application that runs on the Linux target has to set the `COMPONENTS` variable to `main` in the `CMakeLists.txt` of the application's root directory:

```
set(COMPONENTS main)
```

This prevents the automatic inclusion of all components from ESP-IDF to the build process which is otherwise done for convenience.

The host tests have been tested on Ubuntu 20.04 with GCC version 9 and 10.

## 4.31 USB OTG Console

On chips with an integrated USB peripheral, it is possible to use USB Communication Device Class (CDC) to implement the serial console, instead of using UART with an external USB-UART bridge chip. ESP32-S2 ROM code contains a USB CDC implementation, which supports for some basic functionality without requiring the application to include the USB stack:

- Bidirectional serial console, which can be used with *IDF Monitor* or another serial monitor
- Flashing using `esptool.py` and `idf.py flash`.
- *Device Firmware Update (DFU)* interface for flashing the device using `dfu-util` and `idf.py dfu`.

---

**Note:** At the moment, this “USB Console” feature is incompatible with TinyUSB stack. However, if TinyUSB is used, it can provide its own CDC implementation.

---

### 4.31.1 Hardware Requirements

Connect ESP32-S2 to the USB port as follows

GPIO	USB
20	D+ (green)
19	D- (white)
GND	GND (black)
	+5V (red)

Some development boards may offer a USB connector for the internal USB peripheral—in that case, no extra connections are required.

### 4.31.2 Software Configuration

USB console feature can be enabled using `CONFIG_ESP_CONSOLE_USB_CDC` option in menuconfig tool (see *CONFIG\_ESP\_CONSOLE\_UART*).

Once the option is enabled, build the project as usual.

### 4.31.3 Uploading the Application

#### Initial Upload

If the ESP32-S2 is not yet flashed with a program which enables USB console, we can not use `idf.py flash` command with the USB CDC port. There are 3 alternative options to perform the initial upload listed below.

Once the initial upload is done, the application will start up and a USB CDC port will appear in the system.

---

**Note:** The port name may change after the initial upload, so check the port list again before running `idf.py monitor`.

---

#### Initial upload using the ROM download mode, over USB CDC

- Place ESP32-S2 into download mode. To do this, keep GPIO0 low while toggling reset. On many development boards, the “Boot” button is connected to GPIO0, and you can press “Reset” button while holding “Boot”

- A serial port will appear in the system. On most operating systems (Windows 8 and later, Linux, macOS) driver installation is not required. Find the port name using Device Manager (Windows) or by listing `/dev/ttyACM*` devices on Linux or `/dev/cu*` devices on macOS.
- Run `idf.py flash -p PORT` to upload the application, with `PORT` determined in the previous step

### Initial upload using the ROM download mode, over USB DFU

- Place ESP32-S2 into download mode. To do this, keep GPIO0 low while toggling reset. On many development boards, the “Boot” button is connected to GPIO0, and you can press “Reset” button while holding “Boot” button.
- Run `idf.py dfu-flash`.

See [Flashing the DFU Image](#) for details about DFU flashing.

**Initial upload using UART** On development boards with a USB-UART bridge, upload the application over UART: `idf.py flash -p PORT` where `PORT` is the name of the serial port provided by the USB-UART bridge.

### Subsequent Usage

Once the application is uploaded for the first time, you can run `idf.py flash` and `idf.py monitor` as usual.

## 4.31.4 Limitations

There are several limitations to the USB console feature. These may or may not be significant, depending on the type of application being developed, and the development workflow. Most of these limitations stem from the fact that USB CDC is implemented in software, so the console working over USB CDC is more fragile and complex than a console working over UART.

1. If the application crashes, panic handler output may not be sent over USB CDC in some cases. If the memory used by the CDC driver is corrupted, or there is some other system-level issue, CDC may not work for sending panic handler messages over USB. This does work in many situations, but is not guaranteed to work as reliably as the UART output does. Similarly, if the application enters a boot loop before the USB CDC driver has a chance to start up, there will be no console output.
2. If the application accidentally reconfigures the USB peripheral pins, or disables the USB peripheral, USB CDC device will disappear from the system. After fixing the issue in the application, you will need to follow the [Initial Upload](#) process to flash the application again.
3. If the application enters light sleep (including automatic light sleep) or deep sleep mode, USB CDC device will disappear from the system.
4. USB CDC driver reserves some amount of RAM and increases application code size. Keep this in mind if trying to optimize application memory usage.
5. By default, the low-level `esp_rom_printf` feature and `ESP_EARLY_LOG` are disabled when USB CDC is used. These can be enabled using `CONFIG_ESP_CONSOLE_USB_CDC_SUPPORT_ETS_PRINTF` option. With this option enabled, `esp_rom_printf` can be used, at the expense of increased IRAM usage. Keep in mind that the cost of `esp_rom_printf` and `ESP_EARLY_LOG` over USB CDC is significantly higher than over UART. This makes these logging mechanisms much less suitable for “printf debugging”, especially in the interrupt handlers.
6. If you are developing an application which uses the USB peripheral with the TinyUSB stack, this USB Console feature can not be used. This is mainly due to the following reasons:
  - This feature relies on a different USB CDC software stack in ESP32-S2 ROM.
  - USB descriptors used by the ROM CDC stack may be different from the descriptors used by TinyUSB.
  - When developing applications which use USB peripheral, it is very likely that USB functionality will not work or will not fully work at some moments during development. This can be due to misconfigured USB descriptors, errors in the USB stack usage, or other reasons. In this case, using the UART console for flashing and monitoring provides a much better development experience.
7. When debugging the application using JTAG, USB CDC may stop working if the CPU is stopped on a breakpoint. USB CDC operation relies on interrupts from the USB peripheral being serviced periodically. If the

host computer doesn't receive valid responses from the USB device side for some time, it may decide to disconnect the device. The actual time depends on the OS and the driver, and ranges from a few hundred milliseconds to a few seconds.

## 4.32 Wi-Fi Driver

### 4.32.1 ESP32-S2 Wi-Fi Feature List

The following features are supported:

- 4 virtual Wi-Fi interfaces, which are STA, AP, Sniffer and reserved.
- Station-only mode, AP-only mode, station/AP-coexistence mode
- IEEE 802.11b, IEEE 802.11g, IEEE 802.11n, and APIs to configure the protocol mode
- WPA/WPA2/WPA3/WPA2-Enterprise/WPA3-Enterprise/WAPI/WPS and DPP
- AMSDU, AMPDU, HT40, QoS, and other key features
- Modem-sleep
- The Espressif-specific ESP-NOW protocol and Long Range mode, which supports up to **1 km** of data traffic
- Up to 20 MBit/s TCP throughput and 30 MBit/s UDP throughput over the air
- Sniffer
- Both fast scan and all-channel scan
- Multiple antennas
- Channel state information

### 4.32.2 How To Write a Wi-Fi Application

#### Preparation

Generally, the most effective way to begin your own Wi-Fi application is to select an example which is similar to your own application, and port the useful part into your project. It is not a MUST, but it is strongly recommended that you take some time to read this article first, especially if you want to program a robust Wi-Fi application.

This article is supplementary to the Wi-Fi APIs/Examples. It describes the principles of using the Wi-Fi APIs, the limitations of the current Wi-Fi API implementation, and the most common pitfalls in using Wi-Fi. This article also reveals some design details of the Wi-Fi driver. We recommend you to select an [example](#).

#### Setting Wi-Fi Compile-time Options

Refer to [Wi-Fi Menuconfig](#).

#### Init Wi-Fi

Refer to [ESP32-S2 Wi-Fi station General Scenario](#) and [ESP32-S2 Wi-Fi AP General Scenario](#).

#### Start/Connect Wi-Fi

Refer to [ESP32-S2 Wi-Fi station General Scenario](#) and [ESP32-S2 Wi-Fi AP General Scenario](#).



## Event-Handling

Generally, it is easy to write code in “sunny-day” scenarios, such as [WIFI\\_EVENT\\_STA\\_START](#) and [WIFI\\_EVENT\\_STA\\_CONNECTED](#). The hard part is to write routines in “rainy-day” scenarios, such as [WIFI\\_EVENT\\_STA\\_DISCONNECTED](#). Good handling of “rainy-day” scenarios is fundamental to robust Wi-Fi applications. Refer to [ESP32-S2 Wi-Fi Event Description](#), [ESP32-S2 Wi-Fi station General Scenario](#), and [ESP32-S2 Wi-Fi AP General Scenario](#). See also [an overview of event handling in ESP-IDF](#).

## Write Error-Recovery Routines Correctly at All Times

Just like the handling of “rainy-day” scenarios, a good error-recovery routine is also fundamental to robust Wi-Fi applications. Refer to [ESP32-S2 Wi-Fi API Error Code](#).

### 4.32.3 ESP32-S2 Wi-Fi API Error Code

All of the ESP32-S2 Wi-Fi APIs have well-defined return values, namely, the error code. The error code can be categorized into:

- No errors, e.g., ESP\_OK means that the API returns successfully.
- Recoverable errors, such as ESP\_ERR\_NO\_MEM.
- Non-recoverable, non-critical errors.
- Non-recoverable, critical errors.

Whether the error is critical or not depends on the API and the application scenario, and it is defined by the API user.

**The primary principle to write a robust application with Wi-Fi API is to always check the error code and write the error-handling code.** Generally, the error-handling code can be used:

- For recoverable errors, in which case you can write a recoverable-error code. For example, when [esp\\_wifi\\_start\(\)](#) returns ESP\_ERR\_NO\_MEM, the recoverable-error code `vTaskDelay` can be called in order to get a microseconds’ delay for another try.
- For non-recoverable, yet non-critical errors, in which case printing the error code is a good method for error handling.
- For non-recoverable and also critical errors, in which case “assert” may be a good method for error handling. For example, if [esp\\_wifi\\_set\\_mode\(\)](#) returns ESP\_ERR\_WIFI\_NOT\_INIT, it means that the Wi-Fi driver is not initialized by [esp\\_wifi\\_init\(\)](#) successfully. You can detect this kind of error very quickly in the application development phase.

In `esp_err.h`, ESP\_ERROR\_CHECK checks the return values. It is a rather commonplace error-handling code and can be used as the default error-handling code in the application development phase. However, it is strongly recommended that API users write their own error-handling code.

### 4.32.4 ESP32-S2 Wi-Fi API Parameter Initialization

When initializing struct parameters for the API, one of two approaches should be followed:

- Explicitly set all fields of the parameter.
- Use get API to get current configuration first, then set application specific fields.

Initializing or getting the entire structure is very important, because most of the time the value 0 indicates that the default value is used. More fields may be added to the struct in the future and initializing these to zero ensures the application will still work correctly after ESP-IDF is updated to a new release.

### 4.32.5 ESP32-S2 Wi-Fi Programming Model

The ESP32-S2 Wi-Fi programming model is depicted as follows:

The Wi-Fi driver can be considered a black box that knows nothing about high-layer code, such as the TCP/IP stack, application task, and event task. The application task (code) generally calls [Wi-Fi driver APIs](#) to initialize Wi-Fi



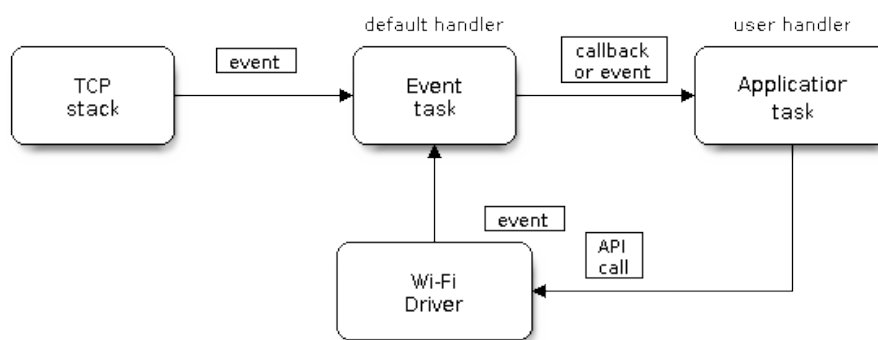

Fig. 42: Wi-Fi Programming Model

and handles Wi-Fi events when necessary. Wi-Fi driver receives API calls, handles them, and posts events to the application.

Wi-Fi event handling is based on the *esp\_event library*. Events are sent by the Wi-Fi driver to the *default event loop*. Application may handle these events in callbacks registered using *esp\_event\_handler\_register()*. Wi-Fi events are also handled by *esp\_netif component* to provide a set of default behaviors. For example, when Wi-Fi station connects to an AP, *esp\_netif* will automatically start the DHCP client by default.

### 4.32.6 ESP32-S2 Wi-Fi Event Description

#### WIFI\_EVENT\_WIFI\_READY

The Wi-Fi driver will never generate this event, which, as a result, can be ignored by the application event callback. This event may be removed in future releases.

#### WIFI\_EVENT\_SCAN\_DONE

The scan-done event is triggered by *esp\_wifi\_scan\_start()* and will arise in the following scenarios:

- The scan is completed, e.g., the target AP is found successfully, or all channels have been scanned.
- The scan is stopped by *esp\_wifi\_scan\_stop()*.
- The *esp\_wifi\_scan\_start()* is called before the scan is completed. A new scan will override the current scan and a scan-done event will be generated.

The scan-done event will not arise in the following scenarios:

- It is a blocked scan.
- The scan is caused by *esp\_wifi\_connect()*.

Upon receiving this event, the event task does nothing. The application event callback needs to call *esp\_wifi\_scan\_get\_ap\_num()* and *esp\_wifi\_scan\_get\_ap\_records()* to fetch the scanned AP list and trigger the Wi-Fi driver to free the internal memory which is allocated during the scan (**do not forget to do this!**). Refer to *ESP32-S2 Wi-Fi Scan* for a more detailed description.

#### WIFI\_EVENT\_STA\_START

If *esp\_wifi\_start()* returns *ESP\_OK* and the current Wi-Fi mode is station or station/AP, then this event will arise. Upon receiving this event, the event task will initialize the LwIP network interface (netif). Generally, the application event callback needs to call *esp\_wifi\_connect()* to connect to the configured AP.

## WIFI\_EVENT\_STA\_STOP

If `esp_wifi_stop()` returns `ESP_OK` and the current Wi-Fi mode is station or station/AP, then this event will arise. Upon receiving this event, the event task will release the station's IP address, stop the DHCP client, remove TCP/UDP-related connections, and clear the LwIP station netif, etc. The application event callback generally does not need to do anything.

## WIFI\_EVENT\_STA\_CONNECTED

If `esp_wifi_connect()` returns `ESP_OK` and the station successfully connects to the target AP, the connection event will arise. Upon receiving this event, the event task starts the DHCP client and begins the DHCP process of getting the IP address. Then, the Wi-Fi driver is ready for sending and receiving data. This moment is good for beginning the application work, provided that the application does not depend on LwIP, namely the IP address. However, if the application is LwIP-based, then you need to wait until the `got ip` event comes in.

## WIFI\_EVENT\_STA\_DISCONNECTED

This event can be generated in the following scenarios:

- When `esp_wifi_disconnect()` or `esp_wifi_stop()` is called and the station is already connected to the AP.
- When `esp_wifi_connect()` is called, but the Wi-Fi driver fails to set up a connection with the AP due to certain reasons, e.g., the scan fails to find the target AP or the authentication times out. If there are more than one AP with the same SSID, the disconnected event will be raised after the station fails to connect all of the found APs.
- When the Wi-Fi connection is disrupted because of specific reasons, e.g., the station continuously loses N beacons, the AP kicks off the station, or the AP's authentication mode is changed.

Upon receiving this event, the default behaviors of the event task are:

- Shutting down the station's LwIP netif.
- Notifying the LwIP task to clear the UDP/TCP connections which cause the wrong status to all sockets. For socket-based applications, the application callback can choose to close all sockets and re-create them, if necessary, upon receiving this event.

The most common event handle code for this event in application is to call `esp_wifi_connect()` to reconnect the Wi-Fi. However, if the event is raised because `esp_wifi_disconnect()` is called, the application should not call `esp_wifi_connect()` to reconnect. It is the application's responsibility to distinguish whether the event is caused by `esp_wifi_disconnect()` or other reasons. Sometimes a better reconnection strategy is required. Refer to *Wi-Fi Reconnect* and *Scan When Wi-Fi Is Connecting*.

Another thing that deserves attention is that the default behavior of LwIP is to abort all TCP socket connections on receiving the disconnect. In most cases, it is not a problem. However, for some special applications, this may not be what they want. Consider the following scenarios:

- The application creates a TCP connection to maintain the application-level keep-alive data that is sent out every 60 seconds.
- Due to certain reasons, the Wi-Fi connection is cut off, and the `WIFI_EVENT_STA_DISCONNECTED` is raised. According to the current implementation, all TCP connections will be removed and the keep-alive socket will be in a wrong status. However, since the application designer believes that the network layer should **ignore** this error at the Wi-Fi layer, the application does not close the socket.
- Five seconds later, the Wi-Fi connection is restored because `esp_wifi_connect()` is called in the application event callback function. **Moreover, the station connects to the same AP and gets the same IPV4 address as before.**
- Sixty seconds later, when the application sends out data with the keep-alive socket, the socket returns an error and the application closes the socket and re-creates it when necessary.

In above scenarios, ideally, the application sockets and the network layer should not be affected, since the Wi-Fi connection only fails temporarily and recovers very quickly. The application can enable "Keep TCP connections when IP changed" via LwIP menuconfig.

### **IP\_EVENT\_STA\_GOT\_IP**

This event arises when the DHCP client successfully gets the IPV4 address from the DHCP server, or when the IPV4 address is changed. The event means that everything is ready and the application can begin its tasks (e.g., creating sockets).

The IPV4 may be changed because of the following reasons:

- The DHCP client fails to renew/rebind the IPV4 address, and the station's IPV4 is reset to 0.
- The DHCP client rebinds to a different address.
- The static-configured IPV4 address is changed.

Whether the IPV4 address is changed or not is indicated by the field `ip_change` of `ip_event_got_ip_t`.

The socket is based on the IPV4 address, which means that, if the IPV4 changes, all sockets relating to this IPV4 will become abnormal. Upon receiving this event, the application needs to close all sockets and recreate the application when the IPV4 changes to a valid one.

### **IP\_EVENT\_GOT\_IP6**

This event arises when the IPV6 SLAAC support auto-configures an address for the ESP32-S2, or when this address changes. The event means that everything is ready and the application can begin its tasks, e.g., creating sockets.

### **IP\_EVENT\_STA\_LOST\_IP**

This event arises when the IPV4 address becomes invalid.

`IP_EVENT_STA_LOST_IP` does not arise immediately after the Wi-Fi disconnects. Instead, it starts an IPV4 address lost timer. If the IPV4 address is got before ip lost timer expires, `IP_EVENT_STA_LOST_IP` does not happen. Otherwise, the event arises when the IPV4 address lost timer expires.

Generally, the application can ignore this event, because it is just a debug event to inform that the IPV4 address is lost.

### **WIFI\_EVENT\_AP\_START**

Similar to [WIFI\\_EVENT\\_STA\\_START](#).

### **WIFI\_EVENT\_AP\_STOP**

Similar to [WIFI\\_EVENT\\_STA\\_STOP](#).

### **WIFI\_EVENT\_AP\_STACONNECTED**

Every time a station is connected to ESP32-S2 AP, the [WIFI\\_EVENT\\_AP\\_STACONNECTED](#) will arise. Upon receiving this event, the event task will do nothing, and the application callback can also ignore it. However, you may want to do something, for example, to get the info of the connected STA.

### **WIFI\_EVENT\_AP\_STADISCONNECTED**

This event can happen in the following scenarios:

- The application calls `esp_wifi_disconnect()`, or `esp_wifi_deinit_sta()`, to manually disconnect the station.
- The Wi-Fi driver kicks off the station, e.g., because the AP has not received any packets in the past five minutes. The time can be modified by `esp_wifi_set_inactive_time()`.
- The station kicks off the AP.

When this event happens, the event task will do nothing, but the application event callback needs to do something, e.g., close the socket which is related to this station.

### **WIFI\_EVENT\_AP\_PROBEREQRCVED**

This event is disabled by default. The application can enable it via API `esp_wifi_set_event_mask()`. When this event is enabled, it will be raised each time the AP receives a probe request.

### **WIFI\_EVENT\_STA\_BEACON\_TIMEOUT**

If the station does not receive the beacon of the connected AP within the inactive time, the beacon timeout happens, the `WIFI_EVENT_STA_BEACON_TIMEOUT` will arise. The application can set inactive time via API `esp_wifi_set_inactive_time()`.

### **WIFI\_EVENT\_CONNECTIONLESS\_MODULE\_WAKE\_INTERVAL\_START**

The `WIFI_EVENT_CONNECTIONLESS_MODULE_WAKE_INTERVAL_START` will arise at the start of connectionless module *Interval*. See *connectionless module power save*.

## **4.32.7 ESP32-S2 Wi-Fi Station General Scenario**

Below is a “big scenario” which describes some small scenarios in station mode:

### **1. Wi-Fi/LwIP Init Phase**

- s1.1: The main task calls `esp_netif_init()` to create an LwIP core task and initialize LwIP-related work.
- s1.2: The main task calls `esp_event_loop_create()` to create a system Event task and initialize an application event's callback function. In the scenario above, the application event's callback function does nothing but relaying the event to the application task.
- s1.3: The main task calls `esp_netif_create_default_wifi_ap()` or `esp_netif_create_default_wifi_sta()` to create default network interface instance binding station or AP with TCP/IP stack.
- s1.4: The main task calls `esp_wifi_init()` to create the Wi-Fi driver task and initialize the Wi-Fi driver.
- s1.5: The main task calls OS API to create the application task.

Step 1.1 ~ 1.5 is a recommended sequence that initializes a Wi-Fi-/LwIP-based application. However, it is **NOT** a must-follow sequence, which means that you can create the application task in step 1.1 and put all other initializations in the application task. Moreover, you may not want to create the application task in the initialization phase if the application task depends on the sockets. Rather, you can defer the task creation until the IP is obtained.

### **2. Wi-Fi Configuration Phase**

Once the Wi-Fi driver is initialized, you can start configuring the Wi-Fi driver. In this scenario, the mode is station, so you may need to call `esp_wifi_set_mode()` (`WIFI_MODE_STA`) to configure the Wi-Fi mode as station. You can call other `esp_wifi_set_xxx` APIs to configure more settings, such as the protocol mode, the country code, and the bandwidth. Refer to *ESP32-S2 Wi-Fi Configuration*.

Generally, the Wi-Fi driver should be configured before the Wi-Fi connection is set up. But this is **NOT** mandatory, which means that you can configure the Wi-Fi connection anytime, provided that the Wi-Fi driver is initialized successfully. However, if the configuration does not need to change after the Wi-Fi connection is set up, you should configure the Wi-Fi driver at this stage, because the configuration APIs (such as `esp_wifi_set_protocol()`) will cause the Wi-Fi to reconnect, which may not be desirable.

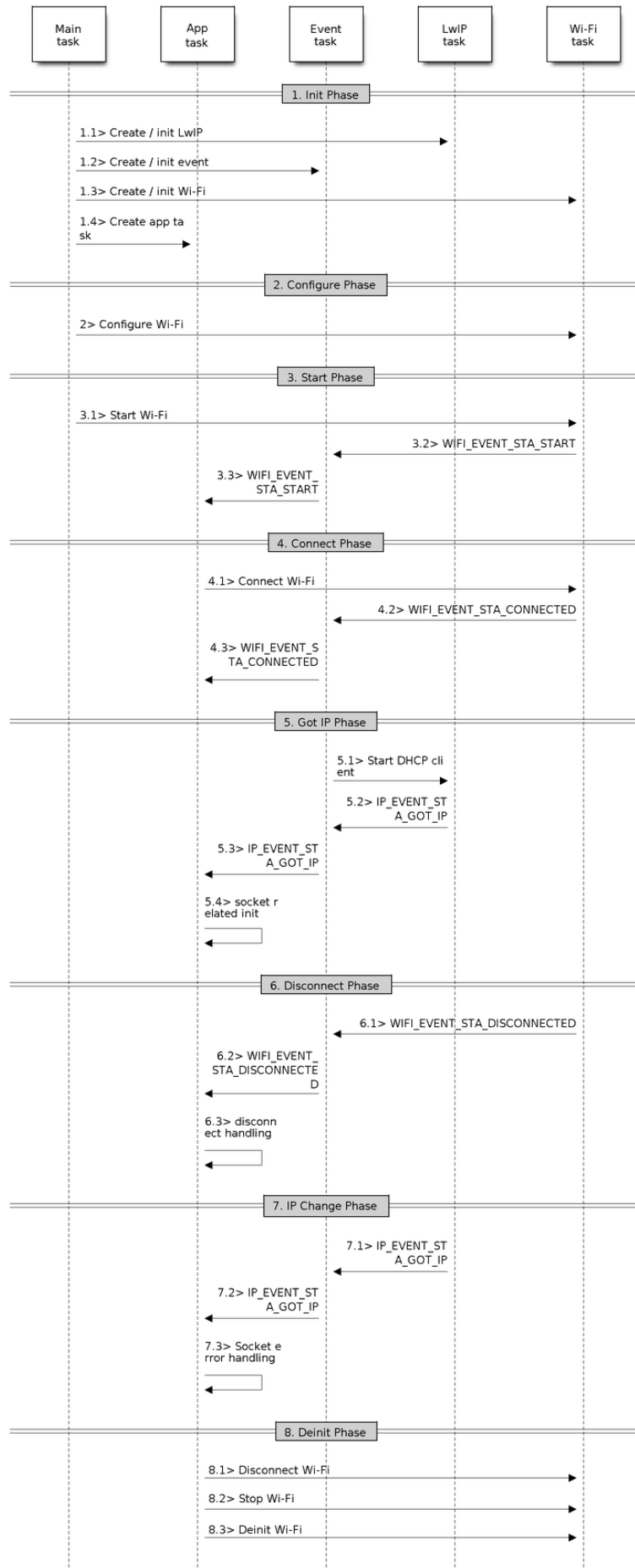

Fig. 43: Sample Wi-Fi Event Scenarios in Station Mode

If the Wi-Fi NVS flash is enabled by menuconfig, all Wi-Fi configuration in this phase, or later phases, will be stored into flash. When the board powers on/reboots, you do not need to configure the Wi-Fi driver from scratch. You only need to call `esp_wifi_get_xxx` APIs to fetch the configuration stored in flash previously. You can also configure the Wi-Fi driver if the previous configuration is not what you want.

### 3. Wi-Fi Start Phase

- s3.1: Call `esp_wifi_start()` to start the Wi-Fi driver.
- s3.2: The Wi-Fi driver posts `WIFI_EVENT_STA_START` to the event task; then, the event task will do some common things and will call the application event callback function.
- s3.3: The application event callback function relays the `WIFI_EVENT_STA_START` to the application task. We recommend that you call `esp_wifi_connect()`. However, you can also call `esp_wifi_connect()` in other phrases after the `WIFI_EVENT_STA_START` arises.

### 4. Wi-Fi Connect Phase

- s4.1: Once `esp_wifi_connect()` is called, the Wi-Fi driver will start the internal scan/connection process.
- s4.2: If the internal scan/connection process is successful, the `WIFI_EVENT_STA_CONNECTED` will be generated. In the event task, it starts the DHCP client, which will finally trigger the DHCP process.
- s4.3: In the above-mentioned scenario, the application event callback will relay the event to the application task. Generally, the application needs to do nothing, and you can do whatever you want, e.g., print a log.

In step 4.2, the Wi-Fi connection may fail because, for example, the password is wrong, or the AP is not found. In a case like this, `WIFI_EVENT_STA_DISCONNECTED` will arise and the reason for such a failure will be provided. For handling events that disrupt Wi-Fi connection, please refer to phase 6.

### 5. Wi-Fi ‘Got IP’ Phase

- s5.1: Once the DHCP client is initialized in step 4.2, the *got IP* phase will begin.
- s5.2: If the IP address is successfully received from the DHCP server, then `IP_EVENT_STA_GOT_IP` will arise and the event task will perform common handling.
- s5.3: In the application event callback, `IP_EVENT_STA_GOT_IP` is relayed to the application task. For LwIP-based applications, this event is very special and means that everything is ready for the application to begin its tasks, e.g., creating the TCP/UDP socket. A very common mistake is to initialize the socket before `IP_EVENT_STA_GOT_IP` is received. **DO NOT start the socket-related work before the IP is received.**

### 6. Wi-Fi Disconnect Phase

- s6.1: When the Wi-Fi connection is disrupted, e.g., the AP is powered off or the RSSI is poor, `WIFI_EVENT_STA_DISCONNECTED` will arise. This event may also arise in phase 3. Here, the event task will notify the LwIP task to clear/remove all UDP/TCP connections. Then, all application sockets will be in a wrong status. In other words, no socket can work properly when this event happens.
- s6.2: In the scenario described above, the application event callback function relays `WIFI_EVENT_STA_DISCONNECTED` to the application task. The recommended actions are: 1) call `esp_wifi_connect()` to reconnect the Wi-Fi, 2) close all sockets, and 3) re-create them if necessary. For details, please refer to `WIFI_EVENT_STA_DISCONNECTED`.

### 7. Wi-Fi IP Change Phase

- s7.1: If the IP address is changed, the `IP_EVENT_STA_GOT_IP` will arise with “ip\_change” set to true.
- s7.2: **This event is important to the application. When it occurs, the timing is good for closing all created sockets and recreating them.**

## 8. Wi-Fi Deinit Phase

- s8.1: Call `esp_wifi_disconnect()` to disconnect the Wi-Fi connectivity.
- s8.2: Call `esp_wifi_stop()` to stop the Wi-Fi driver.
- s8.3: Call `esp_wifi_deinit()` to unload the Wi-Fi driver.

### 4.32.8 ESP32-S2 Wi-Fi AP General Scenario

Below is a “big scenario” which describes some small scenarios in AP mode:

### 4.32.9 ESP32-S2 Wi-Fi Scan

Currently, the `esp_wifi_scan_start()` API is supported only in station or station/AP mode.

#### Scan Type

Mode	Description
Active Scan	Scan by sending a probe request. The default scan is an active scan.
Passive Scan	No probe request is sent out. Just switch to the specific channel and wait for a beacon. Application can enable it via the <code>scan_type</code> field of <code>wifi_scan_config_t</code> .
Foreground Scan	This scan is applicable when there is no Wi-Fi connection in station mode. Foreground or background scanning is controlled by the Wi-Fi driver and cannot be configured by the application.
Background Scan	This scan is applicable when there is a Wi-Fi connection in station mode or in station/AP mode. Whether it is a foreground scan or background scan depends on the Wi-Fi driver and cannot be configured by the application.
All-Channel Scan	It scans all of the channels. If the <code>channel</code> field of <code>wifi_scan_config_t</code> is set to 0, it is an all-channel scan.
Specific Channel Scan	It scans specific channels only. If the <code>channel</code> field of <code>wifi_scan_config_t</code> set to 1-14, it is a specific-channel scan.

The scan modes in above table can be combined arbitrarily, so there are in total 8 different scans:

- All-Channel Background Active Scan
- All-Channel Background Passive Scan
- All-Channel Foreground Active Scan
- All-Channel Foreground Passive Scan
- Specific-Channel Background Active Scan
- Specific-Channel Background Passive Scan
- Specific-Channel Foreground Active Scan
- Specific-Channel Foreground Passive Scan

#### Scan Configuration

The scan type and other per-scan attributes are configured by `esp_wifi_scan_start()`. The table below provides a detailed description of `wifi_scan_config_t`.



Fig. 44: Sample Wi-Fi Event Scenarios in AP Mode



Field	Description
ssid	If the SSID is not NULL, it is only the AP with the same SSID that can be scanned.
bssid	If the BSSID is not NULL, it is only the AP with the same BSSID that can be scanned.
channel	If “channel” is 0, there will be an all-channel scan; otherwise, there will be a specific-channel scan.
show_hidden	If “show_hidden” is 0, the scan ignores the AP with a hidden SSID; otherwise, the scan considers the hidden AP a normal one.
scan_type	If “scan_type” is WIFI_SCAN_TYPE_ACTIVE, the scan is “active” ; otherwise, it is a “passive” one.
scan_time	<p>This field is used to control how long the scan dwells on each channel.</p> <p>For passive scans, scan_time.passive designates the dwell time for each channel.</p> <p>For active scans, dwell times for each channel are listed in the table below. Here, min is short for scan_time.active.min and max is short for scan_time.active.max.</p> <ul style="list-style-type: none"> <li>• min=0, max=0: scan dwells on each channel for 120 ms.</li> <li>• min&gt;0, max=0: scan dwells on each channel for 120 ms.</li> <li>• min=0, max&gt;0: scan dwells on each channel for max ms.</li> <li>• min&gt;0, max&gt;0: the minimum time the scan dwells on each channel is min ms. If no AP is found during this time frame, the scan switches to the next channel. Otherwise, the scan dwells on the channel for max ms.</li> </ul> <p>If you want to improve the performance of the the scan, you can try to modify these two parameters.</p>

There are also some global scan attributes which are configured by API `esp_wifi_set_config()`, refer to [Station Basic Configuration](#)

### Scan All APs on All Channels (Foreground)

Scenario:

The scenario above describes an all-channel, foreground scan. The foreground scan can only occur in station mode where the station does not connect to any AP. Whether it is a foreground or background scan is totally determined by the Wi-Fi driver, and cannot be configured by the application.

Detailed scenario description:

#### Scan Configuration Phase

- s1.1: Call `esp_wifi_set_country()` to set the country info if the default country info is not what you want. Refer to [Wi-Fi Country Code](#).
- s1.2: Call `esp_wifi_scan_start()` to configure the scan. To do so, you can refer to [Scan Configuration](#). Since this is an all-channel scan, just set the SSID/BSSID/channel to 0.

#### Wi-Fi Driver' s Internal Scan Phase

- s2.1: The Wi-Fi driver switches to channel 1. In this case, the scan type is WIFI\_SCAN\_TYPE\_ACTIVE, and a probe request is broadcasted. Otherwise, the Wi-Fi will wait for a beacon from the APs. The Wi-Fi driver will stay in channel 1 for some time. The dwell time is configured in min/max time, with the default value being 120 ms.
- s2.2: The Wi-Fi driver switches to channel 2 and performs the same operation as in step 2.1.
- s2.3: The Wi-Fi driver scans the last channel N, where N is determined by the country code which is configured in step 1.1.

#### Scan-Done Event Handling Phase

- s3.1: When all channels are scanned, `WIFI_EVENT_SCAN_DONE` will arise.

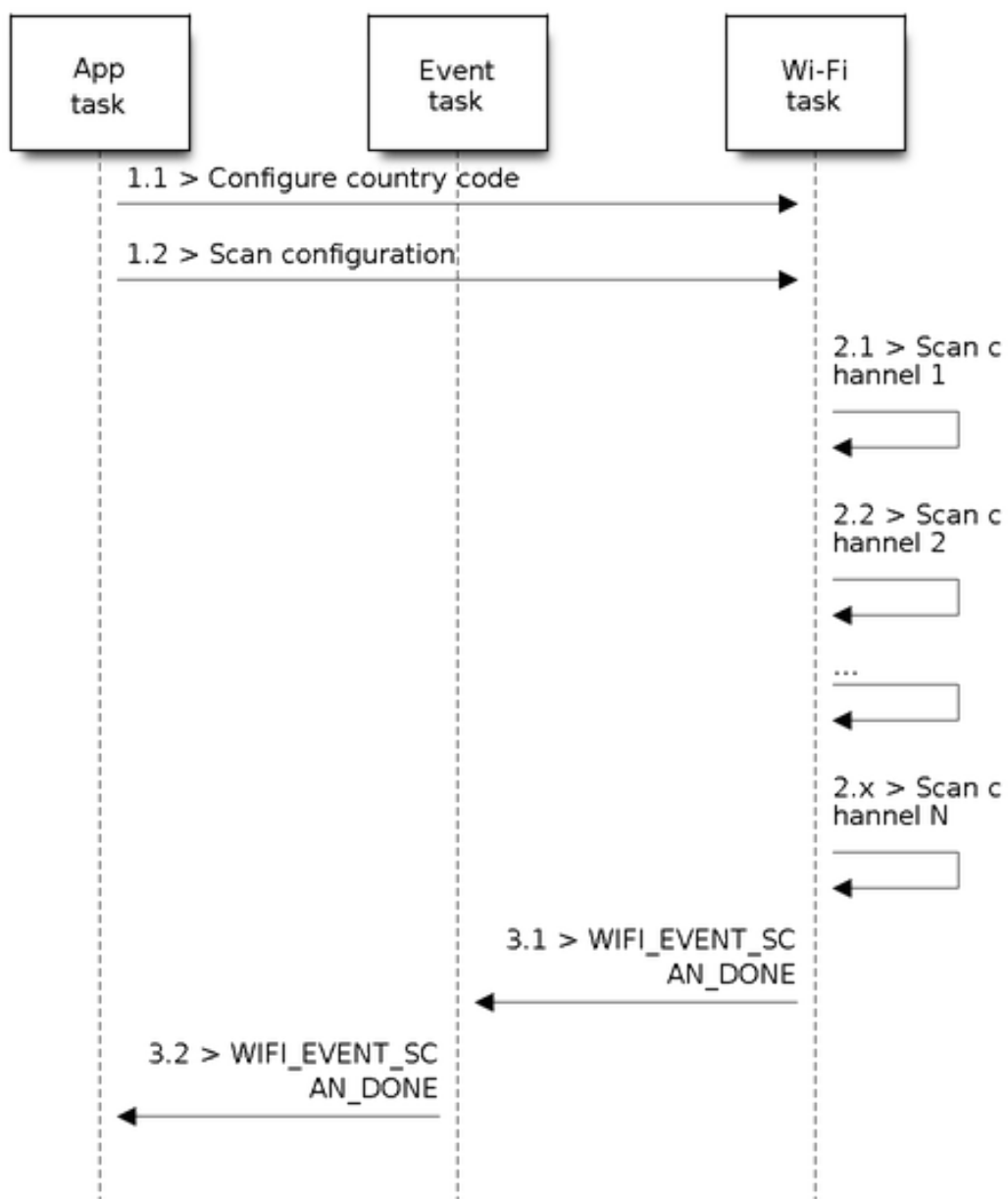

Fig. 45: Foreground Scan of all Wi-Fi Channels

- s3.2: The application's event callback function notifies the application task that `WIFI_EVENT_SCAN_DONE` is received. `esp_wifi_scan_get_ap_num()` is called to get the number of APs that have been found in this scan. Then, it allocates enough entries and calls `esp_wifi_scan_get_ap_records()` to get the AP records. Please note that the AP records in the Wi-Fi driver will be freed once `esp_wifi_scan_get_ap_records()` is called. Do not call `esp_wifi_scan_get_ap_records()` twice for a single scan-done event. If `esp_wifi_scan_get_ap_records()` is not called when the scan-done event occurs, the AP records allocated by the Wi-Fi driver will not be freed. So, make sure you call `esp_wifi_scan_get_ap_records()`, yet only once.

### Scan All APs on All Channels (Background)

Scenario:

The scenario above is an all-channel background scan. Compared to *Scan All APs on All Channels (Foreground)*, the difference in the all-channel background scan is that the Wi-Fi driver will scan the back-to-home channel for 30 ms before it switches to the next channel to give the Wi-Fi connection a chance to transmit/receive data.

### Scan for Specific AP on All Channels

Scenario:

This scan is similar to *Scan All APs on All Channels (Foreground)*. The differences are:

- s1.1: In step 1.2, the target AP will be configured to SSID/BSSID.
- s2.1 ~ s2.N: Each time the Wi-Fi driver scans an AP, it will check whether it is a target AP or not. If the scan is `WIFI_FAST_SCAN` scan and the target AP is found, then the scan-done event will arise and scanning will end; otherwise, the scan will continue. Please note that the first scanned channel may not be channel 1, because the Wi-Fi driver optimizes the scanning sequence.

It is a possible situation that there are multiple APs that match the target AP info, e.g., two APs with the SSID of “ap” are scanned. In this case, if the scan is `WIFI_FAST_SCAN`, then only the first scanned “ap” will be found. If the scan is `WIFI_ALL_CHANNEL_SCAN`, both “ap” will be found and the station will connect the “ap” according to the configured strategy. Refer to *Station Basic Configuration*.

You can scan a specific AP, or all of them, in any given channel. These two scenarios are very similar.

### Scan in Wi-Fi Connect

When `esp_wifi_connect()` is called, the Wi-Fi driver will try to scan the configured AP first. The scan in “Wi-Fi Connect” is the same as *Scan for Specific AP On All Channels*, except that no scan-done event will be generated when the scan is completed. If the target AP is found, the Wi-Fi driver will start the Wi-Fi connection; otherwise, `WIFI_EVENT_STA_DISCONNECTED` will be generated. Refer to *Scan for Specific AP On All Channels*.

### Scan in Blocked Mode

If the block parameter of `esp_wifi_scan_start()` is true, then the scan is a blocked one, and the application task will be blocked until the scan is done. The blocked scan is similar to an unblocked one, except that no scan-done event will arise when the blocked scan is completed.

### Parallel Scan

Two application tasks may call `esp_wifi_scan_start()` at the same time, or the same application task calls `esp_wifi_scan_start()` before it gets a scan-done event. Both scenarios can happen. **However, the Wi-Fi driver does not support multiple concurrent scans adequately. As a result, concurrent scans should be avoided.** Support for concurrent scan will be enhanced in future releases, as the ESP32-S2's Wi-Fi functionality improves continuously.

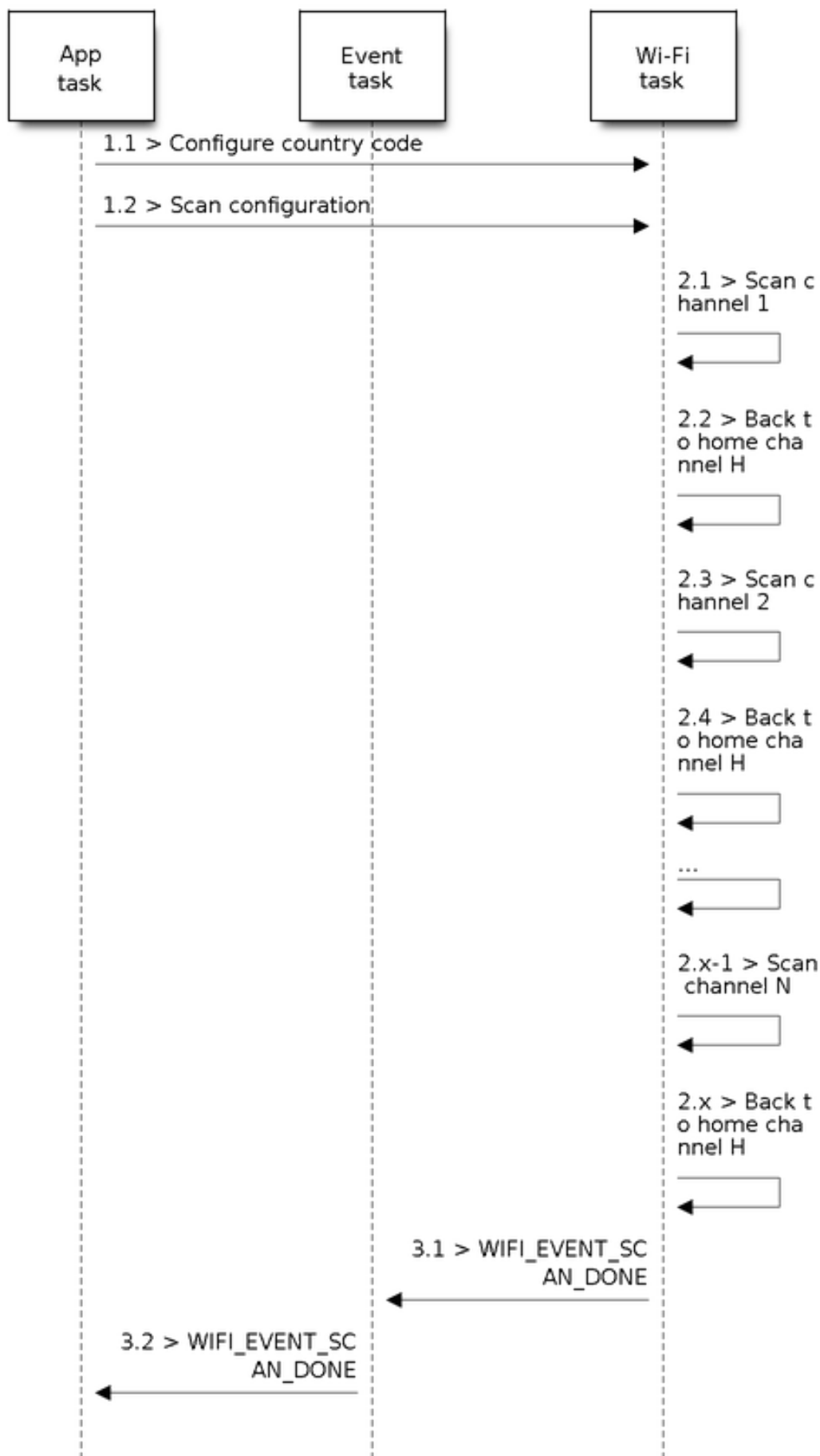

Fig. 46: Background Scan of all Wi-Fi Channels

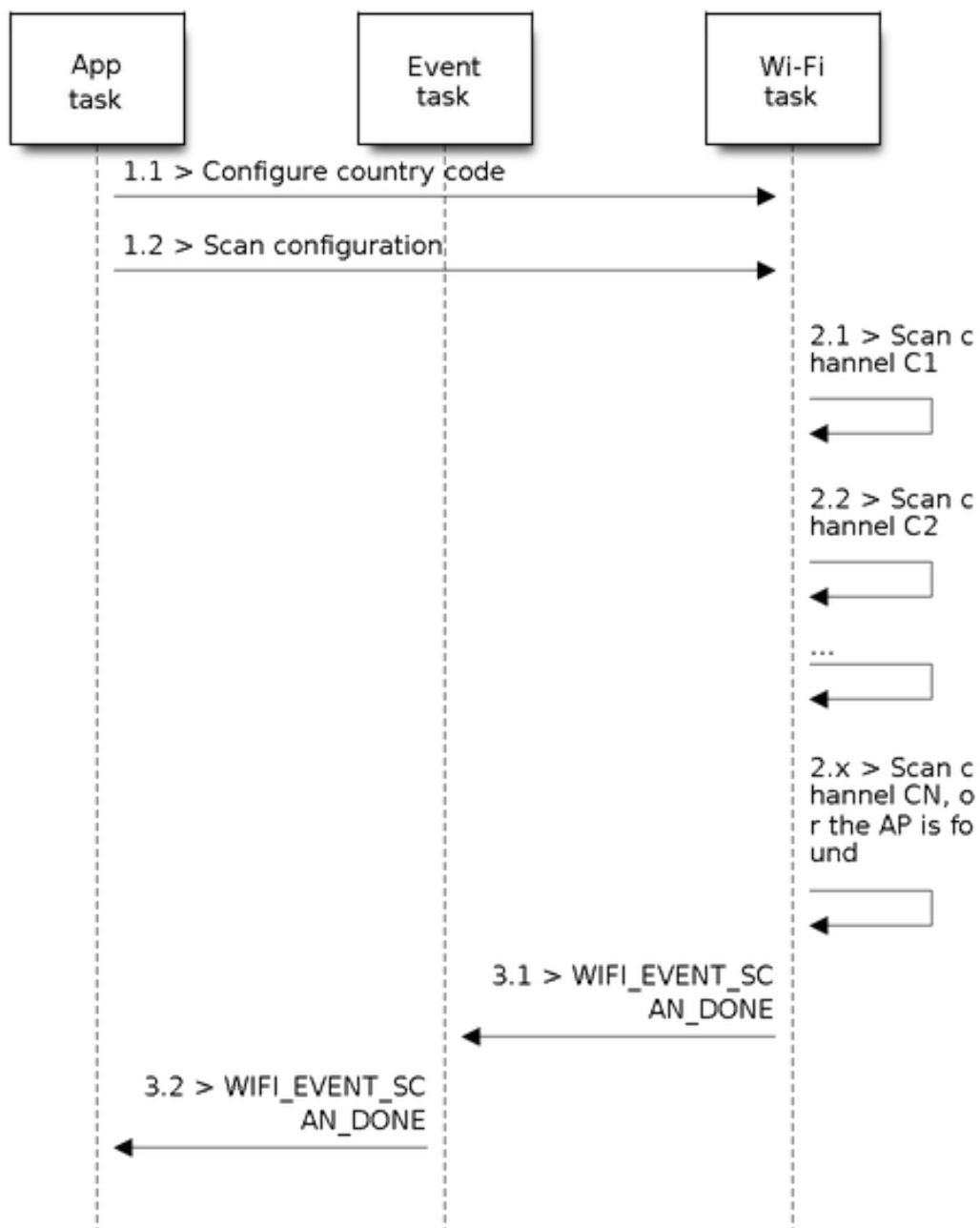

Fig. 47: Scan of specific Wi-Fi Channels

### Scan When Wi-Fi Is Connecting

The `esp_wifi_scan_start()` fails immediately if the Wi-Fi is connecting, because the connecting has higher priority than the scan. If scan fails because of connecting, the recommended strategy is to delay for some time and retry scan again. The scan will succeed once the connecting is completed.

However, the retry/delay strategy may not work all the time. Considering the following scenarios:

- The station is connecting a non-existing AP or it connects the existing AP with a wrong password, it always raises the event `WIFI_EVENT_STA_DISCONNECTED`.
- The application calls `esp_wifi_connect()` to reconnect on receiving the disconnect event.
- Another application task, e.g., the console task, calls `esp_wifi_scan_start()` to do scan, the scan always fails immediately because the station keeps connecting.
- When scan fails, the application simply delays for some time and retries the scan.

In the above scenarios, the scan will never succeed because the connecting is in process. So if the application supports similar scenario, it needs to implement a better reconnection strategy. For example:

- The application can choose to define a maximum continuous reconnection counter and stop reconnecting once the counter reaches the maximum.
- The application can choose to reconnect immediately in the first N continuous reconnection, then give a delay sometime and reconnect again.

The application can define its own reconnection strategy to avoid the scan starve to death. Refer to [<Wi-Fi Reconnect>](#).

#### 4.32.10 ESP32-S2 Wi-Fi Station Connecting Scenario

This scenario depicts the case if only one target AP is found in the scan phase. For scenarios where more than one AP with the same SSID is found, refer to [ESP32-S2 Wi-Fi Station Connecting When Multiple APs Are Found](#).

Generally, the application can ignore the connecting process. Below is a brief introduction to the process for those who are really interested.

Scenario:

##### Scan Phase

- s1.1: The Wi-Fi driver begins scanning in “Wi-Fi Connect” . Refer to [Scan in Wi-Fi Connect](#) for more details.
- s1.2: If the scan fails to find the target AP, `WIFI_EVENT_STA_DISCONNECTED` will arise and the reason code will be `WIFI_REASON_NO_AP_FOUND`. Refer to [Wi-Fi Reason Code](#).

##### Auth Phase

- s2.1: The authentication request packet is sent and the auth timer is enabled.
- s2.2: If the authentication response packet is not received before the authentication timer times out, `WIFI_EVENT_STA_DISCONNECTED` will arise and the reason code will be `WIFI_REASON_AUTH_EXPIRE`. Refer to [Wi-Fi Reason Code](#).
- s2.3: The auth-response packet is received and the auth-timer is stopped.
- s2.4: The AP rejects authentication in the response and `WIFI_EVENT_STA_DISCONNECTED` arises, while the reason code is `WIFI_REASON_AUTH_FAIL` or the reasons specified by the AP. Refer to [Wi-Fi Reason Code](#).

##### Association Phase

- s3.1: The association request is sent and the association timer is enabled.
- s3.2: If the association response is not received before the association timer times out, `WIFI_EVENT_STA_DISCONNECTED` will arise and the reason code will be `WIFI_REASON_ASSOC_EXPIRE`. Refer to [Wi-Fi Reason Code](#).

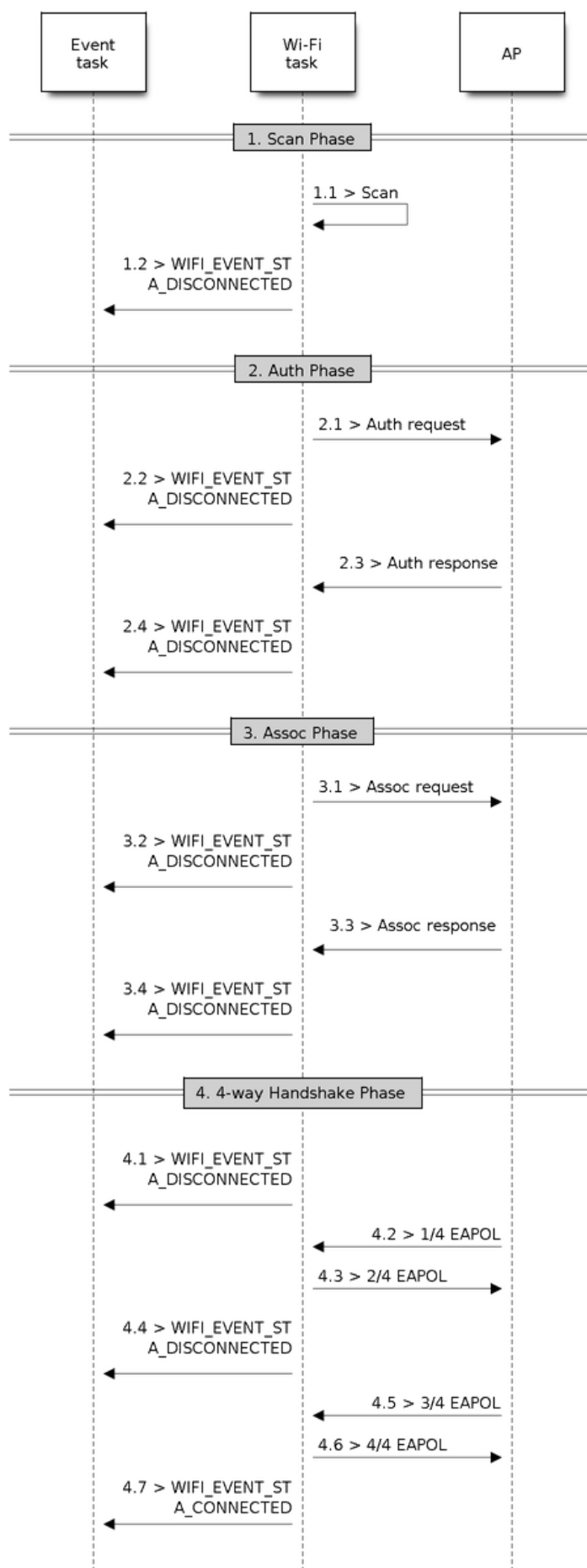

Fig. 48: Wi-Fi Station Connecting Process

- s3.3: The association response is received and the association timer is stopped.
- s3.4: The AP rejects the association in the response and `WIFI_EVENT_STA_DISCONNECTED` arises, while the reason code is the one specified in the association response. Refer to *Wi-Fi Reason Code*.

### Four-way Handshake Phase

- s4.1: The handshake timer is enabled, and the 1/4 EAPOL is not received before the handshake timer expires. `WIFI_EVENT_STA_DISCONNECTED` will arise and the reason code will be `WIFI_REASON_HANDSHAKE_TIMEOUT`. Refer to *Wi-Fi Reason Code*.
- s4.2: The 1/4 EAPOL is received.
- s4.3: The station replies 2/4 EAPOL.
- s4.4: If the 3/4 EAPOL is not received before the handshake timer expires, `WIFI_EVENT_STA_DISCONNECTED` will arise and the reason code will be `WIFI_REASON_HANDSHAKE_TIMEOUT`. Refer to *Wi-Fi Reason Code*.
- s4.5: The 3/4 EAPOL is received.
- s4.6: The station replies 4/4 EAPOL.
- s4.7: The station raises `WIFI_EVENT_STA_CONNECTED`.

### Wi-Fi Reason Code

The table below shows the reason-code defined in ESP32-S2. The first column is the macro name defined in `esp_wifi_types.h`. The common prefix `WIFI_REASON` is removed, which means that `UNSPECIFIED` actually stands for `WIFI_REASON_UNSPECIFIED` and so on. The second column is the value of the reason. The third column is the standard value to which this reason is mapped in section 9.4.1.7 of IEEE 802.11-2020. (For more information, refer to the standard mentioned above.) The last column describes the reason.

Reason code	Value	Mapped To	Description
UNSPECIFIED	1	1	Generally, it means an internal failure, e.g., the memory runs out, the internal TX fails, or the reason is received from the remote side.
AUTH_EXPIRE		2	The previous authentication is no longer valid. For the ESP station, this reason is reported when: <ul style="list-style-type: none"> <li>• auth is timed out.</li> <li>• the reason is received from the AP.</li> </ul> For the ESP AP, this reason is reported when: <ul style="list-style-type: none"> <li>• the AP has not received any packets from the station in the past five minutes.</li> <li>• the AP is stopped by calling <code>esp_wifi_stop()</code>.</li> <li>• the station is de-authed by calling <code>esp_wifi_deauth_sta()</code>.</li> </ul>
AUTH_BEAVE		3	De-authenticated, because the sending station is leaving (or has left). For the ESP station, this reason is reported when: <ul style="list-style-type: none"> <li>• it is received from the AP.</li> </ul>

continues on next page



Table 10 – continued from previous page

Reason code	Value	Mapped To	Description
AS-SOC_EXPIRE	4	4	<p>Disassociated due to inactivity.</p> <p>For the ESP station, this reason is reported when:</p> <ul style="list-style-type: none"> <li>it is received from the AP.</li> </ul> <p>For the ESP AP, this reason is reported when:</p> <ul style="list-style-type: none"> <li>the AP has not received any packets from the station in the past five minutes.</li> <li>the AP is stopped by calling <code>esp_wifi_stop()</code>.</li> <li>the station is de-authed by calling <code>esp_wifi_deauth_sta()</code>.</li> </ul>
AS-SOC_TOOMANY	5	5	<p>Disassociated, because the AP is unable to handle all currently associated STAs at the same time.</p> <p>For the ESP station, this reason is reported when:</p> <ul style="list-style-type: none"> <li>it is received from the AP.</li> </ul> <p>For the ESP AP, this reason is reported when:</p> <ul style="list-style-type: none"> <li>the stations associated with the AP reach the maximum number that the AP can support.</li> </ul>
NOT_AUTHED	6	6	<p>Class-2 frame received from a non-authenticated STA.</p> <p>For the ESP station, this reason is reported when:</p> <ul style="list-style-type: none"> <li>it is received from the AP.</li> </ul> <p>For the ESP AP, this reason is reported when:</p> <ul style="list-style-type: none"> <li>the AP receives a packet with data from a non-authenticated station.</li> </ul>
NOT_ASSOCED	7	7	<p>Class-3 frame received from a non-associated STA.</p> <p>For the ESP station, this reason is reported when:</p> <ul style="list-style-type: none"> <li>it is received from the AP.</li> </ul> <p>For the ESP AP, this reason is reported when:</p> <ul style="list-style-type: none"> <li>the AP receives a packet with data from a non-associated station.</li> </ul>
AS-SOC_LEAVE	8	8	<p>Disassociated, because the sending station is leaving (or has left) BSS.</p> <p>For the ESP station, this reason is reported when:</p> <ul style="list-style-type: none"> <li>it is received from the AP.</li> <li>the station is disconnected by <code>esp_wifi_disconnect()</code> and other APIs.</li> </ul>
AS-SOC_NOT_AUTHED	9	9	<p>station requesting (re)association is not authenticated by the responding STA.</p> <p>For the ESP station, this reason is reported when:</p> <ul style="list-style-type: none"> <li>it is received from the AP.</li> </ul> <p>For the ESP AP, this reason is reported when:</p> <ul style="list-style-type: none"> <li>the AP receives packets with data from an associated, yet not authenticated, station.</li> </ul>
DIS-AS-SOC_PWRCAP_BAD	10	10	<p>Disassociated, because the information in the Power Capability element is unacceptable.</p> <p>For the ESP station, this reason is reported when:</p> <ul style="list-style-type: none"> <li>it is received from the AP.</li> </ul>

continues on next page

Table 10 – continued from previous page

Reason code	Value	Mapped To	Description
DIS-AS-SOC_SUPCHAN_BAD	11	11	Disassociated, because the information in the Supported Channels element is unacceptable. For the ESP station, this reason is reported when: <ul style="list-style-type: none"> <li>it is received from the AP.</li> </ul>
IE_INVABID		13	Invalid element, i.e., an element whose content does not meet the specifications of the Standard in frame formats clause. For the ESP station, this reason is reported when: <ul style="list-style-type: none"> <li>it is received from the AP.</li> </ul> For the ESP AP, this reason is reported when: <ul style="list-style-type: none"> <li>the AP parses a wrong WPA or RSN IE.</li> </ul>
MIC_FAILURE		14	Message integrity code (MIC) failure. For the ESP station, this reason is reported when: <ul style="list-style-type: none"> <li>it is received from the AP.</li> </ul>
4WAY_HANDSHAKE_TIMEOUT			Four-way handshake times out. For legacy reasons, in ESP this reason code is replaced with WIFI_REASON_HANDSHAKE_TIMEOUT. For the ESP station, this reason is reported when: <ul style="list-style-type: none"> <li>the handshake times out.</li> <li>it is received from the AP.</li> </ul>
GROUP_KEY_UPDATE_TIMEOUT			Group-Key Handshake times out. For the ESP station, this reason is reported when: <ul style="list-style-type: none"> <li>it is received from the AP.</li> </ul>
IE_IN_4WAY_DIFFERS	17		The element in the four-way handshake is different from the (Re-)Association Request/Probe and Response/Beacon frame. For the ESP station, this reason is reported when: <ul style="list-style-type: none"> <li>it is received from the AP.</li> <li>the station finds that the four-way handshake IE differs from the IE in the (Re-)Association Request/Probe and Response/Beacon frame.</li> </ul>
GROUP_CIPHER_INVALID			Invalid group cipher. For the ESP station, this reason is reported when: <ul style="list-style-type: none"> <li>it is received from the AP.</li> </ul>
PAIRWISE_CIPHER_INVALID	19	19	Invalid pairwise cipher. For the ESP station, this reason is reported when: <ul style="list-style-type: none"> <li>it is received from the AP.</li> </ul>
AKMP_INVALID		20	Invalid AKMP. For the ESP station, this reason is reported when: - it is received from the AP.
UNSUPP_RSN_IE_VERSION	21	21	Unsupported RSNE version. For the ESP station, this reason is reported when: <ul style="list-style-type: none"> <li>it is received from the AP.</li> </ul>

continues on next page

Table 10 – continued from previous page

Reason code	Value	Mapped To	Description
IN-VALID_RSN_IE_CAP	22	22	Invalid RSNE capabilities. For the ESP station, this reason is reported when: <ul style="list-style-type: none"> <li>it is received from the AP.</li> </ul>
802_1X_AUTH_FAILED	23	23	IEEE 802.1X. authentication failed. For the ESP station, this reason is reported when: <ul style="list-style-type: none"> <li>it is received from the AP.</li> </ul> For the ESP AP, this reason is reported when: <ul style="list-style-type: none"> <li>IEEE 802.1X. authentication fails.</li> </ul>
CIPHER_SUITE_REJECTED	24	24	Cipher suite rejected due to security policies. For the ESP station, this reason is reported when: <ul style="list-style-type: none"> <li>it is received from the AP.</li> </ul>
TDLS_PEER_UNREACHABLE	25	25	TDLS direct-link teardown due to TDLS peer STA unreachable via the TDLS direct link.
TDLS_UNSPECIFIED	26	26	TDLS direct-link teardown for unspecified reason.
SSP_REQUESTED_DISASSOC	27	27	Disassociated because session terminated by SSP request.
NO_SSP_ROAMING_AGREEMENT	28	28	Disassociated because of lack of SSP roaming agreement.
BAD_CIPHER_OR_AKM	29	29	Requested service rejected because of SSP cipher suite or AKM requirement.
NOT_AUTHORIZED_THIS_LOCATION	30	30	Requested service not authorized in this location.
SERVICE_CHANGE_PRECLUDES_TS	31	31	TS deleted because QoS AP lacks sufficient bandwidth for this QoS STA due to a change in BSS service characteristics or operational mode (e.g., an HT BSS change from 40 MHz channel to 20 MHz channel).
UNSPECIFIED_QOS	32	32	Disassociated for unspecified, QoS-related reason.
NOT_ENOUGH_BANDWIDTH	33	33	Disassociated because QoS AP lacks sufficient bandwidth for this QoS STA.
MISSING_ACKS	34	34	Disassociated because excessive number of frames need to be acknowledged, but are not acknowledged due to AP transmissions and/or poor channel conditions.
EXCEEDED_TXOP	35	35	Disassociated because STA is transmitting outside the limits of its TXOPs.
STA_LEAVING	36	36	Requesting STA is leaving the BSS (or resetting).
END_BA	37	37	Requesting STA is no longer using the stream or session.
UNKNOWN_BA	38	38	Requesting STA received frames using a mechanism for which a setup has not been completed.
TIMEOUT	39	39	Requested from peer STA due to timeout
Reserved	40 ~ 45	40 ~ 45	
PEER_INITIATED	46	46	In a Disassociation frame: Disassociated because authorized access limit reached.
AP_INITIATED	47	47	In a Disassociation frame: Disassociated due to external service requirements.
INVALID_FT_ACTION_FRAME_COUNT	48	48	Invalid FT Action frame count.

continues on next page

Table 10 – continued from previous page

Reason code	Value	Mapped To	Description
IN-VALID_PMKID	49	49	Invalid pairwise master key identifier (PMKID).
IN-VALID_MDE	50	50	Invalid MDE.
IN-VALID_FTE	51	51	Invalid FTE
TRANSMISSION_LINK_ESTABLISHMENT_FAILED	67	67	Transmission link establishment in alternative channel failed.
ALTERNATIVE_CHANNEL_OCCUPIED	68	68	The alternative channel is occupied.
BEACON_TIMEOUT	200	reserved	Espressif-specific Wi-Fi reason code: when the station loses N beacons continuously, it will disrupt the connection and report this reason.
NO_AP_FOUND	201	reserved	Espressif-specific Wi-Fi reason code: when the station fails to scan the target AP, this reason code will be reported.
AUTH_FAIL	202	reserved	Espressif-specific Wi-Fi reason code: the authentication fails, but not because of a timeout.
ASSOC_FAIL	203	reserved	Espressif-specific Wi-Fi reason code: the association fails, but not because of ASSOC_EXPIRE or ASSOC_TOOMANY.
HANDSHAKE_TIMEOUT	204	reserved	Espressif-specific Wi-Fi reason code: the handshake fails for the same reason as that in WIFI_REASON_4WAY_HANDSHAKE_TIMEOUT.
CONNECTION_FAIL	205	reserved	Espressif-specific Wi-Fi reason code: the connection to the AP has failed.

### Wi-Fi Reason code related to wrong password

The table below shows the Wi-Fi reason-code may related to wrong password.

Reason code	Value	Description
4WAY_HANDSHAKE_TIMEOUT	204	Four-way handshake times out. Setting wrong password when STA connecting to an encrypted AP.
NO_AP_FOUND	201	This may related to wrong password in the two scenarios: <ul style="list-style-type: none"> <li>Setting password when STA connecting to an unencrypted AP.</li> <li>Doesn't setting password when STA connecting to an encrypted AP.</li> </ul>
HANDSHAKE_TIMEOUT	204	Four-way handshake fails.

### Wi-Fi Reason code related to low RSSI

The table below shows the Wi-Fi reason-code may related to low RSSI.

Reason code	Value	Description
NO_AP_FOUND	FOUND	The station fails to scan the target AP due to low RSSI
HAND-SHAKE_TIMEOUT	204	Four-way handshake fails.

#### 4.32.11 ESP32-S2 Wi-Fi Station Connecting When Multiple APs Are Found

This scenario is similar as *ESP32-S2 Wi-Fi Station Connecting Scenario*. The difference is that the station will not raise the event `WIFI_EVENT_STA_DISCONNECTED` unless it fails to connect all of the found APs.

#### 4.32.12 Wi-Fi Reconnect

The station may disconnect due to many reasons, e.g., the connected AP is restarted. It is the application's responsibility to reconnect. The recommended reconnection strategy is to call `esp_wifi_connect()` on receiving event `WIFI_EVENT_STA_DISCONNECTED`.

Sometimes the application needs more complex reconnection strategy:

- If the disconnect event is raised because the `esp_wifi_disconnect()` is called, the application may not want to do the reconnection.
- If the `esp_wifi_scan_start()` may be called at anytime, a better reconnection strategy is necessary. Refer to *Scan When Wi-Fi Is Connecting*.

Another thing that need to be considered is that the reconnection may not connect the same AP if there are more than one APs with the same SSID. The reconnection always select current best APs to connect.

#### 4.32.13 Wi-Fi Beacon Timeout

The beacon timeout mechanism is used by ESP32-S2 station to detect whether the AP is alive or not. If the station does not receive the beacon of the connected AP within the inactive time, the beacon timeout happens. The application can set inactive time via API `esp_wifi_set_inactive_time()`.

After the beacon times out, the station sends 5 probe requests to the AP. If still no probe response or beacon is received from AP, the station disconnects from the AP and raises the event `WIFI_EVENT_STA_DISCONNECTED`.

It should be considered that the timer used for beacon timeout will be reset during the scanning process. It means that the scan process will affect the triggering of the event `WIFI_EVENT_STA_BEACON_TIMEOUT`.

#### 4.32.14 ESP32-S2 Wi-Fi Configuration

All configurations will be stored into flash when the Wi-Fi NVS is enabled; otherwise, refer to *Wi-Fi NVS Flash*.

##### Wi-Fi Mode

Call `esp_wifi_set_mode()` to set the Wi-Fi mode.

Mode	Description
WIFI_MODE_NULL	NULL mode: in this mode, the internal data struct is not allocated to the station and the AP, while both the station and AP interfaces are not initialized for RX/TX Wi-Fi data. Generally, this mode is used for Sniffer, or when you only want to stop both the station and the AP without calling <code>esp_wifi_deinit()</code> to unload the whole Wi-Fi driver.
WIFI_MODE_STA	Station mode: in this mode, <code>esp_wifi_start()</code> will init the internal station data, while the station's interface is ready for the RX and TX Wi-Fi data. After <code>esp_wifi_connect()</code> , the station will connect to the target AP.
WIFI_MODE_AP	AP mode: in this mode, <code>esp_wifi_start()</code> will init the internal AP data, while the AP's interface is ready for RX/TX Wi-Fi data. Then, the Wi-Fi driver starts broad-casting beacons, and the AP is ready to get connected to other stations.
WIFI_MODE_APSTA	Station/AP coexistence mode: in this mode, <code>esp_wifi_start()</code> will simultaneously init both the station and the AP. This is done in station mode and AP mode. Please note that the channel of the external AP, which the ESP station is connected to, has higher priority over the ESP AP channel.

### Station Basic Configuration

API `esp_wifi_set_config()` can be used to configure the station. And the configuration will be stored in NVS. The table below describes the fields in detail.

Field	Description
ssid	This is the SSID of the target AP, to which the station wants to connect.
password	Password of the target AP.
scan_method	For <code>WIFI_FAST_SCAN</code> scan, the scan ends when the first matched AP is found. For <code>WIFI_ALL_CHANNEL_SCAN</code> , the scan finds all matched APs on all channels. The default scan is <code>WIFI_FAST_SCAN</code> .
bssid_set	If <code>bssid_set</code> is 0, the station connects to the AP whose SSID is the same as the field "ssid", while the field "bssid" is ignored. In all other cases, the station connects to the AP whose SSID is the same as the "ssid" field, while its BSSID is the same the "bssid" field.
bssid	This is valid only when <code>bssid_set</code> is 1; see field "bssid_set".
channel	If the channel is 0, the station scans the channel 1 ~ N to search for the target AP; otherwise, the station starts by scanning the channel whose value is the same as that of the "channel" field, and then scans the channel 1 ~ N but skip the specific channel to find the target AP. For example, if the channel is 3, the scan order will be 3, 1, 2, 4, ..., N. If you do not know which channel the target AP is running on, set it to 0.
sort_method	This field is only for <code>WIFI_ALL_CHANNEL_SCAN</code> . If the <code>sort_method</code> is <code>WIFI_CONNECT_AP_BY_SIGNAL</code> , all matched APs are sorted by signal, and the AP with the best signal will be connected firstly. For example, the station wants to connect an AP whose SSID is "apxx". If the scan finds two APs whose SSID equals to "apxx", and the first AP's signal is -90 dBm while the second AP's signal is -30 dBm, the station connects the second AP firstly, and it would not connect the first one unless it fails to connect the second one. If the <code>sort_method</code> is <code>WIFI_CONNECT_AP_BY_SECURITY</code> , all matched APs are sorted by security. For example, the station wants to connect an AP whose SSID is "apxx". If the scan finds two APs whose SSID is "apxx", and the security of the first found AP is open while the second one is WPA2, the station connects to the second AP firstly, and it would not connect the first one unless it fails to connect the second one.
threshold	The threshold is used to filter the found AP. If the RSSI or security mode is less than the configured threshold, the AP will be discarded. If the RSSI is set to 0, it means the default threshold and the default RSSI threshold are -127 dBm. If the authmode threshold is set to 0, it means the default threshold and the default authmode threshold are open.

**Attention:** WEP/WPA security modes are deprecated in IEEE 802.11-2016 specifications and are recommended not to be used. These modes can be rejected using authmode threshold by setting threshold as WPA2 by threshold.authmode as WIFI\_AUTH\_WPA2\_PSK.

### AP Basic Configuration

API `esp_wifi_set_config()` can be used to configure the AP. And the configuration will be stored in NVS. The table below describes the fields in detail.

Field	Description
ssid	SSID of AP; if the ssid[0] is 0xFF and ssid[1] is 0xFF, the AP defaults the SSID to ESP_aabbcc, where “aabbcc” is the last three bytes of the AP MAC.
password	Password of AP; if the auth mode is WIFI_AUTH_OPEN, this field will be ignored.
ssid_len	Length of SSID; if ssid_len is 0, check the SSID until there is a termination character. If ssid_len > 32, change it to 32; otherwise, set the SSID length according to ssid_len.
channel	Channel of AP; if the channel is out of range, the Wi-Fi driver defaults to channel 1. So, please make sure the channel is within the required range. For more details, refer to <a href="#">Wi-Fi Country Code</a> .
authmode	Auth mode of ESP AP; currently, ESP AP does not support AUTH_WEP. If the authmode is an invalid value, AP defaults the value to WIFI_AUTH_OPEN.
ssid_hidden	If ssid_hidden is 1, AP does not broadcast the SSID; otherwise, it does broadcast the SSID.
max_connection	The max number of stations allowed to connect in, the default value is 10. ESP Wi-Fi supports up to 15 (ESP_WIFI_MAX_CONN_NUM) Wi-Fi connections. Please note that ESP AP and ESP-NOW share the same encryption hardware keys, so the max_connection parameter will be affected by the <a href="#">CONFIG_ESP_WIFI_ESPNOW_MAX_ENCRYPT_NUM</a> . The total number of encryption hardware keys is 17, if <a href="#">CONFIG_ESP_WIFI_ESPNOW_MAX_ENCRYPT_NUM</a> <= 2, the max_connection can be set up to 15, otherwise the max_connection can be set up to (17 - <a href="#">CONFIG_ESP_WIFI_ESPNOW_MAX_ENCRYPT_NUM</a> ).
beacon_interval	Beacon interval; the value is 100 ~ 60000 ms, with default value being 100 ms. If the value is out of range, AP defaults it to 100 ms.

### Wi-Fi Protocol Mode

Currently, the ESP-IDF supports the following protocol modes:

Protocol Mode	Description
802.11b	Call <code>esp_wifi_set_protocol(ifx, WIFI_PROTOCOL_11B)</code> to set the station/AP to 802.11b-only mode.
802.11bg	Call <code>esp_wifi_set_protocol(ifx, WIFI_PROTOCOL_11B WIFI_PROTOCOL_11G)</code> to set the station/AP to 802.11bg mode.
802.11g	Call <code>esp_wifi_set_protocol(ifx, WIFI_PROTOCOL_11B WIFI_PROTOCOL_11G)</code> and <code>esp_wifi_config_11b_rate(ifx, true)</code> to set the station/AP to 802.11g mode.
802.11bgn	Call <code>esp_wifi_set_protocol(ifx, WIFI_PROTOCOL_11B WIFI_PROTOCOL_11G WIFI_PROTOCOL_11N)</code> to set the station/ AP to BGN mode.
802.11gn	Call <code>esp_wifi_set_protocol(ifx, WIFI_PROTOCOL_11B WIFI_PROTOCOL_11G WIFI_PROTOCOL_11N)</code> and <code>esp_wifi_config_11b_rate(ifx, true)</code> to set the station/AP to 802.11gn mode.
802.11 BGNLR	Call <code>esp_wifi_set_protocol(ifx, WIFI_PROTOCOL_11B WIFI_PROTOCOL_11G WIFI_PROTOCOL_11N WIFI_PROTOCOL_LR)</code> to set the station/AP to BGN and the LR mode.
802.11 LR	Call <code>esp_wifi_set_protocol(ifx, WIFI_PROTOCOL_LR)</code> to set the station/AP only to the LR mode. <b>This mode is an Espressif-patented mode which can achieve a one-kilometer line of sight range. Please make sure both the station and the AP are connected to an ESP device.</b>

### Long Range (LR)

Long Range (LR) mode is an Espressif-patented Wi-Fi mode which can achieve a one-kilometer line of sight range. Compared to the traditional 802.11b mode, it has better reception sensitivity, stronger anti-interference ability, and longer transmission distance.

**LR Compatibility** Since LR is Espressif-unique Wi-Fi mode, only ESP32-S2 devices can transmit and receive the LR data. In other words, the ESP32-S2 device should NOT transmit the data in LR data rate if the connected device does not support LR. The application can achieve this by configuring suitable Wi-Fi mode. If the negotiated mode supports LR, the ESP32-S2 may transmit data in LR rate. Otherwise, ESP32-S2 will transmit all data in traditional Wi-Fi data rate.

The following table depicts the Wi-Fi mode negotiation:

APSTA	BGN	BG	B	BGNLR	BGLR	BLR	LR
BGN	BGN	BG	B	BGN	BG	B	•
BG	BG	BG	B	BG	BG	B	•
B	B	B	B	B	B	B	•
BGNLR	•	•	•	BGNLR	BGLR	BLR	LR
BGLR	•	•	•	BGLR	BGLR	BLR	LR
BLR	•	•	•	BLR	BLR	BLR	LR
LR	•	•	•	LR	LR	LR	LR

In the above table, the row is the Wi-Fi mode of AP and the column is the Wi-Fi mode of station. The “-” indicates Wi-Fi mode of the AP and station are not compatible.



According to the table, the following conclusions can be drawn:

- For LR-enabled AP of ESP32-S2, it is incompatible with traditional 802.11 mode, because the beacon is sent in LR mode.
- For LR-enabled station of ESP32-S2 whose mode is NOT LR-only mode, it is compatible with traditional 802.11 mode.
- If both station and AP are ESP32-S2 devices and both of them have enabled LR mode, the negotiated mode supports LR.

If the negotiated Wi-Fi mode supports both traditional 802.11 mode and LR mode, it is the Wi-Fi driver's responsibility to automatically select the best data rate in different Wi-Fi modes and the application can ignore it.

**LR Impacts to Traditional Wi-Fi Device** The data transmission in LR rate has no impacts on the traditional Wi-Fi device because:

- The CCA and backoff process in LR mode are consistent with 802.11 specification.
- The traditional Wi-Fi device can detect the LR signal via CCA and do backoff.

In other words, the transmission impact in LR mode is similar to that in 802.11b mode.

**LR Transmission Distance** The reception sensitivity gain of LR is about 4 dB larger than that of the traditional 802.11b mode. Theoretically, the transmission distance is about 2 to 2.5 times the distance of 11B.

**LR Throughput** The LR rate has very limited throughput, because the raw PHY data rate LR is 1/2 Mbps and 1/4 Mbps.

**When to Use LR** The general conditions for using LR are:

- Both the AP and station are Espressif devices.
- Long distance Wi-Fi connection and data transmission is required.
- Data throughput requirements are very small, such as remote device control.

### Wi-Fi Country Code

Call `esp_wifi_set_country()` to set the country info. The table below describes the fields in detail. Please consult local 2.4 GHz RF operating regulations before configuring these fields.

Field	Description
cc[3]	Country code string. This attribute identifies the country or noncountry entity in which the station/AP is operating. If it is a country, the first two octets of this string is the two-character country info as described in the document ISO/IEC3166-1. The third octet is one of the following: <ul style="list-style-type: none"> <li>• an ASCII space character, which means the regulations under which the station/AP is operating encompass all environments for the current frequency band in the country.</li> <li>• an ASCII ‘O’ character, which means the regulations under which the station/AP is operating are for an outdoor environment only.</li> <li>• an ASCII ‘I’ character, which means the regulations under which the station/AP is operating are for an indoor environment only.</li> <li>• an ASCII ‘X’ character, which means the station/AP is operating under a non-country entity. The first two octets of the noncountry entity is two ASCII ‘XX’ characters.</li> <li>• the binary representation of the Operating Class table number currently in use. Refer to Annex E of IEEE Std 802.11-2020.</li> </ul>
schan	Start channel. It is the minimum channel number of the regulations under which the station/AP can operate.
nchan	Total number of channels as per the regulations. For example, if the schan=1, nchan=13, then the station/AP can send data from channel 1 to 13.
policy	Country policy. This field controls which country info will be used if the configured country info is in conflict with the connected AP’ s. For more details on related policies, see the following section.

The default country info is:

```
wifi_country_t config = {
    .cc = "01",
    .schan = 1,
    .nchan = 11,
    .policy = WIFI_COUNTRY_POLICY_AUTO,
};
```

If the Wi-Fi Mode is station/AP coexist mode, they share the same configured country info. Sometimes, the country info of AP, to which the station is connected, is different from the country info of configured. For example, the configured station has country info:

```
wifi_country_t config = {
    .cc = "JP",
    .schan = 1,
    .nchan = 14,
    .policy = WIFI_COUNTRY_POLICY_AUTO,
};
```

but the connected AP has country info:

```
wifi_country_t config = {
    .cc = "CN",
    .schan = 1,
    .nchan = 13,
};
```

then country info of connected AP’ s is used.

The following table depicts which country info is used in different Wi-Fi modes and different country policies, and it also describes the impact on active scan.

Wi-Fi Mode	Policy	Description
Station	WIFI_COUNTRY_POLICY_AUTO	If the connected AP has country IE in its beacon, the country info equals to the country info in beacon. Otherwise, use the default country info. For scan: Use active scan from 1 to 11 and use passive scan from 12 to 14. Always keep in mind that if an AP with hidden SSID and station is set to a passive scan channel, the passive scan will not find it. In other words, if the application hopes to find the AP with hidden SSID in every channel, the policy of country info should be configured to WIFI_COUNTRY_POLICY_MANUAL.
Station	WIFI_COUNTRY_POLICY_MANUAL	Always use the configured country info. For scan: Use active scan from schan to schan+nchan-1.
AP	WIFI_COUNTRY_POLICY_AUTO	Always use the configured country info.
AP	WIFI_COUNTRY_POLICY_MANUAL	Always use the configured country info.
Station/AP-coexistence	WIFI_COUNTRY_POLICY_AUTO	Station: Same as station mode with policy WIFI_COUNTRY_POLICY_AUTO. AP: If the station does not connect to any external AP, the AP uses the configured country info. If the station connects to an external AP, the AP has the same country info as the station.
Station/AP-coexistence	WIFI_COUNTRY_POLICY_MANUAL	Station: Same as station mode with policy WIFI_COUNTRY_POLICY_MANUAL. AP: Same as AP mode with policy WIFI_COUNTRY_POLICY_MANUAL.

**Home Channel** In AP mode, the home channel is defined as the AP channel. In station mode, home channel is defined as the channel of AP which the station is connected to. In station/AP-coexistence mode, the home channel of AP and station must be the same, and if they are different, the station's home channel is always in priority. For example, assume that the AP is on channel 6, and the station connects to an AP whose channel is 9. Since the station's home channel has higher priority, the AP needs to switch its channel from 6 to 9 to make sure that it has the same home channel as the station. While switching channel, the ESP32-S2 in AP mode will notify the connected stations about the channel migration using a Channel Switch Announcement (CSA). Station that supports channel switching will transit without disconnecting and reconnecting to the AP.

### Wi-Fi Vendor IE Configuration

By default, all Wi-Fi management frames are processed by the Wi-Fi driver, and the application can ignore them. However, some applications may have to handle the beacon, probe request, probe response, and other management frames. For example, if you insert some vendor-specific IE into the management frames, it is only the management frames which contain this vendor-specific IE that will be processed. In ESP32-S2, `esp_wifi_set_vendor_ie()` and `esp_wifi_set_vendor_ie_cb()` are responsible for this kind of tasks.

#### 4.32.15 Wi-Fi Easy Connect™ (DPP)

Wi-Fi Easy Connect™ (or Device Provisioning Protocol) is a secure and standardized provisioning protocol for configuring Wi-Fi devices. More information can be found in [esp\\_dpp](#).

## WPA2-Enterprise

WPA2-Enterprise is the secure authentication mechanism for enterprise wireless networks. It uses RADIUS server for authentication of network users before connecting to the Access Point. The authentication process is based on 802.1X policy and comes with different Extended Authentication Protocol (EAP) methods such as TLS, TTLS, and PEAP. RADIUS server authenticates the users based on their credentials (username and password), digital certificates, or both. When ESP32-S2 in station mode tries to connect an AP in enterprise mode, it sends authentication request to AP which is sent to RADIUS server by AP for authenticating the station. Based on different EAP methods, the parameters can be set in configuration which can be opened using `idf.py menuconfig`. WPA2\_Enterprise is supported by ESP32-S2 only in station mode.

For establishing a secure connection, AP and station negotiate and agree on the best possible cipher suite to be used. ESP32-S2 supports 802.1X/EAP (WPA) method of AKM and Advanced encryption standard with Counter Mode Cipher Block Chaining Message Authentication protocol (AES-CCM) cipher suite. It also supports the cipher suites supported by mbedtls if `USE_MBEDTLS_CRYPT` flag is set.

### ESP32-S2 currently supports the following EAP methods:

- EAP-TLS: This is a certificate-based method and only requires SSID and EAP-IDF.
- PEAP: This is a Protected EAP method. Username and Password are mandatory.
- **EAP-TTLS: This is a credential-based method. Only server authentication is mandatory while user authentication is optional.**
  - PAP: Password Authentication Protocol.
  - CHAP: Challenge Handshake Authentication Protocol.
  - MSCHAP and MSCHAP-V2.
- EAP-FAST: This is an authentication method based on Protected Access Credentials (PAC) which also uses identity and password. Currently, `USE_MBEDTLS_CRYPT` flag should be disabled to use this feature.

Detailed information on creating certificates and how to run `wpa2_enterprise` example on ESP32-S2 can be found in [wifi/wifi\\_enterprise](#).

## 4.32.16 Wireless Network Management

Wireless Network Management allows client devices to exchange information about the network topology, including information related to RF environment. This makes each client network-aware, facilitating overall improvement in the performance of the wireless network. It is part of 802.11v specification. It also enables the client to support Network assisted Roaming. - Network assisted Roaming: Enables WLAN to send messages to associated clients, resulting clients to associate with APs with better link metrics. This is useful for both load balancing and in directing poorly connected clients.

Current implementation of 802.11v includes support for BSS transition management frames.

## 4.32.17 Radio Resource Measurement

Radio Resource Measurement (802.11k) is intended to improve the way traffic is distributed within a network. In a WLAN, each device normally connects to the access point (AP) that provides the strongest signal. Depending on the number and geographic locations of the subscribers, this arrangement can sometimes lead to excessive demand on one AP and underutilization of others, resulting in degradation of overall network performance. In a network conforming to 802.11k, if the AP having the strongest signal is loaded to its full capacity, a wireless device can be moved to one of the underutilized APs. Even though the signal may be weaker, the overall throughput is greater because more efficient use is made of the network resources.

Current implementation of 802.11k includes support for beacon measurement report, link measurement report, and neighbor request.

Refer ESP-IDF example [examples/wifi/roaming/README.md](#) to set up and use these APIs. Example code only demonstrates how these APIs can be used, and the application should define its own algorithm and cases as required.

### 4.32.18 Fast BSS Transition

Fast BSS transition (802.11R FT), is a standard to permit continuous connectivity aboard wireless devices in motion, with fast and secure client transitions from one Basic Service Set (abbreviated BSS, and also known as a base station or more colloquially, an access point) to another performed in a nearly seamless manner **avoiding 802.11 4 way handshake**. 802.11R specifies transitions between access points by redefining the security key negotiation protocol, allowing both the negotiation and requests for wireless resources to occur in parallel. The key derived from the server to be cached in the wireless network, so that a reasonable number of future connections can be based on the cached key, avoiding the 802.1X process

ESP32-S2 station supports FT for WPA2-PSK networks. Do note that ESP32-S2 station only support FT over the air protocol only.

A config option `CONFIG_WPA_11R_SUPPORT` and configuration parameter `ft_enabled` in `wifi_sta_config_t` is provided to enable 802.11R support for station. Refer ESP-IDF example [examples/wifi/roaming/README.md](#) for further details.

### 4.32.19 Wi-Fi Location

Wi-Fi Location will improve the accuracy of a device's location data beyond the Access Point, which will enable creation of new and feature-rich applications and services such as geo-fencing, network management, and navigation. One of the protocols used to determine the device location with respect to the Access Point is Fine Timing Measurement which calculates Time-of-Flight of a Wi-Fi frame.

#### Fine Timing Measurement (FTM)

FTM is used to measure Wi-Fi Round Trip Time (Wi-Fi RTT) which is the time a Wi-Fi signal takes to travel from a device to another device and back again. Using Wi-Fi RTT, the distance between the devices can be calculated with a simple formula of  $RTT * c / 2$ , where  $c$  is the speed of light.

FTM uses timestamps given by Wi-Fi interface hardware at the time of arrival or departure of frames exchanged between a pair of devices. One entity called FTM Initiator (mostly a station device) discovers the FTM Responder (can be a station or an Access Point) and negotiates to start an FTM procedure. The procedure uses multiple Action frames sent in bursts and its ACK's to gather the timestamps data. FTM Initiator gathers the data in the end to calculate an average Round-Trip-Time.

ESP32-S2 supports FTM in below configuration:

- ESP32-S2 as FTM Initiator in station mode.
- ESP32-S2 as FTM Responder in AP mode.

Distance measurement using RTT is not accurate, and factors such as RF interference, multi-path travel, antenna orientation, and lack of calibration increase these inaccuracies. For better results, it is suggested to perform FTM between two ESP32-S2 devices as station and AP.

Refer to ESP-IDF example [examples/wifi/ftm/README.md](#) for steps on how to set up and perform FTM.

### 4.32.20 ESP32-S2 Wi-Fi Power-saving Mode

This subsection will briefly introduce the concepts and usage related to Wi-Fi Power Saving Mode, for a more detailed introduction please refer to the [Low Power Mode User Guide](#)

#### Station Sleep

Currently, ESP32-S2 Wi-Fi supports the Modem-sleep mode which refers to the legacy power-saving mode in the IEEE 802.11 protocol. Modem-sleep mode works in station-only mode and the station must connect to the AP first. If the Modem-sleep mode is enabled, station will switch between active and sleep state periodically. In sleep state,

RF, PHY and BB are turned off in order to reduce power consumption. Station can keep connection with AP in modem-sleep mode.

Modem-sleep mode includes minimum and maximum power-saving modes. In minimum power-saving mode, station wakes up every DTIM to receive beacon. Broadcast data will not be lost because it is transmitted after DTIM. However, it cannot save much more power if DTIM is short for DTIM is determined by AP.

In maximum power-saving mode, station wakes up in every listen interval to receive beacon. This listen interval can be set to be longer than the AP DTIM period. Broadcast data may be lost because station may be in sleep state at DTIM time. If listen interval is longer, more power is saved, but broadcast data is more easy to lose. Listen interval can be configured by calling API `esp_wifi_set_config()` before connecting to AP.

Call `esp_wifi_set_ps(WIFI_PS_MIN_MODEM)` to enable Modem-sleep minimum power-saving mode or `esp_wifi_set_ps(WIFI_PS_MAX_MODEM)` to enable Modem-sleep maximum power-saving mode after calling `esp_wifi_init()`. When station connects to AP, Modem-sleep will start. When station disconnects from AP, Modem-sleep will stop.

Call `esp_wifi_set_ps(WIFI_PS_NONE)` to disable Modem-sleep entirely. This has much higher power consumption, but provides minimum latency for receiving Wi-Fi data in real time. When Modem-sleep is enabled, received Wi-Fi data can be delayed for as long as the DTIM period (minimum power-saving mode) or the listen interval (maximum power-saving mode).

The default Modem-sleep mode is `WIFI_PS_MIN_MODEM`.

### AP Sleep

Currently, ESP32-S2 AP does not support all of the power-saving feature defined in Wi-Fi specification. To be specific, the AP only caches unicast data for the stations connect to this AP, but does not cache the multicast data for the stations. If stations connected to the ESP32-S2 AP are power-saving enabled, they may experience multicast packet loss.

In the future, all power-saving features will be supported on ESP32-S2 AP.

### Disconnected State Sleep

Disconnected state is the duration without Wi-Fi connection between `esp_wifi_start()` to `esp_wifi_stop()`.

Currently, ESP32-S2 Wi-Fi supports sleep mode in disconnected state if running at station mode. This feature could be configured by Menuconfig choice `CONFIG_ESP_WIFI_STA_DISCONNECTED_PM_ENABLE`.

If `CONFIG_ESP_WIFI_STA_DISCONNECTED_PM_ENABLE` is enabled, RF, PHY and BB would be turned off in disconnected state when IDLE. The current would be same with current at modem-sleep.

The choice `CONFIG_ESP_WIFI_STA_DISCONNECTED_PM_ENABLE` would be selected by default, while it would be selected forcefully in Menuconfig at coexistence mode.

### Connectionless Modules Power-saving

Connectionless modules are those Wi-Fi modules not relying on Wi-Fi connection, e.g ESP-NOW, DPP, FTM. These modules start from `esp_wifi_start()`, working until `esp_wifi_stop()`.

Currently, if ESP-NOW works at station mode, its supported to sleep at both connected state and disconnected state.

**Connectionless Modules TX** For each connectionless module, its supported to TX at any sleeping time without any extra configuration.

Meanwhile, `esp_wifi_80211_tx()` is supported at sleep as well.

**Connectionless Modules RX** For each connectionless module, two parameters shall be configured to RX at sleep, which are *Window* and *Interval*.

At the start of *Interval* time, RF, PHY, BB would be turned on and kept for *Window* time. Connectionless Module could RX in the duration.

#### Interval

- There is only one *Interval*. Its configured by `esp_wifi_set_connectionless_interval()`. The unit is milliseconds.
- The default value of *Interval* is `ESP_WIFI_CONNECTIONLESS_INTERVAL_DEFAULT_MODE`.
- Event `WIFI_EVENT_CONNECTIONLESS_MODULE_WAKE_INTERVAL_START` would be posted at the start of *Interval*. Since *Window* also starts at that moment, its recommended to TX in that event.
- At connected state, the start of *Interval* would be aligned with TBTT.

#### Window

- Each connectionless module has its own *Window* after start. Connectionless Modules Power-saving would work with the max one among them.
- *Window* is configured by `module_name_set_wake_window()`. The unit is milliseconds.
- The default value of *Window* is the maximum.

Table 11: RF, PHY and BB usage under different circumstances

		Interval	
		ESP_WIFI_CONNECTIONLESS_INTERVAL_DEFAULT_MODE	
Win- dow	0	not used	
	1 - max- imum	default mode	used periodically (Window < Interval) / used all time (Window ≥ Interval)

**Default mode** If *Interval* is `ESP_WIFI_CONNECTIONLESS_INTERVAL_DEFAULT_MODE` with non-zero *Window*, Connectionless Modules Power-saving would work in default mode.

In default mode, RF, PHY, BB would be kept on if no coexistence with non-Wi-Fi protocol.

With coexistence, RF, PHY, BB resources are allocated by coexistence module to Wi-Fi connectionless module and non-Wi-Fi module, using time-division method. In default mode, Wi-Fi connectionless module is allowed to use RF, BB, PHY periodically under a stable performance.

Its recommended to configure Connectionless Modules Power-saving to default mode if there is Wi-Fi connectionless module coexists with non-Wi-Fi module.

### 4.32.21 ESP32-S2 Wi-Fi Throughput

The table below shows the best throughput results gained in Espressif's lab and in a shielded box.

Type/Throughput	Air In Lab	Shield-box	Test Tool	IDF Version (commit ID)
Raw 802.11 Packet RX	N/A	<b>130 MBit/s</b>	Internal tool	NA
Raw 802.11 Packet TX	N/A	<b>130 MBit/s</b>	Internal tool	NA
UDP RX	30 MBit/s	70 MBit/s	iperf example	15575346
UDP TX	30 MBit/s	50 MBit/s	iperf example	15575346
TCP RX	20 MBit/s	32 MBit/s	iperf example	15575346
TCP TX	20 MBit/s	37 MBit/s	iperf example	15575346

When the throughput is tested by iperf example, the sdkconfig is <examples/wifi/iperf/sdkconfig.defaults.esp32s2>.



### 4.32.22 Wi-Fi 80211 Packet Send

The `esp_wifi_80211_tx()` API can be used to:

- Send the beacon, probe request, probe response, and action frame.
- Send the non-QoS data frame.

It cannot be used for sending encrypted or QoS frames.

#### Preconditions of Using `esp_wifi_80211_tx()`

- The Wi-Fi mode is station, or AP, or station/AP.
- Either `esp_wifi_set_promiscuous(true)`, or `esp_wifi_start()`, or both of these APIs return ESP\_OK. This is because Wi-Fi hardware must be initialized before `esp_wifi_80211_tx()` is called. In ESP32-S2, both `esp_wifi_set_promiscuous(true)` and `esp_wifi_start()` can trigger the initialization of Wi-Fi hardware.
- The parameters of `esp_wifi_80211_tx()` are hereby correctly provided.

#### Data Rate

- The default data rate is 1 Mbps.
- Can set any rate through `esp_wifi_config_80211_tx_rate()` API.
- Can set any bandwidth through `esp_wifi_set_bandwidth()` API.

#### Side-Effects to Avoid in Different Scenarios

Theoretically, if the side-effects the API imposes on the Wi-Fi driver or other stations/APs are not considered, a raw 802.11 packet can be sent over the air with any destination MAC, any source MAC, any BSSID, or any other types of packet. However, robust or useful applications should avoid such side-effects. The table below provides some tips and recommendations on how to avoid the side-effects of `esp_wifi_80211_tx()` in different scenarios.



Scenario	Description
No Wi-Fi connection	<p>In this scenario, no Wi-Fi connection is set up, so there are no side-effects on the Wi-Fi driver. If <code>en_sys_seq==true</code>, the Wi-Fi driver is responsible for the sequence control. If <code>en_sys_seq==false</code>, the application needs to ensure that the buffer has the correct sequence. Theoretically, the MAC address can be any address. However, this may impact other stations/APs with the same MAC/BSSID.</p> <p>Side-effect example#1 The application calls <code>esp_wifi_80211_tx()</code> to send a beacon with <code>BSSID == mac_x</code> in AP mode, but the <code>mac_x</code> is not the MAC of the AP interface. Moreover, there is another AP, e.g., “other-AP”, whose BSSID is <code>mac_x</code>. If this happens, an “unexpected behavior” may occur, because the stations which connect to the “other-AP” cannot figure out whether the beacon is from the “other-AP” or the <code>esp_wifi_80211_tx()</code>. To avoid the above-mentioned side-effects, it is recommended that:</p> <ul style="list-style-type: none"> <li>• If <code>esp_wifi_80211_tx</code> is called in station mode, the first MAC should be a multicast MAC or the exact target-device’s MAC, while the second MAC should be that of the station interface.</li> <li>• If <code>esp_wifi_80211_tx</code> is called in AP mode, the first MAC should be a multicast MAC or the exact target-device’s MAC, while the second MAC should be that of the AP interface.</li> </ul> <p>The recommendations above are only for avoiding side-effects and can be ignored when there are good reasons.</p>
Have Wi-Fi connection	<p>When the Wi-Fi connection is already set up, and the sequence is controlled by the application, the latter may impact the sequence control of the Wi-Fi connection as a whole. So, the <code>en_sys_seq</code> need to be true, otherwise <code>ESP_ERR_INVALID_ARG</code> is returned. The MAC-address recommendations in the “No Wi-Fi connection” scenario also apply to this scenario.</p> <p>If the Wi-Fi mode is station mode, the MAC address1 is the MAC of AP to which the station is connected, and the MAC address2 is the MAC of station interface, it is said that the packet is sent from the station to AP. Otherwise, if the Wi-Fi is in AP mode, the MAC address1 is the MAC of the station that connects to this AP, and the MAC address2 is the MAC of AP interface, it is said that the packet is sent from the AP to station. To avoid conflicting with Wi-Fi connections, the following checks are applied:</p> <ul style="list-style-type: none"> <li>• If the packet type is data and is sent from the station to AP, the ToDS bit in IEEE 80211 frame control should be 1 and the FromDS bit should be 0. Otherwise, the packet will be discarded by Wi-Fi driver.</li> <li>• If the packet type is data and is sent from the AP to station, the ToDS bit in IEEE 80211 frame control should be 0 and the FromDS bit should be 1. Otherwise, the packet will be discarded by Wi-Fi driver.</li> <li>• If the packet is sent from station to AP or from AP to station, the Power Management, More Data, and Re-Transmission bits should be 0. Otherwise, the packet will be discarded by Wi-Fi driver.</li> </ul> <p><code>ESP_ERR_INVALID_ARG</code> is returned if any check fails.</p>

### 4.32.23 Wi-Fi Sniffer Mode

The Wi-Fi sniffer mode can be enabled by `esp_wifi_set_promiscuous()`. If the sniffer mode is enabled, the following packets **can** be dumped to the application:

- 802.11 Management frame.
- 802.11 Data frame, including MPDU, AMPDU, and AMSDU.
- 802.11 MIMO frame, for MIMO frame, the sniffer only dumps the length of the frame.
- 802.11 Control frame.
- 802.11 CRC error frame.

The following packets will **NOT** be dumped to the application:

- Other 802.11 error frames.

For frames that the sniffer **can** dump, the application can additionally decide which specific type of

packets can be filtered to the application by using `esp_wifi_set_promiscuous_filter()` and `esp_wifi_set_promiscuous_ctrl_filter()`. By default, it will filter all 802.11 data and management frames to the application. If you want to filter the 802.11 control frames, the filter parameter in `esp_wifi_set_promiscuous_filter()` should include `WIFI_PROMIS_FILTER_MASK_CTRL` type, and if you want to differentiate control frames further, then call `esp_wifi_set_promiscuous_ctrl_filter()`.

The Wi-Fi sniffer mode can be enabled in the Wi-Fi mode of `WIFI_MODE_NULL`, `WIFI_MODE_STA`, `WIFI_MODE_AP`, or `WIFI_MODE_APSTA`. In other words, the sniffer mode is active when the station is connected to the AP, or when the AP has a Wi-Fi connection. Please note that the sniffer has a **great impact** on the throughput of the station or AP Wi-Fi connection. Generally, the sniffer should be enabled **only if** the station/AP Wi-Fi connection does not experience heavy traffic.

Another noteworthy issue about the sniffer is the callback `wifi_promiscuous_cb_t`. The callback will be called directly in the Wi-Fi driver task, so if the application has a lot of work to do for each filtered packet, the recommendation is to post an event to the application task in the callback and defer the real work to the application task.

### 4.32.24 Wi-Fi Multiple Antennas

The Wi-Fi multiple antennas selecting can be depicted as following picture:

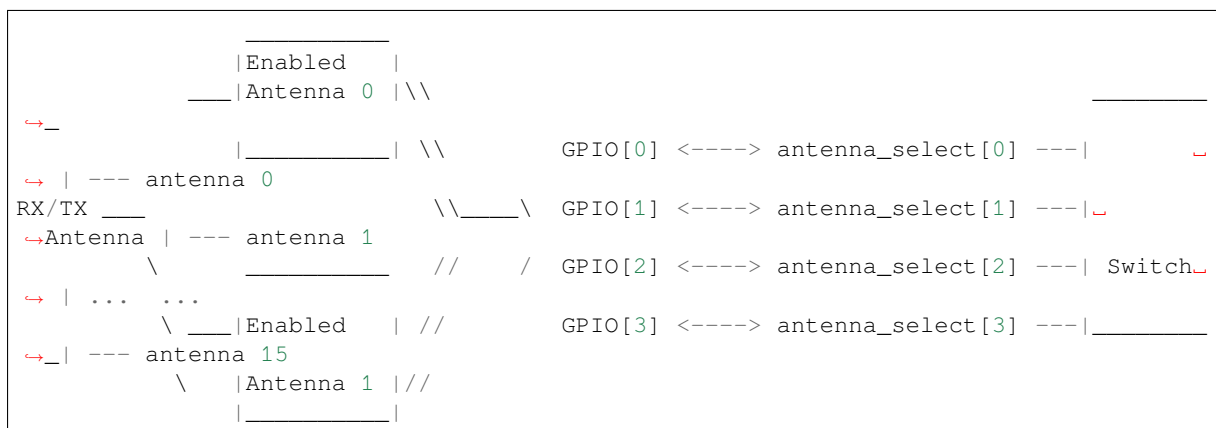

ESP32-S2 supports up to sixteen antennas through external antenna switch. The antenna switch can be controlled by up to four address pins - `antenna_select[0:3]`. Different input value of `antenna_select[0:3]` means selecting different antenna. For example, the value '0b1011' means the antenna 11 is selected. The default value of `antenna_select[3:0]` is '0b0000', which means the antenna 0 is selected by default.

Up to four GPIOs are connected to the four active high antenna\_select pins. ESP32-S2 can select the antenna by control the GPIO[0:3]. The API `esp_wifi_set_ant_gpio()` is used to configure which GPIOs are connected to antenna\_selects. If GPIO[x] is connected to antenna\_select[x], then `gpio_config->gpio_cfg[x].gpio_select` should be set to 1 and `gpio_config->gpio_cfg[x].gpio_num` should be provided.

For the specific implementation of the antenna switch, there may be illegal values in `antenna_select[0:3]`. It means that ESP32-S2 may support less than sixteen antennas through the switch. For example, ESP32-WROOM-DA which uses RTC6603SP as the antenna switch, supports two antennas. Two GPIOs are connected to two active high antenna selection inputs. The value '0b01' means the antenna 0 is selected, the value '0b10' means the antenna 1 is selected. Values '0b00' and '0b11' are illegal.

Although up to sixteen antennas are supported, only one or two antennas can be simultaneously enabled for RX/TX. The API `esp_wifi_set_ant()` is used to configure which antennas are enabled.

The enabled antennas selecting algorithm is also configured by `esp_wifi_set_ant()`. The RX/TX antenna mode can be `WIFI_ANT_MODE_ANT0`, `WIFI_ANT_MODE_ANT1`, or `WIFI_ANT_MODE_AUTO`. If the antenna mode is `WIFI_ANT_MODE_ANT0`, the enabled antenna 0 is selected for RX/TX data. If the antenna mode is `WIFI_ANT_MODE_ANT1`, the enabled antenna 1 is selected for RX/TX data. Otherwise, Wi-Fi automatically selects the enabled antenna that has better signal.

If the RX antenna mode is `WIFI_ANT_MODE_AUTO`, the default antenna mode also needs to be set, because the RX antenna switching only happens when some conditions are met. For example, the RX antenna starts to switch if the RSSI is lower than -65 dBm or another antenna has better signal. RX uses the default antenna if the conditions are not met. If the default antenna mode is `WIFI_ANT_MODE_ANT1`, the enabled antenna 1 is used as the default RX antenna, otherwise the enabled antenna 0 is used.

Some limitations need to be considered:

- The TX antenna can be set to `WIFI_ANT_MODE_AUTO` only if the RX antenna mode is `WIFI_ANT_MODE_AUTO`, because TX antenna selecting algorithm is based on RX antenna in `WIFI_ANT_MODE_AUTO` type.
- When the TX antenna mode or RX antenna mode is configured to `WIFI_ANT_MODE_AUTO` the switching mode will easily trigger the switching phase, as long as there is deterioration of the RF signal. So in situations where the RF signal is not stable, the antenna switching will occur frequently, resulting in an RF performance that may not meet expectations.
- Currently, Bluetooth® does not support the multiple antennas feature, so please do not use multiple antennas related APIs.

Following is the recommended scenarios to use the multiple antennas:

- The applications can always choose to select a specified antenna or implement their own antenna selecting algorithm, e.g., selecting the antenna mode based on the information collected by the application. Refer to ESP-IDF example <examples/wifi/antenna/README.md> for the antenna selecting algorithm design.
- Both RX/TX antenna modes are configured to `WIFI_ANT_MODE_ANT0` or `WIFI_ANT_MODE_ANT1`.

### Wi-Fi Multiple Antennas Configuration

Generally, following steps can be taken to configure the multiple antennas:

- Configure which GPIOs are connected to the antenna\_selects. For example, if four antennas are supported and GPIO20/GPIO21 are connected to antenna\_select[0]/antenna\_select[1], the configurations look like:

```
wifi_ant_gpio_config_t ant_gpio_config = {
    .gpio_cfg[0] = { .gpio_select = 1, .gpio_num = 20 },
    .gpio_cfg[1] = { .gpio_select = 1, .gpio_num = 21 }
};
```

- Configure which antennas are enabled and how RX/TX use the enabled antennas. For example, if antenna1 and antenna3 are enabled, the RX needs to select the better antenna automatically and uses antenna1 as its default antenna, the TX always selects the antenna3. The configuration looks like:

```
wifi_ant_config_t config = {
    .rx_ant_mode = WIFI_ANT_MODE_AUTO,
    .rx_ant_default = WIFI_ANT_ANT0,
    .tx_ant_mode = WIFI_ANT_MODE_ANT1,
    .enabled_ant0 = 1,
    .enabled_ant1 = 3
};
```

#### 4.32.25 Wi-Fi Channel State Information

Channel state information (CSI) refers to the channel information of a Wi-Fi connection. In ESP32-S2, this information consists of channel frequency responses of sub-carriers and is estimated when packets are received from the transmitter. Each channel frequency response of sub-carrier is recorded by two bytes of signed characters. The first one is imaginary part and the second one is real part. There are up to three fields of channel frequency responses according to the type of received packet. They are legacy long training field (LLTF), high throughput LTF (HT-LTF), and space time block code HT-LTF (STBC-HT-LTF). For different types of packets which are received on channels with different state, the sub-carrier index and total bytes of signed characters of CSI are shown in the following table.

chan- nel	sec- ondary chan- nel	none			below					above				
		sig- nal mode	non HT	HT	non HT	HT	non HT	HT	40 MHz	non HT	HT	non HT	HT	
packet in- for- ma- tion	chan- nel band- width	20 MHz	20 MHz	20 MHz	20 MHz	20 MHz	40 MHz	20 MHz	20 MHz	40 MHz	20 MHz	20 MHz	40 MHz	
	STBC	non STBC	non STBC	STBC	non STBC	non STBC	STBC	non STBC	STBC	non STBC	STBC	non STBC	STBC	
sub- carrier in- dex	LLTF	0~31, - 32~ 1	0~31, - 32~ 1	0~31, - 32~ 1	0~63	0~63	0~63	0~63	0~63	- 64~ 1	- 64~ 1	- 64~ 1	- 64~ 1	- 64~ 1
	HT- LTF	•	0~31, - 32~ 1	0~31, - 32~ 1	•	0~63	0~62	0~63, - 64~ 1	0~60, - 60~ 1	•	- 64~ 1	- 62~ 1	0~63, - 64~ 1	0~60, - 60~ 1
	STBC- HT- LTF	•	•	0~31, - 32~ 1	•	•	0~62	•	0~60, - 60~ 1	•	•	- 62~ 1	•	0~60, - 60~ 1
total bytes		128	256	384	128	256	380	384	612	128	256	376	384	612

All of the information in the table can be found in the structure `wifi_csi_info_t`.

- Secondary channel refers to `secondary_channel` field of `rx_ctrl` field.
- Signal mode of packet refers to `sig_mode` field of `rx_ctrl` field.
- Channel bandwidth refers to `cwb` field of `rx_ctrl` field.
- STBC refers to `stbc` field of `rx_ctrl` field.
- Total bytes refers to `len` field.
- The CSI data corresponding to each Long Training Field (LTF) type is stored in a buffer starting from the `buf` field. Each item is stored as two bytes: imaginary part followed by real part. The order of each item is the same as the sub-carrier in the table. The order of LTF is: LLTF, HT-LTF, STBC-HT-LTF. However, all 3 LTFs may not be present, depending on the channel and packet information (see above).
- If `first_word_invalid` field of `wifi_csi_info_t` is true, it means that the first four bytes of CSI data is invalid due to a hardware limitation in ESP32-S2.
- More information like RSSI, noise floor of RF, receiving time and antenna is in the `rx_ctrl` field.

When imaginary part and real part data of sub-carrier are used, please refer to the table below.

PHY standard	Sub-carrier range	Pilot sub-carrier	Sub-carrier(total/data)
802.11a/g	-26 to +26	-21, -7, +7, +21	52 total, 48 usable
802.11n, 20MHz	-28 to +28	-21, -7, +7, +21	56 total, 52 usable
802.11n, 40MHz	-57 to +57	-53, -25, -11, +11, +25, +53	114 total, 108 usable

#### Note:

- For STBC packet, CSI is provided for every space-time stream without CSD (cyclic shift delay). As each cyclic shift on the additional chains shall be -200 ns, only the CSD angle of first space-time stream is recorded in sub-carrier 0 of HT-LTF and STBC-HT-LTF for there is no channel frequency response in sub-carrier 0. CSD[10:0] is 11 bits, ranging from -pi to pi.
- If LLTF, HT-LTF, or STBC-HT-LTF is not enabled by calling API `esp_wifi_set_csi_config()`, the total bytes of CSI data will be fewer than that in the table. For example, if LLTF and HT-LTF is not enabled

and STBC-HT-LTF is enabled, when a packet is received with the condition above/HT/40MHz/STBC, the total bytes of CSI data is 244  $((61 + 60) * 2 + 2 = 244$ . The result is aligned to four bytes, and the last two bytes are invalid).

---

### 4.32.26 Wi-Fi Channel State Information Configure

To use Wi-Fi CSI, the following steps need to be done.

- Select Wi-Fi CSI in menuconfig. Go to `Menuconfig > Components config > Wi-Fi > Wi-Fi CSI (Channel State Information)`.
- Set CSI receiving callback function by calling API `esp_wifi_set_csi_rx_cb()`.
- Configure CSI by calling API `esp_wifi_set_csi_config()`.
- Enable CSI by calling API `esp_wifi_set_csi()`.

The CSI receiving callback function runs from Wi-Fi task. So, do not do lengthy operations in the callback function. Instead, post necessary data to a queue and handle it from a lower priority task. Because station does not receive any packet when it is disconnected and only receives packets from AP when it is connected, it is suggested to enable sniffer mode to receive more CSI data by calling `esp_wifi_set_promiscuous()`.

### 4.32.27 Wi-Fi HT20/40

ESP32-S2 supports Wi-Fi bandwidth HT20 or HT40 and does not support HT20/40 coexist. `esp_wifi_set_bandwidth()` can be used to change the default bandwidth of station or AP. The default bandwidth for ESP32-S2 station and AP is HT40.

In station mode, the actual bandwidth is firstly negotiated during the Wi-Fi connection. It is HT40 only if both the station and the connected AP support HT40, otherwise it is HT20. If the bandwidth of connected AP is changes, the actual bandwidth is negotiated again without Wi-Fi disconnecting.

Similarly, in AP mode, the actual bandwidth is negotiated between AP and the stations that connect to the AP. It is HT40 if the AP and one of the stations support HT40, otherwise it is HT20.

In station/AP coexist mode, the station/AP can configure HT20/40 separately. If both station and AP are negotiated to HT40, the HT40 channel should be the channel of station because the station always has higher priority than AP in ESP32-S2. For example, the configured bandwidth of AP is HT40, the configured primary channel is 6, and the configured secondary channel is 10. The station is connected to a router whose primary channel is 6 and secondary channel is 2, then the actual channel of AP is changed to primary 6 and secondary 2 automatically.

Theoretically, the HT40 can gain better throughput because the maximum raw physical (PHY) data rate for HT40 is 150 Mbps while it is 72 Mbps for HT20. However, if the device is used in some special environment, e.g., there are too many other Wi-Fi devices around the ESP32-S2 device, the performance of HT40 may be degraded. So if the applications need to support same or similar scenarios, it is recommended that the bandwidth is always configured to HT20.

### 4.32.28 Wi-Fi QoS

ESP32-S2 supports all the mandatory features required in WFA Wi-Fi QoS Certification.

Four ACs (Access Category) are defined in Wi-Fi specification, and each AC has its own priority to access the Wi-Fi channel. Moreover, a map rule is defined to map the QoS priority of other protocol, e.g., 802.11D or TCP/IP precedence is mapped to Wi-Fi AC.

The table below describes how the IP Precedences are mapped to Wi-Fi ACs in ESP32-S2. It also indicates whether the AMPDU is supported for this AC. The table is sorted from high to low priority. That is to say, the AC\_VO has the highest priority.

IP Precedence	Wi-Fi AC	Support AMPDU?
6, 7	AC_VO (Voice)	No
4, 5	AC_VI (Video)	Yes
3, 0	AC_BE (Best Effort)	Yes
1, 2	AC_BK (Background)	Yes

The application can make use of the QoS feature by configuring the IP precedence via socket option IP\_TOS. Here is an example to make the socket to use VI queue:

```
const int ip_precedence_vi = 4;
const int ip_precedence_offset = 5;
int priority = (ip_precedence_vi << ip_precedence_offset);
setsockopt(socket_id, IPPROTO_IP, IP_TOS, &priority, sizeof(priority));
```

Theoretically, the higher priority AC has better performance than the lower priority AC. However, it is not always true. Here are some suggestions about how to use the Wi-Fi QoS:

- Some really important application traffic can be put into the AC\_VO queue. But avoid using the AC\_VO queue for heavy traffic, as it may impact the management frames which also use this queue. Eventually, it is worth noting that the AC\_VO queue does not support AMPDU, and its performance with heavy traffic is no better than other queues.
- Avoid using more than two precedences supported by different AMPDUs, e.g., when socket A uses precedence 0, socket B uses precedence 1, and socket C uses precedence 2. This can be a bad design because it may need much more memory. To be specific, the Wi-Fi driver may generate a Block Ack session for each precedence and it needs more memory if the Block Ack session is set up.

#### 4.32.29 Wi-Fi AMSDU

ESP32-S2 supports receiving and transmitting AMSDU. AMSDU TX is disabled by default, since enable AMSDU TX need more memory. Select [CONFIG\\_ESP32\\_WIFI\\_AMSDU\\_TX\\_ENABLED](#) to enable AMSDU Tx feature, it depends on [CONFIG\\_SPIRAM](#).

#### 4.32.30 Wi-Fi Fragment

supports Wi-Fi receiving fragment, but does not support Wi-Fi transmitting fragment.

#### 4.32.31 WPS Enrollee

ESP32-S2 supports WPS enrollee feature in Wi-Fi mode [WIFI\\_MODE\\_STA](#) or [WIFI\\_MODE\\_APSTA](#). Currently, ESP32-S2 supports WPS enrollee type PBC and PIN.

#### 4.32.32 Wi-Fi Buffer Usage

This section is only about the dynamic buffer configuration.

##### Why Buffer Configuration Is Important

In order to get a high-performance system, consider the memory usage/configuration carefully for the following reasons:

- the available memory in ESP32-S2 is limited.
- currently, the default type of buffer in LwIP and Wi-Fi drivers is “dynamic” , **which means that both the LwIP and Wi-Fi share memory with the application**. Programmers should always keep this in mind; otherwise, they will face a memory issue, such as “running out of heap memory” .

- it is very dangerous to run out of heap memory, as this will cause ESP32-S2 an “undefined behavior” . Thus, enough heap memory should be reserved for the application, so that it never runs out of it.
- the Wi-Fi throughput heavily depends on memory-related configurations, such as the TCP window size and Wi-Fi RX/TX dynamic buffer number.
- the peak heap memory that the ESP32-S2 LwIP/Wi-Fi may consume depends on a number of factors, such as the maximum TCP/UDP connections that the application may have.
- the total memory that the application requires is also an important factor when considering memory configuration.

Due to these reasons, there is not a good-for-all application configuration. Rather, it is recommended to consider memory configurations separately for every different application.

### Dynamic vs. Static Buffer

The default type of buffer in Wi-Fi drivers is “dynamic” . Most of the time the dynamic buffer can significantly save memory. However, it makes the application programming a little more difficult, because in this case the application needs to consider memory usage in Wi-Fi.

lwIP also allocates buffers at the TCP/IP layer, and this buffer allocation is also dynamic. See [lwIP documentation section about memory use and performance](#).

### Peak Wi-Fi Dynamic Buffer

The Wi-Fi driver supports several types of buffer (refer to [Wi-Fi Buffer Configure](#)). However, this section is about the usage of the dynamic Wi-Fi buffer only. The peak heap memory that Wi-Fi consumes is the **theoretically-maximum memory** that the Wi-Fi driver consumes. Generally, the peak memory depends on:

- the number of dynamic RX buffers that are configured: `wifi_rx_dynamic_buf_num`
- the number of dynamic TX buffers that are configured: `wifi_tx_dynamic_buf_num`
- the maximum packet size that the Wi-Fi driver can receive: `wifi_rx_pkt_size_max`
- the maximum packet size that the Wi-Fi driver can send: `wifi_tx_pkt_size_max`

So, the peak memory that the Wi-Fi driver consumes can be calculated with the following formula:

$$\text{wifi\_dynamic\_peek\_memory} = (\text{wifi\_rx\_dynamic\_buf\_num} * \text{wifi\_rx\_pkt\_size\_max}) + (\text{wifi\_tx\_dynamic\_buf\_num} * \text{wifi\_tx\_pkt\_size\_max})$$

Generally, the dynamic TX long buffers and dynamic TX long long buffers can be ignored, because they are management frames which only have a small impact on the system.

### 4.32.33 How to Improve Wi-Fi Performance

The performance of ESP32-S2 Wi-Fi is affected by many parameters, and there are mutual constraints between each parameter. A proper configuration cannot only improve performance, but also increase available memory for applications and improve stability.

This section briefly explains the operating mode of the Wi-Fi/LwIP protocol stack and the role of each parameter. It also gives several recommended configuration ranks to help choose the appropriate rank according to the usage scenario.

### Protocol Stack Operation Mode

The ESP32-S2 protocol stack is divided into four layers: Application, LwIP, Wi-Fi, and Hardware.

- During receiving, hardware puts the received packet into DMA buffer, and then transfers it into the RX buffer of Wi-Fi and LwIP in turn for related protocol processing, and finally to the application layer. The Wi-Fi RX buffer and the LwIP RX buffer shares the same buffer by default. In other words, the Wi-Fi forwards the packet to LwIP by reference by default.



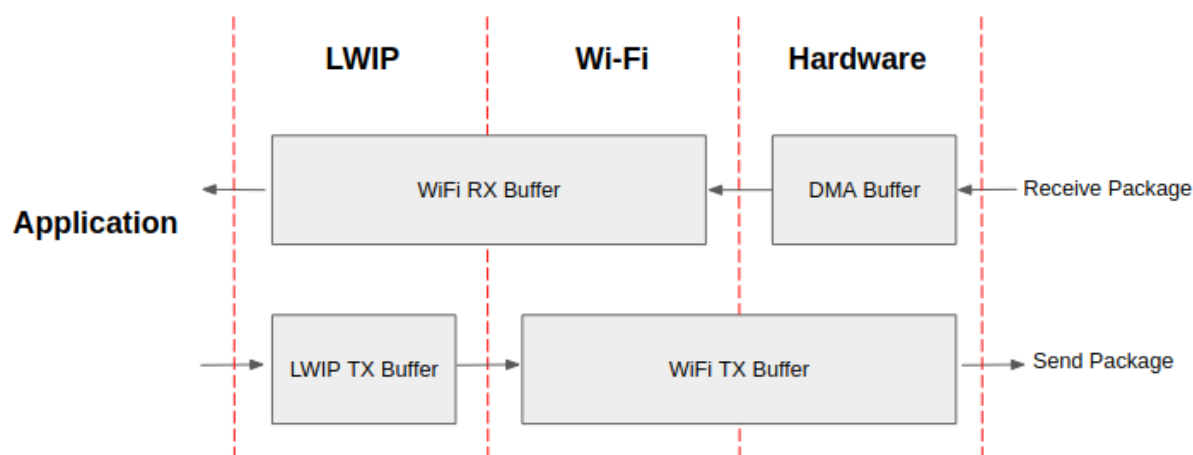

Fig. 49: ESP32-S2 datapath

- During sending, the application copies the messages to be sent into the TX buffer of the LwIP layer for TCP/IP encapsulation. The messages will then be passed to the TX buffer of the Wi-Fi layer for MAC encapsulation and wait to be sent.

### Parameters

Increasing the size or number of the buffers mentioned above properly can improve Wi-Fi performance. Meanwhile, it will reduce available memory to the application. The following is an introduction to the parameters that users need to configure:

#### RX direction:

- **`CONFIG_ESP32_WIFI_STATIC_RX_BUFFER_NUM`** This parameter indicates the number of DMA buffer at the hardware layer. Increasing this parameter will increase the sender's one-time receiving throughput, thereby improving the Wi-Fi protocol stack ability to handle burst traffic.
- **`CONFIG_ESP32_WIFI_DYNAMIC_RX_BUFFER_NUM`** This parameter indicates the number of RX buffer in the Wi-Fi layer. Increasing this parameter will improve the performance of packet reception. This parameter needs to match the RX buffer size of the LwIP layer.
- **`CONFIG_ESP32_WIFI_RX_BA_WIN`** This parameter indicates the size of the AMPDU BA Window at the receiving end. This parameter should be configured to the smaller value between twice of `CONFIG_ESP32_WIFI_STATIC_RX_BUFFER_NUM` and `CONFIG_ESP32_WIFI_DYNAMIC_RX_BUFFER_NUM`.
- **`CONFIG_LWIP_TCP_WND_DEFAULT`** This parameter represents the RX buffer size of the LwIP layer for each TCP stream. Its value should be configured to the value of `WIFI_DYNAMIC_RX_BUFFER_NUM` (KB) to reach a high and stable performance. Meanwhile, in case of multiple streams, this value needs to be reduced proportionally.

#### TX direction:

- **`CONFIG_ESP32_WIFI_TX_BUFFER`** This parameter indicates the type of TX buffer, it is recommended to configure it as a dynamic buffer, which can make full use of memory.
- **`CONFIG_ESP32_WIFI_DYNAMIC_TX_BUFFER_NUM`** This parameter indicates the number of TX buffer on the Wi-Fi layer. Increasing this parameter will improve the performance of packet sending. The parameter value needs to match the TX buffer size of the LwIP layer.
- **`CONFIG_LWIP_TCP_SND_BUF_DEFAULT`** This parameter represents the TX buffer size of the LwIP layer for each TCP stream. Its value should be configured to the value of `WIFI_DYNAMIC_TX_BUFFER_NUM` (KB) to reach a high and stable performance. In case of multiple streams, this value needs to be reduced proportionally.

#### Throughput optimization by placing code in IRAM:



- ***CONFIG\_ESP32\_WIFI\_IRAM\_OPT*** If this option is enabled, some Wi-Fi functions are moved to IRAM, improving throughput. This increases IRAM usage by 15 kB.
- ***CONFIG\_ESP32\_WIFI\_RX\_IRAM\_OPT*** If this option is enabled, some Wi-Fi RX functions are moved to IRAM, improving throughput. This increases IRAM usage by 16 kB.
- ***CONFIG\_LWIP\_IRAM\_OPTIMIZATION*** If this option is enabled, some LwIP functions are moved to IRAM, improving throughput. This increases IRAM usage by 13 kB.

**CACHE:**

- ***CONFIG\_ESP32S2\_INSTRUCTION\_CACHE\_SIZE*** Configure the size of the instruction Cache.
- ***CONFIG\_ESP32S2\_INSTRUCTION\_CACHE\_LINE\_SIZE*** Configure the width of the instruction Cache bus.

---

**Note:** The buffer size mentioned above is fixed as 1.6 KB.

---

**How to Configure Parameters**

The memory of ESP32-S2 is shared by protocol stack and applications.

Here, several configuration ranks are given. In most cases, the user should select a suitable rank for parameter configuration according to the size of the memory occupied by the application.

The parameters not mentioned in the following table should be set to the default.

Rank	lperf	High-performance	Default	Memory saving	Minimum
Available memory (KB)	4.1	24.2	78.4	86.5	116.4
WIFI_STATIC_RX_BUFFER_NUM	6	6	6	4	3
WIFI_DYNAMIC_RX_BUFFER_NUM	12	12	12	8	6
WIFI_DYNAMIC_TX_BUFFER_NUM	12	12	12	8	6
WIFI_RX_BA_WIN	9	9	6	4	3
TCP_SND_BUF (KB)	DEFAULT	18	12	8	6
TCP_WND_DEFAULT (KB)	DEFAULT	18	12	8	6
WIFI_IRAM_OPT	15	15	15	15	0
WIFI_RX_IRAM_OPT	16	16	16	0	0
LWIP_IRAM_OPTIMIZATION	13	13	0	0	0
INSTRUCTION_CACHE	16	16	16	16	8
INSTRUCTION_CACHE_LINE	16	16	16	16	16
TCP TX throughput (Mbit/s)	37.6	33.1	22.5	12.2	5.5
TCP RX throughput (Mbit/s)	31.5	28.1	20.1	13.1	7.2
UDP TX throughput (Mbit/s)	58.1	57.3	28.1	22.6	8.7
UDP RX throughput (Mbit/s)	78.1	66.7	65.3	53.8	28.5

**Note:** The test was performed with a single stream in a shielded box using an ASUS RT-N66U router. ESP32-S2's CPU is single core with 240 MHz. ESP32-S2's flash is in QIO mode with 80 MHz.

#### Ranks:

- **Iperf rank** ESP32-S2 extreme performance rank used to test extreme performance.
- **High-performance rank** The ESP32-S2's high-performance configuration rank, suitable for scenarios where the application occupies less memory and has high-performance requirements.
- **Default rank** ESP32-S2's default configuration rank, the available memory, and performance are in balance.
- **Memory saving rank** This rank is suitable for scenarios where the application requires a large amount of memory, and the transceiver performance will be reduced in this rank.
- **Minimum rank** This is the minimum configuration rank of ESP32-S2. The protocol stack only uses the necessary memory for running. It is suitable for scenarios where there is no requirement for performance and the application requires lots of space.

#### Using PSRAM

PSRAM is generally used when the application takes up a lot of memory. In this mode, the `CONFIG_ESP32_WIFI_TX_BUFFER` is forced to be static. `CONFIG_ESP32_WIFI_STATIC_TX_BUFFER_NUM` indicates the number of DMA buffers at the hardware layer, and increasing this parameter can improve performance. The following are the recommended ranks for using PSRAM:

Rank	Iperf	Default	Memory saving	Minimum
Available memory (KB)	70.6	96.4	118.8	148.2
WIFI_STATIC_RX_BUFFER_NUM	8	8	6	4
WIFI_DYNAMIC_RX_BUFFER_NUM	64	64	64	64
WIFI_STATIC_TX_BUFFER_NUM	8	8	6	4
WIFI_RX_BA_WIN	6	6	6	Disable
TCP_SND_BUF_DEFAULT (KB)	32	32	32	32
TCP_WND_DEFAULT (KB)	32	32	32	32
WIFI_IRAM_OPT	15	15	15	0
WIFI_RX_IRAM_OPT	16	16	0	0
LWIP_IRAM_OPTIMIZATION	0	0	0	0
INSTRUCTION_CACHE	16	16	16	8
INSTRUCTION_CACHE_LINE	16	16	16	16
DATA_CACHE	8	8	8	8
DATA_CACHE_LINE	32	32	32	32
TCP TX throughput (Mbit/s)	40.1	29.2	20.1	8.9
TCP RX throughput (Mbit/s)	21.9	16.8	14.8	9.6
UDP TX throughput (Mbit/s)	50.1	25.7	22.4	10.2
UDP RX throughput (Mbit/s)	45.3	43.1	28.5	15.1

**Note:** Reaching peak performance may cause task watchdog. It is a normal phenomenon considering the CPU may

have no time for lower priority tasks.

### 4.32.34 Wi-Fi Menuconfig

#### Wi-Fi Buffer Configure

If you are going to modify the default number or type of buffer, it would be helpful to also have an overview of how the buffer is allocated/freed in the data path. The following diagram shows this process in the TX direction:

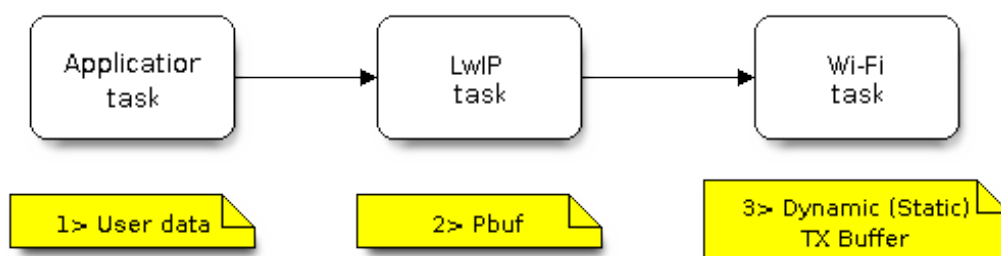

Fig. 50: TX Buffer Allocation

Description:

- The application allocates the data which needs to be sent out.
- The application calls TCP/IP-/Socket-related APIs to send the user data. These APIs will allocate a PBUF used in LwIP, and make a copy of the user data.
- When LwIP calls a Wi-Fi API to send the PBUF, the Wi-Fi API will allocate a “Dynamic Tx Buffer” or “Static Tx Buffer”, make a copy of the LwIP PBUF, and finally send the data.

The following diagram shows how buffer is allocated/freed in the RX direction:

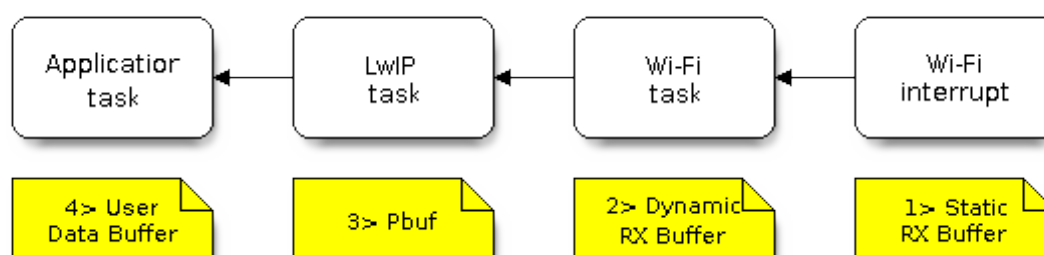

Fig. 51: RX Buffer Allocation

Description:

- The Wi-Fi hardware receives a packet over the air and puts the packet content to the “Static Rx Buffer”, which is also called “RX DMA Buffer”.
- The Wi-Fi driver allocates a “Dynamic Rx Buffer”, makes a copy of the “Static Rx Buffer”, and returns the “Static Rx Buffer” to hardware.
- The Wi-Fi driver delivers the packet to the upper-layer (LwIP), and allocates a PBUF for holding the “Dynamic Rx Buffer”.
- The application receives data from LwIP.

The diagram shows the configuration of the Wi-Fi internal buffer.

Buffer Type	Alloc Type	Default	Configurable	Description
Static RX Buffer (Hardware RX Buffer)	Static	10 * 1600 Bytes	Yes	<p>This is a kind of DMA memory. It is initialized in <code>esp_wifi_init()</code> and freed in <code>esp_wifi_deinit()</code>. The ‘Static Rx Buffer’ forms the hardware receiving list. Upon receiving a frame over the air, hardware writes the frame into the buffer and raises an interrupt to the CPU. Then, the Wi-Fi driver reads the content from the buffer and returns the buffer back to the list.</p> <p>If needs be, the application can reduce the memory statically allocated by Wi-Fi. It can reduce this value from 10 to 6 to save 6400 Bytes of memory. It is not recommended to reduce the configuration to a value less than 6 unless the AMPDU feature is disabled.</p>
Dynamic RX Buffer	Dynamic	32	Yes	<p>The buffer length is variable and it depends on the received frames’ length. When the Wi-Fi driver receives a frame from the ‘Hardware Rx Buffer’, the ‘Dynamic Rx Buffer’ needs to be allocated from the heap. The number of the Dynamic Rx Buffer, configured in the menuconfig, is used to limit the total un-freed Dynamic Rx Buffer number.</p>
Dynamic TX Buffer	Dynamic	32	Yes	<p>This is a kind of DMA memory. It is allocated to the heap. When the upper-layer (LwIP) sends packets to the Wi-Fi driver, it firstly allocates a ‘Dynamic TX Buffer’ and makes a copy of the upper-layer buffer.</p> <p>The Dynamic and Static TX Buffers are mutually exclusive.</p>
Static TX Buffer	Static	16 * 1600Bytes	Yes	<p>This is a kind of DMA memory. It is initialized in <code>esp_wifi_init()</code> and freed in <code>esp_wifi_deinit()</code>. When the upper-layer (LwIP) sends packets to the Wi-Fi driver, it firstly allocates a ‘Static TX Buffer’ and makes a copy of the upper-layer buffer.</p> <p>The Dynamic and Static TX Buffer are mutually exclusive.</p> <p>The TX buffer must be a DMA buffer. For this reason, if PSRAM is enabled, the TX buffer must be static.</p>
Management Short Buffer	Dynamic	8	NO	Wi-Fi driver’ s internal buffer.
Management Long Buffer	Dynamic	32	NO	Wi-Fi driver’ s internal buffer.
Management Long Long Buffer	Dynamic	32	NO	Wi-Fi driver’ s internal buffer.

## Wi-Fi NVS Flash

If the Wi-Fi NVS flash is enabled, all Wi-Fi configurations set via the Wi-Fi APIs will be stored into flash, and the Wi-Fi driver will start up with these configurations the next time it powers on/reboots. However, the application can choose to disable the Wi-Fi NVS flash if it does not need to store the configurations into persistent memory, or has its own persistent storage, or simply due to debugging reasons, etc.

## Wi-Fi Aggregate MAC Protocol Data Unit (AMPDU)

ESP32-S2 supports both receiving and transmitting AMPDU, and the AMPDU can greatly improve the Wi-Fi throughput.

Generally, the AMPDU should be enabled. Disabling AMPDU is usually for debugging purposes.

### 4.32.35 Troubleshooting

Please refer to a separate document with *Espressif Wireshark User Guide*.

## Espressif Wireshark User Guide

### 1. Overview

**1.1 What is Wireshark?** *Wireshark* (originally named “Ethereal” ) is a network packet analyzer that captures network packets and displays the packet data as detailed as possible. It uses WinPcap as its interface to directly capture network traffic going through a network interface controller (NIC).

You could think of a network packet analyzer as a measuring device used to examine what is going on inside a network cable, just like a voltmeter is used by an electrician to examine what is going on inside an electric cable.

In the past, such tools were either very expensive, proprietary, or both. However, with the advent of Wireshark, all that has changed.

Wireshark is released under the terms of the GNU General Public License, which means you can use the software and the source code free of charge. It also allows you to modify and customize the source code.

Wireshark is, perhaps, one of the best open source packet analyzers available today.

**1.2 Some Intended Purposes** Here are some examples of how Wireshark is typically used:

- Network administrators use it to troubleshoot network problems.
- Network security engineers use it to examine security problems.
- Developers use it to debug protocol implementations.
- People use it to learn more about network protocol internals.

Beside these examples, Wireshark can be used for many other purposes.

**1.3 Features** The main features of Wireshark are as follows:

- Available for UNIX and Windows
- Captures live packet data from a network interface
- Displays packets along with detailed protocol information
- Opens/saves the captured packet data
- Imports/exports packets into a number of file formats, supported by other capture programs
- Advanced packet filtering
- Searches for packets based on multiple criteria

- Colorizes packets according to display filters
- Calculates statistics
- ...and a lot more!

### 1.4 Wireshark Can or Can't Do

- **Live capture from different network media.**  
Wireshark can capture traffic from different network media, including wireless LAN.
- **Import files from many other capture programs.**  
Wireshark can import data from a large number of file formats, supported by other capture programs.
- **Export files for many other capture programs.**  
Wireshark can export data into a large number of file formats, supported by other capture programs.
- **Numerous protocol dissectors.**  
Wireshark can dissect, or decode, a large number of protocols.
- **Wireshark is not an intrusion detection system.**  
It will not warn you if there are any suspicious activities on your network. However, if strange things happen, Wireshark might help you figure out what is really going on.
- **Wireshark does not manipulate processes on the network, it can only perform “measurements” within it.**  
Wireshark does not send packets on the network or influence it in any other way, except for resolving names (converting numerical address values into a human readable format), but even that can be disabled.

**2. Where to Get Wireshark** You can get Wireshark from the official website: <https://www.wireshark.org/download.html>

Wireshark can run on various operating systems. Please download the correct version according to the operating system you are using.

### 3. Step-by-step Guide This demonstration uses Wireshark 2.2.6 on Linux.

#### a) Start Wireshark

On Linux, you can run the shell script provided below. It starts Wireshark, then configures NIC and the channel for packet capture.

```
ifconfig $1 down
iwconfig $1 mode monitor
iwconfig $1 channel $2
ifconfig $1 up
Wireshark&
```

In the above script, the parameter \$1 represents NIC and \$2 represents channel. For example, `wlan0` in `./xxx.sh wlan0 6`, specifies the NIC for packet capture, and `6` identifies the channel of an AP or Soft-AP.

#### b) Run the Shell Script to Open Wireshark and Display Capture Interface

#### c) Select the Interface to Start Packet Capture

As the red markup shows in the picture above, many interfaces are available. The first one is a local NIC and the second one is a wireless NIC.

Please select the NIC according to your requirements. This document will use the wireless NIC to demonstrate packet capture.

Double click `wlan0` to start packet capture.

#### d) Set up Filters

Since all packets in the channel will be captured, and many of them are not needed, you have to set up filters to get the packets that you need.

Please find the picture below with the red markup, indicating where the filters should be set up.

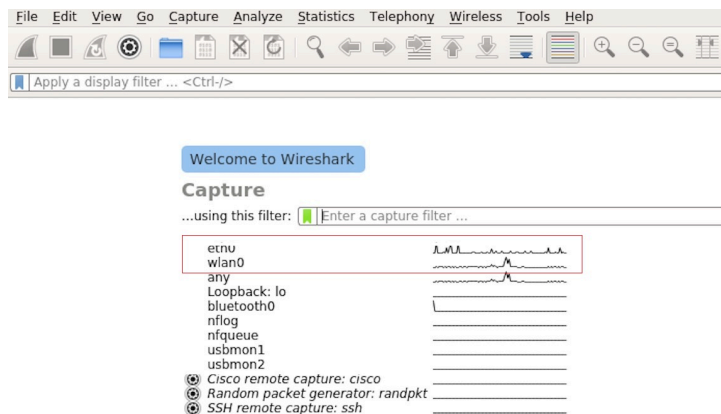

Fig. 52: Wireshark Capture Interface

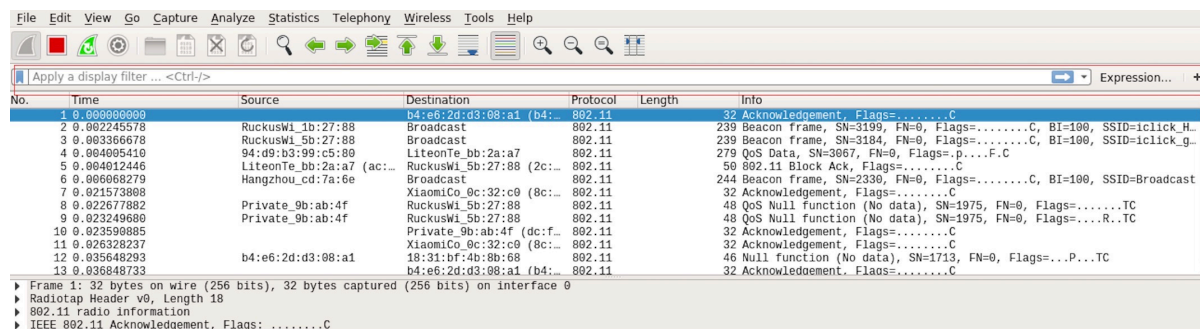

Fig. 53: Setting up Filters in Wireshark

Click *Filter*, the top left blue button in the picture below. The *display filter* dialogue box will appear.

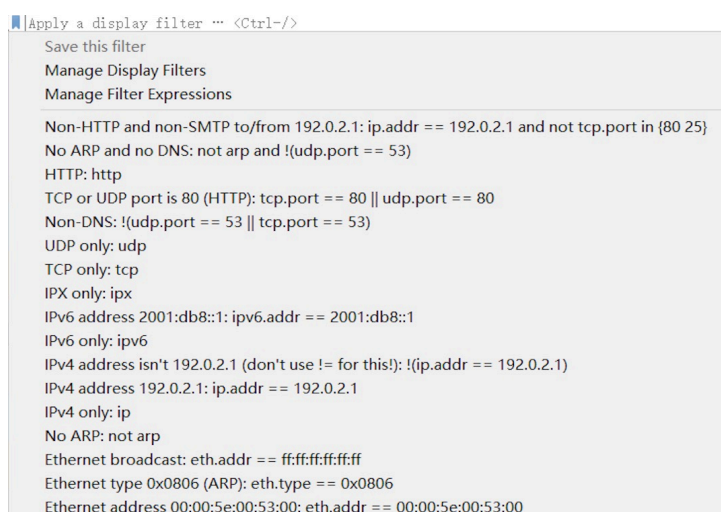

Fig. 54: *Display Filter* Dialogue Box

Click the *Expression* button to bring up the *Filter Expression* dialogue box and set the filter according to your requirements.

**The quickest way:** enter the filters directly in the toolbar.

Click on this area to enter or modify the filters. If you enter a wrong or unfinished filter, the built-in syntax check turns the background red. As soon as the correct expression is entered, the background becomes green.

The previously entered filters are automatically saved. You can access them anytime by opening the drop down list.

For example, as shown in the picture below, enter two MAC addresses as the filters and click *Apply* (the blue arrow). In this case, only the packet data transmitted between these two MAC addresses will be captured.

#### e) Packet List

You can click any packet in the packet list and check the detailed information about it in the box below the list. For example, if you click the first packet, its details will appear in that box.

#### f) Stop/Start Packet Capture

As shown in the picture below, click the red button to stop capturing the current packet.

Click the top left blue button to start or resume packet capture.

#### g) Save the Current Packet

On Linux, go to *File -> Export Packet Dissections -> As Plain Text File* to save the packet.

Please note that *All packets*, *Displayed* and *All expanded* must be selected.

By default, Wireshark saves the captured packet in a libpcap file. You can also save the file in other formats, e.g. txt, to analyze it in other tools.

## 4.33 Wi-Fi Security

### 4.33.1 ESP32-S2 Wi-Fi Security Features

- Support for Protected Management Frames (PMF)
- Support for WPA3-Personal
- Support for Opportunistic Wireless Encryption



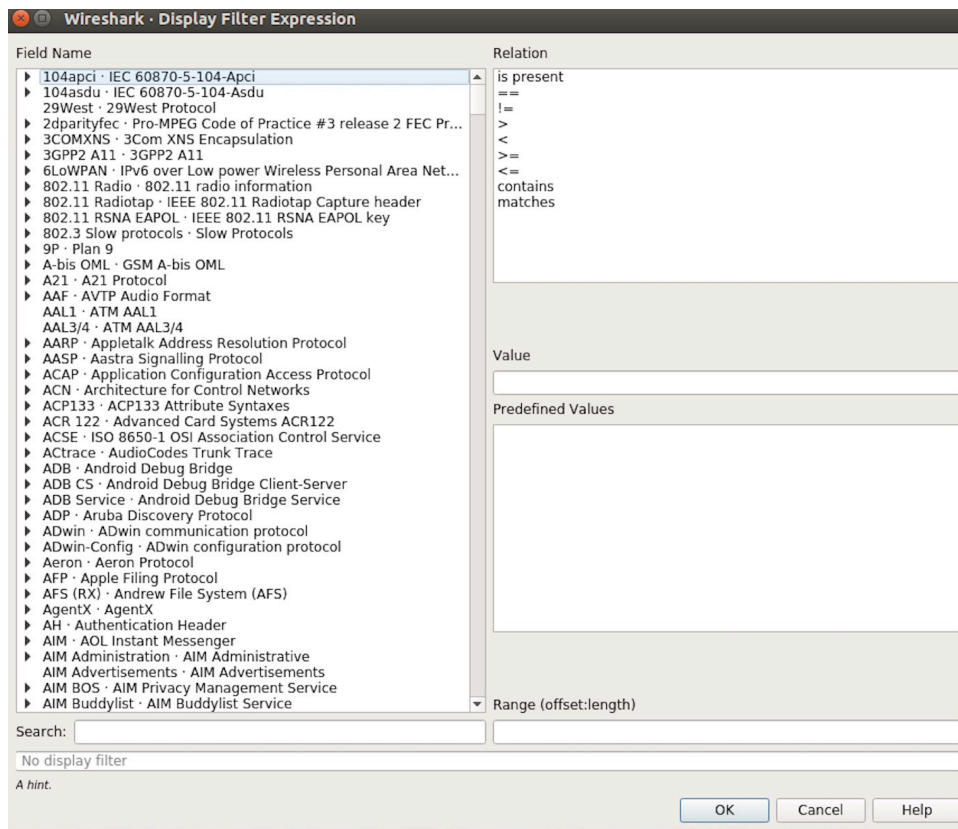

Fig. 55: Filter Expression Dialogue Box



Fig. 56: Filter Toolbar

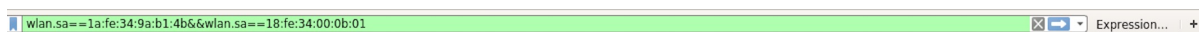

Fig. 57: Example of MAC Addresses applied in the Filter Toolbar

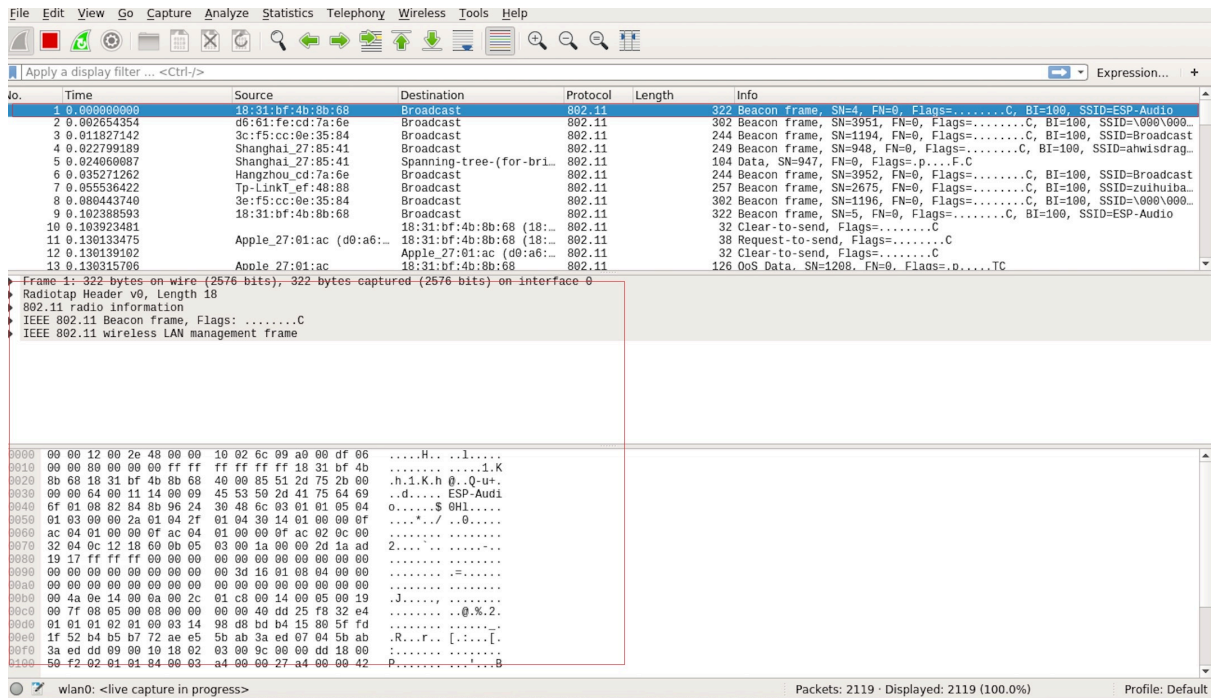

Fig. 58: Example of Packet List Details

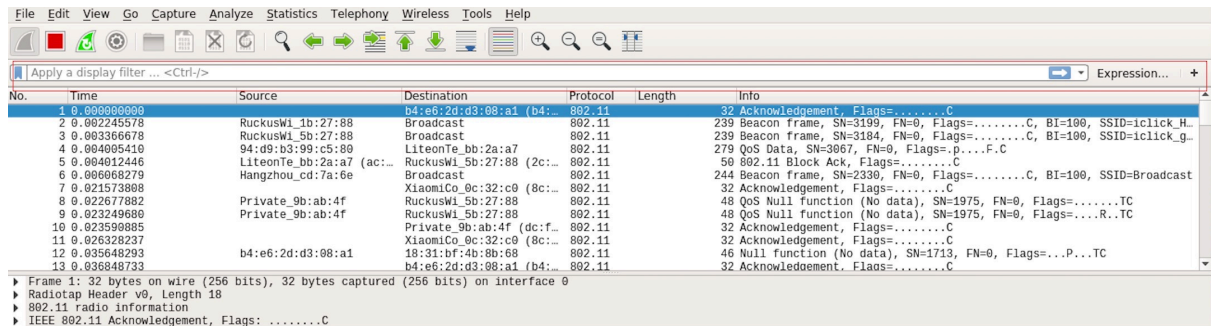

Fig. 59: Stopping Packet Capture

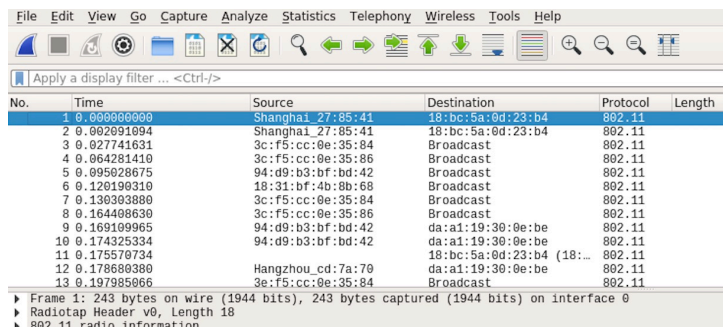

Fig. 60: Starting or Resuming the Packets Capture

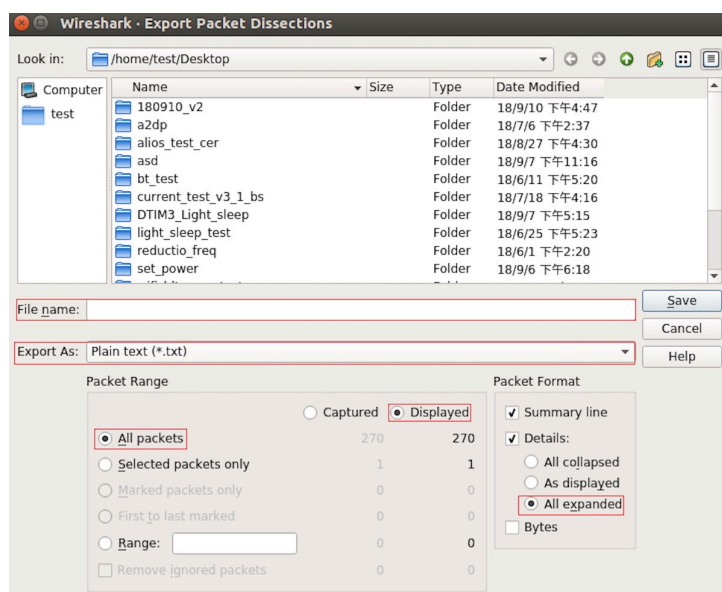

Fig. 61: Saving Captured Packets

In addition to traditional security methods (WEP/WPA-TKIP/WPA2-CCMP), ESP32-S2 Wi-Fi supports state-of-the-art security protocols, namely Protected Management, Wi-Fi Protected Access 3 and Enhanced Open based on Opportunistic Wireless Encryption. WPA3 provides better privacy and robustness against known attacks on traditional modes. Enhanced Open enhances security and privacy of users connecting to open (public) Wireless Network without authentication.

### 4.33.2 Protected Management Frames (PMF)

#### Introduction

In Wi-Fi, management frames such as beacons, probes, (de)authentication, (dis)association are used by non-AP stations to scan and connect to an AP. Unlike data frames, these frames are sent unencrypted. An attacker can use eavesdropping and packet injection to send spoofed (de)authentication/(dis)association frames at the right time, leading to attacks such as Denial-of-Service (DOS) and man-in-the-middle

PMF provides protection against these attacks by encrypting unicast management frames and providing integrity checks for broadcast management frames. These include deauthentication, disassociation and robust management frames. It also provides Secure Association (SA) teardown mechanism to prevent spoofed association/authentication frames from disconnecting already connected clients.

**There are 3 types of PMF configuration modes on both station and AP side -**

- PMF Optional
- PMF Required
- PMF Disabled

#### API & Usage

ESP32-S2 supports PMF in both Station and SoftAP mode. For both, the default mode is PMF Optional and disabling PMF is not possible. For even higher security, PMF required mode can be enabled by setting the `required` flag in `pmf_cfg` while using the `esp_wifi_set_config()` API. This will result in the device only connecting to a PMF enabled device and rejecting others.

**Attention:** `capable` flag in `pmf_cfg` is deprecated and set to true internally. This is to take the additional security benefit of PMF whenever possible.

### 4.33.3 WiFi Enterprise

#### Introduction

Enterprise security is the secure authentication mechanism for enterprise wireless networks. It uses RADIUS server for authentication of network users before connecting to the Access Point. The authentication process is based on 802.1X policy and comes with different Extended Authentication Protocol (EAP) methods such as TLS, TTLS, PEAP and EAP-FAST. RADIUS server authenticates the users based on their credentials (username and password), digital certificates or both.

#### ESP32-S2 supports WiFi Enterprise only in station mode.

ESP32-S2 Supports **WPA2-Enterprise** and **WPA3-Enterprise**. WPA3-Enterprise builds upon the foundation of WPA2-Enterprise with the additional requirement of using Protected Management Frames (PMF) and server certificate validation on all WPA3 connections. **WPA3-Enterprise also offers an addition secure mode using 192-bit minimum-strength security protocols and cryptographic tools to better protect sensitive data.** The 192-bit security mode offered by WPA3-Enterprise ensures the right combination of cryptographic tools are used and sets a consistent baseline of security within a WPA3 network. WPA3-Enterprise 192-bit mode is only supported by modules having `SOC_WIFI_GCMP_SUPPORT` support. Enable `CONFIG_WPA_SUITE_B_192` flag to support WPA3-Enterprise with 192-bit mode.

#### ESP32-S2 supports the following EAP methods:

- EAP-TLS: This is a certificate-based method and only requires SSID and EAP-IDF.
- PEAP: This is a Protected EAP method. Username and password are mandatory.
- **EAP-TTLS: This is a credential-based method. Only server authentication is mandatory while user authentication is optional.**
  - PAP: Password Authentication Protocol.
  - CHAP: Challenge Handshake Authentication Protocol.
  - MSCHAP and MSCHAP-V2.
- EAP-FAST: This is an authentication method based on Protected Access Credentials (PAC) which also uses identity and password. Currently, `CONFIG_WPA_MBEDTLS_TLS_CLIENT` flag should be disabled to use this feature.

Example [wifi/wifi\\_enterprise](#) demonstrates all the supported WiFi Enterprise methods except EAP-FAST. Please refer [wifi/wifi\\_eap\\_fast](#) for EAP-FAST example. EAP method can be selected from the Example Configuration menu in `idf.py menuconfig`. Refer to [examples/wifi/wifi\\_enterprise/README.md](#) for information on how to generate certificates and run the example.

### 4.33.4 WPA3-Personal

#### Introduction

Wi-Fi Protected Access-3 (WPA3) is a set of enhancements to Wi-Fi access security intended to replace the current WPA2 standard. It includes new features and capabilities that offer significantly better protection against different types of attacks. It improves upon WPA2-Personal in following ways:

- WPA3 uses Simultaneous Authentication of Equals (SAE), which is password-authenticated key agreement method based on Diffie-Hellman key exchange. Unlike WPA2, the technology is resistant to offline-dictionary attack, where the attacker attempts to determine shared password based on captured 4-way handshake without any further network interaction.
- Disallows outdated protocols such as TKIP, which is susceptible to simple attacks like MIC key recovery attack.
- Mandates Protected Management Frames (PMF), which provides protection for unicast and multicast robust management frames which include Disassoc and Deauth frames. This means that the attacker cannot disrupt an established WPA3 session by sending forged Assoc frames to the AP or Deauth/Disassoc frames to the Station.
- Provides forward secrecy, which means the captured data cannot be decrypted even if password is compromised after data transmission.

**ESP32-S2 station also supports following additional Wi-Fi CERTIFIED WPA3™ features.**

- **Transition Disable** : WPA3 defines transition modes for client devices so that they can connect to a network even when some of the APs in that network do not support the strongest security mode. Client device implementations typically configure network profiles in a transition mode by default. However, such a client device could be subject to an active downgrade attack in which the attacker causes the client device to use a lower security mode in order to exploit a vulnerability with that mode. WPA3 has introduced the Transition Disable feature to mitigate such attacks, by enabling client devices to change from a transition mode to an “only” mode when connecting to a network, once that network indicates it fully supports the higher security mode. Enable `transition_disable` in `wifi_sta_config_t` to enable this feature for ESP32-S2 station.
- **SAE PWE Methods**: ESP32-S2 station supports SAE Password Element derivation method *Hunting And Pecking* and *Hash to Element (H2E)*. H2E is computationally efficient as it uses less iterations than Hunt and Peck, also it mitigates side channel attacks. These can be configured using parameter `sae_pwe_h2e` from `wifi_sta_config_t` for station. Hunt and peck, H2E both can be enabled by using `WPA3_SAE_PWE_BOTH` configuration.

Please refer to [Security](#) section of Wi-Fi Alliance’s official website for further details.

### Setting up WPA3 Personal with ESP32-S2

A config option `CONFIG_ESP32_WIFI_ENABLE_WPA3_SAE` is provided to Enable/Disable WPA3 for station. By default it is kept enabled, if disabled ESP32-S2 will not be able to establish a WPA3 connection. Additionally, since PMF is mandated by WPA3 protocol, PMF Mode Optional is set by default for station. PMF Required can be configured using WiFi config.

Refer to [Protected Management Frames \(PMF\)](#) on how to set this mode.

After configuring all required settings for WPA3-Personal station, application developers need not worry about the underlying security mode of the AP. WPA3-Personal is now the highest supported protocol in terms of security, so it will be automatically selected for the connection whenever available. For example, if an AP is configured to be in WPA3 Transition Mode, where it will advertise as both WPA2 and WPA3 capable, Station will choose WPA3 for the connection with above settings. Note that Wi-Fi stack size requirement will increase 3kB when “Enable WPA3-Personal” is used.

## 4.33.5 Wi-Fi Enhanced Open™

### Introduction

Enhanced open is used for providing security and privacy to users connecting to open (public) wireless networks, particularly in scenarios where user authentication is not desired or distribution of credentials impractical. Each user is provided with unique individual encryption keys that protect data exchange between a user device and the Wi-Fi network. Protected Management Frames further protects management traffic between the access point and user device. Enhanced Open is based on Opportunistic Wireless Encryption (OWE) standard. OWE Transition Mode enables a seamless transition from Open unencrypted WLANs to OWE WLANs without adversely impacting the end user experience.

**ESP32-S2 supports Wi-Fi Enhanced Open™ only in station mode.**

### Setting up OWE with ESP32-S2

A config option `CONFIG_ESP32_WIFI_ENABLE_WPA3_OWE_STA` and configuration parameter `owe_enabled` in `wifi_sta_config_t` is provided to enable OWE support for station. To use OWE transition mode, along with the config provided above, `authmode` from `wifi_scan_threshold_t` should be set to `WIFI_AUTH_OPEN`.

## 4.34 Reproducible Builds



### 4.34.1 Introduction

ESP-IDF build system has support for [reproducible builds](#).

When reproducible builds are enabled, the application built with ESP-IDF doesn't depend on the build environment. Both the .elf file and .bin files of the application remains exactly the same, even if the following variables change:

- Directory where the project is located
- Directory where ESP-IDF is located (`IDF_PATH`)
- Build time

### 4.34.2 Reasons for non-reproducible builds

There are several reasons why an application may depend on the build environment, even when the same source code and tools versions are used.

- In C code, `__FILE__` preprocessor macro is expanded to the full path of the source file.
- `__DATE__` and `__TIME__` preprocessor macros are expanded to compilation date and time.
- When the compiler generates object files, it adds sections with debug information. These sections help debuggers, like GDB, to locate the source code which corresponds to a particular location in the machine code. These sections typically contain paths of relevant source files. These paths may be absolute, and will include the path to ESP-IDF or to the project.

There are also other possible reasons, such as unstable order of inputs and non-determinism in the build system.

### 4.34.3 Enabling reproducible builds in ESP-IDF

Reproducible builds can be enabled in ESP-IDF using `CONFIG_APP_REPRODUCIBLE_BUILD` option.

This option is disabled by default. It can be enabled in `menuconfig`.

The option may also be added into `sdkconfig.defaults`. If adding the option into `sdkconfig.defaults`, delete the `sdkconfig` file and run the build again. See [Custom sdkconfig defaults](#) for more information.

### 4.34.4 How reproducible builds are achieved

ESP-IDF achieves reproducible builds using the following measures:

- In ESP-IDF source code, `__DATE__` and `__TIME__` macros are not used when reproducible builds are enabled. Note, if the application source code uses these macros, the build will not be reproducible.
- ESP-IDF build system passes a set of `-fmacro-prefix-map` and `-fdebug-prefix-map` flags to replace base paths with placeholders:
  - Path to ESP-IDF is replaced with `/IDF`
  - Path to the project is replaced with `/IDF_PROJECT`
  - Path to the build directory is replaced with `/IDF_BUILD`
  - Paths to components are replaced with `/COMPONENT_NAME_DIR` (where `NAME` is the name of the component)
- Build date and time are not included into the *application metadata structure* if `CONFIG_APP_REPRODUCIBLE_BUILD` is enabled.
- ESP-IDF build system ensures that source file lists, component lists and other sequences are sorted before passing them to CMake. Various other parts of the build system, such as the linker script generator also perform sorting to ensure that same output is produced regardless of the environment.

### 4.34.5 Reproducible builds and debugging

When reproducible builds are enabled, file names included in debug information sections are altered as shown in the previous section. Due to this fact, the debugger (GDB) is not able to locate the source files for the given code location.

This issue can be solved using GDB `set substitute-path` command. For example, by adding the following command to GDB init script, the altered paths can be reverted to the original ones:

```
set substitute-path /COMPONENT_FREERTOS_DIR /home/user/esp/esp-idf/components/  
↪freertos
```

ESP-IDF build system generates a file with the list of such `set substitute-path` commands automatically during the build process. The file is called `prefix_map_gdbinit` and is located in the project `build` directory.

When `idf.py gdb` is used to start debugging, this additional `gdbinit` file is automatically passed to GDB. When launching GDB manually or from an IDE, please pass this additional `gdbinit` script to GDB using `-x build/prefix_map_gdbinit` argument.

#### 4.34.6 Factors which still affect reproducible builds

Note that the built application still depends on:

- ESP-IDF version
- Versions of the build tools (CMake, Ninja) and the cross-compiler

*IDF Docker Image* can be used to ensure that these factors do not affect the build.

### 4.35 Low Power Mode User Guide

The document has not been translated into English yet. In the meantime, please refer to the Chinese version.

# Chapter 5

## Migration Guides

### 5.1 ESP-IDF 5.x Migration Guide

#### 5.1.1 Migration from 4.4 to 5.0

##### Build System

**Migrating from GNU Make Build System** ESP-IDF v5.0 no longer supports GNU make-based projects. Please follow the [build system](#) guide for migration.

**Update Fragment File Grammar** Please follow the [migrate linker script fragment files grammar](#) chapter for migrating v3.x grammar to the new one.

**Specify Component Requirements Explicitly** In previous versions of ESP-IDF, some components were always added as public requirements (dependencies) to every component in the build, in addition to the [common component requirements](#):

- driver
- efuse
- esp\_timer
- lwip
- vfs
- esp\_wifi
- esp\_event
- esp\_netif
- esp\_eth
- esp\_phy

This means that it was possible to include header files of those components without specifying them as requirements in `idf_component_register`. This behavior was caused by transitive dependencies of various common components.

In ESP-IDF v5.0, this behavior is fixed and these components are no longer added as public requirements by default.

Every component depending on one of the components which isn't part of common requirements has to declare this dependency explicitly. This can be done by adding `REQUIRES <component_name>` or `PRIV_REQUIRES`



`<component_name>` in `idf_component_register` call inside component's `CMakeLists.txt`. See [Component Requirements](#) for more information on specifying requirements.

**Setting `COMPONENT_DIRS` and `EXTRA_COMPONENT_DIRS` Variables** ESP-IDF v5.0 includes a number of improvements to support building projects with space characters in their paths. To make that possible, there are some changes related to setting `COMPONENT_DIRS` and `EXTRA_COMPONENT_DIRS` variables in project `CMakeLists.txt` files.

Adding non-existent directories to `COMPONENT_DIRS` or `EXTRA_COMPONENT_DIRS` is no longer supported and will result in an error.

Using string concatenation to define `COMPONENT_DIRS` or `EXTRA_COMPONENT_DIRS` variables is now deprecated. These variables should be defined as CMake lists, instead. For example, use:

```
set(EXTRA_COMPONENT_DIRS path1 path2)
list(APPEND EXTRA_COMPONENT_DIRS path3)
```

instead of:

```
set(EXTRA_COMPONENT_DIRS "path1 path2")
set(EXTRA_COMPONENT_DIRS "${EXTRA_COMPONENT_DIRS} path3")
```

Defining these variables as CMake lists is compatible with previous ESP-IDF versions.

**Update Usage of `target_link_libraries` with `project_elf`** ESP-IDF v5.0 fixes CMake variable propagation issues for components. This issue caused compiler flags and definitions that were supposed to apply to one component to be applied to every component in the project.

As a side effect of this, user projects from ESP-IDF v5.0 onwards must use `target_link_libraries` with `project_elf` explicitly and custom CMake projects must specify `PRIVATE`, `PUBLIC`, or `INTERFACE` arguments. This is a breaking change and is not backward compatible with previous ESP-IDF versions.

For example:

```
target_link_libraries(${project_elf} PRIVATE "-Wl,--wrap=esp_panic_handler")
```

instead of:

```
target_link_libraries(${project_elf} "-Wl,--wrap=esp_panic_handler")
```

**Update CMake Version** In ESP-IDF v5.0 minimal CMake version was increased to 3.16 and versions lower than 3.16 are not supported anymore. Run `tools/idf_tools.py install cmake` to install a suitable version if your OS version doesn't have one.

This affects ESP-IDF users who use system-provided CMake and custom CMake.

**Reorder the Applying of the Target-Specific Config Files** ESP-IDF v5.0 reorders the applying order of target-specific config files and other files listed in `SDKCONFIG_DEFAULTS`. Now, target-specific files will be applied right after the file brings it in, before all latter files in `SDKCONFIG_DEFAULTS`.

For example:

```
If ``SDKCONFIG_DEFAULTS="sdkconfig.defaults;sdkconfig_devkit1"`` , and there is a
↪file ``sdkconfig.defaults.esp32`` in the same folder, then the files will be
↪applied in the following order: (1) sdkconfig.defaults (2) sdkconfig.defaults.
↪esp32 (3) sdkconfig_devkit1.
```

If you have a key with different values in the target-specific files of the former item (e.g., `sdkconfig.defaults.esp32` above) and the latter item (e.g., `sdkconfig_devkit1` above), please note the latter will override the target-specific file of the former.

If you do want to have some target-specific config values, please put it into the target-specific file of the latter item (e.g., `sdkconfig_devkit1.esp32`).

## GCC

**GCC Version** The previous GCC version was GCC 8.4.0. This has now been upgraded to GCC 11.2.0 on all targets. Users that need to port their code from GCC 8.4.0 to 11.2.0 should refer to the series of official GCC porting guides listed below:

- [Porting to GCC 9](#)
- [Porting to GCC 10](#)
- [Porting to GCC 11](#)

**Warnings** The upgrade to GCC 11.2.0 has resulted in the addition of new warnings, or enhancements to existing warnings. The full details of all GCC warnings can be found in [GCC Warning Options](#). Users are advised to double-check their code, then fix the warnings if possible. Unfortunately, depending on the warning and the complexity of the user's code, some warnings will be false positives that require non-trivial fixes. In such cases, users can choose to suppress the warning in multiple ways. This section outlines some common warnings that users are likely to encounter, and ways to suppress them.

**Warning:** Users are advised to check that a warning is indeed a false positive before attempting to suppress them it.

**-Wstringop-overflow, -Wstringop-overread, -Wstringop-truncation, and -Warray-bounds** Users that use memory/string copy/compare functions will run into one of the `-Wstringop` warnings if the compiler cannot properly determine the size of the memory/string. The examples below demonstrate code that triggers these warnings and how to suppress them.

```
#pragma GCC diagnostic push
#pragma GCC diagnostic ignored "-Wstringop-overflow"
#pragma GCC diagnostic ignored "-Warray-bounds"
    memset(RTC_SLOW_MEM, 0, CONFIG_ULP_COPROC_RESERVE_MEM); // <<-- This line_
↳leads to warnings
#pragma GCC diagnostic pop
```

```
#pragma GCC diagnostic push
#if __GNUC__ >= 11
#pragma GCC diagnostic ignored "-Wstringop-overread" // <<-- This key had been_
↳introduced since GCC 11
#endif
#pragma GCC diagnostic ignored "-Warray-bounds"
    memcpy(backup_write_data, (void *)EFUSE_PGM_DATA0_REG, sizeof(backup_
↳write_data)); // <<-- This line leads to warnings
#pragma GCC diagnostic pop
```

**-Waddress-of-packed-member** GCC will issue this warning when accessing an unaligned member of a packed `struct` due to the incurred penalty of unaligned memory access. However, all ESP chips (on both Xtensa and RISC-V architectures) allow for unaligned memory access and incur no extra penalty. Thus, this warning can be ignored in most cases.

```

components/bt/host/bluedroid/btc/profile/std/gatt/btc_gatt_util.c: In function
↳'btc_to_bta_gatt_id':
components/bt/host/bluedroid/btc/profile/std/gatt/btc_gatt_util.c:105:21: warning:␣
↳taking address of packed member of 'struct <anonymous>' may result in an␣
↳unaligned pointer value [-Waddress-of-packed-member]
   105 |         btc_to_bta_uuid(&p_dest->uuid, &p_src->uuid);
       |                         ^~~~~~

```

If the warning occurs in multiple places across multiple source files, users can suppress the warning at the CMake level as demonstrated below.

```

set_source_files_properties(
    "host/bluedroid/bta/gatt/bta_gattc_act.c"
    "host/bluedroid/bta/gatt/bta_gattc_cache.c"
    "host/bluedroid/btc/profile/std/gatt/btc_gatt_util.c"
    "host/bluedroid/btc/profile/std/gatt/btc_gatts.c"
    PROPERTIES COMPILE_FLAGS -Wno-address-of-packed-member)

```

However, if there are only one or two instances, users can suppress the warning directly in the source code itself as demonstrated below.

```

#pragma GCC diagnostic push
#if __GNUC__ >= 9
#pragma GCC diagnostic ignored "-Waddress-of-packed-member" <<-- This key had been␣
↳introduced since GCC 9
#endif
    uint32_t* reg_ptr = (uint32_t*)src;
#pragma GCC diagnostic pop

```

**llabs () for 64-bit Integers** The function `abs ()` from `stdlib.h` takes `int` argument. Please use `llabs ()` for types that are intended to be 64-bit. It is particularly important for `time_t`.

### Espressif Toolchain Changes

**int32\_t and uint32\_t for Xtensa Compiler** The types `int32_t` and `uint32_t` have been changed from the previous `int` and `unsigned int` to `long` and `unsigned long` respectively for the Xtensa compiler. This change now matches upstream GCC which `long` integers for `int32_t` and `uint32_t` on Xtensa, RISC-V, and other architectures.

	2021r2 and older, GCC 8	2022r1, GCC 11
Xtensa	(unsigned) int	(unsigned) long
riscv32	(unsigned) long	(unsigned) long

The change mostly affects code that formats strings using types provided by `<inttypes.h>`. Users will need to replace placeholders such as `%i` and `%x` with `PRId32` and `PRIdxx` respectively.

In other cases, it should be noted that enums have the `int` type.

In common, `int32_t` and `int`, as well as `uint32_t` and `unsigned int`, are different types.

**Removing CONFIG\_COMPILER\_DISABLE\_GCC8\_WARNINGS Build Option** `CONFIG_COMPILER_DISABLE_GCC8_WARNINGS` option was introduced to allow building of legacy code dating from the rigid GCC 5 toolchain. However, enough time has passed to allow for the warnings to be fixed, thus this option has been removed.

For now in GCC 11, users are advised to review their code and fix the compiler warnings where possible.

## Networking

### Wi-Fi

**Callback function type `esp_now_recv_cb_t`** Previously, the first parameter of `esp_now_recv_cb_t` was of type `const uint8_t *mac_addr`, which only included the address of ESP-NOW peer device.

This now changes. The first parameter is of type `esp_now_recv_info_t`, which has members `src_addr`, `des_addr` and `rx_ctrl`. Therefore, the following updates are required:

- Redefine ESP-NOW receive callback function.
- `src_addr` can be used to replace original `mac_addr`.
- `des_addr` is the destination MAC address of ESP-NOW packet, which can be unicast or broadcast address. With `des_addr`, the user can distinguish unicast and broadcast ESP-NOW packets where broadcast ESP-NOW packets can be non-encrypted even when encryption policy is configured for the ESP-NOW.
- `rx_ctrl` is Rx control info of the ESP-NOW packet, which provides more information about the packet.

Please refer to the ESP-NOW example: [wifi/espnow/main/espnow\\_example\\_main.c](#)

### Ethernet

**`esp_eth_ioctl()` API** Previously, the `esp_eth_ioctl()` API had the following issues:

- The third parameter (which is of type `void *`) would accept an `int/bool` type arguments (i.e., not pointers) as input in some cases. However, these cases were not documented properly.
- To pass `int/bool` type argument as the third parameter, the argument had to be “unnaturally” casted to a `void *` type, to prevent a compiler warning as demonstrated in the code snippet below. This casting could lead to misuse of the `esp_eth_ioctl()` function.

```
esp_eth_ioctl(eth_handle, ETH_CMD_S_FLOW_CTRL, (void *)true);
```

Therefore, the usage of `esp_eth_ioctl()` is now unified. Arguments to the third parameter must be passed as pointers to a specific data type to/from where data will be stored/read by `esp_eth_ioctl()`. The code snippets below demonstrate the usage of `esp_eth_ioctl()`.

Usage example to set Ethernet configuration:

```
eth_duplex_t new_duplex_mode = ETH_DUPLEX_HALF;
esp_eth_ioctl(eth_handle, ETH_CMD_S_DUPLEX_MODE, &new_duplex_mode);
```

Usage example to get Ethernet configuration:

```
eth_duplex_t duplex_mode;
esp_eth_ioctl(eth_handle, ETH_CMD_G_DUPLEX_MODE, &duplex_mode);
```

**KSZ8041/81 and LAN8720 Driver Update** The KSZ8041/81 and LAN8720 drivers are updated to support more devices (i.e., generations) from their associated product families. The drivers can recognize particular chip numbers and their potential support by the driver.

As a result, the specific “chip number” functions calls are replaced by generic ones as follows:

- Removed `esp_eth_phy_new_ksz8041()` and `esp_eth_phy_new_ksz8081()`, and use `esp_eth_phy_new_ksz80xx()` instead
- Removed `esp_eth_phy_new_lan8720()`, and use `esp_eth_phy_new_lan87xx()` instead

**ESP NETIF Glue Event Handlers** `esp_eth_set_default_handlers()` and `esp_eth_clear_default_handlers()` functions are removed. Registration of the default IP layer handlers for Ethernet is now handled automatically. If you have already followed the suggestion to fully initialize the Ethernet driver and network interface before registering their Ethernet/IP event handlers, then no action is required (except for deleting the affected functions). Otherwise, you may start the Ethernet driver right after they register the user event handler.

**PHY Address Auto-detect** The Ethernet PHY address auto-detect function `esp_eth_detect_phy_addr()` is renamed to `esp_eth_phy_802_3_detect_phy_addr()` and its header declaration is moved to `esp_eth/include/esp_eth_phy_802_3.h`.

**SPI-Ethernet Module Initialization** The SPI-Ethernet Module initialization is now simplified. Previously, you had to manually allocate an SPI device using `spi_bus_add_device()` before instantiating the SPI-Ethernet MAC.

Now, you no longer need to call `spi_bus_add_device()` as SPI devices are allocated internally. As a result, the `eth_dm9051_config_t`, `eth_w5500_config_t`, and `eth_ksz8851snl_config_t` configuration structures are updated to include members for SPI device configuration (e.g., to allow fine tuning of SPI timing which may be dependent on PCB design). Likewise, the `ETH_DM9051_DEFAULT_CONFIG`, `ETH_W5500_DEFAULT_CONFIG`, and `ETH_KSZ8851SNL_DEFAULT_CONFIG` configuration initialization macros are updated to accept new input parameters. Refer to *Ethernet API Reference Guide* for an example of SPI-Ethernet Module initialization.

**SPI-Ethernet Modules Initialization** The SPI-Ethernet Module's initialization has been simplified. The previous initialization process required you to manually allocate an SPI device using `spi_bus_add_device()` before instantiating the SPI-Ethernet MAC.

Now, you no longer need to call `spi_bus_add_device()` as the allocation of the SPI device is done internally. As a result, the `eth_dm9051_config_t`, `eth_w5500_config_t`, and `eth_ksz8851snl_config_t` configuration structures were updated to include members for SPI device configuration (e.g., to allow fine tuning of SPI timing which may be dependent on PCB design). Likewise, the `ETH_DM9051_DEFAULT_CONFIG`, `ETH_W5500_DEFAULT_CONFIG`, and `ETH_KSZ8851SNL_DEFAULT_CONFIG` configuration initialization macros have been updated to accept new input parameters. Refer to the *Ethernet API-Reference Guide* for an example of SPI-Ethernet Module initialization

**Ethernet Driver** APIs for creating MAC instances (`esp_eth_mac_new_*`(*)*) have been reworked to accept two parameters, instead of one common configuration. Now, the configuration includes

- Vendor specific MAC configuration
- Ethernet driver MAC configuration

This is applicable to internal Ethernet MAC `esp_eth_mac_new_esp32()` as well as to external MAC devices, such as `esp_eth_mac_new_ksz8851snl()`, `esp_eth_mac_new_dm9051()`, and `esp_eth_mac_new_w5500()`

**TCP/IP Adapter** The TCP/IP Adapter was a network interface abstraction component used in ESP-IDF prior to v4.1. This section outlines migration from `tcpip_adapter` API to its successor *ESP-NETIF*.

## Updating Network Connection Code

### Network Stack Initialization

- You may simply replace `tcpip_adapter_init()` with `esp_netif_init()`. However, please should note that the `esp_netif_init()` function now returns standard error codes. See *ESP-NETIF* for more details.
- The `esp_netif_deinit()` function is provided to de-initialize the network stack.

- You should also replace `#include "tcpip_adapter.h"` with `#include "esp_netif.h"`.

**Network Interface Creation** Previously, the TCP/IP Adapter defined the following network interfaces statically:

- WiFi Station
- WiFi Access Point
- Ethernet

This now changes. Network interface instance should be explicitly constructed, so that the *ESP-NETIF* can connect to the TCP/IP stack. For example, after the TCP/IP stack and the event loop are initialized, the initialization code for WiFi must explicitly call `esp_netif_create_default_wifi_sta();` or `esp_netif_create_default_wifi_ap();`.

Please refer to the example initialization code for these three interfaces:

- WiFi Station: [wifi/getting\\_started/station/main/station\\_example\\_main.c](#)
- WiFi Access Point: [wifi/getting\\_started/softAP/main/softap\\_example\\_main.c](#)
- Ethernet: [ethernet/basic/main/ethernet\\_example\\_main.c](#)

**Other tcpip\_adapter API Replacement** All the `tcpip_adapter` functions have their `esp-netif` counter-part. Please refer to the `esp_netif.h` grouped into these sections:

- [Setters/Getters](#)
- [DHCP](#)
- [DNS](#)
- [IP address](#)

The TCP/IP Adapter API `tcpip_adapter_get_sta_list()` that was used to acquire a list of associated Wi-Fi stations to the Software Access Point (softAP) has been moved to the Wi-Fi component and re-named to `esp_wifi_ap_get_sta_list_with_ip()`, which is a special case of the ESP-NETIF API `esp_netif_dhcps_get_clients_by_mac()` that could be used more generally to provide a list of clients connected to a DHCP server no matter which network interface the server is running on.

**Default Event Handlers** Event handlers are moved from `tcpip_adapter` to appropriate driver code. There is no change from application code perspective, as all events should be handled in the same way. Please note that for IP-related event handlers, application code usually receives IP addresses in the form of an `esp-netif` specific struct instead of the LwIP structs. However, both structs are binary compatible.

This is the preferred way to print the address:

```
ESP_LOGI(TAG, "got ip:" IPSTR "\n", IP2STR(&event->ip_info.ip));
```

Instead of

```
ESP_LOGI(TAG, "got ip:%s\n", ip4addr_ntoa(&event->ip_info.ip));
```

Since `ip4addr_ntoa()` is a LwIP API, the `esp-netif` provides `esp_ip4addr_ntoa()` as a replacement. However, the above method using `IP2STR()` is generally preferred.

**IP Addresses** You are advised to use `esp-netif` defined IP structures. Please note that with default compatibility enabled, the LwIP structs will still work.

- [esp-netif IP address definitions](#)

**Next Steps** To port an application which may fully benefit from the *ESP-NETIF*, you also need to disable the `tcpip_adapter` compatibility layer in the component configuration option. Please go to `ESP_NETIF Adapter > Enable backward compatible tcpip_adapter interface`. After that, check if your project compiles.

The TCP/IP adapter includes many dependencies. Thus, disabling its compatibility might help separate the application from using specific TCP/IP stack API directly.

## Peripherals

**Peripheral Clock Gating** As usual, peripheral clock gating is still handled by driver itself, users don't need to take care of the peripheral module clock gating.

However, for advanced users who implement their own drivers based on `hal` and `soc` components, the previous clock gating include path has been changed from `driver/periph_ctrl.h` to `esp_private/periph_ctrl.h`.

**RTC Subsystem Control** RTC control APIs have been moved from `driver/rtc_cntl.h` to `esp_private/rtc_ctrl.h`.

## ADC

**ADC Oneshot & Continuous Mode drivers** The ADC oneshot mode driver has been redesigned.

- The new driver is in `esp_adc` component and the include path is `esp_adc/adc_oneshot.h`.
- The legacy driver is still available in the previous include path `driver/adc.h`.

The ADC continuous mode driver has been moved from `driver` component to `esp_adc` component.

- The include path has been changed from `driver/adc.h` to `esp_adc/adc_continuous.h`.

Attempting to use the legacy include path `driver/adc.h` of either driver will trigger the build warning below by default. However, the warning can be suppressed by enabling the `CONFIG_ADC_SUPPRESS_DEPRECATED_WARN` Kconfig option.

```
legacy adc driver is deprecated, please migrate to use esp_adc/adc_oneshot.h and
↳esp_adc/adc_continuous.h for oneshot mode and continuous mode drivers
↳respectively
```

**ADC Calibration Driver** The ADC calibration driver has been redesigned.

- The new driver is in `esp_adc` component and the include path is `esp_adc/adc_cal.h` and `esp_adc/adc_cal_scheme.h`.

Legacy driver is still available by including `esp_adc_cal.h`. However, if users still would like to use the include path of the legacy driver, users should add `esp_adc` component to the list of component requirements in `CMakeLists.txt`.

Attempting to use the legacy include path `esp_adc_cal.h` will trigger the build warning below by default. However, the warning can be suppressed by enabling the `CONFIG_ADC_CALI_SUPPRESS_DEPRECATED_WARN` Kconfig option.

```
legacy adc calibration driver is deprecated, please migrate to use esp_adc/adc_
↳cali.h and esp_adc/adc_cal_scheme.h
```

## API Changes

- The ADC power management APIs `adc_power_acquire` and `adc_power_release` have made private and moved to `esp_private/adc_share_hw_ctrl.h`.
  - The two APIs were previously made public due to a HW errata workaround.
  - Now, ADC power management is completely handled internally by drivers.



- Users who still require this API can include `esp_private/adc_share_hw_ctrl.h` to continue using these functions.
- `driver/adc2_wifi_private.h` has been moved to `esp_private/adc_share_hw_ctrl.h`.
- Enums `ADC_UNIT_BOTH`, `ADC_UNIT_ALTER`, and `ADC_UNIT_MAX` in `adc_unit_t` have been removed.
- The following enumerations have been removed as some of their enumeration values are not supported on all chips. This would lead to the driver triggering a runtime error if an unsupported value is used.
  - Enum `ADC_CHANNEL_MAX`
  - Enum `ADC_ATTEN_MAX`
  - Enum `ADC_CONV_UNIT_MAX`
- API `hall_sensor_read` on ESP32 has been removed. Hall sensor is no longer supported on ESP32.
- API `adc_set_i2s_data_source` and `adc_i2s_mode_init` have been deprecated. Related enum `adc_i2s_source_t` has been deprecated. Please migrate to use `esp_adc/adc_continuous.h`.
- API `adc_digi_filter_reset`, `adc_digi_filter_set_config`, `adc_digi_filter_get_config` and `adc_digi_filter_enable` have been removed. These APIs behaviours are not guaranteed. Enum `adc_digi_filter_idx_t`, `adc_digi_filter_mode_t` and structure `adc_digi_iir_filter_t` have been removed as well.
- API `esp_adc_cal_characterize` has been deprecated, please migrate to `adc_cali_create_scheme_curve_fitting` or `adc_cali_create_scheme_line_fitting` instead.
- API `esp_adc_cal_raw_to_voltage` has been deprecated, please migrate to `adc_cali_raw_to_voltage` instead.
- API `esp_adc_cal_get_voltage` has been deprecated, please migrate to `adc_one_shot_get_calibrated_result` instead.

## GPIO

- The previous Kconfig option `RTCIO_SUPPORT_RTC_GPIO_DESC` has been removed, thus the `rtc_gpio_desc` array is unavailable. Please use `rtc_io_desc` array instead.
- The user callback of a GPIO interrupt should no longer read the GPIO interrupt status register to get the GPIO's pin number of triggering the interrupt. You should use the callback argument to determine the GPIO's pin number instead.
  - Previously, when a GPIO interrupt occurs, the GPIO's interrupt status register is cleared after calling the user callbacks. Thus, it was possible for users to read the GPIO's interrupt status register inside the callback to determine which GPIO was used to trigger the interrupt.
  - However, clearing the interrupt status register after calling the user callbacks can potentially cause edge-triggered interrupts to be lost. For example, if an edge-triggered interrupt (re)is triggered while the user callbacks are being called, that interrupt will be cleared without its registered user callback being handled.
  - Now, the GPIO's interrupt status register is cleared **before** invoking the user callbacks. Thus, users can no longer read the GPIO interrupt status register to determine which pin has triggered the interrupt. Instead, users should use the callback argument to pass the pin number.

**Sigma-Delta Modulator** The Sigma-Delta Modulator driver has been redesigned into *SDM*.

- The new driver implements a factory pattern, where the SDM channels are managed in a pool internally, thus users don't have to fix a SDM channel to a GPIO manually.
- All SDM channels can be allocated dynamically.

Although it's recommended to use the new driver APIs, the legacy driver is still available in the previous include path `driver/sigmadelta.h`. However, by default, including `driver/sigmadelta.h` will trigger the build warning below. The warning can be suppressed by Kconfig option `CONFIG_SDM_SUPPRESS_DEPRECATED_WARN`.

The legacy sigma-delta driver is deprecated, please use `driver/sdm.h`

The major breaking changes in concept and usage are listed as follows:

### Breaking Changes in Concepts



- SDM channel representation has changed from `sigmadelta_channel_t` to `sdm_channel_handle_t`, which is an opaque pointer.
- SDM channel configurations are stored in `sdm_config_t` now, instead the previous `sigmadelta_config_t`.
- In the legacy driver, users don't have to set the clock source for SDM channel. But in the new driver, users need to set a proper one in the `sdm_config_t::clk_src`. The available clock sources are listed in the `soc_periph_sdm_clk_src_t`.
- In the legacy driver, users need to set a `prescale` for the channel, which reflects the frequency in which the modulator outputs a pulse. In the new driver, users should use `sdm_config_t::sample_rate_hz`.

### Breaking Changes in Usage

- Channel configuration was done by channel allocation, in `sdm_new_channel()`. In the new driver, only the `duty` can be changed at runtime, by `sdm_channel_set_duty()`. Other parameters like `gpio` number and `prescale` are only allowed to set during channel allocation.
- Before further channel operations, users should **enable** the channel in advance, by calling `sdm_channel_enable()`. This function will help to manage some system level services, like **Power Management**.

**Timer Group Driver** Timer Group driver has been redesigned into *GPTimer*, which aims to unify and simplify the usage of general purpose timer.

Although it's recommended to use the the new driver APIs, the legacy driver is still available in the previous include path `driver/timer.h`. However, by default, including `driver/timer.h` will trigger the build warning below. The warning can be suppressed by the Kconfig option `CONFIG_GPTIMER_SUPPRESS_DEPRECATED_WARN`.

```
legacy timer group driver is deprecated, please migrate to driver/gptimer.h
```

The major breaking changes in concept and usage are listed as follows:

### Breaking Changes in Concepts

- `timer_group_t` and `timer_idx_t` which used to identify the hardware timer are removed from user's code. In the new driver, a timer is represented by `gptimer_handle_t`.
- Definition of timer clock source is moved to `gptimer_clock_source_t`, the previous `timer_src_clk_t` is not used.
- Definition of timer count direction is moved to `gptimer_count_direction_t`, the previous `timer_count_dir_t` is not used.
- Only level interrupt is supported, `timer_intr_t` and `timer_intr_mode_t` are not used.
- Auto-reload is enabled by set the `gptimer_alarm_config_t::auto_reload_on_alarm` flag. `timer_autoreload_t` is not used.

### Breaking Changes in Usage

- Timer initialization is done by creating a timer instance from `gptimer_new_timer()`. Basic configurations like clock source, resolution and direction should be set in `gptimer_config_t`. Note that, specific configurations of alarm events are not needed during the installation stage of the driver.
- Alarm event is configured by `gptimer_set_alarm_action()`, with parameters set in the `gptimer_alarm_config_t`.
- Setting and getting count value are done by `gptimer_get_raw_count()` and `gptimer_set_raw_count()`. The driver doesn't help convert the raw value into UTC time-stamp. Instead, the conversion should be done from user's side as the timer resolution is also known to the user.
- The driver will install the interrupt service as well if `gptimer_event_callbacks_t::on_alarm` is set to a valid callback function. In the callback, users do not have to deal with the low level registers (like "clear interrupt status", "re-enable alarm event" and so on). So functions like `timer_group_get_intr_status_in_isr` and `timer_group_get_auto_reload_in_isr` are not used anymore.

- To update the alarm configurations when alarm event happens, one can call `gptimer_set_alarm_action()` in the interrupt callback, then the alarm will be re-enabled again.
- Alarm will always be re-enabled by the driver if `gptimer_alarm_config_t::auto_reload_on_alarm` is set to true.

### UART

Removed/Deprecated items	Replacement	Remarks
<code>uart_isr_register()</code>	None	UART interrupt handling is implemented by driver itself.
<code>uart_isr_free()</code>	None	UART interrupt handling is implemented by driver itself.
<code>use_ref_tick</code> in <code>uart_config_t</code>	<code>uart_config_t::source_clk</code>	Select the clock source.
<code>uart_enable_pattern_detection</code>	<code>uart_enable_pattern_detection</code>	Enable pattern detection interrupt.

### I2C

Removed/Deprecated items	Replacement	Remarks
<code>i2c_isr_register()</code>	None	I2C interrupt handling is implemented by driver itself.
<code>i2c_isr_register()</code>	None	I2C interrupt handling is implemented by driver itself.
<code>i2c_opmode_t</code>	None	It' s not used anywhere in esp-idf.

### SPI

Removed/Deprecated items	Replacement	Remarks
<code>spi_cal_clock()</code>	<code>spi_get_actual_clock()</code>	Get SPI real working frequency.

- The internal header file `spi_common_internal.h` has been moved to `esp_private/spi_common_internal.h`.

### LEDC

Removed/Deprecated items	Replacement	Remarks
<code>bit_num</code> in <code>ledc_timer_config_t</code>	<code>ledc_timer_config_t::duty_resolution</code>	Set resolution of the duty cycle.

**Pulse Counter Driver** Pulse counter driver has been redesigned (see [PCNT](#)), which aims to unify and simplify the usage of PCNT peripheral.

Although it' s recommended to use the new driver APIs, the legacy driver is still available in the previous include path `driver/pcnt.h`. However, including `driver/pcnt.h` will trigger the build warning below by default. The warning can be suppressed by the Kconfig option `CONFIG_PCNT_SUPPRESS_DEPRECATED_WARN`.

```
legacy pcnt driver is deprecated, please migrate to use driver/pulse_cnt.h
```

The major breaking changes in concept and usage are listed as follows:

#### Breaking Changes in Concepts

- `pcnt_port_t`, `pcnt_unit_t` and `pcnt_channel_t` which used to identify the hardware unit and channel are removed from user' s code. In the new driver, PCNT unit is represented by `pcnt_unit_handle_t`, likewise, PCNT channel is represented by `pcnt_channel_handle_t`. Both of them are opaque pointers.
- `pcnt_evt_type_t` is not used any more, they have been replaced by a universal **Watch Point Event**. In the event callback `pcnt_watch_cb_t`, it' s still possible to distinguish different watch points from `pcnt_watch_event_data_t`.

- `pcnt_count_mode_t` is replaced by `pcnt_channel_edge_action_t`, and `pcnt_ctrl_mode_t` is replaced by `pcnt_channel_level_action_t`.

### Breaking Changes in Usage

- Previously, the PCNT unit configuration and channel configuration were combined into a single function: `pcnt_unit_config`. They are now split into the two factory APIs: `pcnt_new_unit()` and `pcnt_new_channel()` respectively.
  - Only the count range is necessary for initializing a PCNT unit. GPIO number assignment has been moved to `pcnt_new_channel()`.
  - High/Low control mode and positive/negative edge count mode are set by stand-alone functions: `pcnt_channel_set_edge_action()` and `pcnt_channel_set_level_action()`.
- `pcnt_get_counter_value` is replaced by `pcnt_unit_get_count()`.
- `pcnt_counter_pause` is replaced by `pcnt_unit_stop()`.
- `pcnt_counter_resume` is replaced by `pcnt_unit_start()`.
- `pcnt_counter_clear` is replaced by `pcnt_unit_clear_count()`.
- `pcnt_intr_enable` and `pcnt_intr_disable` are removed. In the new driver, the interrupt is enabled by registering event callbacks `pcnt_unit_register_event_callbacks()`.
- `pcnt_event_enable` and `pcnt_event_disable` are removed. In the new driver, the PCNT events are enabled/disabled by adding/removing watch points `pcnt_unit_add_watch_point()`, `pcnt_unit_remove_watch_point()`.
- `pcnt_set_event_value` is removed. In the new driver, event value is also set when adding watch point by `pcnt_unit_add_watch_point()`.
- `pcnt_get_event_value` and `pcnt_get_event_status` are removed. In the new driver, these information are provided by event callback `pcnt_watch_cb_t` in the `pcnt_watch_event_data_t`.
- `pcnt_isr_register` and `pcnt_isr_unregister` are removed. Register of the ISR handler from user's code is no longer permitted. Users should register event callbacks instead by calling `pcnt_unit_register_event_callbacks()`.
- `pcnt_set_pin` is removed and the new driver no longer allows the switching of the GPIO at runtime. If users want to change to other GPIOs, please delete the existing PCNT channel by `pcnt_del_channel()` and reinstall with the new GPIO number by `pcnt_new_channel()`.
- `pcnt_filter_enable`, `pcnt_filter_disable` and `pcnt_set_filter_value` are replaced by `pcnt_unit_set_glitch_filter()`. Meanwhile, `pcnt_get_filter_value` has been removed.
- `pcnt_set_mode` is replaced by `pcnt_channel_set_edge_action()` and `pcnt_channel_set_level_action()`.
- `pcnt_isr_service_install`, `pcnt_isr_service_uninstall`, `pcnt_isr_handler_add` and `pcnt_isr_handler_remove` are replaced by `pcnt_unit_register_event_callbacks()`. The default ISR handler is lazy installed in the new driver.

**Temperature Sensor Driver** The temperature sensor driver has been redesigned and it is recommended to use the new driver. However, the old driver is still available but cannot be used with the new driver simultaneously.

The new driver can be included via `driver/temperature_sensor.h`. The old driver is still available in the previous include path `driver/temp_sensor.h`. However, including `driver/temp_sensor.h` will trigger the build warning below by default. The warning can be suppressed by enabling the menuconfig option `CONFIG_TEMP_SENSOR_SUPPRESS_DEPRECATED_WARN`.

```
legacy temperature sensor driver is deprecated, please migrate to driver/
↳temperature_sensor.h
```

Configuration contents has been changed. In the old version, users need to configure `clk_div` and `dac_offset`. While in the new version, users only need to choose `tsens_range`.

The process of using temperature sensor has been changed. In the old version, users can use `config->start->read_celsius` to get value. In the new version, users should install the temperature sensor driver firstly, by `temperature_sensor_install` and uninstall it when finished. For more information, please refer to [Temperature Sensor](#).

**RMT Driver** RMT driver has been redesigned (see *RMT transceiver*), which aims to unify and extend the usage of RMT peripheral.

Although it's recommended to use the new driver APIs, the legacy driver is still available in the previous include path `driver/rmt.h`. However, including `driver/rmt.h` will trigger the build warning below by default. The warning can be suppressed by the Kconfig option `CONFIG_RMT_SUPPRESS_DEPRECATED_WARN`.

The legacy RMT driver is deprecated, please use `driver/rmt_tx.h` and/or `driver/rmt_rx.h`

The major breaking changes in concept and usage are listed as follows:

### Breaking Changes in Concepts

- `rmt_channel_t` which used to identify the hardware channel are removed from user space. In the new driver, RMT channel is represented by `rmt_channel_handle_t`. The channel is dynamically allocated by the driver, instead of designated by user.
- `rmt_item32_t` is replaced by `rmt_symbol_word_t`, which avoids a nested union inside a struct.
- `rmt_mem_t` is removed, as we don't allow users to access RMT memory block (a.k.a. RMTMEM) directly. Direct access to RMTMEM doesn't make sense but make mistakes, especially when the RMT channel also connected with a DMA channel.
- `rmt_mem_owner_t` is removed, as the ownership is controlled by driver, not by user anymore.
- `rmt_source_clk_t` is replaced by `rmt_clock_source_t`, and note they're not binary compatible.
- `rmt_data_mode_t` is removed, the RMT memory access mode is configured to always use Non-FIFO and DMA mode.
- `rmt_mode_t` is removed, as the driver has stand alone install functions for TX and RX channels.
- `rmt_idle_level_t` is removed, setting IDLE level for TX channel is available in `rmt_transmit_config_t::eot_level`.
- `rmt_carrier_level_t` is removed, setting carrier polarity is available in `rmt_carrier_config_t::polarity_active_low`.
- `rmt_channel_status_t` and `rmt_channel_status_result_t` are removed, they're not used anywhere.
- Transmitting by RMT channel doesn't expect user to prepare the RMT symbols, instead, user needs to provide an RMT Encoder to tell the driver how to convert user data into RMT symbols.

### Breaking Changes in Usage

- Channel installation has been separated for TX and RX channels into `rmt_new_tx_channel()` and `rmt_new_rx_channel()`.
- `rmt_set_clk_div` and `rmt_get_clk_div` are removed. Channel clock configuration can only be done during channel installation.
- `rmt_set_rx_idle_thresh` and `rmt_get_rx_idle_thresh` are removed. In the new driver, the RX channel IDLE threshold is redesigned into a new concept `rmt_receive_config_t::signal_range_max_ns`.
- `rmt_set_mem_block_num` and `rmt_get_mem_block_num` are removed. In the new driver, the memory block number is determined by `rmt_tx_channel_config_t::mem_block_symbols` and `rmt_rx_channel_config_t::mem_block_symbols`.
- `rmt_set_tx_carrier` is removed, the new driver uses `rmt_apply_carrier()` to set carrier behavior.
- `rmt_set_mem_pd` and `rmt_get_mem_pd` are removed. The memory power is managed by the driver automatically.
- `rmt_memory_rw_rst`, `rmt_tx_memory_reset` and `rmt_rx_memory_reset` are removed. Memory reset is managed by the driver automatically.
- `rmt_tx_start` and `rmt_rx_start` are merged into a single function `rmt_enable()`, for both TX and RX channels.
- `rmt_tx_stop` and `rmt_rx_stop` are merged into a single function `rmt_disable()`, for both TX and RX channels.
- `rmt_set_memory_owner` and `rmt_get_memory_owner` are removed. RMT memory owner guard is added automatically by the driver.

- `rmt_set_tx_loop_mode` and `rmt_get_tx_loop_mode` are removed. In the new driver, the loop mode is configured in `rmt_transmit_config_t::loop_count`.
- `rmt_set_source_clk` and `rmt_get_source_clk` are removed. Configuring clock source is only possible during channel installation by `rmt_tx_channel_config_t::clk_src` and `rmt_rx_channel_config_t::clk_src`.
- `rmt_set_rx_filter` is removed. In the new driver, the filter threshold is redesigned into a new concept `rmt_receive_config_t::signal_range_min_ns`.
- `rmt_set_idle_level` and `rmt_get_idle_level` are removed. Setting IDLE level for TX channel is available in `rmt_transmit_config_t::eot_level`.
- `rmt_set_rx_intr_en`, `rmt_set_err_intr_en`, `rmt_set_tx_intr_en`, `rmt_set_tx_thr_intr_en` and `rmt_set_rx_thr_intr_en` are removed. The new driver doesn't allow user to turn on/off interrupt from user space. Instead, it provides callback functions.
- `rmt_set_gpio` and `rmt_set_pin` are removed. The new driver doesn't support to switch GPIO dynamically at runtime.
- `rmt_config` is removed. In the new driver, basic configuration is done during the channel installation stage.
- `rmt_isr_register` and `rmt_isr_deregister` are removed, the interrupt is allocated by the driver itself.
- `rmt_driver_install` is replaced by `rmt_new_tx_channel()` and `rmt_new_rx_channel()`.
- `rmt_driver_uninstall` is replaced by `rmt_del_channel()`.
- `rmt_fill_tx_items`, `rmt_write_items` and `rmt_write_sample` are removed. In the new driver, user needs to provide an encoder to "translate" the user data into RMT symbols.
- `rmt_get_counter_clock` is removed, as the channel clock resolution is configured by user from `rmt_tx_channel_config_t::resolution_hz`.
- `rmt_wait_tx_done` is replaced by `rmt_tx_wait_all_done()`.
- `rmt_translator_init`, `rmt_translator_set_context` and `rmt_translator_get_context` are removed. In the new driver, the translator has been replaced by the RMT encoder.
- `rmt_get_ringbuf_handle` is removed. The new driver doesn't use Ringbuffer to save RMT symbols. Instead, the incoming data are saved to the user provided buffer directly. The user buffer can even be mounted to DMA link internally.
- `rmt_register_tx_end_callback` is replaced by `rmt_tx_register_event_callbacks()`, where user can register `rmt_tx_event_callbacks_t::on_trans_done` event callback.
- `rmt_set_intr_enable_mask` and `rmt_clr_intr_enable_mask` are removed, as the interrupt is handled by the driver, user doesn't need to take care of it.
- `rmt_add_channel_to_group` and `rmt_remove_channel_from_group` are replaced by RMT sync manager. Please refer to `rmt_new_sync_manager()`.
- `rmt_set_tx_loop_count` is removed. The loop count in the new driver is configured in `rmt_transmit_config_t::loop_count`.
- `rmt_enable_tx_loop_autostop` is removed. In the new driver, TX loop auto stop is always enabled if available, it's not configurable anymore.

## LCD

- The LCD panel initialization flow is slightly changed. Now the `esp_lcd_panel_init()` won't turn on the display automatically. User needs to call `esp_lcd_panel_disp_on_off()` to manually turn on the display. Note, this is different from turning on backlight. With this breaking change, user can flash a predefined pattern to the screen before turning on the screen. This can help avoid random noise on the screen after a power on reset.
- `esp_lcd_panel_disp_off()` is deprecated, please use `esp_lcd_panel_disp_on_off()` instead.
- `dc_as_cmd_phase` is removed. The SPI LCD driver currently doesn't support a 9-bit SPI LCD. Please always use a dedicated GPIO to control the LCD D/C line.
- The way to register RGB panel event callbacks has been moved from the `esp_lcd_rgb_panel_config_t` into a separate API `esp_lcd_rgb_panel_register_event_callbacks()`. However, the event callback signature is not changed.
- Previous `relax_on_idle` flag in `esp_lcd_rgb_panel_config_t` has been renamed into `esp_lcd_rgb_panel_config_t::refresh_on_demand`, which expresses the same meaning but

with a clear name.

- If the RGB LCD is created with the `refresh_on_demand` flag enabled, the driver will not start a refresh in the `esp_lcd_panel_draw_bitmap()`. Now users have to call `esp_lcd_rgb_panel_refresh()` to refresh the screen by themselves.
- `esp_lcd_color_space_t` is deprecated, please use `lcd_color_space_t` to describe the color space, and use `lcd_rgb_element_order_t` to describe the data order of RGB color.

### Dedicated GPIO Driver

- All of the dedicated GPIO related Low Level (LL) functions in `cpu_ll.h` have been moved to `dedic_gpio_cpu_ll.h` and renamed.

**I2S driver** The I2S driver has been redesigned (see [I2S Driver](#)), which aims to rectify the shortcomings of the driver that were exposed when supporting all the new features of ESP32-C3 & ESP32-S3. The new driver's APIs are available by including corresponding I2S mode's header files `driver/include/driver/i2s_std.h`, `driver/include/driver/i2s_pdm.h`, or `driver/include/driver/i2s_tdm.h`.

Meanwhile, the old driver's APIs in `driver/deprecated/driver/i2s.h` are still supported for backward compatibility. But there will be warnings if users keep using the old APIs in their projects, these warnings can be suppressed by the Kconfig option `CONFIG_I2S_SUPPRESS_DEPRECATED_WARN`.

Here is the general overview of the current I2S files:

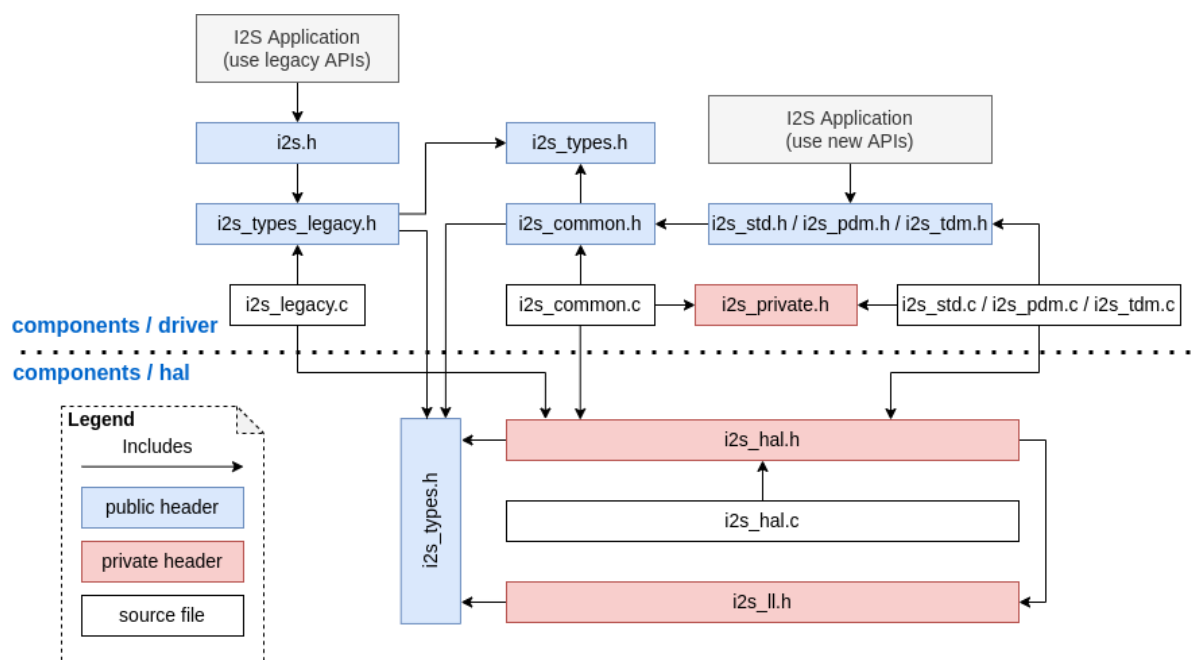

### Breaking changes in Concepts

**Independent TX/RX channels** The minimum control unit in new I2S driver are now individual TX/RX channels instead of an entire I2S controller (that consists of multiple channels).

- The TX and RX channels of the same I2S controller can be controlled separately, meaning that they are configured such that they can be started or stopped separately.
- The `c:type:i2s_chan_handle_t` handle type is used to uniquely identify I2S channels. All the APIs will require the channel handle and users need to maintain the channel handles by themselves.
- On the ESP32-C3 and ESP32-S3, TX and RX channels in the same controller can be configured to different clocks or modes.
- However, on the ESP32 and ESP32-S2, the TX and RX channels of the same controller still share some hardware resources. Thus, configurations may cause one channel to affect another channel in the same controller.



- The channels can be registered to an available I2S controller automatically by setting `i2s_port_t::I2S_NUM_AUTO` as I2S port ID which will cause the driver to search for the available TX/RX channels. However, the driver also supports registering channels to a specific port.
- In order to distinguish between TX/RX channels and sound channels, the term ‘channel’ in the context of the I2S driver will only refer to TX/RX channels. Meanwhile, sound channels will be referred to as “slots”.

**I2S Mode Categorization** I2S communication modes are categorized into the following three modes. Note that:

- **Standard mode:** Standard mode always has two slots, it can support Philips, MSB, and PCM (short frame sync) formats. Please refer to `driver/include/driver/i2s_std.h` for more details.
- **PDM mode:** PDM mode only supports two slots with 16-bit data width, but the configurations of PDM TX and PDM RX are slightly different. For PDM TX, the sample rate can be set by `i2s_pdm_tx_clk_config_t::sample_rate`, and its clock frequency depends on the up-sampling configuration. For PDM RX, the sample rate can be set by `i2s_pdm_rx_clk_config_t::sample_rate`, and its clock frequency depends on the down-sampling configuration. Please refer to `driver/include/driver/i2s_pdm.h` for details.
- **TDM mode:** TDM mode can support up to 16 slots. It can work in Philips, MSB, PCM (short frame sync), and PCM (long frame sync) formats. Please refer to `driver/include/driver/i2s_tdm.h` for details.

When allocating a new channel in a specific mode, users should initialize that channel by its corresponding function. It is strongly recommended to use the helper macros to generate the default configurations in case the default values are changed in the future.

**Independent Slot and Clock Configuration** The slot configurations and clock configurations can be configured separately.

- Call `i2s_channel_init_std_mode()`, `i2s_channel_init_pdm_rx_mode()`, `i2s_channel_init_pdm_tx_mode()`, or `i2s_channel_init_tdm_mode()` to initialize the slot/clock/gpio\_pin configurations.
- Calling `i2s_channel_reconfig_std_slot()`, `i2s_channel_reconfig_pdm_rx_slot()`, `i2s_channel_reconfig_pdm_tx_slot()`, or `i2s_channel_reconfig_tdm_slot()` can change the slot configurations after initialization.
- Calling `i2s_channel_reconfig_std_clock()`, `i2s_channel_reconfig_pdm_rx_clock()`, `i2s_channel_reconfig_pdm_tx_clock()`, or `i2s_channel_reconfig_tdm_clock()` can change the clock configurations after initialization.
- Calling `i2s_channel_reconfig_std_gpio()`, `i2s_channel_reconfig_pdm_rx_gpio()`, `i2s_channel_reconfig_pdm_tx_gpio()`, or `i2s_channel_reconfig_tdm_gpio()` can change the GPIO configurations after initialization.

### Misc

- States and state-machine are adopted in the new I2S driver to avoid APIs called in wrong state.
- ADC and DAC modes are removed. They will only be supported in their own drivers and the legacy I2S driver.

**Breaking Changes in Usage** To use the new I2S driver, please follow these steps:

1. Call `i2s_new_channel()` to acquire channel handles. We should specify the work role and I2S port in this step. Besides, the TX or RX channel handle will be generated by the driver. Inputting both two TX and RX channel handles is not necessary but at least one handle is needed. In the case of inputting both two handles, the driver will work at the duplex mode. Both TX and RX channels will be available on a same port, and they will share the MCLK, BCLK and WS signal. But if only one of the TX or RX channel handle is inputted, this channel will only work in the simplex mode.
2. Call `i2s_channel_init_std_mode()`, `i2s_channel_init_pdm_rx_mode()`, `i2s_channel_init_pdm_tx_mode()` or `i2s_channel_init_tdm_mode()` to initialize the channel to the specified mode. Corresponding slot, clock and GPIO configurations are needed in this step.
3. (Optional) Call `i2s_channel_register_event_callback()` to register the ISR event callback functions. I2S events now can be received by the callback function synchronously, instead of from the event queue asynchronously.

4. Call `i2s_channel_enable()` to start the hardware of I2S channel. In the new driver, I2S won't start automatically after installed, and users are supposed to know clearly whether the channel has started or not.
5. Read or write data by `i2s_channel_read()` or `i2s_channel_write()`. Certainly, only the RX channel handle is supposed to be inputted in `i2s_channel_read()` and the TX channel handle in `i2s_channel_write()`.
6. (Optional) The slot, clock and GPIO configurations can be changed by corresponding 'reconfig' functions, but `i2s_channel_disable()` must be called before updating the configurations.
7. Call `i2s_channel_disable()` to stop the hardware of I2S channel.
8. Call `i2s_del_channel()` to delete and release the resources of the channel if it is not needed any more, but the channel must be disabled before deleting it.

**TWAI Driver** The deprecated CAN peripheral driver is removed. Please use TWAI driver instead (i.e. include `driver/twai.h` in your application).

**Register Access Macros** Previously, all register access macros could be used as expressions, so the following was allowed:

```
uint32_t val = REG_SET_BITS(reg, mask);
```

In ESP-IDF v5.0, register access macros which write or read-modify-write the register can no longer be used as expressions, and can only be used as statements. This applies to the following macros: `REG_WRITE`, `REG_SET_BIT`, `REG_CLR_BIT`, `REG_SET_BITS`, `REG_SET_FIELD`, `WRITE_PERI_REG`, `CLEAR_PERI_REG_MASK`, `SET_PERI_REG_MASK`, `SET_PERI_REG_BITS`.

To store the value which would have been written into the register, split the operation as follows:

```
uint32_t new_val = REG_READ(reg) | mask;
REG_WRITE(reg, new_val);
```

To get the value of the register after modification (which may be different from the value written), add an explicit read:

```
REG_SET_BITS(reg, mask);
uint32_t new_val = REG_READ(reg);
```

## Protocols

**Mbed TLS** For ESP-IDF v5.0, [Mbed TLS](#) has been updated from v2.x to v3.1.0.

For more details about Mbed TLS' s migration from version 2.x to version 3.0 or greater, please refer to the [official guide](#).

## Breaking Changes (Summary)

### Most structure fields are now private

- Direct access to fields of structures (`struct` types) declared in public headers is no longer supported.
- Appropriate accessor functions (getter/setter) must be used for the same. A temporary workaround would be to use `MBEDTLS_PRIVATE` macro (**not recommended**).
- For more details, refer to the [official guide](#).



## SSL

- Removed support for TLS 1.0, 1.1, and DTLS 1.0
- Removed support for SSL 3.0

### Deprecated Functions Were Removed from Cryptography Modules

- The functions `MBEDTLS*_ret()` (related to MD, SHA, RIPEMD, RNG, HMAC modules) was renamed to replace the corresponding functions without `_ret` appended and updated return value.
- For more details, refer to the [official guide](#).

**Deprecated Config Options** Following are some of the important config options deprecated by this update. The configs related to and/or dependent on these have also been deprecated.

- `MBEDTLS_SSL_PROTO_SSL3` : Support for SSL 3.0
- `MBEDTLS_SSL_PROTO_TLS1` : Support for TLS 1.0
- `MBEDTLS_SSL_PROTO_TLS1_1` : Support for TLS 1.1
- `MBEDTLS_SSL_PROTO_DTLS` : Support for DTLS 1.1 (Only DTLS 1.2 is supported now)
- `MBEDTLS_DES_C` : Support for 3DES ciphersuites
- `MBEDTLS_RC4_MODE` : Support for RC4-based ciphersuites

---

**Note:** This list includes only major options configurable through `idf.py menuconfig`. For more details on deprecated options, refer to the [official guide](#).

---

## Miscellaneous

**Disabled Diffie-Hellman Key Exchange Modes** The Diffie-Hellman Key Exchange modes have now been disabled by default due to security risks (see warning text [here](#)). Related configs are given below:

- `MBEDTLS_DHM_C` : Support for the Diffie-Hellman-Merkle module
- `MBEDTLS_KEY_EXCHANGE_DHE_PSK` : Support for Diffie-Hellman PSK (pre-shared-key) TLS authentication modes
- `MBEDTLS_KEY_EXCHANGE_DHE_RSA` : Support for cipher suites with the prefix `TLS-DHE-RSA-WITH-`

---

**Note:** During the initial step of the handshake (i.e. `client_hello`), the server selects a cipher from the list that the client publishes. As the `DHE_PSK/DHE_RSA` ciphers have now been disabled by the above change, the server would fall back to an alternative cipher; if in a rare case, it does not support any other cipher, the handshake would fail. To retrieve the list of ciphers supported by the server, one must attempt to connect with the server with a specific cipher from the client-side. Few utilities can help do this, e.g. `sslscan`.

---

### Remove `certs` Module from X509 Library

- The `MBEDTLS_CERTS_H` header is no longer available in `MBEDTLS_3_1`. Most applications can safely remove it from the list of includes.

### Breaking Change for `esp_crt_bundle_set` API

- The `esp_crt_bundle_set()` API now requires one additional argument named `bundle_size`. The return type of the API has also been changed to `esp_err_t` from `void`.

### Breaking Change for `esp_ds_rsa_sign` API

- The `esp_ds_rsa_sign()` API now requires one less argument. The argument `mode` is no longer required.

## HTTPS Server

**Breaking Changes (Summary)** Names of variables holding different certs in `httpd_ssl_config_t` structure have been updated.

- `httpd_ssl_config::servercert` variable inherits role of `cacert_pem` variable.
- `httpd_ssl_config::servercert_len` variable inherits role of `cacert_len` variable
- `httpd_ssl_config::cacert_pem` variable inherits role of `client_verify_cert_pem` variable
- `httpd_ssl_config::cacert_len` variable inherits role of `client_verify_cert_len` variable

The return type of the `httpd_ssl_stop()` API has been changed to `esp_err_t` from `void`.

## ESP HTTPS OTA

### Breaking Changes (Summary)

- The function `esp_https_ota()` now requires pointer to `esp_https_ota_config_t` as argument instead of pointer to `esp_http_client_config_t`.

## ESP-TLS

### Breaking Changes (Summary)

**esp\_tls\_t Structure is Now Private** The `esp_tls_t` has now been made completely private. You cannot access its internal structures directly. Any necessary data that needs to be obtained from the ESP-TLS handle can be done through respective getter/setter functions. If there is a requirement of a specific getter/setter function, please raise an [issue](#) on ESP-IDF.

The list of newly added getter/setter function is as follows:

- `esp_tls_get_ssl_context()` - Obtain the ssl context of the underlying ssl stack from the ESP-TLS handle.

**Function Deprecations And Recommended Alternatives** Following table summarizes the deprecated functions removed and their alternatives to be used from ESP-IDF v5.0 onwards.

Deprecated Function	Alternative
<code>esp_tls_conn_new()</code>	<code>esp_tls_conn_new_sync()</code>
<code>esp_tls_conn_delete()</code>	<code>esp_tls_conn_destroy()</code>

- The function `esp_tls_conn_http_new()` has now been termed as deprecated. Please use the alternative function `esp_tls_conn_http_new_sync()` (or its asynchronous `esp_tls_conn_http_new_async()`). Note that the alternatives need an additional parameter `esp_tls_t`, which has to be initialized using the `esp_tls_init()` function.

## HTTP Server

### Breaking Changes (Summary)

- `http_server.h` header is no longer available in `esp_http_server`. Please use `esp_http_server.h` instead.

## ESP HTTP Client

### Breaking Changes (Summary)

- The functions `esp_http_client_read()` and `esp_http_client_fetch_headers()` now return an additional return value `-ESP_ERR_HTTP_EAGAIN` for timeout errors - call timed-out before any data was ready.

## TCP Transport

### Breaking Changes (Summary)

- The function `esp_transport_read()` now returns 0 for a connection timeout and `< 0` for other errors. Please refer `esp_tcp_transport_err_t` for all possible return values.

## MQTT Client

### Breaking Changes (Summary)

- `esp_mqtt_client_config_t` have all fields grouped in sub structs.

Most common configurations are listed below:

- Broker address now is set in `esp_mqtt_client_config_t::broker::address::uri`
- Security related to broker verification in `esp_mqtt_client_config_t::broker::verification`
- Client username is set in `esp_mqtt_client_config_t::credentials::username`
- `esp_mqtt_client_config_t` no longer supports the `user_context` field. Please use `esp_mqtt_client_register_event()` instead for registering an event handler; the last argument `event_handler_arg` can be used to pass user context to the handler.

## ESP-Modbus

**Breaking Changes (Summary)** The ESP-IDF component `freemodbus` has been removed from ESP-IDF and is supported as a separate component. Additional information for the `ESP-Modbus` component can be found in the separate repository:

- [ESP-Modbus component on GitHub](#)

The main component folder of the new application shall include the component manager manifest file `idf_component.yml` as in the example below:

```
dependencies:
  espressif/esp-modbus:
    version: "^1.0"
```

The `esp-modbus` component can be found in [component manager registry](#). Refer to [component manager documentation](#) for more information on how to set up the component manager.

For applications targeting v4.x releases of ESP-IDF that need to use new `esp-modbus` component, adding the component manager manifest file `idf_component.yml` will be sufficient to pull in the new component. However, users should also exclude the legacy `freemodbus` component from the build. This can be achieved using the statement below in the project's `CMakeLists.txt`:

```
set(EXCLUDE_COMPONENTS freemodbus)
```

## Provisioning

**Protocomm** The `pop` field in the `protocomm_set_security()` API is now deprecated. Please use the `sec_params` field instead of `pop`. This parameter should contain the structure (including the security parameters) as required by the protocol version used.

For example, when using security version 2, the `sec_params` parameter should contain the pointer to the structure of type `protocomm_security2_params_t`.

## Wi-Fi Provisioning

- The `pop` field in the `wifi_prov_mgr_start_provisioning()` API is now deprecated. For backward compatibility, `pop` can be still passed as a string for security1. However for Security2 the `wifi_prov_sec_params` argument needs to be passed instead of `pop`. This parameter should contain the structure (containing the security parameters) as required by the protocol version used. For example, when using security version 2, the `wifi_prov_sec_params` parameter should contain the pointer to the structure of type `wifi_prov_security2_params_t`. For security 1 the behaviour and the usage of the API remains same.
- The API `wifi_prov_mgr_is_provisioned()` does not return `ESP_ERR_INVALID_STATE` error any more. This API now works without any dependency on provisioning manager initialization state.

**ESP Local Control** The `pop` field in the `esp_local_ctrl_proto_sec_cfg_t` API is now deprecated. Please use the `sec_params` field instead of `pop`. This field should contain the structure (containing the security parameters) as required by the protocol version used.

For example, when using security version 2, the `sec_params` field should contain pointer to the structure of type `esp_local_ctrl_security2_params_t`.

## Removed or Deprecated Components

**Components Moved to IDF Component Registry** Following components are removed from ESP-IDF and moved to IDF Component Registry:

- `libsodium`
- `cbor`
- `jsmn`
- `esp_modem`
- `nghttp`
- `mdns`
- `esp_websocket_client`
- `asio`
- `freemodbus`
- `sh2lib`
- `expat`
- `coap`
- `esp-cryptoauthlib`
- `qrcode`
- `tjpgd`
- `esp_serial_slave_link`
- `tinyusb`

---

**Note:** Please note that http parser functionality which was previously part of `nghttp` component is now part of `http_parser` component.

---

These components can be installed using `idf.py add-dependency` command.

For example, to install libsodium component with the exact version X.Y, run `idf.py add-dependency libsodium==X.Y`.

To install libsodium component with the latest version compatible to X.Y according to [semver](#) rules, run `idf.py add-dependency libsodium~X.Y`.

To find out which versions of each component are available, open <https://components.espressif.com>, search for the component by its name and check the versions listed on the component page.

**Deprecated Components** The following components are removed since they were deprecated in IDF v4.x:

- `tcpip_adapter`. Please use the *ESP-NETIF* component instead; you can follow the *TCP/IP Adapter*.

---

**Note:** OpenSSL-API component is no longer supported. It is not available in the IDF Component Registry, either. Please use *ESP-TLS* or *mbedtls* API directly.

---

The targets components are no longer necessary after refactoring and have been removed:

- `esp32`
- `esp32s2`
- `esp32s3`
- `esp32c2`
- `esp32c3`
- `esp32h2`

## Storage

**New Component for the Partition APIs** Breaking change: all the Partition API code has been moved to a new component `esp_partition`. For the complete list of affected functions and data-types, see header file `esp_partition.h`.

These API functions and data-types were previously a part of the `spi_flash` component, and thus possible dependencies on the `spi_flash` in existing applications may cause the build failure, in case of direct `esp_partition_*` APIs/data-types use (for instance, fatal error: `esp_partition.h: No such file or directory at lines with #include "esp_partition.h"`). If you encounter such an issue, please update your project's `CMakeLists.txt` file as follows:

Original dependency setup:

```
idf_component_register(...
    REQUIRES spi_flash)
```

Updated dependency setup:

```
idf_component_register(...
    REQUIRES spi_flash esp_partition)
```

---

**Note:** Please update relevant `REQUIRES` or `PRIV_REQUIRES` section according to your project. The above-presented code snippet is just an example.

---

If the issue persists, please let us know and we will assist you with your code migration.

**SDMMC/SDSPI** SD card frequency on SDMMC/SDSPI interface can be now configured through `sdmmc_host_t.max_freq_khz` to a specific value, not only `SDMMC_FREQ_PROBING` (400 kHz), `SDMMC_FREQ_DEFAULT` (20 MHz), or `SDMMC_FREQ_HIGHSPEED` (40 MHz). Previously, in case you have specified a custom frequency other than any of the above-mentioned values, the closest lower-or-equal one was selected anyway.

Now, the underlying drivers calculate the nearest fitting value, given by available frequency dividers instead of an enumeration item selection. This could cause troubles in communication with your SD card without a change of the existing application code. If you encounter such an issue, please, keep trying different frequencies around your desired value unless you find the one working well. To check the frequency value calculated and actually applied, use `void sdmmc_card_print_info(FILE* stream, const sdmmc_card_t* card)` function.

**FatFs** FatFs is now updated to v0.14. As a result, the function signature of `f_mkfs()` has changed. The new signature is `FRESULT f_mkfs(const TCHAR* path, const MKFS_PARM* opt, void* work, UINT len);` which uses `MKFS_PARM` struct as a second argument.

**Partition Table** The partition table generator no longer supports misaligned partitions. When generating a partition table, ESP-IDF only accepts partitions with offsets that align to 4 KB. This change only affects generating new partition tables. Reading and writing to already existing partitions remains unchanged.

**VFS** The `esp_vfs_semihost_register()` function signature is changed as follows:

- The new signature is `esp_err_t esp_vfs_semihost_register(const char* base_path);`
- The `host_path` parameter of the old signature no longer exists. Instead, the OpenOCD command `ESP_SEMIHOST_BASEDIR` should be used to set the full path on the host.

**Function Signature Changes** The following functions now return `esp_err_t` instead of `void` or `nvs_iterator_t`. Previously, when parameters were invalid or when something goes wrong internally, these functions would `assert()` or return a `nullptr`. With an `esp_err_t` returned, you can get better error reporting.

- `nvs_entry_find()`
- `nvs_entry_next()`
- `nvs_entry_info()`

Because the `esp_err_t` return type changes, the usage patterns of `nvs_entry_find()` and `nvs_entry_next()` become different. Both functions now modify iterators via parameters instead of returning an iterator.

The old programming pattern to iterate over an NVS partition was as follows:

```
nvs_iterator_t it = nvs_entry_find(<nvs_partition_name>, <namespace>, NVS_TYPE_
↳ANY);
while (it != NULL) {
    nvs_entry_info_t info;
    nvs_entry_info(it, &info);
    it = nvs_entry_next(it);
    printf("key '%s', type '%d'", info.key, info.type);
};
```

The new programming pattern to iterate over an NVS partition is now:

```
nvs_iterator_t it = nullptr;
esp_err_t res = nvs_entry_find(<nvs_partition_name>, <namespace>, NVS_TYPE_ANY, &
↳it);
while (res == ESP_OK) {
    nvs_entry_info_t info;
    nvs_entry_info(it, &info); // Can omit error check if parameters are
↳guaranteed to be non-NULL
    printf("key '%s', type '%d'", info.key, info.type);
    res = nvs_entry_next(&it);
}
nvs_release_iterator(it);
```

**Iterator Validity** Note that because the function signature changes, if there is a parameter error, you may get an invalid iterator from `nvs_entry_find()`. Hence, it is important to initialize the iterator to `NULL` before using `nvs_entry_find()`, so that you can avoid complex error checking before calling `nvs_release_iterator()`. A good example is the programming pattern above.

**Removed SDSPI Deprecated API** Structure `sdspi_slot_config_t` and function `sdspi_host_init_slot()` are removed, and replaced by structure `sdspi_device_config_t` and function `sdspi_host_init_device()` respectively.

**ROM SPI Flash** In versions before v5.0, ROM SPI flash functions were included via `esp32**/rom/spi_flash.h`. Thus, code written to support different ESP chips might be filled with ROM headers of different targets. Furthermore, not all of the APIs could be used on all ESP chips.

Now, the common APIs are extracted to `esp_rom_spiflash.h`. Although it is not a breaking change, you are strongly recommended to only use the functions from this header (i.e., prefixed with `esp_rom_spiflash` and included by `esp_rom_spiflash.h`) for better cross-compatibility between ESP chips.

To make ROM SPI flash APIs clearer, the following functions are also renamed:

- `esp_rom_spiflash_lock()` to `esp_rom_spiflash_set_bp()`
- `esp_rom_spiflash_unlock()` to `esp_rom_spiflash_clear_bp()`

**SPI Flash Driver** The `esp_flash_speed_t` enum type is now deprecated. Instead, you may now directly pass the real clock frequency value to the flash configuration structure. The following example demonstrates how to configure a flash frequency of 80MHz:

```
esp_flash_spi_device_config_t dev_cfg = {
    // Other members
    .freq_mhz = 80,
    // Other members
};
```

**Legacy SPI Flash Driver** To make SPI flash drivers more stable, the legacy SPI flash driver is removed from v5.0. The legacy SPI flash driver refers to default `spi_flash` driver since v3.0, and the SPI flash driver with configuration option `CONFIG_SPI_FLASH_USE_LEGACY_IMPL` enabled since v4.0. The major breaking change here is that the legacy `spi_flash` driver is no longer supported from v5.0. Therefore, the legacy driver APIs and the `CONFIG_SPI_FLASH_USE_LEGACY_IMPL` configuration option are both removed. Please use the new `spi_flash` driver's APIs instead.

Removed items	Replacement
<code>spi_flash_erase_sector()</code>	<code>esp_flash_erase_region()</code>
<code>spi_flash_erase_range()</code>	<code>esp_flash_erase_region()</code>
<code>spi_flash_write()</code>	<code>esp_flash_write()</code>
<code>spi_flash_read()</code>	<code>esp_flash_read()</code>
<code>spi_flash_write_encrypted()</code>	<code>esp_flash_write_encrypted()</code>
<code>spi_flash_read_encrypted()</code>	<code>esp_flash_read_encrypted()</code>

**Note:** New functions with prefix `esp_flash` accept an additional `esp_flash_t*` parameter. You can simply set it to `NULL`. This will make the function to run the main flash (`esp_flash_default_chip`).

The `esp_spi_flash.h` header is deprecated as system functions are no longer public. To use flash memory mapping APIs, you may include `spi_flash_mmap.h` instead.

## System

**Inter-Processor Call** IPC (Inter-Processor Call) feature is no longer a stand-alone component and has been integrated into the `esp_system` component.

Thus, any project presenting a `CMakeLists.txt` file with the parameters `PRIV_REQUIRES esp_ipc` or `REQUIRES esp_ipc` should be modified to simply remove these options as the `esp_system` component is included by default.

**ESP Clock** The ESP Clock API (functions/types/macros prefixed with `esp_clk`) has been made into a private API. Thus, the previous include paths `#include "ESP32-S2/clk.h"` and `#include "esp_clk.h"` have been removed. If users still require usage of the ESP Clock API (though this is not recommended), it can be included via `#include "esp_private/esp_clk.h"`.

---

**Note:** Private APIs are not stable and no are longer subject to the ESP-IDF versioning scheme's breaking change rules. Thus, it is not recommended for users to continue calling private APIs in their applications.

---

**Cache Error Interrupt** The Cache Error Interrupt API (functions/types/macros prefixed with `esp_cache_err`) has been made into a private API. Thus, the previous include path `#include "ESP32-S2/cache_err_int.h"` has been removed. If users still require usage of the Cache Error Interrupt API (though this is not recommended), it can be included via `#include "esp_private/cache_err_int.h"`.

## bootloader\_support

- The function `bootloader_common_get_reset_reason()` has been removed. Please use the function `esp_rom_get_reset_reason()` in the ROM component.
- The functions `esp_secure_boot_verify_sbv2_signature_block()` and `esp_secure_boot_verify_rsa_signature_block()` have been removed without replacement. We do not expect users to use these directly. If they are indeed still necessary, please open a feature request on [GitHub](#) explaining why these functions are necessary to you.

**Brownout** The Brownout API (functions/types/macros prefixed with `esp_brownout`) has been made into a private API. Thus, the previous include path `#include "brownout.h"` has been removed. If users still require usage of the Brownout API (though this is not recommended), it can be included via `#include "esp_private/brownout.h"`.

**Trax** The Trax API (functions/types/macros prefixed with `trax_`) has been made into a private API. Thus, the previous include path `#include "trax.h"` has been removed. If users still require usage of the Trax API (though this is not recommended), it can be included via `#include "esp_private/trax.h"`.

**ROM** The previously deprecated ROM-related header files located in `components/esp32/rom/` (old include path: `rom/*.h`) have been moved. Please use the new target-specific path from `components/esp_rom/include/ESP32-S2/` (new include path: `ESP32-S2/rom/*.h`).

## esp\_hw\_support

- The header files `soc/cpu.h` have been deleted and deprecated CPU util functions have been removed. ESP-IDF developers should include `esp_cpu.h` instead for equivalent functions.
- The header files `hal/cpu_ll.h`, `hal/cpu_hal.h`, `hal/soc_ll.h`, `hal/soc_hal.h` and `interrupt_controller_hal.h` CPU API functions have been deprecated. ESP-IDF developers should include `esp_cpu.h` instead for equivalent functions.



- The header file `compare_set.h` have been deleted. ESP-IDF developers should use `esp_cpu_compare_and_set()` function provided in `esp_cpu.h` instead.
- `esp_cpu_get_ccount()`, `esp_cpu_set_ccount()` and `esp_cpu_in_ocd_debug_mode()` were removed from `esp_cpu.h`. ESP-IDF developers should use respectively `esp_cpu_get_cycle_count()`, `esp_cpu_set_cycle_count()` and `esp_cpu_dbgr_is_attached()` instead.
- The header file `esp_intr.h` has been deleted. Please include `esp_intr_alloc.h` to allocate and manipulate interrupts.
- The Panic API (functions/types/macros prefixed with `esp_panic`) has been made into a private API. Thus, the previous include path `#include "esp_panic.h"` has been removed. If users still require usage of the Trax API (though this is not recommended), it can be included via `#include "esp_private/panic_reason.h"`. Besides, developers should include `esp_debug_helpers.h` instead to use any debug-related helper functions, e.g., `print_backtrace`.
- The header file `soc_log.h` is now renamed to `esp_hw_log.h` and has been made private. Users are encouraged to use logging APIs provided under `esp_log.h` instead.
- The header files `spinlock.h`, `clk_ctrl_os.h`, and `rtc_wdt.h` must now be included without the `soc` prefix. For example, `#include "spinlock.h"`.
- `esp_chip_info()` returns the chip version in the format `= 100 * major eFuse version + minor eFuse version`. Thus, the revision in the `esp_chip_info_t` structure is expanded to `uint16_t` to fit the new format.

### PSRAM

- The target-specific header file `spiram.h` and the header file `esp_spiram.h` have been removed. A new component `esp_psram` is created instead. For PSRAM/SPIRAM-related functions, users now include `esp_psram.h` and set the `esp_psram` component as a component requirement in their `CMakeLists.txt` project files.
- `esp_spiram_get_chip_size` and `esp_spiram_get_size` have been deleted. You should use `esp_psram_get_size` instead.

### eFuse

- The parameter type of function `esp_secure_boot_read_key_digests()` changed from `ets_secure_boot_key_digests_t*` to `esp_secure_boot_key_digests_t*`. The new type is the same as the old one, except that the `allow_key_revoke` flag has been removed. The latter was always set to `true` in current code, not providing additional information.
- Added eFuse wafer revisions: major and minor. The `esp_efuse_get_chip_ver()` API is not compatible with these changes, so it was removed. Instead, please use the following APIs: `efuse_hal_get_major_chip_version()`, `efuse_hal_get_minor_chip_version()` or `efuse_hal_chip_revision()`.

**esp\_common** `EXT_RAM_ATTR` is deprecated. Use the new macro `EXT_RAM_BSS_ATTR` to put `.bss` on PSRAM.

### esp\_system

- The header files `esp_random.h`, `esp_mac.h`, and `esp_chip_info.h`, which were all previously indirectly included via the header file `esp_system.h`, must now be included directly. These indirect inclusions from `esp_system.h` have been removed.
- The Backtrace Parser API (functions/types/macros prefixed with `esp_ah_frame_`) has been made into a private API. Thus, the previous include path `#include "eh_frame_parser.h"` has been removed. If users still require usage of the Backtrace Parser API (though this is not recommended), it can be included via `#include "esp_private/eh_frame_parser.h"`.
- The Interrupt Watchdog API (functions/types/macros prefixed with `esp_int_wdt_`) has been made into a private API. Thus, the previous include path `#include "esp_int_wdt.h"` has been removed. If users still require usage of the Interrupt Watchdog API (though this is not recommended), it can be included via `#include "esp_private/esp_int_wdt.h"`.

### SOC Dependency

- Public API headers listed in the Doxyfiles will not expose unstable and unnecessary soc header files, such as `soc/soc.h` and `soc/rtc.h`. That means the user has to explicitly include them in their code if these “missing” header files are still wanted.
- Kconfig option `LEGACY_INCLUDE_COMMON_HEADERS` is also removed.
- The header file `soc/soc_memory_types.h` has been deprecated. Users should use the `esp_memory_utils.h` instead. Including `soc/soc_memory_types.h` will bring a build warning like `soc_memory_types.h` is deprecated, please migrate to `esp_memory_utils.h`.

**APP Trace** One of the timestamp sources has changed from the legacy timer group driver to the new *GPTimer*. Kconfig choices like `APPTRACE_SV_TS_SOURCE_TIMER00` has been changed to `APPTRACE_SV_TS_SOURCE_GPTIMER`. User no longer need to choose the group and timer ID.

**esp\_timer** The FRC2-based legacy implementation of `esp_timer` available on ESP32 has been removed. The simpler and more efficient implementation based on the LAC timer is now the only option.

**ESP Image** The image SPI speed enum definitions have been renamed.

- Enum `ESP_IMAGE_SPI_SPEED_80M` has been renamed to `ESP_IMAGE_SPI_SPEED_DIV_1`.
- Enum `ESP_IMAGE_SPI_SPEED_40M` has been renamed to `ESP_IMAGE_SPI_SPEED_DIV_2`.
- Enum `ESP_IMAGE_SPI_SPEED_26M` has been renamed to `ESP_IMAGE_SPI_SPEED_DIV_3`.
- Enum `ESP_IMAGE_SPI_SPEED_20M` has been renamed to `ESP_IMAGE_SPI_SPEED_DIV_4`.

### Task Watchdog Timers

- The API for `esp_task_wdt_init()` has changed as follows:
  - Configuration is now passed as a configuration structure.
  - The function will now handle subscribing of the idle tasks if configured to do so.
- The former `CONFIG_ESP_TASK_WDT` configuration option has been renamed to `CONFIG_ESP_TASK_WDT_INIT` and a new `CONFIG_ESP_TASK_WDT_EN` option has been introduced.

### FreeRTOS

**Legacy API and Data Types** Previously, the `configENABLE_BACKWARD_COMPATIBILITY` option was set by default, thus allowing pre FreeRTOS v8.0.0 function names and data types to be used. The `configENABLE_BACKWARD_COMPATIBILITY` is now disabled by default, thus legacy FreeRTOS names/types are no longer supported by default. Users should do one of the followings:

- Update their code to remove usage of legacy FreeRTOS names/types.
- Enable the `CONFIG_FREERTOS_ENABLE_BACKWARD_COMPATIBILITY` to explicitly allow the usage of legacy names/types.

**Tasks Snapshot** The header `task_snapshot.h` has been removed from `freertos/task.h`. ESP-IDF developers should include `freertos/task_snapshot.h` if they need tasks snapshot API.

The function `vTaskGetSnapshot()` now returns `BaseType_t`. Return value shall be `pdTRUE` on success and `pdFALSE` otherwise.

**FreeRTOS Asserts** Previously, FreeRTOS asserts were configured separately from the rest of the system using the `FREERTOS_ASSERT` kconfig option. This option has now been removed and the configuration is now done through `COMPILER_OPTIMIZATION_ASSERTION_LEVEL`.

**Port Macro API** The file `portmacro_deprecated.h` which was added to maintain backward compatibility for deprecated APIs is removed. Users are advised to use the alternate functions for the deprecated APIs as listed below:

- `portENTER_CRITICAL_NESTED()` is removed. Users should use the `portSET_INTERRUPT_MASK_FROM_ISR()` macro instead.
- `portEXIT_CRITICAL_NESTED()` is removed. Users should use the `portCLEAR_INTERRUPT_MASK_FROM_ISR()` macro instead.
- `vPortCPUInitializeMutex()` is removed. Users should use the `spinlock_initialize()` function instead.
- `vPortCPUAcquireMutex()` is removed. Users should use the `spinlock_acquire()` function instead.
- `vPortCPUAcquireMutexTimeout()` is removed. Users should use the `spinlock_acquire()` function instead.
- `vPortCPUReleaseMutex()` is removed. Users should use the `spinlock_release()` function instead.

### App Update

- The functions `esp_ota_get_app_description()` and `esp_ota_get_app_elf_sha256()` have been termed as deprecated. Please use the alternative functions `esp_app_get_description()` and `esp_app_get_elf_sha256()` respectively. These functions have now been moved to a new component `esp_app_format`. (Refer header file `esp_app_desc.h`)

### Bootloader Support

- The `esp_app_desc_t` structure, which used to be declared in `esp_app_format.h`, is now declared in `esp_app_desc.h`.
- The function `bootloader_common_get_partition_description()` has now been made private. Please use the alternative function `esp_ota_get_partition_description()`. Note that this function takes `esp_partition_t` as its first argument instead of `esp_partition_pos_t`.

**Chip Revision** The bootloader checks the chip revision at the beginning of the application loading. The application can only be loaded if the version is  $\geq$  `CONFIG_ESP32S2_REV_MIN` and  $<$  `CONFIG_ESP32S2_REV_MAX_FULL`.

During the OTA upgrade, the version requirements and chip revision in the application header are checked for compatibility. The application can only be updated if the version is  $\geq$  `CONFIG_ESP32S2_REV_MIN` and  $<$  `CONFIG_ESP32S2_REV_MAX_FULL`.

### Tools

**IDF Monitor** IDF Monitor makes the following changes regarding baud-rate:

- IDF monitor now uses the custom console baud-rate (`CONFIG_ESP_CONSOLE_UART_BAUDRATE`) by default instead of 115200.
- Setting a custom baud from menuconfig is no longer supported.
- A custom baud-rate can be specified from command line with the `idf.py monitor -b <baud>` command or through setting environment variables.
- Please note that the baud-rate argument has been renamed from `-B` to `-b` in order to be consistent with the global baud-rate `idf.py -b <baud>`. Run `idf.py monitor --help` for more information.

**Deprecated Commands** `idf.py` sub-commands and `cmake` target names have been unified to use hyphens (-) instead of underscores (\_). Using a deprecated sub-command or target name will produce a warning. Users are advised to migrate to using the new sub-commands and target names. The following changes have been made:

Table 1: Deprecated Sub-command and Target Names

Old Name	New Name
<code>efuse_common_table</code>	<code>efuse-common-table</code>
<code>efuse_custom_table</code>	<code>efuse-custom-table</code>
<code>erase_flash</code>	<code>erase-flash</code>
<code>partition_table</code>	<code>partition-table</code>
<code>partition_table-flash</code>	<code>partition-table-flash</code>
<code>post_debug</code>	<code>post-debug</code>
<code>show_efuse_table</code>	<code>show-efuse-table</code>
<code>erase_otadata</code>	<code>erase-otadata</code>
<code>read_otadata</code>	<code>read-otadata</code>

**Esptool** The `CONFIG_ESPTOOLPY_FLASHSIZE_DETECT` option has been renamed to `CONFIG_ESPTOOLPY_HEADER_FLASHSIZE_UPDATE` and has been disabled by default. New and existing projects migrated to ESP-IDF v5.0 will have to set `CONFIG_ESPTOOLPY_FLASHSIZE`. If this is not possible due to an unknown flash size at build time, then `CONFIG_ESPTOOLPY_HEADER_FLASHSIZE_UPDATE` can be enabled. However, once enabled, to keep the digest valid, a SHA256 digest will no longer be appended to the image when updating the binary header with the flash size during flashing.

**Windows Environment** The Msys/Mingw-based Windows environment support got deprecated in ESP-IDF v4.0 and was entirely removed in v5.0. Please use *ESP-IDF Tools Installer* to set up a compatible environment. The options include Windows Command Line, Power Shell and the graphical user interface based on Eclipse IDE. In addition, a VS Code-based environment can be set up with the supported plugin: <https://github.com/espressif/vscode-esp-idf-extension>.

## WiFi

**WiFi Enterprise security** APIs defined in `esp_wpa2.h` have been deprecated. Please use newer APIs from `esp_eap_client.h`.



## Chapter 6

# Libraries and Frameworks

### 6.1 Cloud Frameworks

ESP32-S2 supports multiple cloud frameworks using agents built on top of ESP-IDF. Here are the pointers to various supported cloud frameworks' agents and examples:

#### 6.1.1 ESP RainMaker

ESP RainMaker is a complete solution for accelerated AIoT development. [ESP RainMaker on GitHub](#).

#### 6.1.2 AWS IoT

<https://github.com/espressif/esp-aws-iot> is an open source repository for ESP32-S2 based on Amazon Web Services' `aws-iot-device-sdk-embedded-C`.

#### 6.1.3 Azure IoT

<https://github.com/espressif/esp-azure> is an open source repository for ESP32-S2 based on Microsoft Azure' s `azure-iot-sdk-c` SDK.

#### 6.1.4 Google IoT Core

<https://github.com/espressif/esp-google-iot> is an open source repository for ESP32-S2 based on Google' s `iot-device-sdk-embedded-c` SDK.

#### 6.1.5 Aliyun IoT

<https://github.com/espressif/esp-aliyun> is an open source repository for ESP32-S2 based on Aliyun' s `iotkit-embedded` SDK.

#### 6.1.6 Joylink IoT

<https://github.com/espressif/esp-joylink> is an open source repository for ESP32-S2 based on Joylink' s `joylink_dev_sdk` SDK.

### 6.1.7 Tencent IoT

<https://github.com/espressif/esp-welink> is an open source repository for ESP32-S2 based on Tencent's [welink SDK](#).

### 6.1.8 Tencentyun IoT

<https://github.com/espressif/esp-qcloud> is an open source repository for ESP32-S2 based on Tencentyun's [qcloud-iot-sdk-embedded-c SDK](#).

### 6.1.9 Baidu IoT

<https://github.com/espressif/esp-baidu-iot> is an open source repository for ESP32-S2 based on Baidu's [iot-sdk-c SDK](#).

## 6.2 Espressif's Frameworks

Here you will find a collection of the official Espressif libraries and frameworks.

### 6.2.1 Espressif Audio Development Framework

The ESP-ADF is a comprehensive framework for audio applications including:

- CODEC's HAL
- Music Players and Recorders
- Audio Processing
- Bluetooth Speakers
- Internet Radios
- Hands-free devices
- Speech Recognition

This framework is available at GitHub: [ESP-ADF](#).

### 6.2.2 ESP-CSI

ESP-CSI is an experimental implementation that uses the Wi-Fi Channel State Information to detect the presence of a human body.

See [ESP-CSI](#) project for more information about it.

### 6.2.3 Espressif DSP Library

The library provides algorithms optimized specifically for digital signal processing applications. This library supports:

- Matrix multiplication
- Dot product
- FFT (Fast Fourier Transform)
- IIR (Infinite Impulse Response)
- FIR (Finite Impulse Response)
- Vector math operations

This library is available here: [ESP-DSP library](#).

## 6.2.4 ESP-WIFI-MESH Development Framework

This framework is based on the ESP-WIFI-MESH protocol with the following features:

- Fast network configuration
- Stable upgrade
- Efficient debugging
- LAN control
- Various application demos

[ESP-MDF](#).

## 6.2.5 ESP-WHO

The ESP-WHO is a face detection and recognition framework using the ESP32 and camera. To know more about the project, see [ESP-WHO](#) on GitHub.

## 6.2.6 ESP RainMaker

[ESP RainMaker](#) is a complete solution for accelerated AIoT development. Using ESP RainMaker, you can create AIoT devices from the firmware to the integration with voice-assistant, phone apps and cloud backend.

[ESP RainMaker on GitHub](#).

## 6.2.7 ESP-IoT-Solution

[ESP-IoT-Solution](#) contains commonly used device drivers and code frameworks when developing IoT systems. The device drivers and code frameworks within the ESP-IoT-Solution are organized as separate components, allowing them to be easily integrated into an ESP-IDF project.

ESP-IoT-Solution includes:

- Device drivers for sensors, display, audio, GUI, input, actuators, etc.
- Framework and documentation for low power, security, storage, etc.
- Guide for Espressif open source solutions from practical application point.

[ESP-IoT-Solution on GitHub](#).

## 6.2.8 ESP-Protocols

[ESP-Protocols](#) repository contains collection of protocol components for ESP-IDF. The code within the ESP-Protocols is organized into separate components, allowing them to be easily integrated into an ESP-IDF project. In addition to that, each component is available in [IDF Component Registry](#).

ESP-Protocols components:

- [esp\\_modem](#) enables connectivity with GSM/LTE modems using AT commands or PPP protocol, see the [esp\\_modem documentation](#).
- [mdns](#) (mDNS) is a multicast UDP service that is used to provide local network service and host discovery, see the [mdns documentation](#).
- [esp\\_websocket\\_client](#) is a managed component for *esp-idf* that contains implementation of [WebSocket protocol client](<https://datatracker.ietf.org/doc/html/rfc6455>) for ESP32, see the [esp\\_websocket\\_client documentation](#).
- [asio](#) is a cross-platform C++ library, see <https://think-async.com/Asio/>. It provides a consistent asynchronous model using a modern C++ approach. , see the [asio documentation](#).



## 6.2.9 ESP-BSP

[ESP-BSP](#) repository contains Board Support Packages (BSPs) for various Espressif's and 3rd party development boards. BSPs are useful for quick start on a supported board. Usually they contain pinout definition and helper functions, that will initialize peripherals for the specific board. Additionally, the BSP would contain drivers for external chips populated on the development board, such as sensors, displays, audio codecs etc.

# Chapter 7

## Contributions Guide

We welcome contributions to the esp-idf project!

### 7.1 How to Contribute

Contributions to esp-idf - fixing bugs, adding features, adding documentation - are welcome. We accept contributions via [Github Pull Requests](#).

### 7.2 Before Contributing

Before sending us a Pull Request, please consider this list of points:

- Is the contribution entirely your own work, or already licensed under an Apache License 2.0 compatible Open Source License? If not then we unfortunately cannot accept it. Please check the [Copyright Header Guide](#) for additional information.
- Does any new code conform to the esp-idf [Style Guide](#)?
- Have you installed the [pre-commit hook](#) for esp-idf project?
- Does the code documentation follow requirements in [Documenting Code](#)?
- Is the code adequately commented for people to understand how it is structured?
- Is there documentation or examples that go with code contributions? There are additional suggestions for writing good examples in [examples](#) readme.
- Are comments and documentation written in clear English, with no spelling or grammar errors?
- Example contributions are also welcome. Please check the [Creating Examples](#) guide for these.
- If the contribution contains multiple commits, are they grouped together into logical changes (one major change per pull request)? Are any commits with names like “fixed typo” [squashed into previous commits](#)?
- If you’re unsure about any of these points, please open the Pull Request anyhow and then ask us for feedback.

### 7.3 Pull Request Process

After you open the Pull Request, there will probably be some discussion in the comments field of the request itself.

Once the Pull Request is ready to merge, it will first be merged into our internal git system for in-house automated testing.

If this process passes, it will be merged into the public GitHub repository.

## 7.4 Legal Part

Before a contribution can be accepted, you will need to sign our *Contributor Agreement*. You will be prompted for this automatically as part of the Pull Request process.

## 7.5 Related Documents

### 7.5.1 Espressif IoT Development Framework Style Guide

#### About This Guide

Purpose of this style guide is to encourage use of common coding practices within the ESP-IDF.

Style guide is a set of rules which are aimed to help create readable, maintainable, and robust code. By writing code which looks the same way across the code base we help others read and comprehend the code. By using same conventions for spaces and newlines we reduce chances that future changes will produce huge unreadable diffs. By following common patterns for module structure and by using language features consistently we help others understand code behavior.

We try to keep rules simple enough, which means that they can not cover all potential cases. In some cases one has to bend these simple rules to achieve readability, maintainability, or robustness.

When doing modifications to third-party code used in ESP-IDF, follow the way that particular project is written. That will help propose useful changes for merging into upstream project.

#### C Code Formatting

##### Naming

- Any variable or function which is only used in a single source file should be declared `static`.
- Public names (non-static variables and functions) should be namespaced with a per-component or per-unit prefix, to avoid naming collisions. ie `esp_vfs_register()` or `esp_console_run()`. Starting the prefix with `esp_` for Espressif-specific names is optional, but should be consistent with any other names in the same component.
- Static variables should be prefixed with `s_` for easy identification. For example, `static bool s_invert`.
- Avoid unnecessary abbreviations (ie shortening `data` to `dat`), unless the resulting name would otherwise be very long.

**Indentation** Use 4 spaces for each indentation level. Don't use tabs for indentation. Configure the editor to emit 4 spaces each time you press tab key.

**Vertical Space** Place one empty line between functions. Don't begin or end a function with an empty line.

```
void function1()
{
    do_one_thing();
    do_another_thing();
}
// INCORRECT, don't place empty line here
// place empty line here
void function2()
{
    // INCORRECT, don't use an empty line here
    int var = 0;
    while (var < SOME_CONSTANT) {
        do_stuff(&var);
    }
}
```

(continues on next page)

(continued from previous page)

```

}
}

```

The maximum line length is 120 characters as long as it doesn't seriously affect the readability.

**Horizontal Space** Always add single space after conditional and loop keywords:

```

if (condition) {      // correct
    // ...
}

switch (n) {          // correct
    case 0:
        // ...
}

for(int i = 0; i < CONST; ++i) {    // INCORRECT
    // ...
}

```

Add single space around binary operators. No space is necessary for unary operators. It is okay to drop space around multiply and divide operators:

```

const int y = y0 + (x - x0) * (y1 - y0) / (x1 - x0);    // correct

const int y = y0 + (x - x0)*(y1 - y0)/(x1 - x0);      // also okay

int y_cur = -y;                                       // correct
++y_cur;

const int y = y0+(x-x0)*(y1-y0)/(x1-x0);              // INCORRECT

```

No space is necessary around `.` and `->` operators.

Sometimes adding horizontal space within a line can help make code more readable. For example, you can add space to align function arguments:

```

esp_rom_gpio_connect_in_signal(PIN_CAM_D6,    I2S0I_DATA_IN14_IDX, false);
esp_rom_gpio_connect_in_signal(PIN_CAM_D7,    I2S0I_DATA_IN15_IDX, false);
esp_rom_gpio_connect_in_signal(PIN_CAM_HREF,  I2S0I_H_ENABLE_IDX,  false);
esp_rom_gpio_connect_in_signal(PIN_CAM_PCLK,  I2S0I_DATA_IN15_IDX, false);

```

Note however that if someone goes to add new line with a longer identifier as first argument (e.g. `PIN_CAM_VSYNC`), it will not fit. So other lines would have to be realigned, adding meaningless changes to the commit.

Therefore, use horizontal alignment sparingly, especially if you expect new lines to be added to the list later.

Never use TAB characters for horizontal alignment.

Never add trailing whitespace at the end of the line.

## Braces

- Function definition should have a brace on a separate line:

```

// This is correct:
void function(int arg)
{
}

```

(continues on next page)

(continued from previous page)

```
// NOT like this:
void function(int arg) {
}
```

- Within a function, place opening brace on the same line with conditional and loop statements:

```
if (condition) {
    do_one();
} else if (other_condition) {
    do_two();
}
```

**Comments** Use // for single line comments. For multi-line comments it is okay to use either // on each line or a /\* \*/ block.

Although not directly related to formatting, here are a few notes about using comments effectively.

- Don't use single comments to disable some functionality:

```
void init_something()
{
    setup_dma();
    // load_resources();           // WHY is this thing commented, asks_
    ↪the reader?
    start_timer();
}
```

- If some code is no longer required, remove it completely. If you need it you can always look it up in git history of this file. If you disable some call because of temporary reasons, with an intention to restore it in the future, add explanation on the adjacent line:

```
void init_something()
{
    setup_dma();
    // TODO: we should load resources here, but loader is not fully integrated_
    ↪yet.
    // load_resources();
    start_timer();
}
```

- Same goes for #if 0 ... #endif blocks. Remove code block completely if it is not used. Otherwise, add comment explaining why the block is disabled. Don't use #if 0 ... #endif or comments to store code snippets which you may need in the future.
- Don't add trivial comments about authorship and change date. You can always look up who modified any given line using git. E.g. this comment adds clutter to the code without adding any useful information:

```
void init_something()
{
    setup_dma();
    // XXX add 2016-09-01
    init_dma_list();
    fill_dma_item(0);
    // end XXX add
    start_timer();
}
```

**Line Endings** Commits should only contain files with LF (Unix style) endings.

Windows users can configure git to check out CRLF (Windows style) endings locally and commit LF endings by setting the `core.autocrlf` setting. *Github has a document about setting this option* <[github-line-endings](#)>.

If you accidentally have some commits in your branch that add LF endings, you can convert them to Unix by running this command in an MSYS2 or Unix terminal (change directory to the IDF working directory and check the correct branch is currently checked out, beforehand):

```
git rebase --exec 'git diff-tree --no-commit-id --name-only -r HEAD | xargs ↵
↳dos2unix && git commit -a --amend --no-edit --allow-empty' master
```

(Note that this line rebases on master, change the branch name at the end to rebase on another branch.)

For updating a single commit, it's possible to run `dos2unix FILENAME` and then run `git commit --amend`

**Formatting Your Code** You can use `astyle` program to format your code according to the above recommendations.

If you are writing a file from scratch, or doing a complete rewrite, feel free to re-format the entire file. If you are changing a small portion of file, don't re-format the code you didn't change. This will help others when they review your changes.

To re-format a file, run:

```
tools/format.sh components/my_component/file.c
```

**Type Definitions** Should be snake\_case, ending with `_t` suffix:

```
typedef int signed_32_bit_t;
```

**Enum** Enums should be defined through the `typedef` and be namespaced:

```
typedef enum
{
    MODULE_FOO_ONE,
    MODULE_FOO_TWO,
    MODULE_FOO_THREE
} module_foo_t;
```

**Assertions** The standard C `assert()` function, defined in `assert.h` should be used to check conditions that should be true in source code. In the default configuration, an assert condition that returns `false` or `0` will call `abort()` and trigger a *Fatal Error*.

`assert()` should only be used to detect unrecoverable errors due to a serious internal logic bug or corruption, where it's not possible for the program to continue. For recoverable errors, including errors that are possible due to invalid external input, an *error value should be returned*.

---

**Note:** When asserting a value of type `esp_err_t` is equal to `ESP_OK`, use the [ESP\\_ERROR\\_CHECK macro](#) instead of an `assert()`.

---

It's possible to configure ESP-IDF projects with assertions disabled (see [CONFIG\\_COMPILER\\_OPTIMIZATION\\_ASSERTION\\_LEVEL](#)). Therefore, functions called in an `assert()` statement should not have side-effects.

It's also necessary to use particular techniques to avoid “variable set but not used” warnings when assertions are disabled, due to code patterns such as:

```
int res = do_something();
assert(res == 0);
```

Once the `assert` is optimized out, the `res` value is unused and the compiler will warn about this. However the function `do_something()` must still be called, even if assertions are disabled.

When the variable is declared and initialized in a single statement, a good strategy is to cast it to `void` on a new line. The compiler will not produce a warning, and the variable can still be optimized out of the final binary:

```
int res = do_something();
assert(res == 0);
(void)res;
```

If the variable is declared separately, for example if it is used for multiple assertions, then it can be declared with the GCC attribute `__attribute__((unused))`. The compiler will not produce any unused variable warnings, but the variable can still be optimized out:

```
int res __attribute__((unused));

res = do_something();
assert(res == 0);

res = do_something_else();
assert(res != 0);
```

## Header file guards

All public facing header files should have preprocessor guards. A pragma is preferred:

```
#pragma once
```

over the following pattern:

```
#ifndef FILE_NAME_H
#define FILE_NAME_H
...
#endif // FILE_NAME_H
```

In addition to guard macros, all C header files should have `extern "C"` guards to allow the header to be used from C++ code. Note that the following order should be used: `pragma once`, then any `#include` statements, then `extern "C"` guards:

```
#pragma once

#include <stdint.h>

#ifdef __cplusplus
extern "C" {
#endif

/* declarations go here */

#ifdef __cplusplus
}
#endif
```

## Include statements

When writing `#include` statements, try to maintain the following order:

- C standard library headers.
- Other POSIX standard headers and common extensions to them (such as `sys/queue.h`.)
- Common IDF headers (`esp_log.h`, `esp_system.h`, `esp_timer.h`, `esp_sleep.h`, etc.)

- Headers of other components, such as FreeRTOS.
- Public headers of the current component.
- Private headers.

Use angle brackets for C standard library headers and other POSIX headers (`#include <stdio.h>`).

Use double quotes for all other headers (`#include "esp_log.h"`).

## C++ Code Formatting

The same rules as for C apply. Where they are not enough, apply the following rules.

**File Naming** C++ Header files have the extension `.hpp`. C++ source files have the extension `.cpp`. The latter is important for the compiler to distinguish them from normal C source files.

## Naming

- **Class and struct** names shall be written in CamelCase with a capital letter as beginning. Member variables and methods shall be in snake\_case.
- **Namespaces** shall be in lower snake\_case.
- **Templates** are specified in the line above the function declaration.
- Interfaces in terms of Object-Oriented Programming shall be named without the suffix `...Interface`. Later, this makes it easier to extract interfaces from normal classes and vice versa without making a breaking change.

**Member Order in Classes** In order of precedence:

- First put the public members, then the protected, then private ones. Omit public, protected or private sections without any members.
- First put constructors/destructors, then member functions, then member variables.

For example:

```
class ForExample {
public:
    // first constructors, then default constructor, then destructor
    ForExample(double example_factor_arg);
    ForExample();
    ~ForExample();

    // then remaining public methods
    set_example_factor(double example_factor_arg);

    // then public member variables
    uint32_t public_data_member;

private:
    // first private methods
    void internal_method();

    // then private member variables
    double example_factor;
};
```

## Spacing

- Don't indent inside namespaces.
- Put public, protected and private labels at the same indentation level as the corresponding class label.



**Simple Example**

```

// file spaceship.h
#ifndef SPACESHIP_H_
#define SPACESHIP_H_
#include <cstdlib>

namespace spaceships {

class SpaceShip {
public:
    SpaceShip(size_t crew);
    size_t get_crew_size() const;

private:
    const size_t crew;
};

class SpaceShuttle : public SpaceShip {
public:
    SpaceShuttle();
};

class Sojuz : public SpaceShip {
public:
    Sojuz();
};

template <typename T>
class CargoShip {
public:
    CargoShip(const T &cargo);

private:
    T cargo;
};

} // namespace spaceships

#endif // SPACESHIP_H_

// file spaceship.cpp
#include "spaceship.h"

namespace spaceships {

// Putting the curly braces in the same line for constructors is OK if it only_
↪initializes
// values in the initializer list
SpaceShip::SpaceShip(size_t crew) : crew(crew) { }

size_t SpaceShip::get_crew_size() const
{
    return crew;
}

SpaceShuttle::SpaceShuttle() : SpaceShip(7)
{
    // doing further initialization
}

Sojuz::Sojuz() : SpaceShip(3)
{

```

(continues on next page)

(continued from previous page)

```
    // doing further initialization
}

template <typename T>
CargoShip<T>::CargoShip(const T &cargo) : cargo(cargo) { }

} // namespace spaceships
```

## CMake Code Style

- Indent with four spaces.
- Maximum line length 120 characters. When splitting lines, try to focus on readability where possible (for example, by pairing up keyword/argument pairs on individual lines).
- Don't put anything in the optional parentheses after `endforeach()`, `endif()`, etc.
- Use lowercase (`with_underscores`) for command, function, and macro names.
- For locally scoped variables, use lowercase (`with_underscores`).
- For globally scoped variables, use uppercase (`WITH_UNDERSCORES`).
- Otherwise follow the defaults of the [cmake-lint](#) project.

## Configuring the Code Style for a Project Using EditorConfig

EditorConfig helps developers define and maintain consistent coding styles between different editors and IDEs. The EditorConfig project consists of a file format for defining coding styles and a collection of text editor plugins that enable editors to read the file format and adhere to defined styles. EditorConfig files are easily readable and they work nicely with version control systems.

For more information, see [EditorConfig Website](#).

## Documenting Code

Please see the guide here: [Documenting Code](#).

## Structure

To be written.

## Language Features

To be written.

## 7.5.2 Install pre-commit Hook for ESP-IDF Project

### Required Dependency

Python 3.7.\* or above. This is our recommended python version for IDF developers.

If you still have python versions not compatible, update your python versions before installing the pre-commit hook.

### Install pre-commit

```
Run pip install pre-commit
```

### Install pre-commit hook

1. Go to the IDF Project Directory
2. Run `pre-commit install --allow-missing-config`. Install hook by this approach will let you commit successfully even in branches without the `.pre-commit-config.yaml`
3. pre-commit hook will run automatically when you're running `git commit` command

### Uninstall pre-commit

Run `pre-commit uninstall`

### What's More?

For detailed usage, please refer to the documentation of [pre-commit](#).

### Common Problems For Windows Users

`/usr/bin/env: python: Permission denied.`

If you're in Git Bash, please check the python executable location by run `which python`.

If the executable is under `~/AppData/Local/Microsoft/WindowsApps/`, then it's a link to Windows AppStore, not a real one.

Please install python manually and update this in your PATH environment variable.

Your `%USERPROFILE%` contains non-ASCII characters

`pre-commit` may fail when initializing an environment for a particular hook when the path of `pre-commit`'s cache contains non-ASCII characters. The solution is to set `PRE_COMMIT_HOME` to a path containing only standard characters before running `pre-commit`.

- CMD: `set PRE_COMMIT_HOME=C:\somepath\pre-commit`
- PowerShell: `$Env:PRE_COMMIT_HOME = "C:\somepath\pre-commit"`
- git bash: `export PRE_COMMIT_HOME="/c/somepath/pre-commit"`

## 7.5.3 Documenting Code

The purpose of this description is to provide quick summary on documentation style used in [espressif/esp-idf](#) repository and how to add new documentation.

### Introduction

When documenting code for this repository, please follow [Doxygen style](#). You are doing it by inserting special commands, for instance `@param`, into standard comments blocks, for example:

```
/**
 * @param ratio this is oxygen to air ratio
 */
```

Doxygen is phrasing the code, extracting the commands together with subsequent text, and building documentation out of it.

Typical comment block, that contains documentation of a function, looks like below.

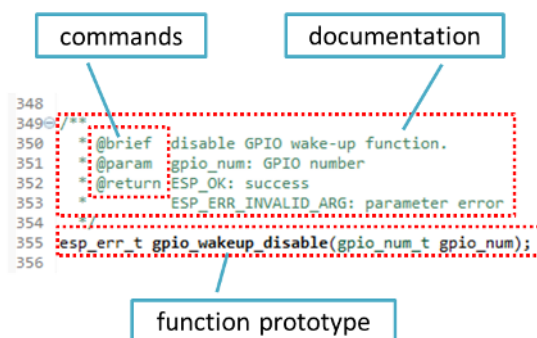

Doxygen supports couple of formatting styles. It also gives you great flexibility on level of details to include in documentation. To get familiar with available features, please check data rich and very well organized [Doxygen Manual](#).

### Why we need it?

The ultimate goal is to ensure that all the code is consistently documented, so we can use tools like [Sphinx](#) and [Breathe](#) to aid preparation and automatic updates of API documentation when the code changes.

With these tools the above piece of code renders like below:

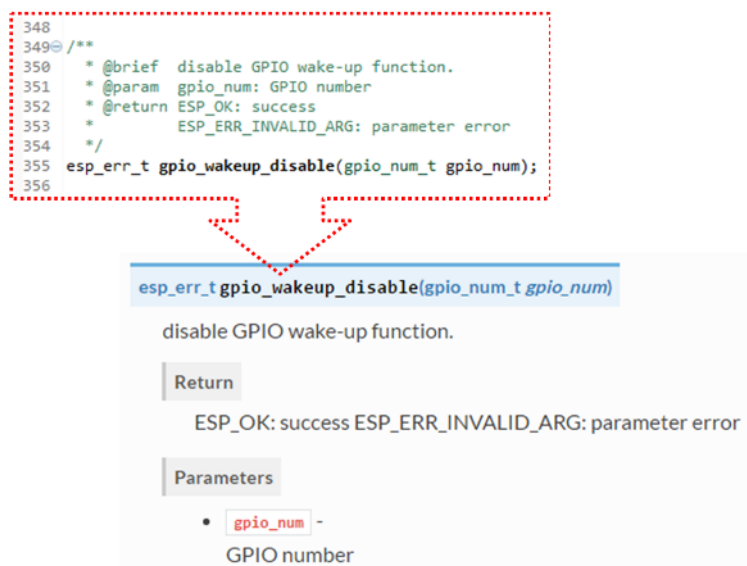

### Go for it!

When writing code for this repository, please follow guidelines below.

1. Document all building blocks of code: functions, structs, typedefs, enums, macros, etc. Provide enough information about purpose, functionality and limitations of documented items, as you would like to see them documented when reading the code by others.
2. Documentation of function should describe what this function does. If it accepts input parameters and returns some value, all of them should be explained.
3. Do not add a data type before parameter or any other characters besides spaces. All spaces and line breaks are compressed into a single space. If you like to break a line, then break it twice.

```

41 @/**
42  * @brief Set log level for given tag
43  *
44  * If logging for given component has already been enabled, changes previous setting.
45  *
46  * @param tag Tag of the log entries to enable. Must be a non-NULL zero terminated string.
47  *           Value "" resets log level for all tags to the given value.
48  *
49  * @param level Selects log level to enable.
50  *             Only logs at this and lower levels will be shown.
51  */
52 void esp_log_level_set(const char* tag, esp_log_level_t level);

```

do not add data type

white spaces are compressed

a line break that will render

this line break will not render

```
void esp_log_level_set(const char* tag, esp_log_level_t level)
```

Set log level for given tag.

If logging for given component has already been enabled, changes previous setting.

**Parameters**

- tag** - Tag of the log entries to enable. Must be a non-NULL zero terminated string. Value "" resets log level for all tags to the given value.
- level** - Selects log level to enable. Only logs at this and lower levels will be shown.

4. If function has void input or does not return any value, then skip @param or @return

```

26 @/**
27  * @brief Initialize BT controller
28  *
29  * This function should be called only once,
30  * before any other BT functions are called.
31  */
32 void bt_controller_init(void);

```

```
void bt_controller_init(void)
```

Initialize BT controller.

This function should be called only once, before any other BT functions are called.

5. When documenting a define as well as members of a struct or enum, place specific comment like below after each member.

```

45 @/**
46  * Mode of opening the non-volatile storage
47  *
48  */
49 @typedef enum {
50     NVS_READONLY, /*!< Read only */
51     NVS_READWRITE /*!< Read and write */
52 } nvs_open_mode;

```

```
enum nvs_open_mode
```

Mode of opening the non-volatile storage.

**Values:**

- NVS\_READONLY**  
Read only
- NVS\_READWRITE**  
Read and write

/\*!< how to documented members \*/

6. To provide well formatted lists, break the line after command (like @return in example below).

```

*
* @return
*   - ESP_OK if erase operation was successful

```

(continues on next page)

(continued from previous page)

```
* - ESP_ERR_NVS_INVALID_HANDLE if handle has been closed or is NULL
* - ESP_ERR_NVS_READ_ONLY if handle was opened as read only
* - ESP_ERR_NVS_NOT_FOUND if the requested key doesn't exist
* - other error codes from the underlying storage driver
*
```

7. Overview of functionality of documented header file, or group of files that make a library, should be placed in a separate README.rst file of the same directory. If this directory contains header files for different APIs, then the file name should be apiname-readme.rst.

### Go one extra mile

Here are a couple of tips on how you can make your documentation even better and more useful to the reader and writer.

When writing codes, please follow the guidelines below:

1. Add code snippets to illustrate implementation. To do so, enclose snippet using @code{c} and @endcode commands.

```
*
* @code{c}
* // Example of using nvs_get_i32:
* int32_t max_buffer_size = 4096; // default value
* esp_err_t err = nvs_get_i32(my_handle, "max_buffer_size", &max_buffer_size);
* assert(err == ESP_OK || err == ESP_ERR_NVS_NOT_FOUND);
* // if ESP_ERR_NVS_NOT_FOUND was returned, max_buffer_size will still
* // have its default value.
* @endcode
*
```

The code snippet should be enclosed in a comment block of the function that it illustrates.

2. To highlight some important information use command @attention or @note.

```
*
* @attention
* 1. This API only impact WIFI_MODE_STA or WIFI_MODE_APSTA mode
* 2. If the ESP32 is connected to an AP, call esp_wifi_disconnect to
* ↪disconnect.
*
```

Above example also shows how to use a numbered list.

3. To provide common description to a group of similar functions, enclose them using /\*\*@{\*/ and /\*\*@}\*/ markup commands:

```
/**@{*/
/**
* @brief common description of similar functions
*
*/
void first_similar_function (void);
void second_similar_function (void);
/**@}*/
```

For practical example see [nvs\\_flash/include/nvs.h](#).

4. You may want to go even further and skip some code like repetitive defines or enumerations. In such case, enclose the code within /\*\* @cond \*/ and /\*\* @endcond \*/ commands. Example of such implementation is provided in [driver/include/driver/gpio.h](#).
5. Use markdown to make your documentation even more readable. You will add headers, links, tables and more.

```
*
* [ESP32-S2 Technical Reference Manual] (https://www.espressif.com/sites/default/files/documentation/esp32-s2\_technical\_reference\_manual\_en.pdf)
*
*
```

**Note:** Code snippets, notes, links, etc. will not make it to the documentation, if not enclosed in a comment block associated with one of documented objects.

6. Prepare one or more complete code examples together with description. Place description to a separate file README.md in specific folder of `examples` directory.

### Standardize Document Format

When it comes to text, please follow guidelines below to provide well formatted Markdown (.md) or reST (.rst) documents.

1. Please ensure that one paragraph is written in one line. Don't break lines like below. Breaking lines to enhance readability is only suitable for writing codes. To make the text easier to read, it is recommended to place an empty line to separate the paragraph.

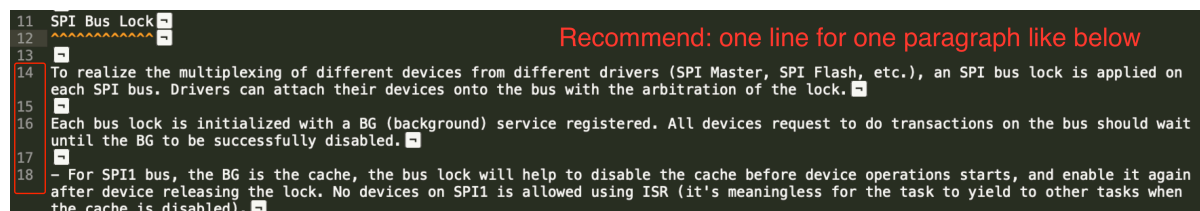

Fig. 1: One line for one paragraph (click to enlarge)

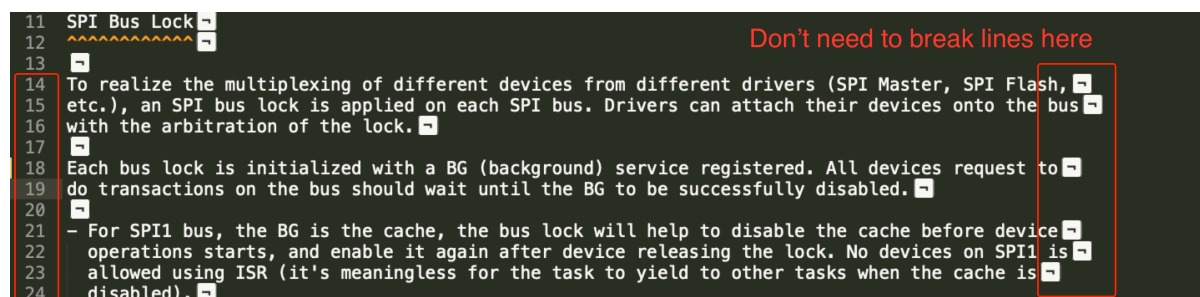

Fig. 2: No line breaks within the same paragraph (click to enlarge)

2. Please make the line number of CN and EN documents consistent like below. The benefit of this approach is that it can save time for both writers and translators. When non-bilingual writers need to update text, they only need to update the same line in the corresponding CN or EN document. For translators, if documents are updated in English, then translators can quickly locate where to update in the corresponding CN document later. Besides, by comparing the total number of lines in EN and CN documents, you can quickly find out whether the CN version lags behind the EN version.

### Building Documentation

The documentation is built with the `esp-docs` Python package, which is a wrapper around [Sphinx](#)

To install it simply do:



Fig. 3: Keep the line number for EN and CN documents consistent (click to enlarge)

```
pip install esp-docs
```

After a successful install then the documentation can be built from the docs folder with:

```
build-docs build
```

or for specific target and language with:

```
build-docs -t esp32 -l en build
```

For more in-depth documentation about *esp-docs* features please see the documentation in the [esp-docs repository](#).

## Wrap up

We love good code that is doing cool things. We love it even better, if it is well documented, so we can quickly make it run and also do the cool things.

Go ahead, contribute your code and documentation!

## Related Documents

- [API Documentation Template](#)

## 7.5.4 Creating Examples

Each ESP-IDF example is a complete project that someone else can copy and adapt the code to solve their own problem. Examples should demonstrate ESP-IDF functionality, while keeping this purpose in mind.

### Structure

- The main directory should contain a source file named `(something)_example_main.c` with the main functionality.
- If the example has additional functionality, split it logically into separate C or C++ source files under main and place a corresponding header file in the same directory.



- If the example has a lot of additional functionality, consider adding a `components` directory to the example project and make some example-specific components with library functionality. Only do this if the components are specific to the example, if they're generic or common functionality then they should be added to ESP-IDF itself.
- The example should have a `README.md` file. Use the [template example README](#) and adapt it for your particular example.
- Examples should have a `pytest_<example name>.py` file for running an automated example test. If submitting a GitHub Pull Request which includes an example, it's OK not to include this file initially. The details can be discussed as part of the [Pull Request](#). Please refer to *IDF Tests with Pytest Guide* for details.

## General Guidelines

Example code should follow the *Espressif IoT Development Framework Style Guide*.

## Checklist

Checklist before submitting a new example:

- Example project name (in `README.md`) uses the word “example”. Use “example” instead of “demo”, “test” or similar words.
- Example does one distinct thing. If the example does more than one thing at a time, split it into two or more examples.
- Example has a `README.md` file which is similar to the [template example README](#).
- Functions and variables in the example are named according to *naming section of the style guide*. (For non-static names which are only specific to the example's source files, you can use `example` or something similar as a prefix.)
- All code in the example is well structured and commented.
- Any unnecessary code (old debugging logs, commented-out code, etc.) is removed from the example.
- Options in the example (like network names, addresses, etc) are not hard-coded. Use configuration items if possible, or otherwise declare macros or constants)
- Configuration items are provided in a `KConfig.projbuild` file with a menu named “Example Configuration”. See existing example projects to see how this is done.
- All original example code has a license header saying it is “in the public domain / CC0”, and a warranty disclaimer clause. Alternatively, the example is licensed under Apache License 2.0. See existing examples for headers to adapt from.
- Any adapted or third party example code has the original license header on it. This code must be licensed compatible with Apache License 2.0.

## 7.5.5 API Documentation Template

---

**Note:** *INSTRUCTIONS*

1. Use this file ([docs/en/api-reference/template.rst](#)) as a template to document API.
  2. Change the file name to the name of the header file that represents documented API.
  3. Include respective files with descriptions from the API folder using `..include::`
    - `README.rst`
    - `example.rst`
    - ...
  4. Optionally provide description right in this file.
  5. Once done, remove all instructions like this one and any superfluous headers.
-

## Overview

---

**Note:** *INSTRUCTIONS*

1. Provide overview where and how this API may be used.
  2. Where applicable include code snippets to illustrate functionality of particular functions.
  3. To distinguish between sections, use the following [heading levels](#):
    - # with overline, for parts
    - \* with overline, for chapters
    - =, for sections
    - -, for subsections
    - ^, for subsubsections
    - ", for paragraphs
- 

## Application Example

---

**Note:** *INSTRUCTIONS*

1. Prepare one or more practical examples to demonstrate functionality of this API.
  2. Each example should follow pattern of projects located in `esp-idf/examples/` folder.
  3. Place example in this folder complete with `README.md` file.
  4. Provide overview of demonstrated functionality in `README.md`.
  5. With good overview reader should be able to understand what example does without opening the source code.
  6. Depending on complexity of example, break down description of code into parts and provide overview of functionality of each part.
  7. Include flow diagram and screenshots of application output if applicable.
  8. Finally add in this section synopsis of each example together with link to respective folder in `esp-idf/examples/`.
- 

## API Reference

---

**Note:** *INSTRUCTIONS*

1. This repository provides for automatic update of API reference documentation using *code markup retrieved by Doxygen from header files*.
1. Update is done on each documentation build by invoking Sphinx extension `:esp_extensions/run_doxygen.py` for all header files listed in the `INPUT` statement of `docs/doxygen/Doxyfile`.
1. Each line of the `INPUT` statement (other than a comment that begins with `##`) contains a path to header file `*.h` that will be used to generate corresponding `*.inc` files:

```
##
## Wi-Fi - API Reference
##
../components/esp32/include/esp_wifi.h \
../components/esp32/include/esp_smartconfig.h \
```

1. When the headers are expanded, any macros defined by default in `sdkconfig.h` as well as any macros defined in SOC-specific `include/soc/*_caps.h` headers will be expanded. This allows the headers to include/exclude material based on the `IDF_TARGET` value.
1. The `*.inc` files contain formatted reference of API members generated automatically on each documentation build. All `*.inc` files are placed in `Sphinx_build` directory. To see directives generated for e.g. `esp_wifi.h`, run `python gen-dxd.py esp32/include/esp_wifi.h`.

1. To show contents of \*.inc file in documentation, include it as follows:

```
.. include-build-file:: inc/esp_wifi.inc
```

For example see [docs/en/api-reference/network/esp\\_wifi.rst](docs/en/api-reference/network/esp_wifi.rst)

1. Optionally, rather than using \*.inc files, you may want to describe API in your own way. See <docs/en/api-reference/storage/fatfs.rst> for example.

Below is the list of common .. doxygen...:: directives:

- Functions - .. doxygenfunction:: name\_of\_function
- Unions - .. doxygenunion:: name\_of\_union
- Structures - .. doxygenstruct:: name\_of\_structure together with :members:
- Macros - .. doxygendefine:: name\_of\_define
- Type Definitions - .. doxygentypedef:: name\_of\_type
- Enumerations - .. doxygenenum:: name\_of\_enumeration

See [Breathe documentation](#) for additional information.

To provide a link to header file, use the *link custom role* directive as follows:

```
* :component_file:`path_to/header_file.h`
```

1. In any case, to generate API reference, the file <docs/doxygen/Doxyfile> should be updated with paths to \*.h headers that are being documented.
  1. When changes are committed and documentation is built, check how this section has been rendered. *Correct annotations* in respective header files, if required.
- 

## 7.5.6 Contributor Agreement

### Individual Contributor Non-Exclusive License Agreement including the Traditional Patent License OPTION

Thank you for your interest in contributing to this Espressif project hosted on GitHub ( “We” or “Us” ).

The purpose of this contributor agreement ( “Agreement” ) is to clarify and document the rights granted by contributors to Us. To make this document effective, please follow the instructions in the [Contributions Guide](#).

**1. DEFINITIONS** “You” means the Individual Copyright owner who submits a Contribution to Us. If You are an employee and submit the Contribution as part of your employment, You have had Your employer approve this Agreement or sign the Entity version of this document.

“**Contribution**” means any original work of authorship (software and/or documentation) including any modifications or additions to an existing work, Submitted by You to Us, in which You own the Copyright. If You do not own the Copyright in the entire work of authorship, please contact Us by submitting a comment on GitHub.

“**Copyright**” means all rights protecting works of authorship owned or controlled by You, including copyright, moral and neighboring rights, as appropriate, for the full term of their existence including any extensions by You.

“**Material**” means the software or documentation made available by Us to third parties. When this Agreement covers more than one software project, the Material means the software or documentation to which the Contribution was Submitted. After You Submit the Contribution, it may be included in the Material.

“**Submit**” means any form of physical, electronic, or written communication sent to Us, including but not limited to electronic mailing lists, source code control systems, and issue tracking systems that are managed by, or on behalf of, Us, but excluding communication that is conspicuously marked or otherwise designated in writing by You as “Not a Contribution.”

“**Submission Date**” means the date You Submit a Contribution to Us.

“**Documentation**” means any non-software portion of a Contribution.

## **2. LICENSE GRANT** 2.1 Copyright License to Us

Subject to the terms and conditions of this Agreement, You hereby grant to Us a worldwide, royalty-free, NON-exclusive, perpetual and irrevocable license, with the right to transfer an unlimited number of non-exclusive licenses or to grant sublicenses to third parties, under the Copyright covering the Contribution to use the Contribution by all means, including, but not limited to:

- to publish the Contribution,
- to modify the Contribution, to prepare derivative works based upon or containing the Contribution and to combine the Contribution with other software code,
- to reproduce the Contribution in original or modified form,
- to distribute, to make the Contribution available to the public, display and publicly perform the Contribution in original or modified form.

2.2 Moral Rights remain unaffected to the extent they are recognized and not waivable by applicable law. Notwithstanding, You may add your name in the header of the source code files of Your Contribution and We will respect this attribution when using Your Contribution.

## **3. PATENTS** 3.1 Patent License

Subject to the terms and conditions of this Agreement You hereby grant to us a worldwide, royalty-free, non-exclusive, perpetual and irrevocable (except as stated in Section 3.2) patent license, with the right to transfer an unlimited number of non-exclusive licenses or to grant sublicenses to third parties, to make, have made, use, sell, offer for sale, import and otherwise transfer the Contribution and the Contribution in combination with the Material (and portions of such combination). This license applies to all patents owned or controlled by You, whether already acquired or hereafter acquired, that would be infringed by making, having made, using, selling, offering for sale, importing or otherwise transferring of Your Contribution(s) alone or by combination of Your Contribution(s) with the Material.

### 3.2 Revocation of Patent License

You reserve the right to revoke the patent license stated in section 3.1 if we make any infringement claim that is targeted at your Contribution and not asserted for a Defensive Purpose. An assertion of claims of the Patents shall be considered for a “Defensive Purpose” if the claims are asserted against an entity that has filed, maintained, threatened, or voluntarily participated in a patent infringement lawsuit against Us or any of Our licensees.

**4. DISCLAIMER** THE CONTRIBUTION IS PROVIDED “AS IS” . MORE PARTICULARLY, ALL EXPRESS OR IMPLIED WARRANTIES INCLUDING, WITHOUT LIMITATION, ANY IMPLIED WARRANTY OF MERCHANTABILITY, FITNESS FOR A PARTICULAR PURPOSE AND NON-INFRINGEMENT ARE EXPRESSLY DISCLAIMED BY YOU TO US AND BY US TO YOU. TO THE EXTENT THAT ANY SUCH WARRANTIES CANNOT BE DISCLAIMED, SUCH WARRANTY IS LIMITED IN DURATION TO THE MINIMUM PERIOD PERMITTED BY LAW.

**5. Consequential Damage Waiver** TO THE MAXIMUM EXTENT PERMITTED BY APPLICABLE LAW, IN NO EVENT WILL YOU OR US BE LIABLE FOR ANY LOSS OF PROFITS, LOSS OF ANTICIPATED SAVINGS, LOSS OF DATA, INDIRECT, SPECIAL, INCIDENTAL, CONSEQUENTIAL AND EXEMPLARY DAMAGES ARISING OUT OF THIS AGREEMENT REGARDLESS OF THE LEGAL OR EQUITABLE THEORY (CONTRACT, TORT OR OTHERWISE) UPON WHICH THE CLAIM IS BASED.

**6. Approximation of Disclaimer and Damage Waiver** IF THE DISCLAIMER AND DAMAGE WAIVER MENTIONED IN SECTION 4 AND SECTION 5 CANNOT BE GIVEN LEGAL EFFECT UNDER APPLICABLE LOCAL LAW, REVIEWING COURTS SHALL APPLY LOCAL LAW THAT MOST CLOSELY APPROXIMATES AN ABSOLUTE WAIVER OF ALL CIVIL LIABILITY IN CONNECTION WITH THE CONTRIBUTION.

**7. Term** 7.1 This Agreement shall come into effect upon Your acceptance of the terms and conditions.

7.2 In the event of a termination of this Agreement Sections 4, 5, 6, 7 and 8 shall survive such termination and shall remain in full force thereafter. For the avoidance of doubt, Contributions that are already licensed under a free and open source license at the date of the termination shall remain in full force after the termination of this Agreement.

**8. Miscellaneous** 8.1 This Agreement and all disputes, claims, actions, suits or other proceedings arising out of this agreement or relating in any way to it shall be governed by the laws of People’s Republic of China excluding its private international law provisions.

8.2 This Agreement sets out the entire agreement between You and Us for Your Contributions to Us and overrides all other agreements or understandings.

8.3 If any provision of this Agreement is found void and unenforceable, such provision will be replaced to the extent possible with a provision that comes closest to the meaning of the original provision and that is enforceable. The terms and conditions set forth in this Agreement shall apply notwithstanding any failure of essential purpose of this Agreement or any limited remedy to the maximum extent possible under law.

8.4 You agree to notify Us of any facts or circumstances of which you become aware that would make this Agreement inaccurate in any respect.

**You**

Date:	
Name:	
Title:	
Address:	

**Us**

Date:	
Name:	
Title:	
Address:	

**7.5.7 Copyright Header Guide**

ESP-IDF is released under [the Apache License 2.0](#) with some additional third-party copyrighted code released under various licenses. For further information please refer to [the list of copyrights and licenses](#).

This page explains how the source code should be properly marked with a copyright header. ESP-IDF uses [The Software Package Data Exchange \(SPDX\)](#) format which is short and can be easily read by humans or processed by automated tools for copyright checks.

**How to Check the Copyright Headers**

Please make sure you have installed [the pre-commit hooks](#) which contain a copyright header checker as well. The checker can suggest a header if it is not able to detect a properly formatted SPDX header.

**What if the Checker’s Suggestion is Incorrect?**

No automated checker (no matter how good is) can replace humans. So the developer’s responsibility is to modify the offered header to be in line with the law and the license restrictions of the original code on which the work is based on. Certain licenses are not compatible between each other. Such corner cases will be covered by the following examples.

The checker can be configured with the `tools/ci/check_copyright_config.yaml` configuration file. Please check the options it offers and consider updating it in order to match the headers correctly.

### Common Examples of Copyright Headers

The simplest case is when the code is not based on any licensed previous work, e.g. it was written completely from scratch. Such code can be decorated with the following copyright header and put under the license of ESP-IDF:

```
/*
 * SPDX-FileCopyrightText: 2015-2022 Espressif Systems (Shanghai) CO LTD
 *
 * SPDX-License-Identifier: Apache-2.0
 */
```

**Less restrictive parts of ESP-IDF** Some parts of ESP-IDF are deliberately under less restrictive licenses in order to ease their re-use in commercial closed source projects. This is the case for [ESP-IDF examples](#) which are in Public domain or under the Creative Commons Zero Universal (CC0) license. The following header can be used in such source files:

```
/*
 * SPDX-FileCopyrightText: 2015-2022 Espressif Systems (Shanghai) CO LTD
 *
 * SPDX-License-Identifier: Unlicense OR CC0-1.0
 */
```

The option allowing multiple licenses joined with the OR keyword from the above example can be achieved with the definition of multiple allowed licenses in the `tools/ci/check_copyright_config.yaml` configuration file. Please use this option with care and only selectively for a limited part of ESP-IDF.

**Third party licenses** Code licensed under different licenses, modified by Espressif Systems and included in ESP-IDF cannot be licensed under Apache License 2.0 not even if the checker suggests it. It is advised to keep the original copyright header and add an SPDX before it.

The following example is a suitable header for a code licensed under the “GNU General Public License v2.0 or later” held by John Doe with some additional modifications done by Espressif Systems:

```
/*
 * SPDX-FileCopyrightText: 1991 John Doe
 *
 * SPDX-License-Identifier: GPL-2.0-or-later
 *
 * SPDX-FileContributor: 2019-2022 Espressif Systems (Shanghai) CO LTD
 */
```

The licenses can be identified and the short SPDX identifiers can be found in the official [SPDX license list](#). Other very common licenses are the GPL-2.0-only, the BSD-3-Clause, and the BSD-2-Clause.

The configuration stored in `tools/ci/check_copyright_config.yaml` offers features useful for third party licenses:

- A different license can be defined for the files part of a third party library.
- The check for a selected set of files can be permanently disabled. Please use this option with care and only in cases when none of the other options are suitable.

## 7.5.8 ESP-IDF Tests with Pytest Guide

This documentation is a guide that introduces the following aspects:

1. The basic idea of different test types in ESP-IDF

2. How to apply the pytest framework to the test python scripts to make sure the apps are working as expected.
3. ESP-IDF CI target test process
4. Run ESP-IDF tests with pytest locally
5. Tips and tricks on pytest

### Disclaimer

In ESP-IDF, we use the following plugins by default:

- [pytest-embedded](#) with default services `esp`, `idf`
- [pytest-rerunfailures](#)

All the introduced concepts and usages are based on the default behavior in ESP-IDF. Not all of them are available in vanilla pytest.

### Installation

All dependencies could be installed by running the install script with the `--enable-pytest` argument, e.g. `$ install.sh --enable-pytest`.

### Common Issues During Installation

**No Package 'dbus-1' found** If you're facing an error message like:

```
configure: error: Package requirements (dbus-1 >= 1.8) were not met:
No package 'dbus-1' found
Consider adjusting the PKG_CONFIG_PATH environment variable if you
installed software in a non-standard prefix.
```

If you're running a ubuntu system, you may need to run:

```
sudo apt-get install libdbus-glib-1-dev
```

or

```
sudo apt-get install libdbus-1-dev
```

For other linux distros, you may Google the error message and find the solution. This issue could be solved by installing the related header files.

**Invalid command 'bdist\_wheel'** If you're facing an error message like:

```
error: invalid command 'bdist_wheel'
```

You may need to run:

```
python -m pip install -U pip
```

Or

```
python -m pip install wheel
```

Before running the pip commands, please make sure you're using the IDF python virtual environment.

## Basic Concepts

**Component-based Unit Tests** Component-based unit tests are our recommended way to test your component. All the test apps should be located under `${IDF_PATH}/components/<COMPONENT_NAME>/test_apps`.

For example:

```

components/
├── my_component/
│   ├── include/
│   │   └── ...
│   ├── test_apps/
│   │   ├── test_app_1
│   │   │   ├── main/
│   │   │   │   └── ...
│   │   │   ├── CMakeLists.txt
│   │   │   └── pytest_my_component_app_1.py
│   │   ├── test_app_2
│   │   │   ├── ...
│   │   │   └── pytest_my_component_app_2.py
│   │   └── parent_folder
│   │       ├── test_app_3
│   │       │   ├── ...
│   │       │   └── pytest_my_component_app_3.py
│   │       └── ...
│   ├── my_component.c
│   └── CMakeLists.txt

```

**Example Tests** Example Tests are tests for examples that are intended to demonstrate parts of the ESP-IDF functionality to our customers.

All the test apps should be located under `${IDF_PATH}/examples`. For more information please refer to the [Examples Readme](#).

For example:

```

examples/
├── parent_folder/
│   └── example_1/
│       ├── main/
│       │   └── ...
│       ├── CMakeLists.txt
│       └── pytest_example_1.py

```

**Custom Tests** Custom Tests are tests that aim to run some arbitrary test internally. They are not intended to demonstrate the ESP-IDF functionality to our customers in any way.

All the test apps should be located under `${IDF_PATH}/tools/test_apps`. For more information please refer to the [Custom Test Readme](#).

## Pytest in ESP-IDF

### Pytest Execution Process

1. Bootstrapping Phase
  - Create session-scoped caches:
    - port-target cache
    - port-app cache
2. Collection Phase
  1. Get all the python files with the prefix `pytest_`



2. Get all the test functions with the prefix `test_`
  3. Apply the [params](#), and duplicate the test functions.
  4. Filter the test cases with CLI options. Introduced detailed usages [here](#)
3. Test Running Phase
    1. Construct the [fixtures](#). In ESP-IDF, the common fixtures are initialized in this order:
      1. `pexpect_proc`: [pexpect](#) instance
      2. `app`: [IdfApp](#) instance  
The information of the app, like `sdkconfig`, `flash_files`, `partition_table`, etc., would be parsed at this phase.
      3. `serial`: [IdfSerial](#) instance  
The port of the host which connected to the target type parsed from the app would be auto-detected.  
The flash files would be auto flashed.
      4. `dut`: [IdfDut](#) instance
    2. Run the real test function
    3. Deconstruct the fixtures in this order:
      1. `dut`
        1. close the `serial` port
        2. (Only for apps with [unity test framework](#)) generate junit report of the unity test cases
      2. `serial`
      3. `app`
      4. `pexpect_proc`: Close the file descriptor
    4. (Only for apps with [unity test framework](#))  
Raise `AssertionError` when detected unity test failed if you call `dut.expect_from_unity_output()` in the test function.
  4. Reporting Phase
    1. Generate junit report of the test functions
    2. Modify the junit report test case name into ESP-IDF test case ID format: `<target>.<config>.<test function name>`
  5. Finalizing Phase (Only for apps with [unity test framework](#))  
Combine the junit reports if the junit reports of the unity test cases are generated.

**Example Code** This code example is taken from `pytest_console_basic.py`.

```
@pytest.mark.esp32
@pytest.mark.esp32c3
@pytest.mark.generic
@pytest.mark.parametrize('config', [
    'history',
    'nohistory',
], indirect=True)
def test_console_advanced(config: str, dut: Dut) -> None:
    if config == 'history':
        dut.expect('Command history enabled')
    elif config == 'nohistory':
        dut.expect('Command history disabled')
```

**Note:** Using `expect_exact` is better here. For further reading about the different types of `expect` functions, please refer to the [pytest-embedded Expecting documentation](#).

**Use Markers to Specify the Supported Targets** You can use markers to specify the supported targets and the test env in CI. You can run `pytest --markers` to get more details about different markers.

```
@pytest.mark.esp32      # <-- support esp32
@pytest.mark.esp32c3    # <-- support esp32c3
@pytest.mark.generic     # <-- test env `generic, would assign to runner with tag_
↳ `generic`
```

Besides, if the test case supports all officially ESP-IDF-supported targets, like esp32, esp32s2, esp32s3, esp32c3 for now (2022.2), you can use a special marker `supported_targets` to apply them all in one line.

This code example is taken from `pytest_gptimer_example.py`.

```
@pytest.mark.supported_targets
@pytest.mark.generic
def test_gptimer_example(dut: Dut) -> None:
    ...
```

**Use Params to Specify the sdkconfig Files** You can use `pytest.mark.parametrize` with “config” to apply the same test to different apps with different sdkconfig files. For more information about `sdkconfig.ci.xxx` files, please refer to the Configuration Files section under [this readme](#).

```
@pytest.mark.parametrize('config', [
    'history',      # <-- run with app built by sdkconfig.ci.history
    'nohistory',   # <-- run with app built by sdkconfig.ci.nohistory
], indirect=True) # <-- `indirect=True` is required
```

Overall, this test function would be replicated to 4 test cases:

- esp32.history.test\_console\_advanced
- esp32.nohistory.test\_console\_advanced
- esp32c3.history.test\_console\_advanced
- esp32c3.nohistory.test\_console\_advanced

## Advanced Examples

### Multi Dut Tests with the Same App

```
@pytest.mark.esp32s2
@pytest.mark.esp32s3
@pytest.mark.usb_host
@pytest.mark.parametrize('count', [
    2,
], indirect=True)
def test_usb_host(dut: Tuple[IdfDut, IdfDut]) -> None:
    device = dut[0] # <-- assume the first dut is the device
    host = dut[1]  # <-- and the second dut is the host
    ...
```

After setting the param `count` to 2, all these fixtures are changed into tuples.

**Multi Dut Tests with Different Apps** This code example is taken from `pytest_wifi_getting_started.py`.

```
@pytest.mark.esp32
@pytest.mark.multi_dut_generic
@pytest.mark.parametrize(
    'count, app_path', [
        (2,
         f'{os.path.join(os.path.dirname(__file__), "softAP")}'|f'{os.path.join(os.
↪path.dirname(__file__), "station")}')],
    ], indirect=True
)
def test_wifi_getting_started(dut: Tuple[IdfDut, IdfDut]) -> None:
    softap = dut[0]
    station = dut[1]
    ...
```

Here the first dut was flashed with the app [softap](#) , and the second dut was flashed with the app [station](#) .

**Note:** Here the `app_path` should be set with absolute path. the `__file__` macro in python would return the absolute path of the test script itself.

**Multi Dut Tests with Different Apps, and Targets** This code example is taken from [pytest\\_wifi\\_getting\\_started.py](#) . As the comment says, for now it' s not running in the ESP-IDF CI.

```
@pytest.mark.parametrize(
    'count, app_path, target', [
        (2,
         f'{os.path.join(os.path.dirname(__file__), "softAP")}|{os.path.join(os.
↳path.dirname(__file__), "station")}|',
         'esp32|esp32s2'),
        (2,
         f'{os.path.join(os.path.dirname(__file__), "softAP")}|{os.path.join(os.
↳path.dirname(__file__), "station")}|',
         'esp32s2|esp32'),
    ],
    indirect=True,
)
def test_wifi_getting_started(dut: Tuple[IdfDut, IdfDut]) -> None:
    softap = dut[0]
    station = dut[1]
    ...
```

Overall, this test function would be replicated to 2 test cases:

- softap with esp32 target, and station with esp32s2 target
- softap with esp32s2 target, and station with esp32 target

**Support different targets with different sdkconfig files** This code example is taken from [pytest\\_panic.py](#) as an advanced example.

```
CONFIGS = [
    pytest.param('coredump_flash_bin_crc', marks=[pytest.mark.esp32, pytest.mark.
↳esp32s2]),
    pytest.param('coredump_flash_elf_sha', marks=[pytest.mark.esp32]), # sha256_
↳only supported on esp32
    pytest.param('coredump_uart_bin_crc', marks=[pytest.mark.esp32, pytest.mark.
↳esp32s2]),
    pytest.param('coredump_uart_elf_crc', marks=[pytest.mark.esp32, pytest.mark.
↳esp32s2]),
    pytest.param('gdbstub', marks=[pytest.mark.esp32, pytest.mark.esp32s2]),
    pytest.param('panic', marks=[pytest.mark.esp32, pytest.mark.esp32s2]),
]

@pytest.mark.parametrize('config', CONFIGS, indirect=True)
...

```

**Use Custom Class** Usually, you can write a custom class in these conditions:

1. Add more reusable functions for a certain number of DUTs
2. Add custom setup and teardown functions in different phases described [here](#)

This code example is taken from [panic/confest.py](#)

```

class PanicTestDut (IdfDut) :
    ...

@pytest.fixture(scope='module')
def monkeypatch_module(request: FixtureRequest) -> MonkeyPatch:
    mp = MonkeyPatch()
    request.addfinalizer(mp.undo)
    return mp

@pytest.fixture(scope='module', autouse=True)
def replace_dut_class(monkeypatch_module: MonkeyPatch) -> None:
    monkeypatch_module setattr('pytest_embedded_idf.dut.IdfDut', PanicTestDut)

```

monkeypatch\_module provide a [module-scoped monkeypatch](#) fixture.

replace\_dut\_class is a [module-scoped autouse](#) fixture. This function replaces the IdfDut class with your custom class.

**Mark Flaky Tests** Sometimes, our test is based on ethernet or wifi. The network may cause the test flaky. We could mark the single test case within the code repo.

This code example is taken from [pytest\\_esp\\_eth.py](#)

```

@pytest.mark.flaky(reruns=3, reruns_delay=5)
def test_esp_eth_ip101(dut: Dut) -> None:
    ...

```

This flaky marker means that if the test function failed, the test case would rerun for a maximum of 3 times with 5 seconds delay.

**Mark Known Failure Cases** Sometimes a test couldn't pass for the following reasons:

- Has a bug
- The success ratio is too low because of environment issue, such as network issue. Retry couldn't help

Now you may mark this test case with marker [xfail](#) with a user-friendly readable reason.

This code example is taken from [pytest\\_panic.py](#)

```

@pytest.mark.xfail('config.getvalue("target") == "esp32s2"', reason='raised_
↳IllegalInstruction instead')
def test_cache_error(dut: PanicTestDut, config: str, test_func_name: str) -> None:

```

This marker means that if the test would be a known failure one on esp32s2.

**Mark Nightly Run Test Cases** Some tests cases are only triggered in nightly run pipelines due to a lack of runners.

```

@pytest.mark.nightly_run

```

This marker means that the test case would only be run with env var NIGHTLY\_RUN or INCLUDE\_NIGHTLY\_RUN.

## Run the Tests in CI

The workflow in CI is simple, build jobs -> target test jobs.

## Build Jobs

## Build Job Names

- Component-based Unit Tests: `build_pytest_components_<target>`
- Example Tests: `build_pytest_examples_<target>`
- Custom Tests: `build_pytest_test_apps_<target>`

**Build Job Command** The command used by CI to build all the relevant tests is: `python $IDF_PATH/tools/ci/ci_build_apps.py <parent_dir> --target <target> -vv --pytest-apps`

All apps which supported the specified target would be built with all supported sdkconfig files under `build_<target>_<config>`.

For example, If you run `python $IDF_PATH/tools/ci/ci_build_apps.py $IDF_PATH/examples/system/console/basic --target esp32 --pytest-apps`, the folder structure would be like this:

```
basic
├── build_esp32_history/
│   └── ...
├── build_esp32_nohistory/
│   └── ...
├── main/
├── CMakeLists.txt
├── pytest_console_basic.py
└── ...
```

All the binaries folders would be uploaded as artifacts under the same directories.

## Target Test Jobs

### Target Test Job Names

- Component-based Unit Tests: `component_ut_pytest_<target>_<test_env>`
- Example Tests: `example_test_pytest_<target>_<test_env>`
- Custom Tests: `test_app_test_pytest_<target>_<test_env>`

**Target Test Job Command** The command used by CI to run all the relevant tests is: `pytest <parent_dir> --target <target> -m <test_env_marker>`

All test cases with the specified target marker and the test env marker under the parent folder would be executed.

The binaries in the target test jobs are downloaded from build jobs, the artifacts would be placed under the same directories.

## Run the Tests Locally

The local executing process is the same as the CI process.

For example, if you want to run all the esp32 tests under the `$IDF_PATH/examples/system/console/basic` folder, you may:

```
$ pip install pytest-embedded-serial-esp pytest-embedded-idf
$ cd $IDF_PATH
$ ./export.sh
$ cd examples/system/console/basic
$ python $IDF_PATH/tools/ci/ci_build_apps.py . --target esp32 -vv --pytest-apps
$ pytest --target esp32
```

## Tips and Tricks

### Filter the Test Cases

- filter by target with `pytest --target <target>`  
pytest would run all the test cases that support specified target.
- filter by sdkconfig file with `pytest --sdkconfig <sdkconfig>`  
if `<sdkconfig>` is default, pytest would run all the test cases with the sdkconfig file `sdkconfig.defaults`.  
In other cases, pytest would run all the test cases with sdkconfig file `sdkconfig.ci.<sdkconfig>`.

**Add New Markers** We're using two types of custom markers, target markers which indicate that the test cases should support this target, and env markers which indicate that the test case should be assigned to runners with these tags in CI.

You can add new markers by adding one line under the `/${IDF_PATH}/pytest.ini` `markers =` section. The grammar should be: `<marker_name>: <marker_description>`

**Generate JUnit Report** You can call pytest with `--junitxml <filepath>` to generate the JUnit report. In ESP-IDF, the test case name would be unified as “`<target>.<config>.<function_name>`” .

**Skip Auto Flash Binary** Skipping auto-flash binary every time would be useful when you're debugging your test script.

You can call pytest with `--skip-autoflash y` to achieve it.

**Record Statistics** Sometimes you may need to record some statistics while running the tests, like the performance test statistics.

You can use `record_xml_attribute` fixture in your test script, and the statistics would be recorded as attributes in the JUnit report.

**Logging System** Sometimes you may need to add some extra logging lines while running the test cases.

You can use `python logging module` to achieve this.

### Known Limitations and Workarounds

**Avoid Using Thread for Performance Test** `pytest-embedded` is using some threads internally to help gather all stdout to the pexpect process. Due to the limitation of `Global Interpreter Lock`, if you're using threads to do performance tests, these threads would block each other and there would be great performance loss.

#### workaround

Use `Process` instead, the APIs should be almost the same as `Thread`.

### Further Readings

- pytest documentation: <https://docs.pytest.org/en/latest/contents.html>
- pytest-embedded documentation: <https://docs.espressif.com/projects/pytest-embedded/en/latest/>



# Chapter 8

## ESP-IDF Versions

The ESP-IDF GitHub repository is updated regularly, especially the master branch where new development takes place.

For production use, there are also stable releases available.

### 8.1 Releases

The documentation for the current stable release version can always be found at this URL:

<https://docs.espressif.com/projects/esp-idf/en/stable/>

Documentation for the latest version (master branch) can always be found at this URL:

<https://docs.espressif.com/projects/esp-idf/en/latest/>

The full history of releases can be found on the GitHub repository [Releases page](#). There you can find release notes, links to each version of the documentation, and instructions for obtaining each version.

### 8.2 Which Version Should I Start With?

- For production purposes, use the [current stable version](#). Stable versions have been manually tested, and are updated with “bugfix releases” which fix bugs without changing other functionality (see [Versioning Scheme](#) for more details). Every stable release version can be found on the [Releases page](#).
- For prototyping, experimentation or for developing new ESP-IDF features, use the [latest version \(master branch in Git\)](#). The latest version in the master branch has all the latest features and has passed automated testing, but has not been completely manually tested ( “bleeding edge” ).
- If a required feature is not yet available in a stable release, but you do not want to use the master branch, it is possible to check out a pre-release version or a release branch. It is recommended to start from a stable version and then follow the instructions for [Updating to a Pre-Release Version](#) or [Updating to a Release Branch](#).
- If you plan to use another project which is based on ESP-IDF, please check the documentation of that project to determine the version(s) of ESP-IDF it is compatible with.

See [Updating ESP-IDF](#) if you already have a local copy of ESP-IDF and wish to update it.

### 8.3 Versioning Scheme

ESP-IDF uses [Semantic Versioning](#). This means that:



- Major Releases, like v3.0, add new functionality and may change functionality. This includes removing deprecated functionality.  
If updating to a new major release (for example, from v2.1 to v3.0), some of your project's code may need updating and functionality may need to be re-tested. The release notes on the [Releases page](#) include lists of Breaking Changes to refer to.
- Minor Releases like v3.1 add new functionality and fix bugs but will not change or remove documented functionality, or make incompatible changes to public APIs.  
If updating to a new minor release (for example, from v3.0 to v3.1), your project's code does not require updating, but you should re-test your project. Pay particular attention to the items mentioned in the release notes on the [Releases page](#).
- Bugfix Releases like v3.0.1 only fix bugs and do not add new functionality.  
If updating to a new bugfix release (for example, from v3.0 to v3.0.1), you do not need to change any code in your project, and you only need to re-test the functionality directly related to bugs listed in the release notes on the [Releases page](#).

## 8.4 Support Periods

Each ESP-IDF major and minor release version has an associated support period. After this period, the release is End of Life and no longer supported.

The [ESP-IDF Support Period Policy](#) explains this in detail, and describes how the support periods for each release are determined.

Each release on the [Releases page](#) includes information about the support period for that particular release.

As a general guideline:

- If starting a new project, use the latest stable release.
- If you have a GitHub account, click the “Watch” button in the top-right of the [Releases page](#) and choose “Releases only”. GitHub will notify you whenever a new release is available. Whenever a bug fix release is available for the version you are using, plan to update to it.
- If possible, periodically update the project to a new major or minor ESP-IDF version (for example, once a year.) The update process should be straightforward for Minor updates, but may require some planning and checking of the release notes for Major updates.
- Always plan to update to a newer release before the release you are using becomes End of Life.

Each ESP-IDF major and minor release (V4.1, V4.2, etc) is supported for 30 months after the initial stable release date.

Supported means that the ESP-IDF team will continue to apply bug fixes, security fixes, etc to the release branch on GitHub, and periodically make new bugfix releases as needed.

Support period is divided into “Service” and “Maintenance” period:

Period	Duration	Recommended for new projects?
Service	12 months	Yes
Maintenance	18 months	No

During the Service period, bugfixes releases are more frequent. In some cases, support for new features may be added during the Service period (this is reserved for features which are needed to meet particular regulatory requirements or standards for new products, and which carry a very low risk of introducing regressions.)

During the Maintenance period, the version is still supported but only bugfixes for high severity issues or security issues will be applied.

Using an “In Service” version is recommended when starting a new project.

Users are encouraged to upgrade all projects to a newer ESP-IDF release before the support period finishes and the release becomes End of Life (EOL). It is our policy to not continue fixing bugs in End of Life releases.

Pre-release versions (betas, previews, *-rc* and *-dev* versions, etc) are not covered by any support period. Sometimes a particular feature is marked as “Preview” in a release, which means it is also not covered by the support period.

The ESP-IDF Programming Guide has information about the [different versions of ESP-IDF](#) (major, minor, bugfix, etc).

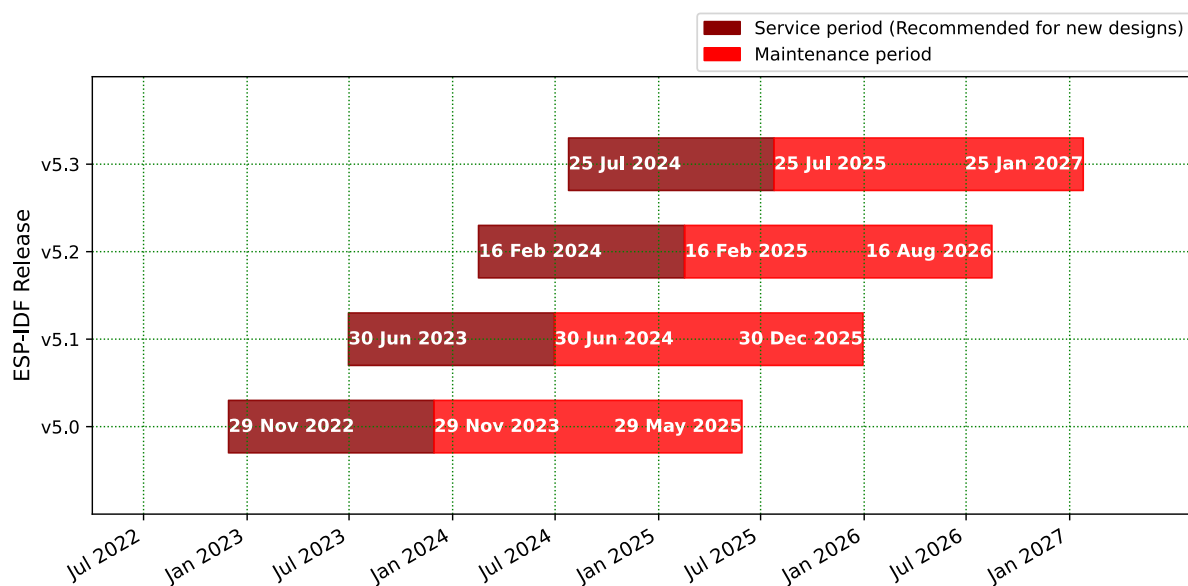

## 8.5 Checking the Current Version

The local ESP-IDF version can be checked by using `idf.py`:

```
idf.py --version
```

The ESP-IDF version is also compiled into the firmware and can be accessed (as a string) via the macro `IDF_VER`. The default ESP-IDF bootloader will print the version on boot (the version information is not always updated if the code in the GitHub repo is updated, it only changes if there is a clean build or if that particular source file is recompiled).

If writing code that needs to support multiple ESP-IDF versions, the version can be checked at compile time using [compile-time macros](#).

Examples of ESP-IDF versions:

Version String	Meaning
v3.2-dev-306-gbeb3611ca	<p>Master branch pre-release.</p> <ul style="list-style-type: none"> <li>- v3.2-dev - in development for version 3.2.</li> <li>- 306 - number of commits after v3.2 development started.</li> <li>- beb3611ca - commit identifier.</li> </ul>
v3.0.2	<p>Stable release, tagged v3.0.2.</p>
v3.1-beta1-75-g346d6b0ea	<p>Beta version in development (on a <i>release branch</i>).</p> <ul style="list-style-type: none"> <li>- v3.1-beta1 - pre-release tag.</li> <li>- 75 - number of commits after the pre-release beta tag was assigned.</li> <li>- 346d6b0ea - commit identifier.</li> </ul>
v3.0.1-dirty	<p>Stable release, tagged v3.0.1.</p> <ul style="list-style-type: none"> <li>- dirty means that there are modifications in the local ESP-IDF directory.</li> </ul>

## 8.6 Git Workflow

The development (Git) workflow of the Espressif ESP-IDF team is as follows:

- New work is always added on the master branch (latest version) first. The ESP-IDF version on `master` is always tagged with `-dev` (for “in development” ), for example `v3.1-dev`.
- Changes are first added to an internal Git repository for code review and testing but are pushed to GitHub after automated testing passes.
- When a new version (developed on `master`) becomes feature complete and “beta” quality, a new branch is made for the release, for example `release/v3.1`. A pre-release tag is also created, for example `v3.1-beta1`. You can see a full [list of branches](#) and a [list of tags](#) on GitHub. Beta pre-releases have release notes which may include a significant number of Known Issues.
- As testing of the beta version progresses, bug fixes will be added to both the `master` branch and the release branch. New features for the next release may start being added to `master` at the same time.
- Once testing is nearly complete a new release candidate is tagged on the release branch, for example `v3.1-rc1`. This is still a pre-release version.
- If no more significant bugs are found or reported, then the final Major or Minor Version is tagged, for example `v3.1`. This version appears on the [Releases page](#).
- As bugs are reported in released versions, the fixes will continue to be committed to the same release branch.
- Regular bugfix releases are made from the same release branch. After manual testing is complete, a bugfix release is tagged (i.e. `v3.1.1`) and appears on the [Releases page](#).

## 8.7 Updating ESP-IDF

Updating ESP-IDF depends on which version(s) you wish to follow:

- [Updating to Stable Release](#) is recommended for production use.

- [Updating to Master Branch](#) is recommended for the latest features, development use, and testing.
- [Updating to a Release Branch](#) is a compromise between the first two.

---

**Note:** These guides assume that you already have a local copy of ESP-IDF cloned. To get one, check Step 2 in the [Getting Started](#) guide for any ESP-IDF version.

---

### 8.7.1 Updating to Stable Release

To update to a new ESP-IDF release (recommended for production use), this is the process to follow:

- Check the [Releases page](#) regularly for new releases.
- When a bugfix release for the version you are using is released (for example, if using v3.0.1 and v3.0.2 is released), check out the new bugfix version into the existing ESP-IDF directory:

```
cd $IDF_PATH
git fetch
git checkout vX.Y.Z
git submodule update --init --recursive
```

- When major or minor updates are released, check the Release Notes on the releases page and decide if you want to update or to stay with your current release. Updating is via the same Git commands shown above.

---

**Note:** If you installed the stable release via zip file instead of using git, it might not be possible to update versions using the commands. In this case, update by downloading a new zip file and replacing the entire `IDF_PATH` directory with its contents.

---

### 8.7.2 Updating to a Pre-Release Version

It is also possible to `git checkout` a tag corresponding to a pre-release version or release candidate, the process is the same as [Updating to Stable Release](#).

Pre-release tags are not always found on the [Releases page](#). Consult the [list of tags](#) on GitHub for a full list. Caveats for using a pre-release are similar to [Updating to a Release Branch](#).

### 8.7.3 Updating to Master Branch

---

**Note:** Using Master branch means living “on the bleeding edge” with the latest ESP-IDF code.

---

To use the latest version on the ESP-IDF master branch, this is the process to follow:

- Check out the master branch locally:

```
cd $IDF_PATH
git checkout master
git pull
git submodule update --init --recursive
```

- Periodically, re-run `git pull` to pull the latest version of master. Note that you may need to change your project or report bugs after updating your master branch.
- To switch from master to a release branch or stable version, run `git checkout` as shown in the other sections.

---

**Important:** It is strongly recommended to regularly run `git pull` and then `git submodule update --init --recursive` so a local copy of master does not get too old. Arbitrary old master branch revisions are effectively unsupported “snapshots” that may have undocumented bugs. For a semi-stable version, try [Updating to a Release Branch](#) instead.

---

## 8.7.4 Updating to a Release Branch

In terms of stability, using a release branch is part-way between using the master branch and only using stable releases. A release branch is always beta quality or better, and receives bug fixes before they appear in each stable release.

You can find a [list of branches](#) on GitHub.

For example, to follow the branch for ESP-IDF v3.1, including any bugfixes for future releases like v3.1.1, etc:

```
cd $IDF_PATH
git fetch
git checkout release/v3.1
git pull
git submodule update --init --recursive
```

Each time you `git pull` this branch, ESP-IDF will be updated with fixes for this release.

---

**Note:** There is no dedicated documentation for release branches. It is recommended to use the documentation for the closest version to the branch which is currently checked out.

---

## Chapter 9

# Resources

### 9.1 PlatformIO



- [What is PlatformIO?](#)
- [Installation](#)
- [Configuration](#)
- [Tutorials](#)
- [Project Examples](#)
- [Next Steps](#)

#### 9.1.1 What is PlatformIO?

PlatformIO is a cross-platform embedded development environment with out-of-the-box support for ESP-IDF.

Since ESP-IDF support within PlatformIO is not maintained by the Espressif team, please report any issues with PlatformIO directly to its developers in [the official PlatformIO repositories](#).

A detailed overview of the PlatformIO ecosystem and its philosophy can be found in [the official PlatformIO documentation](#).

#### 9.1.2 Installation

- [PlatformIO IDE](#) is a toolset for embedded C/C++ development available on Windows, macOS and Linux platforms
- [PlatformIO Core \(CLI\)](#) is a command-line tool that consists of multi-platform build system, platform and library managers and other integration components. It can be used with a variety of code development environments and allows integration with cloud platforms and web services

### 9.1.3 Configuration

Please go through [the official PlatformIO configuration guide](#) for ESP-IDF.

### 9.1.4 Tutorials

- [ESP-IDF and ESP32-DevKitC: debugging, unit testing, project analysis](#)

### 9.1.5 Project Examples

Please check ESP-IDF page in [the official PlatformIO documentation](#)

### 9.1.6 Next Steps

Here are some useful links for exploring the PlatformIO ecosystem:

- Learn more about [integrations with other IDEs/Text Editors](#)
- Get help from [PlatformIO community](#)

## 9.2 Useful Links

- The [esp32.com forum](#) is a place to ask questions and find community resources.
- Check the [Issues](#) section on GitHub if you find a bug or have a feature request. Please check existing [Issues](#) before opening a new one.
- A comprehensive collection of [solutions](#), [practical applications](#), [components and drivers](#) based on ESP-IDF is available in [ESP IoT Solution](#) repository. In most of cases descriptions are provided both in English and in 中文.
- To develop applications using Arduino platform, refer to [Arduino core for the ESP32, ESP32-S2 and ESP32-C3](#).
- Several [books](#) have been written about ESP32 and they are listed on [Espressif](#) web site.
- If you're interested in contributing to ESP-IDF, please check the [Contributions Guide](#).
- For additional ESP32-S2 product related information, please refer to [documentation](#) section of [Espressif](#) site.
- [Download](#) latest and previous versions of this documentation in PDF and HTML format.

# Chapter 10

## Copyrights and Licenses

### 10.1 Software Copyrights

All original source code in this repository is Copyright (C) 2015-2022 Espressif Systems. This source code is licensed under the Apache License 2.0 as described in the file LICENSE.

Additional third party copyrighted code is included under the following licenses.

Where source code headers specify Copyright & License information, this information takes precedence over the summaries made here.

Some examples use external components which are not Apache licensed, please check the copyright description in each example source code.

#### 10.1.1 Firmware Components

These third party libraries can be included into the application (firmware) produced by ESP-IDF.

- [Newlib](#) is licensed under the BSD License and is Copyright of various parties, as described in [COPYING.NEWLIB](#).
- [Xtensa header files](#) are Copyright (C) 2013 Tensilica Inc and are licensed under the MIT License as reproduced in the individual header files.
- Original parts of [FreeRTOS](#) (components/freertos) are Copyright (C) 2017 Amazon.com, Inc. or its affiliates are licensed under the MIT License, as described in [license.txt](#).
- Original parts of [LWIP](#) (components/lwip) are Copyright (C) 2001, 2002 Swedish Institute of Computer Science and are licensed under the BSD License as described in [COPYING file](#).
- [wpa\\_supplicant](#) Copyright (c) 2003-2005 Jouni Malinen and licensed under the BSD license.
- [Fast PBKDF2](#) Copyright (c) 2015 Joseph Birr-Pixton and licensed under CC0 Public Domain Dedication license.
- [FreeBSD net80211](#) Copyright (c) 2004-2008 Sam Leffler, Errno Consulting and licensed under the BSD license.
- [argtable3](#) argument parsing library Copyright (C) 1998-2001,2003-2011,2013 Stewart Heitmann and licensed under 3-clause BSD license. [argtable3](#) also includes the following software components. For details, please see [argtable3 LICENSE file](#).
  - C Hash Table library, Copyright (c) 2002, Christopher Clark and licensed under 3-clause BSD license.
  - The Better String library, Copyright (c) 2014, Paul Hsieh and licensed under 3-clause BSD license.
  - TCL library, Copyright the Regents of the University of California, Sun Microsystems, Inc., Scriptics Corporation, ActiveState Corporation and other parties, and licensed under TCL/TK License.
- [linenoise](#) line editing library Copyright (c) 2010-2014 Salvatore Sanfilippo, Copyright (c) 2010-2013 Pieter Noordhuis, licensed under 2-clause BSD license.
- [FatFS](#) library, Copyright (C) 2017 ChaN, is licensed under [a BSD-style license](#) .
- [cJSON](#) library, Copyright (c) 2009-2017 Dave Gamble and cJSON contributors, is licensed under MIT license as described in [LICENSE file](#) .



- [micro-ecc](#) library, Copyright (c) 2014 Kenneth MacKay, is licensed under 2-clause BSD license.
- [Mbed TLS](#) library, Copyright (C) 2006-2018 ARM Limited, is licensed under Apache License 2.0 as described in [LICENSE file](#).
- [SPIFFS](#) library, Copyright (c) 2013-2017 Peter Andersson, is licensed under MIT license as described in [LICENSE file](#).
- [SD/MMC driver](#) is derived from [OpenBSD SD/MMC driver](#), Copyright (c) 2006 Uwe Stuehler, and is licensed under BSD license.
- [ESP-MQTT](#) MQTT Package (contiki-mqtt) - Copyright (c) 2014, Stephen Robinson, MQTT-ESP - Tuan PM <tuanpm at live dot com> is licensed under Apache License 2.0 as described in [LICENSE file](#).
- [BLE Mesh](#) is adapted from Zephyr Project, Copyright (c) 2017-2018 Intel Corporation and licensed under Apache License 2.0.
- [mynewt-nimble](#) Apache Mynewt NimBLE, Copyright 2015-2018, The Apache Software Foundation, is licensed under Apache License 2.0 as described in [LICENSE file](#).
- [TLSF allocator](#) Two Level Segregated Fit memory allocator, Copyright (c) 2006-2016, Matthew Conte, and licensed under the BSD 3-clause license.
- [openthread](#), Copyright (c) The OpenThread Authors, is licensed under BSD License as described in [LICENSE file](#).
- [UBSAN runtime](#) —Copyright (c) 2016, Linaro Limited and Jiří Závěručky, licensed under the BSD 2-clause license.
- [HTTP Parser](#) Based on src/http/nginx\_http\_parse.c from NGINX copyright Igor Sysoev. Additional changes are licensed under the same terms as NGINX and Joyent, Inc. and other Node contributors. For details please check [LICENSE file](#).
- [SEGGER SystemView](#) target-side library, Copyright (c) 2015-2017 SEGGER Microcontroller GmbH & Co. KG, is licensed under BSD 3-clause license.

### 10.1.2 Documentation

- HTML version of the [ESP-IDF Programming Guide](#) uses the Sphinx theme [sphinx\\_idf\\_theme](#), which is Copyright (c) 2013-2020 Dave Snider, Read the Docs, Inc. & contributors, and Espressif Systems (Shanghai) CO., LTD. It is based on [sphinx\\_rtd\\_theme](#). Both are licensed under MIT license.

## 10.2 ROM Source Code Copyrights

ESP32, ESP32-S and ESP32-C Series SoCs mask ROM hardware includes binaries compiled from portions of the following third party software:

- [Newlib](#), licensed under the BSD License and is Copyright of various parties, as described in [COPYING.NEWLIB](#).
- Xtensa libhal, Copyright (c) Tensilica Inc and licensed under the MIT license (see below).
- [TinyBasic Plus](#), Copyright Mike Field & Scott Lawrence and licensed under the MIT license (see below).
- [miniz](#), by Rich Geldreich - placed into the public domain.
- [wpa\\_supplicant](#) Copyright (c) 2003-2005 Jouni Malinen and licensed under the BSD license.
- [TJpgDec](#) Copyright (C) 2011, ChaN, all right reserved. See below for license.
- **Parts of Zephyr RTOS USB stack:**
  - [DesignWare USB device driver](#) Copyright (c) 2016 Intel Corporation and licensed under Apache 2.0 license.
  - [Generic USB device driver](#) Copyright (c) 2006 Bertrik Sikken ([bertrik@sikken.nl](mailto:bertrik@sikken.nl)), 2016 Intel Corporation and licensed under BSD 3-clause license.
  - [USB descriptors functionality](#) Copyright (c) 2017 PHYTEC Messtechnik GmbH, 2017-2018 Intel Corporation and licensed under Apache 2.0 license.
  - [USB DFU class driver](#) Copyright(c) 2015-2016 Intel Corporation, 2017 PHYTEC Messtechnik GmbH and licensed under BSD 3-clause license.
  - [USB CDC ACM class driver](#) Copyright(c) 2015-2016 Intel Corporation and licensed under Apache 2.0 license

### 10.3 Xtensa libhal MIT License

Copyright (c) 2003, 2006, 2010 Tensilica Inc.

Permission is hereby granted, free of charge, to any person obtaining a copy of this software and associated documentation files (the “Software” ), to deal in the Software without restriction, including without limitation the rights to use, copy, modify, merge, publish, distribute, sublicense, and/or sell copies of the Software, and to permit persons to whom the Software is furnished to do so, subject to the following conditions:

The above copyright notice and this permission notice shall be included in all copies or substantial portions of the Software.

THE SOFTWARE IS PROVIDED “AS IS”, WITHOUT WARRANTY OF ANY KIND, EXPRESS OR IMPLIED, INCLUDING BUT NOT LIMITED TO THE WARRANTIES OF MERCHANTABILITY, FITNESS FOR A PARTICULAR PURPOSE AND NONINFRINGEMENT. IN NO EVENT SHALL THE AUTHORS OR COPYRIGHT HOLDERS BE LIABLE FOR ANY CLAIM, DAMAGES OR OTHER LIABILITY, WHETHER IN AN ACTION OF CONTRACT, TORT OR OTHERWISE, ARISING FROM, OUT OF OR IN CONNECTION WITH THE SOFTWARE OR THE USE OR OTHER DEALINGS IN THE SOFTWARE.

### 10.4 TinyBasic Plus MIT License

Copyright (c) 2012-2013

Permission is hereby granted, free of charge, to any person obtaining a copy of this software and associated documentation files (the “Software” ), to deal in the Software without restriction, including without limitation the rights to use, copy, modify, merge, publish, distribute, sublicense, and/or sell copies of the Software, and to permit persons to whom the Software is furnished to do so, subject to the following conditions:

The above copyright notice and this permission notice shall be included in all copies or substantial portions of the Software.

THE SOFTWARE IS PROVIDED “AS IS”, WITHOUT WARRANTY OF ANY KIND, EXPRESS OR IMPLIED, INCLUDING BUT NOT LIMITED TO THE WARRANTIES OF MERCHANTABILITY, FITNESS FOR A PARTICULAR PURPOSE AND NONINFRINGEMENT. IN NO EVENT SHALL THE AUTHORS OR COPYRIGHT HOLDERS BE LIABLE FOR ANY CLAIM, DAMAGES OR OTHER LIABILITY, WHETHER IN AN ACTION OF CONTRACT, TORT OR OTHERWISE, ARISING FROM, OUT OF OR IN CONNECTION WITH THE SOFTWARE OR THE USE OR OTHER DEALINGS IN THE SOFTWARE.

### 10.5 TJpgDec License

TJpgDec - Tiny JPEG Decompressor R0.01 (C)ChaN, 2011 The TJpgDec is a generic JPEG decompressor module for tiny embedded systems. This is a free software that opened for education, research and commercial developments under license policy of following terms.

Copyright (C) 2011, ChaN, all right reserved.

- The TJpgDec module is a free software and there is NO WARRANTY.
- No restriction on use. You can use, modify and redistribute it for personal, non-profit or commercial products UNDER YOUR RESPONSIBILITY.
- Redistributions of source code must retain the above copyright notice.



# Chapter 11

## About

This is documentation of [ESP-IDF](#), the framework to develop applications for ESP32-S2.

The ESP32-S2 is a 2.4 GHz Wi-Fi SoC, which integrates a Xtensa® 32-bit LX7 CPU.

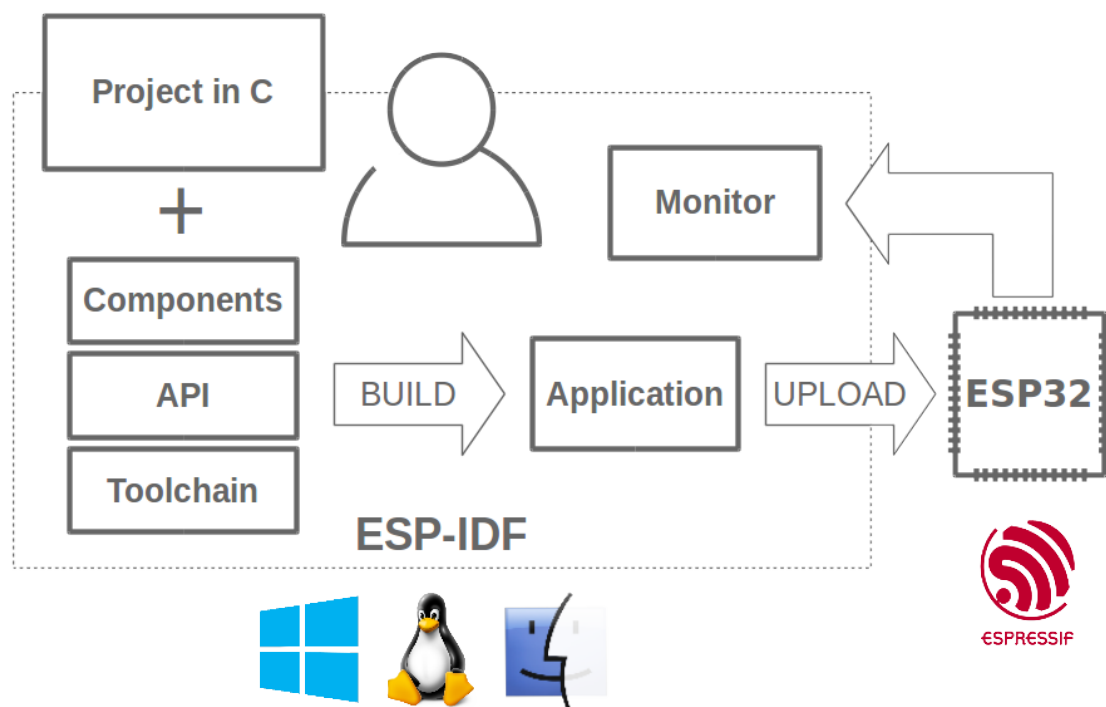

Fig. 1: Espressif IoT Integrated Development Framework

The ESP-IDF, Espressif IoT Development Framework, provides toolchain, API, components and workflows to develop applications for ESP32-S2 using Windows, Linux and macOS operating systems.



## Chapter 12

# Switch Between Languages

The ESP-IDF Programming Guide is now available in two languages. Please refer to the English version if there is any discrepancy.

- English
- Chinese

You can easily change from one language to another by clicking the language link you can find at the top of every document that has a translation.



The screenshot shows a breadcrumb trail: [Home](#) » [API Guides](#) » [Fatal Errors](#). On the right, there is a link [Edit on GitHub](#). Below the breadcrumb, the title **Fatal Errors** is displayed. A link [\[中文\]](#) is circled in red, indicating the Chinese language option. Below the title, the section **Overview** is shown, followed by the text: "In certain situations, execution of the program can not be continued in a well defined way. In ESP-IDF, these situations include:"



# Index

## Symbols

`_ESP_LOG_EARLY_ENABLED` (*C macro*), 1408

`_ip_addr` (*C++ struct*), 347

`_ip_addr::ip4` (*C++ member*), 347

`_ip_addr::ip6` (*C++ member*), 347

`_ip_addr::type` (*C++ member*), 347

`_ip_addr::u_addr` (*C++ member*), 347

[anonymous] (*C++ enum*), 1120, 1464

[anonymous]::ESP\_ERR\_FLASH\_NO\_RESPONSE  
(*C++ enumerator*), 1120

[anonymous]::ESP\_ERR\_FLASH\_SIZE\_NOT\_MATCH  
(*C++ enumerator*), 1120

[anonymous]::ESP\_ERR\_SLEEP\_REJECT  
(*C++ enumerator*), 1464

[anonymous]::ESP\_ERR\_SLEEP\_TOO\_SHORT\_SLEEP\_DURATION  
(*C++ enumerator*), 1464

## A

`adc_atten_t` (*C++ enum*), 360

`adc_atten_t::ADC_ATTEN_DB_0` (*C++ enumerator*), 360

`adc_atten_t::ADC_ATTEN_DB_11` (*C++ enumerator*), 360

`adc_atten_t::ADC_ATTEN_DB_12` (*C++ enumerator*), 360

`adc_atten_t::ADC_ATTEN_DB_2_5` (*C++ enumerator*), 360

`adc_atten_t::ADC_ATTEN_DB_6` (*C++ enumerator*), 360

`adc_bitwidth_t` (*C++ enum*), 360

`adc_bitwidth_t::ADC_BITWIDTH_10` (*C++ enumerator*), 361

`adc_bitwidth_t::ADC_BITWIDTH_11` (*C++ enumerator*), 361

`adc_bitwidth_t::ADC_BITWIDTH_12` (*C++ enumerator*), 361

`adc_bitwidth_t::ADC_BITWIDTH_13` (*C++ enumerator*), 361

`adc_bitwidth_t::ADC_BITWIDTH_9` (*C++ enumerator*), 361

`adc_bitwidth_t::ADC_BITWIDTH_DEFAULT`  
(*C++ enumerator*), 361

`adc_cali_check_scheme` (*C++ function*), 374

`adc_cali_handle_t` (*C++ type*), 374

`adc_cali_raw_to_voltage` (*C++ function*), 374

`adc_cali_scheme_ver_t` (*C++ enum*), 374

`adc_cali_scheme_ver_t::ADC_CALI_SCHEME_VER_CURVE`  
(*C++ enumerator*), 374

`adc_cali_scheme_ver_t::ADC_CALI_SCHEME_VER_LINE_F`  
(*C++ enumerator*), 374

`adc_channel_t` (*C++ enum*), 359

`adc_channel_t::ADC_CHANNEL_0` (*C++ enumerator*), 359

`adc_channel_t::ADC_CHANNEL_1` (*C++ enumerator*), 360

`adc_channel_t::ADC_CHANNEL_2` (*C++ enumerator*), 360

`adc_channel_t::ADC_CHANNEL_3` (*C++ enumerator*), 360

`adc_channel_t::ADC_CHANNEL_4` (*C++ enumerator*), 360

`adc_channel_t::ADC_CHANNEL_5` (*C++ enumerator*), 360

`adc_channel_t::ADC_CHANNEL_6` (*C++ enumerator*), 360

`adc_channel_t::ADC_CHANNEL_7` (*C++ enumerator*), 360

`adc_channel_t::ADC_CHANNEL_8` (*C++ enumerator*), 360

`adc_channel_t::ADC_CHANNEL_9` (*C++ enumerator*), 360

`adc_continuous_callback_t` (*C++ type*), 372

`adc_continuous_channel_to_io` (*C++ function*), 370

`adc_continuous_config` (*C++ function*), 368

`adc_continuous_config_t` (*C++ struct*), 370

`adc_continuous_config_t::adc_pattern`  
(*C++ member*), 370

`adc_continuous_config_t::conv_mode`  
(*C++ member*), 371

`adc_continuous_config_t::format` (*C++ member*), 371

`adc_continuous_config_t::pattern_num`  
(*C++ member*), 370

`adc_continuous_config_t::sample_freq_hz`  
(*C++ member*), 370

`adc_continuous_deinit` (*C++ function*), 369

`adc_continuous_evt_cbs_t` (*C++ struct*), 371

`adc_continuous_evt_cbs_t::on_conv_done`  
(*C++ member*), 371

`adc_continuous_evt_cbs_t::on_pool_ovf`  
(*C++ member*), 371

`adc_continuous_evt_data_t` (*C++ struct*), 371



- adc\_continuous\_evt\_data\_t::conv\_frame\_buffer (C++ member), 371  
 adc\_continuous\_evt\_data\_t::size (C++ member), 371  
 adc\_continuous\_handle\_cfg\_t (C++ struct), 370  
 adc\_continuous\_handle\_cfg\_t::conv\_frame\_buffer (C++ member), 370  
 adc\_continuous\_handle\_cfg\_t::max\_store\_size (C++ member), 370  
 adc\_continuous\_handle\_t (C++ type), 372  
 adc\_continuous\_io\_to\_channel (C++ function), 370  
 adc\_continuous\_new\_handle (C++ function), 368  
 adc\_continuous\_read (C++ function), 369  
 adc\_continuous\_register\_event\_callbacks (C++ function), 368  
 adc\_continuous\_start (C++ function), 369  
 adc\_continuous\_stop (C++ function), 369  
 adc\_digi\_clk\_t (C++ struct), 359  
 adc\_digi\_clk\_t::div\_a (C++ member), 359  
 adc\_digi\_clk\_t::div\_b (C++ member), 359  
 adc\_digi\_clk\_t::div\_num (C++ member), 359  
 adc\_digi\_clk\_t::use\_apll (C++ member), 359  
 adc\_digi\_convert\_mode\_t (C++ enum), 361  
 adc\_digi\_convert\_mode\_t::ADC\_CONV\_ALTERNATE (C++ enumerator), 361  
 adc\_digi\_convert\_mode\_t::ADC\_CONV\_BOTH (C++ enumerator), 361  
 adc\_digi\_convert\_mode\_t::ADC\_CONV\_SINGLE (C++ enumerator), 361  
 adc\_digi\_convert\_mode\_t::ADC\_CONV\_SINGLE\_1 (C++ enumerator), 361  
 adc\_digi\_convert\_mode\_t::ADC\_CONV\_SINGLE\_2 (C++ enumerator), 361  
 adc\_digi\_output\_data\_t (C++ struct), 358  
 adc\_digi\_output\_data\_t::channel (C++ member), 358  
 adc\_digi\_output\_data\_t::data (C++ member), 358  
 adc\_digi\_output\_data\_t::type1 (C++ member), 358  
 adc\_digi\_output\_data\_t::type2 (C++ member), 359  
 adc\_digi\_output\_data\_t::unit (C++ member), 359  
 adc\_digi\_output\_data\_t::val (C++ member), 359  
 adc\_digi\_output\_format\_t (C++ enum), 361  
 adc\_digi\_output\_format\_t::ADC\_DIGI\_OUTPUT\_FORMAT\_TYPE1 (C++ enumerator), 362  
 adc\_digi\_output\_format\_t::ADC\_DIGI\_OUTPUT\_FORMAT\_TYPE2 (C++ enumerator), 362  
 adc\_digi\_pattern\_config\_t (C++ struct), 358  
 adc\_digi\_pattern\_config\_t::atten (C++ member), 358  
 adc\_digi\_pattern\_config\_t::bit\_width (C++ member), 358  
 adc\_digi\_pattern\_config\_t::channel (C++ member), 358  
 adc\_digi\_pattern\_config\_t::unit (C++ member), 358  
 ADC\_MAX\_DELAY (C macro), 371  
 adc\_oneshot\_chan\_cfg\_t (C++ struct), 364  
 adc\_oneshot\_chan\_cfg\_t::atten (C++ member), 364  
 adc\_oneshot\_chan\_cfg\_t::bitwidth (C++ member), 364  
 adc\_oneshot\_channel\_to\_io (C++ function), 363  
 adc\_oneshot\_config\_channel (C++ function), 362  
 adc\_oneshot\_del\_unit (C++ function), 363  
 adc\_oneshot\_io\_to\_channel (C++ function), 363  
 adc\_oneshot\_new\_unit (C++ function), 362  
 adc\_oneshot\_read (C++ function), 362  
 adc\_oneshot\_unit\_handle\_t (C++ type), 364  
 adc\_oneshot\_unit\_init\_cfg\_t (C++ struct), 363  
 adc\_oneshot\_unit\_init\_cfg\_t::ulp\_mode (C++ member), 363  
 adc\_oneshot\_unit\_init\_cfg\_t::unit\_id (C++ member), 363  
 adc\_ulp\_mode\_t (C++ enum), 361  
 adc\_ulp\_mode\_t::ADC\_ULP\_MODE\_DISABLE (C++ enumerator), 361  
 adc\_ulp\_mode\_t::ADC\_ULP\_MODE\_FSM (C++ enumerator), 361  
 adc\_ulp\_mode\_t::ADC\_ULP\_MODE\_RISCV (C++ enumerator), 361  
 adc\_unit\_t (C++ enum), 359  
 adc\_unit\_t::ADC\_UNIT\_1 (C++ enumerator), 359  
 adc\_unit\_t::ADC\_UNIT\_2 (C++ enumerator), 359  
 ALU\_SEL\_ADD (C macro), 1509  
 ALU\_SEL\_AND (C macro), 1509  
 ALU\_SEL\_LSH (C macro), 1509  
 ALU\_SEL\_MOV (C macro), 1509  
 ALU\_SEL\_OR (C macro), 1509  
 ALU\_SEL\_RSH (C macro), 1509  
 ALU\_SEL\_STAGE\_DEC (C macro), 1509  
 ALU\_SEL\_STAGE\_INC (C macro), 1509  
 ALU\_SEL\_STAGE\_RST (C macro), 1509  
 ALU\_SEL\_SUB (C macro), 1509  
 async\_memcpy\_config\_t (C++ struct), 1484  
 async\_memcpy\_config\_t::backlog (C++ member), 1485  
 async\_memcpy\_config\_t::flags (C++ member), 1485  
 async\_memcpy\_config\_t::psram\_trans\_align (C++ member), 1485  
 async\_memcpy\_config\_t::sram\_trans\_align (C++ member), 1485  
 ASYNC\_MEMCPY\_DEFAULT\_CONFIG (C macro), 1485

- 1485  
 async\_memcpy\_event\_t (C++ struct), 1484  
 async\_memcpy\_event\_t::data (C++ member), 1484  
 async\_memcpy\_isr\_cb\_t (C++ type), 1485  
 async\_memcpy\_t (C++ type), 1485
- ## B
- B\_CMP\_E (C macro), 1510  
 B\_CMP\_G (C macro), 1510  
 B\_CMP\_L (C macro), 1510  
 BLE\_ADDR\_LEN (C macro), 1018  
 BLE\_UUID128\_VAL\_LENGTH (C macro), 1018  
 bootloader\_fill\_random (C++ function), 1452  
 bootloader\_random\_disable (C++ function), 1452  
 bootloader\_random\_enable (C++ function), 1452  
 bridgeif\_config (C++ struct), 340  
 bridgeif\_config::max\_fdb\_dyn\_entries (C++ member), 340  
 bridgeif\_config::max\_fdb\_sta\_entries (C++ member), 340  
 bridgeif\_config::max\_ports (C++ member), 340  
 bridgeif\_config\_t (C++ type), 343  
 BS\_CMP\_GE (C macro), 1510  
 BS\_CMP\_L (C macro), 1510  
 BS\_CMP\_LE (C macro), 1510  
 btm\_query\_reason (C++ enum), 276  
 btm\_query\_reason::REASON\_BANDWIDTH (C++ enumerator), 276  
 btm\_query\_reason::REASON\_DELAY (C++ enumerator), 276  
 btm\_query\_reason::REASON\_FRAME\_LOSS (C++ enumerator), 276  
 btm\_query\_reason::REASON\_GRAY\_ZONE (C++ enumerator), 276  
 btm\_query\_reason::REASON\_INTERFERENCE (C++ enumerator), 276  
 btm\_query\_reason::REASON\_LOAD\_BALANCE (C++ enumerator), 276  
 btm\_query\_reason::REASON\_PREMIUM\_AP (C++ enumerator), 276  
 btm\_query\_reason::REASON\_RETRANSMISSIONS (C++ enumerator), 276  
 btm\_query\_reason::REASON\_RSSI (C++ enumerator), 276  
 btm\_query\_reason::REASON\_UNSPECIFIED (C++ enumerator), 276  
 BX\_JUMP\_TYPE\_DIRECT (C macro), 1510  
 BX\_JUMP\_TYPE\_OVF (C macro), 1510  
 BX\_JUMP\_TYPE\_ZERO (C macro), 1510
- ## C
- CHIP\_FEATURE\_BLE (C macro), 1418  
 CHIP\_FEATURE\_BT (C macro), 1418  
 CHIP\_FEATURE\_EMB\_FLASH (C macro), 1418  
 CHIP\_FEATURE\_EMB\_PSRAM (C macro), 1419  
 CHIP\_FEATURE\_IEEE802154 (C macro), 1419  
 CHIP\_FEATURE\_WIFI\_BGN (C macro), 1418  
 CONFIG\_ESPTOOLPY\_FLASHSIZE, 1099  
 CONFIG\_FEATURE\_11R\_BIT (C macro), 232  
 CONFIG\_FEATURE\_CACHE\_TX\_BUF\_BIT (C macro), 232  
 CONFIG\_FEATURE\_FTM\_INITIATOR\_BIT (C macro), 232  
 CONFIG\_FEATURE\_FTM\_RESPONDER\_BIT (C macro), 232  
 CONFIG\_FEATURE\_GCMP\_BIT (C macro), 232  
 CONFIG\_FEATURE\_GMAC\_BIT (C macro), 232  
 CONFIG\_FEATURE\_WIFI\_ENT\_BIT (C macro), 232  
 CONFIG\_FEATURE\_WPA3\_SAE\_BIT (C macro), 232  
 CONFIG\_HEAP\_TRACING\_STACK\_DEPTH (C macro), 1389
- ## D
- DAC\_CHANNEL\_1\_GPIO\_NUM (C macro), 384  
 DAC\_CHANNEL\_2\_GPIO\_NUM (C macro), 384  
 dac\_channel\_t (C++ enum), 385  
 dac\_channel\_t::DAC\_CHANNEL\_1 (C++ enumerator), 385  
 dac\_channel\_t::DAC\_CHANNEL\_2 (C++ enumerator), 385  
 dac\_channel\_t::DAC\_CHANNEL\_MAX (C++ enumerator), 385  
 dac\_cw\_config\_t (C++ struct), 384  
 dac\_cw\_config\_t::en\_ch (C++ member), 384  
 dac\_cw\_config\_t::freq (C++ member), 384  
 dac\_cw\_config\_t::offset (C++ member), 384  
 dac\_cw\_config\_t::phase (C++ member), 384  
 dac\_cw\_config\_t::scale (C++ member), 384  
 dac\_cw\_generator\_config (C++ function), 383  
 dac\_cw\_generator\_disable (C++ function), 383  
 dac\_cw\_generator\_enable (C++ function), 383  
 dac\_cw\_phase\_t (C++ enum), 385  
 dac\_cw\_phase\_t::DAC\_CW\_PHASE\_0 (C++ enumerator), 385  
 dac\_cw\_phase\_t::DAC\_CW\_PHASE\_180 (C++ enumerator), 385  
 dac\_cw\_scale\_t (C++ enum), 385  
 dac\_cw\_scale\_t::DAC\_CW\_SCALE\_1 (C++ enumerator), 385  
 dac\_cw\_scale\_t::DAC\_CW\_SCALE\_2 (C++ enumerator), 385  
 dac\_cw\_scale\_t::DAC\_CW\_SCALE\_4 (C++ enumerator), 385  
 dac\_cw\_scale\_t::DAC\_CW\_SCALE\_8 (C++ enumerator), 385  
 dac\_digi\_config\_t (C++ struct), 384  
 dac\_digi\_config\_t::dig\_clk (C++ member), 385

- dac\_digi\_config\_t::interval (C++ member), 385  
 dac\_digi\_config\_t::mode (C++ member), 385  
 dac\_digi\_controller\_config (C++ function), 382  
 dac\_digi\_convert\_mode\_t (C++ enum), 386  
 dac\_digi\_convert\_mode\_t::DAC\_CONV\_ALTERED (C++ enumerator), 386  
 dac\_digi\_convert\_mode\_t::DAC\_CONV\_MAX (C++ enumerator), 386  
 dac\_digi\_convert\_mode\_t::DAC\_CONV\_NORMAL (C++ enumerator), 386  
 dac\_digi\_deinit (C++ function), 382  
 dac\_digi\_fifo\_reset (C++ function), 382  
 dac\_digi\_init (C++ function), 382  
 dac\_digi\_reset (C++ function), 382  
 dac\_digi\_start (C++ function), 382  
 dac\_digi\_stop (C++ function), 382  
 DAC\_GPIO17\_CHANNEL (C macro), 384  
 DAC\_GPIO18\_CHANNEL (C macro), 384  
 dac\_output\_disable (C++ function), 383  
 dac\_output\_enable (C++ function), 383  
 dac\_output\_voltage (C++ function), 383  
 dac\_pad\_get\_io\_num (C++ function), 382  
 dedic\_gpio\_bundle\_config\_t (C++ struct), 422  
 dedic\_gpio\_bundle\_config\_t::array\_size (C++ member), 422  
 dedic\_gpio\_bundle\_config\_t::flags (C++ member), 423  
 dedic\_gpio\_bundle\_config\_t::gpio\_array (C++ member), 422  
 dedic\_gpio\_bundle\_config\_t::in\_en (C++ member), 423  
 dedic\_gpio\_bundle\_config\_t::in\_invert (C++ member), 423  
 dedic\_gpio\_bundle\_config\_t::out\_en (C++ member), 423  
 dedic\_gpio\_bundle\_config\_t::out\_invert (C++ member), 423  
 dedic\_gpio\_bundle\_handle\_t (C++ type), 423  
 dedic\_gpio\_bundle\_read\_in (C++ function), 422  
 dedic\_gpio\_bundle\_read\_out (C++ function), 421  
 dedic\_gpio\_bundle\_set\_interrupt\_and\_callback (C++ function), 422  
 dedic\_gpio\_bundle\_write (C++ function), 421  
 dedic\_gpio\_del\_bundle (C++ function), 421  
 dedic\_gpio\_get\_in\_mask (C++ function), 421  
 dedic\_gpio\_get\_out\_mask (C++ function), 420  
 dedic\_gpio\_intr\_type\_t (C++ enum), 423  
 dedic\_gpio\_intr\_type\_t::DEDIC\_GPIO\_INTR\_BOTH\_EDGE (C++ enumerator), 424  
 dedic\_gpio\_intr\_type\_t::DEDIC\_GPIO\_INTR\_HIGH\_LEVEL (C++ enumerator), 423  
 dedic\_gpio\_intr\_type\_t::DEDIC\_GPIO\_INTR\_LOW\_LEVEL (C++ enumerator), 423  
 dedic\_gpio\_intr\_type\_t::DEDIC\_GPIO\_INTR\_NEG\_EDGE (C++ enumerator), 423  
 dedic\_gpio\_intr\_type\_t::DEDIC\_GPIO\_INTR\_NONE (C++ enumerator), 423  
 dedic\_gpio\_intr\_type\_t::DEDIC\_GPIO\_INTR\_POS\_EDGE (C++ enumerator), 423  
 dedic\_gpio\_isr\_callback\_t (C++ type), 423  
 dedic\_gpio\_new\_bundle (C++ function), 421  
 DEFAULT\_HTTP\_BUF\_SIZE (C macro), 85  
 dpp\_bootstrap\_type (C++ enum), 280  
 dpp\_bootstrap\_type::DPP\_BOOTSTRAP\_NFC\_URI (C++ enumerator), 280  
 dpp\_bootstrap\_type::DPP\_BOOTSTRAP\_PKEX (C++ enumerator), 280  
 dpp\_bootstrap\_type::DPP\_BOOTSTRAP\_QR\_CODE (C++ enumerator), 280
- ## E
- EFD\_SUPPORT\_ISR (C macro), 1151  
 efuse\_hal\_chip\_revision (C++ function), 1168  
 efuse\_hal\_flash\_encryption\_enabled (C++ function), 1168  
 efuse\_hal\_get\_mac (C++ function), 1168  
 efuse\_hal\_get\_major\_chip\_version (C++ function), 1168  
 efuse\_hal\_get\_minor\_chip\_version (C++ function), 1168  
 emac\_rmii\_clock\_gpio\_t (C++ enum), 302  
 emac\_rmii\_clock\_gpio\_t::EMAC\_APPL\_CLK\_OUT\_GPIO (C++ enumerator), 302  
 emac\_rmii\_clock\_gpio\_t::EMAC\_CLK\_IN\_GPIO (C++ enumerator), 302  
 emac\_rmii\_clock\_gpio\_t::EMAC\_CLK\_OUT\_180\_GPIO (C++ enumerator), 302  
 emac\_rmii\_clock\_gpio\_t::EMAC\_CLK\_OUT\_GPIO (C++ enumerator), 302  
 emac\_rmii\_clock\_mode\_t (C++ enum), 301  
 emac\_rmii\_clock\_mode\_t::EMAC\_CLK\_DEFAULT (C++ enumerator), 301  
 emac\_rmii\_clock\_mode\_t::EMAC\_CLK\_EXT\_IN (C++ enumerator), 301  
 emac\_rmii\_clock\_mode\_t::EMAC\_CLK\_OUT (C++ enumerator), 302  
 eNotifyAction (C++ enum), 1270  
 eNotifyAction::eIncrement (C++ enumerator), 1270  
 eNotifyAction::eNoAction (C++ enumerator), 1270  
 eNotifyAction::eSetBits (C++ enumerator), 1270  
 eNotifyAction::eSetValueWithoutOverwrite (C++ enumerator), 1270  
 eNotifyAction::eSetValueWithOverwrite (C++ enumerator), 1270  
 environment variable  
 ONELEVEL\_SPTOOLPY\_FLASHSIZE, 1099  
 eSleepModeStatus (C++ enum), 1270

- eSleepModeStatus::eAbortSleep (C++ *enumerator*), 1270  
 eSleepModeStatus::eNoTasksWaitingTimeout (C++ *enumerator*), 1270  
 eSleepModeStatus::eStandardSleep (C++ *enumerator*), 1270  
 esp\_alloc\_failed\_hook\_t (C++ *type*), 1374  
 ESP\_APP\_DESC\_MAGIC\_WORD (C *macro*), 1425  
 esp\_app\_desc\_t (C++ *struct*), 1424  
 esp\_app\_desc\_t::app\_elf\_sha256 (C++ *member*), 1425  
 esp\_app\_desc\_t::date (C++ *member*), 1425  
 esp\_app\_desc\_t::idf\_ver (C++ *member*), 1425  
 esp\_app\_desc\_t::magic\_word (C++ *member*), 1424  
 esp\_app\_desc\_t::project\_name (C++ *member*), 1425  
 esp\_app\_desc\_t::reserv1 (C++ *member*), 1424  
 esp\_app\_desc\_t::reserv2 (C++ *member*), 1425  
 esp\_app\_desc\_t::secure\_version (C++ *member*), 1424  
 esp\_app\_desc\_t::time (C++ *member*), 1425  
 esp\_app\_desc\_t::version (C++ *member*), 1425  
 esp\_app\_get\_description (C++ *function*), 1424  
 esp\_app\_get\_elf\_sha256 (C++ *function*), 1424  
 esp\_apprace\_buffer\_get (C++ *function*), 1160  
 esp\_apprace\_buffer\_put (C++ *function*), 1160  
 esp\_apprace\_dest\_t (C++ *enum*), 1163  
 esp\_apprace\_dest\_t::ESP\_APPTRACE\_DEST\_JTAG (C++ *enumerator*), 1163  
 esp\_apprace\_dest\_t::ESP\_APPTRACE\_DEST\_MAX (C++ *enumerator*), 1163  
 esp\_apprace\_dest\_t::ESP\_APPTRACE\_DEST\_SPI (C++ *enumerator*), 1163  
 esp\_apprace\_dest\_t::ESP\_APPTRACE\_DEST\_TRAX (C++ *enumerator*), 1163  
 esp\_apprace\_dest\_t::ESP\_APPTRACE\_DEST\_UART (C++ *enumerator*), 1163  
 esp\_apprace\_down\_buffer\_config (C++ *function*), 1160  
 esp\_apprace\_down\_buffer\_get (C++ *function*), 1161  
 esp\_apprace\_down\_buffer\_put (C++ *function*), 1162  
 esp\_apprace\_fclose (C++ *function*), 1162  
 esp\_apprace\_flush (C++ *function*), 1161  
 esp\_apprace\_flush\_nolock (C++ *function*), 1161  
 esp\_apprace\_fopen (C++ *function*), 1162  
 esp\_apprace\_fread (C++ *function*), 1162  
 esp\_apprace\_fseek (C++ *function*), 1162  
 esp\_apprace\_fstop (C++ *function*), 1163  
 esp\_apprace\_ftell (C++ *function*), 1163  
 esp\_apprace\_fwrite (C++ *function*), 1162  
 esp\_apprace\_host\_is\_connected (C++ *function*), 1162  
 esp\_apprace\_init (C++ *function*), 1160  
 esp\_apprace\_read (C++ *function*), 1161  
 esp\_apprace\_vprintf (C++ *function*), 1161  
 esp\_apprace\_vprintf\_to (C++ *function*), 1161  
 esp\_apprace\_write (C++ *function*), 1160  
 esp\_async\_memcpy (C++ *function*), 1484  
 esp\_async\_memcpy\_install (C++ *function*), 1483  
 esp\_async\_memcpy\_uninstall (C++ *function*), 1484  
 esp\_base\_mac\_addr\_get (C++ *function*), 1416  
 esp\_base\_mac\_addr\_set (C++ *function*), 1416  
 esp\_chip\_id\_t (C++ *enum*), 1157  
 esp\_chip\_id\_t::ESP\_CHIP\_ID\_ESP32 (C++ *enumerator*), 1157  
 esp\_chip\_id\_t::ESP\_CHIP\_ID\_ESP32C2 (C++ *enumerator*), 1158  
 esp\_chip\_id\_t::ESP\_CHIP\_ID\_ESP32C3 (C++ *enumerator*), 1158  
 esp\_chip\_id\_t::ESP\_CHIP\_ID\_ESP32S2 (C++ *enumerator*), 1158  
 esp\_chip\_id\_t::ESP\_CHIP\_ID\_ESP32S3 (C++ *enumerator*), 1158  
 esp\_chip\_id\_t::ESP\_CHIP\_ID\_INVALID (C++ *enumerator*), 1158  
 esp\_chip\_info (C++ *function*), 1418  
 esp\_chip\_info\_t (C++ *struct*), 1418  
 esp\_chip\_info\_t::cores (C++ *member*), 1418  
 esp\_chip\_info\_t::features (C++ *member*), 1418  
 esp\_chip\_info\_t::model (C++ *member*), 1418  
 esp\_chip\_info\_t::revision (C++ *member*), 1418  
 esp\_chip\_model\_t (C++ *enum*), 1419  
 esp\_chip\_model\_t::CHIP\_ESP32 (C++ *enumerator*), 1419  
 esp\_chip\_model\_t::CHIP\_ESP32C2 (C++ *enumerator*), 1419  
 esp\_chip\_model\_t::CHIP\_ESP32C3 (C++ *enumerator*), 1419  
 esp\_chip\_model\_t::CHIP\_ESP32H2 (C++ *enumerator*), 1419  
 esp\_chip\_model\_t::CHIP\_ESP32S2 (C++ *enumerator*), 1419  
 esp\_chip\_model\_t::CHIP\_ESP32S3 (C++ *enumerator*), 1419  
 esp\_console\_cmd\_func\_t (C++ *type*), 1177  
 esp\_console\_cmd\_register (C++ *function*), 1172  
 esp\_console\_cmd\_t (C++ *struct*), 1176  
 esp\_console\_cmd\_t::argtable (C++ *member*), 1177

- [esp\\_console\\_cmd\\_t::command](#) (C++ member), [1176](#)  
[esp\\_console\\_cmd\\_t::func](#) (C++ member), [1176](#)  
[esp\\_console\\_cmd\\_t::help](#) (C++ member), [1176](#)  
[esp\\_console\\_cmd\\_t::hint](#) (C++ member), [1176](#)  
[ESP\\_CONSOLE\\_CONFIG\\_DEFAULT](#) (C macro), [1177](#)  
[esp\\_console\\_config\\_t](#) (C++ struct), [1175](#)  
[esp\\_console\\_config\\_t::hint\\_bold](#) (C++ member), [1175](#)  
[esp\\_console\\_config\\_t::hint\\_color](#) (C++ member), [1175](#)  
[esp\\_console\\_config\\_t::max\\_cmdline\\_args](#) (C++ member), [1175](#)  
[esp\\_console\\_config\\_t::max\\_cmdline\\_length](#) (C++ member), [1175](#)  
[esp\\_console\\_deinit](#) (C++ function), [1172](#)  
[ESP\\_CONSOLE\\_DEV\\_CDC\\_CONFIG\\_DEFAULT](#) (C macro), [1177](#)  
[ESP\\_CONSOLE\\_DEV\\_UART\\_CONFIG\\_DEFAULT](#) (C macro), [1177](#)  
[esp\\_console\\_dev\\_uart\\_config\\_t](#) (C++ struct), [1176](#)  
[esp\\_console\\_dev\\_uart\\_config\\_t::baud\\_rate](#) (C++ member), [1176](#)  
[esp\\_console\\_dev\\_uart\\_config\\_t::channel](#) (C++ member), [1176](#)  
[esp\\_console\\_dev\\_uart\\_config\\_t::rx\\_gpio](#) (C++ member), [1176](#)  
[esp\\_console\\_dev\\_uart\\_config\\_t::tx\\_gpio](#) (C++ member), [1176](#)  
[esp\\_console\\_dev\\_usb\\_cdc\\_config\\_t](#) (C++ struct), [1176](#)  
[esp\\_console\\_get\\_completion](#) (C++ function), [1173](#)  
[esp\\_console\\_get\\_hint](#) (C++ function), [1173](#)  
[esp\\_console\\_init](#) (C++ function), [1172](#)  
[esp\\_console\\_new\\_repl\\_uart](#) (C++ function), [1174](#)  
[esp\\_console\\_new\\_repl\\_usb\\_cdc](#) (C++ function), [1174](#)  
[esp\\_console\\_register\\_help\\_command](#) (C++ function), [1174](#)  
[ESP\\_CONSOLE\\_REPL\\_CONFIG\\_DEFAULT](#) (C macro), [1177](#)  
[esp\\_console\\_repl\\_config\\_t](#) (C++ struct), [1175](#)  
[esp\\_console\\_repl\\_config\\_t::history\\_save\\_path](#) (C++ member), [1175](#)  
[esp\\_console\\_repl\\_config\\_t::max\\_cmdline\\_length](#) (C++ member), [1176](#)  
[esp\\_console\\_repl\\_config\\_t::max\\_history\\_size](#) (C++ member), [1175](#)  
[esp\\_console\\_repl\\_config\\_t::prompt](#) (C++ member), [1176](#)  
[esp\\_console\\_repl\\_config\\_t::task\\_priority](#) (C++ member), [1175](#)  
[esp\\_console\\_repl\\_config\\_t::task\\_stack\\_size](#) (C++ member), [1175](#)  
[esp\\_console\\_repl\\_s](#) (C++ struct), [1177](#)  
[esp\\_console\\_repl\\_s::del](#) (C++ member), [1177](#)  
[esp\\_console\\_repl\\_t](#) (C++ type), [1177](#)  
[esp\\_console\\_run](#) (C++ function), [1172](#)  
[esp\\_console\\_split\\_argv](#) (C++ function), [1173](#)  
[esp\\_console\\_start\\_repl](#) (C++ function), [1175](#)  
[esp\\_cpu\\_clear\\_breakpoint](#) (C++ function), [1421](#)  
[esp\\_cpu\\_clear\\_watchpoint](#) (C++ function), [1422](#)  
[esp\\_cpu\\_compare\\_and\\_set](#) (C++ function), [1423](#)  
[esp\\_cpu\\_configure\\_region\\_protection](#) (C++ function), [1421](#)  
[esp\\_cpu\\_cycle\\_count\\_t](#) (C++ type), [1423](#)  
[esp\\_cpu\\_dbg\\_break](#) (C++ function), [1422](#)  
[esp\\_cpu\\_dbg\\_is\\_attached](#) (C++ function), [1422](#)  
[esp\\_cpu\\_get\\_call\\_addr](#) (C++ function), [1422](#)  
[esp\\_cpu\\_get\\_core\\_id](#) (C++ function), [1420](#)  
[esp\\_cpu\\_get\\_cycle\\_count](#) (C++ function), [1420](#)  
[esp\\_cpu\\_get\\_sp](#) (C++ function), [1420](#)  
[ESP\\_CPU\\_INTR\\_DESC\\_FLAG\\_RESVD](#) (C macro), [1423](#)  
[ESP\\_CPU\\_INTR\\_DESC\\_FLAG\\_SPECIAL](#) (C macro), [1423](#)  
[esp\\_cpu\\_intr\\_desc\\_t](#) (C++ struct), [1423](#)  
[esp\\_cpu\\_intr\\_desc\\_t::flags](#) (C++ member), [1423](#)  
[esp\\_cpu\\_intr\\_desc\\_t::priority](#) (C++ member), [1423](#)  
[esp\\_cpu\\_intr\\_desc\\_t::type](#) (C++ member), [1423](#)  
[esp\\_cpu\\_intr\\_disable](#) (C++ function), [1421](#)  
[esp\\_cpu\\_intr\\_edge\\_ack](#) (C++ function), [1421](#)  
[esp\\_cpu\\_intr\\_enable](#) (C++ function), [1421](#)  
[esp\\_cpu\\_intr\\_get\\_desc](#) (C++ function), [1420](#)  
[esp\\_cpu\\_intr\\_get\\_enabled\\_mask](#) (C++ function), [1421](#)  
[esp\\_cpu\\_intr\\_get\\_handler\\_arg](#) (C++ function), [1421](#)  
[esp\\_cpu\\_intr\\_handler\\_t](#) (C++ type), [1423](#)  
[esp\\_cpu\\_intr\\_has\\_handler](#) (C++ function), [1420](#)  
[esp\\_cpu\\_intr\\_set\\_handler](#) (C++ function), [1421](#)  
[esp\\_cpu\\_intr\\_set\\_ivt\\_addr](#) (C++ function), [1420](#)  
[esp\\_cpu\\_intr\\_type\\_t](#) (C++ enum), [1423](#)  
[esp\\_cpu\\_intr\\_type\\_t::ESP\\_CPU\\_INTR\\_TYPE\\_EDGE](#) (C++ enumerator), [1424](#)  
[esp\\_cpu\\_intr\\_type\\_t::ESP\\_CPU\\_INTR\\_TYPE\\_LEVEL](#) (C++ enumerator), [1423](#)



- esp\_cpu\_intr\_type\_t::ESP\_CPU\_INTR\_TYPE\_ESP\_DRAM\_LOGD (C macro), 1410  
 (C++ enumerator), 1424
- esp\_cpu\_pc\_to\_addr (C++ function), 1420
- esp\_cpu\_reset (C++ function), 1419
- esp\_cpu\_set\_breakpoint (C++ function), 1421
- esp\_cpu\_set\_cycle\_count (C++ function), 1420
- esp\_cpu\_set\_watchpoint (C++ function), 1422
- esp\_cpu\_stall (C++ function), 1419
- esp\_cpu\_unstall (C++ function), 1419
- esp\_cpu\_wait\_for\_intr (C++ function), 1419
- esp\_cpu\_watchpoint\_trigger\_t (C++ enum), 1424
- esp\_cpu\_watchpoint\_trigger\_t::ESP\_CPU\_WATCHPOINT\_TRIGGER\_ACCESS:length (C++ member), 432  
 (C++ enumerator), 1424
- esp\_cpu\_watchpoint\_trigger\_t::ESP\_CPU\_WATCHPOINT\_TRIGGER\_LOAD::M\_prime (C++ member), 432  
 (C++ enumerator), 1424
- esp\_cpu\_watchpoint\_trigger\_t::ESP\_CPU\_WATCHPOINT\_TRIGGER\_STORE::Rb (C++ member), 432  
 (C++ enumerator), 1424
- esp\_ds\_encrypt\_params (C++ function), 431
- esp\_ds\_finish\_sign (C++ function), 430
- esp\_ds\_is\_busy (C++ function), 430
- esp\_ds\_iv\_len (C macro), 432
- esp\_ds\_p\_data\_t (C++ struct), 432
- esp\_ds\_p\_data\_t (C++ type), 433
- esp\_ds\_p\_data\_t::M (C++ member), 432
- esp\_ds\_p\_data\_t::Y (C++ member), 432
- esp\_ds\_sign (C++ function), 429
- esp\_ds\_start\_sign (C++ function), 430
- esp\_eap\_client\_clear\_ca\_cert (C++ function), 269
- esp\_eap\_client\_clear\_certificate\_and\_key (C++ function), 269
- esp\_eap\_client\_clear\_identity (C++ function), 268
- esp\_eap\_client\_clear\_new\_password (C++ function), 269
- esp\_eap\_client\_clear\_password (C++ function), 268
- esp\_eap\_client\_clear\_username (C++ function), 268
- esp\_eap\_client\_get\_disable\_time\_check (C++ function), 270
- esp\_eap\_client\_set\_ca\_cert (C++ function), 269
- esp\_eap\_client\_set\_certificate\_and\_key (C++ function), 269
- esp\_eap\_client\_set\_disable\_time\_check (C++ function), 270
- esp\_eap\_client\_set\_fast\_params (C++ function), 270
- esp\_eap\_client\_set\_identity (C++ function), 268
- esp\_eap\_client\_set\_new\_password (C++ function), 268
- esp\_eap\_client\_set\_pac\_file (C++ function), 270
- esp\_eap\_client\_set\_password (C++ function), 268
- esp\_eap\_client\_set\_suiteb\_192bit\_certification (C++ function), 270
- esp\_eap\_client\_set\_tls\_phase2\_method (C++ function), 270
- esp\_eap\_client\_set\_username (C++ function), 268
- esp\_eap\_client\_use\_default\_cert\_bundle (C++ function), 269
- esp\_digital\_signature\_data (C++ struct), 431
- esp\_digital\_signature\_data::c (C++ member), 432
- esp\_digital\_signature\_data::iv (C++ member), 432
- esp\_digital\_signature\_data::rsa\_length (C++ member), 431
- esp\_digital\_signature\_length\_t (C++ enum), 433
- esp\_digital\_signature\_length\_t::ESP\_DS\_SIGNATURE\_LENGTH\_128 (C++ enumerator), 433
- esp\_digital\_signature\_length\_t::ESP\_DS\_SIGNATURE\_LENGTH\_192 (C++ enumerator), 433
- esp\_digital\_signature\_length\_t::ESP\_DS\_SIGNATURE\_LENGTH\_256 (C++ enumerator), 433
- esp\_digital\_signature\_length\_t::ESP\_DS\_SIGNATURE\_LENGTH\_384 (C++ enumerator), 433
- ESP\_DPP\_AUTH\_TIMEOUT\_SECS (C macro), 279

- (C++ function), 271
- esp\_eap\_fast\_config (C++ struct), 271
- esp\_eap\_fast\_config::fast\_max\_pac\_list\_len (C++ member), 271
- esp\_eap\_fast\_config::fast\_pac\_format\_binary (C++ member), 271
- esp\_eap\_fast\_config::fast\_provisioning (C++ member), 271
- esp\_eap\_ttls\_phase2\_types (C++ enum), 271
- esp\_eap\_ttls\_phase2\_types::ESP\_EAP\_TTLS\_PHASE2\_CHAP (C++ enumerator), 272
- esp\_eap\_ttls\_phase2\_types::ESP\_EAP\_TTLS\_PHASE2\_EAP (C++ enumerator), 271
- esp\_eap\_ttls\_phase2\_types::ESP\_EAP\_TTLS\_PHASE2\_MSCHAP (C++ enumerator), 271
- esp\_eap\_ttls\_phase2\_types::ESP\_EAP\_TTLS\_PHASE2\_MSCHAPV2 (C++ enumerator), 271
- esp\_eap\_ttls\_phase2\_types::ESP\_EAP\_TTLS\_PHASE2\_PAP (C++ enumerator), 272
- ESP\_EARLY\_LOGD (C macro), 1408
- ESP\_EARLY\_LOGE (C macro), 1408
- ESP\_EARLY\_LOGI (C macro), 1408
- ESP\_EARLY\_LOGV (C macro), 1408
- ESP\_EARLY\_LOGW (C macro), 1408
- esp\_efuse\_batch\_write\_begin (C++ function), 1198
- esp\_efuse\_batch\_write\_cancel (C++ function), 1199
- esp\_efuse\_batch\_write\_commit (C++ function), 1199
- esp\_efuse\_block\_is\_empty (C++ function), 1200
- esp\_efuse\_block\_t (C++ enum), 1191
- esp\_efuse\_block\_t::EFUSE\_BLK0 (C++ enumerator), 1191
- esp\_efuse\_block\_t::EFUSE\_BLK1 (C++ enumerator), 1191
- esp\_efuse\_block\_t::EFUSE\_BLK10 (C++ enumerator), 1192
- esp\_efuse\_block\_t::EFUSE\_BLK2 (C++ enumerator), 1191
- esp\_efuse\_block\_t::EFUSE\_BLK3 (C++ enumerator), 1191
- esp\_efuse\_block\_t::EFUSE\_BLK4 (C++ enumerator), 1191
- esp\_efuse\_block\_t::EFUSE\_BLK5 (C++ enumerator), 1192
- esp\_efuse\_block\_t::EFUSE\_BLK6 (C++ enumerator), 1192
- esp\_efuse\_block\_t::EFUSE\_BLK7 (C++ enumerator), 1192
- esp\_efuse\_block\_t::EFUSE\_BLK8 (C++ enumerator), 1192
- esp\_efuse\_block\_t::EFUSE\_BLK9 (C++ enumerator), 1192
- esp\_efuse\_block\_t::EFUSE\_BLK\_KEY0 (C++ enumerator), 1192
- esp\_efuse\_block\_t::EFUSE\_BLK\_KEY1 (C++ enumerator), 1192
- esp\_efuse\_block\_t::EFUSE\_BLK\_KEY2 (C++ enumerator), 1192
- esp\_efuse\_block\_t::EFUSE\_BLK\_KEY3 (C++ enumerator), 1192
- esp\_efuse\_block\_t::EFUSE\_BLK\_KEY4 (C++ enumerator), 1192
- esp\_efuse\_block\_t::EFUSE\_BLK\_KEY5 (C++ enumerator), 1192
- esp\_efuse\_block\_t::EFUSE\_BLK\_KEY\_MAX (C++ enumerator), 1192
- esp\_efuse\_block\_t::EFUSE\_BLK\_MAX (C++ enumerator), 1192
- esp\_efuse\_block\_t::EFUSE\_BLK\_SYS\_DATA\_PART1 (C++ enumerator), 1191
- esp\_efuse\_block\_t::EFUSE\_BLK\_SYS\_DATA\_PART2 (C++ enumerator), 1192
- esp\_efuse\_block\_t::EFUSE\_BLK\_USER\_DATA (C++ enumerator), 1191
- esp\_efuse\_check\_errors (C++ function), 1203
- esp\_efuse\_check\_secure\_version (C++ function), 1198
- esp\_efuse\_coding\_scheme\_t (C++ enum), 1192
- esp\_efuse\_coding\_scheme\_t::EFUSE\_CODING\_SCHEME\_NO (C++ enumerator), 1192
- esp\_efuse\_coding\_scheme\_t::EFUSE\_CODING\_SCHEME\_RS (C++ enumerator), 1193
- esp\_efuse\_count\_unused\_key\_blocks (C++ function), 1202
- esp\_efuse\_desc\_t (C++ struct), 1203
- esp\_efuse\_desc\_t::bit\_count (C++ member), 1204
- esp\_efuse\_desc\_t::bit\_start (C++ member), 1204
- esp\_efuse\_desc\_t::efuse\_block (C++ member), 1203
- esp\_efuse\_disable\_rom\_download\_mode (C++ function), 1197
- esp\_efuse\_enable\_rom\_secure\_download\_mode (C++ function), 1198
- esp\_efuse\_find\_purpose (C++ function), 1200
- esp\_efuse\_find\_unused\_key\_block (C++ function), 1202
- esp\_efuse\_get\_coding\_scheme (C++ function), 1196
- esp\_efuse\_get\_digest\_revoke (C++ function), 1202
- esp\_efuse\_get\_field\_size (C++ function), 1196
- esp\_efuse\_get\_key (C++ function), 1201
- esp\_efuse\_get\_key\_dis\_read (C++ function), 1200
- esp\_efuse\_get\_key\_dis\_write (C++ function), 1200
- esp\_efuse\_get\_key\_purpose (C++ function), 1201
- esp\_efuse\_get\_keypurpose\_dis\_write





- macro*), 342  
 ESP\_ERR\_ESP\_NETIF\_INIT\_FAILED (*C macro*), 343  
 ESP\_ERR\_ESP\_NETIF\_INVALID\_PARAMS (*C macro*), 342  
 ESP\_ERR\_ESP\_NETIF\_IP6\_ADDR\_FAILED (*C macro*), 343  
 ESP\_ERR\_ESP\_NETIF\_MLD6\_FAILED (*C macro*), 343  
 ESP\_ERR\_ESP\_NETIF\_NO\_MEM (*C macro*), 342  
 ESP\_ERR\_ESP\_TLS\_BASE (*C macro*), 71  
 ESP\_ERR\_ESP\_TLS\_CANNOT\_CREATE\_SOCKET (*C macro*), 71  
 ESP\_ERR\_ESP\_TLS\_CANNOT\_RESOLVE\_HOSTNAME (*C macro*), 71  
 ESP\_ERR\_ESP\_TLS\_CONNECTION\_TIMEOUT (*C macro*), 71  
 ESP\_ERR\_ESP\_TLS\_FAILED\_CONNECT\_TO\_HOST (*C macro*), 71  
 ESP\_ERR\_ESP\_TLS\_SE\_FAILED (*C macro*), 71  
 ESP\_ERR\_ESP\_TLS\_SOCKET\_SETOPT\_FAILED (*C macro*), 71  
 ESP\_ERR\_ESP\_TLS\_TCP\_CLOSED\_FIN (*C macro*), 71  
 ESP\_ERR\_ESP\_TLS\_UNSUPPORTED\_PROTOCOL\_FAMILY (*C macro*), 71  
 ESP\_ERR\_ESPNOW\_ARG (*C macro*), 165  
 ESP\_ERR\_ESPNOW\_BASE (*C macro*), 165  
 ESP\_ERR\_ESPNOW\_EXIST (*C macro*), 165  
 ESP\_ERR\_ESPNOW\_FULL (*C macro*), 165  
 ESP\_ERR\_ESPNOW\_IF (*C macro*), 165  
 ESP\_ERR\_ESPNOW\_INTERNAL (*C macro*), 165  
 ESP\_ERR\_ESPNOW\_NO\_MEM (*C macro*), 165  
 ESP\_ERR\_ESPNOW\_NOT\_FOUND (*C macro*), 165  
 ESP\_ERR\_ESPNOW\_NOT\_INIT (*C macro*), 165  
 ESP\_ERR\_FLASH\_BASE (*C macro*), 1207  
 ESP\_ERR\_FLASH\_NOT\_INITIALISED (*C macro*), 1120  
 ESP\_ERR\_FLASH\_OP\_FAIL (*C macro*), 1113  
 ESP\_ERR\_FLASH\_OP\_TIMEOUT (*C macro*), 1113  
 ESP\_ERR\_FLASH\_PROTECTED (*C macro*), 1120  
 ESP\_ERR\_FLASH\_UNSUPPORTED\_CHIP (*C macro*), 1120  
 ESP\_ERR\_FLASH\_UNSUPPORTED\_HOST (*C macro*), 1120  
 ESP\_ERR\_HTTP\_BASE (*C macro*), 85  
 ESP\_ERR\_HTTP\_CONNECT (*C macro*), 85  
 ESP\_ERR\_HTTP\_CONNECTING (*C macro*), 85  
 ESP\_ERR\_HTTP\_CONNECTION\_CLOSED (*C macro*), 85  
 ESP\_ERR\_HTTP\_EAGAIN (*C macro*), 85  
 ESP\_ERR\_HTTP\_FETCH\_HEADER (*C macro*), 85  
 ESP\_ERR\_HTTP\_INVALID\_TRANSPORT (*C macro*), 85  
 ESP\_ERR\_HTTP\_MAX\_REDIRECT (*C macro*), 85  
 ESP\_ERR\_HTTP\_WRITE\_DATA (*C macro*), 85  
 ESP\_ERR\_HTTPD\_ALLOC\_MEM (*C macro*), 138  
 ESP\_ERR\_HTTPD\_BASE (*C macro*), 137  
 ESP\_ERR\_HTTPD\_HANDLER\_EXISTS (*C macro*), 137  
 ESP\_ERR\_HTTPD\_HANDLERS\_FULL (*C macro*), 137  
 ESP\_ERR\_HTTPD\_INVALID\_REQ (*C macro*), 137  
 ESP\_ERR\_HTTPD\_RESP\_HDR (*C macro*), 137  
 ESP\_ERR\_HTTPD\_RESP\_SEND (*C macro*), 138  
 ESP\_ERR\_HTTPD\_RESULT\_TRUNC (*C macro*), 137  
 ESP\_ERR\_HTTPD\_TASK (*C macro*), 138  
 ESP\_ERR\_HTTPS\_OTA\_BASE (*C macro*), 1213  
 ESP\_ERR\_HTTPS\_OTA\_IN\_PROGRESS (*C macro*), 1213  
 ESP\_ERR\_HW\_CRYPTO\_BASE (*C macro*), 1207  
 ESP\_ERR\_HW\_CRYPTO\_DS\_HMAC\_FAIL (*C macro*), 432  
 ESP\_ERR\_HW\_CRYPTO\_DS\_INVALID\_DIGEST (*C macro*), 432  
 ESP\_ERR\_HW\_CRYPTO\_DS\_INVALID\_KEY (*C macro*), 432  
 ESP\_ERR\_HW\_CRYPTO\_DS\_INVALID\_PADDING (*C macro*), 432  
 ESP\_ERR\_INVALID\_ARG (*C macro*), 1206  
 ESP\_ERR\_INVALID\_CRC (*C macro*), 1207  
 ESP\_ERR\_INVALID\_MAC (*C macro*), 1207  
 ESP\_ERR\_INVALID\_RESPONSE (*C macro*), 1207  
 ESP\_ERR\_INVALID\_SIZE (*C macro*), 1206  
 ESP\_ERR\_INVALID\_STATE (*C macro*), 1206  
 ESP\_ERR\_INVALID\_VERSION (*C macro*), 1207  
 ESP\_ERR\_MBEDTLS\_CERT\_PARTLY\_OK (*C macro*), 71  
 ESP\_ERR\_MBEDTLS\_CTR\_DRBG\_SEED\_FAILED (*C macro*), 71  
 ESP\_ERR\_MBEDTLS\_PK\_PARSE\_KEY\_FAILED (*C macro*), 72  
 ESP\_ERR\_MBEDTLS\_SSL\_CONF\_ALPN\_PROTOCOLS\_FAILED (*C macro*), 71  
 ESP\_ERR\_MBEDTLS\_SSL\_CONF\_OWN\_CERT\_FAILED (*C macro*), 72  
 ESP\_ERR\_MBEDTLS\_SSL\_CONF\_PSK\_FAILED (*C macro*), 72  
 ESP\_ERR\_MBEDTLS\_SSL\_CONFIG\_DEFAULTS\_FAILED (*C macro*), 71  
 ESP\_ERR\_MBEDTLS\_SSL\_HANDSHAKE\_FAILED (*C macro*), 72  
 ESP\_ERR\_MBEDTLS\_SSL\_SET\_HOSTNAME\_FAILED (*C macro*), 71  
 ESP\_ERR\_MBEDTLS\_SSL\_SETUP\_FAILED (*C macro*), 72  
 ESP\_ERR\_MBEDTLS\_SSL\_TICKET\_SETUP\_FAILED (*C macro*), 72  
 ESP\_ERR\_MBEDTLS\_SSL\_WRITE\_FAILED (*C macro*), 72  
 ESP\_ERR\_MBEDTLS\_X509\_CRT\_PARSE\_FAILED (*C macro*), 72  
 ESP\_ERR\_MEMPROT\_BASE (*C macro*), 1207  
 ESP\_ERR\_MESH\_ARGUMENT (*C macro*), 199  
 ESP\_ERR\_MESH\_BASE (*C macro*), 1207  
 ESP\_ERR\_MESH\_DISCARD (*C macro*), 199

- ESP\_ERR\_MESH\_DISCARD\_DUPLICATE (C macro), 199
- ESP\_ERR\_MESH\_DISCONNECTED (C macro), 199
- ESP\_ERR\_MESH\_EXCEED\_MTU (C macro), 199
- ESP\_ERR\_MESH\_INTERFACE (C macro), 199
- ESP\_ERR\_MESH\_NO\_MEMORY (C macro), 198
- ESP\_ERR\_MESH\_NO\_PARENT\_FOUND (C macro), 199
- ESP\_ERR\_MESH\_NO\_ROUTE\_FOUND (C macro), 199
- ESP\_ERR\_MESH\_NOT\_ALLOWED (C macro), 198
- ESP\_ERR\_MESH\_NOT\_CONFIG (C macro), 198
- ESP\_ERR\_MESH\_NOT\_INIT (C macro), 198
- ESP\_ERR\_MESH\_NOT\_START (C macro), 198
- ESP\_ERR\_MESH\_NOT\_SUPPORT (C macro), 198
- ESP\_ERR\_MESH\_OPTION\_NULL (C macro), 199
- ESP\_ERR\_MESH\_OPTION\_UNKNOWN (C macro), 199
- ESP\_ERR\_MESH\_PS (C macro), 200
- ESP\_ERR\_MESH\_QUEUE\_FAIL (C macro), 199
- ESP\_ERR\_MESH\_QUEUE\_FULL (C macro), 199
- ESP\_ERR\_MESH\_QUEUE\_READ (C macro), 200
- ESP\_ERR\_MESH\_RECV\_RELEASE (C macro), 200
- ESP\_ERR\_MESH\_TIMEOUT (C macro), 199
- ESP\_ERR\_MESH\_VOTING (C macro), 199
- ESP\_ERR\_MESH\_WIFI\_NOT\_START (C macro), 198
- ESP\_ERR\_MESH\_XMIT (C macro), 199
- ESP\_ERR\_MESH\_XON\_NO\_WINDOW (C macro), 199
- ESP\_ERR\_NO\_MEM (C macro), 1206
- ESP\_ERR\_NOT\_ENOUGH\_UNUSED\_KEY\_BLOCKS (C macro), 1204
- ESP\_ERR\_NOT\_FINISHED (C macro), 1207
- ESP\_ERR\_NOT\_FOUND (C macro), 1206
- ESP\_ERR\_NOT\_SUPPORTED (C macro), 1206
- ESP\_ERR\_NVS\_BASE (C macro), 1074
- ESP\_ERR\_NVS\_CONTENT\_DIFFERS (C macro), 1076
- ESP\_ERR\_NVS\_CORRUPT\_KEY\_PART (C macro), 1076
- ESP\_ERR\_NVS\_ENCR\_NOT\_SUPPORTED (C macro), 1076
- ESP\_ERR\_NVS\_INVALID\_HANDLE (C macro), 1075
- ESP\_ERR\_NVS\_INVALID\_LENGTH (C macro), 1075
- ESP\_ERR\_NVS\_INVALID\_NAME (C macro), 1075
- ESP\_ERR\_NVS\_INVALID\_STATE (C macro), 1075
- ESP\_ERR\_NVS\_KEY\_TOO\_LONG (C macro), 1075
- ESP\_ERR\_NVS\_KEYS\_NOT\_INITIALIZED (C macro), 1076
- ESP\_ERR\_NVS\_NEW\_VERSION\_FOUND (C macro), 1075
- ESP\_ERR\_NVS\_NO\_FREE\_PAGES (C macro), 1075
- ESP\_ERR\_NVS\_NOT\_ENOUGH\_SPACE (C macro), 1075
- ESP\_ERR\_NVS\_NOT\_FOUND (C macro), 1074
- ESP\_ERR\_NVS\_NOT\_INITIALIZED (C macro), 1074
- ESP\_ERR\_NVS\_PAGE\_FULL (C macro), 1075
- ESP\_ERR\_NVS\_PART\_NOT\_FOUND (C macro), 1075
- ESP\_ERR\_NVS\_READ\_ONLY (C macro), 1074
- ESP\_ERR\_NVS\_REMOVE\_FAILED (C macro), 1075
- ESP\_ERR\_NVS\_TYPE\_MISMATCH (C macro), 1074
- ESP\_ERR\_NVS\_VALUE\_TOO\_LONG (C macro), 1075
- ESP\_ERR\_NVS\_WRONG\_ENCRYPTION (C macro), 1076
- ESP\_ERR\_NVS\_XTS\_CFG\_FAILED (C macro), 1075
- ESP\_ERR\_NVS\_XTS\_CFG\_NOT\_FOUND (C macro), 1075
- ESP\_ERR\_NVS\_XTS\_DECR\_FAILED (C macro), 1075
- ESP\_ERR\_NVS\_XTS\_ENCR\_FAILED (C macro), 1075
- ESP\_ERR\_OTA\_BASE (C macro), 1436
- ESP\_ERR\_OTA\_PARTITION\_CONFLICT (C macro), 1436
- ESP\_ERR\_OTA\_ROLLBACK\_FAILED (C macro), 1436
- ESP\_ERR\_OTA\_ROLLBACK\_INVALID\_STATE (C macro), 1436
- ESP\_ERR\_OTA\_SELECT\_INFO\_INVALID (C macro), 1436
- ESP\_ERR\_OTA\_SMALL\_SEC\_VER (C macro), 1436
- ESP\_ERR\_OTA\_VALIDATE\_FAILED (C macro), 1436
- esp\_err\_t (C++ type), 1207
- ESP\_ERR\_TIMEOUT (C macro), 1207
- esp\_err\_to\_name (C++ function), 1206
- esp\_err\_to\_name\_r (C++ function), 1206
- ESP\_ERR\_ULP\_BASE (C macro), 1521
- ESP\_ERR\_ULP\_BRANCH\_OUT\_OF\_RANGE (C macro), 1522
- ESP\_ERR\_ULP\_DUPLICATE\_LABEL (C macro), 1521
- ESP\_ERR\_ULP\_INVALID\_LOAD\_ADDR (C macro), 1521
- ESP\_ERR\_ULP\_SIZE\_TOO\_BIG (C macro), 1521
- ESP\_ERR\_ULP\_UNDEFINED\_LABEL (C macro), 1521
- ESP\_ERR\_WIFI\_BASE (C macro), 1207
- ESP\_ERR\_WIFI\_CONN (C macro), 230
- ESP\_ERR\_WIFI\_DISCARD (C macro), 230
- ESP\_ERR\_WIFI\_IF (C macro), 229
- ESP\_ERR\_WIFI\_INIT\_STATE (C macro), 230
- ESP\_ERR\_WIFI\_MAC (C macro), 230
- ESP\_ERR\_WIFI\_MODE (C macro), 229
- ESP\_ERR\_WIFI\_NOT\_ASSOC (C macro), 230
- ESP\_ERR\_WIFI\_NOT\_CONNECT (C macro), 230
- ESP\_ERR\_WIFI\_NOT\_INIT (C macro), 229
- ESP\_ERR\_WIFI\_NOT\_STARTED (C macro), 229
- ESP\_ERR\_WIFI\_NOT\_STOPPED (C macro), 229
- ESP\_ERR\_WIFI\_NVS (C macro), 230
- ESP\_ERR\_WIFI\_PASSWORD (C macro), 230
- ESP\_ERR\_WIFI\_POST (C macro), 230
- ESP\_ERR\_WIFI\_REGISTRAR (C macro), 274
- ESP\_ERR\_WIFI\_ROC\_IN\_PROGRESS (C macro), 231

- ESP\_ERR\_WIFI\_SSID (*C macro*), 230
- ESP\_ERR\_WIFI\_STATE (*C macro*), 230
- ESP\_ERR\_WIFI\_STOP\_STATE (*C macro*), 230
- ESP\_ERR\_WIFI\_TIMEOUT (*C macro*), 230
- ESP\_ERR\_WIFI\_TX\_DISALLOW (*C macro*), 230
- ESP\_ERR\_WIFI\_WAKE\_FAIL (*C macro*), 230
- ESP\_ERR\_WIFI\_WOULD\_BLOCK (*C macro*), 230
- ESP\_ERR\_WIFI\_WPS\_SM (*C macro*), 274
- ESP\_ERR\_WIFI\_WPS\_TYPE (*C macro*), 274
- ESP\_ERR\_WOLFSSL\_CERT\_VERIFY\_SETUP\_FAILED (*C macro*), 72
- ESP\_ERR\_WOLFSSL\_CTX\_SETUP\_FAILED (*C macro*), 72
- ESP\_ERR\_WOLFSSL\_KEY\_VERIFY\_SETUP\_FAILED (*C macro*), 72
- ESP\_ERR\_WOLFSSL\_SSL\_CONF\_ALPN\_PROTOCOLS\_FAILED (*C macro*), 72
- ESP\_ERR\_WOLFSSL\_SSL\_HANDSHAKE\_FAILED (*C macro*), 72
- ESP\_ERR\_WOLFSSL\_SSL\_SET\_HOSTNAME\_FAILED (*C macro*), 72
- ESP\_ERR\_WOLFSSL\_SSL\_SETUP\_FAILED (*C macro*), 72
- ESP\_ERR\_WOLFSSL\_SSL\_WRITE\_FAILED (*C macro*), 72
- ESP\_ERROR\_CHECK (*C macro*), 1207
- ESP\_ERROR\_CHECK\_WITHOUT\_ABORT (*C macro*), 1207
- esp\_esptouch\_set\_timeout (*C++ function*), 207
- esp\_eth\_config\_t (*C++ struct*), 291
- esp\_eth\_config\_t::check\_link\_period\_ms (*C++ member*), 291
- esp\_eth\_config\_t::mac (*C++ member*), 291
- esp\_eth\_config\_t::on\_lowlevel\_deinit\_done (*C++ member*), 292
- esp\_eth\_config\_t::on\_lowlevel\_init\_done (*C++ member*), 291
- esp\_eth\_config\_t::phy (*C++ member*), 291
- esp\_eth\_config\_t::read\_phy\_reg (*C++ member*), 292
- esp\_eth\_config\_t::stack\_input (*C++ member*), 291
- esp\_eth\_config\_t::write\_phy\_reg (*C++ member*), 292
- esp\_eth\_decrease\_reference (*C++ function*), 291
- esp\_eth\_del\_netif\_glue (*C++ function*), 314
- esp\_eth\_driver\_install (*C++ function*), 288
- esp\_eth\_driver\_uninstall (*C++ function*), 288
- esp\_eth\_handle\_t (*C++ type*), 293
- esp\_eth\_increase\_reference (*C++ function*), 291
- esp\_eth\_io\_cmd\_t (*C++ enum*), 293
- esp\_eth\_io\_cmd\_t::ETH\_CMD\_CUSTOM\_MAC\_CMDS (*C++ enumerator*), 294
- esp\_eth\_io\_cmd\_t::ETH\_CMD\_CUSTOM\_PHY\_CMDS (*C++ enumerator*), 294
- esp\_eth\_io\_cmd\_t::ETH\_CMD\_G\_AUTONEGO (*C++ enumerator*), 293
- esp\_eth\_io\_cmd\_t::ETH\_CMD\_G\_DUPLEX\_MODE (*C++ enumerator*), 294
- esp\_eth\_io\_cmd\_t::ETH\_CMD\_G\_MAC\_ADDR (*C++ enumerator*), 293
- esp\_eth\_io\_cmd\_t::ETH\_CMD\_G\_PHY\_ADDR (*C++ enumerator*), 293
- esp\_eth\_io\_cmd\_t::ETH\_CMD\_G\_SPEED (*C++ enumerator*), 293
- esp\_eth\_io\_cmd\_t::ETH\_CMD\_READ\_PHY\_REG (*C++ enumerator*), 294
- esp\_eth\_io\_cmd\_t::ETH\_CMD\_S\_AUTONEGO (*C++ enumerator*), 293
- esp\_eth\_io\_cmd\_t::ETH\_CMD\_S\_DUPLEX\_MODE (*C++ enumerator*), 294
- esp\_eth\_io\_cmd\_t::ETH\_CMD\_S\_FLOW\_CTRL (*C++ enumerator*), 293
- esp\_eth\_io\_cmd\_t::ETH\_CMD\_S\_MAC\_ADDR (*C++ enumerator*), 293
- esp\_eth\_io\_cmd\_t::ETH\_CMD\_S\_PHY\_ADDR (*C++ enumerator*), 293
- esp\_eth\_io\_cmd\_t::ETH\_CMD\_S\_PHY\_LOOPBACK (*C++ enumerator*), 294
- esp\_eth\_io\_cmd\_t::ETH\_CMD\_S\_PROMISCUOUS (*C++ enumerator*), 293
- esp\_eth\_io\_cmd\_t::ETH\_CMD\_S\_SPEED (*C++ enumerator*), 293
- esp\_eth\_io\_cmd\_t::ETH\_CMD\_WRITE\_PHY\_REG (*C++ enumerator*), 294
- esp\_eth\_ioctl (*C++ function*), 290
- esp\_eth\_mac\_s (*C++ struct*), 296
- esp\_eth\_mac\_s::custom\_ioctl (*C++ member*), 300
- esp\_eth\_mac\_s::deinit (*C++ member*), 297
- esp\_eth\_mac\_s::del (*C++ member*), 300
- esp\_eth\_mac\_s::enable\_flow\_ctrl (*C++ member*), 300
- esp\_eth\_mac\_s::get\_addr (*C++ member*), 299
- esp\_eth\_mac\_s::init (*C++ member*), 297
- esp\_eth\_mac\_s::read\_phy\_reg (*C++ member*), 298
- esp\_eth\_mac\_s::receive (*C++ member*), 298
- esp\_eth\_mac\_s::set\_addr (*C++ member*), 299
- esp\_eth\_mac\_s::set\_duplex (*C++ member*), 299
- esp\_eth\_mac\_s::set\_link (*C++ member*), 299
- esp\_eth\_mac\_s::set\_mediator (*C++ member*), 297
- esp\_eth\_mac\_s::set\_peer\_pause\_ability (*C++ member*), 300
- esp\_eth\_mac\_s::set\_promiscuous (*C++ member*), 300
- esp\_eth\_mac\_s::set\_speed (*C++ member*), 299
- esp\_eth\_mac\_s::start (*C++ member*), 297
- esp\_eth\_mac\_s::stop (*C++ member*), 297

- esp\_eth\_mac\_s::transmit (C++ member), 297  
 esp\_eth\_mac\_s::transmit\_vargs (C++ member), 298  
 esp\_eth\_mac\_s::write\_phy\_reg (C++ member), 299  
 esp\_eth\_mac\_t (C++ type), 301  
 esp\_eth\_mediator\_s (C++ struct), 294  
 esp\_eth\_mediator\_s::on\_state\_changed (C++ member), 295  
 esp\_eth\_mediator\_s::phy\_reg\_read (C++ member), 294  
 esp\_eth\_mediator\_s::phy\_reg\_write (C++ member), 294  
 esp\_eth\_mediator\_s::stack\_input (C++ member), 295  
 esp\_eth\_mediator\_t (C++ type), 295  
 esp\_eth\_netif\_glue\_handle\_t (C++ type), 314  
 esp\_eth\_new\_netif\_glue (C++ function), 314  
 esp\_eth\_phy\_802\_3\_advertise\_pause\_ability (C++ function), 308  
 esp\_eth\_phy\_802\_3\_autonego\_ctrl (C++ function), 308  
 esp\_eth\_phy\_802\_3\_basic\_phy\_deinit (C++ function), 310  
 esp\_eth\_phy\_802\_3\_basic\_phy\_init (C++ function), 310  
 esp\_eth\_phy\_802\_3\_deinit (C++ function), 309  
 esp\_eth\_phy\_802\_3\_del (C++ function), 309  
 esp\_eth\_phy\_802\_3\_detect\_phy\_addr (C++ function), 310  
 esp\_eth\_phy\_802\_3\_get\_addr (C++ function), 308  
 esp\_eth\_phy\_802\_3\_get\_mmd\_addr (C++ function), 311  
 esp\_eth\_phy\_802\_3\_init (C++ function), 309  
 esp\_eth\_phy\_802\_3\_loopback (C++ function), 308  
 esp\_eth\_phy\_802\_3\_mmd\_func\_t (C++ enum), 313  
 esp\_eth\_phy\_802\_3\_mmd\_func\_t::MMD\_FUNC\_ADDRESS (C++ enumerator), 313  
 esp\_eth\_phy\_802\_3\_mmd\_func\_t::MMD\_FUNC\_DATA\_NO\_INC (C++ enumerator), 313  
 esp\_eth\_phy\_802\_3\_mmd\_func\_t::MMD\_FUNC\_DATA\_RW\_INC (C++ enumerator), 313  
 esp\_eth\_phy\_802\_3\_mmd\_func\_t::MMD\_FUNC\_DATA\_WINDO (C++ enumerator), 313  
 esp\_eth\_phy\_802\_3\_obj\_config\_init (C++ function), 312  
 esp\_eth\_phy\_802\_3\_pwrctl (C++ function), 308  
 esp\_eth\_phy\_802\_3\_read\_manufac\_info (C++ function), 310  
 esp\_eth\_phy\_802\_3\_read\_mmd\_data (C++ function), 311  
 esp\_eth\_phy\_802\_3\_read\_mmd\_register (C++ function), 312  
 esp\_eth\_phy\_802\_3\_read\_oui (C++ function), 310  
 esp\_eth\_phy\_802\_3\_reset (C++ function), 307  
 esp\_eth\_phy\_802\_3\_reset\_hw (C++ function), 309  
 esp\_eth\_phy\_802\_3\_set\_addr (C++ function), 308  
 esp\_eth\_phy\_802\_3\_set\_duplex (C++ function), 309  
 esp\_eth\_phy\_802\_3\_set\_link (C++ function), 309  
 esp\_eth\_phy\_802\_3\_set\_mediator (C++ function), 307  
 esp\_eth\_phy\_802\_3\_set\_mmd\_addr (C++ function), 311  
 esp\_eth\_phy\_802\_3\_set\_speed (C++ function), 309  
 esp\_eth\_phy\_802\_3\_write\_mmd\_data (C++ function), 311  
 esp\_eth\_phy\_802\_3\_write\_mmd\_register (C++ function), 312  
 ESP\_ETH\_PHY\_ADDR\_AUTO (C macro), 307  
 esp\_eth\_phy\_into\_phy\_802\_3 (C++ function), 312  
 esp\_eth\_phy\_new\_dp83848 (C++ function), 303  
 esp\_eth\_phy\_new\_ip101 (C++ function), 302  
 esp\_eth\_phy\_new\_ksz80xx (C++ function), 303  
 esp\_eth\_phy\_new\_lan87xx (C++ function), 303  
 esp\_eth\_phy\_new\_rtl8201 (C++ function), 303  
 esp\_eth\_phy\_reg\_rw\_data\_t (C++ struct), 292  
 esp\_eth\_phy\_reg\_rw\_data\_t::reg\_addr (C++ member), 292  
 esp\_eth\_phy\_reg\_rw\_data\_t::reg\_value\_p (C++ member), 293  
 esp\_eth\_phy\_s (C++ struct), 303  
 esp\_eth\_phy\_s::advertise\_pause\_ability (C++ member), 305  
 esp\_eth\_phy\_s::autonego\_ctrl (C++ member), 304  
 esp\_eth\_phy\_s::custom\_ioctl (C++ member), 306  
 esp\_eth\_phy\_s::deinit (C++ member), 304  
 esp\_eth\_phy\_s::del (C++ member), 306  
 esp\_eth\_phy\_s::get\_addr (C++ member), 305  
 esp\_eth\_phy\_s::get\_link (C++ member), 304  
 esp\_eth\_phy\_s::init (C++ member), 304  
 esp\_eth\_phy\_s::loopback (C++ member), 305  
 esp\_eth\_phy\_s::pwrctl (C++ member), 305  
 esp\_eth\_phy\_s::reset (C++ member), 303  
 esp\_eth\_phy\_s::reset\_hw (C++ member), 304  
 esp\_eth\_phy\_s::set\_addr (C++ member), 305  
 esp\_eth\_phy\_s::set\_duplex (C++ member), 306  
 esp\_eth\_phy\_s::set\_link (C++ member), 304  
 esp\_eth\_phy\_s::set\_mediator (C++ member), 303  
 esp\_eth\_phy\_s::set\_speed (C++ member),

- 305
- `esp_eth_phy_t` (C++ type), 307
- `esp_eth_start` (C++ function), 288
- `esp_eth_state_t` (C++ enum), 295
- `esp_eth_state_t::ETH_STATE_DEINIT` (C++ enumerator), 295
- `esp_eth_state_t::ETH_STATE_DUPLEX` (C++ enumerator), 295
- `esp_eth_state_t::ETH_STATE_LINK` (C++ enumerator), 295
- `esp_eth_state_t::ETH_STATE_LLINIT` (C++ enumerator), 295
- `esp_eth_state_t::ETH_STATE_PAUSE` (C++ enumerator), 295
- `esp_eth_state_t::ETH_STATE_SPEED` (C++ enumerator), 295
- `esp_eth_stop` (C++ function), 289
- `esp_eth_transmit` (C++ function), 289
- `esp_eth_transmit_vars` (C++ function), 289
- `esp_eth_update_input_path` (C++ function), 289
- `ESP_EVENT_ANY_BASE` (C macro), 1226
- `ESP_EVENT_ANY_ID` (C macro), 1226
- `ESP_EVENT_DECLARE_BASE` (C macro), 1226
- `ESP_EVENT_DEFINE_BASE` (C macro), 1226
- `esp_event_dump` (C++ function), 1225
- `esp_event_handler_instance_register` (C++ function), 1221
- `esp_event_handler_instance_register_with` (C++ function), 1220
- `esp_event_handler_instance_t` (C++ type), 1227
- `esp_event_handler_instance_unregister` (C++ function), 1223
- `esp_event_handler_instance_unregister_with` (C++ function), 1222
- `esp_event_handler_register` (C++ function), 1219
- `esp_event_handler_register_with` (C++ function), 1220
- `esp_event_handler_t` (C++ type), 1227
- `esp_event_handler_unregister` (C++ function), 1222
- `esp_event_handler_unregister_with` (C++ function), 1222
- `esp_event_isr_post` (C++ function), 1224
- `esp_event_isr_post_to` (C++ function), 1224
- `esp_event_loop_args_t` (C++ struct), 1226
- `esp_event_loop_args_t::queue_size` (C++ member), 1226
- `esp_event_loop_args_t::task_core_id` (C++ member), 1226
- `esp_event_loop_args_t::task_name` (C++ member), 1226
- `esp_event_loop_args_t::task_priority` (C++ member), 1226
- `esp_event_loop_args_t::task_stack_size` (C++ member), 1226
- `esp_event_loop_create` (C++ function), 1218
- `esp_event_loop_create_default` (C++ function), 1218
- `esp_event_loop_delete` (C++ function), 1218
- `esp_event_loop_delete_default` (C++ function), 1218
- `esp_event_loop_handle_t` (C++ type), 1227
- `esp_event_loop_run` (C++ function), 1218
- `esp_event_post` (C++ function), 1223
- `esp_event_post_to` (C++ function), 1224
- `ESP_EXECUTE_EXPRESSION_WITH_STACK` (C macro), 1165
- `esp_execute_shared_stack_function` (C++ function), 1165
- `ESP_FAIL` (C macro), 1206
- `esp_fill_random` (C++ function), 1451
- `esp_flash_chip_driver_initialized` (C++ function), 1104
- `esp_flash_enc_mode_t` (C++ enum), 1131
- `esp_flash_enc_mode_t::ESP_FLASH_ENC_MODE_DEVELOPMENT` (C++ enumerator), 1131
- `esp_flash_enc_mode_t::ESP_FLASH_ENC_MODE_DISABLED` (C++ enumerator), 1131
- `esp_flash_enc_mode_t::ESP_FLASH_ENC_MODE_RELEASE` (C++ enumerator), 1131
- `esp_flash_encrypt_check_and_update` (C++ function), 1129
- `esp_flash_encrypt_contents` (C++ function), 1129
- `esp_flash_encrypt_enable` (C++ function), 1130
- `esp_flash_encrypt_init` (C++ function), 1129
- `esp_flash_encrypt_initialized_once` (C++ function), 1129
- `esp_flash_encrypt_is_write_protected` (C++ function), 1130
- `esp_flash_encrypt_region` (C++ function), 1130
- `esp_flash_encrypt_state` (C++ function), 1129
- `esp_flash_encryption_cfg_verify_release_mode` (C++ function), 1131
- `esp_flash_encryption_enable_secure_features` (C++ function), 1131
- `esp_flash_encryption_enabled` (C++ function), 1129
- `esp_flash_encryption_init_checks` (C++ function), 1130
- `esp_flash_encryption_set_release_mode` (C++ function), 1131
- `esp_flash_erase_chip` (C++ function), 1106
- `esp_flash_erase_region` (C++ function), 1106
- `esp_flash_get_chip_write_protect` (C++ function), 1106
- `esp_flash_get_physical_size` (C++ function), 1105
- `esp_flash_get_protectable_regions` (C++ function), 1107



- esp\_flash\_get\_protected\_region (C++ function), 1107  
 esp\_flash\_get\_size (C++ function), 1105  
 esp\_flash\_init (C++ function), 1104  
 esp\_flash\_io\_mode\_t (C++ enum), 1119  
 esp\_flash\_io\_mode\_t::SPI\_FLASH\_DIO (C++ enumerator), 1119  
 esp\_flash\_io\_mode\_t::SPI\_FLASH\_DOUT (C++ enumerator), 1119  
 esp\_flash\_io\_mode\_t::SPI\_FLASH\_FASTRD (C++ enumerator), 1119  
 esp\_flash\_io\_mode\_t::SPI\_FLASH\_OPI\_DTR (C++ enumerator), 1120  
 esp\_flash\_io\_mode\_t::SPI\_FLASH\_OPI\_STR (C++ enumerator), 1120  
 esp\_flash\_io\_mode\_t::SPI\_FLASH\_QIO (C++ enumerator), 1120  
 esp\_flash\_io\_mode\_t::SPI\_FLASH\_QOUT (C++ enumerator), 1120  
 esp\_flash\_io\_mode\_t::SPI\_FLASH\_READ\_MODE\_MAX (C++ enumerator), 1120  
 esp\_flash\_io\_mode\_t::SPI\_FLASH\_SLOWRD (C++ enumerator), 1119  
 esp\_flash\_is\_quad\_mode (C++ function), 1109  
 esp\_flash\_os\_functions\_t (C++ struct), 1109  
 esp\_flash\_os\_functions\_t::check\_yield (C++ member), 1110  
 esp\_flash\_os\_functions\_t::delay\_us (C++ member), 1110  
 esp\_flash\_os\_functions\_t::end (C++ member), 1110  
 esp\_flash\_os\_functions\_t::get\_system\_time (C++ member), 1110  
 esp\_flash\_os\_functions\_t::get\_temp\_buffer (C++ member), 1110  
 esp\_flash\_os\_functions\_t::region\_protected (C++ member), 1110  
 esp\_flash\_os\_functions\_t::release\_temp\_buffer (C++ member), 1110  
 esp\_flash\_os\_functions\_t::set\_flash\_operation\_status (C++ member), 1110  
 esp\_flash\_os\_functions\_t::start (C++ member), 1110  
 esp\_flash\_os\_functions\_t::yield (C++ member), 1110  
 esp\_flash\_read (C++ function), 1108  
 esp\_flash\_read\_encrypted (C++ function), 1109  
 esp\_flash\_read\_id (C++ function), 1104  
 esp\_flash\_read\_unique\_chip\_id (C++ function), 1105  
 esp\_flash\_region\_t (C++ struct), 1109  
 esp\_flash\_region\_t::offset (C++ member), 1109  
 esp\_flash\_region\_t::size (C++ member), 1109  
 esp\_flash\_set\_chip\_write\_protect (C++ function), 1106  
 esp\_flash\_set\_protected\_region (C++ function), 1107  
 esp\_flash\_speed\_s (C++ enum), 1119  
 esp\_flash\_speed\_s::ESP\_FLASH\_10MHZ (C++ enumerator), 1119  
 esp\_flash\_speed\_s::ESP\_FLASH\_120MHZ (C++ enumerator), 1119  
 esp\_flash\_speed\_s::ESP\_FLASH\_20MHZ (C++ enumerator), 1119  
 esp\_flash\_speed\_s::ESP\_FLASH\_26MHZ (C++ enumerator), 1119  
 esp\_flash\_speed\_s::ESP\_FLASH\_40MHZ (C++ enumerator), 1119  
 esp\_flash\_speed\_s::ESP\_FLASH\_5MHZ (C++ enumerator), 1119  
 esp\_flash\_speed\_s::ESP\_FLASH\_80MHZ (C++ enumerator), 1119  
 esp\_flash\_speed\_s::ESP\_FLASH\_SPEED\_MAX (C++ enumerator), 1119  
 esp\_flash\_speed\_t (C++ type), 1118  
 esp\_flash\_spi\_device\_config\_t (C++ struct), 1103  
 esp\_flash\_spi\_device\_config\_t::cs\_id (C++ member), 1104  
 esp\_flash\_spi\_device\_config\_t::cs\_io\_num (C++ member), 1104  
 esp\_flash\_spi\_device\_config\_t::freq\_mhz (C++ member), 1104  
 esp\_flash\_spi\_device\_config\_t::host\_id (C++ member), 1103  
 esp\_flash\_spi\_device\_config\_t::input\_delay\_ns (C++ member), 1104  
 esp\_flash\_spi\_device\_config\_t::io\_mode (C++ member), 1104  
 esp\_flash\_spi\_device\_config\_t::speed (C++ member), 1104  
 esp\_flash\_t (C++ struct), 1110  
 esp\_flash\_t (C++ type), 1111  
 esp\_flash\_t::busy (C++ member), 1111  
 esp\_flash\_t::chip\_drv (C++ member), 1110  
 esp\_flash\_t::chip\_id (C++ member), 1111  
 esp\_flash\_t::host (C++ member), 1110  
 esp\_flash\_t::hpm\_dummy\_ena (C++ member), 1111  
 esp\_flash\_t::os\_func (C++ member), 1111  
 esp\_flash\_t::os\_func\_data (C++ member), 1111  
 esp\_flash\_t::read\_mode (C++ member), 1111  
 esp\_flash\_t::reserved\_flags (C++ member), 1111  
 esp\_flash\_t::size (C++ member), 1111  
 esp\_flash\_write (C++ function), 1108  
 esp\_flash\_write\_encrypted (C++ function), 1108  
 esp\_flash\_write\_protect\_crypt\_cnt (C++ function), 1130  
 esp\_freertos\_idle\_cb\_t (C++ type), 1365  
 esp\_freertos\_tick\_cb\_t (C++ type), 1366

- esp\_gcov\_dump (C++ function), 1163  
 esp\_get\_deep\_sleep\_wake\_stub (C++ function), 1462  
 esp\_get\_flash\_encryption\_mode (C++ function), 1130  
 esp\_get\_free\_heap\_size (C++ function), 1414  
 esp\_get\_free\_internal\_heap\_size (C++ function), 1414  
 esp\_get\_idf\_version (C++ function), 1415  
 esp\_get\_minimum\_free\_heap\_size (C++ function), 1414  
 ESP\_GOTO\_ON\_ERROR (C macro), 1205  
 ESP\_GOTO\_ON\_ERROR\_ISR (C macro), 1205  
 ESP\_GOTO\_ON\_FALSE (C macro), 1205  
 ESP\_GOTO\_ON\_FALSE\_ISR (C macro), 1205  
 esp\_hmac\_calculate (C++ function), 426  
 esp\_hmac\_jtag\_disable (C++ function), 427  
 esp\_hmac\_jtag\_enable (C++ function), 427  
 esp\_http\_client\_add\_auth (C++ function), 80  
 esp\_http\_client\_auth\_type\_t (C++ enum), 88  
 esp\_http\_client\_auth\_type\_t::HTTP\_AUTH\_TYPE\_BASIC (C++ enumerator), 88  
 esp\_http\_client\_auth\_type\_t::HTTP\_AUTH\_TYPE\_DIGEST (C++ enumerator), 88  
 esp\_http\_client\_auth\_type\_t::HTTP\_AUTH\_TYPE\_NONE (C++ enumerator), 88  
 esp\_http\_client\_cleanup (C++ function), 80  
 esp\_http\_client\_close (C++ function), 80  
 esp\_http\_client\_config\_t (C++ struct), 82  
 esp\_http\_client\_config\_t::auth\_type (C++ member), 82  
 esp\_http\_client\_config\_t::buffer\_size (C++ member), 84  
 esp\_http\_client\_config\_t::buffer\_size\_bytes (C++ member), 84  
 esp\_http\_client\_config\_t::cert\_len (C++ member), 83  
 esp\_http\_client\_config\_t::cert\_pem (C++ member), 83  
 esp\_http\_client\_config\_t::client\_cert\_len (C++ member), 83  
 esp\_http\_client\_config\_t::client\_cert\_pem (C++ member), 83  
 esp\_http\_client\_config\_t::client\_key\_len (C++ member), 83  
 esp\_http\_client\_config\_t::client\_key\_password (C++ member), 83  
 esp\_http\_client\_config\_t::client\_key\_password\_len (C++ member), 83  
 esp\_http\_client\_config\_t::client\_key\_password\_type (C++ member), 83  
 esp\_http\_client\_config\_t::crt\_bundle\_attach (C++ member), 84  
 esp\_http\_client\_config\_t::disable\_auto\_redirect (C++ member), 83  
 esp\_http\_client\_config\_t::ds\_data (C++ member), 84  
 esp\_http\_client\_config\_t::event\_handler (C++ member), 84  
 esp\_http\_client\_config\_t::host (C++ member), 82  
 esp\_http\_client\_config\_t::if\_name (C++ member), 84  
 esp\_http\_client\_config\_t::is\_async (C++ member), 84  
 esp\_http\_client\_config\_t::keep\_alive\_count (C++ member), 84  
 esp\_http\_client\_config\_t::keep\_alive\_enable (C++ member), 84  
 esp\_http\_client\_config\_t::keep\_alive\_idle (C++ member), 84  
 esp\_http\_client\_config\_t::keep\_alive\_interval (C++ member), 84  
 esp\_http\_client\_config\_t::max\_authorization\_retries (C++ member), 84  
 esp\_http\_client\_config\_t::max\_redirection\_count (C++ member), 83  
 esp\_http\_client\_config\_t::method (C++ member), 83  
 esp\_http\_client\_config\_t::password (C++ member), 82  
 esp\_http\_client\_config\_t::path (C++ member), 83  
 esp\_http\_client\_config\_t::port (C++ member), 82  
 esp\_http\_client\_config\_t::query (C++ member), 83  
 esp\_http\_client\_config\_t::skip\_cert\_common\_name\_check (C++ member), 84  
 esp\_http\_client\_config\_t::timeout\_ms (C++ member), 83  
 esp\_http\_client\_config\_t::tls\_version (C++ member), 83  
 esp\_http\_client\_config\_t::transport\_type (C++ member), 84  
 esp\_http\_client\_config\_t::url (C++ member), 82  
 esp\_http\_client\_config\_t::use\_global\_ca\_store (C++ member), 84  
 esp\_http\_client\_config\_t::user\_agent (C++ member), 83  
 esp\_http\_client\_config\_t::user\_data (C++ member), 84  
 esp\_http\_client\_config\_t::username (C++ member), 82  
 esp\_http\_client\_delete\_header (C++ function), 78  
 esp\_http\_client\_event (C++ struct), 82  
 esp\_http\_client\_event::client (C++ member), 82  
 esp\_http\_client\_event::data (C++ member), 82  
 esp\_http\_client\_event::data\_len (C++ member), 82  
 esp\_http\_client\_event::event\_id (C++

- member*), 82  
 esp\_http\_client\_event::header\_key (C++ member), 82  
 esp\_http\_client\_event::header\_value (C++ member), 82  
 esp\_http\_client\_event::user\_data (C++ member), 82  
 esp\_http\_client\_event\_handle\_t (C++ type), 85  
 esp\_http\_client\_event\_id\_t (C++ enum), 85  
 esp\_http\_client\_event\_id\_t::HTTP\_EVENT\_DISCONNECT (C++ enumerator), 86  
 esp\_http\_client\_event\_id\_t::HTTP\_EVENT\_ERROR (C++ enumerator), 85  
 esp\_http\_client\_event\_id\_t::HTTP\_EVENT\_HEADER\_SENT (C++ enumerator), 86  
 esp\_http\_client\_event\_id\_t::HTTP\_EVENT\_HEADERS\_SENT (C++ enumerator), 86  
 esp\_http\_client\_event\_id\_t::HTTP\_EVENT\_ON\_CONNECTED (C++ enumerator), 86  
 esp\_http\_client\_event\_id\_t::HTTP\_EVENT\_ON\_DATA (C++ enumerator), 86  
 esp\_http\_client\_event\_id\_t::HTTP\_EVENT\_ON\_FINISH (C++ enumerator), 86  
 esp\_http\_client\_event\_id\_t::HTTP\_EVENT\_ON\_HEADERS\_SENT (C++ enumerator), 86  
 esp\_http\_client\_event\_id\_t::HTTP\_EVENT\_REDIRECT (C++ enumerator), 86  
 esp\_http\_client\_event\_t (C++ type), 85  
 esp\_http\_client\_fetch\_headers (C++ function), 79  
 esp\_http\_client\_flush\_response (C++ function), 81  
 esp\_http\_client\_get\_chunk\_length (C++ function), 81  
 esp\_http\_client\_get\_content\_length (C++ function), 80  
 esp\_http\_client\_get\_errno (C++ function), 78  
 esp\_http\_client\_get\_header (C++ function), 77  
 esp\_http\_client\_get\_password (C++ function), 77  
 esp\_http\_client\_get\_post\_field (C++ function), 77  
 esp\_http\_client\_get\_status\_code (C++ function), 79  
 esp\_http\_client\_get\_transport\_type (C++ function), 80  
 esp\_http\_client\_get\_url (C++ function), 81  
 esp\_http\_client\_get\_username (C++ function), 77  
 esp\_http\_client\_handle\_t (C++ type), 85  
 esp\_http\_client\_init (C++ function), 76  
 esp\_http\_client\_is\_chunked\_response (C++ function), 79  
 esp\_http\_client\_is\_complete\_data\_received (C++ function), 81  
 esp\_http\_client\_method\_t (C++ enum), 87  
 esp\_http\_client\_method\_t::HTTP\_METHOD\_COPY (C++ enumerator), 87  
 esp\_http\_client\_method\_t::HTTP\_METHOD\_DELETE (C++ enumerator), 87  
 esp\_http\_client\_method\_t::HTTP\_METHOD\_GET (C++ enumerator), 87  
 esp\_http\_client\_method\_t::HTTP\_METHOD\_HEAD (C++ enumerator), 87  
 esp\_http\_client\_method\_t::HTTP\_METHOD\_LOCK (C++ enumerator), 87  
 esp\_http\_client\_method\_t::HTTP\_METHOD\_MAX (C++ enumerator), 87  
 esp\_http\_client\_method\_t::HTTP\_METHOD\_MKCOL (C++ enumerator), 88  
 esp\_http\_client\_method\_t::HTTP\_METHOD\_MOVE (C++ enumerator), 87  
 esp\_http\_client\_method\_t::HTTP\_METHOD\_NOTIFY (C++ enumerator), 87  
 esp\_http\_client\_method\_t::HTTP\_METHOD\_OPTIONS (C++ enumerator), 87  
 esp\_http\_client\_method\_t::HTTP\_METHOD\_PATCH (C++ enumerator), 87  
 esp\_http\_client\_method\_t::HTTP\_METHOD\_POST (C++ enumerator), 87  
 esp\_http\_client\_method\_t::HTTP\_METHOD\_PROPFIND (C++ enumerator), 87  
 esp\_http\_client\_method\_t::HTTP\_METHOD\_PROPPATCH (C++ enumerator), 88  
 esp\_http\_client\_method\_t::HTTP\_METHOD\_PUT (C++ enumerator), 87  
 esp\_http\_client\_method\_t::HTTP\_METHOD\_SUBSCRIBE (C++ enumerator), 87  
 esp\_http\_client\_method\_t::HTTP\_METHOD\_UNLOCK (C++ enumerator), 87  
 esp\_http\_client\_method\_t::HTTP\_METHOD\_UNSUBSCRIBE (C++ enumerator), 87  
 esp\_http\_client\_open (C++ function), 79  
 esp\_http\_client\_perform (C++ function), 76  
 esp\_http\_client\_proto\_ver\_t (C++ enum), 86  
 esp\_http\_client\_proto\_ver\_t::ESP\_HTTP\_CLIENT\_TLS (C++ enumerator), 86  
 esp\_http\_client\_proto\_ver\_t::ESP\_HTTP\_CLIENT\_TLS\_1\_1 (C++ enumerator), 86  
 esp\_http\_client\_proto\_ver\_t::ESP\_HTTP\_CLIENT\_TLS\_1\_2 (C++ enumerator), 86  
 esp\_http\_client\_proto\_ver\_t::ESP\_HTTP\_CLIENT\_TLS\_1\_3 (C++ enumerator), 86  
 esp\_http\_client\_read (C++ function), 79  
 esp\_http\_client\_read\_response (C++ function), 81  
 esp\_http\_client\_reset\_redirect\_counter (C++ function), 80  
 esp\_http\_client\_set\_auth\_type (C++ function), 78  
 esp\_http\_client\_set\_header (C++ function), 77



- esp\_http\_client\_set\_method (C++ function), 78
- esp\_http\_client\_set\_password (C++ function), 78
- esp\_http\_client\_set\_post\_field (C++ function), 76
- esp\_http\_client\_set\_redirection (C++ function), 80
- esp\_http\_client\_set\_timeout\_ms (C++ function), 78
- esp\_http\_client\_set\_url (C++ function), 76
- esp\_http\_client\_set\_username (C++ function), 77
- esp\_http\_client\_transport\_t (C++ enum), 86
- esp\_http\_client\_transport\_t::HTTP\_TRANSPORT\_OVER\_TCP (C++ enumerator), 86
- esp\_http\_client\_transport\_t::HTTP\_TRANSPORT\_OVER\_WIFI (C++ enumerator), 86
- esp\_http\_client\_transport\_t::HTTP\_TRANSPORT\_UNKNOWN (C++ enumerator), 86
- esp\_http\_client\_write (C++ function), 79
- esp\_http\_server\_event\_data (C++ struct), 132
- esp\_http\_server\_event\_data::data\_len (C++ member), 133
- esp\_http\_server\_event\_data::fd (C++ member), 132
- esp\_http\_server\_event\_id\_t (C++ enum), 141
- esp\_http\_server\_event\_id\_t::HTTP\_SERVER\_EVENT\_CONNECTED (C++ enumerator), 142
- esp\_http\_server\_event\_id\_t::HTTP\_SERVER\_EVENT\_ERROR (C++ enumerator), 141
- esp\_http\_server\_event\_id\_t::HTTP\_SERVER\_EVENT\_HEADERS\_SENT (C++ enumerator), 141
- esp\_http\_server\_event\_id\_t::HTTP\_SERVER\_EVENT\_ON\_CONNECTED (C++ enumerator), 141
- esp\_http\_server\_event\_id\_t::HTTP\_SERVER\_EVENT\_ON\_SERVER\_USER\_CB\_ARG::tls (C++ member), 143
- esp\_http\_server\_event\_id\_t::HTTP\_SERVER\_EVENT\_ON\_SERVER\_USER\_CB\_ARG::user\_cb\_state (C++ member), 143
- esp\_http\_server\_event\_id\_t::HTTP\_SERVER\_EVENT\_SEND\_DATA (C++ enumerator), 142
- esp\_http\_server\_event\_id\_t::HTTP\_SERVER\_EVENT\_SEND\_RESPONSE (C++ enumerator), 142
- esp\_http\_server\_event\_id\_t::HTTP\_SERVER\_EVENT\_START (C++ enumerator), 141
- esp\_http\_server\_event\_id\_t::HTTP\_SERVER\_EVENT\_STOP (C++ enumerator), 142
- ESP\_HTTPD\_DEF\_CTRL\_PORT (C macro), 137
- esp\_https\_ota (C++ function), 1210
- esp\_https\_ota\_abort (C++ function), 1212
- esp\_https\_ota\_begin (C++ function), 1210
- esp\_https\_ota\_config\_t (C++ struct), 1213
- esp\_https\_ota\_config\_t::bulk\_flash\_erase (C++ member), 1213
- esp\_https\_ota\_config\_t::http\_client\_init\_cb (C++ member), 1213
- esp\_https\_ota\_config\_t::http\_config (C++ member), 1213
- esp\_https\_ota\_config\_t::max\_http\_request\_size (C++ member), 1213
- esp\_https\_ota\_config\_t::partial\_http\_download (C++ member), 1213
- esp\_https\_ota\_event\_t (C++ enum), 1214
- esp\_https\_ota\_event\_t::ESP\_HTTPS\_OTA\_ABORT (C++ enumerator), 1214
- esp\_https\_ota\_event\_t::ESP\_HTTPS\_OTA\_CONNECTED (C++ enumerator), 1214
- esp\_https\_ota\_event\_t::ESP\_HTTPS\_OTA\_DECRYPT\_CB (C++ enumerator), 1214
- esp\_https\_ota\_event\_t::ESP\_HTTPS\_OTA\_FINISH (C++ enumerator), 1214
- esp\_https\_ota\_event\_t::ESP\_HTTPS\_OTA\_GET\_IMG\_DESC (C++ enumerator), 1214
- esp\_https\_ota\_event\_t::ESP\_HTTPS\_OTA\_START (C++ enumerator), 1214
- esp\_https\_ota\_event\_t::ESP\_HTTPS\_OTA\_UPDATE\_BOOT (C++ enumerator), 1214
- esp\_https\_ota\_event\_t::ESP\_HTTPS\_OTA\_VERIFY\_CHIP (C++ enumerator), 1214
- esp\_https\_ota\_event\_t::ESP\_HTTPS\_OTA\_WRITE\_FLASH (C++ enumerator), 1214
- esp\_https\_ota\_finish (C++ function), 1211
- esp\_https\_ota\_get\_image\_len\_read (C++ function), 1212
- esp\_https\_ota\_get\_image\_size (C++ function), 1213
- esp\_https\_ota\_get\_img\_desc (C++ function), 1213
- esp\_https\_ota\_handle\_t (C++ type), 1213
- esp\_https\_ota\_is\_complete\_data\_received (C++ function), 1211
- esp\_https\_server\_user\_cb (C++ type), 145
- esp\_https\_server\_user\_cb\_arg (C++ struct), 143
- ESP\_IDF\_VERSION\_MAJOR (C macro), 1415
- ESP\_IDF\_VERSION\_MINOR (C macro), 1415
- ESP\_IDF\_VERSION\_PATCH (C macro), 1415
- ESP\_IDF\_VERSION\_VAL (C macro), 1416
- esp\_image\_flash\_size\_t (C++ enum), 1159
- esp\_image\_flash\_size\_t::ESP\_IMAGE\_FLASH\_SIZE\_128MB (C++ enumerator), 1159
- esp\_image\_flash\_size\_t::ESP\_IMAGE\_FLASH\_SIZE\_16MB (C++ enumerator), 1159
- esp\_image\_flash\_size\_t::ESP\_IMAGE\_FLASH\_SIZE\_1MB (C++ enumerator), 1159
- esp\_image\_flash\_size\_t::ESP\_IMAGE\_FLASH\_SIZE\_2MB (C++ enumerator), 1159

- esp\_image\_flash\_size\_t::ESP\_IMAGE\_FLASH\_SIZE\_3CMB (C++ enumerator), 1158  
 (C++ enumerator), 1159  
 esp\_image\_flash\_size\_t::ESP\_IMAGE\_FLASH\_SIZE\_4CB (C++ enumerator), 1158  
 (C++ enumerator), 1159  
 esp\_image\_flash\_size\_t::ESP\_IMAGE\_FLASH\_SIZE\_6CMB (C++ enumerator), 1158  
 (C++ enumerator), 1159  
 esp\_image\_flash\_size\_t::ESP\_IMAGE\_FLASH\_SIZE\_8CB (C++ enumerator), 1158  
 (C++ enumerator), 1159  
 esp\_image\_flash\_size\_t::ESP\_IMAGE\_FLASH\_SIZE\_10CB (C++ enumerator), 1158  
 (C++ enumerator), 1159  
 ESP\_IMAGE\_HEADER\_MAGIC (C macro), 1157  
 esp\_image\_header\_t (C++ struct), 1156  
 esp\_image\_header\_t::chip\_id (C++ member), 1156  
 esp\_image\_header\_t::entry\_addr (C++ member), 1156  
 esp\_image\_header\_t::hash\_appended (C++ member), 1157  
 esp\_image\_header\_t::magic (C++ member), 1156  
 esp\_image\_header\_t::max\_chip\_rev\_full (C++ member), 1157  
 esp\_image\_header\_t::min\_chip\_rev (C++ member), 1157  
 esp\_image\_header\_t::min\_chip\_rev\_full (C++ member), 1157  
 esp\_image\_header\_t::reserved (C++ member), 1157  
 esp\_image\_header\_t::segment\_count (C++ member), 1156  
 esp\_image\_header\_t::spi\_mode (C++ member), 1156  
 esp\_image\_header\_t::spi\_pin\_drv (C++ member), 1156  
 esp\_image\_header\_t::spi\_size (C++ member), 1156  
 esp\_image\_header\_t::spi\_speed (C++ member), 1156  
 esp\_image\_header\_t::wp\_pin (C++ member), 1156  
 ESP\_IMAGE\_MAX\_SEGMENTS (C macro), 1157  
 esp\_image\_segment\_header\_t (C++ struct), 1157  
 esp\_image\_segment\_header\_t::data\_len (C++ member), 1157  
 esp\_image\_segment\_header\_t::load\_addr (C++ member), 1157  
 esp\_image\_spi\_freq\_t (C++ enum), 1158  
 esp\_image\_spi\_freq\_t::ESP\_IMAGE\_SPI\_SPEED\_1 (C++ enumerator), 1159  
 esp\_image\_spi\_freq\_t::ESP\_IMAGE\_SPI\_SPEED\_2 (C++ enumerator), 1158  
 esp\_image\_spi\_freq\_t::ESP\_IMAGE\_SPI\_SPEED\_3 (C++ enumerator), 1158  
 esp\_image\_spi\_freq\_t::ESP\_IMAGE\_SPI\_SPEED\_4 (C++ enumerator), 1158  
 esp\_image\_spi\_mode\_t (C++ enum), 1158  
 esp\_image\_spi\_mode\_t::ESP\_IMAGE\_SPI\_MODE\_DOUT (C++ enumerator), 1158  
 esp\_image\_spi\_mode\_t::ESP\_IMAGE\_SPI\_MODE\_FAST\_READ (C++ enumerator), 1158  
 esp\_image\_spi\_mode\_t::ESP\_IMAGE\_SPI\_MODE\_QIO (C++ enumerator), 1158  
 esp\_image\_spi\_mode\_t::ESP\_IMAGE\_SPI\_MODE\_QOUT (C++ enumerator), 1158  
 esp\_image\_spi\_mode\_t::ESP\_IMAGE\_SPI\_MODE\_SLOW\_READ (C++ enumerator), 1158  
 esp\_intr\_alloc (C++ function), 1399  
 esp\_intr\_alloc\_intrstatus (C++ function), 1399  
 ESP\_INTR\_DISABLE (C macro), 1403  
 esp\_intr\_disable (C++ function), 1400  
 esp\_intr\_disable\_source (C++ function), 1401  
 ESP\_INTR\_ENABLE (C macro), 1403  
 esp\_intr\_enable (C++ function), 1401  
 esp\_intr\_enable\_source (C++ function), 1401  
 ESP\_INTR\_FLAG\_EDGE (C macro), 1402  
 ESP\_INTR\_FLAG\_HIGH (C macro), 1402  
 ESP\_INTR\_FLAG\_INTRDISABLED (C macro), 1402  
 ESP\_INTR\_FLAG\_IRAM (C macro), 1402  
 ESP\_INTR\_FLAG\_LEVEL1 (C macro), 1402  
 ESP\_INTR\_FLAG\_LEVEL2 (C macro), 1402  
 ESP\_INTR\_FLAG\_LEVEL3 (C macro), 1402  
 ESP\_INTR\_FLAG\_LEVEL4 (C macro), 1402  
 ESP\_INTR\_FLAG\_LEVEL5 (C macro), 1402  
 ESP\_INTR\_FLAG\_LEVEL6 (C macro), 1402  
 ESP\_INTR\_FLAG\_LEVELMASK (C macro), 1402  
 ESP\_INTR\_FLAG\_LOWMED (C macro), 1402  
 ESP\_INTR\_FLAG\_NMI (C macro), 1402  
 ESP\_INTR\_FLAG\_SHARED (C macro), 1402  
 esp\_intr\_flags\_to\_level (C++ function), 1401  
 esp\_intr\_free (C++ function), 1400  
 esp\_intr\_get\_cpu (C++ function), 1400  
 esp\_intr\_get\_intno (C++ function), 1400  
 esp\_intr\_mark\_shared (C++ function), 1399  
 esp\_intr\_noniram\_disable (C++ function), 1401  
 esp\_intr\_noniram\_enable (C++ function), 1401  
 esp\_intr\_reserve (C++ function), 1399  
 esp\_intr\_set\_in\_iram (C++ function), 1401  
 esp\_ip4\_addr (C++ struct), 347  
 ESP\_IP4\_ADDR\_1 (C macro), 348  
 esp\_ip4\_addr1\_16 (C macro), 348  
 ESP\_IP4\_ADDR\_2 (C macro), 348  
 esp\_ip4\_addr2\_16 (C macro), 348  
 ESP\_IP4\_ADDR\_3 (C macro), 348  
 esp\_ip4\_addr3\_16 (C macro), 348  
 ESP\_IP4\_ADDR\_4 (C macro), 348  
 esp\_ip4\_addr4\_16 (C macro), 348  
 esp\_ip4\_addr::addr (C++ member), 347  
 ESP\_IP4\_ADDR\_GET\_BYTE (C macro), 348

- esp\_ip4\_addr\_t (C++ type), 348  
 esp\_ip4addr\_aton (C++ function), 336  
 ESP\_IP4ADDR\_INIT (C macro), 348  
 esp\_ip4addr\_ntoa (C++ function), 336  
 ESP\_IP4TOADDR (C macro), 348  
 ESP\_IP4TOUINT32 (C macro), 348  
 esp\_ip6\_addr (C++ struct), 347  
 esp\_ip6\_addr::addr (C++ member), 347  
 esp\_ip6\_addr::zone (C++ member), 347  
 ESP\_IP6\_ADDR\_BLOCK1 (C macro), 347  
 ESP\_IP6\_ADDR\_BLOCK2 (C macro), 347  
 ESP\_IP6\_ADDR\_BLOCK3 (C macro), 347  
 ESP\_IP6\_ADDR\_BLOCK4 (C macro), 347  
 ESP\_IP6\_ADDR\_BLOCK5 (C macro), 347  
 ESP\_IP6\_ADDR\_BLOCK6 (C macro), 348  
 ESP\_IP6\_ADDR\_BLOCK7 (C macro), 348  
 ESP\_IP6\_ADDR\_BLOCK8 (C macro), 348  
 esp\_ip6\_addr\_t (C++ type), 348  
 esp\_ip6\_addr\_type\_t (C++ enum), 349  
 esp\_ip6\_addr\_type\_t::ESP\_IP6\_ADDR\_IS\_GLOBAL (C++ member), 349  
 (C++ enumerator), 349  
 esp\_ip6\_addr\_type\_t::ESP\_IP6\_ADDR\_IS\_IPV4\_MAP (C++ member), 349  
 (C++ enumerator), 349  
 esp\_ip6\_addr\_type\_t::ESP\_IP6\_ADDR\_IS\_LINK\_LOCAL (C++ member), 349  
 (C++ enumerator), 349  
 esp\_ip6\_addr\_type\_t::ESP\_IP6\_ADDR\_IS\_SITE\_LOCAL (C++ member), 349  
 (C++ enumerator), 349  
 esp\_ip6\_addr\_type\_t::ESP\_IP6\_ADDR\_IS\_UNIQUE\_LOCAL (C++ member), 349  
 (C++ enumerator), 349  
 esp\_ip6\_addr\_type\_t::ESP\_IP6\_ADDR\_IS\_UNKNOWN (C++ member), 349  
 (C++ enumerator), 349  
 ESP\_IP6ADDR\_INIT (C macro), 348  
 esp\_ip\_addr\_t (C++ type), 348  
 ESP\_IPADDR\_TYPE\_ANY (C macro), 348  
 ESP\_IPADDR\_TYPE\_V4 (C macro), 348  
 ESP\_IPADDR\_TYPE\_V6 (C macro), 348  
 esp\_lcd\_del\_i80\_bus (C++ function), 483  
 esp\_lcd\_i2c\_bus\_handle\_t (C++ type), 487  
 esp\_lcd\_i80\_bus\_config\_t (C++ struct), 485  
 esp\_lcd\_i80\_bus\_config\_t::bus\_width (C++ member), 486  
 esp\_lcd\_i80\_bus\_config\_t::clk\_src (C++ member), 486  
 esp\_lcd\_i80\_bus\_config\_t::data\_gpio\_num (C++ member), 486  
 esp\_lcd\_i80\_bus\_config\_t::dc\_gpio\_num (C++ member), 485  
 esp\_lcd\_i80\_bus\_config\_t::max\_transfer\_bytes (C++ member), 486  
 esp\_lcd\_i80\_bus\_config\_t::psram\_trans\_align (C++ member), 486  
 esp\_lcd\_i80\_bus\_config\_t::sram\_trans\_align (C++ member), 486  
 esp\_lcd\_i80\_bus\_config\_t::wr\_gpio\_num (C++ member), 486  
 esp\_lcd\_i80\_bus\_handle\_t (C++ type), 487  
 esp\_lcd\_new\_i80\_bus (C++ function), 482  
 esp\_lcd\_new\_panel\_io\_i2c (C++ function), 483  
 esp\_lcd\_new\_panel\_io\_i80 (C++ function), 483  
 esp\_lcd\_new\_panel\_io\_spi (C++ function), 482  
 esp\_lcd\_new\_panel\_nt35510 (C++ function), 490  
 esp\_lcd\_new\_panel\_ssd1306 (C++ function), 490  
 esp\_lcd\_new\_panel\_st7789 (C++ function), 490  
 esp\_lcd\_panel\_del (C++ function), 488  
 esp\_lcd\_panel\_dev\_config\_t (C++ struct), 491  
 esp\_lcd\_panel\_dev\_config\_t::bits\_per\_pixel (C++ member), 491  
 esp\_lcd\_panel\_dev\_config\_t::color\_space (C++ member), 491  
 esp\_lcd\_panel\_dev\_config\_t::data\_endian (C++ member), 491  
 esp\_lcd\_panel\_dev\_config\_t::flags (C++ member), 491  
 esp\_lcd\_panel\_dev\_config\_t::reset\_active\_high (C++ member), 491  
 esp\_lcd\_panel\_dev\_config\_t::reset\_gpio\_num (C++ member), 491  
 esp\_lcd\_panel\_dev\_config\_t::rgb\_ele\_order (C++ member), 491  
 esp\_lcd\_panel\_dev\_config\_t::rgb\_endian (C++ member), 491  
 esp\_lcd\_panel\_dev\_config\_t::vendor\_config (C++ member), 491  
 esp\_lcd\_panel\_disp\_off (C++ function), 490  
 esp\_lcd\_panel\_disp\_on\_off (C++ function), 489  
 esp\_lcd\_panel\_draw\_bitmap (C++ function), 488  
 esp\_lcd\_panel\_handle\_t (C++ type), 480  
 esp\_lcd\_panel\_init (C++ function), 488  
 esp\_lcd\_panel\_invert\_color (C++ function), 489  
 esp\_lcd\_panel\_io\_callbacks\_t (C++ struct), 483  
 esp\_lcd\_panel\_io\_callbacks\_t::on\_color\_trans\_done (C++ member), 483  
 esp\_lcd\_panel\_io\_color\_trans\_done\_cb\_t (C++ type), 487  
 esp\_lcd\_panel\_io\_del (C++ function), 482  
 esp\_lcd\_panel\_io\_event\_data\_t (C++ struct), 483  
 esp\_lcd\_panel\_io\_handle\_t (C++ type), 480  
 esp\_lcd\_panel\_io\_i2c\_config\_t (C++ struct), 485  
 esp\_lcd\_panel\_io\_i2c\_config\_t::control\_phase\_bytes (C++ member), 485  
 esp\_lcd\_panel\_io\_i2c\_config\_t::dc\_bit\_offset (C++ member), 485  
 esp\_lcd\_panel\_io\_i2c\_config\_t::dc\_low\_on\_data (C++ member), 485

- (C++ member), 485
- esp\_lcd\_panel\_io\_i2c\_config\_t::dev\_addr (C++ member), 485
- esp\_lcd\_panel\_io\_i2c\_config\_t::disable\_esc (C++ member), 485
- esp\_lcd\_panel\_io\_i2c\_config\_t::flags (C++ member), 485
- esp\_lcd\_panel\_io\_i2c\_config\_t::lcd\_cmd\_bits (C++ member), 485
- esp\_lcd\_panel\_io\_i2c\_config\_t::lcd\_param\_bits (C++ member), 485
- esp\_lcd\_panel\_io\_i2c\_config\_t::on\_color\_trans\_done (C++ member), 485
- esp\_lcd\_panel\_io\_i2c\_config\_t::user\_ctx (C++ member), 485
- esp\_lcd\_panel\_io\_i80\_config\_t (C++ struct), 486
- esp\_lcd\_panel\_io\_i80\_config\_t::cs\_active\_high (C++ member), 487
- esp\_lcd\_panel\_io\_i80\_config\_t::cs\_gpio\_num (C++ member), 486
- esp\_lcd\_panel\_io\_i80\_config\_t::dc\_cmd\_level (C++ member), 487
- esp\_lcd\_panel\_io\_i80\_config\_t::dc\_data\_level (C++ member), 487
- esp\_lcd\_panel\_io\_i80\_config\_t::dc\_dummy\_level (C++ member), 487
- esp\_lcd\_panel\_io\_i80\_config\_t::dc\_idle\_level (C++ member), 487
- esp\_lcd\_panel\_io\_i80\_config\_t::dc\_level (C++ member), 487
- esp\_lcd\_panel\_io\_i80\_config\_t::flags (C++ member), 487
- esp\_lcd\_panel\_io\_i80\_config\_t::lcd\_cmd\_bits (C++ member), 486
- esp\_lcd\_panel\_io\_i80\_config\_t::lcd\_param\_bits (C++ member), 486
- esp\_lcd\_panel\_io\_i80\_config\_t::on\_color\_trans\_done (C++ member), 486
- esp\_lcd\_panel\_io\_i80\_config\_t::pclk\_active\_high (C++ member), 487
- esp\_lcd\_panel\_io\_i80\_config\_t::pclk\_hz (C++ member), 486
- esp\_lcd\_panel\_io\_i80\_config\_t::pclk\_idle\_level (C++ member), 487
- esp\_lcd\_panel\_io\_i80\_config\_t::reverse\_esc\_order (C++ member), 487
- esp\_lcd\_panel\_io\_i80\_config\_t::swap\_color\_bytes (C++ member), 487
- esp\_lcd\_panel\_io\_i80\_config\_t::trans\_queue\_depth (C++ member), 486
- esp\_lcd\_panel\_io\_i80\_config\_t::user\_ctx (C++ member), 486
- esp\_lcd\_panel\_io\_register\_event\_callbacks (C++ function), 482
- esp\_lcd\_panel\_io\_rx\_param (C++ function), 481
- esp\_lcd\_panel\_io\_spi\_config\_t (C++ struct), 483
- esp\_lcd\_panel\_io\_spi\_config\_t::cs\_gpio\_num (C++ member), 483
- esp\_lcd\_panel\_io\_spi\_config\_t::cs\_high\_active (C++ member), 484
- esp\_lcd\_panel\_io\_spi\_config\_t::dc\_gpio\_num (C++ member), 484
- esp\_lcd\_panel\_io\_spi\_config\_t::dc\_high\_on\_cmd (C++ member), 484
- esp\_lcd\_panel\_io\_spi\_config\_t::dc\_low\_on\_data (C++ member), 484
- esp\_lcd\_panel\_io\_spi\_config\_t::dc\_low\_on\_param (C++ member), 484
- esp\_lcd\_panel\_io\_spi\_config\_t::flags (C++ member), 485
- esp\_lcd\_panel\_io\_spi\_config\_t::lcd\_cmd\_bits (C++ member), 484
- esp\_lcd\_panel\_io\_spi\_config\_t::lcd\_param\_bits (C++ member), 484
- esp\_lcd\_panel\_io\_spi\_config\_t::lsb\_first (C++ member), 484
- esp\_lcd\_panel\_io\_spi\_config\_t::octal\_mode (C++ member), 484
- esp\_lcd\_panel\_io\_spi\_config\_t::on\_color\_trans\_done (C++ member), 484
- esp\_lcd\_panel\_io\_spi\_config\_t::pclk\_hz (C++ member), 484
- esp\_lcd\_panel\_io\_spi\_config\_t::quad\_mode (C++ member), 484
- esp\_lcd\_panel\_io\_spi\_config\_t::sio\_mode (C++ member), 484
- esp\_lcd\_panel\_io\_spi\_config\_t::spi\_mode (C++ member), 484
- esp\_lcd\_panel\_io\_spi\_config\_t::trans\_queue\_depth (C++ member), 484
- esp\_lcd\_panel\_io\_spi\_config\_t::user\_ctx (C++ member), 484
- esp\_lcd\_panel\_io\_tx\_color (C++ function), 481
- esp\_lcd\_panel\_io\_tx\_param (C++ function), 481
- esp\_lcd\_panel\_mirror (C++ function), 488
- esp\_lcd\_panel\_reset (C++ function), 488
- esp\_lcd\_panel\_set\_gap (C++ function), 489
- esp\_lcd\_panel\_swap\_xy (C++ function), 489
- esp\_lcd\_panel\_io\_tx\_color (C++ type), 487
- esp\_light\_sleep\_start (C++ function), 1461
- esp\_local\_ctrl\_add\_property (C++ function), 93
- esp\_local\_ctrl\_config (C++ struct), 96
- esp\_local\_ctrl\_config::handlers (C++ member), 97
- esp\_local\_ctrl\_config::max\_properties (C++ member), 97
- esp\_local\_ctrl\_config::proto\_sec (C++ member), 97
- esp\_local\_ctrl\_config::transport (C++ member), 96

- esp\_local\_ctrl\_config::transport\_config (C++ member), 96  
 esp\_local\_ctrl\_config\_t (C++ type), 98  
 esp\_local\_ctrl\_get\_property (C++ function), 93  
 esp\_local\_ctrl\_get\_transport\_ble (C++ function), 92  
 esp\_local\_ctrl\_get\_transport\_httpd (C++ function), 92  
 esp\_local\_ctrl\_handlers (C++ struct), 95  
 esp\_local\_ctrl\_handlers::get\_prop\_value (C++ member), 95  
 esp\_local\_ctrl\_handlers::set\_prop\_value (C++ member), 95  
 esp\_local\_ctrl\_handlers::usr\_ctx (C++ member), 96  
 esp\_local\_ctrl\_handlers::usr\_ctx\_free\_fn (C++ member), 96  
 esp\_local\_ctrl\_handlers\_t (C++ type), 97  
 esp\_local\_ctrl\_prop (C++ struct), 94  
 esp\_local\_ctrl\_prop::ctx (C++ member), 94  
 esp\_local\_ctrl\_prop::ctx\_free\_fn (C++ member), 94  
 esp\_local\_ctrl\_prop::flags (C++ member), 94  
 esp\_local\_ctrl\_prop::name (C++ member), 94  
 esp\_local\_ctrl\_prop::size (C++ member), 94  
 esp\_local\_ctrl\_prop::type (C++ member), 94  
 esp\_local\_ctrl\_prop\_t (C++ type), 97  
 esp\_local\_ctrl\_prop\_val (C++ struct), 94  
 esp\_local\_ctrl\_prop\_val::data (C++ member), 95  
 esp\_local\_ctrl\_prop\_val::free\_fn (C++ member), 95  
 esp\_local\_ctrl\_prop\_val::size (C++ member), 95  
 esp\_local\_ctrl\_prop\_val\_t (C++ type), 97  
 esp\_local\_ctrl\_proto\_sec (C++ enum), 98  
 esp\_local\_ctrl\_proto\_sec::PROTOCOLCOM\_SEC0 (C++ enumerator), 98  
 esp\_local\_ctrl\_proto\_sec::PROTOCOLCOM\_SEC1 (C++ enumerator), 98  
 esp\_local\_ctrl\_proto\_sec::PROTOCOLCOM\_SEC2 (C++ enumerator), 98  
 esp\_local\_ctrl\_proto\_sec::PROTOCOLCOM\_SEC\_CUSTOM (C++ enumerator), 98  
 esp\_local\_ctrl\_proto\_sec\_cfg (C++ struct), 96  
 esp\_local\_ctrl\_proto\_sec\_cfg::custom\_handle (C++ member), 96  
 esp\_local\_ctrl\_proto\_sec\_cfg::pop (C++ member), 96  
 esp\_local\_ctrl\_proto\_sec\_cfg::sec\_params (C++ member), 96  
 esp\_local\_ctrl\_proto\_sec\_cfg::version (C++ member), 96  
 esp\_local\_ctrl\_proto\_sec\_cfg\_t (C++ type), 98  
 esp\_local\_ctrl\_proto\_sec\_t (C++ type), 97  
 esp\_local\_ctrl\_remove\_property (C++ function), 93  
 esp\_local\_ctrl\_security1\_params\_t (C++ type), 97  
 esp\_local\_ctrl\_security2\_params\_t (C++ type), 98  
 esp\_local\_ctrl\_set\_handler (C++ function), 93  
 esp\_local\_ctrl\_start (C++ function), 92  
 esp\_local\_ctrl\_stop (C++ function), 93  
 ESP\_LOCAL\_CTRL\_TRANSPORT\_BLE (C macro), 97  
 esp\_local\_ctrl\_transport\_config\_ble\_t (C++ type), 97  
 esp\_local\_ctrl\_transport\_config\_httpd\_t (C++ type), 97  
 esp\_local\_ctrl\_transport\_config\_t (C++ union), 94  
 esp\_local\_ctrl\_transport\_config\_t::ble (C++ member), 94  
 esp\_local\_ctrl\_transport\_config\_t::httpd (C++ member), 94  
 ESP\_LOCAL\_CTRL\_TRANSPORT\_HTTPD (C macro), 97  
 esp\_local\_ctrl\_transport\_t (C++ type), 97  
 ESP\_LOG\_BUFFER\_CHAR (C macro), 1407  
 ESP\_LOG\_BUFFER\_CHAR\_LEVEL (C macro), 1407  
 ESP\_LOG\_BUFFER\_HEX (C macro), 1407  
 ESP\_LOG\_BUFFER\_HEX\_LEVEL (C macro), 1407  
 ESP\_LOG\_BUFFER\_HEXDUMP (C macro), 1407  
 ESP\_LOG\_EARLY\_IMPL (C macro), 1408  
 esp\_log\_early\_timestamp (C++ function), 1406  
 ESP\_LOG\_LEVEL (C macro), 1408  
 esp\_log\_level\_get (C++ function), 1405  
 ESP\_LOG\_LEVEL\_LOCAL (C macro), 1409  
 esp\_log\_level\_set (C++ function), 1405  
 esp\_log\_level\_t (C++ enum), 1410  
 esp\_log\_level\_t::ESP\_LOG\_DEBUG (C++ enumerator), 1410  
 esp\_log\_level\_t::ESP\_LOG\_ERROR (C++ enumerator), 1410  
 esp\_log\_level\_t::ESP\_LOG\_INFO (C++ enumerator), 1410  
 esp\_log\_level\_t::ESP\_LOG\_NONE (C++ enumerator), 1410  
 esp\_log\_level\_t::ESP\_LOG\_VERBOSE (C++ enumerator), 1410  
 esp\_log\_level\_t::ESP\_LOG\_WARN (C++ enumerator), 1410  
 esp\_log\_set\_vprintf (C++ function), 1405  
 esp\_log\_system\_timestamp (C++ function), 1406  
 esp\_log\_timestamp (C++ function), 1406



- `esp_log_write` (C++ function), 1406  
`esp_log_writev` (C++ function), 1406  
`ESP_LOGD` (C macro), 1408  
`ESP_LOGE` (C macro), 1408  
`ESP_LOGI` (C macro), 1408  
`ESP_LOGV` (C macro), 1408  
`ESP_LOGW` (C macro), 1408  
`esp_mac_type_t` (C++ enum), 1417  
`esp_mac_type_t::ESP_MAC_BT` (C++ enumerator), 1418  
`esp_mac_type_t::ESP_MAC_ETH` (C++ enumerator), 1418  
`esp_mac_type_t::ESP_MAC_IEEE802154` (C++ enumerator), 1418  
`esp_mac_type_t::ESP_MAC_WIFI_SOFTAP` (C++ enumerator), 1418  
`esp_mac_type_t::ESP_MAC_WIFI_STA` (C++ enumerator), 1417  
`esp_mbo_update_non_pref_chan` (C++ function), 277  
`esp_mesh_allow_root_conflicts` (C++ function), 182  
`esp_mesh_available_txupQ_num` (C++ function), 182  
`esp_mesh_connect` (C++ function), 186  
`esp_mesh_deinit` (C++ function), 172  
`esp_mesh_delete_group_id` (C++ function), 183  
`esp_mesh_disable_ps` (C++ function), 187  
`esp_mesh_disconnect` (C++ function), 186  
`esp_mesh_enable_ps` (C++ function), 187  
`esp_mesh_fix_root` (C++ function), 184  
`esp_mesh_flush_scan_result` (C++ function), 186  
`esp_mesh_flush_upstream_packets` (C++ function), 186  
`esp_mesh_get_active_duty_cycle` (C++ function), 188  
`esp_mesh_get_ap_assoc_expire` (C++ function), 181  
`esp_mesh_get_ap_authmode` (C++ function), 179  
`esp_mesh_get_ap_connections` (C++ function), 179  
`esp_mesh_get_capacity_num` (C++ function), 183  
`esp_mesh_get_config` (C++ function), 177  
`esp_mesh_get_group_list` (C++ function), 183  
`esp_mesh_get_group_num` (C++ function), 183  
`esp_mesh_get_id` (C++ function), 177  
`esp_mesh_get_ie_crypto_key` (C++ function), 184  
`esp_mesh_get_layer` (C++ function), 179  
`esp_mesh_get_max_layer` (C++ function), 178  
`esp_mesh_get_network_duty_cycle` (C++ function), 189  
`esp_mesh_get_non_mesh_connections` (C++ function), 179  
`esp_mesh_get_parent_bssid` (C++ function), 179  
`esp_mesh_get_root_healing_delay` (C++ function), 184  
`esp_mesh_get_router` (C++ function), 177  
`esp_mesh_get_router_bssid` (C++ function), 187  
`esp_mesh_get_routing_table` (C++ function), 181  
`esp_mesh_get_routing_table_size` (C++ function), 181  
`esp_mesh_get_running_active_duty_cycle` (C++ function), 189  
`esp_mesh_get_rx_pending` (C++ function), 182  
`esp_mesh_get_self_organized` (C++ function), 180  
`esp_mesh_get_subnet_nodes_list` (C++ function), 186  
`esp_mesh_get_subnet_nodes_num` (C++ function), 186  
`esp_mesh_get_topology` (C++ function), 187  
`esp_mesh_get_total_node_num` (C++ function), 181  
`esp_mesh_get_tsf_time` (C++ function), 187  
`esp_mesh_get_tx_pending` (C++ function), 182  
`esp_mesh_get_type` (C++ function), 178  
`esp_mesh_get_vote_percentage` (C++ function), 181  
`esp_mesh_get_xon_qsize` (C++ function), 182  
`esp_mesh_init` (C++ function), 172  
`esp_mesh_is_device_active` (C++ function), 188  
`esp_mesh_is_my_group` (C++ function), 183  
`esp_mesh_is_ps_enabled` (C++ function), 188  
`esp_mesh_is_root` (C++ function), 179  
`esp_mesh_is_root_conflicts_allowed` (C++ function), 183  
`esp_mesh_is_root_fixed` (C++ function), 185  
`esp_mesh_post_toDS_state` (C++ function), 181  
`esp_mesh_ps_duty_signaling` (C++ function), 190  
`esp_mesh_recv` (C++ function), 175  
`esp_mesh_recv_toDS` (C++ function), 175  
`esp_mesh_scan_get_ap_ie_len` (C++ function), 185  
`esp_mesh_scan_get_ap_record` (C++ function), 185  
`esp_mesh_send` (C++ function), 173  
`esp_mesh_send_block_time` (C++ function), 175  
`esp_mesh_set_active_duty_cycle` (C++ function), 188  
`esp_mesh_set_ap_assoc_expire` (C++ function), 181  
`esp_mesh_set_ap_authmode` (C++ function), 178  
`esp_mesh_set_ap_connections` (C++ function), 179

- tion*), 179
- `esp_mesh_set_ap_password` (C++ function), 178
- `esp_mesh_set_capacity_num` (C++ function), 183
- `esp_mesh_set_config` (C++ function), 176
- `esp_mesh_set_group_id` (C++ function), 183
- `esp_mesh_set_id` (C++ function), 177
- `esp_mesh_set_ie_crypto_funcs` (C++ function), 184
- `esp_mesh_set_ie_crypto_key` (C++ function), 184
- `esp_mesh_set_max_layer` (C++ function), 178
- `esp_mesh_set_network_duty_cycle` (C++ function), 188
- `esp_mesh_set_parent` (C++ function), 185
- `esp_mesh_set_root_healing_delay` (C++ function), 184
- `esp_mesh_set_router` (C++ function), 177
- `esp_mesh_set_self_organized` (C++ function), 179
- `esp_mesh_set_topology` (C++ function), 187
- `esp_mesh_set_type` (C++ function), 177
- `esp_mesh_set_vote_percentage` (C++ function), 180
- `esp_mesh_set_xon_qsize` (C++ function), 182
- `esp_mesh_start` (C++ function), 173
- `esp_mesh_stop` (C++ function), 173
- `esp_mesh_switch_channel` (C++ function), 186
- `esp_mesh_topology_t` (C++ enum), 206
- `esp_mesh_topology_t::MESH_TOPO_CHAIN` (C++ enumerator), 206
- `esp_mesh_topology_t::MESH_TOPO_TREE` (C++ enumerator), 206
- `esp_mesh_waive_root` (C++ function), 180
- `esp_mqtt_client_config_t` (C++ struct), 50
- `esp_mqtt_client_config_t` (C++ type), 56
- `esp_mqtt_client_config_t::broker` (C++ member), 50
- `esp_mqtt_client_config_t::broker_t` (C++ struct), 50
- `esp_mqtt_client_config_t::broker_t::address` (C++ member), 50
- `esp_mqtt_client_config_t::broker_t::address_t` (C++ struct), 51
- `esp_mqtt_client_config_t::broker_t::address_t::hostname` (C++ member), 51
- `esp_mqtt_client_config_t::broker_t::address_t::port` (C++ member), 51
- `esp_mqtt_client_config_t::broker_t::address_t::transport` (C++ member), 51
- `esp_mqtt_client_config_t::broker_t::address_t::uri` (C++ member), 51
- `esp_mqtt_client_config_t::broker_t::verification` (C++ member), 50
- `esp_mqtt_client_config_t::broker_t::verification_t` (C++ struct), 51
- `esp_mqtt_client_config_t::broker_t::verification_t::certificate` (C++ member), 51
- `esp_mqtt_client_config_t::broker_t::verification_t::certificate_t` (C++ struct), 52
- `esp_mqtt_client_config_t::broker_t::verification_t::certificate_t::out_size` (C++ member), 52
- `esp_mqtt_client_config_t::broker_t::verification_t::certificate_t::size` (C++ member), 52
- `esp_mqtt_client_config_t::credentials` (C++ member), 50
- `esp_mqtt_client_config_t::credentials_t` (C++ struct), 52
- `esp_mqtt_client_config_t::credentials_t::authentication` (C++ member), 52
- `esp_mqtt_client_config_t::credentials_t::authentication_t` (C++ struct), 52
- `esp_mqtt_client_config_t::credentials_t::authentication_t::password` (C++ member), 53
- `esp_mqtt_client_config_t::credentials_t::authentication_t::password_t` (C++ struct), 53
- `esp_mqtt_client_config_t::credentials_t::authentication_t::password_t::client_id` (C++ member), 52
- `esp_mqtt_client_config_t::credentials_t::authentication_t::password_t::set_null` (C++ member), 52
- `esp_mqtt_client_config_t::credentials_t::username` (C++ member), 52
- `esp_mqtt_client_config_t::network` (C++ member), 50
- `esp_mqtt_client_config_t::network_t` (C++ struct), 51

- (C++ struct), 53
- esp\_mqtt\_client\_config\_t::network\_t::disconnect\_return\_code\_t (C++ member), 53
- esp\_mqtt\_client\_config\_t::network\_t::receive\_timeout\_subscribe (C++ member), 53
- esp\_mqtt\_client\_config\_t::network\_t::receive\_timeout\_unsubscribe (C++ member), 53
- esp\_mqtt\_client\_config\_t::network\_t::timeouts\_connect\_return\_code\_t (C++ member), 53
- esp\_mqtt\_client\_config\_t::session (C++ member), 50
- esp\_mqtt\_client\_config\_t::session\_t (C++ struct), 54
- esp\_mqtt\_client\_config\_t::session\_t::disconnect\_return\_code\_t (C++ member), 54
- esp\_mqtt\_client\_config\_t::session\_t::disconnect\_return\_code\_t::MQTT\_CONNECTION\_R (C++ member), 54
- esp\_mqtt\_client\_config\_t::session\_t::keepalive\_return\_code\_t (C++ member), 54
- esp\_mqtt\_client\_config\_t::session\_t::keepalive\_return\_code\_t::MQTT\_CONNECTION\_R (C++ member), 54
- esp\_mqtt\_client\_config\_t::session\_t::last\_will\_return\_code\_t (C++ member), 54
- esp\_mqtt\_client\_config\_t::session\_t::last\_will\_return\_code\_t::MQTT\_CONNECTION\_R (C++ member), 54
- esp\_mqtt\_client\_config\_t::session\_t::last\_will\_return\_codes (C++ struct), 48
- esp\_mqtt\_client\_config\_t::session\_t::last\_will\_return\_codes::connect\_return\_code (C++ member), 49
- esp\_mqtt\_client\_config\_t::session\_t::last\_will\_return\_codes::error\_type (C++ member), 48
- esp\_mqtt\_client\_config\_t::session\_t::last\_will\_return\_codes::esp\_tls\_cert\_verify\_flags (C++ member), 48
- esp\_mqtt\_client\_config\_t::session\_t::last\_will\_return\_codes::esp\_tls\_last\_esp\_err (C++ member), 48
- esp\_mqtt\_client\_config\_t::session\_t::last\_will\_return\_codes::esp\_tls\_stack\_err (C++ member), 48
- esp\_mqtt\_client\_config\_t::session\_t::message\_t (C++ member), 48
- esp\_mqtt\_client\_config\_t::session\_t::message\_t::meout (C++ member), 48
- esp\_mqtt\_client\_config\_t::session\_t::protocol (C++ member), 49
- esp\_mqtt\_client\_config\_t::task (C++ member), 50
- esp\_mqtt\_client\_config\_t::task\_t (C++ struct), 54
- esp\_mqtt\_client\_config\_t::task\_t::priority (C++ member), 55
- esp\_mqtt\_client\_config\_t::task\_t::stack\_size (C++ member), 55
- esp\_mqtt\_client\_destroy (C++ function), 47
- esp\_mqtt\_client\_disconnect (C++ function), 46
- esp\_mqtt\_client\_enqueue (C++ function), 47
- esp\_mqtt\_client\_get\_outbox\_size (C++ function), 48
- esp\_mqtt\_client\_handle\_t (C++ type), 55
- esp\_mqtt\_client\_init (C++ function), 45
- esp\_mqtt\_client\_publish (C++ function), 47
- esp\_mqtt\_client\_reconnect (C++ function), 46
- esp\_mqtt\_client\_register\_event (C++ function), 48
- esp\_mqtt\_client\_set\_uri (C++ function), 46
- esp\_mqtt\_client\_start (C++ function), 46
- esp\_mqtt\_client\_stop (C++ function), 46
- esp\_mqtt\_client\_subscribe (C++ function), 46
- esp\_mqtt\_client\_unsubscribe (C++ function), 46
- esp\_mqtt\_connect\_return\_code\_t (C++ enum), 57
- esp\_mqtt\_connect\_return\_code\_t (C++ type), 55
- esp\_mqtt\_connect\_return\_code\_t::MQTT\_CONNECTION\_A (C++ enumerator), 57
- esp\_mqtt\_connect\_return\_code\_t::MQTT\_CONNECTION\_R (C++ enumerator), 57
- esp\_mqtt\_connect\_return\_code\_t::MQTT\_CONNECTION\_R (C++ enumerator), 57
- esp\_mqtt\_connect\_return\_code\_t::MQTT\_CONNECTION\_R (C++ enumerator), 57
- esp\_mqtt\_connect\_return\_code\_t::MQTT\_CONNECTION\_R (C++ enumerator), 57
- esp\_mqtt\_error\_codes (C++ struct), 48
- esp\_mqtt\_error\_codes::connect\_return\_code (C++ member), 49
- esp\_mqtt\_error\_codes::error\_type (C++ member), 48
- esp\_mqtt\_error\_codes::esp\_tls\_cert\_verify\_flags (C++ member), 48
- esp\_mqtt\_error\_codes::esp\_tls\_last\_esp\_err (C++ member), 48
- esp\_mqtt\_error\_codes::esp\_tls\_stack\_err (C++ member), 48
- esp\_mqtt\_error\_codes::esp\_transport\_sock\_errno (C++ member), 48
- esp\_mqtt\_error\_codes\_t (C++ type), 55
- esp\_mqtt\_error\_type\_t (C++ enum), 57
- esp\_mqtt\_error\_type\_t (C++ type), 55
- esp\_mqtt\_error\_type\_t::MQTT\_ERROR\_TYPE\_CONNECTION (C++ enumerator), 58
- esp\_mqtt\_error\_type\_t::MQTT\_ERROR\_TYPE\_NONE (C++ enumerator), 58
- esp\_mqtt\_error\_type\_t::MQTT\_ERROR\_TYPE\_TCP\_TRANSP (C++ enumerator), 58
- esp\_mqtt\_event\_handle\_t (C++ type), 56
- esp\_mqtt\_event\_id\_t (C++ enum), 56
- esp\_mqtt\_event\_id\_t (C++ type), 55
- esp\_mqtt\_event\_id\_t::MQTT\_EVENT\_ANY (C++ enumerator), 56
- esp\_mqtt\_event\_id\_t::MQTT\_EVENT\_BEFORE\_CONNECT (C++ enumerator), 57
- esp\_mqtt\_event\_id\_t::MQTT\_EVENT\_CONNECTED (C++ enumerator), 56
- esp\_mqtt\_event\_id\_t::MQTT\_EVENT\_DATA (C++ enumerator), 57
- esp\_mqtt\_event\_id\_t::MQTT\_EVENT\_DELETED (C++ enumerator), 57



- esp\_mqtt\_event\_id\_t::MQTT\_EVENT\_DISCONNECTED (C++ enumerator), 56  
 esp\_mqtt\_event\_id\_t::MQTT\_EVENT\_ERROR (C++ enumerator), 56  
 esp\_mqtt\_event\_id\_t::MQTT\_EVENT\_PUBLISH (C++ enumerator), 56  
 esp\_mqtt\_event\_id\_t::MQTT\_EVENT\_SUBSCRIBED (C++ enumerator), 56  
 esp\_mqtt\_event\_id\_t::MQTT\_EVENT\_UNSUBSCRIBED (C++ enumerator), 56  
 esp\_mqtt\_event\_t (C++ struct), 49  
 esp\_mqtt\_event\_t (C++ type), 56  
 esp\_mqtt\_event\_t::client (C++ member), 49  
 esp\_mqtt\_event\_t::current\_data\_offset (C++ member), 49  
 esp\_mqtt\_event\_t::data (C++ member), 49  
 esp\_mqtt\_event\_t::data\_len (C++ member), 49  
 esp\_mqtt\_event\_t::dup (C++ member), 50  
 esp\_mqtt\_event\_t::error\_handle (C++ member), 49  
 esp\_mqtt\_event\_t::event\_id (C++ member), 49  
 esp\_mqtt\_event\_t::msg\_id (C++ member), 49  
 esp\_mqtt\_event\_t::protocol\_ver (C++ member), 50  
 esp\_mqtt\_event\_t::qos (C++ member), 50  
 esp\_mqtt\_event\_t::retain (C++ member), 49  
 esp\_mqtt\_event\_t::session\_present (C++ member), 49  
 esp\_mqtt\_event\_t::topic (C++ member), 49  
 esp\_mqtt\_event\_t::topic\_len (C++ member), 49  
 esp\_mqtt\_event\_t::total\_data\_len (C++ member), 49  
 esp\_mqtt\_protocol\_ver\_t (C++ enum), 58  
 esp\_mqtt\_protocol\_ver\_t (C++ type), 55  
 esp\_mqtt\_protocol\_ver\_t::MQTT\_PROTOCOL\_UNDEFINED (C++ enumerator), 58  
 esp\_mqtt\_protocol\_ver\_t::MQTT\_PROTOCOL\_ESP (C++ enumerator), 58  
 esp\_mqtt\_protocol\_ver\_t::MQTT\_PROTOCOL\_ESP3 (C++ enumerator), 58  
 esp\_mqtt\_protocol\_ver\_t::MQTT\_PROTOCOL\_ESP32 (C++ enumerator), 58  
 esp\_mqtt\_protocol\_ver\_t::MQTT\_PROTOCOL\_ESP8266 (C++ enumerator), 58  
 esp\_mqtt\_set\_config (C++ function), 47  
 esp\_mqtt\_transport\_t (C++ enum), 58  
 esp\_mqtt\_transport\_t (C++ type), 55  
 esp\_mqtt\_transport\_t::MQTT\_TRANSPORT\_OVER\_SSL (C++ enumerator), 345  
 esp\_mqtt\_transport\_t::MQTT\_TRANSPORT\_OVER\_TCP (C++ enumerator), 345  
 esp\_mqtt\_transport\_t::MQTT\_TRANSPORT\_OVER\_WS (C++ enumerator), 345  
 esp\_mqtt\_transport\_t::MQTT\_TRANSPORT\_OVER\_WSS (C++ enumerator), 345  
 esp\_mqtt\_transport\_t::MQTT\_TRANSPORT\_UNKNOWN (C++ enumerator), 345  
 esp\_netif\_action\_add\_ip6\_address (C++ function), 329  
 esp\_netif\_action\_connected (C++ function), 328  
 esp\_netif\_action\_disconnected (C++ function), 328  
 esp\_netif\_action\_got\_ip (C++ function), 328  
 esp\_netif\_action\_join\_ip6\_multicast\_group (C++ function), 329  
 esp\_netif\_action\_leave\_ip6\_multicast\_group (C++ function), 329  
 esp\_netif\_action\_remove\_ip6\_address (C++ function), 329  
 esp\_netif\_action\_start (C++ function), 327  
 esp\_netif\_action\_stop (C++ function), 327  
 esp\_netif\_attach (C++ function), 327  
 esp\_netif\_attach\_wifi\_ap (C++ function), 350  
 esp\_netif\_attach\_wifi\_station (C++ function), 350  
 ESP\_NETIF\_BR\_DROP (C macro), 343  
 ESP\_NETIF\_BR\_FDW\_CPU (C macro), 343  
 ESP\_NETIF\_BR\_FLOOD (C macro), 343  
 esp\_netif\_callback\_fn (C++ type), 338  
 esp\_netif\_config (C++ struct), 342  
 esp\_netif\_config::base (C++ member), 342  
 esp\_netif\_config::driver (C++ member), 342  
 esp\_netif\_config::stack (C++ member), 342  
 esp\_netif\_config\_t (C++ type), 343  
 esp\_netif\_create\_default\_wifi\_ap (C++ function), 351  
 esp\_netif\_create\_default\_wifi\_mesh\_netifs (C++ function), 352  
 esp\_netif\_create\_default\_wifi\_sta (C++ function), 351  
 esp\_netif\_create\_ip6\_linklocal (C++ function), 335  
 esp\_netif\_create\_wifi (C++ function), 351  
 ESP\_NETIF\_DEFAULT\_OPENTHREAD (C macro), 319  
 esp\_netif\_deinit (C++ function), 326  
 esp\_netif\_destroy (C++ function), 326  
 esp\_netif\_destroy\_default\_wifi (C++ function), 351  
 esp\_netif\_dhcp\_option\_id\_t (C++ enum), 344  
 esp\_netif\_dhcp\_option\_id\_t::ESP\_NETIF\_DOMAIN\_NAME (C++ enumerator), 345  
 esp\_netif\_dhcp\_option\_id\_t::ESP\_NETIF\_IP\_ADDRESS (C++ enumerator), 345  
 esp\_netif\_dhcp\_option\_id\_t::ESP\_NETIF\_IP\_REQUEST (C++ enumerator), 345  
 esp\_netif\_dhcp\_option\_id\_t::ESP\_NETIF\_REQUESTED\_IP (C++ enumerator), 345  
 esp\_netif\_dhcp\_option\_id\_t::ESP\_NETIF\_ROUTER\_SOLICIT (C++ enumerator), 345  
 esp\_netif\_dhcp\_option\_id\_t::ESP\_NETIF\_SUBNET\_MASK (C++ enumerator), 345

- (C++ enumerator), 345
- esp\_netif\_dhcp\_option\_id\_t::ESP\_NETIF\_VENDOR\_CLASS\_IDENTIFIER::transmit (C++ member), 341
- (C++ enumerator), 345
- (C++ member), 341
- esp\_netif\_dhcp\_option\_id\_t::ESP\_NETIF\_VENDOR\_SPECIFIC\_INFO::transmit\_wrap (C++ member), 341
- (C++ enumerator), 345
- (C++ member), 341
- esp\_netif\_dhcp\_option\_mode\_t (C++ enum), 344
- esp\_netif\_driver\_ifconfig\_t (C++ type), 343
- esp\_netif\_dhcp\_option\_mode\_t::ESP\_NETIF\_OP\_GET::find\_if (C++ function), 338
- (C++ enumerator), 344
- esp\_netif\_find\_predicate\_t (C++ type), 338
- esp\_netif\_dhcp\_option\_mode\_t::ESP\_NETIF\_OP\_MAX::if\_flags (C++ enum), 346
- (C++ enumerator), 344
- esp\_netif\_flags::ESP\_NETIF\_DHCP\_CLIENT (C++ enumerator), 346
- esp\_netif\_dhcp\_option\_mode\_t::ESP\_NETIF\_OP\_SET (C++ enumerator), 346
- (C++ enumerator), 344
- esp\_netif\_flags::ESP\_NETIF\_DHCP\_SERVER (C++ enumerator), 346
- esp\_netif\_dhcp\_option\_mode\_t::ESP\_NETIF\_OP\_START (C++ enumerator), 346
- (C++ enumerator), 344
- esp\_netif\_flags::ESP\_NETIF\_FLAG\_AUTOUP (C++ enumerator), 346
- esp\_netif\_dhcp\_status\_t (C++ enum), 344
- (C++ enumerator), 344
- esp\_netif\_flags::ESP\_NETIF\_FLAG\_EVENT\_IP\_MODIFIED (C++ enumerator), 346
- esp\_netif\_dhcp\_status\_t::ESP\_NETIF\_DHCP\_STOPPED::if\_flags::ESP\_NETIF\_FLAG\_GARP (C++ enumerator), 346
- (C++ enumerator), 344
- (C++ enumerator), 346
- esp\_netif\_dhcp\_status\_t::ESP\_NETIF\_DHCP\_STARTING::if\_flags::ESP\_NETIF\_FLAG\_IS\_BRIDGE (C++ enumerator), 346
- (C++ enumerator), 344
- (C++ enumerator), 346
- esp\_netif\_dhcp\_status\_t::ESP\_NETIF\_DHCP\_STOPPING::if\_flags::ESP\_NETIF\_FLAG\_IS\_PPP (C++ enumerator), 346
- (C++ enumerator), 344
- (C++ enumerator), 346
- esp\_netif\_dhcpc\_get\_status (C++ function), 333
- esp\_netif\_flags::ESP\_NETIF\_FLAG\_MLDV6\_REPORT (C++ enumerator), 346
- (C++ enumerator), 346
- esp\_netif\_dhcpc\_option (C++ function), 333
- esp\_netif\_flags\_t (C++ type), 343
- esp\_netif\_dhcpc\_start (C++ function), 333
- esp\_netif\_free\_rx\_buffer (C++ function), 354
- esp\_netif\_dhcpc\_stop (C++ function), 333
- esp\_netif\_get\_all\_ip6 (C++ function), 336
- esp\_netif\_dhcps\_get\_clients\_by\_mac (C++ function), 334
- esp\_netif\_get\_desc (C++ function), 337
- esp\_netif\_dhcps\_get\_status (C++ function), 333
- esp\_netif\_get\_dns\_info (C++ function), 335
- esp\_netif\_get\_event\_id (C++ function), 337
- esp\_netif\_dhcps\_option (C++ function), 332
- esp\_netif\_get\_flags (C++ function), 337
- esp\_netif\_dhcps\_start (C++ function), 334
- esp\_netif\_get\_handle\_from\_ifkey (C++ function), 337
- esp\_netif\_dhcps\_stop (C++ function), 334
- esp\_netif\_get\_handle\_from\_netif\_impl (C++ function), 353
- esp\_netif\_dns\_info\_t (C++ struct), 338
- esp\_netif\_get\_hostname (C++ function), 330
- esp\_netif\_dns\_info\_t::ip (C++ member), 338
- esp\_netif\_get\_ifkey (C++ function), 337
- esp\_netif\_get\_io\_driver (C++ function), 336
- esp\_netif\_dns\_type\_t (C++ enum), 344
- ESP\_NETIF\_DNS\_BACKUP (C++ enumerator), 344
- esp\_netif\_get\_ip6\_global (C++ function), 335
- esp\_netif\_dns\_type\_t::ESP\_NETIF\_DNS\_FALLBACK (C++ enumerator), 344
- (C++ enumerator), 344
- esp\_netif\_get\_ip6\_linklocal (C++ function), 335
- esp\_netif\_dns\_type\_t::ESP\_NETIF\_DNS\_MAIN (C++ enumerator), 344
- (C++ enumerator), 344
- esp\_netif\_get\_ip\_info (C++ function), 331
- esp\_netif\_dns\_type\_t::ESP\_NETIF\_DNS\_MAX (C++ enumerator), 344
- (C++ enumerator), 344
- esp\_netif\_get\_mac (C++ function), 330
- esp\_netif\_driver\_base\_s (C++ struct), 341
- esp\_netif\_get\_netif\_impl (C++ function), 354
- esp\_netif\_driver\_base\_s::netif (C++ member), 341
- esp\_netif\_get\_netif\_impl\_index (C++ function), 332
- esp\_netif\_driver\_base\_s::post\_attach (C++ member), 341
- esp\_netif\_get\_netif\_impl\_name (C++ function), 332
- esp\_netif\_driver\_base\_t (C++ type), 343
- esp\_netif\_get\_nr\_of\_ifs (C++ function), 338
- esp\_netif\_driver\_ifconfig (C++ struct), 341
- esp\_netif\_get\_old\_ip\_info (C++ function), 331
- esp\_netif\_driver\_ifconfig::driver\_free\_rx\_buffer (C++ member), 342
- esp\_netif\_get\_route\_prio (C++ function), 337
- esp\_netif\_driver\_ifconfig::handle (C++ member), 342
- (C++ member), 342

- esp\_netif\_htonl (*C macro*), 347  
 esp\_netif\_inherent\_config (*C++ struct*), 340  
 esp\_netif\_inherent\_config::bridge\_info (*C++ member*), 341  
 esp\_netif\_inherent\_config::flags (*C++ member*), 340  
 esp\_netif\_inherent\_config::get\_ip\_event (*C++ member*), 341  
 esp\_netif\_inherent\_config::if\_desc (*C++ member*), 341  
 esp\_netif\_inherent\_config::if\_key (*C++ member*), 341  
 esp\_netif\_inherent\_config::ip\_info (*C++ member*), 341  
 esp\_netif\_inherent\_config::lost\_ip\_event (*C++ member*), 341  
 esp\_netif\_inherent\_config::mac (*C++ member*), 340  
 esp\_netif\_inherent\_config::route\_prio (*C++ member*), 341  
 esp\_netif\_inherent\_config\_t (*C++ type*), 343  
 ESP\_NETIF\_INHERENT\_DEFAULT\_OPENTHREAD (*C macro*), 319  
 esp\_netif\_init (*C++ function*), 326  
 esp\_netif\_iodriver\_handle (*C++ type*), 343  
 esp\_netif\_ip4\_makeu32 (*C macro*), 347  
 esp\_netif\_ip6\_get\_addr\_type (*C++ function*), 346  
 esp\_netif\_ip6\_info\_t (*C++ struct*), 339  
 esp\_netif\_ip6\_info\_t::ip (*C++ member*), 339  
 esp\_netif\_ip\_addr\_copy (*C++ function*), 346  
 esp\_netif\_ip\_event\_type (*C++ enum*), 346  
 esp\_netif\_ip\_event\_type::ESP\_NETIF\_IP\_EVENT\_TYPE\_IP4 (*C++ enumerator*), 346  
 esp\_netif\_ip\_event\_type::ESP\_NETIF\_IP\_EVENT\_TYPE\_IP6 (*C++ enumerator*), 346  
 esp\_netif\_ip\_event\_type\_t (*C++ type*), 343  
 esp\_netif\_ip\_info\_t (*C++ struct*), 338  
 esp\_netif\_ip\_info\_t::gw (*C++ member*), 339  
 esp\_netif\_ip\_info\_t::ip (*C++ member*), 339  
 esp\_netif\_ip\_info\_t::netmask (*C++ member*), 339  
 esp\_netif\_is\_netif\_up (*C++ function*), 331  
 esp\_netif\_join\_ip6\_multicast\_group (*C++ function*), 329  
 esp\_netif\_leave\_ip6\_multicast\_group (*C++ function*), 330  
 esp\_netif\_netstack\_buf\_free (*C++ function*), 338  
 esp\_netif\_netstack\_buf\_ref (*C++ function*), 338  
 esp\_netif\_netstack\_config\_t (*C++ type*), 343  
 esp\_netif\_new (*C++ function*), 326  
 esp\_netif\_next (*C++ function*), 337  
 esp\_netif\_next\_unsafe (*C++ function*), 337  
 esp\_netif\_pair\_mac\_ip\_t (*C++ struct*), 342  
 esp\_netif\_pair\_mac\_ip\_t::ip (*C++ member*), 342  
 esp\_netif\_pair\_mac\_ip\_t::mac (*C++ member*), 342  
 esp\_netif\_receive (*C++ function*), 327  
 esp\_netif\_receive\_t (*C++ type*), 343  
 esp\_netif\_set\_default\_netif (*C++ function*), 329  
 esp\_netif\_set\_dns\_info (*C++ function*), 334  
 esp\_netif\_set\_driver\_config (*C++ function*), 326  
 esp\_netif\_set\_hostname (*C++ function*), 330  
 esp\_netif\_set\_ip4\_addr (*C++ function*), 336  
 esp\_netif\_set\_ip\_info (*C++ function*), 331  
 esp\_netif\_set\_link\_speed (*C++ function*), 354  
 esp\_netif\_set\_mac (*C++ function*), 330  
 esp\_netif\_set\_old\_ip\_info (*C++ function*), 332  
 esp\_netif\_str\_to\_ip4 (*C++ function*), 336  
 esp\_netif\_str\_to\_ip6 (*C++ function*), 336  
 esp\_netif\_t (*C++ type*), 343  
 esp\_netif\_tcpip\_exec (*C++ function*), 338  
 esp\_netif\_transmit (*C++ function*), 354  
 esp\_netif\_transmit\_wrap (*C++ function*), 354  
 esp\_now\_add\_peer (*C++ function*), 162  
 esp\_now\_deinit (*C++ function*), 161  
 esp\_now\_del\_peer (*C++ function*), 162  
 ESP\_NOW\_ETH\_ALEN (*C macro*), 166  
 esp\_now\_fetch\_peer (*C++ function*), 163  
 esp\_now\_get\_peer (*C++ function*), 163  
 esp\_now\_get\_peer\_num (*C++ function*), 163  
 esp\_now\_get\_version (*C++ function*), 161  
 ESP\_NOW\_GET\_VERSION (*C++ function*), 161  
 esp\_now\_is\_peer\_exist (*C++ function*), 163  
 ESP\_NOW\_KEY\_LEN (*C macro*), 166  
 ESP\_NOW\_MAX\_DATA\_LEN (*C macro*), 166  
 ESP\_NOW\_MAX\_ENCRYPT\_PEER\_NUM (*C macro*), 166  
 ESP\_NOW\_MAX\_TOTAL\_PEER\_NUM (*C macro*), 166  
 esp\_now\_mod\_peer (*C++ function*), 162  
 esp\_now\_peer\_info (*C++ struct*), 164  
 esp\_now\_peer\_info::channel (*C++ member*), 164  
 esp\_now\_peer\_info::encrypt (*C++ member*), 164  
 esp\_now\_peer\_info::ifidx (*C++ member*), 164  
 esp\_now\_peer\_info::lmk (*C++ member*), 164  
 esp\_now\_peer\_info::peer\_addr (*C++ member*), 164  
 esp\_now\_peer\_info::priv (*C++ member*), 164  
 esp\_now\_peer\_info\_t (*C++ type*), 166  
 esp\_now\_peer\_num (*C++ struct*), 164  
 esp\_now\_peer\_num::encrypt\_num (*C++ member*), 165

- esp\_now\_peer\_num::total\_num (C++ member), 165  
 esp\_now\_peer\_num\_t (C++ type), 166  
 esp\_now\_rcv\_cb\_t (C++ type), 166  
 esp\_now\_rcv\_info (C++ struct), 165  
 esp\_now\_rcv\_info::des\_addr (C++ member), 165  
 esp\_now\_rcv\_info::rx\_ctrl (C++ member), 165  
 esp\_now\_rcv\_info::src\_addr (C++ member), 165  
 esp\_now\_rcv\_info\_t (C++ type), 166  
 esp\_now\_register\_rcv\_cb (C++ function), 161  
 esp\_now\_register\_send\_cb (C++ function), 161  
 esp\_now\_send (C++ function), 162  
 esp\_now\_send\_cb\_t (C++ type), 166  
 esp\_now\_send\_status\_t (C++ enum), 166  
 esp\_now\_send\_status\_t::ESP\_NOW\_SEND\_FAIL (C++ enumerator), 167  
 esp\_now\_send\_status\_t::ESP\_NOW\_SEND\_SUCCESS (C++ enumerator), 166  
 esp\_now\_set\_pmk (C++ function), 163  
 esp\_now\_set\_wake\_window (C++ function), 164  
 esp\_now\_unregister\_rcv\_cb (C++ function), 161  
 esp\_now\_unregister\_send\_cb (C++ function), 162  
 ESP\_OK (C macro), 1206  
 ESP\_OK\_EFUSE\_CNT (C macro), 1204  
 esp\_openthread\_border\_router\_deinit (C++ function), 320  
 esp\_openthread\_border\_router\_init (C++ function), 320  
 esp\_openthread\_deinit (C++ function), 315  
 esp\_openthread\_event\_t (C++ enum), 317  
 esp\_openthread\_event\_t::OPENTHREAD\_EVENT\_GOT\_IP (C++ member), 317  
 esp\_openthread\_event\_t::OPENTHREAD\_EVENT\_IF\_DOWN (C++ member), 317  
 esp\_openthread\_event\_t::OPENTHREAD\_EVENT\_IF\_UP (C++ member), 317  
 esp\_openthread\_event\_t::OPENTHREAD\_EVENT\_LOST\_IP (C++ member), 318  
 esp\_openthread\_event\_t::OPENTHREAD\_EVENT\_MULTICAST\_JOIN (C++ member), 318  
 esp\_openthread\_event\_t::OPENTHREAD\_EVENT\_MULTICAST\_LEAVE (C++ member), 318  
 esp\_openthread\_event\_t::OPENTHREAD\_EVENT\_START (C++ member), 317  
 esp\_openthread\_event\_t::OPENTHREAD\_EVENT\_STOP (C++ member), 317  
 esp\_openthread\_event\_t::OPENTHREAD\_EVENT\_TREL\_ADD (C++ member), 317  
 esp\_openthread\_event\_t::OPENTHREAD\_EVENT\_TREL\_REMOVE (C++ member), 317  
 esp\_openthread\_event\_t::OPENTHREAD\_EVENT\_TREL\_MOVE\_IP6 (C++ member), 318  
 esp\_openthread\_get\_backbone\_netif (C++ function), 320  
 esp\_openthread\_get\_instance (C++ function), 315  
 esp\_openthread\_get\_netif (C++ function), 319  
 esp\_openthread\_host\_connection\_config\_t (C++ struct), 316  
 esp\_openthread\_host\_connection\_config\_t::host\_connection (C++ member), 316  
 esp\_openthread\_host\_connection\_config\_t::host\_ua (C++ member), 316  
 esp\_openthread\_host\_connection\_mode\_t (C++ enum), 318  
 esp\_openthread\_host\_connection\_mode\_t::HOST\_CONNECTION\_MODE\_UNSPECIFIED (C++ enumerator), 318  
 esp\_openthread\_host\_connection\_mode\_t::HOST\_CONNECTION\_MODE\_STATIC (C++ enumerator), 318  
 esp\_openthread\_host\_connection\_mode\_t::HOST\_CONNECTION\_MODE\_DYNAMIC (C++ enumerator), 318  
 esp\_openthread\_init (C++ function), 314  
 esp\_openthread\_launch\_mainloop (C++ function), 315  
 esp\_openthread\_lock\_acquire (C++ function), 319  
 esp\_openthread\_lock\_deinit (C++ function), 319  
 esp\_openthread\_lock\_init (C++ function), 319  
 esp\_openthread\_lock\_release (C++ function), 319  
 esp\_openthread\_mainloop\_context\_t (C++ struct), 315  
 esp\_openthread\_mainloop\_context\_t::error\_fds (C++ member), 315  
 esp\_openthread\_mainloop\_context\_t::max\_fd (C++ member), 315  
 esp\_openthread\_mainloop\_context\_t::read\_fds (C++ member), 315  
 esp\_openthread\_mainloop\_context\_t::timeout (C++ member), 315  
 esp\_openthread\_mainloop\_context\_t::write\_fds (C++ member), 315  
 esp\_openthread\_netif\_glue\_deinit (C++ function), 317  
 esp\_openthread\_netif\_glue\_init (C++ function), 317  
 esp\_openthread\_platform\_config\_t (C++ struct), 317  
 esp\_openthread\_platform\_config\_t::host\_config (C++ member), 317  
 esp\_openthread\_platform\_config\_t::port\_config (C++ member), 317  
 esp\_openthread\_platform\_config\_t::radio\_config (C++ member), 317  
 esp\_openthread\_port\_config\_t (C++ struct), 316

- esp\_openthread\_port\_config\_t::netif\_queue\_size (C++ function), 1434  
 (C++ member), 317
- esp\_openthread\_port\_config\_t::storage\_partition\_name (C++ member), 317
- esp\_openthread\_port\_config\_t::task\_queue\_size (C++ member), 317
- esp\_openthread\_radio\_config\_t (C++ struct), 316
- esp\_openthread\_radio\_config\_t::radio\_mode (C++ member), 316
- esp\_openthread\_radio\_config\_t::radio\_uart\_config (C++ member), 316
- esp\_openthread\_radio\_mode\_t (C++ enum), 318
- esp\_openthread\_radio\_mode\_t::RADIO\_MODE\_NATIVE (C++ enumerator), 318
- esp\_openthread\_radio\_mode\_t::RADIO\_MODE\_ESP\_TO\_RCP (C++ enumerator), 318
- esp\_openthread\_radio\_mode\_t::RADIO\_MODE\_START\_RCP (C++ enumerator), 318
- esp\_openthread\_rcp\_deinit (C++ function), 320
- esp\_openthread\_rcp\_failure\_handler (C++ type), 317
- esp\_openthread\_register\_rcp\_failure\_handler (C++ function), 320
- esp\_openthread\_set\_backbone\_netif (C++ function), 320
- esp\_openthread\_uart\_config\_t (C++ struct), 316
- esp\_openthread\_uart\_config\_t::port (C++ member), 316
- esp\_openthread\_uart\_config\_t::rx\_pin (C++ member), 316
- esp\_openthread\_uart\_config\_t::tx\_pin (C++ member), 316
- esp\_openthread\_uart\_config\_t::uart\_config (C++ member), 316
- esp\_ota\_abort (C++ function), 1433
- esp\_ota\_begin (C++ function), 1431
- esp\_ota\_check\_rollback\_is\_possible (C++ function), 1435
- esp\_ota\_end (C++ function), 1432
- esp\_ota\_erase\_last\_boot\_app\_partition (C++ function), 1435
- esp\_ota\_get\_app\_description (C++ function), 1431
- esp\_ota\_get\_app\_elf\_sha256 (C++ function), 1431
- esp\_ota\_get\_app\_partition\_count (C++ function), 1434
- esp\_ota\_get\_boot\_partition (C++ function), 1433
- esp\_ota\_get\_last\_invalid\_partition (C++ function), 1435
- esp\_ota\_get\_next\_update\_partition (C++ function), 1434
- esp\_ota\_get\_partition\_description (C++ function), 1434
- esp\_ota\_get\_running\_partition (C++ function), 1433
- esp\_ota\_get\_state\_partition (C++ function), 1435
- esp\_ota\_handle\_t (C++ type), 1436
- esp\_ota\_mark\_app\_invalid\_rollback\_and\_reboot (C++ function), 1434
- esp\_ota\_mark\_app\_valid\_cancel\_rollback (C++ function), 1434
- esp\_ota\_invoke\_secure\_boot\_public\_key (C++ function), 1435
- esp\_ota\_secure\_boot\_public\_key\_index\_t (C++ enum), 1436
- esp\_ota\_secure\_boot\_public\_key\_index\_t::SECURE\_BOOT\_PUBLIC\_KEY\_INDEX\_NATIVE (C++ enumerator), 1436
- esp\_ota\_secure\_boot\_public\_key\_index\_t::SECURE\_BOOT\_PUBLIC\_KEY\_INDEX\_ESP\_TO\_RCP (C++ enumerator), 1436
- esp\_ota\_secure\_boot\_public\_key\_index\_t::SECURE\_BOOT\_PUBLIC\_KEY\_INDEX\_START\_RCP (C++ enumerator), 1436
- esp\_ota\_set\_boot\_partition (C++ function), 1433
- esp\_ota\_write (C++ function), 1432
- esp\_ota\_write\_with\_offset (C++ function), 1432
- esp\_partition\_check\_identity (C++ function), 1124
- esp\_partition\_deregister\_external (C++ function), 1125
- esp\_partition\_erase\_range (C++ function), 1123
- esp\_partition\_find (C++ function), 1121
- esp\_partition\_find\_first (C++ function), 1121
- esp\_partition\_get (C++ function), 1121
- esp\_partition\_get\_sha256 (C++ function), 1124
- esp\_partition\_iterator\_release (C++ function), 1121
- esp\_partition\_iterator\_t (C++ type), 1126
- esp\_partition\_mmap (C++ function), 1123
- esp\_partition\_mmap\_handle\_t (C++ type), 1126
- esp\_partition\_mmap\_memory\_t (C++ enum), 1126
- esp\_partition\_mmap\_memory\_t::ESP\_PARTITION\_MMAPPED (C++ enumerator), 1126
- esp\_partition\_mmap\_memory\_t::ESP\_PARTITION\_MMAPPED\_I (C++ enumerator), 1126
- esp\_partition\_munmap (C++ function), 1124
- esp\_partition\_next (C++ function), 1121
- esp\_partition\_read (C++ function), 1122
- esp\_partition\_read\_raw (C++ function), 1122
- esp\_partition\_register\_external (C++ function), 1125
- ESP\_PARTITION\_SUBTYPE\_OTA (C macro), 1126
- esp\_partition\_subtype\_t (C++ enum), 1127
- esp\_partition\_subtype\_t::ESP\_PARTITION\_SUBTYPE\_OTA (C++ enumerator), 1127





- esp\_phy\_is\_initialized (C++ function), 1736  
 esp\_phy\_load\_cal\_and\_init (C++ function), 1737  
 esp\_phy\_load\_cal\_data\_from\_nvs (C++ function), 1736  
 esp\_phy\_modem\_deinit (C++ function), 1737  
 esp\_phy\_modem\_init (C++ function), 1737  
 esp\_phy\_release\_init\_data (C++ function), 1736  
 esp\_phy\_rf\_get\_on\_ts (C++ function), 1737  
 esp\_phy\_store\_cal\_data\_to\_nvs (C++ function), 1736  
 esp\_phy\_update\_country\_info (C++ function), 1737  
 esp\_ping\_callbacks\_t (C++ struct), 148  
 esp\_ping\_callbacks\_t::cb\_args (C++ member), 148  
 esp\_ping\_callbacks\_t::on\_ping\_end (C++ member), 148  
 esp\_ping\_callbacks\_t::on\_ping\_success (C++ member), 148  
 esp\_ping\_callbacks\_t::on\_ping\_timeout (C++ member), 148  
 esp\_ping\_config\_t (C++ struct), 149  
 esp\_ping\_config\_t::count (C++ member), 149  
 esp\_ping\_config\_t::data\_size (C++ member), 149  
 esp\_ping\_config\_t::interface (C++ member), 149  
 esp\_ping\_config\_t::interval\_ms (C++ member), 149  
 esp\_ping\_config\_t::target\_addr (C++ member), 149  
 esp\_ping\_config\_t::task\_prio (C++ member), 149  
 esp\_ping\_config\_t::task\_stack\_size (C++ member), 149  
 esp\_ping\_config\_t::timeout\_ms (C++ member), 149  
 esp\_ping\_config\_t::tos (C++ member), 149  
 esp\_ping\_config\_t::ttl (C++ member), 149  
 ESP\_PING\_COUNT\_INFINITE (C macro), 149  
 ESP\_PING\_DEFAULT\_CONFIG (C macro), 149  
 esp\_ping\_delete\_session (C++ function), 148  
 esp\_ping\_get\_profile (C++ function), 148  
 esp\_ping\_handle\_t (C++ type), 149  
 esp\_ping\_new\_session (C++ function), 147  
 esp\_ping\_profile\_t (C++ enum), 150  
 esp\_ping\_profile\_t::ESP\_PING\_PROF\_DURATION (C++ enumerator), 150  
 esp\_ping\_profile\_t::ESP\_PING\_PROF\_IPADDR (C++ enumerator), 150  
 esp\_ping\_profile\_t::ESP\_PING\_PROF\_REPLY (C++ enumerator), 150  
 esp\_ping\_profile\_t::ESP\_PING\_PROF\_REQUEST (C++ enumerator), 150  
 esp\_ping\_profile\_t::ESP\_PING\_PROF\_SEQNO (C++ enumerator), 150  
 esp\_ping\_profile\_t::ESP\_PING\_PROF\_SIZE (C++ enumerator), 150  
 esp\_ping\_profile\_t::ESP\_PING\_PROF\_TIMEGAP (C++ enumerator), 150  
 esp\_ping\_profile\_t::ESP\_PING\_PROF\_TOS (C++ enumerator), 150  
 esp\_ping\_profile\_t::ESP\_PING\_PROF\_TTL (C++ enumerator), 150  
 esp\_ping\_start (C++ function), 148  
 esp\_ping\_stop (C++ function), 148  
 esp\_pm\_config\_esp32s2\_t (C++ struct), 1446  
 esp\_pm\_config\_esp32s2\_t::light\_sleep\_enable (C++ member), 1446  
 esp\_pm\_config\_esp32s2\_t::max\_freq\_mhz (C++ member), 1446  
 esp\_pm\_config\_esp32s2\_t::min\_freq\_mhz (C++ member), 1446  
 esp\_pm\_configure (C++ function), 1443  
 esp\_pm\_dump\_locks (C++ function), 1445  
 esp\_pm\_get\_configuration (C++ function), 1443  
 esp\_pm\_lock\_acquire (C++ function), 1444  
 esp\_pm\_lock\_create (C++ function), 1444  
 esp\_pm\_lock\_delete (C++ function), 1445  
 esp\_pm\_lock\_handle\_t (C++ type), 1445  
 esp\_pm\_lock\_release (C++ function), 1444  
 esp\_pm\_lock\_type\_t (C++ enum), 1445  
 esp\_pm\_lock\_type\_t::ESP\_PM\_APB\_FREQ\_MAX (C++ enumerator), 1445  
 esp\_pm\_lock\_type\_t::ESP\_PM\_CPU\_FREQ\_MAX (C++ enumerator), 1445  
 esp\_pm\_lock\_type\_t::ESP\_PM\_NO\_LIGHT\_SLEEP (C++ enumerator), 1445  
 esp\_pthread\_cfg\_t (C++ struct), 1450  
 esp\_pthread\_cfg\_t::inherit\_cfg (C++ member), 1450  
 esp\_pthread\_cfg\_t::pin\_to\_core (C++ member), 1450  
 esp\_pthread\_cfg\_t::prio (C++ member), 1450  
 esp\_pthread\_cfg\_t::stack\_size (C++ member), 1450  
 esp\_pthread\_cfg\_t::thread\_name (C++ member), 1450  
 esp\_pthread\_get\_cfg (C++ function), 1449  
 esp\_pthread\_get\_default\_config (C++ function), 1449  
 esp\_pthread\_init (C++ function), 1450  
 esp\_pthread\_set\_cfg (C++ function), 1449  
 esp\_random (C++ function), 1451  
 esp\_read\_mac (C++ function), 1417  
 esp\_register\_freertos\_idle\_hook (C++ function), 1364  
 esp\_register\_freertos\_idle\_hook\_for\_cpu (C++ function), 1364  
 esp\_register\_freertos\_tick\_hook (C++ function), 1365

- esp\_register\_freertos\_tick\_hook\_for\_cpu (C++ function), 1365  
 esp\_register\_shutdown\_handler (C++ function), 1413  
 esp\_reset\_reason (C++ function), 1414  
 esp\_reset\_reason\_t (C++ enum), 1414  
 esp\_reset\_reason\_t::ESP\_RST\_BROWNOUT (C++ enumerator), 1415  
 esp\_reset\_reason\_t::ESP\_RST\_DEEPSLEEP (C++ enumerator), 1415  
 esp\_reset\_reason\_t::ESP\_RST\_EXT (C++ enumerator), 1414  
 esp\_reset\_reason\_t::ESP\_RST\_INT\_WDT (C++ enumerator), 1415  
 esp\_reset\_reason\_t::ESP\_RST\_PANIC (C++ enumerator), 1415  
 esp\_reset\_reason\_t::ESP\_RST\_POWERON (C++ enumerator), 1414  
 esp\_reset\_reason\_t::ESP\_RST\_SDIO (C++ enumerator), 1415  
 esp\_reset\_reason\_t::ESP\_RST\_SW (C++ enumerator), 1415  
 esp\_reset\_reason\_t::ESP\_RST\_TASK\_WDT (C++ enumerator), 1415  
 esp\_reset\_reason\_t::ESP\_RST\_UNKNOWN (C++ enumerator), 1414  
 esp\_reset\_reason\_t::ESP\_RST\_WDT (C++ enumerator), 1415  
 esp\_restart (C++ function), 1413  
 ESP\_RETURN\_ON\_ERROR (C macro), 1205  
 ESP\_RETURN\_ON\_ERROR\_ISR (C macro), 1205  
 ESP\_RETURN\_ON\_FALSE (C macro), 1205  
 ESP\_RETURN\_ON\_FALSE\_ISR (C macro), 1205  
 esp\_rom\_delay\_us (C++ function), 1397  
 esp\_rom\_get\_cpu\_ticks\_per\_us (C++ function), 1397  
 esp\_rom\_get\_reset\_reason (C++ function), 1397  
 esp\_rom\_install\_channel\_putc (C++ function), 1397  
 esp\_rom\_install\_uart\_printf (C++ function), 1397  
 esp\_rom\_printf (C++ function), 1396  
 esp\_rom\_route\_intr\_matrix (C++ function), 1397  
 esp\_rom\_software\_reset\_system (C++ function), 1396  
 esp\_rrm\_is\_rrm\_supported\_connection (C++ function), 275  
 esp\_rrm\_send\_neighbor\_rep\_request (C++ function), 275  
 esp\_secure\_boot\_key\_digests\_t (C++ struct), 1204  
 esp\_secure\_boot\_key\_digests\_t::key\_digests (C++ member), 1204  
 esp\_secure\_boot\_read\_key\_digests (C++ function), 1203  
 esp\_set\_deep\_sleep\_wake\_stub (C++ function), 1462  
 esp\_sleep\_config\_gpio\_isolate (C++ function), 1462  
 esp\_sleep\_disable\_bt\_wakeup (C++ function), 1460  
 esp\_sleep\_disable\_wakeup\_source (C++ function), 1457  
 esp\_sleep\_disable\_wifi\_wakeup (C++ function), 1460  
 esp\_sleep\_enable\_bt\_wakeup (C++ function), 1460  
 esp\_sleep\_enable\_ext0\_wakeup (C++ function), 1458  
 esp\_sleep\_enable\_ext1\_wakeup (C++ function), 1459  
 esp\_sleep\_enable\_gpio\_switch (C++ function), 1462  
 esp\_sleep\_enable\_gpio\_wakeup (C++ function), 1460  
 esp\_sleep\_enable\_timer\_wakeup (C++ function), 1458  
 esp\_sleep\_enable\_touchpad\_wakeup (C++ function), 1458  
 esp\_sleep\_enable\_uart\_wakeup (C++ function), 1460  
 esp\_sleep\_enable\_ulp\_wakeup (C++ function), 1457  
 esp\_sleep\_enable\_wifi\_wakeup (C++ function), 1460  
 esp\_sleep\_ext1\_wakeup\_mode\_t (C++ enum), 1462  
 esp\_sleep\_ext1\_wakeup\_mode\_t::ESP\_EXT1\_WAKEUP\_ALL (C++ enumerator), 1463  
 esp\_sleep\_ext1\_wakeup\_mode\_t::ESP\_EXT1\_WAKEUP\_ANY (C++ enumerator), 1463  
 esp\_sleep\_ext1\_wakeup\_mode\_t::ESP\_EXT1\_WAKEUP\_ANY (C++ enumerator), 1462  
 esp\_sleep\_get\_ext1\_wakeup\_status (C++ function), 1461  
 esp\_sleep\_get\_touchpad\_wakeup\_status (C++ function), 1458  
 esp\_sleep\_get\_wakeup\_cause (C++ function), 1462  
 esp\_sleep\_is\_valid\_wakeup\_gpio (C++ function), 1458  
 esp\_sleep\_pd\_config (C++ function), 1461  
 esp\_sleep\_pd\_domain\_t (C++ enum), 1463  
 esp\_sleep\_pd\_domain\_t::ESP\_PD\_DOMAIN\_MAX (C++ enumerator), 1463  
 esp\_sleep\_pd\_domain\_t::ESP\_PD\_DOMAIN\_RTC8M (C++ enumerator), 1463  
 esp\_sleep\_pd\_domain\_t::ESP\_PD\_DOMAIN\_RTC\_FAST\_MEM (C++ enumerator), 1463  
 esp\_sleep\_pd\_domain\_t::ESP\_PD\_DOMAIN\_RTC\_PERIPH (C++ enumerator), 1463  
 esp\_sleep\_pd\_domain\_t::ESP\_PD\_DOMAIN\_RTC\_SLOW\_MEM (C++ enumerator), 1463  
 esp\_sleep\_pd\_domain\_t::ESP\_PD\_DOMAIN\_VDDSDIO (C++ enumerator), 1463



- (C++ enumerator), 1463
- esp\_sleep\_pd\_domain\_t::ESP\_PD\_DOMAIN\_XTAL (C++ enumerator), 1463
- esp\_sleep\_pd\_option\_t (C++ enum), 1463
- esp\_sleep\_pd\_option\_t::ESP\_PD\_OPTION\_AUTO (C++ enumerator), 1463
- esp\_sleep\_pd\_option\_t::ESP\_PD\_OPTION\_OFF (C++ enumerator), 1463
- esp\_sleep\_pd\_option\_t::ESP\_PD\_OPTION\_ON (C++ enumerator), 1463
- esp\_sleep\_source\_t (C++ enum), 1463
- esp\_sleep\_source\_t::ESP\_SLEEP\_WAKEUP\_ALARM (C++ enumerator), 1464
- esp\_sleep\_source\_t::ESP\_SLEEP\_WAKEUP\_BUTTON (C++ enumerator), 1464
- esp\_sleep\_source\_t::ESP\_SLEEP\_WAKEUP\_COAP (C++ enumerator), 1464
- esp\_sleep\_source\_t::ESP\_SLEEP\_WAKEUP\_COAP\_SECURE\_STRING (C++ enumerator), 1464
- esp\_sleep\_source\_t::ESP\_SLEEP\_WAKEUP\_EXAMPLE (C++ enumerator), 1464
- esp\_sleep\_source\_t::ESP\_SLEEP\_WAKEUP\_EXAMPLE\_1 (C++ enumerator), 1464
- esp\_sleep\_source\_t::ESP\_SLEEP\_WAKEUP\_GPIO (C++ enumerator), 1464
- esp\_sleep\_source\_t::ESP\_SLEEP\_WAKEUP\_TIMER (C++ enumerator), 1464
- esp\_sleep\_source\_t::ESP\_SLEEP\_WAKEUP\_TOUCHPAD (C++ enumerator), 1464
- esp\_sleep\_source\_t::ESP\_SLEEP\_WAKEUP\_UART (C++ enumerator), 1464
- esp\_sleep\_source\_t::ESP\_SLEEP\_WAKEUP\_UIE (C++ enumerator), 1464
- esp\_sleep\_source\_t::ESP\_SLEEP\_WAKEUP\_UNDEFINED (C++ enumerator), 1464
- esp\_sleep\_source\_t::ESP\_SLEEP\_WAKEUP\_WIFI (C++ enumerator), 1464
- esp\_sleep\_wakeup\_cause\_t (C++ type), 1462
- esp\_smartconfig\_fast\_mode (C++ function), 207
- esp\_smartconfig\_get\_rvd\_data (C++ function), 208
- esp\_smartconfig\_get\_version (C++ function), 206
- esp\_smartconfig\_set\_type (C++ function), 207
- esp\_smartconfig\_start (C++ function), 206
- esp\_smartconfig\_stop (C++ function), 207
- esp\_sntp\_enabled (C++ function), 1480
- esp\_sntp\_get\_sync\_interval (C macro), 1481
- esp\_sntp\_get\_sync\_mode (C macro), 1481
- esp\_sntp\_get\_sync\_status (C macro), 1481
- esp\_sntp\_getserver (C++ function), 1480
- esp\_sntp\_getservername (C++ function), 1480
- esp\_sntp\_init (C++ function), 1480
- esp\_sntp\_operatingmode\_t (C++ enum), 1482
- esp\_sntp\_operatingmode\_t::ESP\_SNTP\_OPMODE\_POLL (C++ enumerator), 1482
- esp\_sntp\_restart (C macro), 1481
- esp\_sntp\_set\_sync\_interval (C macro), 1481
- esp\_sntp\_set\_sync\_mode (C macro), 1481
- esp\_sntp\_set\_sync\_status (C macro), 1481
- esp\_sntp\_set\_time\_sync\_notification\_cb (C macro), 1481
- esp\_sntp\_setoperatingmode (C++ function), 1480
- esp\_sntp\_setserver (C++ function), 1480
- esp\_sntp\_setservername (C++ function), 1480
- esp\_sntp\_stop (C++ function), 1480
- esp\_sntp\_sync\_time (C macro), 1481
- esp\_spiffs\_check (C++ function), 1134
- esp\_spiffs\_format (C++ function), 1134
- esp\_spiffs\_gc (C++ function), 1134
- esp\_spiffs\_mount (C++ function), 1134
- esp\_spiffs\_mounted (C++ function), 1134
- esp\_supp\_dpp\_bootstrap\_gen (C++ function), 279
- esp\_supp\_dpp\_bootstrap\_t (C++ type), 280
- esp\_supp\_dpp\_deinit (C++ function), 279
- esp\_supp\_dpp\_event\_cb\_t (C++ type), 280
- esp\_supp\_dpp\_event\_t (C++ enum), 280
- esp\_supp\_dpp\_event\_t::ESP\_SUPP\_DPP\_CFG\_RECVD (C++ enumerator), 280
- esp\_supp\_dpp\_event\_t::ESP\_SUPP\_DPP\_FAIL (C++ enumerator), 280
- esp\_supp\_dpp\_event\_t::ESP\_SUPP\_DPP\_URI\_READY (C++ enumerator), 280
- esp\_supp\_dpp\_init (C++ function), 278
- esp\_supp\_dpp\_start\_listen (C++ function), 279
- esp\_supp\_dpp\_stop\_listen (C++ function), 279
- esp\_system\_abort (C++ function), 1414
- esp\_sysview\_flush (C++ function), 1164
- esp\_sysview\_heap\_trace\_alloc (C++ function), 1164
- esp\_sysview\_heap\_trace\_free (C++ function), 1164
- esp\_sysview\_heap\_trace\_start (C++ function), 1164
- esp\_sysview\_heap\_trace\_stop (C++ function), 1164
- esp\_sysview\_vprintf (C++ function), 1164
- esp\_task\_wdt\_add (C++ function), 1531
- esp\_task\_wdt\_add\_user (C++ function), 1531
- esp\_task\_wdt\_config\_t (C++ struct), 1532
- esp\_task\_wdt\_config\_t::idle\_core\_mask (C++ member), 1533
- esp\_task\_wdt\_config\_t::timeout\_ms (C++ member), 1533
- esp\_task\_wdt\_config\_t::trigger\_panic (C++ member), 1533
- esp\_task\_wdt\_deinit (C++ function), 1531
- esp\_task\_wdt\_delete (C++ function), 1532

- esp\_task\_wdt\_delete\_user (C++ function), 1532  
 esp\_task\_wdt\_init (C++ function), 1530  
 esp\_task\_wdt\_isr\_user\_handler (C++ function), 1532  
 esp\_task\_wdt\_reconfigure (C++ function), 1530  
 esp\_task\_wdt\_reset (C++ function), 1531  
 esp\_task\_wdt\_reset\_user (C++ function), 1531  
 esp\_task\_wdt\_status (C++ function), 1532  
 esp\_task\_wdt\_user\_handle\_t (C++ type), 1533  
 esp\_timer\_cb\_t (C++ type), 1396  
 esp\_timer\_create (C++ function), 1392  
 esp\_timer\_create\_args\_t (C++ struct), 1395  
 esp\_timer\_create\_args\_t::arg (C++ member), 1395  
 esp\_timer\_create\_args\_t::callback (C++ member), 1395  
 esp\_timer\_create\_args\_t::dispatch\_method (C++ member), 1396  
 esp\_timer\_create\_args\_t::name (C++ member), 1396  
 esp\_timer\_create\_args\_t::skip\_unhandled\_event (C++ member), 1396  
 esp\_timer\_deinit (C++ function), 1392  
 esp\_timer\_delete (C++ function), 1394  
 esp\_timer\_dispatch\_t (C++ enum), 1396  
 esp\_timer\_dispatch\_t::ESP\_TIMER\_MAX (C++ enumerator), 1396  
 esp\_timer\_dispatch\_t::ESP\_TIMER\_TASK (C++ enumerator), 1396  
 esp\_timer\_dump (C++ function), 1395  
 esp\_timer\_early\_init (C++ function), 1392  
 esp\_timer\_get\_expiry\_time (C++ function), 1394  
 esp\_timer\_get\_next\_alarm (C++ function), 1394  
 esp\_timer\_get\_next\_alarm\_for\_wake\_up (C++ function), 1394  
 esp\_timer\_get\_period (C++ function), 1394  
 esp\_timer\_get\_time (C++ function), 1394  
 esp\_timer\_handle\_t (C++ type), 1396  
 esp\_timer\_init (C++ function), 1392  
 esp\_timer\_is\_active (C++ function), 1395  
 esp\_timer\_isr\_dispatch\_need\_yield (C++ function), 1395  
 esp\_timer\_restart (C++ function), 1393  
 esp\_timer\_start\_once (C++ function), 1393  
 esp\_timer\_start\_periodic (C++ function), 1393  
 esp\_timer\_stop (C++ function), 1393  
 esp\_tls\_addr\_family (C++ enum), 70  
 esp\_tls\_addr\_family::ESP\_TLS\_AF\_INET (C++ enumerator), 70  
 esp\_tls\_addr\_family::ESP\_TLS\_AF\_INET6 (C++ enumerator), 70  
 esp\_tls\_addr\_family::ESP\_TLS\_AF\_UNSPEC (C++ enumerator), 70  
 esp\_tls\_addr\_family\_t (C++ type), 69  
 esp\_tls\_cfg (C++ struct), 66  
 esp\_tls\_cfg::addr\_family (C++ member), 68  
 esp\_tls\_cfg::alpn\_protos (C++ member), 67  
 esp\_tls\_cfg::cacert\_buf (C++ member), 67  
 esp\_tls\_cfg::cacert\_bytes (C++ member), 67  
 esp\_tls\_cfg::cacert\_pem\_buf (C++ member), 67  
 esp\_tls\_cfg::cacert\_pem\_bytes (C++ member), 67  
 esp\_tls\_cfg::clientcert\_buf (C++ member), 67  
 esp\_tls\_cfg::clientcert\_bytes (C++ member), 67  
 esp\_tls\_cfg::clientcert\_pem\_buf (C++ member), 67  
 esp\_tls\_cfg::clientcert\_pem\_bytes (C++ member), 67  
 esp\_tls\_cfg::clientkey\_buf (C++ member), 67  
 esp\_tls\_cfg::clientkey\_bytes (C++ member), 67  
 esp\_tls\_cfg::clientkey\_password (C++ member), 67  
 esp\_tls\_cfg::clientkey\_password\_len (C++ member), 68  
 esp\_tls\_cfg::clientkey\_pem\_buf (C++ member), 67  
 esp\_tls\_cfg::clientkey\_pem\_bytes (C++ member), 67  
 esp\_tls\_cfg::common\_name (C++ member), 68  
 esp\_tls\_cfg::crt\_bundle\_attach (C++ member), 68  
 esp\_tls\_cfg::ds\_data (C++ member), 68  
 esp\_tls\_cfg::if\_name (C++ member), 68  
 esp\_tls\_cfg::is\_plain\_tcp (C++ member), 68  
 esp\_tls\_cfg::keep\_alive\_cfg (C++ member), 68  
 esp\_tls\_cfg::non\_block (C++ member), 68  
 esp\_tls\_cfg::psk\_hint\_key (C++ member), 68  
 esp\_tls\_cfg::skip\_common\_name (C++ member), 68  
 esp\_tls\_cfg::timeout\_ms (C++ member), 68  
 esp\_tls\_cfg::tls\_version (C++ member), 69  
 esp\_tls\_cfg::use\_global\_ca\_store (C++ member), 68  
 esp\_tls\_cfg::use\_secure\_element (C++ member), 68  
 esp\_tls\_cfg\_t (C++ type), 69  
 esp\_tls\_conn\_destroy (C++ function), 63  
 esp\_tls\_conn\_http\_new (C++ function), 61  
 esp\_tls\_conn\_http\_new\_async (C++ function), 63



- `esp_vfs_fat_mount_config_t::format_if_mount_failed` (C++ member), 1050
- `esp_vfs_fat_mount_config_t::max_files` (C++ member), 1051
- `esp_vfs_fat_register` (C++ function), 1047
- `esp_vfs_fat_sdcard_unmount` (C++ function), 1049
- `esp_vfs_fat_sdmmc_mount` (C++ function), 1047
- `esp_vfs_fat_sdmmc_mount_config_t` (C++ type), 1051
- `esp_vfs_fat_sdmmc_unmount` (C++ function), 1049
- `esp_vfs_fat_sdspi_mount` (C++ function), 1048
- `esp_vfs_fat_spiflash_mount_ro` (C++ function), 1049
- `esp_vfs_fat_spiflash_mount_rw_wl` (C++ function), 1049
- `esp_vfs_fat_spiflash_unmount_ro` (C++ function), 1050
- `esp_vfs_fat_spiflash_unmount_rw_wl` (C++ function), 1049
- `esp_vfs_fat_unregister_path` (C++ function), 1047
- `ESP_VFS_FLAG_CONTEXT_PTR` (C macro), 1148
- `ESP_VFS_FLAG_DEFAULT` (C macro), 1148
- `esp_vfs_fstat` (C++ function), 1140
- `esp_vfs_id_t` (C++ type), 1148
- `esp_vfs_l2tap_eth_filter` (C++ function), 349
- `esp_vfs_l2tap_intf_register` (C++ function), 349
- `esp_vfs_l2tap_intf_unregister` (C++ function), 349
- `esp_vfs_link` (C++ function), 1140
- `esp_vfs_lseek` (C++ function), 1140
- `esp_vfs_open` (C++ function), 1140
- `ESP_VFS_PATH_MAX` (C macro), 1148
- `esp_vfs_pread` (C++ function), 1142
- `esp_vfs_pwrite` (C++ function), 1142
- `esp_vfs_read` (C++ function), 1140
- `esp_vfs_register` (C++ function), 1140
- `esp_vfs_register_fd` (C++ function), 1141
- `esp_vfs_register_fd_range` (C++ function), 1140
- `esp_vfs_register_fd_with_local_fd` (C++ function), 1141
- `esp_vfs_register_with_id` (C++ function), 1140
- `esp_vfs_rename` (C++ function), 1140
- `esp_vfs_select` (C++ function), 1141
- `esp_vfs_select_sem_t` (C++ struct), 1142
- `esp_vfs_select_sem_t::is_sem_local` (C++ member), 1142
- `esp_vfs_select_sem_t::sem` (C++ member), 1143
- `esp_vfs_select_triggered` (C++ function), 1142
- `esp_vfs_select_triggered_isr` (C++ function), 1142
- `esp_vfs_spiffs_conf_t` (C++ struct), 1135
- `esp_vfs_spiffs_conf_t::base_path` (C++ member), 1135
- `esp_vfs_spiffs_conf_t::format_if_mount_failed` (C++ member), 1135
- `esp_vfs_spiffs_conf_t::max_files` (C++ member), 1135
- `esp_vfs_spiffs_conf_t::partition_label` (C++ member), 1135
- `esp_vfs_spiffs_register` (C++ function), 1134
- `esp_vfs_spiffs_unregister` (C++ function), 1134
- `esp_vfs_stat` (C++ function), 1140
- `esp_vfs_t` (C++ struct), 1143
- `esp_vfs_t::access` (C++ member), 1146
- `esp_vfs_t::access_p` (C++ member), 1146
- `esp_vfs_t::close` (C++ member), 1144
- `esp_vfs_t::close_p` (C++ member), 1144
- `esp_vfs_t::closedir` (C++ member), 1145
- `esp_vfs_t::closedir_p` (C++ member), 1145
- `esp_vfs_t::end_select` (C++ member), 1148
- `esp_vfs_t::fcntl` (C++ member), 1146
- `esp_vfs_t::fcntl_p` (C++ member), 1145
- `esp_vfs_t::flags` (C++ member), 1143
- `esp_vfs_t::fstat` (C++ member), 1144
- `esp_vfs_t::fstat_p` (C++ member), 1144
- `esp_vfs_t::fsync` (C++ member), 1146
- `esp_vfs_t::fsync_p` (C++ member), 1146
- `esp_vfs_t::ftruncate` (C++ member), 1146
- `esp_vfs_t::ftruncate_p` (C++ member), 1146
- `esp_vfs_t::get_socket_select_semaphore` (C++ member), 1148
- `esp_vfs_t::ioctl` (C++ member), 1146
- `esp_vfs_t::ioctl_p` (C++ member), 1146
- `esp_vfs_t::link` (C++ member), 1144
- `esp_vfs_t::link_p` (C++ member), 1144
- `esp_vfs_t::lseek` (C++ member), 1143
- `esp_vfs_t::lseek_p` (C++ member), 1143
- `esp_vfs_t::mkdir` (C++ member), 1145
- `esp_vfs_t::mkdir_p` (C++ member), 1145
- `esp_vfs_t::open` (C++ member), 1144
- `esp_vfs_t::open_p` (C++ member), 1144
- `esp_vfs_t::opendir` (C++ member), 1145
- `esp_vfs_t::opendir_p` (C++ member), 1144
- `esp_vfs_t::pread` (C++ member), 1143
- `esp_vfs_t::pread_p` (C++ member), 1143
- `esp_vfs_t::pwrite` (C++ member), 1144
- `esp_vfs_t::pwrite_p` (C++ member), 1143
- `esp_vfs_t::read` (C++ member), 1143
- `esp_vfs_t::read_p` (C++ member), 1143
- `esp_vfs_t::readdir` (C++ member), 1145
- `esp_vfs_t::readdir_p` (C++ member), 1145
- `esp_vfs_t::readdir_r` (C++ member), 1145
- `esp_vfs_t::readdir_r_p` (C++ member), 1145

- esp\_vfs\_t::rename (C++ member), 1144
- esp\_vfs\_t::rename\_p (C++ member), 1144
- esp\_vfs\_t::rmdir (C++ member), 1145
- esp\_vfs\_t::rmdir\_p (C++ member), 1145
- esp\_vfs\_t::seekdir (C++ member), 1145
- esp\_vfs\_t::seekdir\_p (C++ member), 1145
- esp\_vfs\_t::socket\_select (C++ member), 1147
- esp\_vfs\_t::start\_select (C++ member), 1147
- esp\_vfs\_t::stat (C++ member), 1144
- esp\_vfs\_t::stat\_p (C++ member), 1144
- esp\_vfs\_t::stop\_socket\_select (C++ member), 1147
- esp\_vfs\_t::stop\_socket\_select\_isr (C++ member), 1147
- esp\_vfs\_t::tcdrain (C++ member), 1147
- esp\_vfs\_t::tcdrain\_p (C++ member), 1147
- esp\_vfs\_t::tcflow (C++ member), 1147
- esp\_vfs\_t::tcflow\_p (C++ member), 1147
- esp\_vfs\_t::tcflush (C++ member), 1147
- esp\_vfs\_t::tcflush\_p (C++ member), 1147
- esp\_vfs\_t::tgetattr (C++ member), 1147
- esp\_vfs\_t::tgetattr\_p (C++ member), 1146
- esp\_vfs\_t::tgetsid (C++ member), 1147
- esp\_vfs\_t::tgetsid\_p (C++ member), 1147
- esp\_vfs\_t::tcsendbreak (C++ member), 1147
- esp\_vfs\_t::tcsendbreak\_p (C++ member), 1147
- esp\_vfs\_t::tcsetattr (C++ member), 1146
- esp\_vfs\_t::tcsetattr\_p (C++ member), 1146
- esp\_vfs\_t::telldir (C++ member), 1145
- esp\_vfs\_t::telldir\_p (C++ member), 1145
- esp\_vfs\_t::truncate (C++ member), 1146
- esp\_vfs\_t::truncate\_p (C++ member), 1146
- esp\_vfs\_t::unlink (C++ member), 1144
- esp\_vfs\_t::unlink\_p (C++ member), 1144
- esp\_vfs\_t::utime (C++ member), 1146
- esp\_vfs\_t::utime\_p (C++ member), 1146
- esp\_vfs\_t::write (C++ member), 1143
- esp\_vfs\_t::write\_p (C++ member), 1143
- esp\_vfs\_unlink (C++ function), 1140
- esp\_vfs\_unregister (C++ function), 1141
- esp\_vfs\_unregister\_fd (C++ function), 1141
- esp\_vfs\_unregister\_with\_id (C++ function), 1141
- esp\_vfs\_usb\_serial\_jtag\_use\_driver (C++ function), 1150
- esp\_vfs\_usb\_serial\_jtag\_use\_nonblocking (C++ function), 1150
- esp\_vfs\_utime (C++ function), 1140
- esp\_vfs\_write (C++ function), 1140
- esp\_wake\_deep\_sleep (C++ function), 1462
- esp\_wifi\_80211\_tx (C++ function), 221
- esp\_wifi\_ap\_get\_sta\_aid (C++ function), 219
- esp\_wifi\_ap\_get\_sta\_list (C++ function), 219
- esp\_wifi\_ap\_wps\_disable (C++ function), 273
- esp\_wifi\_ap\_wps\_enable (C++ function), 272
- esp\_wifi\_ap\_wps\_start (C++ function), 273
- esp\_wifi\_clear\_ap\_list (C++ function), 213
- esp\_wifi\_clear\_default\_wifi\_driver\_and\_handlers (C++ function), 351
- esp\_wifi\_clear\_fast\_connect (C++ function), 212
- esp\_wifi\_config\_11b\_rate (C++ function), 225
- esp\_wifi\_config\_80211\_tx\_rate (C++ function), 227
- esp\_wifi\_config\_espnw\_rate (C++ function), 163
- esp\_wifi\_connect (C++ function), 211
- ESP\_WIFI\_CONNECTIONLESS\_INTERVAL\_DEFAULT\_MODE (C macro), 232
- esp\_wifi\_connectionless\_module\_set\_wake\_interval (C++ function), 225
- esp\_wifi\_deauth\_sta (C++ function), 212
- esp\_wifi\_deinit (C++ function), 210
- esp\_wifi\_disable\_pmf\_config (C++ function), 227
- esp\_wifi\_disconnect (C++ function), 212
- esp\_wifi\_force\_wakeup\_acquire (C++ function), 226
- esp\_wifi\_force\_wakeup\_release (C++ function), 226
- esp\_wifi\_ftm\_end\_session (C++ function), 224
- esp\_wifi\_ftm\_get\_report (C++ function), 225
- esp\_wifi\_ftm\_initiate\_session (C++ function), 224
- esp\_wifi\_ftm\_resp\_set\_offset (C++ function), 224
- esp\_wifi\_get\_ant (C++ function), 223
- esp\_wifi\_get\_ant\_gpio (C++ function), 222
- esp\_wifi\_get\_bandwidth (C++ function), 215
- esp\_wifi\_get\_channel (C++ function), 216
- esp\_wifi\_get\_config (C++ function), 219
- esp\_wifi\_get\_country (C++ function), 217
- esp\_wifi\_get\_country\_code (C++ function), 227
- esp\_wifi\_get\_event\_mask (C++ function), 221
- esp\_wifi\_get\_inactive\_time (C++ function), 223
- esp\_wifi\_get\_mac (C++ function), 217
- esp\_wifi\_get\_max\_tx\_power (C++ function), 221
- esp\_wifi\_get\_mode (C++ function), 211
- esp\_wifi\_get\_promiscuous (C++ function), 218
- esp\_wifi\_get\_promiscuous\_ctrl\_filter (C++ function), 218
- esp\_wifi\_get\_promiscuous\_filter (C++ function), 218
- esp\_wifi\_get\_protocol (C++ function), 215
- esp\_wifi\_get\_ps (C++ function), 214
- esp\_wifi\_get\_tsf\_time (C++ function), 223



- esp\_wifi\_init (C++ function), 210  
 ESP\_WIFI\_MAX\_CONN\_NUM (C macro), 251  
 esp\_wifi\_restore (C++ function), 211  
 esp\_wifi\_scan\_get\_ap\_num (C++ function), 213  
 esp\_wifi\_scan\_get\_ap\_record (C++ function), 213  
 esp\_wifi\_scan\_get\_ap\_records (C++ function), 213  
 esp\_wifi\_scan\_start (C++ function), 212  
 esp\_wifi\_scan\_stop (C++ function), 213  
 esp\_wifi\_set\_ant (C++ function), 223  
 esp\_wifi\_set\_ant\_gpio (C++ function), 222  
 esp\_wifi\_set\_bandwidth (C++ function), 215  
 esp\_wifi\_set\_channel (C++ function), 215  
 esp\_wifi\_set\_config (C++ function), 218  
 esp\_wifi\_set\_country (C++ function), 216  
 esp\_wifi\_set\_country\_code (C++ function), 226  
 esp\_wifi\_set\_csi (C++ function), 222  
 esp\_wifi\_set\_csi\_config (C++ function), 222  
 esp\_wifi\_set\_csi\_rx\_cb (C++ function), 222  
 esp\_wifi\_set\_default\_wifi\_ap\_handlers (C++ function), 351  
 esp\_wifi\_set\_default\_wifi\_sta\_handlers (C++ function), 351  
 esp\_wifi\_set\_event\_mask (C++ function), 221  
 esp\_wifi\_set\_inactive\_time (C++ function), 223  
 esp\_wifi\_set\_mac (C++ function), 217  
 esp\_wifi\_set\_max\_tx\_power (C++ function), 220  
 esp\_wifi\_set\_mode (C++ function), 210  
 esp\_wifi\_set\_promiscuous (C++ function), 217  
 esp\_wifi\_set\_promiscuous\_ctrl\_filter (C++ function), 218  
 esp\_wifi\_set\_promiscuous\_filter (C++ function), 218  
 esp\_wifi\_set\_promiscuous\_rx\_cb (C++ function), 217  
 esp\_wifi\_set\_protocol (C++ function), 214  
 esp\_wifi\_set\_ps (C++ function), 214  
 esp\_wifi\_set\_rssi\_threshold (C++ function), 224  
 esp\_wifi\_set\_storage (C++ function), 220  
 esp\_wifi\_set\_vendor\_ie (C++ function), 220  
 esp\_wifi\_set\_vendor\_ie\_cb (C++ function), 220  
 esp\_wifi\_sta\_enterprise\_disable (C++ function), 267  
 esp\_wifi\_sta\_enterprise\_enable (C++ function), 267  
 esp\_wifi\_sta\_get\_aid (C++ function), 227  
 esp\_wifi\_sta\_get\_ap\_info (C++ function), 214  
 esp\_wifi\_sta\_get\_negotiated\_phymode (C++ function), 227  
 esp\_wifi\_sta\_get\_rssi (C++ function), 227  
 esp\_wifi\_start (C++ function), 211  
 esp\_wifi\_status\_dump (C++ function), 224  
 esp\_wifi\_stop (C++ function), 211  
 esp\_wifi\_wps\_disable (C++ function), 272  
 esp\_wifi\_wps\_enable (C++ function), 272  
 esp\_wifi\_wps\_start (C++ function), 272  
 esp\_wnm\_is\_btm\_supported\_connection (C++ function), 276  
 esp\_wnm\_send\_bss\_transition\_mgmt\_query (C++ function), 276  
 esp\_wps\_config\_t (C++ struct), 273  
 esp\_wps\_config\_t::factory\_info (C++ member), 274  
 esp\_wps\_config\_t::pin (C++ member), 274  
 esp\_wps\_config\_t::wps\_type (C++ member), 274  
 essl\_clear\_intr (C++ function), 105  
 essl\_get\_intr (C++ function), 105  
 essl\_get\_intr\_ena (C++ function), 105  
 essl\_get\_packet (C++ function), 104  
 essl\_get\_rx\_data\_size (C++ function), 103  
 essl\_get\_tx\_buffer\_num (C++ function), 103  
 essl\_handle\_t (C++ type), 106  
 essl\_init (C++ function), 103  
 essl\_read\_reg (C++ function), 104  
 essl\_reset\_cnt (C++ function), 103  
 essl\_sdio\_config\_t (C++ struct), 106  
 essl\_sdio\_config\_t::card (C++ member), 107  
 essl\_sdio\_config\_t::recv\_buffer\_size (C++ member), 107  
 essl\_sdio\_deinit\_dev (C++ function), 106  
 essl\_sdio\_init\_dev (C++ function), 106  
 essl\_send\_packet (C++ function), 103  
 essl\_send\_slave\_intr (C++ function), 106  
 essl\_set\_intr\_ena (C++ function), 105  
 essl\_spi\_config\_t (C++ struct), 112  
 essl\_spi\_config\_t::rx\_sync\_reg (C++ member), 112  
 essl\_spi\_config\_t::spi (C++ member), 112  
 essl\_spi\_config\_t::tx\_buf\_size (C++ member), 112  
 essl\_spi\_config\_t::tx\_sync\_reg (C++ member), 112  
 essl\_spi\_deinit\_dev (C++ function), 107  
 essl\_spi\_get\_packet (C++ function), 107  
 essl\_spi\_init\_dev (C++ function), 107  
 essl\_spi\_rdbuf (C++ function), 109  
 essl\_spi\_rdbuf\_polling (C++ function), 109  
 essl\_spi\_rddma (C++ function), 110  
 essl\_spi\_rddma\_done (C++ function), 111  
 essl\_spi\_rddma\_seg (C++ function), 110  
 essl\_spi\_read\_reg (C++ function), 107  
 essl\_spi\_reset\_cnt (C++ function), 108  
 essl\_spi\_send\_packet (C++ function), 108  
 essl\_spi\_wrbuff (C++ function), 109  
 essl\_spi\_wrbuff\_polling (C++ function), 110

- essl\_spi\_wrdma (C++ function), 111  
 essl\_spi\_wrdma\_done (C++ function), 112  
 essl\_spi\_wrdma\_seg (C++ function), 111  
 essl\_spi\_write\_reg (C++ function), 108  
 essl\_wait\_for\_ready (C++ function), 103  
 essl\_wait\_int (C++ function), 105  
 essl\_write\_reg (C++ function), 104  
 eTaskGetState (C++ function), 1247  
 eTaskState (C++ enum), 1269  
 eTaskState::eBlocked (C++ enumerator), 1270  
 eTaskState::eDeleted (C++ enumerator), 1270  
 eTaskState::eInvalid (C++ enumerator), 1270  
 eTaskState::eReady (C++ enumerator), 1270  
 eTaskState::eRunning (C++ enumerator), 1269  
 eTaskState::eSuspended (C++ enumerator), 1270  
 ETH\_DEFAULT\_CONFIG (C macro), 293  
 eth\_event\_t (C++ enum), 296  
 eth\_event\_t::ETHERNET\_EVENT\_CONNECTED (C++ enumerator), 296  
 eth\_event\_t::ETHERNET\_EVENT\_DISCONNECTED (C++ enumerator), 296  
 eth\_event\_t::ETHERNET\_EVENT\_START (C++ enumerator), 296  
 eth\_event\_t::ETHERNET\_EVENT\_STOP (C++ enumerator), 296  
 eth\_mac\_clock\_config\_t (C++ union), 296  
 eth\_mac\_clock\_config\_t::clock\_gpio (C++ member), 296  
 eth\_mac\_clock\_config\_t::clock\_mode (C++ member), 296  
 eth\_mac\_clock\_config\_t::mii (C++ member), 296  
 eth\_mac\_clock\_config\_t::rmii (C++ member), 296  
 eth\_mac\_config\_t (C++ struct), 301  
 eth\_mac\_config\_t::flags (C++ member), 301  
 eth\_mac\_config\_t::rx\_task\_prio (C++ member), 301  
 eth\_mac\_config\_t::rx\_task\_stack\_size (C++ member), 301  
 eth\_mac\_config\_t::sw\_reset\_timeout\_ms (C++ member), 301  
 ETH\_MAC\_DEFAULT\_CONFIG (C macro), 301  
 ETH\_MAC\_FLAG\_PIN\_TO\_CORE (C macro), 301  
 ETH\_MAC\_FLAG\_WORK\_WITH\_CACHE\_DISABLE (C macro), 301  
 eth\_phy\_autoneg\_cmd\_t (C++ enum), 307  
 eth\_phy\_autoneg\_cmd\_t::ESP\_ETH\_PHY\_AUTONEGO\_DISABLE (C++ enumerator), 307  
 eth\_phy\_autoneg\_cmd\_t::ESP\_ETH\_PHY\_AUTONEGO\_ENABLE (C++ enumerator), 307  
 eth\_phy\_autoneg\_cmd\_t::ESP\_ETH\_PHY\_AUTONEGO\_GSTAT (C++ enumerator), 307  
 eth\_phy\_autoneg\_cmd\_t::ESP\_ETH\_PHY\_AUTONEGO\_RESTART (C++ enumerator), 307  
 eth\_phy\_config\_t (C++ struct), 306  
 eth\_phy\_config\_t::autonego\_timeout\_ms (C++ member), 307  
 eth\_phy\_config\_t::phy\_addr (C++ member), 306  
 eth\_phy\_config\_t::reset\_gpio\_num (C++ member), 307  
 eth\_phy\_config\_t::reset\_timeout\_ms (C++ member), 307  
 ETH\_PHY\_DEFAULT\_CONFIG (C macro), 307  
 ETS\_INTERNAL\_INTR\_SOURCE\_OFF (C macro), 1403  
 ETS\_INTERNAL\_PROFILING\_INTR\_SOURCE (C macro), 1403  
 ETS\_INTERNAL\_SW0\_INTR\_SOURCE (C macro), 1403  
 ETS\_INTERNAL\_SW1\_INTR\_SOURCE (C macro), 1403  
 ETS\_INTERNAL\_TIMER0\_INTR\_SOURCE (C macro), 1402  
 ETS\_INTERNAL\_TIMER1\_INTR\_SOURCE (C macro), 1403  
 ETS\_INTERNAL\_TIMER2\_INTR\_SOURCE (C macro), 1403  
 ETS\_INTERNAL\_UNUSED\_INTR\_SOURCE (C macro), 1403  
 EventBits\_t (C++ type), 1329  
 eventfd (C++ function), 1150  
 EventGroupHandle\_t (C++ type), 1329
- ## F
- ff\_diskio\_impl\_t (C++ struct), 1045  
 ff\_diskio\_impl\_t::init (C++ member), 1045  
 ff\_diskio\_impl\_t::ioctl (C++ member), 1045  
 ff\_diskio\_impl\_t::read (C++ member), 1045  
 ff\_diskio\_impl\_t::status (C++ member), 1045  
 ff\_diskio\_impl\_t::write (C++ member), 1045  
 ff\_diskio\_register (C++ function), 1044  
 ff\_diskio\_register\_raw\_partition (C++ function), 1045  
 ff\_diskio\_register\_sdmmc (C++ function), 1045  
 ff\_diskio\_register\_wl\_partition (C++ function), 1045
- ## G
- get\_phy\_version\_str (C++ function), 1737  
 gpio\_config (C++ function), 387  
 gpio\_config\_t (C++ struct), 394  
 gpio\_config\_t::intr\_type (C++ member), 394  
 gpio\_config\_t::mode (C++ member), 394  
 gpio\_config\_t::pin\_bit\_mask (C++ member), 394  
 gpio\_config\_t::pull\_down\_en (C++ member), 394

- `gpio_config_t::pull_up_en` (C++ member), 394
- `gpio_deep_sleep_hold_dis` (C++ function), 393
- `gpio_deep_sleep_hold_en` (C++ function), 392
- `gpio_drive_cap_t` (C++ enum), 402
- `gpio_drive_cap_t::GPIO_DRIVE_CAP_0` (C++ enumerator), 402
- `gpio_drive_cap_t::GPIO_DRIVE_CAP_1` (C++ enumerator), 402
- `gpio_drive_cap_t::GPIO_DRIVE_CAP_2` (C++ enumerator), 402
- `gpio_drive_cap_t::GPIO_DRIVE_CAP_3` (C++ enumerator), 402
- `gpio_drive_cap_t::GPIO_DRIVE_CAP_DEFAULT` (C++ enumerator), 402
- `gpio_drive_cap_t::GPIO_DRIVE_CAP_MAX` (C++ enumerator), 402
- `gpio_force_hold_all` (C++ function), 393
- `gpio_force_unhold_all` (C++ function), 393
- `gpio_get_drive_capability` (C++ function), 392
- `gpio_get_level` (C++ function), 389
- `gpio_hold_dis` (C++ function), 392
- `gpio_hold_en` (C++ function), 392
- `gpio_install_isr_service` (C++ function), 391
- `gpio_int_type_t` (C++ enum), 400
- `gpio_int_type_t::GPIO_INTR_ANYEDGE` (C++ enumerator), 400
- `gpio_int_type_t::GPIO_INTR_DISABLE` (C++ enumerator), 400
- `gpio_int_type_t::GPIO_INTR_HIGH_LEVEL` (C++ enumerator), 400
- `gpio_int_type_t::GPIO_INTR_LOW_LEVEL` (C++ enumerator), 400
- `gpio_int_type_t::GPIO_INTR_MAX` (C++ enumerator), 400
- `gpio_int_type_t::GPIO_INTR_NEGEDGE` (C++ enumerator), 400
- `gpio_int_type_t::GPIO_INTR_POSEDGE` (C++ enumerator), 400
- `gpio_intr_disable` (C++ function), 388
- `gpio_intr_enable` (C++ function), 388
- `gpio_iomux_in` (C++ function), 393
- `gpio_iomux_out` (C++ function), 393
- `GPIO_IS_VALID_DIGITAL_IO_PAD` (C macro), 394
- `GPIO_IS_VALID_GPIO` (C macro), 394
- `GPIO_IS_VALID_OUTPUT_GPIO` (C macro), 394
- `gpio_isr_handle_t` (C++ type), 395
- `gpio_isr_handler_add` (C++ function), 391
- `gpio_isr_handler_remove` (C++ function), 391
- `gpio_isr_register` (C++ function), 390
- `gpio_isr_t` (C++ type), 395
- `gpio_mode_t` (C++ enum), 400
- `gpio_mode_t::GPIO_MODE_DISABLE` (C++ enumerator), 400
- `gpio_mode_t::GPIO_MODE_INPUT` (C++ enumerator), 401
- `gpio_mode_t::GPIO_MODE_INPUT_OUTPUT` (C++ enumerator), 401
- `gpio_mode_t::GPIO_MODE_INPUT_OUTPUT_OD` (C++ enumerator), 401
- `gpio_mode_t::GPIO_MODE_OUTPUT` (C++ enumerator), 401
- `gpio_mode_t::GPIO_MODE_OUTPUT_OD` (C++ enumerator), 401
- `gpio_num_t` (C++ enum), 397
- `gpio_num_t::GPIO_NUM_0` (C++ enumerator), 397
- `gpio_num_t::GPIO_NUM_1` (C++ enumerator), 397
- `gpio_num_t::GPIO_NUM_10` (C++ enumerator), 398
- `gpio_num_t::GPIO_NUM_11` (C++ enumerator), 398
- `gpio_num_t::GPIO_NUM_12` (C++ enumerator), 398
- `gpio_num_t::GPIO_NUM_13` (C++ enumerator), 398
- `gpio_num_t::GPIO_NUM_14` (C++ enumerator), 398
- `gpio_num_t::GPIO_NUM_15` (C++ enumerator), 398
- `gpio_num_t::GPIO_NUM_16` (C++ enumerator), 398
- `gpio_num_t::GPIO_NUM_17` (C++ enumerator), 398
- `gpio_num_t::GPIO_NUM_18` (C++ enumerator), 398
- `gpio_num_t::GPIO_NUM_19` (C++ enumerator), 398
- `gpio_num_t::GPIO_NUM_2` (C++ enumerator), 397
- `gpio_num_t::GPIO_NUM_20` (C++ enumerator), 398
- `gpio_num_t::GPIO_NUM_21` (C++ enumerator), 399
- `gpio_num_t::GPIO_NUM_26` (C++ enumerator), 399
- `gpio_num_t::GPIO_NUM_27` (C++ enumerator), 399
- `gpio_num_t::GPIO_NUM_28` (C++ enumerator), 399
- `gpio_num_t::GPIO_NUM_29` (C++ enumerator), 399
- `gpio_num_t::GPIO_NUM_3` (C++ enumerator), 397
- `gpio_num_t::GPIO_NUM_30` (C++ enumerator), 399
- `gpio_num_t::GPIO_NUM_31` (C++ enumerator), 399
- `gpio_num_t::GPIO_NUM_32` (C++ enumerator), 399
- `gpio_num_t::GPIO_NUM_33` (C++ enumerator), 399



- [399](#)
- [gpio\\_num\\_t::GPIO\\_NUM\\_34 \(C++ enumerator\), 399](#)
- [gpio\\_num\\_t::GPIO\\_NUM\\_35 \(C++ enumerator\), 399](#)
- [gpio\\_num\\_t::GPIO\\_NUM\\_36 \(C++ enumerator\), 399](#)
- [gpio\\_num\\_t::GPIO\\_NUM\\_37 \(C++ enumerator\), 399](#)
- [gpio\\_num\\_t::GPIO\\_NUM\\_38 \(C++ enumerator\), 399](#)
- [gpio\\_num\\_t::GPIO\\_NUM\\_39 \(C++ enumerator\), 399](#)
- [gpio\\_num\\_t::GPIO\\_NUM\\_4 \(C++ enumerator\), 397](#)
- [gpio\\_num\\_t::GPIO\\_NUM\\_40 \(C++ enumerator\), 399](#)
- [gpio\\_num\\_t::GPIO\\_NUM\\_41 \(C++ enumerator\), 400](#)
- [gpio\\_num\\_t::GPIO\\_NUM\\_42 \(C++ enumerator\), 400](#)
- [gpio\\_num\\_t::GPIO\\_NUM\\_43 \(C++ enumerator\), 400](#)
- [gpio\\_num\\_t::GPIO\\_NUM\\_44 \(C++ enumerator\), 400](#)
- [gpio\\_num\\_t::GPIO\\_NUM\\_45 \(C++ enumerator\), 400](#)
- [gpio\\_num\\_t::GPIO\\_NUM\\_46 \(C++ enumerator\), 400](#)
- [gpio\\_num\\_t::GPIO\\_NUM\\_5 \(C++ enumerator\), 398](#)
- [gpio\\_num\\_t::GPIO\\_NUM\\_6 \(C++ enumerator\), 398](#)
- [gpio\\_num\\_t::GPIO\\_NUM\\_7 \(C++ enumerator\), 398](#)
- [gpio\\_num\\_t::GPIO\\_NUM\\_8 \(C++ enumerator\), 398](#)
- [gpio\\_num\\_t::GPIO\\_NUM\\_9 \(C++ enumerator\), 398](#)
- [gpio\\_num\\_t::GPIO\\_NUM\\_MAX \(C++ enumerator\), 400](#)
- [gpio\\_num\\_t::GPIO\\_NUM\\_NC \(C++ enumerator\), 397](#)
- [GPIO\\_PIN\\_COUNT \(C macro\), 394](#)
- [GPIO\\_PIN\\_REG\\_0 \(C macro\), 395](#)
- [GPIO\\_PIN\\_REG\\_1 \(C macro\), 395](#)
- [GPIO\\_PIN\\_REG\\_10 \(C macro\), 395](#)
- [GPIO\\_PIN\\_REG\\_11 \(C macro\), 395](#)
- [GPIO\\_PIN\\_REG\\_12 \(C macro\), 395](#)
- [GPIO\\_PIN\\_REG\\_13 \(C macro\), 395](#)
- [GPIO\\_PIN\\_REG\\_14 \(C macro\), 395](#)
- [GPIO\\_PIN\\_REG\\_15 \(C macro\), 395](#)
- [GPIO\\_PIN\\_REG\\_16 \(C macro\), 395](#)
- [GPIO\\_PIN\\_REG\\_17 \(C macro\), 396](#)
- [GPIO\\_PIN\\_REG\\_18 \(C macro\), 396](#)
- [GPIO\\_PIN\\_REG\\_19 \(C macro\), 396](#)
- [GPIO\\_PIN\\_REG\\_2 \(C macro\), 395](#)
- [GPIO\\_PIN\\_REG\\_20 \(C macro\), 396](#)
- [GPIO\\_PIN\\_REG\\_21 \(C macro\), 396](#)
- [GPIO\\_PIN\\_REG\\_22 \(C macro\), 396](#)
- [GPIO\\_PIN\\_REG\\_23 \(C macro\), 396](#)
- [GPIO\\_PIN\\_REG\\_24 \(C macro\), 396](#)
- [GPIO\\_PIN\\_REG\\_25 \(C macro\), 396](#)
- [GPIO\\_PIN\\_REG\\_26 \(C macro\), 396](#)
- [GPIO\\_PIN\\_REG\\_27 \(C macro\), 396](#)
- [GPIO\\_PIN\\_REG\\_28 \(C macro\), 396](#)
- [GPIO\\_PIN\\_REG\\_29 \(C macro\), 396](#)
- [GPIO\\_PIN\\_REG\\_3 \(C macro\), 395](#)
- [GPIO\\_PIN\\_REG\\_30 \(C macro\), 396](#)
- [GPIO\\_PIN\\_REG\\_31 \(C macro\), 396](#)
- [GPIO\\_PIN\\_REG\\_32 \(C macro\), 396](#)
- [GPIO\\_PIN\\_REG\\_33 \(C macro\), 396](#)
- [GPIO\\_PIN\\_REG\\_34 \(C macro\), 396](#)
- [GPIO\\_PIN\\_REG\\_35 \(C macro\), 396](#)
- [GPIO\\_PIN\\_REG\\_36 \(C macro\), 396](#)
- [GPIO\\_PIN\\_REG\\_37 \(C macro\), 396](#)
- [GPIO\\_PIN\\_REG\\_38 \(C macro\), 396](#)
- [GPIO\\_PIN\\_REG\\_39 \(C macro\), 396](#)
- [GPIO\\_PIN\\_REG\\_4 \(C macro\), 395](#)
- [GPIO\\_PIN\\_REG\\_40 \(C macro\), 397](#)
- [GPIO\\_PIN\\_REG\\_41 \(C macro\), 397](#)
- [GPIO\\_PIN\\_REG\\_42 \(C macro\), 397](#)
- [GPIO\\_PIN\\_REG\\_43 \(C macro\), 397](#)
- [GPIO\\_PIN\\_REG\\_44 \(C macro\), 397](#)
- [GPIO\\_PIN\\_REG\\_45 \(C macro\), 397](#)
- [GPIO\\_PIN\\_REG\\_46 \(C macro\), 397](#)
- [GPIO\\_PIN\\_REG\\_47 \(C macro\), 397](#)
- [GPIO\\_PIN\\_REG\\_48 \(C macro\), 397](#)
- [GPIO\\_PIN\\_REG\\_5 \(C macro\), 395](#)
- [GPIO\\_PIN\\_REG\\_6 \(C macro\), 395](#)
- [GPIO\\_PIN\\_REG\\_7 \(C macro\), 395](#)
- [GPIO\\_PIN\\_REG\\_8 \(C macro\), 395](#)
- [GPIO\\_PIN\\_REG\\_9 \(C macro\), 395](#)
- [gpio\\_port\\_t \(C++ enum\), 397](#)
- [gpio\\_port\\_t::GPIO\\_PORT\\_0 \(C++ enumerator\), 397](#)
- [gpio\\_port\\_t::GPIO\\_PORT\\_MAX \(C++ enumerator\), 397](#)
- [gpio\\_pull\\_mode\\_t \(C++ enum\), 401](#)
- [gpio\\_pull\\_mode\\_t::GPIO\\_FLOATING \(C++ enumerator\), 401](#)
- [gpio\\_pull\\_mode\\_t::GPIO\\_PULLDOWN\\_ONLY \(C++ enumerator\), 401](#)
- [gpio\\_pull\\_mode\\_t::GPIO\\_PULLUP\\_ONLY \(C++ enumerator\), 401](#)
- [gpio\\_pull\\_mode\\_t::GPIO\\_PULLUP\\_PULLDOWN \(C++ enumerator\), 401](#)
- [gpio\\_pulldown\\_dis \(C++ function\), 391](#)
- [gpio\\_pulldown\\_en \(C++ function\), 390](#)
- [gpio\\_pulldown\\_t \(C++ enum\), 401](#)
- [gpio\\_pulldown\\_t::GPIO\\_PULLDOWN\\_DISABLE \(C++ enumerator\), 401](#)
- [gpio\\_pulldown\\_t::GPIO\\_PULLDOWN\\_ENABLE \(C++ enumerator\), 401](#)
- [gpio\\_pullup\\_dis \(C++ function\), 390](#)
- [gpio\\_pullup\\_en \(C++ function\), 390](#)

- [gpio\\_pullup\\_t \(C++ enum\), 401](#)  
[gpio\\_pullup\\_t::GPIO\\_PULLUP\\_DISABLE \(C++ enumerator\), 401](#)  
[gpio\\_pullup\\_t::GPIO\\_PULLUP\\_ENABLE \(C++ enumerator\), 401](#)  
[gpio\\_reset\\_pin \(C++ function\), 388](#)  
[gpio\\_set\\_direction \(C++ function\), 389](#)  
[gpio\\_set\\_drive\\_capability \(C++ function\), 391](#)  
[gpio\\_set\\_intr\\_type \(C++ function\), 388](#)  
[gpio\\_set\\_level \(C++ function\), 389](#)  
[gpio\\_set\\_pull\\_mode \(C++ function\), 389](#)  
[gpio\\_sleep\\_sel\\_dis \(C++ function\), 393](#)  
[gpio\\_sleep\\_sel\\_en \(C++ function\), 393](#)  
[gpio\\_sleep\\_set\\_direction \(C++ function\), 393](#)  
[gpio\\_sleep\\_set\\_pull\\_mode \(C++ function\), 394](#)  
[gpio\\_uninstall\\_isr\\_service \(C++ function\), 391](#)  
[gpio\\_wakeup\\_disable \(C++ function\), 390](#)  
[gpio\\_wakeup\\_enable \(C++ function\), 390](#)  
[gptimer\\_alarm\\_cb\\_t \(C++ type\), 417](#)  
[gptimer\\_alarm\\_config\\_t \(C++ struct\), 417](#)  
[gptimer\\_alarm\\_config\\_t::alarm\\_count \(C++ member\), 417](#)  
[gptimer\\_alarm\\_config\\_t::auto\\_reload\\_on\\_alarm \(C++ member\), 417](#)  
[gptimer\\_alarm\\_config\\_t::flags \(C++ member\), 417](#)  
[gptimer\\_alarm\\_config\\_t::reload\\_count \(C++ member\), 417](#)  
[gptimer\\_alarm\\_event\\_data\\_t \(C++ struct\), 416](#)  
[gptimer\\_alarm\\_event\\_data\\_t::alarm\\_value \(C++ member\), 416](#)  
[gptimer\\_alarm\\_event\\_data\\_t::count\\_value \(C++ member\), 416](#)  
[gptimer\\_clock\\_source\\_t \(C++ type\), 417](#)  
[gptimer\\_config\\_t \(C++ struct\), 416](#)  
[gptimer\\_config\\_t::clk\\_src \(C++ member\), 416](#)  
[gptimer\\_config\\_t::direction \(C++ member\), 416](#)  
[gptimer\\_config\\_t::flags \(C++ member\), 417](#)  
[gptimer\\_config\\_t::intr\\_priority \(C++ member\), 416](#)  
[gptimer\\_config\\_t::intr\\_shared \(C++ member\), 417](#)  
[gptimer\\_config\\_t::resolution\\_hz \(C++ member\), 416](#)  
[gptimer\\_count\\_direction\\_t \(C++ enum\), 418](#)  
[gptimer\\_count\\_direction\\_t::GPTIMER\\_COUNT\\_DOWN \(C++ enumerator\), 418](#)  
[gptimer\\_count\\_direction\\_t::GPTIMER\\_COUNT\\_UP \(C++ enumerator\), 418](#)  
[gptimer\\_del\\_timer \(C++ function\), 412](#)  
[gptimer\\_disable \(C++ function\), 414](#)  
[gptimer\\_enable \(C++ function\), 414](#)  
[gptimer\\_event\\_callbacks\\_t \(C++ struct\), 416](#)  
[gptimer\\_event\\_callbacks\\_t::on\\_alarm \(C++ member\), 416](#)  
[gptimer\\_get\\_raw\\_count \(C++ function\), 413](#)  
[gptimer\\_handle\\_t \(C++ type\), 417](#)  
[gptimer\\_new\\_timer \(C++ function\), 412](#)  
[gptimer\\_register\\_event\\_callbacks \(C++ function\), 413](#)  
[gptimer\\_set\\_alarm\\_action \(C++ function\), 413](#)  
[gptimer\\_set\\_raw\\_count \(C++ function\), 412](#)  
[gptimer\\_start \(C++ function\), 415](#)  
[gptimer\\_stop \(C++ function\), 415](#)
- ## H
- [heap\\_caps\\_add\\_region \(C++ function\), 1374](#)  
[heap\\_caps\\_add\\_region\\_with\\_caps \(C++ function\), 1375](#)  
[heap\\_caps\\_aligned\\_alloc \(C++ function\), 1369](#)  
[heap\\_caps\\_aligned\\_calloc \(C++ function\), 1369](#)  
[heap\\_caps\\_aligned\\_free \(C++ function\), 1369](#)  
[heap\\_caps\\_calloc \(C++ function\), 1370](#)  
[heap\\_caps\\_calloc\\_prefer \(C++ function\), 1372](#)  
[heap\\_caps\\_check\\_integrity \(C++ function\), 1371](#)  
[heap\\_caps\\_check\\_integrity\\_addr \(C++ function\), 1371](#)  
[heap\\_caps\\_check\\_integrity\\_all \(C++ function\), 1371](#)  
[heap\\_caps\\_dump \(C++ function\), 1372](#)  
[heap\\_caps\\_dump\\_all \(C++ function\), 1372](#)  
[heap\\_caps\\_enable\\_nonos\\_stack\\_heaps \(C++ function\), 1374](#)  
[heap\\_caps\\_free \(C++ function\), 1369](#)  
[heap\\_caps\\_get\\_allocated\\_size \(C++ function\), 1373](#)  
[heap\\_caps\\_get\\_free\\_size \(C++ function\), 1370](#)  
[heap\\_caps\\_get\\_info \(C++ function\), 1371](#)  
[heap\\_caps\\_get\\_largest\\_free\\_block \(C++ function\), 1370](#)  
[heap\\_caps\\_get\\_minimum\\_free\\_size \(C++ function\), 1370](#)  
[heap\\_caps\\_get\\_total\\_size \(C++ function\), 1370](#)  
[heap\\_caps\\_init \(C++ function\), 1374](#)  
[heap\\_caps\\_malloc \(C++ function\), 1368](#)  
[heap\\_caps\\_malloc\\_extmem\\_enable \(C++ function\), 1372](#)  
[heap\\_caps\\_malloc\\_prefer \(C++ function\), 1372](#)  
[heap\\_caps\\_print\\_heap\\_info \(C++ function\), 1371](#)  
[heap\\_caps\\_realloc \(C++ function\), 1369](#)

- [heap\\_caps\\_realloc\\_prefer \(C++ function\), 1372](#)  
[heap\\_caps\\_register\\_failed\\_alloc\\_callback \(C++ function\), 1368](#)  
[heap\\_trace\\_dump \(C++ function\), 1389](#)  
[heap\\_trace\\_get \(C++ function\), 1388](#)  
[heap\\_trace\\_get\\_count \(C++ function\), 1388](#)  
[heap\\_trace\\_init\\_standalone \(C++ function\), 1387](#)  
[heap\\_trace\\_init\\_tohost \(C++ function\), 1388](#)  
[heap\\_trace\\_mode\\_t \(C++ enum\), 1390](#)  
[heap\\_trace\\_mode\\_t::HEAP\\_TRACE\\_ALL \(C++ enumerator\), 1390](#)  
[heap\\_trace\\_mode\\_t::HEAP\\_TRACE\\_LEAKS \(C++ enumerator\), 1390](#)  
[heap\\_trace\\_record\\_t \(C++ struct\), 1389](#)  
[heap\\_trace\\_record\\_t::address \(C++ member\), 1389](#)  
[heap\\_trace\\_record\\_t::allocated\\_by \(C++ member\), 1389](#)  
[heap\\_trace\\_record\\_t::ccount \(C++ member\), 1389](#)  
[heap\\_trace\\_record\\_t::freed\\_by \(C++ member\), 1389](#)  
[heap\\_trace\\_record\\_t::size \(C++ member\), 1389](#)  
[heap\\_trace\\_resume \(C++ function\), 1388](#)  
[heap\\_trace\\_start \(C++ function\), 1388](#)  
[heap\\_trace\\_stop \(C++ function\), 1388](#)  
[hmac\\_key\\_id\\_t \(C++ enum\), 427](#)  
[hmac\\_key\\_id\\_t::HMAC\\_KEY0 \(C++ enumerator\), 427](#)  
[hmac\\_key\\_id\\_t::HMAC\\_KEY1 \(C++ enumerator\), 427](#)  
[hmac\\_key\\_id\\_t::HMAC\\_KEY2 \(C++ enumerator\), 427](#)  
[hmac\\_key\\_id\\_t::HMAC\\_KEY3 \(C++ enumerator\), 427](#)  
[hmac\\_key\\_id\\_t::HMAC\\_KEY4 \(C++ enumerator\), 427](#)  
[hmac\\_key\\_id\\_t::HMAC\\_KEY5 \(C++ enumerator\), 427](#)  
[hmac\\_key\\_id\\_t::HMAC\\_KEY\\_MAX \(C++ enumerator\), 428](#)  
[http\\_client\\_init\\_cb\\_t \(C++ type\), 1213](#)  
[http\\_event\\_handle\\_cb \(C++ type\), 85](#)  
[HTTPD\\_200 \(C macro\), 136](#)  
[HTTPD\\_204 \(C macro\), 137](#)  
[HTTPD\\_207 \(C macro\), 137](#)  
[HTTPD\\_400 \(C macro\), 137](#)  
[HTTPD\\_404 \(C macro\), 137](#)  
[HTTPD\\_408 \(C macro\), 137](#)  
[HTTPD\\_500 \(C macro\), 137](#)  
[httpd\\_close\\_func\\_t \(C++ type\), 140](#)  
[httpd\\_config \(C++ struct\), 133](#)  
[httpd\\_config::backlog\\_conn \(C++ member\), 133](#)  
[httpd\\_config::close\\_fn \(C++ member\), 134](#)  
[httpd\\_config::core\\_id \(C++ member\), 133](#)  
[httpd\\_config::ctrl\\_port \(C++ member\), 133](#)  
[httpd\\_config::enable\\_so\\_linger \(C++ member\), 134](#)  
[httpd\\_config::global\\_transport\\_ctx \(C++ member\), 134](#)  
[httpd\\_config::global\\_transport\\_ctx\\_free\\_fn \(C++ member\), 134](#)  
[httpd\\_config::global\\_user\\_ctx \(C++ member\), 134](#)  
[httpd\\_config::global\\_user\\_ctx\\_free\\_fn \(C++ member\), 134](#)  
[httpd\\_config::keep\\_alive\\_count \(C++ member\), 134](#)  
[httpd\\_config::keep\\_alive\\_enable \(C++ member\), 134](#)  
[httpd\\_config::keep\\_alive\\_idle \(C++ member\), 134](#)  
[httpd\\_config::keep\\_alive\\_interval \(C++ member\), 134](#)  
[httpd\\_config::linger\\_timeout \(C++ member\), 134](#)  
[httpd\\_config::lru\\_purge\\_enable \(C++ member\), 133](#)  
[httpd\\_config::max\\_open\\_sockets \(C++ member\), 133](#)  
[httpd\\_config::max\\_resp\\_headers \(C++ member\), 133](#)  
[httpd\\_config::max\\_uri\\_handlers \(C++ member\), 133](#)  
[httpd\\_config::open\\_fn \(C++ member\), 134](#)  
[httpd\\_config::recv\\_wait\\_timeout \(C++ member\), 133](#)  
[httpd\\_config::send\\_wait\\_timeout \(C++ member\), 133](#)  
[httpd\\_config::server\\_port \(C++ member\), 133](#)  
[httpd\\_config::stack\\_size \(C++ member\), 133](#)  
[httpd\\_config::task\\_priority \(C++ member\), 133](#)  
[httpd\\_config::uri\\_match\\_fn \(C++ member\), 135](#)  
[httpd\\_config\\_t \(C++ type\), 140](#)  
[HTTPD\\_DEFAULT\\_CONFIG \(C macro\), 137](#)  
[httpd\\_err\\_code\\_t \(C++ enum\), 141](#)  
[httpd\\_err\\_code\\_t::HTTPD\\_400\\_BAD\\_REQUEST \(C++ enumerator\), 141](#)  
[httpd\\_err\\_code\\_t::HTTPD\\_401\\_UNAUTHORIZED \(C++ enumerator\), 141](#)  
[httpd\\_err\\_code\\_t::HTTPD\\_403\\_FORBIDDEN \(C++ enumerator\), 141](#)  
[httpd\\_err\\_code\\_t::HTTPD\\_404\\_NOT\\_FOUND \(C++ enumerator\), 141](#)  
[httpd\\_err\\_code\\_t::HTTPD\\_405\\_METHOD\\_NOT\\_ALLOWED \(C++ enumerator\), 141](#)  
[httpd\\_err\\_code\\_t::HTTPD\\_408\\_REQ\\_TIMEOUT \(C++ enumerator\), 141](#)

- [httpd\\_err\\_code\\_t::HTTPD\\_411\\_LENGTH\\_REQUIRED \(C++ enumerator\), 141](#)  
[httpd\\_err\\_code\\_t::HTTPD\\_414\\_URI\\_TOO\\_LONG \(C++ enumerator\), 141](#)  
[httpd\\_err\\_code\\_t::HTTPD\\_431\\_REQ\\_HDR\\_FIELD\\_TOO\\_LARGE \(C++ enumerator\), 141](#)  
[httpd\\_err\\_code\\_t::HTTPD\\_500\\_INTERNAL\\_SERVER\\_ERROR \(C++ enumerator\), 141](#)  
[httpd\\_err\\_code\\_t::HTTPD\\_501\\_METHOD\\_NOT\\_IMPLEMENTED \(C++ enumerator\), 141](#)  
[httpd\\_err\\_code\\_t::HTTPD\\_505\\_VERSION\\_NOT\\_SUPPORTED \(C++ enumerator\), 141](#)  
[httpd\\_err\\_code\\_t::HTTPD\\_ERR\\_CODE\\_MAX \(C++ enumerator\), 141](#)  
[httpd\\_err\\_handler\\_func\\_t \(C++ type\), 139](#)  
[httpd\\_free\\_ctx\\_fn\\_t \(C++ type\), 140](#)  
[httpd\\_get\\_client\\_list \(C++ function\), 132](#)  
[httpd\\_get\\_global\\_transport\\_ctx \(C++ function\), 131](#)  
[httpd\\_get\\_global\\_user\\_ctx \(C++ function\), 131](#)  
[httpd\\_handle\\_t \(C++ type\), 139](#)  
[HTTPD\\_MAX\\_REQ\\_HDR\\_LEN \(C macro\), 136](#)  
[HTTPD\\_MAX\\_URI\\_LEN \(C macro\), 136](#)  
[httpd\\_method\\_t \(C++ type\), 139](#)  
[httpd\\_open\\_func\\_t \(C++ type\), 140](#)  
[httpd\\_pending\\_func\\_t \(C++ type\), 139](#)  
[httpd\\_query\\_key\\_value \(C++ function\), 122](#)  
[httpd\\_queue\\_work \(C++ function\), 130](#)  
[httpd\\_rcv\\_func\\_t \(C++ type\), 138](#)  
[httpd\\_register\\_err\\_handler \(C++ function\), 129](#)  
[httpd\\_register\\_uri\\_handler \(C++ function\), 118](#)  
[httpd\\_req \(C++ struct\), 135](#)  
[httpd\\_req::aux \(C++ member\), 135](#)  
[httpd\\_req::content\\_len \(C++ member\), 135](#)  
[httpd\\_req::free\\_ctx \(C++ member\), 136](#)  
[httpd\\_req::handle \(C++ member\), 135](#)  
[httpd\\_req::ignore\\_sess\\_ctx\\_changes \(C++ member\), 136](#)  
[httpd\\_req::method \(C++ member\), 135](#)  
[httpd\\_req::sess\\_ctx \(C++ member\), 135](#)  
[httpd\\_req::uri \(C++ member\), 135](#)  
[httpd\\_req::user\\_ctx \(C++ member\), 135](#)  
[httpd\\_req\\_get\\_cookie\\_val \(C++ function\), 122](#)  
[httpd\\_req\\_get\\_hdr\\_value\\_len \(C++ function\), 121](#)  
[httpd\\_req\\_get\\_hdr\\_value\\_str \(C++ function\), 121](#)  
[httpd\\_req\\_get\\_url\\_query\\_len \(C++ function\), 121](#)  
[httpd\\_req\\_get\\_url\\_query\\_str \(C++ function\), 122](#)  
[httpd\\_req\\_rcv \(C++ function\), 120](#)  
[httpd\\_req\\_t \(C++ type\), 138](#)  
[httpd\\_req\\_to\\_sockfd \(C++ function\), 120](#)  
[httpd\\_resp\\_send \(C++ function\), 123](#)  
[httpd\\_resp\\_send\\_404 \(C++ function\), 126](#)  
[httpd\\_resp\\_send\\_408 \(C++ function\), 127](#)  
[httpd\\_resp\\_send\\_500 \(C++ function\), 127](#)  
[httpd\\_resp\\_send\\_chunk \(C++ function\), 124](#)  
[httpd\\_resp\\_send\\_err \(C++ function\), 126](#)  
[httpd\\_resp\\_sendstr \(C++ function\), 124](#)  
[httpd\\_resp\\_sendstr\\_chunk \(C++ function\), 125](#)  
[httpd\\_resp\\_set\\_hdr \(C++ function\), 125](#)  
[httpd\\_resp\\_set\\_status \(C++ function\), 125](#)  
[httpd\\_resp\\_set\\_type \(C++ function\), 125](#)  
[HTTPD\\_RESP\\_USE\\_STRLEN \(C macro\), 138](#)  
[httpd\\_send \(C++ function\), 127](#)  
[httpd\\_send\\_func\\_t \(C++ type\), 138](#)  
[httpd\\_sess\\_get\\_ctx \(C++ function\), 130](#)  
[httpd\\_sess\\_get\\_transport\\_ctx \(C++ function\), 131](#)  
[httpd\\_sess\\_set\\_ctx \(C++ function\), 130](#)  
[httpd\\_sess\\_set\\_pending\\_override \(C++ function\), 119](#)  
[httpd\\_sess\\_set\\_rcv\\_override \(C++ function\), 119](#)  
[httpd\\_sess\\_set\\_send\\_override \(C++ function\), 119](#)  
[httpd\\_sess\\_set\\_transport\\_ctx \(C++ function\), 131](#)  
[httpd\\_sess\\_trigger\\_close \(C++ function\), 131](#)  
[httpd\\_sess\\_update\\_lru\\_counter \(C++ function\), 132](#)  
[HTTPD\\_SOCK\\_ERR\\_FAIL \(C macro\), 136](#)  
[HTTPD\\_SOCK\\_ERR\\_INVALID \(C macro\), 136](#)  
[HTTPD\\_SOCK\\_ERR\\_TIMEOUT \(C macro\), 136](#)  
[httpd\\_socket\\_rcv \(C++ function\), 128](#)  
[httpd\\_socket\\_send \(C++ function\), 128](#)  
[httpd\\_ssl\\_config \(C++ struct\), 143](#)  
[httpd\\_ssl\\_config::cacert\\_len \(C++ member\), 144](#)  
[httpd\\_ssl\\_config::cacert\\_pem \(C++ member\), 144](#)  
[httpd\\_ssl\\_config::cert\\_select\\_cb \(C++ member\), 144](#)  
[httpd\\_ssl\\_config::httpd \(C++ member\), 143](#)  
[httpd\\_ssl\\_config::port\\_insecure \(C++ member\), 144](#)  
[httpd\\_ssl\\_config::port\\_secure \(C++ member\), 144](#)  
[httpd\\_ssl\\_config::prvtkey\\_len \(C++ member\), 144](#)  
[httpd\\_ssl\\_config::prvtkey\\_pem \(C++ member\), 144](#)  
[httpd\\_ssl\\_config::servercert \(C++ member\), 143](#)  
[httpd\\_ssl\\_config::servercert\\_len \(C++ member\), 144](#)  
[httpd\\_ssl\\_config::session\\_tickets \(C++ member\), 144](#)

- [httpd\\_ssl\\_config::ssl\\_userdata](#) (C++ member), 144  
[httpd\\_ssl\\_config::transport\\_mode](#) (C++ member), 144  
[httpd\\_ssl\\_config::use\\_secure\\_element](#) (C++ member), 144  
[httpd\\_ssl\\_config::user\\_cb](#) (C++ member), 144  
[HTTPD\\_SSL\\_CONFIG\\_DEFAULT](#) (C macro), 144  
[httpd\\_ssl\\_config\\_t](#) (C++ type), 145  
[httpd\\_ssl\\_start](#) (C++ function), 143  
[httpd\\_ssl\\_stop](#) (C++ function), 143  
[httpd\\_ssl\\_transport\\_mode\\_t](#) (C++ enum), 145  
[httpd\\_ssl\\_transport\\_mode\\_t::HTTPD\\_SSL\\_TRANSPORT\\_MODE\\_INSECURE](#) (C++ enumerator), 145  
[httpd\\_ssl\\_transport\\_mode\\_t::HTTPD\\_SSL\\_TRANSPORT\\_MODE\\_SECURE](#) (C++ enumerator), 145  
[httpd\\_ssl\\_user\\_cb\\_state\\_t](#) (C++ enum), 145  
[httpd\\_ssl\\_user\\_cb\\_state\\_t::HTTPD\\_SSL\\_USER\\_CB\\_STATE\\_SESSION\\_CLOSED](#) (C++ enumerator), 145  
[httpd\\_ssl\\_user\\_cb\\_state\\_t::HTTPD\\_SSL\\_USER\\_CB\\_STATE\\_SESSION\\_CREATED](#) (C++ enumerator), 145  
[httpd\\_start](#) (C++ function), 129  
[httpd\\_stop](#) (C++ function), 130  
[HTTPD\\_TYPE\\_JSON](#) (C macro), 137  
[HTTPD\\_TYPE\\_OCTET](#) (C macro), 137  
[HTTPD\\_TYPE\\_TEXT](#) (C macro), 137  
[httpd\\_unregister\\_uri](#) (C++ function), 119  
[httpd\\_unregister\\_uri\\_handler](#) (C++ function), 118  
[httpd\\_uri](#) (C++ struct), 136  
[httpd\\_uri::handler](#) (C++ member), 136  
[httpd\\_uri::method](#) (C++ member), 136  
[httpd\\_uri::uri](#) (C++ member), 136  
[httpd\\_uri::user\\_ctx](#) (C++ member), 136  
[httpd\\_uri\\_match\\_func\\_t](#) (C++ type), 140  
[httpd\\_uri\\_match\\_wildcard](#) (C++ function), 123  
[httpd\\_uri\\_t](#) (C++ type), 138  
[httpd\\_work\\_fn\\_t](#) (C++ type), 140  
[HttpStatus\\_Code](#) (C++ enum), 88  
[HttpStatus\\_Code::HttpStatus\\_BadRequest](#) (C++ enumerator), 88  
[HttpStatus\\_Code::HttpStatus\\_Forbidden](#) (C++ enumerator), 88  
[HttpStatus\\_Code::HttpStatus\\_Found](#) (C++ enumerator), 88  
[HttpStatus\\_Code::HttpStatus\\_InternalServerError](#) (C++ enumerator), 89  
[HttpStatus\\_Code::HttpStatus\\_MovedPermanently](#) (C++ enumerator), 88  
[HttpStatus\\_Code::HttpStatus\\_MultipleChoices](#) (C++ enumerator), 88  
[HttpStatus\\_Code::HttpStatus\\_NotFound](#) (C++ enumerator), 89  
[HttpStatus\\_Code::HttpStatus\\_Ok](#) (C++ enumerator), 88  
[HttpStatus\\_Code::HttpStatus\\_PermanentRedirect](#) (C++ enumerator), 88  
[HttpStatus\\_Code::HttpStatus\\_SeeOther](#) (C++ enumerator), 88  
[HttpStatus\\_Code::HttpStatus\\_TemporaryRedirect](#) (C++ enumerator), 88  
[HttpStatus\\_Code::HttpStatus\\_Unauthorized](#) (C++ enumerator), 88  
**I**  
[i2c\\_ack\\_type\\_t](#) (C++ enum), 450  
[i2c\\_ack\\_type\\_t::I2C\\_MASTER\\_ACK](#) (C++ enumerator), 450  
[i2c\\_ack\\_type\\_t::I2C\\_MASTER\\_ACK\\_MAX](#) (C++ enumerator), 450  
[i2c\\_ack\\_type\\_t::I2C\\_MASTER\\_LAST\\_NACK](#) (C++ enumerator), 450  
[i2c\\_ack\\_type\\_t::I2C\\_MASTER\\_NACK](#) (C++ enumerator), 450  
[i2c\\_addr\\_mode\\_t](#) (C++ enum), 449  
[i2c\\_addr\\_mode\\_t::I2C\\_ADDR\\_BIT\\_10](#) (C++ enumerator), 449  
[i2c\\_addr\\_mode\\_t::I2C\\_ADDR\\_BIT\\_7](#) (C++ enumerator), 449  
[i2c\\_addr\\_mode\\_t::I2C\\_ADDR\\_BIT\\_MAX](#) (C++ enumerator), 450  
[I2C\\_APB\\_CLK\\_FREQ](#) (C macro), 448  
[i2c\\_clock\\_source\\_t](#) (C++ type), 449  
[i2c\\_cmd\\_handle\\_t](#) (C++ type), 448  
[i2c\\_cmd\\_link\\_create](#) (C++ function), 441  
[i2c\\_cmd\\_link\\_create\\_static](#) (C++ function), 441  
[i2c\\_cmd\\_link\\_delete](#) (C++ function), 442  
[i2c\\_cmd\\_link\\_delete\\_static](#) (C++ function), 442  
[i2c\\_config\\_t](#) (C++ struct), 447  
[i2c\\_config\\_t::addr\\_10bit\\_en](#) (C++ member), 447  
[i2c\\_config\\_t::clk\\_flags](#) (C++ member), 448  
[i2c\\_config\\_t::clk\\_speed](#) (C++ member), 447  
[i2c\\_config\\_t::master](#) (C++ member), 447  
[i2c\\_config\\_t::maximum\\_speed](#) (C++ member), 447  
[i2c\\_config\\_t::mode](#) (C++ member), 447  
[i2c\\_config\\_t::scl\\_io\\_num](#) (C++ member), 447  
[i2c\\_config\\_t::scl\\_pullup\\_en](#) (C++ member), 447  
[i2c\\_config\\_t::sda\\_io\\_num](#) (C++ member), 447  
[i2c\\_config\\_t::sda\\_pullup\\_en](#) (C++ member), 447  
[i2c\\_config\\_t::slave](#) (C++ member), 448  
[i2c\\_config\\_t::slave\\_addr](#) (C++ member), 447  
[i2c\\_driver\\_delete](#) (C++ function), 439  
[i2c\\_driver\\_install](#) (C++ function), 439  
[i2c\\_filter\\_disable](#) (C++ function), 445



- `i2c_filter_enable` (C++ function), 445
- `i2c_get_data_mode` (C++ function), 447
- `i2c_get_data_timing` (C++ function), 446
- `i2c_get_period` (C++ function), 444
- `i2c_get_start_timing` (C++ function), 445
- `i2c_get_stop_timing` (C++ function), 445
- `i2c_get_timeout` (C++ function), 446
- `I2C_INTERNAL_STRUCT_SIZE` (C macro), 448
- `I2C_LINK_RECOMMENDED_SIZE` (C macro), 448
- `i2c_master_cmd_begin` (C++ function), 443
- `i2c_master_read` (C++ function), 443
- `i2c_master_read_byte` (C++ function), 442
- `i2c_master_read_from_device` (C++ function), 440
- `i2c_master_start` (C++ function), 442
- `i2c_master_stop` (C++ function), 443
- `i2c_master_write` (C++ function), 442
- `i2c_master_write_byte` (C++ function), 442
- `i2c_master_write_read_device` (C++ function), 441
- `i2c_master_write_to_device` (C++ function), 440
- `i2c_mode_t` (C++ enum), 449
- `i2c_mode_t::I2C_MODE_MASTER` (C++ enumerator), 449
- `i2c_mode_t::I2C_MODE_MAX` (C++ enumerator), 449
- `i2c_mode_t::I2C_MODE_SLAVE` (C++ enumerator), 449
- `I2C_NUM_0` (C macro), 448
- `I2C_NUM_1` (C macro), 448
- `I2C_NUM_MAX` (C macro), 448
- `i2c_param_config` (C++ function), 439
- `i2c_port_t` (C++ type), 449
- `i2c_reset_rx_fifo` (C++ function), 440
- `i2c_reset_tx_fifo` (C++ function), 440
- `i2c_rw_t` (C++ enum), 449
- `i2c_rw_t::I2C_MASTER_READ` (C++ enumerator), 449
- `i2c_rw_t::I2C_MASTER_WRITE` (C++ enumerator), 449
- `I2C_SCLK_SRC_FLAG_AWARE_DFS` (C macro), 448
- `I2C_SCLK_SRC_FLAG_FOR_NOMAL` (C macro), 448
- `I2C_SCLK_SRC_FLAG_LIGHT_SLEEP` (C macro), 448
- `i2c_set_data_mode` (C++ function), 446
- `i2c_set_data_timing` (C++ function), 446
- `i2c_set_period` (C++ function), 444
- `i2c_set_pin` (C++ function), 440
- `i2c_set_start_timing` (C++ function), 445
- `i2c_set_stop_timing` (C++ function), 445
- `i2c_set_timeout` (C++ function), 446
- `i2c_slave_read_buffer` (C++ function), 444
- `i2c_slave_write_buffer` (C++ function), 443
- `i2c_trans_mode_t` (C++ enum), 449
- `i2c_trans_mode_t::I2C_DATA_MODE_LSB_FIRST` (C++ enumerator), 449
- `i2c_trans_mode_t::I2C_DATA_MODE_MAX` (C++ enumerator), 449
- `i2c_trans_mode_t::I2C_DATA_MODE_MSB_FIRST` (C++ enumerator), 449
- `i2s_chan_config_t` (C++ struct), 469
- `i2s_chan_config_t::auto_clear` (C++ member), 470
- `i2s_chan_config_t::dma_desc_num` (C++ member), 470
- `i2s_chan_config_t::dma_frame_num` (C++ member), 470
- `i2s_chan_config_t::id` (C++ member), 469
- `i2s_chan_config_t::role` (C++ member), 470
- `i2s_chan_handle_t` (C++ type), 471
- `i2s_chan_info_t` (C++ struct), 470
- `i2s_chan_info_t::dir` (C++ member), 470
- `i2s_chan_info_t::id` (C++ member), 470
- `i2s_chan_info_t::mode` (C++ member), 470
- `i2s_chan_info_t::pair_chan` (C++ member), 470
- `i2s_chan_info_t::role` (C++ member), 470
- `I2S_CHANNEL_DEFAULT_CONFIG` (C macro), 470
- `i2s_channel_disable` (C++ function), 467
- `i2s_channel_enable` (C++ function), 467
- `i2s_channel_get_info` (C++ function), 467
- `i2s_channel_init_std_mode` (C++ function), 461
- `i2s_channel_read` (C++ function), 468
- `i2s_channel_reconfig_std_clock` (C++ function), 462
- `i2s_channel_reconfig_std_gpio` (C++ function), 463
- `i2s_channel_reconfig_std_slot` (C++ function), 462
- `i2s_channel_register_event_callback` (C++ function), 468
- `i2s_channel_write` (C++ function), 467
- `i2s_clock_src_t` (C++ type), 472
- `i2s_comm_mode_t` (C++ enum), 471
- `i2s_comm_mode_t::I2S_COMM_MODE_NONE` (C++ enumerator), 471
- `i2s_comm_mode_t::I2S_COMM_MODE_STD` (C++ enumerator), 471
- `i2s_data_bit_width_t` (C++ enum), 473
- `i2s_data_bit_width_t::I2S_DATA_BIT_WIDTH_16BIT` (C++ enumerator), 473
- `i2s_data_bit_width_t::I2S_DATA_BIT_WIDTH_24BIT` (C++ enumerator), 473
- `i2s_data_bit_width_t::I2S_DATA_BIT_WIDTH_32BIT` (C++ enumerator), 473
- `i2s_data_bit_width_t::I2S_DATA_BIT_WIDTH_8BIT` (C++ enumerator), 473
- `i2s_del_channel` (C++ function), 466
- `i2s_dir_t` (C++ enum), 472
- `i2s_dir_t::I2S_DIR_RX` (C++ enumerator), 472
- `i2s_dir_t::I2S_DIR_TX` (C++ enumerator), 472

- i2s\_event\_callbacks\_t* (C++ struct), 469  
*i2s\_event\_callbacks\_t::on\_recv* (C++ member), 469  
*i2s\_event\_callbacks\_t::on\_recv\_q\_ovf* (C++ member), 469  
*i2s\_event\_callbacks\_t::on\_send\_q\_ovf* (C++ member), 469  
*i2s\_event\_callbacks\_t::on\_sent* (C++ member), 469  
*i2s\_event\_data\_t* (C++ struct), 471  
*i2s\_event\_data\_t::data* (C++ member), 471  
*i2s\_event\_data\_t::size* (C++ member), 471  
I2S\_GPIO\_UNUSED (C macro), 470  
*i2s\_isr\_callback\_t* (C++ type), 471  
*i2s\_mclk\_multiple\_t* (C++ enum), 471  
*i2s\_mclk\_multiple\_t::I2S\_MCLK\_MULTIPLE\_128* (C++ enumerator), 472  
*i2s\_mclk\_multiple\_t::I2S\_MCLK\_MULTIPLE\_256* (C++ enumerator), 472  
*i2s\_mclk\_multiple\_t::I2S\_MCLK\_MULTIPLE\_384* (C++ enumerator), 472  
*i2s\_mclk\_multiple\_t::I2S\_MCLK\_MULTIPLE\_512* (C++ enumerator), 472  
*i2s\_new\_channel* (C++ function), 466  
*i2s\_pdm\_slot\_mask\_t* (C++ enum), 474  
*i2s\_pdm\_slot\_mask\_t::I2S\_PDM\_SLOT\_BOTH* (C++ enumerator), 474  
*i2s\_pdm\_slot\_mask\_t::I2S\_PDM\_SLOT\_LEFT* (C++ enumerator), 474  
*i2s\_pdm\_slot\_mask\_t::I2S\_PDM\_SLOT\_RIGHT* (C++ enumerator), 474  
*i2s\_port\_t* (C++ enum), 471  
*i2s\_port\_t::I2S\_NUM\_0* (C++ enumerator), 471  
*i2s\_port\_t::I2S\_NUM\_AUTO* (C++ enumerator), 471  
*i2s\_role\_t* (C++ enum), 472  
*i2s\_role\_t::I2S\_ROLE\_MASTER* (C++ enumerator), 473  
*i2s\_role\_t::I2S\_ROLE\_SLAVE* (C++ enumerator), 473  
*i2s\_slot\_bit\_width\_t* (C++ enum), 473  
*i2s\_slot\_bit\_width\_t::I2S\_SLOT\_BIT\_WIDTH\_AUTO* (C++ enumerator), 473  
*i2s\_slot\_bit\_width\_t::I2S\_SLOT\_BIT\_WIDTH\_16BIT* (C++ enumerator), 473  
*i2s\_slot\_bit\_width\_t::I2S\_SLOT\_BIT\_WIDTH\_24BIT* (C++ enumerator), 473  
*i2s\_slot\_bit\_width\_t::I2S\_SLOT\_BIT\_WIDTH\_32BIT* (C++ enumerator), 473  
*i2s\_slot\_bit\_width\_t::I2S\_SLOT\_BIT\_WIDTH\_8BIT* (C++ enumerator), 473  
*i2s\_slot\_bit\_width\_t::I2S\_SLOT\_BIT\_WIDTH\_AUTO* (C++ enumerator), 473  
*i2s\_slot\_mode\_t* (C++ enum), 472  
*i2s\_slot\_mode\_t::I2S\_SLOT\_MODE\_MONO* (C++ enumerator), 472  
*i2s\_slot\_mode\_t::I2S\_SLOT\_MODE\_STEREO* (C++ enumerator), 472  
*i2s\_std\_clk\_config\_t* (C++ struct), 464  
*i2s\_std\_clk\_config\_t::clk\_src* (C++ member), 464  
*i2s\_std\_clk\_config\_t::mclk\_multiple* (C++ member), 464  
*i2s\_std\_clk\_config\_t::sample\_rate\_hz* (C++ member), 464  
I2S\_STD\_CLK\_DEFAULT\_CONFIG (C macro), 465  
*i2s\_std\_config\_t* (C++ struct), 465  
*i2s\_std\_config\_t::clk\_cfg* (C++ member), 465  
*i2s\_std\_config\_t::gpio\_cfg* (C++ member), 465  
*i2s\_std\_config\_t::slot\_cfg* (C++ member), 465  
*i2s\_std\_gpio\_config\_t* (C++ struct), 464  
*i2s\_std\_gpio\_config\_t::bclk* (C++ member), 464  
*i2s\_std\_gpio\_config\_t::bclk\_inv* (C++ member), 464  
*i2s\_std\_gpio\_config\_t::din* (C++ member), 464  
*i2s\_std\_gpio\_config\_t::dout* (C++ member), 464  
*i2s\_std\_gpio\_config\_t::invert\_flags* (C++ member), 464  
*i2s\_std\_gpio\_config\_t::mclk* (C++ member), 464  
*i2s\_std\_gpio\_config\_t::mclk\_inv* (C++ member), 464  
*i2s\_std\_gpio\_config\_t::ws* (C++ member), 464  
*i2s\_std\_gpio\_config\_t::ws\_inv* (C++ member), 464  
I2S\_STD\_MSB\_SLOT\_DEFAULT\_CONFIG (C macro), 465  
I2S\_STD\_PCM\_SLOT\_DEFAULT\_CONFIG (C macro), 465  
I2S\_STD\_PHILIPS\_SLOT\_DEFAULT\_CONFIG (C macro), 465  
*i2s\_std\_slot\_config\_t* (C++ struct), 463  
*i2s\_std\_slot\_config\_t::bit\_shift* (C++ member), 463  
*i2s\_std\_slot\_config\_t::data\_bit\_width* (C++ member), 463  
*i2s\_std\_slot\_config\_t::msb\_right* (C++ member), 463  
*i2s\_std\_slot\_config\_t::slot\_bit\_width* (C++ member), 463  
*i2s\_std\_slot\_config\_t::slot\_mask* (C++ member), 463  
*i2s\_std\_slot\_config\_t::slot\_mode* (C++ member), 463  
*i2s\_std\_slot\_config\_t::ws\_pol* (C++ member), 463  
*i2s\_std\_slot\_config\_t::ws\_width* (C++ member), 463  
*i2s\_std\_slot\_mask\_t* (C++ enum), 473  
*i2s\_std\_slot\_mask\_t::I2S\_STD\_SLOT\_BOTH* (C++ enumerator), 474

- i2s\_std\_slot\_mask\_t::I2S\_STD\_SLOT\_LEFT* *intr\_handle\_data\_t* (C++ type), 1403  
 (C++ enumerator), 474  
*i2s\_std\_slot\_mask\_t::I2S\_STD\_SLOT\_RIGHT* *intr\_handler\_t* (C++ type), 1403  
 (C++ enumerator), 474  
*I\_ADC* (C macro), 1512  
*I\_ADDI* (C macro), 1516  
*I\_ADDR* (C macro), 1516  
*I\_ANDI* (C macro), 1516  
*I\_ANDR* (C macro), 1516  
*I\_BE* (C macro), 1515  
*I\_BG* (C macro), 1515  
*I\_BL* (C macro), 1515  
*I\_BSGE* (C macro), 1516  
*I\_BSL* (C macro), 1516  
*I\_BSLE* (C macro), 1516  
*I\_BXFI* (C macro), 1516  
*I\_BXFR* (C macro), 1516  
*I\_BXI* (C macro), 1515  
*I\_BXR* (C macro), 1515  
*I\_BXZI* (C macro), 1516  
*I\_BXZR* (C macro), 1515  
*I\_DELAY* (C macro), 1511  
*I\_END* (C macro), 1511  
*I\_HALT* (C macro), 1511  
*I\_LD* (C macro), 1515  
*I\_LD\_MANUAL* (C macro), 1514  
*I\_LDH* (C macro), 1515  
*I\_LDL* (C macro), 1515  
*I\_LSHI* (C macro), 1517  
*I\_LSHR* (C macro), 1516  
*I\_MOVI* (C macro), 1517  
*I\_MOVR* (C macro), 1516  
*I\_ORI* (C macro), 1517  
*I\_ORR* (C macro), 1516  
*I\_RD\_REG* (C macro), 1511  
*I\_RSHI* (C macro), 1517  
*I\_RSHR* (C macro), 1516  
*I\_ST* (C macro), 1512  
*I\_ST32* (C macro), 1513  
*I\_ST\_AUTO* (C macro), 1513  
*I\_ST\_MANUAL* (C macro), 1512  
*I\_STAGE\_DEC* (C macro), 1517  
*I\_STAGE\_INC* (C macro), 1517  
*I\_STAGE\_RST* (C macro), 1517  
*I\_STH* (C macro), 1513  
*I\_STH\_LABEL* (C macro), 1513  
*I\_STI* (C macro), 1514  
*I\_STI32* (C macro), 1514  
*I\_STI\_LABEL* (C macro), 1514  
*I\_STL* (C macro), 1513  
*I\_STL\_LABEL* (C macro), 1513  
*I\_STO* (C macro), 1514  
*I\_SUBI* (C macro), 1516  
*I\_SUBR* (C macro), 1516  
*I\_TSENS* (C macro), 1511  
*I\_WAKE* (C macro), 1511  
*I\_WR\_REG* (C macro), 1511  
*I\_WR\_REG\_BIT* (C macro), 1511  
*intr\_handle\_data\_t* (C++ type), 1403  
*intr\_handle\_t* (C++ type), 1403  
*intr\_handler\_t* (C++ type), 1403  
*IP2STR* (C macro), 348  
*ip\_event\_add\_ip6\_t* (C++ struct), 339  
*ip\_event\_add\_ip6\_t::addr* (C++ member), 340  
*ip\_event\_add\_ip6\_t::preferred* (C++ member), 340  
*ip\_event\_ap\_staipassigned\_t* (C++ struct), 340  
*ip\_event\_ap\_staipassigned\_t::esp\_netif* (C++ member), 340  
*ip\_event\_ap\_staipassigned\_t::ip* (C++ member), 340  
*ip\_event\_ap\_staipassigned\_t::mac* (C++ member), 340  
*ip\_event\_got\_ip6\_t* (C++ struct), 339  
*ip\_event\_got\_ip6\_t::esp\_netif* (C++ member), 339  
*ip\_event\_got\_ip6\_t::ip6\_info* (C++ member), 339  
*ip\_event\_got\_ip6\_t::ip\_index* (C++ member), 339  
*ip\_event\_got\_ip\_t* (C++ struct), 339  
*ip\_event\_got\_ip\_t::esp\_netif* (C++ member), 339  
*ip\_event\_got\_ip\_t::ip\_changed* (C++ member), 339  
*ip\_event\_got\_ip\_t::ip\_info* (C++ member), 339  
*ip\_event\_t* (C++ enum), 345  
*ip\_event\_t::IP\_EVENT\_AP\_STAIPASSIGNED* (C++ enumerator), 345  
*ip\_event\_t::IP\_EVENT\_ETH\_GOT\_IP* (C++ enumerator), 345  
*ip\_event\_t::IP\_EVENT\_ETH\_LOST\_IP* (C++ enumerator), 345  
*ip\_event\_t::IP\_EVENT\_GOT\_IP6* (C++ enumerator), 345  
*ip\_event\_t::IP\_EVENT\_PPP\_GOT\_IP* (C++ enumerator), 346  
*ip\_event\_t::IP\_EVENT\_PPP\_LOST\_IP* (C++ enumerator), 346  
*ip\_event\_t::IP\_EVENT\_STA\_GOT\_IP* (C++ enumerator), 345  
*ip\_event\_t::IP\_EVENT\_STA\_LOST\_IP* (C++ enumerator), 345  
*IPSTR* (C macro), 348  
*IPV62STR* (C macro), 348  
*IPV6STR* (C macro), 348  
**L**  
*l2tap\_ioctl\_opt\_t* (C++ enum), 350  
*l2tap\_ioctl\_opt\_t::L2TAP\_G\_DEVICE\_DRV\_HNDL* (C++ enumerator), 350  
*l2tap\_ioctl\_opt\_t::L2TAP\_G\_INTF\_DEVICE* (C++ enumerator), 350



- l2tap\_ioctl\_opt\_t::L2TAP\_G\_RCV\_FILTER (C++ enumerator), 350  
 l2tap\_ioctl\_opt\_t::L2TAP\_S\_DEVICE\_DRV\_HANDLE (C++ enumerator), 350  
 l2tap\_ioctl\_opt\_t::L2TAP\_S\_INTF\_DEVICE (C++ enumerator), 350  
 l2tap\_ioctl\_opt\_t::L2TAP\_S\_RCV\_FILTER (C++ enumerator), 350  
 l2tap\_iodriver\_handle (C++ type), 350  
 L2TAP\_VFS\_CONFIG\_DEFAULT (C macro), 350  
 l2tap\_vfs\_config\_t (C++ struct), 349  
 l2tap\_vfs\_config\_t::base\_path (C++ member), 350  
 L2TAP\_VFS\_DEFAULT\_PATH (C macro), 350  
 lcd\_clock\_source\_t (C++ type), 479  
 lcd\_color\_range\_t (C++ enum), 480  
 lcd\_color\_range\_t::LCD\_COLOR\_RANGE\_FULL (C++ enumerator), 480  
 lcd\_color\_range\_t::LCD\_COLOR\_RANGE\_LIMIT (C++ enumerator), 480  
 lcd\_color\_space\_t (C++ enum), 479  
 lcd\_color\_space\_t::LCD\_COLOR\_SPACE\_RGB (C++ enumerator), 479  
 lcd\_color\_space\_t::LCD\_COLOR\_SPACE\_YUV (C++ enumerator), 479  
 lcd\_rgb\_data\_endian\_t (C++ enum), 479  
 lcd\_rgb\_data\_endian\_t::LCD\_RGB\_DATA\_ENDIAN\_BIG (C++ enumerator), 479  
 lcd\_rgb\_data\_endian\_t::LCD\_RGB\_DATA\_ENDIAN\_LITTLE (C++ enumerator), 479  
 lcd\_rgb\_element\_order\_t (C++ enum), 479  
 lcd\_rgb\_element\_order\_t::LCD\_RGB\_ELEMENT\_ORDER\_RGB (C++ enumerator), 479  
 lcd\_rgb\_element\_order\_t::LCD\_RGB\_ELEMENT\_ORDER\_BGR (C++ enumerator), 479  
 lcd\_yuv\_conv\_std\_t (C++ enum), 480  
 lcd\_yuv\_conv\_std\_t::LCD\_YUV\_CONV\_STD\_BT601 (C++ enumerator), 480  
 lcd\_yuv\_conv\_std\_t::LCD\_YUV\_CONV\_STD\_BT601\_1 (C++ enumerator), 480  
 lcd\_yuv\_sample\_t (C++ enum), 480  
 lcd\_yuv\_sample\_t::LCD\_YUV\_SAMPLE\_411 (C++ enumerator), 480  
 lcd\_yuv\_sample\_t::LCD\_YUV\_SAMPLE\_420 (C++ enumerator), 480  
 lcd\_yuv\_sample\_t::LCD\_YUV\_SAMPLE\_422 (C++ enumerator), 480  
 LEDC\_APB\_CLK\_HZ (C macro), 506  
 ledc\_bind\_channel\_timer (C++ function), 500  
 ledc\_cb\_event\_t (C++ enum), 506  
 ledc\_cb\_event\_t::LEDC\_FADE\_END\_EVT (C++ enumerator), 506  
 ledc\_cb\_param\_t (C++ struct), 505  
 ledc\_cb\_param\_t::channel (C++ member), 505  
 ledc\_cb\_param\_t::duty (C++ member), 505  
 ledc\_cb\_param\_t::event (C++ member), 505  
 ledc\_cb\_param\_t::speed\_mode (C++ member), 505  
 ledc\_cb\_register (C++ function), 503  
 ledc\_cb\_t (C++ type), 506  
 ledc\_cbs\_t (C++ struct), 505  
 ledc\_cbs\_t::fade\_cb (C++ member), 506  
 ledc\_channel\_config (C++ function), 495  
 ledc\_channel\_config\_t (C++ struct), 504  
 ledc\_channel\_config\_t::channel (C++ member), 504  
 ledc\_channel\_config\_t::duty (C++ member), 504  
 ledc\_channel\_config\_t::flags (C++ member), 504  
 ledc\_channel\_config\_t::gpio\_num (C++ member), 504  
 ledc\_channel\_config\_t::hpoint (C++ member), 504  
 ledc\_channel\_config\_t::intr\_type (C++ member), 504  
 ledc\_channel\_config\_t::output\_invert (C++ member), 504  
 ledc\_channel\_config\_t::speed\_mode (C++ member), 504  
 ledc\_channel\_config\_t::timer\_sel (C++ member), 504  
 ledc\_channel\_t (C++ enum), 508  
 ledc\_channel\_t::LEDC\_CHANNEL\_0 (C++ enumerator), 508  
 ledc\_channel\_t::LEDC\_CHANNEL\_1 (C++ enumerator), 508  
 ledc\_channel\_t::LEDC\_CHANNEL\_2 (C++ enumerator), 509  
 ledc\_channel\_t::LEDC\_CHANNEL\_3 (C++ enumerator), 509  
 ledc\_channel\_t::LEDC\_CHANNEL\_4 (C++ enumerator), 509  
 ledc\_channel\_t::LEDC\_CHANNEL\_5 (C++ enumerator), 509  
 ledc\_channel\_t::LEDC\_CHANNEL\_6 (C++ enumerator), 509  
 ledc\_channel\_t::LEDC\_CHANNEL\_7 (C++ enumerator), 509  
 ledc\_channel\_t::LEDC\_CHANNEL\_MAX (C++ enumerator), 509  
 ledc\_clk\_cfg\_t (C++ enum), 507  
 ledc\_clk\_cfg\_t::LEDC\_AUTO\_CLK (C++ enumerator), 507  
 ledc\_clk\_cfg\_t::LEDC\_USE\_APB\_CLK (C++ enumerator), 507  
 ledc\_clk\_cfg\_t::LEDC\_USE\_REF\_TICK (C++ enumerator), 508  
 ledc\_clk\_cfg\_t::LEDC\_USE\_RTC8M\_CLK (C++ enumerator), 508  
 ledc\_clk\_cfg\_t::LEDC\_USE\_XTAL\_CLK (C++ enumerator), 508  
 ledc\_clk\_src\_t (C++ enum), 508  
 ledc\_clk\_src\_t::LEDC\_APB\_CLK (C++ enumerator), 508

- `ledc_clk_src_t::LEDC_REF_TICK` (C++ *enumerator*), 508  
`ledc_clk_src_t::LEDC_SCLK` (C++ *enumerator*), 508  
`ledc_duty_direction_t` (C++ *enum*), 507  
`ledc_duty_direction_t::LEDC_DUTY_DIR_DECREASE` (C++ *enumerator*), 507  
(C++ *enumerator*), 507  
`ledc_duty_direction_t::LEDC_DUTY_DIR_INCREASE` (C++ *enumerator*), 507  
(C++ *enumerator*), 507  
`ledc_duty_direction_t::LEDC_DUTY_DIR_MAX` (C++ *enumerator*), 507  
(C++ *enumerator*), 507  
`LEDC_ERR_DUTY` (C *macro*), 506  
`LEDC_ERR_VAL` (C *macro*), 506  
`ledc_fade_func_install` (C++ *function*), 501  
`ledc_fade_func_uninstall` (C++ *function*), 501  
`ledc_fade_mode_t` (C++ *enum*), 510  
`ledc_fade_mode_t::LEDC_FADE_MAX` (C++ *enumerator*), 510  
`ledc_fade_mode_t::LEDC_FADE_NO_WAIT` (C++ *enumerator*), 510  
`ledc_fade_mode_t::LEDC_FADE_WAIT_DONE` (C++ *enumerator*), 510  
`ledc_fade_start` (C++ *function*), 501  
`ledc_fade_stop` (C++ *function*), 502  
`ledc_get_duty` (C++ *function*), 498  
`ledc_get_freq` (C++ *function*), 497  
`ledc_get_hpoint` (C++ *function*), 497  
`ledc_intr_type_t` (C++ *enum*), 507  
`ledc_intr_type_t::LEDC_INTR_DISABLE` (C++ *enumerator*), 507  
`ledc_intr_type_t::LEDC_INTR_FADE_END` (C++ *enumerator*), 507  
`ledc_intr_type_t::LEDC_INTR_MAX` (C++ *enumerator*), 507  
`ledc_isr_handle_t` (C++ *type*), 506  
`ledc_isr_register` (C++ *function*), 499  
`ledc_mode_t` (C++ *enum*), 506  
`ledc_mode_t::LEDC_LOW_SPEED_MODE` (C++ *enumerator*), 506  
`ledc_mode_t::LEDC_SPEED_MODE_MAX` (C++ *enumerator*), 507  
`LEDC_REF_CLK_HZ` (C *macro*), 506  
`ledc_set_duty` (C++ *function*), 497  
`ledc_set_duty_and_update` (C++ *function*), 502  
`ledc_set_duty_with_hpoint` (C++ *function*), 497  
`ledc_set_fade` (C++ *function*), 498  
`ledc_set_fade_step_and_start` (C++ *function*), 503  
`ledc_set_fade_time_and_start` (C++ *function*), 502  
`ledc_set_fade_with_step` (C++ *function*), 500  
`ledc_set_fade_with_time` (C++ *function*), 500  
`ledc_set_freq` (C++ *function*), 496  
`ledc_set_pin` (C++ *function*), 496  
`ledc_slow_clk_sel_t` (C++ *enum*), 507  
`ledc_slow_clk_sel_t::LEDC_SLOW_CLK_APB` (C++ *enumerator*), 507  
`ledc_slow_clk_sel_t::LEDC_SLOW_CLK_RTC8M` (C++ *enumerator*), 507  
`ledc_slow_clk_sel_t::LEDC_SLOW_CLK_XTAL`  
`ledc_stop` (C++ *function*), 496  
`ledc_timer_bit_t` (C++ *enum*), 509  
`ledc_timer_bit_t::LEDC_TIMER_10_BIT` (C++ *enumerator*), 510  
`ledc_timer_bit_t::LEDC_TIMER_11_BIT` (C++ *enumerator*), 510  
`ledc_timer_bit_t::LEDC_TIMER_12_BIT` (C++ *enumerator*), 510  
`ledc_timer_bit_t::LEDC_TIMER_13_BIT` (C++ *enumerator*), 510  
`ledc_timer_bit_t::LEDC_TIMER_14_BIT` (C++ *enumerator*), 510  
`ledc_timer_bit_t::LEDC_TIMER_1_BIT` (C++ *enumerator*), 509  
`ledc_timer_bit_t::LEDC_TIMER_2_BIT` (C++ *enumerator*), 509  
`ledc_timer_bit_t::LEDC_TIMER_3_BIT` (C++ *enumerator*), 509  
`ledc_timer_bit_t::LEDC_TIMER_4_BIT` (C++ *enumerator*), 509  
`ledc_timer_bit_t::LEDC_TIMER_5_BIT` (C++ *enumerator*), 509  
`ledc_timer_bit_t::LEDC_TIMER_6_BIT` (C++ *enumerator*), 509  
`ledc_timer_bit_t::LEDC_TIMER_7_BIT` (C++ *enumerator*), 509  
`ledc_timer_bit_t::LEDC_TIMER_8_BIT` (C++ *enumerator*), 509  
`ledc_timer_bit_t::LEDC_TIMER_9_BIT` (C++ *enumerator*), 509  
`ledc_timer_bit_t::LEDC_TIMER_BIT_MAX` (C++ *enumerator*), 510  
`ledc_timer_config` (C++ *function*), 495  
`ledc_timer_config_t` (C++ *struct*), 505  
`ledc_timer_config_t::clk_cfg` (C++ *member*), 505  
`ledc_timer_config_t::duty_resolution` (C++ *member*), 505  
`ledc_timer_config_t::freq_hz` (C++ *member*), 505  
`ledc_timer_config_t::speed_mode` (C++ *member*), 505  
`ledc_timer_config_t::timer_num` (C++ *member*), 505  
`ledc_timer_pause` (C++ *function*), 499  
`ledc_timer_resume` (C++ *function*), 499  
`ledc_timer_rst` (C++ *function*), 499  
`ledc_timer_set` (C++ *function*), 499  
`ledc_timer_t` (C++ *enum*), 508  
`ledc_timer_t::LEDC_TIMER_0` (C++ *enumerator*), 508  
`ledc_timer_t::LEDC_TIMER_1` (C++ *enumerator*), 508

tor), 508  
 ledc\_timer\_t::LEDC\_TIMER\_2 (C++ enumerator), 508  
 ledc\_timer\_t::LEDC\_TIMER\_3 (C++ enumerator), 508  
 ledc\_timer\_t::LEDC\_TIMER\_MAX (C++ enumerator), 508  
 ledc\_update\_duty (C++ function), 495  
 linenoiseCompletions (C++ type), 1177

## M

M\_BE (C macro), 1517  
 M\_BG (C macro), 1517  
 M\_BL (C macro), 1517  
 M\_BRANCH (C macro), 1517  
 M\_BX (C macro), 1517  
 M\_BXF (C macro), 1518  
 M\_BXZ (C macro), 1517  
 M\_LABEL (C macro), 1517  
 MAC2STR (C macro), 1417  
 MACSTR (C macro), 1417  
 MALLOC\_CAP\_32BIT (C macro), 1373  
 MALLOC\_CAP\_8BIT (C macro), 1373  
 MALLOC\_CAP\_DEFAULT (C macro), 1374  
 MALLOC\_CAP\_DMA (C macro), 1373  
 MALLOC\_CAP\_EXEC (C macro), 1373  
 MALLOC\_CAP\_INTERNAL (C macro), 1373  
 MALLOC\_CAP\_INVALID (C macro), 1374  
 MALLOC\_CAP\_IRAM\_8BIT (C macro), 1374  
 MALLOC\_CAP\_PID2 (C macro), 1373  
 MALLOC\_CAP\_PID3 (C macro), 1373  
 MALLOC\_CAP\_PID4 (C macro), 1373  
 MALLOC\_CAP\_PID5 (C macro), 1373  
 MALLOC\_CAP\_PID6 (C macro), 1373  
 MALLOC\_CAP\_PID7 (C macro), 1373  
 MALLOC\_CAP\_RETENTION (C macro), 1374  
 MALLOC\_CAP\_RTCRAM (C macro), 1374  
 MALLOC\_CAP\_SPIRAM (C macro), 1373  
 MAX\_BLE\_DEVNAME\_LEN (C macro), 1018  
 MAX\_BLE\_MANUFACTURER\_DATA\_LEN (C macro), 1018  
 MAX\_FDS (C macro), 1148  
 MAX\_PASSPHRASE\_LEN (C macro), 253  
 MAX\_SSID\_LEN (C macro), 253  
 MAX\_WPS\_AP\_CRED (C macro), 253  
 mesh\_addr\_t (C++ union), 190  
 mesh\_addr\_t::addr (C++ member), 190  
 mesh\_addr\_t::mip (C++ member), 190  
 mesh\_ap\_cfg\_t (C++ struct), 196  
 mesh\_ap\_cfg\_t::max\_connection (C++ member), 196  
 mesh\_ap\_cfg\_t::nonmesh\_max\_connection (C++ member), 196  
 mesh\_ap\_cfg\_t::password (C++ member), 196  
 MESH\_ASSOC\_FLAG\_NETWORK\_FREE (C macro), 200  
 MESH\_ASSOC\_FLAG\_ROOT\_FIXED (C macro), 201  
 MESH\_ASSOC\_FLAG\_ROOTS\_FOUND (C macro), 201  
 MESH\_ASSOC\_FLAG\_STA\_VOTE\_EXPIRE (C macro), 200  
 MESH\_ASSOC\_FLAG\_VOTE\_IN\_PROGRESS (C macro), 200  
 mesh\_cfg\_t (C++ struct), 196  
 mesh\_cfg\_t::allow\_channel\_switch (C++ member), 196  
 mesh\_cfg\_t::channel (C++ member), 196  
 mesh\_cfg\_t::crypto\_funcs (C++ member), 197  
 mesh\_cfg\_t::mesh\_ap (C++ member), 197  
 mesh\_cfg\_t::mesh\_id (C++ member), 197  
 mesh\_cfg\_t::router (C++ member), 197  
 MESH\_DATA\_DROP (C macro), 200  
 MESH\_DATA\_ENC (C macro), 200  
 MESH\_DATA\_FROMDS (C macro), 200  
 MESH\_DATA\_GROUP (C macro), 200  
 MESH\_DATA\_NONBLOCK (C macro), 200  
 MESH\_DATA\_P2P (C macro), 200  
 mesh\_data\_t (C++ struct), 195  
 mesh\_data\_t::data (C++ member), 195  
 mesh\_data\_t::proto (C++ member), 195  
 mesh\_data\_t::size (C++ member), 195  
 mesh\_data\_t::tos (C++ member), 195  
 MESH\_DATA\_TODS (C macro), 200  
 mesh\_disconnect\_reason\_t (C++ enum), 205  
 mesh\_disconnect\_reason\_t::MESH\_REASON\_CYCLIC (C++ enumerator), 205  
 mesh\_disconnect\_reason\_t::MESH\_REASON\_DIFF\_ID (C++ enumerator), 205  
 mesh\_disconnect\_reason\_t::MESH\_REASON\_EMPTY\_PASSW (C++ enumerator), 205  
 mesh\_disconnect\_reason\_t::MESH\_REASON\_IE\_UNKNOWN (C++ enumerator), 205  
 mesh\_disconnect\_reason\_t::MESH\_REASON\_LEAF (C++ enumerator), 205  
 mesh\_disconnect\_reason\_t::MESH\_REASON\_PARENT\_IDLE (C++ enumerator), 205  
 mesh\_disconnect\_reason\_t::MESH\_REASON\_PARENT\_STOP (C++ enumerator), 205  
 mesh\_disconnect\_reason\_t::MESH\_REASON\_PARENT\_UNEN (C++ enumerator), 205  
 mesh\_disconnect\_reason\_t::MESH\_REASON\_PARENT\_WORS (C++ enumerator), 205  
 mesh\_disconnect\_reason\_t::MESH\_REASON\_ROOTS (C++ enumerator), 205  
 mesh\_disconnect\_reason\_t::MESH\_REASON\_SCAN\_FAIL (C++ enumerator), 205  
 mesh\_disconnect\_reason\_t::MESH\_REASON\_WAIVE\_ROOT (C++ enumerator), 205  
 mesh\_event\_channel\_switch\_t (C++ struct), 192  
 mesh\_event\_channel\_switch\_t::channel (C++ member), 192  
 mesh\_event\_child\_connected\_t (C++ type), 201

mesh\_event\_child\_disconnected\_t (C++ type), 201  
 mesh\_event\_connected\_t (C++ struct), 192  
 mesh\_event\_connected\_t::connected (C++ member), 192  
 mesh\_event\_connected\_t::duty (C++ member), 192  
 mesh\_event\_connected\_t::self\_layer (C++ member), 192  
 mesh\_event\_disconnected\_t (C++ type), 201  
 mesh\_event\_find\_network\_t (C++ struct), 193  
 mesh\_event\_find\_network\_t::channel (C++ member), 193  
 mesh\_event\_find\_network\_t::router\_bssid (C++ member), 193  
 mesh\_event\_id\_t (C++ enum), 201  
 mesh\_event\_id\_t::MESH\_EVENT\_CHANNEL\_SWITCH (C++ enumerator), 202  
 mesh\_event\_id\_t::MESH\_EVENT\_CHILD\_CONNECTED (C++ enumerator), 202  
 mesh\_event\_id\_t::MESH\_EVENT\_CHILD\_DISCONNECTED (C++ enumerator), 202  
 mesh\_event\_id\_t::MESH\_EVENT\_FIND\_NETWORK (C++ enumerator), 203  
 mesh\_event\_id\_t::MESH\_EVENT\_LAYER\_CHANGE (C++ enumerator), 202  
 mesh\_event\_id\_t::MESH\_EVENT\_MAX (C++ enumerator), 203  
 mesh\_event\_id\_t::MESH\_EVENT\_NETWORK\_STATE (C++ enumerator), 203  
 mesh\_event\_id\_t::MESH\_EVENT\_NO\_PARENT\_FOUND (C++ enumerator), 202  
 mesh\_event\_id\_t::MESH\_EVENT\_PARENT\_CONNECTED (C++ enumerator), 202  
 mesh\_event\_id\_t::MESH\_EVENT\_PARENT\_DISCONNECTED (C++ enumerator), 202  
 mesh\_event\_id\_t::MESH\_EVENT\_PS\_CHILD\_DUTY (C++ enumerator), 203  
 mesh\_event\_id\_t::MESH\_EVENT\_PS\_DEVICE\_DUTY (C++ enumerator), 203  
 mesh\_event\_id\_t::MESH\_EVENT\_PS\_PARENT\_DUTY (C++ enumerator), 203  
 mesh\_event\_id\_t::MESH\_EVENT\_ROOT\_ADDRESS (C++ enumerator), 202  
 mesh\_event\_id\_t::MESH\_EVENT\_ROOT\_ASKED\_YIELD (C++ enumerator), 203  
 mesh\_event\_id\_t::MESH\_EVENT\_ROOT\_FIXED (C++ enumerator), 203  
 mesh\_event\_id\_t::MESH\_EVENT\_ROOT\_SWITCH\_ACK (C++ enumerator), 202  
 mesh\_event\_id\_t::MESH\_EVENT\_ROOT\_SWITCH\_REQ (C++ enumerator), 202  
 mesh\_event\_id\_t::MESH\_EVENT\_ROUTER\_SWITCH (C++ enumerator), 203  
 mesh\_event\_id\_t::MESH\_EVENT\_ROUTING\_TABLE\_ADD (C++ enumerator), 202  
 mesh\_event\_id\_t::MESH\_EVENT\_ROUTING\_TABLE\_REMOVE (C++ enumerator), 202  
 mesh\_event\_id\_t::MESH\_EVENT\_SCAN\_DONE (C++ enumerator), 203  
 mesh\_event\_id\_t::MESH\_EVENT\_STARTED (C++ enumerator), 201  
 mesh\_event\_id\_t::MESH\_EVENT\_STOP\_RECONNECTION (C++ enumerator), 203  
 mesh\_event\_id\_t::MESH\_EVENT\_STOPPED (C++ enumerator), 202  
 mesh\_event\_id\_t::MESH\_EVENT\_TODS\_STATE (C++ enumerator), 202  
 mesh\_event\_id\_t::MESH\_EVENT\_VOTE\_STARTED (C++ enumerator), 202  
 mesh\_event\_id\_t::MESH\_EVENT\_VOTE\_STOPPED (C++ enumerator), 202  
 mesh\_event\_info\_t (C++ union), 190  
 mesh\_event\_info\_t::channel\_switch (C++ member), 190  
 mesh\_event\_info\_t::child\_connected (C++ member), 190  
 mesh\_event\_info\_t::child\_disconnected (C++ member), 190  
 mesh\_event\_info\_t::connected (C++ member), 190  
 mesh\_event\_info\_t::disconnected (C++ member), 191  
 mesh\_event\_info\_t::find\_network (C++ member), 191  
 mesh\_event\_info\_t::layer\_change (C++ member), 191  
 mesh\_event\_info\_t::network\_state (C++ member), 191  
 mesh\_event\_info\_t::no\_parent (C++ member), 191  
 mesh\_event\_info\_t::ps\_duty (C++ member), 191  
 mesh\_event\_info\_t::root\_addr (C++ member), 191  
 mesh\_event\_info\_t::root\_conflict (C++ member), 191  
 mesh\_event\_info\_t::root\_fixed (C++ member), 191  
 mesh\_event\_info\_t::router\_switch (C++ member), 191  
 mesh\_event\_info\_t::routing\_table (C++ member), 190  
 mesh\_event\_info\_t::scan\_done (C++ member), 191  
 mesh\_event\_info\_t::switch\_req (C++ member), 191  
 mesh\_event\_info\_t::toDS\_state (C++ member), 191  
 mesh\_event\_info\_t::vote\_started (C++ member), 191  
 mesh\_event\_layer\_change\_t (C++ struct), 193  
 mesh\_event\_layer\_change\_t::new\_layer (C++ member), 193  
 mesh\_event\_network\_state\_t (C++ struct), 194

- mesh\_event\_network\_state\_t::is\_rootless (C++ member), 195  
 mesh\_event\_no\_parent\_found\_t (C++ struct), 192  
 mesh\_event\_no\_parent\_found\_t::scan\_times (C++ member), 193  
 mesh\_event\_ps\_duty\_t (C++ struct), 195  
 mesh\_event\_ps\_duty\_t::child\_connected (C++ member), 195  
 mesh\_event\_ps\_duty\_t::duty (C++ member), 195  
 mesh\_event\_root\_address\_t (C++ type), 201  
 mesh\_event\_root\_conflict\_t (C++ struct), 194  
 mesh\_event\_root\_conflict\_t::addr (C++ member), 194  
 mesh\_event\_root\_conflict\_t::capacity (C++ member), 194  
 mesh\_event\_root\_conflict\_t::rssi (C++ member), 194  
 mesh\_event\_root\_fixed\_t (C++ struct), 194  
 mesh\_event\_root\_fixed\_t::is\_fixed (C++ member), 194  
 mesh\_event\_root\_switch\_req\_t (C++ struct), 193  
 mesh\_event\_root\_switch\_req\_t::rc\_addr (C++ member), 193  
 mesh\_event\_root\_switch\_req\_t::reason (C++ member), 193  
 mesh\_event\_router\_switch\_t (C++ type), 201  
 mesh\_event\_routing\_table\_change\_t (C++ struct), 194  
 mesh\_event\_routing\_table\_change\_t::rt\_size\_change (C++ member), 194  
 mesh\_event\_routing\_table\_change\_t::rt\_size\_new (C++ member), 194  
 mesh\_event\_scan\_done\_t (C++ struct), 194  
 mesh\_event\_scan\_done\_t::number (C++ member), 194  
 mesh\_event\_toDS\_state\_t (C++ enum), 206  
 mesh\_event\_toDS\_state\_t::MESH\_TODS\_REACHABLE (C++ enumerator), 206  
 mesh\_event\_toDS\_state\_t::MESH\_TODS\_UNREACHABLE (C++ enumerator), 206  
 mesh\_event\_vote\_started\_t (C++ struct), 193  
 mesh\_event\_vote\_started\_t::attempts (C++ member), 193  
 mesh\_event\_vote\_started\_t::rc\_addr (C++ member), 193  
 mesh\_event\_vote\_started\_t::reason (C++ member), 193  
 MESH\_INIT\_CONFIG\_DEFAULT (C macro), 201  
 MESH\_MPS (C macro), 198  
 MESH\_MTU (C macro), 198  
 MESH\_OPT\_RECV\_DS\_ADDR (C macro), 200  
 MESH\_OPT\_SEND\_GROUP (C macro), 200  
 mesh\_opt\_t (C++ struct), 195  
 mesh\_opt\_t::len (C++ member), 195  
 mesh\_opt\_t::type (C++ member), 195  
 mesh\_opt\_t::val (C++ member), 195  
 mesh\_proto\_t (C++ enum), 204  
 mesh\_proto\_t::MESH\_PROTO\_AP (C++ enumerator), 204  
 mesh\_proto\_t::MESH\_PROTO\_BIN (C++ enumerator), 204  
 mesh\_proto\_t::MESH\_PROTO\_HTTP (C++ enumerator), 204  
 mesh\_proto\_t::MESH\_PROTO\_JSON (C++ enumerator), 204  
 mesh\_proto\_t::MESH\_PROTO\_MQTT (C++ enumerator), 204  
 mesh\_proto\_t::MESH\_PROTO\_STA (C++ enumerator), 204  
 MESH\_PS\_DEVICE\_DUTY\_DEMAND (C macro), 201  
 MESH\_PS\_DEVICE\_DUTY\_REQUEST (C macro), 201  
 MESH\_PS\_NETWORK\_DUTY\_APPLIED\_ENTIRE (C macro), 201  
 MESH\_PS\_NETWORK\_DUTY\_APPLIED\_UPLINK (C macro), 201  
 MESH\_PS\_NETWORK\_DUTY\_MASTER (C macro), 201  
 mesh\_rc\_config\_t (C++ union), 191  
 mesh\_rc\_config\_t::attempts (C++ member), 192  
 mesh\_rc\_config\_t::rc\_addr (C++ member), 192  
 MESH\_ROOT\_LAYER (C macro), 198  
 mesh\_router\_t (C++ struct), 195  
 mesh\_router\_t::allow\_router\_switch\_size\_change (C++ member), 196  
 mesh\_router\_t::bssid (C++ member), 196  
 mesh\_router\_t::password (C++ member), 196  
 mesh\_router\_t::ssid (C++ member), 196  
 mesh\_router\_t::ssid\_len (C++ member), 196  
 mesh\_rx\_pending\_t (C++ struct), 198  
 mesh\_rx\_pending\_t::toDS (C++ member), 198  
 mesh\_rx\_pending\_t::toSelf (C++ member), 198  
 mesh\_tos\_t (C++ enum), 204  
 mesh\_tos\_t::MESH\_TOS\_DEF (C++ enumerator), 204  
 mesh\_tos\_t::MESH\_TOS\_E2E (C++ enumerator), 204  
 mesh\_tos\_t::MESH\_TOS\_P2P (C++ enumerator), 204  
 mesh\_tx\_pending\_t (C++ struct), 197  
 mesh\_tx\_pending\_t::broadcast (C++ member), 198  
 mesh\_tx\_pending\_t::mgmt (C++ member), 197  
 mesh\_tx\_pending\_t::to\_child (C++ member), 197  
 mesh\_tx\_pending\_t::to\_child\_p2p (C++ member), 197  
 mesh\_tx\_pending\_t::to\_parent (C++ member), 197



- [mesh\\_tx\\_pending\\_t::to\\_parent\\_p2p \(C++ member\), 197](#)  
[mesh\\_type\\_t \(C++ enum\), 203](#)  
[mesh\\_type\\_t::MESH\\_IDLE \(C++ enumerator\), 203](#)  
[mesh\\_type\\_t::MESH\\_LEAF \(C++ enumerator\), 204](#)  
[mesh\\_type\\_t::MESH\\_NODE \(C++ enumerator\), 204](#)  
[mesh\\_type\\_t::MESH\\_ROOT \(C++ enumerator\), 203](#)  
[mesh\\_type\\_t::MESH\\_STA \(C++ enumerator\), 204](#)  
[mesh\\_vote\\_reason\\_t \(C++ enum\), 204](#)  
[mesh\\_vote\\_reason\\_t::MESH\\_VOTE\\_REASON\\_CHILD\\_INITIATED \(C++ enumerator\), 205](#)  
[mesh\\_vote\\_reason\\_t::MESH\\_VOTE\\_REASON\\_ROOT\\_INITIATED \(C++ enumerator\), 205](#)  
[mesh\\_vote\\_t \(C++ struct\), 197](#)  
[mesh\\_vote\\_t::config \(C++ member\), 197](#)  
[mesh\\_vote\\_t::is\\_rc\\_specified \(C++ member\), 197](#)  
[mesh\\_vote\\_t::percentage \(C++ member\), 197](#)  
[MessageBufferHandle\\_t \(C++ type\), 1346](#)  
[mip\\_t \(C++ struct\), 192](#)  
[mip\\_t::ip4 \(C++ member\), 192](#)  
[mip\\_t::port \(C++ member\), 192](#)  
[MQTT\\_ERROR\\_TYPE\\_ESP\\_TLS \(C macro\), 55](#)  
[mqtt\\_event\\_callback\\_t \(C++ type\), 56](#)  
[multi\\_heap\\_aligned\\_alloc \(C++ function\), 1376](#)  
[multi\\_heap\\_aligned\\_free \(C++ function\), 1376](#)  
[multi\\_heap\\_check \(C++ function\), 1377](#)  
[multi\\_heap\\_dump \(C++ function\), 1377](#)  
[multi\\_heap\\_free \(C++ function\), 1376](#)  
[multi\\_heap\\_free\\_size \(C++ function\), 1377](#)  
[multi\\_heap\\_get\\_allocated\\_size \(C++ function\), 1377](#)  
[multi\\_heap\\_get\\_info \(C++ function\), 1378](#)  
[multi\\_heap\\_handle\\_t \(C++ type\), 1379](#)  
[multi\\_heap\\_info\\_t \(C++ struct\), 1378](#)  
[multi\\_heap\\_info\\_t::allocated\\_blocks \(C++ member\), 1378](#)  
[multi\\_heap\\_info\\_t::free\\_blocks \(C++ member\), 1378](#)  
[multi\\_heap\\_info\\_t::largest\\_free\\_block \(C++ member\), 1378](#)  
[multi\\_heap\\_info\\_t::minimum\\_free\\_bytes \(C++ member\), 1378](#)  
[multi\\_heap\\_info\\_t::total\\_allocated\\_bytes \(C++ member\), 1378](#)  
[multi\\_heap\\_info\\_t::total\\_blocks \(C++ member\), 1378](#)  
[multi\\_heap\\_info\\_t::total\\_free\\_bytes \(C++ member\), 1378](#)  
[multi\\_heap\\_malloc \(C++ function\), 1376](#)  
[multi\\_heap\\_minimum\\_free\\_size \(C++ function\), 1378](#)  
[multi\\_heap\\_realloc \(C++ function\), 1376](#)  
[multi\\_heap\\_register \(C++ function\), 1377](#)  
[multi\\_heap\\_set\\_lock \(C++ function\), 1377](#)
- ## N
- [name\\_uuid \(C++ struct\), 1017](#)  
[name\\_uuid::name \(C++ member\), 1017](#)  
[name\\_uuid::uuid \(C++ member\), 1017](#)  
[neighbor\\_rep\\_request\\_cb \(C++ type\), 275](#)  
[non\\_pref\\_chan \(C++ struct\), 277](#)  
[non\\_pref\\_chan::chan \(C++ member\), 277](#)  
[non\\_pref\\_chan::oper\\_class \(C++ member\), 277](#)  
[non\\_pref\\_chan::preference \(C++ member\), 277](#)  
[non\\_pref\\_chan::reason \(C++ member\), 277](#)  
[non\\_pref\\_chan\\_reason \(C++ enum\), 277](#)  
[non\\_pref\\_chan\\_reason::NON\\_PREF\\_CHAN\\_REASON\\_EXT\\_INT \(C++ enumerator\), 278](#)  
[non\\_pref\\_chan\\_reason::NON\\_PREF\\_CHAN\\_REASON\\_INT\\_INT \(C++ enumerator\), 278](#)  
[non\\_pref\\_chan\\_reason::NON\\_PREF\\_CHAN\\_REASON\\_RSSI \(C++ enumerator\), 278](#)  
[non\\_pref\\_chan\\_reason::NON\\_PREF\\_CHAN\\_REASON\\_UNSPECIFIED \(C++ enumerator\), 277](#)  
[non\\_pref\\_chan\\_s \(C++ struct\), 277](#)  
[non\\_pref\\_chan\\_s::chan \(C++ member\), 277](#)  
[non\\_pref\\_chan\\_s::non\\_pref\\_chan\\_num \(C++ member\), 277](#)  
[nvs\\_close \(C++ function\), 1071](#)  
[nvs\\_commit \(C++ function\), 1071](#)  
[NVS\\_DEFAULT\\_PART\\_NAME \(C macro\), 1076](#)  
[nvs\\_entry\\_find \(C++ function\), 1072](#)  
[nvs\\_entry\\_info \(C++ function\), 1073](#)  
[nvs\\_entry\\_info\\_t \(C++ struct\), 1074](#)  
[nvs\\_entry\\_info\\_t::key \(C++ member\), 1074](#)  
[nvs\\_entry\\_info\\_t::namespace\\_name \(C++ member\), 1074](#)  
[nvs\\_entry\\_info\\_t::type \(C++ member\), 1074](#)  
[nvs\\_entry\\_next \(C++ function\), 1073](#)  
[nvs\\_erase\\_all \(C++ function\), 1071](#)  
[nvs\\_erase\\_key \(C++ function\), 1070](#)  
[nvs\\_flash\\_deinit \(C++ function\), 1063](#)  
[nvs\\_flash\\_deinit\\_partition \(C++ function\), 1063](#)  
[nvs\\_flash\\_erase \(C++ function\), 1063](#)  
[nvs\\_flash\\_erase\\_partition \(C++ function\), 1064](#)  
[nvs\\_flash\\_erase\\_partition\\_ptr \(C++ function\), 1064](#)  
[nvs\\_flash\\_generate\\_keys \(C++ function\), 1065](#)  
[nvs\\_flash\\_init \(C++ function\), 1062](#)  
[nvs\\_flash\\_init\\_partition \(C++ function\), 1063](#)  
[nvs\\_flash\\_init\\_partition\\_ptr \(C++ function\), 1063](#)

- nvs\_flash\_read\_security\_cfg (C++ *function*), 1065  
 nvs\_flash\_secure\_init (C++ *function*), 1064  
 nvs\_flash\_secure\_init\_partition (C++ *function*), 1064  
 nvs\_get\_blob (C++ *function*), 1069  
 nvs\_get\_i16 (C++ *function*), 1068  
 nvs\_get\_i32 (C++ *function*), 1068  
 nvs\_get\_i64 (C++ *function*), 1068  
 nvs\_get\_i8 (C++ *function*), 1067  
 nvs\_get\_stats (C++ *function*), 1071  
 nvs\_get\_str (C++ *function*), 1068  
 nvs\_get\_u16 (C++ *function*), 1068  
 nvs\_get\_u32 (C++ *function*), 1068  
 nvs\_get\_u64 (C++ *function*), 1068  
 nvs\_get\_u8 (C++ *function*), 1067  
 nvs\_get\_used\_entry\_count (C++ *function*), 1072  
 nvs\_handle (C++ *type*), 1076  
 nvs\_handle\_t (C++ *type*), 1076  
 nvs\_iterator\_t (C++ *type*), 1076  
 NVS\_KEY\_NAME\_MAX\_SIZE (C *macro*), 1076  
 NVS\_KEY\_SIZE (C *macro*), 1065  
 nvs\_open (C++ *function*), 1069  
 nvs\_open\_from\_partition (C++ *function*), 1069  
 nvs\_open\_mode (C++ *type*), 1076  
 nvs\_open\_mode\_t (C++ *enum*), 1076  
 nvs\_open\_mode\_t::NVS\_READONLY (C++ *enumerator*), 1076  
 nvs\_open\_mode\_t::NVS\_READWRITE (C++ *enumerator*), 1076  
 NVS\_PART\_NAME\_MAX\_SIZE (C *macro*), 1076  
 nvs\_release\_iterator (C++ *function*), 1073  
 nvs\_sec\_cfg\_t (C++ *struct*), 1065  
 nvs\_sec\_cfg\_t::eky (C++ *member*), 1065  
 nvs\_sec\_cfg\_t::tky (C++ *member*), 1065  
 nvs\_set\_blob (C++ *function*), 1070  
 nvs\_set\_i16 (C++ *function*), 1066  
 nvs\_set\_i32 (C++ *function*), 1066  
 nvs\_set\_i64 (C++ *function*), 1066  
 nvs\_set\_i8 (C++ *function*), 1066  
 nvs\_set\_str (C++ *function*), 1066  
 nvs\_set\_u16 (C++ *function*), 1066  
 nvs\_set\_u32 (C++ *function*), 1066  
 nvs\_set\_u64 (C++ *function*), 1066  
 nvs\_set\_u8 (C++ *function*), 1066  
 nvs\_stats\_t (C++ *struct*), 1074  
 nvs\_stats\_t::free\_entries (C++ *member*), 1074  
 nvs\_stats\_t::namespace\_count (C++ *member*), 1074  
 nvs\_stats\_t::total\_entries (C++ *member*), 1074  
 nvs\_stats\_t::used\_entries (C++ *member*), 1074  
 nvs\_type\_t (C++ *enum*), 1077  
 nvs\_type\_t::NVS\_TYPE\_ANY (C++ *enumerator*), 1077  
 nvs\_type\_t::NVS\_TYPE\_BLOB (C++ *enumerator*), 1077  
 nvs\_type\_t::NVS\_TYPE\_I16 (C++ *enumerator*), 1077  
 nvs\_type\_t::NVS\_TYPE\_I32 (C++ *enumerator*), 1077  
 nvs\_type\_t::NVS\_TYPE\_I64 (C++ *enumerator*), 1077  
 nvs\_type\_t::NVS\_TYPE\_I8 (C++ *enumerator*), 1077  
 nvs\_type\_t::NVS\_TYPE\_STR (C++ *enumerator*), 1077  
 nvs\_type\_t::NVS\_TYPE\_U16 (C++ *enumerator*), 1077  
 nvs\_type\_t::NVS\_TYPE\_U32 (C++ *enumerator*), 1077  
 nvs\_type\_t::NVS\_TYPE\_U64 (C++ *enumerator*), 1077  
 nvs\_type\_t::NVS\_TYPE\_U8 (C++ *enumerator*), 1077
- ## O
- OPCODE\_ADC (C *macro*), 1508  
 OPCODE\_ALU (C *macro*), 1508  
 OPCODE\_BRANCH (C *macro*), 1509  
 OPCODE\_DELAY (C *macro*), 1508  
 OPCODE\_END (C *macro*), 1510  
 OPCODE\_HALT (C *macro*), 1510  
 OPCODE\_I2C (C *macro*), 1508  
 OPCODE\_LD (C *macro*), 1510  
 OPCODE\_MACRO (C *macro*), 1510  
 OPCODE\_RD\_REG (C *macro*), 1508  
 OPCODE\_ST (C *macro*), 1508  
 OPCODE\_TSENS (C *macro*), 1510  
 OPCODE\_WR\_REG (C *macro*), 1508  
 OTA\_SIZE\_UNKNOWN (C *macro*), 1435  
 OTA\_WITH\_SEQUENTIAL\_WRITES (C *macro*), 1435
- ## P
- pcnt\_chan\_config\_t (C++ *struct*), 522  
 pcnt\_chan\_config\_t::edge\_gpio\_num (C++ *member*), 523  
 pcnt\_chan\_config\_t::flags (C++ *member*), 523  
 pcnt\_chan\_config\_t::invert\_edge\_input (C++ *member*), 523  
 pcnt\_chan\_config\_t::invert\_level\_input (C++ *member*), 523  
 pcnt\_chan\_config\_t::io\_loop\_back (C++ *member*), 523  
 pcnt\_chan\_config\_t::level\_gpio\_num (C++ *member*), 523  
 pcnt\_chan\_config\_t::virt\_edge\_io\_level (C++ *member*), 523  
 pcnt\_chan\_config\_t::virt\_level\_io\_level (C++ *member*), 523

- pcnt\_channel\_edge\_action\_t (C++ *enum*), 524  
 pcnt\_channel\_edge\_action\_t::PCNT\_CHANNEL\_EDGE\_ACTION\_DECREASE (C++ *enumerator*), 524  
 pcnt\_channel\_edge\_action\_t::PCNT\_CHANNEL\_EDGE\_ACTION\_HOLD (C++ *enumerator*), 524  
 pcnt\_channel\_edge\_action\_t::PCNT\_CHANNEL\_EDGE\_ACTION\_INCREASE (C++ *enumerator*), 524  
 pcnt\_channel\_handle\_t (C++ *type*), 523  
 pcnt\_channel\_level\_action\_t (C++ *enum*), 524  
 pcnt\_channel\_level\_action\_t::PCNT\_CHANNEL\_LEVEL\_ACTION\_HOLD (C++ *enumerator*), 524  
 pcnt\_channel\_level\_action\_t::PCNT\_CHANNEL\_LEVEL\_ACTION\_INCREASE (C++ *enumerator*), 524  
 pcnt\_channel\_level\_action\_t::PCNT\_CHANNEL\_LEVEL\_ACTION\_RESET (C++ *enumerator*), 524  
 pcnt\_channel\_set\_edge\_action (C++ *function*), 521  
 pcnt\_channel\_set\_level\_action (C++ *function*), 521  
 pcnt\_del\_channel (C++ *function*), 521  
 pcnt\_del\_unit (C++ *function*), 516  
 pcnt\_event\_callbacks\_t (C++ *struct*), 522  
 pcnt\_event\_callbacks\_t::on\_reach (C++ *member*), 522  
 pcnt\_glitch\_filter\_config\_t (C++ *struct*), 523  
 pcnt\_glitch\_filter\_config\_t::max\_glitch\_time (C++ *member*), 523  
 pcnt\_new\_channel (C++ *function*), 520  
 pcnt\_new\_unit (C++ *function*), 516  
 pcnt\_unit\_add\_watch\_point (C++ *function*), 520  
 pcnt\_unit\_clear\_count (C++ *function*), 519  
 pcnt\_unit\_config\_t (C++ *struct*), 522  
 pcnt\_unit\_config\_t::accum\_count (C++ *member*), 522  
 pcnt\_unit\_config\_t::flags (C++ *member*), 522  
 pcnt\_unit\_config\_t::high\_limit (C++ *member*), 522  
 pcnt\_unit\_config\_t::intr\_priority (C++ *member*), 522  
 pcnt\_unit\_config\_t::low\_limit (C++ *member*), 522  
 pcnt\_unit\_disable (C++ *function*), 518  
 pcnt\_unit\_enable (C++ *function*), 517  
 pcnt\_unit\_get\_count (C++ *function*), 519  
 pcnt\_unit\_handle\_t (C++ *type*), 523  
 pcnt\_unit\_register\_event\_callbacks (C++ *function*), 519  
 pcnt\_unit\_remove\_watch\_point (C++ *function*), 520  
 pcnt\_unit\_set\_glitch\_filter (C++ *function*), 517  
 pcnt\_unit\_start (C++ *function*), 518  
 pcnt\_unit\_stop (C++ *function*), 518  
 pcnt\_unit\_zero\_cross\_mode\_t (C++ *enum*), 524  
 pcnt\_unit\_zero\_cross\_mode\_t::PCNT\_UNIT\_ZERO\_CROSS\_MODE\_HOLD (C++ *enumerator*), 525  
 pcnt\_unit\_zero\_cross\_mode\_t::PCNT\_UNIT\_ZERO\_CROSS\_MODE\_INCREASE (C++ *enumerator*), 525  
 pcnt\_unit\_zero\_cross\_mode\_t::PCNT\_UNIT\_ZERO\_CROSS\_MODE\_RESET (C++ *enumerator*), 525  
 pcnt\_watch\_cb\_t (C++ *type*), 523  
 pcnt\_watch\_event\_data\_t (C++ *struct*), 522  
 pcnt\_watch\_event\_data\_t::watch\_point\_value (C++ *member*), 522  
 pcnt\_watch\_event\_data\_t::zero\_cross\_mode (C++ *member*), 522  
 pcQueueGetName (C++ *function*), 1277  
 pcTaskGetName (C++ *function*), 1252  
 pcTimerGetName (C++ *function*), 1310  
 PendedFunction\_t (C++ *type*), 1321  
 phy\_802\_3\_t (C++ *struct*), 313  
 phy\_802\_3\_t::addr (C++ *member*), 313  
 phy\_802\_3\_t::autonego\_timeout\_ms (C++ *member*), 313  
 phy\_802\_3\_t::eth (C++ *member*), 313  
 phy\_802\_3\_t::link\_status (C++ *member*), 313  
 phy\_802\_3\_t::parent (C++ *member*), 313  
 phy\_802\_3\_t::reset\_gpio\_num (C++ *member*), 313  
 phy\_802\_3\_t::reset\_timeout\_ms (C++ *member*), 313  
 phy\_init\_param\_set (C++ *function*), 1737  
 phy\_wifi\_enable\_set (C++ *function*), 1737  
 PIN\_LEN (C *macro*), 274  
 print\_class\_descriptor\_cb (C++ *type*), 721  
 protocomm\_add\_endpoint (C++ *function*), 1009  
 protocomm\_ble\_config (C++ *struct*), 1017  
 protocomm\_ble\_config::ble\_addr (C++ *member*), 1018  
 protocomm\_ble\_config::ble\_bonding (C++ *member*), 1017  
 protocomm\_ble\_config::ble\_link\_encryption (C++ *member*), 1017  
 protocomm\_ble\_config::ble\_sm\_sc (C++ *member*), 1017  
 protocomm\_ble\_config::device\_name (C++ *member*), 1017  
 protocomm\_ble\_config::manufacturer\_data (C++ *member*), 1017  
 protocomm\_ble\_config::manufacturer\_data\_len (C++ *member*), 1017  
 protocomm\_ble\_config::nu\_lookup (C++ *member*), 1017  
 protocomm\_ble\_config::nu\_lookup\_count (C++ *member*), 1017  
 protocomm\_ble\_config::service\_uuid (C++ *member*), 1017



- protocomm\_ble\_config\_t (C++ type), 1018  
 protocomm\_ble\_name\_uuid\_t (C++ type), 1018  
 protocomm\_ble\_start (C++ function), 1016  
 protocomm\_ble\_stop (C++ function), 1016  
 protocomm\_close\_session (C++ function), 1010  
 protocomm\_delete (C++ function), 1009  
 protocomm\_http\_server\_config\_t (C++ struct), 1015  
 protocomm\_http\_server\_config\_t::port (C++ member), 1015  
 protocomm\_http\_server\_config\_t::stack\_size (C++ member), 1016  
 protocomm\_http\_server\_config\_t::task\_priority (C++ member), 1016  
 protocomm\_httpd\_config\_data\_t (C++ union), 1015  
 protocomm\_httpd\_config\_data\_t::config (C++ member), 1015  
 protocomm\_httpd\_config\_data\_t::handle (C++ member), 1015  
 protocomm\_httpd\_config\_t (C++ struct), 1016  
 protocomm\_httpd\_config\_t::data (C++ member), 1016  
 protocomm\_httpd\_config\_t::ext\_handle\_ptr (C++ member), 1016  
 PROTOCOMM\_HTTPD\_DEFAULT\_CONFIG (C macro), 1016  
 protocomm\_httpd\_start (C++ function), 1015  
 protocomm\_httpd\_stop (C++ function), 1015  
 protocomm\_new (C++ function), 1009  
 protocomm\_open\_session (C++ function), 1010  
 protocomm\_remove\_endpoint (C++ function), 1010  
 protocomm\_req\_handle (C++ function), 1010  
 protocomm\_req\_handler\_t (C++ type), 1012  
 protocomm\_security (C++ struct), 1013  
 protocomm\_security1\_params (C++ struct), 1013  
 protocomm\_security1\_params::data (C++ member), 1013  
 protocomm\_security1\_params::len (C++ member), 1013  
 protocomm\_security1\_params\_t (C++ type), 1014  
 protocomm\_security2\_params (C++ struct), 1013  
 protocomm\_security2\_params::salt (C++ member), 1013  
 protocomm\_security2\_params::salt\_len (C++ member), 1013  
 protocomm\_security2\_params::verifier (C++ member), 1013  
 protocomm\_security2\_params::verifier\_len (C++ member), 1013  
 protocomm\_security2\_params\_t (C++ type), 1014  
 protocomm\_security::cleanup (C++ member), 1013  
 protocomm\_security::close\_transport\_session (C++ member), 1014  
 protocomm\_security::decrypt (C++ member), 1014  
 protocomm\_security::encrypt (C++ member), 1014  
 protocomm\_security::init (C++ member), 1013  
 protocomm\_security::new\_transport\_session (C++ member), 1014  
 protocomm\_security::security\_req\_handler (C++ member), 1014  
 protocomm\_security::ver (C++ member), 1013  
 protocomm\_security\_handle\_t (C++ type), 1014  
 protocomm\_security\_pop\_t (C++ type), 1014  
 protocomm\_security\_t (C++ type), 1014  
 protocomm\_set\_security (C++ function), 1011  
 protocomm\_set\_version (C++ function), 1012  
 protocomm\_t (C++ type), 1012  
 protocomm\_unset\_security (C++ function), 1012  
 protocomm\_unset\_version (C++ function), 1012  
 psk\_hint\_key\_t (C++ type), 69  
 psk\_key\_hint (C++ struct), 66  
 psk\_key\_hint::hint (C++ member), 66  
 psk\_key\_hint::key (C++ member), 66  
 psk\_key\_hint::key\_size (C++ member), 66  
 PTHREAD\_STACK\_MIN (C macro), 1450  
 pvTaskGetThreadLocalStoragePointer (C++ function), 1254  
 pvTimerGetTimerID (C++ function), 1307  
 pxTaskGetStackStart (C++ function), 1253
- ## Q
- QueueHandle\_t (C++ type), 1289  
 QueueSetHandle\_t (C++ type), 1289  
 QueueSetMemberHandle\_t (C++ type), 1289
- ## R
- R0 (C macro), 1507  
 R1 (C macro), 1507  
 R2 (C macro), 1507  
 R3 (C macro), 1508  
 RD\_REG\_PERIPH\_RTC\_CNTL (C macro), 1508  
 RD\_REG\_PERIPH\_RTC\_I2C (C macro), 1508  
 RD\_REG\_PERIPH\_RTC\_IO (C macro), 1508  
 RD\_REG\_PERIPH\_SENS (C macro), 1508  
 RingbufferType\_t (C++ enum), 1364  
 RingbufferType\_t::RINGBUF\_TYPE\_ALLOWSPILT (C++ enumerator), 1364  
 RingbufferType\_t::RINGBUF\_TYPE\_BYTEBUF (C++ enumerator), 1364  
 RingbufferType\_t::RINGBUF\_TYPE\_MAX (C++ enumerator), 1364

- RingbufferType\_t::RINGBUF\_TYPE\_NOSPLIT (C++ enumerator), 1364
- RingbufHandle\_t (C++ type), 1363
- rmt\_alloc\_encoder\_mem (C++ function), 548
- rmt\_apply\_carrier (C++ function), 545
- rmt\_bytes\_encoder\_config\_t (C++ struct), 549
- rmt\_bytes\_encoder\_config\_t::bit0 (C++ member), 549
- rmt\_bytes\_encoder\_config\_t::bit1 (C++ member), 549
- rmt\_bytes\_encoder\_config\_t::flags (C++ member), 549
- rmt\_bytes\_encoder\_config\_t::msb\_first (C++ member), 549
- rmt\_bytes\_encoder\_update\_config (C++ function), 547
- rmt\_carrier\_config\_t (C++ struct), 546
- rmt\_carrier\_config\_t::always\_on (C++ member), 547
- rmt\_carrier\_config\_t::duty\_cycle (C++ member), 546
- rmt\_carrier\_config\_t::flags (C++ member), 547
- rmt\_carrier\_config\_t::frequency\_hz (C++ member), 546
- rmt\_carrier\_config\_t::polarity\_active\_low (C++ member), 546
- rmt\_channel\_handle\_t (C++ type), 550
- rmt\_clock\_source\_t (C++ type), 551
- rmt\_copy\_encoder\_config\_t (C++ struct), 549
- rmt\_del\_channel (C++ function), 545
- rmt\_del\_encoder (C++ function), 548
- rmt\_del\_sync\_manager (C++ function), 540
- rmt\_disable (C++ function), 546
- rmt\_enable (C++ function), 546
- rmt\_encode\_state\_t (C++ enum), 549
- rmt\_encode\_state\_t::RMT\_ENCODING\_COMPLETE (C++ enumerator), 549
- rmt\_encode\_state\_t::RMT\_ENCODING\_MEM\_FULL (C++ enumerator), 550
- rmt\_encode\_state\_t::RMT\_ENCODING\_RESET (C++ enumerator), 549
- rmt\_encoder\_handle\_t (C++ type), 550
- rmt\_encoder\_reset (C++ function), 548
- rmt\_encoder\_t (C++ struct), 548
- rmt\_encoder\_t (C++ type), 549
- rmt\_encoder\_t::del (C++ member), 549
- rmt\_encoder\_t::encode (C++ member), 548
- rmt\_encoder\_t::reset (C++ member), 549
- rmt\_new\_bytes\_encoder (C++ function), 547
- rmt\_new\_copy\_encoder (C++ function), 547
- rmt\_new\_rx\_channel (C++ function), 543
- rmt\_new\_sync\_manager (C++ function), 540
- rmt\_new\_tx\_channel (C++ function), 539
- rmt\_receive (C++ function), 543
- rmt\_receive\_config\_t (C++ struct), 545
- rmt\_receive\_config\_t::signal\_range\_max\_ns (C++ member), 545
- rmt\_receive\_config\_t::signal\_range\_min\_ns (C++ member), 545
- rmt\_rx\_channel\_config\_t (C++ struct), 544
- rmt\_rx\_channel\_config\_t::clk\_src (C++ member), 544
- rmt\_rx\_channel\_config\_t::flags (C++ member), 545
- rmt\_rx\_channel\_config\_t::gpio\_num (C++ member), 544
- rmt\_rx\_channel\_config\_t::intr\_priority (C++ member), 545
- rmt\_rx\_channel\_config\_t::invert\_in (C++ member), 545
- rmt\_rx\_channel\_config\_t::io\_loop\_back (C++ member), 545
- rmt\_rx\_channel\_config\_t::mem\_block\_symbols (C++ member), 545
- rmt\_rx\_channel\_config\_t::resolution\_hz (C++ member), 544
- rmt\_rx\_channel\_config\_t::with\_dma (C++ member), 545
- rmt\_rx\_done\_callback\_t (C++ type), 551
- rmt\_rx\_done\_event\_data\_t (C++ struct), 550
- rmt\_rx\_done\_event\_data\_t::num\_symbols (C++ member), 550
- rmt\_rx\_done\_event\_data\_t::received\_symbols (C++ member), 550
- rmt\_rx\_event\_callbacks\_t (C++ struct), 544
- rmt\_rx\_event\_callbacks\_t::on\_recv\_done (C++ member), 544
- rmt\_rx\_register\_event\_callbacks (C++ function), 544
- rmt\_symbol\_word\_t (C++ union), 551
- rmt\_symbol\_word\_t::duration0 (C++ member), 551
- rmt\_symbol\_word\_t::duration1 (C++ member), 551
- rmt\_symbol\_word\_t::level0 (C++ member), 551
- rmt\_symbol\_word\_t::level1 (C++ member), 551
- rmt\_symbol\_word\_t::val (C++ member), 551
- rmt\_symbol\_word\_t::[anonymous] (C++ member), 551
- rmt\_sync\_manager\_config\_t (C++ struct), 542
- rmt\_sync\_manager\_config\_t::array\_size (C++ member), 543
- rmt\_sync\_manager\_config\_t::tx\_channel\_array (C++ member), 543
- rmt\_sync\_manager\_handle\_t (C++ type), 550
- rmt\_sync\_reset (C++ function), 541
- rmt\_transmit (C++ function), 539
- rmt\_transmit\_config\_t (C++ struct), 542
- rmt\_transmit\_config\_t::eot\_level (C++ member), 542
- rmt\_transmit\_config\_t::flags (C++ member), 542

- rmt\_transmit\_config\_t::loop\_count (C++ member), 542  
 rmt\_transmit\_config\_t::queue\_nonblocking (C++ member), 542  
 rmt\_tx\_channel\_config\_t (C++ struct), 541  
 rmt\_tx\_channel\_config\_t::clk\_src (C++ member), 541  
 rmt\_tx\_channel\_config\_t::flags (C++ member), 542  
 rmt\_tx\_channel\_config\_t::gpio\_num (C++ member), 541  
 rmt\_tx\_channel\_config\_t::intr\_priority (C++ member), 542  
 rmt\_tx\_channel\_config\_t::invert\_out (C++ member), 542  
 rmt\_tx\_channel\_config\_t::io\_loop\_back (C++ member), 542  
 rmt\_tx\_channel\_config\_t::io\_od\_mode (C++ member), 542  
 rmt\_tx\_channel\_config\_t::mem\_block\_symbols (C++ member), 541  
 rmt\_tx\_channel\_config\_t::resolution\_hz (C++ member), 541  
 rmt\_tx\_channel\_config\_t::trans\_queue\_depth (C++ member), 542  
 rmt\_tx\_channel\_config\_t::with\_dma (C++ member), 542  
 rmt\_tx\_done\_callback\_t (C++ type), 550  
 rmt\_tx\_done\_event\_data\_t (C++ struct), 550  
 rmt\_tx\_done\_event\_data\_t::num\_symbols (C++ member), 550  
 rmt\_tx\_event\_callbacks\_t (C++ struct), 541  
 rmt\_tx\_event\_callbacks\_t::on\_trans\_done (C++ member), 541  
 rmt\_tx\_register\_event\_callbacks (C++ function), 540  
 rmt\_tx\_wait\_all\_done (C++ function), 539  
 rtc\_gpio\_deinit (C++ function), 402  
 rtc\_gpio\_force\_hold\_dis\_all (C++ function), 405  
 rtc\_gpio\_force\_hold\_en\_all (C++ function), 405  
 rtc\_gpio\_get\_drive\_capability (C++ function), 404  
 rtc\_gpio\_get\_level (C++ function), 403  
 rtc\_gpio\_hold\_dis (C++ function), 404  
 rtc\_gpio\_hold\_en (C++ function), 404  
 rtc\_gpio\_init (C++ function), 402  
 RTC\_GPIO\_IS\_VALID\_GPIO (C macro), 405  
 rtc\_gpio\_is\_valid\_gpio (C++ function), 402  
 rtc\_gpio\_isolate (C++ function), 405  
 rtc\_gpio\_mode\_t (C++ enum), 405  
 rtc\_gpio\_mode\_t::RTC\_GPIO\_MODE\_DISABLED (C++ enumerator), 406  
 rtc\_gpio\_mode\_t::RTC\_GPIO\_MODE\_INPUT\_ONLY (C++ enumerator), 405  
 rtc\_gpio\_mode\_t::RTC\_GPIO\_MODE\_INPUT\_OUTPUT (C++ enumerator), 406  
 rtc\_gpio\_mode\_t::RTC\_GPIO\_MODE\_INPUT\_OUTPUT\_OD (C++ enumerator), 406  
 rtc\_gpio\_mode\_t::RTC\_GPIO\_MODE\_OUTPUT\_OD (C++ enumerator), 406  
 rtc\_gpio\_mode\_t::RTC\_GPIO\_MODE\_OUTPUT\_ONLY (C++ enumerator), 406  
 rtc\_gpio\_pulldown\_dis (C++ function), 404  
 rtc\_gpio\_pulldown\_en (C++ function), 403  
 rtc\_gpio\_pullup\_dis (C++ function), 404  
 rtc\_gpio\_pullup\_en (C++ function), 403  
 rtc\_gpio\_set\_direction (C++ function), 403  
 rtc\_gpio\_set\_direction\_in\_sleep (C++ function), 403  
 rtc\_gpio\_set\_drive\_capability (C++ function), 404  
 rtc\_gpio\_set\_level (C++ function), 403  
 rtc\_gpio\_wakeup\_disable (C++ function), 405  
 rtc\_gpio\_wakeup\_enable (C++ function), 405  
 rtc\_io\_number\_get (C++ function), 402  
 RISC\_SLOW\_MEM (C macro), 1523
- ## S
- sdm\_channel\_disable (C++ function), 560  
 sdm\_channel\_enable (C++ function), 560  
 sdm\_channel\_handle\_t (C++ type), 561  
 sdm\_channel\_set\_duty (C++ function), 560  
 sdm\_clock\_source\_t (C++ type), 562  
 sdm\_config\_t (C++ struct), 561  
 sdm\_config\_t::clk\_src (C++ member), 561  
 sdm\_config\_t::flags (C++ member), 561  
 sdm\_config\_t::gpio\_num (C++ member), 561  
 sdm\_config\_t::invert\_out (C++ member), 561  
 sdm\_config\_t::io\_loop\_back (C++ member), 561  
 sdm\_config\_t::sample\_rate\_hz (C++ member), 561  
 sdm\_del\_channel (C++ function), 560  
 sdm\_new\_channel (C++ function), 559  
 sdmmc\_can\_discard (C++ function), 1084  
 sdmmc\_can\_trim (C++ function), 1084  
 sdmmc\_card\_init (C++ function), 1083  
 sdmmc\_card\_print\_info (C++ function), 1083  
 sdmmc\_card\_t (C++ struct), 1092  
 sdmmc\_card\_t::cid (C++ member), 1092  
 sdmmc\_card\_t::csd (C++ member), 1093  
 sdmmc\_card\_t::ext\_csd (C++ member), 1093  
 sdmmc\_card\_t::host (C++ member), 1092  
 sdmmc\_card\_t::is\_ddr (C++ member), 1093  
 sdmmc\_card\_t::is\_mem (C++ member), 1093  
 sdmmc\_card\_t::is\_mmc (C++ member), 1093  
 sdmmc\_card\_t::is\_sdio (C++ member), 1093  
 sdmmc\_card\_t::log\_bus\_width (C++ member), 1093  
 sdmmc\_card\_t::max\_freq\_khz (C++ member), 1093  
 sdmmc\_card\_t::num\_io\_functions (C++ member), 1093

- sdmmc\_card\_t::ocr (C++ member), 1092  
 sdmmc\_card\_t::raw\_cid (C++ member), 1092  
 sdmmc\_card\_t::rca (C++ member), 1093  
 sdmmc\_card\_t::reserved (C++ member), 1093  
 sdmmc\_card\_t::scr (C++ member), 1093  
 sdmmc\_card\_t::ssr (C++ member), 1093  
 sdmmc\_cid\_t (C++ struct), 1088  
 sdmmc\_cid\_t::date (C++ member), 1089  
 sdmmc\_cid\_t::mfg\_id (C++ member), 1088  
 sdmmc\_cid\_t::name (C++ member), 1088  
 sdmmc\_cid\_t::oem\_id (C++ member), 1088  
 sdmmc\_cid\_t::revision (C++ member), 1089  
 sdmmc\_cid\_t::serial (C++ member), 1089  
 sdmmc\_command\_t (C++ struct), 1090  
 sdmmc\_command\_t::arg (C++ member), 1091  
 sdmmc\_command\_t::blklen (C++ member), 1091  
 sdmmc\_command\_t::data (C++ member), 1091  
 sdmmc\_command\_t::datalen (C++ member), 1091  
 sdmmc\_command\_t::error (C++ member), 1091  
 sdmmc\_command\_t::flags (C++ member), 1091  
 sdmmc\_command\_t::opcode (C++ member), 1090  
 sdmmc\_command\_t::response (C++ member), 1091  
 sdmmc\_command\_t::timeout\_ms (C++ member), 1091  
 sdmmc\_csd\_t (C++ struct), 1088  
 sdmmc\_csd\_t::capacity (C++ member), 1088  
 sdmmc\_csd\_t::card\_command\_class (C++ member), 1088  
 sdmmc\_csd\_t::csd\_ver (C++ member), 1088  
 sdmmc\_csd\_t::mmc\_ver (C++ member), 1088  
 sdmmc\_csd\_t::read\_block\_len (C++ member), 1088  
 sdmmc\_csd\_t::sector\_size (C++ member), 1088  
 sdmmc\_csd\_t::tr\_speed (C++ member), 1088  
 sdmmc\_erase\_arg\_t (C++ enum), 1094  
 sdmmc\_erase\_arg\_t::SDMMC\_DISCARD\_ARG (C++ enumerator), 1094  
 sdmmc\_erase\_arg\_t::SDMMC\_ERASE\_ARG (C++ enumerator), 1094  
 sdmmc\_erase\_sectors (C++ function), 1084  
 sdmmc\_ext\_csd\_t (C++ struct), 1090  
 sdmmc\_ext\_csd\_t::erase\_mem\_state (C++ member), 1090  
 sdmmc\_ext\_csd\_t::power\_class (C++ member), 1090  
 sdmmc\_ext\_csd\_t::rev (C++ member), 1090  
 sdmmc\_ext\_csd\_t::sec\_feature (C++ member), 1090  
 SDMMC\_FREQ\_26M (C macro), 1094  
 SDMMC\_FREQ\_52M (C macro), 1094  
 SDMMC\_FREQ\_DEFAULT (C macro), 1094  
 SDMMC\_FREQ\_HIGHSPEED (C macro), 1094  
 SDMMC\_FREQ\_PROBING (C macro), 1094  
 sdmmc\_full\_erase (C++ function), 1085  
 sdmmc\_get\_status (C++ function), 1083  
 SDMMC\_HOST\_FLAG\_1BIT (C macro), 1093  
 SDMMC\_HOST\_FLAG\_4BIT (C macro), 1093  
 SDMMC\_HOST\_FLAG\_8BIT (C macro), 1093  
 SDMMC\_HOST\_FLAG\_DDR (C macro), 1094  
 SDMMC\_HOST\_FLAG\_DEINIT\_ARG (C macro), 1094  
 SDMMC\_HOST\_FLAG\_SPI (C macro), 1094  
 sdmmc\_host\_t (C++ struct), 1091  
 sdmmc\_host\_t::command\_timeout\_ms (C++ member), 1092  
 sdmmc\_host\_t::deinit (C++ member), 1092  
 sdmmc\_host\_t::deinit\_p (C++ member), 1092  
 sdmmc\_host\_t::do\_transaction (C++ member), 1092  
 sdmmc\_host\_t::flags (C++ member), 1091  
 sdmmc\_host\_t::get\_bus\_width (C++ member), 1092  
 sdmmc\_host\_t::init (C++ member), 1091  
 sdmmc\_host\_t::io\_int\_enable (C++ member), 1092  
 sdmmc\_host\_t::io\_int\_wait (C++ member), 1092  
 sdmmc\_host\_t::io\_voltage (C++ member), 1091  
 sdmmc\_host\_t::max\_freq\_khz (C++ member), 1091  
 sdmmc\_host\_t::set\_bus\_ddr\_mode (C++ member), 1092  
 sdmmc\_host\_t::set\_bus\_width (C++ member), 1091  
 sdmmc\_host\_t::set\_card\_clk (C++ member), 1092  
 sdmmc\_host\_t::set\_cclk\_always\_on (C++ member), 1092  
 sdmmc\_host\_t::slot (C++ member), 1091  
 sdmmc\_io\_enable\_int (C++ function), 1087  
 sdmmc\_io\_get\_cis\_data (C++ function), 1087  
 sdmmc\_io\_print\_cis\_info (C++ function), 1087  
 sdmmc\_io\_read\_blocks (C++ function), 1086  
 sdmmc\_io\_read\_byte (C++ function), 1085  
 sdmmc\_io\_read\_bytes (C++ function), 1085  
 sdmmc\_io\_wait\_int (C++ function), 1087  
 sdmmc\_io\_write\_blocks (C++ function), 1086  
 sdmmc\_io\_write\_byte (C++ function), 1085  
 sdmmc\_io\_write\_bytes (C++ function), 1086  
 sdmmc\_mmc\_can\_sanitize (C++ function), 1084  
 sdmmc\_mmc\_sanitize (C++ function), 1085  
 sdmmc\_read\_sectors (C++ function), 1084  
 sdmmc\_response\_t (C++ type), 1094  
 sdmmc\_scr\_t (C++ struct), 1089  
 sdmmc\_scr\_t::bus\_width (C++ member), 1089  
 sdmmc\_scr\_t::erase\_mem\_state (C++ member), 1089  
 sdmmc\_scr\_t::reserved (C++ member), 1089  
 sdmmc\_scr\_t::rsvd\_mnf (C++ member), 1089  
 sdmmc\_scr\_t::sd\_spec (C++ member), 1089

- sdmmc\_ssr\_t (C++ struct), 1089
- sdmmc\_ssr\_t::alloc\_unit\_kb (C++ member), 1089
- sdmmc\_ssr\_t::cur\_bus\_width (C++ member), 1089
- sdmmc\_ssr\_t::discard\_support (C++ member), 1089
- sdmmc\_ssr\_t::erase\_offset (C++ member), 1090
- sdmmc\_ssr\_t::erase\_size\_au (C++ member), 1089
- sdmmc\_ssr\_t::erase\_timeout (C++ member), 1090
- sdmmc\_ssr\_t::fule\_support (C++ member), 1090
- sdmmc\_ssr\_t::reserved (C++ member), 1090
- sdmmc\_switch\_func\_rsp\_t (C++ struct), 1090
- sdmmc\_switch\_func\_rsp\_t::data (C++ member), 1090
- sdmmc\_write\_sectors (C++ function), 1083
- SDSPI\_DEFAULT\_DMA (C macro), 556
- SDSPI\_DEFAULT\_HOST (C macro), 556
- sdspi\_dev\_handle\_t (C++ type), 556
- SDSPI\_DEVICE\_CONFIG\_DEFAULT (C macro), 556
- sdspi\_device\_config\_t (C++ struct), 555
- sdspi\_device\_config\_t::gpio\_cd (C++ member), 556
- sdspi\_device\_config\_t::gpio\_cs (C++ member), 556
- sdspi\_device\_config\_t::gpio\_int (C++ member), 556
- sdspi\_device\_config\_t::gpio\_wp (C++ member), 556
- sdspi\_device\_config\_t::host\_id (C++ member), 556
- SDSPI\_HOST\_DEFAULT (C macro), 556
- sdspi\_host\_deinit (C++ function), 555
- sdspi\_host\_do\_transaction (C++ function), 554
- sdspi\_host\_init (C++ function), 554
- sdspi\_host\_init\_device (C++ function), 554
- sdspi\_host\_io\_int\_enable (C++ function), 555
- sdspi\_host\_io\_int\_wait (C++ function), 555
- sdspi\_host\_remove\_device (C++ function), 554
- sdspi\_host\_set\_card\_clk (C++ function), 555
- SDSPI\_SLOT\_NO\_CD (C macro), 556
- SDSPI\_SLOT\_NO\_CS (C macro), 556
- SDSPI\_SLOT\_NO\_INT (C macro), 556
- SDSPI\_SLOT\_NO\_WP (C macro), 556
- SemaphoreHandle\_t (C++ type), 1303
- semBINARY\_SEMAPHORE\_QUEUE\_LENGTH (C macro), 1290
- semGIVE\_BLOCK\_TIME (C macro), 1290
- semSEMAPHORE\_QUEUE\_ITEM\_LENGTH (C macro), 1290
- shared\_stack\_function (C++ type), 1165
- shutdown\_handler\_t (C++ type), 1414
- slave\_cb\_t (C++ type), 597
- slave\_transaction\_cb\_t (C++ type), 589
- smartconfig\_event\_got\_ssid\_pswd\_t (C++ struct), 208
- smartconfig\_event\_got\_ssid\_pswd\_t::bssid (C++ member), 208
- smartconfig\_event\_got\_ssid\_pswd\_t::bssid\_set (C++ member), 208
- smartconfig\_event\_got\_ssid\_pswd\_t::cellphone\_ip (C++ member), 208
- smartconfig\_event\_got\_ssid\_pswd\_t::password (C++ member), 208
- smartconfig\_event\_got\_ssid\_pswd\_t::ssid (C++ member), 208
- smartconfig\_event\_got\_ssid\_pswd\_t::token (C++ member), 208
- smartconfig\_event\_got\_ssid\_pswd\_t::type (C++ member), 208
- smartconfig\_event\_t (C++ enum), 209
- smartconfig\_event\_t::SC\_EVENT\_FOUND\_CHANNEL (C++ enumerator), 209
- smartconfig\_event\_t::SC\_EVENT\_GOT\_SSID\_PSWD (C++ enumerator), 209
- smartconfig\_event\_t::SC\_EVENT\_SCAN\_DONE (C++ enumerator), 209
- smartconfig\_event\_t::SC\_EVENT\_SEND\_ACK\_DONE (C++ enumerator), 209
- SMARTCONFIG\_START\_CONFIG\_DEFAULT (C macro), 209
- smartconfig\_start\_config\_t (C++ struct), 208
- smartconfig\_start\_config\_t::enable\_log (C++ member), 208
- smartconfig\_start\_config\_t::esp\_touch\_v2\_enable\_c (C++ member), 208
- smartconfig\_start\_config\_t::esp\_touch\_v2\_key (C++ member), 208
- smartconfig\_type\_t (C++ enum), 209
- smartconfig\_type\_t::SC\_TYPE\_AIRKISS (C++ enumerator), 209
- smartconfig\_type\_t::SC\_TYPE\_ESPTOUCH (C++ enumerator), 209
- smartconfig\_type\_t::SC\_TYPE\_ESPTOUCH\_AIRKISS (C++ enumerator), 209
- smartconfig\_type\_t::SC\_TYPE\_ESPTOUCH\_V2 (C++ enumerator), 209
- sntp\_get\_sync\_interval (C++ function), 1480
- sntp\_get\_sync\_mode (C++ function), 1479
- sntp\_get\_sync\_status (C++ function), 1479
- sntp\_restart (C++ function), 1480
- sntp\_set\_sync\_interval (C++ function), 1480
- sntp\_set\_sync\_mode (C++ function), 1479
- sntp\_set\_sync\_status (C++ function), 1480
- sntp\_set\_time\_sync\_notification\_cb (C++ function), 1480
- sntp\_sync\_mode\_t (C++ enum), 1481



sntp\_sync\_mode\_t::SNTP\_SYNC\_MODE\_IMMEDIATE (C++ enumerator), 1481  
 sntp\_sync\_mode\_t::SNTP\_SYNC\_MODE\_SMOOTH (C++ enumerator), 1481  
 sntp\_sync\_status\_t (C++ enum), 1481  
 sntp\_sync\_status\_t::SNTP\_SYNC\_STATUS\_COMPLETED (C++ enumerator), 1482  
 sntp\_sync\_status\_t::SNTP\_SYNC\_STATUS\_IN\_PROGRESS (C++ enumerator), 1482  
 sntp\_sync\_status\_t::SNTP\_SYNC\_STATUS\_RESET (C++ enumerator), 1481  
 sntp\_sync\_time (C++ function), 1479  
 sntp\_sync\_time\_cb\_t (C++ type), 1481  
 SOC\_ADC\_ARBITER\_SUPPORTED (C macro), 1466  
 SOC\_ADC\_ATTEN\_NUM (C macro), 1467  
 SOC\_ADC\_CALIBRATION\_V1\_SUPPORTED (C macro), 1467  
 SOC\_ADC\_CHANNEL\_NUM (C macro), 1467  
 SOC\_ADC\_DIG\_CTRL\_SUPPORTED (C macro), 1466  
 SOC\_ADC\_DIG\_SUPPORTED\_UNIT (C macro), 1467  
 SOC\_ADC\_DIGI\_CONTROLLER\_NUM (C macro), 1467  
 SOC\_ADC\_DIGI\_DATA\_BYTES\_PER\_CONV (C macro), 1467  
 SOC\_ADC\_DIGI\_MAX\_BITWIDTH (C macro), 1467  
 SOC\_ADC\_DIGI\_MIN\_BITWIDTH (C macro), 1467  
 SOC\_ADC\_DIGI\_RESULT\_BYTES (C macro), 1467  
 SOC\_ADC\_DMA\_SUPPORTED (C macro), 1467  
 SOC\_ADC\_FILTER\_SUPPORTED (C macro), 1467  
 SOC\_ADC\_MAX\_CHANNEL\_NUM (C macro), 1467  
 SOC\_ADC\_MONITOR\_SUPPORTED (C macro), 1467  
 SOC\_ADC\_PATT\_LEN\_MAX (C macro), 1467  
 SOC\_ADC\_PERIPH\_NUM (C macro), 1467  
 SOC\_ADC\_RTC\_CTRL\_SUPPORTED (C macro), 1466  
 SOC\_ADC\_RTC\_MAX\_BITWIDTH (C macro), 1467  
 SOC\_ADC\_RTC\_MIN\_BITWIDTH (C macro), 1467  
 SOC\_ADC\_SAMPLE\_FREQ\_THRES\_HIGH (C macro), 1467  
 SOC\_ADC\_SAMPLE\_FREQ\_THRES\_LOW (C macro), 1467  
 SOC\_ADC\_SUPPORTED (C macro), 1465  
 SOC\_AES\_CRYPT\_DMA (C macro), 1475  
 SOC\_AES\_SUPPORT\_AES\_128 (C macro), 1475  
 SOC\_AES\_SUPPORT\_AES\_192 (C macro), 1475  
 SOC\_AES\_SUPPORT\_AES\_256 (C macro), 1475  
 SOC\_AES\_SUPPORT\_DMA (C macro), 1474  
 SOC\_AES\_SUPPORT\_GCM (C macro), 1474  
 SOC\_AES\_SUPPORTED (C macro), 1466  
 SOC\_APLL\_MAX\_HZ (C macro), 1469  
 SOC\_APLL\_MIN\_HZ (C macro), 1469  
 SOC\_APLL\_MULTIPLIER\_OUT\_MAX\_HZ (C macro), 1469  
 SOC\_APLL\_MULTIPLIER\_OUT\_MIN\_HZ (C macro), 1469  
 SOC\_ASYNC\_MEMCPY\_SUPPORTED (C macro), 1465  
 SOC\_BROWNOUT\_RESET\_SUPPORTED (C macro), 1467  
 SOC\_CACHE\_SUPPORT\_WRAP (C macro), 1465  
 SOC\_CCOMP\_TIMER\_SUPPORTED (C macro), 1465  
 SOC\_CLK\_APLL\_SUPPORTED (C macro), 1469  
 SOC\_CLK\_RC\_FAST\_D256\_FREQ\_APPROX (C macro), 375  
 SOC\_CLK\_RC\_FAST\_FREQ\_APPROX (C macro), 375  
 SOC\_CLK\_RC\_SLOW\_FREQ\_APPROX (C macro), 375  
 SOC\_CLK\_XTAL32K\_FREQ\_APPROX (C macro), 375  
 SOC\_COEX\_HW\_PTI (C macro), 1476  
 SOC\_CP\_DMA\_MAX\_BUFFER\_SIZE (C macro), 1468  
 SOC\_CP\_DMA\_SUPPORTED (C macro), 1465  
 SOC\_CPU\_BREAKPOINTS\_NUM (C macro), 1468  
 soc\_cpu\_clk\_src\_t (C++ enum), 376  
 soc\_cpu\_clk\_src\_t::SOC\_CPU\_CLK\_SRC\_APLL (C++ enumerator), 377  
 soc\_cpu\_clk\_src\_t::SOC\_CPU\_CLK\_SRC\_INVALID (C++ enumerator), 377  
 soc\_cpu\_clk\_src\_t::SOC\_CPU\_CLK\_SRC\_PLL (C++ enumerator), 377  
 soc\_cpu\_clk\_src\_t::SOC\_CPU\_CLK\_SRC\_RC\_FAST (C++ enumerator), 377  
 soc\_cpu\_clk\_src\_t::SOC\_CPU\_CLK\_SRC\_XTAL (C++ enumerator), 376  
 SOC\_CPU\_CORES\_NUM (C macro), 1468  
 SOC\_CPU\_INTR\_NUM (C macro), 1468  
 SOC\_CPU\_WATCHPOINT\_MAX\_REGION\_SIZE (C macro), 1468  
 SOC\_CPU\_WATCHPOINTS\_NUM (C macro), 1468  
 SOC\_DAC\_PERIPH\_NUM (C macro), 1468  
 SOC\_DAC\_RESOLUTION (C macro), 1468  
 SOC\_DAC\_SUPPORTED (C macro), 1465  
 SOC\_DEDIC\_GPIO\_ALLOW\_REG\_ACCESS (C macro), 1468  
 SOC\_DEDIC\_GPIO\_HAS\_INTERRUPT (C macro), 1468  
 SOC\_DEDIC\_GPIO\_IN\_CHANNELS\_NUM (C macro), 1468  
 SOC\_DEDIC\_GPIO\_OUT\_AUTO\_ENABLE (C macro), 1468  
 SOC\_DEDIC\_GPIO\_OUT\_CHANNELS\_NUM (C macro), 1468  
 SOC\_DEDICATED\_GPIO\_SUPPORTED (C macro), 1465  
 SOC\_DIG\_SIGN\_SUPPORTED (C macro), 1466  
 SOC\_EFUSE\_DIS\_BOOT\_REMAP (C macro), 1474  
 SOC\_EFUSE\_DIS\_DOWNLOAD\_DCACHE (C macro), 1474  
 SOC\_EFUSE\_DIS\_LEGACY\_SPI\_BOOT (C macro), 1474  
 SOC\_EFUSE\_HARD\_DIS\_JTAG (C macro), 1474  
 SOC\_EFUSE\_KEY\_PURPOSE\_FIELD (C macro), 1465  
 SOC\_EFUSE\_REVOKE\_BOOT\_KEY\_DIGESTS (C macro), 1474  
 SOC\_EFUSE\_SECURE\_BOOT\_KEY\_DIGESTS (C macro), 1474

- SOC\_EFUSE\_SOFT\_DIS\_JTAG (C macro), 1474
- SOC\_FLASH\_ENC\_SUPPORTED (C macro), 1466
- SOC\_FLASH\_ENCRYPTED\_XTS\_AES\_BLOCK\_MAX (C macro), 1475
- SOC\_FLASH\_ENCRYPTION\_XTS\_AES (C macro), 1475
- SOC\_FLASH\_ENCRYPTION\_XTS\_AES\_128 (C macro), 1475
- SOC\_FLASH\_ENCRYPTION\_XTS\_AES\_256 (C macro), 1475
- SOC\_FLASH\_ENCRYPTION\_XTS\_AES\_OPTIONS (C macro), 1475
- SOC\_GPIO\_PIN\_COUNT (C macro), 1468
- SOC\_GPIO\_PORT (C macro), 1468
- SOC\_GPIO\_SUPPORT\_FORCE\_HOLD (C macro), 1468
- SOC\_GPIO\_SUPPORT\_RTC\_INDEPENDENT (C macro), 1468
- SOC\_GPIO\_VALID\_DIGITAL\_IO\_PAD\_MASK (C macro), 1468
- SOC\_GPIO\_VALID\_GPIO\_MASK (C macro), 1468
- SOC\_GPIO\_VALID\_OUTPUT\_GPIO\_MASK (C macro), 1468
- SOC\_GPTIMER\_CLKS (C macro), 375
- SOC\_HMAC\_SUPPORTED (C macro), 1466
- SOC\_I2C\_CLKS (C macro), 376
- SOC\_I2C\_FIFO\_LEN (C macro), 1469
- SOC\_I2C\_NUM (C macro), 1469
- SOC\_I2C\_SUPPORT\_APB (C macro), 1469
- SOC\_I2C\_SUPPORT\_HW\_CLR\_BUS (C macro), 1469
- SOC\_I2C\_SUPPORT\_REF\_TICK (C macro), 1469
- SOC\_I2C\_SUPPORT\_SLAVE (C macro), 1469
- SOC\_I2S\_APLL\_MAX\_FREQ (C macro), 1469
- SOC\_I2S\_APLL\_MIN\_FREQ (C macro), 1469
- SOC\_I2S\_APLL\_MIN\_RATE (C macro), 1469
- SOC\_I2S\_CLKS (C macro), 376
- SOC\_I2S\_HW\_VERSION\_1 (C macro), 1469
- SOC\_I2S\_LCD\_I80\_VARIANT (C macro), 1469
- SOC\_I2S\_NUM (C macro), 1469
- SOC\_I2S\_SUPPORTED (C macro), 1466
- SOC\_I2S\_SUPPORTS\_APLL (C macro), 1469
- SOC\_I2S\_SUPPORTS\_DMA\_EQUAL (C macro), 1469
- SOC\_I2S\_SUPPORTS\_LCD\_CAMERA (C macro), 1469
- SOC\_LCD\_CLKS (C macro), 376
- SOC\_LCD\_I80\_BUS\_WIDTH (C macro), 1470
- SOC\_LCD\_I80\_BUSES (C macro), 1469
- SOC\_LCD\_I80\_SUPPORTED (C macro), 1469
- SOC\_LEDC\_CHANNEL\_NUM (C macro), 1470
- SOC\_LEDC\_HAS\_TIMER\_SPECIFIC\_MUX (C macro), 1470
- SOC\_LEDC\_SUPPORT\_APB\_CLOCK (C macro), 1470
- SOC\_LEDC\_SUPPORT\_FADE\_STOP (C macro), 1470
- SOC\_LEDC\_SUPPORT\_REF\_TICK (C macro), 1470
- SOC\_LEDC\_SUPPORT\_XTAL\_CLOCK (C macro), 1470
- SOC\_LEDC\_TIMER\_BIT\_WIDE\_NUM (C macro), 1470
- SOC\_MEMPROT\_CPU\_PREFETCH\_PAD\_SIZE (C macro), 1475
- SOC\_MEMPROT\_MEM\_ALIGN\_SIZE (C macro), 1475
- SOC\_MEMPROT\_SUPPORTED (C macro), 1466
- SOC\_MEMSPI\_IS\_INDEPENDENT (C macro), 1472
- SOC\_MEMSPI\_SRC\_FREQ\_20M\_SUPPORTED (C macro), 1472
- SOC\_MEMSPI\_SRC\_FREQ\_26M\_SUPPORTED (C macro), 1472
- SOC\_MEMSPI\_SRC\_FREQ\_40M\_SUPPORTED (C macro), 1472
- SOC\_MEMSPI\_SRC\_FREQ\_80M\_SUPPORTED (C macro), 1472
- SOC\_MMU\_LINEAR\_ADDRESS\_REGION\_NUM (C macro), 1468
- soc\_module\_clk\_t (C++ enum), 378
- soc\_module\_clk\_t::SOC\_MOD\_CLK\_APB (C++ enumerator), 378
- soc\_module\_clk\_t::SOC\_MOD\_CLK\_APLL (C++ enumerator), 378
- soc\_module\_clk\_t::SOC\_MOD\_CLK\_CPU (C++ enumerator), 378
- soc\_module\_clk\_t::SOC\_MOD\_CLK\_PLL\_F160M (C++ enumerator), 378
- soc\_module\_clk\_t::SOC\_MOD\_CLK\_RC\_FAST (C++ enumerator), 378
- soc\_module\_clk\_t::SOC\_MOD\_CLK\_RC\_FAST\_D256 (C++ enumerator), 378
- soc\_module\_clk\_t::SOC\_MOD\_CLK\_REF\_TICK (C++ enumerator), 378
- soc\_module\_clk\_t::SOC\_MOD\_CLK\_RTC\_FAST (C++ enumerator), 378
- soc\_module\_clk\_t::SOC\_MOD\_CLK\_RTC\_SLOW (C++ enumerator), 378
- soc\_module\_clk\_t::SOC\_MOD\_CLK\_TEMP\_SENSOR (C++ enumerator), 378
- soc\_module\_clk\_t::SOC\_MOD\_CLK\_XTAL (C++ enumerator), 378
- soc\_module\_clk\_t::SOC\_MOD\_CLK\_XTAL32K (C++ enumerator), 378
- SOC\_MPI\_SUPPORTED (C macro), 1466
- SOC\_MPU\_CONFIGURABLE\_REGIONS\_SUPPORTED (C macro), 1470
- SOC\_MPU\_MIN\_REGION\_SIZE (C macro), 1470
- SOC\_MPU\_REGION\_RO\_SUPPORTED (C macro), 1470
- SOC\_MPU\_REGION\_WO\_SUPPORTED (C macro), 1470
- SOC\_MPU\_REGIONS\_MAX\_NUM (C macro), 1470
- SOC\_PCNT\_CHANNELS\_PER\_UNIT (C macro), 1470
- SOC\_PCNT\_GROUPS (C macro), 1470
- SOC\_PCNT\_SUPPORTED (C macro), 1465
- SOC\_PCNT\_THRES\_POINT\_PER\_UNIT (C macro), 1470
- SOC\_PCNT\_UNITS\_PER\_GROUP (C macro), 1470
- soc\_periph\_gptimer\_clk\_src\_t (C++ enum), 379
- soc\_periph\_gptimer\_clk\_src\_t::GPTIMER\_CLK\_SRC\_APB

(C++ enumerator), 379  
 soc\_periph\_gptimer\_clk\_src\_t::GPTIMER\_CLK\_SRC\_DEFAULT (C++ enumerator), 379  
 soc\_periph\_gptimer\_clk\_src\_t::GPTIMER\_CLK\_SRC\_APB (C++ enumerator), 380  
 soc\_periph\_gptimer\_clk\_src\_t::GPTIMER\_CLK\_SRC\_DEFAULT (C++ enumerator), 379  
 soc\_periph\_i2c\_clk\_src\_t (C++ enum), 381  
 soc\_periph\_i2c\_clk\_src\_t::I2C\_CLK\_SRC\_APB (C++ enumerator), 381  
 soc\_periph\_i2c\_clk\_src\_t::I2C\_CLK\_SRC\_DEFAULT (C++ enumerator), 381  
 soc\_periph\_i2c\_clk\_src\_t::I2C\_CLK\_SRC\_FAST (C++ enumerator), 381  
 soc\_periph\_i2s\_clk\_src\_t (C++ enum), 380  
 soc\_periph\_i2s\_clk\_src\_t::I2S\_CLK\_SRC\_APLL (C++ enumerator), 380  
 soc\_periph\_i2s\_clk\_src\_t::I2S\_CLK\_SRC\_DEFAULT (C++ enumerator), 380  
 soc\_periph\_i2s\_clk\_src\_t::I2S\_CLK\_SRC\_PLL160M (C++ enumerator), 380  
 soc\_periph\_lcd\_clk\_src\_t (C++ enum), 379  
 soc\_periph\_lcd\_clk\_src\_t::LCD\_CLK\_SRC\_DEFAULT (C++ enumerator), 379  
 soc\_periph\_lcd\_clk\_src\_t::LCD\_CLK\_SRC\_PLL160M (C++ enumerator), 379  
 soc\_periph\_rmt\_clk\_src\_legacy\_t (C++ enum), 380  
 soc\_periph\_rmt\_clk\_src\_legacy\_t::RMT\_CHANNELS\_PER\_GROUP (C++ enumerator), 380  
 soc\_periph\_rmt\_clk\_src\_legacy\_t::RMT\_CHANNELS\_PER\_GROUPS (C++ enumerator), 380  
 soc\_periph\_rmt\_clk\_src\_legacy\_t::RMT\_BASECLK (C++ enumerator), 380  
 soc\_periph\_rmt\_clk\_src\_t (C++ enum), 379  
 soc\_periph\_rmt\_clk\_src\_t::RMT\_CLK\_SRC\_APB (C++ enumerator), 379  
 soc\_periph\_rmt\_clk\_src\_t::RMT\_CLK\_SRC\_DEFAULT (C++ enumerator), 379  
 soc\_periph\_rmt\_clk\_src\_t::RMT\_CLK\_SRC\_FAST (C++ enumerator), 379  
 soc\_periph\_sdm\_clk\_src\_t (C++ enum), 381  
 soc\_periph\_sdm\_clk\_src\_t::SDM\_CLK\_SRC\_APB (C++ enumerator), 381  
 soc\_periph\_sdm\_clk\_src\_t::SDM\_CLK\_SRC\_DEFAULT (C++ enumerator), 381  
 soc\_periph\_temperature\_sensor\_clk\_src\_t (C++ enum), 380  
 soc\_periph\_temperature\_sensor\_clk\_src\_t::TEMPERATURE\_SENSOR\_CLK\_SRC\_DEFAULT (C++ enumerator), 380  
 soc\_periph\_temperature\_sensor\_clk\_src\_t::TEMPERATURE\_SENSOR\_CLK\_SRC\_FAST (C++ enumerator), 380  
 soc\_periph\_tg\_clk\_src\_legacy\_t (C++ enum), 379  
 soc\_periph\_tg\_clk\_src\_legacy\_t::TIMER\_SRC\_CLK\_APB (C++ enumerator), 379  
 soc\_periph\_tg\_clk\_src\_legacy\_t::TIMER\_SRC\_CLK\_DEFAULT (C++ enumerator), 379  
 soc\_periph\_tg\_clk\_src\_legacy\_t::TIMER\_SRC\_CLK\_MAX\_BIT\_LEN (C++ enumerator), 379  
 soc\_periph\_uart\_clk\_src\_legacy\_t (C++ enum), 380  
 soc\_periph\_uart\_clk\_src\_legacy\_t::UART\_SCLK\_APB (C++ enumerator), 380  
 soc\_periph\_uart\_clk\_src\_legacy\_t::UART\_SCLK\_DEFAULT (C++ enumerator), 380  
 soc\_periph\_uart\_clk\_src\_legacy\_t::UART\_SCLK\_REF\_T (C++ enumerator), 380  
 soc\_periph\_uart\_clk\_src\_legacy\_t::UART\_SCLK\_REF\_TICK (C++ enumerator), 380  
 soc\_periph\_uart\_clk\_src\_legacy\_t::UART\_SCLK\_REF\_TICK\_SUPPORT\_RTC\_FAST\_MEM\_PD (C++ macro), 1476  
 soc\_periph\_uart\_clk\_src\_legacy\_t::SOC\_PM\_SUPPORT\_RTC\_PERIPH\_PD (C++ macro), 1476  
 soc\_periph\_uart\_clk\_src\_legacy\_t::SOC\_PM\_SUPPORT\_RTC\_SLOW\_MEM\_PD (C++ macro), 1476  
 soc\_periph\_uart\_clk\_src\_legacy\_t::SOC\_PM\_SUPPORT\_TOUCH\_SENSOR\_WAKEUP (C++ macro), 1475  
 soc\_periph\_uart\_clk\_src\_legacy\_t::SOC\_PM\_SUPPORT\_WIFI\_PD (C++ macro), 1475  
 soc\_periph\_uart\_clk\_src\_legacy\_t::SOC\_PM\_SUPPORT\_WIFI\_WAKEUP (C++ macro), 1475  
 soc\_periph\_uart\_clk\_src\_legacy\_t::SOC\_RAM\_DMA\_CAPABLE (C++ macro), 1466  
 soc\_periph\_uart\_clk\_src\_legacy\_t::SOC\_REG\_TO\_ULP\_PERIPH\_SEL (C++ function), 1503  
 soc\_periph\_uart\_clk\_src\_legacy\_t::SOC\_RISCV\_COPROC\_SUPPORTED (C++ macro), 1465  
 soc\_periph\_uart\_clk\_src\_legacy\_t::SOC\_RMT\_CHANNEL\_CLK\_INDEPENDENT (C++ macro), 1471  
 soc\_periph\_uart\_clk\_src\_legacy\_t::SOC\_RMT\_CHANNELS\_PER\_GROUP (C++ macro), 1470  
 soc\_periph\_uart\_clk\_src\_legacy\_t::SOC\_RMT\_CLKS (C++ macro), 376  
 soc\_periph\_uart\_clk\_src\_legacy\_t::SOC\_RMT\_DEFAULT\_GROUPS (C++ macro), 1470  
 soc\_periph\_uart\_clk\_src\_legacy\_t::SOC\_RMT\_MEM\_WORDS\_PER\_CHANNEL (C++ macro), 1471  
 soc\_periph\_uart\_clk\_src\_legacy\_t::SOC\_RMT\_RX\_CANDIDATES\_PER\_GROUP (C++ macro), 1470  
 soc\_periph\_uart\_clk\_src\_legacy\_t::SOC\_RMT\_SUPPORT\_APB (C++ macro), 1471  
 soc\_periph\_uart\_clk\_src\_legacy\_t::SOC\_RMT\_SUPPORT\_REF\_TICK (C++ macro), 1471  
 soc\_periph\_uart\_clk\_src\_legacy\_t::SOC\_RMT\_SUPPORT\_RX\_DEMODULATION (C++ macro), 1471  
 soc\_periph\_uart\_clk\_src\_legacy\_t::SOC\_RMT\_SUPPORT\_TX\_ASYNC\_STOP (C++ macro), 1471  
 soc\_periph\_uart\_clk\_src\_legacy\_t::SOC\_RMT\_SUPPORT\_TX\_CARRIER\_DATA\_ONLY (C++ macro), 1471  
 soc\_periph\_uart\_clk\_src\_legacy\_t::SOC\_RMT\_SUPPORT\_TX\_LOOP\_COUNT (C++ macro), 1471  
 soc\_periph\_uart\_clk\_src\_legacy\_t::SOC\_RMT\_SUPPORT\_TX\_SYNCHRO (C++ macro), 1471  
 soc\_periph\_uart\_clk\_src\_legacy\_t::SOC\_RMT\_SUPPORTED (C++ macro), 1466  
 soc\_periph\_uart\_clk\_src\_legacy\_t::SOC\_RMT\_TX\_CANDIDATES\_PER\_GROUP (C++ macro), 1470  
 soc\_periph\_uart\_clk\_src\_legacy\_t::SOC\_ROOT\_CLK\_EXT\_XTAL32K (C++ enum), 376  
 soc\_periph\_uart\_clk\_src\_legacy\_t::SOC\_ROOT\_CLK\_INT\_RC\_FAST (C++ enum), 376  
 soc\_periph\_uart\_clk\_src\_legacy\_t::SOC\_ROOT\_CLK\_INT\_RC\_SLOW (C++ enum), 376  
 soc\_periph\_uart\_clk\_src\_legacy\_t::SOC\_RTC\_FAST\_CLK\_SRC\_T (C++ enum), 377





- 1473
- SOC\_UART\_BITRATE\_MAX (*C macro*), 1473
- SOC\_UART\_FIFO\_LEN (*C macro*), 1473
- SOC\_UART\_NUM (*C macro*), 1473
- SOC\_UART\_SUPPORT\_APB\_CLK (*C macro*), 1473
- SOC\_UART\_SUPPORT\_REF\_TICK (*C macro*), 1473
- SOC\_UART\_SUPPORT\_WAKEUP\_INT (*C macro*), 1473
- SOC\_ULP\_SUPPORTED (*C macro*), 1465
- SOC\_USB\_OTG\_PERIPH\_NUM (*C macro*), 1473
- SOC\_USB\_OTG\_SUPPORTED (*C macro*), 1465
- SOC\_WIFI\_CSI\_SUPPORT (*C macro*), 1476
- SOC\_WIFI\_FTM\_SUPPORT (*C macro*), 1476
- SOC\_WIFI\_GCMP\_SUPPORT (*C macro*), 1476
- SOC\_WIFI\_HW\_TSF (*C macro*), 1476
- SOC\_WIFI\_LIGHT\_SLEEP\_CLK\_WIDTH (*C macro*), 1475
- SOC\_WIFI\_MESH\_SUPPORT (*C macro*), 1476
- SOC\_WIFI\_SUPPORTED (*C macro*), 1465
- SOC\_WIFI\_WAPI\_SUPPORT (*C macro*), 1476
- SOC\_XT\_WDT\_SUPPORTED (*C macro*), 1466
- SOC\_XTAL\_SUPPORT\_40M (*C macro*), 1466
- spi\_bus\_add\_device (*C++ function*), 575
- spi\_bus\_add\_flash\_device (*C++ function*), 1103
- spi\_bus\_config\_t (*C++ struct*), 572
- spi\_bus\_config\_t::data0\_io\_num (*C++ member*), 572
- spi\_bus\_config\_t::data1\_io\_num (*C++ member*), 572
- spi\_bus\_config\_t::data2\_io\_num (*C++ member*), 572
- spi\_bus\_config\_t::data3\_io\_num (*C++ member*), 572
- spi\_bus\_config\_t::data4\_io\_num (*C++ member*), 572
- spi\_bus\_config\_t::data5\_io\_num (*C++ member*), 572
- spi\_bus\_config\_t::data6\_io\_num (*C++ member*), 572
- spi\_bus\_config\_t::data7\_io\_num (*C++ member*), 572
- spi\_bus\_config\_t::flags (*C++ member*), 573
- spi\_bus\_config\_t::intr\_flags (*C++ member*), 573
- spi\_bus\_config\_t::max\_transfer\_sz (*C++ member*), 573
- spi\_bus\_config\_t::miso\_io\_num (*C++ member*), 572
- spi\_bus\_config\_t::mosi\_io\_num (*C++ member*), 572
- spi\_bus\_config\_t::quadhd\_io\_num (*C++ member*), 572
- spi\_bus\_config\_t::quadwp\_io\_num (*C++ member*), 572
- spi\_bus\_config\_t::sclk\_io\_num (*C++ member*), 572
- spi\_bus\_free (*C++ function*), 571
- spi\_bus\_get\_max\_transaction\_len (*C++ function*), 578
- spi\_bus\_initialize (*C++ function*), 571
- spi\_bus\_remove\_device (*C++ function*), 575
- spi\_bus\_remove\_flash\_device (*C++ function*), 1103
- spi\_clock\_source\_t (*C++ enum*), 569
- spi\_clock\_source\_t::SPI\_CLK\_APB (*C++ enumerator*), 569
- spi\_clock\_source\_t::SPI\_CLK\_XTAL (*C++ enumerator*), 569
- spi\_command\_t (*C++ enum*), 570
- spi\_command\_t::SPI\_CMD\_HD\_EN\_QPI (*C++ enumerator*), 570
- spi\_command\_t::SPI\_CMD\_HD\_INT0 (*C++ enumerator*), 570
- spi\_command\_t::SPI\_CMD\_HD\_INT1 (*C++ enumerator*), 570
- spi\_command\_t::SPI\_CMD\_HD\_INT2 (*C++ enumerator*), 571
- spi\_command\_t::SPI\_CMD\_HD\_RDBUF (*C++ enumerator*), 570
- spi\_command\_t::SPI\_CMD\_HD\_RDDMA (*C++ enumerator*), 570
- spi\_command\_t::SPI\_CMD\_HD\_SEG\_END (*C++ enumerator*), 570
- spi\_command\_t::SPI\_CMD\_HD\_WR\_END (*C++ enumerator*), 570
- spi\_command\_t::SPI\_CMD\_HD\_WRBUF (*C++ enumerator*), 570
- spi\_command\_t::SPI\_CMD\_HD\_WRDMA (*C++ enumerator*), 570
- spi\_common\_dma\_t (*C++ enum*), 574
- spi\_common\_dma\_t::SPI\_DMA\_CH\_AUTO (*C++ enumerator*), 574
- spi\_common\_dma\_t::SPI\_DMA\_DISABLED (*C++ enumerator*), 574
- SPI\_DEVICE\_3WIRE (*C macro*), 582
- spi\_device\_acquire\_bus (*C++ function*), 577
- SPI\_DEVICE\_BIT\_LSBFIRST (*C macro*), 582
- SPI\_DEVICE\_CLK\_AS\_CS (*C macro*), 582
- SPI\_DEVICE\_DDRCLK (*C macro*), 582
- spi\_device\_get\_trans\_result (*C++ function*), 576
- SPI\_DEVICE\_HALFDUPLEX (*C macro*), 582
- spi\_device\_handle\_t (*C++ type*), 583
- spi\_device\_interface\_config\_t (*C++ struct*), 578
- spi\_device\_interface\_config\_t::address\_bits (*C++ member*), 579
- spi\_device\_interface\_config\_t::clock\_speed\_hz (*C++ member*), 579
- spi\_device\_interface\_config\_t::command\_bits (*C++ member*), 578
- spi\_device\_interface\_config\_t::cs\_ena\_posttrans (*C++ member*), 579
- spi\_device\_interface\_config\_t::cs\_ena\_pretrans (*C++ member*), 579

- spi\_device\_interface\_config\_t::dummy\_bits (C++ member), 1115  
 (C++ member), 579
- spi\_device\_interface\_config\_t::duty\_cycle\_pos (C++ member), 1116  
 (C++ member), 579
- spi\_device\_interface\_config\_t::flags (C++ member), 1115  
 (C++ member), 579
- spi\_device\_interface\_config\_t::input\_delay\_ns (C++ member), 1116  
 (C++ member), 579
- spi\_device\_interface\_config\_t::mode (C++ member), 1115  
 (C++ member), 579
- spi\_device\_interface\_config\_t::post\_cb (C++ member), 580
- spi\_device\_interface\_config\_t::pre\_cb (C++ member), 579
- spi\_device\_interface\_config\_t::queue\_size (C++ member), 579
- spi\_device\_interface\_config\_t::spics\_io\_spi (C++ member), 579
- SPI\_DEVICE\_NO\_DUMMY (C macro), 582
- spi\_device\_polling\_end (C++ function), 577
- spi\_device\_polling\_start (C++ function), 576
- spi\_device\_polling\_transmit (C++ function), 577
- SPI\_DEVICE\_POSITIVE\_CS (C macro), 582
- spi\_device\_queue\_trans (C++ function), 575
- spi\_device\_release\_bus (C++ function), 577
- SPI\_DEVICE\_RXBIT\_LSBFIRST (C macro), 582
- spi\_device\_transmit (C++ function), 576
- SPI\_DEVICE\_TXBIT\_LSBFIRST (C macro), 582
- spi\_dma\_chan\_t (C++ type), 574
- spi\_event\_t (C++ enum), 569
- spi\_event\_t::SPI\_EV\_BUF\_RX (C++ enumerator), 570
- spi\_event\_t::SPI\_EV\_BUF\_TX (C++ enumerator), 569
- spi\_event\_t::SPI\_EV\_CMD9 (C++ enumerator), 570
- spi\_event\_t::SPI\_EV\_CMDA (C++ enumerator), 570
- spi\_event\_t::SPI\_EV\_RECV (C++ enumerator), 570
- spi\_event\_t::SPI\_EV\_RECV\_DMA\_READY (C++ enumerator), 570
- spi\_event\_t::SPI\_EV\_SEND (C++ enumerator), 570
- spi\_event\_t::SPI\_EV\_SEND\_DMA\_READY (C++ enumerator), 570
- spi\_event\_t::SPI\_EV\_TRANS (C++ enumerator), 570
- spi\_flash\_cache2phys (C++ function), 1113
- SPI\_FLASH\_CACHE2PHYS\_FAIL (C macro), 1113
- spi\_flash\_chip\_t (C++ type), 1111
- SPI\_FLASH\_CONFIG\_CONF\_BITS (C macro), 1118
- spi\_flash\_encryption\_t (C++ struct), 1115
- spi\_flash\_encryption\_t::flash\_encryption\_destroy (C++ member), 1116
- spi\_flash\_encryption\_t::flash\_encryption\_disable (C++ member), 1115
- spi\_flash\_encryption\_t::flash\_encryption\_done (C++ member), 1115
- spi\_flash\_encryption\_t::flash\_encryption\_enable (C++ member), 1115
- spi\_flash\_host\_driver\_s (C++ struct), 1116
- spi\_flash\_host\_driver\_s::check\_suspend (C++ member), 1118
- spi\_flash\_host\_driver\_s::common\_command (C++ member), 1116
- spi\_flash\_host\_driver\_s::configure\_host\_io\_mode (C++ member), 1117
- spi\_flash\_host\_driver\_s::dev\_config (C++ member), 1116
- spi\_flash\_host\_driver\_s::erase\_block (C++ member), 1117
- spi\_flash\_host\_driver\_s::erase\_chip (C++ member), 1116
- spi\_flash\_host\_driver\_s::erase\_sector (C++ member), 1116
- spi\_flash\_host\_driver\_s::flush\_cache (C++ member), 1118
- spi\_flash\_host\_driver\_s::host\_status (C++ member), 1117
- spi\_flash\_host\_driver\_s::poll\_cmd\_done (C++ member), 1118
- spi\_flash\_host\_driver\_s::program\_page (C++ member), 1117
- spi\_flash\_host\_driver\_s::read (C++ member), 1117
- spi\_flash\_host\_driver\_s::read\_data\_slicer (C++ member), 1117
- spi\_flash\_host\_driver\_s::read\_id (C++ member), 1116
- spi\_flash\_host\_driver\_s::read\_status (C++ member), 1117
- spi\_flash\_host\_driver\_s::resume (C++ member), 1118
- spi\_flash\_host\_driver\_s::set\_write\_protect (C++ member), 1117
- spi\_flash\_host\_driver\_s::supports\_direct\_read (C++ member), 1117
- spi\_flash\_host\_driver\_s::supports\_direct\_write (C++ member), 1117
- spi\_flash\_host\_driver\_s::sus\_setup (C++ member), 1118
- spi\_flash\_host\_driver\_s::suspend (C++ member), 1118
- spi\_flash\_host\_driver\_s::write\_data\_slicer (C++ member), 1117
- spi\_flash\_host\_driver\_t (C++ type), 1118
- spi\_flash\_host\_inst\_t (C++ struct), 1116
- spi\_flash\_host\_inst\_t::driver (C++ member), 1116

- [spi\\_flash\\_mmap \(C++ function\), 1112](#)  
[spi\\_flash\\_mmap\\_dump \(C++ function\), 1112](#)  
[spi\\_flash\\_mmap\\_get\\_free\\_pages \(C++ function\), 1112](#)  
[spi\\_flash\\_mmap\\_handle\\_t \(C++ type\), 1114](#)  
[spi\\_flash\\_mmap\\_memory\\_t \(C++ enum\), 1114](#)  
[spi\\_flash\\_mmap\\_memory\\_t::SPI\\_FLASH\\_MMAPPAGE\\_SIZE \(C++ enumerator\), 1114](#)  
[spi\\_flash\\_mmap\\_memory\\_t::SPI\\_FLASH\\_MMAPPINSTR \(C++ enumerator\), 1114](#)  
[spi\\_flash\\_mmap\\_pages \(C++ function\), 1112](#)  
[SPI\\_FLASH\\_MMU\\_PAGE\\_SIZE \(C macro\), 1113](#)  
[spi\\_flash\\_munmap \(C++ function\), 1112](#)  
[SPI\\_FLASH\\_OPI\\_FLAG \(C macro\), 1118](#)  
[SPI\\_FLASH\\_OS\\_IS\\_ERASING\\_STATUS\\_FLAG \(C macro\), 1111](#)  
[spi\\_flash\\_phys2cache \(C++ function\), 1113](#)  
[SPI\\_FLASH\\_READ\\_MODE\\_MIN \(C macro\), 1118](#)  
[SPI\\_FLASH\\_SEC\\_SIZE \(C macro\), 1113](#)  
[spi\\_flash\\_sus\\_cmd\\_conf \(C++ struct\), 1115](#)  
[spi\\_flash\\_sus\\_cmd\\_conf::cmd\\_rdsr \(C++ member\), 1115](#)  
[spi\\_flash\\_sus\\_cmd\\_conf::res\\_cmd \(C++ member\), 1115](#)  
[spi\\_flash\\_sus\\_cmd\\_conf::reserved \(C++ member\), 1115](#)  
[spi\\_flash\\_sus\\_cmd\\_conf::sus\\_cmd \(C++ member\), 1115](#)  
[spi\\_flash\\_sus\\_cmd\\_conf::sus\\_mask \(C++ member\), 1115](#)  
[SPI\\_FLASH\\_TRANS\\_FLAG\\_BYTE\\_SWAP \(C macro\), 1118](#)  
[SPI\\_FLASH\\_TRANS\\_FLAG\\_CMD16 \(C macro\), 1118](#)  
[SPI\\_FLASH\\_TRANS\\_FLAG\\_IGNORE\\_BASEIO \(C macro\), 1118](#)  
[spi\\_flash\\_trans\\_t \(C++ struct\), 1114](#)  
[spi\\_flash\\_trans\\_t::address \(C++ member\), 1114](#)  
[spi\\_flash\\_trans\\_t::address\\_bitlen \(C++ member\), 1114](#)  
[spi\\_flash\\_trans\\_t::command \(C++ member\), 1115](#)  
[spi\\_flash\\_trans\\_t::dummy\\_bitlen \(C++ member\), 1115](#)  
[spi\\_flash\\_trans\\_t::flags \(C++ member\), 1115](#)  
[spi\\_flash\\_trans\\_t::io\\_mode \(C++ member\), 1115](#)  
[spi\\_flash\\_trans\\_t::miso\\_data \(C++ member\), 1114](#)  
[spi\\_flash\\_trans\\_t::miso\\_len \(C++ member\), 1114](#)  
[spi\\_flash\\_trans\\_t::mosi\\_data \(C++ member\), 1114](#)  
[spi\\_flash\\_trans\\_t::mosi\\_len \(C++ member\), 1114](#)  
[spi\\_flash\\_trans\\_t::reserved \(C++ member\), 1114](#)  
[SPI\\_FLASH\\_YIELD\\_REQ\\_SUSPEND \(C macro\), 1111](#)  
[SPI\\_FLASH\\_YIELD\\_REQ\\_YIELD \(C macro\), 1111](#)  
[SPI\\_FLASH\\_YIELD\\_STA\\_RESUME \(C macro\), 1111](#)  
[spi\\_get\\_actual\\_clock \(C++ function\), 578](#)  
[spi\\_get\\_freq\\_limit \(C++ function\), 578](#)  
[spi\\_get\\_timing \(C++ function\), 578](#)  
[spi\\_host\\_device\\_t \(C++ enum\), 569](#)  
[spi\\_host\\_device\\_t::SPI1\\_HOST \(C++ enumerator\), 569](#)  
[spi\\_host\\_device\\_t::SPI2\\_HOST \(C++ enumerator\), 569](#)  
[spi\\_host\\_device\\_t::SPI3\\_HOST \(C++ enumerator\), 569](#)  
[spi\\_host\\_device\\_t::SPI\\_HOST\\_MAX \(C++ enumerator\), 569](#)  
[spi\\_line\\_mode\\_t \(C++ struct\), 569](#)  
[spi\\_line\\_mode\\_t::addr\\_lines \(C++ member\), 569](#)  
[spi\\_line\\_mode\\_t::cmd\\_lines \(C++ member\), 569](#)  
[spi\\_line\\_mode\\_t::data\\_lines \(C++ member\), 569](#)  
[SPI\\_MASTER\\_FREQ\\_10M \(C macro\), 581](#)  
[SPI\\_MASTER\\_FREQ\\_11M \(C macro\), 581](#)  
[SPI\\_MASTER\\_FREQ\\_13M \(C macro\), 581](#)  
[SPI\\_MASTER\\_FREQ\\_16M \(C macro\), 581](#)  
[SPI\\_MASTER\\_FREQ\\_20M \(C macro\), 581](#)  
[SPI\\_MASTER\\_FREQ\\_26M \(C macro\), 581](#)  
[SPI\\_MASTER\\_FREQ\\_40M \(C macro\), 582](#)  
[SPI\\_MASTER\\_FREQ\\_80M \(C macro\), 582](#)  
[SPI\\_MASTER\\_FREQ\\_8M \(C macro\), 581](#)  
[SPI\\_MASTER\\_FREQ\\_9M \(C macro\), 581](#)  
[SPI\\_MAX\\_DMA\\_LEN \(C macro\), 573](#)  
[SPI\\_SLAVE\\_BIT\\_LSBFIRST \(C macro\), 589](#)  
[spi\\_slave\\_chan\\_t \(C++ enum\), 597](#)  
[spi\\_slave\\_chan\\_t::SPI\\_SLAVE\\_CHAN\\_RX \(C++ enumerator\), 597](#)  
[spi\\_slave\\_chan\\_t::SPI\\_SLAVE\\_CHAN\\_TX \(C++ enumerator\), 597](#)  
[spi\\_slave\\_free \(C++ function\), 586](#)  
[spi\\_slave\\_get\\_trans\\_result \(C++ function\), 587](#)  
[SPI\\_SLAVE\\_HD\\_APPEND\\_MODE \(C macro\), 596](#)  
[spi\\_slave\\_hd\\_append\\_trans \(C++ function\), 593](#)  
[SPI\\_SLAVE\\_HD\\_BIT\\_LSBFIRST \(C macro\), 596](#)  
[spi\\_slave\\_hd\\_callback\\_config\\_t \(C++ struct\), 595](#)  
[spi\\_slave\\_hd\\_callback\\_config\\_t::arg \(C++ member\), 595](#)  
[spi\\_slave\\_hd\\_callback\\_config\\_t::cb\\_buffer\\_rx \(C++ member\), 595](#)  
[spi\\_slave\\_hd\\_callback\\_config\\_t::cb\\_buffer\\_tx \(C++ member\), 595](#)  
[spi\\_slave\\_hd\\_callback\\_config\\_t::cb\\_cmd9 \(C++ member\), 595](#)  
[spi\\_slave\\_hd\\_callback\\_config\\_t::cb\\_cmdA](#)

- (C++ member), 595
- `spi_slave_hd_callback_config_t::cb_recv` (C++ member), 595
- `spi_slave_hd_callback_config_t::cb_recv_dma_ready` (C++ member), 595
- `spi_slave_hd_callback_config_t::cb_send_dma_ready` (C++ member), 595
- `spi_slave_hd_callback_config_t::cb_sent` (C++ member), 595
- `spi_slave_hd_data_t` (C++ struct), 594
- `spi_slave_hd_data_t::arg` (C++ member), 595
- `spi_slave_hd_data_t::data` (C++ member), 594
- `spi_slave_hd_data_t::len` (C++ member), 594
- `spi_slave_hd_data_t::trans_len` (C++ member), 594
- `spi_slave_hd_deinit` (C++ function), 592
- `spi_slave_hd_event_t` (C++ struct), 595
- `spi_slave_hd_event_t::event` (C++ member), 595
- `spi_slave_hd_event_t::trans` (C++ member), 595
- `spi_slave_hd_get_append_trans_res` (C++ function), 594
- `spi_slave_hd_get_trans_res` (C++ function), 593
- `spi_slave_hd_init` (C++ function), 592
- `spi_slave_hd_queue_trans` (C++ function), 592
- `spi_slave_hd_read_buffer` (C++ function), 593
- `SPI_SLAVE_HD_RXBIT_LSBFIRST` (C macro), 596
- `spi_slave_hd_slot_config_t` (C++ struct), 595
- `spi_slave_hd_slot_config_t::address_bits` (C++ member), 596
- `spi_slave_hd_slot_config_t::cb_config` (C++ member), 596
- `spi_slave_hd_slot_config_t::command_bits` (C++ member), 596
- `spi_slave_hd_slot_config_t::dma_chan` (C++ member), 596
- `spi_slave_hd_slot_config_t::dummy_bits` (C++ member), 596
- `spi_slave_hd_slot_config_t::flags` (C++ member), 596
- `spi_slave_hd_slot_config_t::mode` (C++ member), 596
- `spi_slave_hd_slot_config_t::queue_size` (C++ member), 596
- `spi_slave_hd_slot_config_t::spics_io_num` (C++ member), 596
- `SPI_SLAVE_HD_TXBIT_LSBFIRST` (C macro), 596
- `spi_slave_hd_write_buffer` (C++ function), 593
- `spi_slave_initialize` (C++ function), 586
- `spi_slave_interface_config_t` (C++ struct), 588
- `spi_slave_interface_config_t::flags` (C++ member), 588
- `spi_slave_interface_config_t::mode` (C++ member), 588
- `spi_slave_interface_config_t::post_setup_cb` (C++ member), 588
- `spi_slave_interface_config_t::post_trans_cb` (C++ member), 588
- `spi_slave_interface_config_t::queue_size` (C++ member), 588
- `spi_slave_interface_config_t::spics_io_num` (C++ member), 588
- `spi_slave_queue_trans` (C++ function), 587
- `SPI_SLAVE_RXBIT_LSBFIRST` (C macro), 589
- `spi_slave_transaction_t` (C++ struct), 588
- `spi_slave_transaction_t` (C++ type), 589
- `spi_slave_transaction_t::length` (C++ member), 588
- `spi_slave_transaction_t::rx_buffer` (C++ member), 589
- `spi_slave_transaction_t::trans_len` (C++ member), 589
- `spi_slave_transaction_t::tx_buffer` (C++ member), 589
- `spi_slave_transaction_t::user` (C++ member), 589
- `spi_slave_transmit` (C++ function), 587
- `SPI_SLAVE_TXBIT_LSBFIRST` (C macro), 589
- `SPI_SWAP_DATA_RX` (C macro), 573
- `SPI_SWAP_DATA_TX` (C macro), 573
- `SPI_TRANS_CS_KEEP_ACTIVE` (C macro), 583
- `SPI_TRANS_MODE_DIO` (C macro), 582
- `SPI_TRANS_MODE_DIOQIO_ADDR` (C macro), 583
- `SPI_TRANS_MODE_OCT` (C macro), 583
- `SPI_TRANS_MODE_QIO` (C macro), 582
- `SPI_TRANS_MULTILINE_ADDR` (C macro), 583
- `SPI_TRANS_MULTILINE_CMD` (C macro), 583
- `SPI_TRANS_USE_RXDATA` (C macro), 582
- `SPI_TRANS_USE_TXDATA` (C macro), 582
- `SPI_TRANS_VARIABLE_ADDR` (C macro), 583
- `SPI_TRANS_VARIABLE_CMD` (C macro), 583
- `SPI_TRANS_VARIABLE_DUMMY` (C macro), 583
- `spi_transaction_ext_t` (C++ struct), 581
- `spi_transaction_ext_t::address_bits` (C++ member), 581
- `spi_transaction_ext_t::base` (C++ member), 581
- `spi_transaction_ext_t::command_bits` (C++ member), 581
- `spi_transaction_ext_t::dummy_bits` (C++ member), 581
- `spi_transaction_t` (C++ struct), 580
- `spi_transaction_t` (C++ type), 583
- `spi_transaction_t::addr` (C++ member), 580



- [spi\\_transaction\\_t::cmd \(C++ member\), 580](#)  
[spi\\_transaction\\_t::flags \(C++ member\), 580](#)  
[spi\\_transaction\\_t::length \(C++ member\), 580](#)  
[spi\\_transaction\\_t::rx\\_buffer \(C++ member\), 580](#)  
[spi\\_transaction\\_t::rx\\_data \(C++ member\), 581](#)  
[spi\\_transaction\\_t::rxlength \(C++ member\), 580](#)  
[spi\\_transaction\\_t::tx\\_buffer \(C++ member\), 580](#)  
[spi\\_transaction\\_t::tx\\_data \(C++ member\), 580](#)  
[spi\\_transaction\\_t::user \(C++ member\), 580](#)  
[SPICOMMON\\_BUSFLAG\\_DUAL \(C macro\), 574](#)  
[SPICOMMON\\_BUSFLAG\\_GPIO\\_PINS \(C macro\), 573](#)  
[SPICOMMON\\_BUSFLAG\\_IO4\\_IO7 \(C macro\), 574](#)  
[SPICOMMON\\_BUSFLAG\\_IOMUX\\_PINS \(C macro\), 573](#)  
[SPICOMMON\\_BUSFLAG\\_MASTER \(C macro\), 573](#)  
[SPICOMMON\\_BUSFLAG\\_MISO \(C macro\), 574](#)  
[SPICOMMON\\_BUSFLAG\\_MOSI \(C macro\), 574](#)  
[SPICOMMON\\_BUSFLAG\\_NATIVE\\_PINS \(C macro\), 574](#)  
[SPICOMMON\\_BUSFLAG\\_OCTAL \(C macro\), 574](#)  
[SPICOMMON\\_BUSFLAG\\_QUAD \(C macro\), 574](#)  
[SPICOMMON\\_BUSFLAG\\_SCLK \(C macro\), 574](#)  
[SPICOMMON\\_BUSFLAG\\_SLAVE \(C macro\), 573](#)  
[SPICOMMON\\_BUSFLAG\\_WPHD \(C macro\), 574](#)  
[StaticRingbuffer\\_t \(C++ type\), 1363](#)  
[StreamBufferHandle\\_t \(C++ type\), 1338](#)  
[SUB\\_OPCODE\\_ALU\\_CNT \(C macro\), 1509](#)  
[SUB\\_OPCODE\\_ALU\\_IMM \(C macro\), 1509](#)  
[SUB\\_OPCODE\\_ALU\\_REG \(C macro\), 1508](#)  
[SUB\\_OPCODE\\_B \(C macro\), 1509](#)  
[SUB\\_OPCODE\\_BS \(C macro\), 1509](#)  
[SUB\\_OPCODE\\_BX \(C macro\), 1509](#)  
[SUB\\_OPCODE\\_END \(C macro\), 1510](#)  
[SUB\\_OPCODE\\_MACRO\\_BRANCH \(C macro\), 1511](#)  
[SUB\\_OPCODE\\_MACRO\\_LABEL \(C macro\), 1511](#)  
[SUB\\_OPCODE\\_MACRO\\_LABELPC \(C macro\), 1511](#)  
[SUB\\_OPCODE\\_SLEEP \(C macro\), 1510](#)  
[SUB\\_OPCODE\\_ST \(C macro\), 1508](#)  
[SUB\\_OPCODE\\_ST\\_AUTO \(C macro\), 1508](#)  
[SUB\\_OPCODE\\_ST\\_OFFSET \(C macro\), 1508](#)
- T**
- [taskDISABLE\\_INTERRUPTS \(C macro\), 1267](#)  
[taskENABLE\\_INTERRUPTS \(C macro\), 1267](#)  
[taskENTER\\_CRITICAL \(C macro\), 1267](#)  
[taskENTER\\_CRITICAL\\_FROM\\_ISR \(C macro\), 1267](#)  
[taskENTER\\_CRITICAL\\_ISR \(C macro\), 1267](#)  
[taskEXIT\\_CRITICAL \(C macro\), 1267](#)  
[taskEXIT\\_CRITICAL\\_FROM\\_ISR \(C macro\), 1267](#)  
[taskEXIT\\_CRITICAL\\_ISR \(C macro\), 1267](#)  
[TaskHandle\\_t \(C++ type\), 1269](#)  
[TaskHookFunction\\_t \(C++ type\), 1269](#)  
[taskSCHEDULER\\_NOT\\_STARTED \(C macro\), 1267](#)  
[taskSCHEDULER\\_RUNNING \(C macro\), 1267](#)  
[taskSCHEDULER\\_SUSPENDED \(C macro\), 1267](#)  
[taskYIELD \(C macro\), 1267](#)  
[TEMPERATURE\\_SENSOR\\_CONFIG\\_DEFAULT \(C macro\), 600](#)  
[temperature\\_sensor\\_config\\_t \(C++ struct\), 600](#)  
[temperature\\_sensor\\_config\\_t::clk\\_src \(C++ member\), 600](#)  
[temperature\\_sensor\\_config\\_t::range\\_max \(C++ member\), 600](#)  
[temperature\\_sensor\\_config\\_t::range\\_min \(C++ member\), 600](#)  
[temperature\\_sensor\\_disable \(C++ function\), 599](#)  
[temperature\\_sensor\\_enable \(C++ function\), 599](#)  
[temperature\\_sensor\\_get\\_celsius \(C++ function\), 599](#)  
[temperature\\_sensor\\_handle\\_t \(C++ type\), 600](#)  
[temperature\\_sensor\\_install \(C++ function\), 599](#)  
[temperature\\_sensor\\_uninstall \(C++ function\), 599](#)  
[TimerCallbackFunction\\_t \(C++ type\), 1321](#)  
[TimerHandle\\_t \(C++ type\), 1321](#)  
[tls\\_keep\\_alive\\_cfg \(C++ struct\), 66](#)  
[tls\\_keep\\_alive\\_cfg::keep\\_alive\\_count \(C++ member\), 66](#)  
[tls\\_keep\\_alive\\_cfg::keep\\_alive\\_enable \(C++ member\), 66](#)  
[tls\\_keep\\_alive\\_cfg::keep\\_alive\\_idle \(C++ member\), 66](#)  
[tls\\_keep\\_alive\\_cfg::keep\\_alive\\_interval \(C++ member\), 66](#)  
[tls\\_keep\\_alive\\_cfg\\_t \(C++ type\), 69](#)  
[TlsDeleteCallbackFunction\\_t \(C++ type\), 1269](#)  
[tmrCOMMAND\\_CHANGE\\_PERIOD \(C macro\), 1311](#)  
[tmrCOMMAND\\_CHANGE\\_PERIOD\\_FROM\\_ISR \(C macro\), 1311](#)  
[tmrCOMMAND\\_DELETE \(C macro\), 1311](#)  
[tmrCOMMAND\\_EXECUTE\\_CALLBACK \(C macro\), 1311](#)  
[tmrCOMMAND\\_EXECUTE\\_CALLBACK\\_FROM\\_ISR \(C macro\), 1311](#)  
[tmrCOMMAND\\_RESET \(C macro\), 1311](#)  
[tmrCOMMAND\\_RESET\\_FROM\\_ISR \(C macro\), 1311](#)  
[tmrCOMMAND\\_START \(C macro\), 1311](#)  
[tmrCOMMAND\\_START\\_DONT\\_TRACE \(C macro\), 1311](#)  
[tmrCOMMAND\\_START\\_FROM\\_ISR \(C macro\), 1311](#)  
[tmrCOMMAND\\_STOP \(C macro\), 1311](#)

- tmrCOMMAND\_STOP\_FROM\_ISR (*C macro*), 1311  
 tmrFIRST\_FROM\_ISR\_COMMAND (*C macro*), 1311  
 touch\_button\_callback\_t (*C++ type*), 647  
 touch\_button\_config\_t (*C++ struct*), 646  
 touch\_button\_config\_t::channel\_num (*C++ member*), 647  
 touch\_button\_config\_t::channel\_sens (*C++ member*), 647  
 touch\_button\_create (*C++ function*), 644  
 touch\_button\_delete (*C++ function*), 645  
 touch\_button\_event\_t (*C++ enum*), 647  
 touch\_button\_event\_t::TOUCH\_BUTTON\_EVT\_MAX (*C++ enumerator*), 647  
 touch\_button\_event\_t::TOUCH\_BUTTON\_EVT\_TOUCH\_INTERRUPT (*C++ enumerator*), 647  
 touch\_button\_event\_t::TOUCH\_BUTTON\_EVT\_TOUCH\_INTERRUPT\_ON\_CALCULATION (*C++ enumerator*), 647  
 touch\_button\_event\_t::TOUCH\_BUTTON\_EVT\_TOUCH\_INTERRUPT\_ON\_LONGPRESS (*C++ enumerator*), 647  
 touch\_button\_event\_t::TOUCH\_BUTTON\_EVT\_TOUCH\_INTERRUPT\_ON\_PRESS (*C++ enumerator*), 647  
 touch\_button\_event\_t::TOUCH\_BUTTON\_EVT\_TOUCH\_INTERRUPT\_ON\_RELEASE (*C++ enumerator*), 647  
 touch\_button\_get\_message (*C++ function*), 646  
 touch\_button\_global\_config\_t (*C++ struct*), 646  
 touch\_button\_global\_config\_t::default\_timeout (*C++ member*), 646  
 touch\_button\_global\_config\_t::threshold (*C++ member*), 646  
 TOUCH\_BUTTON\_GLOBAL\_DEFAULT\_CONFIG (*C macro*), 647  
 touch\_button\_handle\_t (*C++ type*), 647  
 touch\_button\_install (*C++ function*), 644  
 touch\_button\_message\_t (*C++ struct*), 647  
 touch\_button\_message\_t::event (*C++ member*), 647  
 touch\_button\_set\_callback (*C++ function*), 645  
 touch\_button\_set\_dispatch\_method (*C++ function*), 645  
 touch\_button\_set\_longpress (*C++ function*), 646  
 touch\_button\_subscribe\_event (*C++ function*), 645  
 touch\_button\_uninstall (*C++ function*), 644  
 touch\_cnt\_slope\_t (*C++ enum*), 623  
 touch\_cnt\_slope\_t::TOUCH\_PAD\_SLOPE\_0 (*C++ enumerator*), 623  
 touch\_cnt\_slope\_t::TOUCH\_PAD\_SLOPE\_1 (*C++ enumerator*), 623  
 touch\_cnt\_slope\_t::TOUCH\_PAD\_SLOPE\_2 (*C++ enumerator*), 623  
 touch\_cnt\_slope\_t::TOUCH\_PAD\_SLOPE\_3 (*C++ enumerator*), 623  
 touch\_cnt\_slope\_t::TOUCH\_PAD\_SLOPE\_4 (*C++ enumerator*), 623  
 touch\_cnt\_slope\_t::TOUCH\_PAD\_SLOPE\_5 (*C++ enumerator*), 623  
 touch\_cnt\_slope\_t::TOUCH\_PAD\_SLOPE\_6 (*C++ enumerator*), 623  
 touch\_cnt\_slope\_t::TOUCH\_PAD\_SLOPE\_7 (*C++ enumerator*), 624  
 touch\_cnt\_slope\_t::TOUCH\_PAD\_SLOPE\_MAX (*C++ enumerator*), 624  
 TOUCH\_DEBOUNCE\_CNT\_MAX (*C macro*), 620  
 touch\_elem\_dispatch\_t (*C++ enum*), 644  
 touch\_elem\_dispatch\_t::TOUCH\_ELEM\_DISP\_CALLBACK (*C++ enumerator*), 644  
 touch\_elem\_dispatch\_t::TOUCH\_ELEM\_DISP\_EVENT (*C++ enumerator*), 644  
 touch\_elem\_dispatch\_t::TOUCH\_ELEM\_DISP\_MAX (*C++ enumerator*), 644  
 TOUCH\_ELEM\_EVENT\_NONE (*C macro*), 643  
 TOUCH\_ELEM\_EVENT\_ON\_CALCULATION (*C macro*), 643  
 TOUCH\_ELEM\_EVENT\_ON\_LONGPRESS (*C macro*), 643  
 TOUCH\_ELEM\_EVENT\_ON\_PRESS (*C macro*), 643  
 TOUCH\_ELEM\_EVENT\_ON\_RELEASE (*C macro*), 643  
 touch\_elem\_event\_t (*C++ type*), 643  
 touch\_elem\_global\_config\_t (*C++ struct*), 642  
 touch\_elem\_global\_config\_t::hardware\_timeout (*C++ member*), 642  
 touch\_elem\_global\_config\_t::software\_timeout (*C++ member*), 642  
 TOUCH\_ELEM\_GLOBAL\_DEFAULT\_CONFIG (*C macro*), 643  
 touch\_elem\_handle\_t (*C++ type*), 643  
 touch\_elem\_hw\_config\_t (*C++ struct*), 641  
 touch\_elem\_hw\_config\_t::benchmark\_calibration\_threshold (*C++ member*), 642  
 touch\_elem\_hw\_config\_t::benchmark\_debounce\_count (*C++ member*), 642  
 touch\_elem\_hw\_config\_t::benchmark\_filter\_mode (*C++ member*), 642  
 touch\_elem\_hw\_config\_t::benchmark\_jitter\_step (*C++ member*), 642  
 touch\_elem\_hw\_config\_t::denoise\_equivalent\_cap (*C++ member*), 641  
 touch\_elem\_hw\_config\_t::denoise\_level (*C++ member*), 641  
 touch\_elem\_hw\_config\_t::lower\_voltage (*C++ member*), 641  
 touch\_elem\_hw\_config\_t::sample\_count (*C++ member*), 642  
 touch\_elem\_hw\_config\_t::sleep\_cycle (*C++ member*), 642  
 touch\_elem\_hw\_config\_t::smooth\_filter\_mode (*C++ member*), 641  
 touch\_elem\_hw\_config\_t::suspend\_channel\_polarity (*C++ member*), 641  
 touch\_elem\_hw\_config\_t::upper\_voltage (*C++ member*), 641  
 touch\_elem\_hw\_config\_t::voltage\_attenuation (*C++ member*), 641  
 touch\_elem\_message\_t (*C++ struct*), 642

- touch\_elem\_message\_t::arg (C++ member), 643  
 touch\_elem\_message\_t::child\_msg (C++ member), 643  
 touch\_elem\_message\_t::element\_type (C++ member), 643  
 touch\_elem\_message\_t::handle (C++ member), 643  
 touch\_elem\_sw\_config\_t (C++ struct), 641  
 touch\_elem\_sw\_config\_t::event\_message\_size (C++ member), 641  
 touch\_elem\_sw\_config\_t::intr\_message\_size (C++ member), 641  
 touch\_elem\_sw\_config\_t::processing\_period (C++ member), 641  
 touch\_elem\_sw\_config\_t::waterproof\_threshold (C++ member), 641  
 touch\_elem\_type\_t (C++ enum), 643  
 touch\_elem\_type\_t::TOUCH\_ELEM\_TYPE\_BUTTON (C++ enumerator), 643  
 touch\_elem\_type\_t::TOUCH\_ELEM\_TYPE\_MATRIX (C++ enumerator), 644  
 touch\_elem\_type\_t::TOUCH\_ELEM\_TYPE\_SLIDER (C++ enumerator), 644  
 touch\_elem\_waterproof\_config\_t (C++ struct), 642  
 touch\_elem\_waterproof\_config\_t::guard\_channel (C++ member), 642  
 touch\_elem\_waterproof\_config\_t::guard\_sensitivity (C++ member), 642  
 touch\_element\_install (C++ function), 639  
 touch\_element\_message\_receive (C++ function), 639  
 touch\_element\_start (C++ function), 639  
 touch\_element\_stop (C++ function), 639  
 touch\_element\_uninstall (C++ function), 639  
 touch\_element\_waterproof\_add (C++ function), 640  
 touch\_element\_waterproof\_install (C++ function), 640  
 touch\_element\_waterproof\_remove (C++ function), 640  
 touch\_element\_waterproof\_uninstall (C++ function), 640  
 touch\_filter\_config (C++ struct), 619  
 touch\_filter\_config::debounce\_cnt (C++ member), 619  
 touch\_filter\_config::jitter\_step (C++ member), 619  
 touch\_filter\_config::mode (C++ member), 619  
 touch\_filter\_config::noise\_thr (C++ member), 619  
 touch\_filter\_config::smh\_lvl (C++ member), 619  
 touch\_filter\_config\_t (C++ type), 621  
 touch\_filter\_mode\_t (C++ enum), 627  
 touch\_filter\_mode\_t::TOUCH\_PAD\_FILTER\_IIR\_16 (C++ enumerator), 627  
 touch\_filter\_mode\_t::TOUCH\_PAD\_FILTER\_IIR\_256 (C++ enumerator), 627  
 touch\_filter\_mode\_t::TOUCH\_PAD\_FILTER\_IIR\_32 (C++ enumerator), 627  
 touch\_filter\_mode\_t::TOUCH\_PAD\_FILTER\_IIR\_4 (C++ enumerator), 627  
 touch\_filter\_mode\_t::TOUCH\_PAD\_FILTER\_IIR\_64 (C++ enumerator), 627  
 touch\_filter\_mode\_t::TOUCH\_PAD\_FILTER\_IIR\_8 (C++ enumerator), 627  
 touch\_filter\_mode\_t::TOUCH\_PAD\_FILTER\_JITTER (C++ enumerator), 627  
 touch\_filter\_mode\_t::TOUCH\_PAD\_FILTER\_MAX (C++ enumerator), 627  
 touch\_fsm\_mode\_t (C++ enum), 624  
 touch\_fsm\_mode\_t::TOUCH\_FSM\_MODE\_MAX (C++ enumerator), 624  
 touch\_fsm\_mode\_t::TOUCH\_FSM\_MODE\_SW (C++ enumerator), 624  
 touch\_fsm\_mode\_t::TOUCH\_FSM\_MODE\_TIMER (C++ enumerator), 624  
 touch\_high\_volt\_t (C++ enum), 622  
 touch\_high\_volt\_t::TOUCH\_HVOLT\_2V4 (C++ enumerator), 622  
 touch\_high\_volt\_t::TOUCH\_HVOLT\_2V5 (C++ enumerator), 622  
 touch\_high\_volt\_t::TOUCH\_HVOLT\_2V6 (C++ enumerator), 622  
 touch\_high\_volt\_t::TOUCH\_HVOLT\_2V7 (C++ enumerator), 622  
 touch\_high\_volt\_t::TOUCH\_HVOLT\_KEEP (C++ enumerator), 622  
 touch\_high\_volt\_t::TOUCH\_HVOLT\_MAX (C++ enumerator), 622  
 TOUCH\_JITTER\_STEP\_MAX (C macro), 620  
 touch\_low\_volt\_t (C++ enum), 622  
 touch\_low\_volt\_t::TOUCH\_LVOLT\_0V5 (C++ enumerator), 622  
 touch\_low\_volt\_t::TOUCH\_LVOLT\_0V6 (C++ enumerator), 622  
 touch\_low\_volt\_t::TOUCH\_LVOLT\_0V7 (C++ enumerator), 622  
 touch\_low\_volt\_t::TOUCH\_LVOLT\_0V8 (C++ enumerator), 622  
 touch\_low\_volt\_t::TOUCH\_LVOLT\_KEEP (C++ enumerator), 622  
 touch\_low\_volt\_t::TOUCH\_LVOLT\_MAX (C++ enumerator), 623  
 touch\_matrix\_callback\_t (C++ type), 655  
 touch\_matrix\_config\_t (C++ struct), 654  
 touch\_matrix\_config\_t::x\_channel\_array (C++ member), 654  
 touch\_matrix\_config\_t::x\_channel\_num (C++ member), 654  
 touch\_matrix\_config\_t::x\_sensitivity\_array (C++ member), 654





- [touch\\_pad\\_filter\\_enable \(C++ function\), 609](#)  
[touch\\_pad\\_filter\\_get\\_config \(C++ function\), 609](#)  
[touch\\_pad\\_filter\\_read\\_smooth \(C++ function\), 609](#)  
[touch\\_pad\\_filter\\_set\\_config \(C++ function\), 609](#)  
[touch\\_pad\\_fsm\\_start \(C++ function\), 603](#)  
[touch\\_pad\\_fsm\\_stop \(C++ function\), 603](#)  
[touch\\_pad\\_get\\_channel\\_mask \(C++ function\), 606](#)  
[touch\\_pad\\_get\\_charge\\_discharge\\_times \(C++ function\), 604](#)  
[touch\\_pad\\_get\\_cnt\\_mode \(C++ function\), 615](#)  
[touch\\_pad\\_get\\_current\\_meas\\_channel \(C++ function\), 607](#)  
[touch\\_pad\\_get\\_fsm\\_mode \(C++ function\), 616](#)  
[touch\\_pad\\_get\\_idle\\_channel\\_connect \(C++ function\), 605](#)  
[touch\\_pad\\_get\\_meas\\_time \(C++ function\), 605](#)  
[touch\\_pad\\_get\\_measurement\\_interval \(C++ function\), 604](#)  
[touch\\_pad\\_get\\_status \(C++ function\), 616](#)  
[touch\\_pad\\_get\\_thresh \(C++ function\), 606](#)  
[touch\\_pad\\_get\\_voltage \(C++ function\), 615](#)  
[touch\\_pad\\_get\\_wakeup\\_status \(C++ function\), 616](#)  
[TOUCH\\_PAD\\_GPIO10\\_CHANNEL \(C macro\), 617](#)  
[TOUCH\\_PAD\\_GPIO11\\_CHANNEL \(C macro\), 618](#)  
[TOUCH\\_PAD\\_GPIO12\\_CHANNEL \(C macro\), 618](#)  
[TOUCH\\_PAD\\_GPIO13\\_CHANNEL \(C macro\), 618](#)  
[TOUCH\\_PAD\\_GPIO14\\_CHANNEL \(C macro\), 618](#)  
[TOUCH\\_PAD\\_GPIO1\\_CHANNEL \(C macro\), 617](#)  
[TOUCH\\_PAD\\_GPIO2\\_CHANNEL \(C macro\), 617](#)  
[TOUCH\\_PAD\\_GPIO3\\_CHANNEL \(C macro\), 617](#)  
[TOUCH\\_PAD\\_GPIO4\\_CHANNEL \(C macro\), 617](#)  
[TOUCH\\_PAD\\_GPIO5\\_CHANNEL \(C macro\), 617](#)  
[TOUCH\\_PAD\\_GPIO6\\_CHANNEL \(C macro\), 617](#)  
[TOUCH\\_PAD\\_GPIO7\\_CHANNEL \(C macro\), 617](#)  
[TOUCH\\_PAD\\_GPIO8\\_CHANNEL \(C macro\), 617](#)  
[TOUCH\\_PAD\\_GPIO9\\_CHANNEL \(C macro\), 617](#)  
[TOUCH\\_PAD\\_HIGH\\_VOLTAGE\\_THRESHOLD \(C macro\), 620](#)  
[TOUCH\\_PAD\\_IDLE\\_CH\\_CONNECT\\_DEFAULT \(C macro\), 620](#)  
[touch\\_pad\\_init \(C++ function\), 614](#)  
[touch\\_pad\\_intr\\_clear \(C++ function\), 607](#)  
[touch\\_pad\\_intr\\_disable \(C++ function\), 607](#)  
[touch\\_pad\\_intr\\_enable \(C++ function\), 607](#)  
[TOUCH\\_PAD\\_INTR\\_MASK\\_ALL \(C macro\), 620](#)  
[touch\\_pad\\_intr\\_mask\\_t \(C++ enum\), 625](#)  
[touch\\_pad\\_intr\\_mask\\_t::TOUCH\\_PAD\\_INTR\\_MASK\\_ACTIVE \(C++ enumerator\), 625](#)  
[touch\\_pad\\_intr\\_mask\\_t::TOUCH\\_PAD\\_INTR\\_MASK\\_DONE \(C++ enumerator\), 625](#)  
[touch\\_pad\\_intr\\_mask\\_t::TOUCH\\_PAD\\_INTR\\_MASK\\_HPACTIVE \(C++ enumerator\), 625](#)  
[touch\\_pad\\_intr\\_mask\\_t::TOUCH\\_PAD\\_INTR\\_MASK\\_SCAN\\_DONE \(C++ enumerator\), 625](#)  
[touch\\_pad\\_intr\\_mask\\_t::TOUCH\\_PAD\\_INTR\\_MASK\\_TIMEOUT \(C++ enumerator\), 625](#)  
[touch\\_pad\\_io\\_init \(C++ function\), 615](#)  
[touch\\_pad\\_isr\\_deregister \(C++ function\), 616](#)  
[touch\\_pad\\_isr\\_register \(C++ function\), 607](#)  
[TOUCH\\_PAD\\_LOW\\_VOLTAGE\\_THRESHOLD \(C macro\), 620](#)  
[touch\\_pad\\_meas\\_is\\_done \(C++ function\), 616](#)  
[TOUCH\\_PAD\\_MEASURE\\_CYCLE\\_DEFAULT \(C macro\), 620](#)  
[TOUCH\\_PAD\\_NUM10\\_GPIO\\_NUM \(C macro\), 618](#)  
[TOUCH\\_PAD\\_NUM11\\_GPIO\\_NUM \(C macro\), 618](#)  
[TOUCH\\_PAD\\_NUM12\\_GPIO\\_NUM \(C macro\), 618](#)  
[TOUCH\\_PAD\\_NUM13\\_GPIO\\_NUM \(C macro\), 618](#)  
[TOUCH\\_PAD\\_NUM14\\_GPIO\\_NUM \(C macro\), 618](#)  
[TOUCH\\_PAD\\_NUM1\\_GPIO\\_NUM \(C macro\), 617](#)  
[TOUCH\\_PAD\\_NUM2\\_GPIO\\_NUM \(C macro\), 617](#)  
[TOUCH\\_PAD\\_NUM3\\_GPIO\\_NUM \(C macro\), 617](#)  
[TOUCH\\_PAD\\_NUM4\\_GPIO\\_NUM \(C macro\), 617](#)  
[TOUCH\\_PAD\\_NUM5\\_GPIO\\_NUM \(C macro\), 617](#)  
[TOUCH\\_PAD\\_NUM6\\_GPIO\\_NUM \(C macro\), 617](#)  
[TOUCH\\_PAD\\_NUM7\\_GPIO\\_NUM \(C macro\), 617](#)  
[TOUCH\\_PAD\\_NUM8\\_GPIO\\_NUM \(C macro\), 617](#)  
[TOUCH\\_PAD\\_NUM9\\_GPIO\\_NUM \(C macro\), 617](#)  
[touch\\_pad\\_proximity\\_enable \(C++ function\), 611](#)  
[touch\\_pad\\_proximity\\_get\\_count \(C++ function\), 611](#)  
[touch\\_pad\\_proximity\\_get\\_data \(C++ function\), 611](#)  
[touch\\_pad\\_proximity\\_set\\_count \(C++ function\), 611](#)  
[touch\\_pad\\_read\\_benchmark \(C++ function\), 608](#)  
[touch\\_pad\\_read\\_intr\\_status\\_mask \(C++ function\), 607](#)  
[touch\\_pad\\_read\\_raw\\_data \(C++ function\), 608](#)  
[touch\\_pad\\_reset \(C++ function\), 607](#)  
[touch\\_pad\\_reset\\_benchmark \(C++ function\), 609](#)  
[touch\\_pad\\_set\\_channel\\_mask \(C++ function\), 606](#)  
[touch\\_pad\\_set\\_charge\\_discharge\\_times \(C++ function\), 604](#)  
[touch\\_pad\\_set\\_cnt\\_mode \(C++ function\), 615](#)  
[touch\\_pad\\_set\\_fsm\\_mode \(C++ function\), 616](#)  
[touch\\_pad\\_set\\_idle\\_channel\\_connect \(C++ function\), 605](#)  
[touch\\_pad\\_set\\_meas\\_time \(C++ function\), 604](#)  
[touch\\_pad\\_set\\_measurement\\_interval \(C++ function\), 604](#)  
[touch\\_pad\\_set\\_thresh \(C++ function\), 605](#)  
[touch\\_pad\\_set\\_voltage \(C++ function\), 615](#)  
[touch\\_pad\\_shield\\_driver\\_t \(C++ enum\), 626](#)  
[touch\\_pad\\_shield\\_driver\\_t::TOUCH\\_PAD\\_SHIELD\\_DRV\\_L \(C++ enumerator\), 626](#)

---

touch\_pad\_shield\_driver\_t::TOUCH\_PAD\_SHIELD\_PAD\_H1: TOUCH\_PAD\_NUM12 (C++ enumerator), 626  
 touch\_pad\_shield\_driver\_t::TOUCH\_PAD\_SHIELD\_PAD\_H2: TOUCH\_PAD\_NUM13 (C++ enumerator), 626  
 touch\_pad\_shield\_driver\_t::TOUCH\_PAD\_SHIELD\_PAD\_H3: TOUCH\_PAD\_NUM14 (C++ enumerator), 626  
 touch\_pad\_shield\_driver\_t::TOUCH\_PAD\_SHIELD\_PAD\_H4: TOUCH\_PAD\_NUM2 (C++ enumerator), 621  
 touch\_pad\_shield\_driver\_t::TOUCH\_PAD\_SHIELD\_PAD\_H5: TOUCH\_PAD\_NUM3 (C++ enumerator), 621  
 touch\_pad\_shield\_driver\_t::TOUCH\_PAD\_SHIELD\_PAD\_H6: TOUCH\_PAD\_NUM4 (C++ enumerator), 621  
 touch\_pad\_shield\_driver\_t::TOUCH\_PAD\_SHIELD\_PAD\_H7: TOUCH\_PAD\_NUM5 (C++ enumerator), 621  
 touch\_pad\_shield\_driver\_t::TOUCH\_PAD\_SHIELD\_PAD\_MAX: TOUCH\_PAD\_NUM6 (C++ enumerator), 621  
 touch\_pad\_sleep\_channel\_enable (C++ touch\_pad\_t::TOUCH\_PAD\_NUM7 (C++ enumerator), 612  
 touch\_pad\_sleep\_channel\_enable\_proximity (C++ function), 612  
 touch\_pad\_sleep\_channel\_get\_info (C++ touch\_pad\_t::TOUCH\_PAD\_NUM9 (C++ enumerator), 612  
 touch\_pad\_sleep\_channel\_read\_benchmark TOUCH\_PAD\_THRESHOLD\_MAX (C macro), 620  
 touch\_pad\_sleep\_channel\_read\_data TOUCH\_PAD\_TIE\_OPT\_DEFAULT (C macro), 620  
 touch\_pad\_sleep\_channel\_read\_proximity touch\_pad\_timeout\_resume (C++ function), 608  
 touch\_pad\_sleep\_channel\_read\_smooth touch\_pad\_timeout\_set (C++ function), 608  
 touch\_pad\_sleep\_channel\_reset\_benchmark touch\_pad\_waterproof (C++ struct), 618  
 touch\_pad\_sleep\_channel\_set\_work\_time touch\_pad\_waterproof::guard\_ring\_pad (C++ member), 618  
 touch\_pad\_sleep\_channel\_t (C++ struct), 619 touch\_pad\_waterproof::shield\_driver (C++ member), 619  
 touch\_pad\_sleep\_channel\_t::en\_proximity touch\_pad\_waterproof\_disable (C++ function), 611  
 touch\_pad\_sleep\_channel\_t::touch\_num touch\_pad\_waterproof\_enable (C++ function), 610  
 TOUCH\_PAD\_SLEEP\_CYCLE\_DEFAULT (C macro), 620 touch\_pad\_waterproof\_get\_config (C++ function), 610  
 touch\_pad\_sleep\_get\_threshold (C++ function), 613 touch\_pad\_waterproof\_set\_config (C++ function), 610  
 touch\_pad\_sleep\_set\_threshold (C++ function), 612 touch\_pad\_waterproof\_t (C++ type), 620  
 TOUCH\_PAD\_SLOPE\_DEFAULT (C macro), 620 TOUCH\_PROXIMITY\_MEAS\_NUM\_MAX (C macro), 620  
 touch\_pad\_sw\_start (C++ function), 603 touch\_slider\_callback\_t (C++ type), 651  
 touch\_pad\_t (C++ enum), 621 touch\_slider\_config\_t (C++ struct), 650  
 touch\_pad\_t::TOUCH\_PAD\_MAX (C++ enumerator), 622 touch\_slider\_config\_t::channel\_array (C++ member), 650  
 touch\_pad\_t::TOUCH\_PAD\_NUM0 (C++ enumerator), 621 touch\_slider\_config\_t::channel\_num (C++ member), 650  
 touch\_pad\_t::TOUCH\_PAD\_NUM1 (C++ enumerator), 621 touch\_slider\_config\_t::position\_range (C++ member), 650  
 touch\_pad\_t::TOUCH\_PAD\_NUM10 (C++ enumerator), 621 touch\_slider\_config\_t::sensitivity\_array (C++ member), 650  
 touch\_pad\_t::TOUCH\_PAD\_NUM11 (C++ enumerator), 621 touch\_slider\_create (C++ function), 648  
 touch\_pad\_t::TOUCH\_PAD\_NUM12 (C++ enumerator), 621 touch\_slider\_delete (C++ function), 648  
 touch\_pad\_t::TOUCH\_PAD\_NUM13 (C++ enumerator), 621 touch\_slider\_event\_t (C++ enum), 651  
 touch\_pad\_t::TOUCH\_PAD\_NUM14 (C++ enumerator), 621 touch\_slider\_event\_t::TOUCH\_SLIDER\_EVT\_MAX (C++ enumerator), 651

- touch\_slider\_event\_t::TOUCH\_SLIDER\_EVT\_ON\_CALIBRATION (C++ enumerator), 651
- touch\_slider\_event\_t::TOUCH\_SLIDER\_EVT\_ON\_PRESS (C++ enumerator), 651
- touch\_slider\_event\_t::TOUCH\_SLIDER\_EVT\_ON\_RELEASE (C++ enumerator), 651
- touch\_slider\_get\_message (C++ function), 649
- touch\_slider\_global\_config\_t (C++ struct), 649
- touch\_slider\_global\_config\_t::benchmark\_update (C++ member), 650
- touch\_slider\_global\_config\_t::calculate\_channel (C++ member), 650
- touch\_slider\_global\_config\_t::filter\_reset\_time (C++ member), 650
- touch\_slider\_global\_config\_t::position\_filter\_width (C++ member), 650
- touch\_slider\_global\_config\_t::position\_filter\_width\_atten (C++ member), 650
- touch\_slider\_global\_config\_t::quantify\_lower\_threshold (C++ member), 649
- touch\_slider\_global\_config\_t::threshold\_divider (C++ member), 650
- TOUCH\_SLIDER\_GLOBAL\_DEFAULT\_CONFIG (C macro), 651
- touch\_slider\_handle\_t (C++ type), 651
- touch\_slider\_install (C++ function), 648
- touch\_slider\_message\_t (C++ struct), 650
- touch\_slider\_message\_t::event (C++ member), 650
- touch\_slider\_message\_t::position (C++ member), 650
- touch\_slider\_position\_t (C++ type), 651
- touch\_slider\_set\_callback (C++ function), 649
- touch\_slider\_set\_dispatch\_method (C++ function), 649
- touch\_slider\_subscribe\_event (C++ function), 648
- touch\_slider\_uninstall (C++ function), 648
- touch\_smooth\_mode\_t (C++ enum), 627
- touch\_smooth\_mode\_t::TOUCH\_PAD\_SMOOTH\_IIR\_2 (C++ enumerator), 628
- touch\_smooth\_mode\_t::TOUCH\_PAD\_SMOOTH\_IIR\_4 (C++ enumerator), 628
- touch\_smooth\_mode\_t::TOUCH\_PAD\_SMOOTH\_IIR\_8 (C++ enumerator), 628
- touch\_smooth\_mode\_t::TOUCH\_PAD\_SMOOTH\_MAX (C++ enumerator), 628
- touch\_smooth\_mode\_t::TOUCH\_PAD\_SMOOTH\_OFF (C++ enumerator), 628
- touch\_tie\_opt\_t (C++ enum), 624
- touch\_tie\_opt\_t::TOUCH\_PAD\_TIE\_OPT\_HIGH (C++ enumerator), 624
- touch\_tie\_opt\_t::TOUCH\_PAD\_TIE\_OPT\_LOW (C++ enumerator), 624
- touch\_tie\_opt\_t::TOUCH\_PAD\_TIE\_OPT\_MAX (C++ enumerator), 624
- touch\_trigger\_mode\_t (C++ enum), 624
- touch\_trigger\_mode\_t::TOUCH\_TRIGGER\_ABOVE (C++ enumerator), 624
- touch\_trigger\_mode\_t::TOUCH\_TRIGGER\_BELOW (C++ enumerator), 624
- touch\_trigger\_mode\_t::TOUCH\_TRIGGER\_MAX (C++ enumerator), 624
- touch\_trigger\_src\_t (C++ enum), 624
- touch\_trigger\_src\_t::TOUCH\_TRIGGER\_SOURCE\_BOTH (C++ enumerator), 624
- touch\_trigger\_src\_t::TOUCH\_TRIGGER\_SOURCE\_MAX (C++ enumerator), 625
- touch\_trigger\_src\_t::TOUCH\_TRIGGER\_SOURCE\_SET1 (C++ enumerator), 624
- touch\_volt\_atten\_t (C++ enum), 623
- touch\_volt\_atten\_t::TOUCH\_HVOLT\_ATTEN\_0V (C++ enumerator), 623
- touch\_volt\_atten\_t::TOUCH\_HVOLT\_ATTEN\_0V5 (C++ enumerator), 623
- touch\_volt\_atten\_t::TOUCH\_HVOLT\_ATTEN\_1V (C++ enumerator), 623
- touch\_volt\_atten\_t::TOUCH\_HVOLT\_ATTEN\_1V5 (C++ enumerator), 623
- touch\_volt\_atten\_t::TOUCH\_HVOLT\_ATTEN\_KEEP (C++ enumerator), 623
- touch\_volt\_atten\_t::TOUCH\_HVOLT\_ATTEN\_MAX (C++ enumerator), 623
- TOUCH\_WATERPROOF\_GUARD\_NOUSE (C macro), 643
- transaction\_cb\_t (C++ type), 583
- tskDEFAULT\_INDEX\_TO\_NOTIFY (C macro), 1267
- tskIDLE\_PRIORITY (C macro), 1267
- tskKERNEL\_VERSION\_BUILD (C macro), 1266
- tskKERNEL\_VERSION\_MAJOR (C macro), 1266
- tskKERNEL\_VERSION\_MINOR (C macro), 1266
- tskKERNEL\_VERSION\_NUMBER (C macro), 1266
- tskMPU\_REGION\_DEVICE\_MEMORY (C macro), 1267
- tskMPU\_REGION\_EXECUTE\_NEVER (C macro), 1266
- tskMPU\_REGION\_NORMAL\_MEMORY (C macro), 1267
- tskMPU\_REGION\_READ\_ONLY (C macro), 1266
- tskMPU\_REGION\_READ\_WRITE (C macro), 1266
- tskNO\_AFFINITY (C macro), 1267
- twai\_clear\_receive\_queue (C++ function), 670
- twai\_clear\_transmit\_queue (C++ function), 670
- twai\_driver\_install (C++ function), 667
- twai\_driver\_uninstall (C++ function), 667
- TWAI\_ERR\_PASS\_THRESH (C macro), 667
- twai\_filter\_config\_t (C++ struct), 666
- twai\_filter\_config\_t::acceptance\_code (C++ member), 666
- twai\_filter\_config\_t::acceptance\_mask (C++ member), 666

- (C++ member), 666
- twai\_filter\_config\_t::single\_filter (C++ member), 666
- TWAI\_FRAME\_EXTD\_ID\_LEN\_BYTES (C macro), 666
- TWAI\_FRAME\_MAX\_DLC (C macro), 666
- TWAI\_FRAME\_STD\_ID\_LEN\_BYTES (C macro), 666
- twai\_general\_config\_t (C++ struct), 670
- twai\_general\_config\_t::alerts\_enabled (C++ member), 671
- twai\_general\_config\_t::bus\_off\_io (C++ member), 671
- twai\_general\_config\_t::clkout\_divider (C++ member), 671
- twai\_general\_config\_t::clkout\_io (C++ member), 671
- twai\_general\_config\_t::intr\_flags (C++ member), 671
- twai\_general\_config\_t::mode (C++ member), 671
- twai\_general\_config\_t::rx\_io (C++ member), 671
- twai\_general\_config\_t::rx\_queue\_len (C++ member), 671
- twai\_general\_config\_t::tx\_io (C++ member), 671
- twai\_general\_config\_t::tx\_queue\_len (C++ member), 671
- twai\_get\_status\_info (C++ function), 670
- twai\_initiate\_recovery (C++ function), 670
- TWAI\_IO\_UNUSED (C macro), 672
- twai\_message\_t (C++ struct), 665
- twai\_message\_t::data (C++ member), 665
- twai\_message\_t::data\_length\_code (C++ member), 665
- twai\_message\_t::dlc\_non\_comp (C++ member), 665
- twai\_message\_t::extd (C++ member), 665
- twai\_message\_t::flags (C++ member), 665
- twai\_message\_t::identifier (C++ member), 665
- twai\_message\_t::reserved (C++ member), 665
- twai\_message\_t::rtr (C++ member), 665
- twai\_message\_t::self (C++ member), 665
- twai\_message\_t::ss (C++ member), 665
- twai\_mode\_t (C++ enum), 667
- twai\_mode\_t::TWAI\_MODE\_LISTEN\_ONLY (C++ enumerator), 667
- twai\_mode\_t::TWAI\_MODE\_NO\_ACK (C++ enumerator), 667
- twai\_mode\_t::TWAI\_MODE\_NORMAL (C++ enumerator), 667
- twai\_read\_alerts (C++ function), 669
- twai\_receive (C++ function), 669
- twai\_reconfigure\_alerts (C++ function), 669
- twai\_start (C++ function), 668
- twai\_state\_t (C++ enum), 672
- twai\_state\_t::TWAI\_STATE\_BUS\_OFF (C++ enumerator), 672
- twai\_state\_t::TWAI\_STATE\_RECOVERING (C++ enumerator), 672
- twai\_state\_t::TWAI\_STATE\_RUNNING (C++ enumerator), 672
- twai\_state\_t::TWAI\_STATE\_STOPPED (C++ enumerator), 672
- twai\_status\_info\_t (C++ struct), 671
- twai\_status\_info\_t::arb\_lost\_count (C++ member), 672
- twai\_status\_info\_t::bus\_error\_count (C++ member), 672
- twai\_status\_info\_t::msgs\_to\_rx (C++ member), 671
- twai\_status\_info\_t::msgs\_to\_tx (C++ member), 671
- twai\_status\_info\_t::rx\_error\_counter (C++ member), 672
- twai\_status\_info\_t::rx\_missed\_count (C++ member), 672
- twai\_status\_info\_t::rx\_overrun\_count (C++ member), 672
- twai\_status\_info\_t::state (C++ member), 671
- twai\_status\_info\_t::tx\_error\_counter (C++ member), 672
- twai\_status\_info\_t::tx\_failed\_count (C++ member), 672
- TWAI\_STD\_ID\_MASK (C macro), 666
- twai\_stop (C++ function), 668
- twai\_timing\_config\_t (C++ struct), 665
- twai\_timing\_config\_t::brp (C++ member), 666
- twai\_timing\_config\_t::sjw (C++ member), 666
- twai\_timing\_config\_t::triple\_sampling (C++ member), 666
- twai\_timing\_config\_t::tseg\_1 (C++ member), 666
- twai\_timing\_config\_t::tseg\_2 (C++ member), 666
- twai\_transmit (C++ function), 668
- ## U
- uart\_at\_cmd\_t (C++ struct), 692
- uart\_at\_cmd\_t::char\_num (C++ member), 692
- uart\_at\_cmd\_t::cmd\_char (C++ member), 692
- uart\_at\_cmd\_t::gap\_tout (C++ member), 692
- uart\_at\_cmd\_t::post\_idle (C++ member), 692
- uart\_at\_cmd\_t::pre\_idle (C++ member), 692
- UART\_BITRATE\_MAX (C macro), 691
- uart\_clear\_intr\_status (C++ function), 681
- uart\_config\_t (C++ struct), 693
- uart\_config\_t::baud\_rate (C++ member), 693



- uart\_config\_t::data\_bits (C++ member), 693
- uart\_config\_t::flow\_ctrl (C++ member), 693
- uart\_config\_t::parity (C++ member), 693
- uart\_config\_t::rx\_flow\_ctrl\_thresh (C++ member), 693
- uart\_config\_t::source\_clk (C++ member), 693
- uart\_config\_t::stop\_bits (C++ member), 693
- UART\_CTS\_GPIO16\_DIRECT\_CHANNEL (C macro), 697
- UART\_CTS\_GPIO20\_DIRECT\_CHANNEL (C macro), 697
- uart\_disable\_intr\_mask (C++ function), 682
- uart\_disable\_pattern\_det\_intr (C++ function), 686
- uart\_disable\_rx\_intr (C++ function), 682
- uart\_disable\_tx\_intr (C++ function), 682
- uart\_driver\_delete (C++ function), 679
- uart\_driver\_install (C++ function), 679
- uart\_enable\_intr\_mask (C++ function), 682
- uart\_enable\_pattern\_det\_baud\_intr (C++ function), 686
- uart\_enable\_rx\_intr (C++ function), 682
- uart\_enable\_tx\_intr (C++ function), 682
- uart\_event\_t (C++ struct), 690
- uart\_event\_t::size (C++ member), 690
- uart\_event\_t::timeout\_flag (C++ member), 690
- uart\_event\_t::type (C++ member), 690
- uart\_event\_type\_t (C++ enum), 691
- uart\_event\_type\_t::UART\_BREAK (C++ enumerator), 691
- uart\_event\_type\_t::UART\_BUFFER\_FULL (C++ enumerator), 691
- uart\_event\_type\_t::UART\_DATA (C++ enumerator), 691
- uart\_event\_type\_t::UART\_DATA\_BREAK (C++ enumerator), 691
- uart\_event\_type\_t::UART\_EVENT\_MAX (C++ enumerator), 692
- uart\_event\_type\_t::UART\_FIFO\_OVF (C++ enumerator), 691
- uart\_event\_type\_t::UART\_FRAME\_ERR (C++ enumerator), 691
- uart\_event\_type\_t::UART\_PARITY\_ERR (C++ enumerator), 691
- uart\_event\_type\_t::UART\_PATTERN\_DET (C++ enumerator), 691
- uart\_event\_type\_t::UART\_WAKEUP (C++ enumerator), 692
- UART\_FIFO\_LEN (C macro), 691
- uart\_flush (C++ function), 685
- uart\_flush\_input (C++ function), 685
- uart\_get\_baudrate (C++ function), 681
- uart\_get\_buffered\_data\_len (C++ function), 685
- uart\_get\_collision\_flag (C++ function), 688
- uart\_get\_hw\_flow\_ctrl (C++ function), 681
- uart\_get\_parity (C++ function), 680
- uart\_get\_sclk\_freq (C++ function), 680
- uart\_get\_stop\_bits (C++ function), 680
- uart\_get\_tx\_buffer\_free\_size (C++ function), 686
- uart\_get\_wakeup\_threshold (C++ function), 689
- uart\_get\_word\_length (C++ function), 679
- UART\_GPIO15\_DIRECT\_CHANNEL (C macro), 696
- UART\_GPIO16\_DIRECT\_CHANNEL (C macro), 696
- UART\_GPIO17\_DIRECT\_CHANNEL (C macro), 697
- UART\_GPIO18\_DIRECT\_CHANNEL (C macro), 697
- UART\_GPIO19\_DIRECT\_CHANNEL (C macro), 697
- UART\_GPIO20\_DIRECT\_CHANNEL (C macro), 697
- UART\_GPIO43\_DIRECT\_CHANNEL (C macro), 696
- UART\_GPIO44\_DIRECT\_CHANNEL (C macro), 696
- uart\_hw\_flowcontrol\_t (C++ enum), 695
- uart\_hw\_flowcontrol\_t::UART\_HW\_FLOWCTRL\_CTS (C++ enumerator), 695
- uart\_hw\_flowcontrol\_t::UART\_HW\_FLOWCTRL\_CTS\_RTS (C++ enumerator), 695
- uart\_hw\_flowcontrol\_t::UART\_HW\_FLOWCTRL\_DISABLE (C++ enumerator), 695
- uart\_hw\_flowcontrol\_t::UART\_HW\_FLOWCTRL\_MAX (C++ enumerator), 695
- uart\_hw\_flowcontrol\_t::UART\_HW\_FLOWCTRL\_RTS (C++ enumerator), 695
- uart\_intr\_config (C++ function), 684
- uart\_intr\_config\_t (C++ struct), 690
- uart\_intr\_config\_t::intr\_enable\_mask (C++ member), 690
- uart\_intr\_config\_t::rx\_timeout\_thresh (C++ member), 690
- uart\_intr\_config\_t::rxfifo\_full\_thresh (C++ member), 690
- uart\_intr\_config\_t::txfifo\_empty\_intr\_thresh (C++ member), 690
- uart\_is\_driver\_installed (C++ function), 679
- uart\_isr\_handle\_t (C++ type), 691
- uart\_mode\_t (C++ enum), 693
- uart\_mode\_t::UART\_MODE\_IRDA (C++ enumerator), 694
- uart\_mode\_t::UART\_MODE\_RS485\_APP\_CTRL (C++ enumerator), 694
- uart\_mode\_t::UART\_MODE\_RS485\_COLLISION\_DETECT (C++ enumerator), 694
- uart\_mode\_t::UART\_MODE\_RS485\_HALF\_DUPLEX (C++ enumerator), 694
- uart\_mode\_t::UART\_MODE\_UART (C++ enumerator), 693
- UART\_NUM\_0 (C macro), 691
- UART\_NUM\_0\_CTS\_DIRECT\_GPIO\_NUM (C macro), 696
- UART\_NUM\_0\_RTS\_DIRECT\_GPIO\_NUM (C

- macro*), 697
- UART\_NUM\_0\_RXD\_DIRECT\_GPIO\_NUM *(C macro)*, 696
- UART\_NUM\_0\_TXD\_DIRECT\_GPIO\_NUM *(C macro)*, 696
- UART\_NUM\_1 *(C macro)*, 691
- UART\_NUM\_1\_CTS\_DIRECT\_GPIO\_NUM *(C macro)*, 697
- UART\_NUM\_1\_RTS\_DIRECT\_GPIO\_NUM *(C macro)*, 697
- UART\_NUM\_1\_RXD\_DIRECT\_GPIO\_NUM *(C macro)*, 697
- UART\_NUM\_1\_TXD\_DIRECT\_GPIO\_NUM *(C macro)*, 697
- UART\_NUM\_MAX *(C macro)*, 691
- uart\_param\_config *(C++ function)*, 684
- uart\_parity\_t *(C++ enum)*, 694
- uart\_parity\_t::UART\_PARITY\_DISABLE *(C++ enumerator)*, 695
- uart\_parity\_t::UART\_PARITY\_EVEN *(C++ enumerator)*, 695
- uart\_parity\_t::UART\_PARITY\_ODD *(C++ enumerator)*, 695
- uart\_pattern\_get\_pos *(C++ function)*, 687
- uart\_pattern\_pop\_pos *(C++ function)*, 686
- uart\_pattern\_queue\_reset *(C++ function)*, 687
- UART\_PIN\_NO\_CHANGE *(C macro)*, 691
- uart\_port\_t *(C++ type)*, 693
- uart\_read\_bytes *(C++ function)*, 685
- UART\_RTS\_GPIO15\_DIRECT\_CHANNEL *(C macro)*, 697
- UART\_RTS\_GPIO19\_DIRECT\_CHANNEL *(C macro)*, 697
- UART\_RXD\_GPIO18\_DIRECT\_CHANNEL *(C macro)*, 697
- UART\_RXD\_GPIO44\_DIRECT\_CHANNEL *(C macro)*, 697
- uart\_sclk\_t *(C++ type)*, 693
- uart\_set\_always\_rx\_timeout *(C++ function)*, 690
- uart\_set\_baudrate *(C++ function)*, 680
- uart\_set\_dtr *(C++ function)*, 683
- uart\_set\_hw\_flow\_ctrl *(C++ function)*, 681
- uart\_set\_line\_inverse *(C++ function)*, 681
- uart\_set\_loop\_back *(C++ function)*, 689
- uart\_set\_mode *(C++ function)*, 687
- uart\_set\_parity *(C++ function)*, 680
- uart\_set\_pin *(C++ function)*, 682
- uart\_set\_rts *(C++ function)*, 683
- uart\_set\_rx\_full\_threshold *(C++ function)*, 687
- uart\_set\_rx\_timeout *(C++ function)*, 688
- uart\_set\_stop\_bits *(C++ function)*, 680
- uart\_set\_sw\_flow\_ctrl *(C++ function)*, 681
- uart\_set\_tx\_empty\_threshold *(C++ function)*, 688
- uart\_set\_tx\_idle\_num *(C++ function)*, 683
- uart\_set\_wakeup\_threshold *(C++ function)*, 688
- uart\_set\_word\_length *(C++ function)*, 679
- uart\_signal\_inv\_t *(C++ enum)*, 695
- uart\_signal\_inv\_t::UART\_SIGNAL\_CTS\_INV *(C++ enumerator)*, 695
- uart\_signal\_inv\_t::UART\_SIGNAL\_DSR\_INV *(C++ enumerator)*, 696
- uart\_signal\_inv\_t::UART\_SIGNAL\_DTR\_INV *(C++ enumerator)*, 696
- uart\_signal\_inv\_t::UART\_SIGNAL\_INV\_DISABLE *(C++ enumerator)*, 695
- uart\_signal\_inv\_t::UART\_SIGNAL\_IRDA\_RX\_INV *(C++ enumerator)*, 695
- uart\_signal\_inv\_t::UART\_SIGNAL\_IRDA\_TX\_INV *(C++ enumerator)*, 695
- uart\_signal\_inv\_t::UART\_SIGNAL\_RTS\_INV *(C++ enumerator)*, 696
- uart\_signal\_inv\_t::UART\_SIGNAL\_RXD\_INV *(C++ enumerator)*, 695
- uart\_signal\_inv\_t::UART\_SIGNAL\_TXD\_INV *(C++ enumerator)*, 696
- uart\_stop\_bits\_t *(C++ enum)*, 694
- uart\_stop\_bits\_t::UART\_STOP\_BITS\_1 *(C++ enumerator)*, 694
- uart\_stop\_bits\_t::UART\_STOP\_BITS\_1\_5 *(C++ enumerator)*, 694
- uart\_stop\_bits\_t::UART\_STOP\_BITS\_2 *(C++ enumerator)*, 694
- uart\_stop\_bits\_t::UART\_STOP\_BITS\_MAX *(C++ enumerator)*, 694
- uart\_sw\_flowctrl\_t *(C++ struct)*, 692
- uart\_sw\_flowctrl\_t::xoff\_char *(C++ member)*, 692
- uart\_sw\_flowctrl\_t::xoff\_thrd *(C++ member)*, 693
- uart\_sw\_flowctrl\_t::xon\_char *(C++ member)*, 692
- uart\_sw\_flowctrl\_t::xon\_thrd *(C++ member)*, 692
- uart\_tx\_chars *(C++ function)*, 684
- UART\_TXD\_GPIO17\_DIRECT\_CHANNEL *(C macro)*, 697
- UART\_TXD\_GPIO43\_DIRECT\_CHANNEL *(C macro)*, 697
- uart\_wait\_tx\_done *(C++ function)*, 684
- uart\_wait\_tx\_idle\_polling *(C++ function)*, 689
- uart\_word\_length\_t *(C++ enum)*, 694
- uart\_word\_length\_t::UART\_DATA\_5\_BITS *(C++ enumerator)*, 694
- uart\_word\_length\_t::UART\_DATA\_6\_BITS *(C++ enumerator)*, 694
- uart\_word\_length\_t::UART\_DATA\_7\_BITS *(C++ enumerator)*, 694
- uart\_word\_length\_t::UART\_DATA\_8\_BITS *(C++ enumerator)*, 694
- uart\_word\_length\_t::UART\_DATA\_BITS\_MAX

- (C++ enumerator), 694
- uart\_write\_bytes (C++ function), 684
- uart\_write\_bytes\_with\_break (C++ function), 685
- ulp\_insn (C++ union), 1503
- ulp\_insn::adc (C++ member), 1507
- ulp\_insn::addr (C++ member), 1505
- ulp\_insn::alu\_cnt (C++ member), 1506
- ulp\_insn::alu\_imm (C++ member), 1506
- ulp\_insn::alu\_reg (C++ member), 1506
- ulp\_insn::b (C++ member), 1506
- ulp\_insn::bx (C++ member), 1505
- ulp\_insn::cmp (C++ member), 1505
- ulp\_insn::cycles (C++ member), 1503
- ulp\_insn::data (C++ member), 1506
- ulp\_insn::delay (C++ member), 1504
- ulp\_insn::dreg (C++ member), 1504
- ulp\_insn::end (C++ member), 1507
- ulp\_insn::halt (C++ member), 1505
- ulp\_insn::high (C++ member), 1506
- ulp\_insn::high\_bits (C++ member), 1507
- ulp\_insn::i2c (C++ member), 1507
- ulp\_insn::i2c\_addr (C++ member), 1507
- ulp\_insn::i2c\_sel (C++ member), 1507
- ulp\_insn::imm (C++ member), 1505
- ulp\_insn::label (C++ member), 1504
- ulp\_insn::ld (C++ member), 1505
- ulp\_insn::low (C++ member), 1506
- ulp\_insn::low\_bits (C++ member), 1507
- ulp\_insn::macro (C++ member), 1507
- ulp\_insn::mux (C++ member), 1506
- ulp\_insn::offset (C++ member), 1504
- ulp\_insn::opcode (C++ member), 1503
- ulp\_insn::periph\_sel (C++ member), 1506
- ulp\_insn::rd\_reg (C++ member), 1506
- ulp\_insn::rd\_upper (C++ member), 1505
- ulp\_insn::reg (C++ member), 1505
- ulp\_insn::reserved (C++ member), 1507
- ulp\_insn::rw (C++ member), 1507
- ulp\_insn::sar\_sel (C++ member), 1506
- ulp\_insn::sel (C++ member), 1506
- ulp\_insn::sign (C++ member), 1506
- ulp\_insn::sreg (C++ member), 1504
- ulp\_insn::st (C++ member), 1505
- ulp\_insn::sub\_opcode (C++ member), 1505
- ulp\_insn::treg (C++ member), 1506
- ulp\_insn::tsens (C++ member), 1507
- ulp\_insn::type (C++ member), 1505
- ulp\_insn::unused (C++ member), 1503
- ulp\_insn::unused1 (C++ member), 1504
- ulp\_insn::unused2 (C++ member), 1505
- ulp\_insn::unused3 (C++ member), 1506
- ulp\_insn::upper (C++ member), 1504
- ulp\_insn::wait\_delay (C++ member), 1507
- ulp\_insn::wakeup (C++ member), 1507
- ulp\_insn::wr\_reg (C++ member), 1506
- ulp\_insn::wr\_way (C++ member), 1504
- ulp\_insn\_t (C++ type), 1522
- ulp\_load\_binary (C++ function), 1521
- ulp\_process\_macros\_and\_load (C++ function), 1520
- ulp\_riscv\_cfg\_t (C++ struct), 1527
- ulp\_riscv\_cfg\_t::wakeup\_source (C++ member), 1527
- ulp\_riscv\_config\_and\_run (C++ function), 1526
- ULP\_RISCV\_DEFAULT\_CONFIG (C macro), 1527
- ulp\_riscv\_halt (C++ function), 1527
- ulp\_riscv\_load\_binary (C++ function), 1526
- ulp\_riscv\_run (C++ function), 1526
- ulp\_riscv\_timer\_resume (C++ function), 1527
- ulp\_riscv\_timer\_stop (C++ function), 1526
- ulp\_riscv\_wakeup\_source\_t (C++ enum), 1527
- ulp\_riscv\_wakeup\_source\_t::ULP\_RISCV\_WAKEUP\_SOURCE\_0 (C++ enumerator), 1527
- ulp\_riscv\_wakeup\_source\_t::ULP\_RISCV\_WAKEUP\_SOURCE\_1 (C++ enumerator), 1527
- ulp\_run (C++ function), 1521
- ulp\_set\_wakeup\_period (C++ function), 1522
- ulp\_timer\_resume (C++ function), 1522
- ulp\_timer\_stop (C++ function), 1522
- ulTaskGenericNotifyTake (C++ function), 1263
- ulTaskGenericNotifyValueClear (C++ function), 1264
- ulTaskGetIdleRunTimeCounter (C++ function), 1258
- ulTaskNotifyTake (C macro), 1269
- ulTaskNotifyTakeIndexed (C macro), 1269
- ulTaskNotifyValueClear (C macro), 1269
- ulTaskNotifyValueClearIndexed (C macro), 1269
- USB\_B\_DESCRIPTOR\_TYPE\_BOS (C macro), 732
- USB\_B\_DESCRIPTOR\_TYPE\_CONFIGURATION (C macro), 731
- USB\_B\_DESCRIPTOR\_TYPE\_CS\_RADIO\_CONTROL (C macro), 732
- USB\_B\_DESCRIPTOR\_TYPE\_DEBUG (C macro), 732
- USB\_B\_DESCRIPTOR\_TYPE\_DEVICE (C macro), 731
- USB\_B\_DESCRIPTOR\_TYPE\_DEVICE\_CAPABILITY (C macro), 732
- USB\_B\_DESCRIPTOR\_TYPE\_DEVICE\_QUALIFIER (C macro), 731
- USB\_B\_DESCRIPTOR\_TYPE\_ENCRYPTION\_TYPE (C macro), 732
- USB\_B\_DESCRIPTOR\_TYPE\_ENDPOINT (C macro), 731
- USB\_B\_DESCRIPTOR\_TYPE\_INTERFACE (C macro), 731
- USB\_B\_DESCRIPTOR\_TYPE\_INTERFACE\_ASSOCIATION (C macro), 732
- USB\_B\_DESCRIPTOR\_TYPE\_INTERFACE\_POWER (C macro), 731



- USB\_B\_DESCRIPTOR\_TYPE\_KEY (C macro), 732  
 USB\_B\_DESCRIPTOR\_TYPE\_OTG (C macro), 731  
 USB\_B\_DESCRIPTOR\_TYPE\_OTHER\_SPEED\_CONF (C macro), 731  
 USB\_B\_DESCRIPTOR\_TYPE\_PIPE\_USAGE (C macro), 732  
 USB\_B\_DESCRIPTOR\_TYPE\_RPIPE (C macro), 732  
 USB\_B\_DESCRIPTOR\_TYPE\_SECURITY (C macro), 732  
 USB\_B\_DESCRIPTOR\_TYPE\_STRING (C macro), 731  
 USB\_B\_DESCRIPTOR\_TYPE\_WIRE\_ADAPTER (C macro), 732  
 USB\_B\_DESCRIPTOR\_TYPE\_WIRELESS\_ENDPOINT\_COMP (C macro), 732  
 USB\_B\_ENDPOINT\_ADDRESS\_EP\_DIR\_MASK (C macro), 736  
 USB\_B\_ENDPOINT\_ADDRESS\_EP\_NUM\_MASK (C macro), 736  
 USB\_B\_REQUEST\_CLEAR\_FEATURE (C macro), 733  
 USB\_B\_REQUEST\_GET\_CONFIGURATION (C macro), 733  
 USB\_B\_REQUEST\_GET\_DESCRIPTOR (C macro), 733  
 USB\_B\_REQUEST\_GET\_INTERFACE (C macro), 733  
 USB\_B\_REQUEST\_GET\_STATUS (C macro), 733  
 USB\_B\_REQUEST\_SET\_ADDRESS (C macro), 733  
 USB\_B\_REQUEST\_SET\_CONFIGURATION (C macro), 733  
 USB\_B\_REQUEST\_SET\_DESCRIPTOR (C macro), 733  
 USB\_B\_REQUEST\_SET\_FEATURE (C macro), 733  
 USB\_B\_REQUEST\_SET\_INTERFACE (C macro), 733  
 USB\_B\_REQUEST\_SYNCH\_FRAME (C macro), 733  
 USB\_BM\_ATTRIBUTES\_BATTERY (C macro), 735  
 USB\_BM\_ATTRIBUTES\_ONE (C macro), 735  
 USB\_BM\_ATTRIBUTES\_SELFPOWER (C macro), 735  
 USB\_BM\_ATTRIBUTES\_SYNC\_ADAPTIVE (C macro), 736  
 USB\_BM\_ATTRIBUTES\_SYNC\_ASYNC (C macro), 736  
 USB\_BM\_ATTRIBUTES\_SYNC\_NONE (C macro), 736  
 USB\_BM\_ATTRIBUTES\_SYNC\_SYNC (C macro), 736  
 USB\_BM\_ATTRIBUTES\_SYNCTYPE\_MASK (C macro), 736  
 USB\_BM\_ATTRIBUTES\_USAGE\_DATA (C macro), 736  
 USB\_BM\_ATTRIBUTES\_USAGE\_FEEDBACK (C macro), 736  
 USB\_BM\_ATTRIBUTES\_USAGE\_IMPLICIT\_FB (C macro), 736  
 USB\_BM\_ATTRIBUTES\_USAGETYPE\_MASK (C macro), 736  
 USB\_BM\_ATTRIBUTES\_WAKEUP (C macro), 735  
 USB\_BM\_ATTRIBUTES\_XFER\_BULK (C macro), 736  
 USB\_BM\_ATTRIBUTES\_XFER\_CONTROL (C macro), 736  
 USB\_BM\_ATTRIBUTES\_XFER\_INT (C macro), 736  
 USB\_BM\_ATTRIBUTES\_XFER\_ISOC (C macro), 736  
 USB\_BM\_ATTRIBUTES\_XFERTYPE\_MASK (C macro), 736  
 USB\_BM\_REQUEST\_TYPE\_DIR\_IN (C macro), 732  
 USB\_BM\_REQUEST\_TYPE\_DIR\_OUT (C macro), 732  
 USB\_BM\_REQUEST\_TYPE\_RECIP\_DEVICE (C macro), 732  
 USB\_BM\_REQUEST\_TYPE\_RECIP\_ENDPOINT (C macro), 733  
 USB\_BM\_REQUEST\_TYPE\_RECIP\_INTERFACE (C macro), 733  
 USB\_BM\_REQUEST\_TYPE\_RECIP\_MASK (C macro), 733  
 USB\_BM\_REQUEST\_TYPE\_RECIP\_OTHER (C macro), 733  
 USB\_BM\_REQUEST\_TYPE\_TYPE\_CLASS (C macro), 732  
 USB\_BM\_REQUEST\_TYPE\_TYPE\_MASK (C macro), 732  
 USB\_BM\_REQUEST\_TYPE\_TYPE\_RESERVED (C macro), 732  
 USB\_BM\_REQUEST\_TYPE\_TYPE\_STANDARD (C macro), 732  
 USB\_BM\_REQUEST\_TYPE\_TYPE\_VENDOR (C macro), 732  
 USB\_CLASS\_APP\_SPEC (C macro), 735  
 USB\_CLASS\_AUDIO (C macro), 734  
 USB\_CLASS\_AUDIO\_VIDEO (C macro), 735  
 USB\_CLASS\_BILLBOARD (C macro), 735  
 USB\_CLASS\_CDC\_DATA (C macro), 735  
 USB\_CLASS\_COMM (C macro), 734  
 USB\_CLASS\_CONTENT\_SEC (C macro), 735  
 USB\_CLASS\_CSCID (C macro), 735  
 USB\_CLASS\_HID (C macro), 734  
 USB\_CLASS\_HUB (C macro), 734  
 USB\_CLASS\_MASS\_STORAGE (C macro), 734  
 USB\_CLASS\_MISC (C macro), 735  
 USB\_CLASS\_PER\_INTERFACE (C macro), 734  
 USB\_CLASS\_PERSONAL\_HEALTHCARE (C macro), 735  
 USB\_CLASS\_PHYSICAL (C macro), 734  
 USB\_CLASS\_PRINTER (C macro), 734  
 USB\_CLASS\_STILL\_IMAGE (C macro), 734  
 USB\_CLASS\_USB\_TYPE\_C\_BRIDGE (C macro), 735  
 USB\_CLASS\_VENDOR\_SPEC (C macro), 735  
 USB\_CLASS\_VIDEO (C macro), 735  
 USB\_CLASS\_WIRELESS\_CONTROLLER (C macro),

- 735
- USB\_CONFIG\_DESC\_SIZE (*C macro*), 735
- usb\_config\_desc\_t (*C++ union*), 728
- usb\_config\_desc\_t::bConfigurationValue (*C++ member*), 728
- usb\_config\_desc\_t::bDescriptorType (*C++ member*), 728
- usb\_config\_desc\_t::bLength (*C++ member*), 728
- usb\_config\_desc\_t::bmAttributes (*C++ member*), 728
- usb\_config\_desc\_t::bMaxPower (*C++ member*), 728
- usb\_config\_desc\_t::bNumInterfaces (*C++ member*), 728
- usb\_config\_desc\_t::iConfiguration (*C++ member*), 728
- usb\_config\_desc\_t::USB\_DESC\_ATTR (*C++ member*), 728
- usb\_config\_desc\_t::val (*C++ member*), 728
- usb\_config\_desc\_t::wTotalLength (*C++ member*), 728
- USB\_DESC\_ATTR (*C macro*), 731
- USB\_DEVICE\_DESC\_SIZE (*C macro*), 734
- usb\_device\_desc\_t (*C++ union*), 726
- usb\_device\_desc\_t::bcdDevice (*C++ member*), 727
- usb\_device\_desc\_t::bcdUSB (*C++ member*), 727
- usb\_device\_desc\_t::bDescriptorType (*C++ member*), 727
- usb\_device\_desc\_t::bDeviceClass (*C++ member*), 727
- usb\_device\_desc\_t::bDeviceProtocol (*C++ member*), 727
- usb\_device\_desc\_t::bDeviceSubClass (*C++ member*), 727
- usb\_device\_desc\_t::bLength (*C++ member*), 727
- usb\_device\_desc\_t::bMaxPacketSize0 (*C++ member*), 727
- usb\_device\_desc\_t::bNumConfigurations (*C++ member*), 727
- usb\_device\_desc\_t::idProduct (*C++ member*), 727
- usb\_device\_desc\_t::idVendor (*C++ member*), 727
- usb\_device\_desc\_t::iManufacturer (*C++ member*), 727
- usb\_device\_desc\_t::iProduct (*C++ member*), 727
- usb\_device\_desc\_t::iSerialNumber (*C++ member*), 727
- usb\_device\_desc\_t::USB\_DESC\_ATTR (*C++ member*), 727
- usb\_device\_desc\_t::val (*C++ member*), 728
- usb\_device\_handle\_t (*C++ type*), 724
- usb\_device\_info\_t (*C++ struct*), 721
- usb\_device\_info\_t::bConfigurationValue (*C++ member*), 721
- usb\_device\_info\_t::bMaxPacketSize0 (*C++ member*), 721
- usb\_device\_info\_t::dev\_addr (*C++ member*), 721
- usb\_device\_info\_t::speed (*C++ member*), 721
- usb\_device\_info\_t::str\_desc\_manufacturer (*C++ member*), 721
- usb\_device\_info\_t::str\_desc\_product (*C++ member*), 722
- usb\_device\_info\_t::str\_desc\_serial\_num (*C++ member*), 722
- usb\_device\_state\_t (*C++ enum*), 737
- usb\_device\_state\_t::USB\_DEVICE\_STATE\_ADDRESS (*C++ enumerator*), 737
- usb\_device\_state\_t::USB\_DEVICE\_STATE\_ATTACHED (*C++ enumerator*), 737
- usb\_device\_state\_t::USB\_DEVICE\_STATE\_CONFIGURED (*C++ enumerator*), 737
- usb\_device\_state\_t::USB\_DEVICE\_STATE\_DEFAULT (*C++ enumerator*), 737
- usb\_device\_state\_t::USB\_DEVICE\_STATE\_NOT\_ATTACHED (*C++ enumerator*), 737
- usb\_device\_state\_t::USB\_DEVICE\_STATE\_POWERED (*C++ enumerator*), 737
- usb\_device\_state\_t::USB\_DEVICE\_STATE\_SUSPENDED (*C++ enumerator*), 737
- USB\_EP\_DESC\_GET\_EP\_DIR (*C macro*), 737
- USB\_EP\_DESC\_GET\_EP\_NUM (*C macro*), 737
- USB\_EP\_DESC\_GET\_MPS (*C macro*), 737
- USB\_EP\_DESC\_GET\_XFERTYPE (*C macro*), 736
- USB\_EP\_DESC\_SIZE (*C macro*), 736
- usb\_ep\_desc\_t (*C++ union*), 730
- usb\_ep\_desc\_t::bDescriptorType (*C++ member*), 730
- usb\_ep\_desc\_t::bEndpointAddress (*C++ member*), 730
- usb\_ep\_desc\_t::bInterval (*C++ member*), 730
- usb\_ep\_desc\_t::bLength (*C++ member*), 730
- usb\_ep\_desc\_t::bmAttributes (*C++ member*), 730
- usb\_ep\_desc\_t::USB\_DESC\_ATTR (*C++ member*), 731
- usb\_ep\_desc\_t::val (*C++ member*), 731
- usb\_ep\_desc\_t::wMaxPacketSize (*C++ member*), 730
- usb\_host\_client\_config\_t (*C++ struct*), 717
- usb\_host\_client\_config\_t::async (*C++ member*), 718
- usb\_host\_client\_config\_t::callback\_arg (*C++ member*), 718
- usb\_host\_client\_config\_t::client\_event\_callback (*C++ member*), 717
- usb\_host\_client\_config\_t::is\_synchronous (*C++ member*), 717

- usb\_host\_client\_config\_t::max\_num\_events (C++ member), 717
- usb\_host\_client\_deregister (C++ function), 711
- usb\_host\_client\_event\_cb\_t (C++ type), 718
- usb\_host\_client\_event\_msg\_t (C++ struct), 716
- usb\_host\_client\_event\_msg\_t::address (C++ member), 716
- usb\_host\_client\_event\_msg\_t::dev\_gone (C++ member), 717
- usb\_host\_client\_event\_msg\_t::dev\_hdl (C++ member), 717
- usb\_host\_client\_event\_msg\_t::event (C++ member), 716
- usb\_host\_client\_event\_msg\_t::new\_dev (C++ member), 716
- usb\_host\_client\_event\_t (C++ enum), 718
- usb\_host\_client\_event\_t::USB\_HOST\_CLIENT\_EVENT\_DESC\_GONE (C++ enumerator), 718
- usb\_host\_client\_event\_t::USB\_HOST\_CLIENT\_EVENT\_NEW\_DEV (C++ enumerator), 718
- usb\_host\_client\_handle\_events (C++ function), 711
- usb\_host\_client\_handle\_t (C++ type), 718
- usb\_host\_client\_register (C++ function), 710
- usb\_host\_client\_unblock (C++ function), 711
- usb\_host\_config\_t (C++ struct), 717
- usb\_host\_config\_t::intr\_flags (C++ member), 717
- usb\_host\_config\_t::skip\_phy\_setup (C++ member), 717
- usb\_host\_device\_addr\_list\_fill (C++ function), 712
- usb\_host\_device\_close (C++ function), 712
- usb\_host\_device\_free\_all (C++ function), 712
- usb\_host\_device\_info (C++ function), 712
- usb\_host\_device\_open (C++ function), 711
- usb\_host\_endpoint\_clear (C++ function), 715
- usb\_host\_endpoint\_flush (C++ function), 714
- usb\_host\_endpoint\_halt (C++ function), 714
- usb\_host\_get\_active\_config\_descriptor (C++ function), 713
- usb\_host\_get\_device\_descriptor (C++ function), 713
- usb\_host\_install (C++ function), 709
- usb\_host\_interface\_claim (C++ function), 713
- usb\_host\_interface\_release (C++ function), 714
- USB\_HOST\_LIB\_EVENT\_FLAGS\_ALL\_FREE (C macro), 718
- USB\_HOST\_LIB\_EVENT\_FLAGS\_NO\_CLIENTS (C macro), 718
- usb\_host\_lib\_handle\_events (C++ function), 710
- usb\_host\_lib\_info (C++ function), 710
- usb\_host\_lib\_info\_t (C++ struct), 717
- usb\_host\_lib\_info\_t::num\_clients (C++ member), 717
- usb\_host\_lib\_info\_t::num\_devices (C++ member), 717
- usb\_host\_lib\_unblock (C++ function), 710
- usb\_host\_transfer\_alloc (C++ function), 715
- usb\_host\_transfer\_free (C++ function), 715
- usb\_host\_transfer\_submit (C++ function), 716
- usb\_host\_transfer\_submit\_control (C++ function), 716
- usb\_host\_uninstall (C++ function), 710
- USB\_IAD\_DESC\_SIZE (C macro), 736
- usb\_iad\_desc\_t (C++ union), 728
- usb\_iad\_desc\_t::bDescriptorType (C++ member), 729
- usb\_iad\_desc\_t::bFirstInterface (C++ member), 729
- usb\_iad\_desc\_t::bFunctionClass (C++ member), 729
- usb\_iad\_desc\_t::bFunctionProtocol (C++ member), 729
- usb\_iad\_desc\_t::bFunctionSubClass (C++ member), 729
- usb\_iad\_desc\_t::bInterfaceCount (C++ member), 729
- usb\_iad\_desc\_t::bLength (C++ member), 729
- usb\_iad\_desc\_t::iFunction (C++ member), 729
- usb\_iad\_desc\_t::USB\_DESC\_ATTR (C++ member), 729
- usb\_iad\_desc\_t::val (C++ member), 729
- USB\_INTF\_DESC\_SIZE (C macro), 736
- usb\_intf\_desc\_t (C++ union), 729
- usb\_intf\_desc\_t::bAlternateSetting (C++ member), 729
- usb\_intf\_desc\_t::bDescriptorType (C++ member), 729
- usb\_intf\_desc\_t::bInterfaceClass (C++ member), 730
- usb\_intf\_desc\_t::bInterfaceNumber (C++ member), 729
- usb\_intf\_desc\_t::bInterfaceProtocol (C++ member), 730
- usb\_intf\_desc\_t::bInterfaceSubClass (C++ member), 730
- usb\_intf\_desc\_t::bLength (C++ member), 729
- usb\_intf\_desc\_t::bNumEndpoints (C++ member), 730
- usb\_intf\_desc\_t::iInterface (C++ member), 730
- usb\_intf\_desc\_t::USB\_DESC\_ATTR (C++ member), 730
- usb\_intf\_desc\_t::val (C++ member), 730
- usb\_isoc\_packet\_desc\_t (C++ struct), 722

- usb\_isoc\_packet\_desc\_t::actual\_num\_bytes (C++ member), 722  
 usb\_isoc\_packet\_desc\_t::num\_bytes (C++ member), 722  
 usb\_isoc\_packet\_desc\_t::status (C++ member), 722  
 usb\_parse\_endpoint\_descriptor\_by\_address (C++ function), 720  
 usb\_parse\_endpoint\_descriptor\_by\_index (C++ function), 720  
 usb\_parse\_interface\_descriptor (C++ function), 719  
 usb\_parse\_interface\_number\_of\_alternate (C++ function), 719  
 usb\_parse\_next\_descriptor (C++ function), 719  
 usb\_parse\_next\_descriptor\_of\_type (C++ function), 719  
 usb\_print\_config\_descriptor (C++ function), 720  
 usb\_print\_device\_descriptor (C++ function), 720  
 usb\_print\_string\_descriptor (C++ function), 721  
 usb\_round\_up\_to\_mps (C++ function), 721  
 USB\_SETUP\_PACKET\_INIT\_GET\_CONFIG (C macro), 734  
 USB\_SETUP\_PACKET\_INIT\_GET\_CONFIG\_DESC (C macro), 734  
 USB\_SETUP\_PACKET\_INIT\_GET\_DEVICE\_DESC (C macro), 734  
 USB\_SETUP\_PACKET\_INIT\_GET\_STR\_DESC (C macro), 734  
 USB\_SETUP\_PACKET\_INIT\_SET\_ADDR (C macro), 734  
 USB\_SETUP\_PACKET\_INIT\_SET\_CONFIG (C macro), 734  
 USB\_SETUP\_PACKET\_INIT\_SET\_INTERFACE (C macro), 734  
 USB\_SETUP\_PACKET\_SIZE (C macro), 732  
 usb\_setup\_packet\_t (C++ union), 726  
 usb\_setup\_packet\_t::bmRequestType (C++ member), 726  
 usb\_setup\_packet\_t::bRequest (C++ member), 726  
 usb\_setup\_packet\_t::val (C++ member), 726  
 usb\_setup\_packet\_t::wIndex (C++ member), 726  
 usb\_setup\_packet\_t::wLength (C++ member), 726  
 usb\_setup\_packet\_t::wValue (C++ member), 726  
 usb\_setup\_packet\_t::[anonymous] (C++ member), 726  
 usb\_speed\_t (C++ enum), 724  
 usb\_speed\_t::USB\_SPEED\_FULL (C++ enumerator), 725  
 usb\_speed\_t::USB\_SPEED\_LOW (C++ enumerator), 724  
 USB\_STANDARD\_DESC\_SIZE (C macro), 734  
 usb\_standard\_desc\_t (C++ union), 726  
 usb\_standard\_desc\_t::bDescriptorType (C++ member), 726  
 usb\_standard\_desc\_t::bLength (C++ member), 726  
 usb\_standard\_desc\_t::USB\_DESC\_ATTR (C++ member), 726  
 usb\_standard\_desc\_t::val (C++ member), 726  
 USB\_STR\_DESC\_SIZE (C macro), 737  
 usb\_str\_desc\_t (C++ union), 731  
 usb\_str\_desc\_t::bDescriptorType (C++ member), 731  
 usb\_str\_desc\_t::bLength (C++ member), 731  
 usb\_str\_desc\_t::USB\_DESC\_ATTR (C++ member), 731  
 usb\_str\_desc\_t::val (C++ member), 731  
 usb\_str\_desc\_t::wData (C++ member), 731  
 USB\_SUBCLASS\_VENDOR\_SPEC (C macro), 735  
 usb\_transfer\_cb\_t (C++ type), 724  
 USB\_TRANSFER\_FLAG\_ZERO\_PACK (C macro), 723  
 usb\_transfer\_s (C++ struct), 722  
 usb\_transfer\_s::actual\_num\_bytes (C++ member), 722  
 usb\_transfer\_s::bEndpointAddress (C++ member), 723  
 usb\_transfer\_s::callback (C++ member), 723  
 usb\_transfer\_s::context (C++ member), 723  
 usb\_transfer\_s::data\_buffer (C++ member), 722  
 usb\_transfer\_s::data\_buffer\_size (C++ member), 722  
 usb\_transfer\_s::device\_handle (C++ member), 722  
 usb\_transfer\_s::flags (C++ member), 722  
 usb\_transfer\_s::isoc\_packet\_desc (C++ member), 723  
 usb\_transfer\_s::num\_bytes (C++ member), 722  
 usb\_transfer\_s::num\_isoc\_packets (C++ member), 723  
 usb\_transfer\_s::status (C++ member), 723  
 usb\_transfer\_s::timeout\_ms (C++ member), 723  
 usb\_transfer\_status\_t (C++ enum), 725  
 usb\_transfer\_status\_t::USB\_TRANSFER\_STATUS\_CANCEL (C++ enumerator), 725  
 usb\_transfer\_status\_t::USB\_TRANSFER\_STATUS\_COMPLETED (C++ enumerator), 725  
 usb\_transfer\_status\_t::USB\_TRANSFER\_STATUS\_ERROR (C++ enumerator), 725  
 usb\_transfer\_status\_t::USB\_TRANSFER\_STATUS\_NO\_DEVICE (C++ enumerator), 725  
 usb\_transfer\_status\_t::USB\_TRANSFER\_STATUS\_OVERFLOW (C++ enumerator), 725

- (C++ enumerator), 725
- usb\_transfer\_status\_t::USB\_TRANSFER\_STATUS\_SKIPPED (C++ member), 240
- (C++ enumerator), 725
- usb\_transfer\_status\_t::USB\_TRANSFER\_STATUS\_SUCCESS (C++ member), 240
- (C++ enumerator), 725
- usb\_transfer\_status\_t::USB\_TRANSFER\_STATUS\_UNKNOWN (C++ member), 240
- (C++ enumerator), 725
- usb\_transfer\_t (C++ type), 724
- usb\_transfer\_type\_t (C++ enum), 725
- usb\_transfer\_type\_t::USB\_TRANSFER\_TYPE\_BULK (C++ enumerator), 725
- usb\_transfer\_type\_t::USB\_TRANSFER\_TYPE\_CONTROL (C++ enumerator), 725
- usb\_transfer\_type\_t::USB\_TRANSFER\_TYPE\_INTERRUPT (C++ enumerator), 725
- usb\_transfer\_type\_t::USB\_TRANSFER\_TYPE\_ISOCHRONOUS (C++ enumerator), 725
- USB\_W\_VALUE\_DT\_CONFIG (C macro), 733
- USB\_W\_VALUE\_DT\_DEVICE (C macro), 733
- USB\_W\_VALUE\_DT\_DEVICE\_QUALIFIER (C macro), 733
- USB\_W\_VALUE\_DT\_ENDPOINT (C macro), 733
- USB\_W\_VALUE\_DT\_INTERFACE (C macro), 733
- USB\_W\_VALUE\_DT\_INTERFACE\_POWER (C macro), 734
- USB\_W\_VALUE\_DT\_OTHER\_SPEED\_CONFIG (C macro), 733
- USB\_W\_VALUE\_DT\_STRING (C macro), 733
- uxQueueMessagesWaiting (C++ function), 1274
- uxQueueMessagesWaitingFromISR (C++ function), 1277
- uxQueueSpacesAvailable (C++ function), 1274
- uxSemaphoreGetCount (C macro), 1302
- uxTaskGetNumberOfTasks (C++ function), 1252
- uxTaskGetStackHighWaterMark (C++ function), 1253
- uxTaskGetStackHighWaterMark2 (C++ function), 1253
- uxTaskGetSystemState (C++ function), 1255
- uxTaskPriorityGet (C++ function), 1246
- uxTaskPriorityGetFromISR (C++ function), 1247
- uxTimerGetReloadMode (C++ function), 1310
- vendor\_ie\_data\_t::vendor\_oui\_type (C++ member), 240
- vEventGroupDelete (C++ function), 1327
- vFreeISRBufferDelete (C macro), 1344
- vprintf\_like\_t (C++ type), 1410
- vTaskDeleteFromISR (C++ function), 1277
- vQueueDelete (C++ function), 1274
- vQueueUnregisterQueue (C++ function), 1277
- vRingbufferDelete (C++ function), 1361
- vRingbufferGetInfo (C++ function), 1363
- vRingbufferReturnItem (C++ function), 1361
- vRingbufferReturnItemFromISR (C++ function), 1361
- vSemaphoreCreateBinary (C macro), 1290
- vSemaphoreDelete (C macro), 1302
- vTaskDeleteFromISR (C++ function), 1334
- vTaskAllocateMPURegions (C++ function), 1242
- vTaskDelay (C++ function), 1244
- vTaskDelayUntil (C macro), 1267
- vTaskDelete (C++ function), 1244
- vTaskEndScheduler (C++ function), 1250
- vTaskGenericNotifyGiveFromISR (C++ function), 1262
- vTaskGetInfo (C++ function), 1247
- vTaskGetRunTimeStats (C++ function), 1257
- vTaskList (C++ function), 1257
- vTaskNotifyGiveFromISR (C macro), 1269
- vTaskNotifyGiveIndexedFromISR (C macro), 1269
- vTaskPrioritySet (C++ function), 1248
- vTaskResume (C++ function), 1249
- vTaskSetApplicationTaskTag (C++ function), 1253
- vTaskSetThreadLocalStoragePointer (C++ function), 1254
- vTaskSetThreadLocalStoragePointerAndDelCallback (C++ function), 1254
- vTaskSetTimeoutState (C++ function), 1265
- vTaskStartScheduler (C++ function), 1250
- vTaskSuspend (C++ function), 1248
- vTaskSuspendAll (C++ function), 1251
- vTimerSetReloadMode (C++ function), 1310
- vTimerSetTimerID (C++ function), 1307
- ## V
- vApplicationGetIdleTaskMemory (C++ function), 1255
- vApplicationGetTimerTaskMemory (C++ function), 1311
- vendor\_ie\_data\_t (C++ struct), 240
- vendor\_ie\_data\_t::element\_id (C++ member), 240
- vendor\_ie\_data\_t::length (C++ member), 240
- vendor\_ie\_data\_t::payload (C++ member), 240
- vendor\_ie\_data\_t::vendor\_oui (C++ member), 240
- ## W
- wifi\_action\_rx\_cb\_t (C++ type), 253
- wifi\_action\_tx\_req\_t (C++ struct), 245
- wifi\_action\_tx\_req\_t::data (C++ member), 245
- wifi\_action\_tx\_req\_t::data\_len (C++ member), 245
- wifi\_action\_tx\_req\_t::dest\_mac (C++ member), 245
- wifi\_action\_tx\_req\_t::ifx (C++ member), 245
- wifi\_action\_tx\_req\_t::no\_ack (C++ member), 245



- wifi\_action\_tx\_req\_t::rx\_cb (C++ member), 245
- wifi\_active\_scan\_time\_t (C++ struct), 234
- wifi\_active\_scan\_time\_t::max (C++ member), 234
- wifi\_active\_scan\_time\_t::min (C++ member), 234
- WIFI\_AMPDU\_RX\_ENABLED (C macro), 231
- WIFI\_AMPDU\_TX\_ENABLED (C macro), 231
- WIFI\_AMSDU\_TX\_ENABLED (C macro), 231
- wifi\_ant\_config\_t (C++ struct), 244
- wifi\_ant\_config\_t::enabled\_ant0 (C++ member), 244
- wifi\_ant\_config\_t::enabled\_ant1 (C++ member), 245
- wifi\_ant\_config\_t::rx\_ant\_default (C++ member), 244
- wifi\_ant\_config\_t::rx\_ant\_mode (C++ member), 244
- wifi\_ant\_config\_t::tx\_ant\_mode (C++ member), 244
- wifi\_ant\_gpio\_config\_t (C++ struct), 244
- wifi\_ant\_gpio\_config\_t::gpio\_cfg (C++ member), 244
- wifi\_ant\_gpio\_t (C++ struct), 244
- wifi\_ant\_gpio\_t::gpio\_num (C++ member), 244
- wifi\_ant\_gpio\_t::gpio\_select (C++ member), 244
- wifi\_ant\_mode\_t (C++ enum), 261
- wifi\_ant\_mode\_t::WIFI\_ANT\_MODE\_ANT0 (C++ enumerator), 261
- wifi\_ant\_mode\_t::WIFI\_ANT\_MODE\_ANT1 (C++ enumerator), 262
- wifi\_ant\_mode\_t::WIFI\_ANT\_MODE\_AUTO (C++ enumerator), 262
- wifi\_ant\_mode\_t::WIFI\_ANT\_MODE\_MAX (C++ enumerator), 262
- wifi\_ant\_t (C++ enum), 259
- wifi\_ant\_t::WIFI\_ANT\_ANT0 (C++ enumerator), 259
- wifi\_ant\_t::WIFI\_ANT\_ANT1 (C++ enumerator), 259
- wifi\_ant\_t::WIFI\_ANT\_MAX (C++ enumerator), 259
- wifi\_ap\_config\_t (C++ struct), 236
- wifi\_ap\_config\_t::authmode (C++ member), 237
- wifi\_ap\_config\_t::beacon\_interval (C++ member), 237
- wifi\_ap\_config\_t::channel (C++ member), 237
- wifi\_ap\_config\_t::ftm\_responder (C++ member), 237
- wifi\_ap\_config\_t::max\_connection (C++ member), 237
- wifi\_ap\_config\_t::pairwise\_cipher (C++ member), 237
- wifi\_ap\_config\_t::password (C++ member), 237
- wifi\_ap\_config\_t::pmf\_cfg (C++ member), 237
- wifi\_ap\_config\_t::ssid (C++ member), 237
- wifi\_ap\_config\_t::ssid\_hidden (C++ member), 237
- wifi\_ap\_config\_t::ssid\_len (C++ member), 237
- wifi\_ap\_record\_t (C++ struct), 235
- wifi\_ap\_record\_t::ant (C++ member), 235
- wifi\_ap\_record\_t::authmode (C++ member), 235
- wifi\_ap\_record\_t::bssid (C++ member), 235
- wifi\_ap\_record\_t::country (C++ member), 236
- wifi\_ap\_record\_t::ftm\_initiator (C++ member), 236
- wifi\_ap\_record\_t::ftm\_responder (C++ member), 236
- wifi\_ap\_record\_t::group\_cipher (C++ member), 235
- wifi\_ap\_record\_t::pairwise\_cipher (C++ member), 235
- wifi\_ap\_record\_t::phy\_11b (C++ member), 235
- wifi\_ap\_record\_t::phy\_11g (C++ member), 235
- wifi\_ap\_record\_t::phy\_11n (C++ member), 235
- wifi\_ap\_record\_t::phy\_lr (C++ member), 236
- wifi\_ap\_record\_t::primary (C++ member), 235
- wifi\_ap\_record\_t::reserved (C++ member), 236
- wifi\_ap\_record\_t::rssi (C++ member), 235
- wifi\_ap\_record\_t::second (C++ member), 235
- wifi\_ap\_record\_t::ssid (C++ member), 235
- wifi\_ap\_record\_t::wps (C++ member), 236
- wifi\_auth\_mode\_t (C++ enum), 254
- wifi\_auth\_mode\_t::WIFI\_AUTH\_ENTERPRISE (C++ enumerator), 254
- wifi\_auth\_mode\_t::WIFI\_AUTH\_MAX (C++ enumerator), 255
- wifi\_auth\_mode\_t::WIFI\_AUTH\_OPEN (C++ enumerator), 254
- wifi\_auth\_mode\_t::WIFI\_AUTH\_OWE (C++ enumerator), 255
- wifi\_auth\_mode\_t::WIFI\_AUTH\_WAPI\_PSK (C++ enumerator), 255
- wifi\_auth\_mode\_t::WIFI\_AUTH\_WEP (C++ enumerator), 254
- wifi\_auth\_mode\_t::WIFI\_AUTH\_WPA2\_ENTERPRISE (C++ enumerator), 254
- wifi\_auth\_mode\_t::WIFI\_AUTH\_WPA2\_PSK (C++ enumerator), 254

- wifi\_auth\_mode\_t::WIFI\_AUTH\_WPA2\_WPA3\_PSK (C++ enumerator), 254
- wifi\_auth\_mode\_t::WIFI\_AUTH\_WPA3\_ENT\_192 (C++ enumerator), 255
- wifi\_auth\_mode\_t::WIFI\_AUTH\_WPA3\_PSK (C++ enumerator), 254
- wifi\_auth\_mode\_t::WIFI\_AUTH\_WPA\_PSK (C++ enumerator), 254
- wifi\_auth\_mode\_t::WIFI\_AUTH\_WPA\_WPA2\_PSK (C++ enumerator), 254
- wifi\_bandwidth\_t (C++ enum), 259
- wifi\_bandwidth\_t::WIFI\_BW\_HT20 (C++ enumerator), 260
- wifi\_bandwidth\_t::WIFI\_BW\_HT40 (C++ enumerator), 260
- WIFI\_CACHE\_TX\_BUFFER\_NUM (C macro), 231
- wifi\_cipher\_type\_t (C++ enum), 258
- wifi\_cipher\_type\_t::WIFI\_CIPHER\_TYPE\_AES\_CMACE128 (C++ enumerator), 258
- wifi\_cipher\_type\_t::WIFI\_CIPHER\_TYPE\_AES\_CMACE128 (C++ enumerator), 258
- wifi\_cipher\_type\_t::WIFI\_CIPHER\_TYPE\_AES\_CMACE256 (C++ enumerator), 258
- wifi\_cipher\_type\_t::WIFI\_CIPHER\_TYPE\_CCMP (C++ enumerator), 258
- wifi\_cipher\_type\_t::WIFI\_CIPHER\_TYPE\_GCM128 (C++ enumerator), 258
- wifi\_cipher\_type\_t::WIFI\_CIPHER\_TYPE\_GCM256 (C++ enumerator), 258
- wifi\_cipher\_type\_t::WIFI\_CIPHER\_TYPE\_NONE (C++ enumerator), 258
- wifi\_cipher\_type\_t::WIFI\_CIPHER\_TYPE\_SMC4 (C++ enumerator), 258
- wifi\_cipher\_type\_t::WIFI\_CIPHER\_TYPE\_TKIP (C++ enumerator), 258
- wifi\_cipher\_type\_t::WIFI\_CIPHER\_TYPE\_TKIP\_CCMP (C++ enumerator), 258
- wifi\_cipher\_type\_t::WIFI\_CIPHER\_TYPE\_UNKNOWN (C++ enumerator), 259
- wifi\_cipher\_type\_t::WIFI\_CIPHER\_TYPE\_WEP104 (C++ enumerator), 258
- wifi\_cipher\_type\_t::WIFI\_CIPHER\_TYPE\_WEP40 (C++ enumerator), 258
- wifi\_config\_t (C++ union), 233
- wifi\_config\_t::ap (C++ member), 233
- wifi\_config\_t::sta (C++ member), 233
- wifi\_country\_policy\_t (C++ enum), 254
- wifi\_country\_policy\_t::WIFI\_COUNTRY\_POLICY\_AUTO (C++ enumerator), 254
- wifi\_country\_policy\_t::WIFI\_COUNTRY\_POLICY\_MANUAL (C++ enumerator), 254
- wifi\_country\_t (C++ struct), 233
- wifi\_country\_t::cc (C++ member), 233
- wifi\_country\_t::max\_tx\_power (C++ member), 233
- wifi\_country\_t::nchan (C++ member), 233
- wifi\_country\_t::policy (C++ member), 234
- wifi\_country\_t::schan (C++ member), 233
- wifi\_csi\_cb\_t (C++ type), 232
- wifi\_csi\_config\_t (C++ struct), 243
- wifi\_csi\_config\_t::channel\_filter\_en (C++ member), 243
- wifi\_csi\_config\_t::dump\_ack\_en (C++ member), 243
- wifi\_csi\_config\_t::htltof\_en (C++ member), 243
- wifi\_csi\_config\_t::lltof\_en (C++ member), 243
- wifi\_csi\_config\_t::ltof\_merge\_en (C++ member), 243
- wifi\_csi\_config\_t::manu\_scale (C++ member), 243
- wifi\_csi\_config\_t::shift (C++ member), 243
- wifi\_csi\_config\_t::stbc\_htltof2\_en (C++ member), 243
- WIFI\_CSI\_ENABLED (C macro), 231
- wifi\_csi\_info\_t (C++ struct), 243
- wifi\_csi\_info\_t::buf (C++ member), 244
- wifi\_csi\_info\_t::dmac (C++ member), 243
- wifi\_csi\_info\_t::first\_word\_invalid (C++ member), 244
- wifi\_csi\_info\_t::len (C++ member), 244
- wifi\_csi\_info\_t::mac (C++ member), 243
- wifi\_csi\_info\_t::rx\_ctrl (C++ member), 243
- WIFI\_DEFAULT\_RX\_BA\_WIN (C macro), 231
- WIFI\_DYNAMIC\_TX\_BUFFER\_NUM (C macro), 231
- WIFI\_ENABLE\_11R (C macro), 232
- WIFI\_ENABLE\_ENTERPRISE (C macro), 232
- WIFI\_ENABLE\_GCMP (C macro), 231
- WIFI\_ENABLE\_GMAC (C macro), 232
- WIFI\_ENABLE\_SPIRAM (C macro), 231
- WIFI\_ENABLE\_WPA3\_SAE (C macro), 231
- wifi\_err\_reason\_t (C++ enum), 255
- wifi\_err\_reason\_t::WIFI\_REASON\_4WAY\_HANDSHAKE\_TIMEOUT (C++ enumerator), 255
- wifi\_err\_reason\_t::WIFI\_REASON\_802\_1X\_AUTH\_FAILED (C++ enumerator), 256
- wifi\_err\_reason\_t::WIFI\_REASON\_AKMP\_INVALID (C++ enumerator), 256
- wifi\_err\_reason\_t::WIFI\_REASON\_ALTERATIVE\_CHANNEL (C++ enumerator), 257
- wifi\_err\_reason\_t::WIFI\_REASON\_AP\_INITIATED (C++ enumerator), 257
- wifi\_err\_reason\_t::WIFI\_REASON\_AP\_TSF\_RESET (C++ enumerator), 257
- wifi\_err\_reason\_t::WIFI\_REASON\_ASSOC\_COMEBACK\_TIMEOUT (C++ enumerator), 257
- wifi\_err\_reason\_t::WIFI\_REASON\_ASSOC\_EXPIRE (C++ enumerator), 255
- wifi\_err\_reason\_t::WIFI\_REASON\_ASSOC\_FAIL (C++ enumerator), 257
- wifi\_err\_reason\_t::WIFI\_REASON\_ASSOC\_LEAVE (C++ enumerator), 255
- wifi\_err\_reason\_t::WIFI\_REASON\_ASSOC\_NOT\_AUTHED





- (C++ member), 248
- wifi\_event\_ap\_stadisconnected\_t (C++ struct), 248
- wifi\_event\_ap\_stadisconnected\_t::aid (C++ member), 248
- wifi\_event\_ap\_stadisconnected\_t::is\_mesh\_child (C++ member), 248
- wifi\_event\_ap\_stadisconnected\_t::mac (C++ member), 248
- wifi\_event\_ap\_wps\_rg\_fail\_reason\_t (C++ struct), 250
- wifi\_event\_ap\_wps\_rg\_fail\_reason\_t::peer\_macaddr (C++ member), 251
- wifi\_event\_ap\_wps\_rg\_fail\_reason\_t::reason (C++ member), 251
- wifi\_event\_ap\_wps\_rg\_pin\_t (C++ struct), 250
- wifi\_event\_ap\_wps\_rg\_pin\_t::pin\_code (C++ member), 250
- wifi\_event\_ap\_wps\_rg\_success\_t (C++ struct), 251
- wifi\_event\_ap\_wps\_rg\_success\_t::peer\_macaddr (C++ member), 251
- wifi\_event\_bss\_rssi\_low\_t (C++ struct), 248
- wifi\_event\_bss\_rssi\_low\_t::rssi (C++ member), 249
- wifi\_event\_ftm\_report\_t (C++ struct), 249
- wifi\_event\_ftm\_report\_t::dist\_est (C++ member), 249
- wifi\_event\_ftm\_report\_t::ftm\_report\_data (C++ member), 250
- wifi\_event\_ftm\_report\_t::ftm\_report\_num\_entries (C++ member), 250
- wifi\_event\_ftm\_report\_t::peer\_mac (C++ member), 249
- wifi\_event\_ftm\_report\_t::rtt\_est (C++ member), 249
- wifi\_event\_ftm\_report\_t::rtt\_raw (C++ member), 249
- wifi\_event\_ftm\_report\_t::status (C++ member), 249
- WIFI\_EVENT\_MASK\_ALL (C macro), 252
- WIFI\_EVENT\_MASK\_AP\_PROBEREQRECVED (C macro), 253
- WIFI\_EVENT\_MASK\_NONE (C macro), 252
- wifi\_event\_roc\_done\_t (C++ struct), 250
- wifi\_event\_roc\_done\_t::context (C++ member), 250
- wifi\_event\_sta\_authmode\_change\_t (C++ struct), 247
- wifi\_event\_sta\_authmode\_change\_t::new\_mode (C++ member), 247
- wifi\_event\_sta\_authmode\_change\_t::old\_mode (C++ member), 247
- wifi\_event\_sta\_connected\_t (C++ struct), 246
- wifi\_event\_sta\_connected\_t::authmode (C++ member), 246
- wifi\_event\_sta\_connected\_t::bssid (C++ member), 246
- wifi\_event\_sta\_connected\_t::channel (C++ member), 246
- wifi\_event\_sta\_connected\_t::ssid (C++ member), 246
- wifi\_event\_sta\_connected\_t::ssid\_len (C++ member), 246
- wifi\_event\_sta\_disconnected\_t (C++ struct), 246
- wifi\_event\_sta\_disconnected\_t::bssid (C++ member), 247
- wifi\_event\_sta\_disconnected\_t::reason (C++ member), 247
- wifi\_event\_sta\_disconnected\_t::rssi (C++ member), 247
- wifi\_event\_sta\_disconnected\_t::ssid (C++ member), 246
- wifi\_event\_sta\_disconnected\_t::ssid\_len (C++ member), 246
- wifi\_event\_sta\_scan\_done\_t (C++ struct), 246
- wifi\_event\_sta\_scan\_done\_t::number (C++ member), 246
- wifi\_event\_sta\_scan\_done\_t::scan\_id (C++ member), 246
- wifi\_event\_sta\_scan\_done\_t::status (C++ member), 246
- wifi\_event\_sta\_wps\_er\_pin\_t (C++ struct), 247
- wifi\_event\_sta\_wps\_er\_pin\_t::pin\_code (C++ member), 247
- wifi\_event\_sta\_wps\_er\_success\_t (C++ struct), 247
- wifi\_event\_sta\_wps\_er\_success\_t::ap\_cred (C++ member), 247
- wifi\_event\_sta\_wps\_er\_success\_t::ap\_cred\_cnt (C++ member), 247
- wifi\_event\_sta\_wps\_er\_success\_t::passphrase (C++ member), 247
- wifi\_event\_sta\_wps\_er\_success\_t::ssid (C++ member), 247
- wifi\_event\_sta\_wps\_fail\_reason\_t (C++ enum), 266
- wifi\_event\_sta\_wps\_fail\_reason\_t::WPS\_FAIL\_REASON (C++ enumerator), 266
- wifi\_event\_sta\_wps\_fail\_reason\_t::WPS\_FAIL\_REASON (C++ enumerator), 266
- wifi\_event\_sta\_wps\_fail\_reason\_t::WPS\_FAIL\_REASON (C++ enumerator), 266
- wifi\_event\_sta\_wps\_fail\_reason\_t::WPS\_FAIL\_REASON (C++ enumerator), 266
- wifi\_event\_t (C++ enum), 264
- wifi\_event\_t::WIFI\_EVENT\_ACTION\_TX\_STATUS (C++ enumerator), 265
- wifi\_event\_t::WIFI\_EVENT\_AP\_PROBEREQRECVED (C++ enumerator), 265
- wifi\_event\_t::WIFI\_EVENT\_AP\_STACONNECTED

- (C++ enumerator), 265
- wifi\_event\_t::WIFI\_EVENT\_AP\_STADISCONNECTED (C++ member), 245  
(C++ enumerator), 265
- wifi\_event\_t::WIFI\_EVENT\_AP\_START (C++ enumerator), 265
- wifi\_event\_t::WIFI\_EVENT\_AP\_STOP (C++ enumerator), 265
- wifi\_event\_t::WIFI\_EVENT\_AP\_WPS\_RG\_FAILED (C++ enumerator), 265
- wifi\_event\_t::WIFI\_EVENT\_AP\_WPS\_RG\_PBC\_OVERFLOW (C++ enumerator), 266
- wifi\_event\_t::WIFI\_EVENT\_AP\_WPS\_RG\_PIN (C++ enumerator), 266
- wifi\_event\_t::WIFI\_EVENT\_AP\_WPS\_RG\_SUCCESS (C++ enumerator), 265
- wifi\_event\_t::WIFI\_EVENT\_AP\_WPS\_RG\_TIMEOUT (C++ enumerator), 266
- wifi\_event\_t::WIFI\_EVENT\_CONNECTIONLESS\_MODULE\_WAKEUP\_INTERVAL\_START (C++ member), 249
- wifi\_event\_t::WIFI\_EVENT\_FTM\_REPORT (C++ enumerator), 265
- wifi\_event\_t::WIFI\_EVENT\_MAX (C++ enumerator), 266
- wifi\_event\_t::WIFI\_EVENT\_ROC\_DONE (C++ enumerator), 265
- wifi\_event\_t::WIFI\_EVENT\_SCAN\_DONE (C++ enumerator), 264
- wifi\_event\_t::WIFI\_EVENT\_STA\_AUTHMODE\_CHANGE (C++ enumerator), 264
- wifi\_event\_t::WIFI\_EVENT\_STA\_BEACON\_TIMEOUT (C++ enumerator), 265
- wifi\_event\_t::WIFI\_EVENT\_STA\_BSS\_RSSI\_LOW (C++ enumerator), 265
- wifi\_event\_t::WIFI\_EVENT\_STA\_CONNECTED (C++ enumerator), 264
- wifi\_event\_t::WIFI\_EVENT\_STA\_DISCONNECTED (C++ enumerator), 264
- wifi\_event\_t::WIFI\_EVENT\_STA\_START (C++ enumerator), 264
- wifi\_event\_t::WIFI\_EVENT\_STA\_STOP (C++ enumerator), 264
- wifi\_event\_t::WIFI\_EVENT\_STA\_WPS\_ER\_FAILED (C++ enumerator), 264
- wifi\_event\_t::WIFI\_EVENT\_STA\_WPS\_ER\_PBC\_OVERFLOW (C++ enumerator), 265
- wifi\_event\_t::WIFI\_EVENT\_STA\_WPS\_ER\_PIN (C++ enumerator), 265
- wifi\_event\_t::WIFI\_EVENT\_STA\_WPS\_ER\_SUCCESS (C++ enumerator), 264
- wifi\_event\_t::WIFI\_EVENT\_STA\_WPS\_ER\_TIMEOUT (C++ enumerator), 265
- wifi\_event\_t::WIFI\_EVENT\_WIFI\_READY (C++ enumerator), 264
- WIFI\_FEATURE\_CAPS (C macro), 232
- WIFI\_FTM\_INITIATOR (C macro), 231
- wifi\_ftm\_initiator\_cfg\_t (C++ struct), 245
- wifi\_ftm\_initiator\_cfg\_t::burst\_period (C++ member), 245
- wifi\_ftm\_initiator\_cfg\_t::channel (C++ member), 245
- wifi\_ftm\_initiator\_cfg\_t::frm\_count (C++ member), 245
- wifi\_ftm\_initiator\_cfg\_t::resp\_mac (C++ member), 245
- wifi\_ftm\_initiator\_cfg\_t::use\_get\_report\_api (C++ member), 245
- wifi\_ftm\_report\_entry\_t (C++ struct), 249
- wifi\_ftm\_report\_entry\_t::dlog\_token (C++ member), 249
- wifi\_ftm\_report\_entry\_t::rssi (C++ member), 249
- wifi\_ftm\_report\_entry\_t::rtt (C++ member), 249
- wifi\_ftm\_report\_entry\_t::t1 (C++ member), 249
- wifi\_ftm\_report\_entry\_t::t2 (C++ member), 249
- wifi\_ftm\_report\_entry\_t::t3 (C++ member), 249
- wifi\_ftm\_report\_entry\_t::t4 (C++ member), 249
- WIFI\_FTM\_RESPONDER (C macro), 231
- wifi\_ftm\_status\_t (C++ enum), 266
- wifi\_ftm\_status\_t::FTM\_STATUS\_CONF\_REJECTED (C++ enumerator), 266
- wifi\_ftm\_status\_t::FTM\_STATUS\_FAIL (C++ enumerator), 266
- wifi\_ftm\_status\_t::FTM\_STATUS\_NO\_RESPONSE (C++ enumerator), 266
- wifi\_ftm\_status\_t::FTM\_STATUS\_NO\_VALID\_MSMT (C++ enumerator), 266
- wifi\_ftm\_status\_t::FTM\_STATUS\_SUCCESS (C++ enumerator), 266
- wifi\_ftm\_status\_t::FTM\_STATUS\_UNSUPPORTED (C++ enumerator), 266
- wifi\_ftm\_status\_t::FTM\_STATUS\_USER\_TERM (C++ enumerator), 267
- WIFI\_INIT\_CONFIG\_DEFAULT (C macro), 232
- WIFI\_INIT\_CONFIG\_MAGIC (C macro), 231
- wifi\_init\_config\_t (C++ struct), 228
- wifi\_init\_config\_t::ampdu\_rx\_enable (C++ member), 228
- wifi\_init\_config\_t::ampdu\_tx\_enable (C++ member), 228
- wifi\_init\_config\_t::amsdu\_tx\_enable (C++ member), 229
- wifi\_init\_config\_t::beacon\_max\_len (C++ member), 229
- wifi\_init\_config\_t::cache\_tx\_buf\_num (C++ member), 228
- wifi\_init\_config\_t::csi\_enable (C++ member), 228
- wifi\_init\_config\_t::dynamic\_rx\_buf\_num (C++ member), 228
- wifi\_init\_config\_t::dynamic\_tx\_buf\_num (C++ member), 228

- wifi\_init\_config\_t::espnw\_max\_encrypt (C++ member), 229
- wifi\_init\_config\_t::feature\_caps (C++ member), 229
- wifi\_init\_config\_t::magic (C++ member), 229
- wifi\_init\_config\_t::mgmt\_sbuf\_num (C++ member), 229
- wifi\_init\_config\_t::nano\_enable (C++ member), 229
- wifi\_init\_config\_t::nvs\_enable (C++ member), 229
- wifi\_init\_config\_t::osi\_funcs (C++ member), 228
- wifi\_init\_config\_t::rx\_ba\_win (C++ member), 229
- wifi\_init\_config\_t::rx\_mgmt\_buf\_num (C++ member), 228
- wifi\_init\_config\_t::rx\_mgmt\_buf\_type (C++ member), 228
- wifi\_init\_config\_t::sta\_disconnected\_pm (C++ member), 229
- wifi\_init\_config\_t::static\_rx\_buf\_num (C++ member), 228
- wifi\_init\_config\_t::static\_tx\_buf\_num (C++ member), 228
- wifi\_init\_config\_t::tx\_buf\_type (C++ member), 228
- wifi\_init\_config\_t::wifi\_task\_core\_id (C++ member), 229
- wifi\_init\_config\_t::wpa\_crypto\_funcs (C++ member), 228
- wifi\_interface\_t (C++ enum), 254
- wifi\_interface\_t::WIFI\_IF\_AP (C++ enumerator), 254
- wifi\_interface\_t::WIFI\_IF\_STA (C++ enumerator), 254
- WIFI\_MGMT\_SBUF\_NUM (C macro), 231
- wifi\_mode\_t (C++ enum), 253
- wifi\_mode\_t::WIFI\_MODE\_AP (C++ enumerator), 253
- wifi\_mode\_t::WIFI\_MODE\_APSTA (C++ enumerator), 253
- wifi\_mode\_t::WIFI\_MODE\_MAX (C++ enumerator), 254
- wifi\_mode\_t::WIFI\_MODE\_NULL (C++ enumerator), 253
- wifi\_mode\_t::WIFI\_MODE\_STA (C++ enumerator), 253
- WIFI\_NANO\_FORMAT\_ENABLED (C macro), 231
- WIFI\_NVS\_ENABLED (C macro), 231
- WIFI\_OFFCHAN\_TX\_CANCEL (C macro), 251
- WIFI\_OFFCHAN\_TX\_REQ (C macro), 251
- wifi\_phy\_mode\_t (C++ enum), 261
- wifi\_phy\_mode\_t::WIFI\_PHY\_MODE\_11B (C++ enumerator), 261
- wifi\_phy\_mode\_t::WIFI\_PHY\_MODE\_11G (C++ enumerator), 261
- wifi\_phy\_mode\_t::WIFI\_PHY\_MODE\_HE20 (C++ enumerator), 261
- wifi\_phy\_mode\_t::WIFI\_PHY\_MODE\_HT20 (C++ enumerator), 261
- wifi\_phy\_mode\_t::WIFI\_PHY\_MODE\_HT40 (C++ enumerator), 261
- wifi\_phy\_mode\_t::WIFI\_PHY\_MODE\_LR (C++ enumerator), 261
- wifi\_phy\_rate\_t (C++ enum), 262
- wifi\_phy\_rate\_t::WIFI\_PHY\_RATE\_11M\_L (C++ enumerator), 262
- wifi\_phy\_rate\_t::WIFI\_PHY\_RATE\_11M\_S (C++ enumerator), 262
- wifi\_phy\_rate\_t::WIFI\_PHY\_RATE\_12M (C++ enumerator), 262
- wifi\_phy\_rate\_t::WIFI\_PHY\_RATE\_18M (C++ enumerator), 263
- wifi\_phy\_rate\_t::WIFI\_PHY\_RATE\_1M\_L (C++ enumerator), 262
- wifi\_phy\_rate\_t::WIFI\_PHY\_RATE\_24M (C++ enumerator), 262
- wifi\_phy\_rate\_t::WIFI\_PHY\_RATE\_2M\_L (C++ enumerator), 262
- wifi\_phy\_rate\_t::WIFI\_PHY\_RATE\_2M\_S (C++ enumerator), 262
- wifi\_phy\_rate\_t::WIFI\_PHY\_RATE\_36M (C++ enumerator), 263
- wifi\_phy\_rate\_t::WIFI\_PHY\_RATE\_48M (C++ enumerator), 262
- wifi\_phy\_rate\_t::WIFI\_PHY\_RATE\_54M (C++ enumerator), 262
- wifi\_phy\_rate\_t::WIFI\_PHY\_RATE\_5M\_L (C++ enumerator), 262
- wifi\_phy\_rate\_t::WIFI\_PHY\_RATE\_5M\_S (C++ enumerator), 262
- wifi\_phy\_rate\_t::WIFI\_PHY\_RATE\_6M (C++ enumerator), 262
- wifi\_phy\_rate\_t::WIFI\_PHY\_RATE\_9M (C++ enumerator), 263
- wifi\_phy\_rate\_t::WIFI\_PHY\_RATE\_LORA\_250K (C++ enumerator), 264
- wifi\_phy\_rate\_t::WIFI\_PHY\_RATE\_LORA\_500K (C++ enumerator), 264
- wifi\_phy\_rate\_t::WIFI\_PHY\_RATE\_MAX (C++ enumerator), 264
- wifi\_phy\_rate\_t::WIFI\_PHY\_RATE\_MCS0\_LGI (C++ enumerator), 263
- wifi\_phy\_rate\_t::WIFI\_PHY\_RATE\_MCS0\_SGI (C++ enumerator), 263
- wifi\_phy\_rate\_t::WIFI\_PHY\_RATE\_MCS1\_LGI (C++ enumerator), 263
- wifi\_phy\_rate\_t::WIFI\_PHY\_RATE\_MCS1\_SGI (C++ enumerator), 263
- wifi\_phy\_rate\_t::WIFI\_PHY\_RATE\_MCS2\_LGI (C++ enumerator), 263
- wifi\_phy\_rate\_t::WIFI\_PHY\_RATE\_MCS2\_SGI (C++ enumerator), 263
- wifi\_phy\_rate\_t::WIFI\_PHY\_RATE\_MCS3\_LGI (C++ enumerator), 263

- (C++ enumerator), 263
- wifi\_phy\_rate\_t::WIFI\_PHY\_RATE\_MCS3\_SGI (C++ enumerator), 263
- wifi\_phy\_rate\_t::WIFI\_PHY\_RATE\_MCS4\_LGI (C++ enumerator), 263
- wifi\_phy\_rate\_t::WIFI\_PHY\_RATE\_MCS4\_SGI (C++ enumerator), 263
- wifi\_phy\_rate\_t::WIFI\_PHY\_RATE\_MCS5\_LGI (C++ enumerator), 263
- wifi\_phy\_rate\_t::WIFI\_PHY\_RATE\_MCS5\_SGI (C++ enumerator), 264
- wifi\_phy\_rate\_t::WIFI\_PHY\_RATE\_MCS6\_LGI (C++ enumerator), 263
- wifi\_phy\_rate\_t::WIFI\_PHY\_RATE\_MCS6\_SGI (C++ enumerator), 264
- wifi\_phy\_rate\_t::WIFI\_PHY\_RATE\_MCS7\_LGI (C++ enumerator), 263
- wifi\_phy\_rate\_t::WIFI\_PHY\_RATE\_MCS7\_SGI (C++ enumerator), 264
- wifi\_pkt\_rx\_ctrl\_t (C++ struct), 240
- wifi\_pkt\_rx\_ctrl\_t::\_\_pad0\_\_ (C++ member), 240
- wifi\_pkt\_rx\_ctrl\_t::\_\_pad10\_\_ (C++ member), 242
- wifi\_pkt\_rx\_ctrl\_t::\_\_pad1\_\_ (C++ member), 240
- wifi\_pkt\_rx\_ctrl\_t::\_\_pad2\_\_ (C++ member), 241
- wifi\_pkt\_rx\_ctrl\_t::\_\_pad3\_\_ (C++ member), 241
- wifi\_pkt\_rx\_ctrl\_t::\_\_pad4\_\_ (C++ member), 241
- wifi\_pkt\_rx\_ctrl\_t::\_\_pad5\_\_ (C++ member), 241
- wifi\_pkt\_rx\_ctrl\_t::\_\_pad6\_\_ (C++ member), 242
- wifi\_pkt\_rx\_ctrl\_t::\_\_pad7\_\_ (C++ member), 242
- wifi\_pkt\_rx\_ctrl\_t::\_\_pad8\_\_ (C++ member), 242
- wifi\_pkt\_rx\_ctrl\_t::\_\_pad9\_\_ (C++ member), 242
- wifi\_pkt\_rx\_ctrl\_t::aggregation (C++ member), 241
- wifi\_pkt\_rx\_ctrl\_t::ampdu\_cnt (C++ member), 241
- wifi\_pkt\_rx\_ctrl\_t::ant (C++ member), 242
- wifi\_pkt\_rx\_ctrl\_t::channel (C++ member), 241
- wifi\_pkt\_rx\_ctrl\_t::cwb (C++ member), 241
- wifi\_pkt\_rx\_ctrl\_t::fec\_coding (C++ member), 241
- wifi\_pkt\_rx\_ctrl\_t::mcs (C++ member), 241
- wifi\_pkt\_rx\_ctrl\_t::noise\_floor (C++ member), 242
- wifi\_pkt\_rx\_ctrl\_t::not\_sounding (C++ member), 241
- wifi\_pkt\_rx\_ctrl\_t::rate (C++ member), 240
- wifi\_pkt\_rx\_ctrl\_t::rssi (C++ member), 240
- wifi\_pkt\_rx\_ctrl\_t::rx\_state (C++ member), 242
- wifi\_pkt\_rx\_ctrl\_t::secondary\_channel (C++ member), 241
- wifi\_pkt\_rx\_ctrl\_t::sgi (C++ member), 241
- wifi\_pkt\_rx\_ctrl\_t::sig\_len (C++ member), 242
- wifi\_pkt\_rx\_ctrl\_t::sig\_mode (C++ member), 240
- wifi\_pkt\_rx\_ctrl\_t::smoothing (C++ member), 241
- wifi\_pkt\_rx\_ctrl\_t::stbc (C++ member), 241
- wifi\_pkt\_rx\_ctrl\_t::timestamp (C++ member), 241
- wifi\_pmf\_config\_t (C++ struct), 236
- wifi\_pmf\_config\_t::capable (C++ member), 236
- wifi\_pmf\_config\_t::required (C++ member), 236
- WIFI\_PROMIS\_CTRL\_FILTER\_MASK\_ACK (C macro), 252
- WIFI\_PROMIS\_CTRL\_FILTER\_MASK\_ALL (C macro), 252
- WIFI\_PROMIS\_CTRL\_FILTER\_MASK\_BA (C macro), 252
- WIFI\_PROMIS\_CTRL\_FILTER\_MASK\_BAR (C macro), 252
- WIFI\_PROMIS\_CTRL\_FILTER\_MASK\_CFEND (C macro), 252
- WIFI\_PROMIS\_CTRL\_FILTER\_MASK\_CFENDACK (C macro), 252
- WIFI\_PROMIS\_CTRL\_FILTER\_MASK\_CTS (C macro), 252
- WIFI\_PROMIS\_CTRL\_FILTER\_MASK\_PSPOLL (C macro), 252
- WIFI\_PROMIS\_CTRL\_FILTER\_MASK\_RTS (C macro), 252
- WIFI\_PROMIS\_CTRL\_FILTER\_MASK\_WRAPPER (C macro), 252
- WIFI\_PROMIS\_FILTER\_MASK\_ALL (C macro), 251
- WIFI\_PROMIS\_FILTER\_MASK\_CTRL (C macro), 251
- WIFI\_PROMIS\_FILTER\_MASK\_DATA (C macro), 251
- WIFI\_PROMIS\_FILTER\_MASK\_DATA\_AMPDU (C macro), 252
- WIFI\_PROMIS\_FILTER\_MASK\_DATA\_MPDU (C macro), 252
- WIFI\_PROMIS\_FILTER\_MASK\_FCSFAIL (C macro), 252
- WIFI\_PROMIS\_FILTER\_MASK\_MGMT (C macro), 251
- WIFI\_PROMIS\_FILTER\_MASK\_MISC (C macro), 251

- 252
- wifi\_promiscuous\_cb\_t (C++ type), 232
- wifi\_promiscuous\_filter\_t (C++ struct), 242
- wifi\_promiscuous\_filter\_t::filter\_mask (C++ member), 243
- wifi\_promiscuous\_pkt\_t (C++ struct), 242
- wifi\_promiscuous\_pkt\_t::payload (C++ member), 242
- wifi\_promiscuous\_pkt\_t::rx\_ctrl (C++ member), 242
- wifi\_promiscuous\_pkt\_type\_t (C++ enum), 261
- wifi\_promiscuous\_pkt\_type\_t::WIFI\_PKT\_GWRL (C++ enumerator), 261
- wifi\_promiscuous\_pkt\_type\_t::WIFI\_PKT\_DATA (C++ enumerator), 261
- wifi\_promiscuous\_pkt\_type\_t::WIFI\_PKT\_MGMT (C++ enumerator), 261
- wifi\_promiscuous\_pkt\_type\_t::WIFI\_PKT\_MISC (C++ enumerator), 261
- WIFI\_PROTOCOL\_11B (C macro), 251
- WIFI\_PROTOCOL\_11G (C macro), 251
- WIFI\_PROTOCOL\_11N (C macro), 251
- WIFI\_PROTOCOL\_LR (C macro), 251
- wifi\_prov\_cb\_event\_t (C++ enum), 1038
- wifi\_prov\_cb\_event\_t::WIFI\_PROV\_CRED\_FAIL (C++ enumerator), 1038
- wifi\_prov\_cb\_event\_t::WIFI\_PROV\_CRED\_RECV (C++ enumerator), 1038
- wifi\_prov\_cb\_event\_t::WIFI\_PROV\_CRED\_SUCCESS (C++ enumerator), 1038
- wifi\_prov\_cb\_event\_t::WIFI\_PROV\_DEINIT (C++ enumerator), 1038
- wifi\_prov\_cb\_event\_t::WIFI\_PROV\_END (C++ enumerator), 1038
- wifi\_prov\_cb\_event\_t::WIFI\_PROV\_INIT (C++ enumerator), 1038
- wifi\_prov\_cb\_event\_t::WIFI\_PROV\_START (C++ enumerator), 1038
- wifi\_prov\_cb\_func\_t (C++ type), 1037
- wifi\_prov\_config\_data\_handler (C++ function), 1041
- wifi\_prov\_config\_get\_data\_t (C++ struct), 1041
- wifi\_prov\_config\_get\_data\_t::conn\_info (C++ member), 1041
- wifi\_prov\_config\_get\_data\_t::fail\_reason (C++ member), 1041
- wifi\_prov\_config\_get\_data\_t::wifi\_state (C++ member), 1041
- wifi\_prov\_config\_handlers (C++ struct), 1042
- wifi\_prov\_config\_handlers::apply\_config\_handler (C++ member), 1042
- wifi\_prov\_config\_handlers::ctx (C++ member), 1042
- wifi\_prov\_config\_handlers::get\_status\_handler (C++ member), 1042
- wifi\_prov\_config\_handlers::set\_config\_handler (C++ member), 1042
- wifi\_prov\_config\_handlers\_t (C++ type), 1042
- wifi\_prov\_config\_set\_data\_t (C++ struct), 1041
- wifi\_prov\_config\_set\_data\_t::bssid (C++ member), 1042
- wifi\_prov\_config\_set\_data\_t::channel (C++ member), 1042
- wifi\_prov\_config\_set\_data\_t::password (C++ member), 1042
- wifi\_prov\_config\_set\_data\_t::ssid (C++ member), 1042
- wifi\_prov\_ctx\_t (C++ type), 1042
- WIFI\_PROV\_EVENT\_HANDLER\_NONE (C macro), 1037
- wifi\_prov\_event\_handler\_t (C++ struct), 1036
- wifi\_prov\_event\_handler\_t::event\_cb (C++ member), 1036
- wifi\_prov\_event\_handler\_t::user\_data (C++ member), 1036
- wifi\_prov\_mgr\_config\_t (C++ struct), 1037
- wifi\_prov\_mgr\_config\_t::app\_event\_handler (C++ member), 1037
- wifi\_prov\_mgr\_config\_t::scheme (C++ member), 1037
- wifi\_prov\_mgr\_config\_t::scheme\_event\_handler (C++ member), 1037
- wifi\_prov\_mgr\_configure\_sta (C++ function), 1035
- wifi\_prov\_mgr\_deinit (C++ function), 1031
- wifi\_prov\_mgr\_disable\_auto\_stop (C++ function), 1033
- wifi\_prov\_mgr\_endpoint\_create (C++ function), 1034
- wifi\_prov\_mgr\_endpoint\_register (C++ function), 1034
- wifi\_prov\_mgr\_endpoint\_unregister (C++ function), 1034
- wifi\_prov\_mgr\_get\_wifi\_disconnect\_reason (C++ function), 1035
- wifi\_prov\_mgr\_get\_wifi\_state (C++ function), 1035
- wifi\_prov\_mgr\_init (C++ function), 1031
- wifi\_prov\_mgr\_is\_provisioned (C++ function), 1031
- wifi\_prov\_mgr\_reset\_provisioning (C++ function), 1035
- wifi\_prov\_mgr\_reset\_sm\_state\_on\_failure (C++ function), 1035
- wifi\_prov\_mgr\_set\_app\_info (C++ function), 1033
- wifi\_prov\_mgr\_start\_provisioning (C++ function), 1031
- wifi\_prov\_mgr\_stop\_provisioning (C++ function), 1032



- wifi\_prov\_mgr\_wait (C++ function), 1033
- wifi\_prov\_scheme (C++ struct), 1036
- wifi\_prov\_scheme::delete\_config (C++ member), 1036
- wifi\_prov\_scheme::new\_config (C++ member), 1036
- wifi\_prov\_scheme::prov\_start (C++ member), 1036
- wifi\_prov\_scheme::prov\_stop (C++ member), 1036
- wifi\_prov\_scheme::set\_config\_endpoint (C++ member), 1036
- wifi\_prov\_scheme::set\_config\_service (C++ member), 1036
- wifi\_prov\_scheme::wifi\_mode (C++ member), 1036
- wifi\_prov\_scheme\_ble\_event\_cb\_free\_ble (C++ function), 1039
- wifi\_prov\_scheme\_ble\_event\_cb\_free\_bt (C++ function), 1039
- wifi\_prov\_scheme\_ble\_event\_cb\_free\_btdm (C++ function), 1039
- WIFI\_PROV\_SCHEME\_BLE\_EVENT\_HANDLER\_FREE\_BLE (C macro), 1040
- WIFI\_PROV\_SCHEME\_BLE\_EVENT\_HANDLER\_FREE\_BT (C macro), 1040
- WIFI\_PROV\_SCHEME\_BLE\_EVENT\_HANDLER\_FREE\_BTDM (C macro), 1040
- wifi\_prov\_scheme\_ble\_set\_mfg\_data (C++ function), 1039
- wifi\_prov\_scheme\_ble\_set\_random\_addr (C++ function), 1039
- wifi\_prov\_scheme\_ble\_set\_service\_uuid (C++ function), 1039
- wifi\_prov\_scheme\_softap\_set\_httpd\_handler (C++ function), 1040
- wifi\_prov\_scheme\_t (C++ type), 1037
- wifi\_prov\_security (C++ enum), 1038
- wifi\_prov\_security2\_params\_t (C++ type), 1037
- wifi\_prov\_security::WIFI\_PROV\_SECURITY\_0 (C++ enumerator), 1038
- wifi\_prov\_security::WIFI\_PROV\_SECURITY\_1 (C++ enumerator), 1038
- wifi\_prov\_security::WIFI\_PROV\_SECURITY\_2 (C++ enumerator), 1038
- wifi\_prov\_security\_t (C++ type), 1037
- wifi\_prov\_sta\_conn\_info\_t (C++ struct), 1041
- wifi\_prov\_sta\_conn\_info\_t::auth\_mode (C++ member), 1041
- wifi\_prov\_sta\_conn\_info\_t::bssid (C++ member), 1041
- wifi\_prov\_sta\_conn\_info\_t::channel (C++ member), 1041
- wifi\_prov\_sta\_conn\_info\_t::ip\_addr (C++ member), 1041
- wifi\_prov\_sta\_conn\_info\_t::ssid (C++ member), 1041
- wifi\_prov\_sta\_conn\_info\_t::ssid (C++ member), 1041
- wifi\_prov\_sta\_fail\_reason\_t (C++ enum), 1043
- wifi\_prov\_sta\_fail\_reason\_t::WIFI\_PROV\_STA\_AP\_NOT\_CONNECTED (C++ enumerator), 1043
- wifi\_prov\_sta\_fail\_reason\_t::WIFI\_PROV\_STA\_AUTH\_FAILED (C++ enumerator), 1043
- wifi\_prov\_sta\_state\_t (C++ enum), 1043
- wifi\_prov\_sta\_state\_t::WIFI\_PROV\_STA\_CONNECTED (C++ enumerator), 1043
- wifi\_prov\_sta\_state\_t::WIFI\_PROV\_STA\_CONNECTING (C++ enumerator), 1043
- wifi\_prov\_sta\_state\_t::WIFI\_PROV\_STA\_DISCONNECTED (C++ enumerator), 1043
- wifi\_ps\_type\_t (C++ enum), 259
- wifi\_ps\_type\_t::WIFI\_PS\_MAX\_MODEM (C++ enumerator), 259
- wifi\_ps\_type\_t::WIFI\_PS\_MIN\_MODEM (C++ enumerator), 259
- wifi\_ps\_type\_t::WIFI\_PS\_NONE (C++ enumerator), 259
- WIFI\_ROC\_CANCEL (C macro), 251
- WIFI\_ROC\_REQ (C macro), 251
- WIFI\_RX\_MGMT\_BUF\_NUM\_DEF (C macro), 231
- wifi\_sae\_pwe\_method\_t (C++ enum), 260
- wifi\_sae\_pwe\_method\_t::WPA3\_SAE\_PWE\_BOTH (C++ enumerator), 260
- wifi\_sae\_pwe\_method\_t::WPA3\_SAE\_PWE\_HASH\_TO\_ELEMENT (C++ enumerator), 260
- wifi\_sae\_pwe\_method\_t::WPA3\_SAE\_PWE\_HUNT\_AND\_PECK (C++ enumerator), 260
- wifi\_sae\_pwe\_method\_t::WPA3\_SAE\_PWE\_UNSPECIFIED (C++ enumerator), 260
- wifi\_scan\_config\_t (C++ struct), 234
- wifi\_scan\_config\_t::bssid (C++ member), 234
- wifi\_scan\_config\_t::channel (C++ member), 234
- wifi\_scan\_config\_t::home\_chan\_dwell\_time (C++ member), 235
- wifi\_scan\_config\_t::scan\_time (C++ member), 235
- wifi\_scan\_config\_t::scan\_type (C++ member), 234
- wifi\_scan\_config\_t::show\_hidden (C++ member), 234
- wifi\_scan\_config\_t::ssid (C++ member), 234
- wifi\_scan\_method\_t (C++ enum), 259
- wifi\_scan\_method\_t::WIFI\_ALL\_CHANNEL\_SCAN (C++ enumerator), 259
- wifi\_scan\_method\_t::WIFI\_FAST\_SCAN (C++ enumerator), 259
- wifi\_scan\_threshold\_t (C++ struct), 236
- wifi\_scan\_threshold\_t::authmode (C++ member), 236
- wifi\_scan\_threshold\_t::rssi (C++ member), 236

- wifi\_scan\_time\_t (C++ struct), 234
- wifi\_scan\_time\_t::active (C++ member), 234
- wifi\_scan\_time\_t::passive (C++ member), 234
- wifi\_scan\_type\_t (C++ enum), 258
- wifi\_scan\_type\_t::WIFI\_SCAN\_TYPE\_ACTIVE (C++ enumerator), 258
- wifi\_scan\_type\_t::WIFI\_SCAN\_TYPE\_PASSIVE (C++ enumerator), 258
- wifi\_second\_chan\_t (C++ enum), 257
- wifi\_second\_chan\_t::WIFI\_SECOND\_CHAN\_ABOVE (C++ enumerator), 257
- wifi\_second\_chan\_t::WIFI\_SECOND\_CHAN\_BELOW (C++ enumerator), 257
- wifi\_second\_chan\_t::WIFI\_SECOND\_CHAN\_NONE (C++ enumerator), 257
- WIFI\_SOFTAP\_BEACON\_MAX\_LEN (C macro), 231
- wifi\_sort\_method\_t (C++ enum), 259
- wifi\_sort\_method\_t::WIFI\_CONNECT\_AP\_BY\_SECURITY (C++ enumerator), 259
- wifi\_sort\_method\_t::WIFI\_CONNECT\_AP\_BY\_SIGNAL (C++ enumerator), 259
- wifi\_sta\_config\_t (C++ struct), 237
- wifi\_sta\_config\_t::bssid (C++ member), 238
- wifi\_sta\_config\_t::bssid\_set (C++ member), 238
- wifi\_sta\_config\_t::btm\_enabled (C++ member), 238
- wifi\_sta\_config\_t::channel (C++ member), 238
- wifi\_sta\_config\_t::failure\_retry\_cnt (C++ member), 239
- wifi\_sta\_config\_t::ft\_enabled (C++ member), 238
- wifi\_sta\_config\_t::listen\_interval (C++ member), 238
- wifi\_sta\_config\_t::mbo\_enabled (C++ member), 238
- wifi\_sta\_config\_t::owe\_enabled (C++ member), 238
- wifi\_sta\_config\_t::password (C++ member), 238
- wifi\_sta\_config\_t::pmf\_cfg (C++ member), 238
- wifi\_sta\_config\_t::reserved (C++ member), 239
- wifi\_sta\_config\_t::rm\_enabled (C++ member), 238
- wifi\_sta\_config\_t::sae\_pwe\_h2e (C++ member), 239
- wifi\_sta\_config\_t::scan\_method (C++ member), 238
- wifi\_sta\_config\_t::sort\_method (C++ member), 238
- wifi\_sta\_config\_t::ssid (C++ member), 238
- wifi\_sta\_config\_t::threshold (C++ member), 238
- wifi\_sta\_config\_t::transition\_disable (C++ member), 238
- WIFI\_STA\_DISCONNECTED\_PM\_ENABLED (C macro), 231
- wifi\_sta\_info\_t (C++ struct), 239
- wifi\_sta\_info\_t::is\_mesh\_child (C++ member), 239
- wifi\_sta\_info\_t::mac (C++ member), 239
- wifi\_sta\_info\_t::phy\_11b (C++ member), 239
- wifi\_sta\_info\_t::phy\_11g (C++ member), 239
- wifi\_sta\_info\_t::phy\_11n (C++ member), 239
- wifi\_sta\_info\_t::phy\_lr (C++ member), 239
- wifi\_sta\_info\_t::reserved (C++ member), 239
- wifi\_sta\_info\_t::rssi (C++ member), 239
- wifi\_sta\_info\_t::security\_list\_t (C++ struct), 239
- wifi\_sta\_info\_t::num (C++ member), 240
- wifi\_sta\_info\_t::sta (C++ member), 240
- WIFI\_STATIC\_TX\_BUFFER\_NUM (C macro), 231
- WIFI\_STATUS\_ALL (C macro), 253
- WIFI\_STATUS\_BUFFER (C macro), 253
- WIFI\_STATUS\_DIAG (C macro), 253
- WIFI\_STATUS\_HW (C macro), 253
- WIFI\_STATUS\_PS (C macro), 253
- WIFI\_STATUS\_RXTX (C macro), 253
- wifi\_storage\_t (C++ enum), 260
- wifi\_storage\_t::WIFI\_STORAGE\_FLASH (C++ enumerator), 260
- wifi\_storage\_t::WIFI\_STORAGE\_RAM (C++ enumerator), 260
- WIFI\_TASK\_CORE\_ID (C macro), 231
- WIFI\_VENDOR\_IE\_ELEMENT\_ID (C macro), 251
- wifi\_vendor\_ie\_id\_t (C++ enum), 260
- wifi\_vendor\_ie\_id\_t::WIFI\_VND\_IE\_ID\_0 (C++ enumerator), 260
- wifi\_vendor\_ie\_id\_t::WIFI\_VND\_IE\_ID\_1 (C++ enumerator), 261
- wifi\_vendor\_ie\_type\_t (C++ enum), 260
- wifi\_vendor\_ie\_type\_t::WIFI\_VND\_IE\_TYPE\_ASSOC\_REQ (C++ enumerator), 260
- wifi\_vendor\_ie\_type\_t::WIFI\_VND\_IE\_TYPE\_ASSOC\_RES (C++ enumerator), 260
- wifi\_vendor\_ie\_type\_t::WIFI\_VND\_IE\_TYPE\_BEACON (C++ enumerator), 260
- wifi\_vendor\_ie\_type\_t::WIFI\_VND\_IE\_TYPE\_PROBE\_REQ (C++ enumerator), 260
- wifi\_vendor\_ie\_type\_t::WIFI\_VND\_IE\_TYPE\_PROBE\_RES (C++ enumerator), 260
- wl\_erase\_range (C++ function), 1152
- wl\_handle\_t (C++ type), 1154
- WL\_INVALID\_HANDLE (C macro), 1154
- wl\_mount (C++ function), 1152
- wl\_read (C++ function), 1153
- wl\_sector\_size (C++ function), 1153

- [wl\\_size \(C++ function\), 1153](#)  
[wl\\_unmount \(C++ function\), 1152](#)  
[wl\\_write \(C++ function\), 1153](#)  
[WPS\\_CONFIG\\_INIT\\_DEFAULT \(C macro\), 274](#)  
[wps\\_factory\\_information\\_t \(C++ struct\), 273](#)  
[wps\\_factory\\_information\\_t::device\\_name \(C++ member\), 273](#)  
[wps\\_factory\\_information\\_t::manufacturer \(C++ member\), 273](#)  
[wps\\_factory\\_information\\_t::model\\_name \(C++ member\), 273](#)  
[wps\\_factory\\_information\\_t::model\\_number \(C++ member\), 273](#)  
[wps\\_fail\\_reason\\_t \(C++ enum\), 267](#)  
[wps\\_fail\\_reason\\_t::WPS\\_AP\\_FAIL\\_REASON\\_401 \(C++ enumerator\), 267](#)  
[wps\\_fail\\_reason\\_t::WPS\\_AP\\_FAIL\\_REASON\\_403 \(C++ enumerator\), 267](#)  
[wps\\_fail\\_reason\\_t::WPS\\_AP\\_FAIL\\_REASON\\_404 \(C++ enumerator\), 267](#)  
[wps\\_fail\\_reason\\_t::WPS\\_AP\\_FAIL\\_REASON\\_405 \(C++ enumerator\), 267](#)  
[WPS\\_MAX\\_DEVICE\\_NAME\\_LEN \(C macro\), 274](#)  
[WPS\\_MAX\\_MANUFACTURER\\_LEN \(C macro\), 274](#)  
[WPS\\_MAX\\_MODEL\\_NAME\\_LEN \(C macro\), 274](#)  
[WPS\\_MAX\\_MODEL\\_NUMBER\\_LEN \(C macro\), 274](#)  
[wps\\_type \(C++ enum\), 275](#)  
[wps\\_type::WPS\\_TYPE\\_DISABLE \(C++ enumerator\), 275](#)  
[wps\\_type::WPS\\_TYPE\\_MAX \(C++ enumerator\), 275](#)  
[wps\\_type::WPS\\_TYPE\\_PBC \(C++ enumerator\), 275](#)  
[wps\\_type::WPS\\_TYPE\\_PIN \(C++ enumerator\), 275](#)  
[wps\\_type\\_t \(C++ type\), 274](#)
- X**
- [xEventGroupClearBits \(C++ function\), 1324](#)  
[xEventGroupClearBitsFromISR \(C macro\), 1327](#)  
[xEventGroupCreate \(C++ function\), 1321](#)  
[xEventGroupCreateStatic \(C++ function\), 1322](#)  
[xEventGroupGetBits \(C macro\), 1329](#)  
[xEventGroupGetBitsFromISR \(C++ function\), 1327](#)  
[xEventGroupSetBits \(C++ function\), 1324](#)  
[xEventGroupSetBitsFromISR \(C macro\), 1328](#)  
[xEventGroupSync \(C++ function\), 1325](#)  
[xEventGroupWaitBits \(C++ function\), 1322](#)  
[xMessageBufferCreate \(C macro\), 1338](#)  
[xMessageBufferCreateStatic \(C macro\), 1338](#)  
[xMessageBufferIsEmpty \(C macro\), 1344](#)  
[xMessageBufferIsFull \(C macro\), 1344](#)  
[xMessageBufferNextLengthBytes \(C macro\), 1345](#)  
[xMessageBufferReceive \(C macro\), 1342](#)  
[xMessageBufferReceiveCompletedFromISR \(C macro\), 1345](#)  
[xMessageBufferReceiveFromISR \(C macro\), 1343](#)  
[xMessageBufferReset \(C macro\), 1344](#)  
[xMessageBufferSend \(C macro\), 1339](#)  
[xMessageBufferSendCompletedFromISR \(C macro\), 1345](#)  
[xMessageBufferSendFromISR \(C macro\), 1341](#)  
[xMessageBufferSpaceAvailable \(C macro\), 1345](#)  
[xMessageBufferSpacesAvailable \(C macro\), 1345](#)  
[xQueueAddToSet \(C++ function\), 1278](#)  
[xQueueCreate \(C macro\), 1279](#)  
[xQueueCreateSet \(C++ function\), 1277](#)  
[xQueueCreateStatic \(C macro\), 1280](#)  
[xQueueGenericCreate \(C++ function\), 1277](#)  
[xQueueGenericCreateStatic \(C++ function\), 1277](#)  
[xQueueGenericSend \(C++ function\), 1270](#)  
[xQueueGenericSendFromISR \(C++ function\), 1274](#)  
[xQueueGiveFromISR \(C++ function\), 1275](#)  
[xQueueIsQueueEmptyFromISR \(C++ function\), 1277](#)  
[xQueueIsQueueFullFromISR \(C++ function\), 1277](#)  
[xQueueOverwrite \(C macro\), 1284](#)  
[xQueueOverwriteFromISR \(C macro\), 1287](#)  
[xQueuePeek \(C++ function\), 1272](#)  
[xQueuePeekFromISR \(C++ function\), 1273](#)  
[xQueueReceive \(C++ function\), 1273](#)  
[xQueueReceiveFromISR \(C++ function\), 1275](#)  
[xQueueRemoveFromSet \(C++ function\), 1278](#)  
[xQueueReset \(C macro\), 1289](#)  
[xQueueSelectFromSet \(C++ function\), 1279](#)  
[xQueueSelectFromSetFromISR \(C++ function\), 1279](#)  
[xQueueSend \(C macro\), 1283](#)  
[xQueueSendFromISR \(C macro\), 1288](#)  
[xQueueSendToBack \(C macro\), 1282](#)  
[xQueueSendToBackFromISR \(C macro\), 1286](#)  
[xQueueSendToFront \(C macro\), 1281](#)  
[xQueueSendToFrontFromISR \(C macro\), 1285](#)  
[xRingbufferAddToQueueSetRead \(C++ function\), 1362](#)  
[xRingbufferCanRead \(C++ function\), 1362](#)  
[xRingbufferCreate \(C++ function\), 1356](#)  
[xRingbufferCreateNoSplit \(C++ function\), 1356](#)  
[xRingbufferCreateStatic \(C++ function\), 1356](#)  
[xRingbufferGetCurFreeSize \(C++ function\), 1362](#)  
[xRingbufferGetMaxItemSize \(C++ function\), 1362](#)  
[xRingbufferPrintInfo \(C++ function\), 1363](#)



- [xRingbufferReceive \(C++ function\), 1358](#)  
[xRingbufferReceiveFromISR \(C++ function\), 1359](#)  
[xRingbufferReceiveSplit \(C++ function\), 1359](#)  
[xRingbufferReceiveSplitFromISR \(C++ function\), 1359](#)  
[xRingbufferReceiveUpTo \(C++ function\), 1360](#)  
[xRingbufferReceiveUpToFromISR \(C++ function\), 1360](#)  
[xRingbufferRemoveFromQueueSetRead \(C++ function\), 1362](#)  
[xRingbufferSend \(C++ function\), 1357](#)  
[xRingbufferSendAcquire \(C++ function\), 1358](#)  
[xRingbufferSendComplete \(C++ function\), 1358](#)  
[xRingbufferSendFromISR \(C++ function\), 1357](#)  
[xSemaphoreCreateBinary \(C macro\), 1290](#)  
[xSemaphoreCreateBinaryStatic \(C macro\), 1290](#)  
[xSemaphoreCreateCounting \(C macro\), 1299](#)  
[xSemaphoreCreateCountingStatic \(C macro\), 1301](#)  
[xSemaphoreCreateMutex \(C macro\), 1297](#)  
[xSemaphoreCreateMutexStatic \(C macro\), 1298](#)  
[xSemaphoreGetMutexHolder \(C macro\), 1302](#)  
[xSemaphoreGetMutexHolderFromISR \(C macro\), 1302](#)  
[xSemaphoreGive \(C macro\), 1293](#)  
[xSemaphoreGiveFromISR \(C macro\), 1295](#)  
[xSemaphoreGiveRecursive \(C macro\), 1294](#)  
[xSemaphoreTake \(C macro\), 1291](#)  
[xSemaphoreTakeFromISR \(C macro\), 1297](#)  
[xSemaphoreTakeRecursive \(C macro\), 1292](#)  
[xSTATIC\\_RINGBUFFER \(C++ struct\), 1363](#)  
[xStreamBufferBytesAvailable \(C++ function\), 1334](#)  
[xStreamBufferCreate \(C macro\), 1336](#)  
[xStreamBufferCreateStatic \(C macro\), 1337](#)  
[xStreamBufferIsEmpty \(C++ function\), 1334](#)  
[xStreamBufferIsFull \(C++ function\), 1334](#)  
[xStreamBufferReceive \(C++ function\), 1332](#)  
[xStreamBufferReceiveCompletedFromISR \(C++ function\), 1335](#)  
[xStreamBufferReceiveFromISR \(C++ function\), 1333](#)  
[xStreamBufferReset \(C++ function\), 1334](#)  
[xStreamBufferSend \(C++ function\), 1329](#)  
[xStreamBufferSendCompletedFromISR \(C++ function\), 1335](#)  
[xStreamBufferSendFromISR \(C++ function\), 1331](#)  
[xStreamBufferSetTriggerLevel \(C++ function\), 1335](#)  
[xStreamBufferSpacesAvailable \(C++ function\), 1334](#)  
[xTaskAbortDelay \(C++ function\), 1246](#)  
[xTaskCallApplicationTaskHook \(C++ function\), 1255](#)  
[xTaskCatchUpTicks \(C++ function\), 1266](#)  
[xTaskCheckForTimeOut \(C++ function\), 1265](#)  
[xTaskCreate \(C++ function\), 1237](#)  
[xTaskCreatePinnedToCore \(C++ function\), 1237](#)  
[xTaskCreateRestricted \(C++ function\), 1241](#)  
[xTaskCreateStatic \(C++ function\), 1239](#)  
[xTaskCreateStaticPinnedToCore \(C++ function\), 1239](#)  
[xTaskDelayUntil \(C++ function\), 1245](#)  
[xTaskGenericNotify \(C++ function\), 1258](#)  
[xTaskGenericNotifyFromISR \(C++ function\), 1259](#)  
[xTaskGenericNotifyStateClear \(C++ function\), 1264](#)  
[xTaskGenericNotifyWait \(C++ function\), 1261](#)  
[xTaskGetApplicationTaskTag \(C++ function\), 1254](#)  
[xTaskGetApplicationTaskTagFromISR \(C++ function\), 1254](#)  
[xTaskGetHandle \(C++ function\), 1253](#)  
[xTaskGetIdleTaskHandle \(C++ function\), 1255](#)  
[xTaskGetTickCount \(C++ function\), 1252](#)  
[xTaskGetTickCountFromISR \(C++ function\), 1252](#)  
[xTaskNotify \(C macro\), 1267](#)  
[xTaskNotifyAndQuery \(C macro\), 1268](#)  
[xTaskNotifyAndQueryFromISR \(C macro\), 1268](#)  
[xTaskNotifyAndQueryIndexed \(C macro\), 1268](#)  
[xTaskNotifyAndQueryIndexedFromISR \(C macro\), 1268](#)  
[xTaskNotifyFromISR \(C macro\), 1268](#)  
[xTaskNotifyGive \(C macro\), 1269](#)  
[xTaskNotifyGiveIndexed \(C macro\), 1268](#)  
[xTaskNotifyIndexed \(C macro\), 1267](#)  
[xTaskNotifyIndexedFromISR \(C macro\), 1268](#)  
[xTaskNotifyStateClear \(C macro\), 1269](#)  
[xTaskNotifyStateClearIndexed \(C macro\), 1269](#)  
[xTaskNotifyWait \(C macro\), 1268](#)  
[xTaskNotifyWaitIndexed \(C macro\), 1268](#)  
[xTaskResumeAll \(C++ function\), 1251](#)  
[xTaskResumeFromISR \(C++ function\), 1250](#)  
[xtensa\\_perfmon\\_config \(C++ struct\), 1439](#)  
[xtensa\\_perfmon\\_config::call\\_function \(C++ member\), 1440](#)  
[xtensa\\_perfmon\\_config::call\\_params \(C++ member\), 1440](#)  
[xtensa\\_perfmon\\_config::callback \(C++ member\), 1440](#)  
[xtensa\\_perfmon\\_config::callback\\_params \(C++ member\), 1440](#)  
[xtensa\\_perfmon\\_config::counters\\_size \(C++ member\), 1440](#)  
[xtensa\\_perfmon\\_config::max\\_deviation \(C++ member\), 1440](#)

`xtensa_perfmon_config::repeat_count`  
(C++ member), 1440

`xtensa_perfmon_config::select_mask`  
(C++ member), 1440

`xtensa_perfmon_config::tracelevel`  
(C++ member), 1440

`xtensa_perfmon_config_t` (C++ type), 1440

`xtensa_perfmon_dump` (C++ function), 1439

`xtensa_perfmon_exec` (C++ function), 1439

`xtensa_perfmon_init` (C++ function), 1438

`xtensa_perfmon_overflow` (C++ function),  
1439

`xtensa_perfmon_reset` (C++ function), 1438

`xtensa_perfmon_start` (C++ function), 1438

`xtensa_perfmon_stop` (C++ function), 1438

`xtensa_perfmon_value` (C++ function), 1438

`xtensa_perfmon_view_cb` (C++ function), 1439

`xTimerChangePeriod` (C macro), 1313

`xTimerChangePeriodFromISR` (C macro), 1318

`xTimerCreate` (C++ function), 1303

`xTimerCreateStatic` (C++ function), 1305

`xTimerDelete` (C macro), 1314

`xTimerGetExpiryTime` (C++ function), 1310

`xTimerGetPeriod` (C++ function), 1310

`xTimerGetTimerDaemonTaskHandle` (C++  
function), 1308

`xTimerIsTimerActive` (C++ function), 1308

`xTimerPendFunctionCall` (C++ function), 1310

`xTimerPendFunctionCallFromISR` (C++ func-  
tion), 1308

`xTimerReset` (C macro), 1314

`xTimerResetFromISR` (C macro), 1320

`xTimerStart` (C macro), 1311

`xTimerStartFromISR` (C macro), 1316

`xTimerStop` (C macro), 1312

`xTimerStopFromISR` (C macro), 1318