

ESP32-C3

ESP-IDF Programming Guide



Release v4.3.4
Espressif Systems
Sep 12, 2022

Table of contents

Table of contents	i
1 Get Started	3
1.1 Introduction	3
1.2 What You Need	3
1.3 Development Board Overviews	4
1.3.1 ESP32-C3-DevKitM-1	4
1.3.2 ESP32-C3-DevKitC-02	9
1.4 Installation Step by Step	13
1.4.1 Setting up Development Environment	13
1.4.2 Creating Your First Project	13
1.5 Step 1. Install prerequisites	14
1.5.1 Standard Setup of Toolchain for Windows	14
1.5.2 Standard Setup of Toolchain for Linux	19
1.5.3 Standard Setup of Toolchain for macOS	20
1.6 Step 2. Get ESP-IDF	21
1.6.1 Linux and macOS	21
1.6.2 Windows	21
1.7 Step 3. Set up the tools	22
1.7.1 Windows	22
1.7.2 Linux and macOS	22
1.7.3 Alternative File Downloads	22
1.7.4 Customizing the tools installation path	23
1.8 Step 4. Set up the environment variables	23
1.8.1 Windows	23
1.8.2 Linux and macOS	23
1.9 Step 5. Start a Project	24
1.9.1 Linux and macOS	24
1.9.2 Windows	24
1.10 Step 6. Connect Your Device	24
1.11 Step 7. Configure	25
1.11.1 Linux and macOS	25
1.11.2 Windows	25
1.12 Step 8. Build the Project	26
1.13 Step 9. Flash onto the Device	26
1.13.1 Encountered Issues While Flashing?	26
1.13.2 Normal Operation	27
1.14 Step 10. Monitor	28
1.15 Updating ESP-IDF	29
1.16 Related Documents	29
1.16.1 Establish Serial Connection with ESP32-C3	29
1.16.2 Build and Flash with Eclipse IDE	35
1.16.3 Getting Started with VS Code IDE	36
1.16.4 IDF Monitor	36
1.16.5 Customized Setup of Toolchain	41
2 API Reference	47

2.1	Bluetooth API	47
2.1.1	Controller && VHCI	47
2.1.2	BT COMMON	54
2.1.3	BT LE	59
2.1.4	NimBLE-based host APIs	151
2.1.5	ESP-BLE-MESH	154
2.2	Networking APIs	366
2.2.1	Wi-Fi	366
2.2.2	Ethernet	448
2.2.3	IP Network Layer	469
2.2.4	Application Layer	486
2.3	Peripherals API	486
2.3.1	Analog to Digital Converter	486
2.3.2	General Purpose Timer	503
2.3.3	GPIO & RTC GPIO	513
2.3.4	HMAC	526
2.3.5	Digital Signature	529
2.3.6	I2C Driver	534
2.3.7	I2S	548
2.3.8	LED Control	558
2.3.9	RMT	570
2.3.10	SD SPI Host Driver	588
2.3.11	Sigma-delta Modulation	592
2.3.12	SPI Master Driver	595
2.3.13	SPI Slave Driver	611
2.3.14	TWAI	617
2.3.15	UART	632
2.4	Application Protocols	653
2.4.1	ASIO port	653
2.4.2	ESP-MQTT	654
2.4.3	ESP-TLS	665
2.4.4	ESP HTTP Client	678
2.4.5	HTTP Server	691
2.4.6	HTTPS server	712
2.4.7	ICMP Echo	715
2.4.8	ESP Local Control	719
2.4.9	mDNS Service	727
2.4.10	ESP-Modbus	736
2.4.11	ESP WebSocket Client	741
2.4.12	ESP Serial Slave Link	748
2.4.13	ESP x509 Certificate Bundle	761
2.4.14	IP Network Layer	763
2.5	Provisioning API	763
2.5.1	Protocol Communication	763
2.5.2	Unified Provisioning	773
2.5.3	Wi-Fi Provisioning	778
2.6	Storage API	793
2.6.1	FAT Filesystem Support	793
2.6.2	Manufacturing Utility	798
2.6.3	Non-volatile storage library	802
2.6.4	NVS Partition Generator Utility	822
2.6.5	SD/SDIO/MMC Driver	829
2.6.6	SPI Flash API	837
2.6.7	SPIFFS Filesystem	860
2.6.8	Virtual filesystem component	863
2.6.9	Wear Levelling API	875
2.7	System API	879
2.7.1	App Image Format	879

2.7.2	Application Level Tracing	884
2.7.3	The Async memcpy API	888
2.7.4	Console	891
2.7.5	eFuse Manager	899
2.7.6	Error Codes and Helper Functions	918
2.7.7	ESP HTTPS OTA	919
2.7.8	ESP-pthread	923
2.7.9	Event Loop Library	925
2.7.10	FreeRTOS	941
2.7.11	FreeRTOS Additions	1034
2.7.12	Heap Memory Allocation	1050
2.7.13	Heap Memory Debugging	1061
2.7.14	High Resolution Timer	1072
2.7.15	Call function with external stack	1076
2.7.16	Interrupt allocation	1077
2.7.17	Logging library	1082
2.7.18	Miscellaneous System APIs	1087
2.7.19	Over The Air Updates (OTA)	1094
2.7.20	Power Management	1105
2.7.21	Sleep Modes	1110
2.7.22	Watchdogs	1117
2.7.23	System Time	1121
2.7.24	Internal and Unstable APIs	1125
2.8	Project Configuration	1125
2.8.1	Introduction	1125
2.8.2	Project Configuration Menu	1126
2.8.3	Using sdkconfig.defaults	1126
2.8.4	Kconfig Formatting Rules	1126
2.8.5	Backward Compatibility of Kconfig Options	1127
2.8.6	Configuration Options Reference	1127
2.8.7	Customisations	1348
2.9	Error Codes Reference	1348
3	ESP32-C3 Hardware Reference	1355
3.1	ESP32-C3 Modules and Boards	1355
3.1.1	Related Documents	1355
3.2	Previous Versions of ESP32-C3 Modules and Boards	1355
3.2.1	Related Documents	1355
3.3	Chip Series Comparison	1355
3.3.1	Related Documents	1358
4	API Guides	1359
4.1	Application Level Tracing library	1359
4.1.1	Overview	1359
4.1.2	Modes of Operation	1359
4.1.3	Configuration Options and Dependencies	1360
4.1.4	How to use this library	1361
4.2	Application Startup Flow	1369
4.2.1	First stage bootloader	1369
4.2.2	Second stage bootloader	1370
4.2.3	Application startup	1370
4.3	BluFi	1371
4.3.1	Overview	1372
4.3.2	The BluFi Flow	1372
4.3.3	The flow chart of BluFi	1372
4.3.4	The Frame Formats Defined in BluFi	1372
4.3.5	The Security Implementation of ESP32-C3	1377
4.3.6	GATT Related Instructions	1378

4.4	Bootloader	1378
4.4.1	Bootloader compatibility	1378
4.4.2	Factory reset	1379
4.4.3	Boot from test app partition	1380
4.4.4	Fast boot from Deep Sleep	1380
4.4.5	Custom bootloader	1380
4.5	Build System	1380
4.5.1	Overview	1380
4.5.2	Using the Build System	1381
4.5.3	Example Project	1385
4.5.4	Project CMakeLists File	1385
4.5.5	Component CMakeLists Files	1387
4.5.6	Component Configuration	1389
4.5.7	Preprocessor Definitions	1389
4.5.8	Component Requirements	1389
4.5.9	Overriding Parts of the Project	1392
4.5.10	Configuration-Only Components	1393
4.5.11	Debugging CMake	1393
4.5.12	Example Component CMakeLists	1394
4.5.13	Custom sdkconfig defaults	1398
4.5.14	Flash arguments	1398
4.5.15	Building the Bootloader	1398
4.5.16	Selecting the Target	1399
4.5.17	Writing Pure CMake Components	1399
4.5.18	Using Third-Party CMake Projects with Components	1400
4.5.19	Using Prebuilt Libraries with Components	1400
4.5.20	Using ESP-IDF in Custom CMake Projects	1401
4.5.21	ESP-IDF CMake Build System API	1401
4.5.22	File Globbing & Incremental Builds	1405
4.5.23	Build System Metadata	1406
4.5.24	Build System Internals	1406
4.5.25	Migrating from ESP-IDF GNU Make System	1408
4.6	Deep Sleep Wake Stubs	1410
4.6.1	Rules for Wake Stubs	1410
4.6.2	Implementing A Stub	1410
4.6.3	Loading Code Into RTC Memory	1410
4.6.4	Loading Data Into RTC Memory	1411
4.6.5	CRC Check For Wake Stubs	1411
4.7	Error Handling	1411
4.7.1	Overview	1411
4.7.2	Error codes	1412
4.7.3	Converting error codes to error messages	1412
4.7.4	ESP_ERROR_CHECK macro	1412
4.7.5	Error handling patterns	1413
4.7.6	C++ Exceptions	1413
4.8	ESP-BLE-MESH	1414
4.8.1	Getting Started with ESP-BLE-MESH	1414
4.8.2	ESP-BLE-MESH Examples	1420
4.8.3	ESP-BLE-MESH Demo Videos	1422
4.8.4	ESP-BLE-MESH FAQ	1422
4.8.5	Related Documents	1422
4.9	ESP-MESH	1451
4.9.1	Overview	1451
4.9.2	Introduction	1451
4.9.3	ESP-MESH Concepts	1452
4.9.4	Building a Network	1458
4.9.5	Managing a Network	1463
4.9.6	Data Transmission	1466

4.9.7	Channel Switching	1468
4.9.8	Performance	1471
4.9.9	Further Notes	1472
4.10	Core Dump	1472
4.10.1	Overview	1472
4.10.2	Configurations	1472
4.10.3	Save core dump to flash	1473
4.10.4	Print core dump to UART	1473
4.10.5	ROM Functions in Backtraces	1474
4.10.6	Dumping variables on demand	1474
4.10.7	Running <code>espcoredump.py</code>	1474
4.11	Event Handling	1475
4.11.1	Wi-Fi, Ethernet, and IP Events	1475
4.11.2	Mesh Events	1477
4.11.3	Bluetooth Events	1477
4.12	Fatal Errors	1477
4.12.1	Overview	1477
4.12.2	Panic Handler	1477
4.12.3	Register Dump and Backtrace	1478
4.12.4	GDB Stub	1480
4.12.5	Guru Meditation Errors	1481
4.12.6	Other Fatal Errors	1482
4.13	Flash Encryption	1483
4.13.1	Introduction	1483
4.13.2	Relevant eFuses	1483
4.13.3	Flash Encryption Process	1484
4.13.4	Flash Encryption Configuration	1485
4.13.5	Possible Failures	1490
4.13.6	ESP32-C3 Flash Encryption Status	1491
4.13.7	Reading and Writing Data in Encrypted Flash	1492
4.13.8	Updating Encrypted Flash	1493
4.13.9	Disabling Flash Encryption	1493
4.13.10	Key Points About Flash Encryption	1493
4.13.11	Limitations of Flash Encryption	1494
4.13.12	Flash Encryption and Secure Boot	1494
4.13.13	Advanced Features	1494
4.13.14	Technical Details	1495
4.14	ESP-IDF FreeRTOS SMP Changes	1495
4.14.1	Overview	1495
4.14.2	Tasks and Task Creation	1496
4.14.3	Scheduling	1496
4.14.4	Critical Sections & Disabling Interrupts	1499
4.14.5	Task Deletion	1499
4.14.6	Thread Local Storage Pointers & Deletion Callbacks	1499
4.14.7	Configuring ESP-IDF FreeRTOS	1500
4.15	Hardware Abstraction	1500
4.15.1	Architecture	1501
4.15.2	LL (Low Level) Layer	1501
4.15.3	HAL (Hardware Abstraction Layer)	1502
4.16	JTAG Debugging	1503
4.16.1	Introduction	1503
4.16.2	How it Works?	1504
4.16.3	Selecting JTAG Adapter	1505
4.16.4	Setup of OpenOCD	1505
4.16.5	Configuring ESP32-C3 Target	1506
4.16.6	Launching Debugger	1508
4.16.7	Debugging Examples	1508
4.16.8	Building OpenOCD from Sources	1508

4.16.9	Tips and Quirks	1513
4.16.10	Related Documents	1517
4.17	Linker Script Generation	1542
4.17.1	Overview	1542
4.17.2	Quick Start	1542
4.17.3	Linker Script Generation Internals	1545
4.18	Memory Types	1551
4.18.1	DRAM (Data RAM)	1551
4.18.2	IRAM (Instruction RAM)	1551
4.18.3	IROM (code executed from Flash)	1552
4.18.4	RTC fast memory	1552
4.18.5	DROM (data stored in Flash)	1553
4.18.6	DMA Capable Requirement	1553
4.18.7	DMA Buffer in the stack	1553
4.19	lwIP	1554
4.19.1	Supported APIs	1554
4.19.2	BSD Sockets API	1554
4.19.3	Netconn API	1558
4.19.4	lwIP FreeRTOS Task	1558
4.19.5	esp-lwip custom modifications	1559
4.19.6	Performance Optimization	1560
4.20	Partition Tables	1561
4.20.1	Overview	1561
4.20.2	Built-in Partition Tables	1561
4.20.3	Creating Custom Tables	1562
4.20.4	Generating Binary Partition Table	1564
4.20.5	Flashing the partition table	1564
4.20.6	Partition Tool (parttool.py)	1565
4.21	RF calibration	1566
4.21.1	Partial calibration	1566
4.21.2	Full calibration	1566
4.21.3	No calibration	1567
4.21.4	PHY initialization data	1567
4.22	Secure Boot V2	1567
4.22.1	Background	1567
4.22.2	Advantages	1568
4.22.3	Secure Boot V2 Process	1568
4.22.4	Signature Block Format	1568
4.22.5	Verifying the signature Block	1569
4.22.6	Bootloader Size	1569
4.22.7	eFuse usage	1569
4.22.8	How To Enable Secure Boot V2	1569
4.22.9	Restrictions after Secure Boot is enabled	1570
4.22.10	Generating Secure Boot Signing Key	1571
4.22.11	Remote Signing of Images	1571
4.22.12	Secure Boot Best Practices	1571
4.22.13	Key Management	1571
4.22.14	Multiple Keys	1572
4.22.15	Key Revocation	1572
4.22.16	Technical Details	1572
4.22.17	Secure Boot & Flash Encryption	1573
4.22.18	Signed App Verification Without Hardware Secure Boot	1573
4.22.19	Advanced Features	1574
4.23	Thread Local Storage	1574
4.23.1	Overview	1574
4.23.2	FreeRTOS Native API	1574
4.23.3	Pthread API	1574
4.23.4	C11 Standard	1575







4.24	Tools	1575
4.24.1	Downloadable Tools	1575
4.24.2	IDF Docker Image	1583
4.24.3	IDF Windows Installer	1585
4.24.4	IDF Component Manager	1586
4.25	Unit Testing in ESP32-C3	1587
4.25.1	Normal Test Cases	1587
4.25.2	Multi-device Test Cases	1588
4.25.3	Multi-stage Test Cases	1589
4.25.4	Tests For Different Targets	1589
4.25.5	Building Unit Test App	1590
4.25.6	Running Unit Tests	1591
4.25.7	Timing Code with Cache Compensated Timer	1592
4.25.8	Mocks	1592
4.26	USB Serial/JTAG Controller Console	1593
4.26.1	Hardware Requirements	1593
4.26.2	Software Configuration	1593
4.26.3	Uploading the Application	1593
4.26.4	Limitations	1594
4.27	Wi-Fi Driver	1594
4.27.1	ESP32-C3 Wi-Fi Feature List	1594
4.27.2	How To Write a Wi-Fi Application	1594
4.27.3	ESP32-C3 Wi-Fi API Error Code	1595
4.27.4	ESP32-C3 Wi-Fi API Parameter Initialization	1595
4.27.5	ESP32-C3 Wi-Fi Programming Model	1596
4.27.6	ESP32-C3 Wi-Fi Event Description	1596
4.27.7	ESP32-C3 Wi-Fi Station General Scenario	1599
4.27.8	ESP32-C3 Wi-Fi AP General Scenario	1602
4.27.9	ESP32-C3 Wi-Fi Scan	1602
4.27.10	ESP32-C3 Wi-Fi Station Connecting Scenario	1609
4.27.11	ESP32-C3 Wi-Fi Station Connecting When Multiple APs Are Found	1613
4.27.12	Wi-Fi Reconnect	1613
4.27.13	Wi-Fi Beacon Timeout	1613
4.27.14	ESP32-C3 Wi-Fi Configuration	1613
4.27.15	Wi-Fi Easy Connect™ (DPP)	1618
4.27.16	Wireless Network Management	1619
4.27.17	Radio Resource Measurement	1619
4.27.18	Wi-Fi Location	1619
4.27.19	ESP32-C3 Wi-Fi Power-saving Mode	1620
4.27.20	ESP32-C3 Wi-Fi Throughput	1621
4.27.21	Wi-Fi 80211 Packet Send	1621
4.27.22	Wi-Fi Sniffer Mode	1622
4.27.23	Wi-Fi Multiple Antennas	1623
4.27.24	Wi-Fi Channel State Information	1624
4.27.25	Wi-Fi Channel State Information Configure	1626
4.27.26	Wi-Fi HT20/40	1626
4.27.27	Wi-Fi QoS	1626
4.27.28	Wi-Fi AMSDU	1627
4.27.29	Wi-Fi Fragment	1627
4.27.30	WPS Enrollee	1627
4.27.31	Wi-Fi Buffer Usage	1627
4.27.32	How to improve Wi-Fi performance	1628
4.27.33	Wi-Fi Menuconfig	1630
4.27.34	Troubleshooting	1633
4.28	Wi-Fi Security	1637
4.28.1	ESP32-C3 Wi-Fi Security Features	1639
4.28.2	Protected Management Frames (PMF)	1639
4.28.3	WPA3-Personal	1640

5	Libraries and Frameworks	1641
5.1	Cloud Frameworks	1641
5.1.1	AWS IoT	1641
5.1.2	Azure IoT	1641
5.1.3	Google IoT Core	1641
5.1.4	Aliyun IoT	1641
5.1.5	Joylink IoT	1641
5.1.6	Tencent IoT	1641
5.1.7	Tencentyun IoT	1642
5.1.8	Baidu IoT	1642
6	Contributions Guide	1643
6.1	How to Contribute	1643
6.2	Before Contributing	1643
6.3	Pull Request Process	1643
6.4	Legal Part	1644
6.5	Related Documents	1644
6.5.1	Espressif IoT Development Framework Style Guide	1644
6.5.2	Install pre-commit Hook for ESP-IDF Project	1650
6.5.3	Documenting Code	1651
6.5.4	Documentation Add-ons and Extensions Reference	1661
6.5.5	Creating Examples	1664
6.5.6	API Documentation Template	1665
6.5.7	Contributor Agreement	1667
7	ESP-IDF Versions	1671
7.1	Releases	1671
7.2	Which Version Should I Start With?	1671
7.3	Versioning Scheme	1671
7.4	Support Periods	1672
7.5	Checking the Current Version	1673
7.6	Git Workflow	1674
7.7	Updating ESP-IDF	1674
7.7.1	Updating to Stable Release	1675
7.7.2	Updating to a Pre-Release Version	1675
7.7.3	Updating to Master Branch	1675
7.7.4	Updating to a Release Branch	1676
8	Resources	1677
8.1	PlatformIO	1677
8.1.1	What is PlatformIO?	1677
8.1.2	Installation	1677
8.1.3	Configuration	1678
8.1.4	Tutorials	1678
8.1.5	Project Examples	1678
8.1.6	Next Steps	1678
8.2	Useful Links	1678
9	Copyrights and Licenses	1679
9.1	Software Copyrights	1679
9.1.1	Firmware Components	1679
9.1.2	Build Tools	1680
9.1.3	Documentation	1680
9.2	ROM Source Code Copyrights	1680
9.3	Xtensa libhal MIT License	1681
9.4	TinyBasic Plus MIT License	1681
9.5	TJpgDec License	1681
10	About	1683

11 Switch Between Languages	1685
Index	1687
Index	1687

This is the documentation for Espressif IoT Development Framework ([esp-idf](#)). ESP-IDF is the official development framework for the [ESP32](#), [ESP32-S](#) and [ESP32-C Series SoCs](#).

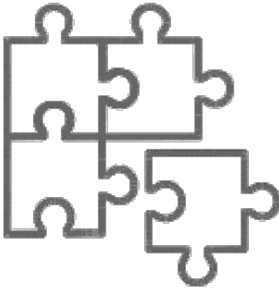
This document describes using ESP-IDF with the ESP32-C3 SoC.

		
Get Started	API Reference	H/W Reference
		
API Guides	Contribute	Resources

Chapter 1

Get Started

This document is intended to help you set up the software development environment for the hardware based on the ESP32-C3 chip by Espressif. After that, a simple example will show you how to use ESP-IDF (Espressif IoT Development Framework) for menu configuration, then for building and flashing firmware onto an ESP32-C3 board.

Note: This is documentation for stable version v4.3.4 of ESP-IDF. Other *ESP-IDF Versions* are also available.

1.1 Introduction

ESP32-C3 is a system on a chip that integrates the following features:

- Wi-Fi (2.4 GHz band)
- Bluetooth Low Energy
- High performance 32-bit RISC-V single-core processor
- Multiple peripherals
- Built-in security hardware

Powered by 40 nm technology, ESP32-C3 provides a robust, highly integrated platform, which helps meet the continuous demands for efficient power usage, compact design, security, high performance, and reliability.

Espressif provides basic hardware and software resources to help application developers realize their ideas using the ESP32-C3 series hardware. The software development framework by Espressif is intended for development of Internet-of-Things (IoT) applications with Wi-Fi, Bluetooth, power management and several other system features.

1.2 What You Need

Hardware:

- An **ESP32-C3** board
- **USB cable** - USB A / micro USB B
- **Computer** running Windows, Linux, or macOS

Software:

You have a choice to either download and install the following software manually

- **Toolchain** to compile code for ESP32-C3
- **Build tools** - CMake and Ninja to build a full **Application** for ESP32-C3
- **ESP-IDF** that essentially contains API (software libraries and source code) for ESP32-C3 and scripts to operate the **Toolchain**

or get through the onboarding process using the following official plugins for integrated development environments (IDE) described in separate documents

- [Eclipse Plugin \(installation link\)](#)
- [VS Code Extension \(setup\)](#)

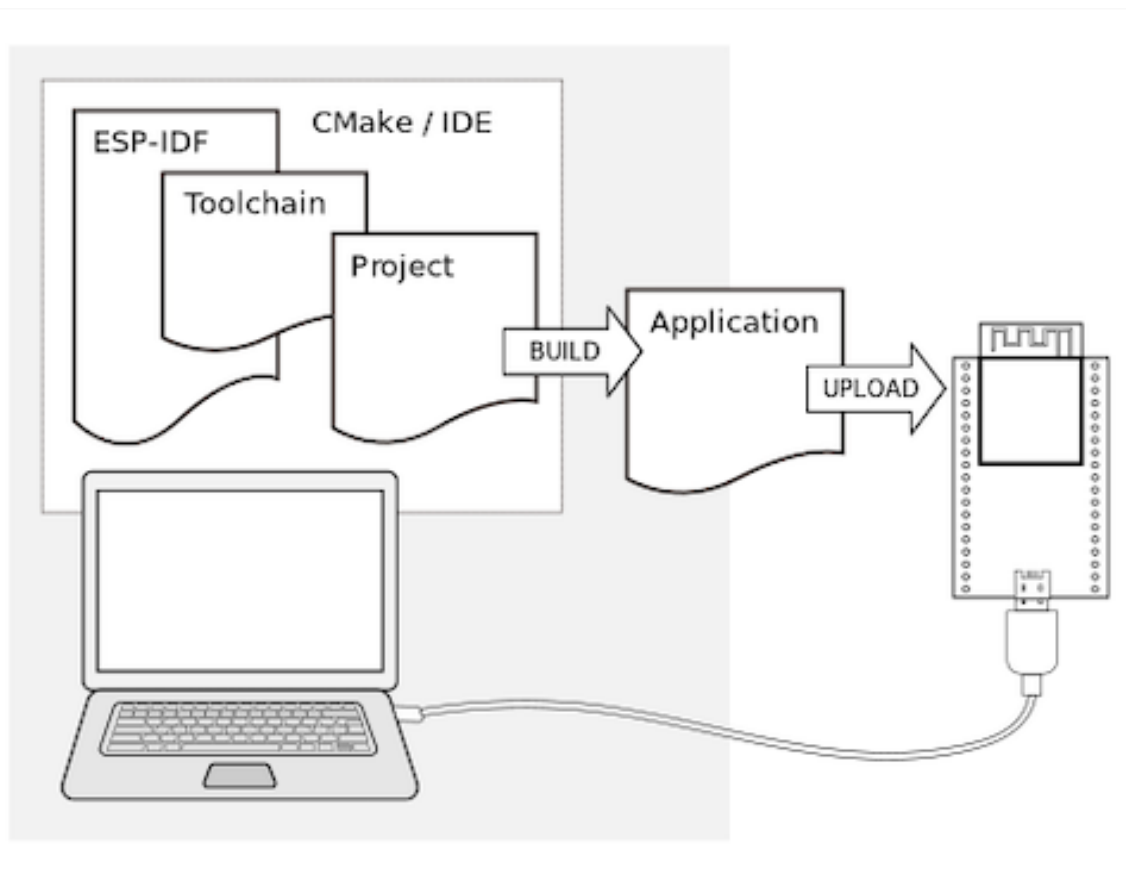

Fig. 1: Development of applications for ESP32-C3

1.3 Development Board Overviews

If you have one of ESP32-C3 development boards listed below, you can click on the link to learn more about its hardware.

1.3.1 ESP32-C3-DevKitM-1

This user guide will help you get started with ESP32-C3-DevKitM-1 and will also provide more in-depth information.

ESP32-C3-DevKitM-1 is an entry-level development board based on [ESP32-C3-MINI-1](#), a module named for its small size. This board integrates complete Wi-Fi and Bluetooth LE functions.

Most of the I/O pins on the ESP32-C3-MINI-1 module are broken out to the pin headers on both sides of this board for easy interfacing. Developers can either connect peripherals with jumper wires or mount ESP32-C3-DevKitM-1 on a breadboard.

The document consists of the following major sections:

- *Getting Started*: Overview of ESP32-C3-DevKitM-1 and hardware/software setup instructions to get started.
- *Hardware Reference*: More detailed information about the ESP32-C3-DevKitM-1's hardware.

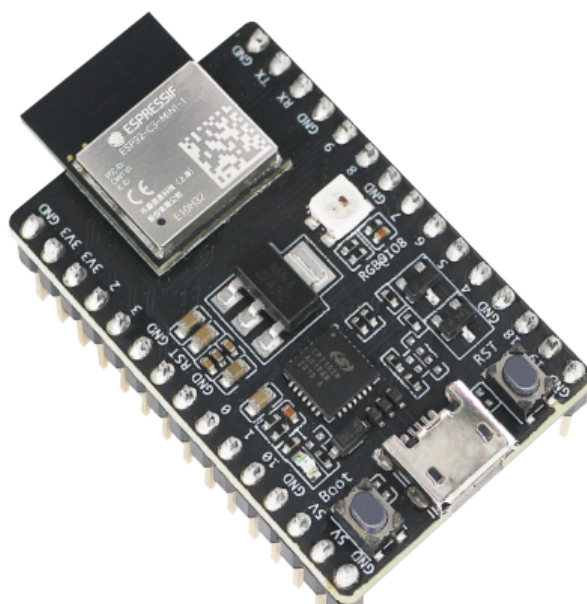

Fig. 2: ESP32-C3-DevKitM-1

- [Hardware Revision Details](#): Revision history, known issues, and links to user guides for previous versions (if any) of ESP32-C3-DevKitM-1.
- [Related Documents](#): Links to related documentation.

Getting Started

This section provides a brief introduction of ESP32-C3-DevKitM-1, instructions on how to do the initial hardware setup and how to flash firmware onto it.

Description of Components The key components of the board are described in a counter-clockwise direction.

Key Component	Description
ESP32-C3-MINI-1	ESP32-C3-MINI-1 is a general-purpose Wi-Fi and Bluetooth LE combo module that comes with a PCB antenna. At the core of this module is ESP32-C3FN4 , a chip that has an embedded flash of 4 MB. Since flash is packaged in the ESP32-C3FN4 chip, rather than integrated into the module, ESP32-C3-MINI-1 has a smaller package size.
5 V to 3.3 V LDO	Power regulator that converts a 5 V supply into a 3.3 V output.
5 V Power On LED	Turns on when the USB power is connected to the board.
Pin Headers	All available GPIO pins (except for the SPI bus for flash) are broken out to the pin headers on the board. For details, please see Header Block .
Boot Button	Download button. Holding down Boot and then pressing Reset initiates Firmware Download mode for downloading firmware through the serial port.
Micro-USB Port	USB interface. Power supply for the board as well as the communication interface between a computer and the ESP32-C3FN4 chip.
Reset Button	Press this button to restart the system.
USB-to-UART Bridge	Single USB-UART bridge chip provides transfer rates up to 3 Mbps.
RGB LED	Addressable RGB LED, driven by GPIO8.

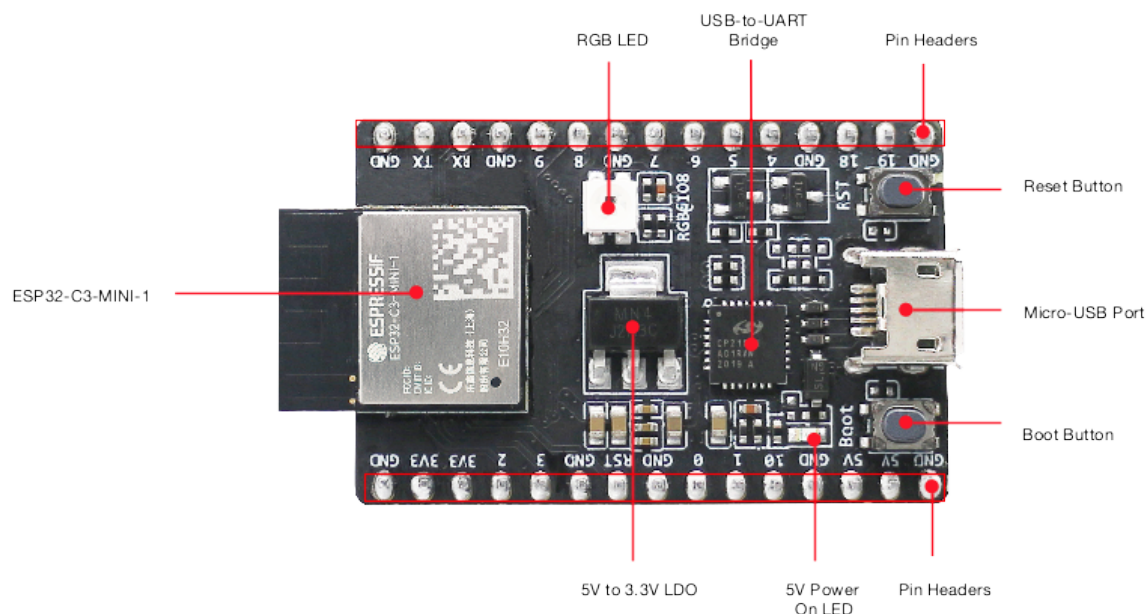

Fig. 3: ESP32-C3-DevKitM-1 - front

Start Application Development Before powering up your ESP32-C3-DevKitM-1, please make sure that it is in good condition with no obvious signs of damage.

Required Hardware

- ESP32-C3-DevKitM-1
- USB 2.0 cable (Standard-A to Micro-B)
- Computer running Windows, Linux, or macOS

Note: Be sure to use an appropriate USB cable. Some cables are for charging only and do not provide the needed data lines nor work for programming the boards.

Software Setup Please proceed to *Get Started*, where Section *Installation Step by Step* will quickly help you set up the development environment and then flash an application example onto your ESP32-C3-DevKitM-1.

Contents and Packaging

Retail Orders If you order one or several samples, each ESP32-C3-DevKitM-1 comes in an individual package in either antistatic bag or any packaging depending on your retailer.

For retail orders, please go to <https://www.espressif.com/en/company/contact/buy-a-sample>.

Wholesale Orders If you order in bulk, the boards come in large cardboard boxes.

For wholesale orders, please go to <https://www.espressif.com/en/contact-us/sales-questions>.

Hardware Reference

Block Diagram The block diagram below shows the components of ESP32-C3-DevKitM-1 and their interconnections.

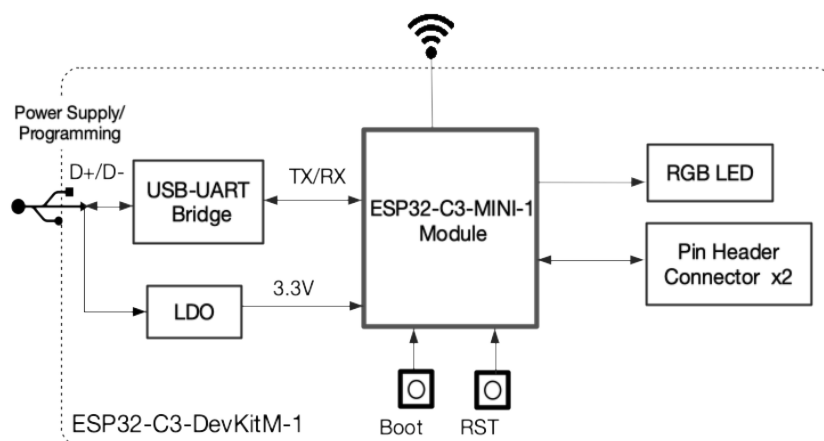

Fig. 4: ESP32-C3-DevKitM-1 (click to enlarge)

Power Supply Options There are three mutually exclusive ways to provide power to the board:

- Micro-USB Port, default power supply
- 5V and GND pin headers
- 3V3 and GND pin headers

It is recommended to use the first option: Micro-USB Port.

Header Block The two tables below provide the **Name** and **Function** of the pin headers on both sides of the board (J1 and J3). The pin header names are shown in *ESP32-C3-DevKitM-1 - front*. The numbering is the same as in the *ESP32-C3-DevKitM-1 Schematic* (PDF).

J1

No.	Name	Type ¹	Function
1	GND	G	Ground
2	3V3	P	3.3 V power supply
3	3V3	P	3.3 V power supply
4	IO2	I/O/T	GPIO2 ² , ADC1_CH2, FSPIQ
5	IO3	I/O/T	GPIO3, ADC1_CH3
6	GND	G	Ground
7	RST	I	CHIP_PU
8	GND	G	Ground
9	IO0	I/O/T	GPIO0, ADC1_CH0, XTAL_32K_P
10	IO1	I/O/T	GPIO1, ADC1_CH1, XTAL_32K_N
11	IO10	I/O/T	GPIO10, FSPICS0
12	GND	G	Ground
13	5V	P	5 V power supply
14	5V	P	5 V power supply
15	GND	G	Ground

¹P: Power supply; I: Input; O: Output; T: High impedance.

²GPIO2, GPIO8, and GPIO9 are strapping pins of the ESP32-C3FN4 chip. These pins are used to control several chip functions depending on binary voltage values applied to the pins during chip power-up or system reset. For description and application of the strapping pins, please refer to Section Strapping Pins in [ESP32-C3 Datasheet](#).

J3

No.	Name	Type ¹	Function
1	GND	G	Ground
2	TX	I/O/T	GPIO21, U0TXD
3	RX	I/O/T	GPIO20, U0RXD
4	GND	G	Ground
5	IO9	I/O/T	GPIO9 ²
6	IO8	I/O/T	GPIO8 ² , RGB LED
7	GND	G	Ground
8	IO7	I/O/T	GPIO7, FSPID, MTDO
9	IO6	I/O/T	GPIO6, FSPICK, MTCK
10	IO5	I/O/T	GPIO5, ADC2_CH0, FSPIWP, MTDI
11	IO4	I/O/T	GPIO4, ADC1_CH4, FSPIHD, MTMS
12	GND	G	Ground
13	IO18	I/O/T	GPIO18
14	IO19	I/O/T	GPIO19
15	GND	G	Ground

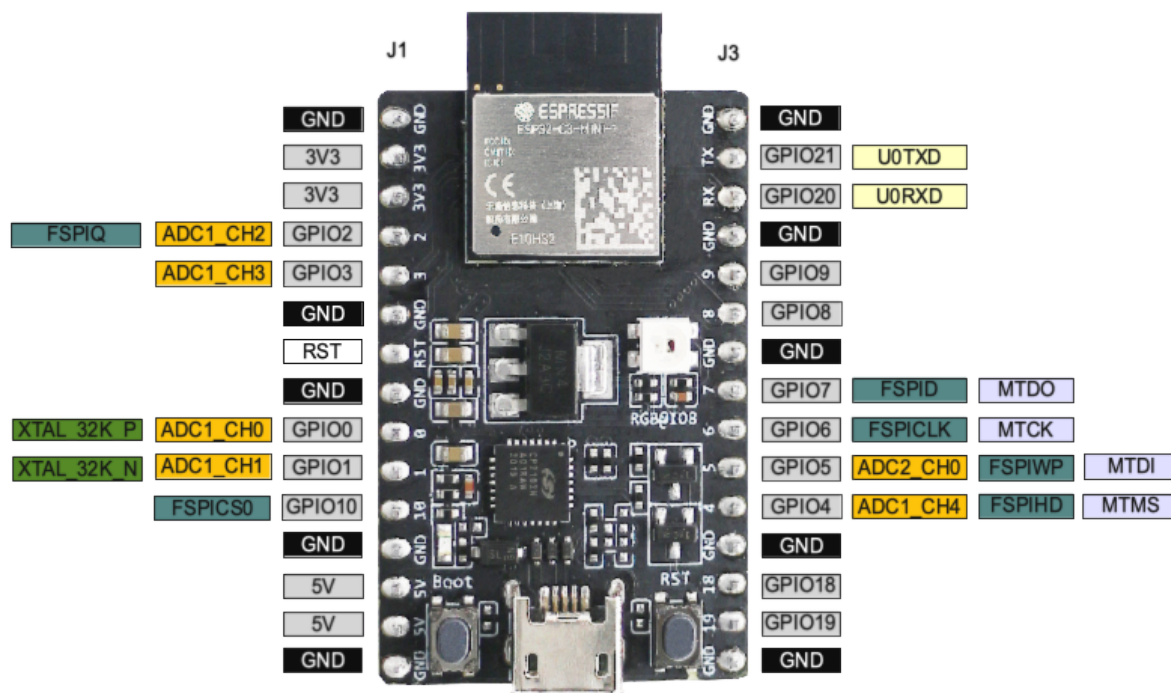

Fig. 5: ESP32-C3-DevKitM-1 Pin Layout (click to enlarge)

Pin Layout

Hardware Revision Details

No previous versions available.

Related Documents

- [Build Secure and Cost-effective Connected Devices with ESP32-C3](#)

- [ESP32-C3 Datasheet \(PDF\)](#)
- [ESP32-C3-MINI-1 Datasheet \(PDF\)](#)
- [ESP32-C3-DevKitM-1 Schematic \(PDF\)](#)
- [ESP32-C3-DevKitM-1 PCB Layout \(PDF\)](#)
- [ESP32-C3-DevKitM-1 Dimensions \(PDF\)](#)
- [ESP32-C3-DevKitM-1 Dimensions source file \(DXF\)](#) - You can view it with [Autodesk Viewer](#) online

For further design documentation for the board, please contact us at sales@espressif.com.

1.3.2 ESP32-C3-DevKitC-02

This user guide will help you get started with ESP32-C3-DevKitC-02 and will also provide more in-depth information.

ESP32-C3-DevKitC-02 is an entry-level development board based on [ESP32-C3-WROOM-02](#), a general-purpose module with 4 MB SPI flash. This board integrates complete Wi-Fi and Bluetooth LE functions.

Most of the I/O pins are broken out to the pin headers on both sides for easy interfacing. Developers can either connect peripherals with jumper wires or mount ESP32-C3-DevKitC-02 on a breadboard.

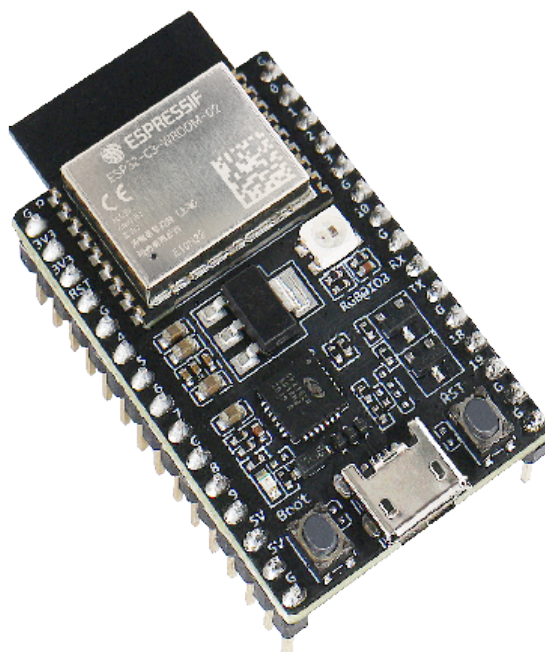

Fig. 6: ESP32-C3-DevKitC-02

The document consists of the following major sections:

- [Getting Started](#): Overview of ESP32-C3-DevKitC-02 and hardware/software setup instructions to get started.
- [Hardware Reference](#): More detailed information about the ESP32-C3-DevKitC-02's hardware.
- [Hardware Revision Details](#): Revision history, known issues, and links to user guides for previous versions (if any) of ESP32-C3-DevKitC-02.
- [Related Documents](#): Links to related documentation.

Getting Started

This section provides a brief introduction of ESP32-C3-DevKitC-02, instructions on how to do the initial hardware setup and how to flash firmware onto it.

Description of Components The key components of the board are described in a counter-clockwise direction.

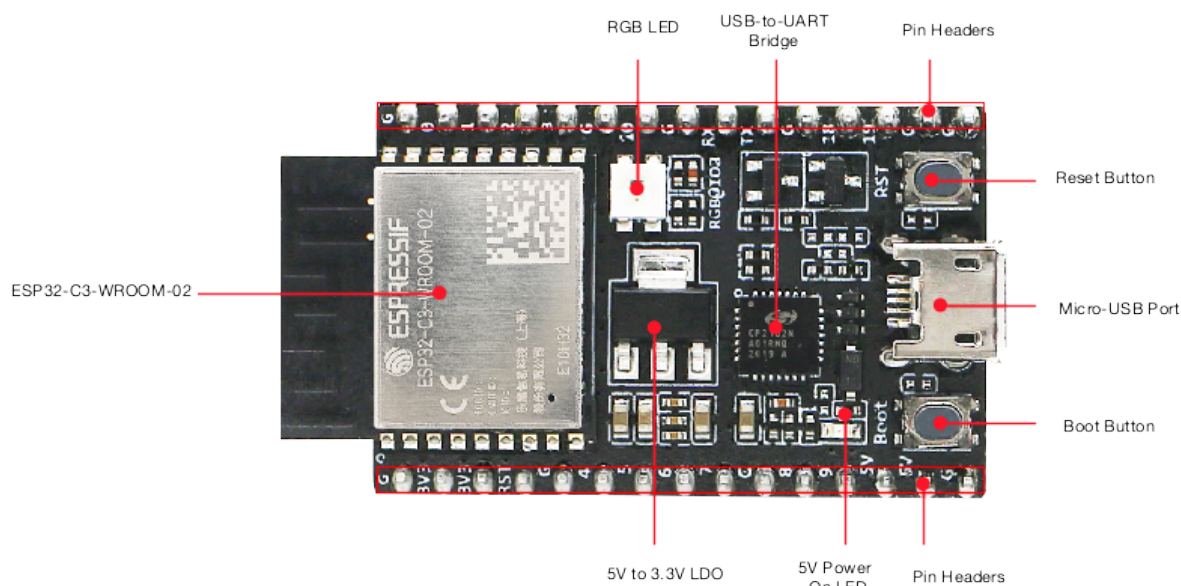

Fig. 7: ESP32-C3-DevKitC-02 - front

Key Component	Description
ESP32-C3-WROOM-02	ESP32-C3-WROOM-02 from Espressif is a powerful and general-purpose module that offers Wi-Fi and Bluetooth LE coexistence. It has a PCB antenna and a 4 MB SPI flash.
5 V to 3.3 V LDO	Power regulator that converts a 5 V supply into a 3.3 V output.
5 V Power On LED	Turns on when the USB power is connected to the board.
Pin Headers	All available GPIO pins (except for the SPI bus for flash) are broken out to the pin headers on the board. For details, please see Header Block .
Boot Button	Download button. Holding down Boot and then pressing Reset initiates Firmware Download mode for downloading firmware through the serial port.
Micro-USB Port	USB interface. Power supply for the board as well as the communication interface between a computer and the ESP32-C3 chip.
Reset Button	Press this button to restart the system.
USB-to-UART Bridge	Single USB-to-UART bridge chip provides transfer rates up to 3 Mbps.
RGB LED	Addressable RGB LED, driven by GPIO8.

Start Application Development Before powering up your ESP32-C3-DevKitC-02, please make sure that it is in good condition with no obvious signs of damage.

Required Hardware

- ESP32-C3-DevKitC-02
- USB 2.0 cable (Standard-A to Micro-B)
- Computer running Windows, Linux, or macOS

Note: Be sure to use an appropriate USB cable. Some cables are for charging only and do not provide the needed data lines nor work for programming the boards.

Software Setup Please proceed to [Get Started](#), where Section [Installation Step by Step](#) will quickly help you set up the development environment and then flash an application example into your ESP32-C3-DevKitC-02.

Contents and Packaging

Retail orders If you order a few samples, each ESP32-C3-DevKitC-02 comes in an individual package in either antistatic bag or any packaging depending on your retailer.

For retail orders, please go to <https://www.espressif.com/en/company/contact/buy-a-sample>.

Wholesale Orders If you order in bulk, the boards come in large cardboard boxes.

For wholesale orders, please go to <https://www.espressif.com/en/contact-us/sales-questions>.

Hardware Reference

Block Diagram The block diagram below shows the components of ESP32-C3-DevKitC-02 and their interconnections.

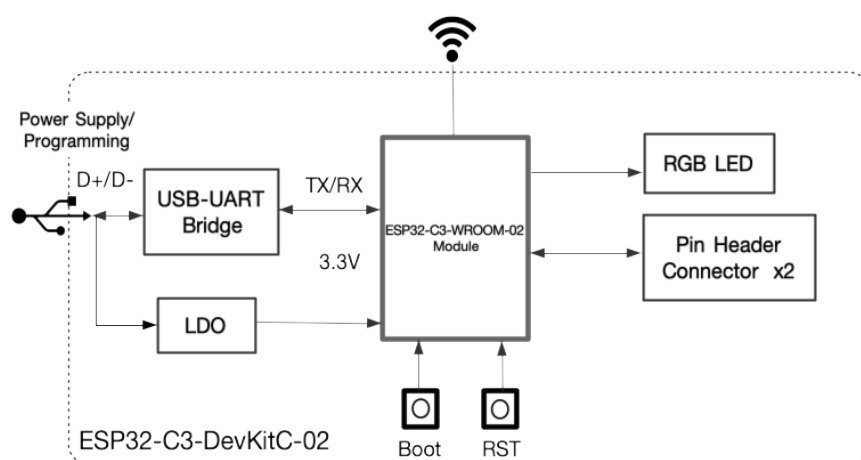

Fig. 8: ESP32-C3-DevKitC-02 (click to enlarge)

Power Supply Options There are three mutually exclusive ways to provide power to the board:

- Micro-USB Port, default power supply
- 5V and GND pin headers
- 3V3 and GND pin headers

It is recommended to use the first option: Micro-USB Port.

Header Block The two tables below provide the **Name** and **Function** of the pin headers on both sides of the board (J1 and J3). The pin header names are shown in *ESP32-C3-DevKitC-02 - front*. The numbering is the same as in the *ESP32-C3-DevKitC-02 Schematic* (PDF).

J1

No.	Name	Type ¹	Function
1	G	G	Ground
2	3V3	P	3.3 V power supply
3	3V3	P	3.3 V power supply
4	RST	I	CHIP_PU
5	G	G	Ground
6	4	I/O/T	GPIO4, ADC1_CH4, FSPIHD, MTMS
7	5	I/O/T	GPIO5, ADC2_CH0, FSPIWP, MTDI
8	6	I/O/T	GPIO6, FSPICLK, MTCK
9	7	I/O/T	GPIO7, FSPID, MTDO
10	G	G	Ground
11	8	I/O/T	GPIO8 ² , RGB LED
12	9	I/O/T	GPIO9 ²
13	5V	P	5 V power supply
14	5V	P	5 V power supply
15	G	G	Ground

J3

No.	Name	Type ¹	Function
1	G	G	Ground
2	0	I/O/T	GPIO0, ADC1_CH0, XTAL_32K_P
3	1	I/O/T	GPIO1, ADC1_CH1, XTAL_32K_N
4	2	I/O/T	GPIO2 ² , ADC1_CH2, FSPIQ
5	3	I/O/T	GPIO3, ADC1_CH3
6	G	G	Ground
7	10	I/O/T	GPIO10, FSPICS0
8	G	G	Ground
9	RX	I/O/T	GPIO20, U0RXD
10	TX	I/O/T	GPIO21, U0TXD
11	G	G	Ground
12	18	I/O/T	GPIO18
13	19	I/O/T	GPIO19
14	G	G	Ground
15	G	G	Ground

Pin Layout**Hardware Revision Details**

No previous versions available.

Related Documents

- [Build Secure and Cost-effective Connected Devices with ESP32-C3](#)
- [ESP32-C3 Datasheet \(PDF\)](#)
- [ESP32-C3-WROOM-02 Datasheet \(PDF\)](#)
- [ESP32-C3-DevKitC-02 Schematic \(PDF\)](#)
- [ESP32-C3-DevKitC-02 PCB Layout \(PDF\)](#)
- [ESP32-C3-DevKitC-02 Dimensions \(PDF\)](#)

P: Power supply; I: Input; O: Output; T: High impedance.

GPIO2, GPIO8, and GPIO9 are strapping pins of the ESP32-C3 chip. These pins are used to control several chip functions depending on binary voltage values applied to the pins during chip power-up or system reset. For description and application of the strapping pins, please refer to Section Strapping Pins in [ESP32-C3 Datasheet](#).

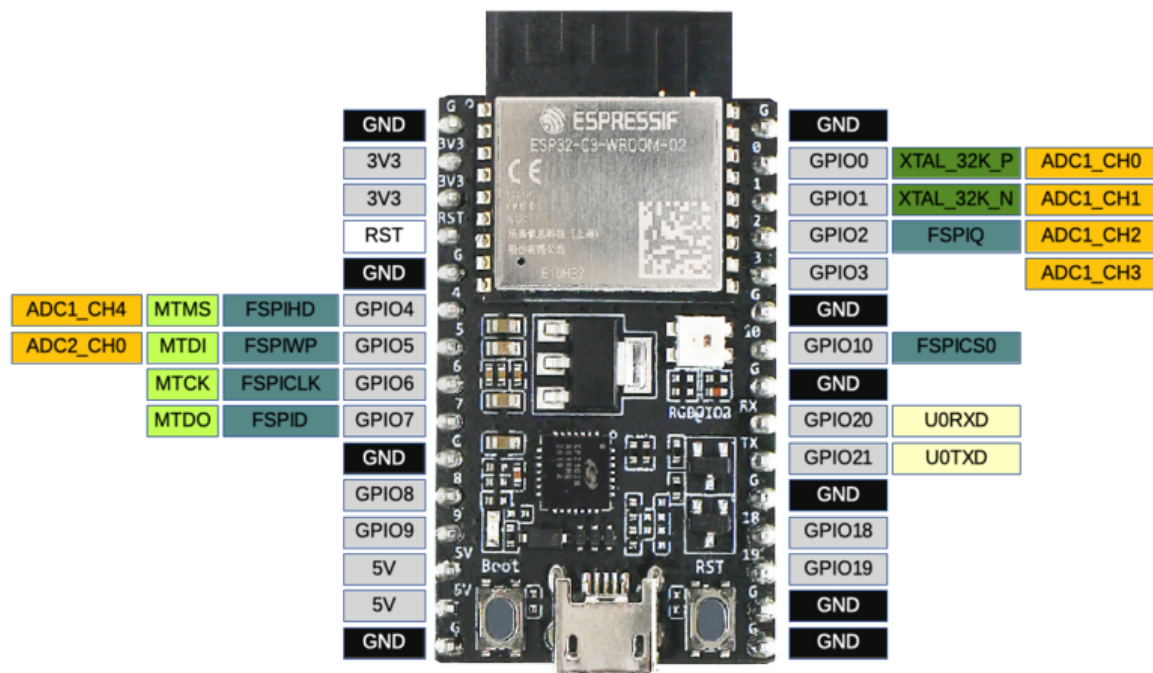

Fig. 9: ESP32-C3-DevKitC-02 Pin Layout (click to enlarge)

- [ESP32-C3-DevKitC-02 Dimensions source file \(DXF\)](#) - You can view it with [Autodesk Viewer](#) online

For further design documentation for the board, please contact us at sales@espressif.com.

1.4 Installation Step by Step

This is a detailed roadmap to walk you through the installation process.

1.4.1 Setting up Development Environment

- *Step 1. Install prerequisites for Windows, Linux, or macOS*
- *Step 2. Get ESP-IDF*
- *Step 3. Set up the tools*
- *Step 4. Set up the environment variables*

1.4.2 Creating Your First Project

- *Step 5. Start a Project*
- *Step 6. Connect Your Device*
- *Step 7. Configure*
- *Step 8. Build the Project*
- *Step 9. Flash onto the Device*
- *Step 10. Monitor*

1.5 Step 1. Install prerequisites

Some tools need to be installed on the computer before proceeding to the next steps. Follow the links below for the instructions for your OS:

1.5.1 Standard Setup of Toolchain for Windows

Introduction

ESP-IDF requires some prerequisite tools to be installed so you can build firmware for supported chips. The prerequisite tools include Python, Git, cross-compilers, CMake and Ninja build tools.

For this Getting Started we're going to use the Command Prompt, but after ESP-IDF is installed you can use *Eclipse* or another graphical IDE with CMake support instead.

Note: Limitation: the installation path of Python or ESP-IDF must not contain white spaces or parentheses.

Limitation: the installation path of Python or ESP-IDF should not contain special characters (non-ASCII) unless the operating system is configured with "Unicode UTF-8" support. System Administrator can enable the support via Control Panel - Change date, time, or number formats - Administrative tab - Change system locale - check the option "Beta: Use Unicode UTF-8 for worldwide language support" - Ok and reboot the computer.

ESP-IDF Tools Installer

The easiest way to install ESP-IDF's prerequisites is to download one of ESP-IDF Tools Installers from this URL: <https://dl.espressif.com/dl/esp-idf/?idf=4.3>

What is the usecase for Online and Offline Installer Online Installer is very small and allows the installation of all available releases of ESP-IDF. The installer will download only necessary dependencies including [Git For Windows](#) during the installation process. The installer stores downloaded files in the cache directory `%userprofile%\espressif`

Offline Installer does not require any network connection. The installer contains all required dependencies including [Git For Windows](#).

Components of the installation The installer deploys the following components:

- Embedded Python
- Cross-compilers
- OpenOCD
- CMake and Ninja build tools
- ESP-IDF

The installer also allows reusing the existing directory with ESP-IDF. The recommended directory is `%userprofile%\Desktop\esp-idf` where `%userprofile%` is your home directory.

Launching ESP-IDF Environment At the end of the installation process you can check out option `Run ESP-IDF PowerShell Environment` or `Run ESP-IDF Command Prompt (cmd.exe)`. The installer will launch ESP-IDF environment in selected prompt.

Run ESP-IDF PowerShell Environment:

Run ESP-IDF Command Prompt (cmd.exe):

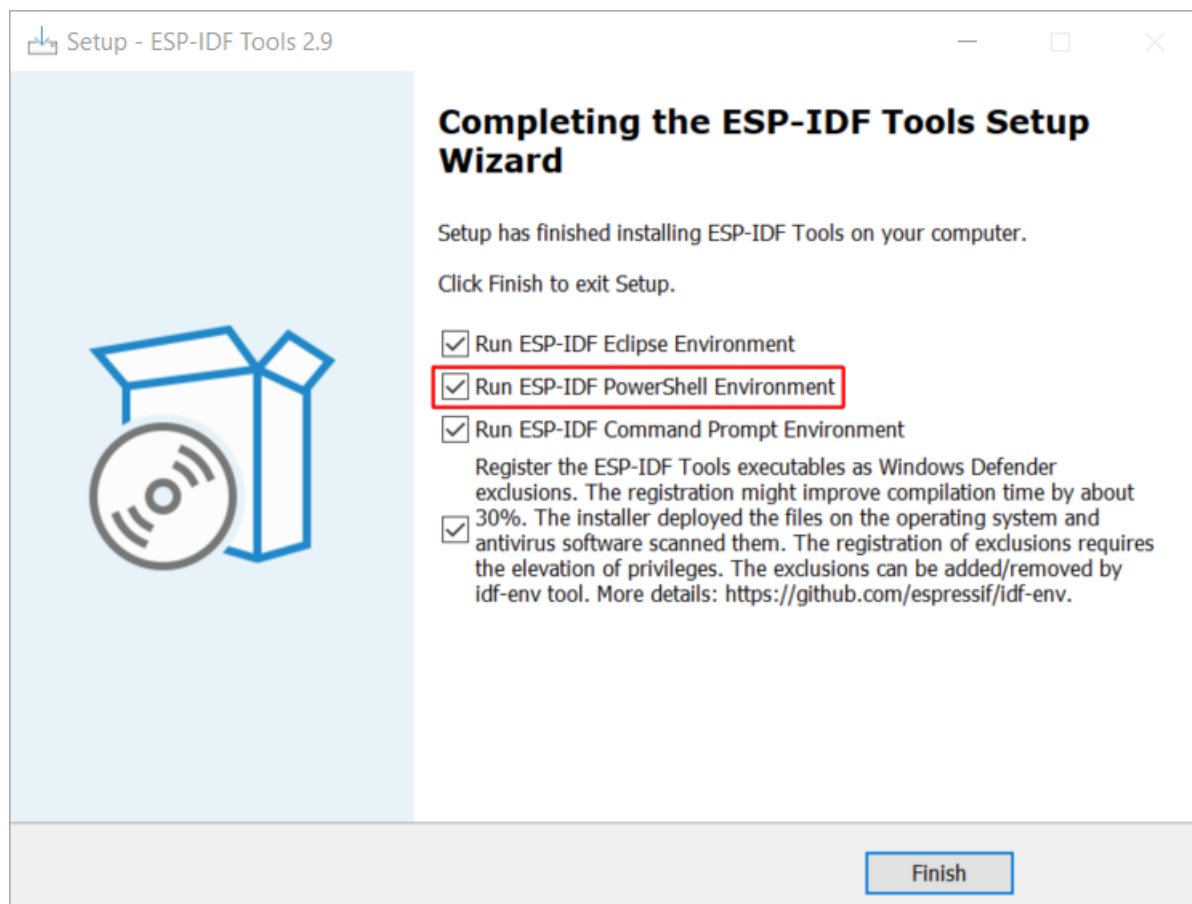

Fig. 10: Completing the ESP-IDF Tools Setup Wizard with Run ESP-IDF PowerShell Environment

```

ESP-IDF PowerShell
Using Python in C:\Users\developer\.espressif\python_env\idf4.1_py3.8_env\Scripts
Python 3.8.7
Using Git in C:\Program Files\Git\cmd/
git version 2.29.2.windows.1
Setting IDF_PATH: C:\Users\developer\Desktop\esp-idf
Adding ESP-IDF tools to PATH...
C:\Users\developer\.espressif\tools\xtensa-esp32-elf\esp-2020r3-8.4.0\xtensa-esp32-elf\bin
C:\Users\developer\.espressif\tools\xtensa-esp32s2-elf\esp-2020r3-8.4.0\xtensa-esp32s2-elf\bin
C:\Users\developer\.espressif\tools\esp32ulp-elf\2.28.51-esp-20191205\esp32ulp-elf-binutils\bin
C:\Users\developer\.espressif\tools\esp32s2ulp-elf\2.28.51-esp-20191205\esp32s2ulp-elf-binutils\bin
C:\Users\developer\.espressif\tools\cmake\3.13.4\bin
C:\Users\developer\.espressif\tools\openocd-esp32\v0.10.0-esp32-20200709\openocd-esp32\bin
C:\Users\developer\.espressif\tools\ninja\1.9.0\
C:\Users\developer\.espressif\tools\idf-exe\1.0.1\
C:\Users\developer\.espressif\tools\ccache\3.7\
C:\Users\developer\Desktop\esp-idf\tools
Checking if Python packages are up to date...
Python requirements from C:\Users\developer\Desktop\esp-idf\requirements.txt are satisfied.

Done! You can now compile ESP-IDF projects.
Go to the project directory and run:
  idf.py build

PS C:\Users\developer\Desktop\esp-idf>

```

Fig. 11: ESP-IDF PowerShell

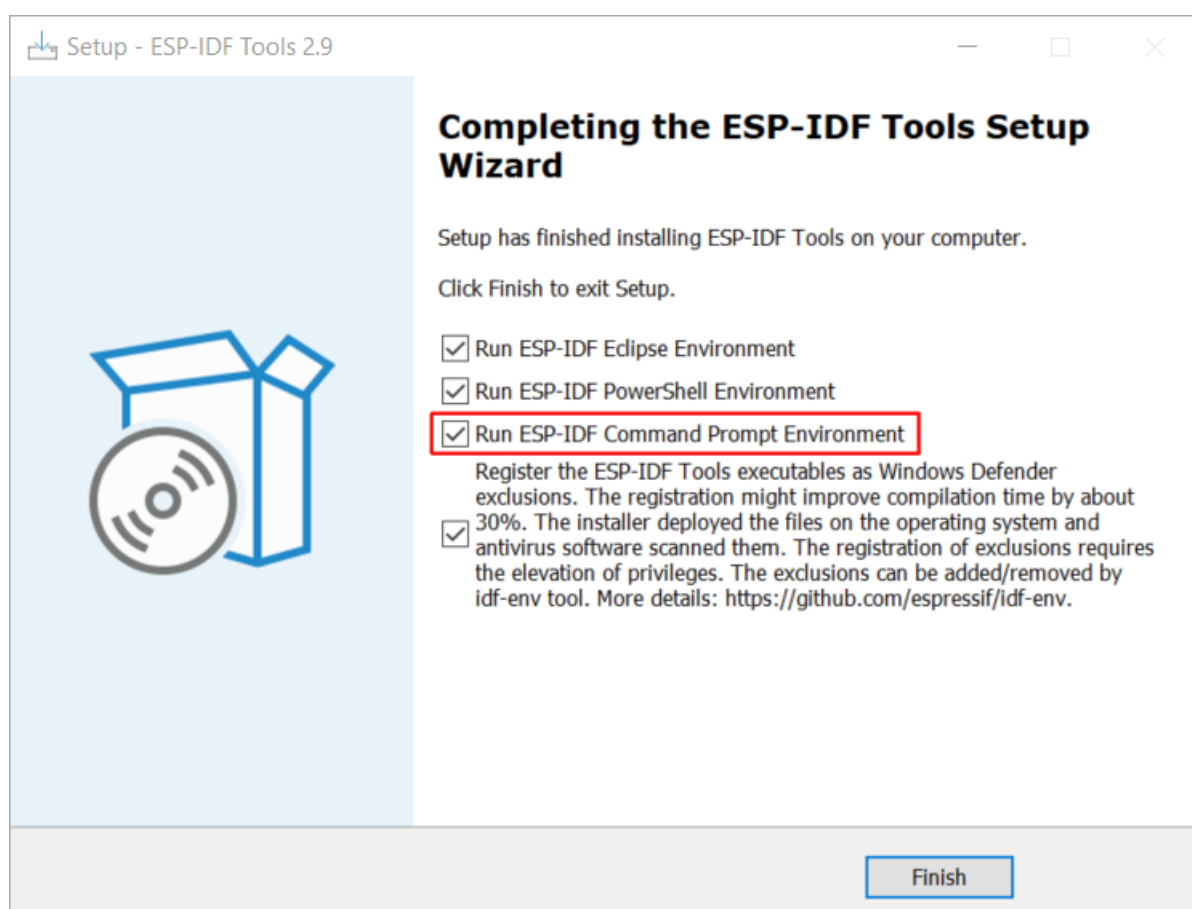

Fig. 12: Completing the ESP-IDF Tools Setup Wizard with Run ESP-IDF Command Prompt (cmd.exe)



```
ESP-IDF Command Prompt (cmd.exe)
Using Python in C:\Users\test\AppData\Local\Programs\Python\Python37\
Python 3.7.8
Using Git in C:\Users\test\Git\cmd\
git version 2.30.0.windows.1
Setting IDF_PATH: C:\Users\test\esp\esp-idf

Adding ESP-IDF tools to PATH...
  C:\Users\test\.espressif\tools\xtensa-esp32-elf\esp-2020r3-8.4.0\xtensa-esp32-elf\bin
  C:\Users\test\.espressif\tools\xtensa-esp32s2-elf\esp-2020r3-8.4.0\xtensa-esp32s2-elf\bin
  C:\Users\test\.espressif\tools\xtensa-esp32s3-elf\esp-2020r3-8.4.0\xtensa-esp32s3-elf\bin
  C:\Users\test\.espressif\tools\riscv32-esp-elf\1.24.0.123_64eb9ff-8.4.0\riscv32-esp-elf\bin
  C:\Users\test\.espressif\tools\esp32ulp-elf\2.28.51-esp-20191205\esp32ulp-elf-binutils\bin
  C:\Users\test\.espressif\tools\esp32s2ulp-elf\2.28.51-esp-20191205\esp32s2ulp-elf-binutils\bin
  C:\Users\test\.espressif\tools\cmake\3.16.4\bin
  C:\Users\test\.espressif\tools\openocd-esp32\v0.10.0-esp32-20200709\openocd-esp32\bin
  C:\Users\test\.espressif\tools\ninja\1.10.0\
  C:\Users\test\.espressif\tools\idf-exe\1.0.1\
  C:\Users\test\.espressif\tools\ccache\3.7\
  C:\Users\test\.espressif\tools\dfu-util\0.9\dfu-util-0.9-win64
  C:\Users\test\.espressif\python_env\idf4.3_py3.7_env\Scripts
  C:\Users\test\esp\esp-idf\tools

Checking if Python packages are up to date...
Python requirements from C:\Users\test\esp\esp-idf\requirements.txt are satisfied.

Done! You can now compile ESP-IDF projects.
Go to the project directory and run:

idf.py build

C:\Users\test\esp\esp-idf>
```

Fig. 13: ESP-IDF Command Prompt

Using the Command Prompt

For the remaining Getting Started steps, we're going to use the Windows Command Prompt.

ESP-IDF Tools Installer also creates a shortcut in the Start menu to launch the ESP-IDF Command Prompt. This shortcut launches the Command Prompt (`cmd.exe`) and runs `export.bat` script to set up the environment variables (`PATH`, `IDF_PATH` and others). Inside this command prompt, all the installed tools are available.

Note that this shortcut is specific to the ESP-IDF directory selected in the ESP-IDF Tools Installer. If you have multiple ESP-IDF directories on the computer (for example, to work with different versions of ESP-IDF), you have two options to use them:

1. Create a copy of the shortcut created by the ESP-IDF Tools Installer, and change the working directory of the new shortcut to the ESP-IDF directory you wish to use.
2. Alternatively, run `cmd.exe`, then change to the ESP-IDF directory you wish to use, and run `export.bat`. Note that unlike the previous option, this way requires Python and Git to be present in `PATH`. If you get errors related to Python or Git not being found, use the first option.

Next Steps

If the ESP-IDF Tools Installer has finished successfully, then the development environment setup is complete. Proceed directly to [Step 5. Start a Project](#).

Related Documents

For advanced users who want to customize the install process:

Updating ESP-IDF tools on Windows

Install ESP-IDF tools using a script From the Windows Command Prompt, change to the directory where ESP-IDF is installed. Then run:

```
install.bat
```

For Powershell, change to the directory where ESP-IDF is installed. Then run:

```
install.ps1
```

This will download and install the tools necessary to use ESP-IDF. If the specific version of the tool is already installed, no action will be taken. The tools are downloaded and installed into a directory specified during ESP-IDF Tools Installer process. By default, this is `C:\Users\username\.espressif`.

Add ESP-IDF tools to PATH using an export script ESP-IDF tools installer creates a Start menu shortcut for “ESP-IDF Command Prompt”. This shortcut opens a Command Prompt window where all the tools are already available.

In some cases, you may want to work with ESP-IDF in a Command Prompt window which wasn't started using that shortcut. If this is the case, follow the instructions below to add ESP-IDF tools to `PATH`.

In the command prompt where you need to use ESP-IDF, change to the directory where ESP-IDF is installed, then execute `export.bat`:

```
cd %userprofile%\esp\esp-idf
export.bat
```

Alternatively in the Powershell where you need to use ESP-IDF, change to the directory where ESP-IDF is installed, then execute `export.ps1`:

```
cd ~/esp/esp-idf
export.ps1
```

When this is done, the tools will be available in this command prompt.

1.5.2 Standard Setup of Toolchain for Linux

Install Prerequisites

To compile with ESP-IDF you need to get the following packages. The command to run depends on which distribution of Linux you are using:

- Ubuntu and Debian:

```
sudo apt-get install git wget flex bison gperf python3 python3-pip python3-
↳setuptools cmake ninja-build ccache libffi-dev libssl-dev dfu-util libusb-1.
↳0-0
```

- CentOS 7 & 8:

```
sudo yum -y update && sudo yum install git wget flex bison gperf python3
↳python3-pip python3-setuptools cmake ninja-build ccache dfu-util libusb
```

CentOS 7 is still supported but CentOS version 8 is recommended for a better user experience.

- Arch:

```
sudo pacman -S --needed gcc git make flex bison gperf python-pip cmake ninja
↳ccache dfu-util libusb
```

Note:

- CMake version 3.5 or newer is required for use with ESP-IDF. Older Linux distributions may require updating, enabling of a “backports” repository, or installing of a “cmake3” package rather than “cmake” .
 - If you do not see your Linux distribution in the above list then please check its documentation to find out which command to use for package installation.
-

Additional Tips

Permission issues /dev/ttyUSB0 With some Linux distributions you may get the Failed to open port /dev/ttyUSB0 error message when flashing the ESP32-C3. *This can be solved by adding the current user to the dialout group.*

Fixing broken pip on Ubuntu 16.04

Package python3-pip could be broken without possibility to upgrade it. Package has to be removed and installed manually using script [get-pip.py](#):

```
apt remove python3-pip python3-virtualenv; rm -r ~/.local
rm -r ~/.espressif/python_env && python get-pip.py
```

Python 2 deprecation

Python 2 reached its [end of life](#) and support for it in ESP-IDF will be removed soon. Please install Python 3.6 or higher. Instructions for popular Linux distributions are listed above.

Next Steps

To carry on with development environment setup, proceed to [Step 2. Get ESP-IDF](#).

1.5.3 Standard Setup of Toolchain for macOS

Install Prerequisites

ESP-IDF will use the version of Python installed by default on macOS.

- install pip:

```
sudo easy_install pip
```

- install CMake & Ninja build:

- If you have [HomeBrew](#), you can run:

```
brew install cmake ninja dfu-util
```

- If you have [MacPorts](#), you can run:

```
sudo port install cmake ninja dfu-util
```

- Otherwise, consult the [CMake](#) and [Ninja](#) home pages for macOS installation downloads.

- It is strongly recommended to also install [ccache](#) for faster builds. If you have [HomeBrew](#), this can be done via `brew install ccache` or `sudo port install ccache` on [MacPorts](#).

Note: If an error like this is shown during any step:

```
xcrun: error: invalid active developer path (/Library/Developer/CommandLineTools), ␣  
↳missing xcrun at: /Library/Developer/CommandLineTools/usr/bin/xcrun
```

Then you will need to install the XCode command line tools to continue. You can install these by running `xcode-select --install`.

Installing Python 3 Basing on macOS [Catalina 10.15 release notes](#), use of Python 2.7 is not recommended and Python 2.7 will not be included by default in future versions of macOS. Check what Python you currently have:

```
python --version
```

If the output is like `Python 2.7.17`, your default interpreter is Python 2.7. If so, also check if Python 3 isn't already installed on your computer:

```
python3 --version
```

If above command returns an error, it means Python 3 is not installed.

Below is an overview of steps to install Python 3.

- Installing with [HomeBrew](#) can be done as follows:

```
brew install python3
```

- If you have [MacPorts](#), you can run:



```
sudo port install python38
```

Python 2 deprecation

Python 2 reached its [end of life](#) and support for it in ESP-IDF will be removed soon. Please install Python 3.6 or higher. Instructions for macOS are listed above.

Next Steps

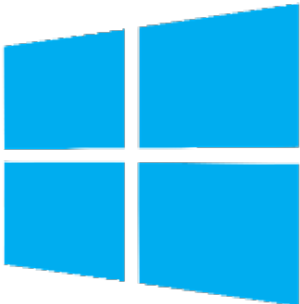
To carry on with development environment setup, proceed to [Step 2. Get ESP-IDF](#).

		
Windows	Linux	Mac OS

Note: This guide uses the directory `~/esp` on Linux and macOS or `%userprofile%\esp` on Windows as an installation folder for ESP-IDF. You can use any directory, but you will need to adjust paths for the commands respectively. Keep in mind that ESP-IDF does not support spaces in paths.

1.6 Step 2. Get ESP-IDF

To build applications for the ESP32-C3, you need the software libraries provided by Espressif in [ESP-IDF repository](#).

To get ESP-IDF, navigate to your installation directory and clone the repository with `git clone`, following instructions below specific to your operating system.

1.6.1 Linux and macOS

Open Terminal, and run the following commands:

```
mkdir -p ~/esp
cd ~/esp
git clone -b v4.3.4 --recursive https://github.com/espressif/esp-idf.git
```

ESP-IDF will be downloaded into `~/esp/esp-idf`.

Consult [ESP-IDF Versions](#) for information about which ESP-IDF version to use in a given situation.

1.6.2 Windows

In addition to installing the tools, [ESP-IDF Tools Installer](#) for Windows introduced in Step 1 can also download a copy of ESP-IDF.

Consult [ESP-IDF Versions](#) for information about which ESP-IDF version to use in a given situation.

If you wish to download ESP-IDF without the help of ESP-IDF Tools Installer, refer to these [instructions](#).

1.7 Step 3. Set up the tools

Aside from the ESP-IDF, you also need to install the tools used by ESP-IDF, such as the compiler, debugger, Python packages, etc.

1.7.1 Windows

ESP-IDF Tools Installer for Windows introduced in Step 1 installs all the required tools.

If you want to install the tools without the help of ESP-IDF Tools Installer, open the Command Prompt and follow these steps:

```
cd %userprofile%\esp\esp-idf
install.bat esp32c3
```

or with Windows PowerShell

```
cd ~/esp/esp-idf
./install.ps1 esp32c3
```

1.7.2 Linux and macOS

```
cd ~/esp/esp-idf
./install.sh esp32c3
```

or with Fish shell

```
cd ~/esp/esp-idf
./install.fish esp32c3
```

Note: To install tools for multiple targets you can specify those targets at once. For example: `./install.sh esp32, esp32c3, esp32s3`. To install tools for all supported targets, run the script without specifying targets `./install.sh` or use `./install.sh all`.

1.7.3 Alternative File Downloads

The tools installer downloads a number of files attached to GitHub Releases. If accessing GitHub is slow then it is possible to set an environment variable to prefer Espressif's download server for GitHub asset downloads.

Note: This setting only controls individual tools downloaded from GitHub releases, it doesn't change the URLs used to access any Git repositories.

Windows

To prefer the Espressif download server when running the ESP-IDF Tools Installer or installing tools from the command line, open the System control panel, then click on Advanced Settings. Add a new Environment Variable (of type either User or System) with the name `IDF_GITHUB_ASSETS` and value `dl.espressif.com/github_assets`. Click OK once done.

If the command line window or ESP-IDF Tools Installer window was already open before you added the new environment variable, you will need to close and reopen it.

While this environment variable is still set, the ESP-IDF Tools Installer and the command line installer will prefer the Espressif download server.

Linux and macOS

To prefer the Espressif download server when installing tools, use the following sequence of commands when running `install.sh`:

```
cd ~/esp/esp-idf
export IDF_GITHUB_ASSETS="dl.espressif.com/github_assets"
./install.sh
```

1.7.4 Customizing the tools installation path

The scripts introduced in this step install compilation tools required by ESP-IDF inside the user home directory: `$HOME/.espressif` on Linux and macOS, `%USERPROFILE%\espressif` on Windows. If you wish to install the tools into a different directory, set the environment variable `IDF_TOOLS_PATH` before running the installation scripts. Make sure that your user account has sufficient permissions to read and write this path.

If changing the `IDF_TOOLS_PATH`, make sure it is set to the same value every time the Install script (`install.bat`, `install.ps1` or `install.sh`) and an Export script (`export.bat`, `export.ps1` or `export.sh`) are executed.

1.8 Step 4. Set up the environment variables

The installed tools are not yet added to the `PATH` environment variable. To make the tools usable from the command line, some environment variables must be set. ESP-IDF provides another script which does that.

1.8.1 Windows

ESP-IDF Tools Installer for Windows creates an “ESP-IDF Command Prompt” shortcut in the Start Menu. This shortcut opens the Command Prompt and sets up all the required environment variables. You can open this shortcut and proceed to the next step.

Alternatively, if you want to use ESP-IDF in an existing Command Prompt window, you can run:

```
%userprofile%\esp\esp-idf\export.bat
```

or with Windows PowerShell

```
.$HOME/esp/esp-idf/export.ps1
```

1.8.2 Linux and macOS

In the terminal where you are going to use ESP-IDF, run:

```
.$HOME/esp/esp-idf/export.sh
```

or for fish (supported only since fish version 3.0.0):

```
.$HOME/esp/esp-idf/export.fish
```

Note the space between the leading dot and the path!

If you plan to use `esp-idf` frequently, you can create an alias for executing `export.sh`:

1. Copy and paste the following command to your shell's profile (`.profile`, `.bashrc`, `.zprofile`, etc.)

```
alias get_idf='. $HOME/esp/esp-idf/export.sh'
```

2. Refresh the configuration by restarting the terminal session or by running `source [path to profile]`, for example, `source ~/.bashrc`.

Now you can run `get_idf` to set up or refresh the esp-idf environment in any terminal session.

Technically, you can add `export .sh` to your shell's profile directly; however, it is not recommended. Doing so activates IDF virtual environment in every terminal session (including those where IDF is not needed), defeating the purpose of the virtual environment and likely affecting other software.

1.9 Step 5. Start a Project

Now you are ready to prepare your application for ESP32-C3. You can start with [get-started/hello_world](#) project from [examples](#) directory in IDF.

Copy the project [get-started/hello_world](#) to `~/esp` directory:

1.9.1 Linux and macOS

```
cd ~/esp
cp -r $IDF_PATH/examples/get-started/hello_world .
```

1.9.2 Windows

```
cd %userprofile%\esp
xcopy /e /i %IDF_PATH%\examples\get-started\hello_world hello_world
```

There is a range of example projects in the [examples](#) directory in ESP-IDF. You can copy any project in the same way as presented above and run it. It is also possible to build examples in-place, without copying them first.

Important: The ESP-IDF build system does not support spaces in the paths to either ESP-IDF or to projects.

1.10 Step 6. Connect Your Device

Now connect your ESP32-C3 board to the computer and check under what serial port the board is visible.

Serial ports have the following patterns in their names:

- **Windows:** names like COM1
- **Linux:** starting with `/dev/tty`
- **macOS:** starting with `/dev/cu`.

If you are not sure how to check the serial port name, please refer to [Establish Serial Connection with ESP32-C3](#) for full details.

Note: Keep the port name handy as you will need it in the next steps.

1.11 Step 7. Configure

Navigate to your `hello_world` directory from [Step 5. Start a Project](#), set ESP32-C3 chip as the target and run the project configuration utility `menuconfig`.

1.11.1 Linux and macOS

```
cd ~/esp/hello_world
idf.py set-target esp32c3
idf.py menuconfig
```

1.11.2 Windows

```
cd %userprofile%\esp\hello_world
idf.py set-target esp32c3
idf.py menuconfig
```

Setting the target with `idf.py set-target esp32c3` should be done once, after opening a new project. If the project contains some existing builds and configuration, they will be cleared and initialized. The target may be saved in environment variable to skip this step at all. See [Selecting the Target](#) for additional information.

If the previous steps have been done correctly, the following menu appears:

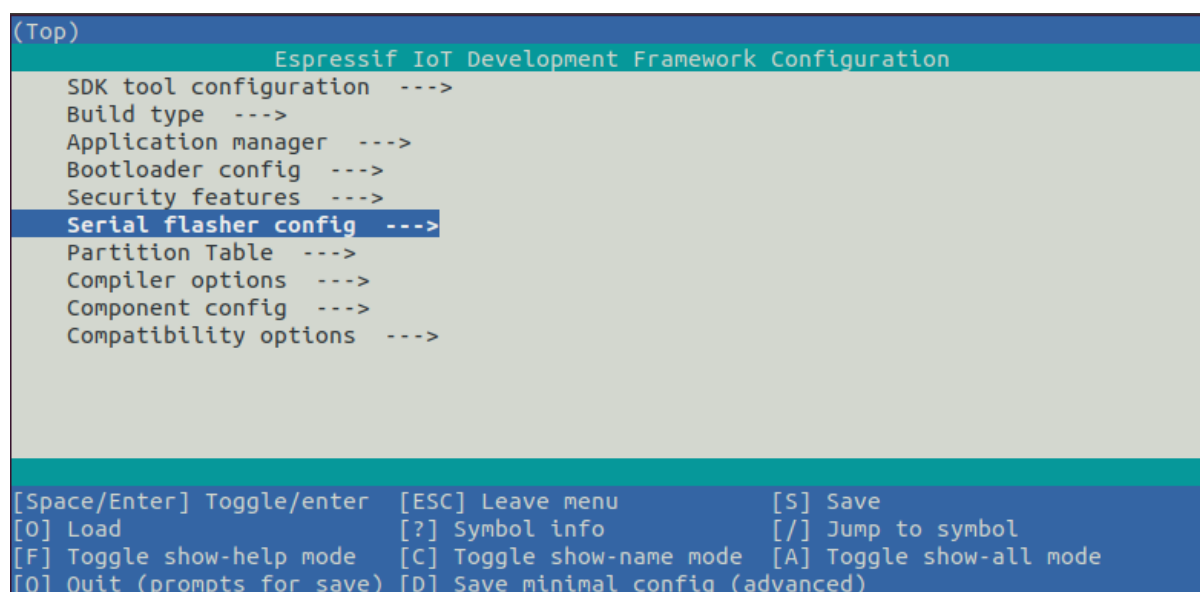

```
(Top)
Espressif IoT Development Framework Configuration
SDK tool configuration --->
Build type --->
Application manager --->
Bootloader config --->
Security features --->
Serial flasher config --->
Partition Table --->
Compiler options --->
Component config --->
Compatibility options --->

[Space/Enter] Toggle/enter  [ESC] Leave menu          [S] Save
[O] Load                    [?] Symbol info          [/] Jump to symbol
[F] Toggle show-help mode  [C] Toggle show-name mode [A] Toggle show-all mode
[Q] Quit (prompts for save) [D] Save minimal config (advanced)
```

Fig. 14: Project configuration - Home window

You are using this menu to set up project specific variables, e.g. Wi-Fi network name and password, the processor speed, etc. Setting up the project with `menuconfig` may be skipped for “hello_word”. This example will run with default configuration.

Note: The colors of the menu could be different in your terminal. You can change the appearance with the option `--style`. Please run `idf.py menuconfig --help` for further information.

1.12 Step 8. Build the Project

Build the project by running:

```
idf.py build
```

This command will compile the application and all ESP-IDF components, then it will generate the bootloader, partition table, and application binaries.

```
$ idf.py build
Running cmake in directory /path/to/hello_world/build
Executing "cmake -G Ninja --warn-uninitialized /path/to/hello_world"...
Warn about uninitialized values.
-- Found Git: /usr/bin/git (found version "2.17.0")
-- Building empty aws_iot component due to configuration
-- Component names: ...
-- Component paths: ...

... (more lines of build system output)

[527/527] Generating hello-world.bin
esptool.py v2.3.1

Project build complete. To flash, run this command:
../../components/esptool_py/esptool/esptool.py -p (PORT) -b 921600 write_flash -
↪-flash_mode dio --flash_size detect --flash_freq 40m 0x10000 build/hello-world.
↪bin build 0x1000 build/bootloader/bootloader.bin 0x8000 build/partition_table/
↪partition-table.bin
or run 'idf.py -p PORT flash'
```

If there are no errors, the build will finish by generating the firmware binary .bin files.

1.13 Step 9. Flash onto the Device

Flash the binaries that you just built (bootloader.bin, partition-table.bin and hello-world.bin) onto your ESP32-C3 board by running:

```
idf.py -p PORT [-b BAUD] flash
```

Replace PORT with your ESP32-C3 board's serial port name from [Step 6. Connect Your Device](#).

You can also change the flasher baud rate by replacing BAUD with the baud rate you need. The default baud rate is 460800.

For more information on idf.py arguments, see [idf.py](#).

Note: The option `flash` automatically builds and flashes the project, so running `idf.py build` is not necessary.

1.13.1 Encountered Issues While Flashing?

If you run the given command and see errors such as “Failed to connect”, there might be several reasons for this. One of the reasons might be issues encountered by `esptool.py`, the utility that is called by the build system to reset the chip, interact with the ROM bootloader, and flash firmware. One simple solution to try is manual reset described below, and if it does not help you can find more details about possible issues in [Troubleshooting](#).

`esptool.py` resets ESP32-C3 automatically by asserting DTR and RTS control lines of the USB to serial converter chip, i.e., FTDI or CP210x (for more information, see [Establish Serial Connection with ESP32-C3](#)). The DTR and RTS control lines are in turn connected to GPIO9 and CHIP_PU (EN) pins of ESP32-C3, thus changes in the voltage

levels of DTR and RTS will boot ESP32-C3 into Firmware Download mode. As an example, check the [schematic](#) for the ESP32 DevKitC development board.

In general, you should have no problems with the official esp-idf development boards. However, `esptool.py` is not able to reset your hardware automatically in the following cases:

- Your hardware does not have the DTR and RTS lines connected to GPIO9 and CHIP_PU
- The DTR and RTS lines are configured differently
- There are no such serial control lines at all

Depending on the kind of hardware you have, it may also be possible to manually put your ESP32-C3 board into Firmware Download mode (reset).

- For development boards produced by Espressif, this information can be found in the respective getting started guides or user guides. For example, to manually reset an esp-idf development board, hold down the **Boot** button (GPIO9) and press the **EN** button (CHIP_PU).
- For other types of hardware, try pulling GPIO9 down.

1.13.2 Normal Operation

When flashing, you will see the output log similar to the following:

```
...
esptool.py --chip esp32c3 -p /dev/ttyUSB0 -b 460800 --before=default_reset --
↳after=hard_reset write_flash --flash_mode dio --flash_freq 80m --flash_size 2MB_
↳0x8000 partition_table/partition-table.bin 0x0 bootloader/bootloader.bin 0x10000_
↳hello-world.bin
esptool.py v3.0
Serial port /dev/ttyUSB0
Connecting....
Chip is ESP32-C3
Features: Wi-Fi
Crystal is 40MHz
MAC: 7c:df:a1:40:02:a4
Uploading stub...
Running stub...
Stub running...
Changing baud rate to 460800
Changed.
Configuring flash size...
Compressed 3072 bytes to 103...
Writing at 0x00008000... (100 %)
Wrote 3072 bytes (103 compressed) at 0x00008000 in 0.0 seconds (effective 4238.1_
↳kbit/s)...
Hash of data verified.
Compressed 18960 bytes to 11311...
Writing at 0x00000000... (100 %)
Wrote 18960 bytes (11311 compressed) at 0x00000000 in 0.3 seconds (effective 584.9_
↳kbit/s)...
Hash of data verified.
Compressed 145520 bytes to 71984...
Writing at 0x00010000... (20 %)
Writing at 0x00014000... (40 %)
Writing at 0x00018000... (60 %)
Writing at 0x0001c000... (80 %)
Writing at 0x00020000... (100 %)
Wrote 145520 bytes (71984 compressed) at 0x00010000 in 2.3 seconds (effective 504.
↳4 kbit/s)...
Hash of data verified.
Leaving...
```

(continues on next page)

(continued from previous page)

```
Hard resetting via RTS pin...
Done
```

If there are no issues by the end of the flash process, the board will reboot and start up the “hello_world” application.

If you’d like to use the Eclipse or VS Code IDE instead of running `idf.py`, check out the [Eclipse guide](#), [VS Code guide](#).

1.14 Step 10. Monitor

To check if “hello_world” is indeed running, type `idf.py -p PORT monitor` (Do not forget to replace `PORT` with your serial port name).

This command launches the *IDF Monitor* application:

```
$ idf.py -p /dev/ttyUSB0 monitor
Running idf_monitor in directory [...]/esp/hello_world/build
Executing "python [...]/esp-idf/tools/idf_monitor.py -b 115200 [...]/esp/hello_
↪world/build/hello-world.elf"...
--- idf_monitor on /dev/ttyUSB0 115200 ---
--- Quit: Ctrl+] | Menu: Ctrl+T | Help: Ctrl+T followed by Ctrl+H ---
ets Jun  8 2016 00:22:57

rst:0x1 (POWERON_RESET),boot:0x13 (SPI_FAST_FLASH_BOOT)
ets Jun  8 2016 00:22:57
...
```

After startup and diagnostic logs scroll up, you should see “Hello world!” printed out by the application.

```
...
Hello world!
Restarting in 10 seconds...
This is esp32c3 chip with 1 CPU core(s), WiFi/BLE, silicon revision 0, 2MB_
↪external flash
Minimum free heap size: 337332 bytes
Restarting in 9 seconds...
Restarting in 8 seconds...
Restarting in 7 seconds...
```

To exit IDF monitor use the shortcut `Ctrl+]`.

Note: You can combine building, flashing and monitoring into one step by running:

```
idf.py -p PORT flash monitor
```

See also:

- [IDF Monitor](#) for handy shortcuts and more details on using IDF monitor.
- [idf.py](#) for a full reference of `idf.py` commands and options.

That’s all that you need to get started with ESP32-C3!

Now you are ready to try some other [examples](#), or go straight to developing your own applications.

Important: Some of examples do not support ESP32-C3 because required hardware is not included in ESP32-C3 so it cannot be supported.

If building an example, please check the README file for the Supported Targets table. If this is present including ESP32-C3 target, or the table does not exist at all, the example will work on ESP32-C3.

1.15 Updating ESP-IDF

You should update ESP-IDF from time to time, as newer versions fix bugs and provide new features. The simplest way to do the update is to delete the existing `esp-idf` folder and clone it again, as if performing the initial installation described in [Step 2. Get ESP-IDF](#).

Another solution is to update only what has changed. *The update procedure depends on the version of ESP-IDF you are using.*

After updating ESP-IDF, execute the Install script again, in case the new ESP-IDF version requires different versions of tools. See instructions at [Step 3. Set up the tools](#).

Once the new tools are installed, update the environment using the Export script. See instructions at [Step 4. Set up the environment variables](#).

1.16 Related Documents

1.16.1 Establish Serial Connection with ESP32-C3

This section provides guidance how to establish serial connection between ESP32-C3 and PC.

Connect ESP32-C3 to PC

Connect the ESP32-C3 board to the PC using the USB cable. If device driver does not install automatically, identify USB to serial converter chip on your ESP32-C3 board (or external converter dongle), search for drivers in internet and install them.

Below is the list of USB to serial converter chips installed on most of the ESP32-C3 boards produced by Espressif together with links to the drivers:

- CP210x: [CP210x USB to UART Bridge VCP Drivers](#)
- FTDI: [FTDI Virtual COM Port Drivers](#)

Please check the board user guide for specific USB to serial converter chip used. The drivers above are primarily for reference. Under normal circumstances, the drivers should be bundled with an operating system and automatically installed upon connecting the board to the PC.

Check port on Windows

Check the list of identified COM ports in the Windows Device Manager. Disconnect ESP32-C3 and connect it back, to verify which port disappears from the list and then shows back again.

Figures below show serial port for ESP32 DevKitC and ESP32 WROVER KIT

Check port on Linux and macOS

To check the device name for the serial port of your ESP32-C3 board (or external converter dongle), run this command two times, first with the board / dongle unplugged, then with plugged in. The port which appears the second time is the one you need:

Linux



Fig. 15: USB to UART bridge of ESP32-DevKitC in Windows Device Manager

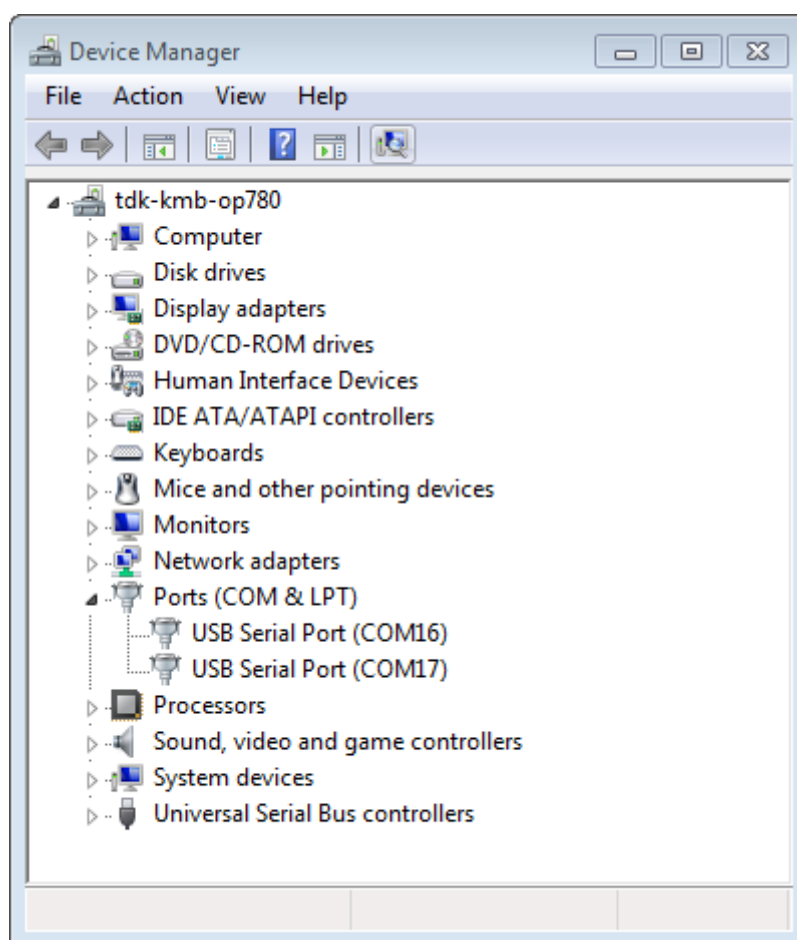

Fig. 16: Two USB Serial Ports of ESP-WROVER-KIT in Windows Device Manager

```
ls /dev/tty*
```

macOS

```
ls /dev/cu.*
```

Note: macOS users: if you don't see the serial port then check you have the USB/serial drivers installed as shown in the Getting Started guide for your particular development board. For macOS High Sierra (10.13), you may also have to explicitly allow the drivers to load. Open System Preferences -> Security & Privacy -> General and check if there is a message shown here about "System Software from developer ..." where the developer name is Silicon Labs or FTDI.

Adding user to dialout on Linux

The currently logged user should have read and write access the serial port over USB. On most Linux distributions, this is done by adding the user to `dialout` group with the following command:

```
sudo usermod -a -G dialout $USER
```

on Arch Linux this is done by adding the user to `uucp` group with the following command:

```
sudo usermod -a -G uucp $USER
```

Make sure you re-login to enable read and write permissions for the serial port.

Verify serial connection

Now verify that the serial connection is operational. You can do this using a serial terminal program by checking if you get any output on the terminal after resetting ESP32-C3.

Windows and Linux In this example we will use [PuTTY SSH Client](#) that is available for both Windows and Linux. You can use other serial program and set communication parameters like below.

Run terminal, set identified serial port, baud rate = 115200, data bits = 8, stop bits = 1, and parity = N. Below are example screen shots of setting the port and such transmission parameters (in short described as 115200-8-1-N) on Windows and Linux. Remember to select exactly the same serial port you have identified in steps above.

Then open serial port in terminal and check, if you see any log printed out by ESP32-C3. The log contents will depend on application loaded to ESP32-C3, see [Example Output](#).

Note: Close the serial terminal after verification that communication is working. If you keep the terminal session open, the serial port will be inaccessible for uploading firmware later.

macOS To spare you the trouble of installing a serial terminal program, macOS offers the `screen` command.

- As discussed in [Check port on Linux and macOS](#), run:

```
ls /dev/cu.*
```

- You should see similar output:

```
/dev/cu.Bluetooth-Incoming-Port /dev/cu.SLAB_USBtoUART /dev/cu.SLAB_
↪USBtoUART7
```

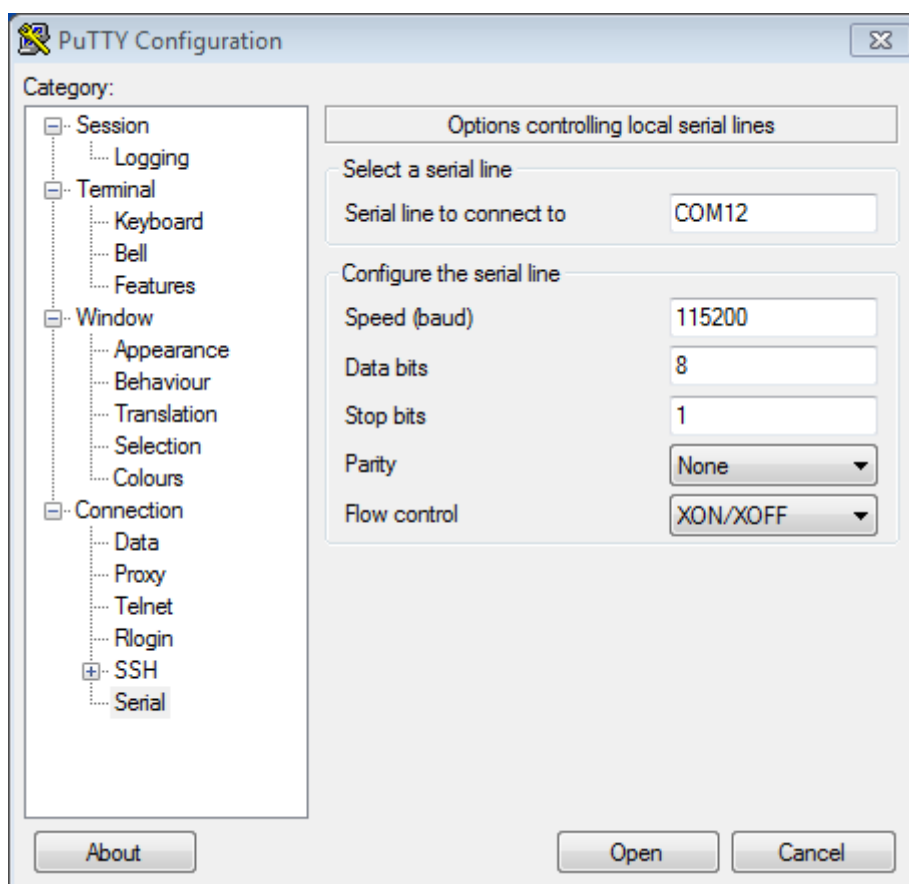

Fig. 17: Setting Serial Communication in PuTTY on Windows

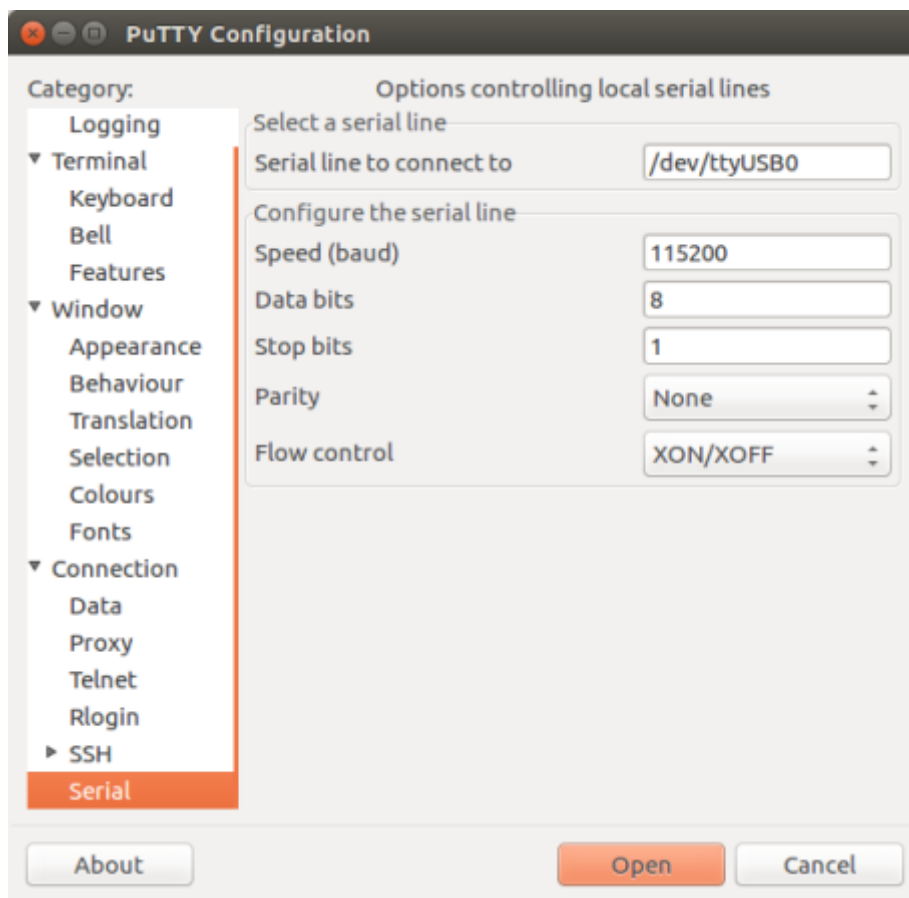

Fig. 18: Setting Serial Communication in PuTTY on Linux

- The output will vary depending on the type and the number of boards connected to your PC. Then pick the device name of your board and run:

```
screen /dev/cu.device_name 115200
```

Replace `device_name` with the name found running `ls /dev/cu.*`.

- What you are looking for is some log displayed by the **screen**. The log contents will depend on application loaded to ESP32-C3, see [Example Output](#). To exit the **screen** session type `Ctrl-A + \`.

Note: Do not forget to **exit the screen session** after verifying that the communication is working. If you fail to do it and just close the terminal window, the serial port will be inaccessible for uploading firmware later.

Example Output An example log by ESP32-C3 is shown below. Reset the board if you do not see anything.

```
ets Jun  8 2016 00:22:57

rst:0x5 (DEEPSLEEP_RESET),boot:0x13 (SPI_FAST_FLASH_BOOT)
ets Jun  8 2016 00:22:57

rst:0x7 (TG0WDT_SYS_RESET),boot:0x13 (SPI_FAST_FLASH_BOOT)
configsip: 0, SPIWP:0x00
clk_drv:0x00,q_drv:0x00,d_drv:0x00,cs0_drv:0x00,hd_drv:0x00,wp_drv:0x00
mode:DIO, clock div:2
load:0x3fff0008,len:8
load:0x3fff0010,len:3464
load:0x40078000,len:7828
load:0x40080000,len:252
entry 0x40080034
I (44) boot: ESP-IDF v2.0-rc1-401-gf9fba35 2nd stage bootloader
I (45) boot: compile time 18:48:10

...
```

If you can see readable log output, it means serial connection is working and you are ready to proceed with installation and finally upload of application to ESP32-C3.

Note: For some serial port wiring configurations, the serial RTS & DTR pins need to be disabled in the terminal program before the ESP32-C3 will boot and produce serial output. This depends on the hardware itself, most development boards (including all Espressif boards) *do not* have this issue. The issue is present if RTS & DTR are wired directly to the EN & GPIO0 pins. See the [esptool documentation](#) for more details.

If you got here from [Step 6. Connect Your Device](#) when installing s/w for ESP32-C3 development, then you can continue with [Step 7. Configure](#).

1.16.2 Build and Flash with Eclipse IDE

ESP-IDF V4.0 has a new CMake-based build system as the default build system.

There is a new ESP-IDF Eclipse Plugin that works with the CMake-based build system. Please refer to [Espressif IDF Eclipse Plugins](#) IDF for further instructions.

Note: In [Espressif IDF Eclipse Plugins](#), though screenshots are captured from macOS, installation instructions are applicable for Windows, Linux and macOS.

1.16.3 Getting Started with VS Code IDE

We have official support for VS Code and we aim to provide complete end to end support for all actions related to ESP-IDF namely build, flash, monitor, debug, tracing, core-dump, System Trace Viewer, etc.

Quick Install Guide

Recommended way to install ESP-IDF Visual Studio Code Extension is by downloading it from [VS Code Marketplace](#) or following [Quick Installation Guide](#).

Review the *tutorials* <<https://github.com/espressif/vscode-esp-idf-extension/blob/master/docs/tutorial/toc.md>> for ESP-IDF Visual Studio Code Extension to learn how to use all features.

Supported Features

- **Setup**, will help you to quickly install ESP-IDF and its relevant toolchain with just few clicks.
- **Build**, with one click build and multi target build, you can easily build and deploy your applications.
- **Flash**, with both UART and JTAG flash out of the box.
- **Monitoring** comes with built-in terminal where you can trigger IDF Monitor Commands from within VS Code as you are used to in traditional terminals.
- **Debugging** <<https://github.com/espressif/vscode-esp-idf-extension/blob/master/docs/tutorial/debugging.md>>, with out of box hardware debugging and also support for postmortem debugging like core-dump, you can analyze the bugs with convenience.
- **GUI Menu Config**, provides with simplified UI for configuring your chip.
- **App & Heap Tracing**, provides support for collecting traces from your application and simplified UI for analyzing them.
- **System View Tracing Viewer**, aims to read and display the `.svdat` files into trace UI, we also support multiple core tracing views.
- **IDF Size Analysis Overview** presents an UI for binary size analysis.
- **Rainmaker Cloud**, we have inbuilt Rainmaker Cloud support where you can edit/read state of your connected IoT devices easily.
- **Code Coverage**, we have inbuilt code coverage support which shall highlight in color which line have been covered. We also render the existing HTML report directly inside the IDE.

Bugs & Feature Requests

If you face an issue with certain feature of VS Code or VS Code in general we recommend to ask your question in the [forum](#), or open a [github issue](#) for our dev teams to review.

We also welcome new feature request, most of the features we have today is result of people asking it to implement, or improve certain aspect of the extension, [raise your feature request on github](#).

1.16.4 IDF Monitor

The IDF monitor tool is mainly a serial terminal program which relays serial data to and from the target device's serial port. It also provides some IDF-specific features.

This tool can be launched from an IDF project by running `idf.py monitor`.

For the legacy GNU Make system, run `make monitor`.

Keyboard Shortcuts

For easy interaction with IDF Monitor, use the keyboard shortcuts given in the table.

Keyboard Shortcut	Action	Description
Ctrl+]]	Exit the program	
Ctrl+T	Menu escape key	Press and follow it by one of the keys given below.
• Ctrl+T	Send the menu character itself to remote	
• Ctrl+]]	Send the exit character itself to remote	
• Ctrl+P	Reset target into bootloader to pause app via RTS line	Resets the target, into bootloader via the RTS line (if connected), so that the board runs nothing. Useful when you need to wait for another device to startup.
• Ctrl+R	Reset target board via RTS	Resets the target board and re-starts the application via the RTS line (if connected).
• Ctrl+F	Build and flash the project	Pauses idf_monitor to run the project flash target, then resumes idf_monitor. Any changed source files are recompiled and then re-flashed. Target encrypted-flash is run if idf_monitor was started with argument -E.
• Ctrl+A (or A)	Build and flash the app only	Pauses idf_monitor to run the app-flash target, then resumes idf_monitor. Similar to the flash target, but only the main app is built and re-flashed. Target encrypted-app-flash is run if idf_monitor was started with argument -E.
• Ctrl+Y	Stop/resume log output printing on screen	Discards all incoming serial data while activated. Allows to quickly pause and examine log output without quitting the monitor.
• Ctrl+L	Stop/resume log output saved to file	Creates a file in the project directory and the output is written to that file until this is disabled with the same keyboard shortcut (or IDF Monitor exits).
• Ctrl+H (or H)	Display all keyboard shortcuts	
• Ctrl+X (or X)	Exit the program	

Any keys pressed, other than Ctrl-] and Ctrl-T, will be sent through the serial port.

IDF-specific features

Automatic Address Decoding Whenever ESP-IDF outputs a hexadecimal code address of the form 0x4_____, IDF Monitor uses [addr2line](#) to look up the location in the source code and find the function name.

If an ESP-IDF app crashes and panics, a register dump and backtrace is produced, such as the following:

```

abort() was called at PC 0x42067cd5 on core 0

Stack dump detected
Core 0 register dump:
MEPC   : 0x40386488  RA       : 0x40386b02  SP       : 0x3fc9a350  GP       : _
↳0x3fc923c0
TP     : 0xa5a5a5a5  T0      : 0x37363534  T1      : 0x7271706f  T2      : _
↳0x33323130
S0/FP  : 0x00000004  S1      : 0x3fc9a3b4  A0      : 0x3fc9a37c  A1      : _
↳0x3fc9a3b2
A2     : 0x00000000  A3      : 0x3fc9a3a9  A4      : 0x00000001  A5      : _
↳0x3fc99000

```

(continues on next page)

(continued from previous page)

```

A6      : 0x7a797877  A7      : 0x76757473  S2      : 0xa5a5a5a5  S3      : _
↳0xa5a5a5a5
S4      : 0xa5a5a5a5  S5      : 0xa5a5a5a5  S6      : 0xa5a5a5a5  S7      : _
↳0xa5a5a5a5
S8      : 0xa5a5a5a5  S9      : 0xa5a5a5a5  S10     : 0xa5a5a5a5  S11     : _
↳0xa5a5a5a5
T3      : 0x6e6d6c6b  T4      : 0x6a696867  T5      : 0x66656463  T6      : _
↳0x62613938
MSTATUS : 0x00001881  MTVEC   : 0x40380001  MCAUSE  : 0x00000007  MTVAL   : _
↳0x00000000

MHARTID : 0x00000000

Stack memory:
3fc9a350: 0xa5a5a5a5 0xa5a5a5a5 0x3fc9a3b0 0x403906cc 0xa5a5a5a5 0xa5a5a5a5_
↳0xa5a5a5a50
3fc9a370: 0x3fc9a3b4 0x3fc9423c 0x3fc9a3b0 0x726f6261 0x20292874 0x20736177_
↳0x6c6c61635
3fc9a390: 0x43502074 0x34783020 0x37363032 0x20356463 0x63206e6f 0x2065726f_
↳0x000000300
3fc9a3b0: 0x00000030 0x36303234 0x35646337 0x3c093700 0x0000002a 0xa5a5a5a5_
↳0x3c0937f48
3fc9a3d0: 0x00000001 0x3c0917f8 0x3c0937d4 0x0000002a 0xa5a5a5a5 0xa5a5a5a5_
↳0xa5a5a5a5e
3fc9a3f0: 0x0001f24c 0x000000c8 0x00000000 0x0001c200 0xffffffff 0xffffffff_
↳0x000000200
3fc9a410: 0x00001000 0x00000002 0x3c093818 0x3fccb470 0xa5a5a5a5 0xa5a5a5a5_
↳0xa5a5a5a56
.....

```

IDF Monitor adds more details to the dump by analyzing the stack dump:

```

abort() was called at PC 0x42067cd5 on core 0
0x42067cd5: __assert_func at /builds/idf/croscstool-NG/.build/riscv32-esp-elf/src/
↳newlib/newlib/libc/stdlib/assert.c:62 (discriminator 8)

Stack dump detected
Core 0 register dump:
MEPC    : 0x40386488  RA      : 0x40386b02  SP      : 0x3fc9a350  GP      : _
↳0x3fc923c0
0x40386488: panic_abort at /home/marius/esp-idf_2/components/esp_system/panic.c:367

0x40386b02: rtos_int_enter at /home/marius/esp-idf_2/components/freertos/port/
↳riscv/portasm.S:35

TP      : 0xa5a5a5a5  T0      : 0x37363534  T1      : 0x7271706f  T2      : _
↳0x33323130
S0/FP   : 0x00000004  S1      : 0x3fc9a3b4  A0      : 0x3fc9a37c  A1      : _
↳0x3fc9a3b2
A2      : 0x00000000  A3      : 0x3fc9a3a9  A4      : 0x00000001  A5      : _
↳0x3fc99000
A6      : 0x7a797877  A7      : 0x76757473  S2      : 0xa5a5a5a5  S3      : _
↳0xa5a5a5a5
S4      : 0xa5a5a5a5  S5      : 0xa5a5a5a5  S6      : 0xa5a5a5a5  S7      : _
↳0xa5a5a5a5
S8      : 0xa5a5a5a5  S9      : 0xa5a5a5a5  S10     : 0xa5a5a5a5  S11     : _
↳0xa5a5a5a5
T3      : 0x6e6d6c6b  T4      : 0x6a696867  T5      : 0x66656463  T6      : _
↳0x62613938
MSTATUS : 0x00001881  MTVEC   : 0x40380001  MCAUSE  : 0x00000007  MTVAL   : _
↳0x00000000

```

(continues on next page)

(continued from previous page)

```

MHARTID : 0x00000000

Backtrace:
panic_abort (details=details@entry=0x3fc9a37c "abort() was called at PC 0x42067cd5_
↳ on core 0") at /home/marius/esp-idf_2/components/esp_system/panic.c:367
367      *((int *) 0) = 0; // NOLINT(clang-analyzer-core.NullDereference) should be_
↳ an invalid operation on targets
#0  panic_abort (details=details@entry=0x3fc9a37c "abort() was called at PC_
↳ 0x42067cd5 on core 0") at /home/marius/esp-idf_2/components/esp_system/panic.
↳ c:367
#1  0x40386b02 in esp_system_abort (details=details@entry=0x3fc9a37c "abort() was_
↳ called at PC 0x42067cd5 on core 0") at /home/marius/esp-idf_2/components/esp_
↳ system/system_api.c:108
#2  0x403906cc in abort () at /home/marius/esp-idf_2/components/newlib/abort.c:46
#3  0x42067cd8 in __assert_func (file=file@entry=0x3c0937f4 "", line=line@entry=42,
↳ func=func@entry=0x3c0937d4 <__func__.8540> "", _
↳ failedexpr=failedexpr@entry=0x3c0917f8 "") at /builds/idf/crosstool-NG/.build/
↳ riscv32-esp-elf/src/newlib/newlib/libc/stdlib/assert.c:62
#4  0x4200729e in app_main () at ../main/iperf_example_main.c:42
#5  0x42086cd6 in main_task (args=<optimized out>) at /home/marius/esp-idf_2/
↳ components/freertos/port/port_common.c:133
#6  0x40389f3a in vPortEnterCritical () at /home/marius/esp-idf_2/components/
↳ freertos/port/riscv/port.c:129

```

To decode each address, IDF Monitor runs the following command in the background:

```
riscv32-esp-elf-addr2line -pfiaC -e build/PROJECT.elf ADDRESS
```

Note: Set environment variable `ESP_MONITOR_DECODE` to 0 or call `idf_monitor.py` with specific command line option: `idf_monitor.py --disable-address-decoding` to disable address decoding.

Launching GDB with GDBStub By default, if esp-idf crashes, the panic handler prints relevant registers and the stack dump (similar to the ones above) over the serial port. Then it resets the board.

Optionally, the panic handler can be configured to run GDBStub, the tool which can communicate with [GDB](#) project debugger. GDBStub allows to read memory, examine call stack frames and variables, etc. It is not as versatile as JTAG debugging, but this method does not require any special hardware.

To enable GDBStub, open the project configuration menu (`idf.py menuconfig`) and set [CONFIG_ESP_SYSTEM_PANIC](#) to Invoke GDBStub.

In this case, if the panic handler is triggered, as soon as IDF Monitor sees that GDBStub has loaded, it automatically pauses serial monitoring and runs GDB with necessary arguments. After GDB exits, the board is reset via the RTS serial line. If this line is not connected, please reset the board manually by pressing its Reset button.

In the background, IDF Monitor runs the following command:

```
riscv32-esp-elf-gdb -ex "set serial baud BAUD" -ex "target remote PORT" -ex_
↳ interrupt build/PROJECT.elf :idf_target:`Hello NAME chip`
```

Output Filtering IDF monitor can be invoked as `idf.py monitor --print-filter="xyz"`, where `--print-filter` is the parameter for output filtering. The default value is an empty string, which means that everything is printed.

Restrictions on what to print can be specified as a series of `<tag>:<log_level>` items where `<tag>` is the tag string and `<log_level>` is a character from the set {N, E, W, I, D, V, *} referring to a level for [logging](#).

For example, `PRINT_FILTER="tag1:W"` matches and prints only the outputs written with `ESP_LOGW("tag1", ...)` or at lower verbosity level, i.e. `ESP_LOGE("tag1", ...)`. Not specifying a `<log_level>` or using `*` defaults to Verbose level.

Note: Use primary logging to disable at compilation the outputs you do not need through the *logging library*. Output filtering with IDF monitor is a secondary solution which can be useful for adjusting the filtering options without recompiling the application.

Your app tags must not contain spaces, asterisks `*`, or colons `:` to be compatible with the output filtering feature.

If the last line of the output in your app is not followed by a carriage return, the output filtering might get confused, i.e., the monitor starts to print the line and later finds out that the line should not have been written. This is a known issue and can be avoided by always adding a carriage return (especially when no output follows immediately afterwards).

Examples Of Filtering Rules:

- `*` can be used to match any tags. However, the string `PRINT_FILTER="*:I tag1:E"` with regards to `tag1` prints errors only, because the rule for `tag1` has a higher priority over the rule for `*`.
- The default (empty) rule is equivalent to `*:V` because matching every tag at the Verbose level or lower means matching everything.
- `*:N` suppresses not only the outputs from logging functions, but also the prints made by `printf`, etc. To avoid this, use `*:E` or a higher verbosity level.
- Rules `"tag1:V"`, `"tag1:v"`, `"tag1:"`, `"tag1:*"`, and `"tag1"` are equivalent.
- Rule `"tag1:W tag1:E"` is equivalent to `"tag1:E"` because any consequent occurrence of the same tag name overwrites the previous one.
- Rule `"tag1:I tag2:W"` only prints `tag1` at the Info verbosity level or lower and `tag2` at the Warning verbosity level or lower.
- Rule `"tag1:I tag2:W tag3:N"` is essentially equivalent to the previous one because `tag3:N` specifies that `tag3` should not be printed.
- `tag3:N` in the rule `"tag1:I tag2:W tag3:N *:V"` is more meaningful because without `tag3:N` the `tag3` messages could have been printed; the errors for `tag1` and `tag2` will be printed at the specified (or lower) verbosity level and everything else will be printed by default.

A More Complex Filtering Example The following log snippet was acquired without any filtering options:

```
load:0x40078000,len:13564
entry 0x40078d4c
E (31) esp_image: image at 0x30000 has invalid magic byte
W (31) esp_image: image at 0x30000 has invalid SPI mode 255
E (39) boot: Factory app partition is not bootable
I (568) cpu_start: Pro cpu up.
I (569) heap_init: Initializing. RAM available for dynamic allocation:
I (603) cpu_start: Pro cpu start user code
D (309) light_driver: [light_init, 74]:status: 1, mode: 2
D (318) vfs: esp_vfs_register_fd_range is successful for range <54; 64) and VFS ID_
↪1
I (328) wifi: wifi driver task: 3ffdbf84, prio:23, stack:4096, core=0
```

The captured output for the filtering options `PRINT_FILTER="wifi esp_image:E light_driver:I"` is given below:

```
E (31) esp_image: image at 0x30000 has invalid magic byte
I (328) wifi: wifi driver task: 3ffdbf84, prio:23, stack:4096, core=0
```

The options `PRINT_FILTER="light_driver:D esp_image:N boot:N cpu_start:N vfs:N wifi:N *:V"` show the following output:

```
load:0x40078000,len:13564
entry 0x40078d4c
I (569) heap_init: Initializing. RAM available for dynamic allocation:
D (309) light_driver: [light_init, 74]:status: 1, mode: 2
```

Known Issues with IDF Monitor

Issues Observed on Windows

- If in the Windows environment you receive the error “winpty: command not found”, fix it by running `pacman -S winpty`.
- Arrow keys, as well as some other keys, do not work in GDB due to Windows Console limitations.
- Occasionally, when “idf.py” or “make” exits, it might stall for up to 30 seconds before IDF Monitor resumes.
- When “gdb” is run, it might stall for a short time before it begins communicating with the GDBStub.

1.16.5 Customized Setup of Toolchain

Instead of downloading binary toolchain from Espressif website (see [Step 3. Set up the tools](#)) you may build the toolchain yourself.

If you can't think of a reason why you need to build it yourself, then probably it's better to stick with the binary version. However, here are some of the reasons why you might want to compile it from source:

- if you want to customize toolchain build configuration
- if you want to use a different GCC version (such as 4.8.5)
- if you want to hack gcc or newlib or libstdc++
- if you are curious and/or have time to spare
- if you don't trust binaries downloaded from the Internet

In any case, here are the instructions to compile the toolchain yourself.

Setup Windows Toolchain from Scratch

This is a step-by-step alternative to running the [ESP-IDF Tools Installer](#) for the CMake-based build system. Installing all of the tools by hand allows more control over the process, and also provides the information for advanced users to customize the install.

To quickly setup the toolchain and other tools in standard way, using the ESP-IDF Tools installer, proceed to section [Standard Setup of Toolchain for Windows](#).

Note: The GNU Make based build system requires the [MSYS2](#) Unix compatibility environment on Windows. The CMake-based build system does not require this environment.

Get ESP-IDF

Note: Previous versions of ESP-IDF used the [MSYS2 bash terminal](#) command line. The current cmake-based build system can run in the regular **Windows Command Prompt** which is used here.

If you use a bash-based terminal or PowerShell, please note that some command syntax will be different to what is shown below.

Open Command Prompt and run the following commands:

```
mkdir %userprofile%\esp
cd %userprofile%\esp
git clone -b v4.3.4 --recursive https://github.com/espressif/esp-idf.git
```

ESP-IDF will be downloaded into %userprofile%\esp\esp-idf.

Consult [ESP-IDF Versions](#) for information about which ESP-IDF version to use in a given situation.

Note: The `git clone` option `-b v4.3.4` tells git to clone the tag in the ESP-IDF repository `git clone` corresponding to this version of the documentation.

Note: As a fallback, it is also possible to download a zip file of this stable release from the [Releases page](#). Do not download the “Source code” zip file(s) generated automatically by GitHub, they do not work with ESP-IDF.

Note: Do not miss the `--recursive` option. If you have already cloned ESP-IDF without this option, run another command to get all the submodules:

```
cd esp-idf
git submodule update --init
```

Tools

CMake Download the latest stable release of [CMake](#) for Windows and run the installer.

When the installer asks for Install Options, choose either “Add CMake to the system PATH for all users” or “Add CMake to the system PATH for the current user” .

Ninja build

Note: Ninja currently only provides binaries for 64-bit Windows. It is possible to use CMake and `idf.py` with other build tools, such as mingw-make, on 32-bit windows. However this is currently undocumented.

Download the [Ninja](#) latest stable Windows release from the ([download page](#)).

The Ninja for Windows download is a .zip file containing a single `ninja.exe` file which needs to be unzipped to a directory which is then *added to your Path* (or you can choose a directory which is already on your Path).

Python Download the latest [Python](#) for Windows installer, and run it.

The “Customise” step of the Python installer gives a list of options. The last option is “Add python.exe to Path” . Change this option to select “Will be installed” .

Once Python is installed, open a Windows Command Prompt from the Start menu and run the following command:

```
pip install --user pyserial
```

Toolchain Setup Download the precompiled Windows toolchain:

https://dl.espressif.com/dl/xtensa-esp32-elf-gcc8_4_0-esp-2021r2-patch3-win32.zip

Unzip the zip file to C:\Program Files (or some other location). The zip file contains a single directory `riscv32-esp-elf`.

Next, the `bin` subdirectory of this directory must be *added to your Path*. For example, the directory to add may be `C:\Program Files\riscv32-esp-elf\bin`.

Note: If you already have the MSYS2 environment (for use with the “GNU Make” build system) installed, you can skip the separate download and add the directory `C:\msys32\opt\riscv32-esp-elf\bin` to the Path instead, as the toolchain is included in the MSYS2 environment.

Adding Directory to Path To add any new directory to your Windows Path environment variable:

Open the System control panel and navigate to the Environment Variables dialog. (On Windows 10, this is found under Advanced System Settings).

Double-click the Path variable (either User or System Path, depending if you want other users to have this directory on their path.) Go to the end of the value, and append `; <new value>`.

Next Steps To carry on with development environment setup, proceed to [Step 3. Set up the tools.](#)

Setup Linux Toolchain from Scratch

The following instructions are alternative to downloading binary toolchain from Espressif website. To quickly setup the binary toolchain, instead of compiling it yourself, backup and proceed to section [Standard Setup of Toolchain for Linux.](#)

Note: The reason you might need to build your own toolchain is to solve the Y2K38 problem (time_t expand to 64 bits instead of 32 bits).

Install Prerequisites To compile with ESP-IDF you need to get the following packages:

- CentOS 7:

```
sudo yum -y update && sudo yum install git wget ncurses-devel flex bison gperf_
↳python3 python3-pip cmake ninja-build ccache dfu-util libusbx
```

CentOS 7 is still supported but CentOS version 8 is recommended for a better user experience.

- Ubuntu and Debian:

```
sudo apt-get install git wget libncurses-dev flex bison gperf python3 python3-
↳pip python3-setuptools python3-serial python3-cryptography python3-future_
↳python3-pyparsing python3-pyelftools cmake ninja-build ccache libffi-dev_
↳libssl-dev dfu-util libusb-1.0-0
```

- Arch:

```
sudo pacman -Sy --needed gcc git make ncurses flex bison gperf python-pyserial_
↳python-cryptography python-future python-pyparsing python-pyelftools cmake_
↳ninja ccache dfu-util libusb
```

Note: CMake version 3.5 or newer is required for use with ESP-IDF. Older Linux distributions may require updating, enabling of a “backports” repository, or installing of a “cmake3” package rather than “cmake” .

Compile the Toolchain from Source

- Install dependencies:
 - CentOS 7:

```
sudo yum install gawk gperf grep gettext ncurses-devel python3 python3-  
↳devel automake bison flex texinfo help2man libtool make
```

– Ubuntu pre-16.04:

```
sudo apt-get install gawk gperf grep gettext libncurses-dev python python-  
↳dev automake bison flex texinfo help2man libtool make
```

– Ubuntu 16.04 or newer:

```
sudo apt-get install gawk gperf grep gettext python python-dev automake  
↳bison flex texinfo help2man libtool libtool-bin make
```

– Debian 9:

```
sudo apt-get install gawk gperf grep gettext libncurses-dev python python-  
↳dev automake bison flex texinfo help2man libtool libtool-bin make
```

– Arch:

```
sudo pacman -Sy --needed python-pip
```

Create the working directory and go into it:

```
mkdir -p ~/esp  
cd ~/esp
```

Download crosstool-NG and build it:

```
git clone https://github.com/espressif/crosstool-NG.git  
cd crosstool-NG  
git checkout esp-2021r2-patch3  
git submodule update --init  
./bootstrap && ./configure --enable-local && make
```

Note: To create a toolchain with support for 64-bit `time_t`, you need to remove the `--enable-newlib-long-time_t` option from the `crosstool-NG/samples/xtensa-esp32-elf/crosstool.config` file in 33 and 43 lines.

Build the toolchain:

```
./ct-ng riscv32-esp-elf  
./ct-ng build  
chmod -R u+w builds/riscv32-esp-elf
```

Toolchain will be built in `~/esp/crosstool-NG/builds/riscv32-esp-elf`.

Add Toolchain to PATH The custom toolchain needs to be copied to a binary directory and added to the `PATH`.

Choose a directory, for example `~/esp/riscv32-esp-elf/`, and copy the build output to this directory.

To use it, you will need to update your `PATH` environment variable in `~/.profile` file. To make `riscv32-esp-elf` available for all terminal sessions, add the following line to your `~/.profile` file:

```
export PATH="$HOME/esp/riscv32-esp-elf/bin:$PATH"
```

Note: If you have `/bin/bash` set as login shell, and both `.bash_profile` and `.profile` exist, then update `.bash_profile` instead. In CentOS, `alias` should set in `.bashrc`.

Log off and log in back to make the `.profile` changes effective. Run the following command to verify if `PATH` is correctly set:

```
printenv PATH
```

You are looking for similar result containing toolchain's path at the beginning of displayed string:

```
$ printenv PATH
/home/user-name/esp/riscv32-esp-elf/bin:/home/user-name/bin:/home/user-name/.local/
↪bin:/usr/local/sbin:/usr/local/bin:/usr/sbin:/usr/bin:/sbin:/bin:/usr/games:/usr/
↪local/games:/snap/bin
```

Instead of `/home/user-name` there should be a home path specific to your installation.

Python 2 deprecation Python 2 reached its [end of life](#) and support for it in ESP-IDF will be removed soon. Please install Python 3.6 or higher. Instructions for popular Linux distributions are listed above.

Next Steps To carry on with development environment setup, proceed to [Step 2. Get ESP-IDF](#).

Setup Toolchain for Mac OS from Scratch

Package Manager To set up the toolchain from scratch, rather than [downloading a pre-compiled toolchain](#), you will need to install either the [MacPorts](#) or [Homebrew](#) package manager.

MacPorts needs a full XCode installation, while Homebrew only needs XCode command line tools.

See [Customized Setup of Toolchain](#) section for some of the reasons why installing the toolchain from scratch may be necessary.

Install Prerequisites

- install pip:

```
sudo easy_install pip
```

- install pyserial:

```
pip install --user pyserial
```

- install CMake & Ninja build:
 - If you have Homebrew, you can run:

```
brew install cmake ninja dfu-util
```

- If you have MacPorts, you can run:

```
sudo port install cmake ninja dfu-util
```

Compile the Toolchain from Source

- Install dependencies:
 - with MacPorts:

```
sudo port install gsed gawk binutils gperf grep gettext wget libtool↵
↪autoconf automake make
```

- with Homebrew:

```
brew install gnu-sed gawk binutils gperftools gettext wget help2man↵
↪libtool autoconf automake make
```

Create a case-sensitive filesystem image:

```
hdiutil create ~/esp/crosstool.dmg -volname "ctng" -size 10g -fs "Case-sensitive_↵  
↵HFS+"
```

Mount it:

```
hdiutil mount ~/esp/crosstool.dmg
```

Create a symlink to your work directory:

```
mkdir -p ~/esp  
ln -s /Volumes/ctng ~/esp/ctng-volume
```

Go into the newly created directory:

```
cd ~/esp/ctng-volume
```

Download crosstool-NG and build it:

```
git clone https://github.com/espressif/crosstool-NG.git  
cd crosstool-NG  
git checkout esp-2021r2-patch3  
git submodule update --init  
./bootstrap && ./configure --enable-local && make
```

Build the toolchain:

```
./ct-ng riscv32-esp-elf  
./ct-ng build  
chmod -R u+w builds/riscv32-esp-elf
```

Toolchain will be built in `~/esp/ctng-volume/crosstool-NG/builds/riscv32-esp-elf`. To use it, you need to add `~/esp/ctng-volume/crosstool-NG/builds/riscv32-esp-elf/bin` to PATH environment variable.

Python 2 deprecation Python 2 reached its [end of life](#) and support for it in ESP-IDF will be removed soon. Please install Python 3.6 or higher. Instructions for macOS are listed above.

Next Steps To carry on with development environment setup, proceed to [Step 2. Get ESP-IDF](#).

Chapter 2

API Reference

2.1 Bluetooth API

2.1.1 Controller & VHCI

Application Example

Check `bluetooth/hci` folder in ESP-IDF examples, which contains the following application:

- This is a BLE advertising demo with virtual HCI interface. Send `Reset/ADV_PARAM/ADV_DATA/ADV_ENABLE` HCI command for BLE advertising - `bluetooth/hci/controller_vhci_ble_adv`.

API Reference

Header File

- `bt/include/esp32/include/esp_bt.h`

Functions

`esp_err_t esp_ble_tx_power_set(esp_ble_power_type_t power_type, esp_power_level_t power_level)`

Set BLE TX power Connection Tx power should only be set after connection created.

Return ESP_OK - success, other - failed

Parameters

- `power_type`: : The type of which tx power, could set Advertising/Connection/Default and etc
- `power_level`: Power level(index) corresponding to absolute value(dbm)

`esp_power_level_t esp_ble_tx_power_get(esp_ble_power_type_t power_type)`

Get BLE TX power Connection Tx power should only be get after connection created.

Return ≥ 0 - Power level, < 0 - Invalid

Parameters

- `power_type`: : The type of which tx power, could set Advertising/Connection/Default and etc

`esp_err_t esp_bredr_tx_power_set(esp_power_level_t min_power_level, esp_power_level_t max_power_level)`

Set BR/EDR TX power BR/EDR power control will use the power in range of minimum value and maximum value. The power level will effect the global BR/EDR TX power, such inquire, page, connection and so on. Please call the function after `esp_bt_controller_enable` and before any function which cause RF do TX. So you can call the function before doing discovery, profile init and so on. For example, if you want BR/EDR use the new TX power to do inquire, you should call this function before inquire. Another word, If call this function when BR/EDR is in inquire(ING), please do inquire again after call this function. Default minimum power level is `ESP_PWR_LVL_N0`, and maximum power level is `ESP_PWR_LVL_P3`.

Return ESP_OK - success, other - failed

Parameters

- `min_power_level`: The minimum power level
- `max_power_level`: The maximum power level

esp_err_t **esp_bredr_tx_power_get** (*esp_power_level_t* *`min_power_level`, *esp_power_level_t* *`max_power_level`)

Get BR/EDR TX power If the argument is not NULL, then store the corresponding value.

Return ESP_OK - success, other - failed

Parameters

- `min_power_level`: The minimum power level
- `max_power_level`: The maximum power level

esp_err_t **esp_bredr_sco_datapath_set** (*esp_sco_data_path_t* `data_path`)

Set default SCO data path Should be called after controller is enabled, and before (e)SCO link is established.

Return ESP_OK - success, other - failed

Parameters

- `data_path`: SCO data path

esp_err_t **esp_bt_controller_init** (*esp_bt_controller_config_t* *`cfg`)

Initialize BT controller to allocate task and other resource. This function should be called only once, before any other BT functions are called.

Return ESP_OK - success, other - failed

Parameters

- `cfg`: Initial configuration of BT controller. Different from previous version, there's a mode and some connection configuration in "cfg" to configure controller work mode and allocate the resource which is needed.

esp_err_t **esp_bt_controller_deinit** (void)

De-initialize BT controller to free resource and delete task. You should stop advertising and scanning, as well as disconnect all existing connections before de-initializing BT controller.

This function should be called only once, after any other BT functions are called.

Return ESP_OK - success, other - failed

esp_err_t **esp_bt_controller_enable** (*esp_bt_mode_t* `mode`)

Enable BT controller. Due to a known issue, you cannot call `esp_bt_controller_enable()` a second time to change the controller mode dynamically. To change controller mode, call `esp_bt_controller_disable()` and then call `esp_bt_controller_enable()` with the new mode.

Return ESP_OK - success, other - failed

Parameters

- `mode`: : the mode(BLE/BT/BTDM) to enable. For compatible of API, retain this argument. This mode must be equal as the mode in "cfg" of `esp_bt_controller_init()`.

esp_err_t **esp_bt_controller_disable** (void)

Disable BT controller.

Return ESP_OK - success, other - failed

esp_bt_controller_status_t **esp_bt_controller_get_status** (void)

Get BT controller is initialised/de-initialised/enabled/disabled.

Return status value

bool **esp_vhci_host_check_send_available** (void)

`esp_vhci_host_check_send_available` used for check actively if the host can send packet to controller or not.

Return true for ready to send, false means cannot send packet

void **esp_vhci_host_send_packet** (uint8_t *`data`, uint16_t `len`)

`esp_vhci_host_send_packet` host send packet to controller

Should not call this function from within a critical section or when the scheduler is suspended.

Parameters

- `data`: the packet point
- `len`: the packet length

esp_err_t **esp_vhci_host_register_callback** (const *esp_vhci_host_callback_t* *callback)

`esp_vhci_host_register_callback` register the `vhci` reference callback struct defined by `vhci_host_callback` structure.

Return `ESP_OK` - success, `ESP_FAIL` - failed

Parameters

- `callback`: *esp_vhci_host_callback* type variable

esp_err_t **esp_bt_controller_mem_release** (*esp_bt_mode_t* mode)

`esp_bt_controller_mem_release` release the controller memory as per the mode

This function releases the BSS, data and other sections of the controller to heap. The total size is about 70k bytes.

`esp_bt_controller_mem_release(mode)` should be called only before `esp_bt_controller_init()` or after `esp_bt_controller_deinit()`.

Note that once BT controller memory is released, the process cannot be reversed. It means you cannot use the bluetooth mode which you have released by this function.

If your firmware will later upgrade the Bluetooth controller mode (BLE -> BT Classic or disabled -> enabled) then do not call this function.

If the app calls `esp_bt_controller_enable(ESP_BT_MODE_BLE)` to use BLE only then it is safe to call `esp_bt_controller_mem_release(ESP_BT_MODE_CLASSIC_BT)` at initialization time to free unused BT Classic memory.

If the mode is `ESP_BT_MODE_BTDM`, then it may be useful to call API `esp_bt_mem_release(ESP_BT_MODE_BTDM)` instead, which internally calls `esp_bt_controller_mem_release(ESP_BT_MODE_BTDM)` and additionally releases the BSS and data consumed by the BT/BLE host stack to heap. For more details about usage please refer to the documentation of `esp_bt_mem_release()` function

Return `ESP_OK` - success, other - failed

Parameters

- `mode`: : the mode want to release memory

esp_err_t **esp_bt_mem_release** (*esp_bt_mode_t* mode)

`esp_bt_mem_release` release controller memory and BSS and data section of the BT/BLE host stack as per the mode

This function first releases controller memory by internally calling `esp_bt_controller_mem_release()`. Additionally, if the mode is set to `ESP_BT_MODE_BTDM`, it also releases the BSS and data consumed by the BT/BLE host stack to heap

Note that once BT memory is released, the process cannot be reversed. It means you cannot use the bluetooth mode which you have released by this function.

If your firmware will later upgrade the Bluetooth controller mode (BLE -> BT Classic or disabled -> enabled) then do not call this function.

If you never intend to use bluetooth in a current boot-up cycle, you can call `esp_bt_mem_release(ESP_BT_MODE_BTDM)` before `esp_bt_controller_init` or after `esp_bt_controller_deinit`.

For example, if a user only uses bluetooth for setting the WiFi configuration, and does not use bluetooth in the rest of the product operation” . In such cases, after receiving the WiFi configuration, you can disable/deinit bluetooth and release its memory. Below is the sequence of APIs to be called for such scenarios:

```
esp_bluedroid_disable();
esp_bluedroid_deinit();
esp_bt_controller_disable();
```

(continues on next page)

(continued from previous page)

```
esp_bt_controller_deinit();
esp_bt_mem_release(ESP_BT_MODE_BTDM);
```

Note In case of NimBLE host, to release BSS and data memory to heap, the mode needs to be set to `ESP_BT_MODE_BTDM` as controller is dual mode.

Return `ESP_OK` - success, other - failed

Parameters

- `mode`: : the mode whose memory is to be released

esp_err_t **esp_bt_sleep_enable**(void)

enable bluetooth to enter modem sleep

Note that this function shall not be invoked before `esp_bt_controller_enable()`

There are currently two options for bluetooth modem sleep, one is ORIG mode, and another is EVED Mode. EVED Mode is intended for BLE only.

For ORIG mode: Bluetooth modem sleep is enabled in controller start up by default if `CONFIG_CTRL_BTDM_MODEM_SLEEP` is set and “ORIG mode” is selected. In ORIG modem sleep mode, bluetooth controller will switch off some components and pause to work every now and then, if there is no event to process; and wakeup according to the scheduled interval and resume the work. It can also wakeup earlier upon external request using function “`esp_bt_controller_wakeup_request`” .

Return

- `ESP_OK` : success
- other : failed

esp_err_t **esp_bt_sleep_disable**(void)

disable bluetooth modem sleep

Note that this function shall not be invoked before `esp_bt_controller_enable()`

If `esp_bt_sleep_disable()` is called, bluetooth controller will not be allowed to enter modem sleep;

If ORIG modem sleep mode is in use, if this function is called, bluetooth controller may not immediately wake up if it is dormant then. In this case, `esp_bt_controller_wakeup_request()` can be used to shorten the time for wakeup.

Return

- `ESP_OK` : success
- other : failed

esp_err_t **esp_ble_scan_duplicate_list_flush**(void)

Manually clear scan duplicate list.

Note that scan duplicate list will be automatically cleared when the maximum amount of device in the filter is reached the amount of device in the filter can be configured in `menuconfig`.

Note This function name is incorrectly spelled, it will be fixed in release 5.x version.

Return

- `ESP_OK` : success
- other : failed

void **esp_wifi_bt_power_domain_on**(void)

bt Wi-Fi power domain power on

void **esp_wifi_bt_power_domain_off**(void)

bt Wi-Fi power domain power off

Structures

struct esp_bt_controller_config_t

Controller config options, depend on config mask. Config mask indicate which functions enabled, this means some options or parameters of some functions enabled by config mask.

Public Members

- uint16_t controller_task_stack_size**
Bluetooth controller task stack size
- uint8_t controller_task_prio**
Bluetooth controller task priority
- uint8_t hci_uart_no**
If use UART1/2 as HCI IO interface, indicate UART number
- uint32_t hci_uart_baudrate**
If use UART1/2 as HCI IO interface, indicate UART baudrate
- uint8_t scan_duplicate_mode**
scan duplicate mode
- uint8_t scan_duplicate_type**
scan duplicate type
- uint16_t normal_adv_size**
Normal adv size for scan duplicate
- uint16_t mesh_adv_size**
Mesh adv size for scan duplicate
- uint16_t send_adv_reserved_size**
Controller minimum memory value
- uint32_t controller_debug_flag**
Controller debug log flag
- uint8_t mode**
Controller mode: BR/EDR, BLE or Dual Mode
- uint8_t ble_max_conn**
BLE maximum connection numbers
- uint8_t bt_max_acl_conn**
BR/EDR maximum ACL connection numbers
- uint8_t bt_sco_datapath**
SCO data path, i.e. HCI or PCM module
- bool auto_latency**
BLE auto latency, used to enhance classic BT performance
- bool bt_legacy_auth_vs_evt**
BR/EDR Legacy auth complete event required to protect from BIAS attack
- uint8_t bt_max_sync_conn**
BR/EDR maximum ACL connection numbers. Effective in menuconfig
- uint8_t ble_sca**
BLE low power crystal accuracy index
- uint8_t pcm_role**
PCM role (master & slave)
- uint8_t pcm_polar**
PCM polar trig (falling clk edge & rising clk edge)
- bool hli**
Using high level interrupt or not
- uint32_t magic**
Magic number

struct esp_vhci_host_callback

esp_vhci_host_callback used for vhci call host function to notify what host need to do

Public Members

void (***notify_host_send_available**) (void)

callback used to notify that the host can send packet to controller

int (***notify_host_rcv**) (uint8_t *data, uint16_t len)

callback used to notify that the controller has a packet to send to the host

Macros

ESP_BT_CONTROLLER_CONFIG_MAGIC_VAL

BT_CONTROLLER_INIT_CONFIG_DEFAULT ()

Type Definitions

typedef struct esp_vhci_host_callback esp_vhci_host_callback_t

esp_vhci_host_callback used for vhci call host function to notify what host need to do

Enumerations

enum esp_bt_mode_t

Bluetooth mode for controller enable/disable.

Values:

ESP_BT_MODE_IDLE = 0x00

Bluetooth is not running

ESP_BT_MODE_BLE = 0x01

Run BLE mode

ESP_BT_MODE_CLASSIC_BT = 0x02

Run Classic BT mode

ESP_BT_MODE_BTDM = 0x03

Run dual mode

enum [anonymous]

BLE sleep clock accuracy(SCA), values for ble_sca field in *esp_bt_controller_config_t*, currently only ESP_BLE_SCA_500PPM and ESP_BLE_SCA_250PPM are supported.

Values:

ESP_BLE_SCA_500PPM = 0

BLE SCA at 500ppm

ESP_BLE_SCA_250PPM

BLE SCA at 250ppm

ESP_BLE_SCA_150PPM

BLE SCA at 150ppm

ESP_BLE_SCA_100PPM

BLE SCA at 100ppm

ESP_BLE_SCA_75PPM

BLE SCA at 75ppm

ESP_BLE_SCA_50PPM

BLE SCA at 50ppm

ESP_BLE_SCA_30PPM

BLE SCA at 30ppm

ESP_BLE_SCA_20PPM
BLE SCA at 20ppm

enum esp_bt_controller_status_t

Bluetooth controller enable/disable/initialised/de-initialised status.

Values:

ESP_BT_CONTROLLER_STATUS_IDLE = 0

ESP_BT_CONTROLLER_STATUS_INITED

ESP_BT_CONTROLLER_STATUS_ENABLED

ESP_BT_CONTROLLER_STATUS_NUM

enum esp_ble_power_type_t

BLE tx power type ESP_BLE_PWR_TYPE_CONN_HDL0-8: for each connection, and only be set after connection completed. when disconnect, the correspond TX power is not effected. ESP_BLE_PWR_TYPE_ADV : for advertising/scan response. ESP_BLE_PWR_TYPE_SCAN : for scan. ESP_BLE_PWR_TYPE_DEFAULT : if each connection' s TX power is not set, it will use this default value. if neither in scan mode nor in adv mode, it will use this default value. If none of power type is set, system will use ESP_PWR_LVL_P3 as default for ADV/SCAN/CONN0-9.

Values:

ESP_BLE_PWR_TYPE_CONN_HDL0 = 0
For connection handle 0

ESP_BLE_PWR_TYPE_CONN_HDL1 = 1
For connection handle 1

ESP_BLE_PWR_TYPE_CONN_HDL2 = 2
For connection handle 2

ESP_BLE_PWR_TYPE_CONN_HDL3 = 3
For connection handle 3

ESP_BLE_PWR_TYPE_CONN_HDL4 = 4
For connection handle 4

ESP_BLE_PWR_TYPE_CONN_HDL5 = 5
For connection handle 5

ESP_BLE_PWR_TYPE_CONN_HDL6 = 6
For connection handle 6

ESP_BLE_PWR_TYPE_CONN_HDL7 = 7
For connection handle 7

ESP_BLE_PWR_TYPE_CONN_HDL8 = 8
For connection handle 8

ESP_BLE_PWR_TYPE_ADV = 9
For advertising

ESP_BLE_PWR_TYPE_SCAN = 10
For scan

ESP_BLE_PWR_TYPE_DEFAULT = 11
For default, if not set other, it will use default value

ESP_BLE_PWR_TYPE_NUM = 12
TYPE numbers

enum esp_power_level_t

Bluetooth TX power level(index), it' s just a index corresponding to power(dbm).

Values:

ESP_PWR_LVL_N12 = 0
Corresponding to -12dbm

ESP_PWR_LVL_N9 = 1
Corresponding to -9dbm

ESP_PWR_LVL_N6 = 2
Corresponding to -6dbm

ESP_PWR_LVL_N3 = 3
Corresponding to -3dbm

ESP_PWR_LVL_N0 = 4
Corresponding to 0dbm

ESP_PWR_LVL_P3 = 5
Corresponding to +3dbm

ESP_PWR_LVL_P6 = 6
Corresponding to +6dbm

ESP_PWR_LVL_P9 = 7
Corresponding to +9dbm

ESP_PWR_LVL_N14 = [ESP_PWR_LVL_N12](#)
Backward compatibility! Setting to -14dbm will actually result to -12dbm

ESP_PWR_LVL_N11 = [ESP_PWR_LVL_N9](#)
Backward compatibility! Setting to -11dbm will actually result to -9dbm

ESP_PWR_LVL_N8 = [ESP_PWR_LVL_N6](#)
Backward compatibility! Setting to -8dbm will actually result to -6dbm

ESP_PWR_LVL_N5 = [ESP_PWR_LVL_N3](#)
Backward compatibility! Setting to -5dbm will actually result to -3dbm

ESP_PWR_LVL_N2 = [ESP_PWR_LVL_N0](#)
Backward compatibility! Setting to -2dbm will actually result to 0dbm

ESP_PWR_LVL_P1 = [ESP_PWR_LVL_P3](#)
Backward compatibility! Setting to +1dbm will actually result to +3dbm

ESP_PWR_LVL_P4 = [ESP_PWR_LVL_P6](#)
Backward compatibility! Setting to +4dbm will actually result to +6dbm

ESP_PWR_LVL_P7 = [ESP_PWR_LVL_P9](#)
Backward compatibility! Setting to +7dbm will actually result to +9dbm

enum esp_sco_data_path_t
Bluetooth audio data transport path.

Values:

ESP_SCO_DATA_PATH_HCI = 0
data over HCI transport

ESP_SCO_DATA_PATH_PCM = 1
data over PCM interface

2.1.2 BT COMMON

BT GENERIC DEFINES

API Reference

Header File

- [bt/host/bluedroid/api/include/api/esp_bt_defs.h](#)

Structures

struct esp_bt_uuid_t
UUID type.

Public Members

uint16_t len
UUID length, 16bit, 32bit or 128bit

uint16_t uuid16
16bit UUID

uint32_t uuid32
32bit UUID

uint8_t uuid128[ESP_UUID_LEN_128]
128bit UUID

union esp_bt_uuid_t::[anonymous] uuid
UUID

Macros

ESP_BLUEDROID_STATUS_CHECK (status)

ESP_BT_OCTET16_LEN

ESP_BT_OCTET8_LEN

ESP_DEFAULT_GATT_IF

Default GATT interface id.

ESP_BLE_PRIM_ADV_INT_MIN

Minimum advertising interval for undirected and low duty cycle directed advertising

ESP_BLE_PRIM_ADV_INT_MAX

Maximum advertising interval for undirected and low duty cycle directed advertising

ESP_BLE_CONN_INT_MIN

relate to BTM_BLE_CONN_INT_MIN in stack/btm_ble_api.h

ESP_BLE_CONN_INT_MAX

relate to BTM_BLE_CONN_INT_MAX in stack/btm_ble_api.h

ESP_BLE_CONN_LATENCY_MAX

relate to ESP_BLE_CONN_LATENCY_MAX in stack/btm_ble_api.h

ESP_BLE_CONN_SUP_TOUT_MIN

relate to BTM_BLE_CONN_SUP_TOUT_MIN in stack/btm_ble_api.h

ESP_BLE_CONN_SUP_TOUT_MAX

relate to ESP_BLE_CONN_SUP_TOUT_MAX in stack/btm_ble_api.h

ESP_BLE_CONN_PARAM_UNDEF

ESP_BLE_SCAN_PARAM_UNDEF

ESP_BLE_IS_VALID_PARAM (x, min, max)

Check the param is valid or not.

ESP_UUID_LEN_16

ESP_UUID_LEN_32

ESP_UUID_LEN_128

ESP_BD_ADDR_LEN

Bluetooth address length.

ESP_BLE_ENC_KEY_MASK

Used to exchange the encryption key in the init key & response key.

ESP_BLE_ID_KEY_MASK

Used to exchange the IRK key in the init key & response key.

ESP_BLE_CSR_KEY_MASK

Used to exchange the CSRK key in the init key & response key.

ESP_BLE_LINK_KEY_MASK

Used to exchange the link key (this key just used in the BLE & BR/EDR coexist mode) in the init key & response key.

ESP_APP_ID_MIN

Minimum of the application id.

ESP_APP_ID_MAX

Maximum of the application id.

ESP_BD_ADDR_STR

ESP_BD_ADDR_HEX (addr)

Type Definitions

```
typedef uint8_t esp_bt_octet16_t[ESP_BT_OCTET16_LEN]
```

```
typedef uint8_t esp_bt_octet8_t[ESP_BT_OCTET8_LEN]
```

```
typedef uint8_t esp_link_key[ESP_BT_OCTET16_LEN]
```

```
typedef uint8_t esp_bd_addr_t[ESP_BD_ADDR_LEN]
```

Bluetooth device address.

```
typedef uint8_t esp_ble_key_mask_t
```

Enumerations

```
enum esp_bt_status_t
```

Status Return Value.

Values:

ESP_BT_STATUS_SUCCESS = 0

ESP_BT_STATUS_FAIL

ESP_BT_STATUS_NOT_READY

ESP_BT_STATUS_NOMEM

ESP_BT_STATUS_BUSY

ESP_BT_STATUS_DONE = 5

ESP_BT_STATUS_UNSUPPORTED

ESP_BT_STATUS_PARM_INVALID

ESP_BT_STATUS_UNHANDLED

ESP_BT_STATUS_AUTH_FAILURE

ESP_BT_STATUS_RMT_DEV_DOWN = 10

ESP_BT_STATUS_AUTH_REJECTED

ESP_BT_STATUS_INVALID_STATIC_RAND_ADDR

```
ESP_BT_STATUS_PENDING
ESP_BT_STATUS_UNACCEPT_CONN_INTERVAL
ESP_BT_STATUS_PARAM_OUT_OF_RANGE
ESP_BT_STATUS_TIMEOUT
ESP_BT_STATUS_PEER_LE_DATA_LEN_UNSUPPORTED
ESP_BT_STATUS_CONTROL_LE_DATA_LEN_UNSUPPORTED
ESP_BT_STATUS_ERR_ILLEGAL_PARAMETER_FMT
ESP_BT_STATUS_MEMORY_FULL = 20
ESP_BT_STATUS_EIR_TOO_LARGE
enum esp_bt_dev_type_t
Bluetooth device type.

Values:
ESP_BT_DEVICE_TYPE_BREDR = 0x01
ESP_BT_DEVICE_TYPE_BLE = 0x02
ESP_BT_DEVICE_TYPE_DUMO = 0x03

enum esp_ble_addr_type_t
BLE device address type.

Values:
BLE_ADDR_TYPE_PUBLIC = 0x00
BLE_ADDR_TYPE_RANDOM = 0x01
BLE_ADDR_TYPE_RPA_PUBLIC = 0x02
BLE_ADDR_TYPE_RPA_RANDOM = 0x03

enum esp_ble_wl_addr_type_t
white list address type

Values:
BLE_WL_ADDR_TYPE_PUBLIC = 0x00
BLE_WL_ADDR_TYPE_RANDOM = 0x01
```

BT MAIN API

API Reference

Header File

- [bt/host/bluedroid/api/include/api/esp_bt_main.h](#)

Functions

esp_bluedroid_status_t **esp_bluedroid_get_status** (void)
Get bluetooth stack status.

Return Bluetooth stack status

esp_err_t **esp_bluedroid_enable** (void)
Enable bluetooth, must after esp_bluedroid_init().

Return

- ESP_OK : Succeed

- Other : Failed

esp_err_t **esp_bluedroid_disable** (void)

Disable bluetooth, must prior to esp_bluedroid_deinit().

Return

- ESP_OK : Succeed
- Other : Failed

esp_err_t **esp_bluedroid_init** (void)

Init and alloc the resource for bluetooth, must be prior to every bluetooth stuff.

Return

- ESP_OK : Succeed
- Other : Failed

esp_err_t **esp_bluedroid_deinit** (void)

Deinit and free the resource for bluetooth, must be after every bluetooth stuff.

Return

- ESP_OK : Succeed
- Other : Failed

Enumerations

enum esp_bluedroid_status_t

Bluetooth stack status type, to indicate whether the bluetooth stack is ready.

Values:

ESP_BLUEDROID_STATUS_UNINITIALIZED = 0

Bluetooth not initialized

ESP_BLUEDROID_STATUS_INITIALIZED

Bluetooth initialized but not enabled

ESP_BLUEDROID_STATUS_ENABLED

Bluetooth initialized and enabled

BT DEVICE APIs

Overview Bluetooth device reference APIs.

API Reference

Header File

- [bt/host/bluedroid/api/include/api/esp_bt_device.h](#)

Functions

const uint8_t ***esp_bt_dev_get_address** (void)

Get bluetooth device address. Must use after “esp_bluedroid_enable” .

Return bluetooth device address (six bytes), or NULL if bluetooth stack is not enabled

esp_err_t **esp_bt_dev_set_device_name** (**const** char **name*)

Set bluetooth device name. This function should be called after esp_bluedroid_enable() completes successfully.

A BR/EDR/LE device type shall have a single Bluetooth device name which shall be identical irrespective of the physical channel used to perform the name discovery procedure.

Return

- ESP_OK : Succeed

- `ESP_ERR_INVALID_ARG` : if name is NULL pointer or empty, or string length out of limit
- `ESP_ERR_INVALID_STATE` : if bluetooth stack is not yet enabled
- `ESP_FAIL` : others

Parameters

- `[in]` name: : device name to be set

2.1.3 BT LE

GAP API

Application Example Check `bluetooth/bluedroid/ble` folder in ESP-IDF examples, which contains the following demos and their tutorials:

- This is a SMP security client demo and its tutorial. This demo initiates its security parameters and acts as a GATT client, which can send a security request to the peer device and then complete the encryption procedure.
 - [bluetooth/bluedroid/ble/gatt_security_client](#)
 - [GATT Security Client Example Walkthrough](#)
- This is a SMP security server demo and its tutorial. This demo initiates its security parameters and acts as a GATT server, which can send a pair request to the peer device and then complete the encryption procedure.
 - [bluetooth/bluedroid/ble/gatt_security_server](#)
 - [GATT Security Server Example Walkthrough](#)

API Reference

Header File

- [bt/host/bluedroid/api/include/api/esp_gap_ble_api.h](#)

Functions

`esp_err_t esp_ble_gap_register_callback (esp_gap_ble_cb_t callback)`

This function is called to occur gap event, such as scan result.

Return

- `ESP_OK` : success
- other : failed

Parameters

- `[in]` callback: callback function

`esp_err_t esp_ble_gap_config_adv_data (esp_ble_adv_data_t *adv_data)`

This function is called to override the BTA default ADV parameters.

Return

- `ESP_OK` : success
- other : failed

Parameters

- `[in]` adv_data: Pointer to User defined ADV data structure. This memory space can not be freed until callback of config_adv_data is received.

`esp_err_t esp_ble_gap_set_scan_params (esp_ble_scan_params_t *scan_params)`

This function is called to set scan parameters.

Return

- `ESP_OK` : success
- other : failed

Parameters

- `[in]` scan_params: Pointer to User defined scan_params data structure. This memory space can not be freed until callback of set_scan_params

`esp_err_t esp_ble_gap_start_scanning (uint32_t duration)`

This procedure keep the device scanning the peer device which advertising on the air.

Return

- ESP_OK : success
- other : failed

Parameters

- [in] duration: Keeping the scanning time, the unit is second.

esp_err_t **esp_ble_gap_stop_scanning** (void)

This function call to stop the device scanning the peer device which advertising on the air.

Return

- ESP_OK : success
- other : failed

esp_err_t **esp_ble_gap_start_advertising** (*esp_ble_adv_params_t* *adv_params)

This function is called to start advertising.

Return

- ESP_OK : success
- other : failed

Parameters

- [in] adv_params: pointer to User defined adv_params data structure.

esp_err_t **esp_ble_gap_stop_advertising** (void)

This function is called to stop advertising.

Return

- ESP_OK : success
- other : failed

esp_err_t **esp_ble_gap_update_conn_params** (*esp_ble_conn_update_params_t* *params)

Update connection parameters, can only be used when connection is up.

Return

- ESP_OK : success
- other : failed

Parameters

- [in] params: - connection update parameters

esp_err_t **esp_ble_gap_set_pkt_data_len** (*esp_bd_addr_t* remote_device, *uint16_t* tx_data_length)

This function is to set maximum LE data packet size.

Return

- ESP_OK : success
- other : failed

esp_err_t **esp_ble_gap_set_rand_addr** (*esp_bd_addr_t* rand_addr)

This function sets the static Random Address and Non-Resolvable Private Address for the application.

Return

- ESP_OK : success
- other : failed

Parameters

- [in] rand_addr: the random address which should be setting

esp_err_t **esp_ble_gap_clear_rand_addr** (void)

This function clears the random address for the application.

Return

- ESP_OK : success
- other : failed

esp_err_t **esp_ble_gap_config_local_privacy** (bool privacy_enable)

Enable/disable privacy on the local device.

Return

- ESP_OK : success
- other : failed

Parameters

- [in] `privacy_enable`: - enable/disable privacy on remote device.

esp_err_t **esp_ble_gap_config_local_icon** (uint16_t *icon*)

set local gap appearance icon

Return

- ESP_OK : success
- other : failed

Parameters

- [in] `icon`: - External appearance value, these values are defined by the Bluetooth SIG, please refer to <https://www.bluetooth.com/specifications/gatt/viewer?attributeXmlFile=org.bluetooth.characteristic.gap.appearance.xml>

esp_err_t **esp_ble_gap_update_whitelist** (bool *add_remove*, *esp_bd_addr_t* *remote_bda*, *esp_ble_wl_addr_type_t* *wl_addr_type*)

Add or remove device from white list.

Return

- ESP_OK : success
- other : failed

Parameters

- [in] `add_remove`: the value is true if added the ble device to the white list, and false remove to the white list.
- [in] `remote_bda`: the remote device address add/remove from the white list.
- [in] `wl_addr_type`: whitelist address type

esp_err_t **esp_ble_gap_clear_whitelist** (void)

Clear all white list.

Return

- ESP_OK : success
- other : failed

esp_err_t **esp_ble_gap_get_whitelist_size** (uint16_t **length*)

Get the whitelist size in the controller.

Return

- ESP_OK : success
- other : failed

Parameters

- [out] `length`: the white list length.

esp_err_t **esp_ble_gap_set_prefer_conn_params** (*esp_bd_addr_t* *bd_addr*, uint16_t *min_conn_int*, uint16_t *max_conn_int*, uint16_t *slave_latency*, uint16_t *supervision_tout*)

This function is called to set the preferred connection parameters when default connection parameter is not desired before connecting. This API can only be used in the master role.

Return

- ESP_OK : success
- other : failed

Parameters

- [in] `bd_addr`: BD address of the peripheral
- [in] `min_conn_int`: minimum preferred connection interval
- [in] `max_conn_int`: maximum preferred connection interval
- [in] `slave_latency`: preferred slave latency
- [in] `supervision_tout`: preferred supervision timeout

esp_err_t **esp_ble_gap_set_device_name** (const char **name*)

Set device name to the local device.

Return

- ESP_OK : success
- other : failed

Parameters

- [in] name: - device name.

esp_err_t **esp_ble_gap_get_local_used_addr** (*esp_bd_addr_t* local_used_addr, uint8_t *addr_type)

This function is called to get local used address and address type. uint8_t *esp_bt_dev_get_address(void) get the public address.

Return - ESP_OK : success

- other : failed

Parameters

- [in] local_used_addr: - current local used ble address (six bytes)
- [in] addr_type: - ble address type

uint8_t ***esp_ble_resolve_adv_data** (uint8_t *adv_data, uint8_t type, uint8_t *length)

This function is called to get ADV data for a specific type.

Return pointer of ADV data

Parameters

- [in] adv_data: - pointer of ADV data which to be resolved
- [in] type: - finding ADV data type
- [out] length: - return the length of ADV data not including type

esp_err_t **esp_ble_gap_config_adv_data_raw** (uint8_t *raw_data, uint32_t raw_data_len)

This function is called to set raw advertising data. User need to fill ADV data by self.

Return

- ESP_OK : success
- other : failed

Parameters

- [in] raw_data: : raw advertising data
- [in] raw_data_len: : raw advertising data length , less than 31 bytes

esp_err_t **esp_ble_gap_config_scan_rsp_data_raw** (uint8_t *raw_data, uint32_t raw_data_len)

This function is called to set raw scan response data. User need to fill scan response data by self.

Return

- ESP_OK : success
- other : failed

Parameters

- [in] raw_data: : raw scan response data
- [in] raw_data_len: : raw scan response data length , less than 31 bytes

esp_err_t **esp_ble_gap_read_rssi** (*esp_bd_addr_t* remote_addr)

This function is called to read the RSSI of remote device. The address of link policy results are returned in the gap callback function with ESP_GAP_BLE_READ_RSSI_COMPLETE_EVT event.

Return

- ESP_OK : success
- other : failed

Parameters

- [in] remote_addr: : The remote connection device address.

esp_err_t **esp_ble_gap_add_duplicate_scan_exceptional_device** (*esp_ble_duplicate_exceptional_info_type_t* type, *esp_duplicate_info_t* device_info)

This function is called to add a device info into the duplicate scan exceptional list.

Return

- ESP_OK : success

- other : failed

Parameters

- [in] type: device info type, it is defined in `esp_ble_duplicate_exceptional_info_type_t` when type is `MESH_BEACON_TYPE`, `MESH_PROV_SRV_ADV` or `MESH_PROXY_SRV_ADV` , device_info is invalid.
- [in] device_info: the device information.

esp_err_t **esp_ble_gap_remove_duplicate_scan_exceptional_device** (*esp_ble_duplicate_exceptional_info_type_t* type, *esp_duplicate_info_t* device_info)

This function is called to remove a device info from the duplicate scan exceptional list.

Return

- ESP_OK : success
- other : failed

Parameters

- [in] type: device info type, it is defined in `esp_ble_duplicate_exceptional_info_type_t` when type is `MESH_BEACON_TYPE`, `MESH_PROV_SRV_ADV` or `MESH_PROXY_SRV_ADV` , device_info is invalid.
- [in] device_info: the device information.

esp_err_t **esp_ble_gap_clean_duplicate_scan_exceptional_list** (*esp_duplicate_scan_exceptional_list_type_t* list_type)

This function is called to clean the duplicate scan exceptional list. This API will delete all device information in the duplicate scan exceptional list.

Return

- ESP_OK : success
- other : failed

Parameters

- [in] list_type: duplicate scan exceptional list type, the value can be one or more of `esp_duplicate_scan_exceptional_list_type_t`.

esp_err_t **esp_ble_gap_set_security_param** (*esp_ble_sm_param_t* param_type, void *value, uint8_t len)

Set a GAP security parameter value. Overrides the default value.

Secure connection is highly recommended to avoid some major vulnerabilities like ‘Impersonation in the Pin Pairing Protocol’ (CVE-2020-26555) and ‘Authentication of the LE Legacy Pairing Protocol’ .

To accept only secure connection mode, it is necessary do as following:

1. Set bit `ESP_LE_AUTH_REQ_SC_ONLY` (param_type is `ESP_BLE_SM_AUTHEN_REQ_MODE`), bit `ESP_LE_AUTH_BOND` and bit `ESP_LE_AUTH_REQ_MITM` is optional as required.
2. Set to `ESP_BLE_ONLY_ACCEPT_SPECIFIED_AUTH_ENABLE` (param_type is `ESP_BLE_SM_ONLY_ACCEPT_SPECIFIED_SEC_AUTH`).

Return - ESP_OK : success

- other : failed

Parameters

- [in] param_type: : the type of the param which to be set
- [in] value: : the param value
- [in] len: : the length of the param value

esp_err_t **esp_ble_gap_security_rsp** (*esp_bd_addr_t* bd_addr, bool accept)

Grant security request access.

Return - ESP_OK : success

- other : failed

Parameters

- [in] bd_addr: : BD address of the peer
- [in] accept: : accept the security request or not

esp_err_t esp_ble_set_encryption (*esp_bd_addr_t* *bd_addr*, *esp_ble_sec_act_t* *sec_act*)

Set a gap parameter value. Use this function to change the default GAP parameter values.

Return - ESP_OK : success

- other : failed

Parameters

- [in] *bd_addr*: : the address of the peer device need to encryption
- [in] *sec_act*: : This is the security action to indicate what kind of BLE security level is required for the BLE link if the BLE is supported

esp_err_t esp_ble_passkey_reply (*esp_bd_addr_t* *bd_addr*, *bool* *accept*, *uint32_t* *passkey*)

Reply the key value to the peer device in the legacy connection stage.

Return - ESP_OK : success

- other : failed

Parameters

- [in] *bd_addr*: : BD address of the peer
- [in] *accept*: : passkey entry successful or declined.
- [in] *passkey*: : passkey value, must be a 6 digit number, can be lead by 0.

esp_err_t esp_ble_confirm_reply (*esp_bd_addr_t* *bd_addr*, *bool* *accept*)

Reply the confirm value to the peer device in the secure connection stage.

Return - ESP_OK : success

- other : failed

Parameters

- [in] *bd_addr*: : BD address of the peer device
- [in] *accept*: : numbers to compare are the same or different.

esp_err_t esp_ble_remove_bond_device (*esp_bd_addr_t* *bd_addr*)

Removes a device from the security database list of peer device. It manages unpairing event while connected.

Return - ESP_OK : success

- other : failed

Parameters

- [in] *bd_addr*: : BD address of the peer device

int esp_ble_get_bond_device_num (*void*)

Get the device number from the security database list of peer device. It will return the device bonded number immediately.

Return - ≥ 0 : bonded devices number.

- ESP_FAIL : failed

esp_err_t esp_ble_get_bond_device_list (*int* **dev_num*, *esp_ble_bond_dev_t* **dev_list*)

Get the device from the security database list of peer device. It will return the device bonded information immediately.

Return - ESP_OK : success

- other : failed

Parameters

- [inout] *dev_num*: Indicate the *dev_list* array(buffer) size as input. If *dev_num* is large enough, it means the actual number as output. Suggest that *dev_num* value equal to *esp_ble_get_bond_device_num*().
- [out] *dev_list*: an array(buffer) of *esp_ble_bond_dev_t* type. Use for storing the bonded devices address. The *dev_list* should be allocated by who call this API.

esp_err_t esp_ble_oob_req_reply (*esp_bd_addr_t* *bd_addr*, *uint8_t* **TK*, *uint8_t* *len*)

This function is called to provide the OOB data for SMP in response to ESP_GAP_BLE_OOB_REQ_EVT.

Return - ESP_OK : success

- other : failed

Parameters

- [in] *bd_addr*: BD address of the peer device.
- [in] *TK*: TK value, the TK value shall be a 128-bit random number

- [in] len: length of tk, should always be 128-bit

esp_err_t **esp_ble_gap_disconnect** (*esp_bd_addr_t* remote_device)

This function is to disconnect the physical connection of the peer device gattc may have multiple virtual GATT server connections when multiple app_id registered. esp_ble_gattc_close (esp_gatt_if_t gattc_if, uint16_t conn_id) only close one virtual GATT server connection. if there exist other virtual GATT server connections, it does not disconnect the physical connection. esp_ble_gap_disconnect(esp_bd_addr_t remote_device) disconnect the physical connection directly.

Return - ESP_OK : success

- other : failed

Parameters

- [in] remote_device: : BD address of the peer device

esp_err_t **esp_ble_get_current_conn_params** (*esp_bd_addr_t* bd_addr, *esp_gap_conn_params_t* *conn_params)

This function is called to read the connection parameters information of the device.

Return - ESP_OK : success

- other : failed

Parameters

- [in] bd_addr: BD address of the peer device.
- [out] conn_params: the connection parameters information

esp_err_t **esp_gap_ble_set_channels** (*esp_gap_ble_channels_t* channels)

BLE set channels.

Return - ESP_OK : success

- ESP_ERR_INVALID_STATE: if bluetooth stack is not yet enabled
- other : failed

Parameters

- [in] channels: : The n th such field (in the range 0 to 36) contains the value for the link layer channel index n. 0 means channel n is bad. 1 means channel n is unknown. The most significant bits are reserved and shall be set to 0. At least one channel shall be marked as unknown.

esp_err_t **esp_gap_ble_set_authorization** (*esp_bd_addr_t* bd_addr, bool authorize)

This function is called to authorized a link after Authentication(MITM protection)

Return - ESP_OK : success

- other : failed

Parameters

- [in] bd_addr: BD address of the peer device.
- [out] authorize: Authorized the link or not.

esp_err_t **esp_ble_gap_read_phy** (*esp_bd_addr_t* bd_addr)

This function is used to read the current transmitter PHY and receiver PHY on the connection identified by remote address.

Return - ESP_OK : success

- other : failed

Parameters

- [in] bd_addr: : BD address of the peer device

esp_err_t **esp_ble_gap_set_prefered_default_phy** (*esp_ble_gap_phy_mask_t* tx_phy_mask, *esp_ble_gap_phy_mask_t* rx_phy_mask)

This function is used to allows the Host to specify its preferred values for the transmitter PHY and receiver PHY to be used for all subsequent connections over the LE transport.

Return - ESP_OK : success

- other : failed

Parameters

- [in] tx_phy_mask: : indicates the transmitter PHYs that the Host prefers the Controller to use
- [in] rx_phy_mask: : indicates the receiver PHYs that the Host prefers the Controller to use

esp_err_t **esp_ble_gap_set_prefered_phy** (*esp_bd_addr_t* *bd_addr*, *esp_ble_gap_all_phys_t* *all_phys_mask*, *esp_ble_gap_phy_mask_t* *tx_phy_mask*, *esp_ble_gap_phy_mask_t* *rx_phy_mask*, *esp_ble_gap_prefer_phy_options_t* *phy_options*)

This function is used to set the PHY preferences for the connection identified by the remote address. The Controller might not be able to make the change (e.g. because the peer does not support the requested PHY) or may decide that the current PHY is preferable.

Return - ESP_OK : success

- other : failed

Parameters

- [in] *bd_addr*: : remote address
- [in] *all_phys_mask*: : a bit field that allows the Host to specify
- [in] *tx_phy_mask*: : a bit field that indicates the transmitter PHYs that the Host prefers the Controller to use
- [in] *rx_phy_mask*: : a bit field that indicates the receiver PHYs that the Host prefers the Controller to use
- [in] *phy_options*: : a bit field that allows the Host to specify options for PHYs

esp_err_t **esp_ble_gap_ext_adv_set_rand_addr** (*uint8_t* *instance*, *esp_bd_addr_t* *rand_addr*)

This function is used by the Host to set the random device address specified by the Random_Address parameter.

Return - ESP_OK : success

- other : failed

Parameters

- [in] *instance*: : Used to identify an advertising set
- [in] *rand_addr*: : Random Device Address

esp_err_t **esp_ble_gap_ext_adv_set_params** (*uint8_t* *instance*, *const esp_ble_gap_ext_adv_params_t* **params*)

This function is used by the Host to set the advertising parameters.

Return - ESP_OK : success

- other : failed

Parameters

- [in] *instance*: : identifies the advertising set whose parameters are being configured.
- [in] *params*: : advertising parameters

esp_err_t **esp_ble_gap_config_ext_adv_data_raw** (*uint8_t* *instance*, *uint16_t* *length*, *const uint8_t* **data*)

This function is used to set the data used in advertising PDUs that have a data field.

Return - ESP_OK : success

- other : failed

Parameters

- [in] *instance*: : identifies the advertising set whose data are being configured
- [in] *length*: : data length
- [in] *data*: : data information

esp_err_t **esp_ble_gap_config_ext_scan_rsp_data_raw** (*uint8_t* *instance*, *uint16_t* *length*, *const uint8_t* **scan_rsp_data*)

This function is used to provide scan response data used in scanning response PDUs.

Return - ESP_OK : success

- other : failed

Parameters

- [in] *instance*: : identifies the advertising set whose response data are being configured.
- [in] *length*: : response data length
- [in] *scan_rsp_data*: : response data information

esp_err_t **esp_ble_gap_ext_adv_start** (*uint8_t* *num_adv*, *const esp_ble_gap_ext_adv_t* **ext_adv*)

This function is used to request the Controller to enable one or more advertising sets using the advertising sets identified by the instance parameter.

Return - ESP_OK : success

- other : failed

Parameters

- [in] num_adv: : Number of advertising sets to enable or disable
- [in] ext_adv: : adv parameters

esp_err_t **esp_ble_gap_ext_adv_stop** (uint8_t num_adv, const uint8_t *ext_adv_inst)

This function is used to request the Controller to disable one or more advertising sets using the advertising sets identified by the instance parameter.

Return - ESP_OK : success

- other : failed

Parameters

- [in] num_adv: : Number of advertising sets to enable or disable
- [in] ext_adv_inst: : ext adv instance

esp_err_t **esp_ble_gap_ext_adv_set_remove** (uint8_t instance)

This function is used to remove an advertising set from the Controller.

Return - ESP_OK : success

- other : failed

Parameters

- [in] instance: : Used to identify an advertising set

esp_err_t **esp_ble_gap_ext_adv_set_clear** (void)

This function is used to remove all existing advertising sets from the Controller.

Return - ESP_OK : success

- other : failed

esp_err_t **esp_ble_gap_periodic_adv_set_params** (uint8_t instance, const esp_ble_gap_periodic_adv_params_t *params)

This function is used by the Host to set the parameters for periodic advertising.

Return - ESP_OK : success

- other : failed

Parameters

- [in] instance: : identifies the advertising set whose periodic advertising parameters are being configured.
- [in] params: : periodic adv parameters

esp_err_t **esp_ble_gap_config_periodic_adv_data_raw** (uint8_t instance, uint16_t length, const uint8_t *data)

This function is used to set the data used in periodic advertising PDUs.

Return - ESP_OK : success

- other : failed

Parameters

- [in] instance: : identifies the advertising set whose periodic advertising parameters are being configured.
- [in] length: : the length of periodic data
- [in] data: : periodic data information

esp_err_t **esp_ble_gap_periodic_adv_start** (uint8_t instance)

This function is used to request the Controller to enable the periodic advertising for the advertising set specified.

Return - ESP_OK : success

- other : failed

Parameters

- [in] instance: : Used to identify an advertising set

esp_err_t **esp_ble_gap_periodic_adv_stop** (uint8_t instance)

This function is used to request the Controller to disable the periodic advertising for the advertising set specified.

Return - ESP_OK : success

- other : failed

Parameters

- [in] instance: : Used to identify an advertising set

esp_err_t **esp_ble_gap_set_ext_scan_params** (const *esp_ble_ext_scan_params_t* *params)

This function is used to set the extended scan parameters to be used on the advertising channels.

Return - ESP_OK : success

- other : failed

Parameters

- [in] params: : scan parameters

esp_err_t **esp_ble_gap_start_ext_scan** (uint32_t duration, uint16_t period)

This function is used to enable scanning.

Return - ESP_OK : success

- other : failed

Parameters

- [in] duration: : Scan duration
- [in] period: : Time interval from when the Controller started its last Scan Duration until it begins the subsequent Scan Duration.

esp_err_t **esp_ble_gap_stop_ext_scan** (void)

This function is used to disable scanning.

Return - ESP_OK : success

- other : failed

esp_err_t **esp_ble_gap_periodic_adv_create_sync** (const *esp_ble_gap_periodic_adv_sync_params_t* *params)

This function is used to synchronize with periodic advertising from an advertiser and begin receiving periodic advertising packets.

Return - ESP_OK : success

- other : failed

Parameters

- [in] params: : sync parameters

esp_err_t **esp_ble_gap_periodic_adv_sync_cancel** (void)

This function is used to cancel the LE_Periodic_Advertising_Create_Sync command while it is pending.

Return - ESP_OK : success

- other : failed

esp_err_t **esp_ble_gap_periodic_adv_sync_terminate** (uint16_t sync_handle)

This function is used to stop reception of the periodic advertising identified by the Sync Handle parameter.

Return - ESP_OK : success

- other : failed

Parameters

- [in] sync_handle: : identify the periodic advertiser

esp_err_t **esp_ble_gap_periodic_adv_add_dev_to_list** (*esp_ble_addr_type_t* addr_type, *esp_bd_addr_t* addr, uint8_t sid)

This function is used to add a single device to the Periodic Advertiser list stored in the Controller.

Return - ESP_OK : success

- other : failed

Parameters

- [in] addr_type: : address type
- [in] addr: : Device Address
- [in] sid: : Advertising SID subfield in the ADI field used to identify the Periodic Advertising

```
esp_err_t esp_ble_gap_periodic_adv_remove_dev_from_list (esp_ble_addr_type_t
                                                         addr_type, esp_bd_addr_t
                                                         addr, uint8_t sid)
```

This function is used to remove one device from the list of Periodic Advertisers stored in the Controller. Removals from the Periodic Advertisers List take effect immediately.

Return - ESP_OK : success

- other : failed

Parameters

- [in] *addr_type*: : address type
- [in] *addr*: : Device Address
- [in] *sid*: : Advertising SID subfield in the ADI field used to identify the Periodic Advertising

```
esp_err_t esp_ble_gap_periodic_adv_clear_dev (void)
```

This function is used to remove all devices from the list of Periodic Advertisers in the Controller.

Return - ESP_OK : success

- other : failed

```
esp_err_t esp_ble_gap_prefer_ext_connect_params_set (esp_bd_addr_t addr,
                                                      esp_ble_gap_phy_mask_t
                                                      phy_mask, const
                                                      esp_ble_gap_conn_params_t
                                                      *phy_1m_conn_params, const
                                                      esp_ble_gap_conn_params_t
                                                      *phy_2m_conn_params, const
                                                      esp_ble_gap_conn_params_t
                                                      *phy_coded_conn_params)
```

This function is used to set aux connection parameters.

Return - ESP_OK : success

- other : failed

Parameters

- [in] *addr*: : device address
- [in] *phy_mask*: : indicates the PHY(s) on which the advertising packets should be received on the primary advertising channel and the PHYs for which connection parameters have been specified.
- [in] *phy_1m_conn_params*: : Scan connectable advertisements on the LE 1M PHY. Connection parameters for the LE 1M PHY are provided.
- [in] *phy_2m_conn_params*: : Connection parameters for the LE 2M PHY are provided.
- [in] *phy_coded_conn_params*: : Scan connectable advertisements on the LE Coded PHY. Connection parameters for the LE Coded PHY are provided.

Unions

```
union esp_ble_key_value_t
```

```
#include <esp_gap_ble_api.h> union type of the security key value
```

Public Members

```
esp_ble_penc_keys_t penc_key  
received peer encryption key
```

```
esp_ble_pcsrkeys_t pcsrkey  
received peer device SRK
```

```
esp_ble_pidkeys_t pid_key  
peer device ID key
```

```
esp_ble_lenckeys_t lenc_key  
local encryption reproduction keys LTK = = d1(ER,DIV,0)
```

```
esp_ble_lcsrkeys_t lcsrkey  
local device CSRK = d1(ER,DIV,1)
```

union esp_ble_sec_t

#include <esp_gap_ble_api.h> union associated with ble security

Public Members

esp_ble_sec_key_notif_t **key_notif**

passkey notification

esp_ble_sec_req_t **ble_req**

BLE SMP related request

esp_ble_key_t **ble_key**

BLE SMP keys used when pairing

esp_ble_local_id_keys_t **ble_id_keys**

BLE IR event

esp_ble_auth_cmpl_t **auth_cmpl**

Authentication complete indication.

union esp_ble_gap_cb_param_t

#include <esp_gap_ble_api.h> Gap callback parameters union.

Public Members

struct *esp_ble_gap_cb_param_t::ble_adv_data_cmpl_evt_param* **adv_data_cmpl**

Event parameter of ESP_GAP_BLE_ADV_DATA_SET_COMPLETE_EVT

struct *esp_ble_gap_cb_param_t::ble_scan_rsp_data_cmpl_evt_param* **scan_rsp_data_cmpl**

Event parameter of ESP_GAP_BLE_SCAN_RSP_DATA_SET_COMPLETE_EVT

struct *esp_ble_gap_cb_param_t::ble_scan_param_cmpl_evt_param* **scan_param_cmpl**

Event parameter of ESP_GAP_BLE_SCAN_PARAM_SET_COMPLETE_EVT

struct *esp_ble_gap_cb_param_t::ble_scan_result_evt_param* **scan_rst**

Event parameter of ESP_GAP_BLE_SCAN_RESULT_EVT

struct *esp_ble_gap_cb_param_t::ble_adv_data_raw_cmpl_evt_param* **adv_data_raw_cmpl**

Event parameter of ESP_GAP_BLE_ADV_DATA_RAW_SET_COMPLETE_EVT

struct *esp_ble_gap_cb_param_t::ble_scan_rsp_data_raw_cmpl_evt_param* **scan_rsp_data_raw_cmpl**

Event parameter of ESP_GAP_BLE_SCAN_RSP_DATA_RAW_SET_COMPLETE_EVT

struct *esp_ble_gap_cb_param_t::ble_adv_start_cmpl_evt_param* **adv_start_cmpl**

Event parameter of ESP_GAP_BLE_ADV_START_COMPLETE_EVT

struct *esp_ble_gap_cb_param_t::ble_scan_start_cmpl_evt_param* **scan_start_cmpl**

Event parameter of ESP_GAP_BLE_SCAN_START_COMPLETE_EVT

esp_ble_sec_t **ble_security**

ble gap security union type

struct *esp_ble_gap_cb_param_t::ble_scan_stop_cmpl_evt_param* **scan_stop_cmpl**

Event parameter of ESP_GAP_BLE_SCAN_STOP_COMPLETE_EVT

struct *esp_ble_gap_cb_param_t::ble_adv_stop_cmpl_evt_param* **adv_stop_cmpl**

Event parameter of ESP_GAP_BLE_ADV_STOP_COMPLETE_EVT

struct *esp_ble_gap_cb_param_t::ble_set_rand_cmpl_evt_param* **set_rand_addr_cmpl**

Event parameter of ESP_GAP_BLE_SET_STATIC_RAND_ADDR_EVT

struct *esp_ble_gap_cb_param_t::ble_update_conn_params_evt_param* **update_conn_params**

Event parameter of ESP_GAP_BLE_UPDATE_CONN_PARAMS_EVT

struct *esp_ble_gap_cb_param_t::ble_pkt_data_length_cmpl_evt_param* **pkt_data_lenth_cmpl**

Event parameter of ESP_GAP_BLE_SET_PKT_LENGTH_COMPLETE_EVT

```

struct esp_ble_gap_cb_param_t::ble_local_privacy_cmpl_evt_param local_privacy_cmpl
    Event parameter of ESP_GAP_BLE_SET_LOCAL_PRIVACY_COMPLETE_EVT

struct esp_ble_gap_cb_param_t::ble_remove_bond_dev_cmpl_evt_param remove_bond_dev_cmpl
    Event parameter of ESP_GAP_BLE_REMOVE_BOND_DEV_COMPLETE_EVT

struct esp_ble_gap_cb_param_t::ble_clear_bond_dev_cmpl_evt_param clear_bond_dev_cmpl
    Event parameter of ESP_GAP_BLE_CLEAR_BOND_DEV_COMPLETE_EVT

struct esp_ble_gap_cb_param_t::ble_get_bond_dev_cmpl_evt_param get_bond_dev_cmpl
    Event parameter of ESP_GAP_BLE_GET_BOND_DEV_COMPLETE_EVT

struct esp_ble_gap_cb_param_t::ble_read_rssi_cmpl_evt_param read_rssi_cmpl
    Event parameter of ESP_GAP_BLE_READ_RSSI_COMPLETE_EVT

struct esp_ble_gap_cb_param_t::ble_update_whitelist_cmpl_evt_param update_whitelist_cmpl
    Event parameter of ESP_GAP_BLE_UPDATE_WHITELIST_COMPLETE_EVT

struct esp_ble_gap_cb_param_t::ble_update_duplicate_exceptional_list_cmpl_evt_param update_duplicate_except
    Event parameter of ESP_GAP_BLE_UPDATE_DUPLICATE_EXCEPTIONAL_LIST_COMPLETE_EVT

struct esp_ble_gap_cb_param_t::ble_set_channels_evt_param ble_set_channels
    Event parameter of ESP_GAP_BLE_SET_CHANNELS_EVT

struct esp_ble_gap_cb_param_t::ble_read_phy_cmpl_evt_param read_phy
    Event parameter of ESP_GAP_BLE_READ_PHY_COMPLETE_EVT

struct esp_ble_gap_cb_param_t::ble_set_perf_def_phy_cmpl_evt_param set_perf_def_phy
    Event parameter of ESP_GAP_BLE_SET_PREFERED_DEFAULT_PHY_COMPLETE_EVT

struct esp_ble_gap_cb_param_t::ble_set_perf_phy_cmpl_evt_param set_perf_phy
    Event parameter of ESP_GAP_BLE_SET_PREFERED_PHY_COMPLETE_EVT

struct esp_ble_gap_cb_param_t::ble_ext_adv_set_rand_addr_cmpl_evt_param ext_adv_set_rand_addr
    Event parameter of ESP_GAP_BLE_EXT_ADV_SET_RAND_ADDR_COMPLETE_EVT

struct esp_ble_gap_cb_param_t::ble_ext_adv_set_params_cmpl_evt_param ext_adv_set_params
    Event parameter of ESP_GAP_BLE_EXT_ADV_SET_PARAMS_COMPLETE_EVT

struct esp_ble_gap_cb_param_t::ble_ext_adv_data_set_cmpl_evt_param ext_adv_data_set
    Event parameter of ESP_GAP_BLE_EXT_ADV_DATA_SET_COMPLETE_EVT

struct esp_ble_gap_cb_param_t::ble_ext_adv_scan_rsp_set_cmpl_evt_param scan_rsp_set
    Event parameter of ESP_GAP_BLE_EXT_SCAN_RSP_DATA_SET_COMPLETE_EVT

struct esp_ble_gap_cb_param_t::ble_ext_adv_start_cmpl_evt_param ext_adv_start
    Event parameter of ESP_GAP_BLE_EXT_ADV_START_COMPLETE_EVT

struct esp_ble_gap_cb_param_t::ble_ext_adv_stop_cmpl_evt_param ext_adv_stop
    Event parameter of ESP_GAP_BLE_EXT_ADV_STOP_COMPLETE_EVT

struct esp_ble_gap_cb_param_t::ble_ext_adv_set_remove_cmpl_evt_param ext_adv_remove
    Event parameter of ESP_GAP_BLE_EXT_ADV_SET_REMOVE_COMPLETE_EVT

struct esp_ble_gap_cb_param_t::ble_ext_adv_set_clear_cmpl_evt_param ext_adv_clear
    Event parameter of ESP_GAP_BLE_EXT_ADV_SET_CLEAR_COMPLETE_EVT

struct esp_ble_gap_cb_param_t::ble_periodic_adv_set_params_cmpl_param peroid_adv_set_params
    Event parameter of ESP_GAP_BLE_PERIODIC_ADV_SET_PARAMS_COMPLETE_EVT

struct esp_ble_gap_cb_param_t::ble_periodic_adv_data_set_cmpl_param period_adv_data_set
    Event parameter of ESP_GAP_BLE_PERIODIC_ADV_DATA_SET_COMPLETE_EVT

struct esp_ble_gap_cb_param_t::ble_periodic_adv_start_cmpl_param period_adv_start
    Event parameter of ESP_GAP_BLE_PERIODIC_ADV_START_COMPLETE_EVT

struct esp_ble_gap_cb_param_t::ble_periodic_adv_stop_cmpl_param period_adv_stop
    Event parameter of ESP_GAP_BLE_PERIODIC_ADV_STOP_COMPLETE_EVT

```



```

struct esp_ble_gap_cb_param_t::ble_period_adv_create_sync_cmpl_param period_adv_create_sync
    Event parameter of ESP_GAP_BLE_PERIODIC_ADV_CREATE_SYNC_COMPLETE_EVT

struct esp_ble_gap_cb_param_t::ble_period_adv_sync_cancel_cmpl_param period_adv_sync_cancel
    Event parameter of ESP_GAP_BLE_PERIODIC_ADV_SYNC_CANCEL_COMPLETE_EVT

struct esp_ble_gap_cb_param_t::ble_period_adv_sync_terminate_cmpl_param period_adv_sync_term
    Event parameter of ESP_GAP_BLE_PERIODIC_ADV_SYNC_TERMINATE_COMPLETE_EVT

struct esp_ble_gap_cb_param_t::ble_period_adv_add_dev_cmpl_param period_adv_add_dev
    Event parameter of ESP_GAP_BLE_PERIODIC_ADV_ADD_DEV_COMPLETE_EVT

struct esp_ble_gap_cb_param_t::ble_period_adv_remove_dev_cmpl_param period_adv_remove_dev
    Event parameter of ESP_GAP_BLE_PERIODIC_ADV_REMOVE_DEV_COMPLETE_EVT

struct esp_ble_gap_cb_param_t::ble_period_adv_clear_dev_cmpl_param period_adv_clear_dev
    Event parameter of ESP_GAP_BLE_PERIODIC_ADV_CLEAR_DEV_COMPLETE_EVT

struct esp_ble_gap_cb_param_t::ble_set_ext_scan_params_cmpl_param set_ext_scan_params
    Event parameter of ESP_GAP_BLE_SET_EXT_SCAN_PARAMS_COMPLETE_EVT

struct esp_ble_gap_cb_param_t::ble_ext_scan_start_cmpl_param ext_scan_start
    Event parameter of ESP_GAP_BLE_EXT_SCAN_START_COMPLETE_EVT

struct esp_ble_gap_cb_param_t::ble_ext_scan_stop_cmpl_param ext_scan_stop
    Event parameter of ESP_GAP_BLE_EXT_SCAN_STOP_COMPLETE_EVT

struct esp_ble_gap_cb_param_t::ble_ext_conn_params_set_cmpl_param ext_conn_params_set
    Event parameter of ESP_GAP_BLE_PREFER_EXT_CONN_PARAMS_SET_COMPLETE_EVT

struct esp_ble_gap_cb_param_t::ble_adv_terminate_param adv_terminate
    Event parameter of ESP_GAP_BLE_ADV_TERMINATED_EVT

struct esp_ble_gap_cb_param_t::ble_scan_req_received_param scan_req_received
    Event parameter of ESP_GAP_BLE_SCAN_REQ_RECEIVED_EVT

struct esp_ble_gap_cb_param_t::ble_channel_sel_alg_param channel_sel_alg
    Event parameter of ESP_GAP_BLE_CHANNEL_SELETE_ALGORITHM_EVT

struct esp_ble_gap_cb_param_t::ble_periodic_adv_sync_lost_param periodic_adv_sync_lost
    Event parameter of ESP_GAP_BLE_PERIODIC_ADV_SYNC_LOST_EVT

struct esp_ble_gap_cb_param_t::ble_periodic_adv_sync_estab_param periodic_adv_sync_estab
    Event parameter of ESP_GAP_BLE_PERIODIC_ADV_SYNC_ESTAB_EVT

struct esp_ble_gap_cb_param_t::ble_phy_update_cmpl_param phy_update
    Event parameter of ESP_GAP_BLE_PHY_UPDATE_COMPLETE_EVT

struct esp_ble_gap_cb_param_t::ble_ext_adv_report_param ext_adv_report
    Event parameter of ESP_GAP_BLE_EXT_ADV_REPORT_EVT

struct esp_ble_gap_cb_param_t::ble_periodic_adv_report_param period_adv_report
    Event parameter of ESP_GAP_BLE_PERIODIC_ADV_REPORT_EVT

struct ble_adv_data_cmpl_evt_param
    #include <esp_gap_ble_api.h> ESP_GAP_BLE_ADV_DATA_SET_COMPLETE_EVT.

```

Public Members

esp_bt_status_t **status**

Indicate the set advertising data operation success status

```

struct ble_adv_data_raw_cmpl_evt_param
    #include <esp_gap_ble_api.h> ESP_GAP_BLE_ADV_DATA_RAW_SET_COMPLETE_EVT.

```

Public Members

esp_bt_status_t **status**

Indicate the set raw advertising data operation success status

```
struct ble_adv_start_cmpl_evt_param
#include <esp_gap_ble_api.h> ESP_GAP_BLE_ADV_START_COMPLETE_EVT.
```

Public Members

esp_bt_status_t **status**

Indicate advertising start operation success status

```
struct ble_adv_stop_cmpl_evt_param
#include <esp_gap_ble_api.h> ESP_GAP_BLE_ADV_STOP_COMPLETE_EVT.
```

Public Members

esp_bt_status_t **status**

Indicate adv stop operation success status

```
struct ble_adv_terminate_param
#include <esp_gap_ble_api.h> ESP_GAP_BLE_ADV_TERMINATED_EVT.
```

Public Members

uint8_t **status**

Indicate adv terminate status

uint8_t **adv_instance**

extend advertising handle

uint16_t **conn_idx**

connection index

uint8_t **completed_event**

the number of completed extend advertising events

```
struct ble_channel_sel_alg_param
#include <esp_gap_ble_api.h> ESP_GAP_BLE_CHANNEL_SELETE_ALGORITHM_EVT.
```

Public Members

uint16_t **conn_handle**

connection handle

uint8_t **channel_sel_alg**

channel selection algorithm

```
struct ble_clear_bond_dev_cmpl_evt_param
#include <esp_gap_ble_api.h> ESP_GAP_BLE_CLEAR_BOND_DEV_COMPLETE_EVT.
```

Public Members

esp_bt_status_t **status**

Indicate the clear bond device operation success status

```
struct ble_ext_adv_data_set_cmpl_evt_param  
#include <esp_gap_ble_api.h> ESP_GAP_BLE_EXT_ADV_DATA_SET_COMPLETE_EVT.
```

Public Members

esp_bt_status_t **status**
Indicate extend advertising data set status

```
struct ble_ext_adv_report_param  
#include <esp_gap_ble_api.h> ESP_GAP_BLE_EXT_ADV_REPORT_EVT.
```

Public Members

esp_ble_gap_ext_adv_reprot_t **params**
extend advertising report parameters

```
struct ble_ext_adv_scan_rsp_set_cmpl_evt_param  
#include <esp_gap_ble_api.h> ESP_GAP_BLE_EXT_SCAN_RSP_DATA_SET_COMPLETE_EVT.
```

Public Members

esp_bt_status_t **status**
Indicate extend advertising sacn response data set status

```
struct ble_ext_adv_set_clear_cmpl_evt_param  
#include <esp_gap_ble_api.h> ESP_GAP_BLE_EXT_ADV_SET_CLEAR_COMPLETE_EVT.
```

Public Members

esp_bt_status_t **status**
Indicate advertising stop operation success status

```
struct ble_ext_adv_set_params_cmpl_evt_param  
#include <esp_gap_ble_api.h> ESP_GAP_BLE_EXT_ADV_SET_PARAMS_COMPLETE_EVT.
```

Public Members

esp_bt_status_t **status**
Indicate extend advertising parameters set status

```
struct ble_ext_adv_set_rand_addr_cmpl_evt_param  
#include <esp_gap_ble_api.h> ESP_GAP_BLE_EXT_ADV_SET_RAND_ADDR_COMPLETE_EVT.
```

Public Members

esp_bt_status_t **status**
Indicate extend advertising random address set status

```
struct ble_ext_adv_set_remove_cmpl_evt_param  
#include <esp_gap_ble_api.h> ESP_GAP_BLE_EXT_ADV_SET_REMOVE_COMPLETE_EVT.
```

Public Members

esp_bt_status_t **status**

Indicate advertising stop operation success status

```
struct ble_ext_adv_start_cmpl_evt_param
#include <esp_gap_ble_api.h> ESP_GAP_BLE_EXT_ADV_START_COMPLETE_EVT.
```

Public Members

esp_bt_status_t **status**

Indicate advertising start operation success status

```
struct ble_ext_adv_stop_cmpl_evt_param
#include <esp_gap_ble_api.h> ESP_GAP_BLE_EXT_ADV_STOP_COMPLETE_EVT.
```

Public Members

esp_bt_status_t **status**

Indicate advertising stop operation success status

```
struct ble_ext_conn_params_set_cmpl_param
#include <esp_gap_ble_api.h> ESP_GAP_BLE_PREFER_EXT_CONN_PARAMS_SET_COMPLETE_EVT.
```

Public Members

esp_bt_status_t **status**

Indicate extend connection parameters set status

```
struct ble_ext_scan_start_cmpl_param
#include <esp_gap_ble_api.h> ESP_GAP_BLE_EXT_SCAN_START_COMPLETE_EVT.
```

Public Members

esp_bt_status_t **status**

Indicate extend advertising start status

```
struct ble_ext_scan_stop_cmpl_param
#include <esp_gap_ble_api.h> ESP_GAP_BLE_EXT_SCAN_STOP_COMPLETE_EVT.
```

Public Members

esp_bt_status_t **status**

Indicate extend advertising stop status

```
struct ble_get_bond_dev_cmpl_evt_param
#include <esp_gap_ble_api.h> ESP_GAP_BLE_GET_BOND_DEV_COMPLETE_EVT.
```

Public Members

esp_bt_status_t **status**

Indicate the get bond device operation success status

uint8_t **dev_num**

Indicate the get number device in the bond list

esp_ble_bond_dev_t *bond_dev
the pointer to the bond device Structure

```
struct ble_local_privacy_cmpl_evt_param
#include <esp_gap_ble_api.h> ESP_GAP_BLE_SET_LOCAL_PRIVACY_COMPLETE_EVT.
```

Public Members

esp_bt_status_t status
Indicate the set local privacy operation success status

```
struct ble_period_adv_add_dev_cmpl_param
#include <esp_gap_ble_api.h> ESP_GAP_BLE_PERIODIC_ADV_ADD_DEV_COMPLETE_EVT.
```

Public Members

esp_bt_status_t status
Indicate periodic advertising device list add status

```
struct ble_period_adv_clear_dev_cmpl_param
#include <esp_gap_ble_api.h> ESP_GAP_BLE_PERIODIC_ADV_CLEAR_DEV_COMPLETE_EVT.
```

Public Members

esp_bt_status_t status
Indicate periodic advertising device list clean status

```
struct ble_period_adv_create_sync_cmpl_param
#include <esp_gap_ble_api.h> ESP_GAP_BLE_PERIODIC_ADV_CREATE_SYNC_COMPLETE_EVT.
```

Public Members

esp_bt_status_t status
Indicate periodic advertising create sync status

```
struct ble_period_adv_remove_dev_cmpl_param
#include <esp_gap_ble_api.h> ESP_GAP_BLE_PERIODIC_ADV_REMOVE_DEV_COMPLETE_EVT.
```

Public Members

esp_bt_status_t status
Indicate periodic advertising device list remove status

```
struct ble_period_adv_sync_cancel_cmpl_param
#include <esp_gap_ble_api.h> ESP_GAP_BLE_PERIODIC_ADV_SYNC_CANCEL_COMPLETE_EVT.
```

Public Members

esp_bt_status_t status
Indicate periodic advertising sync cancel status

```
struct ble_period_adv_sync_terminate_cmpl_param
#include <esp_gap_ble_api.h> ESP_GAP_BLE_PERIODIC_ADV_SYNC_TERMINATE_COMPLETE_EVT.
```

Public Members

esp_bt_status_t **status**

Indicate periodic advertising sync terminate status

```
struct ble_periodic_adv_data_set_cmpl_param
#include <esp_gap_ble_api.h> ESP_GAP_BLE_PERIODIC_ADV_DATA_SET_COMPLETE_EVT.
```

Public Members

esp_bt_status_t **status**

Indicate periodic advertising data set status

```
struct ble_periodic_adv_report_param
#include <esp_gap_ble_api.h> ESP_GAP_BLE_PERIODIC_ADV_REPORT_EVT.
```

Public Members

esp_ble_gap_periodic_adv_report_t **params**

periodic advertising report parameters

```
struct ble_periodic_adv_set_params_cmpl_param
#include <esp_gap_ble_api.h> ESP_GAP_BLE_PERIODIC_ADV_SET_PARAMS_COMPLETE_EVT.
```

Public Members

esp_bt_status_t **status**

Indicate periodic advertising parameters set status

```
struct ble_periodic_adv_start_cmpl_param
#include <esp_gap_ble_api.h> ESP_GAP_BLE_PERIODIC_ADV_START_COMPLETE_EVT.
```

Public Members

esp_bt_status_t **status**

Indicate periodic advertising start status

```
struct ble_periodic_adv_stop_cmpl_param
#include <esp_gap_ble_api.h> ESP_GAP_BLE_PERIODIC_ADV_STOP_COMPLETE_EVT.
```

Public Members

esp_bt_status_t **status**

Indicate periodic advertising stop status

```
struct ble_periodic_adv_sync_estab_param
#include <esp_gap_ble_api.h> ESP_GAP_BLE_PERIODIC_ADV_SYNC_ESTAB_EVT.
```

Public Members

uint8_t status

periodic advertising sync status

uint16_t sync_handle

periodic advertising sync handle

uint8_t sid
periodic advertising sid

esp_ble_addr_type_t **adv_addr_type**
periodic advertising address type

esp_bd_addr_t **adv_addr**
periodic advertising address

esp_ble_gap_phy_t **adv_phy**
periodic advertising phy type

uint16_t period_adv_interval
periodic advertising interval

uint8_t adv_clk_accuracy
periodic advertising clock accuracy

struct ble_periodic_adv_sync_lost_param
#include <esp_gap_ble_api.h> ESP_GAP_BLE_PERIODIC_ADV_SYNC_LOST_EVT.

Public Members

uint16_t sync_handle
sync handle

struct ble_phy_update_cmpl_param
#include <esp_gap_ble_api.h> ESP_GAP_BLE_PHY_UPDATE_COMPLETE_EVT.

Public Members

esp_bt_status_t **status**
phy update status

esp_bd_addr_t **bda**
address

esp_ble_gap_phy_t **tx_phy**
tx phy type

esp_ble_gap_phy_t **rx_phy**
rx phy type

struct ble_pkt_data_length_cmpl_evt_param
#include <esp_gap_ble_api.h> ESP_GAP_BLE_SET_PKT_LENGTH_COMPLETE_EVT.

Public Members

esp_bt_status_t **status**
Indicate the set pkt data length operation success status

esp_ble_pkt_data_length_params_t **params**
pkt data length value

struct ble_read_phy_cmpl_evt_param
#include <esp_gap_ble_api.h> ESP_GAP_BLE_READ_PHY_COMPLETE_EVT.

Public Members

esp_bt_status_t **status**
read phy complete status

esp_bd_addr_t **bda**
read phy address

esp_ble_gap_phy_t **tx_phy**
tx phy type

esp_ble_gap_phy_t **rx_phy**
rx phy type

struct ble_read_rssi_cmpl_evt_param
#include <esp_gap_ble_api.h> ESP_GAP_BLE_READ_RSSI_COMPLETE_EVT.

Public Members

esp_bt_status_t **status**
Indicate the read adv tx power operation success status

int8_t **rssi**
The ble remote device rssi value, the range is from -127 to 20, the unit is dbm, if the RSSI cannot be read, the RSSI metric shall be set to 127.

esp_bd_addr_t **remote_addr**
The remote device address

struct ble_remove_bond_dev_cmpl_evt_param
#include <esp_gap_ble_api.h> ESP_GAP_BLE_REMOVE_BOND_DEV_COMPLETE_EVT.

Public Members

esp_bt_status_t **status**
Indicate the remove bond device operation success status

esp_bd_addr_t **bd_addr**
The device address which has been remove from the bond list

struct ble_scan_param_cmpl_evt_param
#include <esp_gap_ble_api.h> ESP_GAP_BLE_SCAN_PARAM_SET_COMPLETE_EVT.

Public Members

esp_bt_status_t **status**
Indicate the set scan param operation success status

struct ble_scan_req_received_param
#include <esp_gap_ble_api.h> ESP_GAP_BLE_SCAN_REQ_RECEIVED_EVT.

Public Members

uint8_t **adv_instance**
extend advertising handle

esp_ble_addr_type_t **scan_addr_type**
scanner address type

esp_bd_addr_t **scan_addr**
scanner address

struct ble_scan_result_evt_param
#include <esp_gap_ble_api.h> ESP_GAP_BLE_SCAN_RESULT_EVT.

Public Members

esp_gap_search_evt_t **search_evt**
Search event type

esp_bd_addr_t **bda**
Bluetooth device address which has been searched

esp_bt_dev_type_t **dev_type**
Device type

esp_ble_addr_type_t **ble_addr_type**
Ble device address type

esp_ble_evt_type_t **ble_evt_type**
Ble scan result event type

int **rssi**
Searched device' s RSSI

uint8_t **ble_adv**[ESP_BLE_ADV_DATA_LEN_MAX + ESP_BLE_SCAN_RSP_DATA_LEN_MAX]
Received EIR

int **flag**
Advertising data flag bit

int **num_resps**
Scan result number

uint8_t **adv_data_len**
Adv data length

uint8_t **scan_rsp_len**
Scan response length

uint32_t **num_dis**
The number of discard packets

struct ble_scan_rsp_data_cmpl_evt_param
#include <esp_gap_ble_api.h> ESP_GAP_BLE_SCAN_RSP_DATA_SET_COMPLETE_EVT.

Public Members

esp_bt_status_t **status**
Indicate the set scan response data operation success status

struct ble_scan_rsp_data_raw_cmpl_evt_param
#include <esp_gap_ble_api.h> ESP_GAP_BLE_SCAN_RSP_DATA_RAW_SET_COMPLETE_EVT.

Public Members

esp_bt_status_t **status**
Indicate the set raw advertising data operation success status

struct ble_scan_start_cmpl_evt_param
#include <esp_gap_ble_api.h> ESP_GAP_BLE_SCAN_START_COMPLETE_EVT.

Public Members

esp_bt_status_t **status**

Indicate scan start operation success status

```
struct ble_scan_stop_cmpl_evt_param  
#include <esp_gap_ble_api.h> ESP_GAP_BLE_SCAN_STOP_COMPLETE_EVT.
```

Public Members

esp_bt_status_t **status**

Indicate scan stop operation success status

```
struct ble_set_channels_evt_param  
#include <esp_gap_ble_api.h> ESP_GAP_BLE_SET_CHANNELS_EVT.
```

Public Members

esp_bt_status_t **stat**

BLE set channel status

```
struct ble_set_ext_scan_params_cmpl_param  
#include <esp_gap_ble_api.h> ESP_GAP_BLE_SET_EXT_SCAN_PARAMS_COMPLETE_EVT.
```

Public Members

esp_bt_status_t **status**

Indicate extend advertising parameters set status

```
struct ble_set_perf_def_phy_cmpl_evt_param  
#include <esp_gap_ble_api.h> ESP_GAP_BLE_SET_PREFERED_DEFAULT_PHY_COMPLETE_EVT.
```

Public Members

esp_bt_status_t **status**

Indicate perf default phy set status

```
struct ble_set_perf_phy_cmpl_evt_param  
#include <esp_gap_ble_api.h> ESP_GAP_BLE_SET_PREFERED_PHY_COMPLETE_EVT.
```

Public Members

esp_bt_status_t **status**

Indicate perf phy set status

```
struct ble_set_rand_cmpl_evt_param  
#include <esp_gap_ble_api.h> ESP_GAP_BLE_SET_STATIC_RAND_ADDR_EVT.
```

Public Members

esp_bt_status_t **status**

Indicate set static rand address operation success status

```
struct ble_update_conn_params_evt_param  
#include <esp_gap_ble_api.h> ESP_GAP_BLE_UPDATE_CONN_PARAMS_EVT.
```

Public Members

esp_bt_status_t **status**

Indicate update connection parameters success status

esp_bd_addr_t **bda**

Bluetooth device address

uint16_t **min_int**

Min connection interval

uint16_t **max_int**

Max connection interval

uint16_t **latency**

Slave latency for the connection in number of connection events. Range: 0x0000 to 0x01F3

uint16_t **conn_int**

Current connection interval

uint16_t **timeout**

Supervision timeout for the LE Link. Range: 0x000A to 0x0C80. Mandatory Range: 0x000A to 0x0C80 Time = N * 10 msec

struct ble_update_duplicate_exceptional_list_cmpl_evt_param

#include <esp_gap_ble_api.h> ESP_GAP_BLE_UPDATE_DUPLICATE_EXCEPTIONAL_LIST_COMPLETE_EVT.

Public Members

esp_bt_status_t **status**

Indicate update duplicate scan exceptional list operation success status

uint8_t **subcode**

Define in *esp_bt_duplicate_exceptional_subcode_type_t*

uint16_t **length**

The length of *device_info*

esp_duplicate_info_t **device_info**

device information, when subcode is ESP_BLE_DUPLICATE_EXCEPTIONAL_LIST_CLEAN, the value is invalid

struct ble_update_whitelist_cmpl_evt_param

#include <esp_gap_ble_api.h> ESP_GAP_BLE_UPDATE_WHITELIST_COMPLETE_EVT.

Public Members

esp_bt_status_t **status**

Indicate the add or remove whitelist operation success status

esp_ble_wl_operation_t **wl_operation**

The value is ESP_BLE_WHITELIST_ADD if add address to whitelist operation success, ESP_BLE_WHITELIST_REMOVE if remove address from the whitelist operation success

Structures

struct esp_ble_adv_params_t

Advertising parameters.

Public Members**uint16_t adv_int_min**

Minimum advertising interval for undirected and low duty cycle directed advertising. Range: 0x0020 to 0x4000 Default: N = 0x0800 (1.28 second) Time = N * 0.625 msec Time Range: 20 ms to 10.24 sec

uint16_t adv_int_max

Maximum advertising interval for undirected and low duty cycle directed advertising. Range: 0x0020 to 0x4000 Default: N = 0x0800 (1.28 second) Time = N * 0.625 msec Time Range: 20 ms to 10.24 sec Advertising max interval

esp_ble_adv_type_t adv_type

Advertising type

esp_ble_addr_type_t own_addr_type

Owner bluetooth device address type

esp_bd_addr_t peer_addr

Peer device bluetooth device address

esp_ble_addr_type_t peer_addr_type

Peer device bluetooth device address type, only support public address type and random address type

esp_ble_adv_channel_t channel_map

Advertising channel map

esp_ble_adv_filter_t adv_filter_policy

Advertising filter policy

struct esp_ble_adv_data_t

Advertising data content, according to “Supplement to the Bluetooth Core Specification” .

Public Members**bool set_scan_rsp**

Set this advertising data as scan response or not

bool include_name

Advertising data include device name or not

bool include_txpower

Advertising data include TX power

int min_interval

Advertising data show slave preferred connection min interval. The connection interval in the following manner: $\text{connIntervalmin} = \text{Conn_Interval_Min} * 1.25 \text{ ms}$ Conn_Interval_Min range: 0x0006 to 0x0C80 Value of 0xFFFF indicates no specific minimum. Values not defined above are reserved for future use.

int max_interval

Advertising data show slave preferred connection max interval. The connection interval in the following manner: $\text{connIntervalmax} = \text{Conn_Interval_Max} * 1.25 \text{ ms}$ Conn_Interval_Max range: 0x0006 to 0x0C80 Conn_Interval_Max shall be equal to or greater than the Conn_Interval_Min. Value of 0xFFFF indicates no specific maximum. Values not defined above are reserved for future use.

int appearance

External appearance of device

uint16_t manufacturer_len

Manufacturer data length

uint8_t *p_manufacturer_data

Manufacturer data point

uint16_t service_data_len

Service data length

`uint8_t *p_service_data`
Service data point

`uint16_t service_uuid_len`
Service uuid length

`uint8_t *p_service_uuid`
Service uuid array point

`uint8_t flag`
Advertising flag of discovery mode, see BLE_ADV_DATA_FLAG detail

struct esp_ble_scan_params_t
Ble scan parameters.

Public Members

`esp_ble_scan_type_t scan_type`
Scan type

`esp_ble_addr_type_t own_addr_type`
Owner address type

`esp_ble_scan_filter_t scan_filter_policy`
Scan filter policy

`uint16_t scan_interval`
Scan interval. This is defined as the time interval from when the Controller started its last LE scan until it begins the subsequent LE scan. Range: 0x0004 to 0x4000 Default: 0x0010 (10 ms) Time = N * 0.625 msec Time Range: 2.5 msec to 10.24 seconds

`uint16_t scan_window`
Scan window. The duration of the LE scan. LE_Scan_Window shall be less than or equal to LE_Scan_Interval Range: 0x0004 to 0x4000 Default: 0x0010 (10 ms) Time = N * 0.625 msec Time Range: 2.5 msec to 10240 msec

`esp_ble_scan_duplicate_t scan_duplicate`
The Scan_Duplicates parameter controls whether the Link Layer should filter out duplicate advertising reports (BLE_SCAN_DUPLICATE_ENABLE) to the Host, or if the Link Layer should generate advertising reports for each packet received

struct esp_gap_conn_params_t
connection parameters information

Public Members

`uint16_t interval`
connection interval

`uint16_t latency`
Slave latency for the connection in number of connection events. Range: 0x0000 to 0x01F3

`uint16_t timeout`
Supervision timeout for the LE Link. Range: 0x000A to 0x0C80. Mandatory Range: 0x000A to 0x0C80 Time = N * 10 msec Time Range: 100 msec to 32 seconds

struct esp_ble_conn_update_params_t
Connection update parameters.

Public Members*esp_bd_addr_t* **bda**

Bluetooth device address

uint16_t **min_int**

Min connection interval

uint16_t **max_int**

Max connection interval

uint16_t **latency**

Slave latency for the connection in number of connection events. Range: 0x0000 to 0x01F3

uint16_t **timeout**

Supervision timeout for the LE Link. Range: 0x000A to 0x0C80. Mandatory Range: 0x000A to 0x0C80

Time = N * 10 msec Time Range: 100 msec to 32 seconds

struct esp_ble_pkt_data_length_params_t

BLE pkt data length keys.

Public Membersuint16_t **rx_len**

pkt rx data length value

uint16_t **tx_len**

pkt tx data length value

struct esp_ble_penc_keys_t

BLE encryption keys.

Public Members*esp_bt_octet16_t* **ltk**

The long term key

esp_bt_octet8_t **rand**

The random number

uint16_t **ediv**

The ediv value

uint8_t **sec_level**

The security level of the security link

uint8_t **key_size**

The key size(7~16) of the security link

struct esp_ble_pcsrkeys_t

BLE CSRK keys.

Public Membersuint32_t **counter**

The counter

esp_bt_octet16_t **csrkey**

The csrkey

uint8_t **sec_level**

The security level

struct esp_ble_pid_keys_t
BLE pid keys.

Public Members

esp_bt_octet16_t **irk**
The irk value

esp_ble_addr_type_t **addr_type**
The address type

esp_bd_addr_t **static_addr**
The static address

struct esp_ble_lenc_keys_t
BLE Encryption reproduction keys.

Public Members

esp_bt_octet16_t **ltk**
The long term key

uint16_t **div**
The div value

uint8_t **key_size**
The key size of the security link

uint8_t **sec_level**
The security level of the security link

struct esp_ble_lcsrkeys_t
BLE SRK keys.

Public Members

uint32_t **counter**
The counter value

uint16_t **div**
The div value

uint8_t **sec_level**
The security level of the security link

esp_bt_octet16_t **csrkey**
The csrkey value

struct esp_ble_sec_key_notif_t
Structure associated with ESP_KEY_NOTIF_EVT.

Public Members

esp_bd_addr_t **bd_addr**
peer address

uint32_t **passkey**
the numeric value for comparison. If just_works, do not show this number to UI

struct esp_ble_sec_req_t
Structure of the security request.

Public Members

esp_bd_addr_t **bd_addr**
peer address

struct esp_ble_bond_key_info_t
struct type of the bond key information value

Public Members

esp_ble_key_mask_t **key_mask**
the key mask to indicate witch key is present

esp_ble_penc_keys_t **penc_key**
received peer encryption key

esp_ble_pcsrkeys_t **pcsrk_key**
received peer device SRK

esp_ble_pid_keys_t **pid_key**
peer device ID key

struct esp_ble_bond_dev_t
struct type of the bond device value

Public Members

esp_bd_addr_t **bd_addr**
peer address

esp_ble_bond_key_info_t **bond_key**
the bond key information

struct esp_ble_key_t
union type of the security key value

Public Members

esp_bd_addr_t **bd_addr**
peer address

esp_ble_key_type_t **key_type**
key type of the security link

esp_ble_key_value_t **p_key_value**
the pointer to the key value

struct esp_ble_local_id_keys_t
structure type of the ble local id keys value

Public Members

esp_bt_octet16_t **ir**
the 16 bits of the ir value

esp_bt_octet16_t **irk**
the 16 bits of the ir key value

esp_bt_octet16_t **dhk**
the 16 bits of the dh key value

struct esp_ble_auth_cmpl_t

Structure associated with ESP_AUTH_CMPL_EVT.

Public Members*esp_bd_addr_t* **bd_addr**

BD address peer device.

bool **key_present**

Valid link key value in key element

esp_link_key **key**

Link key associated with peer device.

uint8_t **key_type**

The type of Link Key

bool **success**

TRUE of authentication succeeded, FALSE if failed.

uint8_t **fail_reason**

The HCI reason/error code for when success=FALSE

esp_ble_addr_type_t **addr_type**

Peer device address type

esp_bt_dev_type_t **dev_type**

Device type

esp_ble_auth_req_t **auth_mode**

authentication mode

struct esp_ble_gap_ext_adv_params_t

ext adv parameters

Public Members*esp_ble_ext_adv_type_mask_t* **type**

ext adv type

uint32_t **interval_min**

ext adv minimum interval

uint32_t **interval_max**

ext adv maximum interval

esp_ble_adv_channel_t **channel_map**

ext adv channel map

esp_ble_addr_type_t **own_addr_type**

ext adv own address type

esp_ble_addr_type_t **peer_addr_type**

ext adv peer address type

esp_bd_addr_t **peer_addr**

ext adv peer address

esp_ble_adv_filter_t **filter_policy**

ext adv filter policy

int8_t **tx_power**

ext adv tx power

esp_ble_gap_pri_phy_t **primary_phy**

ext adv primary phy

uint8_t **max_skip**
ext adv maximum skip

esp_ble_gap_phy_t **secondary_phy**
ext adv secondary phy

uint8_t **sid**
ext adv sid

bool **scan_req_notif**
ext adv sacn request event notify

struct esp_ble_ext_scan_cfg_t
ext scan config

Public Members

esp_ble_scan_type_t **scan_type**
ext scan type

uint16_t **scan_interval**
ext scan interval

uint16_t **scan_window**
ext scan window

struct esp_ble_ext_scan_params_t
ext scan parameters

Public Members

esp_ble_addr_type_t **own_addr_type**
ext scan own addresss type

esp_ble_scan_filter_t **filter_policy**
ext scan filter policy

esp_ble_scan_duplicate_t **scan_duplicate**
ext scan duplicate scan

esp_ble_ext_scan_cfg_mask_t **cfg_mask**
ext scan config mask

esp_ble_ext_scan_cfg_t **uncoded_cfg**
ext scan uncoded config parameters

esp_ble_ext_scan_cfg_t **coded_cfg**
ext scan coded config parameters

struct esp_ble_gap_conn_params_t
create extend connection parameters

Public Members

uint16_t **scan_interval**
init scan interval

uint16_t **scan_window**
init scan window

uint16_t **interval_min**
minimum interval

`uint16_t interval_max`
maximum interval

`uint16_t latency`
ext scan type

`uint16_t supervision_timeout`
connection supervision timeout

`uint16_t min_ce_len`
minimum ce length

`uint16_t max_ce_len`
maximum ce length

`struct esp_ble_gap_ext_adv_t`
extend adv enable parameters

Public Members

`uint8_t instance`
advertising handle

`int duration`
advertising duration

`int max_events`
maximum number of extended advertising events

`struct esp_ble_gap_periodic_adv_params_t`
periodic adv parameters

Public Members

`uint16_t interval_min`
periodic advertising minimum interval

`uint16_t interval_max`
periodic advertising maximum interval

`uint8_t properties`
periodic advertising properties

`struct esp_ble_gap_periodic_adv_sync_params_t`
periodic adv sync parameters

Public Members

`esp_ble_gap_sync_t filter_policy`
periodic advertising sync filter policy

`uint8_t sid`
periodic advertising sid

`esp_ble_addr_type_t addr_type`
periodic advertising address type

`esp_bd_addr_t addr`
periodic advertising address

`uint16_t skip`
the maximum number of periodic advertising events that can be skipped

`uint16_t sync_timeout`
synchronization timeout

struct esp_ble_gap_ext_adv_reprot_t
extend adv report parameters

Public Members

`esp_ble_gap_adv_type_t event_type`
extend advertising type

`uint8_t addr_type`
extend advertising address type

`esp_bd_addr_t addr`
extend advertising address

`esp_ble_gap_pri_phy_t primary_phy`
extend advertising primary phy

`esp_ble_gap_phy_t secondly_phy`
extend advertising secondary phy

`uint8_t sid`
extend advertising sid

`uint8_t tx_power`
extend advertising tx power

`int8_t rssi`
extend advertising rssi

`uint16_t per_adv_interval`
periodic advertising interval

`uint8_t dir_addr_type`
direct address type

`esp_bd_addr_t dir_addr`
direct address

`esp_ble_gap_ext_adv_data_status_t data_status`
data type

`uint8_t adv_data_len`
extend advertising data length

`uint8_t adv_data[251]`
extend advertising data

struct esp_ble_gap_periodic_adv_report_t
periodic adv report parameters

Public Members

`uint16_t sync_handle`
periodic advertising train handle

`uint8_t tx_power`
periodic advertising tx power

`int8_t rssi`
periodic advertising rssi

`esp_ble_gap_ext_adv_data_status_t data_status`
periodic advertising data type

`uint8_t data_length`
periodic advertising data length

`uint8_t data[251]`
periodic advertising data

struct esp_ble_gap_periodic_adv_sync_estab_t
periodic adv sync establish parameters

Public Members

`uint8_t status`
periodic advertising sync status

`uint16_t sync_handle`
periodic advertising train handle

`uint8_t sid`
periodic advertising sid

esp_ble_addr_type_t `addr_type`
periodic advertising address type

esp_bd_addr_t `adv_addr`
periodic advertising address

esp_ble_gap_phy_t `adv_phy`
periodic advertising adv phy type

`uint16_t period_adv_interval`
periodic advertising interval

`uint8_t adv_clk_accuracy`
periodic advertising clock accuracy

Macros

ESP_BLE_ADV_FLAG_LIMIT_DISC
BLE_ADV_DATA_FLAG data flag bit definition used for advertising data flag

ESP_BLE_ADV_FLAG_GEN_DISC

ESP_BLE_ADV_FLAG_BREDR_NOT_SPT

ESP_BLE_ADV_FLAG_DMT_CONTROLLER_SPT

ESP_BLE_ADV_FLAG_DMT_HOST_SPT

ESP_BLE_ADV_FLAG_NON_LIMIT_DISC

ESP_LE_KEY_NONE

ESP_LE_KEY_PENC

ESP_LE_KEY_PID

ESP_LE_KEY_PCSRK

ESP_LE_KEY_PLK

ESP_LE_KEY_LLK

ESP_LE_KEY_LENC

ESP_LE_KEY_LID

ESP_LE_KEY_LCSRK

ESP_LE_AUTH_NO_BOND

ESP_LE_AUTH_BOND

ESP_LE_AUTH_REQ_MITM
ESP_LE_AUTH_REQ_BOND_MITM
0101
ESP_LE_AUTH_REQ_SC_ONLY
ESP_LE_AUTH_REQ_SC_BOND
ESP_LE_AUTH_REQ_SC_MITM
ESP_LE_AUTH_REQ_SC_MITM_BOND
ESP_BLE_ONLY_ACCEPT_SPECIFIED_AUTH_DISABLE
ESP_BLE_ONLY_ACCEPT_SPECIFIED_AUTH_ENABLE
ESP_BLE_OOB_DISABLE
ESP_BLE_OOB_ENABLE
ESP_IO_CAP_OUT
ESP_IO_CAP_IO
ESP_IO_CAP_IN
ESP_IO_CAP_NONE
ESP_IO_CAP_KBDISP
ESP_BLE_APPEARANCE_UNKNOWN
ESP_BLE_APPEARANCE_GENERIC_PHONE
ESP_BLE_APPEARANCE_GENERIC_COMPUTER
ESP_BLE_APPEARANCE_GENERIC_WATCH
ESP_BLE_APPEARANCE_SPORTS_WATCH
ESP_BLE_APPEARANCE_GENERIC_CLOCK
ESP_BLE_APPEARANCE_GENERIC_DISPLAY
ESP_BLE_APPEARANCE_GENERIC_REMOTE
ESP_BLE_APPEARANCE_GENERIC_EYEGLASSES
ESP_BLE_APPEARANCE_GENERIC_TAG
ESP_BLE_APPEARANCE_GENERIC_KEYRING
ESP_BLE_APPEARANCE_GENERIC_MEDIA_PLAYER
ESP_BLE_APPEARANCE_GENERIC_BARCODE_SCANNER
ESP_BLE_APPEARANCE_GENERIC_THERMOMETER
ESP_BLE_APPEARANCE_THERMOMETER_EAR
ESP_BLE_APPEARANCE_GENERIC_HEART_RATE
ESP_BLE_APPEARANCE_HEART_RATE_BELT
ESP_BLE_APPEARANCE_GENERIC_BLOOD_PRESSURE
ESP_BLE_APPEARANCE_BLOOD_PRESSURE_ARM
ESP_BLE_APPEARANCE_BLOOD_PRESSURE_WRIST
ESP_BLE_APPEARANCE_GENERIC_HID
ESP_BLE_APPEARANCE_HID_KEYBOARD
ESP_BLE_APPEARANCE_HID_MOUSE

ESP_BLE_APPEARANCE_HID_JOYSTICK
ESP_BLE_APPEARANCE_HID_GAMEPAD
ESP_BLE_APPEARANCE_HID_DIGITIZER_TABLET
ESP_BLE_APPEARANCE_HID_CARD_READER
ESP_BLE_APPEARANCE_HID_DIGITAL_PEN
ESP_BLE_APPEARANCE_HID_BARCODE_SCANNER
ESP_BLE_APPEARANCE_GENERIC_GLUCOSE
ESP_BLE_APPEARANCE_GENERIC_WALKING
ESP_BLE_APPEARANCE_WALKING_IN_SHOE
ESP_BLE_APPEARANCE_WALKING_ON_SHOE
ESP_BLE_APPEARANCE_WALKING_ON_HIP
ESP_BLE_APPEARANCE_GENERIC_CYCLING
ESP_BLE_APPEARANCE_CYCLING_COMPUTER
ESP_BLE_APPEARANCE_CYCLING_SPEED
ESP_BLE_APPEARANCE_CYCLING_CADENCE
ESP_BLE_APPEARANCE_CYCLING_POWER
ESP_BLE_APPEARANCE_CYCLING_SPEED_CADENCE
ESP_BLE_APPEARANCE_GENERIC_PULSE_OXIMETER
ESP_BLE_APPEARANCE_PULSE_OXIMETER_FINGERTIP
ESP_BLE_APPEARANCE_PULSE_OXIMETER_WRIST
ESP_BLE_APPEARANCE_GENERIC_WEIGHT
ESP_BLE_APPEARANCE_GENERIC_PERSONAL_MOBILITY_DEVICE
ESP_BLE_APPEARANCE_POWERED_WHEELCHAIR
ESP_BLE_APPEARANCE_MOBILITY_SCOOTER
ESP_BLE_APPEARANCE_GENERIC_CONTINUOUS_GLUCOSE_MONITOR
ESP_BLE_APPEARANCE_GENERIC_INSULIN_PUMP
ESP_BLE_APPEARANCE_INSULIN_PUMP_DURABLE_PUMP
ESP_BLE_APPEARANCE_INSULIN_PUMP_PATCH_PUMP
ESP_BLE_APPEARANCE_INSULIN_PEN
ESP_BLE_APPEARANCE_GENERIC_MEDICATION_DELIVERY
ESP_BLE_APPEARANCE_GENERIC_OUTDOOR_SPORTS
ESP_BLE_APPEARANCE_OUTDOOR_SPORTS_LOCATION
ESP_BLE_APPEARANCE_OUTDOOR_SPORTS_LOCATION_AND_NAV
ESP_BLE_APPEARANCE_OUTDOOR_SPORTS_LOCATION_POD
ESP_BLE_APPEARANCE_OUTDOOR_SPORTS_LOCATION_POD_AND_NAV
ESP_GAP_BLE_CHANNELS_LEN
ESP_GAP_BLE_ADD_WHITELIST_COMPLETE_EVT
This is the old name, just for backwards compatibility.
ESP_BLE_ADV_DATA_LEN_MAX
Advertising data maximum length.

ESP_BLE_SCAN_RSP_DATA_LEN_MAX

Scan response data maximum length.

BLE_BIT (n)

ESP_BLE_GAP_SET_EXT_ADV_PROP_NONCONN_NONSCANNABLE_UNDIRECTED

ESP_BLE_GAP_SET_EXT_ADV_PROP_CONNECTABLE

ESP_BLE_GAP_SET_EXT_ADV_PROP_SCANNABLE

ESP_BLE_GAP_SET_EXT_ADV_PROP_DIRECTED

ESP_BLE_GAP_SET_EXT_ADV_PROP_HD_DIRECTED

ESP_BLE_GAP_SET_EXT_ADV_PROP_LEGACY

ESP_BLE_GAP_SET_EXT_ADV_PROP_ANON_ADV

ESP_BLE_GAP_SET_EXT_ADV_PROP_INCLUDE_TX_PWR

ESP_BLE_GAP_SET_EXT_ADV_PROP_MASK

ESP_BLE_GAP_SET_EXT_ADV_PROP_LEGACY_IND

ESP_BLE_GAP_SET_EXT_ADV_PROP_LEGACY_LD_DIR

ESP_BLE_GAP_SET_EXT_ADV_PROP_LEGACY_HD_DIR

ESP_BLE_GAP_SET_EXT_ADV_PROP_LEGACY_SCAN

ESP_BLE_GAP_SET_EXT_ADV_PROP_LEGACY_NONCONN

ESP_BLE_GAP_PHY_1M

ESP_BLE_GAP_PHY_2M

ESP_BLE_GAP_PHY_CODED

ESP_BLE_GAP_NO_PREFER_TRANSMIT_PHY

ESP_BLE_GAP_NO_PREFER_RECEIVE_PHY

ESP_BLE_GAP_PRI_PHY_1M

ESP_BLE_GAP_PRI_PHY_CODED

ESP_BLE_GAP_PHY_1M_PREF_MASK

ESP_BLE_GAP_PHY_2M_PREF_MASK

ESP_BLE_GAP_PHY_CODED_PREF_MASK

ESP_BLE_GAP_PHY_OPTIONS_NO_PREF

ESP_BLE_GAP_PHY_OPTIONS_PREF_S2_CODING

ESP_BLE_GAP_PHY_OPTIONS_PREF_S8_CODING

ESP_BLE_GAP_EXT_SCAN_CFG_UNCODE_MASK

ESP_BLE_GAP_EXT_SCAN_CFG_CODE_MASK

ESP_BLE_GAP_EXT_ADV_DATA_COMPLETE

ESP_BLE_GAP_EXT_ADV_DATA_INCOMPLETE

ESP_BLE_GAP_EXT_ADV_DATA_TRUNCATED

ESP_BLE_GAP_SYNC_POLICY_BY_ADV_INFO

ESP_BLE_GAP_SYNC_POLICY_BY_PERIODIC_LIST

ESP_BLE_ADV_REPORT_EXT_ADV_IND

ESP_BLE_ADV_REPORT_EXT_SCAN_IND

ESP_BLE_ADV_REPORT_EXT_DIRECT_ADV
ESP_BLE_ADV_REPORT_EXT_SCAN_RSP
ESP_BLE_LEGACY_ADV_TYPE_IND
ESP_BLE_LEGACY_ADV_TYPE_DIRECT_IND
ESP_BLE_LEGACY_ADV_TYPE_SCAN_IND
ESP_BLE_LEGACY_ADV_TYPE_NONCON_IND
ESP_BLE_LEGACY_ADV_TYPE_SCAN_RSP_TO_ADV_IND
ESP_BLE_LEGACY_ADV_TYPE_SCAN_RSP_TO_ADV_SCAN_IND

Type Definitions

```
typedef uint8_t esp_ble_key_type_t
typedef uint8_t esp_ble_auth_req_t
    combination of the above bit pattern

typedef uint8_t esp_ble_io_cap_t
    combination of the io capability

typedef uint8_t esp_gap_ble_channels[ESP_GAP_BLE_CHANNELS_LEN]
typedef uint8_t esp_duplicate_info_t[ESP_BD_ADDR_LEN]
typedef uint16_t esp_ble_ext_adv_type_mask_t
typedef uint8_t esp_ble_gap_phy_t
typedef uint8_t esp_ble_gap_all_phys_t
typedef uint8_t esp_ble_gap_pri_phy_t
typedef uint8_t esp_ble_gap_phy_mask_t
typedef uint16_t esp_ble_gap_prefer_phy_options_t
typedef uint8_t esp_ble_ext_scan_cfg_mask_t
typedef uint8_t esp_ble_gap_ext_adv_data_status_t
typedef uint8_t esp_ble_gap_sync_t
typedef uint8_t esp_ble_gap_adv_type_t
typedef void (*esp_gap_ble_cb_t) (esp_gap_ble_cb_event_t event, esp_ble_gap_cb_param_t
    *param)
```

GAP callback function type.

Parameters

- event: : Event type
- param: : Point to callback parameter, currently is union type

Enumerations

```
enum esp_gap_ble_cb_event_t
    GAP BLE callback event type.
```

Values:

```
ESP_GAP_BLE_ADV_DATA_SET_COMPLETE_EVT = 0
    When advertising data set complete, the event comes
ESP_GAP_BLE_SCAN_RSP_DATA_SET_COMPLETE_EVT
    When scan response data set complete, the event comes
ESP_GAP_BLE_SCAN_PARAM_SET_COMPLETE_EVT
    When scan parameters set complete, the event comes
```

ESP_GAP_BLE_SCAN_RESULT_EVT

When one scan result ready, the event comes each time

ESP_GAP_BLE_ADV_DATA_RAW_SET_COMPLETE_EVT

When raw advertising data set complete, the event comes

ESP_GAP_BLE_SCAN_RSP_DATA_RAW_SET_COMPLETE_EVT

When raw advertising data set complete, the event comes

ESP_GAP_BLE_ADV_START_COMPLETE_EVT

When start advertising complete, the event comes

ESP_GAP_BLE_SCAN_START_COMPLETE_EVT

When start scan complete, the event comes

ESP_GAP_BLE_AUTH_CMPL_EVT = 8**ESP_GAP_BLE_KEY_EVT****ESP_GAP_BLE_SEC_REQ_EVT****ESP_GAP_BLE_PASSKEY_NOTIF_EVT****ESP_GAP_BLE_PASSKEY_REQ_EVT****ESP_GAP_BLE_OOB_REQ_EVT****ESP_GAP_BLE_LOCAL_IR_EVT****ESP_GAP_BLE_LOCAL_ER_EVT****ESP_GAP_BLE_NC_REQ_EVT****ESP_GAP_BLE_ADV_STOP_COMPLETE_EVT**

When stop adv complete, the event comes

ESP_GAP_BLE_SCAN_STOP_COMPLETE_EVT

When stop scan complete, the event comes

ESP_GAP_BLE_SET_STATIC_RAND_ADDR_EVT = 19

When set the static rand address complete, the event comes

ESP_GAP_BLE_UPDATE_CONN_PARAMS_EVT

When update connection parameters complete, the event comes

ESP_GAP_BLE_SET_PKT_LENGTH_COMPLETE_EVT

When set pkt length complete, the event comes

ESP_GAP_BLE_SET_LOCAL_PRIVACY_COMPLETE_EVT

When Enable/disable privacy on the local device complete, the event comes

ESP_GAP_BLE_REMOVE_BOND_DEV_COMPLETE_EVT

When remove the bond device complete, the event comes

ESP_GAP_BLE_CLEAR_BOND_DEV_COMPLETE_EVT

When clear the bond device clear complete, the event comes

ESP_GAP_BLE_GET_BOND_DEV_COMPLETE_EVT

When get the bond device list complete, the event comes

ESP_GAP_BLE_READ_RSSI_COMPLETE_EVT

When read the rssi complete, the event comes

ESP_GAP_BLE_UPDATE_WHITELIST_COMPLETE_EVT

When add or remove whitelist complete, the event comes

ESP_GAP_BLE_UPDATE_DUPLICATE_EXCEPTIONAL_LIST_COMPLETE_EVT

When update duplicate exceptional list complete, the event comes

ESP_GAP_BLE_SET_CHANNELS_EVT = 29

When setting BLE channels complete, the event comes

```
ESP_GAP_BLE_READ_PHY_COMPLETE_EVT
ESP_GAP_BLE_SET_PREFERED_DEFAULT_PHY_COMPLETE_EVT
ESP_GAP_BLE_SET_PREFERED_PHY_COMPLETE_EVT
ESP_GAP_BLE_EXT_ADV_SET RAND_ADDR_COMPLETE_EVT
ESP_GAP_BLE_EXT_ADV_SET_PARAMS_COMPLETE_EVT
ESP_GAP_BLE_EXT_ADV_DATA_SET_COMPLETE_EVT
ESP_GAP_BLE_EXT_SCAN_RSP_DATA_SET_COMPLETE_EVT
ESP_GAP_BLE_EXT_ADV_START_COMPLETE_EVT
ESP_GAP_BLE_EXT_ADV_STOP_COMPLETE_EVT
ESP_GAP_BLE_EXT_ADV_SET_REMOVE_COMPLETE_EVT
ESP_GAP_BLE_EXT_ADV_SET_CLEAR_COMPLETE_EVT
ESP_GAP_BLE_PERIODIC_ADV_SET_PARAMS_COMPLETE_EVT
ESP_GAP_BLE_PERIODIC_ADV_DATA_SET_COMPLETE_EVT
ESP_GAP_BLE_PERIODIC_ADV_START_COMPLETE_EVT
ESP_GAP_BLE_PERIODIC_ADV_STOP_COMPLETE_EVT
ESP_GAP_BLE_PERIODIC_ADV_CREATE_SYNC_COMPLETE_EVT
ESP_GAP_BLE_PERIODIC_ADV_SYNC_CANCEL_COMPLETE_EVT
ESP_GAP_BLE_PERIODIC_ADV_SYNC_TERMINATE_COMPLETE_EVT
ESP_GAP_BLE_PERIODIC_ADV_ADD_DEV_COMPLETE_EVT
ESP_GAP_BLE_PERIODIC_ADV_REMOVE_DEV_COMPLETE_EVT
ESP_GAP_BLE_PERIODIC_ADV_CLEAR_DEV_COMPLETE_EVT
ESP_GAP_BLE_SET_EXT_SCAN_PARAMS_COMPLETE_EVT
ESP_GAP_BLE_EXT_SCAN_START_COMPLETE_EVT
ESP_GAP_BLE_EXT_SCAN_STOP_COMPLETE_EVT
ESP_GAP_BLE_PREFER_EXT_CONN_PARAMS_SET_COMPLETE_EVT
ESP_GAP_BLE_PHY_UPDATE_COMPLETE_EVT
ESP_GAP_BLE_EXT_ADV_REPORT_EVT
ESP_GAP_BLE_SCAN_TIMEOUT_EVT
ESP_GAP_BLE_ADV_TERMINATED_EVT
ESP_GAP_BLE_SCAN_REQ_RECEIVED_EVT
ESP_GAP_BLE_CHANNEL_SELETE_ALGORITHM_EVT
ESP_GAP_BLE_PERIODIC_ADV_REPORT_EVT
ESP_GAP_BLE_PERIODIC_ADV_SYNC_LOST_EVT
ESP_GAP_BLE_PERIODIC_ADV_SYNC_ESTAB_EVT
ESP_GAP_BLE_EVT_MAX
enum esp_ble_adv_data_type
    The type of advertising data(not adv_type)
    Values:
    ESP_BLE_AD_TYPE_FLAG = 0x01
    ESP_BLE_AD_TYPE_16SRV_PART = 0x02
```

```
ESP_BLE_AD_TYPE_16SRV_CMPL = 0x03
ESP_BLE_AD_TYPE_32SRV_PART = 0x04
ESP_BLE_AD_TYPE_32SRV_CMPL = 0x05
ESP_BLE_AD_TYPE_128SRV_PART = 0x06
ESP_BLE_AD_TYPE_128SRV_CMPL = 0x07
ESP_BLE_AD_TYPE_NAME_SHORT = 0x08
ESP_BLE_AD_TYPE_NAME_CMPL = 0x09
ESP_BLE_AD_TYPE_TX_PWR = 0x0A
ESP_BLE_AD_TYPE_DEV_CLASS = 0x0D
ESP_BLE_AD_TYPE_SM_TK = 0x10
ESP_BLE_AD_TYPE_SM_OOB_FLAG = 0x11
ESP_BLE_AD_TYPE_INT_RANGE = 0x12
ESP_BLE_AD_TYPE_SOL_SRV_UUID = 0x14
ESP_BLE_AD_TYPE_128SOL_SRV_UUID = 0x15
ESP_BLE_AD_TYPE_SERVICE_DATA = 0x16
ESP_BLE_AD_TYPE_PUBLIC_TARGET = 0x17
ESP_BLE_AD_TYPE_RANDOM_TARGET = 0x18
ESP_BLE_AD_TYPE_APPEARANCE = 0x19
ESP_BLE_AD_TYPE_ADV_INT = 0x1A
ESP_BLE_AD_TYPE_LE_DEV_ADDR = 0x1b
ESP_BLE_AD_TYPE_LE_ROLE = 0x1c
ESP_BLE_AD_TYPE_SPAIR_C256 = 0x1d
ESP_BLE_AD_TYPE_SPAIR_R256 = 0x1e
ESP_BLE_AD_TYPE_32SOL_SRV_UUID = 0x1f
ESP_BLE_AD_TYPE_32SERVICE_DATA = 0x20
ESP_BLE_AD_TYPE_128SERVICE_DATA = 0x21
ESP_BLE_AD_TYPE_LE_SECURE_CONFIRM = 0x22
ESP_BLE_AD_TYPE_LE_SECURE_RANDOM = 0x23
ESP_BLE_AD_TYPE_URI = 0x24
ESP_BLE_AD_TYPE_INDOOR_POSITION = 0x25
ESP_BLE_AD_TYPE_TRANS_DISC_DATA = 0x26
ESP_BLE_AD_TYPE_LE_SUPPORT_FEATURE = 0x27
ESP_BLE_AD_TYPE_CHAN_MAP_UPDATE = 0x28
ESP_BLE_AD_MANUFACTURER_SPECIFIC_TYPE = 0xFF
```

```
enum esp_ble_adv_type_t
```

Advertising mode.

Values:

```
ADV_TYPE_IND = 0x00
```

```
ADV_TYPE_DIRECT_IND_HIGH = 0x01
```

```
ADV_TYPE_SCAN_IND = 0x02
ADV_TYPE_NONCONN_IND = 0x03
ADV_TYPE_DIRECT_IND_LOW = 0x04
```

```
enum esp_ble_adv_channel_t
```

Advertising channel mask.

Values:

```
ADV_CHNL_37 = 0x01
ADV_CHNL_38 = 0x02
ADV_CHNL_39 = 0x04
ADV_CHNL_ALL = 0x07
```

```
enum esp_ble_adv_filter_t
```

Values:

```
ADV_FILTER_ALLOW_SCAN_ANY_CON_ANY = 0x00
    Allow both scan and connection requests from anyone.

ADV_FILTER_ALLOW_SCAN_WLST_CON_ANY
    Allow both scan req from White List devices only and connection req from anyone.

ADV_FILTER_ALLOW_SCAN_ANY_CON_WLST
    Allow both scan req from anyone and connection req from White List devices only.

ADV_FILTER_ALLOW_SCAN_WLST_CON_WLST
    Allow scan and connection requests from White List devices only.
```

```
enum esp_ble_sec_act_t
```

Values:

```
ESP_BLE_SEC_ENCRYPT = 1
ESP_BLE_SEC_ENCRYPT_NO_MITM
ESP_BLE_SEC_ENCRYPT_MITM
```

```
enum esp_ble_sm_param_t
```

Values:

```
ESP_BLE_SM_PASSKEY = 0
ESP_BLE_SM_AUTHEN_REQ_MODE
ESP_BLE_SM_IOCAP_MODE
ESP_BLE_SM_SET_INIT_KEY
ESP_BLE_SM_SET_RSP_KEY
ESP_BLE_SM_MAX_KEY_SIZE
ESP_BLE_SM_MIN_KEY_SIZE
ESP_BLE_SM_SET_STATIC_PASSKEY
ESP_BLE_SM_CLEAR_STATIC_PASSKEY
ESP_BLE_SM_ONLY_ACCEPT_SPECIFIED_SEC_AUTH
ESP_BLE_SM_OOB_SUPPORT
ESP_BLE_APP_ENC_KEY_SIZE
ESP_BLE_SM_MAX_PARAM
```

enum esp_ble_scan_type_t

Ble scan type.

*Values:***BLE_SCAN_TYPE_PASSIVE** = 0x0

Passive scan

BLE_SCAN_TYPE_ACTIVE = 0x1

Active scan

enum esp_ble_scan_filter_t

Ble scan filter type.

*Values:***BLE_SCAN_FILTER_ALLOW_ALL** = 0x0

Accept all :

1. advertisement packets except directed advertising packets not addressed to this device (default).

BLE_SCAN_FILTER_ALLOW_ONLY_WLST = 0x1

Accept only :

1. advertisement packets from devices where the advertiser' s address is in the White list.
2. Directed advertising packets which are not addressed for this device shall be ignored.

BLE_SCAN_FILTER_ALLOW_UND_RPA_DIR = 0x2

Accept all :

1. undirected advertisement packets, and
2. directed advertising packets where the initiator address is a resolvable private address, and
3. directed advertising packets addressed to this device.

BLE_SCAN_FILTER_ALLOW_WLIST_RPA_DIR = 0x3

Accept all :

1. advertisement packets from devices where the advertiser' s address is in the White list, and
2. directed advertising packets where the initiator address is a resolvable private address, and
3. directed advertising packets addressed to this device.

enum esp_ble_scan_duplicate_t

Ble scan duplicate type.

*Values:***BLE_SCAN_DUPLICATE_DISABLE** = 0x0

the Link Layer should generate advertising reports to the host for each packet received

BLE_SCAN_DUPLICATE_ENABLE = 0x1

the Link Layer should filter out duplicate advertising reports to the Host

BLE_SCAN_DUPLICATE_MAX = 0x2

0x02 -0xFF, Reserved for future use

enum esp_gap_search_evt_t

Sub Event of ESP_GAP_BLE_SCAN_RESULT_EVT.

*Values:***ESP_GAP_SEARCH_INQ_RES_EVT** = 0

Inquiry result for a peer device.

ESP_GAP_SEARCH_INQ_CMPL_EVT = 1

Inquiry complete.

ESP_GAP_SEARCH_DISC_RES_EVT = 2

Discovery result for a peer device.

ESP_GAP_SEARCH_DISC_BLE_RES_EVT = 3
Discovery result for BLE GATT based service on a peer device.

ESP_GAP_SEARCH_DISC_CMPL_EVT = 4
Discovery complete.

ESP_GAP_SEARCH_DI_DISC_CMPL_EVT = 5
Discovery complete.

ESP_GAP_SEARCH_SEARCH_CANCEL_CMPL_EVT = 6
Search cancelled

ESP_GAP_SEARCH_INQ_DISCARD_NUM_EVT = 7
The number of pkt discarded by flow control

enum esp_ble_evt_type_t

Ble scan result event type, to indicate the result is scan response or advertising data or other.

Values:

ESP_BLE_EVT_CONN_ADV = 0x00
Connectable undirected advertising (ADV_IND)

ESP_BLE_EVT_CONN_DIR_ADV = 0x01
Connectable directed advertising (ADV_DIRECT_IND)

ESP_BLE_EVT_DISC_ADV = 0x02
Scannable undirected advertising (ADV_SCAN_IND)

ESP_BLE_EVT_NON_CONN_ADV = 0x03
Non connectable undirected advertising (ADV_NONCONN_IND)

ESP_BLE_EVT_SCAN_RSP = 0x04
Scan Response (SCAN_RSP)

enum esp_ble_wl_opration_t

Values:

ESP_BLE_WHITELIST_REMOVE = 0X00
remove mac from whitelist

ESP_BLE_WHITELIST_ADD = 0X01
add address to whitelist

enum esp_bt_duplicate_exceptional_subcode_type_t

Values:

ESP_BLE_DUPLICATE_EXCEPTIONAL_LIST_ADD = 0
Add device info into duplicate scan exceptional list

ESP_BLE_DUPLICATE_EXCEPTIONAL_LIST_REMOVE
Remove device info from duplicate scan exceptional list

ESP_BLE_DUPLICATE_EXCEPTIONAL_LIST_CLEAN
Clean duplicate scan exceptional list

enum esp_ble_duplicate_exceptional_info_type_t

Values:

ESP_BLE_DUPLICATE_SCAN_EXCEPTIONAL_INFO_ADV_ADDR = 0
BLE advertising address , device info will be added into ESP_BLE_DUPLICATE_SCAN_EXCEPTIONAL_ADDR_LIST

ESP_BLE_DUPLICATE_SCAN_EXCEPTIONAL_INFO_MESH_LINK_ID
BLE mesh link ID, it is for BLE mesh, device info will be added into ESP_BLE_DUPLICATE_SCAN_EXCEPTIONAL_MESH_LINK_ID_LIST

ESP_BLE_DUPLICATE_SCAN_EXCEPTIONAL_INFO_MESH_BEACON_TYPE
BLE mesh beacon AD type, the format is | Len | 0x2B | Beacon Type | Beacon Data |

ESP_BLE_DUPLICATE_SCAN_EXCEPTIONAL_INFO_MESH_PROV_SRV_ADV

BLE mesh provisioning service uuid, the format is | 0x02 | 0x01 | flags | 0x03 | 0x03 | 0x1827 | ... |

ESP_BLE_DUPLICATE_SCAN_EXCEPTIONAL_INFO_MESH_PROXY_SRV_ADV

BLE mesh adv with proxy service uuid, the format is | 0x02 | 0x01 | flags | 0x03 | 0x03 | 0x1828 | ... |

enum esp_duplicate_scan_exceptional_list_type_t

Values:

ESP_BLE_DUPLICATE_SCAN_EXCEPTIONAL_ADDR_LIST = BLE_BIT(0)

duplicate scan exceptional addr list

ESP_BLE_DUPLICATE_SCAN_EXCEPTIONAL_MESH_LINK_ID_LIST = BLE_BIT(1)

duplicate scan exceptional mesh link ID list

ESP_BLE_DUPLICATE_SCAN_EXCEPTIONAL_MESH_BEACON_TYPE_LIST = BLE_BIT(2)

duplicate scan exceptional mesh beacon type list

ESP_BLE_DUPLICATE_SCAN_EXCEPTIONAL_MESH_PROV_SRV_ADV_LIST = BLE_BIT(3)

duplicate scan exceptional mesh adv with provisioning service uuid

ESP_BLE_DUPLICATE_SCAN_EXCEPTIONAL_MESH_PROXY_SRV_ADV_LIST = BLE_BIT(4)

duplicate scan exceptional mesh adv with provisioning service uuid

ESP_BLE_DUPLICATE_SCAN_EXCEPTIONAL_ALL_LIST = 0xFFFF

duplicate scan exceptional all list

GATT DEFINES

API Reference

Header File

- [bt/host/bluedroid/api/include/api/esp_gatt_defs.h](#)

Unions

union esp_gatt_rsp_t

#include <esp_gatt_defs.h> GATT remote read request response type.

Public Members

esp_gatt_value_t attr_value

Gatt attribute structure

uint16_t **handle**

Gatt attribute handle

Structures

struct esp_gatt_id_t

Gatt id, include uuid and instance id.

Public Members

esp_bt_uuid_t uuid

UUID

uint8_t **inst_id**

Instance id

struct esp_gatt_srvc_id_t

Gatt service id, include id (uuid and instance id) and primary flag.

Public Members*esp_gatt_id_t* **id**

Gatt id, include uuid and instance

bool **is_primary**

This service is primary or not

struct esp_attr_desc_t

Attribute description (used to create database)

Public Membersuint16_t **uuid_length**

UUID length

uint8_t ***uuid_p**

UUID value

uint16_t **perm**

Attribute permission

uint16_t **max_length**

Maximum length of the element

uint16_t **length**

Current length of the element

uint8_t ***value**

Element value array

struct esp_attr_control_t

attribute auto response flag

Public Membersuint8_t **auto_rsp**

if auto_rsp set to ESP_GATT_RSP_BY_APP, means the response of Write/Read operation will be replied by application. if auto_rsp set to ESP_GATT_AUTO_RSP, means the response of Write/Read operation will be replied by GATT stack automatically.

struct esp_gatts_attr_db_t

attribute type added to the gatt server database

Public Members*esp_attr_control_t* **attr_control**

The attribute control type

esp_attr_desc_t **att_desc**

The attribute type

struct esp_attr_value_t

set the attribute value type

Public Members

`uint16_t attr_max_len`
attribute max value length

`uint16_t attr_len`
attribute current value length

`uint8_t *attr_value`
the pointer to attribute value

struct esp_gatts_incl_svc_desc_t
Gatt include service entry element.

Public Members

`uint16_t start_hdl`
Gatt start handle value of included service

`uint16_t end_hdl`
Gatt end handle value of included service

`uint16_t uuid`
Gatt attribute value UUID of included service

struct esp_gatts_incl128_svc_desc_t
Gatt include 128 bit service entry element.

Public Members

`uint16_t start_hdl`
Gatt start handle value of included 128 bit service

`uint16_t end_hdl`
Gatt end handle value of included 128 bit service

struct esp_gatt_value_t
Gatt attribute value.

Public Members

`uint8_t value[ESP_GATT_MAX_ATTR_LEN]`
Gatt attribute value

`uint16_t handle`
Gatt attribute handle

`uint16_t offset`
Gatt attribute value offset

`uint16_t len`
Gatt attribute value length

`uint8_t auth_req`
Gatt authentication request

struct esp_gatt_conn_params_t
Connection parameters information.

Public Members

uint16_t interval
connection interval

uint16_t latency
Slave latency for the connection in number of connection events. Range: 0x0000 to 0x01F3

uint16_t timeout
Supervision timeout for the LE Link. Range: 0x000A to 0x0C80. Mandatory Range: 0x000A to 0x0C80
Time = N * 10 msec Time Range: 100 msec to 32 seconds

struct esp_gattc_multi_t
read multiple attribute

Public Members

uint8_t num_attr
The number of the attribute

uint16_t handles[ESP_GATT_MAX_READ_MULTI_HANDLES]
The handles list

struct esp_gattc_db_elem_t
data base attribute element

Public Members

esp_gatt_db_attr_type_t **type**
The attribute type

uint16_t attribute_handle
The attribute handle, it' s valid for all of the type

uint16_t start_handle
The service start handle, it' s valid only when the type = ESP_GATT_DB_PRIMARY_SERVICE or
ESP_GATT_DB_SECONDARY_SERVICE

uint16_t end_handle
The service end handle, it' s valid only when the type = ESP_GATT_DB_PRIMARY_SERVICE or
ESP_GATT_DB_SECONDARY_SERVICE

esp_gatt_char_prop_t **properties**
The characteristic properties, it' s valid only when the type = ESP_GATT_DB_CHARACTERISTIC

esp_bt_uuid_t **uuid**
The attribute uuid, it' s valid for all of the type

struct esp_gattc_service_elem_t
service element

Public Members

bool **is_primary**
The service flag, true if the service is primary service, else is secondary service

uint16_t start_handle
The start handle of the service

uint16_t end_handle
The end handle of the service

esp_bt_uuid_t **uuid**

The uuid of the service

struct esp_gattc_char_elem_t
characteristic element

Public Members

uint16_t **char_handle**

The characteristic handle

esp_gatt_char_prop_t **properties**

The characteristic properties

esp_bt_uuid_t **uuid**

The characteristic uuid

struct esp_gattc_descr_elem_t
descriptor element

Public Members

uint16_t **handle**

The characteristic descriptor handle

esp_bt_uuid_t **uuid**

The characteristic descriptor uuid

struct esp_gattc_incl_svc_elem_t
include service element

Public Members

uint16_t **handle**

The include service current attribute handle

uint16_t **incl_srvc_s_handle**

The start handle of the service which has been included

uint16_t **incl_srvc_e_handle**

The end handle of the service which has been included

esp_bt_uuid_t **uuid**

The include service uuid

Macros

ESP_GATT_UUID_IMMEDIATE_ALERT_SVC

All “ESP_GATT_UUID_XXX” is attribute types

ESP_GATT_UUID_LINK_LOSS_SVC

ESP_GATT_UUID_TX_POWER_SVC

ESP_GATT_UUID_CURRENT_TIME_SVC

ESP_GATT_UUID_REF_TIME_UPDATE_SVC

ESP_GATT_UUID_NEXT_DST_CHANGE_SVC

ESP_GATT_UUID_GLUKOSE_SVC

ESP_GATT_UUID_HEALTH_THERMOM_SVC

ESP_GATT_UUID_DEVICE_INFO_SVC

ESP_GATT_UUID_HEART_RATE_SVC
ESP_GATT_UUID_PHONE_ALERT_STATUS_SVC
ESP_GATT_UUID_BATTERY_SERVICE_SVC
ESP_GATT_UUID_BLOOD_PRESSURE_SVC
ESP_GATT_UUID_ALERT_NTF_SVC
ESP_GATT_UUID_HID_SVC
ESP_GATT_UUID_SCAN_PARAMETERS_SVC
ESP_GATT_UUID_RUNNING_SPEED_CADENCE_SVC
ESP_GATT_UUID_Automation_IO_SVC
ESP_GATT_UUID_CYCLING_SPEED_CADENCE_SVC
ESP_GATT_UUID_CYCLING_POWER_SVC
ESP_GATT_UUID_LOCATION_AND_NAVIGATION_SVC
ESP_GATT_UUID_ENVIRONMENTAL_SENSING_SVC
ESP_GATT_UUID_BODY_COMPOSITION
ESP_GATT_UUID_USER_DATA_SVC
ESP_GATT_UUID_WEIGHT_SCALE_SVC
ESP_GATT_UUID_BOND_MANAGEMENT_SVC
ESP_GATT_UUID_CONT_GLUCOSE_MONITOR_SVC
ESP_GATT_UUID_PRI_SERVICE
ESP_GATT_UUID_SEC_SERVICE
ESP_GATT_UUID_INCLUDE_SERVICE
ESP_GATT_UUID_CHAR_DECLARE
ESP_GATT_UUID_CHAR_EXT_PROP
ESP_GATT_UUID_CHAR_DESCRIPTION
ESP_GATT_UUID_CHAR_CLIENT_CONFIG
ESP_GATT_UUID_CHAR_SRVR_CONFIG
ESP_GATT_UUID_CHAR_PRESENT_FORMAT
ESP_GATT_UUID_CHAR_AGG_FORMAT
ESP_GATT_UUID_CHAR_VALID_RANGE
ESP_GATT_UUID_EXT_RPT_REF_DESCR
ESP_GATT_UUID_RPT_REF_DESCR
ESP_GATT_UUID_NUM_DIGITALS_DESCR
ESP_GATT_UUID_VALUE_TRIGGER_DESCR
ESP_GATT_UUID_ENV_SENSING_CONFIG_DESCR
ESP_GATT_UUID_ENV_SENSING_MEASUREMENT_DESCR
ESP_GATT_UUID_ENV_SENSING_TRIGGER_DESCR
ESP_GATT_UUID_TIME_TRIGGER_DESCR
ESP_GATT_UUID_GAP_DEVICE_NAME
ESP_GATT_UUID_GAP_ICON

ESP_GATT_UUID_GAP_PREF_CONN_PARAM
ESP_GATT_UUID_GAP_CENTRAL_ADDR_RESOL
ESP_GATT_UUID_GATT_SRV_CHGD
ESP_GATT_UUID_ALERT_LEVEL
ESP_GATT_UUID_TX_POWER_LEVEL
ESP_GATT_UUID_CURRENT_TIME
ESP_GATT_UUID_LOCAL_TIME_INFO
ESP_GATT_UUID_REF_TIME_INFO
ESP_GATT_UUID_NW_STATUS
ESP_GATT_UUID_NW_TRIGGER
ESP_GATT_UUID_ALERT_STATUS
ESP_GATT_UUID_RINGER_CP
ESP_GATT_UUID_RINGER_SETTING
ESP_GATT_UUID_GM_MEASUREMENT
ESP_GATT_UUID_GM_CONTEXT
ESP_GATT_UUID_GM_CONTROL_POINT
ESP_GATT_UUID_GM_FEATURE
ESP_GATT_UUID_SYSTEM_ID
ESP_GATT_UUID_MODEL_NUMBER_STR
ESP_GATT_UUID_SERIAL_NUMBER_STR
ESP_GATT_UUID_FW_VERSION_STR
ESP_GATT_UUID_HW_VERSION_STR
ESP_GATT_UUID_SW_VERSION_STR
ESP_GATT_UUID_MANU_NAME
ESP_GATT_UUID_IEEE_DATA
ESP_GATT_UUID_PNP_ID
ESP_GATT_UUID_HID_INFORMATION
ESP_GATT_UUID_HID_REPORT_MAP
ESP_GATT_UUID_HID_CONTROL_POINT
ESP_GATT_UUID_HID_REPORT
ESP_GATT_UUID_HID_PROTO_MODE
ESP_GATT_UUID_HID_BT_KB_INPUT
ESP_GATT_UUID_HID_BT_KB_OUTPUT
ESP_GATT_UUID_HID_BT_MOUSE_INPUT
ESP_GATT_HEART_RATE_MEAS
 Heart Rate Measurement.
ESP_GATT_BODY_SENSOR_LOCATION
 Body Sensor Location.
ESP_GATT_HEART_RATE_CNTL_POINT
 Heart Rate Control Point.

ESP_GATT_UUID_BATTERY_LEVEL
ESP_GATT_UUID_SC_CONTROL_POINT
ESP_GATT_UUID_SENSOR_LOCATION
ESP_GATT_UUID_RSC_MEASUREMENT
ESP_GATT_UUID_RSC_FEATURE
ESP_GATT_UUID_CSC_MEASUREMENT
ESP_GATT_UUID_CSC_FEATURE
ESP_GATT_UUID_SCAN_INT_WINDOW
ESP_GATT_UUID_SCAN_REFRESH
ESP_GATT_ILLEGAL_UUID
GATT INVALID UUID.
ESP_GATT_ILLEGAL_HANDLE
GATT INVALID HANDLE.
ESP_GATT_ATTR_HANDLE_MAX
GATT attribute max handle.
ESP_GATT_MAX_READ_MULTI_HANDLES
ESP_GATT_PERM_READ
Attribute permissions.
ESP_GATT_PERM_READ_ENCRYPTED
ESP_GATT_PERM_READ_ENC_MITM
ESP_GATT_PERM_WRITE
ESP_GATT_PERM_WRITE_ENCRYPTED
ESP_GATT_PERM_WRITE_ENC_MITM
ESP_GATT_PERM_WRITE_SIGNED
ESP_GATT_PERM_WRITE_SIGNED_MITM
ESP_GATT_PERM_READ_AUTHORIZATION
ESP_GATT_PERM_WRITE_AUTHORIZATION
ESP_GATT_CHAR_PROP_BIT_BROADCAST
ESP_GATT_CHAR_PROP_BIT_READ
ESP_GATT_CHAR_PROP_BIT_WRITE_NR
ESP_GATT_CHAR_PROP_BIT_WRITE
ESP_GATT_CHAR_PROP_BIT_NOTIFY
ESP_GATT_CHAR_PROP_BIT_INDICATE
ESP_GATT_CHAR_PROP_BIT_AUTH
ESP_GATT_CHAR_PROP_BIT_EXT_PROP
ESP_GATT_MAX_ATTR_LEN
GATT maximum attribute length.
ESP_GATT_RSP_BY_APP
ESP_GATT_AUTO_RSP
ESP_GATT_IF_NONE

If callback report `gattc_if/gatts_if` as this macro, means this event is not correspond to any app

Type Definitions

```
typedef uint16_t esp_gatt_perm_t
```

```
typedef uint8_t esp_gatt_char_prop_t
```

```
typedef uint8_t esp_gatt_if_t
```

Gatt interface type, different application on GATT client use different gatt_if

Enumerations

```
enum esp_gatt_prep_write_type
```

Attribute write data type from the client.

Values:

```
ESP_GATT_PREP_WRITE_CANCEL = 0x00
```

Prepare write cancel

```
ESP_GATT_PREP_WRITE_EXEC = 0x01
```

Prepare write execute

```
enum esp_gatt_status_t
```

GATT success code and error codes.

Values:

```
ESP_GATT_OK = 0x0
```

```
ESP_GATT_INVALID_HANDLE = 0x01
```

```
ESP_GATT_READ_NOT_PERMIT = 0x02
```

```
ESP_GATT_WRITE_NOT_PERMIT = 0x03
```

```
ESP_GATT_INVALID_PDU = 0x04
```

```
ESP_GATT_INSUF_AUTHENTICATION = 0x05
```

```
ESP_GATT_REQ_NOT_SUPPORTED = 0x06
```

```
ESP_GATT_INVALID_OFFSET = 0x07
```

```
ESP_GATT_INSUF_AUTHORIZATION = 0x08
```

```
ESP_GATT_PREPARE_Q_FULL = 0x09
```

```
ESP_GATT_NOT_FOUND = 0x0a
```

```
ESP_GATT_NOT_LONG = 0x0b
```

```
ESP_GATT_INSUF_KEY_SIZE = 0x0c
```

```
ESP_GATT_INVALID_ATTR_LEN = 0x0d
```

```
ESP_GATT_ERR_UNLIKELY = 0x0e
```

```
ESP_GATT_INSUF_ENCRYPTION = 0x0f
```

```
ESP_GATT_UNSUPPORT_GRP_TYPE = 0x10
```

```
ESP_GATT_INSUF_RESOURCE = 0x11
```

```
ESP_GATT_NO_RESOURCES = 0x80
```

```
ESP_GATT_INTERNAL_ERROR = 0x81
```

```
ESP_GATT_WRONG_STATE = 0x82
```

```
ESP_GATT_DB_FULL = 0x83
```

```
ESP_GATT_BUSY = 0x84
```

```
ESP_GATT_ERROR = 0x85
```

```
ESP_GATT_CMD_STARTED = 0x86
```

ESP_GATT_ILLEGAL_PARAMETER = 0x87
ESP_GATT_PENDING = 0x88
ESP_GATT_AUTH_FAIL = 0x89
ESP_GATT_MORE = 0x8a
ESP_GATT_INVALID_CFG = 0x8b
ESP_GATT_SERVICE_STARTED = 0x8c
ESP_GATT_ENCRYPED_MITM = [ESP_GATT_OK](#)
ESP_GATT_ENCRYPED_NO_MITM = 0x8d
ESP_GATT_NOT_ENCRYPTED = 0x8e
ESP_GATT_CONGESTED = 0x8f
ESP_GATT_DUP_REG = 0x90
ESP_GATT_ALREADY_OPEN = 0x91
ESP_GATT_CANCEL = 0x92
ESP_GATT_STACK_RSP = 0xe0
ESP_GATT_APP_RSP = 0xe1
ESP_GATT_UNKNOWN_ERROR = 0xef
ESP_GATT_CCC_CFG_ERR = 0xfd
ESP_GATT_PRC_IN_PROGRESS = 0xfe
ESP_GATT_OUT_OF_RANGE = 0xff

enum esp_gatt_conn_reason_t

Gatt Connection reason enum.

Values:

ESP_GATT_CONN_UNKNOWN = 0
Gatt connection unknown

ESP_GATT_CONN_L2C_FAILURE = 1
General L2cap failure

ESP_GATT_CONN_TIMEOUT = 0x08
Connection timeout

ESP_GATT_CONN_TERMINATE_PEER_USER = 0x13
Connection terminate by peer user

ESP_GATT_CONN_TERMINATE_LOCAL_HOST = 0x16
Connection terminated by local host

ESP_GATT_CONN_FAIL_ESTABLISH = 0x3e
Connection fail to establish

ESP_GATT_CONN_LMP_TIMEOUT = 0x22
Connection fail for LMP response tout

ESP_GATT_CONN_CONN_CANCEL = 0x0100
L2CAP connection cancelled

ESP_GATT_CONN_NONE = 0x0101
No connection to cancel

enum esp_gatt_auth_req_t

Gatt authentication request type.

Values:

```
ESP_GATT_AUTH_REQ_NONE = 0
ESP_GATT_AUTH_REQ_NO_MITM = 1
ESP_GATT_AUTH_REQ_MITM = 2
ESP_GATT_AUTH_REQ_SIGNED_NO_MITM = 3
ESP_GATT_AUTH_REQ_SIGNED_MITM = 4
```

```
enum esp_service_source_t
```

Values:

```
ESP_GATT_SERVICE_FROM_REMOTE_DEVICE = 0
ESP_GATT_SERVICE_FROM_NVS_FLASH = 1
ESP_GATT_SERVICE_FROM_UNKNOWN = 2
```

```
enum esp_gatt_write_type_t
```

Gatt write type.

Values:

```
ESP_GATT_WRITE_TYPE_NO_RSP = 1
    Gatt write attribute need no response
ESP_GATT_WRITE_TYPE_RSP
    Gatt write attribute need remote response
```

```
enum esp_gatt_db_attr_type_t
```

the type of attribute element

Values:

```
ESP_GATT_DB_PRIMARY_SERVICE
    Gattc primary service attribute type in the cache
ESP_GATT_DB_SECONDARY_SERVICE
    Gattc secondary service attribute type in the cache
ESP_GATT_DB_CHARACTERISTIC
    Gattc characteristic attribute type in the cache
ESP_GATT_DB_DESCRIPTOR
    Gattc characteristic descriptor attribute type in the cache
ESP_GATT_DB_INCLUDED_SERVICE
    Gattc include service attribute type in the cache
ESP_GATT_DB_ALL
    Gattc all the attribute (primary service & secondary service & include service & char & descriptor) type
    in the cache
```

GATT SERVER API

Application Example Check [bluetooth/bluedroid/ble](#) folder in ESP-IDF examples, which contains the following demos and their tutorials:

- This is a GATT sever demo and its tutorial. This demo creates a GATT service with an attribute table, which releases the user from adding attributes one by one. This is the recommended method of adding attributes.
 - [bluetooth/bluedroid/ble/gatt_server_service_table](#)
 - [GATT Server Service Table Example Walkthrough](#)
- This is a GATT server demo and its tutorial. This demo creates a GATT service by adding attributes one by one as defined by Bluedroid. The recommended method of adding attributes is presented in example above.
 - [bluetooth/bluedroid/ble/gatt_server](#)
 - [GATT Server Example Walkthrough](#)

- This is a BLE SPP-Like demo. This demo, which acts as a GATT server, can receive data from UART and then send the data to the peer device automatically.
 - [bluetooth/bluedroid/ble/ble_spp_server](#)

API Reference

Header File

- [bt/host/bluedroid/api/include/api/esp_gatts_api.h](#)

Functions

esp_err_t **esp_ble_gatts_register_callback** (*esp_gatts_cb_t* callback)

This function is called to register application callbacks with BTA GATTS module.

Return

- ESP_OK : success
- other : failed

esp_err_t **esp_ble_gatts_app_register** (uint16_t app_id)

This function is called to register application identifier.

Return

- ESP_OK : success
- other : failed

esp_err_t **esp_ble_gatts_app_unregister** (*esp_gatt_if_t* gatts_if)

unregister with GATT Server.

Return

- ESP_OK : success
- other : failed

Parameters

- [in] gatts_if: GATT server access interface

esp_err_t **esp_ble_gatts_create_service** (*esp_gatt_if_t* gatts_if, *esp_gatt_srvc_id_t* *service_id, uint16_t num_handle)

Create a service. When service creation is done, a callback event ESP_GATTS_CREATE_EVT is called to report status and service ID to the profile. The service ID obtained in the callback function needs to be used when adding included service and characteristics/descriptors into the service.

Return

- ESP_OK : success
- other : failed

Parameters

- [in] gatts_if: GATT server access interface
- [in] service_id: service ID.
- [in] num_handle: number of handle requested for this service.

esp_err_t **esp_ble_gatts_create_attr_tab** (const *esp_gatts_attr_db_t* *gatts_attr_db, *esp_gatt_if_t* gatts_if, uint8_t max_nb_attr, uint8_t srvc_inst_id)

Create a service attribute tab.

Return

- ESP_OK : success
- other : failed

Parameters

- [in] gatts_attr_db: the pointer to the service attr tab
- [in] gatts_if: GATT server access interface
- [in] max_nb_attr: the number of attribute to be added to the service database.
- [in] srvc_inst_id: the instance id of the service

esp_err_t **esp_ble_gatts_add_included_service**(uint16_t *service_handle*, uint16_t *included_service_handle*)

This function is called to add an included service. This function have to be called between 'esp_ble_gatts_create_service' and 'esp_ble_gatts_add_char'. After included service is included, a callback event ESP_GATTS_ADD_INCL_SRVC_EVT is reported the included service ID.

Return

- ESP_OK : success
- other : failed

Parameters

- [in] *service_handle*: service handle to which this included service is to be added.
- [in] *included_service_handle*: the service ID to be included.

esp_err_t **esp_ble_gatts_add_char**(uint16_t *service_handle*, *esp_bt_uuid_t* **char_uuid*, *esp_gatt_perm_t* *perm*, *esp_gatt_char_prop_t* *property*, *esp_attr_value_t* **char_val*, *esp_attr_control_t* **control*)

This function is called to add a characteristic into a service.

Return

- ESP_OK : success
- other : failed

Parameters

- [in] *service_handle*: service handle to which this included service is to be added.
- [in] *char_uuid*: : Characteristic UUID.
- [in] *perm*: : Characteristic value declaration attribute permission.
- [in] *property*: : Characteristic Properties
- [in] *char_val*: : Characteristic value
- [in] *control*: : attribute response control byte

esp_err_t **esp_ble_gatts_add_char_descr**(uint16_t *service_handle*, *esp_bt_uuid_t* **descr_uuid*, *esp_gatt_perm_t* *perm*, *esp_attr_value_t* **char_descr_val*, *esp_attr_control_t* **control*)

This function is called to add characteristic descriptor. When it's done, a callback event ESP_GATTS_ADD_DESCR_EVT is called to report the status and an ID number for this descriptor.

Return

- ESP_OK : success
- other : failed

Parameters

- [in] *service_handle*: service handle to which this characteristic descriptor is to be added.
- [in] *perm*: descriptor access permission.
- [in] *descr_uuid*: descriptor UUID.
- [in] *char_descr_val*: : Characteristic descriptor value
- [in] *control*: : attribute response control byte

esp_err_t **esp_ble_gatts_delete_service**(uint16_t *service_handle*)

This function is called to delete a service. When this is done, a callback event ESP_GATTS_DELETE_EVT is report with the status.

Return

- ESP_OK : success
- other : failed

Parameters

- [in] *service_handle*: service_handle to be deleted.

esp_err_t **esp_ble_gatts_start_service**(uint16_t *service_handle*)

This function is called to start a service.

Return

- ESP_OK : success
- other : failed

Parameters

- [in] *service_handle*: the service handle to be started.

esp_err_t **esp_ble_gatts_stop_service** (uint16_t *service_handle*)

This function is called to stop a service.

Return

- ESP_OK : success
- other : failed

Parameters

- [in] *service_handle*: - service to be topped.

esp_err_t **esp_ble_gatts_send_indicate** (*esp_gatt_if_t* *gatts_if*, uint16_t *conn_id*, uint16_t *attr_handle*, uint16_t *value_len*, uint8_t **value*, bool *need_confirm*)

Send indicate or notify to GATT client. Set param *need_confirm* as false will send notification, otherwise indication.

Return

- ESP_OK : success
- other : failed

Parameters

- [in] *gatts_if*: GATT server access interface
- [in] *conn_id*: - connection id to indicate.
- [in] *attr_handle*: - attribute handle to indicate.
- [in] *value_len*: - indicate value length.
- [in] *value*: value to indicate.
- [in] *need_confirm*: - Whether a confirmation is required. false sends a GATT notification, true sends a GATT indication.

esp_err_t **esp_ble_gatts_send_response** (*esp_gatt_if_t* *gatts_if*, uint16_t *conn_id*, uint32_t *trans_id*, *esp_gatt_status_t* *status*, *esp_gatt_rsp_t* **rsp*)

This function is called to send a response to a request.

Return

- ESP_OK : success
- other : failed

Parameters

- [in] *gatts_if*: GATT server access interface
- [in] *conn_id*: - connection identifier.
- [in] *trans_id*: - transfer id
- [in] *status*: - response status
- [in] *rsp*: - response data.

esp_err_t **esp_ble_gatts_set_attr_value** (uint16_t *attr_handle*, uint16_t *length*, const uint8_t **value*)

This function is called to set the attribute value by the application.

Return

- ESP_OK : success
- other : failed

Parameters

- [in] *attr_handle*: the attribute handle which to be set
- [in] *length*: the value length
- [in] *value*: the pointer to the attribute value

esp_gatt_status_t **esp_ble_gatts_get_attr_value** (uint16_t *attr_handle*, uint16_t **length*, const uint8_t ***value*)

Retrieve attribute value.

Return

- ESP_GATT_OK : success
- other : failed

Parameters

- [in] *attr_handle*: Attribute handle.
- [out] *length*: pointer to the attribute value length

- [out] value: Pointer to attribute value payload, the value cannot be modified by user

esp_err_t **esp_ble_gatts_open** (*esp_gatt_if_t* gatts_if, *esp_bd_addr_t* remote_bda, bool is_direct)

Open a direct open connection or add a background auto connection.

Return

- ESP_OK : success
- other : failed

Parameters

- [in] gatts_if: GATT server access interface
- [in] remote_bda: remote device bluetooth device address.
- [in] is_direct: direct connection or background auto connection

esp_err_t **esp_ble_gatts_close** (*esp_gatt_if_t* gatts_if, uint16_t conn_id)

Close a connection a remote device.

Return

- ESP_OK : success
- other : failed

Parameters

- [in] gatts_if: GATT server access interface
- [in] conn_id: connection ID to be closed.

esp_err_t **esp_ble_gatts_send_service_change_indication** (*esp_gatt_if_t* gatts_if, *esp_bd_addr_t* remote_bda)

Send service change indication.

Return

- ESP_OK : success
- other : failed

Parameters

- [in] gatts_if: GATT server access interface
- [in] remote_bda: remote device bluetooth device address. If remote_bda is NULL then it will send service change indication to all the connected devices and if not then to a specific device

Unions

union esp_ble_gatts_cb_param_t

#include <esp_gatts_api.h> Gatt server callback parameters union.

Public Members

struct esp_ble_gatts_cb_param_t::gatts_reg_evt_param reg

Gatt server callback param of ESP_GATTS_REG_EVT

struct esp_ble_gatts_cb_param_t::gatts_read_evt_param read

Gatt server callback param of ESP_GATTS_READ_EVT

struct esp_ble_gatts_cb_param_t::gatts_write_evt_param write

Gatt server callback param of ESP_GATTS_WRITE_EVT

struct esp_ble_gatts_cb_param_t::gatts_exec_write_evt_param exec_write

Gatt server callback param of ESP_GATTS_EXEC_WRITE_EVT

struct esp_ble_gatts_cb_param_t::gatts_mtu_evt_param mtu

Gatt server callback param of ESP_GATTS_MTU_EVT

struct esp_ble_gatts_cb_param_t::gatts_conf_evt_param conf

Gatt server callback param of ESP_GATTS_CONF_EVT (confirm)

struct esp_ble_gatts_cb_param_t::gatts_create_evt_param create

Gatt server callback param of ESP_GATTS_CREATE_EVT

```
struct esp_ble_gatts_cb_param_t::gatts_add_incl_srvc_evt_param add_incl_srvc  
    Gatt server callback param of ESP_GATTS_ADD_INCL_SRVC_EVT  
struct esp_ble_gatts_cb_param_t::gatts_add_char_evt_param add_char  
    Gatt server callback param of ESP_GATTS_ADD_CHAR_EVT  
struct esp_ble_gatts_cb_param_t::gatts_add_char_descr_evt_param add_char_descr  
    Gatt server callback param of ESP_GATTS_ADD_CHAR_DESCR_EVT  
struct esp_ble_gatts_cb_param_t::gatts_delete_evt_param del  
    Gatt server callback param of ESP_GATTS_DELETE_EVT  
struct esp_ble_gatts_cb_param_t::gatts_start_evt_param start  
    Gatt server callback param of ESP_GATTS_START_EVT  
struct esp_ble_gatts_cb_param_t::gatts_stop_evt_param stop  
    Gatt server callback param of ESP_GATTS_STOP_EVT  
struct esp_ble_gatts_cb_param_t::gatts_connect_evt_param connect  
    Gatt server callback param of ESP_GATTS_CONNECT_EVT  
struct esp_ble_gatts_cb_param_t::gatts_disconnect_evt_param disconnect  
    Gatt server callback param of ESP_GATTS_DISCONNECT_EVT  
struct esp_ble_gatts_cb_param_t::gatts_open_evt_param open  
    Gatt server callback param of ESP_GATTS_OPEN_EVT  
struct esp_ble_gatts_cb_param_t::gatts_cancel_open_evt_param cancel_open  
    Gatt server callback param of ESP_GATTS_CANCEL_OPEN_EVT  
struct esp_ble_gatts_cb_param_t::gatts_close_evt_param close  
    Gatt server callback param of ESP_GATTS_CLOSE_EVT  
struct esp_ble_gatts_cb_param_t::gatts_congest_evt_param congest  
    Gatt server callback param of ESP_GATTS_CONGEST_EVT  
struct esp_ble_gatts_cb_param_t::gatts_rsp_evt_param rsp  
    Gatt server callback param of ESP_GATTS_RESPONSE_EVT  
struct esp_ble_gatts_cb_param_t::gatts_add_attr_tab_evt_param add_attr_tab  
    Gatt server callback param of ESP_GATTS_CREAT_ATTR_TAB_EVT  
struct esp_ble_gatts_cb_param_t::gatts_set_attr_val_evt_param set_attr_val  
    Gatt server callback param of ESP_GATTS_SET_ATTR_VAL_EVT  
struct esp_ble_gatts_cb_param_t::gatts_send_service_change_evt_param service_change  
    Gatt server callback param of ESP_GATTS_SEND_SERVICE_CHANGE_EVT  
  
struct gatts_add_attr_tab_evt_param  
    #include <esp_gatts_api.h> ESP_GATTS_CREAT_ATTR_TAB_EVT.
```

Public Members

```
esp_gatt_status_t status  
    Operation status  
  
esp_bt_uuid_t svc_uuid  
    Service uuid type  
  
uint8_t svc_inst_id  
    Service id  
  
uint16_t num_handle  
    The number of the attribute handle to be added to the gatts database  
  
uint16_t *handles  
    The number to the handles
```

```
struct gatts_add_char_descr_evt_param  
#include <esp_gatts_api.h> ESP_GATTS_ADD_CHAR_DESCR_EVT.
```

Public Members

esp_gatt_status_t **status**
Operation status

uint16_t **attr_handle**
Descriptor attribute handle

uint16_t **service_handle**
Service attribute handle

esp_bt_uuid_t **descr_uuid**
Characteristic descriptor uuid

```
struct gatts_add_char_evt_param  
#include <esp_gatts_api.h> ESP_GATTS_ADD_CHAR_EVT.
```

Public Members

esp_gatt_status_t **status**
Operation status

uint16_t **attr_handle**
Characteristic attribute handle

uint16_t **service_handle**
Service attribute handle

esp_bt_uuid_t **char_uuid**
Characteristic uuid

```
struct gatts_add_incl_srvc_evt_param  
#include <esp_gatts_api.h> ESP_GATTS_ADD_INCL_SRVC_EVT.
```

Public Members

esp_gatt_status_t **status**
Operation status

uint16_t **attr_handle**
Included service attribute handle

uint16_t **service_handle**
Service attribute handle

```
struct gatts_cancel_open_evt_param  
#include <esp_gatts_api.h> ESP_GATTS_CANCEL_OPEN_EVT.
```

Public Members

esp_gatt_status_t **status**
Operation status

```
struct gatts_close_evt_param  
#include <esp_gatts_api.h> ESP_GATTS_CLOSE_EVT.
```

Public Members***esp_gatt_status_t* status**

Operation status

uint16_t conn_id

Connection id

struct gatts_conf_evt_param*#include <esp_gatts_api.h> ESP_GATTS_CONF_EVT.***Public Members*****esp_gatt_status_t* status**

Operation status

uint16_t conn_id

Connection id

uint16_t handle

attribute handle

uint16_t len

The indication or notification value length, len is valid when send notification or indication failed

uint8_t *value

The indication or notification value , value is valid when send notification or indication failed

struct gatts_congest_evt_param*#include <esp_gatts_api.h> ESP_GATTS_LISTEN_EVT.*

ESP_GATTS_CONGEST_EVT

Public Members**uint16_t conn_id**

Connection id

bool congested

Congested or not

struct gatts_connect_evt_param*#include <esp_gatts_api.h> ESP_GATTS_CONNECT_EVT.***Public Members****uint16_t conn_id**

Connection id

uint8_t link_role

Link role : master role = 0 ; slave role = 1

***esp_bd_addr_t* remote_bda**

Remote bluetooth device address

***esp_gatt_conn_params_t* conn_params**

current Connection parameters

struct gatts_create_evt_param*#include <esp_gatts_api.h> ESP_GATTS_UNREG_EVT.*

ESP_GATTS_CREATE_EVT

Public Members

esp_gatt_status_t **status**

Operation status

uint16_t **service_handle**

Service attribute handle

esp_gatt_srv_id_t **service_id**

Service id, include service uuid and other information

struct gatts_delete_evt_param

#include <esp_gatts_api.h> ESP_GATTS_DELETE_EVT.

Public Members

esp_gatt_status_t **status**

Operation status

uint16_t **service_handle**

Service attribute handle

struct gatts_disconnect_evt_param

#include <esp_gatts_api.h> ESP_GATTS_DISCONNECT_EVT.

Public Members

uint16_t **conn_id**

Connection id

esp_bd_addr_t **remote_bda**

Remote bluetooth device address

esp_gatt_conn_reason_t **reason**

Indicate the reason of disconnection

struct gatts_exec_write_evt_param

#include <esp_gatts_api.h> ESP_GATTS_EXEC_WRITE_EVT.

Public Members

uint16_t **conn_id**

Connection id

uint32_t **trans_id**

Transfer id

esp_bd_addr_t **bda**

The bluetooth device address which been written

uint8_t **exec_write_flag**

Execute write flag

struct gatts_mtu_evt_param

#include <esp_gatts_api.h> ESP_GATTS_MTU_EVT.

Public Members

`uint16_t conn_id`
Connection id

`uint16_t mtu`
MTU size

struct gatts_open_evt_param
#include <esp_gatts_api.h> ESP_GATTS_OPEN_EVT.

Public Members

esp_gatt_status_t **status**
Operation status

struct gatts_read_evt_param
#include <esp_gatts_api.h> ESP_GATTS_READ_EVT.

Public Members

`uint16_t conn_id`
Connection id

`uint32_t trans_id`
Transfer id

esp_bd_addr_t **bda**
The bluetooth device address which been read

`uint16_t handle`
The attribute handle

`uint16_t offset`
Offset of the value, if the value is too long

bool **is_long**
The value is too long or not

bool **need_rsp**
The read operation need to do response

struct gatts_reg_evt_param
#include <esp_gatts_api.h> ESP_GATTS_REG_EVT.

Public Members

esp_gatt_status_t **status**
Operation status

`uint16_t app_id`
Application id which input in register API

struct gatts_rsp_evt_param
#include <esp_gatts_api.h> ESP_GATTS_RESPONSE_EVT.

Public Members***esp_gatt_status_t* status**

Operation status

uint16_t handle

Attribute handle which send response

struct gatts_send_service_change_evt_param*#include <esp_gatts_api.h> ESP_GATTS_SEND_SERVICE_CHANGE_EVT.***Public Members*****esp_gatt_status_t* status**

Operation status

struct gatts_set_attr_val_evt_param*#include <esp_gatts_api.h> ESP_GATTS_SET_ATTR_VAL_EVT.***Public Members****uint16_t srvc_handle**

The service handle

uint16_t attr_handle

The attribute handle

***esp_gatt_status_t* status**

Operation status

struct gatts_start_evt_param*#include <esp_gatts_api.h> ESP_GATTS_START_EVT.***Public Members*****esp_gatt_status_t* status**

Operation status

uint16_t service_handle

Service attribute handle

struct gatts_stop_evt_param*#include <esp_gatts_api.h> ESP_GATTS_STOP_EVT.***Public Members*****esp_gatt_status_t* status**

Operation status

uint16_t service_handle

Service attribute handle

struct gatts_write_evt_param*#include <esp_gatts_api.h> ESP_GATTS_WRITE_EVT.*

Public Members

`uint16_t conn_id`
Connection id

`uint32_t trans_id`
Transfer id

`esp_bd_addr_t bda`
The bluetooth device address which been written

`uint16_t handle`
The attribute handle

`uint16_t offset`
Offset of the value, if the value is too long

`bool need_rsp`
The write operation need to do response

`bool is_prep`
This write operation is prepare write

`uint16_t len`
The write attribute value length

`uint8_t *value`
The write attribute value

Macros

`ESP_GATT_PREP_WRITE_CANCEL`
Prepare write flag to indicate cancel prepare write

`ESP_GATT_PREP_WRITE_EXEC`
Prepare write flag to indicate execute prepare write

Type Definitions

```
typedef void (*esp_gatts_cb_t)(esp_gatts_cb_event_t event, esp_gatt_if_t gatts_if,
                             esp_ble_gatts_cb_param_t *param)
```

GATT Server callback function type.

Parameters

- `event`: : Event type
- `gatts_if`: : GATT server access interface, normally different `gatts_if` correspond to different profile
- `param`: : Point to callback parameter, currently is union type

Enumerations

```
enum esp_gatts_cb_event_t
```

GATT Server callback function events.

Values:

`ESP_GATTS_REG_EVT = 0`
When register application id, the event comes

`ESP_GATTS_READ_EVT = 1`
When gatt client request read operation, the event comes

`ESP_GATTS_WRITE_EVT = 2`
When gatt client request write operation, the event comes

`ESP_GATTS_EXEC_WRITE_EVT = 3`
When gatt client request execute write, the event comes

- ESP_GATTS_MTU_EVT = 4**
When set mtu complete, the event comes
- ESP_GATTS_CONF_EVT = 5**
When receive confirm, the event comes
- ESP_GATTS_UNREG_EVT = 6**
When unregister application id, the event comes
- ESP_GATTS_CREATE_EVT = 7**
When create service complete, the event comes
- ESP_GATTS_ADD_INCL_SRVC_EVT = 8**
When add included service complete, the event comes
- ESP_GATTS_ADD_CHAR_EVT = 9**
When add characteristic complete, the event comes
- ESP_GATTS_ADD_CHAR_DESCR_EVT = 10**
When add descriptor complete, the event comes
- ESP_GATTS_DELETE_EVT = 11**
When delete service complete, the event comes
- ESP_GATTS_START_EVT = 12**
When start service complete, the event comes
- ESP_GATTS_STOP_EVT = 13**
When stop service complete, the event comes
- ESP_GATTS_CONNECT_EVT = 14**
When gatt client connect, the event comes
- ESP_GATTS_DISCONNECT_EVT = 15**
When gatt client disconnect, the event comes
- ESP_GATTS_OPEN_EVT = 16**
When connect to peer, the event comes
- ESP_GATTS_CANCEL_OPEN_EVT = 17**
When disconnect from peer, the event comes
- ESP_GATTS_CLOSE_EVT = 18**
When gatt server close, the event comes
- ESP_GATTS_LISTEN_EVT = 19**
When gatt listen to be connected the event comes
- ESP_GATTS_CONGEST_EVT = 20**
When congest happen, the event comes
- ESP_GATTS_RESPONSE_EVT = 21**
When gatt send response complete, the event comes
- ESP_GATTS_CREAT_ATTR_TAB_EVT = 22**
When gatt create table complete, the event comes
- ESP_GATTS_SET_ATTR_VAL_EVT = 23**
When gatt set attr value complete, the event comes
- ESP_GATTS_SEND_SERVICE_CHANGE_EVT = 24**
When gatt send service change indication complete, the event comes

GATT CLIENT API

Application Example Check [bluetooth/bluedroid/ble](#) folder in ESP-IDF examples, which contains the following demos and their tutorials:

- This is a GATT client demo and its tutorial. This demo can scan for devices, connect to the GATT server and discover its services.
 - [bluetooth/bluedroid/ble/gatt_client](#)
 - [GATT Client Example Walkthrough](#)
- This is a multiple connection demo and its tutorial. This demo can connect to multiple GATT server devices and discover their services.
 - [bluetooth/bluedroid/ble/gattc_multi_connect](#)
 - [GATT Client Multi-connection Example Walkthrough](#)
- This is a BLE SPP-Like demo. This demo, which acts as a GATT client, can receive data from UART and then send the data to the peer device automatically.
 - [bluetooth/bluedroid/ble/ble_spp_client](#)

API Reference

Header File

- [bt/host/bluedroid/api/include/api/esp_gattc_api.h](#)

Functions

esp_err_t **esp_ble_gattc_register_callback** (*esp_gattc_cb_t* callback)

This function is called to register application callbacks with GATTC module.

Return

- ESP_OK: success
- other: failed

Parameters

- [in] callback: : pointer to the application callback function.

esp_err_t **esp_ble_gattc_app_register** (uint16_t app_id)

This function is called to register application callbacks with GATTC module.

Return

- ESP_OK: success
- other: failed

Parameters

- [in] app_id: : Application Identify (UUID), for different application

esp_err_t **esp_ble_gattc_app_unregister** (*esp_gatt_if_t* gattc_if)

This function is called to unregister an application from GATTC module.

Return

- ESP_OK: success
- other: failed

Parameters

- [in] gattc_if: Gatt client access interface.

esp_err_t **esp_ble_gattc_open** (*esp_gatt_if_t* gattc_if, *esp_bd_addr_t* remote_bda, *esp_ble_addr_type_t* remote_addr_type, bool is_direct)

Open a direct connection or add a background auto connection.

Return

- ESP_OK: success
- other: failed

Parameters

- [in] gattc_if: Gatt client access interface.
- [in] remote_bda: remote device bluetooth device address.
- [in] remote_addr_type: remote device bluetooth device the address type.
- [in] is_direct: direct connection or background auto connection (by now, background auto connection is not supported).

esp_err_t **esp_ble_gattc_aux_open** (*esp_gatt_if_t* gattc_if, *esp_bd_addr_t* remote_bda, *esp_ble_addr_type_t* remote_addr_type, bool is_direct)

esp_err_t **esp_ble_gattc_close** (*esp_gatt_if_t* gattc_if, uint16_t conn_id)

Close the virtual connection to the GATT server. gattc may have multiple virtual GATT server connections when multiple app_id registered, this API only close one virtual GATT server connection. if there exist other virtual GATT server connections, it does not disconnect the physical connection. if you want to disconnect the physical connection directly, you can use esp_ble_gap_disconnect(esp_bd_addr_t remote_device).

Return

- ESP_OK: success
- other: failed

Parameters

- [in] gattc_if: Gatt client access interface.
- [in] conn_id: connection ID to be closed.

esp_err_t **esp_ble_gattc_send_mtu_req** (*esp_gatt_if_t* gattc_if, uint16_t conn_id)

Configure the MTU size in the GATT channel. This can be done only once per connection. Before using, use esp_ble_gattc_set_local_mtu() to configure the local MTU size.

Return

- ESP_OK: success
- other: failed

Parameters

- [in] gattc_if: Gatt client access interface.
- [in] conn_id: connection ID.

esp_err_t **esp_ble_gattc_search_service** (*esp_gatt_if_t* gattc_if, uint16_t conn_id, *esp_bt_uuid_t* *filter_uuid)

This function is called to get service from local cache. This function report service search result by a callback event, and followed by a service search complete event.

Return

- ESP_OK: success
- other: failed

Parameters

- [in] gattc_if: Gatt client access interface.
- [in] conn_id: connection ID.
- [in] filter_uuid: a UUID of the service application is interested in. If Null, discover for all services.

esp_gatt_status_t **esp_ble_gattc_get_service** (*esp_gatt_if_t* gattc_if, uint16_t conn_id, *esp_bt_uuid_t* *svc_uuid, *esp_gattc_service_elem_t* *result, uint16_t *count, uint16_t offset)

Find all the service with the given service uuid in the gattc cache, if the svc_uuid is NULL, find all the service. Note: It just get service from local cache, won't get from remote devices. If want to get it from remote device, need to used the esp_ble_gattc_cache_refresh, then call esp_ble_gattc_get_service again.

Return

- ESP_OK: success
- other: failed

Parameters

- [in] gattc_if: Gatt client access interface.
- [in] conn_id: connection ID which identify the server.
- [in] svc_uuid: the pointer to the service uuid.
- [out] result: The pointer to the service which has been found in the gattc cache.
- [inout] count: input the number of service want to find, it will output the number of service has been found in the gattc cache with the given service uuid.
- [in] offset: Offset of the service position to get.

```
esp_gatt_status_t esp_ble_gattc_get_all_char(esp_gatt_if_t gattc_if, uint16_t conn_id,
uint16_t start_handle, uint16_t end_handle,
esp_gattc_char_elem_t *result, uint16_t *count,
uint16_t offset)
```

Find all the characteristic with the given service in the gattc cache Note: It just get characteristic from local cache, won't get from remote devices.

Return

- ESP_OK: success
- other: failed

Parameters

- [in] gattc_if: Gatt client access interface.
- [in] conn_id: connection ID which identify the server.
- [in] start_handle: the attribute start handle.
- [in] end_handle: the attribute end handle
- [out] result: The pointer to the characteristic in the service.
- [inout] count: input the number of characteristic want to find, it will output the number of characteristic has been found in the gattc cache with the given service.
- [in] offset: Offset of the characteristic position to get.

```
esp_gatt_status_t esp_ble_gattc_get_all_descr(esp_gatt_if_t gattc_if, uint16_t conn_id, uint16_t
char_handle, esp_gattc_descr_elem_t *result,
uint16_t *count, uint16_t offset)
```

Find all the descriptor with the given characteristic in the gattc cache Note: It just get descriptor from local cache, won't get from remote devices.

Return

- ESP_OK: success
- other: failed

Parameters

- [in] gattc_if: Gatt client access interface.
- [in] conn_id: connection ID which identify the server.
- [in] char_handle: the given characteristic handle
- [out] result: The pointer to the descriptor in the characteristic.
- [inout] count: input the number of descriptor want to find, it will output the number of descriptor has been found in the gattc cache with the given characteristic.
- [in] offset: Offset of the descriptor position to get.

```
esp_gatt_status_t esp_ble_gattc_get_char_by_uuid(esp_gatt_if_t gattc_if, uint16_t conn_id,
uint16_t start_handle, uint16_t
end_handle, esp_bt_uuid_t char_uuid,
esp_gattc_char_elem_t *result, uint16_t
*count)
```

Find the characteristic with the given characteristic uuid in the gattc cache Note: It just get characteristic from local cache, won't get from remote devices.

Return

- ESP_OK: success
- other: failed

Parameters

- [in] gattc_if: Gatt client access interface.
- [in] conn_id: connection ID which identify the server.
- [in] start_handle: the attribute start handle
- [in] end_handle: the attribute end handle
- [in] char_uuid: the characteristic uuid
- [out] result: The pointer to the characteristic in the service.
- [inout] count: input the number of characteristic want to find, it will output the number of characteristic has been found in the gattc cache with the given service.

```
esp_gatt_status_t esp_ble_gattc_get_descr_by_uuid (esp_gatt_if_t gattc_if, uint16_t conn_id, uint16_t start_handle, uint16_t end_handle, esp_bt_uuid_t char_uuid, esp_bt_uuid_t descr_uuid, esp_gattc_descr_elem_t *result, uint16_t *count)
```

Find the descriptor with the given characteristic uuid in the gattc cache Note: It just get descriptor from local cache, won't get from remote devices.

Return

- ESP_OK: success
- other: failed

Parameters

- [in] gattc_if: Gatt client access interface.
- [in] conn_id: connection ID which identify the server.
- [in] start_handle: the attribute start handle
- [in] end_handle: the attribute end handle
- [in] char_uuid: the characteristic uuid.
- [in] descr_uuid: the descriptor uuid.
- [out] result: The pointer to the descriptor in the given characteristic.
- [inout] count: input the number of descriptor want to find, it will output the number of descriptor has been found in the gattc cache with the given characteristic.

```
esp_gatt_status_t esp_ble_gattc_get_descr_by_char_handle (esp_gatt_if_t gattc_if, uint16_t conn_id, uint16_t char_handle, esp_bt_uuid_t descr_uuid, esp_gattc_descr_elem_t *result, uint16_t *count)
```

Find the descriptor with the given characteristic handle in the gattc cache Note: It just get descriptor from local cache, won't get from remote devices.

Return

- ESP_OK: success
- other: failed

Parameters

- [in] gattc_if: Gatt client access interface.
- [in] conn_id: connection ID which identify the server.
- [in] char_handle: the characteristic handle.
- [in] descr_uuid: the descriptor uuid.
- [out] result: The pointer to the descriptor in the given characteristic.
- [inout] count: input the number of descriptor want to find, it will output the number of descriptor has been found in the gattc cache with the given characteristic.

```
esp_gatt_status_t esp_ble_gattc_get_include_service (esp_gatt_if_t gattc_if, uint16_t conn_id, uint16_t start_handle, uint16_t end_handle, esp_bt_uuid_t *incl_uuid, esp_gattc_incl_svc_elem_t *result, uint16_t *count)
```

Find the include service with the given service handle in the gattc cache Note: It just get include service from local cache, won't get from remote devices.

Return

- ESP_OK: success
- other: failed

Parameters

- [in] gattc_if: Gatt client access interface.
- [in] conn_id: connection ID which identify the server.
- [in] start_handle: the attribute start handle
- [in] end_handle: the attribute end handle
- [in] incl_uuid: the include service uuid
- [out] result: The pointer to the include service in the given service.

- [inout] `count`: input the number of include service want to find, it will output the number of include service has been found in the gattc cache with the given service.

```
esp_gatt_status_t esp_ble_gattc_get_attr_count(esp_gatt_if_t gattc_if, uint16_t conn_id,
                                             esp_gatt_db_attr_type_t type, uint16_t
                                             start_handle, uint16_t end_handle, uint16_t
                                             char_handle, uint16_t *count)
```

Find the attribute count with the given service or characteristic in the gattc cache.

Return

- ESP_OK: success
- other: failed

Parameters

- [in] `gattc_if`: Gatt client access interface.
- [in] `conn_id`: connection ID which identify the server.
- [in] `type`: the attribute type.
- [in] `start_handle`: the attribute start handle, if the type is ESP_GATT_DB_DESCRIPTOR, this parameter should be ignore
- [in] `end_handle`: the attribute end handle, if the type is ESP_GATT_DB_DESCRIPTOR, this parameter should be ignore
- [in] `char_handle`: the characteristic handle, this parameter valid when the type is ESP_GATT_DB_DESCRIPTOR. If the type isn't ESP_GATT_DB_DESCRIPTOR, this parameter should be ignore.
- [out] `count`: output the number of attribute has been found in the gattc cache with the given attribute type.

```
esp_gatt_status_t esp_ble_gattc_get_db(esp_gatt_if_t gattc_if, uint16_t conn_id, uint16_t
                                       start_handle, uint16_t end_handle, esp_gattc_db_elem_t
                                       *db, uint16_t *count)
```

This function is called to get the GATT database. Note: It just get attribute data base from local cache, won't get from remote devices.

Return

- ESP_OK: success
- other: failed

Parameters

- [in] `gattc_if`: Gatt client access interface.
- [in] `start_handle`: the attribute start handle
- [in] `end_handle`: the attribute end handle
- [in] `conn_id`: connection ID which identify the server.
- [in] `db`: output parameter which will contain the GATT database copy. Caller is responsible for freeing it.
- [in] `count`: number of elements in database.

```
esp_err_t esp_ble_gattc_read_char(esp_gatt_if_t gattc_if, uint16_t conn_id, uint16_t handle,
                                  esp_gatt_auth_req_t auth_req)
```

This function is called to read a service's characteristics of the given characteristic handle.

Return

- ESP_OK: success
- other: failed

Parameters

- [in] `gattc_if`: Gatt client access interface.
- [in] `conn_id`: connection ID.
- [in] `handle`: characteristic handle to read.
- [in] `auth_req`: authenticate request type

```
esp_err_t esp_ble_gattc_read_by_type(esp_gatt_if_t gattc_if, uint16_t conn_id, uint16_t
                                       start_handle, uint16_t end_handle, esp_bt_uuid_t *uuid,
                                       esp_gatt_auth_req_t auth_req)
```

This function is called to read a service's characteristics of the given characteristic UUID.

Return

- ESP_OK: success
- other: failed

Parameters

- [in] gattc_if: Gatt client access interface.
- [in] conn_id: : connection ID.
- [in] start_handle: : the attribute start handle.
- [in] end_handle: : the attribute end handle
- [in] uuid: : The UUID of attribute which will be read.
- [in] auth_req: : authenticate request type

```
esp_err_t esp_ble_gattc_read_multiple(esp_gatt_if_t gattc_if, uint16_t conn_id,  
                                     esp_gattc_multi_t *read_multi, esp_gatt_auth_req_t  
                                     auth_req)
```

This function is called to read multiple characteristic or characteristic descriptors.

Return

- ESP_OK: success
- other: failed

Parameters

- [in] gattc_if: Gatt client access interface.
- [in] conn_id: : connection ID.
- [in] read_multi: : pointer to the read multiple parameter.
- [in] auth_req: : authenticate request type

```
esp_err_t esp_ble_gattc_read_char_descr(esp_gatt_if_t gattc_if, uint16_t conn_id, uint16_t han-  
                                         dle, esp_gatt_auth_req_t auth_req)
```

This function is called to read a characteristics descriptor.

Return

- ESP_OK: success
- other: failed

Parameters

- [in] gattc_if: Gatt client access interface.
- [in] conn_id: : connection ID.
- [in] handle: : descriptor handle to read.
- [in] auth_req: : authenticate request type

```
esp_err_t esp_ble_gattc_write_char(esp_gatt_if_t gattc_if, uint16_t conn_id, uint16_t handle,  
                                   uint16_t value_len, uint8_t *value, esp_gatt_write_type_t  
                                   write_type, esp_gatt_auth_req_t auth_req)
```

This function is called to write characteristic value.

Return

- ESP_OK: success
- other: failed

Parameters

- [in] gattc_if: Gatt client access interface.
- [in] conn_id: : connection ID.
- [in] handle: : characteristic handle to write.
- [in] value_len: length of the value to be written.
- [in] value: : the value to be written.
- [in] write_type: : the type of attribute write operation.
- [in] auth_req: : authentication request.

```
esp_err_t esp_ble_gattc_write_char_descr(esp_gatt_if_t gattc_if, uint16_t conn_id,  
                                          uint16_t handle, uint16_t value_len, uint8_t  
                                          *value, esp_gatt_write_type_t write_type,  
                                          esp_gatt_auth_req_t auth_req)
```

This function is called to write characteristic descriptor value.

Return

- ESP_OK: success
- other: failed

Parameters

- [in] `gattc_if`: Gatt client access interface.
- [in] `conn_id`: : connection ID
- [in] `handle`: : descriptor handle to write.
- [in] `value_len`: length of the value to be written.
- [in] `value`: : the value to be written.
- [in] `write_type`: : the type of attribute write operation.
- [in] `auth_req`: : authentication request.

`esp_err_t esp_ble_gattc_prepare_write` (`esp_gatt_if_t gattc_if`, `uint16_t conn_id`, `uint16_t handle`, `uint16_t offset`, `uint16_t value_len`, `uint8_t *value`, `esp_gatt_auth_req_t auth_req`)

This function is called to prepare write a characteristic value.

Return

- `ESP_OK`: success
- other: failed

Parameters

- [in] `gattc_if`: Gatt client access interface.
- [in] `conn_id`: : connection ID.
- [in] `handle`: : characteristic handle to prepare write.
- [in] `offset`: : offset of the write value.
- [in] `value_len`: length of the value to be written.
- [in] `value`: : the value to be written.
- [in] `auth_req`: : authentication request.

`esp_err_t esp_ble_gattc_prepare_write_char_descr` (`esp_gatt_if_t gattc_if`, `uint16_t conn_id`, `uint16_t handle`, `uint16_t offset`, `uint16_t value_len`, `uint8_t *value`, `esp_gatt_auth_req_t auth_req`)

This function is called to prepare write a characteristic descriptor value.

Return

- `ESP_OK`: success
- other: failed

Parameters

- [in] `gattc_if`: Gatt client access interface.
- [in] `conn_id`: : connection ID.
- [in] `handle`: : characteristic descriptor handle to prepare write.
- [in] `offset`: : offset of the write value.
- [in] `value_len`: length of the value to be written.
- [in] `value`: : the value to be written.
- [in] `auth_req`: : authentication request.

`esp_err_t esp_ble_gattc_execute_write` (`esp_gatt_if_t gattc_if`, `uint16_t conn_id`, `bool is_execute`)

This function is called to execute write a prepare write sequence.

Return

- `ESP_OK`: success
- other: failed

Parameters

- [in] `gattc_if`: Gatt client access interface.
- [in] `conn_id`: : connection ID.
- [in] `is_execute`: : execute or cancel.

`esp_err_t esp_ble_gattc_register_for_notify` (`esp_gatt_if_t gattc_if`, `esp_bd_addr_t server_bda`, `uint16_t handle`)

This function is called to register for notification of a service.

Return

- `ESP_OK`: registration succeeds
- other: failed

Parameters

- [in] `gattc_if`: Gatt client access interface.
- [in] `server_bda`: : target GATT server.
- [in] `handle`: : GATT characteristic handle.

esp_err_t **esp_ble_gattc_unregister_for_notify** (*esp_gatt_if_t* `gattc_if`, *esp_bd_addr_t* `server_bda`, `uint16_t handle`)

This function is called to de-register for notification of a service.

Return

- `ESP_OK`: unregister succeeds
- other: failed

Parameters

- [in] `gattc_if`: Gatt client access interface.
- [in] `server_bda`: : target GATT server.
- [in] `handle`: : GATT characteristic handle.

esp_err_t **esp_ble_gattc_cache_refresh** (*esp_bd_addr_t* `remote_bda`)

Refresh the server cache store in the gattc stack of the remote device. If the device is connected, this API will restart the discovery of service information of the remote device.

Return

- `ESP_OK`: success
- other: failed

Parameters

- [in] `remote_bda`: remote device BD address.

esp_err_t **esp_ble_gattc_cache_assoc** (*esp_gatt_if_t* `gattc_if`, *esp_bd_addr_t* `src_addr`, *esp_bd_addr_t* `assoc_addr`, `bool is_assoc`)

Add or delete the associated address with the source address. Note: The role of this API is mainly when the client side has stored a server-side database, when it needs to connect another device, but the device's attribute database is the same as the server database stored on the client-side, calling this API can use the database that the device has stored used as the peer server database to reduce the attribute database search and discovery process and speed up the connection time. The associated address means that device want to use the database has stored in the local cache. The source address means that device want to share the database to the associated address device.

Return

- `ESP_OK`: success
- other: failed

Parameters

- [in] `gattc_if`: Gatt client access interface.
- [in] `src_addr`: the source address which provide the attribute table.
- [in] `assoc_addr`: the associated device address which went to share the attribute table with the source address.
- [in] `is_assoc`: true add the associated device address, false remove the associated device address.

esp_err_t **esp_ble_gattc_cache_get_addr_list** (*esp_gatt_if_t* `gattc_if`)

Get the address list which has store the attribute table in the gattc cache. There will callback `ESP_GATTC_GET_ADDR_LIST_EVT` event when get address list complete.

Return

- `ESP_OK`: success
- other: failed

Parameters

- [in] `gattc_if`: Gatt client access interface.

esp_err_t **esp_ble_gattc_cache_clean** (*esp_bd_addr_t* `remote_bda`)

Clean the service cache of this device in the gattc stack,.

Return

- `ESP_OK`: success
- other: failed

Parameters

- [in] remote_bda: remote device BD address.

Unions**union esp_ble_gattc_cb_param_t***#include <esp_gattc_api.h>* Gatt client callback parameters union.**Public Members****struct esp_ble_gattc_cb_param_t::gattc_reg_evt_param reg**

Gatt client callback param of ESP_GATTC_REG_EVT

struct esp_ble_gattc_cb_param_t::gattc_open_evt_param open

Gatt client callback param of ESP_GATTC_OPEN_EVT

struct esp_ble_gattc_cb_param_t::gattc_close_evt_param close

Gatt client callback param of ESP_GATTC_CLOSE_EVT

struct esp_ble_gattc_cb_param_t::gattc_cfg_mtu_evt_param cfg_mtu

Gatt client callback param of ESP_GATTC_CFG_MTU_EVT

struct esp_ble_gattc_cb_param_t::gattc_search_cmpl_evt_param search_cmpl

Gatt client callback param of ESP_GATTC_SEARCH_CMPL_EVT

struct esp_ble_gattc_cb_param_t::gattc_search_res_evt_param search_res

Gatt client callback param of ESP_GATTC_SEARCH_RES_EVT

struct esp_ble_gattc_cb_param_t::gattc_read_char_evt_param read

Gatt client callback param of ESP_GATTC_READ_CHAR_EVT

struct esp_ble_gattc_cb_param_t::gattc_write_evt_param write

Gatt client callback param of ESP_GATTC_WRITE_DESCR_EVT

struct esp_ble_gattc_cb_param_t::gattc_exec_cmpl_evt_param exec_cmpl

Gatt client callback param of ESP_GATTC_EXEC_EVT

struct esp_ble_gattc_cb_param_t::gattc_notify_evt_param notify

Gatt client callback param of ESP_GATTC_NOTIFY_EVT

struct esp_ble_gattc_cb_param_t::gattc_srvc_chg_evt_param srvc_chg

Gatt client callback param of ESP_GATTC_SRVC_CHG_EVT

struct esp_ble_gattc_cb_param_t::gattc_congest_evt_param congest

Gatt client callback param of ESP_GATTC_CONGEST_EVT

struct esp_ble_gattc_cb_param_t::gattc_reg_for_notify_evt_param reg_for_notify

Gatt client callback param of ESP_GATTC_REG_FOR_NOTIFY_EVT

struct esp_ble_gattc_cb_param_t::gattc_unreg_for_notify_evt_param unreg_for_notify

Gatt client callback param of ESP_GATTC_UNREG_FOR_NOTIFY_EVT

struct esp_ble_gattc_cb_param_t::gattc_connect_evt_param connect

Gatt client callback param of ESP_GATTC_CONNECT_EVT

struct esp_ble_gattc_cb_param_t::gattc_disconnect_evt_param disconnect

Gatt client callback param of ESP_GATTC_DISCONNECT_EVT

struct esp_ble_gattc_cb_param_t::gattc_set_assoc_addr_cmp_evt_param set_assoc_cmp

Gatt client callback param of ESP_GATTC_SET_ASSOC_EVT

struct esp_ble_gattc_cb_param_t::gattc_get_addr_list_evt_param get_addr_list

Gatt client callback param of ESP_GATTC_GET_ADDR_LIST_EVT

struct esp_ble_gattc_cb_param_t::gattc_queue_full_evt_param queue_full

Gatt client callback param of ESP_GATTC_QUEUE_FULL_EVT

```
struct esp_ble_gattc_cb_param_t::gattc_dis_srvc_cmpl_evt_param dis_srvc_cmpl  
    Gatt client callback param of ESP_GATTC_DIS_SRVC_CMPL_EVT
```

```
struct gattc_cfg_mtu_evt_param  
    #include <esp_gattc_api.h> ESP_GATTC_CFG_MTU_EVT.
```

Public Members

```
esp_gatt_status_t status  
    Operation status
```

```
uint16_t conn_id  
    Connection id
```

```
uint16_t mtu  
    MTU size
```

```
struct gattc_close_evt_param  
    #include <esp_gattc_api.h> ESP_GATTC_CLOSE_EVT.
```

Public Members

```
esp_gatt_status_t status  
    Operation status
```

```
uint16_t conn_id  
    Connection id
```

```
esp_bd_addr_t remote_bda  
    Remote bluetooth device address
```

```
esp_gatt_conn_reason_t reason  
    The reason of gatt connection close
```

```
struct gattc_congest_evt_param  
    #include <esp_gattc_api.h> ESP_GATTC_CONGEST_EVT.
```

Public Members

```
uint16_t conn_id  
    Connection id
```

```
bool congested  
    Congested or not
```

```
struct gattc_connect_evt_param  
    #include <esp_gattc_api.h> ESP_GATTC_CONNECT_EVT.
```

Public Members

```
uint16_t conn_id  
    Connection id
```

```
uint8_t link_role  
    Link role : master role = 0 ; slave role = 1
```

```
esp_bd_addr_t remote_bda  
    Remote bluetooth device address
```

```
esp_gatt_conn_params_t conn_params  
    current connection parameters
```

```
struct gattc_dis_srvc_cmpl_evt_param  
#include <esp_gattc_api.h> ESP_GATTC_DIS_SRVC_CMPL_EVT.
```

Public Members

esp_gatt_status_t **status**
Operation status

uint16_t **conn_id**
Connection id

```
struct gattc_disconnect_evt_param  
#include <esp_gattc_api.h> ESP_GATTC_DISCONNECT_EVT.
```

Public Members

esp_gatt_conn_reason_t **reason**
disconnection reason

uint16_t **conn_id**
Connection id

esp_bd_addr_t **remote_bda**
Remote bluetooth device address

```
struct gattc_exec_cmpl_evt_param  
#include <esp_gattc_api.h> ESP_GATTC_EXEC_EVT.
```

Public Members

esp_gatt_status_t **status**
Operation status

uint16_t **conn_id**
Connection id

```
struct gattc_get_addr_list_evt_param  
#include <esp_gattc_api.h> ESP_GATTC_GET_ADDR_LIST_EVT.
```

Public Members

esp_gatt_status_t **status**
Operation status

uint8_t **num_addr**
The number of address in the gattc cache address list

*esp_bd_addr_t****addr_list**
The pointer to the address list which has been get from the gattc cache

```
struct gattc_notify_evt_param  
#include <esp_gattc_api.h> ESP_GATTC_NOTIFY_EVT.
```

Public Members

uint16_t **conn_id**
Connection id

esp_bd_addr_t **remote_bda**

Remote bluetooth device address

uint16_t **handle**

The Characteristic or descriptor handle

uint16_t **value_len**

Notify attribute value

uint8_t ***value**

Notify attribute value

bool **is_notify**

True means notify, false means indicate

struct gattc_open_evt_param

#include <esp_gattc_api.h> ESP_GATTC_OPEN_EVT.

Public Members

esp_gatt_status_t **status**

Operation status

uint16_t **conn_id**

Connection id

esp_bd_addr_t **remote_bda**

Remote bluetooth device address

uint16_t **mtu**

MTU size

struct gattc_queue_full_evt_param

#include <esp_gattc_api.h> ESP_GATTC_QUEUE_FULL_EVT.

Public Members

esp_gatt_status_t **status**

Operation status

uint16_t **conn_id**

Connection id

bool **is_full**

The gattc command queue is full or not

struct gattc_read_char_evt_param

#include <esp_gattc_api.h> ESP_GATTC_READ_CHAR_EVT, ESP_GATTC_READ_DESCR_EVT.

Public Members

esp_gatt_status_t **status**

Operation status

uint16_t **conn_id**

Connection id

uint16_t **handle**

Characteristic handle

uint8_t ***value**

Characteristic value

`uint16_t value_len`
Characteristic value length

struct gattc_reg_evt_param
#include <esp_gattc_api.h> ESP_GATTC_REG_EVT.

Public Members

esp_gatt_status_t **status**
Operation status

`uint16_t app_id`
Application id which input in register API

struct gattc_reg_for_notify_evt_param
#include <esp_gattc_api.h> ESP_GATTC_REG_FOR_NOTIFY_EVT.

Public Members

esp_gatt_status_t **status**
Operation status

`uint16_t handle`
The characteristic or descriptor handle

struct gattc_search_cmpl_evt_param
#include <esp_gattc_api.h> ESP_GATTC_SEARCH_CMPL_EVT.

Public Members

esp_gatt_status_t **status**
Operation status

`uint16_t conn_id`
Connection id

esp_service_source_t **searched_service_source**
The source of the service information

struct gattc_search_res_evt_param
#include <esp_gattc_api.h> ESP_GATTC_SEARCH_RES_EVT.

Public Members

`uint16_t conn_id`
Connection id

`uint16_t start_handle`
Service start handle

`uint16_t end_handle`
Service end handle

esp_gatt_id_t **srvc_id**
Service id, include service uuid and other information

bool **is_primary**
True if this is the primary service

struct gattc_set_assoc_addr_cmp_evt_param
#include <esp_gattc_api.h> ESP_GATTC_SET_ASSOC_EVT.

Public Members

esp_gatt_status_t **status**
Operation status

```
struct gattc_srvc_chg_evt_param
#include <esp_gattc_api.h> ESP_GATTC_SRVC_CHG_EVT.
```

Public Members

esp_bd_addr_t **remote_bda**
Remote bluetooth device address

```
struct gattc_unreg_for_notify_evt_param
#include <esp_gattc_api.h> ESP_GATTC_UNREG_FOR_NOTIFY_EVT.
```

Public Members

esp_gatt_status_t **status**
Operation status

uint16_t **handle**
The characteristic or descriptor handle

```
struct gattc_write_evt_param
#include <esp_gattc_api.h> ESP_GATTC_WRITE_CHAR_EVT, ESP_GATTC_PREP_WRITE_EVT,
ESP_GATTC_WRITE_DESCR_EVT.
```

Public Members

esp_gatt_status_t **status**
Operation status

uint16_t **conn_id**
Connection id

uint16_t **handle**
The Characteristic or descriptor handle

uint16_t **offset**
The prepare write offset, this value is valid only when prepare write

Type Definitions

```
typedef void (*esp_gattc_cb_t) (esp_gattc_cb_event_t event, esp_gatt_if_t gattc_if,
esp_ble_gattc_cb_param_t *param)
GATT Client callback function type.
```

Parameters

- event: : Event type
- gattc_if: : GATT client access interface, normally different gattc_if correspond to different profile
- param: : Point to callback parameter, currently is union type

Enumerations

```
enum esp_gattc_cb_event_t
GATT Client callback function events.
```

Values:

- ESP_GATTC_REG_EVT = 0**
When GATT client is registered, the event comes
- ESP_GATTC_UNREG_EVT = 1**
When GATT client is unregistered, the event comes
- ESP_GATTC_OPEN_EVT = 2**
When GATT virtual connection is set up, the event comes
- ESP_GATTC_READ_CHAR_EVT = 3**
When GATT characteristic is read, the event comes
- ESP_GATTC_WRITE_CHAR_EVT = 4**
When GATT characteristic write operation completes, the event comes
- ESP_GATTC_CLOSE_EVT = 5**
When GATT virtual connection is closed, the event comes
- ESP_GATTC_SEARCH_CMPL_EVT = 6**
When GATT service discovery is completed, the event comes
- ESP_GATTC_SEARCH_RES_EVT = 7**
When GATT service discovery result is got, the event comes
- ESP_GATTC_READ_DESCR_EVT = 8**
When GATT characteristic descriptor read completes, the event comes
- ESP_GATTC_WRITE_DESCR_EVT = 9**
When GATT characteristic descriptor write completes, the event comes
- ESP_GATTC_NOTIFY_EVT = 10**
When GATT notification or indication arrives, the event comes
- ESP_GATTC_PREP_WRITE_EVT = 11**
When GATT prepare-write operation completes, the event comes
- ESP_GATTC_EXEC_EVT = 12**
When write execution completes, the event comes
- ESP_GATTC_ACL_EVT = 13**
When ACL connection is up, the event comes
- ESP_GATTC_CANCEL_OPEN_EVT = 14**
When GATT client ongoing connection is cancelled, the event comes
- ESP_GATTC_SRVC_CHG_EVT = 15**
When “service changed” occurs, the event comes
- ESP_GATTC_ENC_CMPL_CB_EVT = 17**
When encryption procedure completes, the event comes
- ESP_GATTC_CFG_MTU_EVT = 18**
When configuration of MTU completes, the event comes
- ESP_GATTC_ADV_DATA_EVT = 19**
When advertising of data, the event comes
- ESP_GATTC_MULT_ADV_ENB_EVT = 20**
When multi-advertising is enabled, the event comes
- ESP_GATTC_MULT_ADV_UPD_EVT = 21**
When multi-advertising parameters are updated, the event comes
- ESP_GATTC_MULT_ADV_DATA_EVT = 22**
When multi-advertising data arrives, the event comes
- ESP_GATTC_MULT_ADV_DIS_EVT = 23**
When multi-advertising is disabled, the event comes

- ESP_GATTC_CONGEST_EVT = 24**
When GATT connection congestion comes, the event comes
- ESP_GATTC_BTH_SCAN_ENB_EVT = 25**
When batch scan is enabled, the event comes
- ESP_GATTC_BTH_SCAN_CFG_EVT = 26**
When batch scan storage is configured, the event comes
- ESP_GATTC_BTH_SCAN_RD_EVT = 27**
When Batch scan read event is reported, the event comes
- ESP_GATTC_BTH_SCAN_THR_EVT = 28**
When Batch scan threshold is set, the event comes
- ESP_GATTC_BTH_SCAN_PARAM_EVT = 29**
When Batch scan parameters are set, the event comes
- ESP_GATTC_BTH_SCAN_DIS_EVT = 30**
When Batch scan is disabled, the event comes
- ESP_GATTC_SCAN_FLT_CFG_EVT = 31**
When Scan filter configuration completes, the event comes
- ESP_GATTC_SCAN_FLT_PARAM_EVT = 32**
When Scan filter parameters are set, the event comes
- ESP_GATTC_SCAN_FLT_STATUS_EVT = 33**
When Scan filter status is reported, the event comes
- ESP_GATTC_ADV_VSC_EVT = 34**
When advertising vendor spec content event is reported, the event comes
- ESP_GATTC_REG_FOR_NOTIFY_EVT = 38**
When register for notification of a service completes, the event comes
- ESP_GATTC_UNREG_FOR_NOTIFY_EVT = 39**
When unregister for notification of a service completes, the event comes
- ESP_GATTC_CONNECT_EVT = 40**
When the ble physical connection is set up, the event comes
- ESP_GATTC_DISCONNECT_EVT = 41**
When the ble physical connection disconnected, the event comes
- ESP_GATTC_READ_MULTIPLE_EVT = 42**
When the ble characteristic or descriptor multiple complete, the event comes
- ESP_GATTC_QUEUE_FULL_EVT = 43**
When the gattc command queue full, the event comes
- ESP_GATTC_SET_ASSOC_EVT = 44**
When the ble gattc set the associated address complete, the event comes
- ESP_GATTC_GET_ADDR_LIST_EVT = 45**
When the ble get gattc address list in cache finish, the event comes
- ESP_GATTC_DIS_SRVC_CMPL_EVT = 46**
When the ble discover service complete, the event comes

BLUFI API

Overview BLUFI is a profile based GATT to config ESP32 WIFI to connect/disconnect AP or setup a softap and etc. Use should concern these things:

1. The event sent from profile. Then you need to do something as the event indicate.

2. Security reference. You can write your own Security functions such as symmetrical encryption/decryption and checksum functions. Even you can define the “Key Exchange/Negotiation” procedure.

Application Example Check `bluetooth` folder in ESP-IDF examples, which contains the following application:

- This is the BLUFI demo. This demo can set ESP32’s wifi to softap/station/softap&station mode and config wifi connections - `bluetooth/blufi`

API Reference

Header File

- `bt/common/api/include/api/esp_blufi_api.h`

Functions

`esp_err_t esp_blufi_register_callbacks (esp_blufi_callbacks_t *callbacks)`

This function is called to receive blufi callback event.

Return ESP_OK - success, other - failed

Parameters

- `[in] callbacks`: callback functions

`esp_err_t esp_blufi_profile_init (void)`

This function is called to initialize blufi_profile.

Return ESP_OK - success, other - failed

`esp_err_t esp_blufi_profile_deinit (void)`

This function is called to de-initialize blufi_profile.

Return ESP_OK - success, other - failed

`esp_err_t esp_blufi_send_wifi_conn_report (wifi_mode_t opmode, esp_blufi_sta_conn_state_t sta_conn_state, uint8_t softap_conn_num, esp_blufi_extra_info_t *extra_info)`

This function is called to send wifi connection report.

Return ESP_OK - success, other - failed

Parameters

- `opmode`: : wifi opmode
- `sta_conn_state`: : station is already in connection or not
- `softap_conn_num`: : softap connection number
- `extra_info`: : extra information, such as `sta_ssid`, `softap_ssid` and etc.

`esp_err_t esp_blufi_send_wifi_list (uint16_t apCount, esp_blufi_ap_record_t *list)`

This function is called to send wifi list.

Return ESP_OK - success, other - failed

Parameters

- `apCount`: : wifi list count
- `list`: : wifi list

`uint16_t esp_blufi_get_version (void)`

Get BLUFI profile version.

Return Most 8bit significant is Great version, Least 8bit is Sub version

`esp_err_t esp_blufi_send_error_info (esp_blufi_error_state_t state)`

This function is called to send blufi error information.

Return ESP_OK - success, other - failed

Parameters

- `state`: : error state

esp_err_t **esp_blufi_send_custom_data** (uint8_t **data*, uint32_t *data_len*)

This function is called to custom data.

Return ESP_OK - success, other - failed

Parameters

- *data*: : custom data value
- *data_len*: : the length of custom data

Unions

union **esp_blufi_cb_param_t**

#include <esp_blufi_api.h> BLUFI callback parameters union.

Public Members

struct *esp_blufi_cb_param_t::blufi_init_finish_evt_param* **init_finish**

Blufi callback param of ESP_BLUFI_EVENT_INIT_FINISH

struct *esp_blufi_cb_param_t::blufi_deinit_finish_evt_param* **deinit_finish**

Blufi callback param of ESP_BLUFI_EVENT_DEINIT_FINISH

struct *esp_blufi_cb_param_t::blufi_set_wifi_mode_evt_param* **wifi_mode**

Blufi callback param of ESP_BLUFI_EVENT_INIT_FINISH

struct *esp_blufi_cb_param_t::blufi_connect_evt_param* **connect**

Blufi callback param of ESP_BLUFI_EVENT_CONNECT

struct *esp_blufi_cb_param_t::blufi_disconnect_evt_param* **disconnect**

Blufi callback param of ESP_BLUFI_EVENT_DISCONNECT

struct *esp_blufi_cb_param_t::blufi_recv_sta_bssid_evt_param* **sta_bssid**

Blufi callback param of ESP_BLUFI_EVENT_RECV_STA_BSSID

struct *esp_blufi_cb_param_t::blufi_recv_sta_ssid_evt_param* **sta_ssid**

Blufi callback param of ESP_BLUFI_EVENT_RECV_STA_SSID

struct *esp_blufi_cb_param_t::blufi_recv_sta_passwd_evt_param* **sta_passwd**

Blufi callback param of ESP_BLUFI_EVENT_RECV_STA_PASSWD

struct *esp_blufi_cb_param_t::blufi_recv_softap_ssid_evt_param* **softap_ssid**

Blufi callback param of ESP_BLUFI_EVENT_RECV_SOFTAP_SSID

struct *esp_blufi_cb_param_t::blufi_recv_softap_passwd_evt_param* **softap_passwd**

Blufi callback param of ESP_BLUFI_EVENT_RECV_SOFTAP_PASSWD

struct *esp_blufi_cb_param_t::blufi_recv_softap_max_conn_num_evt_param* **softap_max_conn_num**

Blufi callback param of ESP_BLUFI_EVENT_RECV_SOFTAP_MAX_CONN_NUM

struct *esp_blufi_cb_param_t::blufi_recv_softap_auth_mode_evt_param* **softap_auth_mode**

Blufi callback param of ESP_BLUFI_EVENT_RECV_SOFTAP_AUTH_MODE

struct *esp_blufi_cb_param_t::blufi_recv_softap_channel_evt_param* **softap_channel**

Blufi callback param of ESP_BLUFI_EVENT_RECV_SOFTAP_CHANNEL

struct *esp_blufi_cb_param_t::blufi_recv_username_evt_param* **username**

Blufi callback param of ESP_BLUFI_EVENT_RECV_USERNAME

struct *esp_blufi_cb_param_t::blufi_recv_ca_evt_param* **ca**

Blufi callback param of ESP_BLUFI_EVENT_RECV_CA_CERT

struct *esp_blufi_cb_param_t::blufi_recv_client_cert_evt_param* **client_cert**

Blufi callback param of ESP_BLUFI_EVENT_RECV_CLIENT_CERT

struct *esp_blufi_cb_param_t::blufi_recv_server_cert_evt_param* **server_cert**

Blufi callback param of ESP_BLUFI_EVENT_RECV_SERVER_CERT

```
struct esp_blufi_cb_param_t::blufi_rcv_client_pkey_evt_param client_pkey  
    Blufi callback param of ESP_BLUFI_EVENT_RECV_CLIENT_PRIV_KEY  
struct esp_blufi_cb_param_t::blufi_rcv_server_pkey_evt_param server_pkey  
    Blufi callback param of ESP_BLUFI_EVENT_RECV_SERVER_PRIV_KEY  
struct esp_blufi_cb_param_t::blufi_get_error_evt_param report_error  
    Blufi callback param of ESP_BLUFI_EVENT_REPORT_ERROR  
struct esp_blufi_cb_param_t::blufi_rcv_custom_data_evt_param custom_data  
    Blufi callback param of ESP_BLUFI_EVENT_RECV_CUSTOM_DATA  
struct blufi_connect_evt_param  
    #include <esp_blufi_api.h> ESP_BLUFI_EVENT_CONNECT.
```

Public Members

esp_blufi_bd_addr_t **remote_bda**
 Blufi Remote bluetooth device address

uint8_t **server_if**
 server interface

uint16_t **conn_id**
 Connection id

```
struct blufi_deinit_finish_evt_param  
    #include <esp_blufi_api.h> ESP_BLUFI_EVENT_DEINIT_FINISH.
```

Public Members

esp_blufi_deinit_state_t **state**
 De-initial status

```
struct blufi_disconnect_evt_param  
    #include <esp_blufi_api.h> ESP_BLUFI_EVENT_DISCONNECT.
```

Public Members

esp_blufi_bd_addr_t **remote_bda**
 Blufi Remote bluetooth device address

```
struct blufi_get_error_evt_param  
    #include <esp_blufi_api.h> ESP_BLUFI_EVENT_REPORT_ERROR.
```

Public Members

esp_blufi_error_state_t **state**
 Blufi error state

```
struct blufi_init_finish_evt_param  
    #include <esp_blufi_api.h> ESP_BLUFI_EVENT_INIT_FINISH.
```

Public Members

esp_blufi_init_state_t **state**
 Initial status

```
struct blufi_rcv_ca_evt_param  
#include <esp_blufi_api.h> ESP_BLUFI_EVENT_RECV_CA_CERT.
```

Public Members

```
uint8_t *cert  
    CA certificate point  
  
int cert_len  
    CA certificate length
```

```
struct blufi_rcv_client_cert_evt_param  
#include <esp_blufi_api.h> ESP_BLUFI_EVENT_RECV_CLIENT_CERT
```

Public Members

```
uint8_t *cert  
    Client certificate point  
  
int cert_len  
    Client certificate length
```

```
struct blufi_rcv_client_pkey_evt_param  
#include <esp_blufi_api.h> ESP_BLUFI_EVENT_RECV_CLIENT_PRIV_KEY
```

Public Members

```
uint8_t *pkey  
    Client Private Key point, if Client certificate not contain Key  
  
int pkey_len  
    Client Private key length
```

```
struct blufi_rcv_custom_data_evt_param  
#include <esp_blufi_api.h> ESP_BLUFI_EVENT_RECV_CUSTOM_DATA.
```

Public Members

```
uint8_t *data  
    Custom data  
  
uint32_t data_len  
    Custom data Length
```

```
struct blufi_rcv_server_cert_evt_param  
#include <esp_blufi_api.h> ESP_BLUFI_EVENT_RECV_SERVER_CERT
```

Public Members

```
uint8_t *cert  
    Client certificate point  
  
int cert_len  
    Client certificate length
```

```
struct blufi_rcv_server_pkey_evt_param  
#include <esp_blufi_api.h> ESP_BLUFI_EVENT_RECV_SERVER_PRIV_KEY
```

Public Members

`uint8_t *pkey`
Client Private Key point, if Client certificate not contain Key

`int pkey_len`
Client Private key length

struct blufi_recv_softap_auth_mode_evt_param
#include <esp_blufi_api.h> ESP_BLUFI_EVENT_RECV_SOFTAP_AUTH_MODE.

Public Members

`wifi_auth_mode_t auth_mode`
Authentication mode

struct blufi_recv_softap_channel_evt_param
#include <esp_blufi_api.h> ESP_BLUFI_EVENT_RECV_SOFTAP_CHANNEL.

Public Members

`uint8_t channel`
Authentication mode

struct blufi_recv_softap_max_conn_num_evt_param
#include <esp_blufi_api.h> ESP_BLUFI_EVENT_RECV_SOFTAP_MAX_CONN_NUM.

Public Members

`int max_conn_num`
SSID

struct blufi_recv_softap_passwd_evt_param
#include <esp_blufi_api.h> ESP_BLUFI_EVENT_RECV_SOFTAP_PASSWD.

Public Members

`uint8_t *passwd`
Password

`int passwd_len`
Password Length

struct blufi_recv_softap_ssid_evt_param
#include <esp_blufi_api.h> ESP_BLUFI_EVENT_RECV_SOFTAP_SSID.

Public Members

`uint8_t *ssid`
SSID

`int ssid_len`
SSID length

struct blufi_recv_sta_bssid_evt_param
#include <esp_blufi_api.h> ESP_BLUFI_EVENT_RECV_STA_BSSID.

Public Members

uint8_t **bssid**[6]
BSSID

struct blufi_rcv_sta_passwd_evt_param
#include <esp_blufi_api.h> ESP_BLUFI_EVENT_RECV_STA_PASSWD.

Public Members

uint8_t ***passwd**
Password

int **passwd_len**
Password Length

struct blufi_rcv_sta_ssid_evt_param
#include <esp_blufi_api.h> ESP_BLUFI_EVENT_RECV_STA_SSID.

Public Members

uint8_t ***ssid**
SSID

int **ssid_len**
SSID length

struct blufi_rcv_username_evt_param
#include <esp_blufi_api.h> ESP_BLUFI_EVENT_RECV_USERNAME.

Public Members

uint8_t ***name**
Username point

int **name_len**
Username length

struct blufi_set_wifi_mode_evt_param
#include <esp_blufi_api.h> ESP_BLUFI_EVENT_SET_WIFI_MODE.

Public Members

wifi_mode_t **op_mode**
Wifi operation mode

Structures

struct esp_blufi_extra_info_t
BLUFI extra information structure.

Public Members

uint8_t **sta_bssid**[6]
BSSID of station interface

bool **sta_bssid_set**
is BSSID of station interface set

`uint8_t *sta_ssid`
SSID of station interface

`int sta_ssid_len`
length of SSID of station interface

`uint8_t *sta_passwd`
password of station interface

`int sta_passwd_len`
length of password of station interface

`uint8_t *softap_ssid`
SSID of softap interface

`int softap_ssid_len`
length of SSID of softap interface

`uint8_t *softap_passwd`
password of station interface

`int softap_passwd_len`
length of password of station interface

`uint8_t softap_authmode`
authentication mode of softap interface

`bool softap_authmode_set`
is authentication mode of softap interface set

`uint8_t softap_max_conn_num`
max connection number of softap interface

`bool softap_max_conn_num_set`
is max connection number of softap interface set

`uint8_t softap_channel`
channel of softap interface

`bool softap_channel_set`
is channel of softap interface set

`struct esp_blufi_ap_record_t`
Description of an WiFi AP.

Public Members

`uint8_t ssid[33]`
SSID of AP

`int8_t rssi`
signal strength of AP

`struct esp_blufi_callbacks_t`
BLUFI callback functions type.

Public Members

`esp_blufi_event_cb_t event_cb`
BLUFI event callback

`esp_blufi_negotiate_data_handler_t negotiate_data_handler`
BLUFI negotiate data function for negotiate share key

`esp_blufi_encrypt_func_t encrypt_func`
BLUFI encrypt data function with share key generated by negotiate_data_handler

esp_blufi_decrypt_func_t **decrypt_func**

BLUFI decrypt data function with share key generated by negotiate_data_handler

esp_blufi_checksum_func_t **checksum_func**

BLUFI check sum function (FCS)

Macros

ESP_BLUFI_BD_ADDR_LEN

Bluetooth address length.

Type Definitions

typedef uint8_t **esp_blufi_bd_addr_t**[ESP_BLUFI_BD_ADDR_LEN]

Bluetooth device address.

typedef void (***esp_blufi_event_cb_t**) (*esp_blufi_cb_event_t* event, *esp_blufi_cb_param_t* *param)

BLUFI event callback function type.

Parameters

- event: : Event type
- param: : Point to callback parameter, currently is union type

typedef void (***esp_blufi_negotiate_data_handler_t**) (uint8_t *data, int len, uint8_t **output_data, int *output_len, bool *need_free)

BLUFI negotiate data handler.

Parameters

- data: : data from phone
- len: : length of data from phone
- output_data: : data want to send to phone
- output_len: : length of data want to send to phone
- need_free: : output reporting if memory needs to be freed or not *

typedef int (***esp_blufi_encrypt_func_t**) (uint8_t iv8, uint8_t *crypt_data, int crypt_len)

BLUFI encrypt the data after negotiate a share key.

Return Nonnegative number is encrypted length, if error, return negative number;

Parameters

- iv8: : initial vector(8bit), normally, blufi core will input packet sequence number
- crypt_data: : plain text and encrypted data, the encrypt function must support autochthonous encrypt
- crypt_len: : length of plain text

typedef int (***esp_blufi_decrypt_func_t**) (uint8_t iv8, uint8_t *crypt_data, int crypt_len)

BLUFI decrypt the data after negotiate a share key.

Return Nonnegative number is decrypted length, if error, return negative number;

Parameters

- iv8: : initial vector(8bit), normally, blufi core will input packet sequence number
- crypt_data: : encrypted data and plain text, the encrypt function must support autochthonous decrypt
- crypt_len: : length of encrypted text

typedef uint16_t (***esp_blufi_checksum_func_t**) (uint8_t iv8, uint8_t *data, int len)

BLUFI checksum.

Parameters

- iv8: : initial vector(8bit), normally, blufi core will input packet sequence number
- data: : data need to checksum
- len: : length of data

Enumerations**enum esp_blufi_cb_event_t***Values:*

```
ESP_BLUFI_EVENT_INIT_FINISH = 0
ESP_BLUFI_EVENT_DEINIT_FINISH
ESP_BLUFI_EVENT_SET_WIFI_OPMODE
ESP_BLUFI_EVENT_BLE_CONNECT
ESP_BLUFI_EVENT_BLE_DISCONNECT
ESP_BLUFI_EVENT_REQ_CONNECT_TO_AP
ESP_BLUFI_EVENT_REQ_DISCONNECT_FROM_AP
ESP_BLUFI_EVENT_GET_WIFI_STATUS
ESP_BLUFI_EVENT_DEAUTHENTICATE_STA
ESP_BLUFI_EVENT_RECV_STA_BSSID
ESP_BLUFI_EVENT_RECV_STA_SSID
ESP_BLUFI_EVENT_RECV_STA_PASSWD
ESP_BLUFI_EVENT_RECV_SOFTAP_SSID
ESP_BLUFI_EVENT_RECV_SOFTAP_PASSWD
ESP_BLUFI_EVENT_RECV_SOFTAP_MAX_CONN_NUM
ESP_BLUFI_EVENT_RECV_SOFTAP_AUTH_MODE
ESP_BLUFI_EVENT_RECV_SOFTAP_CHANNEL
ESP_BLUFI_EVENT_RECV_USERNAME
ESP_BLUFI_EVENT_RECV_CA_CERT
ESP_BLUFI_EVENT_RECV_CLIENT_CERT
ESP_BLUFI_EVENT_RECV_SERVER_CERT
ESP_BLUFI_EVENT_RECV_CLIENT_PRIV_KEY
ESP_BLUFI_EVENT_RECV_SERVER_PRIV_KEY
ESP_BLUFI_EVENT_RECV_SLAVE_DISCONNECT_BLE
ESP_BLUFI_EVENT_GET_WIFI_LIST
ESP_BLUFI_EVENT_REPORT_ERROR
ESP_BLUFI_EVENT_RECV_CUSTOM_DATA
```

enum esp_blufi_sta_conn_state_t

BLUFI config status.

Values:

```
ESP_BLUFI_STA_CONN_SUCCESS = 0x00
ESP_BLUFI_STA_CONN_FAIL = 0x01
```

enum esp_blufi_init_state_t

BLUFI init status.

Values:

```
ESP_BLUFI_INIT_OK = 0
ESP_BLUFI_INIT_FAILED
```

```
enum esp_blufi_deinit_state_t
```

BLUFI deinit status.

Values:

```
ESP_BLUFI_DEINIT_OK = 0
```

```
ESP_BLUFI_DEINIT_FAILED
```

```
enum esp_blufi_error_state_t
```

Values:

```
ESP_BLUFI_SEQUENCE_ERROR = 0
```

```
ESP_BLUFI_CHECKSUM_ERROR
```

```
ESP_BLUFI_DECRYPT_ERROR
```

```
ESP_BLUFI_ENCRYPT_ERROR
```

```
ESP_BLUFI_INIT_SECURITY_ERROR
```

```
ESP_BLUFI_DH_MALLOC_ERROR
```

```
ESP_BLUFI_DH_PARAM_ERROR
```

```
ESP_BLUFI_READ_PARAM_ERROR
```

```
ESP_BLUFI_MAKE_PUBLIC_ERROR
```

```
ESP_BLUFI_DATA_FORMAT_ERROR
```

2.1.4 NimBLE-based host APIs

Overview

Apache MyNewt NimBLE is a highly configurable and BT SIG qualifiable BLE stack providing both host and controller functionalities. ESP-IDF supports NimBLE host stack which is specifically ported for ESP32 platform and FreeRTOS. The underlying controller is still the same (as in case of Bluedroid) providing VHCI interface. Refer to [NimBLE user guide](#) for a complete list of features and additional information on NimBLE stack. Most features of NimBLE including BLE Mesh are supported by ESP-IDF. The porting layer is kept cleaner by maintaining all the existing APIs of NimBLE along with a single ESP-NimBLE API for initialization, making it simpler for the application developers.

Architecture

Currently, NimBLE host and controller support different transports such as UART and RAM between them. However, RAM transport cannot be used as is in case of ESP as ESP controller supports VHCI interface and buffering schemes used by NimBLE host is incompatible with that used by ESP controller. Therefore, a new transport between NimBLE host and ESP controller has been added. This is depicted in the figure below. This layer is responsible for maintaining pool of transport buffers and formatting buffers exchanges between host and controller as per the requirements.

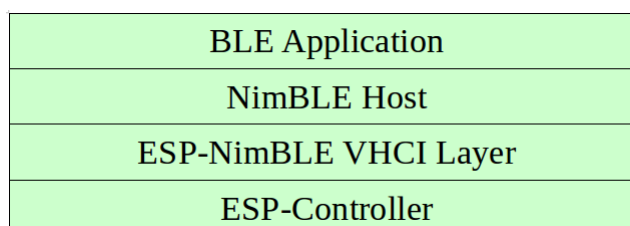

Fig. 1: ESP NimBLE Stack

Threading Model

The NimBLE host can run inside the application thread or can have its own independent thread. This flexibility is inherently provided by NimBLE design. By default, a thread is spawned by the porting function `nimble_port_freertos_init`. This behavior can be changed by overriding the same function. For BLE Mesh, additional thread (advertising thread) is used which keeps on feeding advertisement events to the main thread.

Programming Sequence

To begin with, make sure that the NimBLE stack is enabled from menuconfig *choose NimBLE for the Bluetooth host*.

Typical programming sequence with NimBLE stack consists of the following steps:

- Initialize NVS flash using `nvs_flash_init()` API. This is because ESP controller uses NVS during initialization.
- Call `esp_nimble_hci_and_controller_init()` to initialize ESP controller as well as transport layer. This will also link the host and controller modules together. Alternatively, if ESP controller is already initialized, then `esp_nimble_hci_init()` can be called for the remaining initialization.
- Initialize the host stack using `nimble_port_init`.
- Initialize the required NimBLE host configuration parameters and callbacks
- Perform application specific tasks/initialization
- Run the thread for host stack using `nimble_port_freertos_init`

This documentation does not cover NimBLE APIs. Refer to [NimBLE tutorial](#) for more details on the programming sequence/NimBLE APIs for different scenarios.

API Reference

Header File

- [bt/host/nimble/esp-hci/include/esp_nimble_hci.h](#)

Functions

`esp_err_t esp_nimble_hci_init` (void)

Initialize VHCI transport layer between NimBLE Host and ESP Bluetooth controller.

This function initializes the transport buffers to be exchanged between NimBLE host and ESP controller. It also registers required host callbacks with the controller.

Return

- ESP_OK if the initialization is successful
- Appropriate error code from `esp_err_t` in case of an error

`esp_err_t esp_nimble_hci_and_controller_init` (void)

Initialize ESP Bluetooth controller(link layer) and VHCI transport layer between NimBLE Host and ESP Bluetooth controller.

This function initializes ESP controller in BLE only mode and the transport buffers to be exchanged between NimBLE host and ESP controller. It also registers required host callbacks with the controller.

Below is the sequence of APIs to be called to init/enable NimBLE host and ESP controller:

```
void ble_host_task(void *param)
{
    nimble_port_run(); //This function will return only when nimble_port_
    ↪stop() is executed.
    nimble_port_freertos_deinit();
}

int ret = esp_nimble_hci_and_controller_init();
if (ret != ESP_OK) {
```

(continues on next page)

(continued from previous page)

```

        ESP_LOGE(TAG, "esp_nimble_hci_and_controller_init() failed with error: %d
        ↪", ret);
        return;
    }

    nimble_port_init();

    //Initialize the NimBLE Host configuration

    nimble_port_freertos_init(ble_host_task);

```

`nimble_port_freertos_init()` is an optional call that creates a new task in which the NimBLE host will run. The task function should have a call to `nimble_port_run()`. If a separate task is not required, calling `nimble_port_run()` will run the NimBLE host in the current task.

Return

- ESP_OK if the initialization is successful
- Appropriate error code from `esp_err_t` in case of an error

esp_err_t **esp_nimble_hci_deinit** (void)

Deinitialize VHCI transport layer between NimBLE Host and ESP Bluetooth controller.

Note This function should be called after the NimBLE host is deinitialized.

Return

- ESP_OK if the deinitialization is successful
- Appropriate error codes from `esp_err_t` in case of an error

esp_err_t **esp_nimble_hci_and_controller_deinit** (void)

Deinitialize VHCI transport layer between NimBLE Host and ESP Bluetooth controller and disable and deinitialize the controller.

Below is the sequence of APIs to be called to disable/deinit NimBLE host and ESP controller:

Note This function should not be executed in the context of Bluetooth host task.

Note This function should be called after the NimBLE host is deinitialized.

```

int ret = nimble_port_stop();
if (ret == 0) {
    nimble_port_deinit();

    ret = esp_nimble_hci_and_controller_deinit();
    if (ret != ESP_OK) {
        ESP_LOGE(TAG, "esp_nimble_hci_and_controller_deinit() failed with
        ↪error: %d", ret);
    }
}

```

If `nimble_port_freertos_init()` is used during initialization, then `nimble_port_freertos_deinit()` should be called in the host task after `nimble_port_run()`.

Return

- ESP_OK if the deinitialization is successful
- Appropriate error codes from `esp_err_t` in case of an error

Macros**BLE_HCI_UART_H4_NONE****BLE_HCI_UART_H4_CMD****BLE_HCI_UART_H4_ACL****BLE_HCI_UART_H4_SCO****BLE_HCI_UART_H4_EVT**

2.1.5 ESP-BLE-MESH

With various features of ESP-BLE-MESH, users can create a managed flooding mesh network for several scenarios, such as lighting, sensor and etc.

For an ESP32 to join and work on a ESP-BLE-MESH network, it must be provisioned firstly. By provisioning, the ESP32, as an unprovisioned device, will join the ESP-BLE-MESH network and become a ESP-BLE-MESH node, communicating with other nodes within or beyond the radio range.

Apart from ESP-BLE-MESH nodes, inside ESP-BLE-MESH network, there is also ESP32 that works as ESP-BLE-MESH Provisioner, which could provision unprovisioned devices into ESP-BLE-MESH nodes and configure the nodes with various features.

For information how to start using ESP32 and ESP-BLE-MESH, please see the Section [Getting Started with ESP-BLE-MESH](#). If you are interested in information on ESP-BLE-MESH architecture, including some details of software implementation, please see Section [ESP-BLE-MESH Architecture](#).

Application Examples and Demos

Please refer to Sections [ESP-BLE-MESH Examples](#) and [ESP-BLE-MESH Demo Videos](#).

API Reference

ESP-BLE-MESH APIs are divided into the following parts:

- [ESP-BLE-MESH Definitions](#)
- [ESP-BLE-MESH Core API Reference](#)
- [ESP-BLE-MESH Models API Reference](#)

ESP-BLE-MESH Definitions

This section contains only one header file, which lists the following items of ESP-BLE-MESH.

- ID of all the models and related message opcodes
- Structs of model, element and Composition Data
- Structs of used by ESP-BLE-MESH Node/Provisioner for provisioning
- Structs used to transmit/receive messages
- Event types and related event parameters

Header File

- [bt/esp_ble_mesh/api/esp_ble_mesh_defs.h](#)

Unions

```
union esp_ble_mesh_prov_cb_param_t
#include <esp_ble_mesh_defs.h> BLE Mesh Node/Provisioner callback parameters union.
```

Public Members

```
struct esp_ble_mesh_prov_cb_param_t::ble_mesh_prov_register_comp_param prov_register_comp
Event parameter of ESP_BLE_MESH_PROV_REGISTER_COMP_EVT
```

```
struct esp_ble_mesh_prov_cb_param_t::ble_mesh_set_unprov_dev_name_comp_param node_set_unprov_dev_name
Event parameter of ESP_BLE_MESH_NODE_SET_UNPROV_DEV_NAME_COMP_EVT
```

```
struct esp_ble_mesh_prov_cb_param_t::ble_mesh_prov_enable_comp_param node_prov_enable_comp
Event parameter of ESP_BLE_MESH_NODE_PROV_ENABLE_COMP_EVT
```

```

struct esp_ble_mesh_prov_cb_param_t::ble_mesh_prov_disable_comp_param node_prov_disable_comp
    Event parameter of ESP_BLE_MESH_NODE_PROV_DISABLE_COMP_EVT

struct esp_ble_mesh_prov_cb_param_t::ble_mesh_link_open_evt_param node_prov_link_open
    Event parameter of ESP_BLE_MESH_NODE_PROV_LINK_OPEN_EVT

struct esp_ble_mesh_prov_cb_param_t::ble_mesh_link_close_evt_param node_prov_link_close
    Event parameter of ESP_BLE_MESH_NODE_PROV_LINK_CLOSE_EVT

struct esp_ble_mesh_prov_cb_param_t::ble_mesh_output_num_evt_param node_prov_output_num
    Event parameter of ESP_BLE_MESH_NODE_PROV_OUTPUT_NUMBER_EVT

struct esp_ble_mesh_prov_cb_param_t::ble_mesh_output_str_evt_param node_prov_output_str
    Event parameter of ESP_BLE_MESH_NODE_PROV_OUTPUT_STRING_EVT

struct esp_ble_mesh_prov_cb_param_t::ble_mesh_input_evt_param node_prov_input
    Event parameter of ESP_BLE_MESH_NODE_PROV_INPUT_EVT

struct esp_ble_mesh_prov_cb_param_t::ble_mesh_provision_complete_evt_param node_prov_complete
    Event parameter of ESP_BLE_MESH_NODE_PROV_COMPLETE_EVT

struct esp_ble_mesh_prov_cb_param_t::ble_mesh_provision_reset_param node_prov_reset
    Event parameter of ESP_BLE_MESH_NODE_PROV_RESET_EVT

struct esp_ble_mesh_prov_cb_param_t::ble_mesh_set_oob_pub_key_comp_param node_prov_set_oob_pub_key_comp
    Event parameter of ESP_BLE_MESH_NODE_PROV_SET_OOB_PUB_KEY_COMP_EVT

struct esp_ble_mesh_prov_cb_param_t::ble_mesh_input_number_comp_param node_prov_input_num_comp
    Event parameter of ESP_BLE_MESH_NODE_PROV_INPUT_NUM_COMP_EVT

struct esp_ble_mesh_prov_cb_param_t::ble_mesh_input_string_comp_param node_prov_input_str_comp
    Event parameter of ESP_BLE_MESH_NODE_PROV_INPUT_STR_COMP_EVT

struct esp_ble_mesh_prov_cb_param_t::ble_mesh_proxy_identity_enable_comp_param node_proxy_identity_enable_comp
    Event parameter of ESP_BLE_MESH_NODE_PROXY_IDENTITY_ENABLE_COMP_EVT

struct esp_ble_mesh_prov_cb_param_t::ble_mesh_proxy_gatt_enable_comp_param node_proxy_gatt_enable_comp
    Event parameter of ESP_BLE_MESH_NODE_PROXY_GATT_ENABLE_COMP_EVT

struct esp_ble_mesh_prov_cb_param_t::ble_mesh_proxy_gatt_disable_comp_param node_proxy_gatt_disable_comp
    Event parameter of ESP_BLE_MESH_NODE_PROXY_GATT_DISABLE_COMP_EVT

struct esp_ble_mesh_prov_cb_param_t::ble_mesh_node_add_local_net_key_comp_param node_add_net_key_comp
    Event parameter of ESP_BLE_MESH_NODE_ADD_LOCAL_NET_KEY_COMP_EVT

struct esp_ble_mesh_prov_cb_param_t::ble_mesh_node_add_local_app_key_comp_param node_add_app_key_comp
    Event parameter of ESP_BLE_MESH_NODE_ADD_LOCAL_APP_KEY_COMP_EVT

struct esp_ble_mesh_prov_cb_param_t::ble_mesh_node_bind_local_mod_app_comp_param node_bind_app_key_to_model_comp
    Event parameter of ESP_BLE_MESH_NODE_BIND_APP_KEY_TO_MODEL_COMP_EVT

struct esp_ble_mesh_prov_cb_param_t::ble_mesh_provisioner_rcv_unprov_adv_pkt_param provisioner_rcv_unprov_adv_pkt
    Event parameter of ESP_BLE_MESH_PROVISIONER_RECV_UNPROV_ADV_PKT_EVT

struct esp_ble_mesh_prov_cb_param_t::ble_mesh_provisioner_prov_enable_comp_param provisioner_prov_enable_comp
    Event parameter of ESP_BLE_MESH_PROVISIONER_PROV_ENABLE_COMP_EVT

struct esp_ble_mesh_prov_cb_param_t::ble_mesh_provisioner_prov_disable_comp_param provisioner_prov_disable_comp
    Event parameter of ESP_BLE_MESH_PROVISIONER_PROV_DISABLE_COMP_EVT

struct esp_ble_mesh_prov_cb_param_t::ble_mesh_provisioner_link_open_evt_param provisioner_prov_link_open_evt
    Event parameter of ESP_BLE_MESH_PROVISIONER_PROV_LINK_OPEN_EVT

struct esp_ble_mesh_prov_cb_param_t::ble_mesh_provisioner_prov_read_oob_pub_key_evt_param provisioner_prov_read_oob_pub_key_evt
    Event parameter of ESP_BLE_MESH_PROVISIONER_PROV_READ_OOB_PUB_KEY_EVT

struct esp_ble_mesh_prov_cb_param_t::ble_mesh_provisioner_prov_input_evt_param provisioner_prov_input_evt
    Event parameter of ESP_BLE_MESH_PROVISIONER_PROV_INPUT_EVT

```

```

struct esp_ble_mesh_prov_cb_param_t::ble_mesh_provisioner_prov_output_evt_param provisioner_prov_output
    Event parameter of ESP_BLE_MESH_PROVISIONER_PROV_OUTPUT_EVT

struct esp_ble_mesh_prov_cb_param_t::ble_mesh_provisioner_link_close_evt_param provisioner_prov_link_clos
    Event parameter of ESP_BLE_MESH_PROVISIONER_PROV_LINK_CLOSE_EVT

struct esp_ble_mesh_prov_cb_param_t::ble_mesh_provisioner_prov_comp_param provisioner_prov_complete
    Event parameter of ESP_BLE_MESH_PROVISIONER_PROV_COMPLETE_EVT

struct esp_ble_mesh_prov_cb_param_t::ble_mesh_provisioner_add_unprov_dev_comp_param provisioner_add_unpr
    Event parameter of ESP_BLE_MESH_PROVISIONER_ADD_UNPROV_DEV_COMP_EVT

struct esp_ble_mesh_prov_cb_param_t::ble_mesh_provisioner_prov_dev_with_addr_comp_param provisioner_prov_
    Event parameter of ESP_BLE_MESH_PROVISIONER_PROV_DEV_WITH_ADDR_COMP_EVT

struct esp_ble_mesh_prov_cb_param_t::ble_mesh_provisioner_delete_dev_comp_param provisioner_delete_dev_c
    Event parameter of ESP_BLE_MESH_PROVISIONER_DELETE_DEV_COMP_EVT

struct esp_ble_mesh_prov_cb_param_t::ble_mesh_provisioner_set_dev_uuid_match_comp_param provisioner_set_d
    Event parameter of ESP_BLE_MESH_PROVISIONER_SET_DEV_UUID_MATCH_COMP_EVT

struct esp_ble_mesh_prov_cb_param_t::ble_mesh_provisioner_set_prov_data_info_comp_param provisioner_set_pr
    Event parameter of ESP_BLE_MESH_PROVISIONER_SET_PROV_DATA_INFO_COMP_EVT

struct esp_ble_mesh_prov_cb_param_t::ble_mesh_provisioner_set_static_oob_val_comp_param provisioner_set_sta
    Event parameter of ESP_BLE_MESH_PROVISIONER_SET_STATIC_OOB_VALUE_COMP_EVT

struct esp_ble_mesh_prov_cb_param_t::ble_mesh_provisioner_set_primary_elem_addr_comp_param provisioner_set
    Event parameter of ESP_BLE_MESH_PROVISIONER_SET_PRIMARY_ELEM_ADDR_COMP_EVT

struct esp_ble_mesh_prov_cb_param_t::ble_mesh_provisioner_prov_read_oob_pub_key_comp_param provisioner_pr
    Event parameter of ESP_BLE_MESH_PROVISIONER_PROV_READ_OOB_PUB_KEY_COMP_EVT

struct esp_ble_mesh_prov_cb_param_t::ble_mesh_provisioner_prov_input_num_comp_param provisioner_prov_inp
    Event parameter of ESP_BLE_MESH_PROVISIONER_PROV_INPUT_NUMBER_COMP_EVT

struct esp_ble_mesh_prov_cb_param_t::ble_mesh_provisioner_prov_input_str_comp_param provisioner_prov_inpu
    Event parameter of ESP_BLE_MESH_PROVISIONER_PROV_INPUT_STRING_COMP_EVT

struct esp_ble_mesh_prov_cb_param_t::ble_mesh_provisioner_set_node_name_comp_param provisioner_set_node
    Event parameter of ESP_BLE_MESH_PROVISIONER_SET_NODE_NAME_COMP_EVT

struct esp_ble_mesh_prov_cb_param_t::ble_mesh_provisioner_add_local_app_key_comp_param provisioner_add_ap
    Event parameter of ESP_BLE_MESH_PROVISIONER_ADD_LOCAL_APP_KEY_COMP_EVT

struct esp_ble_mesh_prov_cb_param_t::ble_mesh_provisioner_update_local_app_key_comp_param provisioner_upda
    Event parameter of ESP_BLE_MESH_PROVISIONER_UPDATE_LOCAL_APP_KEY_COMP_EVT

struct esp_ble_mesh_prov_cb_param_t::ble_mesh_provisioner_bind_local_mod_app_comp_param provisioner_bind_
    Event parameter of ESP_BLE_MESH_PROVISIONER_BIND_APP_KEY_TO_MODEL_COMP_EVT

struct esp_ble_mesh_prov_cb_param_t::ble_mesh_provisioner_add_local_net_key_comp_param provisioner_add_ne
    Event parameter of ESP_BLE_MESH_PROVISIONER_ADD_LOCAL_NET_KEY_COMP_EVT

struct esp_ble_mesh_prov_cb_param_t::ble_mesh_provisioner_update_local_net_key_comp_param provisioner_updat
    Event parameter of ESP_BLE_MESH_PROVISIONER_UPDATE_LOCAL_NET_KEY_COMP_EVT

struct esp_ble_mesh_prov_cb_param_t::ble_mesh_provisioner_store_node_comp_data_comp_param provisioner_sto
    Event parameter of ESP_BLE_MESH_PROVISIONER_STORE_NODE_COMP_DATA_COMP_EVT

struct esp_ble_mesh_prov_cb_param_t::ble_mesh_provisioner_delete_node_with_uuid_comp_param provisioner_del
    Event parameter of ESP_BLE_MESH_PROVISIONER_DELETE_NODE_WITH_UUID_COMP_EVT

struct esp_ble_mesh_prov_cb_param_t::ble_mesh_provisioner_delete_node_with_addr_comp_param provisioner_del
    Event parameter of ESP_BLE_MESH_PROVISIONER_DELETE_NODE_WITH_ADDR_COMP_EVT

int err_code
    Indicate the result of enabling/disabling to receive heartbeat messages by the Provisioner

    Indicate the result of setting the heartbeat filter type by the Provisioner

```

Indicate the result of setting the heartbeat filter address by the Provisioner

Indicate the result of directly erasing settings by the Provisioner

Indicate the result of opening settings with index by the Provisioner

Indicate the result of opening settings with user id by the Provisioner

Indicate the result of closing settings with index by the Provisioner

Indicate the result of closing settings with user id by the Provisioner

Indicate the result of deleting settings with index by the Provisioner

Indicate the result of deleting settings with user id by the Provisioner

bool **enable**

Indicate enabling or disabling receiving heartbeat messages

struct *esp_ble_mesh_prov_cb_param_t*::[anonymous] **provisioner_enable_heartbeat_recv_comp**
ESP_BLE_MESH_PROVISIONER_ENABLE_HEARTBEAT_RECV_COMP_EVT.

Event parameters of ESP_BLE_MESH_PROVISIONER_ENABLE_HEARTBEAT_RECV_COMP_EVT

uint8_t **type**

Type of the filter used for receiving heartbeat messages

struct *esp_ble_mesh_prov_cb_param_t*::[anonymous] **provisioner_set_heartbeat_filter_type_comp**
ESP_BLE_MESH_PROVISIONER_SET_HEARTBEAT_FILTER_TYPE_COMP_EVT.

Event parameters of ESP_BLE_MESH_PROVISIONER_SET_HEARTBEAT_FILTER_TYPE_COMP_EVT

uint8_t **op**

Operation (add, remove, clean)

uint16_t **hb_src**

Heartbeat source address

uint16_t **hb_dst**

Heartbeat destination address

struct *esp_ble_mesh_prov_cb_param_t*::[anonymous] **provisioner_set_heartbeat_filter_info_comp**
ESP_BLE_MESH_PROVISIONER_SET_HEARTBEAT_FILTER_INFO_COMP_EVT.

Event parameters of ESP_BLE_MESH_PROVISIONER_SET_HEARTBEAT_FILTER_INFO_COMP_EVT

uint8_t **init_ttl**

Heartbeat InitTTL

uint8_t **rx_ttl**

Heartbeat RxTTL

uint8_t **hops**

Heartbeat hops (InitTTL - RxTTL + 1)

uint16_t **feature**

Bit field of currently active features of the node

int8_t **rss_i**

RSSI of the heartbeat message

struct *esp_ble_mesh_prov_cb_param_t*::[anonymous] **provisioner_rcv_heartbeat**
ESP_BLE_MESH_PROVISIONER_RECV_HEARTBEAT_MESSAGE_EVT.

Event parameters of ESP_BLE_MESH_PROVISIONER_RECV_HEARTBEAT_MESSAGE_EVT

struct *esp_ble_mesh_prov_cb_param_t*::[anonymous] **provisioner_direct_erase_settings_comp**
ESP_BLE_MESH_PROVISIONER_DRIECT_ERASE_SETTINGS_COMP_EVT.

Event parameters of ESP_BLE_MESH_PROVISIONER_DRIECT_ERASE_SETTINGS_COMP_EVT

uint8_t index

Index of Provisioner settings

struct esp_ble_mesh_prov_cb_param_t::[anonymous] provisioner_open_settings_with_index_comp
ESP_BLE_MESH_PROVISIONER_OPEN_SETTINGS_WITH_INDEX_COMP_EVT.

Event parameter of ESP_BLE_MESH_PROVISIONER_OPEN_SETTINGS_WITH_INDEX_COMP_EVT

char **uid**[ESP_BLE_MESH_SETTINGS_UID_SIZE + 1]

Provisioner settings user id

struct esp_ble_mesh_prov_cb_param_t::[anonymous] provisioner_open_settings_with_uid_comp
ESP_BLE_MESH_PROVISIONER_OPEN_SETTINGS_WITH_UID_COMP_EVT.

Event parameters of ESP_BLE_MESH_PROVISIONER_OPEN_SETTINGS_WITH_UID_COMP_EVT

struct esp_ble_mesh_prov_cb_param_t::[anonymous] provisioner_close_settings_with_index_comp
ESP_BLE_MESH_PROVISIONER_CLOSE_SETTINGS_WITH_INDEX_COMP_EVT.

Event parameter of ESP_BLE_MESH_PROVISIONER_CLOSE_SETTINGS_WITH_INDEX_COMP_EVT

struct esp_ble_mesh_prov_cb_param_t::[anonymous] provisioner_close_settings_with_uid_comp
ESP_BLE_MESH_PROVISIONER_CLOSE_SETTINGS_WITH_UID_COMP_EVT.

Event parameters of ESP_BLE_MESH_PROVISIONER_CLOSE_SETTINGS_WITH_UID_COMP_EVT

struct esp_ble_mesh_prov_cb_param_t::[anonymous] provisioner_delete_settings_with_index_comp
ESP_BLE_MESH_PROVISIONER_DELETE_SETTINGS_WITH_INDEX_COMP_EVT.

Event parameter of ESP_BLE_MESH_PROVISIONER_DELETE_SETTINGS_WITH_INDEX_COMP_EVT

struct esp_ble_mesh_prov_cb_param_t::[anonymous] provisioner_delete_settings_with_uid_comp
ESP_BLE_MESH_PROVISIONER_DELETE_SETTINGS_WITH_UID_COMP_EVT.

Event parameters of ESP_BLE_MESH_PROVISIONER_DELETE_SETTINGS_WITH_UID_COMP_EVT

struct esp_ble_mesh_prov_cb_param_t::ble_mesh_set_fast_prov_info_comp_param set_fast_prov_info_comp
Event parameter of ESP_BLE_MESH_SET_FAST_PROV_INFO_COMP_EVT

struct esp_ble_mesh_prov_cb_param_t::ble_mesh_set_fast_prov_action_comp_param set_fast_prov_action_comp
Event parameter of ESP_BLE_MESH_SET_FAST_PROV_ACTION_COMP_EVT

struct esp_ble_mesh_prov_cb_param_t::ble_mesh_heartbeat_msg_rcv_param heartbeat_msg_rcv
Event parameter of ESP_BLE_MESH_HEARTBEAT_MESSAGE_RECV_EVT

struct esp_ble_mesh_prov_cb_param_t::ble_mesh_lpn_enable_comp_param lpn_enable_comp
Event parameter of ESP_BLE_MESH_LPN_ENABLE_COMP_EVT

struct esp_ble_mesh_prov_cb_param_t::ble_mesh_lpn_disable_comp_param lpn_disable_comp
Event parameter of ESP_BLE_MESH_LPN_DISABLE_COMP_EVT

struct esp_ble_mesh_prov_cb_param_t::ble_mesh_lpn_poll_comp_param lpn_poll_comp
Event parameter of ESP_BLE_MESH_LPN_POLL_COMP_EVT

struct esp_ble_mesh_prov_cb_param_t::ble_mesh_lpn_friendship_establish_param lpn_friendship_establish
Event parameter of ESP_BLE_MESH_LPN_FRIENDSHIP_ESTABLISH_EVT

struct esp_ble_mesh_prov_cb_param_t::ble_mesh_lpn_friendship_terminate_param lpn_friendship_terminate
Event parameter of ESP_BLE_MESH_LPN_FRIENDSHIP_TERMINATE_EVT

struct esp_ble_mesh_prov_cb_param_t::ble_mesh_friend_friendship_establish_param frnd_friendship_establish
Event parameter of ESP_BLE_MESH_FRIEND_FRIENDSHIP_ESTABLISH_EVT

struct esp_ble_mesh_prov_cb_param_t::ble_mesh_friend_friendship_terminate_param frnd_friendship_terminate
Event parameter of ESP_BLE_MESH_FRIEND_FRIENDSHIP_TERMINATE_EVT

struct esp_ble_mesh_prov_cb_param_t::ble_mesh_proxy_client_rcv_adv_pkt_param proxy_client_rcv_adv_pkt
Event parameter of ESP_BLE_MESH_PROXY_CLIENT_RECV_ADV_PKT_EVT

struct esp_ble_mesh_prov_cb_param_t::ble_mesh_proxy_client_connected_param proxy_client_connected
Event parameter of ESP_BLE_MESH_PROXY_CLIENT_CONNECTED_EVT

```

struct esp_ble_mesh_prov_cb_param_t::ble_mesh_proxy_client_disconnected_param proxy_client_disconnected
    Event parameter of ESP_BLE_MESH_PROXY_CLIENT_DISCONNECTED_EVT

struct esp_ble_mesh_prov_cb_param_t::ble_mesh_proxy_client_rcv_filter_status_param proxy_client_rcv_filt
    Event parameter of ESP_BLE_MESH_PROXY_CLIENT_RECV_FILTER_STATUS_EVT

struct esp_ble_mesh_prov_cb_param_t::ble_mesh_proxy_client_connect_comp_param proxy_client_connect_comp
    Event parameter of ESP_BLE_MESH_PROXY_CLIENT_CONNECT_COMP_EVT

struct esp_ble_mesh_prov_cb_param_t::ble_mesh_proxy_client_disconnect_comp_param proxy_client_disconnect
    Event parameter of ESP_BLE_MESH_PROXY_CLIENT_DISCONNECT_COMP_EVT

struct esp_ble_mesh_prov_cb_param_t::ble_mesh_proxy_client_set_filter_type_comp_param proxy_client_set_filt
    Event parameter of ESP_BLE_MESH_PROXY_CLIENT_SET_FILTER_TYPE_COMP_EVT

struct esp_ble_mesh_prov_cb_param_t::ble_mesh_proxy_client_add_filter_addr_comp_param proxy_client_add_fi
    Event parameter of ESP_BLE_MESH_PROXY_CLIENT_ADD_FILTER_ADDR_COMP_EVT

struct esp_ble_mesh_prov_cb_param_t::ble_mesh_proxy_client_remove_filter_addr_comp_param proxy_client_remo
    Event parameter of ESP_BLE_MESH_PROXY_CLIENT_REMOVE_FILTER_ADDR_COMP_EVT

struct esp_ble_mesh_prov_cb_param_t::ble_mesh_proxy_server_connected_param proxy_server_connected
    Event parameter of ESP_BLE_MESH_PROXY_SERVER_CONNECTED_EVT

struct esp_ble_mesh_prov_cb_param_t::ble_mesh_proxy_server_disconnected_param proxy_server_disconnected
    Event parameter of ESP_BLE_MESH_PROXY_SERVER_DISCONNECTED_EVT

struct esp_ble_mesh_prov_cb_param_t::ble_mesh_model_sub_group_addr_comp_param model_sub_group_addr_co
    Event parameters of ESP_BLE_MESH_MODEL_SUBSCRIBE_GROUP_ADDR_COMP_EVT

struct esp_ble_mesh_prov_cb_param_t::ble_mesh_model_unsub_group_addr_comp_param model_unsub_group_addr
    Event parameters of ESP_BLE_MESH_MODEL_UNSUBSCRIBE_GROUP_ADDR_COMP_EVT

struct esp_ble_mesh_prov_cb_param_t::ble_mesh_deinit_mesh_comp_param deinit_mesh_comp
    Event parameter of ESP_BLE_MESH_DEINIT_MESH_COMP_EVT

struct ble_mesh_deinit_mesh_comp_param
    #include <esp_ble_mesh_defs.h> ESP_BLE_MESH_DEINIT_MESH_COMP_EVT.

```

Public Members

```

int err_code
    Indicate the result of BLE Mesh deinitialization

```

```

struct ble_mesh_friend_friendship_establish_param
    #include <esp_ble_mesh_defs.h> ESP_BLE_MESH_FRIEND_FRIENDSHIP_ESTABLISH_EVT.

```

Public Members

```

uint16_t lpn_addr
    Low Power Node unicast address

```

```

struct ble_mesh_friend_friendship_terminate_param
    #include <esp_ble_mesh_defs.h> ESP_BLE_MESH_FRIEND_FRIENDSHIP_TERMINATE_EVT.

```

Public Types

```

enum [anonymous]
    This enum value is the reason of friendship termination on the friend node side

    Values:

```

ESP_BLE_MESH_FRND_FRIENDSHIP_TERMINATE_ESTABLISH_FAIL

Friend Offer has been sent, but Friend Offer is not received within 1 second, friendship fails to be established

ESP_BLE_MESH_FRND_FRIENDSHIP_TERMINATE_POLL_TIMEOUT

Friendship is established, PollTimeout timer expires and no Friend Poll/Sub Add/Sub Remove is received

ESP_BLE_MESH_FRND_FRIENDSHIP_TERMINATE_RECV_FRND_REQ

Receive Friend Request from existing Low Power Node

ESP_BLE_MESH_FRND_FRIENDSHIP_TERMINATE_RECV_FRND_CLEAR

Receive Friend Clear from other friend node

ESP_BLE_MESH_FRND_FRIENDSHIP_TERMINATE_DISABLE

Friend feature disabled or corresponding NetKey is deleted

Public Members**uint16_t lpn_addr**

Low Power Node unicast address

***esp_ble_mesh_prov_cb_param_t::ble_mesh_friend_friendship_terminate_param::*[anonymous] reason**

This enum value is the reason of friendship termination on the friend node side Friendship terminated reason

struct ble_mesh_heartbeat_msg_rcv_param

#include <esp_ble_mesh_defs.h> ESP_BLE_MESH_HEARTBEAT_MESSAGE_RECV_EVT.

Public Members**uint8_t hops**

Heartbeat hops (InitTTL - RxTTL + 1)

uint16_t feature

Bit field of currently active features of the node

struct ble_mesh_input_evt_param

#include <esp_ble_mesh_defs.h> ESP_BLE_MESH_NODE_PROV_INPUT_EVT.

Public Members***esp_ble_mesh_input_action_t* action**

Action of Input OOB Authentication

uint8_t size

Size of Input OOB Authentication

struct ble_mesh_input_number_comp_param

#include <esp_ble_mesh_defs.h> ESP_BLE_MESH_NODE_PROV_INPUT_NUM_COMP_EVT.

Public Members**int err_code**

Indicate the result of inputting number

struct ble_mesh_input_string_comp_param

#include <esp_ble_mesh_defs.h> ESP_BLE_MESH_NODE_PROV_INPUT_STR_COMP_EVT.

Public Members

int **err_code**
Indicate the result of inputting string

struct ble_mesh_link_close_evt_param
#include <esp_ble_mesh_defs.h> ESP_BLE_MESH_NODE_PROV_LINK_CLOSE_EVT.

Public Members

esp_ble_mesh_prov_bearer_t **bearer**
Type of the bearer used when device link is closed

struct ble_mesh_link_open_evt_param
#include <esp_ble_mesh_defs.h> ESP_BLE_MESH_NODE_PROV_LINK_OPEN_EVT.

Public Members

esp_ble_mesh_prov_bearer_t **bearer**
Type of the bearer used when device link is open

struct ble_mesh_lpn_disable_comp_param
#include <esp_ble_mesh_defs.h> ESP_BLE_MESH_LPN_DISABLE_COMP_EVT.

Public Members

int **err_code**
Indicate the result of disabling LPN functionality

struct ble_mesh_lpn_enable_comp_param
#include <esp_ble_mesh_defs.h> ESP_BLE_MESH_LPN_ENABLE_COMP_EVT.

Public Members

int **err_code**
Indicate the result of enabling LPN functionality

struct ble_mesh_lpn_friendship_establish_param
#include <esp_ble_mesh_defs.h> ESP_BLE_MESH_LPN_FRIENDSHIP_ESTABLISH_EVT.

Public Members

uint16_t **friend_addr**
Friend Node unicast address

struct ble_mesh_lpn_friendship_terminate_param
#include <esp_ble_mesh_defs.h> ESP_BLE_MESH_LPN_FRIENDSHIP_TERMINATE_EVT.

Public Members

uint16_t **friend_addr**
Friend Node unicast address

struct ble_mesh_lpn_poll_comp_param
#include <esp_ble_mesh_defs.h> ESP_BLE_MESH_LPN_POLL_COMP_EVT.

Public Members

int **err_code**
Indicate the result of sending Friend Poll

struct ble_mesh_model_sub_group_addr_comp_param
*#include <esp_ble_mesh_defs.h>*ESP_BLE_MESH_MODEL_SUBSCRIBE_GROUP_ADDR_COMP_EVT.

Public Members

int **err_code**
Indicate the result of local model subscribing group address

uint16_t **element_addr**
Element address

uint16_t **company_id**
Company ID

uint16_t **model_id**
Model ID

uint16_t **group_addr**
Group Address

struct ble_mesh_model_unsub_group_addr_comp_param
*#include <esp_ble_mesh_defs.h>*ESP_BLE_MESH_MODEL_UNSUBSCRIBE_GROUP_ADDR_COMP_EVT.

Public Members

int **err_code**
Indicate the result of local model unsubscribing group address

uint16_t **element_addr**
Element address

uint16_t **company_id**
Company ID

uint16_t **model_id**
Model ID

uint16_t **group_addr**
Group Address

struct ble_mesh_node_add_local_app_key_comp_param
*#include <esp_ble_mesh_defs.h>*ESP_BLE_MESH_NODE_ADD_LOCAL_APP_KEY_COMP_EVT.

Public Members

int **err_code**
Indicate the result of adding local AppKey by the node

uint16_t **net_idx**
NetKey Index

uint16_t **app_idx**
AppKey Index

struct ble_mesh_node_add_local_net_key_comp_param
*#include <esp_ble_mesh_defs.h>*ESP_BLE_MESH_NODE_ADD_LOCAL_NET_KEY_COMP_EVT.

Public Members

int **err_code**
Indicate the result of adding local NetKey by the node

uint16_t **net_idx**
NetKey Index

struct ble_mesh_node_bind_local_mod_app_comp_param
#include <esp_ble_mesh_defs.h> ESP_BLE_MESH_NODE_BIND_APP_KEY_TO_MODEL_COMP_EVT.

Public Members

int **err_code**
Indicate the result of binding AppKey with model by the node

uint16_t **element_addr**
Element address

uint16_t **app_idx**
AppKey Index

uint16_t **company_id**
Company ID

uint16_t **model_id**
Model ID

struct ble_mesh_output_num_evt_param
#include <esp_ble_mesh_defs.h> ESP_BLE_MESH_NODE_PROV_OUTPUT_NUMBER_EVT.

Public Members

esp_ble_mesh_output_action_t **action**
Action of Output OOB Authentication

uint32_t **number**
Number of Output OOB Authentication

struct ble_mesh_output_str_evt_param
#include <esp_ble_mesh_defs.h> ESP_BLE_MESH_NODE_PROV_OUTPUT_STRING_EVT.

Public Members

char **string**[8]
String of Output OOB Authentication

struct ble_mesh_prov_disable_comp_param
#include <esp_ble_mesh_defs.h> ESP_BLE_MESH_NODE_PROV_DISABLE_COMP_EVT.

Public Members

int **err_code**
Indicate the result of disabling BLE Mesh device

struct ble_mesh_prov_enable_comp_param
#include <esp_ble_mesh_defs.h> ESP_BLE_MESH_NODE_PROV_ENABLE_COMP_EVT.

Public Members

int **err_code**
Indicate the result of enabling BLE Mesh device

struct ble_mesh_prov_register_comp_param
#include <esp_ble_mesh_defs.h> ESP_BLE_MESH_PROV_REGISTER_COMP_EVT.

Public Members

int **err_code**
Indicate the result of BLE Mesh initialization

struct ble_mesh_provision_complete_evt_param
#include <esp_ble_mesh_defs.h> ESP_BLE_MESH_NODE_PROV_COMPLETE_EVT.

Public Members

uint16_t **net_idx**
NetKey Index

uint8_t **net_key**[16]
NetKey

uint16_t **addr**
Primary address

uint8_t **flags**
Flags

uint32_t **iv_index**
IV Index

struct ble_mesh_provision_reset_param
#include <esp_ble_mesh_defs.h> ESP_BLE_MESH_NODE_PROV_RESET_EVT.

struct ble_mesh_provisioner_add_local_app_key_comp_param
#include <esp_ble_mesh_defs.h> ESP_BLE_MESH_PROVISIONER_ADD_LOCAL_APP_KEY_COMP_EVT.

Public Members

int **err_code**
Indicate the result of adding local AppKey by the Provisioner

uint16_t **net_idx**
NetKey Index

uint16_t **app_idx**
AppKey Index

struct ble_mesh_provisioner_add_local_net_key_comp_param
#include <esp_ble_mesh_defs.h> ESP_BLE_MESH_PROVISIONER_ADD_LOCAL_NET_KEY_COMP_EVT.

Public Members

int **err_code**
Indicate the result of adding local NetKey by the Provisioner

uint16_t **net_idx**
NetKey Index

```
struct ble_mesh_provisioner_add_unprov_dev_comp_param  
#include <esp_ble_mesh_defs.h> ESP_BLE_MESH_PROVISIONER_ADD_UNPROV_DEV_COMP_EVT.
```

Public Members

int **err_code**
Indicate the result of adding device into queue by the Provisioner

```
struct ble_mesh_provisioner_bind_local_mod_app_comp_param  
#include <esp_ble_mesh_defs.h> ESP_BLE_MESH_PROVISIONER_BIND_APP_KEY_TO_MODEL_COMP_EVT.
```

Public Members

int **err_code**
Indicate the result of binding AppKey with model by the Provisioner

uint16_t **element_addr**
Element address

uint16_t **app_idx**
AppKey Index

uint16_t **company_id**
Company ID

uint16_t **model_id**
Model ID

```
struct ble_mesh_provisioner_delete_dev_comp_param  
#include <esp_ble_mesh_defs.h> ESP_BLE_MESH_PROVISIONER_DELETE_DEV_COMP_EVT.
```

Public Members

int **err_code**
Indicate the result of deleting device by the Provisioner

```
struct ble_mesh_provisioner_delete_node_with_addr_comp_param  
#include <esp_ble_mesh_defs.h> ESP_BLE_MESH_PROVISIONER_DELETE_NODE_WITH_ADDR_COMP_EVT.
```

Public Members

int **err_code**
Indicate the result of deleting node with unicast address by the Provisioner

uint16_t **unicast_addr**
Node unicast address

```
struct ble_mesh_provisioner_delete_node_with_uuid_comp_param  
#include <esp_ble_mesh_defs.h> ESP_BLE_MESH_PROVISIONER_DELETE_NODE_WITH_UUID_COMP_EVT.
```

Public Members

int **err_code**
Indicate the result of deleting node with uuid by the Provisioner

uint8_t **uuid**[16]
Node device uuid

```
struct ble_mesh_provisioner_link_close_evt_param  
#include <esp_ble_mesh_defs.h> ESP_BLE_MESH_PROVISIONER_PROV_LINK_CLOSE_EVT.
```

Public Members

esp_ble_mesh_prov_bearer_t **bearer**
Type of the bearer used when Provisioner link is closed

uint8_t **reason**
Reason of the closed provisioning link

```
struct ble_mesh_provisioner_link_open_evt_param  
#include <esp_ble_mesh_defs.h> ESP_BLE_MESH_PROVISIONER_PROV_LINK_OPEN_EVT.
```

Public Members

esp_ble_mesh_prov_bearer_t **bearer**
Type of the bearer used when Provisioner link is opened

```
struct ble_mesh_provisioner_prov_comp_param  
#include <esp_ble_mesh_defs.h> ESP_BLE_MESH_PROVISIONER_PROV_COMPLETE_EVT.
```

Public Members

uint16_t **node_idx**
Index of the provisioned device

esp_ble_mesh_octet16_t **device_uuid**
Device UUID of the provisioned device

uint16_t **unicast_addr**
Primary address of the provisioned device

uint8_t **element_num**
Element count of the provisioned device

uint16_t **netkey_idx**
NetKey Index of the provisioned device

```
struct ble_mesh_provisioner_prov_dev_with_addr_comp_param  
#include <esp_ble_mesh_defs.h> ESP_BLE_MESH_PROVISIONER_PROV_DEV_WITH_ADDR_COMP_EVT.
```

Public Members

int **err_code**
Indicate the result of Provisioner starting to provision a device

```
struct ble_mesh_provisioner_prov_disable_comp_param  
#include <esp_ble_mesh_defs.h> ESP_BLE_MESH_PROVISIONER_PROV_DISABLE_COMP_EVT.
```

Public Members

int **err_code**
Indicate the result of disabling BLE Mesh Provisioner

```
struct ble_mesh_provisioner_prov_enable_comp_param  
#include <esp_ble_mesh_defs.h> ESP_BLE_MESH_PROVISIONER_PROV_ENABLE_COMP_EVT.
```

Public Members

int **err_code**
Indicate the result of enabling BLE Mesh Provisioner

struct ble_mesh_provisioner_prov_input_evt_param
#include <esp_ble_mesh_defs.h> ESP_BLE_MESH_PROVISIONER_PROV_INPUT_EVT.

Public Members

esp_ble_mesh_oob_method_t **method**
Method of device Output OOB Authentication

esp_ble_mesh_output_action_t **action**
Action of device Output OOB Authentication

uint8_t **size**
Size of device Output OOB Authentication

uint8_t **link_idx**
Index of the provisioning link

struct ble_mesh_provisioner_prov_input_num_comp_param
#include <esp_ble_mesh_defs.h> ESP_BLE_MESH_PROVISIONER_PROV_INPUT_NUMBER_COMP_EVT.

Public Members

int **err_code**
Indicate the result of inputting number by the Provisioner

struct ble_mesh_provisioner_prov_input_str_comp_param
#include <esp_ble_mesh_defs.h> ESP_BLE_MESH_PROVISIONER_PROV_INPUT_STRING_COMP_EVT.

Public Members

int **err_code**
Indicate the result of inputting string by the Provisioner

struct ble_mesh_provisioner_prov_output_evt_param
#include <esp_ble_mesh_defs.h> ESP_BLE_MESH_PROVISIONER_PROV_OUTPUT_EVT.

Public Members

esp_ble_mesh_oob_method_t **method**
Method of device Input OOB Authentication

esp_ble_mesh_input_action_t **action**
Action of device Input OOB Authentication

uint8_t **size**
Size of device Input OOB Authentication

uint8_t **link_idx**
Index of the provisioning link

char **string**[8]
String output by the Provisioner

uint32_t **number**
Number output by the Provisioner

```
union esp_ble_mesh_prov_cb_param_t::ble_mesh_provisioner_prov_output_evt_param::[anonymous] [anonymous]
```

```
struct ble_mesh_provisioner_prov_read_oob_pub_key_comp_param  
#include <esp_ble_mesh_defs.h>ESP_BLE_MESH_PROVISIONER_PROV_READ_OOB_PUB_KEY_COMP_EVT.
```

Public Members

```
int err_code  
Indicate the result of setting OOB Public Key by the Provisioner
```

```
struct ble_mesh_provisioner_prov_read_oob_pub_key_evt_param  
#include <esp_ble_mesh_defs.h>ESP_BLE_MESH_PROVISIONER_PROV_READ_OOB_PUB_KEY_EVT.
```

Public Members

```
uint8_t link_idx  
Index of the provisioning link
```

```
struct ble_mesh_provisioner_recv_unprov_adv_pkt_param  
#include <esp_ble_mesh_defs.h>ESP_BLE_MESH_PROVISIONER_RECV_UNPROV_ADV_PKT_EVT.
```

Public Members

```
uint8_t dev_uuid[16]  
Device UUID of the unprovisioned device
```

```
esp_ble_mesh_bd_addr_t addr  
Device address of the unprovisioned device
```

```
esp_ble_mesh_addr_type_t addr_type  
Device address type
```

```
uint16_t oob_info  
OOB Info of the unprovisioned device
```

```
uint8_t adv_type  
Advertising type of the unprovisioned device
```

```
esp_ble_mesh_prov_bearer_t bearer  
Bearer of the unprovisioned device
```

```
int8_t rssi  
RSSI of the received advertising packet
```

```
struct ble_mesh_provisioner_set_dev_uuid_match_comp_param  
#include <esp_ble_mesh_defs.h>ESP_BLE_MESH_PROVISIONER_SET_DEV_UUID_MATCH_COMP_EVT.
```

Public Members

```
int err_code  
Indicate the result of setting Device UUID match value by the Provisioner
```

```
struct ble_mesh_provisioner_set_node_name_comp_param  
#include <esp_ble_mesh_defs.h>ESP_BLE_MESH_PROVISIONER_SET_NODE_NAME_COMP_EVT.
```

Public Members**int err_code**

Indicate the result of setting provisioned device name by the Provisioner

uint16_t node_index

Index of the provisioned device

struct ble_mesh_provisioner_set_primary_elem_addr_comp_param*#include <esp_ble_mesh_defs.h>* ESP_BLE_MESH_PROVISIONER_SET_PRIMARY_ELEM_ADDR_COMP_EVT.**Public Members****int err_code**

Indicate the result of setting unicast address of primary element by the Provisioner

struct ble_mesh_provisioner_set_prov_data_info_comp_param*#include <esp_ble_mesh_defs.h>* ESP_BLE_MESH_PROVISIONER_SET_PROV_DATA_INFO_COMP_EVT.**Public Members****int err_code**

Indicate the result of setting provisioning info by the Provisioner

struct ble_mesh_provisioner_set_static_oob_val_comp_param*#include <esp_ble_mesh_defs.h>* ESP_BLE_MESH_PROVISIONER_SET_STATIC_OOB_VALUE_COMP_EVT.**Public Members****int err_code**

Indicate the result of setting static oob value by the Provisioner

struct ble_mesh_provisioner_store_node_comp_data_comp_param*#include <esp_ble_mesh_defs.h>* ESP_BLE_MESH_PROVISIONER_STORE_NODE_COMP_DATA_COMP_EVT.**Public Members****int err_code**

Indicate the result of storing node composition data by the Provisioner

uint16_t addr

Node element address

struct ble_mesh_provisioner_update_local_app_key_comp_param*#include <esp_ble_mesh_defs.h>* ESP_BLE_MESH_PROVISIONER_UPDATE_LOCAL_APP_KEY_COMP_EVT.**Public Members****int err_code**

Indicate the result of updating local AppKey by the Provisioner

uint16_t net_idx

NetKey Index

uint16_t app_idx

AppKey Index

```
struct ble_mesh_provisioner_update_local_net_key_comp_param  
#include <esp_ble_mesh_defs.h> ESP_BLE_MESH_PROVISIONER_UPDATE_LOCAL_NET_KEY_COMP_EVT.
```

Public Members

int **err_code**
Indicate the result of updating local NetKey by the Provisioner

uint16_t **net_idx**
NetKey Index

```
struct ble_mesh_proxy_client_add_filter_addr_comp_param  
#include <esp_ble_mesh_defs.h> ESP_BLE_MESH_PROXY_CLIENT_ADD_FILTER_ADDR_COMP_EVT.
```

Public Members

int **err_code**
Indicate the result of Proxy Client add filter address

uint8_t **conn_handle**
Proxy connection handle

uint16_t **net_idx**
Corresponding NetKey Index

```
struct ble_mesh_proxy_client_connect_comp_param  
#include <esp_ble_mesh_defs.h> ESP_BLE_MESH_PROXY_CLIENT_CONNECT_COMP_EVT.
```

Public Members

int **err_code**
Indicate the result of Proxy Client connect

esp_ble_mesh_bd_addr_t **addr**
Device address of the Proxy Server

esp_ble_mesh_addr_type_t **addr_type**
Device address type

uint16_t **net_idx**
Corresponding NetKey Index

```
struct ble_mesh_proxy_client_connected_param  
#include <esp_ble_mesh_defs.h> ESP_BLE_MESH_PROXY_CLIENT_CONNECTED_EVT.
```

Public Members

esp_ble_mesh_bd_addr_t **addr**
Device address of the Proxy Server

esp_ble_mesh_addr_type_t **addr_type**
Device address type

uint8_t **conn_handle**
Proxy connection handle

uint16_t **net_idx**
Corresponding NetKey Index

```
struct ble_mesh_proxy_client_disconnect_comp_param  
#include <esp_ble_mesh_defs.h> ESP_BLE_MESH_PROXY_CLIENT_DISCONNECT_COMP_EVT.
```

Public Members

int **err_code**
Indicate the result of Proxy Client disconnect

uint8_t **conn_handle**
Proxy connection handle

struct ble_mesh_proxy_client_disconnected_param
#include <esp_ble_mesh_defs.h> ESP_BLE_MESH_PROXY_CLIENT_DISCONNECTED_EVT.

Public Members

esp_ble_mesh_bd_addr_t **addr**
Device address of the Proxy Server

esp_ble_mesh_addr_type_t **addr_type**
Device address type

uint8_t **conn_handle**
Proxy connection handle

uint16_t **net_idx**
Corresponding NetKey Index

uint8_t **reason**
Proxy disconnect reason

struct ble_mesh_proxy_client_rcv_adv_pkt_param
#include <esp_ble_mesh_defs.h> ESP_BLE_MESH_PROXY_CLIENT_RECV_ADV_PKT_EVT.

Public Members

esp_ble_mesh_bd_addr_t **addr**
Device address

esp_ble_mesh_addr_type_t **addr_type**
Device address type

uint16_t **net_idx**
Network ID related NetKey Index

uint8_t **net_id**[8]
Network ID contained in the advertising packet

int8_t **rssi**
RSSI of the received advertising packet

struct ble_mesh_proxy_client_rcv_filter_status_param
#include <esp_ble_mesh_defs.h> ESP_BLE_MESH_PROXY_CLIENT_RECV_FILTER_STATUS_EVT.

Public Members

uint8_t **conn_handle**
Proxy connection handle

uint16_t **server_addr**
Proxy Server primary element address

uint16_t **net_idx**
Corresponding NetKey Index

uint8_t filter_type
Proxy Server filter type(whitelist or blacklist)

uint16_t list_size
Number of addresses in the Proxy Server filter list

struct ble_mesh_proxy_client_remove_filter_addr_comp_param
*#include <esp_ble_mesh_defs.h>*ESP_BLE_MESH_PROXY_CLIENT_REMOVE_FILTER_ADDR_COMP_EVT.

Public Members

int err_code
Indicate the result of Proxy Client remove filter address

uint8_t conn_handle
Proxy connection handle

uint16_t net_idx
Corresponding NetKey Index

struct ble_mesh_proxy_client_set_filter_type_comp_param
*#include <esp_ble_mesh_defs.h>*ESP_BLE_MESH_PROXY_CLIENT_SET_FILTER_TYPE_COMP_EVT.

Public Members

int err_code
Indicate the result of Proxy Client set filter type

uint8_t conn_handle
Proxy connection handle

uint16_t net_idx
Corresponding NetKey Index

struct ble_mesh_proxy_gatt_disable_comp_param
*#include <esp_ble_mesh_defs.h>*ESP_BLE_MESH_NODE_PROXY_GATT_DISABLE_COMP_EVT.

Public Members

int err_code
Indicate the result of disabling Mesh Proxy Service

struct ble_mesh_proxy_gatt_enable_comp_param
*#include <esp_ble_mesh_defs.h>*ESP_BLE_MESH_NODE_PROXY_GATT_ENABLE_COMP_EVT.

Public Members

int err_code
Indicate the result of enabling Mesh Proxy Service

struct ble_mesh_proxy_identity_enable_comp_param
*#include <esp_ble_mesh_defs.h>*ESP_BLE_MESH_NODE_PROXY_IDENTITY_ENABLE_COMP_EVT.

Public Members

int err_code
Indicate the result of enabling Mesh Proxy advertising

```
struct ble_mesh_proxy_server_connected_param  
#include <esp_ble_mesh_defs.h> ESP_BLE_MESH_PROXY_SERVER_CONNECTED_EVT.
```

Public Members

```
uint8_t conn_handle  
Proxy connection handle
```

```
struct ble_mesh_proxy_server_disconnected_param  
#include <esp_ble_mesh_defs.h> ESP_BLE_MESH_PROXY_SERVER_DISCONNECTED_EVT.
```

Public Members

```
uint8_t conn_handle  
Proxy connection handle
```

```
uint8_t reason  
Proxy disconnect reason
```

```
struct ble_mesh_set_fast_prov_action_comp_param  
#include <esp_ble_mesh_defs.h> ESP_BLE_MESH_SET_FAST_PROV_ACTION_COMP_EVT.
```

Public Members

```
uint8_t status_action  
Indicate the result of setting action of fast provisioning
```

```
struct ble_mesh_set_fast_prov_info_comp_param  
#include <esp_ble_mesh_defs.h> ESP_BLE_MESH_SET_FAST_PROV_INFO_COMP_EVT.
```

Public Members

```
uint8_t status_unicast  
Indicate the result of setting unicast address range of fast provisioning
```

```
uint8_t status_net_idx  
Indicate the result of setting NetKey Index of fast provisioning
```

```
uint8_t status_match  
Indicate the result of setting matching Device UUID of fast provisioning
```

```
struct ble_mesh_set_oob_pub_key_comp_param  
#include <esp_ble_mesh_defs.h> ESP_BLE_MESH_NODE_PROV_SET_OOB_PUB_KEY_COMP_EVT.
```

Public Members

```
int err_code  
Indicate the result of setting OOB Public Key
```

```
struct ble_mesh_set_unprov_dev_name_comp_param  
#include <esp_ble_mesh_defs.h> ESP_BLE_MESH_NODE_SET_UNPROV_DEV_NAME_COMP_EVT.
```

Public Members

int **err_code**
Indicate the result of setting BLE Mesh device name

union **esp_ble_mesh_server_state_value_t**
#include <esp_ble_mesh_defs.h> Server model state value union.

Public Members

uint8_t **onoff**
The value of the Generic OnOff state
The value of the Light LC Light OnOff state

struct *esp_ble_mesh_server_state_value_t*::[anonymous] **gen_onoff**
The Generic OnOff state

int16_t **level**
The value of the Generic Level state

struct *esp_ble_mesh_server_state_value_t*::[anonymous] **gen_level**
The Generic Level state

uint8_t **onpowerup**
The value of the Generic OnPowerUp state

struct *esp_ble_mesh_server_state_value_t*::[anonymous] **gen_onpowerup**
The Generic OnPowerUp state

uint16_t **power**
The value of the Generic Power Actual state

struct *esp_ble_mesh_server_state_value_t*::[anonymous] **gen_power_actual**
The Generic Power Actual state

uint16_t **lightness**
The value of the Light Lightness Actual state
The value of the Light Lightness Linear state
The value of the Light CTL Lightness state
The value of the Light HSL Lightness state
The value of the Light xyL Lightness state

struct *esp_ble_mesh_server_state_value_t*::[anonymous] **light_lightness_actual**
The Light Lightness Actual state

struct *esp_ble_mesh_server_state_value_t*::[anonymous] **light_lightness_linear**
The Light Lightness Linear state

struct *esp_ble_mesh_server_state_value_t*::[anonymous] **light_ctl_lightness**
The Light CTL Lightness state

uint16_t **temperature**
The value of the Light CTL Temperature state

int16_t **delta_uv**
The value of the Light CTL Delta UV state

struct *esp_ble_mesh_server_state_value_t*::[anonymous] **light_ctl_temp_delta_uv**
The Light CTL Temperature & Delta UV states

uint16_t **hue**
The value of the Light HSL Hue state

`uint16_t saturation`

The value of the Light HSL Saturation state

`struct esp_ble_mesh_server_state_value_t::[anonymous] light_hsl`

The Light HSL composite state

`struct esp_ble_mesh_server_state_value_t::[anonymous] light_hsl_lightness`

The Light HSL Lightness state

`struct esp_ble_mesh_server_state_value_t::[anonymous] light_hsl_hue`

The Light HSL Hue state

`struct esp_ble_mesh_server_state_value_t::[anonymous] light_hsl_saturation`

The Light HSL Saturation state

`struct esp_ble_mesh_server_state_value_t::[anonymous] light_xyl_lightness`

The Light xyL Lightness state

`struct esp_ble_mesh_server_state_value_t::[anonymous] light_lc_light_onoff`

The Light LC Light OnOff state

`union esp_ble_mesh_model_cb_param_t`

`#include <esp_ble_mesh_defs.h>` BLE Mesh model callback parameters union.

Public Members

`struct esp_ble_mesh_model_cb_param_t::ble_mesh_model_operation_evt_param model_operation`

Event parameter of ESP_BLE_MESH_MODEL_OPERATION_EVT

`struct esp_ble_mesh_model_cb_param_t::ble_mesh_model_send_comp_param model_send_comp`

Event parameter of ESP_BLE_MESH_MODEL_SEND_COMP_EVT

`struct esp_ble_mesh_model_cb_param_t::ble_mesh_model_publish_comp_param model_publish_comp`

Event parameter of ESP_BLE_MESH_MODEL_PUBLISH_COMP_EVT

`struct esp_ble_mesh_model_cb_param_t::ble_mesh_mod_rcv_publish_msg_param client_rcv_publish_msg`

Event parameter of ESP_BLE_MESH_CLIENT_MODEL_RECV_PUBLISH_MSG_EVT

`struct esp_ble_mesh_model_cb_param_t::ble_mesh_client_model_send_timeout_param client_send_timeout`

Event parameter of ESP_BLE_MESH_CLIENT_MODEL_SEND_TIMEOUT_EVT

`struct esp_ble_mesh_model_cb_param_t::ble_mesh_model_publish_update_evt_param model_publish_update`

Event parameter of ESP_BLE_MESH_MODEL_PUBLISH_UPDATE_EVT

`struct esp_ble_mesh_model_cb_param_t::ble_mesh_server_model_update_state_comp_param server_model_update`

Event parameter of ESP_BLE_MESH_SERVER_MODEL_UPDATE_STATE_COMP_EVT

`struct ble_mesh_client_model_send_timeout_param`

`#include <esp_ble_mesh_defs.h>` ESP_BLE_MESH_CLIENT_MODEL_SEND_TIMEOUT_EVT.

Public Members

`uint32_t opcode`

Opcode of the previously sent message

`esp_ble_mesh_model_t *model`

Pointer to the model which sends the previous message

`esp_ble_mesh_msg_ctx_t *ctx`

Pointer to the context of the previous message

`struct ble_mesh_mod_rcv_publish_msg_param`

`#include <esp_ble_mesh_defs.h>` ESP_BLE_MESH_CLIENT_MODEL_RECV_PUBLISH_MSG_EVT.

Public Members

`uint32_t opcode`
Opcode of the unsolicited received message

`esp_ble_mesh_model_t *model`
Pointer to the model which receives the message

`esp_ble_mesh_msg_ctx_t *ctx`
Pointer to the context of the message

`uint16_t length`
Length of the received message

`uint8_t *msg`
Value of the received message

struct ble_mesh_model_operation_evt_param
#include <esp_ble_mesh_defs.h> ESP_BLE_MESH_MODEL_OPERATION_EVT.

Public Members

`uint32_t opcode`
Opcode of the received message

`esp_ble_mesh_model_t *model`
Pointer to the model which receives the message

`esp_ble_mesh_msg_ctx_t *ctx`
Pointer to the context of the received message

`uint16_t length`
Length of the received message

`uint8_t *msg`
Value of the received message

struct ble_mesh_model_publish_comp_param
#include <esp_ble_mesh_defs.h> ESP_BLE_MESH_MODEL_PUBLISH_COMP_EVT.

Public Members

`int err_code`
Indicate the result of publishing a message

`esp_ble_mesh_model_t *model`
Pointer to the model which publishes the message

struct ble_mesh_model_publish_update_evt_param
#include <esp_ble_mesh_defs.h> ESP_BLE_MESH_MODEL_PUBLISH_UPDATE_EVT.

Public Members

`esp_ble_mesh_model_t *model`
Pointer to the model which is going to update its publish message

struct ble_mesh_model_send_comp_param
#include <esp_ble_mesh_defs.h> ESP_BLE_MESH_MODEL_SEND_COMP_EVT.

Public Members

int err_code
Indicate the result of sending a message

uint32_t opcode
Opcode of the message

***esp_ble_mesh_model_t* *model**
Pointer to the model which sends the message

***esp_ble_mesh_msg_ctx_t* *ctx**
Context of the message

struct ble_mesh_server_model_update_state_comp_param
#include <esp_ble_mesh_defs.h> ESP_BLE_MESH_SERVER_MODEL_UPDATE_STATE_COMP_EVT.

Public Members

int err_code
Indicate the result of updating server model state

***esp_ble_mesh_model_t* *model**
Pointer to the server model which state value is updated

***esp_ble_mesh_server_state_type_t* type**
Type of the updated server state

Structures

struct esp_ble_mesh_deinit_param_t
BLE Mesh deinit parameters

Public Members

bool erase_flash
Indicate if erasing flash when deinit mesh stack

struct esp_ble_mesh_elem_t
Abstraction that describes a BLE Mesh Element. This structure is associated with struct `bt_mesh_elem` in `mesh_access.h`

Public Members

uint16_t element_addr
Element Address, assigned during provisioning.

const uint16_t location
Location Descriptor (GATT Bluetooth Namespace Descriptors)

const uint8_t sig_model_count
SIG Model count

const uint8_t vnd_model_count
Vendor Model count

***esp_ble_mesh_model_t* *sig_models**
SIG Models

***esp_ble_mesh_model_t* *vnd_models**
Vendor Models

struct esp_ble_mesh_model_pub_t

Abstraction that describes a model publication context. This structure is associated with struct `bt_mesh_model_pub` in `mesh_access.h`

Public Members*esp_ble_mesh_model_t* ***model**

Pointer to the model to which the context belongs. Initialized by the stack.

uint16_t **publish_addr**

Publish Address.

uint16_t **app_idx** : 12

Publish AppKey Index.

uint16_t **cred** : 1

Friendship Credentials Flag.

uint16_t **send_rel** : 1

Force reliable sending (segment acks)

uint8_t **ttl**

Publish Time to Live.

uint8_t **retransmit**

Retransmit Count & Interval Steps.

uint8_t **period**

Publish Period.

uint8_t **period_div** : 4

Divisor for the Period.

uint8_t **fast_period** : 1

Use FastPeriodDivisor

uint8_t **count** : 3

Retransmissions left.

uint32_t **period_start**

Start of the current period.

struct net_buf_simple ***msg**

Publication buffer, containing the publication message.

This will get correctly created when the publication context has been defined using the `ESP_BLE_MESH_MODEL_PUB_DEFINE` macro.

```
ESP_BLE_MESH_MODEL_PUB_DEFINE(name, size);
```

esp_ble_mesh_cb_t **update**

Callback used to update publish message. Initialized by the stack.

struct k_delayed_work **timer**

Publish Period Timer. Initialized by the stack.

uint8_t **dev_role**

Role of the device that is going to publish messages

struct esp_ble_mesh_model_op_t

Abstraction that describes a model operation context. This structure is associated with struct `bt_mesh_model_op` in `mesh_access.h`

Public Members

const uint32_t **opcode**

Message opcode

const size_t **min_len**

Message minimum length

esp_ble_mesh_cb_t **param_cb**

Callback used to handle message. Initialized by the stack.

struct **esp_ble_mesh_model_cbs_t**

Abstraction that describes a model callback structure. This structure is associated with struct `bt_mesh_model_cb` in `mesh_access.h`.

Public Members

esp_ble_mesh_cb_t **init_cb**

Callback used during model initialization. Initialized by the stack.

struct **esp_ble_mesh_model**

Abstraction that describes a Mesh Model instance. This structure is associated with struct `bt_mesh_model` in `mesh_access.h`.

Public Members

const uint16_t **model_id**

16-bit model identifier

uint16_t **company_id**

16-bit company identifier

uint16_t **vnd_model_id**

16-bit vendor model identifier

struct *esp_ble_mesh_model::[anonymous]::[anonymous]* **vnd**

Structure encapsulating a model ID with a company ID

union *esp_ble_mesh_model::[anonymous]* **[anonymous]**

Model ID

uint8_t **element_idx**

Internal information, mainly for persistent storage Belongs to Nth element

uint8_t **model_idx**

Is the Nth model in the element

uint16_t **flags**

Information about what has changed

esp_ble_mesh_lem_t ***element**

The Element to which this Model belongs

esp_ble_mesh_model_pub_t ***const pub**

Model Publication

uint16_t **keys**[CONFIG_BLE_MESH_MODEL_KEY_COUNT]

AppKey List

uint16_t **groups**[CONFIG_BLE_MESH_MODEL_GROUP_COUNT]

Subscription List (group or virtual addresses)

esp_ble_mesh_model_op_t ***op**

Model operation context

esp_ble_mesh_model_cbs_t *cb
Model callback structure

void ***user_data**
Model-specific user data

struct esp_ble_mesh_msg_ctx_t
Message sending context. This structure is associated with struct bt_mesh_msg_ctx in mesh_access.h

Public Members

uint16_t **net_idx**
NetKey Index of the subnet through which to send the message.

uint16_t **app_idx**
AppKey Index for message encryption.

uint16_t **addr**
Remote address.

uint16_t **recv_dst**
Destination address of a received message. Not used for sending.

int8_t **recv_rssi**
RSSI of received packet. Not used for sending.

uint8_t **recv_ttl** : 7
Received TTL value. Not used for sending.

uint8_t **send_rel** : 1
Force sending reliably by using segment acknowledgement

uint8_t **send_ttl**
TTL, or ESP_BLE_MESH_TTL_DEFAULT for default TTL.

uint32_t **recv_op**
Opcode of a received message. Not used for sending message.

esp_ble_mesh_model_t ***model**
Model corresponding to the message, no need to be initialized before sending message

bool **srv_send**
Indicate if the message is sent by a node server model, no need to be initialized before sending message

struct esp_ble_mesh_prov_t
Provisioning properties & capabilities. This structure is associated with struct bt_mesh_prov in mesh_access.h

struct esp_ble_mesh_comp_t
Node Composition data context. This structure is associated with struct bt_mesh_comp in mesh_access.h

Public Members

uint16_t **cid**
16-bit SIG-assigned company identifier

uint16_t **pid**
16-bit vendor-assigned product identifier

uint16_t **vid**
16-bit vendor-assigned product version identifier

size_t **element_count**
Element count

esp_ble_mesh_lem_t ***elements**
A sequence of elements

struct esp_ble_mesh_unprov_dev_add_t

Information of the device which is going to be added for provisioning.

Public Members

esp_ble_mesh_bd_addr_t **addr**

Device address

esp_ble_mesh_addr_type_t **addr_type**

Device address type

uint8_t **uuid**[16]

Device UUID

uint16_t **oob_info**

Device OOB Info ADD_DEV_START_PROV_NOW_FLAG shall not be set if the bearer has both PB-ADV and PB-GATT enabled

esp_ble_mesh_prov_bearer_t **bearer**

Provisioning Bearer

struct esp_ble_mesh_device_delete_t

Information of the device which is going to be deleted.

Public Members

esp_ble_mesh_bd_addr_t **addr**

Device address

esp_ble_mesh_addr_type_t **addr_type**

Device address type

uint8_t **uuid**[16]

Device UUID

uint8_t **flag**

BIT0: device address; BIT1: device UUID

struct esp_ble_mesh_prov_data_info_t

Information of the provisioner which is going to be updated.

Public Members

uint16_t **net_idx**

NetKey Index

uint8_t **flags**

Flags

uint32_t **iv_index**

IV Index

uint8_t **flag**

BIT0: net_idx; BIT1: flags; BIT2: iv_index

struct esp_ble_mesh_node_t

Information of the provisioned node

Public Members

esp_ble_mesh_bd_addr_t **addr**

Node device address

esp_ble_mesh_addr_type_t **addr_type**

Node device address type

uint8_t **dev_uuid**[16]

Device UUID

uint16_t **oob_info**

Node OOB information

uint16_t **unicast_addr**

Node unicast address

uint8_t **element_num**

Node element number

uint16_t **net_idx**

Node NetKey Index

uint8_t **flags**

Node key refresh flag and iv update flag

uint32_t **iv_index**

Node IV Index

uint8_t **dev_key**[16]

Node device key

char **name**[ESP_BLE_MESH_NODE_NAME_MAX_LEN + 1]

Node name

uint16_t **comp_length**

Length of Composition Data

uint8_t ***comp_data**

Value of Composition Data

struct esp_ble_mesh_fast_prov_info_t

Context of fast provisioning which need to be set.

Public Members

uint16_t **unicast_min**

Minimum unicast address used for fast provisioning

uint16_t **unicast_max**

Maximum unicast address used for fast provisioning

uint16_t **net_idx**

Netkey index used for fast provisioning

uint8_t **flags**

Flags used for fast provisioning

uint32_t **iv_index**

IV Index used for fast provisioning

uint8_t **offset**

Offset of the UUID to be compared

uint8_t **match_len**

Length of the UUID to be compared

`uint8_t match_val[16]`
Value of UUID to be compared

struct esp_ble_mesh_heartbeat_filter_info_t
Context of Provisioner heartbeat filter information to be set

Public Members

`uint16_t hb_src`
Heartbeat source address (unicast address)

`uint16_t hb_dst`
Heartbeat destination address (unicast address or group address)

struct esp_ble_mesh_client_op_pair_t
BLE Mesh client models related definitions.
Client model Get/Set message opcode and corresponding Status message opcode

Public Members

`uint32_t cli_op`
The client message opcode

`uint32_t status_op`
The server status opcode corresponding to the client message opcode

struct esp_ble_mesh_client_t
Client Model user data context.

Public Members

`esp_ble_mesh_model_t *model`
Pointer to the client model. Initialized by the stack.

`int op_pair_size`
Size of the op_pair

`const esp_ble_mesh_client_op_pair_t *op_pair`
Table containing get/set message opcode and corresponding status message opcode

`uint32_t publish_status`
Callback used to handle the received unsolicited message. Initialized by the stack.

`void *internal_data`
Pointer to the internal data of client model

`uint8_t msg_role`
Role of the device (Node/Provisioner) that is going to send messages

struct esp_ble_mesh_client_common_param_t
Common parameters of the messages sent by Client Model.

Public Members

`esp_ble_mesh_opcode_t opcode`
Message opcode

`esp_ble_mesh_model_t *model`
Pointer to the client model structure

esp_ble_mesh_msg_ctx_t **ctx**

The context used to send message

int32_t **msg_timeout**

Timeout value (ms) to get response to the sent message Note: if using default timeout value in menuconfig, make sure to set this value to 0

uint8_t **msg_role**

Role of the device - Node/Provisioner

struct esp_ble_mesh_state_transition_t

Parameters of the server model state transition

Public Functions

BLE_MESH_ATOMIC_DEFINE (flag, *ESP_BLE_MESH_SERVER_FLAG_MAX*)

Flag used to indicate if the transition timer has been started internally.

If the model which contains *esp_ble_mesh_state_transition_t* sets “set_auto_rsp” to *ESP_BLE_MESH_SERVER_RSP_BY_APP*, the handler of the timer shall be initialized by the users.

And users can use this flag to indicate whether the timer is started or not.

Public Members

bool **just_started**

Indicate if the state transition has just started

uint8_t **trans_time**

State transition time

uint8_t **remain_time**

Remaining time of state transition

uint8_t **delay**

Delay before starting state transition

uint32_t **quo_tt**

Duration of each divided transition step

uint32_t **counter**

Number of steps which the transition duration is divided

uint32_t **total_duration**

State transition total duration

int64_t **start_timestamp**

Time when the state transition is started

struct k_delayed_work timer

Timer used for state transition

struct esp_ble_mesh_last_msg_info_t

Parameters of the server model received last same set message.

Public Members

uint8_t **tid**

Transaction number of the last message

uint16_t **src**

Source address of the last message

uint16_t dst
Destination address of the last message

int64_t timestamp
Time when the last message is received

struct esp_ble_mesh_server_rsp_ctrl_t
Parameters of the Server Model response control

Public Members

uint8_t get_auto_rsp : 1
BLE Mesh Server Response Option.

1. If `get_auto_rsp` is set to `ESP_BLE_MESH_SERVER_RSP_BY_APP`, then the response of Client Get messages need to be replied by the application;
 2. If `get_auto_rsp` is set to `ESP_BLE_MESH_SERVER_AUTO_RSP`, then the response of Client Get messages will be replied by the server models;
 3. If `set_auto_rsp` is set to `ESP_BLE_MESH_SERVER_RSP_BY_APP`, then the response of Client Set messages need to be replied by the application;
 4. If `set_auto_rsp` is set to `ESP_BLE_MESH_SERVER_AUTO_RSP`, then the response of Client Set messages will be replied by the server models;
 5. If `status_auto_rsp` is set to `ESP_BLE_MESH_SERVER_RSP_BY_APP`, then the response of Server Status messages need to be replied by the application;
 6. If `status_auto_rsp` is set to `ESP_BLE_MESH_SERVER_AUTO_RSP`, then the response of Server Status messages will be replied by the server models;
- Response control for Client Get messages

uint8_t set_auto_rsp : 1
Response control for Client Set messages

uint8_t status_auto_rsp : 1
Response control for Server Status messages

Macros

ESP_BLE_MESH_SDU_MAX_LEN
< The maximum length of a BLE Mesh message, including Opcode, Payload and TransMIC Length of a short Mesh MIC.

ESP_BLE_MESH_MIC_SHORT
Length of a long Mesh MIC.

ESP_BLE_MESH_MIC_LONG
The maximum length of a BLE Mesh provisioned node name

ESP_BLE_MESH_NODE_NAME_MAX_LEN
The maximum length of a BLE Mesh unprovisioned device name

ESP_BLE_MESH_DEVICE_NAME_MAX_LEN
The maximum length of settings user id

ESP_BLE_MESH_SETTINGS_UID_SIZE
Invalid settings index

ESP_BLE_MESH_INVALID_SETTINGS_IDX
Define the BLE Mesh octet 16 bytes size

ESP_BLE_MESH_OCTET16_LEN

ESP_BLE_MESH_OCTET8_LEN

ESP_BLE_MESH_CID_NVAL
Special TTL value to request using configured default TTL

ESP_BLE_MESH_TTL_DEFAULT
Maximum allowed TTL value

ESP_BLE_MESH_TTL_MAX
ESP_BLE_MESH_ADDR_UNASSIGNED
ESP_BLE_MESH_ADDR_ALL_NODES
ESP_BLE_MESH_ADDR_PROXIES
ESP_BLE_MESH_ADDR_FRIENDS
ESP_BLE_MESH_ADDR_RELAYS
ESP_BLE_MESH_KEY_UNUSED
ESP_BLE_MESH_KEY_DEV
ESP_BLE_MESH_KEY_PRIMARY
ESP_BLE_MESH_KEY_ANY
Primary Network Key index
ESP_BLE_MESH_NET_PRIMARY
Relay state value
ESP_BLE_MESH_RELAY_DISABLED
ESP_BLE_MESH_RELAY_ENABLED
ESP_BLE_MESH_RELAY_NOT_SUPPORTED
Beacon state value
ESP_BLE_MESH_BEACON_DISABLED
ESP_BLE_MESH_BEACON_ENABLED
GATT Proxy state value
ESP_BLE_MESH_GATT_PROXY_DISABLED
ESP_BLE_MESH_GATT_PROXY_ENABLED
ESP_BLE_MESH_GATT_PROXY_NOT_SUPPORTED
Friend state value
ESP_BLE_MESH_FRIEND_DISABLED
ESP_BLE_MESH_FRIEND_ENABLED
ESP_BLE_MESH_FRIEND_NOT_SUPPORTED
Node identity state value
ESP_BLE_MESH_NODE_IDENTITY_STOPPED
ESP_BLE_MESH_NODE_IDENTITY_RUNNING
ESP_BLE_MESH_NODE_IDENTITY_NOT_SUPPORTED
Supported features
ESP_BLE_MESH_FEATURE_RELAY
ESP_BLE_MESH_FEATURE_PROXY
ESP_BLE_MESH_FEATURE_FRIEND
ESP_BLE_MESH_FEATURE_LOW_POWER
ESP_BLE_MESH_FEATURE_ALL_SUPPORTED
ESP_BLE_MESH_ADDR_IS_UNICAST (addr)
ESP_BLE_MESH_ADDR_IS_GROUP (addr)
ESP_BLE_MESH_ADDR_IS_VIRTUAL (addr)
ESP_BLE_MESH_ADDR_IS_RFU (addr)

ESP_BLE_MESH_INVALID_NODE_INDEX**ESP_BLE_MESH_TRANSMIT** (count, int_ms)

Encode transmission count & interval steps.

Note For example, ESP_BLE_MESH_TRANSMIT(2, 20) means that the message will be sent about 90ms(count is 3, step is 1, interval is 30 ms which includes 10ms of advertising interval random delay).

Return BLE Mesh transmit value that can be used e.g. for the default values of the Configuration Model data.

Parameters

- **count**: Number of retransmissions (first transmission is excluded).
- **int_ms**: Interval steps in milliseconds. Must be greater than 0 and a multiple of 10.

ESP_BLE_MESH_GET_TRANSMIT_COUNT (transmit)

Decode transmit count from a transmit value.

Return Transmission count (actual transmissions equal to N + 1).

Parameters

- **transmit**: Encoded transmit count & interval value.

ESP_BLE_MESH_GET_TRANSMIT_INTERVAL (transmit)

Decode transmit interval from a transmit value.

Return Transmission interval in milliseconds.

Parameters

- **transmit**: Encoded transmit count & interval value.

ESP_BLE_MESH_PUBLISH_TRANSMIT (count, int_ms)

Encode Publish Retransmit count & interval steps.

Return BLE Mesh transmit value that can be used e.g. for the default values of the Configuration Model data.

Parameters

- **count**: Number of retransmissions (first transmission is excluded).
- **int_ms**: Interval steps in milliseconds. Must be greater than 0 and a multiple of 50.

ESP_BLE_MESH_GET_PUBLISH_TRANSMIT_COUNT (transmit)

Decode Publish Retransmit count from a given value.

Return Retransmission count (actual transmissions equal to N + 1).

Parameters

- **transmit**: Encoded Publish Retransmit count & interval value.

ESP_BLE_MESH_GET_PUBLISH_TRANSMIT_INTERVAL (transmit)

Decode Publish Retransmit interval from a given value.

Callbacks which are not needed to be initialized by users (set with 0 and will be initialized internally)

Return Transmission interval in milliseconds.

Parameters

- **transmit**: Encoded Publish Retransmit count & interval value.

ESP_BLE_MESH_PROV_STATIC_OOB_MAX_LEN

Maximum length of string used by Output OOB authentication

ESP_BLE_MESH_PROV_OUTPUT_OOB_MAX_LEN

Maximum length of string used by Output OOB authentication

ESP_BLE_MESH_PROV_INPUT_OOB_MAX_LEN

Macros used to define message opcode

ESP_BLE_MESH_MODEL_OP_1 (b0)**ESP_BLE_MESH_MODEL_OP_2** (b0, b1)**ESP_BLE_MESH_MODEL_OP_3** (b0, cid)

This macro is associated with BLE_MESH_MODEL_CB in mesh_access.h

ESP_BLE_MESH_SIG_MODEL (_id, _op, _pub, _user_data)

This macro is associated with BLE_MESH_MODEL_VND_CB in mesh_access.h

ESP_BLE_MESH_VENDOR_MODEL (_company, _id, _op, _pub, _user_data)

ESP_BLE_MESH_ELEMENT (_loc, _mods, _vnd_mods)

Helper to define a BLE Mesh element within an array.

In case the element has no SIG or Vendor models, the helper macro ESP_BLE_MESH_MODEL_NONE can be given instead.

Note This macro is associated with BLE_MESH_ELEM in mesh_access.h

Parameters

- `_loc`: Location Descriptor.
- `_mods`: Array of SIG models.
- `_vnd_mods`: Array of vendor models.

ESP_BLE_MESH_PROV (uuid, sta_val, sta_val_len, out_size, out_act, in_size, in_act)

BT_OCTET32_LEN

BD_ADDR_LEN

ESP_BLE_MESH_ADDR_TYPE_PUBLIC

ESP_BLE_MESH_ADDR_TYPE_RANDOM

ESP_BLE_MESH_ADDR_TYPE_RPA_PUBLIC

ESP_BLE_MESH_ADDR_TYPE_RPA_RANDOM

ESP_BLE_MESH_MODEL_PUB_DEFINE (_name, _msg_len, _role)

Define a model publication context.

Parameters

- `_name`: Variable name given to the context.
- `_msg_len`: Length of the publication message.
- `_role`: Role of the device which contains the model.

ESP_BLE_MESH_MODEL_OP (_opcode, _min_len)

Define a model operation context.

Parameters

- `_opcode`: Message opcode.
- `_min_len`: Message minimum length.

ESP_BLE_MESH_MODEL_OP_END

Define the terminator for the model operation table. Each model operation struct array must use this terminator as the end tag of the operation unit.

ESP_BLE_MESH_MODEL_NONE

Helper to define an empty model array. This structure is associated with BLE_MESH_MODEL_NONE in mesh_access.h

ADD_DEV_RM_AFTER_PROV_FLAG

Device will be removed from queue after provisioned successfully

ADD_DEV_START_PROV_NOW_FLAG

Start provisioning device immediately

ADD_DEV_FLUSHABLE_DEV_FLAG

Device can be remove when queue is full and new device is going to added

DEL_DEV_ADDR_FLAG

DEL_DEV_UUID_FLAG

PROV_DATA_NET_IDX_FLAG

PROV_DATA_FLAGS_FLAG

PROV_DATA_IV_INDEX_FLAG

ESP_BLE_MESH_HEARTBEAT_FILTER_ACCEPTLIST

ESP_BLE_MESH_HEARTBEAT_FILTER_REJECTLIST

Provisioner heartbeat filter operation

ESP_BLE_MESH_HEARTBEAT_FILTER_ADD

ESP_BLE_MESH_HEARTBEAT_FILTER_REMOVE

ESP_BLE_MESH_MODEL_ID_CONFIG_SRV

BLE Mesh models related Model ID and Opcode definitions.

< Foundation Models

ESP_BLE_MESH_MODEL_ID_CONFIG_CLI

ESP_BLE_MESH_MODEL_ID_HEALTH_SRV

ESP_BLE_MESH_MODEL_ID_HEALTH_CLI

Models from the Mesh Model Specification

ESP_BLE_MESH_MODEL_ID_GEN_ONOFF_SRV

ESP_BLE_MESH_MODEL_ID_GEN_ONOFF_CLI

ESP_BLE_MESH_MODEL_ID_GEN_LEVEL_SRV

ESP_BLE_MESH_MODEL_ID_GEN_LEVEL_CLI

ESP_BLE_MESH_MODEL_ID_GEN_DEF_TRANS_TIME_SRV

ESP_BLE_MESH_MODEL_ID_GEN_DEF_TRANS_TIME_CLI

ESP_BLE_MESH_MODEL_ID_GEN_POWER_ONOFF_SRV

ESP_BLE_MESH_MODEL_ID_GEN_POWER_ONOFF_SETUP_SRV

ESP_BLE_MESH_MODEL_ID_GEN_POWER_ONOFF_CLI

ESP_BLE_MESH_MODEL_ID_GEN_POWER_LEVEL_SRV

ESP_BLE_MESH_MODEL_ID_GEN_POWER_LEVEL_SETUP_SRV

ESP_BLE_MESH_MODEL_ID_GEN_POWER_LEVEL_CLI

ESP_BLE_MESH_MODEL_ID_GEN_BATTERY_SRV

ESP_BLE_MESH_MODEL_ID_GEN_BATTERY_CLI

ESP_BLE_MESH_MODEL_ID_GEN_LOCATION_SRV

ESP_BLE_MESH_MODEL_ID_GEN_LOCATION_SETUP_SRV

ESP_BLE_MESH_MODEL_ID_GEN_LOCATION_CLI

ESP_BLE_MESH_MODEL_ID_GEN_ADMIN_PROP_SRV

ESP_BLE_MESH_MODEL_ID_GEN_MANUFACTURER_PROP_SRV

ESP_BLE_MESH_MODEL_ID_GEN_USER_PROP_SRV

ESP_BLE_MESH_MODEL_ID_GEN_CLIENT_PROP_SRV

ESP_BLE_MESH_MODEL_ID_GEN_PROP_CLI

ESP_BLE_MESH_MODEL_ID_SENSOR_SRV

ESP_BLE_MESH_MODEL_ID_SENSOR_SETUP_SRV

ESP_BLE_MESH_MODEL_ID_SENSOR_CLI

ESP_BLE_MESH_MODEL_ID_TIME_SRV

ESP_BLE_MESH_MODEL_ID_TIME_SETUP_SRV

ESP_BLE_MESH_MODEL_ID_TIME_CLI
ESP_BLE_MESH_MODEL_ID_SCENE_SRV
ESP_BLE_MESH_MODEL_ID_SCENE_SETUP_SRV
ESP_BLE_MESH_MODEL_ID_SCENE_CLI
ESP_BLE_MESH_MODEL_ID_SCHEDULER_SRV
ESP_BLE_MESH_MODEL_ID_SCHEDULER_SETUP_SRV
ESP_BLE_MESH_MODEL_ID_SCHEDULER_CLI
ESP_BLE_MESH_MODEL_ID_LIGHT_LIGHTNESS_SRV
ESP_BLE_MESH_MODEL_ID_LIGHT_LIGHTNESS_SETUP_SRV
ESP_BLE_MESH_MODEL_ID_LIGHT_LIGHTNESS_CLI
ESP_BLE_MESH_MODEL_ID_LIGHT_CTL_SRV
ESP_BLE_MESH_MODEL_ID_LIGHT_CTL_SETUP_SRV
ESP_BLE_MESH_MODEL_ID_LIGHT_CTL_CLI
ESP_BLE_MESH_MODEL_ID_LIGHT_CTL_TEMP_SRV
ESP_BLE_MESH_MODEL_ID_LIGHT_HSL_SRV
ESP_BLE_MESH_MODEL_ID_LIGHT_HSL_SETUP_SRV
ESP_BLE_MESH_MODEL_ID_LIGHT_HSL_CLI
ESP_BLE_MESH_MODEL_ID_LIGHT_HSL_HUE_SRV
ESP_BLE_MESH_MODEL_ID_LIGHT_HSL_SAT_SRV
ESP_BLE_MESH_MODEL_ID_LIGHT_XYL_SRV
ESP_BLE_MESH_MODEL_ID_LIGHT_XYL_SETUP_SRV
ESP_BLE_MESH_MODEL_ID_LIGHT_XYL_CLI
ESP_BLE_MESH_MODEL_ID_LIGHT_LC_SRV
ESP_BLE_MESH_MODEL_ID_LIGHT_LC_SETUP_SRV
ESP_BLE_MESH_MODEL_ID_LIGHT_LC_CLI
ESP_BLE_MESH_MODEL_OP_BEACON_GET
Config Beacon Get
ESP_BLE_MESH_MODEL_OP_COMPOSITION_DATA_GET
Config Composition Data Get
ESP_BLE_MESH_MODEL_OP_DEFAULT_TTL_GET
Config Default TTL Get
ESP_BLE_MESH_MODEL_OP_GATT_PROXY_GET
Config GATT Proxy Get
ESP_BLE_MESH_MODEL_OP_RELAY_GET
Config Relay Get
ESP_BLE_MESH_MODEL_OP_MODEL_PUB_GET
Config Model Publication Get
ESP_BLE_MESH_MODEL_OP_FRIEND_GET
Config Friend Get
ESP_BLE_MESH_MODEL_OP_HEARTBEAT_PUB_GET
Config Heartbeat Publication Get

ESP_BLE_MESH_MODEL_OP_HEARTBEAT_SUB_GET
Config Heartbeat Subscription Get

ESP_BLE_MESH_MODEL_OP_NET_KEY_GET
Config NetKey Get

ESP_BLE_MESH_MODEL_OP_APP_KEY_GET
Config AppKey Get

ESP_BLE_MESH_MODEL_OP_NODE_IDENTITY_GET
Config Node Identity Get

ESP_BLE_MESH_MODEL_OP_SIG_MODEL_SUB_GET
Config SIG Model Subscription Get

ESP_BLE_MESH_MODEL_OP_VENDOR_MODEL_SUB_GET
Config Vendor Model Subscription Get

ESP_BLE_MESH_MODEL_OP_SIG_MODEL_APP_GET
Config SIG Model App Get

ESP_BLE_MESH_MODEL_OP_VENDOR_MODEL_APP_GET
Config Vendor Model App Get

ESP_BLE_MESH_MODEL_OP_KEY_REFRESH_PHASE_GET
Config Key Refresh Phase Get

ESP_BLE_MESH_MODEL_OP_LPN_POLLTIMEOUT_GET
Config Low Power Node PollTimeout Get

ESP_BLE_MESH_MODEL_OP_NETWORK_TRANSMIT_GET
Config Network Transmit Get

ESP_BLE_MESH_MODEL_OP_BEACON_SET
Config Beacon Set

ESP_BLE_MESH_MODEL_OP_DEFAULT_TTL_SET
Config Default TTL Set

ESP_BLE_MESH_MODEL_OP_GATT_PROXY_SET
Config GATT Proxy Set

ESP_BLE_MESH_MODEL_OP_RELAY_SET
Config Relay Set

ESP_BLE_MESH_MODEL_OP_MODEL_PUB_SET
Config Model Publication Set

ESP_BLE_MESH_MODEL_OP_MODEL_SUB_ADD
Config Model Subscription Add

ESP_BLE_MESH_MODEL_OP_MODEL_SUB_VIRTUAL_ADDR_ADD
Config Model Subscription Virtual Address Add

ESP_BLE_MESH_MODEL_OP_MODEL_SUB_DELETE
Config Model Subscription Delete

ESP_BLE_MESH_MODEL_OP_MODEL_SUB_VIRTUAL_ADDR_DELETE
Config Model Subscription Virtual Address Delete

ESP_BLE_MESH_MODEL_OP_MODEL_SUB_OVERWRITE
Config Model Subscription Overwrite

ESP_BLE_MESH_MODEL_OP_MODEL_SUB_VIRTUAL_ADDR_OVERWRITE
Config Model Subscription Virtual Address Overwrite

ESP_BLE_MESH_MODEL_OP_NET_KEY_ADD
Config NetKey Add

ESP_BLE_MESH_MODEL_OP_APP_KEY_ADD
Config AppKey Add

ESP_BLE_MESH_MODEL_OP_MODEL_APP_BIND
Config Model App Bind

ESP_BLE_MESH_MODEL_OP_NODE_RESET
Config Node Reset

ESP_BLE_MESH_MODEL_OP_FRIEND_SET
Config Friend Set

ESP_BLE_MESH_MODEL_OP_HEARTBEAT_PUB_SET
Config Heartbeat Publication Set

ESP_BLE_MESH_MODEL_OP_HEARTBEAT_SUB_SET
Config Heartbeat Subscription Set

ESP_BLE_MESH_MODEL_OP_NET_KEY_UPDATE
Config NetKey Update

ESP_BLE_MESH_MODEL_OP_NET_KEY_DELETE
Config NetKey Delete

ESP_BLE_MESH_MODEL_OP_APP_KEY_UPDATE
Config AppKey Update

ESP_BLE_MESH_MODEL_OP_APP_KEY_DELETE
Config AppKey Delete

ESP_BLE_MESH_MODEL_OP_NODE_IDENTITY_SET
Config Node Identity Set

ESP_BLE_MESH_MODEL_OP_KEY_REFRESH_PHASE_SET
Config Key Refresh Phase Set

ESP_BLE_MESH_MODEL_OP_MODEL_PUB_VIRTUAL_ADDR_SET
Config Model Publication Virtual Address Set

ESP_BLE_MESH_MODEL_OP_MODEL_SUB_DELETE_ALL
Config Model Subscription Delete All

ESP_BLE_MESH_MODEL_OP_MODEL_APP_UNBIND
Config Model App Unbind

ESP_BLE_MESH_MODEL_OP_NETWORK_TRANSMIT_SET
Config Network Transmit Set

ESP_BLE_MESH_MODEL_OP_BEACON_STATUS

ESP_BLE_MESH_MODEL_OP_COMPOSITION_DATA_STATUS

ESP_BLE_MESH_MODEL_OP_DEFAULT_TTL_STATUS

ESP_BLE_MESH_MODEL_OP_GATT_PROXY_STATUS

ESP_BLE_MESH_MODEL_OP_RELAY_STATUS

ESP_BLE_MESH_MODEL_OP_MODEL_PUB_STATUS

ESP_BLE_MESH_MODEL_OP_MODEL_SUB_STATUS

ESP_BLE_MESH_MODEL_OP_SIG_MODEL_SUB_LIST

ESP_BLE_MESH_MODEL_OP_VENDOR_MODEL_SUB_LIST

ESP_BLE_MESH_MODEL_OP_NET_KEY_STATUS

ESP_BLE_MESH_MODEL_OP_NET_KEY_LIST

ESP_BLE_MESH_MODEL_OP_APP_KEY_STATUS

ESP_BLE_MESH_MODEL_OP_APP_KEY_LIST
ESP_BLE_MESH_MODEL_OP_NODE_IDENTITY_STATUS
ESP_BLE_MESH_MODEL_OP_MODEL_APP_STATUS
ESP_BLE_MESH_MODEL_OP_SIG_MODEL_APP_LIST
ESP_BLE_MESH_MODEL_OP_VENDOR_MODEL_APP_LIST
ESP_BLE_MESH_MODEL_OP_NODE_RESET_STATUS
ESP_BLE_MESH_MODEL_OP_FRIEND_STATUS
ESP_BLE_MESH_MODEL_OP_KEY_REFRESH_PHASE_STATUS
ESP_BLE_MESH_MODEL_OP_HEARTBEAT_PUB_STATUS
ESP_BLE_MESH_MODEL_OP_HEARTBEAT_SUB_STATUS
ESP_BLE_MESH_MODEL_OP_LPN_POLLTIMEOUT_STATUS
ESP_BLE_MESH_MODEL_OP_NETWORK_TRANSMIT_STATUS
ESP_BLE_MESH_CFG_STATUS_SUCCESS
ESP_BLE_MESH_CFG_STATUS_INVALID_ADDRESS
ESP_BLE_MESH_CFG_STATUS_INVALID_MODEL
ESP_BLE_MESH_CFG_STATUS_INVALID_APPKEY
ESP_BLE_MESH_CFG_STATUS_INVALID_NETKEY
ESP_BLE_MESH_CFG_STATUS_INSUFFICIENT_RESOURCES
ESP_BLE_MESH_CFG_STATUS_KEY_INDEX_ALREADY_STORED
ESP_BLE_MESH_CFG_STATUS_INVALID_PUBLISH_PARAMETERS
ESP_BLE_MESH_CFG_STATUS_NOT_A_SUBSCRIBE_MODEL
ESP_BLE_MESH_CFG_STATUS_STORAGE_FAILURE
ESP_BLE_MESH_CFG_STATUS_FEATURE_NOT_SUPPORTED
ESP_BLE_MESH_CFG_STATUS_CANNOT_UPDATE
ESP_BLE_MESH_CFG_STATUS_CANNOT_REMOVE
ESP_BLE_MESH_CFG_STATUS_CANNOT_BIND
ESP_BLE_MESH_CFG_STATUS_TEMP_UNABLE_TO_CHANGE_STATE
ESP_BLE_MESH_CFG_STATUS_CANNOT_SET
ESP_BLE_MESH_CFG_STATUS_UNSPECIFIED_ERROR
ESP_BLE_MESH_CFG_STATUS_INVALID_BINDING
ESP_BLE_MESH_MODEL_OP_HEALTH_FAULT_GET
Health Fault Get
ESP_BLE_MESH_MODEL_OP_HEALTH_PERIOD_GET
Health Period Get
ESP_BLE_MESH_MODEL_OP_ATTENTION_GET
Health Attention Get
ESP_BLE_MESH_MODEL_OP_HEALTH_FAULT_CLEAR
Health Fault Clear
ESP_BLE_MESH_MODEL_OP_HEALTH_FAULT_CLEAR_UNACK
Health Fault Clear Unacknowledged

ESP_BLE_MESH_MODEL_OP_HEALTH_FAULT_TEST
Health Fault Test

ESP_BLE_MESH_MODEL_OP_HEALTH_FAULT_TEST_UNACK
Health Fault Test Unacknowledged

ESP_BLE_MESH_MODEL_OP_HEALTH_PERIOD_SET
Health Period Set

ESP_BLE_MESH_MODEL_OP_HEALTH_PERIOD_SET_UNACK
Health Period Set Unacknowledged

ESP_BLE_MESH_MODEL_OP_ATTENTION_SET
Health Attention Set

ESP_BLE_MESH_MODEL_OP_ATTENTION_SET_UNACK
Health Attention Set Unacknowledged

ESP_BLE_MESH_MODEL_OP_HEALTH_CURRENT_STATUS

ESP_BLE_MESH_MODEL_OP_HEALTH_FAULT_STATUS

ESP_BLE_MESH_MODEL_OP_HEALTH_PERIOD_STATUS

ESP_BLE_MESH_MODEL_OP_ATTENTION_STATUS

ESP_BLE_MESH_MODEL_OP_GEN_ONOFF_GET

ESP_BLE_MESH_MODEL_OP_GEN_ONOFF_SET

ESP_BLE_MESH_MODEL_OP_GEN_ONOFF_SET_UNACK

ESP_BLE_MESH_MODEL_OP_GEN_ONOFF_STATUS
Generic Level Message Opcode

ESP_BLE_MESH_MODEL_OP_GEN_LEVEL_GET

ESP_BLE_MESH_MODEL_OP_GEN_LEVEL_SET

ESP_BLE_MESH_MODEL_OP_GEN_LEVEL_SET_UNACK

ESP_BLE_MESH_MODEL_OP_GEN_LEVEL_STATUS

ESP_BLE_MESH_MODEL_OP_GEN_DELTA_SET

ESP_BLE_MESH_MODEL_OP_GEN_DELTA_SET_UNACK

ESP_BLE_MESH_MODEL_OP_GEN_MOVE_SET

ESP_BLE_MESH_MODEL_OP_GEN_MOVE_SET_UNACK
Generic Default Transition Time Message Opcode

ESP_BLE_MESH_MODEL_OP_GEN_DEF_TRANS_TIME_GET

ESP_BLE_MESH_MODEL_OP_GEN_DEF_TRANS_TIME_SET

ESP_BLE_MESH_MODEL_OP_GEN_DEF_TRANS_TIME_SET_UNACK

ESP_BLE_MESH_MODEL_OP_GEN_DEF_TRANS_TIME_STATUS
Generic Power OnOff Message Opcode

ESP_BLE_MESH_MODEL_OP_GEN_ONPOWERUP_GET

ESP_BLE_MESH_MODEL_OP_GEN_ONPOWERUP_STATUS
Generic Power OnOff Setup Message Opcode

ESP_BLE_MESH_MODEL_OP_GEN_ONPOWERUP_SET

ESP_BLE_MESH_MODEL_OP_GEN_ONPOWERUP_SET_UNACK
Generic Power Level Message Opcode

ESP_BLE_MESH_MODEL_OP_GEN_POWER_LEVEL_GET

ESP_BLE_MESH_MODEL_OP_GEN_POWER_LEVEL_SET

ESP_BLE_MESH_MODEL_OP_GEN_POWER_LEVEL_SET_UNACK
ESP_BLE_MESH_MODEL_OP_GEN_POWER_LEVEL_STATUS
ESP_BLE_MESH_MODEL_OP_GEN_POWER_LAST_GET
ESP_BLE_MESH_MODEL_OP_GEN_POWER_LAST_STATUS
ESP_BLE_MESH_MODEL_OP_GEN_POWER_DEFAULT_GET
ESP_BLE_MESH_MODEL_OP_GEN_POWER_DEFAULT_STATUS
ESP_BLE_MESH_MODEL_OP_GEN_POWER_RANGE_GET
ESP_BLE_MESH_MODEL_OP_GEN_POWER_RANGE_STATUS
Generic Power Level Setup Message Opcode
ESP_BLE_MESH_MODEL_OP_GEN_POWER_DEFAULT_SET
ESP_BLE_MESH_MODEL_OP_GEN_POWER_DEFAULT_SET_UNACK
ESP_BLE_MESH_MODEL_OP_GEN_POWER_RANGE_SET
ESP_BLE_MESH_MODEL_OP_GEN_POWER_RANGE_SET_UNACK
Generic Battery Message Opcode
ESP_BLE_MESH_MODEL_OP_GEN_BATTERY_GET
ESP_BLE_MESH_MODEL_OP_GEN_BATTERY_STATUS
Generic Location Message Opcode
ESP_BLE_MESH_MODEL_OP_GEN_LOC_GLOBAL_GET
ESP_BLE_MESH_MODEL_OP_GEN_LOC_GLOBAL_STATUS
ESP_BLE_MESH_MODEL_OP_GEN_LOC_LOCAL_GET
ESP_BLE_MESH_MODEL_OP_GEN_LOC_LOCAL_STATUS
Generic Location Setup Message Opcode
ESP_BLE_MESH_MODEL_OP_GEN_LOC_GLOBAL_SET
ESP_BLE_MESH_MODEL_OP_GEN_LOC_GLOBAL_SET_UNACK
ESP_BLE_MESH_MODEL_OP_GEN_LOC_LOCAL_SET
ESP_BLE_MESH_MODEL_OP_GEN_LOC_LOCAL_SET_UNACK
Generic Manufacturer Property Message Opcode
ESP_BLE_MESH_MODEL_OP_GEN_MANUFACTURER_PROPERTIES_GET
ESP_BLE_MESH_MODEL_OP_GEN_MANUFACTURER_PROPERTIES_STATUS
ESP_BLE_MESH_MODEL_OP_GEN_MANUFACTURER_PROPERTY_GET
ESP_BLE_MESH_MODEL_OP_GEN_MANUFACTURER_PROPERTY_SET
ESP_BLE_MESH_MODEL_OP_GEN_MANUFACTURER_PROPERTY_SET_UNACK
ESP_BLE_MESH_MODEL_OP_GEN_MANUFACTURER_PROPERTY_STATUS
Generic Admin Property Message Opcode
ESP_BLE_MESH_MODEL_OP_GEN_ADMIN_PROPERTIES_GET
ESP_BLE_MESH_MODEL_OP_GEN_ADMIN_PROPERTIES_STATUS
ESP_BLE_MESH_MODEL_OP_GEN_ADMIN_PROPERTY_GET
ESP_BLE_MESH_MODEL_OP_GEN_ADMIN_PROPERTY_SET
ESP_BLE_MESH_MODEL_OP_GEN_ADMIN_PROPERTY_SET_UNACK
ESP_BLE_MESH_MODEL_OP_GEN_ADMIN_PROPERTY_STATUS
Generic User Property Message Opcode

ESP_BLE_MESH_MODEL_OP_GEN_USER_PROPERTIES_GET
ESP_BLE_MESH_MODEL_OP_GEN_USER_PROPERTIES_STATUS
ESP_BLE_MESH_MODEL_OP_GEN_USER_PROPERTY_GET
ESP_BLE_MESH_MODEL_OP_GEN_USER_PROPERTY_SET
ESP_BLE_MESH_MODEL_OP_GEN_USER_PROPERTY_SET_UNACK
ESP_BLE_MESH_MODEL_OP_GEN_USER_PROPERTY_STATUS
Generic Client Property Message Opcode
ESP_BLE_MESH_MODEL_OP_GEN_CLIENT_PROPERTIES_GET
ESP_BLE_MESH_MODEL_OP_GEN_CLIENT_PROPERTIES_STATUS
ESP_BLE_MESH_MODEL_OP_SENSOR_DESCRIPTOR_GET
ESP_BLE_MESH_MODEL_OP_SENSOR_DESCRIPTOR_STATUS
ESP_BLE_MESH_MODEL_OP_SENSOR_GET
ESP_BLE_MESH_MODEL_OP_SENSOR_STATUS
ESP_BLE_MESH_MODEL_OP_SENSOR_COLUMN_GET
ESP_BLE_MESH_MODEL_OP_SENSOR_COLUMN_STATUS
ESP_BLE_MESH_MODEL_OP_SENSOR_SERIES_GET
ESP_BLE_MESH_MODEL_OP_SENSOR_SERIES_STATUS
Sensor Setup Message Opcode
ESP_BLE_MESH_MODEL_OP_SENSOR_CADENCE_GET
ESP_BLE_MESH_MODEL_OP_SENSOR_CADENCE_SET
ESP_BLE_MESH_MODEL_OP_SENSOR_CADENCE_SET_UNACK
ESP_BLE_MESH_MODEL_OP_SENSOR_CADENCE_STATUS
ESP_BLE_MESH_MODEL_OP_SENSOR_SETTINGS_GET
ESP_BLE_MESH_MODEL_OP_SENSOR_SETTINGS_STATUS
ESP_BLE_MESH_MODEL_OP_SENSOR_SETTING_GET
ESP_BLE_MESH_MODEL_OP_SENSOR_SETTING_SET
ESP_BLE_MESH_MODEL_OP_SENSOR_SETTING_SET_UNACK
ESP_BLE_MESH_MODEL_OP_SENSOR_SETTING_STATUS
ESP_BLE_MESH_MODEL_OP_TIME_GET
ESP_BLE_MESH_MODEL_OP_TIME_SET
ESP_BLE_MESH_MODEL_OP_TIME_STATUS
ESP_BLE_MESH_MODEL_OP_TIME_ROLE_GET
ESP_BLE_MESH_MODEL_OP_TIME_ROLE_SET
ESP_BLE_MESH_MODEL_OP_TIME_ROLE_STATUS
ESP_BLE_MESH_MODEL_OP_TIME_ZONE_GET
ESP_BLE_MESH_MODEL_OP_TIME_ZONE_SET
ESP_BLE_MESH_MODEL_OP_TIME_ZONE_STATUS
ESP_BLE_MESH_MODEL_OP_TAI.UTC_DELTA_GET
ESP_BLE_MESH_MODEL_OP_TAI.UTC_DELTA_SET

ESP_BLE_MESH_MODEL_OP_TAI.UTC_DELTA_STATUS
Scene Message Opcode

ESP_BLE_MESH_MODEL_OP_SCENE_GET

ESP_BLE_MESH_MODEL_OP_SCENE_RECALL

ESP_BLE_MESH_MODEL_OP_SCENE_RECALL_UNACK

ESP_BLE_MESH_MODEL_OP_SCENE_STATUS

ESP_BLE_MESH_MODEL_OP_SCENE_REGISTER_GET

ESP_BLE_MESH_MODEL_OP_SCENE_REGISTER_STATUS
Scene Setup Message Opcode

ESP_BLE_MESH_MODEL_OP_SCENE_STORE

ESP_BLE_MESH_MODEL_OP_SCENE_STORE_UNACK

ESP_BLE_MESH_MODEL_OP_SCENE_DELETE

ESP_BLE_MESH_MODEL_OP_SCENE_DELETE_UNACK
Scheduler Message Opcode

ESP_BLE_MESH_MODEL_OP_SCHEDULER_ACT_GET

ESP_BLE_MESH_MODEL_OP_SCHEDULER_ACT_STATUS

ESP_BLE_MESH_MODEL_OP_SCHEDULER_GET

ESP_BLE_MESH_MODEL_OP_SCHEDULER_STATUS
Scheduler Setup Message Opcode

ESP_BLE_MESH_MODEL_OP_SCHEDULER_ACT_SET

ESP_BLE_MESH_MODEL_OP_SCHEDULER_ACT_SET_UNACK

ESP_BLE_MESH_MODEL_OP_LIGHT_LIGHTNESS_GET

ESP_BLE_MESH_MODEL_OP_LIGHT_LIGHTNESS_SET

ESP_BLE_MESH_MODEL_OP_LIGHT_LIGHTNESS_SET_UNACK

ESP_BLE_MESH_MODEL_OP_LIGHT_LIGHTNESS_STATUS

ESP_BLE_MESH_MODEL_OP_LIGHT_LIGHTNESS_LINEAR_GET

ESP_BLE_MESH_MODEL_OP_LIGHT_LIGHTNESS_LINEAR_SET

ESP_BLE_MESH_MODEL_OP_LIGHT_LIGHTNESS_LINEAR_SET_UNACK

ESP_BLE_MESH_MODEL_OP_LIGHT_LIGHTNESS_LINEAR_STATUS

ESP_BLE_MESH_MODEL_OP_LIGHT_LIGHTNESS_LAST_GET

ESP_BLE_MESH_MODEL_OP_LIGHT_LIGHTNESS_LAST_STATUS

ESP_BLE_MESH_MODEL_OP_LIGHT_LIGHTNESS_DEFAULT_GET

ESP_BLE_MESH_MODEL_OP_LIGHT_LIGHTNESS_DEFAULT_STATUS

ESP_BLE_MESH_MODEL_OP_LIGHT_LIGHTNESS_RANGE_GET

ESP_BLE_MESH_MODEL_OP_LIGHT_LIGHTNESS_RANGE_STATUS
Light Lightness Setup Message Opcode

ESP_BLE_MESH_MODEL_OP_LIGHT_LIGHTNESS_DEFAULT_SET

ESP_BLE_MESH_MODEL_OP_LIGHT_LIGHTNESS_DEFAULT_SET_UNACK

ESP_BLE_MESH_MODEL_OP_LIGHT_LIGHTNESS_RANGE_SET

ESP_BLE_MESH_MODEL_OP_LIGHT_LIGHTNESS_RANGE_SET_UNACK
Light CTL Message Opcode

ESP_BLE_MESH_MODEL_OP_LIGHT_CTL_GET
ESP_BLE_MESH_MODEL_OP_LIGHT_CTL_SET
ESP_BLE_MESH_MODEL_OP_LIGHT_CTL_SET_UNACK
ESP_BLE_MESH_MODEL_OP_LIGHT_CTL_STATUS
ESP_BLE_MESH_MODEL_OP_LIGHT_CTL_TEMPERATURE_GET
ESP_BLE_MESH_MODEL_OP_LIGHT_CTL_TEMPERATURE_RANGE_GET
ESP_BLE_MESH_MODEL_OP_LIGHT_CTL_TEMPERATURE_RANGE_STATUS
ESP_BLE_MESH_MODEL_OP_LIGHT_CTL_TEMPERATURE_SET
ESP_BLE_MESH_MODEL_OP_LIGHT_CTL_TEMPERATURE_SET_UNACK
ESP_BLE_MESH_MODEL_OP_LIGHT_CTL_TEMPERATURE_STATUS
ESP_BLE_MESH_MODEL_OP_LIGHT_CTL_DEFAULT_GET
ESP_BLE_MESH_MODEL_OP_LIGHT_CTL_DEFAULT_STATUS
 Light CTL Setup Message Opcode
ESP_BLE_MESH_MODEL_OP_LIGHT_CTL_DEFAULT_SET
ESP_BLE_MESH_MODEL_OP_LIGHT_CTL_DEFAULT_SET_UNACK
ESP_BLE_MESH_MODEL_OP_LIGHT_CTL_TEMPERATURE_RANGE_SET
ESP_BLE_MESH_MODEL_OP_LIGHT_CTL_TEMPERATURE_RANGE_SET_UNACK
 Light HSL Message Opcode
ESP_BLE_MESH_MODEL_OP_LIGHT_HSL_GET
ESP_BLE_MESH_MODEL_OP_LIGHT_HSL_HUE_GET
ESP_BLE_MESH_MODEL_OP_LIGHT_HSL_HUE_SET
ESP_BLE_MESH_MODEL_OP_LIGHT_HSL_HUE_SET_UNACK
ESP_BLE_MESH_MODEL_OP_LIGHT_HSL_HUE_STATUS
ESP_BLE_MESH_MODEL_OP_LIGHT_HSL_SATURATION_GET
ESP_BLE_MESH_MODEL_OP_LIGHT_HSL_SATURATION_SET
ESP_BLE_MESH_MODEL_OP_LIGHT_HSL_SATURATION_SET_UNACK
ESP_BLE_MESH_MODEL_OP_LIGHT_HSL_SATURATION_STATUS
ESP_BLE_MESH_MODEL_OP_LIGHT_HSL_SET
ESP_BLE_MESH_MODEL_OP_LIGHT_HSL_SET_UNACK
ESP_BLE_MESH_MODEL_OP_LIGHT_HSL_STATUS
ESP_BLE_MESH_MODEL_OP_LIGHT_HSL_TARGET_GET
ESP_BLE_MESH_MODEL_OP_LIGHT_HSL_TARGET_STATUS
ESP_BLE_MESH_MODEL_OP_LIGHT_HSL_DEFAULT_GET
ESP_BLE_MESH_MODEL_OP_LIGHT_HSL_DEFAULT_STATUS
ESP_BLE_MESH_MODEL_OP_LIGHT_HSL_RANGE_GET
ESP_BLE_MESH_MODEL_OP_LIGHT_HSL_RANGE_STATUS
 Light HSL Setup Message Opcode
ESP_BLE_MESH_MODEL_OP_LIGHT_HSL_DEFAULT_SET
ESP_BLE_MESH_MODEL_OP_LIGHT_HSL_DEFAULT_SET_UNACK
ESP_BLE_MESH_MODEL_OP_LIGHT_HSL_RANGE_SET

ESP_BLE_MESH_MODEL_OP_LIGHT_HSL_RANGE_SET_UNACK
Light xyL Message Opcode

ESP_BLE_MESH_MODEL_OP_LIGHT_XYL_GET

ESP_BLE_MESH_MODEL_OP_LIGHT_XYL_SET

ESP_BLE_MESH_MODEL_OP_LIGHT_XYL_SET_UNACK

ESP_BLE_MESH_MODEL_OP_LIGHT_XYL_STATUS

ESP_BLE_MESH_MODEL_OP_LIGHT_XYL_TARGET_GET

ESP_BLE_MESH_MODEL_OP_LIGHT_XYL_TARGET_STATUS

ESP_BLE_MESH_MODEL_OP_LIGHT_XYL_DEFAULT_GET

ESP_BLE_MESH_MODEL_OP_LIGHT_XYL_DEFAULT_STATUS

ESP_BLE_MESH_MODEL_OP_LIGHT_XYL_RANGE_GET

ESP_BLE_MESH_MODEL_OP_LIGHT_XYL_RANGE_STATUS
Light xyL Setup Message Opcode

ESP_BLE_MESH_MODEL_OP_LIGHT_XYL_DEFAULT_SET

ESP_BLE_MESH_MODEL_OP_LIGHT_XYL_DEFAULT_SET_UNACK

ESP_BLE_MESH_MODEL_OP_LIGHT_XYL_RANGE_SET

ESP_BLE_MESH_MODEL_OP_LIGHT_XYL_RANGE_SET_UNACK
Light Control Message Opcode

ESP_BLE_MESH_MODEL_OP_LIGHT_LC_MODE_GET

ESP_BLE_MESH_MODEL_OP_LIGHT_LC_MODE_SET

ESP_BLE_MESH_MODEL_OP_LIGHT_LC_MODE_SET_UNACK

ESP_BLE_MESH_MODEL_OP_LIGHT_LC_MODE_STATUS

ESP_BLE_MESH_MODEL_OP_LIGHT_LC_OM_GET

ESP_BLE_MESH_MODEL_OP_LIGHT_LC_OM_SET

ESP_BLE_MESH_MODEL_OP_LIGHT_LC_OM_SET_UNACK

ESP_BLE_MESH_MODEL_OP_LIGHT_LC_OM_STATUS

ESP_BLE_MESH_MODEL_OP_LIGHT_LC_LIGHT_ONOFF_GET

ESP_BLE_MESH_MODEL_OP_LIGHT_LC_LIGHT_ONOFF_SET

ESP_BLE_MESH_MODEL_OP_LIGHT_LC_LIGHT_ONOFF_SET_UNACK

ESP_BLE_MESH_MODEL_OP_LIGHT_LC_LIGHT_ONOFF_STATUS

ESP_BLE_MESH_MODEL_OP_LIGHT_LC_PROPERTY_GET

ESP_BLE_MESH_MODEL_OP_LIGHT_LC_PROPERTY_SET

ESP_BLE_MESH_MODEL_OP_LIGHT_LC_PROPERTY_SET_UNACK

ESP_BLE_MESH_MODEL_OP_LIGHT_LC_PROPERTY_STATUS

ESP_BLE_MESH_MODEL_STATUS_SUCCESS

ESP_BLE_MESH_MODEL_STATUS_CANNOT_SET_RANGE_MIN

ESP_BLE_MESH_MODEL_STATUS_CANNOT_SET_RANGE_MAX

ESP_BLE_MESH_SERVER_RSP_BY_APP
Response need to be sent in the application

ESP_BLE_MESH_SERVER_AUTO_RSP
Response will be sent internally

Type Definitions

typedef uint8_t **esp_ble_mesh_octet16_t**[ESP_BLE_MESH_OCTET16_LEN]

Define the BLE Mesh octet 8 bytes size

typedef uint8_t **esp_ble_mesh_octet8_t**[ESP_BLE_MESH_OCTET8_LEN]

Invalid Company ID

typedef uint32_t **esp_ble_mesh_cb_t**

typedef uint8_t **UINT8**

typedef uint16_t **UINT16**

typedef uint32_t **UINT32**

typedef uint64_t **UINT64**

typedef *UINT8* **BT_OCTET32**[BT_OCTET32_LEN]

typedef uint8_t **BD_ADDR**[BD_ADDR_LEN]

typedef uint8_t **esp_ble_mesh_bd_addr_t**[BD_ADDR_LEN]

typedef uint8_t **esp_ble_mesh_addr_type_t**

BLE device address type.

typedef struct *esp_ble_mesh_model* **esp_ble_mesh_model_t**

typedef uint8_t **esp_ble_mesh_dev_add_flag_t**

typedef uint32_t **esp_ble_mesh_opcode_config_client_get_t**

esp_ble_mesh_opcode_config_client_get_t belongs to **esp_ble_mesh_opcode_t**, this typedef is only used to locate the opcodes used by **esp_ble_mesh_config_client_get_state**. The following opcodes will only be used in the **esp_ble_mesh_config_client_get_state** function.

typedef uint32_t **esp_ble_mesh_opcode_config_client_set_t**

esp_ble_mesh_opcode_config_client_set_t belongs to **esp_ble_mesh_opcode_t**, this typedef is only used to locate the opcodes used by **esp_ble_mesh_config_client_set_state**. The following opcodes will only be used in the **esp_ble_mesh_config_client_set_state** function.

typedef uint32_t **esp_ble_mesh_opcode_config_status_t**

esp_ble_mesh_opcode_config_status_t belongs to **esp_ble_mesh_opcode_t**, this typedef is only used to locate the opcodes used by the Config Model messages. The following opcodes are used by the BLE Mesh Config Server Model internally to respond to the Config Client Model's request messages.

typedef uint8_t **esp_ble_mesh_cfg_status_t**

This typedef is only used to indicate the status code contained in some of the Configuration Server Model status message.

typedef uint32_t **esp_ble_mesh_opcode_health_client_get_t**

esp_ble_mesh_opcode_health_client_get_t belongs to **esp_ble_mesh_opcode_t**, this typedef is only used to locate the opcodes used by **esp_ble_mesh_health_client_get_state**. The following opcodes will only be used in the **esp_ble_mesh_health_client_get_state** function.

typedef uint32_t **esp_ble_mesh_opcode_health_client_set_t**

esp_ble_mesh_opcode_health_client_set_t belongs to **esp_ble_mesh_opcode_t**, this typedef is only used to locate the opcodes used by **esp_ble_mesh_health_client_set_state**. The following opcodes will only be used in the **esp_ble_mesh_health_client_set_state** function.

typedef uint32_t **esp_ble_mesh_health_model_status_t**

esp_ble_mesh_health_model_status_t belongs to **esp_ble_mesh_opcode_t**, this typedef is only used to locate the opcodes used by the Health Model messages. The following opcodes are used by the BLE Mesh Health Server Model internally to respond to the Health Client Model's request messages.

typedef uint32_t **esp_ble_mesh_generic_message_opcode_t**

esp_ble_mesh_generic_message_opcode_t belongs to **esp_ble_mesh_opcode_t**, this typedef is only used to locate the opcodes used by functions **esp_ble_mesh_generic_client_get_state** & **esp_ble_mesh_generic_client_set_state**. Generic OnOff Message Opcode

typedef uint32_t **esp_ble_mesh_sensor_message_opcode_t**

esp_ble_mesh_sensor_message_opcode_t belongs to esp_ble_mesh_opcode_t, this typedef is only used to locate the opcodes used by functions esp_ble_mesh_sensor_client_get_state & esp_ble_mesh_sensor_client_set_state.Sensor Message Opcode

typedef uint32_t **esp_ble_mesh_time_scene_message_opcode_t**

esp_ble_mesh_time_scene_message_opcode_t belongs to esp_ble_mesh_opcode_t, this typedef is only used to locate the opcodes used by functions esp_ble_mesh_time_scene_client_get_state & esp_ble_mesh_time_scene_client_set_state.Time Message Opcode

typedef uint32_t **esp_ble_mesh_light_message_opcode_t**

esp_ble_mesh_light_message_opcode_t belongs to esp_ble_mesh_opcode_t, this typedef is only used to locate the opcodes used by functions esp_ble_mesh_light_client_get_state & esp_ble_mesh_light_client_set_state.Light Lightness Message Opcode

typedef uint32_t **esp_ble_mesh_opcode_t**

End of defines of esp_ble_mesh_opcode_t

typedef uint8_t **esp_ble_mesh_model_status_t**

This typedef is only used to indicate the status code contained in some of the server models (e.g. Generic Server Model) status message.

Enumerations

enum **esp_ble_mesh_cb_type_t**

Values:

ESP_BLE_MESH_TYPE_PROV_CB

ESP_BLE_MESH_TYPE_OUTPUT_NUM_CB

ESP_BLE_MESH_TYPE_OUTPUT_STR_CB

ESP_BLE_MESH_TYPE_INTPUT_CB

ESP_BLE_MESH_TYPE_LINK_OPEN_CB

ESP_BLE_MESH_TYPE_LINK_CLOSE_CB

ESP_BLE_MESH_TYPE_COMPLETE_CB

ESP_BLE_MESH_TYPE_RESET_CB

enum **esp_ble_mesh_oob_method_t**

Values:

ESP_BLE_MESH_NO_OOB

ESP_BLE_MESH_STATIC_OOB

ESP_BLE_MESH_OUTPUT_OOB

ESP_BLE_MESH_INPUT_OOB

enum **esp_ble_mesh_output_action_t**

Values:

ESP_BLE_MESH_NO_OUTPUT = 0

ESP_BLE_MESH_BLINK = BIT(0)

ESP_BLE_MESH_BEEP = BIT(1)

ESP_BLE_MESH_VIBRATE = BIT(2)

ESP_BLE_MESH_DISPLAY_NUMBER = BIT(3)

ESP_BLE_MESH_DISPLAY_STRING = BIT(4)

enum **esp_ble_mesh_input_action_t**

Values:

ESP_BLE_MESH_NO_INPUT = 0

ESP_BLE_MESH_PUSH = BIT(0)

ESP_BLE_MESH_TWIST = BIT(1)

ESP_BLE_MESH_ENTER_NUMBER = BIT(2)

ESP_BLE_MESH_ENTER_STRING = BIT(3)

enum esp_ble_mesh_prov_bearer_t

Values:

ESP_BLE_MESH_PROV_ADV = BIT(0)

ESP_BLE_MESH_PROV_GATT = BIT(1)

enum esp_ble_mesh_prov_oob_info_t

Values:

ESP_BLE_MESH_PROV_OOB_OTHER = BIT(0)

ESP_BLE_MESH_PROV_OOB_URI = BIT(1)

ESP_BLE_MESH_PROV_OOB_2D_CODE = BIT(2)

ESP_BLE_MESH_PROV_OOB_BAR_CODE = BIT(3)

ESP_BLE_MESH_PROV_OOB_NFC = BIT(4)

ESP_BLE_MESH_PROV_OOB_NUMBER = BIT(5)

ESP_BLE_MESH_PROV_OOB_STRING = BIT(6)

ESP_BLE_MESH_PROV_OOB_ON_BOX = BIT(11)

ESP_BLE_MESH_PROV_OOB_IN_BOX = BIT(12)

ESP_BLE_MESH_PROV_OOB_ON_PAPER = BIT(13)

ESP_BLE_MESH_PROV_OOB_IN_MANUAL = BIT(14)

ESP_BLE_MESH_PROV_OOB_ON_DEV = BIT(15)

enum esp_ble_mesh_dev_role_t

Values:

ROLE_NODE = 0

ROLE_PROVISIONER

ROLE_FAST_PROV

enum esp_ble_mesh_fast_prov_action_t

Values:

FAST_PROV_ACT_NONE

FAST_PROV_ACT_ENTER

FAST_PROV_ACT_SUSPEND

FAST_PROV_ACT_EXIT

FAST_PROV_ACT_MAX

enum esp_ble_mesh_proxy_filter_type_t

Values:

PROXY_FILTER_WHITELIST

PROXY_FILTER_BLACKLIST

enum esp_ble_mesh_prov_cb_event_t

Values:

- ESP_BLE_MESH_PROV_REGISTER_COMP_EVT**
Initialize BLE Mesh provisioning capabilities and internal data information completion event
- ESP_BLE_MESH_NODE_SET_UNPROV_DEV_NAME_COMP_EVT**
Set the unprovisioned device name completion event
- ESP_BLE_MESH_NODE_PROV_ENABLE_COMP_EVT**
Enable node provisioning functionality completion event
- ESP_BLE_MESH_NODE_PROV_DISABLE_COMP_EVT**
Disable node provisioning functionality completion event
- ESP_BLE_MESH_NODE_PROV_LINK_OPEN_EVT**
Establish a BLE Mesh link event
- ESP_BLE_MESH_NODE_PROV_LINK_CLOSE_EVT**
Close a BLE Mesh link event
- ESP_BLE_MESH_NODE_PROV_OOB_PUB_KEY_EVT**
Generate Node input OOB public key event
- ESP_BLE_MESH_NODE_PROV_OUTPUT_NUMBER_EVT**
Generate Node Output Number event
- ESP_BLE_MESH_NODE_PROV_OUTPUT_STRING_EVT**
Generate Node Output String event
- ESP_BLE_MESH_NODE_PROV_INPUT_EVT**
Event requiring the user to input a number or string
- ESP_BLE_MESH_NODE_PROV_COMPLETE_EVT**
Provisioning done event
- ESP_BLE_MESH_NODE_PROV_RESET_EVT**
Provisioning reset event
- ESP_BLE_MESH_NODE_PROV_SET_OOB_PUB_KEY_COMP_EVT**
Node set oob public key completion event
- ESP_BLE_MESH_NODE_PROV_INPUT_NUMBER_COMP_EVT**
Node input number completion event
- ESP_BLE_MESH_NODE_PROV_INPUT_STRING_COMP_EVT**
Node input string completion event
- ESP_BLE_MESH_NODE_PROXY_IDENTITY_ENABLE_COMP_EVT**
Enable BLE Mesh Proxy Identity advertising completion event
- ESP_BLE_MESH_NODE_PROXY_GATT_ENABLE_COMP_EVT**
Enable BLE Mesh GATT Proxy Service completion event
- ESP_BLE_MESH_NODE_PROXY_GATT_DISABLE_COMP_EVT**
Disable BLE Mesh GATT Proxy Service completion event
- ESP_BLE_MESH_NODE_ADD_LOCAL_NET_KEY_COMP_EVT**
Node add NetKey locally completion event
- ESP_BLE_MESH_NODE_ADD_LOCAL_APP_KEY_COMP_EVT**
Node add AppKey locally completion event
- ESP_BLE_MESH_NODE_BIND_APP_KEY_TO_MODEL_COMP_EVT**
Node bind AppKey to model locally completion event
- ESP_BLE_MESH_PROVISIONER_PROV_ENABLE_COMP_EVT**
Provisioner enable provisioning functionality completion event
- ESP_BLE_MESH_PROVISIONER_PROV_DISABLE_COMP_EVT**
Provisioner disable provisioning functionality completion event

- ESP_BLE_MESH_PROVISIONER_RECV_UNPROV_ADV_PKT_EVT**
Provisioner receives unprovisioned device beacon event
- ESP_BLE_MESH_PROVISIONER_PROV_READ_OOB_PUB_KEY_EVT**
Provisioner read unprovisioned device OOB public key event
- ESP_BLE_MESH_PROVISIONER_PROV_INPUT_EVT**
Provisioner input value for provisioning procedure event
- ESP_BLE_MESH_PROVISIONER_PROV_OUTPUT_EVT**
Provisioner output value for provisioning procedure event
- ESP_BLE_MESH_PROVISIONER_PROV_LINK_OPEN_EVT**
Provisioner establish a BLE Mesh link event
- ESP_BLE_MESH_PROVISIONER_PROV_LINK_CLOSE_EVT**
Provisioner close a BLE Mesh link event
- ESP_BLE_MESH_PROVISIONER_PROV_COMPLETE_EVT**
Provisioner provisioning done event
- ESP_BLE_MESH_PROVISIONER_ADD_UNPROV_DEV_COMP_EVT**
Provisioner add a device to the list which contains devices that are waiting/going to be provisioned completion event
- ESP_BLE_MESH_PROVISIONER_PROV_DEV_WITH_ADDR_COMP_EVT**
Provisioner start to provision an unprovisioned device completion event
- ESP_BLE_MESH_PROVISIONER_DELETE_DEV_COMP_EVT**
Provisioner delete a device from the list, close provisioning link with the device completion event
- ESP_BLE_MESH_PROVISIONER_SET_DEV_UUID_MATCH_COMP_EVT**
Provisioner set the value to be compared with part of the unprovisioned device UUID completion event
- ESP_BLE_MESH_PROVISIONER_SET_PROV_DATA_INFO_COMP_EVT**
Provisioner set net_idx/flags/iv_index used for provisioning completion event
- ESP_BLE_MESH_PROVISIONER_SET_STATIC_OOB_VALUE_COMP_EVT**
Provisioner set static oob value used for provisioning completion event
- ESP_BLE_MESH_PROVISIONER_SET_PRIMARY_ELEM_ADDR_COMP_EVT**
Provisioner set unicast address of primary element completion event
- ESP_BLE_MESH_PROVISIONER_PROV_READ_OOB_PUB_KEY_COMP_EVT**
Provisioner read unprovisioned device OOB public key completion event
- ESP_BLE_MESH_PROVISIONER_PROV_INPUT_NUMBER_COMP_EVT**
Provisioner input number completion event
- ESP_BLE_MESH_PROVISIONER_PROV_INPUT_STRING_COMP_EVT**
Provisioner input string completion event
- ESP_BLE_MESH_PROVISIONER_SET_NODE_NAME_COMP_EVT**
Provisioner set node name completion event
- ESP_BLE_MESH_PROVISIONER_ADD_LOCAL_APP_KEY_COMP_EVT**
Provisioner add local app key completion event
- ESP_BLE_MESH_PROVISIONER_UPDATE_LOCAL_APP_KEY_COMP_EVT**
Provisioner update local app key completion event
- ESP_BLE_MESH_PROVISIONER_BIND_APP_KEY_TO_MODEL_COMP_EVT**
Provisioner bind local model with local app key completion event
- ESP_BLE_MESH_PROVISIONER_ADD_LOCAL_NET_KEY_COMP_EVT**
Provisioner add local network key completion event
- ESP_BLE_MESH_PROVISIONER_UPDATE_LOCAL_NET_KEY_COMP_EVT**
Provisioner update local network key completion event

ESP_BLE_MESH_PROVISIONER_STORE_NODE_COMP_DATA_COMP_EVT
Provisioner store node composition data completion event

ESP_BLE_MESH_PROVISIONER_DELETE_NODE_WITH_UUID_COMP_EVT
Provisioner delete node with uuid completion event

ESP_BLE_MESH_PROVISIONER_DELETE_NODE_WITH_ADDR_COMP_EVT
Provisioner delete node with unicast address completion event

ESP_BLE_MESH_PROVISIONER_ENABLE_HEARTBEAT_RECV_COMP_EVT
Provisioner start to receive heartbeat message completion event

ESP_BLE_MESH_PROVISIONER_SET_HEARTBEAT_FILTER_TYPE_COMP_EVT
Provisioner set the heartbeat filter type completion event

ESP_BLE_MESH_PROVISIONER_SET_HEARTBEAT_FILTER_INFO_COMP_EVT
Provisioner set the heartbeat filter information completion event

ESP_BLE_MESH_PROVISIONER_RECV_HEARTBEAT_MESSAGE_EVT
Provisioner receive heartbeat message event

ESP_BLE_MESH_PROVISIONER_DIRECT_ERASE_SETTINGS_COMP_EVT
Provisioner directly erase settings completion event

ESP_BLE_MESH_PROVISIONER_OPEN_SETTINGS_WITH_INDEX_COMP_EVT
Provisioner open settings with index completion event

ESP_BLE_MESH_PROVISIONER_OPEN_SETTINGS_WITH_UID_COMP_EVT
Provisioner open settings with user id completion event

ESP_BLE_MESH_PROVISIONER_CLOSE_SETTINGS_WITH_INDEX_COMP_EVT
Provisioner close settings with index completion event

ESP_BLE_MESH_PROVISIONER_CLOSE_SETTINGS_WITH_UID_COMP_EVT
Provisioner close settings with user id completion event

ESP_BLE_MESH_PROVISIONER_DELETE_SETTINGS_WITH_INDEX_COMP_EVT
Provisioner delete settings with index completion event

ESP_BLE_MESH_PROVISIONER_DELETE_SETTINGS_WITH_UID_COMP_EVT
Provisioner delete settings with user id completion event

ESP_BLE_MESH_SET_FAST_PROV_INFO_COMP_EVT
Set fast provisioning information (e.g. unicast address range, net_idx, etc.) completion event

ESP_BLE_MESH_SET_FAST_PROV_ACTION_COMP_EVT
Set fast provisioning action completion event

ESP_BLE_MESH_HEARTBEAT_MESSAGE_RECV_EVT
Receive Heartbeat message event

ESP_BLE_MESH_LPN_ENABLE_COMP_EVT
Enable Low Power Node completion event

ESP_BLE_MESH_LPN_DISABLE_COMP_EVT
Disable Low Power Node completion event

ESP_BLE_MESH_LPN_POLL_COMP_EVT
Low Power Node send Friend Poll completion event

ESP_BLE_MESH_LPN_FRIENDSHIP_ESTABLISH_EVT
Low Power Node establishes friendship event

ESP_BLE_MESH_LPN_FRIENDSHIP_TERMINATE_EVT
Low Power Node terminates friendship event

ESP_BLE_MESH_FRIEND_FRIENDSHIP_ESTABLISH_EVT
Friend Node establishes friendship event

ESP_BLE_MESH_FRIEND_FRIENDSHIP_TERMINATE_EVT
Friend Node terminates friendship event

ESP_BLE_MESH_PROXY_CLIENT_RECV_ADV_PKT_EVT
Proxy Client receives Network ID advertising packet event

ESP_BLE_MESH_PROXY_CLIENT_CONNECTED_EVT
Proxy Client establishes connection successfully event

ESP_BLE_MESH_PROXY_CLIENT_DISCONNECTED_EVT
Proxy Client terminates connection successfully event

ESP_BLE_MESH_PROXY_CLIENT_RECV_FILTER_STATUS_EVT
Proxy Client receives Proxy Filter Status event

ESP_BLE_MESH_PROXY_CLIENT_CONNECT_COMP_EVT
Proxy Client connect completion event

ESP_BLE_MESH_PROXY_CLIENT_DISCONNECT_COMP_EVT
Proxy Client disconnect completion event

ESP_BLE_MESH_PROXY_CLIENT_SET_FILTER_TYPE_COMP_EVT
Proxy Client set filter type completion event

ESP_BLE_MESH_PROXY_CLIENT_ADD_FILTER_ADDR_COMP_EVT
Proxy Client add filter address completion event

ESP_BLE_MESH_PROXY_CLIENT_REMOVE_FILTER_ADDR_COMP_EVT
Proxy Client remove filter address completion event

ESP_BLE_MESH_PROXY_SERVER_CONNECTED_EVT
Proxy Server establishes connection successfully event

ESP_BLE_MESH_PROXY_SERVER_DISCONNECTED_EVT
Proxy Server terminates connection successfully event

ESP_BLE_MESH_MODEL_SUBSCRIBE_GROUP_ADDR_COMP_EVT
Local model subscribes group address completion event

ESP_BLE_MESH_MODEL_UNSUBSCRIBE_GROUP_ADDR_COMP_EVT
Local model unsubscribes group address completion event

ESP_BLE_MESH_DEINIT_MESH_COMP_EVT
De-initialize BLE Mesh stack completion event

ESP_BLE_MESH_PROV_EVT_MAX

enum [anonymous]

BLE Mesh server models related definitions.

This enum value is the flag of transition timer operation

Values:

ESP_BLE_MESH_SERVER_TRANS_TIMER_START

ESP_BLE_MESH_SERVER_FLAG_MAX

enum esp_ble_mesh_server_state_type_t

This enum value is the type of server model states

Values:

ESP_BLE_MESH_GENERIC_ONOFF_STATE

ESP_BLE_MESH_GENERIC_LEVEL_STATE

ESP_BLE_MESH_GENERIC_ONPOWERUP_STATE

ESP_BLE_MESH_GENERIC_POWER_ACTUAL_STATE

ESP_BLE_MESH_LIGHT_LIGHTNESS_ACTUAL_STATE

```
ESP_BLE_MESH_LIGHT_LIGHTNESS_LINEAR_STATE
ESP_BLE_MESH_LIGHT_CTL_LIGHTNESS_STATE
ESP_BLE_MESH_LIGHT_CTL_TEMP_DELTA_UV_STATE
ESP_BLE_MESH_LIGHT_HSL_STATE
ESP_BLE_MESH_LIGHT_HSL_LIGHTNESS_STATE
ESP_BLE_MESH_LIGHT_HSL_HUE_STATE
ESP_BLE_MESH_LIGHT_HSL_SATURATION_STATE
ESP_BLE_MESH_LIGHT_XYL_LIGHTNESS_STATE
ESP_BLE_MESH_LIGHT_LC_LIGHT_ONOFF_STATE
ESP_BLE_MESH_SERVER_MODEL_STATE_MAX
```

```
enum esp_ble_mesh_model_cb_event_t
```

Values:

```
ESP_BLE_MESH_MODEL_OPERATION_EVT
    User-defined models receive messages from peer devices (e.g. get, set, status, etc) event
ESP_BLE_MESH_MODEL_SEND_COMP_EVT
    User-defined models send messages completion event
ESP_BLE_MESH_MODEL_PUBLISH_COMP_EVT
    User-defined models publish messages completion event
ESP_BLE_MESH_CLIENT_MODEL_RECV_PUBLISH_MSG_EVT
    User-defined client models receive publish messages event
ESP_BLE_MESH_CLIENT_MODEL_SEND_TIMEOUT_EVT
    Timeout event for the user-defined client models that failed to receive response from peer server models
ESP_BLE_MESH_MODEL_PUBLISH_UPDATE_EVT
    When a model is configured to publish messages periodically, this event will occur during every publish
    period
ESP_BLE_MESH_SERVER_MODEL_UPDATE_STATE_COMP_EVT
    Server models update state value completion event
ESP_BLE_MESH_MODEL_EVT_MAX
```

ESP-BLE-MESH Core API Reference

This section contains ESP-BLE-MESH Core related APIs, which can be used to initialize ESP-BLE-MESH stack, provision, send/publish messages, etc.

This API reference covers six components:

- [ESP-BLE-MESH Stack Initialization](#)
- [Reading of Local Data Information](#)
- [Low Power Operation \(Updating\)](#)
- [Send/Publish Messages, add Local AppKey, etc.](#)
- [ESP-BLE-MESH Node/Provisioner Provisioning](#)
- [ESP-BLE-MESH GATT Proxy Server](#)

ESP-BLE-MESH Stack Initialization

Header File

- [bt/esp_ble_mesh/api/core/include/esp_ble_mesh_common_api.h](#)

Functions

esp_err_t **esp_ble_mesh_init** (*esp_ble_mesh_prov_t* *prov, *esp_ble_mesh_comp_t* *comp)

Initialize BLE Mesh module. This API initializes provisioning capabilities and composition data information.

Note After calling this API, the device needs to call `esp_ble_mesh_prov_enable()` to enable provisioning functionality again.

Return ESP_OK on success or error code otherwise.

Parameters

- [in] prov: Pointer to the device provisioning capabilities. This pointer must remain valid during the lifetime of the BLE Mesh device.
- [in] comp: Pointer to the device composition data information. This pointer must remain valid during the lifetime of the BLE Mesh device.

esp_err_t **esp_ble_mesh_deinit** (*esp_ble_mesh_deinit_param_t* *param)

De-initialize BLE Mesh module.

Note This function shall be invoked after `esp_ble_mesh_client_model_deinit()`.

Return ESP_OK on success or error code otherwise.

Parameters

- [in] param: Pointer to the structure of BLE Mesh deinit parameters.

Reading of Local Data Information

Header File

- [bt/esp_ble_mesh/api/core/include/esp_ble_mesh_local_data_operation_api.h](#)

Functions

int32_t **esp_ble_mesh_get_model_publish_period** (*esp_ble_mesh_model_t* *model)

Get the model publish period, the unit is ms.

Return Publish period value on success, 0 or (negative) error code from `errno.h` on failure.

Parameters

- [in] model: Model instance pointer.

uint16_t **esp_ble_mesh_get_primary_element_address** (void)

Get the address of the primary element.

Return Address of the primary element on success, or ESP_BLE_MESH_ADDR_UNASSIGNED on failure which means the device has not been provisioned.

uint16_t ***esp_ble_mesh_is_model_subscribed_to_group** (*esp_ble_mesh_model_t* *model, *uint16_t* group_addr)

Check if the model has subscribed to the given group address. Note: E.g., once a status message is received and the destination address is a group address, the model uses this API to check if it is successfully subscribed to the given group address.

Return Pointer to the group address within the Subscription List of the model on success, or NULL on failure which means the model has not subscribed to the given group address. Note: With the pointer to the group address returned, you can reset the group address to 0x0000 in order to unsubscribe the model from the group.

Parameters

- [in] model: Pointer to the model.
- [in] group_addr: Group address.

esp_ble_mesh_elem_t ***esp_ble_mesh_find_element** (*uint16_t* element_addr)

Find the BLE Mesh element pointer via the element address.

Return Pointer to the element on success, or NULL on failure.

Parameters

- [in] element_addr: Element address.

`uint8_t esp_ble_mesh_get_element_count` (void)

Get the number of elements that have been registered.

Return Number of elements.

`esp_ble_mesh_model_t *esp_ble_mesh_find_vendor_model` (const `esp_ble_mesh_elem_t` **element*, `uint16_t` *company_id*, `uint16_t` *model_id*)

Find the Vendor specific model with the given element, the company ID and the Vendor Model ID.

Return Pointer to the Vendor Model on success, or NULL on failure which means the Vendor Model is not found.

Parameters

- [in] *element*: Element to which the model belongs.
- [in] *company_id*: A 16-bit company identifier assigned by the Bluetooth SIG.
- [in] *model_id*: A 16-bit vendor-assigned model identifier.

`esp_ble_mesh_model_t *esp_ble_mesh_find_sig_model` (const `esp_ble_mesh_elem_t` **element*, `uint16_t` *model_id*)

Find the SIG model with the given element and Model id.

Return Pointer to the SIG Model on success, or NULL on failure which means the SIG Model is not found.

Parameters

- [in] *element*: Element to which the model belongs.
- [in] *model_id*: SIG model identifier.

`const esp_ble_mesh_comp_t *esp_ble_mesh_get_composition_data` (void)

Get the Composition data which has been registered.

Return Pointer to the Composition data on success, or NULL on failure which means the Composition data is not initialized.

`esp_err_t esp_ble_mesh_model_subscribe_group_addr` (`uint16_t` *element_addr*, `uint16_t` *company_id*, `uint16_t` *model_id*, `uint16_t` *group_addr*)

A local model of node or Provisioner subscribes a group address.

Note This function shall not be invoked before node is provisioned or Provisioner is enabled.

Return ESP_OK on success or error code otherwise.

Parameters

- [in] *element_addr*: Unicast address of the element to which the model belongs.
- [in] *company_id*: A 16-bit company identifier.
- [in] *model_id*: A 16-bit model identifier.
- [in] *group_addr*: The group address to be subscribed.

`esp_err_t esp_ble_mesh_model_unsubscribe_group_addr` (`uint16_t` *element_addr*, `uint16_t` *company_id*, `uint16_t` *model_id*, `uint16_t` *group_addr*)

A local model of node or Provisioner unsubscribes a group address.

Note This function shall not be invoked before node is provisioned or Provisioner is enabled.

Return ESP_OK on success or error code otherwise.

Parameters

- [in] *element_addr*: Unicast address of the element to which the model belongs.
- [in] *company_id*: A 16-bit company identifier.
- [in] *model_id*: A 16-bit model identifier.
- [in] *group_addr*: The subscribed group address.

`const uint8_t *esp_ble_mesh_node_get_local_net_key` (`uint16_t` *net_idx*)

This function is called by Node to get the local NetKey.

Return NetKey on success, or NULL on failure.

Parameters

- [in] *net_idx*: NetKey index.

const uint8_t ***esp_ble_mesh_node_get_local_app_key** (uint16_t *app_idx*)

This function is called by Node to get the local AppKey.

Return AppKey on success, or NULL on failure.

Parameters

- [in] *app_idx*: AppKey index.

esp_err_t **esp_ble_mesh_node_add_local_net_key** (**const** uint8_t *net_key*[16], uint16_t *net_idx*)

This function is called by Node to add a local NetKey.

Note This function can only be called after the device is provisioned.

Return ESP_OK on success or error code otherwise.

Parameters

- [in] *net_key*: NetKey to be added.
- [in] *net_idx*: NetKey Index.

esp_err_t **esp_ble_mesh_node_add_local_app_key** (**const** uint8_t *app_key*[16], uint16_t *net_idx*, uint16_t *app_idx*)

This function is called by Node to add a local AppKey.

Note The *net_idx* must be an existing one. This function can only be called after the device is provisioned.

Return ESP_OK on success or error code otherwise.

Parameters

- [in] *app_key*: AppKey to be added.
- [in] *net_idx*: NetKey Index.
- [in] *app_idx*: AppKey Index.

esp_err_t **esp_ble_mesh_node_bind_app_key_to_local_model** (uint16_t *element_addr*,
uint16_t *company_id*,
uint16_t *model_id*, uint16_t *app_idx*)

This function is called by Node to bind AppKey to model locally.

Note If going to bind *app_key* with local vendor model, the *company_id* shall be set to 0xFFFF. This function can only be called after the device is provisioned.

Return ESP_OK on success or error code otherwise.

Parameters

- [in] *element_addr*: Node local element address
- [in] *company_id*: Node local company id
- [in] *model_id*: Node local model id
- [in] *app_idx*: Node local appkey index

Low Power Operation (Updating)

Header File

- [bt/esp_ble_mesh/api/core/include/esp_ble_mesh_low_power_api.h](#)

Functions

esp_err_t **esp_ble_mesh_lpn_enable** (void)

Enable BLE Mesh device LPN functionality.

Note This API enables LPN functionality. Once called, the proper Friend Request will be sent.

Return ESP_OK on success or error code otherwise.

esp_err_t **esp_ble_mesh_lpn_disable** (bool *force*)

Disable BLE Mesh device LPN functionality.

Return ESP_OK on success or error code otherwise.

Parameters

- `[in] force`: when disabling LPN functionality, use this flag to indicate whether directly clear corresponding information or just send friend clear to disable it if friendship has already been established.

`esp_err_t esp_ble_mesh_lpn_poll` (void)

LPN tries to poll messages from the Friend Node.

Note The Friend Poll message is sent by a Low Power node to ask the Friend node to send a message that it has stored for the Low Power node. Users can call this API to send Friend Poll message manually. If this API is not invoked, the bottom layer of the Low Power node will send Friend Poll before the PollTimeout timer expires. If the corresponding Friend Update is received and MD is set to 0, which means there are no messages for the Low Power node, then the Low Power node will stop scanning.

Return ESP_OK on success or error code otherwise.

Send/Publish Messages, add Local AppKey, etc.

Header File

- [bt/esp_ble_mesh/api/core/include/esp_ble_mesh_networking_api.h](#)

Functions

`esp_err_t esp_ble_mesh_register_custom_model_callback` (*esp_ble_mesh_model_cb_t callback*)

Register BLE Mesh callback for user-defined models' operations. This callback can report the following events generated for the user-defined models:

- Call back the messages received by user-defined client and server models to the application layer;
- If users call `esp_ble_mesh_server/client_model_send`, this callback notifies the application layer of the `send_complete` event;
- If user-defined client model sends a message that requires response, and the response message is received after the timer expires, the response message will be reported to the application layer as published by a peer device;
- If the user-defined client model fails to receive the response message during a specified period of time, a timeout event will be reported to the application layer.

Note The client models (i.e. Config Client model, Health Client model, Generic Client models, Sensor Client model, Scene Client model and Lighting Client models) that have been realized internally have their specific register functions. For example, `esp_ble_mesh_register_config_client_callback` is the register function for Config Client Model.

Return ESP_OK on success or error code otherwise.

Parameters

- `[in] callback`: Pointer to the callback function.

`esp_err_t esp_ble_mesh_model_msg_opcode_init` (uint8_t *data, uint32_t opcode)

Add the message opcode to the beginning of the model message before sending or publishing the model message.

Note This API is only used to set the opcode of the message.

Return ESP_OK on success or error code otherwise.

Parameters

- `[in] data`: Pointer to the message data.
- `[in] opcode`: The message opcode.

`esp_err_t esp_ble_mesh_client_model_init` (*esp_ble_mesh_model_t *model*)

Initialize the user-defined client model. All user-defined client models shall call this function to initialize the client model internal data. Note: Before calling this API, the `op_pair_size` and `op_pair` variables within the `user_data` (defined using `esp_ble_mesh_client_t`) of the client model need to be initialized.

Return ESP_OK on success or error code otherwise.

Parameters

- `[in] model`: BLE Mesh Client model to which the message belongs.

esp_err_t **esp_ble_mesh_client_model_deinit** (*esp_ble_mesh_model_t* *model)

De-initialize the user-defined client model.

Note This function shall be invoked before `esp_ble_mesh_deinit()` is called.

Return ESP_OK on success or error code otherwise.

Parameters

- [in] model: Pointer of the Client model.

esp_err_t **esp_ble_mesh_server_model_send_msg** (*esp_ble_mesh_model_t* *model,
esp_ble_mesh_msg_ctx_t *ctx, uint32_t
opcode, uint16_t length, uint8_t *data)

Send server model messages (such as server model status messages).

Return ESP_OK on success or error code otherwise.

Parameters

- [in] model: BLE Mesh Server Model to which the message belongs.
- [in] ctx: Message context, includes keys, TTL, etc.
- [in] opcode: Message opcode.
- [in] length: Message length (exclude the message opcode).
- [in] data: Parameters of Access Payload (exclude the message opcode) to be sent.

esp_err_t **esp_ble_mesh_client_model_send_msg** (*esp_ble_mesh_model_t* *model,
esp_ble_mesh_msg_ctx_t *ctx, uint32_t
opcode, uint16_t length, uint8_t *data,
int32_t msg_timeout, bool need_rsp,
esp_ble_mesh_dev_role_t device_role)

Send client model message (such as model get, set, etc).

Return ESP_OK on success or error code otherwise.

Parameters

- [in] model: BLE Mesh Client Model to which the message belongs.
- [in] ctx: Message context, includes keys, TTL, etc.
- [in] opcode: Message opcode.
- [in] length: Message length (exclude the message opcode).
- [in] data: Parameters of the Access Payload (exclude the message opcode) to be sent.
- [in] msg_timeout: Time to get response to the message (in milliseconds).
- [in] need_rsp: TRUE if the opcode requires the peer device to reply, FALSE otherwise.
- [in] device_role: Role of the device (Node/Provisioner) that sends the message.

esp_err_t **esp_ble_mesh_model_publish** (*esp_ble_mesh_model_t* *model, uint32_t opcode, uint16_t
length, uint8_t *data, *esp_ble_mesh_dev_role_t* de-
vice_role)

Send a model publication message.

Note Before calling this function, the user needs to ensure that the model publica-
tion message (*esp_ble_mesh_model_pub_t:msg*) contains a valid message to be sent.
And if users want to update the publishing message, this API should be called in
ESP_BLE_MESH_MODEL_PUBLISH_UPDATE_EVT with the message updated.

Return ESP_OK on success or error code otherwise.

Parameters

- [in] model: Mesh (client) Model publishing the message.
- [in] opcode: Message opcode.
- [in] length: Message length (exclude the message opcode).
- [in] data: Parameters of the Access Payload (exclude the message opcode) to be sent.
- [in] device_role: Role of the device (node/provisioner) publishing the message of the type
esp_ble_mesh_dev_role_t.

esp_err_t **esp_ble_mesh_server_model_update_state** (*esp_ble_mesh_model_t* *model,
esp_ble_mesh_server_state_type_t type,
esp_ble_mesh_server_state_value_t
*value)

Update a server model state value. If the model publication state is set properly (e.g. publish address is set to a valid address), it will publish corresponding status message.

Note Currently this API is used to update bound state value, not for all server model states.

Return ESP_OK on success or error code otherwise.

Parameters

- [in] model: Server model which is going to update the state.
- [in] type: Server model state type.
- [in] value: Server model state value.

esp_err_t **esp_ble_mesh_node_local_reset** (void)

Reset the provisioning procedure of the local BLE Mesh node.

Note All provisioning information in this node will be deleted and the node needs to be reprovisioned. The API function `esp_ble_mesh_node_prov_enable()` needs to be called to start a new provisioning procedure.

Return ESP_OK on success or error code otherwise.

esp_err_t **esp_ble_mesh_provisioner_set_node_name** (uint16_t *index*, const char **name*)

This function is called to set the node (provisioned device) name.

Note *index* is obtained from the parameters of ESP_BLE_MESH_PROVISIONER_PROV_COMPLETE_EVT.

Return ESP_OK on success or error code otherwise.

Parameters

- [in] *index*: Index of the node in the node queue.
- [in] *name*: Name (end by '\0') to be set for the node.

const char ***esp_ble_mesh_provisioner_get_node_name** (uint16_t *index*)

This function is called to get the node (provisioned device) name.

Note *index* is obtained from the parameters of ESP_BLE_MESH_PROVISIONER_PROV_COMPLETE_EVT.

Return Node name on success, or NULL on failure.

Parameters

- [in] *index*: Index of the node in the node queue.

uint16_t **esp_ble_mesh_provisioner_get_node_index** (const char **name*)

This function is called to get the node (provisioned device) index.

Return Node index on success, or an invalid value (0xFFFF) on failure.

Parameters

- [in] *name*: Name of the node (end by '\0').

esp_err_t **esp_ble_mesh_provisioner_store_node_comp_data** (uint16_t *unicast_addr*,
uint8_t **data*, uint16_t
length)

This function is called to store the Composition Data of the node.

Return ESP_OK on success or error code otherwise.

Parameters

- [in] *unicast_addr*: Element address of the node
- [in] *data*: Pointer of Composition Data
- [in] *length*: Length of Composition Data

esp_ble_mesh_node_t ***esp_ble_mesh_provisioner_get_node_with_uuid** (const uint8_t
uuid[16])

This function is called to get the provisioned node information with the node device uuid.

Return Pointer of the node info struct or NULL on failure.

Parameters

- [in] *uuid*: Device UUID of the node

esp_ble_mesh_node_t ***esp_ble_mesh_provisioner_get_node_with_addr** (uint16_t *uni-*
cast_addr)

This function is called to get the provisioned node information with the node unicast address.

Return Pointer of the node info struct or NULL on failure.

Parameters

- [in] *unicast_addr*: Unicast address of the node

esp_ble_mesh_node_t ***esp_ble_mesh_provisioner_get_node_with_name**(const char *name)

This function is called to get the provisioned node information with the node name.

Return Pointer of the node info struct or NULL on failure.

Parameters

- [in] name: Name of the node (end by '\0').

uint16_t **esp_ble_mesh_provisioner_get_prov_node_count**(void)

This function is called by Provisioner to get provisioned node count.

Return Number of the provisioned nodes.

const *esp_ble_mesh_node_t* ****esp_ble_mesh_provisioner_get_node_table_entry**(void)

This function is called by Provisioner to get the entry of the node table.

Note After invoking the function to get the entry of nodes, users can use the “for” loop combined with the macro CONFIG_BLE_MESH_MAX_PROV_NODES to get each node’s information. Before trying to read the node’s information, users need to check if the node exists, i.e. if the *(*esp_ble_mesh_node_t* **node) is NULL. For example: `` const *esp_ble_mesh_node_t* **entry = esp_ble_mesh_provisioner_get_node_table_entry(); for (int i = 0; i < CONFIG_BLE_MESH_MAX_PROV_NODES; i++) { const *esp_ble_mesh_node_t* *node = entry[i]; if (node) { …… } } ``

Return Pointer to the start of the node table.

esp_err_t **esp_ble_mesh_provisioner_delete_node_with_uuid**(const uint8_t uuid[16])

This function is called to delete the provisioned node information with the node device uuid.

Return ESP_OK on success or error code otherwise.

Parameters

- [in] uuid: Device UUID of the node

esp_err_t **esp_ble_mesh_provisioner_delete_node_with_addr**(uint16_t unicast_addr)

This function is called to delete the provisioned node information with the node unicast address.

Return ESP_OK on success or error code otherwise.

Parameters

- [in] unicast_addr: Unicast address of the node

esp_err_t **esp_ble_mesh_provisioner_add_local_app_key**(const uint8_t app_key[16], uint16_t net_idx, uint16_t app_idx)

This function is called to add a local AppKey for Provisioner.

Note app_key: If set to NULL, app_key will be generated internally. net_idx: Should be an existing one. app_idx: If it is going to be generated internally, it should be set to 0xFFFF, and the new app_idx will be reported via an event.

Return ESP_OK on success or error code otherwise.

Parameters

- [in] app_key: The app key to be set for the local BLE Mesh stack.
- [in] net_idx: The network key index.
- [in] app_idx: The app key index.

esp_err_t **esp_ble_mesh_provisioner_update_local_app_key**(const uint8_t app_key[16], uint16_t net_idx, uint16_t app_idx)

This function is used to update a local AppKey for Provisioner.

Return ESP_OK on success or error code otherwise.

Parameters

- [in] app_key: Value of the AppKey.
- [in] net_idx: Corresponding NetKey Index.
- [in] app_idx: The AppKey Index

```
const uint8_t *esp_ble_mesh_provisioner_get_local_app_key (uint16_t net_idx, uint16_t app_idx)
```

This function is called by Provisioner to get the local app key value.

Return App key on success, or NULL on failure.

Parameters

- [in] *net_idx*: Network key index.
- [in] *app_idx*: Application key index.

```
esp_err_t esp_ble_mesh_provisioner_bind_app_key_to_local_model (uint16_t element_addr,  
uint16_t app_idx,  
uint16_t model_id,  
uint16_t company_id)
```

This function is called by Provisioner to bind own model with proper app key.

Note *company_id*: If going to bind *app_key* with local vendor model, *company_id* should be set to 0xFFFF.

Return ESP_OK on success or error code otherwise.

Parameters

- [in] *element_addr*: Provisioner local element address
- [in] *app_idx*: Provisioner local appkey index
- [in] *model_id*: Provisioner local model id
- [in] *company_id*: Provisioner local company id

```
esp_err_t esp_ble_mesh_provisioner_add_local_net_key (const uint8_t net_key[16],  
uint16_t net_idx)
```

This function is called by Provisioner to add local network key.

Note *net_key*: If set to NULL, *net_key* will be generated internally. *net_idx*: If it is going to be generated internally, it should be set to 0xFFFF, and the new *net_idx* will be reported via an event.

Return ESP_OK on success or error code otherwise.

Parameters

- [in] *net_key*: The network key to be added to the Provisioner local BLE Mesh stack.
- [in] *net_idx*: The network key index.

```
esp_err_t esp_ble_mesh_provisioner_update_local_net_key (const uint8_t net_key[16],  
uint16_t net_idx)
```

This function is called by Provisioner to update a local network key.

Return ESP_OK on success or error code otherwise.

Parameters

- [in] *net_key*: Value of the NetKey.
- [in] *net_idx*: The NetKey Index.

```
const uint8_t *esp_ble_mesh_provisioner_get_local_net_key (uint16_t net_idx)
```

This function is called by Provisioner to get the local network key value.

Return Network key on success, or NULL on failure.

Parameters

- [in] *net_idx*: Network key index.

```
esp_err_t esp_ble_mesh_provisioner_recv_heartbeat (bool enable)
```

This function is called by Provisioner to enable or disable receiving heartbeat messages.

Note If enabling receiving heartbeat message successfully, the filter will be an empty rejectlist by default, which means all heartbeat messages received by the Provisioner will be reported to the application layer.

Return ESP_OK on success or error code otherwise.

Parameters

- [in] *enable*: Enable or disable receiving heartbeat messages.

```
esp_err_t esp_ble_mesh_provisioner_set_heartbeat_filter_type (uint8_t type)
```

This function is called by Provisioner to set the heartbeat filter type.

- Note** 1. If the filter type is not the same with the current value, then all the filter entries will be cleaned.
1. If the previous type is rejectlist, and changed to acceptlist, then the filter will be an empty acceptlist, which means no heartbeat messages will be reported. Users need to add SRC or DST into the filter entry, then heartbeat messages from the SRC or to the DST will be reported.

Return ESP_OK on success or error code otherwise.

Parameters

- [in] type: Heartbeat filter type (acceptlist or rejectlist).

esp_err_t **esp_ble_mesh_provisioner_set_heartbeat_filter_info** (uint8_t *op*,
esp_ble_mesh_heartbeat_filter_info_t
**info*)

This function is called by Provisioner to add or remove a heartbeat filter entry.

1. If the operation is “REMOVE” , the “hb_src” can be set to the SRC (can only be a unicast address) of heartbeat messages, and the “hb_dst” can be set to the DST (unicast address or group address), at least one of them needs to be set.

- The filter entry with the same SRC or DST will be removed.

- Note** 1. If the operation is “ADD” , the “hb_src” can be set to the SRC (can only be a unicast address) of heartbeat messages, and the “hb_dst” can be set to the DST (unicast address or group address), at least one of them needs to be set.

- If only one of them is set, the filter entry will only use the configured SRC or DST to filter heartbeat messages.
- If both of them are set, the SRC and DST will both be used to decide if a heartbeat message will be handled.
- If SRC or DST already exists in some filter entry, then the corresponding entry will be cleaned firstly, then a new entry will be allocated to store the information.

Return ESP_OK on success or error code otherwise.

Parameters

- [in] op: Add or REMOVE
- [in] info: Heartbeat filter entry information, including: hb_src - Heartbeat source address; hb_dst - Heartbeat destination address;

esp_err_t **esp_ble_mesh_provisioner_direct_erase_settings** (void)

This function is called by Provisioner to directly erase the mesh information from nvs namespace.

Note This function can be invoked when the mesh stack is not initialized or has been de-initialized.

Return ESP_OK on success or error code otherwise.

esp_err_t **esp_ble_mesh_provisioner_open_settings_with_index** (uint8_t *index*)

This function is called by Provisioner to open a nvs namespace for storing mesh information.

Note Before open another nvs namespace, the previously opened nvs namespace must be closed firstly.

Return ESP_OK on success or error code otherwise.

Parameters

- [in] index: Settings index.

esp_err_t **esp_ble_mesh_provisioner_open_settings_with_uid** (const char **uid*)

This function is called by Provisioner to open a nvs namespace for storing mesh information.

Note Before open another nvs namespace, the previously opened nvs namespace must be closed firstly.

Return ESP_OK on success or error code otherwise.

Parameters

- [in] uid: Settings user id.

esp_err_t **esp_ble_mesh_provisioner_close_settings_with_index** (uint8_t *index*, bool
erase)

This function is called by Provisioner to close a nvs namespace which is opened previously for storing mesh information.

Note 1. Before closing the nvs namespace, it must be open.

1. When the function is invoked, the Provisioner functionality will be disabled firstly, and: a) If the “erase” flag is set to false, the mesh information will be cleaned (e.g. removing NetKey, AppKey,

- nodes, etc) from the mesh stack. b) If the “erase” flag is set to true, the mesh information stored in the nvs namespace will also be erased besides been cleaned from the mesh stack.
2. If Provisioner tries to work properly again, we can invoke the open function to open a new nvs namespace or a previously added one, and restore the mesh information from it if not erased.
 3. The working process shall be as following: a) Open settings A b) Start to provision and control nodes c) Close settings A d) Open settings B e) Start to provision and control other nodes f) Close settings B g) ……

Return ESP_OK on success or error code otherwise.

Parameters

- [in] index: Settings index.
- [in] erase: Indicate if erasing mesh information.

esp_err_t **esp_ble_mesh_provisioner_close_settings_with_uid**(const char *uid, bool erase)

This function is called by Provisioner to close a nvs namespace which is opened previously for storing mesh information.

Note 1. Before closing the nvs namespace, it must be open.

1. When the function is invoked, the Provisioner functionality will be disabled firstly, and: a) If the “erase” flag is set to false, the mesh information will be cleaned (e.g. removing NetKey, AppKey, nodes, etc) from the mesh stack. b) If the “erase” flag is set to true, the mesh information stored in the nvs namespace will also be erased besides been cleaned from the mesh stack.
2. If Provisioner tries to work properly again, we can invoke the open function to open a new nvs namespace or a previously added one, and restore the mesh information from it if not erased.
3. The working process shall be as following: a) Open settings A b) Start to provision and control nodes c) Close settings A d) Open settings B e) Start to provision and control other nodes f) Close settings B g) ……

Return ESP_OK on success or error code otherwise.

Parameters

- [in] uid: Settings user id.
- [in] erase: Indicate if erasing mesh information.

esp_err_t **esp_ble_mesh_provisioner_delete_settings_with_index**(uint8_t index)

This function is called by Provisioner to erase the mesh information and settings user id from a nvs namespace.

Note When this function is called, the nvs namespace must not be open. This function is used to erase the mesh information and settings user id which are not used currently.

Return ESP_OK on success or error code otherwise.

Parameters

- [in] index: Settings index.

esp_err_t **esp_ble_mesh_provisioner_delete_settings_with_uid**(const char *uid)

This function is called by Provisioner to erase the mesh information and settings user id from a nvs namespace.

Note When this function is called, the nvs namespace must not be open. This function is used to erase the mesh information and settings user id which are not used currently.

Return ESP_OK on success or error code otherwise.

Parameters

- [in] uid: Settings user id.

const char ***esp_ble_mesh_provisioner_get_settings_uid**(uint8_t index)

This function is called by Provisioner to get settings user id.

Return Setting user id on success or NULL on failure.

Parameters

- [in] index: Settings index.

uint8_t **esp_ble_mesh_provisioner_get_settings_index**(const char *uid)

This function is called by Provisioner to get settings index.

Return Settings index.

Parameters

- [in] uid: Settings user id.

`uint8_t esp_ble_mesh_provisioner_get_free_settings_count` (void)

This function is called by Provisioner to get the number of free settings user id.

Return Number of free settings user id.

`const uint8_t *esp_ble_mesh_get_fast_prov_app_key` (uint16_t *net_idx*, uint16_t *app_idx*)

This function is called to get fast provisioning application key.

Return Application key on success, or NULL on failure.

Parameters

- [in] *net_idx*: Network key index.
- [in] *app_idx*: Application key index.

Type Definitions

```
typedef void (*esp_ble_mesh_model_cb_t) (esp_ble_mesh_model_cb_event_t          event,  
                                         esp_ble_mesh_model_cb_param_t *param)  
: event, event code of user-defined model events; param, parameters of user-defined model events
```

ESP-BLE-MESH Node/Provisioner Provisioning

Header File

- [bt/esp_ble_mesh/api/core/include/esp_ble_mesh_provisioning_api.h](#)

Functions

`esp_err_t esp_ble_mesh_register_prov_callback` (*esp_ble_mesh_prov_cb_t* *callback*)

Register BLE Mesh provisioning callback.

Return ESP_OK on success or error code otherwise.

Parameters

- [in] *callback*: Pointer to the callback function.

`bool esp_ble_mesh_node_is_provisioned` (void)

Check if a device has been provisioned.

Return TRUE if the device is provisioned, FALSE if the device is unprovisioned.

`esp_err_t esp_ble_mesh_node_prov_enable` (*esp_ble_mesh_prov_bearer_t* *bearers*)

Enable specific provisioning bearers to get the device ready for provisioning.

Note PB-ADV: send unprovisioned device beacon. PB-GATT: send connectable advertising packets.

Return ESP_OK on success or error code otherwise.

Parameters

- *bearers*: Bit-wise OR of provisioning bearers.

`esp_err_t esp_ble_mesh_node_prov_disable` (*esp_ble_mesh_prov_bearer_t* *bearers*)

Disable specific provisioning bearers to make a device inaccessible for provisioning.

Return ESP_OK on success or error code otherwise.

Parameters

- *bearers*: Bit-wise OR of provisioning bearers.

`esp_err_t esp_ble_mesh_node_set_oob_pub_key` (uint8_t *pub_key_x*[32], uint8_t *pub_key_y*[32],
uint8_t *private_key*[32])

Unprovisioned device set own oob public key & private key pair.

Note In order to avoid suffering brute-forcing attack (CVE-2020-26559). The Bluetooth SIG recommends that potentially vulnerable mesh provisioners use an out-of-band mechanism to exchange the public keys. So as an unprovisioned device, it should use this function to input the Public Key exchanged through the out-of-band mechanism.

Return ESP_OK on success or error code otherwise.

Parameters

- [in] *pub_key_x*: Unprovisioned device's Public Key X

- [in] `pub_key_y`: Unprovisioned device' s Public Key Y
- [in] `private_key`: Unprovisioned device' s Private Key

esp_err_t **esp_ble_mesh_node_input_number** (uint32_t *number*)

Provide provisioning input OOB number.

Note This is intended to be called if the user has received `ESP_BLE_MESH_NODE_PROV_INPUT_EVT` with `ESP_BLE_MESH_ENTER_NUMBER` as the action.

Return `ESP_OK` on success or error code otherwise.

Parameters

- [in] `number`: Number input by device.

esp_err_t **esp_ble_mesh_node_input_string** (const char **string*)

Provide provisioning input OOB string.

Note This is intended to be called if the user has received `ESP_BLE_MESH_NODE_PROV_INPUT_EVT` with `ESP_BLE_MESH_ENTER_STRING` as the action.

Return `ESP_OK` on success or error code otherwise.

Parameters

- [in] `string`: String input by device.

esp_err_t **esp_ble_mesh_set_unprovisioned_device_name** (const char **name*)

Using this function, an unprovisioned device can set its own device name, which will be broadcasted in its advertising data.

Note This API applicable to PB-GATT mode only by setting the name to the scan response data, it doesn' t apply to PB-ADV mode.

Return `ESP_OK` on success or error code otherwise.

Parameters

- [in] `name`: Unprovisioned device name

esp_err_t **esp_ble_mesh_provisioner_read_oob_pub_key** (uint8_t *link_idx*, uint8_t *pub_key_x*[32], uint8_t *pub_key_y*[32])

Provisioner inputs unprovisioned device' s oob public key.

Note In order to avoid suffering brute-forcing attack (CVE-2020-26559). The Bluetooth SIG recommends that potentially vulnerable mesh provisioners use an out-of-band mechanism to exchange the public keys.

Return `ESP_OK` on success or error code otherwise.

Parameters

- [in] `link_idx`: The provisioning link index
- [in] `pub_key_x`: Unprovisioned device' s Public Key X
- [in] `pub_key_y`: Unprovisioned device' s Public Key Y

esp_err_t **esp_ble_mesh_provisioner_input_string** (const char **string*, uint8_t *link_idx*)

Provide provisioning input OOB string.

This is intended to be called after the *esp_ble_mesh_prov_t* `prov_input_num` callback has been called with `ESP_BLE_MESH_ENTER_STRING` as the action.

Return `ESP_OK` on success or error code otherwise.

Parameters

- [in] `string`: String input by Provisioner.
- [in] `link_idx`: The provisioning link index.

esp_err_t **esp_ble_mesh_provisioner_input_number** (uint32_t *number*, uint8_t *link_idx*)

Provide provisioning input OOB number.

This is intended to be called after the *esp_ble_mesh_prov_t* `prov_input_num` callback has been called with `ESP_BLE_MESH_ENTER_NUMBER` as the action.

Return `ESP_OK` on success or error code otherwise.

Parameters

- [in] `number`: Number input by Provisioner.
- [in] `link_idx`: The provisioning link index.

esp_err_t **esp_ble_mesh_provisioner_prov_enable** (*esp_ble_mesh_prov_bearer_t* bearers)

Enable one or more provisioning bearers.

Note PB-ADV: Enable BLE scan. PB-GATT: Initialize corresponding BLE Mesh Proxy info.

Return ESP_OK on success or error code otherwise.

Parameters

- [in] bearers: Bit-wise OR of provisioning bearers.

esp_err_t **esp_ble_mesh_provisioner_prov_disable** (*esp_ble_mesh_prov_bearer_t* bearers)

Disable one or more provisioning bearers.

Note PB-ADV: Disable BLE scan. PB-GATT: Break any existing BLE Mesh Provisioning connections.

Return ESP_OK on success or error code otherwise.

Parameters

- [in] bearers: Bit-wise OR of provisioning bearers.

esp_err_t **esp_ble_mesh_provisioner_add_unprov_dev** (*esp_ble_mesh_unprov_dev_add_t* *add_dev,
esp_ble_mesh_dev_add_flag_t flags)

Add unprovisioned device info to the unprov_dev queue.

Return ESP_OK on success or error code otherwise.

Note : 1. Currently address type only supports public address and static random address.

1. If device UUID and/or device address as well as address type already exist in the device queue, but the bearer is different from the existing one, add operation will also be successful and it will update the provision bearer supported by the device.
2. For example, if the Provisioner wants to add an unprovisioned device info before receiving its unprovisioned device beacon or Mesh Provisioning advertising packets, the Provisioner can use this API to add the device info with each one or both of device UUID and device address added. When the Provisioner gets the device's advertising packets, it will start provisioning the device internally.
 - In this situation, the Provisioner can set bearers with each one or both of ESP_BLE_MESH_PROV_ADV and ESP_BLE_MESH_PROV_GATT enabled, and cannot set flags with ADD_DEV_START_PROV_NOW_FLAG enabled.
3. Another example is when the Provisioner receives the unprovisioned device's beacon or Mesh Provisioning advertising packets, the advertising packets will be reported on to the application layer using the callback registered by the function esp_ble_mesh_register_prov_callback. And in the callback, the Provisioner can call this API to start provisioning the device.
 - If the Provisioner uses PB-ADV to provision, either one or both of device UUID and device address can be added, bearers shall be set with ESP_BLE_MESH_PROV_ADV enabled and the flags shall be set with ADD_DEV_START_PROV_NOW_FLAG enabled.
 - If the Provisioner uses PB-GATT to provision, both the device UUID and device address need to be added, bearers shall be set with ESP_BLE_MESH_PROV_GATT enabled, and the flags shall be set with ADD_DEV_START_PROV_NOW_FLAG enabled.
 - If the Provisioner just wants to store the unprovisioned device info when receiving its advertising packets and start to provision it the next time (e.g. after receiving its advertising packets again), then it can add the device info with either one or both of device UUID and device address included. Bearers can be set with either one or both of ESP_BLE_MESH_PROV_ADV and ESP_BLE_MESH_PROV_GATT enabled (recommend to enable the bearer which will receive its advertising packets, because if the other bearer is enabled, the Provisioner is not aware if the device supports the bearer), and flags cannot be set with ADD_DEV_START_PROV_NOW_FLAG enabled.
 - Note: ESP_BLE_MESH_PROV_ADV, ESP_BLE_MESH_PROV_GATT and ADD_DEV_START_PROV_NOW_FLAG can not be enabled at the same time.

Parameters

- [in] add_dev: Pointer to a struct containing the device information
- [in] flags: Flags indicate several operations on the device information
 - Remove device information from queue after device has been provisioned (BIT0)
 - Start provisioning immediately after device is added to queue (BIT1)
 - Device can be removed if device queue is full (BIT2)

```
esp_err_t esp_ble_mesh_provisioner_prov_device_with_addr (const uint8_t uuid[16],
                                                         esp_ble_mesh_bd_addr_t
                                                         addr,
                                                         esp_ble_mesh_addr_type_t
                                                         addr_type,
                                                         esp_ble_mesh_prov_bearer_t
                                                         bearer, uint16_t oob_info,
                                                         uint16_t unicast_addr)
```

Provision an unprovisioned device and assign a fixed unicast address for it in advance.

Return Zero on success or (negative) error code otherwise.

Note : 1. Currently address type only supports public address and static random address.

1. Bearer must be equal to ESP_BLE_MESH_PROV_ADV or ESP_BLE_MESH_PROV_GATT, since Provisioner will start to provision a device immediately once this function is invoked. And the input bearer must be identical with the one within the parameters of the ESP_BLE_MESH_PROVISIONER_RECV_UNPROV_ADV_PKT_EVT event.
2. If this function is used by a Provisioner to provision devices, the application should take care of the assigned unicast address and avoid overlap of the unicast addresses of different nodes.
3. Recommend to use only one of the functions “esp_ble_mesh_provisioner_add_unprov_dev” and “esp_ble_mesh_provisioner_prov_device_with_addr” by a Provisioner.

Parameters

- [in] *uuid*: Device UUID of the unprovisioned device
- [in] *addr*: Device address of the unprovisioned device
- [in] *addr_type*: Device address type of the unprovisioned device
- [in] *bearer*: Provisioning bearer going to be used by Provisioner
- [in] *oob_info*: OOB info of the unprovisioned device
- [in] *unicast_addr*: Unicast address going to be allocated for the unprovisioned device

```
esp_err_t esp_ble_mesh_provisioner_delete_dev (esp_ble_mesh_device_delete_t *del_dev)
```

Delete device from queue, and reset current provisioning link with the device.

Note If the device is in the queue, remove it from the queue; if the device is being provisioned, terminate the provisioning procedure. Either one of the device address or device UUID can be used as input.

Return ESP_OK on success or error code otherwise.

Parameters

- [in] *del_dev*: Pointer to a struct containing the device information.

```
esp_err_t esp_ble_mesh_provisioner_set_dev_uuid_match (const uint8_t *match_val,
                                                       uint8_t match_len, uint8_t
                                                       offset, bool prov_after_match)
```

This function is called by Provisioner to set the part of the device UUID to be compared before starting to provision.

Return ESP_OK on success or error code otherwise.

Parameters

- [in] *match_val*: Value to be compared with the part of the device UUID.
- [in] *match_len*: Length of the compared match value.
- [in] *offset*: Offset of the device UUID to be compared (based on zero).
- [in] *prov_after_match*: Flag used to indicate whether provisioner should start to provision the device immediately if the part of the UUID matches.

```
esp_err_t esp_ble_mesh_provisioner_set_prov_data_info (esp_ble_mesh_prov_data_info_t
                                                       *prov_data_info)
```

This function is called by Provisioner to set provisioning data information before starting to provision.

Return ESP_OK on success or error code otherwise.

Parameters

- [in] *prov_data_info*: Pointer to a struct containing net_idx or flags or iv_index.

```
esp_err_t esp_ble_mesh_provisioner_set_static_oob_value (const uint8_t *value,
                                                         uint8_t length)
```

This function is called by Provisioner to set static oob value used for provisioning.

AuthValues selected using a cryptographically secure random or pseudorandom number generator and having the maximum permitted entropy (128-bits) will be most difficult to brute-force. AuthValues with reduced entropy or generated in a predictable manner will not grant the same level of protection against this vulnerability. Selecting a new AuthValue with each provisioning attempt can also make it more difficult to launch a brute-force attack by requiring the attacker to restart the search with each provisioning attempt (CVE-2020-26556).

Note The Bluetooth SIG recommends that mesh implementations enforce a randomly selected AuthValue using all of the available bits, where permitted by the implementation. A large entropy helps ensure that a brute-force of the AuthValue, even a static AuthValue, cannot normally be completed in a reasonable time (CVE-2020-26557).

Return ESP_OK on success or error code otherwise.

Parameters

- [in] *value*: Pointer to the static oob value.
- [in] *length*: Length of the static oob value.

esp_err_t **esp_ble_mesh_provisioner_set_primary_elem_addr** (uint16_t *addr*)

This function is called by Provisioner to set own Primary element address.

Note This API must be invoked when BLE Mesh initialization is completed successfully, and can be invoked before Provisioner functionality is enabled. Once this API is invoked successfully, the *prov_unicast_addr* value in the struct *esp_ble_mesh_prov_t* will be ignored, and Provisioner will use this address as its own primary element address. And if the unicast address going to assigned for the next unprovisioned device is smaller than the input address + element number of Provisioner, then the address for the next unprovisioned device will be recalculated internally.

Return ESP_OK on success or error code otherwise.

Parameters

- [in] *addr*: Unicast address of the Primary element of Provisioner.

esp_err_t **esp_ble_mesh_set_fast_prov_info** (*esp_ble_mesh_fast_prov_info_t* **fast_prov_info*)

This function is called to set provisioning data information before starting fast provisioning.

Return ESP_OK on success or error code otherwise.

Parameters

- [in] *fast_prov_info*: Pointer to a struct containing unicast address range, *net_idx*, etc.

esp_err_t **esp_ble_mesh_set_fast_prov_action** (*esp_ble_mesh_fast_prov_action_t* *action*)

This function is called to start/suspend/exit fast provisioning.

Return ESP_OK on success or error code otherwise.

Parameters

- [in] *action*: fast provisioning action (i.e. enter, suspend, exit).

Type Definitions

```
typedef void (*esp_ble_mesh_prov_cb_t) (esp_ble_mesh_prov_cb_event_t          event,
                                       esp_ble_mesh_prov_cb_param_t *param)
: event, event code of provisioning events; param, parameters of provisioning events
typedef void (*esp_ble_mesh_prov_adv_cb_t) (const esp_ble_mesh_bd_addr_t      addr,
                                           const esp_ble_mesh_addr_type_t     addr_type,
                                           const uint8_t                     adv_type,
                                           const uint8_t                     dev_uuid,
                                           const uint16_t                    oob_info,
                                           esp_ble_mesh_prov_bearer_t         bearer)
```

Callback for Provisioner that received advertising packets from unprovisioned devices which are not in the unprovisioned device queue.

Report on the unprovisioned device beacon and mesh provisioning service adv data to application.

Parameters

- [in] *addr*: Pointer to the unprovisioned device address.
- [in] *addr_type*: Unprovisioned device address type.
- [in] *adv_type*: Adv packet type (ADV_IND or ADV_NONCONN_IND).
- [in] *dev_uuid*: Unprovisioned device UUID pointer.
- [in] *oob_info*: OOB information of the unprovisioned device.

- [in] bearer: Adv packet received from PB-GATT or PB-ADV bearer.

ESP-BLE-MESH GATT Proxy Server

Header File

- [bt/esp_ble_mesh/api/core/include/esp_ble_mesh_proxy_api.h](#)

Functions

esp_err_t **esp_ble_mesh_proxy_identity_enable** (void)

Enable advertising with Node Identity.

Note This API requires that GATT Proxy support be enabled. Once called, each subnet starts advertising using Node Identity for the next 60 seconds, and after 60s Network ID will be advertised. Under normal conditions, the BLE Mesh Proxy Node Identity and Network ID advertising will be enabled automatically by BLE Mesh stack after the device is provisioned.

Return ESP_OK on success or error code otherwise.

esp_err_t **esp_ble_mesh_proxy_gatt_enable** (void)

Enable BLE Mesh GATT Proxy Service.

Return ESP_OK on success or error code otherwise.

esp_err_t **esp_ble_mesh_proxy_gatt_disable** (void)

Disconnect the BLE Mesh GATT Proxy connection if there is any, and disable the BLE Mesh GATT Proxy Service.

Return ESP_OK on success or error code otherwise.

esp_err_t **esp_ble_mesh_proxy_client_connect** (*esp_ble_mesh_bd_addr_t* *addr*,
esp_ble_mesh_addr_type_t *addr_type*, *uint16_t*
net_idx)

Proxy Client creates a connection with the Proxy Server.

Return ESP_OK on success or error code otherwise.

Parameters

- [in] *addr*: Device address of the Proxy Server.
- [in] *addr_type*: Device address type(public or static random).
- [in] *net_idx*: NetKey Index related with Network ID in the Mesh Proxy advertising packet.

esp_err_t **esp_ble_mesh_proxy_client_disconnect** (*uint8_t* *conn_handle*)

Proxy Client terminates a connection with the Proxy Server.

Return ESP_OK on success or error code otherwise.

Parameters

- [in] *conn_handle*: Proxy connection handle.

esp_err_t **esp_ble_mesh_proxy_client_set_filter_type** (*uint8_t* *conn_handle*,
uint16_t *net_idx*,
esp_ble_mesh_proxy_filter_type_t
filter_type)

Proxy Client sets the filter type of the Proxy Server.

Return ESP_OK on success or error code otherwise.

Parameters

- [in] *conn_handle*: Proxy connection handle.
- [in] *net_idx*: Corresponding NetKey Index.
- [in] *filter_type*: whitelist or blacklist.

esp_err_t **esp_ble_mesh_proxy_client_add_filter_addr** (*uint8_t* *conn_handle*, *uint16_t*
net_idx, *uint16_t* **addr*, *uint16_t*
addr_num)

Proxy Client adds address to the Proxy Server filter list.

Return ESP_OK on success or error code otherwise.

Parameters

- [in] `conn_handle`: Proxy connection handle.
- [in] `net_idx`: Corresponding NetKey Index.
- [in] `addr`: Pointer to the filter address.
- [in] `addr_num`: Number of the filter address.

`esp_err_t esp_ble_mesh_proxy_client_remove_filter_addr` (`uint8_t conn_handle`, `uint16_t net_idx`, `uint16_t *addr`, `uint16_t addr_num`)

Proxy Client removes address from the Proxy Server filter list.

Return ESP_OK on success or error code otherwise.

Parameters

- [in] `conn_handle`: Proxy connection handle.
- [in] `net_idx`: Corresponding NetKey Index.
- [in] `addr`: Pointer to the filter address.
- [in] `addr_num`: Number of the filter address.

ESP-BLE-MESH Models API Reference

This section contains ESP-BLE-MESH Model related APIs, event types, event parameters, etc.

There are six categories of models:

- *Configuration Client/Server Models*
- *Health Client/Server Models*
- *Generic Client/Server Models*
- *Sensor Client/Server Models*
- *Time and Scenes Client/Server Models*
- *Lighting Client/Server Models*

Note: Definitions related to Server Models are being updated, and will be released soon.

Configuration Client/Server Models

Header File

- [bt/esp_ble_mesh/api/models/include/esp_ble_mesh_config_model_api.h](#)

Functions

`esp_err_t esp_ble_mesh_register_config_client_callback` (`esp_ble_mesh_cfg_client_cb_t callback`)

Register BLE Mesh Config Client Model callback.

Return ESP_OK on success or error code otherwise.

Parameters

- [in] `callback`: Pointer to the callback function.

`esp_err_t esp_ble_mesh_register_config_server_callback` (`esp_ble_mesh_cfg_server_cb_t callback`)

Register BLE Mesh Config Server Model callback.

Return ESP_OK on success or error code otherwise.

Parameters

- [in] `callback`: Pointer to the callback function.

esp_err_t **esp_ble_mesh_config_client_get_state** (*esp_ble_mesh_client_common_param_t* *params, *esp_ble_mesh_cfg_client_get_state_t* *get_state)

Get the value of Config Server Model states using the Config Client Model get messages.

Note If you want to find the opcodes and corresponding meanings accepted by this API, please refer to `esp_ble_mesh_opcode_config_client_get_t` in `esp_ble_mesh_defs.h`

Return ESP_OK on success or error code otherwise.

Parameters

- [in] `params`: Pointer to BLE Mesh common client parameters.
- [in] `get_state`: Pointer to a union, each kind of opcode corresponds to one structure inside. Shall not be set to NULL.

esp_err_t **esp_ble_mesh_config_client_set_state** (*esp_ble_mesh_client_common_param_t* *params, *esp_ble_mesh_cfg_client_set_state_t* *set_state)

Set the value of the Configuration Server Model states using the Config Client Model set messages.

Note If you want to find the opcodes and corresponding meanings accepted by this API, please refer to `esp_ble_mesh_opcode_config_client_set_t` in `esp_ble_mesh_defs.h`

Return ESP_OK on success or error code otherwise.

Parameters

- [in] `params`: Pointer to BLE Mesh common client parameters.
- [in] `set_state`: Pointer to a union, each kind of opcode corresponds to one structure inside. Shall not be set to NULL.

Unions

union `esp_ble_mesh_cfg_client_get_state_t`

`#include <esp_ble_mesh_config_model_api.h>` For ESP_BLE_MESH_MODEL_OP_BEACON_GET ESP_BLE_MESH_MODEL_OP_COMPOSITION_DATA_GET ESP_BLE_MESH_MODEL_OP_DEFAULT_TTL_GET ESP_BLE_MESH_MODEL_OP_GATT_PROXY_GET ESP_BLE_MESH_MODEL_OP_RELAY_GET ESP_BLE_MESH_MODEL_OP_MODEL_PUB_GET ESP_BLE_MESH_MODEL_OP_FRIEND_GET ESP_BLE_MESH_MODEL_OP_HEARTBEAT_PUB_GET ESP_BLE_MESH_MODEL_OP_HEARTBEAT_SUB_GET the `get_state` parameter in the `esp_ble_mesh_config_client_get_state` function should not be set to NULL.

Public Members

esp_ble_mesh_cfg_model_pub_get_t **model_pub_get**

For ESP_BLE_MESH_MODEL_OP_MODEL_PUB_GET.

esp_ble_mesh_cfg_composition_data_get_t **comp_data_get**

For ESP_BLE_MESH_MODEL_OP_COMPOSITION_DATA_GET.

esp_ble_mesh_cfg_sig_model_sub_get_t **sig_model_sub_get**

For ESP_BLE_MESH_MODEL_OP_SIG_MODEL_SUB_GET

esp_ble_mesh_cfg_vnd_model_sub_get_t **vnd_model_sub_get**

For ESP_BLE_MESH_MODEL_OP_VENDOR_MODEL_SUB_GET

esp_ble_mesh_cfg_app_key_get_t **app_key_get**

For ESP_BLE_MESH_MODEL_OP_APP_KEY_GET.

esp_ble_mesh_cfg_node_identity_get_t **node_identity_get**

For ESP_BLE_MESH_MODEL_OP_NODE_IDENTITY_GET.

esp_ble_mesh_cfg_sig_model_app_get_t **sig_model_app_get**

For ESP_BLE_MESH_MODEL_OP_SIG_MODEL_APP_GET

esp_ble_mesh_cfg_vnd_model_app_get_t **vnd_model_app_get**

For ESP_BLE_MESH_MODEL_OP_VENDOR_MODEL_APP_GET

esp_ble_mesh_cfg_kr_phase_get_t **kr_phase_get**

For ESP_BLE_MESH_MODEL_OP_KEY_REFRESH_PHASE_GET

esp_ble_mesh_cfg_lpn_polltimeout_get_t **lpn_pollto_get**

For ESP_BLE_MESH_MODEL_OP_LPN_POLLTIMEOUT_GET

union esp_ble_mesh_cfg_client_set_state_t

```
#include <esp_ble_mesh_config_model_api.h> For ESP_BLE_MESH_MODEL_OP_BEACON_SET
ESP_BLE_MESH_MODEL_OP_DEFAULT_TTL_SET ESP_BLE_MESH_MODEL_OP_GATT_PROXY_SET
ESP_BLE_MESH_MODEL_OP_RELAY_SET ESP_BLE_MESH_MODEL_OP_MODEL_PUB_SET
ESP_BLE_MESH_MODEL_OP_MODEL_SUB_ADD ESP_BLE_MESH_MODEL_OP_MODEL_SUB_VIRTUAL_ADDR
ESP_BLE_MESH_MODEL_OP_MODEL_SUB_DELETE ESP_BLE_MESH_MODEL_OP_MODEL_SUB_VIRTUAL_ADDR
ESP_BLE_MESH_MODEL_OP_MODEL_SUB_OVERWRITE ESP_BLE_MESH_MODEL_OP_MODEL_SUB_VIRTUAL_ADDR
ESP_BLE_MESH_MODEL_OP_NET_KEY_ADD ESP_BLE_MESH_MODEL_OP_APP_KEY_ADD
ESP_BLE_MESH_MODEL_OP_MODEL_APP_BIND ESP_BLE_MESH_MODEL_OP_NODE_RESET
ESP_BLE_MESH_MODEL_OP_FRIEND_SET ESP_BLE_MESH_MODEL_OP_HEARTBEAT_PUB_SET
ESP_BLE_MESH_MODEL_OP_HEARTBEAT_SUB_SET the set_state parameter in the
esp_ble_mesh_config_client_set_state function should not be set to NULL.
```

Public Members

esp_ble_mesh_cfg_beacon_set_t **beacon_set**

For ESP_BLE_MESH_MODEL_OP_BEACON_SET

esp_ble_mesh_cfg_default_ttl_set_t **default_ttl_set**

For ESP_BLE_MESH_MODEL_OP_DEFAULT_TTL_SET

esp_ble_mesh_cfg_friend_set_t **friend_set**

For ESP_BLE_MESH_MODEL_OP_FRIEND_SET

esp_ble_mesh_cfg_gatt_proxy_set_t **gatt_proxy_set**

For ESP_BLE_MESH_MODEL_OP_GATT_PROXY_SET

esp_ble_mesh_cfg_relay_set_t **relay_set**

For ESP_BLE_MESH_MODEL_OP_RELAY_SET

esp_ble_mesh_cfg_net_key_add_t **net_key_add**

For ESP_BLE_MESH_MODEL_OP_NET_KEY_ADD

esp_ble_mesh_cfg_app_key_add_t **app_key_add**

For ESP_BLE_MESH_MODEL_OP_APP_KEY_ADD

esp_ble_mesh_cfg_model_app_bind_t **model_app_bind**

For ESP_BLE_MESH_MODEL_OP_MODEL_APP_BIND

esp_ble_mesh_cfg_model_pub_set_t **model_pub_set**

For ESP_BLE_MESH_MODEL_OP_MODEL_PUB_SET

esp_ble_mesh_cfg_model_sub_add_t **model_sub_add**

For ESP_BLE_MESH_MODEL_OP_MODEL_SUB_ADD

esp_ble_mesh_cfg_model_sub_delete_t **model_sub_delete**

For ESP_BLE_MESH_MODEL_OP_MODEL_SUB_DELETE

esp_ble_mesh_cfg_model_sub_overwrite_t **model_sub_overwrite**

For ESP_BLE_MESH_MODEL_OP_MODEL_SUB_OVERWRITE

esp_ble_mesh_cfg_model_sub_va_add_t **model_sub_va_add**

For ESP_BLE_MESH_MODEL_OP_MODEL_SUB_VIRTUAL_ADDR_ADD

esp_ble_mesh_cfg_model_sub_va_delete_t **model_sub_va_delete**

For ESP_BLE_MESH_MODEL_OP_MODEL_SUB_VIRTUAL_ADDR_DELETE

esp_ble_mesh_cfg_model_sub_va_overwrite_t **model_sub_va_overwrite**

For ESP_BLE_MESH_MODEL_OP_MODEL_SUB_VIRTUAL_ADDR_OVERWRITE

esp_ble_mesh_cfg_heartbeat_pub_set_t **heartbeat_pub_set**

For ESP_BLE_MESH_MODEL_OP_HEARTBEAT_PUB_SET

esp_ble_mesh_cfg_heartbeat_sub_set_t **heartbeat_sub_set**
For ESP_BLE_MESH_MODEL_OP_HEARTBEAT_SUB_SET

esp_ble_mesh_cfg_model_pub_va_set_t **model_pub_va_set**
For ESP_BLE_MESH_MODEL_OP_MODEL_PUB_VIRTUAL_ADDR_SET

esp_ble_mesh_cfg_model_sub_delete_all_t **model_sub_delete_all**
For ESP_BLE_MESH_MODEL_OP_MODEL_SUB_DELETE_ALL

esp_ble_mesh_cfg_net_key_update_t **net_key_update**
For ESP_BLE_MESH_MODEL_OP_NET_KEY_UPDATE

esp_ble_mesh_cfg_net_key_delete_t **net_key_delete**
For ESP_BLE_MESH_MODEL_OP_NET_KEY_DELETE

esp_ble_mesh_cfg_app_key_update_t **app_key_update**
For ESP_BLE_MESH_MODEL_OP_APP_KEY_UPDATE

esp_ble_mesh_cfg_app_key_delete_t **app_key_delete**
For ESP_BLE_MESH_MODEL_OP_APP_KEY_DELETE

esp_ble_mesh_cfg_node_identity_set_t **node_identity_set**
For ESP_BLE_MESH_MODEL_OP_NODE_IDENTITY_SET

esp_ble_mesh_cfg_model_app_unbind_t **model_app_unbind**
For ESP_BLE_MESH_MODEL_OP_MODEL_APP_UNBIND

esp_ble_mesh_cfg_kr_phase_set_t **kr_phase_set**
For ESP_BLE_MESH_MODEL_OP_KEY_REFRESH_PHASE_SET

esp_ble_mesh_cfg_net_transmit_set_t **net_transmit_set**
For ESP_BLE_MESH_MODEL_OP_NETWORK_TRANSMIT_SET

union esp_ble_mesh_cfg_client_common_cb_param_t
#include <esp_ble_mesh_config_model_api.h> Configuration Client Model received message union.

Public Members

esp_ble_mesh_cfg_beacon_status_cb_t **beacon_status**
The beacon status value

esp_ble_mesh_cfg_comp_data_status_cb_t **comp_data_status**
The composition data status value

esp_ble_mesh_cfg_default_ttl_status_cb_t **default_ttl_status**
The default_ttl status value

esp_ble_mesh_cfg_gatt_proxy_status_cb_t **gatt_proxy_status**
The gatt_proxy status value

esp_ble_mesh_cfg_relay_status_cb_t **relay_status**
The relay status value

esp_ble_mesh_cfg_model_pub_status_cb_t **model_pub_status**
The model publication status value

esp_ble_mesh_cfg_model_sub_status_cb_t **model_sub_status**
The model subscription status value

esp_ble_mesh_cfg_net_key_status_cb_t **netkey_status**
The netkey status value

esp_ble_mesh_cfg_app_key_status_cb_t **appkey_status**
The appkey status value

esp_ble_mesh_cfg_mod_app_status_cb_t **model_app_status**
The model app status value

esp_ble_mesh_cfg_friend_status_cb_t **friend_status**

The friend status value

esp_ble_mesh_cfg_hb_pub_status_cb_t **heartbeat_pub_status**

The heartbeat publication status value

esp_ble_mesh_cfg_hb_sub_status_cb_t **heartbeat_sub_status**

The heartbeat subscription status value

esp_ble_mesh_cfg_net_trans_status_cb_t **net_transmit_status**

The network transmit status value

esp_ble_mesh_cfg_model_sub_list_cb_t **model_sub_list**

The model subscription list value

esp_ble_mesh_cfg_net_key_list_cb_t **netkey_list**

The network key index list value

esp_ble_mesh_cfg_app_key_list_cb_t **appkey_list**

The application key index list value

esp_ble_mesh_cfg_node_id_status_cb_t **node_identity_status**

The node identity status value

esp_ble_mesh_cfg_model_app_list_cb_t **model_app_list**

The model application key index list value

esp_ble_mesh_cfg_kr_phase_status_cb_t **kr_phase_status**

The key refresh phase status value

esp_ble_mesh_cfg_lpn_pollto_status_cb_t **lpn_timeout_status**

The low power node poll timeout status value

union esp_ble_mesh_cfg_server_state_change_t

#include <esp_ble_mesh_config_model_api.h> Configuration Server model state change value union.

Public Members

esp_ble_mesh_state_change_cfg_mod_pub_set_t **mod_pub_set**

The `recv_op` in `ctx` can be used to decide which state is changed. Config Model Publication Set

esp_ble_mesh_state_change_cfg_model_sub_add_t **mod_sub_add**

Config Model Subscription Add

esp_ble_mesh_state_change_cfg_model_sub_delete_t **mod_sub_delete**

Config Model Subscription Delete

esp_ble_mesh_state_change_cfg_netkey_add_t **netkey_add**

Config NetKey Add

esp_ble_mesh_state_change_cfg_netkey_update_t **netkey_update**

Config NetKey Update

esp_ble_mesh_state_change_cfg_netkey_delete_t **netkey_delete**

Config NetKey Delete

esp_ble_mesh_state_change_cfg_appkey_add_t **appkey_add**

Config AppKey Add

esp_ble_mesh_state_change_cfg_appkey_update_t **appkey_update**

Config AppKey Update

esp_ble_mesh_state_change_cfg_appkey_delete_t **appkey_delete**

Config AppKey Delete

esp_ble_mesh_state_change_cfg_model_app_bind_t **mod_app_bind**

Config Model App Bind

esp_ble_mesh_state_change_cfg_model_app_unbind_t **mod_app_unbind**
Config Model App Unbind

esp_ble_mesh_state_change_cfg_kr_phase_set_t **kr_phase_set**
Config Key Refresh Phase Set

union esp_ble_mesh_cfg_server_cb_value_t
#include <esp_ble_mesh_config_model_api.h> Configuration Server model callback value union.

Public Members

esp_ble_mesh_cfg_server_state_change_t **state_change**
ESP_BLE_MESH_CFG_SERVER_STATE_CHANGE_EVT

Structures

struct esp_ble_mesh_cfg_srv
Configuration Server Model context

Public Members

esp_ble_mesh_model_t ***model**
Pointer to Configuration Server Model

uint8_t **net_transmit**
Network Transmit state

uint8_t **relay**
Relay Mode state

uint8_t **relay_retransmit**
Relay Retransmit state

uint8_t **beacon**
Secure Network Beacon state

uint8_t **gatt_proxy**
GATT Proxy state

uint8_t **friend_state**
Friend state

uint8_t **default_ttl**
Default TTL

struct k_delayed_work timer
Heartbeat Publication timer

uint16_t **dst**
Destination address for Heartbeat messages

uint16_t **count**
Number of Heartbeat messages to be sent
Number of Heartbeat messages received

uint8_t **period**
Period for sending Heartbeat messages

uint8_t **ttl**
TTL to be used when sending Heartbeat messages

uint16_t **feature**
Bit field indicating features that trigger Heartbeat messages when changed

uint16_t net_idx
NetKey Index used by Heartbeat Publication

struct esp_ble_mesh_cfg_srv::[anonymous] heartbeat_pub
Heartbeat Publication

int64_t expiry
Timestamp when Heartbeat subscription period is expired

uint16_t src
Source address for Heartbeat messages

uint8_t min_hops
Minimum hops when receiving Heartbeat messages

uint8_t max_hops
Maximum hops when receiving Heartbeat messages

esp_ble_mesh_cb_t heartbeat_recv_cb
Optional heartbeat subscription tracking function

struct esp_ble_mesh_cfg_srv::[anonymous] heartbeat_sub
Heartbeat Subscription

struct esp_ble_mesh_cfg_composition_data_get_t
Parameters of Config Composition Data Get.

Public Members

uint8_t page
Page number of the Composition Data.

struct esp_ble_mesh_cfg_model_pub_get_t
Parameters of Config Model Publication Get.

Public Members

uint16_t element_addr
The element address

uint16_t model_id
The model id

uint16_t company_id
The company id, if not a vendor model, shall set to 0xFFFF

struct esp_ble_mesh_cfg_sig_model_sub_get_t
Parameters of Config SIG Model Subscription Get.

Public Members

uint16_t element_addr
The element address

uint16_t model_id
The model id

struct esp_ble_mesh_cfg_vnd_model_sub_get_t
Parameters of Config Vendor Model Subscription Get.

Public Members**uint16_t element_addr**

The element address

uint16_t model_id

The model id

uint16_t company_id

The company id, if not a vendor model, shall set to 0xFFFF

struct esp_ble_mesh_cfg_app_key_get_t

Parameters of Config AppKey Get.

Public Members**uint16_t net_idx**

The network key index

struct esp_ble_mesh_cfg_node_identity_get_t

Parameters of Config Node Identity Get.

Public Members**uint16_t net_idx**

The network key index

struct esp_ble_mesh_cfg_sig_model_app_get_t

Parameters of Config SIG Model App Get.

Public Members**uint16_t element_addr**

The element address

uint16_t model_id

The model id

struct esp_ble_mesh_cfg_vnd_model_app_get_t

Parameters of Config Vendor Model App Get.

Public Members**uint16_t element_addr**

The element address

uint16_t model_id

The model id

uint16_t company_id

The company id, if not a vendor model, shall set to 0xFFFF

struct esp_ble_mesh_cfg_kr_phase_get_t

Parameters of Config Key Refresh Phase Get.

Public Members

`uint16_t net_idx`
The network key index

`struct esp_ble_mesh_cfg_lpn_polltimeout_get_t`
Parameters of Config Low Power Node PollTimeout Get.

Public Members

`uint16_t lpn_addr`
The unicast address of the Low Power node

`struct esp_ble_mesh_cfg_beacon_set_t`
Parameters of Config Beacon Set.

Public Members

`uint8_t beacon`
New Secure Network Beacon state

`struct esp_ble_mesh_cfg_default_ttl_set_t`
Parameters of Config Default TTL Set.

Public Members

`uint8_t ttl`
The default TTL state value

`struct esp_ble_mesh_cfg_friend_set_t`
Parameters of Config Friend Set.

Public Members

`uint8_t friend_state`
The friend state value

`struct esp_ble_mesh_cfg_gatt_proxy_set_t`
Parameters of Config GATT Proxy Set.

Public Members

`uint8_t gatt_proxy`
The GATT Proxy state value

`struct esp_ble_mesh_cfg_relay_set_t`
Parameters of Config Relay Set.

Public Members

`uint8_t relay`
The relay value

`uint8_t relay_retransmit`
The relay retransmit value

`struct esp_ble_mesh_cfg_net_key_add_t`
Parameters of Config NetKey Add.

Public Members

uint16_t net_idx
The network key index

uint8_t net_key[16]
The network key value

struct esp_ble_mesh_cfg_app_key_add_t
Parameters of Config AppKey Add.

Public Members

uint16_t net_idx
The network key index

uint16_t app_idx
The app key index

uint8_t app_key[16]
The app key value

struct esp_ble_mesh_cfg_model_app_bind_t
Parameters of Config Model App Bind.

Public Members

uint16_t element_addr
The element address

uint16_t model_app_idx
Index of the app key to bind with the model

uint16_t model_id
The model id

uint16_t company_id
The company id, if not a vendor model, shall set to 0xFFFF

struct esp_ble_mesh_cfg_model_pub_set_t
Parameters of Config Model Publication Set.

Public Members

uint16_t element_addr
The element address

uint16_t publish_addr
Value of the publish address

uint16_t publish_app_idx
Index of the application key

bool cred_flag
Value of the Friendship Credential Flag

uint8_t publish_ttl
Default TTL value for the publishing messages

uint8_t publish_period
Period for periodic status publishing

`uint8_t publish_retransmit`

Number of retransmissions and number of 50-millisecond steps between retransmissions

`uint16_t model_id`

The model id

`uint16_t company_id`

The company id, if not a vendor model, shall set to 0xFFFF

struct esp_ble_mesh_cfg_model_sub_add_t

Parameters of Config Model Subscription Add.

Public Members

`uint16_t element_addr`

The element address

`uint16_t sub_addr`

The address to be added to the Subscription List

`uint16_t model_id`

The model id

`uint16_t company_id`

The company id, if not a vendor model, shall set to 0xFFFF

struct esp_ble_mesh_cfg_model_sub_delete_t

Parameters of Config Model Subscription Delete.

Public Members

`uint16_t element_addr`

The element address

`uint16_t sub_addr`

The address to be removed from the Subscription List

`uint16_t model_id`

The model id

`uint16_t company_id`

The company id, if not a vendor model, shall set to 0xFFFF

struct esp_ble_mesh_cfg_model_sub_overwrite_t

Parameters of Config Model Subscription Overwrite.

Public Members

`uint16_t element_addr`

The element address

`uint16_t sub_addr`

The address to be added to the Subscription List

`uint16_t model_id`

The model id

`uint16_t company_id`

The company id, if not a vendor model, shall set to 0xFFFF

struct esp_ble_mesh_cfg_model_sub_va_add_t

Parameters of Config Model Subscription Virtual Address Add.

Public Members**uint16_t element_addr**

The element address

uint8_t label_uuid[16]

The Label UUID of the virtual address to be added to the Subscription List

uint16_t model_id

The model id

uint16_t company_id

The company id, if not a vendor model, shall set to 0xFFFF

struct esp_ble_mesh_cfg_model_sub_va_delete_t

Parameters of Config Model Subscription Virtual Address Delete.

Public Members**uint16_t element_addr**

The element address

uint8_t label_uuid[16]

The Label UUID of the virtual address to be removed from the Subscription List

uint16_t model_id

The model id

uint16_t company_id

The company id, if not a vendor model, shall set to 0xFFFF

struct esp_ble_mesh_cfg_model_sub_va_overwrite_t

Parameters of Config Model Subscription Virtual Address Overwrite.

Public Members**uint16_t element_addr**

The element address

uint8_t label_uuid[16]

The Label UUID of the virtual address to be added to the Subscription List

uint16_t model_id

The model id

uint16_t company_id

The company id, if not a vendor model, shall set to 0xFFFF

struct esp_ble_mesh_cfg_model_pub_va_set_t

Parameters of Config Model Publication Virtual Address Set.

Public Members**uint16_t element_addr**

The element address

uint8_t label_uuid[16]

Value of the Label UUID publish address

uint16_t publish_app_idx

Index of the application key

bool **cred_flag**
Value of the Friendship Credential Flag

uint8_t **publish_ttl**
Default TTL value for the publishing messages

uint8_t **publish_period**
Period for periodic status publishing

uint8_t **publish_retransmit**
Number of retransmissions and number of 50-millisecond steps between retransmissions

uint16_t **model_id**
The model id

uint16_t **company_id**
The company id, if not a vendor model, shall set to 0xFFFF

struct esp_ble_mesh_cfg_model_sub_delete_all_t
Parameters of Config Model Subscription Delete All.

Public Members

uint16_t **element_addr**
The element address

uint16_t **model_id**
The model id

uint16_t **company_id**
The company id, if not a vendor model, shall set to 0xFFFF

struct esp_ble_mesh_cfg_net_key_update_t
Parameters of Config NetKey Update.

Public Members

uint16_t **net_idx**
The network key index

uint8_t **net_key**[16]
The network key value

struct esp_ble_mesh_cfg_net_key_delete_t
Parameters of Config NetKey Delete.

Public Members

uint16_t **net_idx**
The network key index

struct esp_ble_mesh_cfg_app_key_update_t
Parameters of Config AppKey Update.

Public Members

uint16_t **net_idx**
The network key index

uint16_t **app_idx**
The app key index

`uint8_t app_key[16]`
The app key value

struct esp_ble_mesh_cfg_app_key_delete_t
Parameters of Config AppKey Delete.

Public Members

`uint16_t net_idx`
The network key index

`uint16_t app_idx`
The app key index

struct esp_ble_mesh_cfg_node_identity_set_t
Parameters of Config Node Identity Set.

Public Members

`uint16_t net_idx`
The network key index

`uint8_t identity`
New Node Identity state

struct esp_ble_mesh_cfg_model_app_unbind_t
Parameters of Config Model App Unbind.

Public Members

`uint16_t element_addr`
The element address

`uint16_t model_app_idx`
Index of the app key to bind with the model

`uint16_t model_id`
The model id

`uint16_t company_id`
The company id, if not a vendor model, shall set to 0xFFFF

struct esp_ble_mesh_cfg_kr_phase_set_t
Parameters of Config Key Refresh Phase Set.

Public Members

`uint16_t net_idx`
The network key index

`uint8_t transition`
New Key Refresh Phase Transition

struct esp_ble_mesh_cfg_net_transmit_set_t
Parameters of Config Network Transmit Set.

Public Members

`uint8_t net_transmit`
Network Transmit State

`struct esp_ble_mesh_cfg_heartbeat_pub_set_t`
Parameters of Config Model Heartbeat Publication Set.

Public Members

`uint16_t dst`
Destination address for Heartbeat messages

`uint8_t count`
Number of Heartbeat messages to be sent

`uint8_t period`
Period for sending Heartbeat messages

`uint8_t ttl`
TTL to be used when sending Heartbeat messages

`uint16_t feature`
Bit field indicating features that trigger Heartbeat messages when changed

`uint16_t net_idx`
NetKey Index

`struct esp_ble_mesh_cfg_heartbeat_sub_set_t`
Parameters of Config Model Heartbeat Subscription Set.

Public Members

`uint16_t src`
Source address for Heartbeat messages

`uint16_t dst`
Destination address for Heartbeat messages

`uint8_t period`
Period for receiving Heartbeat messages

`struct esp_ble_mesh_cfg_beacon_status_cb_t`
Parameter of Config Beacon Status

Public Members

`uint8_t beacon`
Secure Network Beacon state value

`struct esp_ble_mesh_cfg_comp_data_status_cb_t`
Parameters of Config Composition Data Status

Public Members

`uint8_t page`
Page number of the Composition Data

`struct net_buf_simple *composition_data`
Pointer to Composition Data for the identified page

struct esp_ble_mesh_cfg_default_ttl_status_cb_t
Parameter of Config Default TTL Status

Public Members

uint8_t default_ttl
Default TTL state value

struct esp_ble_mesh_cfg_gatt_proxy_status_cb_t
Parameter of Config GATT Proxy Status

Public Members

uint8_t gatt_proxy
GATT Proxy state value

struct esp_ble_mesh_cfg_relay_status_cb_t
Parameters of Config Relay Status

Public Members

uint8_t relay
Relay state value

uint8_t retransmit
Relay retransmit value(number of retransmissions and number of 10-millisecond steps between retransmissions)

struct esp_ble_mesh_cfg_model_pub_status_cb_t
Parameters of Config Model Publication Status

Public Members

uint8_t status
Status Code for the request message

uint16_t element_addr
Address of the element

uint16_t publish_addr
Value of the publish address

uint16_t app_idx
Index of the application key

bool cred_flag
Value of the Friendship Credential Flag

uint8_t ttl
Default TTL value for the outgoing messages

uint8_t period
Period for periodic status publishing

uint8_t transmit
Number of retransmissions and number of 50-millisecond steps between retransmissions

uint16_t company_id
Company ID

uint16_t model_id
Model ID

struct esp_ble_mesh_cfg_model_sub_status_cb_t
Parameters of Config Model Subscription Status

Public Members

uint8_t status
Status Code for the request message

uint16_t element_addr
Address of the element

uint16_t sub_addr
Value of the address

uint16_t company_id
Company ID

uint16_t model_id
Model ID

struct esp_ble_mesh_cfg_net_key_status_cb_t
Parameters of Config NetKey Status

Public Members

uint8_t status
Status Code for the request message

uint16_t net_idx
Index of the NetKey

struct esp_ble_mesh_cfg_app_key_status_cb_t
Parameters of Config AppKey Status

Public Members

uint8_t status
Status Code for the request message

uint16_t net_idx
Index of the NetKey

uint16_t app_idx
Index of the application key

struct esp_ble_mesh_cfg_mod_app_status_cb_t
Parameters of Config Model App Status

Public Members

uint8_t status
Status Code for the request message

uint16_t element_addr
Address of the element

uint16_t app_idx
Index of the application key

uint16_t company_id
Company ID

`uint16_t model_id`
Model ID

`struct esp_ble_mesh_cfg_friend_status_cb_t`
Parameter of Config Friend Status

Public Members

`uint8_t friend_state`
Friend state value

`struct esp_ble_mesh_cfg_hb_pub_status_cb_t`
Parameters of Config Heartbeat Publication Status

Public Members

`uint8_t status`
Status Code for the request message

`uint16_t dst`
Destination address for Heartbeat messages

`uint8_t count`
Number of Heartbeat messages remaining to be sent

`uint8_t period`
Period for sending Heartbeat messages

`uint8_t ttl`
TTL to be used when sending Heartbeat messages

`uint16_t features`
Features that trigger Heartbeat messages when changed

`uint16_t net_idx`
Index of the NetKey

`struct esp_ble_mesh_cfg_hb_sub_status_cb_t`
Parameters of Config Heartbeat Subscription Status

Public Members

`uint8_t status`
Status Code for the request message

`uint16_t src`
Source address for Heartbeat messages

`uint16_t dst`
Destination address for Heartbeat messages

`uint8_t period`
Remaining Period for processing Heartbeat messages

`uint8_t count`
Number of Heartbeat messages received

`uint8_t min_hops`
Minimum hops when receiving Heartbeat messages

`uint8_t max_hops`
Maximum hops when receiving Heartbeat messages

struct esp_ble_mesh_cfg_net_trans_status_cb_t
Parameters of Config Network Transmit Status

Public Members

uint8_t net_trans_count : 3
Number of transmissions for each Network PDU originating from the node

uint8_t net_trans_step : 5
Maximum hops when receiving Heartbeat messages

struct esp_ble_mesh_cfg_model_sub_list_cb_t
Parameters of Config SIG/Vendor Subscription List

Public Members

uint8_t status
Status Code for the request message

uint16_t element_addr
Address of the element

uint16_t company_id
Company ID

uint16_t model_id
Model ID

struct net_buf_simple *sub_addr
A block of all addresses from the Subscription List

struct esp_ble_mesh_cfg_net_key_list_cb_t
Parameter of Config NetKey List

Public Members

struct net_buf_simple *net_idx
A list of NetKey Indexes known to the node

struct esp_ble_mesh_cfg_app_key_list_cb_t
Parameters of Config AppKey List

Public Members

uint8_t status
Status Code for the request message

uint16_t net_idx
NetKey Index of the NetKey that the AppKeys are bound to

struct net_buf_simple *app_idx
A list of AppKey indexes that are bound to the NetKey identified by NetKeyIndex

struct esp_ble_mesh_cfg_node_id_status_cb_t
Parameters of Config Node Identity Status

Public Members

uint8_t status
Status Code for the request message

uint16_t net_idx
Index of the NetKey

uint8_t identity
Node Identity state

struct esp_ble_mesh_cfg_model_app_list_cb_t
Parameters of Config SIG/Vendor Model App List

Public Members

uint8_t status
Status Code for the request message

uint16_t element_addr
Address of the element

uint16_t company_id
Company ID

uint16_t model_id
Model ID

struct net_buf_simple *app_idx
All AppKey indexes bound to the Model

struct esp_ble_mesh_cfg_kr_phase_status_cb_t
Parameters of Config Key Refresh Phase Status

Public Members

uint8_t status
Status Code for the request message

uint16_t net_idx
Index of the NetKey

uint8_t phase
Key Refresh Phase state

struct esp_ble_mesh_cfg_lpn_pollto_status_cb_t
Parameters of Config Low Power Node PollTimeout Status

Public Members

uint16_t lpn_addr
The unicast address of the Low Power node

int32_t poll_timeout
The current value of the PollTimeout timer of the Low Power node

struct esp_ble_mesh_cfg_client_cb_param_t
Configuration Client Model callback parameters

Public Members**int error_code**

Appropriate error code

***esp_ble_mesh_client_common_param_t* *params**

The client common parameters

***esp_ble_mesh_cfg_client_common_cb_param_t* status_cb**

The config status message callback values

struct esp_ble_mesh_state_change_cfg_mod_pub_set_t

Configuration Server model related context.

Public Members**uint16_t element_addr**

Element Address

uint16_t pub_addr

Publish Address

uint16_t app_idx

AppKey Index

bool cred_flag

Friendship Credential Flag

uint8_t pub_ttl

Publish TTL

uint8_t pub_period

Publish Period

uint8_t pub_retransmit

Publish Retransmit

uint16_t company_id

Company ID

uint16_t model_id

Model ID

struct esp_ble_mesh_state_change_cfg_model_sub_add_t

Parameters of Config Model Subscription Add

Public Members**uint16_t element_addr**

Element Address

uint16_t sub_addr

Subscription Address

uint16_t company_id

Company ID

uint16_t model_id

Model ID

struct esp_ble_mesh_state_change_cfg_model_sub_delete_t

Parameters of Config Model Subscription Delete

Public Members

`uint16_t element_addr`
Element Address

`uint16_t sub_addr`
Subscription Address

`uint16_t company_id`
Company ID

`uint16_t model_id`
Model ID

`struct esp_ble_mesh_state_change_cfg_netkey_add_t`
Parameters of Config NetKey Add

Public Members

`uint16_t net_idx`
NetKey Index

`uint8_t net_key[16]`
NetKey

`struct esp_ble_mesh_state_change_cfg_netkey_update_t`
Parameters of Config NetKey Update

Public Members

`uint16_t net_idx`
NetKey Index

`uint8_t net_key[16]`
NetKey

`struct esp_ble_mesh_state_change_cfg_netkey_delete_t`
Parameter of Config NetKey Delete

Public Members

`uint16_t net_idx`
NetKey Index

`struct esp_ble_mesh_state_change_cfg_appkey_add_t`
Parameters of Config AppKey Add

Public Members

`uint16_t net_idx`
NetKey Index

`uint16_t app_idx`
AppKey Index

`uint8_t app_key[16]`
AppKey

`struct esp_ble_mesh_state_change_cfg_appkey_update_t`
Parameters of Config AppKey Update

Public Members

uint16_t **net_idx**
NetKey Index

uint16_t **app_idx**
AppKey Index

uint8_t **app_key**[16]
AppKey

struct esp_ble_mesh_state_change_cfg_appkey_delete_t
Parameters of Config AppKey Delete

Public Members

uint16_t **net_idx**
NetKey Index

uint16_t **app_idx**
AppKey Index

struct esp_ble_mesh_state_change_cfg_model_app_bind_t
Parameters of Config Model App Bind

Public Members

uint16_t **element_addr**
Element Address

uint16_t **app_idx**
AppKey Index

uint16_t **company_id**
Company ID

uint16_t **model_id**
Model ID

struct esp_ble_mesh_state_change_cfg_model_app_unbind_t
Parameters of Config Model App Unbind

Public Members

uint16_t **element_addr**
Element Address

uint16_t **app_idx**
AppKey Index

uint16_t **company_id**
Company ID

uint16_t **model_id**
Model ID

struct esp_ble_mesh_state_change_cfg_kr_phase_set_t
Parameters of Config Key Refresh Phase Set

Public Members

`uint16_t net_idx`

NetKey Index

`uint8_t kr_phase`

New Key Refresh Phase Transition

struct `esp_ble_mesh_cfg_server_cb_param_t`

Configuration Server model callback parameters

Public Members

`esp_ble_mesh_model_t *model`

Pointer to the server model structure

`esp_ble_mesh_msg_ctx_t ctx`

Context of the received message

`esp_ble_mesh_cfg_server_cb_value_t value`

Value of the received configuration messages

Macros

ESP_BLE_MESH_MODEL_CFG_SRV (`srv_data`)

Define a new Config Server Model.

Note The Config Server Model can only be included by a Primary Element.

Return New Config Server Model instance.

Parameters

- `srv_data`: Pointer to a unique Config Server Model `user_data`.

ESP_BLE_MESH_MODEL_CFG_CLI (`cli_data`)

Define a new Config Client Model.

Note The Config Client Model can only be included by a Primary Element.

Return New Config Client Model instance.

Parameters

- `cli_data`: Pointer to a unique struct `esp_ble_mesh_client_t`.

Type Definitions

typedef struct `esp_ble_mesh_cfg_srv` `esp_ble_mesh_cfg_srv_t`

Configuration Server Model context

typedef void (`*esp_ble_mesh_cfg_client_cb_t`) (`esp_ble_mesh_cfg_client_cb_event_t` `event`,
`esp_ble_mesh_cfg_client_cb_param_t`
`*param`)

Bluetooth Mesh Config Client and Server Model functions.

Configuration Client Model callback function type

Parameters

- `event`: Event type
- `param`: Pointer to callback parameter

typedef void (`*esp_ble_mesh_cfg_server_cb_t`) (`esp_ble_mesh_cfg_server_cb_event_t` `event`,
`esp_ble_mesh_cfg_server_cb_param_t`
`*param`)

Configuration Server Model callback function type.

Parameters

- `event`: Event type
- `param`: Pointer to callback parameter

Enumerations

enum esp_ble_mesh_cfg_client_cb_event_t
This enum value is the event of Configuration Client Model

Values:

ESP_BLE_MESH_CFG_CLIENT_GET_STATE_EVT

ESP_BLE_MESH_CFG_CLIENT_SET_STATE_EVT

ESP_BLE_MESH_CFG_CLIENT_PUBLISH_EVT

ESP_BLE_MESH_CFG_CLIENT_TIMEOUT_EVT

ESP_BLE_MESH_CFG_CLIENT_EVT_MAX

enum esp_ble_mesh_cfg_server_cb_event_t
This enum value is the event of Configuration Server model

Values:

ESP_BLE_MESH_CFG_SERVER_STATE_CHANGE_EVT

ESP_BLE_MESH_CFG_SERVER_EVT_MAX

Health Client/Server Models

Header File

- [bt/esp_ble_mesh/api/models/include/esp_ble_mesh_health_model_api.h](#)

Functions

esp_err_t **esp_ble_mesh_register_health_client_callback** (*esp_ble_mesh_health_client_cb_t* callback)

Register BLE Mesh Health Model callback, the callback will report Health Client & Server Model events.

Return ESP_OK on success or error code otherwise.

Parameters

- [in] callback: Pointer to the callback function.

esp_err_t **esp_ble_mesh_register_health_server_callback** (*esp_ble_mesh_health_server_cb_t* callback)

Register BLE Mesh Health Server Model callback.

Return ESP_OK on success or error code otherwise.

Parameters

- [in] callback: Pointer to the callback function.

esp_err_t **esp_ble_mesh_health_client_get_state** (*esp_ble_mesh_client_common_param_t* *params, *esp_ble_mesh_health_client_get_state_t* *get_state)

This function is called to get the Health Server states using the Health Client Model get messages.

Note If you want to find the opcodes and corresponding meanings accepted by this API, please refer to esp_ble_mesh_opcode_health_client_get_t in esp_ble_mesh_defs.h

Return ESP_OK on success or error code otherwise.

Parameters

- [in] params: Pointer to BLE Mesh common client parameters.
- [in] get_state: Pointer to a union, each kind of opcode corresponds to one structure inside. Shall not be set to NULL.

esp_err_t **esp_ble_mesh_health_client_set_state** (*esp_ble_mesh_client_common_param_t* *params, *esp_ble_mesh_health_client_set_state_t* *set_state)

This function is called to set the Health Server states using the Health Client Model set messages.

Note If you want to find the opcodes and corresponding meanings accepted by this API, please refer to `esp_ble_mesh_opcode_health_client_set_t` in `esp_ble_mesh_defs.h`

Return ESP_OK on success or error code otherwise.

Parameters

- [in] `params`: Pointer to BLE Mesh common client parameters.
- [in] `set_state`: Pointer to a union, each kind of opcode corresponds to one structure inside. Shall not be set to NULL.

esp_err_t `esp_ble_mesh_health_server_fault_update` (*esp_ble_mesh_elem_t* **element*)

This function is called by the Health Server Model to update the context of its Health Current status.

Return ESP_OK on success or error code otherwise.

Parameters

- [in] `element`: The element to which the Health Server Model belongs.

Unions

union `esp_ble_mesh_health_client_get_state_t`

`#include <esp_ble_mesh_health_model_api.h>` For ESP_BLE_MESH_MODEL_OP_HEALTH_FAULT_GET ESP_BLE_MESH_MODEL_OP_ATTENTION_GET ESP_BLE_MESH_MODEL_OP_HEALTH_PERIOD_GET the `get_state` parameter in the `esp_ble_mesh_health_client_get_state` function should not be set to NULL.

Public Members

esp_ble_mesh_health_fault_get_t `fault_get`

For ESP_BLE_MESH_MODEL_OP_HEALTH_FAULT_GET.

union `esp_ble_mesh_health_client_set_state_t`

`#include <esp_ble_mesh_health_model_api.h>` For ESP_BLE_MESH_MODEL_OP_HEALTH_FAULT_CLEAR ESP_BLE_MESH_MODEL_OP_HEALTH_FAULT_CLEAR_UNACK ESP_BLE_MESH_MODEL_OP_HEALTH_FAULT_TEST_UNACK ESP_BLE_MESH_MODEL_OP_HEALTH_PERIOD_SET_UNACK ESP_BLE_MESH_MODEL_OP_ATTENTION_SET_UNACK the `set_state` parameter in the `esp_ble_mesh_health_client_set_state` function should not be set to NULL.

Public Members

esp_ble_mesh_health_attention_set_t `attention_set`

For ESP_BLE_MESH_MODEL_OP_ATTENTION_SET or ESP_BLE_MESH_MODEL_OP_ATTENTION_SET_UNACK.

esp_ble_mesh_health_period_set_t `period_set`

For ESP_BLE_MESH_MODEL_OP_HEALTH_PERIOD_SET or ESP_BLE_MESH_MODEL_OP_HEALTH_PERIOD_SET_UNACK.

esp_ble_mesh_health_fault_test_t `fault_test`

For ESP_BLE_MESH_MODEL_OP_HEALTH_FAULT_TEST or ESP_BLE_MESH_MODEL_OP_HEALTH_FAULT_TEST_UNACK.

esp_ble_mesh_health_fault_clear_t `fault_clear`

For ESP_BLE_MESH_MODEL_OP_HEALTH_FAULT_CLEAR or ESP_BLE_MESH_MODEL_OP_HEALTH_FAULT_CLEAR_UNACK.

union `esp_ble_mesh_health_client_common_cb_param_t`

`#include <esp_ble_mesh_health_model_api.h>` Health Client Model received message union.

Public Members

esp_ble_mesh_health_current_status_cb_t `current_status`

The health current status value

esp_ble_mesh_health_fault_status_cb_t **fault_status**

The health fault status value

esp_ble_mesh_health_period_status_cb_t **period_status**

The health period status value

esp_ble_mesh_health_attention_status_cb_t **attention_status**

The health attention status value

union esp_ble_mesh_health_server_cb_param_t

#include <esp_ble_mesh_health_model_api.h> Health Server Model callback parameters union.

Public Members

esp_ble_mesh_health_fault_update_comp_cb_t **fault_update_comp**

ESP_BLE_MESH_HEALTH_SERVER_FAULT_UPDATE_COMP_EVT

esp_ble_mesh_health_fault_clear_cb_t **fault_clear**

ESP_BLE_MESH_HEALTH_SERVER_FAULT_CLEAR_EVT

esp_ble_mesh_health_fault_test_cb_t **fault_test**

ESP_BLE_MESH_HEALTH_SERVER_FAULT_TEST_EVT

esp_ble_mesh_health_attention_on_cb_t **attention_on**

ESP_BLE_MESH_HEALTH_SERVER_ATTENTION_ON_EVT

esp_ble_mesh_health_attention_off_cb_t **attention_off**

ESP_BLE_MESH_HEALTH_SERVER_ATTENTION_OFF_EVT

Structures

struct esp_ble_mesh_health_srv_cb_t

ESP BLE Mesh Health Server callback

Public Members

esp_ble_mesh_cb_t **fault_clear**

Clear health registered faults. Initialized by the stack.

esp_ble_mesh_cb_t **fault_test**

Run a specific health test. Initialized by the stack.

esp_ble_mesh_cb_t **attention_on**

Health attention on callback. Initialized by the stack.

esp_ble_mesh_cb_t **attention_off**

Health attention off callback. Initialized by the stack.

struct esp_ble_mesh_health_test_t

ESP BLE Mesh Health Server test Context

Public Members

uint8_t id_count

Number of Health self-test ID

const uint8_t *test_ids

Array of Health self-test IDs

uint16_t company_id

Company ID used to identify the Health Fault state

uint8_t prev_test_id

Current test ID of the health fault test

`uint8_t current_faults[ESP_BLE_MESH_HEALTH_FAULT_ARRAY_SIZE]`
Array of current faults

`uint8_t registered_faults[ESP_BLE_MESH_HEALTH_FAULT_ARRAY_SIZE]`
Array of registered faults

struct esp_ble_mesh_health_srv_t
ESP BLE Mesh Health Server Model Context

Public Members

`esp_ble_mesh_model_t *model`
Pointer to Health Server Model

`esp_ble_mesh_health_srv_cb_t health_cb`
Health callback struct

struct k_delayed_work attention_timer
Attention Timer state

`bool attention_timer_start`
Attention Timer start flag

`esp_ble_mesh_health_test_t health_test`
Health Server fault test

struct esp_ble_mesh_health_fault_get_t
Parameter of Health Fault Get

Public Members

`uint16_t company_id`
Bluetooth assigned 16-bit Company ID

struct esp_ble_mesh_health_attention_set_t
Parameter of Health Attention Set

Public Members

`uint8_t attention`
Value of the Attention Timer state

struct esp_ble_mesh_health_period_set_t
Parameter of Health Period Set

Public Members

`uint8_t fast_period_divisor`
Divider for the Publish Period

struct esp_ble_mesh_health_fault_test_t
Parameter of Health Fault Test

Public Members

`uint16_t company_id`
Bluetooth assigned 16-bit Company ID

`uint8_t test_id`
ID of a specific test to be performed

struct esp_ble_mesh_health_fault_clear_t
Parameter of Health Fault Clear

Public Members

uint16_t **company_id**
Bluetooth assigned 16-bit Company ID

struct esp_ble_mesh_health_current_status_cb_t
Parameters of Health Current Status

Public Members

uint8_t **test_id**
ID of a most recently performed test

uint16_t **company_id**
Bluetooth assigned 16-bit Company ID

struct net_buf_simple *fault_array
FaultArray field contains a sequence of 1-octet fault values

struct esp_ble_mesh_health_fault_status_cb_t
Parameters of Health Fault Status

Public Members

uint8_t **test_id**
ID of a most recently performed test

uint16_t **company_id**
Bluetooth assigned 16-bit Company ID

struct net_buf_simple *fault_array
FaultArray field contains a sequence of 1-octet fault values

struct esp_ble_mesh_health_period_status_cb_t
Parameter of Health Period Status

Public Members

uint8_t **fast_period_divisor**
Divider for the Publish Period

struct esp_ble_mesh_health_attention_status_cb_t
Parameter of Health Attention Status

Public Members

uint8_t **attention**
Value of the Attention Timer state

struct esp_ble_mesh_health_client_cb_param_t
Health Client Model callback parameters

Public Members**int error_code**

Appropriate error code

esp_ble_mesh_client_common_param_t *params

The client common parameters.

esp_ble_mesh_health_client_common_cb_param_t status_cb

The health message status callback values

struct esp_ble_mesh_health_fault_update_comp_cb_t

Parameter of publishing Health Current Status completion event

Public Members**int error_code**

The result of publishing Health Current Status

esp_ble_mesh_elem_t *element

Pointer to the element which contains the Health Server Model

struct esp_ble_mesh_health_fault_clear_cb_t

Parameters of Health Fault Clear event

Public Members**esp_ble_mesh_model_t *model**

Pointer to the Health Server Model

uint16_t company_id

Bluetooth assigned 16-bit Company ID

struct esp_ble_mesh_health_fault_test_cb_t

Parameters of Health Fault Test event

Public Members**esp_ble_mesh_model_t *model**

Pointer to the Health Server Model

uint8_t test_id

ID of a specific test to be performed

uint16_t company_id

Bluetooth assigned 16-bit Company ID

struct esp_ble_mesh_health_attention_on_cb_t

Parameter of Health Attention On event

Public Members**esp_ble_mesh_model_t *model**

Pointer to the Health Server Model

uint8_t time

Duration of attention timer on (in seconds)

struct esp_ble_mesh_health_attention_off_cb_t

Parameter of Health Attention Off event

Public Members

esp_ble_mesh_model_t *model
Pointer to the Health Server Model

Macros

ESP_BLE_MESH_MODEL_HEALTH_SRV (srv, pub)
Define a new Health Server Model.

Note The Health Server Model can only be included by a Primary Element.

Return New Health Server Model instance.

Parameters

- *srv*: Pointer to the unique struct *esp_ble_mesh_health_srv_t*.
- *pub*: Pointer to the unique struct *esp_ble_mesh_model_pub_t*.

ESP_BLE_MESH_MODEL_HEALTH_CLI (cli_data)
Define a new Health Client Model.

Note This API needs to be called for each element on which the application needs to have a Health Client Model.

Return New Health Client Model instance.

Parameters

- *cli_data*: Pointer to the unique struct *esp_ble_mesh_client_t*.

ESP_BLE_MESH_HEALTH_PUB_DEFINE (_name, _max, _role)
A helper to define a health publication context

Parameters

- *_name*: Name given to the publication context variable.
- *_max*: Maximum number of faults the element can have.
- *_role*: Role of the device which contains the model.

ESP_BLE_MESH_HEALTH_STANDARD_TEST
SIG identifier of Health Fault Test. 0x01 ~ 0xFF: Vendor Specific Test.

ESP_BLE_MESH_NO_FAULT
Fault values of Health Fault Test. 0x33 ~ 0x7F: Reserved for Future Use. 0x80 ~ 0xFF: Vendor Specific Warning/Error.

ESP_BLE_MESH_BATTERY_LOW_WARNING

ESP_BLE_MESH_BATTERY_LOW_ERROR

ESP_BLE_MESH_SUPPLY_VOLTAGE_TOO_LOW_WARNING

ESP_BLE_MESH_SUPPLY_VOLTAGE_TOO_LOW_ERROR

ESP_BLE_MESH_SUPPLY_VOLTAGE_TOO_HIGH_WARNING

ESP_BLE_MESH_SUPPLY_VOLTAGE_TOO_HIGH_ERROR

ESP_BLE_MESH_POWER_SUPPLY_INTERRUPTED_WARNING

ESP_BLE_MESH_POWER_SUPPLY_INTERRUPTED_ERROR

ESP_BLE_MESH_NO_LOAD_WARNING

ESP_BLE_MESH_NO_LOAD_ERROR

ESP_BLE_MESH_OVERLOAD_WARNING

ESP_BLE_MESH_OVERLOAD_ERROR

ESP_BLE_MESH_OVERHEAT_WARNING

ESP_BLE_MESH_OVERHEAT_ERROR

ESP_BLE_MESH_CONDENSATION_WARNING

ESP_BLE_MESH_CONDENSATION_ERROR
ESP_BLE_MESH_VIBRATION_WARNING
ESP_BLE_MESH_VIBRATION_ERROR
ESP_BLE_MESH_CONFIGURATION_WARNING
ESP_BLE_MESH_CONFIGURATION_ERROR
ESP_BLE_MESH_ELEMENT_NOT_CALIBRATED_WARNING
ESP_BLE_MESH_ELEMENT_NOT_CALIBRATED_ERROR
ESP_BLE_MESH_MEMORY_WARNING
ESP_BLE_MESH_MEMORY_ERROR
ESP_BLE_MESH_SELF_TEST_WARNING
ESP_BLE_MESH_SELF_TEST_ERROR
ESP_BLE_MESH_INPUT_TOO_LOW_WARNING
ESP_BLE_MESH_INPUT_TOO_LOW_ERROR
ESP_BLE_MESH_INPUT_TOO_HIGH_WARNING
ESP_BLE_MESH_INPUT_TOO_HIGH_ERROR
ESP_BLE_MESH_INPUT_NO_CHANGE_WARNING
ESP_BLE_MESH_INPUT_NO_CHANGE_ERROR
ESP_BLE_MESH_ACTUATOR_BLOCKED_WARNING
ESP_BLE_MESH_ACTUATOR_BLOCKED_ERROR
ESP_BLE_MESH_HOUSING_OPENED_WARNING
ESP_BLE_MESH_HOUSING_OPENED_ERROR
ESP_BLE_MESH_TAMPER_WARNING
ESP_BLE_MESH_TAMPER_ERROR
ESP_BLE_MESH_DEVICE_MOVED_WARNING
ESP_BLE_MESH_DEVICE_MOVED_ERROR
ESP_BLE_MESH_DEVICE_DROPPED_WARNING
ESP_BLE_MESH_DEVICE_DROPPED_ERROR
ESP_BLE_MESH_OVERFLOW_WARNING
ESP_BLE_MESH_OVERFLOW_ERROR
ESP_BLE_MESH_EMPTY_WARNING
ESP_BLE_MESH_EMPTY_ERROR
ESP_BLE_MESH_INTERNAL_BUS_WARNING
ESP_BLE_MESH_INTERNAL_BUS_ERROR
ESP_BLE_MESH_MECHANISM_JAMMED_WARNING
ESP_BLE_MESH_MECHANISM_JAMMED_ERROR
ESP_BLE_MESH_HEALTH_FAULT_ARRAY_SIZE

Type Definitions

typedef void (***esp_ble_mesh_health_client_cb_t**) (*esp_ble_mesh_health_client_cb_event_t* event, *esp_ble_mesh_health_client_cb_param_t* *param)

Bluetooth Mesh Health Client and Server Model function.

Health Client Model callback function type

Parameters

- event: Event type
- param: Pointer to callback parameter

typedef void (***esp_ble_mesh_health_server_cb_t**) (*esp_ble_mesh_health_server_cb_event_t* event, *esp_ble_mesh_health_server_cb_param_t* *param)

Health Server Model callback function type.

Parameters

- event: Event type
- param: Pointer to callback parameter

Enumerations

enum **esp_ble_mesh_health_client_cb_event_t**

This enum value is the event of Health Client Model

Values:

ESP_BLE_MESH_HEALTH_CLIENT_GET_STATE_EVT

ESP_BLE_MESH_HEALTH_CLIENT_SET_STATE_EVT

ESP_BLE_MESH_HEALTH_CLIENT_PUBLISH_EVT

ESP_BLE_MESH_HEALTH_CLIENT_TIMEOUT_EVT

ESP_BLE_MESH_HEALTH_CLIENT_EVT_MAX

enum **esp_ble_mesh_health_server_cb_event_t**

This enum value is the event of Health Server Model

Values:

ESP_BLE_MESH_HEALTH_SERVER_FAULT_UPDATE_COMP_EVT

ESP_BLE_MESH_HEALTH_SERVER_FAULT_CLEAR_EVT

ESP_BLE_MESH_HEALTH_SERVER_FAULT_TEST_EVT

ESP_BLE_MESH_HEALTH_SERVER_ATTENTION_ON_EVT

ESP_BLE_MESH_HEALTH_SERVER_ATTENTION_OFF_EVT

ESP_BLE_MESH_HEALTH_SERVER_EVT_MAX

Generic Client/Server Models

Header File

- [bt/esp_ble_mesh/api/models/include/esp_ble_mesh_generic_model_api.h](#)

Functions

esp_err_t **esp_ble_mesh_register_generic_client_callback** (*esp_ble_mesh_generic_client_cb_t* callback)

Register BLE Mesh Generic Client Model callback.

Return ESP_OK on success or error code otherwise.

Parameters

- [in] `callback`: Pointer to the callback function.

esp_err_t **esp_ble_mesh_generic_client_get_state** (*esp_ble_mesh_client_common_param_t* *params, *esp_ble_mesh_generic_client_get_state_t* *get_state)

Get the value of Generic Server Model states using the Generic Client Model get messages.

Note If you want to find the opcodes and corresponding meanings accepted by this API, please refer to `esp_ble_mesh_generic_message_opcode_t` in `esp_ble_mesh_defs.h`

Return `ESP_OK` on success or error code otherwise.

Parameters

- [in] `params`: Pointer to BLE Mesh common client parameters.
- [in] `get_state`: Pointer to generic get message value. Shall not be set to NULL.

esp_err_t **esp_ble_mesh_generic_client_set_state** (*esp_ble_mesh_client_common_param_t* *params, *esp_ble_mesh_generic_client_set_state_t* *set_state)

Set the value of Generic Server Model states using the Generic Client Model set messages.

Note If you want to find the opcodes and corresponding meanings accepted by this API, please refer to `esp_ble_mesh_generic_message_opcode_t` in `esp_ble_mesh_defs.h`

Return `ESP_OK` on success or error code otherwise.

Parameters

- [in] `params`: Pointer to BLE Mesh common client parameters.
- [in] `set_state`: Pointer to generic set message value. Shall not be set to NULL.

esp_err_t **esp_ble_mesh_register_generic_server_callback** (*esp_ble_mesh_generic_server_cb_t* callback)

Register BLE Mesh Generic Server Model callback.

Return `ESP_OK` on success or error code otherwise.

Parameters

- [in] `callback`: Pointer to the callback function.

Unions

union `esp_ble_mesh_generic_client_get_state_t`
#include <esp_ble_mesh_generic_model_api.h> Generic Client Model get message union.

Public Members

esp_ble_mesh_gen_user_property_get_t **user_property_get**
 For `ESP_BLE_MESH_MODEL_OP_GEN_USER_PROPERTY_GET`

esp_ble_mesh_gen_admin_property_get_t **admin_property_get**
 For `ESP_BLE_MESH_MODEL_OP_GEN_ADMIN_PROPERTY_GET`

esp_ble_mesh_gen_manufacturer_property_get_t **manufacturer_property_get**
 For `ESP_BLE_MESH_MODEL_OP_GEN_MANUFACTURER_PROPERTY_SET`

esp_ble_mesh_gen_client_properties_get_t **client_properties_get**
 For `ESP_BLE_MESH_MODEL_OP_GEN_CLIENT_PROPERTIES_GET`

union `esp_ble_mesh_generic_client_set_state_t`
#include <esp_ble_mesh_generic_model_api.h> Generic Client Model set message union.

Public Members

esp_ble_mesh_gen_onoff_set_t **onoff_set**
 For `ESP_BLE_MESH_MODEL_OP_GEN_ONOFF_SET` & `ESP_BLE_MESH_MODEL_OP_GEN_ONOFF_SET_UN`

```

esp_ble_mesh_gen_level_set_t level_set
    For ESP_BLE_MESH_MODEL_OP_GEN_LEVEL_SET & ESP_BLE_MESH_MODEL_OP_GEN_LEVEL_SET_UNACK

esp_ble_mesh_gen_delta_set_t delta_set
    For ESP_BLE_MESH_MODEL_OP_GEN_DELTA_SET & ESP_BLE_MESH_MODEL_OP_GEN_DELTA_SET_UNACK

esp_ble_mesh_gen_move_set_t move_set
    For ESP_BLE_MESH_MODEL_OP_GEN_MOVE_SET & ESP_BLE_MESH_MODEL_OP_GEN_MOVE_SET_UNACK

esp_ble_mesh_gen_def_trans_time_set_t def_trans_time_set
    For ESP_BLE_MESH_MODEL_OP_GEN_DEF_TRANS_TIME_SET &
      ESP_BLE_MESH_MODEL_OP_GEN_DEF_TRANS_TIME_SET_UNACK

esp_ble_mesh_gen_onpowerup_set_t power_set
    For ESP_BLE_MESH_MODEL_OP_GEN_ONPOWERUP_SET &
      ESP_BLE_MESH_MODEL_OP_GEN_ONPOWERUP_SET_UNACK

esp_ble_mesh_gen_power_level_set_t power_level_set
    For ESP_BLE_MESH_MODEL_OP_GEN_POWER_LEVEL_SET &
      ESP_BLE_MESH_MODEL_OP_GEN_POWER_LEVEL_SET_UNACK

esp_ble_mesh_gen_power_default_set_t power_default_set
    For ESP_BLE_MESH_MODEL_OP_GEN_POWER_DEFAULT_SET &
      ESP_BLE_MESH_MODEL_OP_GEN_POWER_DEFAULT_SET_UNACK

esp_ble_mesh_gen_power_range_set_t power_range_set
    For ESP_BLE_MESH_MODEL_OP_GEN_POWER_RANGE_SET &
      ESP_BLE_MESH_MODEL_OP_GEN_POWER_RANGE_SET_UNACK

esp_ble_mesh_gen_loc_global_set_t loc_global_set
    For ESP_BLE_MESH_MODEL_OP_GEN_LOC_GLOBAL_SET &
      ESP_BLE_MESH_MODEL_OP_GEN_LOC_GLOBAL_SET_UNACK

esp_ble_mesh_gen_loc_local_set_t loc_local_set
    For ESP_BLE_MESH_MODEL_OP_GEN_LOC_LOCAL_SET &
      ESP_BLE_MESH_MODEL_OP_GEN_LOC_LOCAL_SET_UNACK

esp_ble_mesh_gen_user_property_set_t user_property_set
    For ESP_BLE_MESH_MODEL_OP_GEN_USER_PROPERTY_SET &
      ESP_BLE_MESH_MODEL_OP_GEN_USER_PROPERTY_SET_UNACK

esp_ble_mesh_gen_admin_property_set_t admin_property_set
    For ESP_BLE_MESH_MODEL_OP_GEN_ADMIN_PROPERTY_SET &
      ESP_BLE_MESH_MODEL_OP_GEN_ADMIN_PROPERTY_SET_UNACK

esp_ble_mesh_gen_manufacturer_property_set_t manufacturer_property_set
    For ESP_BLE_MESH_MODEL_OP_GEN_MANUFACTURER_PROPERTY_SET &
      ESP_BLE_MESH_MODEL_OP_GEN_MANUFACTURER_PROPERTY_SET_UNACK

```

```
union esp_ble_mesh_gen_client_status_cb_t
```

```
#include <esp_ble_mesh_generic_model_api.h> Generic Client Model received message union.
```

Public Members

```

esp_ble_mesh_gen_onoff_status_cb_t onoff_status
    For ESP_BLE_MESH_MODEL_OP_GEN_ONOFF_STATUS

esp_ble_mesh_gen_level_status_cb_t level_status
    For ESP_BLE_MESH_MODEL_OP_GEN_LEVEL_STATUS

esp_ble_mesh_gen_def_trans_time_status_cb_t def_trans_time_status
    For ESP_BLE_MESH_MODEL_OP_GEN_DEF_TRANS_TIME_STATUS

esp_ble_mesh_gen_onpowerup_status_cb_t onpowerup_status
    For ESP_BLE_MESH_MODEL_OP_GEN_ONPOWERUP_STATUS

```

esp_ble_mesh_gen_power_level_status_cb_t **power_level_status**
For ESP_BLE_MESH_MODEL_OP_GEN_POWER_LEVEL_STATUS

esp_ble_mesh_gen_power_last_status_cb_t **power_last_status**
For ESP_BLE_MESH_MODEL_OP_GEN_POWER_LAST_STATUS

esp_ble_mesh_gen_power_default_status_cb_t **power_default_status**
For ESP_BLE_MESH_MODEL_OP_GEN_POWER_DEFAULT_STATUS

esp_ble_mesh_gen_power_range_status_cb_t **power_range_status**
For ESP_BLE_MESH_MODEL_OP_GEN_POWER_RANGE_STATUS

esp_ble_mesh_gen_battery_status_cb_t **battery_status**
For ESP_BLE_MESH_MODEL_OP_GEN_BATTERY_STATUS

esp_ble_mesh_gen_loc_global_status_cb_t **location_global_status**
For ESP_BLE_MESH_MODEL_OP_GEN_LOC_GLOBAL_STATUS

esp_ble_mesh_gen_loc_local_status_cb_t **location_local_status**
ESP_BLE_MESH_MODEL_OP_GEN_LOC_LOCAL_STATUS

esp_ble_mesh_gen_user_properties_status_cb_t **user_properties_status**
ESP_BLE_MESH_MODEL_OP_GEN_USER_PROPERTIES_STATUS

esp_ble_mesh_gen_user_property_status_cb_t **user_property_status**
ESP_BLE_MESH_MODEL_OP_GEN_USER_PROPERTY_STATUS

esp_ble_mesh_gen_admin_properties_status_cb_t **admin_properties_status**
ESP_BLE_MESH_MODEL_OP_GEN_ADMIN_PROPERTIES_STATUS

esp_ble_mesh_gen_admin_property_status_cb_t **admin_property_status**
ESP_BLE_MESH_MODEL_OP_GEN_ADMIN_PROPERTY_STATUS

esp_ble_mesh_gen_manufacturer_properties_status_cb_t **manufacturer_properties_status**
ESP_BLE_MESH_MODEL_OP_GEN_MANUFACTURER_PROPERTIES_STATUS

esp_ble_mesh_gen_manufacturer_property_status_cb_t **manufacturer_property_status**
ESP_BLE_MESH_MODEL_OP_GEN_MANUFACTURER_PROPERTY_STATUS

esp_ble_mesh_gen_client_properties_status_cb_t **client_properties_status**
ESP_BLE_MESH_MODEL_OP_GEN_CLIENT_PROPERTIES_STATUS

union esp_ble_mesh_generic_server_state_change_t
#include <esp_ble_mesh_generic_model_api.h> Generic Server Model state change value union.

Public Members

esp_ble_mesh_state_change_gen_onoff_set_t **onoff_set**
The recv_op in ctx can be used to decide which state is changed. Generic OnOff Set

esp_ble_mesh_state_change_gen_level_set_t **level_set**
Generic Level Set

esp_ble_mesh_state_change_gen_delta_set_t **delta_set**
Generic Delta Set

esp_ble_mesh_state_change_gen_move_set_t **move_set**
Generic Move Set

esp_ble_mesh_state_change_gen_def_trans_time_set_t **def_trans_time_set**
Generic Default Transition Time Set

esp_ble_mesh_state_change_gen_onpowerup_set_t **onpowerup_set**
Generic OnPowerUp Set

esp_ble_mesh_state_change_gen_power_level_set_t **power_level_set**
Generic Power Level Set

esp_ble_mesh_state_change_gen_power_default_set_t **power_default_set**
Generic Power Default Set

esp_ble_mesh_state_change_gen_power_range_set_t **power_range_set**
Generic Power Range Set

esp_ble_mesh_state_change_gen_loc_global_set_t **loc_global_set**
Generic Location Global Set

esp_ble_mesh_state_change_gen_loc_local_set_t **loc_local_set**
Generic Location Local Set

esp_ble_mesh_state_change_gen_user_property_set_t **user_property_set**
Generic User Property Set

esp_ble_mesh_state_change_gen_admin_property_set_t **admin_property_set**
Generic Admin Property Set

esp_ble_mesh_state_change_gen_manu_property_set_t **manu_property_set**
Generic Manufacturer Property Set

union esp_ble_mesh_generic_server_rcv_get_msg_t
#include <esp_ble_mesh_generic_model_api.h> Generic Server Model received get message union.

Public Members

esp_ble_mesh_server_rcv_gen_user_property_get_t **user_property**
Generic User Property Get

esp_ble_mesh_server_rcv_gen_admin_property_get_t **admin_property**
Generic Admin Property Get

esp_ble_mesh_server_rcv_gen_manufacturer_property_get_t **manu_property**
Generic Manufacturer Property Get

esp_ble_mesh_server_rcv_gen_client_properties_get_t **client_properties**
Generic Client Properties Get

union esp_ble_mesh_generic_server_rcv_set_msg_t
#include <esp_ble_mesh_generic_model_api.h> Generic Server Model received set message union.

Public Members

esp_ble_mesh_server_rcv_gen_onoff_set_t **onoff**
Generic OnOff Set/Generic OnOff Set Unack

esp_ble_mesh_server_rcv_gen_level_set_t **level**
Generic Level Set/Generic Level Set Unack

esp_ble_mesh_server_rcv_gen_delta_set_t **delta**
Generic Delta Set/Generic Delta Set Unack

esp_ble_mesh_server_rcv_gen_move_set_t **move**
Generic Move Set/Generic Move Set Unack

esp_ble_mesh_server_rcv_gen_def_trans_time_set_t **def_trans_time**
Generic Default Transition Time Set/Generic Default Transition Time Set Unack

esp_ble_mesh_server_rcv_gen_onpowerup_set_t **onpowerup**
Generic OnPowerUp Set/Generic OnPowerUp Set Unack

esp_ble_mesh_server_rcv_gen_power_level_set_t **power_level**
Generic Power Level Set/Generic Power Level Set Unack

esp_ble_mesh_server_rcv_gen_power_default_set_t **power_default**
Generic Power Default Set/Generic Power Default Set Unack

esp_ble_mesh_server_rcv_gen_power_range_set_t **power_range**

Generic Power Range Set/Generic Power Range Set Unack

esp_ble_mesh_server_rcv_gen_loc_global_set_t **location_global**

Generic Location Global Set/Generic Location Global Set Unack

esp_ble_mesh_server_rcv_gen_loc_local_set_t **location_local**

Generic Location Local Set/Generic Location Local Set Unack

esp_ble_mesh_server_rcv_gen_user_property_set_t **user_property**

Generic User Property Set/Generic User Property Set Unack

esp_ble_mesh_server_rcv_gen_admin_property_set_t **admin_property**

Generic Admin Property Set/Generic Admin Property Set Unack

esp_ble_mesh_server_rcv_gen_manufacturer_property_set_t **manu_property**

Generic Manufacturer Property Set/Generic Manufacturer Property Set Unack

union esp_ble_mesh_generic_server_cb_value_t

#include <esp_ble_mesh_generic_model_api.h> Generic Server Model callback value union.

Public Members

esp_ble_mesh_generic_server_state_change_t **state_change**

ESP_BLE_MESH_GENERIC_SERVER_STATE_CHANGE_EVT

esp_ble_mesh_generic_server_rcv_get_msg_t **get**

ESP_BLE_MESH_GENERIC_SERVER_RECV_GET_MSG_EVT

esp_ble_mesh_generic_server_rcv_set_msg_t **set**

ESP_BLE_MESH_GENERIC_SERVER_RECV_SET_MSG_EVT

Structures

struct esp_ble_mesh_gen_onoff_set_t

Bluetooth Mesh Generic Client Model Get and Set parameters structure.

Parameters of Generic OnOff Set.

Public Members

bool **op_en**

Indicate if optional parameters are included

uint8_t **onoff**

Target value of Generic OnOff state

uint8_t **tid**

Transaction ID

uint8_t **trans_time**

Time to complete state transition (optional)

uint8_t **delay**

Indicate message execution delay (C.1)

struct esp_ble_mesh_gen_level_set_t

Parameters of Generic Level Set.

Public Members

bool **op_en**

Indicate if optional parameters are included

int16_t level
Target value of Generic Level state

uint8_t tid
Transaction ID

uint8_t trans_time
Time to complete state transition (optional)

uint8_t delay
Indicate message execution delay (C.1)

struct esp_ble_mesh_gen_delta_set_t
Parameters of Generic Delta Set.

Public Members

bool op_en
Indicate if optional parameters are included

int32_t level
Delta change of Generic Level state

uint8_t tid
Transaction ID

uint8_t trans_time
Time to complete state transition (optional)

uint8_t delay
Indicate message execution delay (C.1)

struct esp_ble_mesh_gen_move_set_t
Parameters of Generic Move Set.

Public Members

bool op_en
Indicate if optional parameters are included

int16_t delta_level
Delta Level step to calculate Move speed for Generic Level state

uint8_t tid
Transaction ID

uint8_t trans_time
Time to complete state transition (optional)

uint8_t delay
Indicate message execution delay (C.1)

struct esp_ble_mesh_gen_def_trans_time_set_t
Parameter of Generic Default Transition Time Set.

Public Members

uint8_t trans_time
The value of the Generic Default Transition Time state

struct esp_ble_mesh_gen_onpowerup_set_t
Parameter of Generic OnPowerUp Set.

Public Members**uint8_t onpowerup**

The value of the Generic OnPowerUp state

struct esp_ble_mesh_gen_power_level_set_t

Parameters of Generic Power Level Set.

Public Members**bool op_en**

Indicate if optional parameters are included

uint16_t power

Target value of Generic Power Actual state

uint8_t tid

Transaction ID

uint8_t trans_time

Time to complete state transition (optional)

uint8_t delay

Indicate message execution delay (C.1)

struct esp_ble_mesh_gen_power_default_set_t

Parameter of Generic Power Default Set.

Public Members**uint16_t power**

The value of the Generic Power Default state

struct esp_ble_mesh_gen_power_range_set_t

Parameters of Generic Power Range Set.

Public Members**uint16_t range_min**

Value of Range Min field of Generic Power Range state

uint16_t range_max

Value of Range Max field of Generic Power Range state

struct esp_ble_mesh_gen_loc_global_set_t

Parameters of Generic Location Global Set.

Public Members**int32_t global_latitude**

Global Coordinates (Latitude)

int32_t global_longitude

Global Coordinates (Longitude)

int16_t global_altitude

Global Altitude

struct esp_ble_mesh_gen_loc_local_set_t

Parameters of Generic Location Local Set.

Public Members

int16_t local_north
Local Coordinates (North)

int16_t local_east
Local Coordinates (East)

int16_t local_altitude
Local Altitude

uint8_t floor_number
Floor Number

uint16_t uncertainty
Uncertainty

struct esp_ble_mesh_gen_user_property_get_t
Parameter of Generic User Property Get.

Public Members

uint16_t property_id
Property ID identifying a Generic User Property

struct esp_ble_mesh_gen_user_property_set_t
Parameters of Generic User Property Set.

Public Members

uint16_t property_id
Property ID identifying a Generic User Property

struct net_buf_simple *property_value
Raw value for the User Property

struct esp_ble_mesh_gen_admin_property_get_t
Parameter of Generic Admin Property Get.

Public Members

uint16_t property_id
Property ID identifying a Generic Admin Property

struct esp_ble_mesh_gen_admin_property_set_t
Parameters of Generic Admin Property Set.

Public Members

uint16_t property_id
Property ID identifying a Generic Admin Property

uint8_t user_access
Enumeration indicating user access

struct net_buf_simple *property_value
Raw value for the Admin Property

struct esp_ble_mesh_gen_manufacturer_property_get_t
Parameter of Generic Manufacturer Property Get.

Public Members

`uint16_t property_id`
Property ID identifying a Generic Manufacturer Property

struct esp_ble_mesh_gen_manufacturer_property_set_t
Parameters of Generic Manufacturer Property Set.

Public Members

`uint16_t property_id`
Property ID identifying a Generic Manufacturer Property

`uint8_t user_access`
Enumeration indicating user access

struct esp_ble_mesh_gen_client_properties_get_t
Parameter of Generic Client Properties Get.

Public Members

`uint16_t property_id`
A starting Client Property ID present within an element

struct esp_ble_mesh_gen_onoff_status_cb_t
Bluetooth Mesh Generic Client Model Get and Set callback parameters structure.
Parameters of Generic OnOff Status.

Public Members

`bool op_en`
Indicate if optional parameters are included

`uint8_t present_onoff`
Current value of Generic OnOff state

`uint8_t target_onoff`
Target value of Generic OnOff state (optional)

`uint8_t remain_time`
Time to complete state transition (C.1)

struct esp_ble_mesh_gen_level_status_cb_t
Parameters of Generic Level Status.

Public Members

`bool op_en`
Indicate if optional parameters are included

`int16_t present_level`
Current value of Generic Level state

`int16_t target_level`
Target value of the Generic Level state (optional)

`uint8_t remain_time`
Time to complete state transition (C.1)

struct esp_ble_mesh_gen_def_trans_time_status_cb_t
Parameter of Generic Default Transition Time Status.

Public Members**uint8_t trans_time**

The value of the Generic Default Transition Time state

struct esp_ble_mesh_gen_onpowerup_status_cb_t

Parameter of Generic OnPowerUp Status.

Public Members**uint8_t onpowerup**

The value of the Generic OnPowerUp state

struct esp_ble_mesh_gen_power_level_status_cb_t

Parameters of Generic Power Level Status.

Public Members**bool op_en**

Indicate if optional parameters are included

uint16_t present_power

Current value of Generic Power Actual state

uint16_t target_power

Target value of Generic Power Actual state (optional)

uint8_t remain_time

Time to complete state transition (C.1)

struct esp_ble_mesh_gen_power_last_status_cb_t

Parameter of Generic Power Last Status.

Public Members**uint16_t power**

The value of the Generic Power Last state

struct esp_ble_mesh_gen_power_default_status_cb_t

Parameter of Generic Power Default Status.

Public Members**uint16_t power**

The value of the Generic Default Last state

struct esp_ble_mesh_gen_power_range_status_cb_t

Parameters of Generic Power Range Status.

Public Members**uint8_t status_code**

Status Code for the request message

uint16_t range_min

Value of Range Min field of Generic Power Range state

uint16_t range_max

Value of Range Max field of Generic Power Range state

struct esp_ble_mesh_gen_battery_status_cb_t
Parameters of Generic Battery Status.

Public Members

uint32_t battery_level : 8
Value of Generic Battery Level state

uint32_t time_to_discharge : 24
Value of Generic Battery Time to Discharge state

uint32_t time_to_charge : 24
Value of Generic Battery Time to Charge state

uint32_t flags : 8
Value of Generic Battery Flags state

struct esp_ble_mesh_gen_loc_global_status_cb_t
Parameters of Generic Location Global Status.

Public Members

int32_t global_latitude
Global Coordinates (Latitude)

int32_t global_longitude
Global Coordinates (Longitude)

int16_t global_altitude
Global Altitude

struct esp_ble_mesh_gen_loc_local_status_cb_t
Parameters of Generic Location Local Status.

Public Members

int16_t local_north
Local Coordinates (North)

int16_t local_east
Local Coordinates (East)

int16_t local_altitude
Local Altitude

uint8_t floor_number
Floor Number

uint16_t uncertainty
Uncertainty

struct esp_ble_mesh_gen_user_properties_status_cb_t
Parameter of Generic User Properties Status.

Public Members

struct net_buf_simple *property_ids
Buffer contains a sequence of N User Property IDs

struct esp_ble_mesh_gen_user_property_status_cb_t
Parameters of Generic User Property Status.

Public Members**bool op_en**

Indicate if optional parameters are included

uint16_t property_id

Property ID identifying a Generic User Property

uint8_t user_access

Enumeration indicating user access (optional)

struct net_buf_simple *property_value

Raw value for the User Property (C.1)

struct esp_ble_mesh_gen_admin_properties_status_cb_t

Parameter of Generic Admin Properties Status.

Public Members**struct net_buf_simple *property_ids**

Buffer contains a sequence of N Admin Property IDs

struct esp_ble_mesh_gen_admin_property_status_cb_t

Parameters of Generic Admin Property Status.

Public Members**bool op_en**

Indicate if optional parameters are included

uint16_t property_id

Property ID identifying a Generic Admin Property

uint8_t user_access

Enumeration indicating user access (optional)

struct net_buf_simple *property_value

Raw value for the Admin Property (C.1)

struct esp_ble_mesh_gen_manufacturer_properties_status_cb_t

Parameter of Generic Manufacturer Properties Status.

Public Members**struct net_buf_simple *property_ids**

Buffer contains a sequence of N Manufacturer Property IDs

struct esp_ble_mesh_gen_manufacturer_property_status_cb_t

Parameters of Generic Manufacturer Property Status.

Public Members**bool op_en**

Indicate if optional parameters are included

uint16_t property_id

Property ID identifying a Generic Manufacturer Property

uint8_t user_access

Enumeration indicating user access (optional)

struct net_buf_simple ***property_value**
Raw value for the Manufacturer Property (C.1)

struct esp_ble_mesh_gen_client_properties_status_cb_t
Parameter of Generic Client Properties Status.

Public Members

struct net_buf_simple ***property_ids**
Buffer contains a sequence of N Client Property IDs

struct esp_ble_mesh_generic_client_cb_param_t
Generic Client Model callback parameters

Public Members

int **error_code**
Appropriate error code

esp_ble_mesh_client_common_param_t ***params**
The client common parameters.

esp_ble_mesh_gen_client_status_cb_t **status_cb**
The generic status message callback values

struct esp_ble_mesh_gen_onoff_state_t
Parameters of Generic OnOff state

Public Members

uint8_t **onoff**
The present value of the Generic OnOff state

uint8_t **target_onoff**
The target value of the Generic OnOff state

struct esp_ble_mesh_gen_onoff_srv_t
User data of Generic OnOff Server Model

Public Members

esp_ble_mesh_model_t ***model**
Pointer to the Generic OnOff Server Model. Initialized internally.

esp_ble_mesh_server_rsp_ctrl_t **rsp_ctrl**
Response control of the server model received messages

esp_ble_mesh_gen_onoff_state_t **state**
Parameters of the Generic OnOff state

esp_ble_mesh_last_msg_info_t **last**
Parameters of the last received set message

esp_ble_mesh_state_transition_t **transition**
Parameters of state transition

struct esp_ble_mesh_gen_level_state_t
Parameters of Generic Level state

Public Members**int16_t level**

The present value of the Generic Level state

int16_t target_level

The target value of the Generic Level state

int16_t last_level

When a new transaction starts, level should be set to last_last, and use “level + incoming delta” to calculate the target level. In another word, “last_level” is used to record “level” of the last transaction, and “last_delta” is used to record the previously received delta_level value. The last value of the Generic Level state

int32_t last_delta

The last delta change of the Generic Level state

bool move_start

Indicate if the transition of the Generic Level state has been started

bool positive

Indicate if the transition is positive or negative

struct esp_ble_mesh_gen_level_srv_t

User data of Generic Level Server Model

Public Members*esp_ble_mesh_model_t* ***model**

Pointer to the Generic Level Server Model. Initialized internally.

esp_ble_mesh_server_rsp_ctrl_t **rsp_ctrl**

Response control of the server model received messages

esp_ble_mesh_gen_level_state_t **state**

Parameters of the Generic Level state

esp_ble_mesh_last_msg_info_t **last**

Parameters of the last received set message

esp_ble_mesh_state_transition_t **transition**

Parameters of state transition

int32_t tt_delta_level

Delta change value of level state transition

struct esp_ble_mesh_gen_def_trans_time_state_t

Parameter of Generic Default Transition Time state

Public Members**uint8_t trans_time**

The value of the Generic Default Transition Time state

struct esp_ble_mesh_gen_def_trans_time_srv_t

User data of Generic Default Transition Time Server Model

Public Members*esp_ble_mesh_model_t* ***model**

Pointer to the Generic Default Transition Time Server Model. Initialized internally.

esp_ble_mesh_server_rsp_ctrl_t **rsp_ctrl**

Response control of the server model received messages

esp_ble_mesh_gen_def_trans_time_state_t **state**

Parameters of the Generic Default Transition Time state

struct esp_ble_mesh_gen_onpowerup_state_t

Parameter of Generic OnPowerUp state

Public Members

uint8_t **onpowerup**

The value of the Generic OnPowerUp state

struct esp_ble_mesh_gen_power_onoff_srv_t

User data of Generic Power OnOff Server Model

Public Members

esp_ble_mesh_model_t ***model**

Pointer to the Generic Power OnOff Server Model. Initialized internally.

esp_ble_mesh_server_rsp_ctrl_t **rsp_ctrl**

Response control of the server model received messages

esp_ble_mesh_gen_onpowerup_state_t ***state**

Parameters of the Generic OnPowerUp state

struct esp_ble_mesh_gen_power_onoff_setup_srv_t

User data of Generic Power OnOff Setup Server Model

Public Members

esp_ble_mesh_model_t ***model**

Pointer to the Generic Power OnOff Setup Server Model. Initialized internally.

esp_ble_mesh_server_rsp_ctrl_t **rsp_ctrl**

Response control of the server model received messages

esp_ble_mesh_gen_onpowerup_state_t ***state**

Parameters of the Generic OnPowerUp state

struct esp_ble_mesh_gen_power_level_state_t

Parameters of Generic Power Level state

Public Members

uint16_t **power_actual**

The present value of the Generic Power Actual state

uint16_t **target_power_actual**

The target value of the Generic Power Actual state

uint16_t **power_last**

The value of the Generic Power Last state

uint16_t **power_default**

The value of the Generic Power Default state

uint8_t **status_code**

The status code of setting Generic Power Range state

`uint16_t power_range_min`
The minimum value of the Generic Power Range state

`uint16_t power_range_max`
The maximum value of the Generic Power Range state

struct esp_ble_mesh_gen_power_level_srv_t
User data of Generic Power Level Server Model

Public Members

`esp_ble_mesh_model_t *model`
Pointer to the Generic Power Level Server Model. Initialized internally.

`esp_ble_mesh_server_rsp_ctrl_t rsp_ctrl`
Response control of the server model received messages

`esp_ble_mesh_gen_power_level_state_t *state`
Parameters of the Generic Power Level state

`esp_ble_mesh_last_msg_info_t last`
Parameters of the last received set message

`esp_ble_mesh_state_transition_t transition`
Parameters of state transition

`int32_t tt_delta_level`
Delta change value of level state transition

struct esp_ble_mesh_gen_power_level_setup_srv_t
User data of Generic Power Level Setup Server Model

Public Members

`esp_ble_mesh_model_t *model`
Pointer to the Generic Power Level Setup Server Model. Initialized internally.

`esp_ble_mesh_server_rsp_ctrl_t rsp_ctrl`
Response control of the server model received messages

`esp_ble_mesh_gen_power_level_state_t *state`
Parameters of the Generic Power Level state

struct esp_ble_mesh_gen_battery_state_t
Parameters of Generic Battery state

Public Members

`uint32_t battery_level : 8`
The value of the Generic Battery Level state

`uint32_t time_to_discharge : 24`
The value of the Generic Battery Time to Discharge state

`uint32_t time_to_charge : 24`
The value of the Generic Battery Time to Charge state

`uint32_t battery_flags : 8`
The value of the Generic Battery Flags state

struct esp_ble_mesh_gen_battery_srv_t
User data of Generic Battery Server Model

Public Members

esp_ble_mesh_model_t ***model**

Pointer to the Generic Battery Server Model. Initialized internally.

esp_ble_mesh_server_rsp_ctrl_t **rsp_ctrl**

Response control of the server model received messages

esp_ble_mesh_gen_battery_state_t **state**

Parameters of the Generic Battery state

struct esp_ble_mesh_gen_location_state_t

Parameters of Generic Location state

Public Members

int32_t **global_latitude**

The value of the Global Latitude field

int32_t **global_longitude**

The value of the Global Longitude field

int16_t **global_altitude**

The value of the Global Altitude field

int16_t **local_north**

The value of the Local North field

int16_t **local_east**

The value of the Local East field

int16_t **local_altitude**

The value of the Local Altitude field

uint8_t **floor_number**

The value of the Floor Number field

uint16_t **uncertainty**

The value of the Uncertainty field

struct esp_ble_mesh_gen_location_srv_t

User data of Generic Location Server Model

Public Members

esp_ble_mesh_model_t ***model**

Pointer to the Generic Location Server Model. Initialized internally.

esp_ble_mesh_server_rsp_ctrl_t **rsp_ctrl**

Response control of the server model received messages

esp_ble_mesh_gen_location_state_t ***state**

Parameters of the Generic Location state

struct esp_ble_mesh_gen_location_setup_srv_t

User data of Generic Location Setup Server Model

Public Members

esp_ble_mesh_model_t ***model**

Pointer to the Generic Location Setup Server Model. Initialized internally.

esp_ble_mesh_server_rsp_ctrl_t **rsp_ctrl**

Response control of the server model received messages

esp_ble_mesh_gen_location_state_t ***state**

Parameters of the Generic Location state

struct esp_ble_mesh_generic_property_t

Parameters of Generic Property states

Public Members

uint16_t **id**

The value of User/Admin/Manufacturer Property ID

uint8_t **user_access**

The value of User Access field

uint8_t **admin_access**

The value of Admin Access field

uint8_t **manu_access**

The value of Manufacturer Access field

struct net_buf_simple *val

The value of User/Admin/Manufacturer Property

struct esp_ble_mesh_gen_user_prop_srv_t

User data of Generic User Property Server Model

Public Members

esp_ble_mesh_model_t ***model**

Pointer to the Generic User Property Server Model. Initialized internally.

esp_ble_mesh_server_rsp_ctrl_t **rsp_ctrl**

Response control of the server model received messages

uint8_t **property_count**

Generic User Property count

esp_ble_mesh_generic_property_t ***properties**

Parameters of the Generic User Property state

struct esp_ble_mesh_gen_admin_prop_srv_t

User data of Generic Admin Property Server Model

Public Members

esp_ble_mesh_model_t ***model**

Pointer to the Generic Admin Property Server Model. Initialized internally.

esp_ble_mesh_server_rsp_ctrl_t **rsp_ctrl**

Response control of the server model received messages

uint8_t **property_count**

Generic Admin Property count

esp_ble_mesh_generic_property_t ***properties**

Parameters of the Generic Admin Property state

struct esp_ble_mesh_gen_manu_prop_srv_t

User data of Generic Manufacturer Property Server Model

Public Members

esp_ble_mesh_model_t ***model**

Pointer to the Generic Manufacturer Property Server Model. Initialized internally.

esp_ble_mesh_server_rsp_ctrl_t **rsp_ctrl**

Response control of the server model received messages

uint8_t **property_count**

Generic Manufacturer Property count

esp_ble_mesh_generic_property_t ***properties**

Parameters of the Generic Manufacturer Property state

struct esp_ble_mesh_gen_client_prop_srv_t

User data of Generic Client Property Server Model

Public Members

esp_ble_mesh_model_t ***model**

Pointer to the Generic Client Property Server Model. Initialized internally.

esp_ble_mesh_server_rsp_ctrl_t **rsp_ctrl**

Response control of the server model received messages

uint8_t **id_count**

Generic Client Property ID count

uint16_t ***property_ids**

Parameters of the Generic Client Property state

struct esp_ble_mesh_state_change_gen_onoff_set_t

Parameter of Generic OnOff Set state change event

Public Members

uint8_t **onoff**

The value of Generic OnOff state

struct esp_ble_mesh_state_change_gen_level_set_t

Parameter of Generic Level Set state change event

Public Members

int16_t **level**

The value of Generic Level state

struct esp_ble_mesh_state_change_gen_delta_set_t

Parameter of Generic Delta Set state change event

Public Members

int16_t **level**

The value of Generic Level state

struct esp_ble_mesh_state_change_gen_move_set_t

Parameter of Generic Move Set state change event

Public Members**int16_t level**

The value of Generic Level state

struct esp_ble_mesh_state_change_gen_def_trans_time_set_t

Parameter of Generic Default Transition Time Set state change event

Public Members**uint8_t trans_time**

The value of Generic Default Transition Time state

struct esp_ble_mesh_state_change_gen_onpowerup_set_t

Parameter of Generic OnPowerUp Set state change event

Public Members**uint8_t onpowerup**

The value of Generic OnPowerUp state

struct esp_ble_mesh_state_change_gen_power_level_set_t

Parameter of Generic Power Level Set state change event

Public Members**uint16_t power**

The value of Generic Power Actual state

struct esp_ble_mesh_state_change_gen_power_default_set_t

Parameter of Generic Power Default Set state change event

Public Members**uint16_t power**

The value of Generic Power Default state

struct esp_ble_mesh_state_change_gen_power_range_set_t

Parameters of Generic Power Range Set state change event

Public Members**uint16_t range_min**

The minimum value of Generic Power Range state

uint16_t range_max

The maximum value of Generic Power Range state

struct esp_ble_mesh_state_change_gen_loc_global_set_t

Parameters of Generic Location Global Set state change event

Public Members**int32_t latitude**

The Global Latitude value of Generic Location state

int32_t longitude
The Global Longitude value of Generic Location state

int16_t altitude
The Global Altitude value of Generic Location state

struct esp_ble_mesh_state_change_gen_loc_local_set_t
Parameters of Generic Location Local Set state change event

Public Members

int16_t north
The Local North value of Generic Location state

int16_t east
The Local East value of Generic Location state

int16_t altitude
The Local Altitude value of Generic Location state

uint8_t floor_number
The Floor Number value of Generic Location state

uint16_t uncertainty
The Uncertainty value of Generic Location state

struct esp_ble_mesh_state_change_gen_user_property_set_t
Parameters of Generic User Property Set state change event

Public Members

uint16_t id
The property id of Generic User Property state

struct net_buf_simple *value
The property value of Generic User Property state

struct esp_ble_mesh_state_change_gen_admin_property_set_t
Parameters of Generic Admin Property Set state change event

Public Members

uint16_t id
The property id of Generic Admin Property state

uint8_t access
The property access of Generic Admin Property state

struct net_buf_simple *value
The property value of Generic Admin Property state

struct esp_ble_mesh_state_change_gen_manu_property_set_t
Parameters of Generic Manufacturer Property Set state change event

Public Members

uint16_t id
The property id of Generic Manufacturer Property state

uint8_t access
The property value of Generic Manufacturer Property state

struct esp_ble_mesh_server_rcv_gen_user_property_get_t
Context of the received Generic User Property Get message

Public Members

uint16_t **property_id**
Property ID identifying a Generic User Property

struct esp_ble_mesh_server_rcv_gen_admin_property_get_t
Context of the received Generic Admin Property Get message

Public Members

uint16_t **property_id**
Property ID identifying a Generic Admin Property

struct esp_ble_mesh_server_rcv_gen_manufacturer_property_get_t
Context of the received Generic Manufacturer Property message

Public Members

uint16_t **property_id**
Property ID identifying a Generic Manufacturer Property

struct esp_ble_mesh_server_rcv_gen_client_properties_get_t
Context of the received Generic Client Properties Get message

Public Members

uint16_t **property_id**
A starting Client Property ID present within an element

struct esp_ble_mesh_server_rcv_gen_onoff_set_t
Context of the received Generic OnOff Set message

Public Members

bool **op_en**
Indicate if optional parameters are included

uint8_t **onoff**
Target value of Generic OnOff state

uint8_t **tid**
Transaction ID

uint8_t **trans_time**
Time to complete state transition (optional)

uint8_t **delay**
Indicate message execution delay (C.1)

struct esp_ble_mesh_server_rcv_gen_level_set_t
Context of the received Generic Level Set message

Public Members

bool **op_en**
Indicate if optional parameters are included

int16_t **level**
Target value of Generic Level state

uint8_t **tid**
Transaction ID

uint8_t **trans_time**
Time to complete state transition (optional)

uint8_t **delay**
Indicate message execution delay (C.1)

struct esp_ble_mesh_server_rcv_gen_delta_set_t
Context of the received Generic Delta Set message

Public Members

bool **op_en**
Indicate if optional parameters are included

int32_t **delta_level**
Delta change of Generic Level state

uint8_t **tid**
Transaction ID

uint8_t **trans_time**
Time to complete state transition (optional)

uint8_t **delay**
Indicate message execution delay (C.1)

struct esp_ble_mesh_server_rcv_gen_move_set_t
Context of the received Generic Move Set message

Public Members

bool **op_en**
Indicate if optional parameters are included

int16_t **delta_level**
Delta Level step to calculate Move speed for Generic Level state

uint8_t **tid**
Transaction ID

uint8_t **trans_time**
Time to complete state transition (optional)

uint8_t **delay**
Indicate message execution delay (C.1)

struct esp_ble_mesh_server_rcv_gen_def_trans_time_set_t
Context of the received Generic Default Transition Time Set message

Public Members**uint8_t trans_time**

The value of the Generic Default Transition Time state

struct esp_ble_mesh_server_rcv_gen_onpowerup_set_t

Context of the received Generic OnPowerUp Set message

Public Members**uint8_t onpowerup**

The value of the Generic OnPowerUp state

struct esp_ble_mesh_server_rcv_gen_power_level_set_t

Context of the received Generic Power Level Set message

Public Members**bool op_en**

Indicate if optional parameters are included

uint16_t power

Target value of Generic Power Actual state

uint8_t tid

Transaction ID

uint8_t trans_time

Time to complete state transition (optional)

uint8_t delay

Indicate message execution delay (C.1)

struct esp_ble_mesh_server_rcv_gen_power_default_set_t

Context of the received Generic Power Default Set message

Public Members**uint16_t power**

The value of the Generic Power Default state

struct esp_ble_mesh_server_rcv_gen_power_range_set_t

Context of the received Generic Power Range Set message

Public Members**uint16_t range_min**

Value of Range Min field of Generic Power Range state

uint16_t range_max

Value of Range Max field of Generic Power Range state

struct esp_ble_mesh_server_rcv_gen_loc_global_set_t

Context of the received Generic Location Global Set message

Public Members

`int32_t global_latitude`
Global Coordinates (Latitude)

`int32_t global_longitude`
Global Coordinates (Longitude)

`int16_t global_altitude`
Global Altitude

struct esp_ble_mesh_server_rcv_gen_loc_local_set_t
Context of the received Generic Location Local Set message

Public Members

`int16_t local_north`
Local Coordinates (North)

`int16_t local_east`
Local Coordinates (East)

`int16_t local_altitude`
Local Altitude

`uint8_t floor_number`
Floor Number

`uint16_t uncertainty`
Uncertainty

struct esp_ble_mesh_server_rcv_gen_user_property_set_t
Context of the received Generic User Property Set message

Public Members

`uint16_t property_id`
Property ID identifying a Generic User Property

struct net_buf_simple *property_value
Raw value for the User Property

struct esp_ble_mesh_server_rcv_gen_admin_property_set_t
Context of the received Generic Admin Property Set message

Public Members

`uint16_t property_id`
Property ID identifying a Generic Admin Property

`uint8_t user_access`
Enumeration indicating user access

struct net_buf_simple *property_value
Raw value for the Admin Property

struct esp_ble_mesh_server_rcv_gen_manufacturer_property_set_t
Context of the received Generic Manufacturer Property Set message

Public Members

`uint16_t property_id`
Property ID identifying a Generic Manufacturer Property

`uint8_t user_access`
Enumeration indicating user access

`struct esp_ble_mesh_generic_server_cb_param_t`
Generic Server Model callback parameters

Public Members

`esp_ble_mesh_model_t *model`
Pointer to Generic Server Models

`esp_ble_mesh_msg_ctx_t ctx`
Context of the received messages

`esp_ble_mesh_generic_server_cb_value_t value`
Value of the received Generic Messages

Macros

`ESP_BLE_MESH_MODEL_GEN_ONOFF_CLI` (`cli_pub`, `cli_data`)
Define a new Generic OnOff Client Model.

Note This API needs to be called for each element on which the application needs to have a Generic OnOff Client Model.

Return New Generic OnOff Client Model instance.

Parameters

- `cli_pub`: Pointer to the unique struct `esp_ble_mesh_model_pub_t`.
- `cli_data`: Pointer to the unique struct `esp_ble_mesh_client_t`.

`ESP_BLE_MESH_MODEL_GEN_LEVEL_CLI` (`cli_pub`, `cli_data`)
Define a new Generic Level Client Model.

Note This API needs to be called for each element on which the application needs to have a Generic Level Client Model.

Return New Generic Level Client Model instance.

Parameters

- `cli_pub`: Pointer to the unique struct `esp_ble_mesh_model_pub_t`.
- `cli_data`: Pointer to the unique struct `esp_ble_mesh_client_t`.

`ESP_BLE_MESH_MODEL_GEN_DEF_TRANS_TIME_CLI` (`cli_pub`, `cli_data`)
Define a new Generic Default Transition Time Client Model.

Note This API needs to be called for each element on which the application needs to have a Generic Default Transition Time Client Model.

Return New Generic Default Transition Time Client Model instance.

Parameters

- `cli_pub`: Pointer to the unique struct `esp_ble_mesh_model_pub_t`.
- `cli_data`: Pointer to the unique struct `esp_ble_mesh_client_t`.

`ESP_BLE_MESH_MODEL_GEN_POWER_ONOFF_CLI` (`cli_pub`, `cli_data`)
Define a new Generic Power OnOff Client Model.

Note This API needs to be called for each element on which the application needs to have a Generic Power OnOff Client Model.

Return New Generic Power OnOff Client Model instance.

Parameters

- `cli_pub`: Pointer to the unique struct `esp_ble_mesh_model_pub_t`.
- `cli_data`: Pointer to the unique struct `esp_ble_mesh_client_t`.

ESP_BLE_MESH_MODEL_GEN_POWER_LEVEL_CLI (cli_pub, cli_data)

Define a new Generic Power Level Client Model.

Note This API needs to be called for each element on which the application needs to have a Generic Power Level Client Model.

Return New Generic Power Level Client Model instance.

Parameters

- cli_pub: Pointer to the unique struct *esp_ble_mesh_model_pub_t*.
- cli_data: Pointer to the unique struct *esp_ble_mesh_client_t*.

ESP_BLE_MESH_MODEL_GEN_BATTERY_CLI (cli_pub, cli_data)

Define a new Generic Battery Client Model.

Note This API needs to be called for each element on which the application needs to have a Generic Battery Client Model.

Return New Generic Battery Client Model instance.

Parameters

- cli_pub: Pointer to the unique struct *esp_ble_mesh_model_pub_t*.
- cli_data: Pointer to the unique struct *esp_ble_mesh_client_t*.

ESP_BLE_MESH_MODEL_GEN_LOCATION_CLI (cli_pub, cli_data)

Define a new Generic Location Client Model.

Note This API needs to be called for each element on which the application needs to have a Generic Location Client Model.

Return New Generic Location Client Model instance.

Parameters

- cli_pub: Pointer to the unique struct *esp_ble_mesh_model_pub_t*.
- cli_data: Pointer to the unique struct *esp_ble_mesh_client_t*.

ESP_BLE_MESH_MODEL_GEN_PROPERTY_CLI (cli_pub, cli_data)

Define a new Generic Property Client Model.

Note This API needs to be called for each element on which the application needs to have a Generic Property Client Model.

Return New Generic Location Client Model instance.

Parameters

- cli_pub: Pointer to the unique struct *esp_ble_mesh_model_pub_t*.
- cli_data: Pointer to the unique struct *esp_ble_mesh_client_t*.

ESP_BLE_MESH_MODEL_GEN_ONOFF_SRV (srv_pub, srv_data)

Generic Server Models related context.

Define a new Generic OnOff Server Model.

Note 1. The Generic OnOff Server Model is a root model.

1. This model shall support model publication and model subscription.

Return New Generic OnOff Server Model instance.

Parameters

- srv_pub: Pointer to the unique struct *esp_ble_mesh_model_pub_t*.
- srv_data: Pointer to the unique struct *esp_ble_mesh_gen_onoff_srv_t*.

ESP_BLE_MESH_MODEL_GEN_LEVEL_SRV (srv_pub, srv_data)

Define a new Generic Level Server Model.

Note 1. The Generic Level Server Model is a root model.

1. This model shall support model publication and model subscription.

Return New Generic Level Server Model instance.

Parameters

- srv_pub: Pointer to the unique struct *esp_ble_mesh_model_pub_t*.
- srv_data: Pointer to the unique struct *esp_ble_mesh_gen_level_srv_t*.

ESP_BLE_MESH_MODEL_GEN_DEF_TRANS_TIME_SRV (srv_pub, srv_data)

Define a new Generic Default Transition Time Server Model.

Note 1. The Generic Default Transition Time Server Model is a root model.
1. This model shall support model publication and model subscription.

Return New Generic Default Transition Time Server Model instance.

Parameters

- `srv_pub`: Pointer to the unique struct *esp_ble_mesh_model_pub_t*.
- `srv_data`: Pointer to the unique struct *esp_ble_mesh_gen_def_trans_time_srv_t*.

ESP_BLE_MESH_MODEL_GEN_POWER_ONOFF_SRV (`srv_pub`, `srv_data`)

Define a new Generic Power OnOff Server Model.

Note 1. The Generic Power OnOff Server model extends the Generic OnOff Server model. When this model is present on an element, the corresponding Generic Power OnOff Setup Server model shall also be present.

1. This model may be used to represent a variety of devices that do not fit any of the model descriptions that have been defined but support the generic properties of On/Off.

2. This model shall support model publication and model subscription.

Return New Generic Power OnOff Server Model instance.

Parameters

- `srv_pub`: Pointer to the unique struct *esp_ble_mesh_model_pub_t*.
- `srv_data`: Pointer to the unique struct *esp_ble_mesh_gen_power_onoff_srv_t*.

ESP_BLE_MESH_MODEL_GEN_POWER_ONOFF_SETUP_SRV (`srv_pub`, `srv_data`)

Define a new Generic Power OnOff Setup Server Model.

Note 1. The Generic Power OnOff Setup Server model extends the Generic Power OnOff Server model and the Generic Default Transition Time Server model.

1. This model shall support model subscription.

Return New Generic Power OnOff Setup Server Model instance.

Parameters

- `srv_pub`: Pointer to the unique struct *esp_ble_mesh_model_pub_t*.
- `srv_data`: Pointer to the unique struct *esp_ble_mesh_gen_power_onoff_setup_srv_t*.

ESP_BLE_MESH_MODEL_GEN_POWER_LEVEL_SRV (`srv_pub`, `srv_data`)

Define a new Generic Power Level Server Model.

Note 1. The Generic Power Level Server model extends the Generic Power OnOff Server model and the Generic Level Server model. When this model is present on an Element, the corresponding Generic Power Level Setup Server model shall also be present.

1. This model shall support model publication and model subscription.

Return New Generic Power Level Server Model instance.

Parameters

- `srv_pub`: Pointer to the unique struct *esp_ble_mesh_model_pub_t*.
- `srv_data`: Pointer to the unique struct *esp_ble_mesh_gen_power_level_srv_t*.

ESP_BLE_MESH_MODEL_GEN_POWER_LEVEL_SETUP_SRV (`srv_pub`, `srv_data`)

Define a new Generic Power Level Setup Server Model.

Note 1. The Generic Power Level Setup Server model extends the Generic Power Level Server model and the Generic Power OnOff Setup Server model.

1. This model shall support model subscription.

Return New Generic Power Level Setup Server Model instance.

Parameters

- `srv_pub`: Pointer to the unique struct *esp_ble_mesh_model_pub_t*.
- `srv_data`: Pointer to the unique struct *esp_ble_mesh_gen_power_level_setup_srv_t*.

ESP_BLE_MESH_MODEL_GEN_BATTERY_SRV (`srv_pub`, `srv_data`)

Define a new Generic Battery Server Model.

Note 1. The Generic Battery Server Model is a root model.

1. This model shall support model publication and model subscription.

2. The model may be used to represent an element that is powered by a battery.

Return New Generic Battery Server Model instance.

Parameters

- `srv_pub`: Pointer to the unique struct `esp_ble_mesh_model_pub_t`.
- `srv_data`: Pointer to the unique struct `esp_ble_mesh_gen_battery_srv_t`.

ESP_BLE_MESH_MODEL_GEN_LOCATION_SRV (`srv_pub`, `srv_data`)

Define a new Generic Location Server Model.

Note 1. The Generic Location Server model is a root model. When this model is present on an Element, the corresponding Generic Location Setup Server model shall also be present.

1. This model shall support model publication and model subscription.
2. The model may be used to represent an element that knows its location (global or local).

Return New Generic Location Server Model instance.

Parameters

- `srv_pub`: Pointer to the unique struct `esp_ble_mesh_model_pub_t`.
- `srv_data`: Pointer to the unique struct `esp_ble_mesh_gen_location_srv_t`.

ESP_BLE_MESH_MODEL_GEN_LOCATION_SETUP_SRV (`srv_pub`, `srv_data`)

Define a new Generic Location Setup Server Model.

Note 1. The Generic Location Setup Server model extends the Generic Location Server model.

1. This model shall support model subscription.

Return New Generic Location Setup Server Model instance.

Parameters

- `srv_pub`: Pointer to the unique struct `esp_ble_mesh_model_pub_t`.
- `srv_data`: Pointer to the unique struct `esp_ble_mesh_gen_location_setup_srv_t`.

ESP_BLE_MESH_MODEL_GEN_USER_PROP_SRV (`srv_pub`, `srv_data`)

Define a new Generic User Property Server Model.

Note 1. The Generic User Property Server model is a root model.

1. This model shall support model publication and model subscription.

Return New Generic User Property Server Model instance.

Parameters

- `srv_pub`: Pointer to the unique struct `esp_ble_mesh_model_pub_t`.
- `srv_data`: Pointer to the unique struct `esp_ble_mesh_gen_user_prop_srv_t`.

ESP_BLE_MESH_MODEL_GEN_ADMIN_PROP_SRV (`srv_pub`, `srv_data`)

Define a new Generic Admin Property Server Model.

Note 1. The Generic Admin Property Server model extends the Generic User Property Server model.

1. This model shall support model publication and model subscription.

Return New Generic Admin Property Server Model instance.

Parameters

- `srv_pub`: Pointer to the unique struct `esp_ble_mesh_model_pub_t`.
- `srv_data`: Pointer to the unique struct `esp_ble_mesh_gen_admin_prop_srv_t`.

ESP_BLE_MESH_MODEL_GEN_MANUFACTURER_PROP_SRV (`srv_pub`, `srv_data`)

Define a new Generic Manufacturer Property Server Model.

Note 1. The Generic Manufacturer Property Server model extends the Generic User Property Server model.

1. This model shall support model publication and model subscription.

Return New Generic Manufacturer Property Server Model instance.

Parameters

- `srv_pub`: Pointer to the unique struct `esp_ble_mesh_model_pub_t`.
- `srv_data`: Pointer to the unique struct `esp_ble_mesh_gen_manu_prop_srv_t`.

ESP_BLE_MESH_MODEL_GEN_CLIENT_PROP_SRV (`srv_pub`, `srv_data`)

Define a new Generic User Property Server Model.

Note 1. The Generic Client Property Server model is a root model.

1. This model shall support model publication and model subscription.

Return New Generic Client Property Server Model instance.

Parameters

- `srv_pub`: Pointer to the unique struct `esp_ble_mesh_model_pub_t`.
- `srv_data`: Pointer to the unique struct `esp_ble_mesh_gen_client_prop_srv_t`.

Type Definitions

```
typedef void (*esp_ble_mesh_generic_client_cb_t) (esp_ble_mesh_generic_client_cb_event_t  
event,  
esp_ble_mesh_generic_client_cb_param_t  
*param)
```

Bluetooth Mesh Generic Client Model function.

Generic Client Model callback function type

Parameters

- event: Event type
- param: Pointer to callback parameter

```
typedef void (*esp_ble_mesh_generic_server_cb_t) (esp_ble_mesh_generic_server_cb_event_t  
event,  
esp_ble_mesh_generic_server_cb_param_t  
*param)
```

Bluetooth Mesh Generic Server Model function.

Generic Server Model callback function type

Parameters

- event: Event type
- param: Pointer to callback parameter

Enumerations

```
enum esp_ble_mesh_generic_client_cb_event_t  
This enum value is the event of Generic Client Model
```

Values:

```
ESP_BLE_MESH_GENERIC_CLIENT_GET_STATE_EVT
```

```
ESP_BLE_MESH_GENERIC_CLIENT_SET_STATE_EVT
```

```
ESP_BLE_MESH_GENERIC_CLIENT_PUBLISH_EVT
```

```
ESP_BLE_MESH_GENERIC_CLIENT_TIMEOUT_EVT
```

```
ESP_BLE_MESH_GENERIC_CLIENT_EVT_MAX
```

```
enum esp_ble_mesh_gen_user_prop_access_t  
This enum value is the access value of Generic User Property
```

Values:

```
ESP_BLE_MESH_GEN_USER_ACCESS_PROHIBIT
```

```
ESP_BLE_MESH_GEN_USER_ACCESS_READ
```

```
ESP_BLE_MESH_GEN_USER_ACCESS_WRITE
```

```
ESP_BLE_MESH_GEN_USER_ACCESS_READ_WRITE
```

```
enum esp_ble_mesh_gen_admin_prop_access_t  
This enum value is the access value of Generic Admin Property
```

Values:

```
ESP_BLE_MESH_GEN_ADMIN_NOT_USER_PROP
```

```
ESP_BLE_MESH_GEN_ADMIN_ACCESS_READ
```

```
ESP_BLE_MESH_GEN_ADMIN_ACCESS_WRITE
```

```
ESP_BLE_MESH_GEN_ADMIN_ACCESS_READ_WRITE
```

```
enum esp_ble_mesh_gen_manu_prop_access_t  
This enum value is the access value of Generic Manufacturer Property
```

Values:

ESP_BLE_MESH_GEN_MANU_NOT_USER_PROP

ESP_BLE_MESH_GEN_MANU_ACCESS_READ

enum esp_ble_mesh_generic_server_cb_event_t

This enum value is the event of Generic Server Model

Values:

ESP_BLE_MESH_GENERIC_SERVER_STATE_CHANGE_EVT

1. When `get_auto_rsp` is set to `ESP_BLE_MESH_SERVER_AUTO_RSP`, no event will be callback to the application layer when Generic Get messages are received.
2. When `set_auto_rsp` is set to `ESP_BLE_MESH_SERVER_AUTO_RSP`, this event will be callback to the application layer when Generic Set/Set Unack messages are received.

ESP_BLE_MESH_GENERIC_SERVER_RECV_GET_MSG_EVT

When `get_auto_rsp` is set to `ESP_BLE_MESH_SERVER_RSP_BY_APP`, this event will be callback to the application layer when Generic Get messages are received.

ESP_BLE_MESH_GENERIC_SERVER_RECV_SET_MSG_EVT

When `set_auto_rsp` is set to `ESP_BLE_MESH_SERVER_RSP_BY_APP`, this event will be callback to the application layer when Generic Set/Set Unack messages are received.

ESP_BLE_MESH_GENERIC_SERVER_EVT_MAX

Sensor Client/Server Models

Header File

- [bt/esp_ble_mesh/api/models/include/esp_ble_mesh_sensor_model_api.h](#)

Functions

esp_err_t **esp_ble_mesh_register_sensor_client_callback** (*esp_ble_mesh_sensor_client_cb_t* callback)

Register BLE Mesh Sensor Client Model callback.

Return ESP_OK on success or error code otherwise.

Parameters

- [in] `callback`: Pointer to the callback function.

esp_err_t **esp_ble_mesh_sensor_client_get_state** (*esp_ble_mesh_client_common_param_t* *params, *esp_ble_mesh_sensor_client_get_state_t* *get_state)

Get the value of Sensor Server Model states using the Sensor Client Model get messages.

Note If you want to know the opcodes and corresponding meanings accepted by this API, please refer to `esp_ble_mesh_sensor_message_opcode_t` in `esp_ble_mesh_defs.h`

Return ESP_OK on success or error code otherwise.

Parameters

- [in] `params`: Pointer to BLE Mesh common client parameters.
- [in] `get_state`: Pointer to sensor get message value. Shall not be set to NULL.

esp_err_t **esp_ble_mesh_sensor_client_set_state** (*esp_ble_mesh_client_common_param_t* *params, *esp_ble_mesh_sensor_client_set_state_t* *set_state)

Set the value of Sensor Server Model states using the Sensor Client Model set messages.

Note If you want to know the opcodes and corresponding meanings accepted by this API, please refer to `esp_ble_mesh_sensor_message_opcode_t` in `esp_ble_mesh_defs.h`

Return ESP_OK on success or error code otherwise.

Parameters

- [in] `params`: Pointer to BLE Mesh common client parameters.
- [in] `set_state`: Pointer to sensor set message value. Shall not be set to NULL.

esp_err_t **esp_ble_mesh_register_sensor_server_callback** (*esp_ble_mesh_sensor_server_cb_t* callback)

Register BLE Mesh Sensor Server Model callback.

Return ESP_OK on success or error code otherwise.

Parameters

- [in] callback: Pointer to the callback function.

Unions

union esp_ble_mesh_sensor_client_get_state_t
#include <esp_ble_mesh_sensor_model_api.h> Sensor Client Model get message union.

Public Members

esp_ble_mesh_sensor_descriptor_get_t **descriptor_get**
For ESP_BLE_MESH_MODEL_OP_SENSOR_DESCRIPTOR_GET

esp_ble_mesh_sensor_cadence_get_t **cadence_get**
For ESP_BLE_MESH_MODEL_OP_SENSOR_CADENCE_GET

esp_ble_mesh_sensor_settings_get_t **settings_get**
For ESP_BLE_MESH_MODEL_OP_SENSOR_SETTINGS_GET

esp_ble_mesh_sensor_setting_get_t **setting_get**
For ESP_BLE_MESH_MODEL_OP_SENSOR_SETTING_GET

esp_ble_mesh_sensor_get_t **sensor_get**
For ESP_BLE_MESH_MODEL_OP_SENSOR_GET

esp_ble_mesh_sensor_column_get_t **column_get**
For ESP_BLE_MESH_MODEL_OP_SENSOR_COLUMN_GET

esp_ble_mesh_sensor_series_get_t **series_get**
For ESP_BLE_MESH_MODEL_OP_SENSOR_SERIES_GET

union esp_ble_mesh_sensor_client_set_state_t
#include <esp_ble_mesh_sensor_model_api.h> Sensor Client Model set message union.

Public Members

esp_ble_mesh_sensor_cadence_set_t **cadence_set** &
For ESP_BLE_MESH_MODEL_OP_SENSOR_CADENCE_SET
ESP_BLE_MESH_MODEL_OP_SENSOR_CADENCE_SET_UNACK

esp_ble_mesh_sensor_setting_set_t **setting_set** &
For ESP_BLE_MESH_MODEL_OP_SENSOR_SETTING_SET
ESP_BLE_MESH_MODEL_OP_SENSOR_SETTING_SET_UNACK

union esp_ble_mesh_sensor_client_status_cb_t
#include <esp_ble_mesh_sensor_model_api.h> Sensor Client Model received message union.

Public Members

esp_ble_mesh_sensor_descriptor_status_cb_t **descriptor_status**
For ESP_BLE_MESH_MODEL_OP_SENSOR_DESCRIPTOR_STATUS

esp_ble_mesh_sensor_cadence_status_cb_t **cadence_status**
For ESP_BLE_MESH_MODEL_OP_SENSOR_CADENCE_STATUS

esp_ble_mesh_sensor_settings_status_cb_t **settings_status**
For ESP_BLE_MESH_MODEL_OP_SENSOR_SETTINGS_STATUS

esp_ble_mesh_sensor_setting_status_cb_t **setting_status**
For ESP_BLE_MESH_MODEL_OP_SENSOR_SETTING_STATUS

esp_ble_mesh_sensor_status_cb_t **sensor_status**
For ESP_BLE_MESH_MODEL_OP_SENSOR_STATUS

esp_ble_mesh_sensor_column_status_cb_t **column_status**
For ESP_BLE_MESH_MODEL_OP_SENSOR_COLUMN_STATUS

esp_ble_mesh_sensor_series_status_cb_t **series_status**
For ESP_BLE_MESH_MODEL_OP_SENSOR_SERIES_STATUS

union esp_ble_mesh_sensor_server_state_change_t
#include <esp_ble_mesh_sensor_model_api.h> Sensor Server Model state change value union.

Public Members

esp_ble_mesh_state_change_sensor_cadence_set_t **sensor_cadence_set**
The rcv_op in ctx can be used to decide which state is changed.Sensor Cadence Set

esp_ble_mesh_state_change_sensor_setting_set_t **sensor_setting_set**
Sensor Setting Set

union esp_ble_mesh_sensor_server_rcv_get_msg_t
#include <esp_ble_mesh_sensor_model_api.h> Sensor Server Model received get message union.

Public Members

esp_ble_mesh_server_rcv_sensor_descriptor_get_t **sensor_descriptor**
Sensor Descriptor Get

esp_ble_mesh_server_rcv_sensor_cadence_get_t **sensor_cadence**
Sensor Cadence Get

esp_ble_mesh_server_rcv_sensor_settings_get_t **sensor_settings**
Sensor Settings Get

esp_ble_mesh_server_rcv_sensor_setting_get_t **sensor_setting**
Sensor Setting Get

esp_ble_mesh_server_rcv_sensor_get_t **sensor_data**
Sensor Get

esp_ble_mesh_server_rcv_sensor_column_get_t **sensor_column**
Sensor Column Get

esp_ble_mesh_server_rcv_sensor_series_get_t **sensor_series**
Sensor Series Get

union esp_ble_mesh_sensor_server_rcv_set_msg_t
#include <esp_ble_mesh_sensor_model_api.h> Sensor Server Model received set message union.

Public Members

esp_ble_mesh_server_rcv_sensor_cadence_set_t **sensor_cadence**
Sensor Cadence Set

esp_ble_mesh_server_rcv_sensor_setting_set_t **sensor_setting**
Sensor Setting Set

union esp_ble_mesh_sensor_server_cb_value_t
#include <esp_ble_mesh_sensor_model_api.h> Sensor Server Model callback value union.

Public Members

esp_ble_mesh_sensor_server_state_change_t **state_change**
ESP_BLE_MESH_SENSOR_SERVER_STATE_CHANGE_EVT

esp_ble_mesh_sensor_server_rcv_get_msg_t **get**
ESP_BLE_MESH_SENSOR_SERVER_RECV_GET_MSG_EVT

esp_ble_mesh_sensor_server_rcv_set_msg_t **set**
ESP_BLE_MESH_SENSOR_SERVER_RECV_SET_MSG_EVT

Structures

struct esp_ble_mesh_sensor_descriptor_get_t
Bluetooth Mesh Sensor Client Model Get and Set parameters structure.
Parameters of Sensor Descriptor Get

Public Members

bool **op_en**
Indicate if optional parameters are included

uint16_t **property_id**
Property ID of a sensor (optional)

struct esp_ble_mesh_sensor_cadence_get_t
Parameter of Sensor Cadence Get

Public Members

uint16_t **property_id**
Property ID of a sensor

struct esp_ble_mesh_sensor_cadence_set_t
Parameters of Sensor Cadence Set

Public Members

uint16_t **property_id**
Property ID for the sensor

uint8_t **fast_cadence_period_divisor** : 7
Divisor for the publish period

uint8_t **status_trigger_type** : 1
The unit and format of the Status Trigger Delta fields

struct net_buf_simple *status_trigger_delta_down
Delta down value that triggers a status message

struct net_buf_simple *status_trigger_delta_up
Delta up value that triggers a status message

uint8_t **status_min_interval**
Minimum interval between two consecutive Status messages

struct net_buf_simple *fast_cadence_low
Low value for the fast cadence range

struct net_buf_simple *fast_cadence_high
Fast value for the fast cadence range

struct esp_ble_mesh_sensor_settings_get_t
Parameter of Sensor Settings Get

Public Members

uint16_t **sensor_property_id**
Property ID of a sensor

struct esp_ble_mesh_sensor_setting_get_t
Parameters of Sensor Setting Get

Public Members

uint16_t **sensor_property_id**
Property ID of a sensor

uint16_t **sensor_setting_property_id**
Setting ID identifying a setting within a sensor

struct esp_ble_mesh_sensor_setting_set_t
Parameters of Sensor Setting Set

Public Members

uint16_t **sensor_property_id**
Property ID identifying a sensor

uint16_t **sensor_setting_property_id**
Setting ID identifying a setting within a sensor

struct net_buf_simple *sensor_setting_raw
Raw value for the setting

struct esp_ble_mesh_sensor_get_t
Parameters of Sensor Get

Public Members

bool **op_en**
Indicate if optional parameters are included

uint16_t **property_id**
Property ID for the sensor (optional)

struct esp_ble_mesh_sensor_column_get_t
Parameters of Sensor Column Get

Public Members

uint16_t **property_id**
Property identifying a sensor

struct net_buf_simple *raw_value_x
Raw value identifying a column

struct esp_ble_mesh_sensor_series_get_t
Parameters of Sensor Series Get

Public Members

bool **op_en**
Indicate if optional parameters are included

uint16_t **property_id**
Property identifying a sensor

struct net_buf_simple ***raw_value_x1**
Raw value identifying a starting column (optional)

struct net_buf_simple ***raw_value_x2**
Raw value identifying an ending column (C.1)

struct **esp_ble_mesh_sensor_descriptor_status_cb_t**
Bluetooth Mesh Sensor Client Model Get and Set callback parameters structure.

Parameter of Sensor Descriptor Status

Public Members

struct net_buf_simple ***descriptor**
Sequence of 8-octet sensor descriptors (optional)

struct **esp_ble_mesh_sensor_cadence_status_cb_t**
Parameters of Sensor Cadence Status

Public Members

uint16_t **property_id**
Property for the sensor

struct net_buf_simple ***sensor_cadence_value**
Value of sensor cadence state

struct **esp_ble_mesh_sensor_settings_status_cb_t**
Parameters of Sensor Settings Status

Public Members

uint16_t **sensor_property_id**
Property ID identifying a sensor

struct net_buf_simple ***sensor_setting_property_ids**
A sequence of N sensor setting property IDs (optional)

struct **esp_ble_mesh_sensor_setting_status_cb_t**
Parameters of Sensor Setting Status

Public Members

bool **op_en**
Indicate id optional parameters are included

uint16_t **sensor_property_id**
Property ID identifying a sensor

uint16_t **sensor_setting_property_id**
Setting ID identifying a setting within a sensor

`uint8_t sensor_setting_access`
Read/Write access rights for the setting (optional)

`struct net_buf_simple *sensor_setting_raw`
Raw value for the setting

`struct esp_ble_mesh_sensor_status_cb_t`
Parameter of Sensor Status

Public Members

`struct net_buf_simple *marshalled_sensor_data`
Value of sensor data state (optional)

`struct esp_ble_mesh_sensor_column_status_cb_t`
Parameters of Sensor Column Status

Public Members

`uint16_t property_id`
Property identifying a sensor and the Y axis

`struct net_buf_simple *sensor_column_value`
Left values of sensor column status

`struct esp_ble_mesh_sensor_series_status_cb_t`
Parameters of Sensor Series Status

Public Members

`uint16_t property_id`
Property identifying a sensor and the Y axis

`struct net_buf_simple *sensor_series_value`
Left values of sensor series status

`struct esp_ble_mesh_sensor_client_cb_param_t`
Sensor Client Model callback parameters

Public Members

`int error_code`
0: success, otherwise failure. For the error code values please refer to `errno.h` file. A negative sign is added to the standard error codes in `errno.h`.

`esp_ble_mesh_client_common_param_t *params`
The client common parameters.

`esp_ble_mesh_sensor_client_status_cb_t status_cb`
The sensor status message callback values

`struct esp_ble_mesh_sensor_descriptor_t`
Parameters of Sensor Descriptor state

Public Members

`uint32_t positive_tolerance : 12`
The value of Sensor Positive Tolerance field

uint32_t negative_tolerance : 12
The value of Sensor Negative Tolerance field

uint32_t sampling_function : 8
The value of Sensor Sampling Function field

uint8_t measure_period
The value of Sensor Measurement Period field

uint8_t update_interval
The value of Sensor Update Interval field

struct esp_ble_mesh_sensor_setting_t
Parameters of Sensor Setting state

Public Members

uint16_t property_id
The value of Sensor Setting Property ID field

uint8_t access
The value of Sensor Setting Access field

struct net_buf_simple *raw
The value of Sensor Setting Raw field

struct esp_ble_mesh_sensor_cadence_t
Parameters of Sensor Cadence state

Public Members

uint8_t period_divisor : 7
The value of Fast Cadence Period Divisor field

uint8_t trigger_type : 1
The value of Status Trigger Type field

struct net_buf_simple *trigger_delta_down
Note: The parameter “size” in `trigger_delta_down`, `trigger_delta_up`, `fast_cadence_low` & `fast_cadence_high` indicates the exact length of these four parameters, and they are associated with the Sensor Property ID. Users need to initialize the “size” precisely. The value of Status Trigger Delta Down field

struct net_buf_simple *trigger_delta_up
The value of Status Trigger Delta Up field

uint8_t min_interval
The value of Status Min Interval field

struct net_buf_simple *fast_cadence_low
The value of Fast Cadence Low field

struct net_buf_simple *fast_cadence_high
The value of Fast Cadence High field

struct esp_ble_mesh_sensor_data_t
Parameters of Sensor Data state

Public Members

uint8_t format : 1
Format A: The Length field is a 1-based uint4 value (valid range 0x0–0xF, representing range of 1–16).

Format B: The Length field is a 1-based uint7 value (valid range 0x0–0x7F, representing range of 1 – 127). The value 0x7F represents a length of zero. The value of the Sensor Data format

uint8_t length : 7
The value of the Sensor Data length

struct net_buf_simple *raw_value
The value of Sensor Data raw value

struct esp_ble_mesh_sensor_series_column_t
Parameters of Sensor Series Column state

Public Members

struct net_buf_simple *raw_value_x
The value of Sensor Raw Value X field

struct net_buf_simple *column_width
The value of Sensor Column Width field

struct net_buf_simple *raw_value_y
The value of Sensor Raw Value Y field

struct esp_ble_mesh_sensor_state_t
Parameters of Sensor states

Public Members

uint16_t sensor_property_id
The value of Sensor Property ID field

esp_ble_mesh_sensor_descriptor_t descriptor
Parameters of the Sensor Descriptor state

const uint8_t setting_count
Multiple Sensor Setting states may be present for each sensor. The Sensor Setting Property ID values shall be unique for each Sensor Property ID that identifies a sensor within an element.

esp_ble_mesh_sensor_setting_t *settings
Parameters of the Sensor Setting state

esp_ble_mesh_sensor_cadence_t *cadence
The Sensor Cadence state may be not supported by sensors based on device properties referencing “non-scalar characteristics” such as “histograms” or “composite characteristics”. Parameters of the Sensor Cadence state

esp_ble_mesh_sensor_data_t sensor_data
Parameters of the Sensor Data state

esp_ble_mesh_sensor_series_column_t series_column
Parameters of the Sensor Series Column state

struct esp_ble_mesh_sensor_srv_t
User data of Sensor Server Model

Public Members

esp_ble_mesh_model_t *model
Pointer to the Sensor Server Model. Initialized internally.

esp_ble_mesh_server_rsp_ctrl_t rsp_ctrl
Response control of the server model received messages

const uint8_t state_count
Sensor state count

esp_ble_mesh_sensor_state_t *states
Parameters of the Sensor states

struct esp_ble_mesh_sensor_setup_srv_t
User data of Sensor Setup Server Model

Public Members

esp_ble_mesh_model_t *model
Pointer to the Sensor Setup Server Model. Initialized internally.

esp_ble_mesh_server_rsp_ctrl_t rsp_ctrl
Response control of the server model received messages

const uint8_t state_count
Sensor state count

esp_ble_mesh_sensor_state_t *states
Parameters of the Sensor states

struct esp_ble_mesh_state_change_sensor_cadence_set_t
Parameters of Sensor Cadence Set state change event

Public Members

uint16_t **property_id**
The value of Sensor Property ID state

uint8_t **period_divisor** : 7
The value of Fast Cadence Period Divisor state

uint8_t **trigger_type** : 1
The value of Status Trigger Type state

struct net_buf_simple ***trigger_delta_down**
The value of Status Trigger Delta Down state

struct net_buf_simple ***trigger_delta_up**
The value of Status Trigger Delta Up state

uint8_t **min_interval**
The value of Status Min Interval state

struct net_buf_simple ***fast_cadence_low**
The value of Fast Cadence Low state

struct net_buf_simple ***fast_cadence_high**
The value of Fast Cadence High state

struct esp_ble_mesh_state_change_sensor_setting_set_t
Parameters of Sensor Setting Set state change event

Public Members

uint16_t **property_id**
The value of Sensor Property ID state

uint16_t **setting_property_id**
The value of Sensor Setting Property ID state

struct net_buf_simple ***setting_value**

The value of Sensor Property Value state

struct esp_ble_mesh_server_rcv_sensor_descriptor_get_t

Context of the received Sensor Descriptor Get message

Public Members

bool **op_en**

Indicate if optional parameters are included

uint16_t **property_id**

Property ID of a sensor (optional)

struct esp_ble_mesh_server_rcv_sensor_cadence_get_t

Context of the received Sensor Cadence Get message

Public Members

uint16_t **property_id**

Property ID of a sensor

struct esp_ble_mesh_server_rcv_sensor_settings_get_t

Context of the received Sensor Settings Get message

Public Members

uint16_t **property_id**

Property ID of a sensor

struct esp_ble_mesh_server_rcv_sensor_setting_get_t

Context of the received Sensor Setting Get message

Public Members

uint16_t **property_id**

Property ID of a sensor

uint16_t **setting_property_id**

Setting ID identifying a setting within a sensor

struct esp_ble_mesh_server_rcv_sensor_get_t

Context of the received Sensor Get message

Public Members

bool **op_en**

Indicate if optional parameters are included

uint16_t **property_id**

Property ID for the sensor (optional)

struct esp_ble_mesh_server_rcv_sensor_column_get_t

Context of the received Sensor Column Get message

Public Members**uint16_t property_id**

Property identifying a sensor

struct net_buf_simple *raw_value_x

Raw value identifying a column

struct esp_ble_mesh_server_rcv_sensor_series_get_t

Context of the received Sensor Series Get message

Public Members**bool op_en**

Indicate if optional parameters are included

uint16_t property_id

Property identifying a sensor

struct net_buf_simple *raw_value

Raw value containing X1 and X2 (optional)

struct esp_ble_mesh_server_rcv_sensor_cadence_set_t

Context of the received Sensor Cadence Set message

Public Members**uint16_t property_id**

Property ID for the sensor

struct net_buf_simple *cadence

Value of Sensor Cadence state

struct esp_ble_mesh_server_rcv_sensor_setting_set_t

Context of the received Sensor Setting Set message

Public Members**uint16_t property_id**

Property ID identifying a sensor

uint16_t setting_property_id

Setting ID identifying a setting within a sensor

struct net_buf_simple *setting_raw

Raw value for the setting

struct esp_ble_mesh_sensor_server_cb_param_t

Sensor Server Model callback parameters

Public Members*esp_ble_mesh_model_t *model*

Pointer to Sensor Server Models

esp_ble_mesh_msg_ctx_t ctx

Context of the received messages

esp_ble_mesh_sensor_server_cb_value_t value

Value of the received Sensor Messages

Macros**ESP_BLE_MESH_MODEL_SENSOR_CLI** (cli_pub, cli_data)

Define a new Sensor Client Model.

Note This API needs to be called for each element on which the application needs to have a Sensor Client Model.**Return** New Sensor Client Model instance.**Parameters**

- cli_pub: Pointer to the unique struct *esp_ble_mesh_model_pub_t*.
- cli_data: Pointer to the unique struct *esp_ble_mesh_client_t*.

ESP_BLE_MESH_MODEL_SENSOR_SRV (srv_pub, srv_data)

Sensor Server Models related context.

Define a new Sensor Server Model.

Note 1. The Sensor Server model is a root model. When this model is present on an element, the corresponding Sensor Setup Server model shall also be present.

1. This model shall support model publication and model subscription.

Return New Sensor Server Model instance.**Parameters**

- srv_pub: Pointer to the unique struct *esp_ble_mesh_model_pub_t*.
- srv_data: Pointer to the unique struct *esp_ble_mesh_sensor_srv_t*.

ESP_BLE_MESH_MODEL_SENSOR_SETUP_SRV (srv_pub, srv_data)

Define a new Sensor Setup Server Model.

Note 1. The Sensor Setup Server model extends the Sensor Server model.

1. This model shall support model publication and model subscription.

Return New Sensor Setup Server Model instance.**Parameters**

- srv_pub: Pointer to the unique struct *esp_ble_mesh_model_pub_t*.
- srv_data: Pointer to the unique struct *esp_ble_mesh_sensor_setup_srv_t*.

ESP_BLE_MESH_INVALID_SENSOR_PROPERTY_ID

Invalid Sensor Property ID

ESP_BLE_MESH_SENSOR_PROPERTY_ID_LEN

Length of Sensor Property ID

ESP_BLE_MESH_SENSOR_DESCRIPTOR_LEN

Length of Sensor Descriptor state

ESP_BLE_MESH_SENSOR_UNSPECIFIED_POS_TOLERANCE

Unspecified Sensor Positive Tolerance

ESP_BLE_MESH_SENSOR_UNSPECIFIED_NEG_TOLERANCE

Unspecified Sensor Negative Tolerance

ESP_BLE_MESH_SENSOR_NOT_APPL_MEASURE_PERIOD

Not applicable Sensor Measurement Period

ESP_BLE_MESH_SENSOR_NOT_APPL_UPDATE_INTERVAL

Not applicable Sensor Update Interval

ESP_BLE_MESH_INVALID_SENSOR_SETTING_PROPERTY_ID

Invalid Sensor Setting Property ID

ESP_BLE_MESH_SENSOR_SETTING_PROPERTY_ID_LEN

Length of Sensor Setting Property ID

ESP_BLE_MESH_SENSOR_SETTING_ACCESS_LEN

Length of Sensor Setting Access

ESP_BLE_MESH_SENSOR_SETTING_ACCESS_READ

Sensor Setting Access - Read

ESP_BLE_MESH_SENSOR_SETTING_ACCESS_READ_WRITE

Sensor Setting Access - Read & Write

ESP_BLE_MESH_SENSOR_DIVISOR_TRIGGER_TYPE_LEN

Length of Sensor Divisor Trigger Type

ESP_BLE_MESH_SENSOR_STATUS_MIN_INTERVAL_LEN

Length of Sensor Status Min Interval

ESP_BLE_MESH_SENSOR_PERIOD_DIVISOR_MAX_VALUE

Maximum value of Sensor Period Divisor

ESP_BLE_MESH_SENSOR_STATUS_MIN_INTERVAL_MAX

Maximum value of Sensor Status Min Interval

ESP_BLE_MESH_SENSOR_STATUS_TRIGGER_TYPE_CHAR

Sensor Status Trigger Type - Format Type of the characteristic that the Sensor Property ID state references

ESP_BLE_MESH_SENSOR_STATUS_TRIGGER_TYPE_UINT16

Sensor Status Trigger Type - Format Type “uint16”

ESP_BLE_MESH_SENSOR_DATA_FORMAT_A

Sensor Data Format A

ESP_BLE_MESH_SENSOR_DATA_FORMAT_B

Sensor Data Format B

ESP_BLE_MESH_SENSOR_DATA_FORMAT_A_MP_ID_LEN

MPID length of Sensor Data Format A

ESP_BLE_MESH_SENSOR_DATA_FORMAT_B_MP_ID_LEN

MPID length of Sensor Data Format B

ESP_BLE_MESH_SENSOR_DATA_ZERO_LEN

Zero length of Sensor Data.

Note: The Length field is a 1-based uint7 value (valid range 0x0–0x7F, representing range of 1–127). The value 0x7F represents a length of zero.

ESP_BLE_MESH_GET_SENSOR_DATA_FORMAT (_data)

Get format of the sensor data.

Note Multiple sensor data may be concatenated. Make sure the _data pointer is updated before getting the format of the corresponding sensor data.

Return Format of the sensor data.

Parameters

- _data: Pointer to the start of the sensor data.

ESP_BLE_MESH_GET_SENSOR_DATA_LENGTH (_data, _fmt)

Get length of the sensor data.

Note Multiple sensor data may be concatenated. Make sure the _data pointer is updated before getting the length of the corresponding sensor data.

Return Length (zero-based) of the sensor data.

Parameters

- _data: Pointer to the start of the sensor data.
- _fmt: Format of the sensor data.

ESP_BLE_MESH_GET_SENSOR_DATA_PROPERTY_ID (_data, _fmt)

Get Sensor Property ID of the sensor data.

Note Multiple sensor data may be concatenated. Make sure the _data pointer is updated before getting Sensor Property ID of the corresponding sensor data.

Return Sensor Property ID of the sensor data.

Parameters

- _data: Pointer to the start of the sensor data.
- _fmt: Format of the sensor data.

ESP_BLE_MESH_SENSOR_DATA_FORMAT_A_MPID (*_len*, *_id*)

Generate a MPID value for sensor data with Format A.

Note 1. The Format field is 0b0 and indicates that Format A is used.

1. The Length field is a 1-based uint4 value (valid range 0x0–0xF, representing range of 1–16).
2. The Property ID is an 11-bit bit field representing 11 LSb of a Property ID.
3. This format may be used for Property Values that are not longer than 16 octets and for Property IDs less than 0x0800.

Return 2-octet MPID value for sensor data with Format A.

Parameters

- *_len*: Length of Sensor Raw value.
- *_id*: Sensor Property ID.

ESP_BLE_MESH_SENSOR_DATA_FORMAT_B_MPID (*_len*, *_id*)

Generate a MPID value for sensor data with Format B.

Note 1. The Format field is 0b1 and indicates Format B is used.

1. The Length field is a 1-based uint7 value (valid range 0x0–0x7F, representing range of 1–127). The value 0x7F represents a length of zero.
2. The Property ID is a 16-bit bit field representing a Property ID.
3. This format may be used for Property Values not longer than 128 octets and for any Property IDs. Property values longer than 128 octets are not supported by the Sensor Status message.
4. Exclude the generated 1-octet value, the 2-octet Sensor Property ID

Return 3-octet MPID value for sensor data with Format B.

Parameters

- *_len*: Length of Sensor Raw value.
- *_id*: Sensor Property ID.

Type Definitions

```
typedef void (*esp_ble_mesh_sensor_client_cb_t) (esp_ble_mesh_sensor_client_cb_event_t
                                                event, esp_ble_mesh_sensor_client_cb_param_t
                                                *param)
```

Bluetooth Mesh Sensor Client Model function.

Sensor Client Model callback function type

Parameters

- *event*: Event type
- *param*: Pointer to callback parameter

```
typedef void (*esp_ble_mesh_sensor_server_cb_t) (esp_ble_mesh_sensor_server_cb_event_t
                                                event, esp_ble_mesh_sensor_server_cb_param_t
                                                *param)
```

Bluetooth Mesh Sensor Server Model function.

Sensor Server Model callback function type

Parameters

- *event*: Event type
- *param*: Pointer to callback parameter

Enumerations

```
enum esp_ble_mesh_sensor_client_cb_event_t
```

This enum value is the event of Sensor Client Model

Values:

```
ESP_BLE_MESH_SENSOR_CLIENT_GET_STATE_EVT
```

```
ESP_BLE_MESH_SENSOR_CLIENT_SET_STATE_EVT
```

```
ESP_BLE_MESH_SENSOR_CLIENT_PUBLISH_EVT
```

```
ESP_BLE_MESH_SENSOR_CLIENT_TIMEOUT_EVT
```

ESP_BLE_MESH_SENSOR_CLIENT_EVT_MAX
enum esp_ble_mesh_sensor_sample_func
 This enum value is value of Sensor Sampling Function

Values:

ESP_BLE_MESH_SAMPLE_FUNC_UNSPECIFIED
ESP_BLE_MESH_SAMPLE_FUNC_INSTANTANEOUS
ESP_BLE_MESH_SAMPLE_FUNC_ARITHMETIC_MEAN
ESP_BLE_MESH_SAMPLE_FUNC_RMS
ESP_BLE_MESH_SAMPLE_FUNC_MAXIMUM
ESP_BLE_MESH_SAMPLE_FUNC_MINIMUM
ESP_BLE_MESH_SAMPLE_FUNC_ACCUMULATED
ESP_BLE_MESH_SAMPLE_FUNC_COUNT

enum esp_ble_mesh_sensor_server_cb_event_t
 This enum value is the event of Sensor Server Model

Values:

ESP_BLE_MESH_SENSOR_SERVER_STATE_CHANGE_EVT

1. When `get_auto_rsp` is set to `ESP_BLE_MESH_SERVER_AUTO_RSP`, no event will be callback to the application layer when Sensor Get messages are received.
2. When `set_auto_rsp` is set to `ESP_BLE_MESH_SERVER_AUTO_RSP`, this event will be callback to the application layer when Sensor Set/Set Unack messages are received.

ESP_BLE_MESH_SENSOR_SERVER_RECV_GET_MSG_EVT

When `get_auto_rsp` is set to `ESP_BLE_MESH_SERVER_RSP_BY_APP`, this event will be callback to the application layer when Sensor Get messages are received.

ESP_BLE_MESH_SENSOR_SERVER_RECV_SET_MSG_EVT

When `set_auto_rsp` is set to `ESP_BLE_MESH_SERVER_RSP_BY_APP`, this event will be callback to the application layer when Sensor Set/Set Unack messages are received.

ESP_BLE_MESH_SENSOR_SERVER_EVT_MAX

Time and Scenes Client/Server Models

Header File

- [bt/esp_ble_mesh/api/models/include/esp_ble_mesh_time_scene_model_api.h](#)

Functions

esp_err_t **esp_ble_mesh_register_time_scene_client_callback** (*esp_ble_mesh_time_scene_client_cb_t* callback)

Register BLE Mesh Time Scene Client Model callback.

Return ESP_OK on success or error code otherwise.

Parameters

- [in] `callback`: Pointer to the callback function.

esp_err_t **esp_ble_mesh_time_scene_client_get_state** (*esp_ble_mesh_client_common_param_t* *params, *esp_ble_mesh_time_scene_client_get_state_t* *get_state)

Get the value of Time Scene Server Model states using the Time Scene Client Model get messages.

Note If you want to know the opcodes and corresponding meanings accepted by this API, please refer to `esp_ble_mesh_time_scene_message_opcode_t` in `esp_ble_mesh_defs.h`

Return ESP_OK on success or error code otherwise.

Parameters

- [in] `params`: Pointer to BLE Mesh common client parameters.
- [in] `get_state`: Pointer to time scene get message value. Shall not be set to NULL.

```
esp_err_t esp_ble_mesh_time_scene_client_set_state(esp_ble_mesh_client_common_param_t
                                                *params,
                                                esp_ble_mesh_time_scene_client_set_state_t
                                                *set_state)
```

Set the value of Time Scene Server Model states using the Time Scene Client Model set messages.

Note If you want to know the opcodes and corresponding meanings accepted by this API, please refer to `esp_ble_mesh_time_scene_message_opcode_t` in `esp_ble_mesh_defs.h`

Return ESP_OK on success or error code otherwise.

Parameters

- [in] `params`: Pointer to BLE Mesh common client parameters.
- [in] `set_state`: Pointer to time scene set message value. Shall not be set to NULL.

```
esp_err_t esp_ble_mesh_register_time_scene_server_callback(esp_ble_mesh_time_scene_server_cb_t
                                                         callback)
```

Register BLE Mesh Time and Scenes Server Model callback.

Return ESP_OK on success or error code otherwise.

Parameters

- [in] `callback`: Pointer to the callback function.

Unions

```
union esp_ble_mesh_time_scene_client_get_state_t
#include <esp_ble_mesh_time_scene_model_api.h> Time Scene Client Model get message union.
```

Public Members

```
esp_ble_mesh_scheduler_act_get_t scheduler_act_get
For ESP_BLE_MESH_MODEL_OP_SCHEDULER_ACT_GET
union esp_ble_mesh_time_scene_client_set_state_t
#include <esp_ble_mesh_time_scene_model_api.h> Time Scene Client Model set message union.
```

Public Members

```
esp_ble_mesh_time_set_t time_set
For ESP_BLE_MESH_MODEL_OP_TIME_SET
esp_ble_mesh_time_zone_set_t time_zone_set
For ESP_BLE_MESH_MODEL_OP_TIME_ZONE_SET
esp_ble_mesh_tai_utc_delta_set_t tai_utc_delta_set
For ESP_BLE_MESH_MODEL_OP_TAI_UTC_DELTA_SET
esp_ble_mesh_time_role_set_t time_role_set
For ESP_BLE_MESH_MODEL_OP_TIME_ROLE_SET
esp_ble_mesh_scene_store_t scene_store
For ESP_BLE_MESH_MODEL_OP_SCENE_STORE & ESP_BLE_MESH_MODEL_OP_SCENE_STORE_UNACK
esp_ble_mesh_scene_recall_t scene_recall
For ESP_BLE_MESH_MODEL_OP_SCENE_RECALL & ESP_BLE_MESH_MODEL_OP_SCENE_RECALL_UNACK
esp_ble_mesh_scene_delete_t scene_delete
For ESP_BLE_MESH_MODEL_OP_SCENE_DELETE & ESP_BLE_MESH_MODEL_OP_SCENE_DELETE_UNACK
```

```
esp_ble_mesh_scheduler_act_set_t scheduler_act_set
    For ESP_BLE_MESH_MODEL_OP_SCHEDULER_ACT_SET &
    ESP_BLE_MESH_MODEL_OP_SCHEDULER_ACT_SET_UNACK
```

```
union esp_ble_mesh_time_scene_client_status_cb_t
    #include <esp_ble_mesh_time_scene_model_api.h> Time Scene Client Model received message union.
```

Public Members

```
esp_ble_mesh_time_status_cb_t time_status
    For ESP_BLE_MESH_MODEL_OP_TIME_STATUS

esp_ble_mesh_time_zone_status_cb_t time_zone_status
    For ESP_BLE_MESH_MODEL_OP_TIME_ZONE_STATUS

esp_ble_mesh_tai_utc_delta_status_cb_t tai_utc_delta_status
    For ESP_BLE_MESH_MODEL_OP_TAI_UTC_DELTA_STATUS

esp_ble_mesh_time_role_status_cb_t time_role_status
    For ESP_BLE_MESH_MODEL_OP_TIME_ROLE_STATUS

esp_ble_mesh_scene_status_cb_t scene_status
    For ESP_BLE_MESH_MODEL_OP_SCENE_STATUS

esp_ble_mesh_scene_register_status_cb_t scene_register_status
    For ESP_BLE_MESH_MODEL_OP_SCENE_REGISTER_STATUS

esp_ble_mesh_scheduler_status_cb_t scheduler_status
    For ESP_BLE_MESH_MODEL_OP_SCHEDULER_STATUS

esp_ble_mesh_scheduler_act_status_cb_t scheduler_act_status
    For ESP_BLE_MESH_MODEL_OP_SCHEDULER_ACT_STATUS
```

```
union esp_ble_mesh_time_scene_server_state_change_t
    #include <esp_ble_mesh_time_scene_model_api.h> Time Scene Server Model state change value union.
```

Public Members

```
esp_ble_mesh_state_change_time_set_t time_set
    The rcv_op in ctx can be used to decide which state is changed. Time Set

esp_ble_mesh_state_change_time_status_t time_status
    Time Status

esp_ble_mesh_state_change_time_zone_set_t time_zone_set
    Time Zone Set

esp_ble_mesh_state_change_tai_utc_delta_set_t tai_utc_delta_set
    TAI UTC Delta Set

esp_ble_mesh_state_change_time_role_set_t time_role_set
    Time Role Set

esp_ble_mesh_state_change_scene_store_t scene_store
    Scene Store

esp_ble_mesh_state_change_scene_recall_t scene_recall
    Scene Recall

esp_ble_mesh_state_change_scene_delete_t scene_delete
    Scene Delete

esp_ble_mesh_state_change_scheduler_act_set_t scheduler_act_set
    Scheduler Action Set
```

union esp_ble_mesh_time_scene_server_rcv_get_msg_t
#include <esp_ble_mesh_time_scene_model_api.h> Time Scene Server Model received get message union.

Public Members

esp_ble_mesh_server_rcv_scheduler_act_get_t **scheduler_act**
Scheduler Action Get

union esp_ble_mesh_time_scene_server_rcv_set_msg_t
#include <esp_ble_mesh_time_scene_model_api.h> Time Scene Server Model received set message union.

Public Members

esp_ble_mesh_server_rcv_time_set_t **time**
Time Set

esp_ble_mesh_server_rcv_time_zone_set_t **time_zone**
Time Zone Set

esp_ble_mesh_server_rcv_tai_utc_delta_set_t **tai_utc_delta**
TAI-UTC Delta Set

esp_ble_mesh_server_rcv_time_role_set_t **time_role**
Time Role Set

esp_ble_mesh_server_rcv_scene_store_t **scene_store**
Scene Store/Scene Store Unack

esp_ble_mesh_server_rcv_scene_recall_t **scene_recall**
Scene Recall/Scene Recall Unack

esp_ble_mesh_server_rcv_scene_delete_t **scene_delete**
Scene Delete/Scene Delete Unack

esp_ble_mesh_server_rcv_scheduler_act_set_t **scheduler_act**
Scheduler Action Set/Scheduler Action Set Unack

union esp_ble_mesh_time_scene_server_rcv_status_msg_t
#include <esp_ble_mesh_time_scene_model_api.h> Time Scene Server Model received status message union.

Public Members

esp_ble_mesh_server_rcv_time_status_t **time_status**
Time Status

union esp_ble_mesh_time_scene_server_cb_value_t
#include <esp_ble_mesh_time_scene_model_api.h> Time Scene Server Model callback value union.

Public Members

esp_ble_mesh_time_scene_server_state_change_t **state_change**
ESP_BLE_MESH_TIME_SCENE_SERVER_STATE_CHANGE_EVT

esp_ble_mesh_time_scene_server_rcv_get_msg_t **get**
ESP_BLE_MESH_TIME_SCENE_SERVER_RECV_GET_MSG_EVT

esp_ble_mesh_time_scene_server_rcv_set_msg_t **set**
ESP_BLE_MESH_TIME_SCENE_SERVER_RECV_SET_MSG_EVT

esp_ble_mesh_time_scene_server_rcv_status_msg_t **status**
ESP_BLE_MESH_TIME_SCENE_SERVER_RECV_STATUS_MSG_EVT

Structures

struct esp_ble_mesh_time_set_t

Bluetooth Mesh Time Scene Client Model Get and Set parameters structure.

Parameters of Time Set

Public Members

uint8_t **tai_seconds**[5]

The current TAI time in seconds

uint8_t **sub_second**

The sub-second time in units of 1/256 second

uint8_t **uncertainty**

The estimated uncertainty in 10-millisecond steps

uint16_t **time_authority** : 1

0 = No Time Authority, 1 = Time Authority

uint16_t **tai_utc_delta** : 15

Current difference between TAI and UTC in seconds

uint8_t **time_zone_offset**

The local time zone offset in 15-minute increments

struct esp_ble_mesh_time_zone_set_t

Parameters of Time Zone Set

Public Members

uint8_t **time_zone_offset_new**

Upcoming local time zone offset

uint8_t **tai_zone_change**[5]

TAI Seconds time of the upcoming Time Zone Offset change

struct esp_ble_mesh_tai_utc_delta_set_t

Parameters of TAI-UTC Delta Set

Public Members

uint16_t **tai_utc_delta_new** : 15

Upcoming difference between TAI and UTC in seconds

uint16_t **padding** : 1

Always 0b0. Other values are Prohibited.

uint8_t **tai_delta_change**[5]

TAI Seconds time of the upcoming TAI-UTC Delta change

struct esp_ble_mesh_time_role_set_t

Parameter of Time Role Set

Public Members

uint8_t **time_role**

The Time Role for the element

struct esp_ble_mesh_scene_store_t

Parameter of Scene Store

Public Members

`uint16_t scene_number`
The number of scenes to be stored

struct esp_ble_mesh_scene_recall_t
Parameters of Scene Recall

Public Members

`bool op_en`
Indicate if optional parameters are included

`uint16_t scene_number`
The number of scenes to be recalled

`uint8_t tid`
Transaction ID

`uint8_t trans_time`
Time to complete state transition (optional)

`uint8_t delay`
Indicate message execution delay (C.1)

struct esp_ble_mesh_scene_delete_t
Parameter of Scene Delete

Public Members

`uint16_t scene_number`
The number of scenes to be deleted

struct esp_ble_mesh_scheduler_act_get_t
Parameter of Scheduler Action Get

Public Members

`uint8_t index`
Index of the Schedule Register entry to get

struct esp_ble_mesh_scheduler_act_set_t
Parameters of Scheduler Action Set

Public Members

`uint64_t index : 4`
Index of the Schedule Register entry to set

`uint64_t year : 7`
Scheduled year for the action

`uint64_t month : 12`
Scheduled month for the action

`uint64_t day : 5`
Scheduled day of the month for the action

`uint64_t hour : 5`
Scheduled hour for the action

`uint64_t minute` : 6
Scheduled minute for the action

`uint64_t second` : 6
Scheduled second for the action

`uint64_t day_of_week` : 7
Schedule days of the week for the action

`uint64_t action` : 4
Action to be performed at the scheduled time

`uint64_t trans_time` : 8
Transition time for this action

`uint16_t scene_number`
Transition time for this action

struct esp_ble_mesh_time_status_cb_t
Bluetooth Mesh Time Scene Client Model Get and Set callback parameters structure.
Parameters of Time Status

Public Members

`uint8_t tai_seconds`[5]
The current TAI time in seconds

`uint8_t sub_second`
The sub-second time in units of 1/256 second

`uint8_t uncertainty`
The estimated uncertainty in 10-millisecond steps

`uint16_t time_authority` : 1
0 = No Time Authority, 1 = Time Authority

`uint16_t tai_utc_delta` : 15
Current difference between TAI and UTC in seconds

`uint8_t time_zone_offset`
The local time zone offset in 15-minute increments

struct esp_ble_mesh_time_zone_status_cb_t
Parameters of Time Zone Status

Public Members

`uint8_t time_zone_offset_curr`
Current local time zone offset

`uint8_t time_zone_offset_new`
Upcoming local time zone offset

`uint8_t tai_zone_change`[5]
TAI Seconds time of the upcoming Time Zone Offset change

struct esp_ble_mesh_tai_utc_delta_status_cb_t
Parameters of TAI-UTC Delta Status

Public Members

`uint16_t tai_utc_delta_curr` : 15
Current difference between TAI and UTC in seconds

`uint16_t padding_1 : 1`
Always 0b0. Other values are Prohibited.

`uint16_t tai_utc_delta_new : 15`
Upcoming difference between TAI and UTC in seconds

`uint16_t padding_2 : 1`
Always 0b0. Other values are Prohibited.

`uint8_t tai_delta_change[5]`
TAI Seconds time of the upcoming TAI-UTC Delta change

struct esp_ble_mesh_time_role_status_cb_t
Parameter of Time Role Status

Public Members

`uint8_t time_role`
The Time Role for the element

struct esp_ble_mesh_scene_status_cb_t
Parameters of Scene Status

Public Members

`bool op_en`
Indicate if optional parameters are included

`uint8_t status_code`
Status code of the last operation

`uint16_t current_scene`
Scene Number of the current scene

`uint16_t target_scene`
Scene Number of the target scene (optional)

`uint8_t remain_time`
Time to complete state transition (C.1)

struct esp_ble_mesh_scene_register_status_cb_t
Parameters of Scene Register Status

Public Members

`uint8_t status_code`
Status code for the previous operation

`uint16_t current_scene`
Scene Number of the current scene

struct net_buf_simple *scenes
A list of scenes stored within an element

struct esp_ble_mesh_scheduler_status_cb_t
Parameter of Scheduler Status

Public Members

`uint16_t schedules`
Bit field indicating defined Actions in the Schedule Register

struct esp_ble_mesh_scheduler_act_status_cb_t
Parameters of Scheduler Action Status

Public Members

uint64_t **index** : 4
Enumerates (selects) a Schedule Register entry

uint64_t **year** : 7
Scheduled year for the action

uint64_t **month** : 12
Scheduled month for the action

uint64_t **day** : 5
Scheduled day of the month for the action

uint64_t **hour** : 5
Scheduled hour for the action

uint64_t **minute** : 6
Scheduled minute for the action

uint64_t **second** : 6
Scheduled second for the action

uint64_t **day_of_week** : 7
Schedule days of the week for the action

uint64_t **action** : 4
Action to be performed at the scheduled time

uint64_t **trans_time** : 8
Transition time for this action

uint16_t **scene_number**
Transition time for this action

struct esp_ble_mesh_time_scene_client_cb_param_t
Time Scene Client Model callback parameters

Public Members

int **error_code**
Appropriate error code

esp_ble_mesh_client_common_param_t ***params**
The client common parameters.

esp_ble_mesh_time_scene_client_status_cb_t **status_cb**
The scene status message callback values

struct esp_ble_mesh_time_state_t
Parameters of Time state

Public Members

uint8_t **tai_seconds**[5]
The value of the TAI Seconds state

uint8_t **subsecond**
The value of the Subsecond field

uint8_t uncertainty
The value of the Uncertainty field

uint8_t time_zone_offset_curr
The value of the Time Zone Offset Current field

uint8_t time_zone_offset_new
The value of the Time Zone Offset New state

uint8_t tai_zone_change[5]
The value of the TAI of Zone Chaneg field

uint16_t time_authority : 1
The value of the Time Authority bit

uint16_t tai_utc_delta_curr : 15
The value of the TAI-UTC Delta Current state

uint16_t tai_utc_delta_new : 15
The value of the TAI-UTC Delta New state

uint8_t tai_delta_change[5]
The value of the TAI of Delta Change field

struct esp_ble_mesh_time_state_t::[anonymous] time
Parameters of the Time state

uint8_t time_role
The value of the Time Role state

struct esp_ble_mesh_time_srv_t
User data of Time Server Model

Public Members

esp_ble_mesh_model_t *model
Pointer to the Time Server Model. Initialized internally.

esp_ble_mesh_server_rsp_ctrl_t rsp_ctrl
Response control of the server model received messages

esp_ble_mesh_time_state_t *state
Parameters of the Time state

struct esp_ble_mesh_time_setup_srv_t
User data of Time Setup Server Model

Public Members

esp_ble_mesh_model_t *model
Pointer to the Time Setup Server Model. Initialized internally.

esp_ble_mesh_server_rsp_ctrl_t rsp_ctrl
Response control of the server model received messages

esp_ble_mesh_time_state_t *state
Parameters of the Time state

struct esp_ble_mesh_scene_register_t

1. Scene Store is an operation of storing values of a present state of an element.
2. The structure and meaning of the stored state is determined by a model. States to be stored are specified by each model.
3. The Scene Store operation shall persistently store all values of all states marked as Stored with Scene for all models present on all elements of a node.

4. If a model is extending another model, the extending model shall determine the Stored with Scene behavior of that model. Parameters of Scene Register state

Public Members

`uint16_t scene_number`

The value of the Scene Number

`uint8_t scene_type`

The value of the Scene Type

`struct net_buf_simple *scene_value`

Scene value may use a union to represent later, the union contains structures of all the model states which can be stored in a scene. The value of the Scene Value

`struct esp_ble_mesh_scenes_state_t`

Parameters of Scenes state.

Scenes serve as memory banks for storage of states (e.g., a power level or a light level/color). Values of states of an element can be stored as a scene and can be recalled later from the scene memory.

A scene is represented by a Scene Number, which is a 16-bit non-zero, mesh-wide value. (There can be a maximum of 65535 scenes in a mesh network.) The meaning of a scene, as well as the state storage container associated with it, are determined by a model.

The Scenes state change may start numerous parallel model transitions. In that case, each individual model handles the transition internally.

The scene transition is defined as a group of individual model transitions started by a Scene Recall operation. The scene transition is in progress when at least one transition from the group of individual model transitions is in progress.

Public Members

`const uint16_t scene_count`

The Scenes state's scene count

`esp_ble_mesh_scene_register_t *scenes`

Parameters of the Scenes state

`uint16_t current_scene`

The Current Scene state is a 16-bit value that contains either the Scene Number of the currently active scene or a value of 0x0000 when no scene is active.

When a Scene Store operation or a Scene Recall operation completes with success, the Current Scene state value shall be to the Scene Number used during that operation.

When the Current Scene Number is deleted from a Scene Register state as a result of Scene Delete operation, the Current Scene state shall be set to 0x0000.

When any of the element's state that is marked as "Stored with Scene" has changed not as a result of a Scene Recall operation, the value of the Current Scene state shall be set to 0x0000.

When a scene transition is in progress, the value of the Current Scene state shall be set to 0x0000. The value of the Current Scene state

`uint16_t target_scene`

The Target Scene state is a 16-bit value that contains the target Scene Number when a scene transition is in progress.

When the scene transition is in progress and the target Scene Number is deleted from a Scene Register state as a result of Scene Delete operation, the Target Scene state shall be set to 0x0000.

When the scene transition is in progress and a new Scene Number is stored in the Scene Register as a result of Scene Store operation, the Target Scene state shall be set to the new Scene Number.

When the scene transition is not in progress, the value of the Target Scene state shall be set to 0x0000. The value of the Target Scene state

`uint8_t status_code`

The status code of the last scene operation

`bool in_progress`

Indicate if the scene transition is in progress

`struct esp_ble_mesh_scene_srv_t`

User data of Scene Server Model

Public Members

`esp_ble_mesh_model_t *model`

Pointer to the Scene Server Model. Initialized internally.

`esp_ble_mesh_server_rsp_ctrl_t rsp_ctrl`

Response control of the server model received messages

`esp_ble_mesh_scenes_state_t *state`

Parameters of the Scenes state

`esp_ble_mesh_last_msg_info_t last`

Parameters of the last received set message

`esp_ble_mesh_state_transition_t transition`

Parameters of state transition

`struct esp_ble_mesh_scene_setup_srv_t`

User data of Scene Setup Server Model

Public Members

`esp_ble_mesh_model_t *model`

Pointer to the Scene Setup Server Model. Initialized internally.

`esp_ble_mesh_server_rsp_ctrl_t rsp_ctrl`

Response control of the server model received messages

`esp_ble_mesh_scenes_state_t *state`

Parameters of the Scenes state

`struct esp_ble_mesh_schedule_register_t`

Parameters of Scheduler Register state

Public Members

`bool in_use`

Indicate if the registered schedule is in use

`uint64_t year : 7`

The value of Scheduled year for the action

`uint64_t month : 12`

The value of Scheduled month for the action

`uint64_t day : 5`

The value of Scheduled day of the month for the action

`uint64_t hour : 5`

The value of Scheduled hour for the action

`uint64_t minute` : 6
The value of Scheduled minute for the action

`uint64_t second` : 6
The value of Scheduled second for the action

`uint64_t day_of_week` : 7
The value of Schedule days of the week for the action

`uint64_t action` : 4
The value of Action to be performed at the scheduled time

`uint64_t trans_time` : 8
The value of Transition time for this action

`uint16_t scene_number`
The value of Scene Number to be used for some actions

struct esp_ble_mesh_scheduler_state_t
Parameters of Scheduler state

Public Members

`const uint8_t schedule_count`
Scheduler count

`esp_ble_mesh_schedule_register_t *schedules`
Up to 16 scheduled entries

struct esp_ble_mesh_scheduler_srv_t
User data of Scheduler Server Model

Public Members

`esp_ble_mesh_model_t *model`
Pointer to the Scheduler Server Model. Initialized internally.

`esp_ble_mesh_server_rsp_ctrl_t rsp_ctrl`
Response control of the server model received messages

`esp_ble_mesh_scheduler_state_t *state`
Parameters of the Scheduler state

struct esp_ble_mesh_scheduler_setup_srv_t
User data of Scheduler Setup Server Model

Public Members

`esp_ble_mesh_model_t *model`
Pointer to the Scheduler Setup Server Model. Initialized internally.

`esp_ble_mesh_server_rsp_ctrl_t rsp_ctrl`
Response control of the server model received messages

`esp_ble_mesh_scheduler_state_t *state`
Parameters of the Scheduler state

struct esp_ble_mesh_state_change_time_set_t
Parameters of Time Set state change event

Public Members

`uint8_t tai_seconds[5]`
The current TAI time in seconds

`uint8_t subsecond`
The sub-second time in units of 1/256 second

`uint8_t uncertainty`
The estimated uncertainty in 10-millisecond steps

`uint16_t time_authority : 1`
0 = No Time Authority, 1 = Time Authority

`uint16_t tai_utc_delta_curr : 15`
Current difference between TAI and UTC in seconds

`uint8_t time_zone_offset_curr`
The local time zone offset in 15-minute increments

struct esp_ble_mesh_state_change_time_status_t
Parameters of Time Status state change event

Public Members

`uint8_t tai_seconds[5]`
The current TAI time in seconds

`uint8_t subsecond`
The sub-second time in units of 1/256 second

`uint8_t uncertainty`
The estimated uncertainty in 10-millisecond steps

`uint16_t time_authority : 1`
0 = No Time Authority, 1 = Time Authority

`uint16_t tai_utc_delta_curr : 15`
Current difference between TAI and UTC in seconds

`uint8_t time_zone_offset_curr`
The local time zone offset in 15-minute increments

struct esp_ble_mesh_state_change_time_zone_set_t
Parameters of Time Zone Set state change event

Public Members

`uint8_t time_zone_offset_new`
Upcoming local time zone offset

`uint8_t tai_zone_change[5]`
TAI Seconds time of the upcoming Time Zone Offset change

struct esp_ble_mesh_state_change_tai_utc_delta_set_t
Parameters of TAI UTC Delta Set state change event

Public Members

`uint16_t tai_utc_delta_new : 15`
Upcoming difference between TAI and UTC in seconds

`uint8_t tai_delta_change[5]`
TAI Seconds time of the upcoming TAI-UTC Delta change

`struct esp_ble_mesh_state_change_time_role_set_t`
Parameter of Time Role Set state change event

Public Members

`uint8_t time_role`
The Time Role for the element

`struct esp_ble_mesh_state_change_scene_store_t`
Parameter of Scene Store state change event

Public Members

`uint16_t scene_number`
The number of scenes to be stored

`struct esp_ble_mesh_state_change_scene_recall_t`
Parameter of Scene Recall state change event

Public Members

`uint16_t scene_number`
The number of scenes to be recalled

`struct esp_ble_mesh_state_change_scene_delete_t`
Parameter of Scene Delete state change event

Public Members

`uint16_t scene_number`
The number of scenes to be deleted

`struct esp_ble_mesh_state_change_scheduler_act_set_t`
Parameter of Scheduler Action Set state change event

Public Members

`uint64_t index : 4`
Index of the Schedule Register entry to set

`uint64_t year : 7`
Scheduled year for the action

`uint64_t month : 12`
Scheduled month for the action

`uint64_t day : 5`
Scheduled day of the month for the action

`uint64_t hour : 5`
Scheduled hour for the action

`uint64_t minute : 6`
Scheduled minute for the action

`uint64_t second : 6`
Scheduled second for the action

`uint64_t day_of_week` : 7
Schedule days of the week for the action

`uint64_t action` : 4
Action to be performed at the scheduled time

`uint64_t trans_time` : 8
Transition time for this action

`uint16_t scene_number`
Scene number to be used for some actions

struct esp_ble_mesh_server_rcv_scheduler_act_get_t
Context of the received Scheduler Action Get message

Public Members

`uint8_t index`
Index of the Schedule Register entry to get

struct esp_ble_mesh_server_rcv_time_set_t
Context of the received Time Set message

Public Members

`uint8_t tai_seconds`[5]
The current TAI time in seconds

`uint8_t subsecond`
The sub-second time in units of 1/256 second

`uint8_t uncertainty`
The estimated uncertainty in 10-millisecond steps

`uint16_t time_authority` : 1
0 = No Time Authority, 1 = Time Authority

`uint16_t tai_utc_delta` : 15
Current difference between TAI and UTC in seconds

`uint8_t time_zone_offset`
The local time zone offset in 15-minute increments

struct esp_ble_mesh_server_rcv_time_zone_set_t
Context of the received Time Zone Set message

Public Members

`uint8_t time_zone_offset_new`
Upcoming local time zone offset

`uint8_t tai_zone_change`[5]
TAI Seconds time of the upcoming Time Zone Offset change

struct esp_ble_mesh_server_rcv_tai_utc_delta_set_t
Context of the received TAI UTC Delta Set message

Public Members

`uint16_t tai_utc_delta_new` : 15
Upcoming difference between TAI and UTC in seconds

`uint16_t padding : 1`
Always 0b0. Other values are Prohibited.

`uint8_t tai_delta_change[5]`
TAI Seconds time of the upcoming TAI-UTC Delta change

struct esp_ble_mesh_server_rcv_time_role_set_t
Context of the received Time Role Set message

Public Members

`uint8_t time_role`
The Time Role for the element

struct esp_ble_mesh_server_rcv_scene_store_t
Context of the received Scene Store message

Public Members

`uint16_t scene_number`
The number of scenes to be stored

struct esp_ble_mesh_server_rcv_scene_recall_t
Context of the received Scene Recall message

Public Members

`bool op_en`
Indicate if optional parameters are included

`uint16_t scene_number`
The number of scenes to be recalled

`uint8_t tid`
Transaction ID

`uint8_t trans_time`
Time to complete state transition (optional)

`uint8_t delay`
Indicate message execution delay (C.1)

struct esp_ble_mesh_server_rcv_scene_delete_t
Context of the received Scene Delete message

Public Members

`uint16_t scene_number`
The number of scenes to be deleted

struct esp_ble_mesh_server_rcv_scheduler_act_set_t
Context of the received Scheduler Action Set message

Public Members

`uint64_t index : 4`
Index of the Schedule Register entry to set

`uint64_t year : 7`
Scheduled year for the action

`uint64_t month` : 12
Scheduled month for the action

`uint64_t day` : 5
Scheduled day of the month for the action

`uint64_t hour` : 5
Scheduled hour for the action

`uint64_t minute` : 6
Scheduled minute for the action

`uint64_t second` : 6
Scheduled second for the action

`uint64_t day_of_week` : 7
Schedule days of the week for the action

`uint64_t action` : 4
Action to be performed at the scheduled time

`uint64_t trans_time` : 8
Transition time for this action

`uint16_t scene_number`
Scene number to be used for some actions

struct esp_ble_mesh_server_rcv_time_status_t
Context of the received Time Status message

Public Members

`uint8_t tai_seconds`[5]
The current TAI time in seconds

`uint8_t subsecond`
The sub-second time in units of 1/256 second

`uint8_t uncertainty`
The estimated uncertainty in 10-millisecond steps

`uint16_t time_authority` : 1
0 = No Time Authority, 1 = Time Authority

`uint16_t tai_utc_delta` : 15
Current difference between TAI and UTC in seconds

`uint8_t time_zone_offset`
The local time zone offset in 15-minute increments

struct esp_ble_mesh_time_scene_server_cb_param_t
Time Scene Server Model callback parameters

Public Members

`esp_ble_mesh_model_t *model`
Pointer to Time and Scenes Server Models

`esp_ble_mesh_msg_ctx_t ctx`
Context of the received messages

`esp_ble_mesh_time_scene_server_cb_value_t value`
Value of the received Time and Scenes Messages

Macros**ESP_BLE_MESH_MODEL_TIME_CLI** (cli_pub, cli_data)

Define a new Time Client Model.

Note This API needs to be called for each element on which the application needs to have a Time Client Model.**Return** New Time Client Model instance.**Parameters**

- cli_pub: Pointer to the unique struct *esp_ble_mesh_model_pub_t*.
- cli_data: Pointer to the unique struct *esp_ble_mesh_client_t*.

ESP_BLE_MESH_MODEL_SCENE_CLI (cli_pub, cli_data)

Define a new Scene Client Model.

Note This API needs to be called for each element on which the application needs to have a Scene Client Model.**Return** New Scene Client Model instance.**Parameters**

- cli_pub: Pointer to the unique struct *esp_ble_mesh_model_pub_t*.
- cli_data: Pointer to the unique struct *esp_ble_mesh_client_t*.

ESP_BLE_MESH_MODEL_SCHEDULER_CLI (cli_pub, cli_data)

Define a new Scheduler Client Model.

Note This API needs to be called for each element on which the application needs to have a Scheduler Client Model.**Return** New Scheduler Client Model instance.**Parameters**

- cli_pub: Pointer to the unique struct *esp_ble_mesh_model_pub_t*.
- cli_data: Pointer to the unique struct *esp_ble_mesh_client_t*.

ESP_BLE_MESH_MODEL_TIME_SRV (srv_pub, srv_data)

Time Scene Server Models related context.

Define a new Time Server Model.

Note 1. The Time Server model is a root model. When this model is present on an Element, the corresponding Time Setup Server model shall also be present.

1. This model shall support model publication and model subscription.

Return New Time Server Model instance.**Parameters**

- srv_pub: Pointer to the unique struct *esp_ble_mesh_model_pub_t*.
- srv_data: Pointer to the unique struct *esp_ble_mesh_time_srv_t*.

ESP_BLE_MESH_MODEL_TIME_SETUP_SRV (srv_data)

Define a new Time Setup Server Model.

Note 1. The Time Setup Server model extends the Time Server model. Time is sensitive information that is propagated across a mesh network.

1. Only an authorized Time Client should be allowed to change the Time and Time Role states. A dedicated application key Bluetooth SIG Proprietary should be used on the Time Setup Server to restrict access to the server to only authorized Time Clients.
2. This model does not support subscribing nor publishing.

Return New Time Setup Server Model instance.**Parameters**

- srv_data: Pointer to the unique struct *esp_ble_mesh_time_setup_srv_t*.

ESP_BLE_MESH_MODEL_SCENE_SRV (srv_pub, srv_data)

Define a new Scene Server Model.

Note 1. The Scene Server model is a root model. When this model is present on an Element, the corresponding Scene Setup Server model shall also be present.

1. This model shall support model publication and model subscription.
2. The model may be present only on the Primary element of a node.

Return New Scene Server Model instance.

Parameters

- `srv_pub`: Pointer to the unique struct `esp_ble_mesh_model_pub_t`.
- `srv_data`: Pointer to the unique struct `esp_ble_mesh_scene_srv_t`.

ESP_BLE_MESH_MODEL_SCENE_SETUP_SRV (`srv_pub`, `srv_data`)

Define a new Scene Setup Server Model.

Note 1. The Scene Setup Server model extends the Scene Server model and the Generic Default Transition Time Server model.

1. This model shall support model subscription.
2. The model may be present only on the Primary element of a node.

Return New Scene Setup Server Model instance.

Parameters

- `srv_pub`: Pointer to the unique struct `esp_ble_mesh_model_pub_t`.
- `srv_data`: Pointer to the unique struct `esp_ble_mesh_scene_setup_srv_t`.

ESP_BLE_MESH_MODEL_SCHEDULER_SRV (`srv_pub`, `srv_data`)

Define a new Scheduler Server Model.

Note 1. The Scheduler Server model extends the Scene Server model. When this model is present on an Element, the corresponding Scheduler Setup Server model shall also be present.

1. This model shall support model publication and model subscription.
2. The model may be present only on the Primary element of a node.
3. The model requires the Time Server model shall be present on the element.

Return New Scheduler Server Model instance.

Parameters

- `srv_pub`: Pointer to the unique struct `esp_ble_mesh_model_pub_t`.
- `srv_data`: Pointer to the unique struct `esp_ble_mesh_scheduler_srv_t`.

ESP_BLE_MESH_MODEL_SCHEDULER_SETUP_SRV (`srv_pub`, `srv_data`)

Define a new Scheduler Setup Server Model.

Note 1. The Scheduler Setup Server model extends the Scheduler Server and the Scene Setup Server models.

1. This model shall support model subscription.
2. The model may be present only on the Primary element of a node.

Return New Scheduler Setup Server Model instance.

Parameters

- `srv_pub`: Pointer to the unique struct `esp_ble_mesh_model_pub_t`.
- `srv_data`: Pointer to the unique struct `esp_ble_mesh_scheduler_setup_srv_t`.

ESP_BLE_MESH_UNKNOWN_TAI_SECONDS

Unknown TAI Seconds

ESP_BLE_MESH_UNKNOWN_TAI_ZONE_CHANGE

Unknown TAI of Zone Change

ESP_BLE_MESH_UNKNOWN_TAI_DELTA_CHANGE

Unknown TAI of Delta Change

ESP_BLE_MESH_TAI_UTC_DELTA_MAX_VALUE

Maximum TAI-UTC Delta value

ESP_BLE_MESH_TAI_SECONDS_LEN

Length of TAI Seconds

ESP_BLE_MESH_TAI_OF_ZONE_CHANGE_LEN

Length of TAI of Zone Change

ESP_BLE_MESH_TAI_OF_DELTA_CHANGE_LEN

Length of TAI of Delta Change

ESP_BLE_MESH_INVALID_SCENE_NUMBER

Invalid Scene Number

ESP_BLE_MESH_SCENE_NUMBER_LEN

Length of the Scene Number

ESP_BLE_MESH_SCHEDULE_YEAR_ANY_YEAR

Any year of the Scheduled year

ESP_BLE_MESH_SCHEDULE_DAY_ANY_DAY

Any day of the Scheduled day

ESP_BLE_MESH_SCHEDULE_HOUR_ANY_HOUR

Any hour of the Scheduled hour

ESP_BLE_MESH_SCHEDULE_HOUR_ONCE_A_DAY

Any hour of the Scheduled Day

ESP_BLE_MESH_SCHEDULE_SEC_ANY_OF_HOUR

Any minute of the Scheduled hour

ESP_BLE_MESH_SCHEDULE_SEC_EVERY_15_MIN

Every 15 minutes of the Scheduled hour

ESP_BLE_MESH_SCHEDULE_SEC_EVERY_20_MIN

Every 20 minutes of the Scheduled hour

ESP_BLE_MESH_SCHEDULE_SEC_ONCE_AN_HOUR

Once of the Scheduled hour

ESP_BLE_MESH_SCHEDULE_SEC_ANY_OF_MIN

Any second of the Scheduled minute

ESP_BLE_MESH_SCHEDULE_SEC_EVERY_15_SEC

Every 15 seconds of the Scheduled minute

ESP_BLE_MESH_SCHEDULE_SEC_EVERY_20_SEC

Every 20 seconds of the Scheduled minute

ESP_BLE_MESH_SCHEDULE_SEC_ONCE_AN_MIN

Once of the Scheduled minute

ESP_BLE_MESH_SCHEDULE_ACT_TURN_OFF

Scheduled Action - Turn Off

ESP_BLE_MESH_SCHEDULE_ACT_TURN_ON

Scheduled Action - Turn On

ESP_BLE_MESH_SCHEDULE_ACT_SCENE_RECALL

Scheduled Action - Scene Recall

ESP_BLE_MESH_SCHEDULE_ACT_NO_ACTION

Scheduled Action - No Action

ESP_BLE_MESH_SCHEDULE_SCENE_NO_SCENE

Scheduled Scene - No Scene

ESP_BLE_MESH_SCHEDULE_ENTRY_MAX_INDEX

Maximum number of Scheduled entries

ESP_BLE_MESH_TIME_NONE

Time Role - None

ESP_BLE_MESH_TIME_AUTHORITY

Time Role - Mesh Time Authority

ESP_BLE_MESH_TIME_RELAY

Time Role - Mesh Time Relay

ESP_BLE_MESH_TIME_CLINET

Time Role - Mesh Time Client

ESP_BLE_MESH_SCENE_SUCCESS

Scene operation - Success

ESP_BLE_MESH_SCENE_REG_FULL
Scene operation - Scene Register Full

ESP_BLE_MESH_SCENE_NOT_FOUND
Scene operation - Scene Not Found

Type Definitions

```
typedef void (*esp_ble_mesh_time_scene_client_cb_t) (esp_ble_mesh_time_scene_client_cb_event_t  
event,  
esp_ble_mesh_time_scene_client_cb_param_t  
*param)
```

Bluetooth Mesh Time Scene Client Model function.

Time Scene Client Model callback function type

Parameters

- event: Event type
- param: Pointer to callback parameter

```
typedef void (*esp_ble_mesh_time_scene_server_cb_t) (esp_ble_mesh_time_scene_server_cb_event_t  
event,  
esp_ble_mesh_time_scene_server_cb_param_t  
*param)
```

Bluetooth Mesh Time and Scenes Server Model function.

Time Scene Server Model callback function type

Parameters

- event: Event type
- param: Pointer to callback parameter

Enumerations

```
enum esp_ble_mesh_time_scene_client_cb_event_t  
This enum value is the event of Time Scene Client Model
```

Values:

ESP_BLE_MESH_TIME_SCENE_CLIENT_GET_STATE_EVT

ESP_BLE_MESH_TIME_SCENE_CLIENT_SET_STATE_EVT

ESP_BLE_MESH_TIME_SCENE_CLIENT_PUBLISH_EVT

ESP_BLE_MESH_TIME_SCENE_CLIENT_TIMEOUT_EVT

ESP_BLE_MESH_TIME_SCENE_CLIENT_EVT_MAX

```
enum esp_ble_mesh_time_scene_server_cb_event_t  
This enum value is the event of Time Scene Server Model
```

Values:

ESP_BLE_MESH_TIME_SCENE_SERVER_STATE_CHANGE_EVT

1. When `get_auto_rsp` is set to `ESP_BLE_MESH_SERVER_AUTO_RSP`, no event will be callback to the application layer when Time Scene Get messages are received.
2. When `set_auto_rsp` is set to `ESP_BLE_MESH_SERVER_AUTO_RSP`, this event will be callback to the application layer when Time Scene Set/Set Unack messages are received.

ESP_BLE_MESH_TIME_SCENE_SERVER_RECV_GET_MSG_EVT

When `get_auto_rsp` is set to `ESP_BLE_MESH_SERVER_RSP_BY_APP`, this event will be callback to the application layer when Time Scene Get messages are received.

ESP_BLE_MESH_TIME_SCENE_SERVER_RECV_SET_MSG_EVT

When `set_auto_rsp` is set to `ESP_BLE_MESH_SERVER_RSP_BY_APP`, this event will be callback to the application layer when Time Scene Set/Set Unack messages are received.

ESP_BLE_MESH_TIME_SCENE_SERVER_RECV_STATUS_MSG_EVT

When `status_auto_rsp` is set to `ESP_BLE_MESH_SERVER_RSP_BY_APP`, this event will be callback to the application layer when Time Status message is received.

ESP_BLE_MESH_TIME_SCENE_SERVER_EVT_MAX**Lighting Client/Server Models****Header File**

- `bt/esp_ble_mesh/api/models/include/esp_ble_mesh_lighting_model_api.h`

Functions

`esp_err_t esp_ble_mesh_register_light_client_callback` (*esp_ble_mesh_light_client_cb_t callback*)

Register BLE Mesh Light Client Model callback.

Return `ESP_OK` on success or error code otherwise.

Parameters

- [in] `callback`: pointer to the callback function.

`esp_err_t esp_ble_mesh_light_client_get_state` (*esp_ble_mesh_client_common_param_t *params, esp_ble_mesh_light_client_get_state_t *get_state*)

Get the value of Light Server Model states using the Light Client Model get messages.

Note If you want to know the opcodes and corresponding meanings accepted by this API, please refer to `esp_ble_mesh_light_message_opcode_t` in `esp_ble_mesh_defs.h`

Return `ESP_OK` on success or error code otherwise.

Parameters

- [in] `params`: Pointer to BLE Mesh common client parameters.
- [in] `get_state`: Pointer of light get message value. Shall not be set to NULL.

`esp_err_t esp_ble_mesh_light_client_set_state` (*esp_ble_mesh_client_common_param_t *params, esp_ble_mesh_light_client_set_state_t *set_state*)

Set the value of Light Server Model states using the Light Client Model set messages.

Note If you want to know the opcodes and corresponding meanings accepted by this API, please refer to `esp_ble_mesh_light_message_opcode_t` in `esp_ble_mesh_defs.h`

Return `ESP_OK` on success or error code otherwise.

Parameters

- [in] `params`: Pointer to BLE Mesh common client parameters.
- [in] `set_state`: Pointer of light set message value. Shall not be set to NULL.

`esp_err_t esp_ble_mesh_register_lighting_server_callback` (*esp_ble_mesh_lighting_server_cb_t callback*)

Register BLE Mesh Lighting Server Model callback.

Return `ESP_OK` on success or error code otherwise.

Parameters

- [in] `callback`: Pointer to the callback function.

Unions

`union esp_ble_mesh_light_client_get_state_t`
`#include <esp_ble_mesh_lighting_model_api.h>` Lighting Client Model get message union.

Public Members

`esp_ble_mesh_light_lc_property_get_t lc_property_get`
 For `ESP_BLE_MESH_MODEL_OP_LIGHT_LC_PROPERTY_GET`

```
union esp_ble_mesh_light_client_set_state_t
#include <esp_ble_mesh_lighting_model_api.h> Lighting Client Model set message union.
```

Public Members

```
esp_ble_mesh_light_lightness_set_t lightness_set
For ESP_BLE_MESH_MODEL_OP_LIGHT_LIGHTNESS_SET &
ESP_BLE_MESH_MODEL_OP_LIGHT_LIGHTNESS_SET_UNACK

esp_ble_mesh_light_lightness_linear_set_t lightness_linear_set
For ESP_BLE_MESH_MODEL_OP_LIGHT_LIGHTNESS_LINEAR_SET &
ESP_BLE_MESH_MODEL_OP_LIGHT_LIGHTNESS_LINEAR_SET_UNACK

esp_ble_mesh_light_lightness_default_set_t lightness_default_set
For ESP_BLE_MESH_MODEL_OP_LIGHT_LIGHTNESS_DEFAULT_SET &
ESP_BLE_MESH_MODEL_OP_LIGHT_LIGHTNESS_DEFAULT_SET_UNACK

esp_ble_mesh_light_lightness_range_set_t lightness_range_set
For ESP_BLE_MESH_MODEL_OP_LIGHT_LIGHTNESS_RANGE_SET &
ESP_BLE_MESH_MODEL_OP_LIGHT_LIGHTNESS_RANGE_SET_UNACK

esp_ble_mesh_light_ctl_set_t ctl_set
For ESP_BLE_MESH_MODEL_OP_LIGHT_CTL_SET & ESP_BLE_MESH_MODEL_OP_LIGHT_CTL_SET_UNACK

esp_ble_mesh_light_ctl_temperature_set_t ctl_temperature_set
For ESP_BLE_MESH_MODEL_OP_LIGHT_CTL_TEMPERATURE_SET &
ESP_BLE_MESH_MODEL_OP_LIGHT_CTL_TEMPERATURE_SET_UNACK

esp_ble_mesh_light_ctl_temperature_range_set_t ctl_temperature_range_set
For ESP_BLE_MESH_MODEL_OP_LIGHT_CTL_TEMPERATURE_RANGE_SET &
ESP_BLE_MESH_MODEL_OP_LIGHT_CTL_TEMPERATURE_RANGE_SET_UNACK

esp_ble_mesh_light_ctl_default_set_t ctl_default_set
For ESP_BLE_MESH_MODEL_OP_LIGHT_CTL_DEFAULT_SET &
ESP_BLE_MESH_MODEL_OP_LIGHT_CTL_DEFAULT_SET_UNACK

esp_ble_mesh_light_hsl_set_t hsl_set
For ESP_BLE_MESH_MODEL_OP_LIGHT_HSL_SET & ESP_BLE_MESH_MODEL_OP_LIGHT_HSL_SET_UNACK

esp_ble_mesh_light_hsl_hue_set_t hsl_hue_set
For ESP_BLE_MESH_MODEL_OP_LIGHT_HSL_HUE_SET & ESP_BLE_MESH_MODEL_OP_LIGHT_HSL_HUE_SET_UNACK

esp_ble_mesh_light_hsl_saturation_set_t hsl_saturation_set
For ESP_BLE_MESH_MODEL_OP_LIGHT_HSL_SATURATION_SET &
ESP_BLE_MESH_MODEL_OP_LIGHT_HSL_SATURATION_SET_UNACK

esp_ble_mesh_light_hsl_default_set_t hsl_default_set
For ESP_BLE_MESH_MODEL_OP_LIGHT_HSL_DEFAULT_SET &
ESP_BLE_MESH_MODEL_OP_LIGHT_HSL_DEFAULT_SET_UNACK

esp_ble_mesh_light_hsl_range_set_t hsl_range_set
For ESP_BLE_MESH_MODEL_OP_LIGHT_HSL_RANGE_SET &
ESP_BLE_MESH_MODEL_OP_LIGHT_HSL_RANGE_SET_UNACK

esp_ble_mesh_light_xyl_set_t xyl_set
For ESP_BLE_MESH_MODEL_OP_LIGHT_XYL_SET & ESP_BLE_MESH_MODEL_OP_LIGHT_XYL_SET_UNACK

esp_ble_mesh_light_xyl_default_set_t xyl_default_set
For ESP_BLE_MESH_MODEL_OP_LIGHT_XYL_DEFAULT_SET &
ESP_BLE_MESH_MODEL_OP_LIGHT_XYL_DEFAULT_SET_UNACK

esp_ble_mesh_light_xyl_range_set_t xyl_range_set
For ESP_BLE_MESH_MODEL_OP_LIGHT_XYL_RANGE_SET &
ESP_BLE_MESH_MODEL_OP_LIGHT_XYL_RANGE_SET_UNACK
```

```

esp_ble_mesh_light_lc_mode_set_t lc_mode_set
    For ESP_BLE_MESH_MODEL_OP_LIGHT_LC_MODE_SET &
    ESP_BLE_MESH_MODEL_OP_LIGHT_LC_MODE_SET_UNACK

esp_ble_mesh_light_lc_om_set_t lc_om_set
    For ESP_BLE_MESH_MODEL_OP_LIGHT_LC_OM_SET & ESP_BLE_MESH_MODEL_OP_LIGHT_LC_OM_SET_UNACK

esp_ble_mesh_light_lc_light_onoff_set_t lc_light_onoff_set
    For ESP_BLE_MESH_MODEL_OP_LIGHT_LC_LIGHT_ONOFF_SET &
    ESP_BLE_MESH_MODEL_OP_LIGHT_LC_LIGHT_ONOFF_SET_UNACK

esp_ble_mesh_light_lc_property_set_t lc_property_set
    For ESP_BLE_MESH_MODEL_OP_LIGHT_LC_PROPERTY_SET &
    ESP_BLE_MESH_MODEL_OP_LIGHT_LC_PROPERTY_SET_UNACK

```

```

union esp_ble_mesh_light_client_status_cb_t
#include <esp_ble_mesh_lighting_model_api.h> Lighting Client Model received message union.

```

Public Members

```

esp_ble_mesh_light_lightness_status_cb_t lightness_status
    For ESP_BLE_MESH_MODEL_OP_LIGHT_LIGHTNESS_STATUS

esp_ble_mesh_light_lightness_linear_status_cb_t lightness_linear_status
    For ESP_BLE_MESH_MODEL_OP_LIGHT_LIGHTNESS_LINEAR_STATUS

esp_ble_mesh_light_lightness_last_status_cb_t lightness_last_status
    For ESP_BLE_MESH_MODEL_OP_LIGHT_LIGHTNESS_LAST_STATUS

esp_ble_mesh_light_lightness_default_status_cb_t lightness_default_status
    For ESP_BLE_MESH_MODEL_OP_LIGHT_LIGHTNESS_DEFAULT_STATUS

esp_ble_mesh_light_lightness_range_status_cb_t lightness_range_status
    For ESP_BLE_MESH_MODEL_OP_LIGHT_LIGHTNESS_RANGE_STATUS

esp_ble_mesh_light_ctl_status_cb_t ctl_status
    For ESP_BLE_MESH_MODEL_OP_LIGHT_CTL_STATUS

esp_ble_mesh_light_ctl_temperature_status_cb_t ctl_temperature_status
    For ESP_BLE_MESH_MODEL_OP_LIGHT_CTL_TEMPERATURE_STATUS

esp_ble_mesh_light_ctl_temperature_range_status_cb_t ctl_temperature_range_status
    For ESP_BLE_MESH_MODEL_OP_LIGHT_CTL_TEMPERATURE_RANGE_STATUS

esp_ble_mesh_light_ctl_default_status_cb_t ctl_default_status
    For ESP_BLE_MESH_MODEL_OP_LIGHT_CTL_DEFAULT_STATUS

esp_ble_mesh_light_hsl_status_cb_t hsl_status
    For ESP_BLE_MESH_MODEL_OP_LIGHT_HSL_STATUS

esp_ble_mesh_light_hsl_target_status_cb_t hsl_target_status
    For ESP_BLE_MESH_MODEL_OP_LIGHT_HSL_TARGET_STATUS

esp_ble_mesh_light_hsl_hue_status_cb_t hsl_hue_status
    For ESP_BLE_MESH_MODEL_OP_LIGHT_HSL_HUE_STATUS

esp_ble_mesh_light_hsl_saturation_status_cb_t hsl_saturation_status
    For ESP_BLE_MESH_MODEL_OP_LIGHT_HSL_SATURATION_STATUS

esp_ble_mesh_light_hsl_default_status_cb_t hsl_default_status
    For ESP_BLE_MESH_MODEL_OP_LIGHT_HSL_DEFAULT_STATUS

esp_ble_mesh_light_hsl_range_status_cb_t hsl_range_status
    For ESP_BLE_MESH_MODEL_OP_LIGHT_HSL_RANGE_STATUS

esp_ble_mesh_light_xyl_status_cb_t xyl_status
    For ESP_BLE_MESH_MODEL_OP_LIGHT_XYL_STATUS

```

esp_ble_mesh_light_xyl_target_status_cb_t **xyl_target_status**

For ESP_BLE_MESH_MODEL_OP_LIGHT_XYL_TARGET_STATUS

esp_ble_mesh_light_xyl_default_status_cb_t **xyl_default_status**

For ESP_BLE_MESH_MODEL_OP_LIGHT_XYL_DEFAULT_STATUS

esp_ble_mesh_light_xyl_range_status_cb_t **xyl_range_status**

For ESP_BLE_MESH_MODEL_OP_LIGHT_XYL_RANGE_STATUS

esp_ble_mesh_light_lc_mode_status_cb_t **lc_mode_status**

For ESP_BLE_MESH_MODEL_OP_LIGHT_LC_MODE_STATUS

esp_ble_mesh_light_lc_om_status_cb_t **lc_om_status**

For ESP_BLE_MESH_MODEL_OP_LIGHT_LC_OM_STATUS

esp_ble_mesh_light_lc_light_onoff_status_cb_t **lc_light_onoff_status**

For ESP_BLE_MESH_MODEL_OP_LIGHT_LC_LIGHT_ONOFF_STATUS

esp_ble_mesh_light_lc_property_status_cb_t **lc_property_status**

For ESP_BLE_MESH_MODEL_OP_LIGHT_LC_PROPERTY_STATUS

union esp_ble_mesh_lighting_server_state_change_t

#include <esp_ble_mesh_lighting_model_api.h> Lighting Server Model state change value union.

Public Members

esp_ble_mesh_state_change_light_lightness_set_t **lightness_set**

The recv_op in ctx can be used to decide which state is changed. Light Lightness Set

esp_ble_mesh_state_change_light_lightness_linear_set_t **lightness_linear_set**

Light Lightness Linear Set

esp_ble_mesh_state_change_light_lightness_default_set_t **lightness_default_set**

Light Lightness Default Set

esp_ble_mesh_state_change_light_lightness_range_set_t **lightness_range_set**

Light Lightness Range Set

esp_ble_mesh_state_change_light_ctl_set_t **ctl_set**

Light CTL Set

esp_ble_mesh_state_change_light_ctl_temperature_set_t **ctl_temp_set**

Light CTL Temperature Set

esp_ble_mesh_state_change_light_ctl_temperature_range_set_t **ctl_temp_range_set**

Light CTL Temperature Range Set

esp_ble_mesh_state_change_light_ctl_default_set_t **ctl_default_set**

Light CTL Default Set

esp_ble_mesh_state_change_light_hsl_set_t **hsl_set**

Light HSL Set

esp_ble_mesh_state_change_light_hsl_hue_set_t **hsl_hue_set**

Light HSL Hue Set

esp_ble_mesh_state_change_light_hsl_saturation_set_t **hsl_saturation_set**

Light HSL Saturation Set

esp_ble_mesh_state_change_light_hsl_default_set_t **hsl_default_set**

Light HSL Default Set

esp_ble_mesh_state_change_light_hsl_range_set_t **hsl_range_set**

Light HSL Range Set

esp_ble_mesh_state_change_light_xyl_set_t **xyl_set**

Light xyL Set

esp_ble_mesh_state_change_light_xyl_default_set_t **xyl_default_set**
Light xyL Default Set

esp_ble_mesh_state_change_light_xyl_range_set_t **xyl_range_set**
Light xyL Range Set

esp_ble_mesh_state_change_light_lc_mode_set_t **lc_mode_set**
Light LC Mode Set

esp_ble_mesh_state_change_light_lc_om_set_t **lc_om_set**
Light LC Occupancy Mode Set

esp_ble_mesh_state_change_light_lc_light_onoff_set_t **lc_light_onoff_set**
Light LC Light OnOff Set

esp_ble_mesh_state_change_light_lc_property_set_t **lc_property_set**
Light LC Property Set

esp_ble_mesh_state_change_sensor_status_t **sensor_status**
Sensor Status

union esp_ble_mesh_lighting_server_recv_get_msg_t
#include <esp_ble_mesh_lighting_model_api.h> Lighting Server Model received get message union.

Public Members

esp_ble_mesh_server_recv_light_lc_property_get_t **lc_property**
Light LC Property Get

union esp_ble_mesh_lighting_server_recv_set_msg_t
#include <esp_ble_mesh_lighting_model_api.h> Lighting Server Model received set message union.

Public Members

esp_ble_mesh_server_recv_light_lightness_set_t **lightness**
Light Lightness Set/Light Lightness Set Unack

esp_ble_mesh_server_recv_light_lightness_linear_set_t **lightness_linear**
Light Lightness Linear Set/Light Lightness Linear Set Unack

esp_ble_mesh_server_recv_light_lightness_default_set_t **lightness_default**
Light Lightness Default Set/Light Lightness Default Set Unack

esp_ble_mesh_server_recv_light_lightness_range_set_t **lightness_range**
Light Lightness Range Set/Light Lightness Range Set Unack

esp_ble_mesh_server_recv_light_ctl_set_t **ctl**
Light CTL Set/Light CTL Set Unack

esp_ble_mesh_server_recv_light_ctl_temperature_set_t **ctl_temp**
Light CTL Temperature Set/Light CTL Temperature Set Unack

esp_ble_mesh_server_recv_light_ctl_temperature_range_set_t **ctl_temp_range**
Light CTL Temperature Range Set/Light CTL Temperature Range Set Unack

esp_ble_mesh_server_recv_light_ctl_default_set_t **ctl_default**
Light CTL Default Set/Light CTL Default Set Unack

esp_ble_mesh_server_recv_light_hsl_set_t **hsl**
Light HSL Set/Light HSL Set Unack

esp_ble_mesh_server_recv_light_hsl_hue_set_t **hsl_hue**
Light HSL Hue Set/Light HSL Hue Set Unack

esp_ble_mesh_server_recv_light_hsl_saturation_set_t **hsl_saturation**
Light HSL Saturation Set/Light HSL Saturation Set Unack

esp_ble_mesh_server_rcv_light_hsl_default_set_t **hsl_default**
Light HSL Default Set/Light HSL Default Set Unack

esp_ble_mesh_server_rcv_light_hsl_range_set_t **hsl_range**
Light HSL Range Set/Light HSL Range Set Unack

esp_ble_mesh_server_rcv_light_xyl_set_t **xyl**
Light xyL Set/Light xyL Set Unack

esp_ble_mesh_server_rcv_light_xyl_default_set_t **xyl_default**
Light xyL Default Set/Light xyL Default Set Unack

esp_ble_mesh_server_rcv_light_xyl_range_set_t **xyl_range**
Light xyL Range Set/Light xyL Range Set Unack

esp_ble_mesh_server_rcv_light_lc_mode_set_t **lc_mode**
Light LC Mode Set/Light LC Mode Set Unack

esp_ble_mesh_server_rcv_light_lc_om_set_t **lc_om**
Light LC OM Set/Light LC OM Set Unack

esp_ble_mesh_server_rcv_light_lc_light_onoff_set_t **lc_light_onoff**
Light LC Light OnOff Set/Light LC Light OnOff Set Unack

esp_ble_mesh_server_rcv_light_lc_property_set_t **lc_property**
Light LC Property Set/Light LC Property Set Unack

union esp_ble_mesh_lighting_server_rcv_status_msg_t
#include <esp_ble_mesh_lighting_model_api.h> Lighting Server Model received status message union.

Public Members

esp_ble_mesh_server_rcv_sensor_status_t **sensor_status**
Sensor Status

union esp_ble_mesh_lighting_server_cb_value_t
#include <esp_ble_mesh_lighting_model_api.h> Lighting Server Model callback value union.

Public Members

esp_ble_mesh_lighting_server_state_change_t **state_change**
ESP_BLE_MESH_LIGHTING_SERVER_STATE_CHANGE_EVT

esp_ble_mesh_lighting_server_rcv_get_msg_t **get**
ESP_BLE_MESH_LIGHTING_SERVER_RECV_GET_MSG_EVT

esp_ble_mesh_lighting_server_rcv_set_msg_t **set**
ESP_BLE_MESH_LIGHTING_SERVER_RECV_SET_MSG_EVT

esp_ble_mesh_lighting_server_rcv_status_msg_t **status**
ESP_BLE_MESH_LIGHTING_SERVER_RECV_STATUS_MSG_EVT

Structures

struct esp_ble_mesh_light_lightness_set_t
Bluetooth Mesh Light Lightness Client Model Get and Set parameters structure.
Parameters of Light Lightness Set

Public Members

bool **op_en**
Indicate if optional parameters are included

uint16_t lightness
Target value of light lightness actual state

uint8_t tid
Transaction ID

uint8_t trans_time
Time to complete state transition (optional)

uint8_t delay
Indicate message execution delay (C.1)

struct esp_ble_mesh_light_lightness_linear_set_t
Parameters of Light Lightness Linear Set

Public Members

bool op_en
Indicate if optional parameters are included

uint16_t lightness
Target value of light lightness linear state

uint8_t tid
Transaction ID

uint8_t trans_time
Time to complete state transition (optional)

uint8_t delay
Indicate message execution delay (C.1)

struct esp_ble_mesh_light_lightness_default_set_t
Parameter of Light Lightness Default Set

Public Members

uint16_t lightness
The value of the Light Lightness Default state

struct esp_ble_mesh_light_lightness_range_set_t
Parameters of Light Lightness Range Set

Public Members

uint16_t range_min
Value of range min field of light lightness range state

uint16_t range_max
Value of range max field of light lightness range state

struct esp_ble_mesh_light_ctl_set_t
Parameters of Light CTL Set

Public Members

bool op_en
Indicate if optional parameters are included

uint16_t ctl_lightness
Target value of light ctl lightness state

uint16_t ctl_temperatru
Target value of light ctl temperature state

int16_t ctl_delta_uv
Target value of light ctl delta UV state

uint8_t tid
Transaction ID

uint8_t trans_time
Time to complete state transition (optional)

uint8_t delay
Indicate message execution delay (C.1)

struct esp_ble_mesh_light_ctl_temperature_set_t
Parameters of Light CTL Temperature Set

Public Members

bool op_en
Indicate if optional parameters are included

uint16_t ctl_temperatru
Target value of light ctl temperature state

int16_t ctl_delta_uv
Target value of light ctl delta UV state

uint8_t tid
Transaction ID

uint8_t trans_time
Time to complete state transition (optional)

uint8_t delay
Indicate message execution delay (C.1)

struct esp_ble_mesh_light_ctl_temperature_range_set_t
Parameters of Light CTL Temperature Range Set

Public Members

uint16_t range_min
Value of temperature range min field of light ctl temperature range state

uint16_t range_max
Value of temperature range max field of light ctl temperature range state

struct esp_ble_mesh_light_ctl_default_set_t
Parameters of Light CTL Default Set

Public Members

uint16_t lightness
Value of light lightness default state

uint16_t temperature
Value of light temperature default state

int16_t delta_uv
Value of light delta UV default state

struct esp_ble_mesh_light_hsl_set_t
Parameters of Light HSL Set

Public Members

bool op_en
Indicate if optional parameters are included

uint16_t hsl_lightness
Target value of light hsl lightness state

uint16_t hsl_hue
Target value of light hsl hue state

uint16_t hsl_saturation
Target value of light hsl saturation state

uint8_t tid
Transaction ID

uint8_t trans_time
Time to complete state transition (optional)

uint8_t delay
Indicate message execution delay (C.1)

struct esp_ble_mesh_light_hsl_hue_set_t
Parameters of Light HSL Hue Set

Public Members

bool op_en
Indicate if optional parameters are included

uint16_t hue
Target value of light hsl hue state

uint8_t tid
Transaction ID

uint8_t trans_time
Time to complete state transition (optional)

uint8_t delay
Indicate message execution delay (C.1)

struct esp_ble_mesh_light_hsl_saturation_set_t
Parameters of Light HSL Saturation Set

Public Members

bool op_en
Indicate if optional parameters are included

uint16_t saturation
Target value of light hsl hue state

uint8_t tid
Transaction ID

uint8_t trans_time
Time to complete state transition (optional)

uint8_t delay

Indicate message execution delay (C.1)

struct esp_ble_mesh_light_hsl_default_set_t

Parameters of Light HSL Default Set

Public Members

uint16_t lightness

Value of light lightness default state

uint16_t hue

Value of light hue default state

uint16_t saturation

Value of light saturation default state

struct esp_ble_mesh_light_hsl_range_set_t

Parameters of Light HSL Range Set

Public Members

uint16_t hue_range_min

Value of hue range min field of light hsl hue range state

uint16_t hue_range_max

Value of hue range max field of light hsl hue range state

uint16_t saturation_range_min

Value of saturation range min field of light hsl saturation range state

uint16_t saturation_range_max

Value of saturation range max field of light hsl saturation range state

struct esp_ble_mesh_light_xyl_set_t

Parameters of Light xyL Set

Public Members

bool op_en

Indicate whether optional parameters included

uint16_t xyl_lightness

The target value of the Light xyL Lightness state

uint16_t xyl_x

The target value of the Light xyL x state

uint16_t xyl_y

The target value of the Light xyL y state

uint8_t tid

Transaction Identifier

uint8_t trans_time

Time to complete state transition (optional)

uint8_t delay

Indicate message execution delay (C.1)

struct esp_ble_mesh_light_xyl_default_set_t

Parameters of Light xyL Default Set

Public Members**uint16_t lightness**

The value of the Light Lightness Default state

uint16_t xy1_x

The value of the Light xyL x Default state

uint16_t xy1_y

The value of the Light xyL y Default state

struct esp_ble_mesh_light_xy1_range_set_t

Parameters of Light xyL Range Set

Public Members**uint16_t xy1_x_range_min**

The value of the xyL x Range Min field of the Light xyL x Range state

uint16_t xy1_x_range_max

The value of the xyL x Range Max field of the Light xyL x Range state

uint16_t xy1_y_range_min

The value of the xyL y Range Min field of the Light xyL y Range state

uint16_t xy1_y_range_max

The value of the xyL y Range Max field of the Light xyL y Range state

struct esp_ble_mesh_light_lc_mode_set_t

Parameter of Light LC Mode Set

Public Members**uint8_t mode**

The target value of the Light LC Mode state

struct esp_ble_mesh_light_lc_om_set_t

Parameter of Light LC OM Set

Public Members**uint8_t mode**

The target value of the Light LC Occupancy Mode state

struct esp_ble_mesh_light_lc_light_onoff_set_t

Parameters of Light LC Light OnOff Set

Public Members**bool op_en**

Indicate whether optional parameters included

uint8_t light_onoff

The target value of the Light LC Light OnOff state

uint8_t tid

Transaction Identifier

uint8_t trans_time

Time to complete state transition (optional)

uint8_t delay

Indicate message execution delay (C.1)

struct esp_ble_mesh_light_lc_property_get_t

Parameter of Light LC Property Get

Public Members

uint16_t property_id

Property ID identifying a Light LC Property

struct esp_ble_mesh_light_lc_property_set_t

Parameters of Light LC Property Set

Public Members

uint16_t property_id

Property ID identifying a Light LC Property

struct net_buf_simple *property_value

Raw value for the Light LC Property

struct esp_ble_mesh_light_lightness_status_cb_t

Bluetooth Mesh Light Lightness Client Model Get and Set callback parameters structure.

Parameters of Light Lightness Status

Public Members

bool op_en

Indicate if optional parameters are included

uint16_t present_lightness

Current value of light lightness actual state

uint16_t target_lightness

Target value of light lightness actual state (optional)

uint8_t remain_time

Time to complete state transition (C.1)

struct esp_ble_mesh_light_lightness_linear_status_cb_t

Parameters of Light Lightness Linear Status

Public Members

bool op_en

Indicate if optional parameters are included

uint16_t present_lightness

Current value of light lightness linear state

uint16_t target_lightness

Target value of light lightness linear state (optional)

uint8_t remain_time

Time to complete state transition (C.1)

struct esp_ble_mesh_light_lightness_last_status_cb_t

Parameter of Light Lightness Last Status

Public Members

`uint16_t lightness`
The value of the Light Lightness Last state

`struct esp_ble_mesh_light_lightness_default_status_cb_t`
Parameter of Light Lightness Default Status

Public Members

`uint16_t lightness`
The value of the Light Lightness default State

`struct esp_ble_mesh_light_lightness_range_status_cb_t`
Parameters of Light Lightness Range Status

Public Members

`uint8_t status_code`
Status Code for the request message

`uint16_t range_min`
Value of range min field of light lightness range state

`uint16_t range_max`
Value of range max field of light lightness range state

`struct esp_ble_mesh_light_ctl_status_cb_t`
Parameters of Light CTL Status

Public Members

`bool op_en`
Indicate if optional parameters are included

`uint16_t present_ctl_lightness`
Current value of light ctl lightness state

`uint16_t present_ctl_temperature`
Current value of light ctl temperature state

`uint16_t target_ctl_lightness`
Target value of light ctl lightness state (optional)

`uint16_t target_ctl_temperature`
Target value of light ctl temperature state (C.1)

`uint8_t remain_time`
Time to complete state transition (C.1)

`struct esp_ble_mesh_light_ctl_temperature_status_cb_t`
Parameters of Light CTL Temperature Status

Public Members

`bool op_en`
Indicate if optional parameters are included

`uint16_t present_ctl_temperature`
Current value of light ctl temperature state

`uint16_t present_ctl_delta_uv`
Current value of light ctl delta UV state

`uint16_t target_ctl_temperature`
Target value of light ctl temperature state (optional)

`uint16_t target_ctl_delta_uv`
Target value of light ctl delta UV state (C.1)

`uint8_t remain_time`
Time to complete state transition (C.1)

struct esp_ble_mesh_light_ctl_temperature_range_status_cb_t
Parameters of Light CTL Temperature Range Status

Public Members

`uint8_t status_code`
Status code for the request message

`uint16_t range_min`
Value of temperature range min field of light ctl temperature range state

`uint16_t range_max`
Value of temperature range max field of light ctl temperature range state

struct esp_ble_mesh_light_ctl_default_status_cb_t
Parameters of Light CTL Default Status

Public Members

`uint16_t lightness`
Value of light lightness default state

`uint16_t temperature`
Value of light temperature default state

`int16_t delta_uv`
Value of light delta UV default state

struct esp_ble_mesh_light_hsl_status_cb_t
Parameters of Light HSL Status

Public Members

`bool op_en`
Indicate if optional parameters are included

`uint16_t hsl_lightness`
Current value of light hsl lightness state

`uint16_t hsl_hue`
Current value of light hsl hue state

`uint16_t hsl_saturation`
Current value of light hsl saturation state

`uint8_t remain_time`
Time to complete state transition (optional)

struct esp_ble_mesh_light_hsl_target_status_cb_t
Parameters of Light HSL Target Status

Public Members

bool **op_en**
Indicate if optional parameters are included

uint16_t **hsl_lightness_target**
Target value of light hsl lightness state

uint16_t **hsl_hue_target**
Target value of light hsl hue state

uint16_t **hsl_saturation_target**
Target value of light hsl saturation state

uint8_t **remain_time**
Time to complete state transition (optional)

struct esp_ble_mesh_light_hsl_hue_status_cb_t
Parameters of Light HSL Hue Status

Public Members

bool **op_en**
Indicate if optional parameters are included

uint16_t **present_hue**
Current value of light hsl hue state

uint16_t **target_hue**
Target value of light hsl hue state (optional)

uint8_t **remain_time**
Time to complete state transition (C.1)

struct esp_ble_mesh_light_hsl_saturation_status_cb_t
Parameters of Light HSL Saturation Status

Public Members

bool **op_en**
Indicate if optional parameters are included

uint16_t **present_saturation**
Current value of light hsl saturation state

uint16_t **target_saturation**
Target value of light hsl saturation state (optional)

uint8_t **remain_time**
Time to complete state transition (C.1)

struct esp_ble_mesh_light_hsl_default_status_cb_t
Parameters of Light HSL Default Status

Public Members

uint16_t **lightness**
Value of light lightness default state

uint16_t **hue**
Value of light hue default state

`uint16_t saturation`

Value of light saturation default state

`struct esp_ble_mesh_light_hsl_range_status_cb_t`

Parameters of Light HSL Range Status

Public Members

`uint8_t status_code`

Status code for the request message

`uint16_t hue_range_min`

Value of hue range min field of light hsl hue range state

`uint16_t hue_range_max`

Value of hue range max field of light hsl hue range state

`uint16_t saturation_range_min`

Value of saturation range min field of light hsl saturation range state

`uint16_t saturation_range_max`

Value of saturation range max field of light hsl saturation range state

`struct esp_ble_mesh_light_xyl_status_cb_t`

Parameters of Light xyL Status

Public Members

`bool op_en`

Indicate whether optional parameters included

`uint16_t xyl_lightness`

The present value of the Light xyL Lightness state

`uint16_t xyl_x`

The present value of the Light xyL x state

`uint16_t xyl_y`

The present value of the Light xyL y state

`uint8_t remain_time`

Time to complete state transition (optional)

`struct esp_ble_mesh_light_xyl_target_status_cb_t`

Parameters of Light xyL Target Status

Public Members

`bool op_en`

Indicate whether optional parameters included

`uint16_t target_xyl_lightness`

The target value of the Light xyL Lightness state

`uint16_t target_xyl_x`

The target value of the Light xyL x state

`uint16_t target_xyl_y`

The target value of the Light xyL y state

`uint8_t remain_time`

Time to complete state transition (optional)

struct esp_ble_mesh_light_xyl_default_status_cb_t
Parameters of Light xyL Default Status

Public Members

uint16_t **lightness**
The value of the Light Lightness Default state

uint16_t **xy1_x**
The value of the Light xyL x Default state

uint16_t **xy1_y**
The value of the Light xyL y Default state

struct esp_ble_mesh_light_xyl_range_status_cb_t
Parameters of Light xyL Range Status

Public Members

uint8_t **status_code**
Status Code for the requesting message

uint16_t **xy1_x_range_min**
The value of the xyL x Range Min field of the Light xyL x Range state

uint16_t **xy1_x_range_max**
The value of the xyL x Range Max field of the Light xyL x Range state

uint16_t **xy1_y_range_min**
The value of the xyL y Range Min field of the Light xyL y Range state

uint16_t **xy1_y_range_max**
The value of the xyL y Range Max field of the Light xyL y Range state

struct esp_ble_mesh_light_lc_mode_status_cb_t
Parameter of Light LC Mode Status

Public Members

uint8_t **mode**
The present value of the Light LC Mode state

struct esp_ble_mesh_light_lc_om_status_cb_t
Parameter of Light LC OM Status

Public Members

uint8_t **mode**
The present value of the Light LC Occupancy Mode state

struct esp_ble_mesh_light_lc_light_onoff_status_cb_t
Parameters of Light LC Light OnOff Status

Public Members

bool **op_en**
Indicate whether optional parameters included

uint8_t **present_light_onoff**
The present value of the Light LC Light OnOff state

uint8_t target_light_onoff
The target value of the Light LC Light OnOff state (Optional)

uint8_t remain_time
Time to complete state transition (C.1)

struct esp_ble_mesh_light_lc_property_status_cb_t
Parameters of Light LC Property Status

Public Members

uint16_t property_id
Property ID identifying a Light LC Property

struct net_buf_simple *property_value
Raw value for the Light LC Property

struct esp_ble_mesh_light_client_cb_param_t
Lighting Client Model callback parameters

Public Members

int error_code
Appropriate error code

esp_ble_mesh_client_common_param_t ***params**
The client common parameters.

esp_ble_mesh_light_client_status_cb_t **status_cb**
The light status message callback values

struct esp_ble_mesh_light_lightness_state_t
Parameters of Light Lightness state

Public Members

uint16_t lightness_linear
The present value of Light Lightness Linear state

uint16_t target_lightness_linear
The target value of Light Lightness Linear state

uint16_t lightness_actual
The present value of Light Lightness Actual state

uint16_t target_lightness_actual
The target value of Light Lightness Actual state

uint16_t lightness_last
The value of Light Lightness Last state

uint16_t lightness_default
The value of Light Lightness Default state

uint8_t status_code
The status code of setting Light Lightness Range state

uint16_t lightness_range_min
The minimum value of Light Lightness Range state

uint16_t lightness_range_max
The maximum value of Light Lightness Range state

struct esp_ble_mesh_light_lightness_srv_t
User data of Light Lightness Server Model

Public Members

esp_ble_mesh_model_t ***model**
Pointer to the Lighting Lightness Server Model. Initialized internally.

esp_ble_mesh_server_rsp_ctrl_t **rsp_ctrl**
Response control of the server model received messages

esp_ble_mesh_light_lightness_state_t ***state**
Parameters of the Light Lightness state

esp_ble_mesh_last_msg_info_t **last**
Parameters of the last received set message

esp_ble_mesh_state_transition_t **actual_transition**
Parameters of state transition

esp_ble_mesh_state_transition_t **linear_transition**
Parameters of state transition

int32_t **tt_delta_lightness_actual**
Delta change value of lightness actual state transition

int32_t **tt_delta_lightness_linear**
Delta change value of lightness linear state transition

struct esp_ble_mesh_light_lightness_setup_srv_t
User data of Light Lightness Setup Server Model

Public Members

esp_ble_mesh_model_t ***model**
Pointer to the Lighting Lightness Setup Server Model. Initialized internally.

esp_ble_mesh_server_rsp_ctrl_t **rsp_ctrl**
Response control of the server model received messages

esp_ble_mesh_light_lightness_state_t ***state**
Parameters of the Light Lightness state

struct esp_ble_mesh_light_ctl_state_t
Parameters of Light CTL state

Public Members

uint16_t **lightness**
The present value of Light CTL Lightness state

uint16_t **target_lightness**
The target value of Light CTL Lightness state

uint16_t **temperature**
The present value of Light CTL Temperature state

uint16_t **target_temperature**
The target value of Light CTL Temperature state

int16_t **delta_uv**
The present value of Light CTL Delta UV state

int16_t target_delta_uv
The target value of Light CTL Delta UV state

uint8_t status_code
The status code of setting Light CTL Temperature Range state

uint16_t temperature_range_min
The minimum value of Light CTL Temperature Range state

uint16_t temperature_range_max
The maximum value of Light CTL Temperature Range state

uint16_t lightness_default
The value of Light Lightness Default state

uint16_t temperature_default
The value of Light CTL Temperature Default state

int16_t delta_uv_default
The value of Light CTL Delta UV Default state

struct esp_ble_mesh_light_ctl_srv_t
User data of Light CTL Server Model

Public Members

esp_ble_mesh_model_t ***model**
Pointer to the Lighting CTL Server Model. Initialized internally.

esp_ble_mesh_server_rsp_ctrl_t **rsp_ctrl**
Response control of the server model received messages

esp_ble_mesh_light_ctl_state_t ***state**
Parameters of the Light CTL state

esp_ble_mesh_last_msg_info_t **last**
Parameters of the last received set message

esp_ble_mesh_state_transition_t **transition**
Parameters of state transition

int32_t tt_delta_lightness
Delta change value of lightness state transition

int32_t tt_delta_temperature
Delta change value of temperature state transition

int32_t tt_delta_delta_uv
Delta change value of delta uv state transition

struct esp_ble_mesh_light_ctl_setup_srv_t
User data of Light CTL Setup Server Model

Public Members

esp_ble_mesh_model_t ***model**
Pointer to the Lighting CTL Setup Server Model. Initialized internally.

esp_ble_mesh_server_rsp_ctrl_t **rsp_ctrl**
Response control of the server model received messages

esp_ble_mesh_light_ctl_state_t ***state**
Parameters of the Light CTL state

struct esp_ble_mesh_light_ctl_temp_srv_t
User data of Light CTL Temperature Server Model

Public Members

esp_ble_mesh_model_t ***model**

Pointer to the Lighting CTL Temperature Server Model. Initialized internally.

esp_ble_mesh_server_rsp_ctrl_t **rsp_ctrl**

Response control of the server model received messages

esp_ble_mesh_light_ctl_state_t ***state**

Parameters of the Light CTL state

esp_ble_mesh_last_msg_info_t **last**

Parameters of the last received set message

esp_ble_mesh_state_transition_t **transition**

Parameters of state transition

int32_t **tt_delta_temperature**

Delta change value of temperature state transition

int32_t **tt_delta_delta_uv**

Delta change value of delta uv state transition

struct esp_ble_mesh_light_hsl_state_t

Parameters of Light HSL state

Public Members

uint16_t **lightness**

The present value of Light HSL Lightness state

uint16_t **target_lightness**

The target value of Light HSL Lightness state

uint16_t **hue**

The present value of Light HSL Hue state

uint16_t **target_hue**

The target value of Light HSL Hue state

uint16_t **saturation**

The present value of Light HSL Saturation state

uint16_t **target_saturation**

The target value of Light HSL Saturation state

uint16_t **lightness_default**

The value of Light Lightness Default state

uint16_t **hue_default**

The value of Light HSL Hue Default state

uint16_t **saturation_default**

The value of Light HSL Saturation Default state

uint8_t **status_code**

The status code of setting Light HSL Hue & Saturation Range state

uint16_t **hue_range_min**

The minimum value of Light HSL Hue Range state

uint16_t **hue_range_max**

The maximum value of Light HSL Hue Range state

uint16_t **saturation_range_min**

The minimum value of Light HSL Saturation state

`uint16_t saturation_range_max`
The maximum value of Light HSL Saturation state

struct esp_ble_mesh_light_hsl_srv_t
User data of Light HSL Server Model

Public Members

`esp_ble_mesh_model_t *model`
Pointer to the Lighting HSL Server Model. Initialized internally.

`esp_ble_mesh_server_rsp_ctrl_t rsp_ctrl`
Response control of the server model received messages

`esp_ble_mesh_light_hsl_state_t *state`
Parameters of the Light HSL state

`esp_ble_mesh_last_msg_info_t last`
Parameters of the last received set message

`esp_ble_mesh_state_transition_t transition`
Parameters of state transition

`int32_t tt_delta_lightness`
Delta change value of lightness state transition

`int32_t tt_delta_hue`
Delta change value of hue state transition

`int32_t tt_delta_saturation`
Delta change value of saturation state transition

struct esp_ble_mesh_light_hsl_setup_srv_t
User data of Light HSL Setup Server Model

Public Members

`esp_ble_mesh_model_t *model`
Pointer to the Lighting HSL Setup Server Model. Initialized internally.

`esp_ble_mesh_server_rsp_ctrl_t rsp_ctrl`
Response control of the server model received messages

`esp_ble_mesh_light_hsl_state_t *state`
Parameters of the Light HSL state

struct esp_ble_mesh_light_hsl_hue_srv_t
User data of Light HSL Hue Server Model

Public Members

`esp_ble_mesh_model_t *model`
Pointer to the Lighting HSL Hue Server Model. Initialized internally.

`esp_ble_mesh_server_rsp_ctrl_t rsp_ctrl`
Response control of the server model received messages

`esp_ble_mesh_light_hsl_state_t *state`
Parameters of the Light HSL state

`esp_ble_mesh_last_msg_info_t last`
Parameters of the last received set message

esp_ble_mesh_state_transition_t **transition**

Parameters of state transition

int32_t **tt_delta_hue**

Delta change value of hue state transition

struct esp_ble_mesh_light_hsl_sat_srv_t

User data of Light HSL Saturation Server Model

Public Members

esp_ble_mesh_model_t ***model**

Pointer to the Lighting HSL Saturation Server Model. Initialized internally.

esp_ble_mesh_server_rsp_ctrl_t **rsp_ctrl**

Response control of the server model received messages

esp_ble_mesh_light_hsl_state_t ***state**

Parameters of the Light HSL state

esp_ble_mesh_last_msg_info_t **last**

Parameters of the last received set message

esp_ble_mesh_state_transition_t **transition**

Parameters of state transition

int32_t **tt_delta_saturation**

Delta change value of saturation state transition

struct esp_ble_mesh_light_xyl_state_t

Parameters of Light xyL state

Public Members

uint16_t **lightness**

The present value of Light xyL Lightness state

uint16_t **target_lightness**

The target value of Light xyL Lightness state

uint16_t **x**

The present value of Light xyL x state

uint16_t **target_x**

The target value of Light xyL x state

uint16_t **y**

The present value of Light xyL y state

uint16_t **target_y**

The target value of Light xyL y state

uint16_t **lightness_default**

The value of Light Lightness Default state

uint16_t **x_default**

The value of Light xyL x Default state

uint16_t **y_default**

The value of Light xyL y Default state

uint8_t **status_code**

The status code of setting Light xyL x & y Range state

uint16_t **x_range_min**

The minimum value of Light xyL x Range state

`uint16_t x_range_max`

The maximum value of Light xyL x Range state

`uint16_t y_range_min`

The minimum value of Light xyL y Range state

`uint16_t y_range_max`

The maximum value of Light xyL y Range state

struct esp_ble_mesh_light_xyl_srv_t

User data of Light xyL Server Model

Public Members

esp_ble_mesh_model_t ***model**

Pointer to the Lighting xyL Server Model. Initialized internally.

esp_ble_mesh_server_rsp_ctrl_t **rsp_ctrl**

Response control of the server model received messages

esp_ble_mesh_light_xyl_state_t ***state**

Parameters of the Light xyL state

esp_ble_mesh_last_msg_info_t **last**

Parameters of the last received set message

esp_ble_mesh_state_transition_t **transition**

Parameters of state transition

`int32_t tt_delta_lightness`

Delta change value of lightness state transition

`int32_t tt_delta_x`

Delta change value of x state transition

`int32_t tt_delta_y`

Delta change value of y state transition

struct esp_ble_mesh_light_xyl_setup_srv_t

User data of Light xyL Setup Server Model

Public Members

esp_ble_mesh_model_t ***model**

Pointer to the Lighting xyL Setup Server Model. Initialized internally.

esp_ble_mesh_server_rsp_ctrl_t **rsp_ctrl**

Response control of the server model received messages

esp_ble_mesh_light_xyl_state_t ***state**

Parameters of the Light xyL state

struct esp_ble_mesh_light_lc_state_t

Parameters of Light LC states

Public Members

`uint32_t mode` : 1

0b0 The controller is turned off.

- The binding with the Light Lightness state is disabled. 0b1 The controller is turned on.
- The binding with the Light Lightness state is enabled. The value of Light LC Mode state

`uint32_t occupancy_mode : 1`

The value of Light LC Occupancy Mode state

`uint32_t light_onoff : 1`

The present value of Light LC Light OnOff state

`uint32_t target_light_onoff : 1`

The target value of Light LC Light OnOff state

`uint32_t occupancy : 1`

The value of Light LC Occupancy state

`uint32_t ambient_luxlevel : 24`

The value of Light LC Ambient LuxLevel state

`uint16_t linear_output`

1. Light LC Linear Output = $\max((\text{Lightness Out})^2/65535, \text{Regulator Output})$
2. If the Light LC Mode state is set to 0b1, the binding is enabled and upon a change of the Light LC Linear Output state, the following operation shall be performed: Light Lightness Linear = Light LC Linear Output
3. If the Light LC Mode state is set to 0b0, the binding is disabled (i.e., upon a change of the Light LC Linear Output state, no operation on the Light Lightness Linear state is performed).The value of Light LC Linear Output state

struct esp_ble_mesh_light_lc_property_state_t

Parameters of Light Property states. The Light LC Property states are read / write states that determine the configuration of a Light Lightness Controller. Each state is represented by a device property and is controlled by Light LC Property messages.

Public Members

`uint32_t time_occupancy_delay`

A timing state that determines the delay for changing the Light LC Occupancy state upon receiving a Sensor Status message from an occupancy sensor.The value of Light LC Time Occupancy Delay state

`uint32_t time_fade_on`

A timing state that determines the time the controlled lights fade to the level determined by the Light LC Lightness On state.The value of Light LC Time Fade On state

`uint32_t time_run_on`

A timing state that determines the time the controlled lights stay at the level determined by the Light LC Lightness On state.The value of Light LC Time Run On state

`uint32_t time_fade`

A timing state that determines the time the controlled lights fade from the level determined by the Light LC Lightness On state to the level determined by the Light Lightness Prolong state.The value of Light LC Time Fade state

`uint32_t time_prolong`

A timing state that determines the time the controlled lights stay at the level determined by the Light LC Lightness Prolong state.The value of Light LC Time Prolong state

`uint32_t time_fade_standby_auto`

A timing state that determines the time the controlled lights fade from the level determined by the Light LC Lightness Prolong state to the level determined by the Light LC Lightness Standby state when the transition is automatic.The value of Light LC Time Fade Standby Auto state

`uint32_t time_fade_standby_manual`

A timing state that determines the time the controlled lights fade from the level determined by the Light LC Lightness Prolong state to the level determined by the Light LC Lightness Standby state when the transition is triggered by a change in the Light LC Light OnOff state.The value of Light LC Time Fade Standby Manual state

uint16_t lightness_on

A lightness state that determines the perceptive light lightness at the Occupancy and Run internal controller states. The value of Light LC Lightness On state

uint16_t lightness_prolong

A lightness state that determines the light lightness at the Prolong internal controller state. The value of Light LC Lightness Prolong state

uint16_t lightness_standby

A lightness state that determines the light lightness at the Standby internal controller state. The value of Light LC Lightness Standby state

uint16_t ambient_luxlevel_on

A uint16 state representing the Ambient LuxLevel level that determines if the controller transitions from the Light Control Standby state. The value of Light LC Ambient LuxLevel On state

uint16_t ambient_luxlevel_prolong

A uint16 state representing the required Ambient LuxLevel level in the Prolong state. The value of Light LC Ambient LuxLevel Prolong state

uint16_t ambient_luxlevel_standby

A uint16 state representing the required Ambient LuxLevel level in the Standby state. The value of Light LC Ambient LuxLevel Standby state

float regulator_kiu

A float32 state representing the integral coefficient that determines the integral part of the equation defining the output of the Light LC PI Feedback Regulator, when Light LC Ambient LuxLevel is less than LuxLevel Out. Valid range: 0.0 ~ 1000.0. The default value is 250.0. The value of Light LC Regulator Kiu state

float regulator_kid

A float32 state representing the integral coefficient that determines the integral part of the equation defining the output of the Light LC PI Feedback Regulator, when Light LC Ambient LuxLevel is greater than or equal to the value of the LuxLevel Out state. Valid range: 0.0 ~ 1000.0. The default value is 25.0. The value of Light LC Regulator Kid state

float regulator_kpu

A float32 state representing the proportional coefficient that determines the proportional part of the equation defining the output of the Light LC PI Feedback Regulator, when Light LC Ambient LuxLevel is less than the value of the LuxLevel Out state. Valid range: 0.0 ~ 1000.0. The default value is 80.0. The value of Light LC Regulator Kpu state

float regulator_kpd

A float32 state representing the proportional coefficient that determines the proportional part of the equation defining the output of the Light LC PI Feedback Regulator, when Light LC Ambient LuxLevel is greater than or equal to the value of the LuxLevel Out state. Valid range: 0.0 ~ 1000.0. The default value is 80.0. The value of Light LC Regulator Kpd state

int8_t regulator_accuracy

A int8 state representing the percentage accuracy of the Light LC PI Feedback Regulator. Valid range: 0.0 ~ 100.0. The default value is 2.0. The value of Light LC Regulator Accuracy state

uint32_t set_occupancy_to_1_delay

If the message Raw field contains a Raw Value for the Time Since Motion Sensed device property, which represents a value less than or equal to the value of the Light LC Occupancy Delay state, it shall delay setting the Light LC Occupancy state to 0b1 by the difference between the value of the Light LC Occupancy Delay state and the received Time Since Motion value. The value of the difference between value of the Light LC Occupancy Delay state and the received Time Since Motion value

struct esp_ble_mesh_light_lc_state_machine_t

Parameters of Light LC state machine

Public Members

`uint8_t fade_on`

The value of transition time of Light LC Time Fade On

`uint8_t fade`

The value of transition time of Light LC Time Fade

`uint8_t fade_standby_auto`

The value of transition time of Light LC Time Fade Standby Auto

`uint8_t fade_standby_manual`

The value of transition time of Light LC Time Fade Standby Manual

struct `esp_ble_mesh_light_lc_state_machine_t::[anonymous] trans_time`

The Fade On, Fade, Fade Standby Auto, and Fade Standby Manual states are transition states that define the transition of the Lightness Out and LuxLevel Out states. This transition can be started as a result of the Light LC State Machine change or as a result of receiving the Light LC Light OnOff Set or Light LC Light Set Unacknowledged message. The value of transition time

`esp_ble_mesh_lc_state_t state`

The value of Light LC state machine state

struct `k_delayed_work timer`

Timer of Light LC state machine

struct `esp_ble_mesh_light_control_t`

Parameters of Light Lightness controller

Public Members

`esp_ble_mesh_light_lc_state_t state`

Parameters of Light LC state

`esp_ble_mesh_light_lc_property_state_t prop_state`

Parameters of Light LC Property state

`esp_ble_mesh_light_lc_state_machine_t state_machine`

Parameters of Light LC state machine

struct `esp_ble_mesh_light_lc_srv_t`

User data of Light LC Server Model

Public Members

`esp_ble_mesh_model_t *model`

Pointer to the Lighting LC Server Model. Initialized internally.

`esp_ble_mesh_server_rsp_ctrl_t rsp_ctrl`

Response control of the server model received messages

`esp_ble_mesh_light_control_t *lc`

Parameters of the Light controller

`esp_ble_mesh_last_msg_info_t last`

Parameters of the last received set message

`esp_ble_mesh_state_transition_t transition`

Parameters of state transition

struct `esp_ble_mesh_light_lc_setup_srv_t`

User data of Light LC Setup Server Model

Public Members

esp_ble_mesh_model_t ***model**

Pointer to the Lighting LC Setup Server Model. Initialized internally.

esp_ble_mesh_server_rsp_ctrl_t **rsp_ctrl**

Response control of the server model received messages

esp_ble_mesh_light_control_t ***lc**

Parameters of the Light controller

struct esp_ble_mesh_state_change_light_lightness_set_t

Parameter of Light Lightness Actual state change event

Public Members

uint16_t **lightness**

The value of Light Lightness Actual state

struct esp_ble_mesh_state_change_light_lightness_linear_set_t

Parameter of Light Lightness Linear state change event

Public Members

uint16_t **lightness**

The value of Light Lightness Linear state

struct esp_ble_mesh_state_change_light_lightness_default_set_t

Parameter of Light Lightness Default state change event

Public Members

uint16_t **lightness**

The value of Light Lightness Default state

struct esp_ble_mesh_state_change_light_lightness_range_set_t

Parameters of Light Lightness Range state change event

Public Members

uint16_t **range_min**

The minimum value of Light Lightness Range state

uint16_t **range_max**

The maximum value of Light Lightness Range state

struct esp_ble_mesh_state_change_light_ctl_set_t

Parameters of Light CTL state change event

Public Members

uint16_t **lightness**

The value of Light CTL Lightness state

uint16_t **temperature**

The value of Light CTL Temperature state

int16_t **delta_uv**

The value of Light CTL Delta UV state

struct esp_ble_mesh_state_change_light_ctl_temperature_set_t
Parameters of Light CTL Temperature state change event

Public Members

uint16_t temperature
The value of Light CTL Temperature state

int16_t delta_uv
The value of Light CTL Delta UV state

struct esp_ble_mesh_state_change_light_ctl_temperature_range_set_t
Parameters of Light CTL Temperature Range state change event

Public Members

uint16_t range_min
The minimum value of Light CTL Temperature Range state

uint16_t range_max
The maximum value of Light CTL Temperature Range state

struct esp_ble_mesh_state_change_light_ctl_default_set_t
Parameters of Light CTL Default state change event

Public Members

uint16_t lightness
The value of Light Lightness Default state

uint16_t temperature
The value of Light CTL Temperature Default state

int16_t delta_uv
The value of Light CTL Delta UV Default state

struct esp_ble_mesh_state_change_light_hsl_set_t
Parameters of Light HSL state change event

Public Members

uint16_t lightness
The value of Light HSL Lightness state

uint16_t hue
The value of Light HSL Hue state

uint16_t saturation
The value of Light HSL Saturation state

struct esp_ble_mesh_state_change_light_hsl_hue_set_t
Parameter of Light HSL Hue state change event

Public Members

uint16_t hue
The value of Light HSL Hue state

struct esp_ble_mesh_state_change_light_hsl_saturation_set_t
Parameter of Light HSL Saturation state change event

Public Members

`uint16_t saturation`
The value of Light HSL Saturation state

`struct esp_ble_mesh_state_change_light_hsl_default_set_t`
Parameters of Light HSL Default state change event

Public Members

`uint16_t lightness`
The value of Light HSL Lightness Default state

`uint16_t hue`
The value of Light HSL Hue Default state

`uint16_t saturation`
The value of Light HSL Saturation Default state

`struct esp_ble_mesh_state_change_light_hsl_range_set_t`
Parameters of Light HSL Range state change event

Public Members

`uint16_t hue_range_min`
The minimum hue value of Light HSL Range state

`uint16_t hue_range_max`
The maximum hue value of Light HSL Range state

`uint16_t saturation_range_min`
The minimum saturation value of Light HSL Range state

`uint16_t saturation_range_max`
The maximum saturation value of Light HSL Range state

`struct esp_ble_mesh_state_change_light_xyl_set_t`
Parameters of Light xyL state change event

Public Members

`uint16_t lightness`
The value of Light xyL Lightness state

`uint16_t x`
The value of Light xyL x state

`uint16_t y`
The value of Light xyL y state

`struct esp_ble_mesh_state_change_light_xyl_default_set_t`
Parameters of Light xyL Default state change event

Public Members

`uint16_t lightness`
The value of Light Lightness Default state

`uint16_t x`
The value of Light xyL x Default state

uint16_t y
The value of Light xyL y Default state

struct esp_ble_mesh_state_change_light_xyl_range_set_t
Parameters of Light xyL Range state change event

Public Members

uint16_t x_range_min
The minimum value of Light xyL x Range state

uint16_t x_range_max
The maximum value of Light xyL x Range state

uint16_t y_range_min
The minimum value of Light xyL y Range state

uint16_t y_range_max
The maximum value of Light xyL y Range state

struct esp_ble_mesh_state_change_light_lc_mode_set_t
Parameter of Light LC Mode state change event

Public Members

uint8_t mode
The value of Light LC Mode state

struct esp_ble_mesh_state_change_light_lc_om_set_t
Parameter of Light LC Occupancy Mode state change event

Public Members

uint8_t mode
The value of Light LC Occupancy Mode state

struct esp_ble_mesh_state_change_light_lc_light_onoff_set_t
Parameter of Light LC Light OnOff state change event

Public Members

uint8_t onoff
The value of Light LC Light OnOff state

struct esp_ble_mesh_state_change_light_lc_property_set_t
Parameters of Light LC Property state change event

Public Members

uint16_t property_id
The property id of Light LC Property state

struct net_buf_simple *property_value
The property value of Light LC Property state

struct esp_ble_mesh_state_change_sensor_status_t
Parameters of Sensor Status state change event

Public Members**uint16_t property_id**

The value of Sensor Property ID

uint8_t occupancy

The value of Light LC Occupancy state

uint32_t set_occupancy_to_1_delay

The value of Light LC Set Occupancy to 1 Delay state

uint32_t ambient_luxlevel

The value of Light LC Ambient Luxlevel state

union esp_ble_mesh_state_change_sensor_status_t::[anonymous] state

Parameters of Sensor Status related state

struct esp_ble_mesh_server_rcv_light_lc_property_get_t

Context of the received Light LC Property Get message

Public Members**uint16_t property_id**

Property ID identifying a Light LC Property

struct esp_ble_mesh_server_rcv_light_lightness_set_t

Context of the received Light Lightness Set message

Public Members**bool op_en**

Indicate if optional parameters are included

uint16_t lightness

Target value of light lightness actual state

uint8_t tid

Transaction ID

uint8_t trans_time

Time to complete state transition (optional)

uint8_t delay

Indicate message execution delay (C.1)

struct esp_ble_mesh_server_rcv_light_lightness_linear_set_t

Context of the received Light Lightness Linear Set message

Public Members**bool op_en**

Indicate if optional parameters are included

uint16_t lightness

Target value of light lightness linear state

uint8_t tid

Transaction ID

uint8_t trans_time

Time to complete state transition (optional)

uint8_t delay

Indicate message execution delay (C.1)

struct esp_ble_mesh_server_rcv_light_lightness_default_set_t

Context of the received Light Lightness Default Set message

Public Members

uint16_t lightness

The value of the Light Lightness Default state

struct esp_ble_mesh_server_rcv_light_lightness_range_set_t

Context of the received Light Lightness Range Set message

Public Members

uint16_t range_min

Value of range min field of light lightness range state

uint16_t range_max

Value of range max field of light lightness range state

struct esp_ble_mesh_server_rcv_light_ctl_set_t

Context of the received Light CTL Set message

Public Members

bool op_en

Indicate if optional parameters are included

uint16_t lightness

Target value of light ctl lightness state

uint16_t temperature

Target value of light ctl temperature state

int16_t delta_uv

Target value of light ctl delta UV state

uint8_t tid

Transaction ID

uint8_t trans_time

Time to complete state transition (optional)

uint8_t delay

Indicate message execution delay (C.1)

struct esp_ble_mesh_server_rcv_light_ctl_temperature_set_t

Context of the received Light CTL Temperature Set message

Public Members

bool op_en

Indicate if optional parameters are included

uint16_t temperature

Target value of light ctl temperature state

int16_t delta_uv

Target value of light ctl delta UV state

uint8_t tid

Transaction ID

uint8_t trans_time

Time to complete state transition (optional)

uint8_t delay

Indicate message execution delay (C.1)

struct esp_ble_mesh_server_rcv_light_ctl_temperature_range_set_t

Context of the received Light CTL Temperature Range Set message

Public Members

uint16_t range_min

Value of temperature range min field of light ctl temperature range state

uint16_t range_max

Value of temperature range max field of light ctl temperature range state

struct esp_ble_mesh_server_rcv_light_ctl_default_set_t

Context of the received Light CTL Default Set message

Public Members

uint16_t lightness

Value of light lightness default state

uint16_t temperature

Value of light temperature default state

int16_t delta_uv

Value of light delta UV default state

struct esp_ble_mesh_server_rcv_light_hsl_set_t

Context of the received Light HSL Set message

Public Members

bool op_en

Indicate if optional parameters are included

uint16_t lightness

Target value of light hsl lightness state

uint16_t hue

Target value of light hsl hue state

uint16_t saturation

Target value of light hsl saturation state

uint8_t tid

Transaction ID

uint8_t trans_time

Time to complete state transition (optional)

uint8_t delay

Indicate message execution delay (C.1)

struct esp_ble_mesh_server_rcv_light_hsl_hue_set_t

Context of the received Light HSL Hue Set message

Public Members

bool **op_en**
Indicate if optional parameters are included

uint16_t **hue**
Target value of light hsl hue state

uint8_t **tid**
Transaction ID

uint8_t **trans_time**
Time to complete state transition (optional)

uint8_t **delay**
Indicate message execution delay (C.1)

struct esp_ble_mesh_server_rcv_light_hsl_saturation_set_t
Context of the received Light HSL Saturation Set message

Public Members

bool **op_en**
Indicate if optional parameters are included

uint16_t **saturation**
Target value of light hsl hue state

uint8_t **tid**
Transaction ID

uint8_t **trans_time**
Time to complete state transition (optional)

uint8_t **delay**
Indicate message execution delay (C.1)

struct esp_ble_mesh_server_rcv_light_hsl_default_set_t
Context of the received Light HSL Default Set message

Public Members

uint16_t **lightness**
Value of light lightness default state

uint16_t **hue**
Value of light hue default state

uint16_t **saturation**
Value of light saturation default state

struct esp_ble_mesh_server_rcv_light_hsl_range_set_t
Context of the received Light HSL Range Set message

Public Members

uint16_t **hue_range_min**
Value of hue range min field of light hsl hue range state

uint16_t **hue_range_max**
Value of hue range max field of light hsl hue range state

uint16_t saturation_range_min
Value of saturation range min field of light hsl saturation range state

uint16_t saturation_range_max
Value of saturation range max field of light hsl saturation range state

struct esp_ble_mesh_server_rcv_light_xyl_set_t
Context of the received Light xyL Set message

Public Members

bool op_en
Indicate whether optional parameters included

uint16_t lightness
The target value of the Light xyL Lightness state

uint16_t x
The target value of the Light xyL x state

uint16_t y
The target value of the Light xyL y state

uint8_t tid
Transaction Identifier

uint8_t trans_time
Time to complete state transition (optional)

uint8_t delay
Indicate message execution delay (C.1)

struct esp_ble_mesh_server_rcv_light_xyl_default_set_t
Context of the received Light xyL Default Set message

Public Members

uint16_t lightness
The value of the Light Lightness Default state

uint16_t x
The value of the Light xyL x Default state

uint16_t y
The value of the Light xyL y Default state

struct esp_ble_mesh_server_rcv_light_xyl_range_set_t
Context of the received Light xyL Range Set message

Public Members

uint16_t x_range_min
The value of the xyL x Range Min field of the Light xyL x Range state

uint16_t x_range_max
The value of the xyL x Range Max field of the Light xyL x Range state

uint16_t y_range_min
The value of the xyL y Range Min field of the Light xyL y Range state

uint16_t y_range_max
The value of the xyL y Range Max field of the Light xyL y Range state

struct esp_ble_mesh_server_rcv_light_lc_mode_set_t
Context of the received Light LC Mode Set message

Public Members

uint8_t mode
The target value of the Light LC Mode state

struct esp_ble_mesh_server_rcv_light_lc_om_set_t
Context of the received Light OM Set message

Public Members

uint8_t mode
The target value of the Light LC Occupancy Mode state

struct esp_ble_mesh_server_rcv_light_lc_light_onoff_set_t
Context of the received Light LC Light OnOff Set message

Public Members

bool op_en
Indicate whether optional parameters included

uint8_t light_onoff
The target value of the Light LC Light OnOff state

uint8_t tid
Transaction Identifier

uint8_t trans_time
Time to complete state transition (optional)

uint8_t delay
Indicate message execution delay (C.1)

struct esp_ble_mesh_server_rcv_light_lc_property_set_t
Context of the received Light LC Property Set message

Public Members

uint16_t property_id
Property ID identifying a Light LC Property

struct net_buf_simple *property_value
Raw value for the Light LC Property

struct esp_ble_mesh_server_rcv_sensor_status_t
Context of the received Sensor Status message

Public Members

struct net_buf_simple *data
Value of sensor data state (optional)

struct esp_ble_mesh_lighting_server_cb_param_t
Lighting Server Model callback parameters

Public Members

esp_ble_mesh_model_t ***model**
Pointer to Lighting Server Models

esp_ble_mesh_msg_ctx_t **ctx**
Context of the received messages

esp_ble_mesh_lighting_server_cb_value_t **value**
Value of the received Lighting Messages

Macros

ESP_BLE_MESH_MODEL_LIGHT_LIGHTNESS_CLI (cli_pub, cli_data)
Define a new Light Lightness Client Model.

Note This API needs to be called for each element on which the application needs to have a Light Lightness Client Model.

Return New Light Lightness Client Model instance.

Parameters

- cli_pub: Pointer to the unique struct *esp_ble_mesh_model_pub_t*.
- cli_data: Pointer to the unique struct *esp_ble_mesh_client_t*.

ESP_BLE_MESH_MODEL_LIGHT_CTL_CLI (cli_pub, cli_data)
Define a new Light CTL Client Model.

Note This API needs to be called for each element on which the application needs to have a Light CTL Client Model.

Return New Light CTL Client Model instance.

Parameters

- cli_pub: Pointer to the unique struct *esp_ble_mesh_model_pub_t*.
- cli_data: Pointer to the unique struct *esp_ble_mesh_client_t*.

ESP_BLE_MESH_MODEL_LIGHT_HSL_CLI (cli_pub, cli_data)
Define a new Light HSL Client Model.

Note This API needs to be called for each element on which the application needs to have a Light HSL Client Model.

Return New Light HSL Client Model instance.

Parameters

- cli_pub: Pointer to the unique struct *esp_ble_mesh_model_pub_t*.
- cli_data: Pointer to the unique struct *esp_ble_mesh_client_t*.

ESP_BLE_MESH_MODEL_LIGHT_XYL_CLI (cli_pub, cli_data)
Define a new Light xyL Client Model.

Note This API needs to be called for each element on which the application needs to have a Light xyL Client Model.

Return New Light xyL Client Model instance.

Parameters

- cli_pub: Pointer to the unique struct *esp_ble_mesh_model_pub_t*.
- cli_data: Pointer to the unique struct *esp_ble_mesh_client_t*.

ESP_BLE_MESH_MODEL_LIGHT_LC_CLI (cli_pub, cli_data)
Define a new Light LC Client Model.

Note This API needs to be called for each element on which the application needs to have a Light LC Client Model.

Return New Light LC Client Model instance.

Parameters

- cli_pub: Pointer to the unique struct *esp_ble_mesh_model_pub_t*.
- cli_data: Pointer to the unique struct *esp_ble_mesh_client_t*.

ESP_BLE_MESH_MODEL_LIGHT_LIGHTNESS_SRV (srv_pub, srv_data)
Lighting Server Models related context.

Define a new Light Lightness Server Model.

Note 1. The Light Lightness Server model extends the Generic Power OnOff Server model and the Generic Level Server model. When this model is present on an Element, the corresponding Light Lightness Setup Server model shall also be present.

1. This model shall support model publication and model subscription.

Return New Light Lightness Server Model instance.

Parameters

- `srv_pub`: Pointer to the unique struct *esp_ble_mesh_model_pub_t*.
- `srv_data`: Pointer to the unique struct *esp_ble_mesh_light_lightness_srv_t*.

ESP_BLE_MESH_MODEL_LIGHT_LIGHTNESS_SETUP_SRV (`srv_pub`, `srv_data`)

Define a new Light Lightness Setup Server Model.

Note 1. The Light Lightness Setup Server model extends the Light Lightness Server model and the Generic Power OnOff Setup Server model.

1. This model shall support model subscription.

Return New Light Lightness Setup Server Model instance.

Parameters

- `srv_pub`: Pointer to the unique struct *esp_ble_mesh_model_pub_t*.
- `srv_data`: Pointer to the unique struct *esp_ble_mesh_light_lightness_setup_srv_t*.

ESP_BLE_MESH_MODEL_LIGHT_CTL_SRV (`srv_pub`, `srv_data`)

Define a new Light CTL Server Model.

Note 1. The Light CTL Server model extends the Light Lightness Server model. When this model is present on an Element, the corresponding Light CTL Temperature Server model and the corresponding Light CTL Setup Server model shall also be present.

1. This model shall support model publication and model subscription.
2. The model requires two elements: the main element and the Temperature element. The Temperature element contains the corresponding Light CTL Temperature Server model and an instance of a Generic Level state bound to the Light CTL Temperature state on the Temperature element. The Light CTL Temperature state on the Temperature element is bound to the Light CTL state on the main element.

Return New Light CTL Server Model instance.

Parameters

- `srv_pub`: Pointer to the unique struct *esp_ble_mesh_model_pub_t*.
- `srv_data`: Pointer to the unique struct *esp_ble_mesh_light_ctl_srv_t*.

ESP_BLE_MESH_MODEL_LIGHT_CTL_SETUP_SRV (`srv_pub`, `srv_data`)

Define a new Light CTL Setup Server Model.

Note 1. The Light CTL Setup Server model extends the Light CTL Server and the Light Lightness Setup Server.

1. This model shall support model subscription.

Return New Light CTL Setup Server Model instance.

Parameters

- `srv_pub`: Pointer to the unique struct *esp_ble_mesh_model_pub_t*.
- `srv_data`: Pointer to the unique struct *esp_ble_mesh_light_ctl_setup_srv_t*.

ESP_BLE_MESH_MODEL_LIGHT_CTL_TEMP_SRV (`srv_pub`, `srv_data`)

Define a new Light CTL Temperature Server Model.

Note 1. The Light CTL Temperature Server model extends the Generic Level Server model.

1. This model shall support model publication and model subscription.

Return New Light CTL Temperature Server Model instance.

Parameters

- `srv_pub`: Pointer to the unique struct *esp_ble_mesh_model_pub_t*.
- `srv_data`: Pointer to the unique struct *esp_ble_mesh_light_ctl_temp_srv_t*.

ESP_BLE_MESH_MODEL_LIGHT_HSL_SRV (`srv_pub`, `srv_data`)

Define a new Light HSL Server Model.

Note 1. The Light HSL Server model extends the Light Lightness Server model. When this model is present on an Element, the corresponding Light HSL Hue Server model and the corresponding Light HSL Saturation Server model and the corresponding Light HSL Setup Server model shall also be present.

1. This model shall support model publication and model subscription.
2. The model requires three elements: the main element and the Hue element and the Saturation element. The Hue element contains the corresponding Light HSL Hue Server model and an instance of a Generic Level state bound to the Light HSL Hue state on the Hue element. The Saturation element contains the corresponding Light HSL Saturation Server model and an instance of a Generic Level state bound to the Light HSL Saturation state on the Saturation element. The Light HSL Hue state on the Hue element is bound to the Light HSL state on the main element and the Light HSL Saturation state on the Saturation element is bound to the Light HSL state on the main element.

Return New Light HSL Server Model instance.

Parameters

- `srv_pub`: Pointer to the unique struct `esp_ble_mesh_model_pub_t`.
- `srv_data`: Pointer to the unique struct `esp_ble_mesh_light_hsl_srv_t`.

ESP_BLE_MESH_MODEL_LIGHT_HSL_SETUP_SRV (`srv_pub`, `srv_data`)

Define a new Light HSL Setup Server Model.

Note 1. The Light HSL Setup Server model extends the Light HSL Server and the Light Lightness Setup Server.

1. This model shall support model subscription.

Return New Light HSL Setup Server Model instance.

Parameters

- `srv_pub`: Pointer to the unique struct `esp_ble_mesh_model_pub_t`.
- `srv_data`: Pointer to the unique struct `esp_ble_mesh_light_hsl_setup_srv_t`.

ESP_BLE_MESH_MODEL_LIGHT_HSL_HUE_SRV (`srv_pub`, `srv_data`)

Define a new Light HSL Hue Server Model.

Note 1. The Light HSL Hue Server model extends the Generic Level Server model. This model is associated with the Light HSL Server model.

1. This model shall support model publication and model subscription.

Return New Light HSL Hue Server Model instance.

Parameters

- `srv_pub`: Pointer to the unique struct `esp_ble_mesh_model_pub_t`.
- `srv_data`: Pointer to the unique struct `esp_ble_mesh_light_hsl_hue_srv_t`.

ESP_BLE_MESH_MODEL_LIGHT_HSL_SAT_SRV (`srv_pub`, `srv_data`)

Define a new Light HSL Saturation Server Model.

Note 1. The Light HSL Saturation Server model extends the Generic Level Server model. This model is associated with the Light HSL Server model.

1. This model shall support model publication and model subscription.

Return New Light HSL Saturation Server Model instance.

Parameters

- `srv_pub`: Pointer to the unique struct `esp_ble_mesh_model_pub_t`.
- `srv_data`: Pointer to the unique struct `esp_ble_mesh_light_hsl_sat_srv_t`.

ESP_BLE_MESH_MODEL_LIGHT_XYL_SRV (`srv_pub`, `srv_data`)

Define a new Light xyL Server Model.

Note 1. The Light xyL Server model extends the Light Lightness Server model. When this model is present on an Element, the corresponding Light xyL Setup Server model shall also be present.

1. This model shall support model publication and model subscription.

Return New Light xyL Server Model instance.

Parameters

- `srv_pub`: Pointer to the unique struct `esp_ble_mesh_model_pub_t`.
- `srv_data`: Pointer to the unique struct `esp_ble_mesh_light_xyl_srv_t`.

ESP_BLE_MESH_MODEL_LIGHT_XYL_SETUP_SRV (`srv_pub`, `srv_data`)

Define a new Light xyL Setup Server Model.

Note 1. The Light xyL Setup Server model extends the Light xyL Server and the Light Lightness Setup Server.
1. This model shall support model subscription.

Return New Light xyL Setup Server Model instance.

Parameters

- `srv_pub`: Pointer to the unique struct `esp_ble_mesh_model_pub_t`.
- `srv_data`: Pointer to the unique struct `esp_ble_mesh_light_xyl_setup_srv_t`.

ESP_BLE_MESH_MODEL_LIGHT_LC_SRV (`srv_pub`, `srv_data`)

Define a new Light LC Server Model.

Note 1. The Light LC (Lightness Control) Server model extends the Light Lightness Server model and the Generic OnOff Server model. When this model is present on an Element, the corresponding Light LC Setup Server model shall also be present.

1. This model shall support model publication and model subscription.
2. This model may be used to represent an element that is a client to a Sensor Server model and controls the Light Lightness Actual state via defined state bindings.

Return New Light LC Server Model instance.

Parameters

- `srv_pub`: Pointer to the unique struct `esp_ble_mesh_model_pub_t`.
- `srv_data`: Pointer to the unique struct `esp_ble_mesh_light_lc_srv_t`.

ESP_BLE_MESH_MODEL_LIGHT_LC_SETUP_SRV (`srv_pub`, `srv_data`)

Define a new Light LC Setup Server Model.

Note 1. The Light LC (Lightness Control) Setup model extends the Light LC Server model.

1. This model shall support model publication and model subscription.
2. This model may be used to configure setup parameters for the Light LC Server model.

Return New Light LC Setup Server Model instance.

Parameters

- `srv_pub`: Pointer to the unique struct `esp_ble_mesh_model_pub_t`.
- `srv_data`: Pointer to the unique struct `esp_ble_mesh_light_lc_setup_srv_t`.

Type Definitions

```
typedef void (*esp_ble_mesh_light_client_cb_t) (esp_ble_mesh_light_client_cb_event_t
                                              event, esp_ble_mesh_light_client_cb_param_t
                                              *param)
```

Bluetooth Mesh Light Client Model function.

Lighting Client Model callback function type

Parameters

- `event`: Event type
- `param`: Pointer to callback parameter

```
typedef void (*esp_ble_mesh_lighting_server_cb_t) (esp_ble_mesh_lighting_server_cb_event_t
                                                  event,
                                                  esp_ble_mesh_lighting_server_cb_param_t
                                                  *param)
```

Bluetooth Mesh Lighting Server Model function.

Lighting Server Model callback function type

Parameters

- `event`: Event type
- `param`: Pointer to callback parameter

Enumerations

```
enum esp_ble_mesh_light_client_cb_event_t
```

This enum value is the event of Lighting Client Model

Values:

```
ESP_BLE_MESH_LIGHT_CLIENT_GET_STATE_EVT
```

```
ESP_BLE_MESH_LIGHT_CLIENT_SET_STATE_EVT
ESP_BLE_MESH_LIGHT_CLIENT_PUBLISH_EVT
ESP_BLE_MESH_LIGHT_CLIENT_TIMEOUT_EVT
ESP_BLE_MESH_LIGHT_CLIENT_EVT_MAX
```

enum esp_ble_mesh_lc_state_t

This enum value is the Light LC State Machine states

Values:

```
ESP_BLE_MESH_LC_OFF
ESP_BLE_MESH_LC_STANDBY
ESP_BLE_MESH_LC_FADE_ON
ESP_BLE_MESH_LC_RUN
ESP_BLE_MESH_LC_FADE
ESP_BLE_MESH_LC_PROLONG
ESP_BLE_MESH_LC_FADE_STANDBY_AUTO
ESP_BLE_MESH_LC_FADE_STANDBY_MANUAL
```

enum esp_ble_mesh_lighting_server_cb_event_t

This enum value is the event of Lighting Server Model

Values:

```
ESP_BLE_MESH_LIGHTING_SERVER_STATE_CHANGE_EVT
```

1. When `get_auto_rsp` is set to `ESP_BLE_MESH_SERVER_AUTO_RSP`, no event will be callback to the application layer when Lighting Get messages are received.
2. When `set_auto_rsp` is set to `ESP_BLE_MESH_SERVER_AUTO_RSP`, this event will be callback to the application layer when Lighting Set/Set Unack messages are received.

```
ESP_BLE_MESH_LIGHTING_SERVER_RECV_GET_MSG_EVT
```

When `get_auto_rsp` is set to `ESP_BLE_MESH_SERVER_RSP_BY_APP`, this event will be callback to the application layer when Lighting Get messages are received.

```
ESP_BLE_MESH_LIGHTING_SERVER_RECV_SET_MSG_EVT
```

When `set_auto_rsp` is set to `ESP_BLE_MESH_SERVER_RSP_BY_APP`, this event will be callback to the application layer when Lighting Set/Set Unack messages are received.

```
ESP_BLE_MESH_LIGHTING_SERVER_RECV_STATUS_MSG_EVT
```

When `status_auto_rsp` is set to `ESP_BLE_MESH_SERVER_RSP_BY_APP`, this event will be callback to the application layer when Sensor Status message is received.

```
ESP_BLE_MESH_LIGHTING_SERVER_EVT_MAX
```

ESP-IDF currently supports two host stacks. The Bluedroid based stack (default) supports classic Bluetooth as well as BLE. On the other hand, Apache NimBLE based stack is BLE only. For users to make a choice:

- For usecases involving classic Bluetooth as well as BLE, Bluedroid should be used.
- For BLE-only usecases, using NimBLE is recommended. It is less demanding in terms of code footprint and runtime memory, making it suitable for such scenarios.

Code examples for this API section are provided in the [bluetooth/bluedroid](#) directory of ESP-IDF examples.

The following examples contain detailed walkthroughs:

- [GATT Client Example Walkthrough](#)
- [GATT Server Service Table Example Walkthrough](#)
- [GATT Server Example Walkthrough](#)
- [GATT Security Client Example Walkthrough](#)
- [GATT Security Server Example Walkthrough](#)
- [GATT Client Multi-connection Example Walkthrough](#)

2.2 Networking APIs

2.2.1 Wi-Fi

Wi-Fi

Introduction The Wi-Fi libraries provide support for configuring and monitoring the ESP32-C3 Wi-Fi networking functionality. This includes configuration for:

- Station mode (aka STA mode or Wi-Fi client mode). ESP32-C3 connects to an access point.
- AP mode (aka Soft-AP mode or Access Point mode). Stations connect to the ESP32-C3.
- Combined AP-STA mode (ESP32-C3 is concurrently an access point and a station connected to another access point).
- Various security modes for the above (WPA, WPA2, WEP, etc.)
- Scanning for access points (active & passive scanning).
- Promiscuous mode for monitoring of IEEE802.11 Wi-Fi packets.

Application Examples The `wifi` directory of ESP-IDF examples contains the following applications:

Code examples for Wi-Fi are provided in the `wifi` directory of ESP-IDF examples.

In addition, there is a simple `esp-idf-template` application to demonstrate a minimal IDF project structure.

API Reference

Header File

- `esp_wifi/include/esp_wifi.h`

Functions

`esp_err_t esp_wifi_init (const wifi_init_config_t *config)`

Initialize WiFi Allocate resource for WiFi driver, such as WiFi control structure, RX/TX buffer, WiFi NVS structure etc. This WiFi also starts WiFi task.

Attention 1. This API must be called before all other WiFi API can be called

Attention 2. Always use `WIFI_INIT_CONFIG_DEFAULT` macro to initialize the configuration to default values, this can guarantee all the fields get correct value when more fields are added into `wifi_init_config_t` in future release. If you want to set your own initial values, overwrite the default values which are set by `WIFI_INIT_CONFIG_DEFAULT`. Please be notified that the field ‘magic’ of `wifi_init_config_t` should always be `WIFI_INIT_CONFIG_MAGIC`!

Return

- `ESP_OK`: succeed
- `ESP_ERR_NO_MEM`: out of memory
- others: refer to error code `esp_err.h`

Parameters

- `config`: pointer to WiFi initialized configuration structure; can point to a temporary variable.

`esp_err_t esp_wifi_deinit (void)`

Deinit WiFi Free all resource allocated in `esp_wifi_init` and stop WiFi task.

Attention 1. This API should be called if you want to remove WiFi driver from the system

Return

- `ESP_OK`: succeed
- `ESP_ERR_WIFI_NOT_INIT`: WiFi is not initialized by `esp_wifi_init`

`esp_err_t esp_wifi_set_mode (wifi_mode_t mode)`

Set the WiFi operating mode.

Set the WiFi operating mode as station, soft-AP or station+soft-AP, The default mode is soft-AP mode.

Return

- ESP_OK: succeed
- ESP_ERR_WIFI_NOT_INIT: WiFi is not initialized by esp_wifi_init
- ESP_ERR_INVALID_ARG: invalid argument
- others: refer to error code in esp_err.h

Parameters

- mode: WiFi operating mode

esp_err_t **esp_wifi_get_mode** (*wifi_mode_t* *mode)

Get current operating mode of WiFi.

Return

- ESP_OK: succeed
- ESP_ERR_WIFI_NOT_INIT: WiFi is not initialized by esp_wifi_init
- ESP_ERR_INVALID_ARG: invalid argument

Parameters

- [out] mode: store current WiFi mode

esp_err_t **esp_wifi_start** (void)

Start WiFi according to current configuration. If mode is WIFI_MODE_STA, it create station control block and start station. If mode is WIFI_MODE_AP, it create soft-AP control block and start soft-AP. If mode is WIFI_MODE_APSTA, it create soft-AP and station control block and start soft-AP and station.

Return

- ESP_OK: succeed
- ESP_ERR_WIFI_NOT_INIT: WiFi is not initialized by esp_wifi_init
- ESP_ERR_INVALID_ARG: invalid argument
- ESP_ERR_NO_MEM: out of memory
- ESP_ERR_WIFI_CONN: WiFi internal error, station or soft-AP control block wrong
- ESP_FAIL: other WiFi internal errors

esp_err_t **esp_wifi_stop** (void)

Stop WiFi. If mode is WIFI_MODE_STA, it stop station and free station control block. If mode is WIFI_MODE_AP, it stop soft-AP and free soft-AP control block. If mode is WIFI_MODE_APSTA, it stop station/soft-AP and free station/soft-AP control block.

Return

- ESP_OK: succeed
- ESP_ERR_WIFI_NOT_INIT: WiFi is not initialized by esp_wifi_init

esp_err_t **esp_wifi_restore** (void)

Restore WiFi stack persistent settings to default values.

This function will reset settings made using the following APIs:

- esp_wifi_set_bandwidth,
- esp_wifi_set_protocol,
- esp_wifi_set_config related
- esp_wifi_set_mode

Return

- ESP_OK: succeed
- ESP_ERR_WIFI_NOT_INIT: WiFi is not initialized by esp_wifi_init

esp_err_t **esp_wifi_connect** (void)

Connect the ESP32 WiFi station to the AP.

Attention 1. This API only impact WIFI_MODE_STA or WIFI_MODE_APSTA mode

Attention 2. If the ESP32 is connected to an AP, call esp_wifi_disconnect to disconnect.

Attention 3. The scanning triggered by esp_wifi_start_scan() will not be effective until connection between ESP32 and the AP is established. If ESP32 is scanning and connecting at the same time, ESP32 will abort scanning and return a warning message and error number ESP_ERR_WIFI_STATE. If you want to do re-connection after ESP32 received disconnect event, remember to add the maximum retry time, otherwise

the called scan will not work. This is especially true when the AP doesn't exist, and you still try reconnection after ESP32 received disconnect event with the reason code `WIFI_REASON_NO_AP_FOUND`.

Return

- `ESP_OK`: succeed
- `ESP_ERR_WIFI_NOT_INIT`: WiFi is not initialized by `esp_wifi_init`
- `ESP_ERR_WIFI_NOT_STARTED`: WiFi is not started by `esp_wifi_start`
- `ESP_ERR_WIFI_CONN`: WiFi internal error, station or soft-AP control block wrong
- `ESP_ERR_WIFI_SSID`: SSID of AP which station connects is invalid

`esp_err_t esp_wifi_disconnect` (void)

Disconnect the ESP32 WiFi station from the AP.

Return

- `ESP_OK`: succeed
- `ESP_ERR_WIFI_NOT_INIT`: WiFi was not initialized by `esp_wifi_init`
- `ESP_ERR_WIFI_NOT_STARTED`: WiFi was not started by `esp_wifi_start`
- `ESP_FAIL`: other WiFi internal errors

`esp_err_t esp_wifi_clear_fast_connect` (void)

Currently this API is just an stub API.

Return

- `ESP_OK`: succeed
- others: fail

`esp_err_t esp_wifi_deauth_sta` (uint16_t aid)

deauthenticate all stations or associated id equals to aid

Return

- `ESP_OK`: succeed
- `ESP_ERR_WIFI_NOT_INIT`: WiFi is not initialized by `esp_wifi_init`
- `ESP_ERR_WIFI_NOT_STARTED`: WiFi was not started by `esp_wifi_start`
- `ESP_ERR_INVALID_ARG`: invalid argument
- `ESP_ERR_WIFI_MODE`: WiFi mode is wrong

Parameters

- `aid`: when aid is 0, deauthenticate all stations, otherwise deauthenticate station whose associated id is aid

`esp_err_t esp_wifi_scan_start` (const `wifi_scan_config_t` *config, bool block)

Scan all available APs.

Attention If this API is called, the found APs are stored in WiFi driver dynamic allocated memory and the will be freed in `esp_wifi_scan_get_ap_records`, so generally, call `esp_wifi_scan_get_ap_records` to cause the memory to be freed once the scan is done

Attention The values of maximum active scan time and passive scan time per channel are limited to 1500 milliseconds. Values above 1500ms may cause station to disconnect from AP and are not recommended.

Return

- `ESP_OK`: succeed
- `ESP_ERR_WIFI_NOT_INIT`: WiFi is not initialized by `esp_wifi_init`
- `ESP_ERR_WIFI_NOT_STARTED`: WiFi was not started by `esp_wifi_start`
- `ESP_ERR_WIFI_TIMEOUT`: blocking scan is timeout
- `ESP_ERR_WIFI_STATE`: wifi still connecting when invoke `esp_wifi_scan_start`
- others: refer to error code in `esp_err.h`

Parameters

- `config`: configuration of scanning
- `block`: if block is true, this API will block the caller until the scan is done, otherwise it will return immediately

`esp_err_t esp_wifi_scan_stop` (void)

Stop the scan in process.

Return

- `ESP_OK`: succeed

- ESP_ERR_WIFI_NOT_INIT: WiFi is not initialized by esp_wifi_init
- ESP_ERR_WIFI_NOT_STARTED: WiFi is not started by esp_wifi_start

esp_err_t **esp_wifi_scan_get_ap_num** (uint16_t *number)

Get number of APs found in last scan.

Attention This API can only be called when the scan is completed, otherwise it may get wrong value.

Return

- ESP_OK: succeed
- ESP_ERR_WIFI_NOT_INIT: WiFi is not initialized by esp_wifi_init
- ESP_ERR_WIFI_NOT_STARTED: WiFi is not started by esp_wifi_start
- ESP_ERR_INVALID_ARG: invalid argument

Parameters

- [out] number: store number of APIs found in last scan

esp_err_t **esp_wifi_scan_get_ap_records** (uint16_t *number, wifi_ap_record_t *ap_records)

Get AP list found in last scan.

Return

- ESP_OK: succeed
- ESP_ERR_WIFI_NOT_INIT: WiFi is not initialized by esp_wifi_init
- ESP_ERR_WIFI_NOT_STARTED: WiFi is not started by esp_wifi_start
- ESP_ERR_INVALID_ARG: invalid argument
- ESP_ERR_NO_MEM: out of memory

Parameters

- [inout] number: As input param, it stores max AP number ap_records can hold. As output param, it receives the actual AP number this API returns.
- ap_records: *wifi_ap_record_t* array to hold the found APs

esp_err_t **esp_wifi_sta_get_ap_info** (wifi_ap_record_t *ap_info)

Get information of AP which the ESP32 station is associated with.

Attention When the obtained country information is empty, it means that the AP does not carry country information

Return

- ESP_OK: succeed
- ESP_ERR_WIFI_CONN: The station interface don't initialized
- ESP_ERR_WIFI_NOT_CONNECT: The station is in disconnect status

Parameters

- ap_info: the *wifi_ap_record_t* to hold AP information sta can get the connected ap's phy mode info through the struct member phy_11b, phy_11g, phy_11n, phy_lr in the *wifi_ap_record_t* struct. For example, phy_11b = 1 imply that ap support 802.11b mode

esp_err_t **esp_wifi_set_ps** (wifi_ps_type_t type)

Set current WiFi power save type.

Attention Default power save type is WIFI_PS_MIN_MODEM.

Return ESP_OK: succeed

Parameters

- type: power save type

esp_err_t **esp_wifi_get_ps** (wifi_ps_type_t *type)

Get current WiFi power save type.

Attention Default power save type is WIFI_PS_MIN_MODEM.

Return ESP_OK: succeed

Parameters

- [out] type: store current power save type

esp_err_t **esp_wifi_set_protocol** (wifi_interface_t ifx, uint8_t protocol_bitmap)

Set protocol type of specified interface The default protocol is (WIFI_PROTOCOL_11B|WIFI_PROTOCOL_11G|WIFI_PROTOCOL_11N|WIFI_PROTOCOL_LR)

Attention Support 802.11b or 802.11bg or 802.11bgn or LR mode

Return

- ESP_OK: succeed
- ESP_ERR_WIFI_NOT_INIT: WiFi is not initialized by esp_wifi_init
- ESP_ERR_WIFI_IF: invalid interface
- others: refer to error codes in esp_err.h

Parameters

- ifx: interfaces
- protocol_bitmap: WiFi protocol bitmap

esp_err_t **esp_wifi_get_protocol** (*wifi_interface_t* ifx, uint8_t *protocol_bitmap)

Get the current protocol bitmap of the specified interface.

Return

- ESP_OK: succeed
- ESP_ERR_WIFI_NOT_INIT: WiFi is not initialized by esp_wifi_init
- ESP_ERR_WIFI_IF: invalid interface
- ESP_ERR_INVALID_ARG: invalid argument
- others: refer to error codes in esp_err.h

Parameters

- ifx: interface
- [out] protocol_bitmap: store current WiFi protocol bitmap of interface ifx

esp_err_t **esp_wifi_set_bandwidth** (*wifi_interface_t* ifx, *wifi_bandwidth_t* bw)

Set the bandwidth of ESP32 specified interface.

Attention 1. API return false if try to configure an interface that is not enabled

Attention 2. WIFI_BW_HT40 is supported only when the interface support 11N

Return

- ESP_OK: succeed
- ESP_ERR_WIFI_NOT_INIT: WiFi is not initialized by esp_wifi_init
- ESP_ERR_WIFI_IF: invalid interface
- ESP_ERR_INVALID_ARG: invalid argument
- others: refer to error codes in esp_err.h

Parameters

- ifx: interface to be configured
- bw: bandwidth

esp_err_t **esp_wifi_get_bandwidth** (*wifi_interface_t* ifx, *wifi_bandwidth_t* *bw)

Get the bandwidth of ESP32 specified interface.

Attention 1. API return false if try to get a interface that is not enable

Return

- ESP_OK: succeed
- ESP_ERR_WIFI_NOT_INIT: WiFi is not initialized by esp_wifi_init
- ESP_ERR_WIFI_IF: invalid interface
- ESP_ERR_INVALID_ARG: invalid argument

Parameters

- ifx: interface to be configured
- [out] bw: store bandwidth of interface ifx

esp_err_t **esp_wifi_set_channel** (uint8_t primary, *wifi_second_chan_t* second)

Set primary/secondary channel of ESP32.

Attention 1. This API should be called after esp_wifi_start()

Attention 2. When ESP32 is in STA mode, this API should not be called when STA is scanning or connecting to an external AP

Attention 3. When ESP32 is in softAP mode, this API should not be called when softAP has connected to external STAs

Attention 4. When ESP32 is in STA+softAP mode, this API should not be called when in the scenarios described above

Return

- ESP_OK: succeed
- ESP_ERR_WIFI_NOT_INIT: WiFi is not initialized by esp_wifi_init

- ESP_ERR_WIFI_IF: invalid interface
- ESP_ERR_INVALID_ARG: invalid argument

Parameters

- `primary`: for HT20, primary is the channel number, for HT40, primary is the primary channel
- `second`: for HT20, second is ignored, for HT40, second is the second channel

`esp_err_t esp_wifi_get_channel (uint8_t *primary, wifi_second_chan_t *second)`

Get the primary/secondary channel of ESP32.

Attention 1. API return false if try to get a interface that is not enable

Return

- ESP_OK: succeed
- ESP_ERR_WIFI_NOT_INIT: WiFi is not initialized by `esp_wifi_init`
- ESP_ERR_INVALID_ARG: invalid argument

Parameters

- `primary`: store current primary channel
- `[out] second`: store current second channel

`esp_err_t esp_wifi_set_country (const wifi_country_t *country)`

configure country info

Attention 1. It is discouraged to call this API since this doesn't validate the per-country rules, it's up to the user to fill in all fields according to local regulations. Please use `esp_wifi_set_country_code` instead.

Attention 2. The default country is CHINA `{.cc="CN", .schan=1, .nchan=13, policy=WIFI_COUNTRY_POLICY_AUTO}`

Attention 3. When the country policy is `WIFI_COUNTRY_POLICY_AUTO`, the country info of the AP to which the station is connected is used. E.g. if the configured country info is `{.cc="USA", .schan=1, .nchan=11}` and the country info of the AP to which the station is connected is `{.cc="JP", .schan=1, .nchan=14}` then the country info that will be used is `{.cc="JP", .schan=1, .nchan=14}`. If the station disconnected from the AP the country info is set back to the country info of the station automatically, `{.cc="US", .schan=1, .nchan=11}` in the example.

Attention 4. When the country policy is `WIFI_COUNTRY_POLICY_MANUAL`, then the configured country info is used always.

Attention 5. When the country info is changed because of configuration or because the station connects to a different external AP, the country IE in probe response/beacon of the soft-AP is also changed.

Attention 6. The country configuration is stored into flash.

Attention 7. When this API is called, the PHY init data will switch to the PHY init data type corresponding to the country info.

Return

- ESP_OK: succeed
- ESP_ERR_WIFI_NOT_INIT: WiFi is not initialized by `esp_wifi_init`
- ESP_ERR_INVALID_ARG: invalid argument

Parameters

- `country`: the configured country info

`esp_err_t esp_wifi_get_country (wifi_country_t *country)`

get the current country info

Return

- ESP_OK: succeed
- ESP_ERR_WIFI_NOT_INIT: WiFi is not initialized by `esp_wifi_init`
- ESP_ERR_INVALID_ARG: invalid argument

Parameters

- `country`: country info

`esp_err_t esp_wifi_set_mac (wifi_interface_t ifx, const uint8_t mac[6])`

Set MAC address of the ESP32 WiFi station or the soft-AP interface.

Attention 1. This API can only be called when the interface is disabled

Attention 2. ESP32 soft-AP and station have different MAC addresses, do not set them to be the same.

Attention 3. The bit 0 of the first byte of ESP32 MAC address can not be 1. For example, the MAC address can set to be "1a:XX:XX:XX:XX:XX", but can not be "15:XX:XX:XX:XX:XX".

Return

- ESP_OK: succeed
- ESP_ERR_WIFI_NOT_INIT: WiFi is not initialized by esp_wifi_init
- ESP_ERR_INVALID_ARG: invalid argument
- ESP_ERR_WIFI_IF: invalid interface
- ESP_ERR_WIFI_MAC: invalid mac address
- ESP_ERR_WIFI_MODE: WiFi mode is wrong
- others: refer to error codes in esp_err.h

Parameters

- `ifx`: interface
- `mac`: the MAC address

esp_err_t **esp_wifi_get_mac** (*wifi_interface_t* ifx, uint8_t mac[6])

Get mac of specified interface.

Return

- ESP_OK: succeed
- ESP_ERR_WIFI_NOT_INIT: WiFi is not initialized by esp_wifi_init
- ESP_ERR_INVALID_ARG: invalid argument
- ESP_ERR_WIFI_IF: invalid interface

Parameters

- `ifx`: interface
- [out] `mac`: store mac of the interface ifx

esp_err_t **esp_wifi_set_promiscuous_rx_cb** (*wifi_promiscuous_cb_t* cb)

Register the RX callback function in the promiscuous mode.

Each time a packet is received, the registered callback function will be called.

Return

- ESP_OK: succeed
- ESP_ERR_WIFI_NOT_INIT: WiFi is not initialized by esp_wifi_init

Parameters

- `cb`: callback

esp_err_t **esp_wifi_set_promiscuous** (bool *en*)

Enable the promiscuous mode.

Return

- ESP_OK: succeed
- ESP_ERR_WIFI_NOT_INIT: WiFi is not initialized by esp_wifi_init

Parameters

- `en`: false - disable, true - enable

esp_err_t **esp_wifi_get_promiscuous** (bool **en*)

Get the promiscuous mode.

Return

- ESP_OK: succeed
- ESP_ERR_WIFI_NOT_INIT: WiFi is not initialized by esp_wifi_init
- ESP_ERR_INVALID_ARG: invalid argument

Parameters

- [out] `en`: store the current status of promiscuous mode

esp_err_t **esp_wifi_set_promiscuous_filter** (const *wifi_promiscuous_filter_t* **filter*)

Enable the promiscuous mode packet type filter.

Note The default filter is to filter all packets except WIFI_PKT_MISC

Return

- ESP_OK: succeed
- ESP_ERR_WIFI_NOT_INIT: WiFi is not initialized by esp_wifi_init

Parameters

- `filter`: the packet type filtered in promiscuous mode.

esp_err_t **esp_wifi_get_promiscuous_filter** (*wifi_promiscuous_filter_t* *filter)

Get the promiscuous filter.

Return

- ESP_OK: succeed
- ESP_ERR_WIFI_NOT_INIT: WiFi is not initialized by esp_wifi_init
- ESP_ERR_INVALID_ARG: invalid argument

Parameters

- [out] filter: store the current status of promiscuous filter

esp_err_t **esp_wifi_set_promiscuous_ctrl_filter** (const *wifi_promiscuous_filter_t* *filter)

Enable subtype filter of the control packet in promiscuous mode.

Note The default filter is to filter none control packet.

Return

- ESP_OK: succeed
- ESP_ERR_WIFI_NOT_INIT: WiFi is not initialized by esp_wifi_init

Parameters

- filter: the subtype of the control packet filtered in promiscuous mode.

esp_err_t **esp_wifi_get_promiscuous_ctrl_filter** (*wifi_promiscuous_filter_t* *filter)

Get the subtype filter of the control packet in promiscuous mode.

Return

- ESP_OK: succeed
- ESP_ERR_WIFI_NOT_INIT: WiFi is not initialized by esp_wifi_init
- ESP_ERR_WIFI_ARG: invalid argument

Parameters

- [out] filter: store the current status of subtype filter of the control packet in promiscuous mode

esp_err_t **esp_wifi_set_config** (*wifi_interface_t* interface, *wifi_config_t* *conf)

Set the configuration of the ESP32 STA or AP.

Attention 1. This API can be called only when specified interface is enabled, otherwise, API fail

Attention 2. For station configuration, bssid_set needs to be 0; and it needs to be 1 only when users need to check the MAC address of the AP.

Attention 3. ESP32 is limited to only one channel, so when in the soft-AP+station mode, the soft-AP will adjust its channel automatically to be the same as the channel of the ESP32 station.

Return

- ESP_OK: succeed
- ESP_ERR_WIFI_NOT_INIT: WiFi is not initialized by esp_wifi_init
- ESP_ERR_INVALID_ARG: invalid argument
- ESP_ERR_WIFI_IF: invalid interface
- ESP_ERR_WIFI_MODE: invalid mode
- ESP_ERR_WIFI_PASSWORD: invalid password
- ESP_ERR_WIFI_NVS: WiFi internal NVS error
- others: refer to the erro code in esp_err.h

Parameters

- interface: interface
- conf: station or soft-AP configuration

esp_err_t **esp_wifi_get_config** (*wifi_interface_t* interface, *wifi_config_t* *conf)

Get configuration of specified interface.

Return

- ESP_OK: succeed
- ESP_ERR_WIFI_NOT_INIT: WiFi is not initialized by esp_wifi_init
- ESP_ERR_INVALID_ARG: invalid argument
- ESP_ERR_WIFI_IF: invalid interface

Parameters

- interface: interface
- [out] conf: station or soft-AP configuration

`esp_err_t esp_wifi_ap_get_sta_list (wifi_sta_list_t *sta)`

Get STAs associated with soft-AP.

Attention SSC only API

Return

- ESP_OK: succeed
- ESP_ERR_WIFI_NOT_INIT: WiFi is not initialized by `esp_wifi_init`
- ESP_ERR_INVALID_ARG: invalid argument
- ESP_ERR_WIFI_MODE: WiFi mode is wrong
- ESP_ERR_WIFI_CONN: WiFi internal error, the station/soft-AP control block is invalid

Parameters

- [out] `sta`: station list ap can get the connected sta's phy mode info through the struct member `phy_11b`, `phy_11g`, `phy_11n`, `phy_11r` in the `wifi_sta_info_t` struct. For example, `phy_11b = 1` imply that sta support 802.11b mode

`esp_err_t esp_wifi_ap_get_sta_aid (const uint8_t mac[6], uint16_t *aid)`

Get AID of STA connected with soft-AP.

Return

- ESP_OK: succeed
- ESP_ERR_WIFI_NOT_INIT: WiFi is not initialized by `esp_wifi_init`
- ESP_ERR_INVALID_ARG: invalid argument
- ESP_ERR_NOT_FOUND: Requested resource not found
- ESP_ERR_WIFI_MODE: WiFi mode is wrong
- ESP_ERR_WIFI_CONN: WiFi internal error, the station/soft-AP control block is invalid

Parameters

- `mac`: STA's mac address
- [out] `aid`: Store the AID corresponding to STA mac

`esp_err_t esp_wifi_set_storage (wifi_storage_t storage)`

Set the WiFi API configuration storage type.

Attention 1. The default value is `WIFI_STORAGE_FLASH`

Return

- ESP_OK: succeed
- ESP_ERR_WIFI_NOT_INIT: WiFi is not initialized by `esp_wifi_init`
- ESP_ERR_INVALID_ARG: invalid argument

Parameters

- `storage`: storage type

`esp_err_t esp_wifi_set_vendor_ie (bool enable, wifi_vendor_ie_type_t type, wifi_vendor_ie_id_t idx, const void *vnd_ie)`

Set 802.11 Vendor-Specific Information Element.

Return

- ESP_OK: succeed
- ESP_ERR_WIFI_NOT_INIT: WiFi is not initialized by `esp_wifi_init()`
- ESP_ERR_INVALID_ARG: Invalid argument, including if first byte of `vnd_ie` is not `WIFI_VENDOR_IE_ELEMENT_ID` (0xDD) or second byte is an invalid length.
- ESP_ERR_NO_MEM: Out of memory

Parameters

- `enable`: If true, specified IE is enabled. If false, specified IE is removed.
- `type`: Information Element type. Determines the frame type to associate with the IE.
- `idx`: Index to set or clear. Each IE type can be associated with up to two elements (indices 0 & 1).
- `vnd_ie`: Pointer to vendor specific element data. First 6 bytes should be a header with fields matching `wifi_vendor_ie_data_t`. If `enable` is false, this argument is ignored and can be NULL. Data does not need to remain valid after the function returns.

`esp_err_t esp_wifi_set_vendor_ie_cb (esp_vendor_ie_cb_t cb, void *ctx)`

Register Vendor-Specific Information Element monitoring callback.

Return

- ESP_OK: succeed

- `ESP_ERR_WIFI_NOT_INIT`: WiFi is not initialized by `esp_wifi_init`

Parameters

- `cb`: Callback function
- `ctx`: Context argument, passed to callback function.

esp_err_t **esp_wifi_set_max_tx_power** (*int8_t power*)

Set maximum transmitting power after WiFi start.

Attention 1. Maximum power before wifi startup is limited by PHY init data bin.

Attention 2. The value set by this API will be mapped to the `max_tx_power` of the structure `wifi_country_t` variable.

Attention 3. Mapping Table {Power, max_tx_power} = {{8, 2}, {20, 5}, {28, 7}, {34, 8}, {44, 11}, {52, 13}, {56, 14}, {60, 15}, {66, 16}, {72, 18}, {80, 20}}.

Attention 4. Param power unit is 0.25dBm, range is [8, 84] corresponding to 2dBm - 20dBm.

Attention 5. Relationship between set value and actual value. As follows: {set value range, actual value} = {{[8, 19],8}, {[20, 27],20}, {[28, 33],28}, {[34, 43],34}, {[44, 51],44}, {[52, 55],52}, {[56, 59],56}, {[60, 65],60}, {[66, 71],66}, {[72, 79],72}, {[80, 84],80}}.

Return

- `ESP_OK`: succeed
- `ESP_ERR_WIFI_NOT_INIT`: WiFi is not initialized by `esp_wifi_init`
- `ESP_ERR_WIFI_NOT_START`: WiFi is not started by `esp_wifi_start`
- `ESP_ERR_WIFI_ARG`: invalid argument, e.g. parameter is out of range

Parameters

- `power`: Maximum WiFi transmitting power.

esp_err_t **esp_wifi_get_max_tx_power** (*int8_t *power*)

Get maximum transmitting power after WiFi start.

Return

- `ESP_OK`: succeed
- `ESP_ERR_WIFI_NOT_INIT`: WiFi is not initialized by `esp_wifi_init`
- `ESP_ERR_WIFI_NOT_START`: WiFi is not started by `esp_wifi_start`
- `ESP_ERR_WIFI_ARG`: invalid argument

Parameters

- `power`: Maximum WiFi transmitting power, unit is 0.25dBm.

esp_err_t **esp_wifi_set_event_mask** (*uint32_t mask*)

Set mask to enable or disable some WiFi events.

Attention 1. Mask can be created by logical OR of various `WIFI_EVENT_MASK_` constants. Events which have corresponding bit set in the mask will not be delivered to the system event handler.

Attention 2. Default WiFi event mask is `WIFI_EVENT_MASK_AP_PROBEREQRCVED`.

Attention 3. There may be lots of stations sending probe request data around. Don't unmask this event unless you need to receive probe request data.

Return

- `ESP_OK`: succeed
- `ESP_ERR_WIFI_NOT_INIT`: WiFi is not initialized by `esp_wifi_init`

Parameters

- `mask`: WiFi event mask.

esp_err_t **esp_wifi_get_event_mask** (*uint32_t *mask*)

Get mask of WiFi events.

Return

- `ESP_OK`: succeed
- `ESP_ERR_WIFI_NOT_INIT`: WiFi is not initialized by `esp_wifi_init`
- `ESP_ERR_WIFI_ARG`: invalid argument

Parameters

- `mask`: WiFi event mask.

esp_err_t **esp_wifi_80211_tx** (*wifi_interface_t ifx*, *const* void **buffer*, *int len*, *bool en_sys_seq*)

Send raw ieee80211 data.

Attention Currently only support for sending beacon/probe request/probe response/action and non-QoS data frame

Return

- ESP_OK: success
- ESP_ERR_WIFI_IF: Invalid interface
- ESP_ERR_INVALID_ARG: Invalid parameter
- ESP_ERR_WIFI_NO_MEM: out of memory

Parameters

- *ifx*: interface if the Wi-Fi mode is Station, the *ifx* should be WIFI_IF_STA. If the Wi-Fi mode is SoftAP, the *ifx* should be WIFI_IF_AP. If the Wi-Fi mode is Station+SoftAP, the *ifx* should be WIFI_IF_STA or WIFI_IF_AP. If the *ifx* is wrong, the API returns ESP_ERR_WIFI_IF.
- *buffer*: raw ieee80211 buffer
- *len*: the length of raw buffer, the *len* must be ≤ 1500 Bytes and ≥ 24 Bytes
- *en_sys_seq*: indicate whether use the internal sequence number. If *en_sys_seq* is false, the sequence in raw buffer is unchanged, otherwise it will be overwritten by WiFi driver with the system sequence number. Generally, if *esp_wifi_80211_tx* is called before the Wi-Fi connection has been set up, both *en_sys_seq==true* and *en_sys_seq==false* are fine. However, if the API is called after the Wi-Fi connection has been set up, *en_sys_seq* must be true, otherwise ESP_ERR_WIFI_ARG is returned.

esp_err_t **esp_wifi_set_csi_rx_cb** (*wifi_csi_cb_t* *cb*, void **ctx*)

Register the RX callback function of CSI data.

Each time a CSI data is received, the callback function will be called.

Return

- ESP_OK: succeed
- ESP_ERR_WIFI_NOT_INIT: WiFi is not initialized by *esp_wifi_init*

Parameters

- *cb*: callback
- *ctx*: context argument, passed to callback function

esp_err_t **esp_wifi_set_csi_config** (const *wifi_csi_config_t* **config*)

Set CSI data configuration.

return

- ESP_OK: succeed
- ESP_ERR_WIFI_NOT_INIT: WiFi is not initialized by *esp_wifi_init*
- ESP_ERR_WIFI_NOT_START: WiFi is not started by *esp_wifi_start* or promiscuous mode is not enabled
- ESP_ERR_INVALID_ARG: invalid argument

Parameters

- *config*: configuration

esp_err_t **esp_wifi_set_csi** (bool *en*)

Enable or disable CSI.

return

- ESP_OK: succeed
- ESP_ERR_WIFI_NOT_INIT: WiFi is not initialized by *esp_wifi_init*
- ESP_ERR_WIFI_NOT_START: WiFi is not started by *esp_wifi_start* or promiscuous mode is not enabled
- ESP_ERR_INVALID_ARG: invalid argument

Parameters

- *en*: true - enable, false - disable

esp_err_t **esp_wifi_set_ant_gpio** (const *wifi_ant_gpio_config_t* **config*)

Set antenna GPIO configuration.

Return

- ESP_OK: succeed

- ESP_ERR_WIFI_NOT_INIT: WiFi is not initialized by esp_wifi_init
- ESP_ERR_WIFI_ARG: Invalid argument, e.g. parameter is NULL, invalid GPIO number etc

Parameters

- config: Antenna GPIO configuration.

esp_err_t **esp_wifi_get_ant_gpio** (*wifi_ant_gpio_config_t* *config)

Get current antenna GPIO configuration.

Return

- ESP_OK: succeed
- ESP_ERR_WIFI_NOT_INIT: WiFi is not initialized by esp_wifi_init
- ESP_ERR_WIFI_ARG: invalid argument, e.g. parameter is NULL

Parameters

- config: Antenna GPIO configuration.

esp_err_t **esp_wifi_set_ant** (const *wifi_ant_config_t* *config)

Set antenna configuration.

Return

- ESP_OK: succeed
- ESP_ERR_WIFI_NOT_INIT: WiFi is not initialized by esp_wifi_init
- ESP_ERR_WIFI_ARG: Invalid argument, e.g. parameter is NULL, invalid antenna mode or invalid GPIO number

Parameters

- config: Antenna configuration.

esp_err_t **esp_wifi_get_ant** (*wifi_ant_config_t* *config)

Get current antenna configuration.

Return

- ESP_OK: succeed
- ESP_ERR_WIFI_NOT_INIT: WiFi is not initialized by esp_wifi_init
- ESP_ERR_WIFI_ARG: invalid argument, e.g. parameter is NULL

Parameters

- config: Antenna configuration.

int64_t **esp_wifi_get_tsf_time** (*wifi_interface_t* interface)

Get the TSF time In Station mode or SoftAP+Station mode if station is not connected or station doesn't receive at least one beacon after connected, will return 0.

Attention Enabling power save may cause the return value inaccurate, except WiFi modem sleep

Return 0 or the TSF time

Parameters

- interface: The interface whose tsf_time is to be retrieved.

esp_err_t **esp_wifi_set_inactive_time** (*wifi_interface_t* ifx, *uint16_t* sec)

Set the inactive time of the ESP32 STA or AP.

Attention 1. For Station, If the station does not receive a beacon frame from the connected SoftAP during the inactive time, disconnect from SoftAP. Default 6s.

Attention 2. For SoftAP, If the softAP doesn't receive any data from the connected STA during inactive time, the softAP will force death the STA. Default is 300s.

Attention 3. The inactive time configuration is not stored into flash

Return

- ESP_OK: succeed
- ESP_ERR_WIFI_NOT_INIT: WiFi is not initialized by esp_wifi_init
- ESP_ERR_WIFI_NOT_STARTED: WiFi is not started by esp_wifi_start
- ESP_ERR_WIFI_ARG: invalid argument, For Station, if sec is less than 3. For SoftAP, if sec is less than 10.

Parameters

- ifx: interface to be configured.
- sec: Inactive time. Unit seconds.

esp_err_t **esp_wifi_get_inactive_time** (*wifi_interface_t* ifx, uint16_t *sec)

Get inactive time of specified interface.

Return

- ESP_OK: succeed
- ESP_ERR_WIFI_NOT_INIT: WiFi is not initialized by esp_wifi_init
- ESP_ERR_WIFI_ARG: invalid argument

Parameters

- ifx: Interface to be configured.
- sec: Inactive time. Unit seconds.

esp_err_t **esp_wifi_stats_dump** (uint32_t modules)

Dump WiFi statistics.

Return

- ESP_OK: succeed
- others: failed

Parameters

- modules: statistic modules to be dumped

esp_err_t **esp_wifi_set_rssi_threshold** (int32_t rssi)

Set RSSI threshold below which APP will get an event.

Attention This API needs to be called every time after WIFI_EVENT_STA_BSS_RSSI_LOW event is received.

Return

- ESP_OK: succeed
- ESP_ERR_WIFI_NOT_INIT: WiFi is not initialized by esp_wifi_init
- ESP_ERR_WIFI_ARG: invalid argument

Parameters

- rssi: threshold value in dbm between -100 to 0

esp_err_t **esp_wifi_ftm_initiate_session** (*wifi_ftm_initiator_cfg_t* *cfg)

Start an FTM Initiator session by sending FTM request. If successful, event WIFI_EVENT_FTM_REPORT is generated with the result of the FTM procedure.

Attention Use this API only in Station mode

Return

- ESP_OK: succeed
- others: failed

Parameters

- cfg: FTM Initiator session configuration

esp_err_t **esp_wifi_ftm_end_session** (void)

End the ongoing FTM Initiator session.

Attention This API works only on FTM Initiator

Return

- ESP_OK: succeed
- others: failed

esp_err_t **esp_wifi_ftm_resp_set_offset** (int16_t offset_cm)

Set offset in cm for FTM Responder. An equivalent offset is calculated in picoseconds and added in TOD of FTM Measurement frame (T1).

Attention Use this API only in AP mode before performing FTM as responder

Return

- ESP_OK: succeed
- others: failed

Parameters

- offset_cm: T1 Offset to be added in centimeters

esp_err_t **esp_wifi_config_11b_rate** (*wifi_interface_t* ifx, bool disable)

Enable or disable 11b rate of specified interface.

Attention 1. This API should be called after `esp_wifi_init()` and before `esp_wifi_start()`.

Attention 2. Only when really need to disable 11b rate call this API otherwise don't call this.

Return

- ESP_OK: succeed
- others: failed

Parameters

- `ifx`: Interface to be configured.
- `disable`: true means disable 11b rate while false means enable 11b rate.

esp_err_t **esp_wifi_set_connectionless_wake_interval** (*uint16_t interval*)

Set interval for station to wake up periodically at disconnected.

Attention 1. Only when ESP_WIFI_STA_DISCONNECTED_PM_ENABLE is enabled, this configuration could work

Attention 2. This configuration only work for station mode and disconnected status

Attention 3. This configuration would influence nothing until some module configure `wake_window`

Attention 4. A sensible interval which is not too small is recommended (e.g. 100ms)

Parameters

- `interval`: how much microsecond would the chip wake up, from 1 to 65535.

esp_err_t **esp_wifi_set_country_code** (*const char *country*, *bool ieee80211d_enabled*)

configure country

Attention 1. When `ieee80211d_enabled`, the country info of the AP to which the station is connected is used. E.g. if the configured country is US and the country info of the AP to which the station is connected is JP then the country info that will be used is JP. If the station disconnected from the AP the country info is set back to the country info of the station automatically, US in the example.

Attention 2. When `ieee80211d_enabled` is disabled, then the configured country info is used always.

Attention 3. When the country info is changed because of configuration or because the station connects to a different external AP, the country IE in probe response/beacon of the soft-AP is also changed.

Attention 4. The country configuration is stored into flash.

Attention 5. When this API is called, the PHY init data will switch to the PHY init data type corresponding to the country info.

Attention 6. Supported country codes are “01” (world safe mode) “AT” ,” AU” ,” BE” ,” BG” ,” BR” ,” CA” ,” CH” ,” CN” ,” CY” ,” CZ” ,” DE” ,” DK” ,” EE” ,” ES” ,” FI” ,” FR” ,” GB” ,” GR” ,” HK” ,” HR” ,” HU” ,” IE” ,” IN” ,” IS” ,” IT” ,” JP” ,” KR” ,” LI” ,” LT” ,” LU” ,” LV” ,” MT” ,” MX” ,” NL” ,” NO” ,” NZ” ,” PL” ,” PT” ,” RO” ,” SE” ,” SI” ,” SK” ,” TW” ,” US”

Attention 7. When country code “01” (world safe mode) is set, SoftAP mode won't contain country IE.

Attention 8. The default country is “CN” and `ieee80211d_enabled` is TRUE.

Return

- ESP_OK: succeed
- ESP_ERR_WIFI_NOT_INIT: WiFi is not initialized by `esp_wifi_init`
- ESP_ERR_INVALID_ARG: invalid argument

Parameters

- `country`: the configured country ISO code
- `ieee80211d_enabled`: 802.11d is enabled or not

esp_err_t **esp_wifi_get_country_code** (*char *country*)

get the current country code

Return

- ESP_OK: succeed
- ESP_ERR_WIFI_NOT_INIT: WiFi is not initialized by `esp_wifi_init`
- ESP_ERR_INVALID_ARG: invalid argument

Parameters

- `country`: country code

esp_err_t **esp_wifi_config_80211_tx_rate** (*wifi_interface_t ifx*, *wifi_phy_rate_t rate*)

Config 80211 tx rate of specified interface.

Attention 1. This API should be called after `esp_wifi_init()` and before `esp_wifi_start()`.

Return

- ESP_OK: succeed
- others: failed

Parameters

- `ifx`: Interface to be configured.
- `rate`: Phy rate to be configured.

esp_err_t **esp_wifi_disable_pmf_config** (*wifi_interface_t* ifx)

Disable PMF configuration for specified interface.

Attention This API should be called after `esp_wifi_set_config()` and before `esp_wifi_start()`.

Return

- ESP_OK: succeed
- others: failed

Parameters

- `ifx`: Interface to be configured.

Structures

struct `wifi_init_config_t`

WiFi stack configuration parameters passed to `esp_wifi_init` call.

Public Members

system_event_handler_t **event_handler**

WiFi event handler

wifi_osi_funcs_t ***osi_funcs**

WiFi OS functions

wpa_crypto_funcs_t **wpa_crypto_funcs**

WiFi station crypto functions when connect

int **static_rx_buf_num**

WiFi static RX buffer number

int **dynamic_rx_buf_num**

WiFi dynamic RX buffer number

int **tx_buf_type**

WiFi TX buffer type

int **static_tx_buf_num**

WiFi static TX buffer number

int **dynamic_tx_buf_num**

WiFi dynamic TX buffer number

int **cache_tx_buf_num**

WiFi TX cache buffer number

int **csi_enable**

WiFi channel state information enable flag

int **ampdu_rx_enable**

WiFi AMPDU RX feature enable flag

int **ampdu_tx_enable**

WiFi AMPDU TX feature enable flag

int **amsdu_tx_enable**

WiFi AMSDU TX feature enable flag

int **nvs_enable**

WiFi NVS flash enable flag

int nano_enable
Nano option for printf/scan family enable flag

int rx_ba_win
WiFi Block Ack RX window size

int wifi_task_core_id
WiFi Task Core ID

int beacon_max_len
WiFi softAP maximum length of the beacon

int mgmt_sbuf_num
WiFi management short buffer number, the minimum value is 6, the maximum value is 32

uint64_t feature_caps
Enables additional WiFi features and capabilities

bool sta_disconnected_pm
WiFi Power Management for station at disconnected status

int magic
WiFi init magic number, it should be the last field

Macros

ESP_ERR_WIFI_NOT_INIT
WiFi driver was not installed by esp_wifi_init

ESP_ERR_WIFI_NOT_STARTED
WiFi driver was not started by esp_wifi_start

ESP_ERR_WIFI_NOT_STOPPED
WiFi driver was not stopped by esp_wifi_stop

ESP_ERR_WIFI_IF
WiFi interface error

ESP_ERR_WIFI_MODE
WiFi mode error

ESP_ERR_WIFI_STATE
WiFi internal state error

ESP_ERR_WIFI_CONN
WiFi internal control block of station or soft-AP error

ESP_ERR_WIFI_NVS
WiFi internal NVS module error

ESP_ERR_WIFI_MAC
MAC address is invalid

ESP_ERR_WIFI_SSID
SSID is invalid

ESP_ERR_WIFI_PASSWORD
Password is invalid

ESP_ERR_WIFI_TIMEOUT
Timeout error

ESP_ERR_WIFI_WAKE_FAIL
WiFi is in sleep state(RF closed) and wakeup fail

ESP_ERR_WIFI_WOULD_BLOCK
The caller would block

ESP_ERR_WIFI_NOT_CONNECT
Station still in disconnect status

ESP_ERR_WIFI_POST
Failed to post the event to WiFi task

ESP_ERR_WIFI_INIT_STATE
Invalid WiFi state when init/deinit is called

ESP_ERR_WIFI_STOP_STATE
Returned when WiFi is stopping

ESP_ERR_WIFI_NOT_ASSOC
The WiFi connection is not associated

ESP_ERR_WIFI_TX_DISALLOW
The WiFi TX is disallowed

WIFI_STATIC_TX_BUFFER_NUM

WIFI_CACHE_TX_BUFFER_NUM

WIFI_DYNAMIC_TX_BUFFER_NUM

WIFI_CSI_ENABLED

WIFI_AMPDU_RX_ENABLED

WIFI_AMPDU_TX_ENABLED

WIFI_AMSDU_TX_ENABLED

WIFI_NVS_ENABLED

WIFI_NANO_FORMAT_ENABLED

WIFI_INIT_CONFIG_MAGIC

WIFI_DEFAULT_RX_BA_WIN

WIFI_TASK_CORE_ID

WIFI_SOFTAP_BEACON_MAX_LEN

WIFI_MGMT_SBUF_NUM

WIFI_STA_DISCONNECTED_PM_ENABLED

CONFIG_FEATURE_WPA3_SAE_BIT

CONFIG_FEATURE_CACHE_TX_BUF_BIT

CONFIG_FEATURE_FTM_INITIATOR_BIT

CONFIG_FEATURE_FTM_RESPONDER_BIT

WIFI_INIT_CONFIG_DEFAULT()

Type Definitions

typedef void (***wifi_promiscuous_cb_t**) (void *buf, *wifi_promiscuous_pkt_type_t* type)

The RX callback function in the promiscuous mode. Each time a packet is received, the callback function will be called.

Parameters

- buf: Data received. Type of data in buffer (*wifi_promiscuous_pkt_t* or *wifi_pkt_rx_ctrl_t*) indicated by 'type' parameter.
- type: promiscuous packet type.

typedef void (***esp_vendor_ie_cb_t**) (void *ctx, *wifi_vendor_ie_type_t* type, **const** uint8_t sa[6], **const** *vendor_ie_data_t* *vnd_ie, int rssi)

Function signature for received Vendor-Specific Information Element callback.

Parameters

- `ctx`: Context argument, as passed to `esp_wifi_set_vendor_ie_cb()` when registering callback.
- `type`: Information element type, based on frame type received.
- `sa`: Source 802.11 address.
- `vnd_ie`: Pointer to the vendor specific element data received.
- `rssi`: Received signal strength indication.

```
typedef void (*wifi_csi_cb_t) (void *ctx, wifi_csi_info_t *data)
```

The RX callback function of Channel State Information(CSI) data.

Each time a CSI data is received, the callback function will be called.

Parameters

- `ctx`: context argument, passed to `esp_wifi_set_csi_rx_cb()` when registering callback function.
- `data`: CSI data received. The memory that it points to will be deallocated after callback function returns.

Header File

- `esp_wifi/include/esp_wifi_types.h`

Unions

```
union wifi_config_t
```

#include <esp_wifi_types.h> Configuration data for ESP32 AP or STA.

The usage of this union (for ap or sta configuration) is determined by the accompanying interface argument passed to `esp_wifi_set_config()` or `esp_wifi_get_config()`

Public Members

wifi_ap_config_t **ap**
configuration of AP

wifi_sta_config_t **sta**
configuration of STA

Structures

```
struct wifi_country_t
```

Structure describing WiFi country-based regional restrictions.

Public Members

char **cc**[3]
country code string

uint8_t **schan**
start channel

uint8_t **nchan**
total channel number

int8_t **max_tx_power**
This field is used for getting WiFi maximum transmitting power, call `esp_wifi_set_max_tx_power` to set the maximum transmitting power.

wifi_country_policy_t **policy**
country policy

```
struct wifi_active_scan_time_t
```

Range of active scan times per channel.

Public Members

`uint32_t min`
minimum active scan time per channel, units: millisecond

`uint32_t max`
maximum active scan time per channel, units: millisecond, values above 1500ms may cause station to disconnect from AP and are not recommended.

struct `wifi_scan_time_t`
Aggregate of active & passive scan time per channel.

Public Members

`wifi_active_scan_time_t active`
active scan time per channel, units: millisecond.

`uint32_t passive`
passive scan time per channel, units: millisecond, values above 1500ms may cause station to disconnect from AP and are not recommended.

struct `wifi_scan_config_t`
Parameters for an SSID scan.

Public Members

`uint8_t *ssid`
SSID of AP

`uint8_t *bssid`
MAC address of AP

`uint8_t channel`
channel, scan the specific channel

`bool show_hidden`
enable to scan AP whose SSID is hidden

`wifi_scan_type_t scan_type`
scan type, active or passive

`wifi_scan_time_t scan_time`
scan time per channel

struct `wifi_ap_record_t`
Description of a WiFi AP.

Public Members

`uint8_t bssid[6]`
MAC address of AP

`uint8_t ssid[33]`
SSID of AP

`uint8_t primary`
channel of AP

`wifi_second_chan_t second`
secondary channel of AP

`int8_t rssi`
signal strength of AP

wifi_auth_mode_t **authmode**
authmode of AP

wifi_cipher_type_t **pairwise_cipher**
pairwise cipher of AP

wifi_cipher_type_t **group_cipher**
group cipher of AP

wifi_ant_t **ant**
antenna used to receive beacon from AP

uint32_t **phy_11b** : 1
bit: 0 flag to identify if 11b mode is enabled or not

uint32_t **phy_11g** : 1
bit: 1 flag to identify if 11g mode is enabled or not

uint32_t **phy_11n** : 1
bit: 2 flag to identify if 11n mode is enabled or not

uint32_t **phy_lr** : 1
bit: 3 flag to identify if low rate is enabled or not

uint32_t **wps** : 1
bit: 4 flag to identify if WPS is supported or not

uint32_t **ftm_responder** : 1
bit: 5 flag to identify if FTM is supported in responder mode

uint32_t **ftm_initiator** : 1
bit: 6 flag to identify if FTM is supported in initiator mode

uint32_t **reserved** : 25
bit: 7..31 reserved

wifi_country_t **country**
country information of AP

struct wifi_scan_threshold_t
Structure describing parameters for a WiFi fast scan.

Public Members

int8_t **rss**
The minimum rssi to accept in the fast scan mode

wifi_auth_mode_t **authmode**
The weakest authmode to accept in the fast scan mode

struct wifi_pmf_config_t
Configuration structure for Protected Management Frame

Public Members

bool **capable**
Deprecated variable. Device will always connect in PMF mode if other device also advertizes PMF capability.

bool **required**
Advertizes that Protected Management Frame is required. Device will not associate to non-PMF capable devices.

struct wifi_ap_config_t
Soft-AP configuration settings for the ESP32.

Public Members

`uint8_t ssid[32]`
SSID of ESP32 soft-AP. If `ssid_len` field is 0, this must be a Null terminated string. Otherwise, length is set according to `ssid_len`.

`uint8_t password[64]`
Password of ESP32 soft-AP.

`uint8_t ssid_len`
Optional length of SSID field.

`uint8_t channel`
Channel of ESP32 soft-AP

`wifi_auth_mode_t authmode`
Auth mode of ESP32 soft-AP. Do not support AUTH_WEP in soft-AP mode

`uint8_t ssid_hidden`
Broadcast SSID or not, default 0, broadcast the SSID

`uint8_t max_connection`
Max number of stations allowed to connect in, default 4, max 10

`uint16_t beacon_interval`
Beacon interval which should be multiples of 100. Unit: TU(time unit, 1 TU = 1024 us). Range: 100 ~ 60000. Default value: 100

`wifi_cipher_type_t pairwise_cipher`
pairwise cipher of SoftAP, group cipher will be derived using this. cipher values are valid starting from `WIFI_CIPHER_TYPE_TKIP`, enum values before that will be considered as invalid and default cipher suites(TKIP+CCMP) will be used. Valid cipher suites in softAP mode are `WIFI_CIPHER_TYPE_TKIP`, `WIFI_CIPHER_TYPE_CCMP` and `WIFI_CIPHER_TYPE_TKIP_CCMP`.

`bool ftm_responder`
Enable FTM Responder mode

`struct wifi_sta_config_t`
STA configuration settings for the ESP32.

Public Members

`uint8_t ssid[32]`
SSID of target AP.

`uint8_t password[64]`
Password of target AP.

`wifi_scan_method_t scan_method`
do all channel scan or fast scan

`bool bssid_set`
whether set MAC address of target AP or not. Generally, `station_config.bssid_set` needs to be 0; and it needs to be 1 only when users need to check the MAC address of the AP.

`uint8_t bssid[6]`
MAC address of target AP

`uint8_t channel`
channel of target AP. Set to 1~13 to scan starting from the specified channel before connecting to AP. If the channel of AP is unknown, set it to 0.

uint16_t listen_interval

Listen interval for ESP32 station to receive beacon when WIFI_PS_MAX_MODEM is set. Units: AP beacon intervals. Defaults to 3 if set to 0.

wifi_sort_method_t sort_method

sort the connect AP in the list by rssi or security mode

wifi_scan_threshold_t threshold

When sort_method is set, only APs which have an auth mode that is more secure than the selected auth mode and a signal stronger than the minimum RSSI will be used.

wifi_pmf_config_t pmf_cfg

Configuration for Protected Management Frame. Will be advertized in RSN Capabilities in RSN IE.

uint32_t rm_enabled : 1

Whether Radio Measurements are enabled for the connection

uint32_t btm_enabled : 1

Whether BSS Transition Management is enabled for the connection

uint32_t reserved : 30

Reserved for future feature set

wifi_sae_pwe_method_t sae_pwe_h2e

Whether SAE hash to element is enabled

struct wifi_sta_info_t

Description of STA associated with AP.

Public Members**uint8_t mac[6]**

mac address

int8_t rssi

current average rssi of sta connected

uint32_t phy_11b : 1

bit: 0 flag to identify if 11b mode is enabled or not

uint32_t phy_11g : 1

bit: 1 flag to identify if 11g mode is enabled or not

uint32_t phy_11n : 1

bit: 2 flag to identify if 11n mode is enabled or not

uint32_t phy_lr : 1

bit: 3 flag to identify if low rate is enabled or not

uint32_t is_mesh_child : 1

bit: 4 flag to identify mesh child

uint32_t reserved : 27

bit: 5..31 reserved

struct wifi_sta_list_t

List of stations associated with the ESP32 Soft-AP.

Public Members**wifi_sta_info_t sta[ESP_WIFI_MAX_CONN_NUM]**

station list

int num

number of stations in the list (other entries are invalid)

struct vendor_ie_data_t

Vendor Information Element header.

The first bytes of the Information Element will match this header. Payload follows.

Public Members

uint8_t **element_id**

Should be set to WIFI_VENDOR_IE_ELEMENT_ID (0xDD)

uint8_t **length**

Length of all bytes in the element data following this field. Minimum 4.

uint8_t **vendor_oui**[3]

Vendor identifier (OUI).

uint8_t **vendor_oui_type**

Vendor-specific OUI type.

uint8_t **payload**[0]

Payload. Length is equal to value in 'length' field, minus 4.

struct wifi_pkt_rx_ctrl_t

Received packet radio metadata header, this is the common header at the beginning of all promiscuous mode RX callback buffers.

Public Members

signed **rss_i** : 8

Received Signal Strength Indicator(RSSI) of packet. unit: dBm

unsigned **rate** : 5

PHY rate encoding of the packet. Only valid for non HT(11bg) packet

unsigned **__pad0__** : 1

reserved

unsigned **sig_mode** : 2

0: non HT(11bg) packet; 1: HT(11n) packet; 3: VHT(11ac) packet

unsigned **__pad1__** : 16

reserved

unsigned **mcs** : 7

Modulation Coding Scheme. If is HT(11n) packet, shows the modulation, range from 0 to 76(MCS0 ~ MCS76)

unsigned **cwb** : 1

Channel Bandwidth of the packet. 0: 20MHz; 1: 40MHz

unsigned **__pad2__** : 16

reserved

unsigned **smoothing** : 1

reserved

unsigned **not_sounding** : 1

reserved

unsigned **__pad3__** : 1

reserved

unsigned **aggregation** : 1

Aggregation. 0: MPDU packet; 1: AMPDU packet

unsigned **stbc** : 2
Space Time Block Code(STBC). 0: non STBC packet; 1: STBC packet

unsigned **fec_coding** : 1
Flag is set for 11n packets which are LDPC

unsigned **sgi** : 1
Short Guide Interval(SGI). 0: Long GI; 1: Short GI

unsigned **__pad4__** : 8
reserved

unsigned **ampdu_cnt** : 8
ampdu cnt

unsigned **channel** : 4
primary channel on which this packet is received

unsigned **secondary_channel** : 4
secondary channel on which this packet is received. 0: none; 1: above; 2: below

unsigned **__pad5__** : 8
reserved

unsigned **timestamp** : 32
timestamp. The local time when this packet is received. It is precise only if modem sleep or light sleep is not enabled. unit: microsecond

unsigned **__pad6__** : 32
reserved

signed **noise_floor** : 8
noise floor of Radio Frequency Module(RF). unit: dBm

unsigned **__pad7__** : 24
reserved

unsigned **__pad8__** : 32
reserved

unsigned **__pad9__** : 31
reserved

unsigned **ant** : 1
antenna number from which this packet is received. 0: WiFi antenna 0; 1: WiFi antenna 1

unsigned **__pad10__** : 32
reserved

unsigned **__pad11__** : 32
reserved

unsigned **__pad12__** : 32
reserved

unsigned **sig_len** : 12
length of packet including Frame Check Sequence(FCS)

unsigned **__pad13__** : 12
reserved

unsigned **rx_state** : 8
state of the packet. 0: no error; others: error numbers which are not public

struct wifi_promiscuous_pkt_t

Payload passed to 'buf' parameter of promiscuous mode RX callback.

Public Members

wifi_pkt_rx_ctrl_t **rx_ctrl**
metadata header

uint8_t **payload**[0]
Data or management payload. Length of payload is described by rx_ctrl.sig_len. Type of content determined by packet type argument of callback.

struct wifi_promiscuous_filter_t
Mask for filtering different packet types in promiscuous mode.

Public Members

uint32_t **filter_mask**
OR of one or more filter values WIFI_PROMIS_FILTER_*

struct wifi_csi_config_t
Channel state information(CSI) configuration type.

Public Members

bool **lltf_en**
enable to receive legacy long training field(lltf) data. Default enabled

bool **htltf_en**
enable to receive HT long training field(htltf) data. Default enabled

bool **stbc_htltf2_en**
enable to receive space time block code HT long training field(stbc-htltf2) data. Default enabled

bool **ltf_merge_en**
enable to generate htltf data by averaging lltf and ht_ltf data when receiving HT packet. Otherwise, use ht_ltf data directly. Default enabled

bool **channel_filter_en**
enable to turn on channel filter to smooth adjacent sub-carrier. Disable it to keep independence of adjacent sub-carrier. Default enabled

bool **manu_scale**
manually scale the CSI data by left shifting or automatically scale the CSI data. If set true, please set the shift bits. false: automatically. true: manually. Default false

uint8_t **shift**
manually left shift bits of the scale of the CSI data. The range of the left shift bits is 0~15

struct wifi_csi_info_t
CSI data type.

Public Members

wifi_pkt_rx_ctrl_t **rx_ctrl**
received packet radio metadata header of the CSI data

uint8_t **mac**[6]
source MAC address of the CSI data

bool **first_word_invalid**
first four bytes of the CSI data is invalid or not

int8_t ***buf**
buffer of CSI data

`uint16_t len`
length of CSI data

struct `wifi_ant_gpio_t`
WiFi GPIO configuration for antenna selection.

Public Members

`uint8_t gpio_select` : 1
Whether this GPIO is connected to external antenna switch

`uint8_t gpio_num` : 7
The GPIO number that connects to external antenna switch

struct `wifi_ant_gpio_config_t`
WiFi GPIOs configuration for antenna selection.

Public Members

`wifi_ant_gpio_t gpio_cfg`[4]
The configurations of GPIOs that connect to external antenna switch

struct `wifi_ant_config_t`
WiFi antenna configuration.

Public Members

`wifi_ant_mode_t rx_ant_mode`
WiFi antenna mode for receiving

`wifi_ant_t rx_ant_default`
Default antenna mode for receiving, it's ignored if `rx_ant_mode` is not `WIFI_ANT_MODE_AUTO`

`wifi_ant_mode_t tx_ant_mode`
WiFi antenna mode for transmission, it can be set to `WIFI_ANT_MODE_AUTO` only if `rx_ant_mode` is set to `WIFI_ANT_MODE_AUTO`

`uint8_t enabled_ant0` : 4
Index (in antenna GPIO configuration) of enabled `WIFI_ANT_MODE_ANT0`

`uint8_t enabled_ant1` : 4
Index (in antenna GPIO configuration) of enabled `WIFI_ANT_MODE_ANT1`

struct `wifi_action_tx_req_t`
Action Frame Tx Request.

Public Members

`wifi_interface_t ifx`
WiFi interface to send request to

`uint8_t dest_mac`[6]
Destination MAC address

bool `no_ack`
Indicates no ack required

`wifi_action_rx_cb_t rx_cb`
Rx Callback to receive any response

`uint32_t data_len`
Length of the appended Data

`uint8_t data[0]`
Appended Data payload

struct wifi_ftm_initiator_cfg_t
FTM Initiator configuration.

Public Members

`uint8_t resp_mac[6]`
MAC address of the FTM Responder

`uint8_t channel`
Primary channel of the FTM Responder

`uint8_t frm_count`
No. of FTM frames requested in terms of 4 or 8 bursts (allowed values - 0(No pref), 16, 24, 32, 64)

`uint16_t burst_period`
Requested time period between consecutive FTM bursts in 100⁷ s of milliseconds (0 - No pref)

struct wifi_event_sta_scan_done_t
Argument structure for WIFI_EVENT_SCAN_DONE event

Public Members

`uint32_t status`
status of scanning APs: 0 — success, 1 - failure

`uint8_t number`
number of scan results

`uint8_t scan_id`
scan sequence number, used for block scan

struct wifi_event_sta_connected_t
Argument structure for WIFI_EVENT_STA_CONNECTED event

Public Members

`uint8_t ssid[32]`
SSID of connected AP

`uint8_t ssid_len`
SSID length of connected AP

`uint8_t bssid[6]`
BSSID of connected AP

`uint8_t channel`
channel of connected AP

`wifi_auth_mode_t authmode`
authentication mode used by AP

struct wifi_event_sta_disconnected_t
Argument structure for WIFI_EVENT_STA_DISCONNECTED event

Public Members

`uint8_t ssid[32]`
SSID of disconnected AP

`uint8_t ssid_len`
SSID length of disconnected AP

`uint8_t bssid[6]`
BSSID of disconnected AP

`uint8_t reason`
reason of disconnection

struct `wifi_event_sta_authmode_change_t`
Argument structure for `WIFI_EVENT_STA_AUTHMODE_CHANGE` event

Public Members

`wifi_auth_mode_t old_mode`
the old auth mode of AP

`wifi_auth_mode_t new_mode`
the new auth mode of AP

struct `wifi_event_sta_wps_er_pin_t`
Argument structure for `WIFI_EVENT_STA_WPS_ER_PIN` event

Public Members

`uint8_t pin_code[8]`
PIN code of station in enrollee mode

struct `wifi_event_sta_wps_er_success_t`
Argument structure for `WIFI_EVENT_STA_WPS_ER_SUCCESS` event

Public Members

`uint8_t ap_cred_cnt`
Number of AP credentials received

`uint8_t ssid[MAX_SSID_LEN]`
SSID of AP

`uint8_t passphrase[MAX_PASSPHRASE_LEN]`
Passphrase for the AP

struct `wifi_event_sta_wps_er_success_t::[anonymous] ap_cred[MAX_WPS_AP_CRED]`
All AP credentials received from WPS handshake

struct `wifi_event_ap_staconnected_t`
Argument structure for `WIFI_EVENT_AP_STACONNECTED` event

Public Members

`uint8_t mac[6]`
MAC address of the station connected to ESP32 soft-AP

`uint8_t aid`
the aid that ESP32 soft-AP gives to the station connected to

`bool is_mesh_child`
flag to identify mesh child

struct `wifi_event_ap_stadisconnected_t`
Argument structure for `WIFI_EVENT_AP_STADISCONNECTED` event

Public Members**uint8_t mac[6]**

MAC address of the station disconnects to ESP32 soft-AP

uint8_t aid

the aid that ESP32 soft-AP gave to the station disconnects to

bool is_mesh_child

flag to identify mesh child

struct wifi_event_ap_probe_req_rx_t

Argument structure for WIFI_EVENT_AP_PROBEREQRECVED event

Public Members**int rssi**

Received probe request signal strength

uint8_t mac[6]

MAC address of the station which send probe request

struct wifi_event_bss_rssi_low_t

Argument structure for WIFI_EVENT_STA_BSS_RSSI_LOW event

Public Members**int32_t rssi**

RSSI value of bss

struct wifi_ftm_report_entry_t

Argument structure for

Public Members**uint8_t dlog_token**

Dialog Token of the FTM frame

int8_t rssi

RSSI of the FTM frame received

uint32_t rtt

Round Trip Time in pSec with a peer

uint64_t t1

Time of departure of FTM frame from FTM Responder in pSec

uint64_t t2

Time of arrival of FTM frame at FTM Initiator in pSec

uint64_t t3

Time of departure of ACK from FTM Initiator in pSec

uint64_t t4

Time of arrival of ACK at FTM Responder in pSec

struct wifi_event_ftm_report_t

Argument structure for WIFI_EVENT_FTM_REPORT event

Public Members**uint8_t peer_mac[6]**

MAC address of the FTM Peer

wifi_ftm_status_t status

Status of the FTM operation

uint32_t rtt_raw

Raw average Round-Trip-Time with peer in Nano-Seconds

uint32_t rtt_est

Estimated Round-Trip-Time with peer in Nano-Seconds

uint32_t dist_est

Estimated one-way distance in Centi-Meters

wifi_ftm_report_entry_t *ftm_report_data

Pointer to FTM Report with multiple entries, should be freed after use

uint8_t ftm_report_num_entries

Number of entries in the FTM Report data

struct wifi_event_action_tx_status_t

Argument structure for WIFI_EVENT_ACTION_TX_STATUS event

Public Members**wifi_interface_t ifx**

WiFi interface to send request to

uint32_t context

Context to identify the request

uint8_t da[6]

Destination MAC address

uint8_t status

Status of the operation

struct wifi_event_roc_done_t

Argument structure for WIFI_EVENT_ROC_DONE event

Public Members**uint32_t context**

Context to identify the request

Macros**WIFI_OFFCHAN_TX_REQ****WIFI_OFFCHAN_TX_CANCEL****WIFI_ROC_REQ****WIFI_ROC_CANCEL****WIFI_PROTOCOL_11B****WIFI_PROTOCOL_11G****WIFI_PROTOCOL_11N****WIFI_PROTOCOL_LR**

ESP_WIFI_MAX_CONN_NUM
max number of stations which can connect to ESP32 soft-AP

WIFI_VENDOR_IE_ELEMENT_ID

WIFI_PROMIS_FILTER_MASK_ALL
filter all packets

WIFI_PROMIS_FILTER_MASK_MGMT
filter the packets with type of WIFI_PKT_MGMT

WIFI_PROMIS_FILTER_MASK_CTRL
filter the packets with type of WIFI_PKT_CTRL

WIFI_PROMIS_FILTER_MASK_DATA
filter the packets with type of WIFI_PKT_DATA

WIFI_PROMIS_FILTER_MASK_MISC
filter the packets with type of WIFI_PKT_MISC

WIFI_PROMIS_FILTER_MASK_DATA_MPDU
filter the MPDU which is a kind of WIFI_PKT_DATA

WIFI_PROMIS_FILTER_MASK_DATA_AMPDU
filter the AMPDU which is a kind of WIFI_PKT_DATA

WIFI_PROMIS_FILTER_MASK_FCSFAIL
filter the FCS failed packets, do not open it in general

WIFI_PROMIS_CTRL_FILTER_MASK_ALL
filter all control packets

WIFI_PROMIS_CTRL_FILTER_MASK_WRAPPER
filter the control packets with subtype of Control Wrapper

WIFI_PROMIS_CTRL_FILTER_MASK_BAR
filter the control packets with subtype of Block Ack Request

WIFI_PROMIS_CTRL_FILTER_MASK_BA
filter the control packets with subtype of Block Ack

WIFI_PROMIS_CTRL_FILTER_MASK_PSPOLL
filter the control packets with subtype of PS-Poll

WIFI_PROMIS_CTRL_FILTER_MASK_RTS
filter the control packets with subtype of RTS

WIFI_PROMIS_CTRL_FILTER_MASK_CTS
filter the control packets with subtype of CTS

WIFI_PROMIS_CTRL_FILTER_MASK_ACK
filter the control packets with subtype of ACK

WIFI_PROMIS_CTRL_FILTER_MASK_CFEND
filter the control packets with subtype of CF-END

WIFI_PROMIS_CTRL_FILTER_MASK_CFENDACK
filter the control packets with subtype of CF-END+CF-ACK

WIFI_EVENT_MASK_ALL
mask all WiFi events

WIFI_EVENT_MASK_NONE
mask none of the WiFi events

WIFI_EVENT_MASK_AP_PROBEREQRECVED
mask SYSTEM_EVENT_AP_PROBEREQRECVED event

MAX_SSID_LEN

MAX_PASSPHRASE_LEN
MAX_WPS_AP_CRED
WIFI_STATIS_BUFFER
WIFI_STATIS_RXTX
WIFI_STATIS_HW
WIFI_STATIS_DIAG
WIFI_STATIS_PS
WIFI_STATIS_ALL

Type Definitions

typedef int (*wifi_action_rx_cb_t) (uint8_t *hdr, uint8_t *payload, size_t len, uint8_t channel)
The Rx callback function of Action Tx operations.

Parameters

- **hdr**: pointer to the IEEE 802.11 Header structure
- **payload**: pointer to the Payload following 802.11 Header
- **len**: length of the Payload
- **channel**: channel number the frame is received on

Enumerations

enum wifi_mode_t

Values:

WIFI_MODE_NULL = 0
null mode

WIFI_MODE_STA
WiFi station mode

WIFI_MODE_AP
WiFi soft-AP mode

WIFI_MODE_APSTA
WiFi station + soft-AP mode

WIFI_MODE_MAX

enum wifi_interface_t

Values:

WIFI_IF_STA = ESP_IF_WIFI_STA

WIFI_IF_AP = ESP_IF_WIFI_AP

enum wifi_country_policy_t

Values:

WIFI_COUNTRY_POLICY_AUTO
Country policy is auto, use the country info of AP to which the station is connected

WIFI_COUNTRY_POLICY_MANUAL
Country policy is manual, always use the configured country info

enum wifi_auth_mode_t

Values:

WIFI_AUTH_OPEN = 0
authenticate mode : open

WIFI_AUTH_WEP
authenticate mode : WEP

WIFI_AUTH_WPA_PSK
authenticate mode : WPA_PSK

WIFI_AUTH_WPA2_PSK
authenticate mode : WPA2_PSK

WIFI_AUTH_WPA_WPA2_PSK
authenticate mode : WPA_WPA2_PSK

WIFI_AUTH_WPA2_ENTERPRISE
authenticate mode : WPA2_ENTERPRISE

WIFI_AUTH_WPA3_PSK
authenticate mode : WPA3_PSK

WIFI_AUTH_WPA2_WPA3_PSK
authenticate mode : WPA2_WPA3_PSK

WIFI_AUTH_WAPI_PSK
authenticate mode : WAPI_PSK

WIFI_AUTH_MAX

enum wifi_err_reason_t

Values:

WIFI_REASON_UNSPECIFIED = 1

WIFI_REASON_AUTH_EXPIRE = 2

WIFI_REASON_AUTH_LEAVE = 3

WIFI_REASON_ASSOC_EXPIRE = 4

WIFI_REASON_ASSOC_TOOMANY = 5

WIFI_REASON_NOT_AUTHED = 6

WIFI_REASON_NOT_ASSOCED = 7

WIFI_REASON_ASSOC_LEAVE = 8

WIFI_REASON_ASSOC_NOT_AUTHED = 9

WIFI_REASON_DISASSOC_PWRCAP_BAD = 10

WIFI_REASON_DISASSOC_SUPCHAN_BAD = 11

WIFI_REASON_IE_INVALID = 13

WIFI_REASON_MIC_FAILURE = 14

WIFI_REASON_4WAY_HANDSHAKE_TIMEOUT = 15

WIFI_REASON_GROUP_KEY_UPDATE_TIMEOUT = 16

WIFI_REASON_IE_IN_4WAY_DIFFERS = 17

WIFI_REASON_GROUP_CIPHER_INVALID = 18

WIFI_REASON_PAIRWISE_CIPHER_INVALID = 19

WIFI_REASON_AKMP_INVALID = 20

WIFI_REASON_UNSUPP_RSN_IE_VERSION = 21

WIFI_REASON_INVALID_RSN_IE_CAP = 22

WIFI_REASON_802_1X_AUTH_FAILED = 23

WIFI_REASON_CIPHER_SUITE_REJECTED = 24

WIFI_REASON_INVALID_PMKID = 53

WIFI_REASON_BEACON_TIMEOUT = 200

WIFI_REASON_NO_AP_FOUND = 201

WIFI_REASON_AUTH_FAIL = 202

WIFI_REASON_ASSOC_FAIL = 203

WIFI_REASON_HANDSHAKE_TIMEOUT = 204

WIFI_REASON_CONNECTION_FAIL = 205

WIFI_REASON_AP_TSF_RESET = 206

WIFI_REASON_ROAMING = 207

enum wifi_second_chan_t

Values:

WIFI_SECOND_CHAN_NONE = 0

the channel width is HT20

WIFI_SECOND_CHAN_ABOVE

the channel width is HT40 and the secondary channel is above the primary channel

WIFI_SECOND_CHAN_BELOW

the channel width is HT40 and the secondary channel is below the primary channel

enum wifi_scan_type_t

Values:

WIFI_SCAN_TYPE_ACTIVE = 0

active scan

WIFI_SCAN_TYPE_PASSIVE

passive scan

enum wifi_cipher_type_t

Values:

WIFI_CIPHER_TYPE_NONE = 0

the cipher type is none

WIFI_CIPHER_TYPE_WEP40

the cipher type is WEP40

WIFI_CIPHER_TYPE_WEP104

the cipher type is WEP104

WIFI_CIPHER_TYPE_TKIP

the cipher type is TKIP

WIFI_CIPHER_TYPE_CCMP

the cipher type is CCMP

WIFI_CIPHER_TYPE_TKIP_CCMP

the cipher type is TKIP and CCMP

WIFI_CIPHER_TYPE_AES_CMAC128

the cipher type is AES-CMAC-128

WIFI_CIPHER_TYPE_SMS4

the cipher type is SMS4

WIFI_CIPHER_TYPE_UNKNOWN

the cipher type is unknown

enum wifi_ant_t

WiFi antenna.

Values:

WIFI_ANT_ANT0
WiFi antenna 0

WIFI_ANT_ANT1
WiFi antenna 1

WIFI_ANT_MAX
Invalid WiFi antenna

enum wifi_scan_method_t

Values:

WIFI_FAST_SCAN = 0
Do fast scan, scan will end after find SSID match AP

WIFI_ALL_CHANNEL_SCAN
All channel scan, scan will end after scan all the channel

enum wifi_sort_method_t

Values:

WIFI_CONNECT_AP_BY_SIGNAL = 0
Sort match AP in scan list by RSSI

WIFI_CONNECT_AP_BY_SECURITY
Sort match AP in scan list by security mode

enum wifi_ps_type_t

Values:

WIFI_PS_NONE
No power save

WIFI_PS_MIN_MODEM
Minimum modem power saving. In this mode, station wakes up to receive beacon every DTIM period

WIFI_PS_MAX_MODEM
Maximum modem power saving. In this mode, interval to receive beacons is determined by the listen_interval parameter in [wifi_sta_config_t](#)

enum wifi_bandwidth_t

Values:

WIFI_BW_HT20 = 1

WIFI_BW_HT40

enum wifi_sae_pwe_method_t

Configuration for SAE PWE derivation

Values:

WPA3_SAE_PWE_UNSPECIFIED

WPA3_SAE_PWE_HUNT_AND_PECK

WPA3_SAE_PWE_HASH_TO_ELEMENT

WPA3_SAE_PWE_BOTH

enum wifi_storage_t

Values:

WIFI_STORAGE_FLASH
all configuration will store in both memory and flash

WIFI_STORAGE_RAM
all configuration will only store in the memory

enum wifi_vendor_ie_type_t

Vendor Information Element type.

Determines the frame type that the IE will be associated with.

Values:

WIFI_VND_IE_TYPE_BEACON

WIFI_VND_IE_TYPE_PROBE_REQ

WIFI_VND_IE_TYPE_PROBE_RESP

WIFI_VND_IE_TYPE_ASSOC_REQ

WIFI_VND_IE_TYPE_ASSOC_RESP

enum wifi_vendor_ie_id_t

Vendor Information Element index.

Each IE type can have up to two associated vendor ID elements.

Values:

WIFI_VND_IE_ID_0

WIFI_VND_IE_ID_1

enum wifi_promiscuous_pkt_type_t

Promiscuous frame type.

Passed to promiscuous mode RX callback to indicate the type of parameter in the buffer.

Values:

WIFI_PKT_MGMT

Management frame, indicates ‘buf’ argument is *wifi_promiscuous_pkt_t*

WIFI_PKT_CTRL

Control frame, indicates ‘buf’ argument is *wifi_promiscuous_pkt_t*

WIFI_PKT_DATA

Data frame, indicates ‘buf’ argument is *wifi_promiscuous_pkt_t*

WIFI_PKT_MISC

Other type, such as MIMO etc. ‘buf’ argument is *wifi_promiscuous_pkt_t* but the payload is zero length.

enum wifi_ant_mode_t

WiFi antenna mode.

Values:

WIFI_ANT_MODE_ANT0

Enable WiFi antenna 0 only

WIFI_ANT_MODE_ANT1

Enable WiFi antenna 1 only

WIFI_ANT_MODE_AUTO

Enable WiFi antenna 0 and 1, automatically select an antenna

WIFI_ANT_MODE_MAX

Invalid WiFi enabled antenna

enum wifi_phy_rate_t

WiFi PHY rate encodings.

Values:

WIFI_PHY_RATE_1M_L = 0x00

1 Mbps with long preamble

WIFI_PHY_RATE_2M_L = 0x01
2 Mbps with long preamble

WIFI_PHY_RATE_5M_L = 0x02
5.5 Mbps with long preamble

WIFI_PHY_RATE_11M_L = 0x03
11 Mbps with long preamble

WIFI_PHY_RATE_2M_S = 0x05
2 Mbps with short preamble

WIFI_PHY_RATE_5M_S = 0x06
5.5 Mbps with short preamble

WIFI_PHY_RATE_11M_S = 0x07
11 Mbps with short preamble

WIFI_PHY_RATE_48M = 0x08
48 Mbps

WIFI_PHY_RATE_24M = 0x09
24 Mbps

WIFI_PHY_RATE_12M = 0x0A
12 Mbps

WIFI_PHY_RATE_6M = 0x0B
6 Mbps

WIFI_PHY_RATE_54M = 0x0C
54 Mbps

WIFI_PHY_RATE_36M = 0x0D
36 Mbps

WIFI_PHY_RATE_18M = 0x0E
18 Mbps

WIFI_PHY_RATE_9M = 0x0F
9 Mbps

WIFI_PHY_RATE_MCS0_LGI = 0x10
MCS0 with long GI, 6.5 Mbps for 20MHz, 13.5 Mbps for 40MHz

WIFI_PHY_RATE_MCS1_LGI = 0x11
MCS1 with long GI, 13 Mbps for 20MHz, 27 Mbps for 40MHz

WIFI_PHY_RATE_MCS2_LGI = 0x12
MCS2 with long GI, 19.5 Mbps for 20MHz, 40.5 Mbps for 40MHz

WIFI_PHY_RATE_MCS3_LGI = 0x13
MCS3 with long GI, 26 Mbps for 20MHz, 54 Mbps for 40MHz

WIFI_PHY_RATE_MCS4_LGI = 0x14
MCS4 with long GI, 39 Mbps for 20MHz, 81 Mbps for 40MHz

WIFI_PHY_RATE_MCS5_LGI = 0x15
MCS5 with long GI, 52 Mbps for 20MHz, 108 Mbps for 40MHz

WIFI_PHY_RATE_MCS6_LGI = 0x16
MCS6 with long GI, 58.5 Mbps for 20MHz, 121.5 Mbps for 40MHz

WIFI_PHY_RATE_MCS7_LGI = 0x17
MCS7 with long GI, 65 Mbps for 20MHz, 135 Mbps for 40MHz

WIFI_PHY_RATE_MCS0_SGI = 0x18
MCS0 with short GI, 7.2 Mbps for 20MHz, 15 Mbps for 40MHz

WIFI_PHY_RATE_MCS1_SGI = 0x19
MCS1 with short GI, 14.4 Mbps for 20MHz, 30 Mbps for 40MHz

WIFI_PHY_RATE_MCS2_SGI = 0x1A
MCS2 with short GI, 21.7 Mbps for 20MHz, 45 Mbps for 40MHz

WIFI_PHY_RATE_MCS3_SGI = 0x1B
MCS3 with short GI, 28.9 Mbps for 20MHz, 60 Mbps for 40MHz

WIFI_PHY_RATE_MCS4_SGI = 0x1C
MCS4 with short GI, 43.3 Mbps for 20MHz, 90 Mbps for 40MHz

WIFI_PHY_RATE_MCS5_SGI = 0x1D
MCS5 with short GI, 57.8 Mbps for 20MHz, 120 Mbps for 40MHz

WIFI_PHY_RATE_MCS6_SGI = 0x1E
MCS6 with short GI, 65 Mbps for 20MHz, 135 Mbps for 40MHz

WIFI_PHY_RATE_MCS7_SGI = 0x1F
MCS7 with short GI, 72.2 Mbps for 20MHz, 150 Mbps for 40MHz

WIFI_PHY_RATE_LORA_250K = 0x29
250 Kbps

WIFI_PHY_RATE_LORA_500K = 0x2A
500 Kbps

WIFI_PHY_RATE_MAX

enum wifi_event_t

WiFi event declarations

Values:

WIFI_EVENT_WIFI_READY = 0
ESP32 WiFi ready

WIFI_EVENT_SCAN_DONE
ESP32 finish scanning AP

WIFI_EVENT_STA_START
ESP32 station start

WIFI_EVENT_STA_STOP
ESP32 station stop

WIFI_EVENT_STA_CONNECTED
ESP32 station connected to AP

WIFI_EVENT_STA_DISCONNECTED
ESP32 station disconnected from AP

WIFI_EVENT_STA_AUTHMODE_CHANGE
the auth mode of AP connected by ESP32 station changed

WIFI_EVENT_STA_WPS_ER_SUCCESS
ESP32 station wps succeeds in enrollee mode

WIFI_EVENT_STA_WPS_ER_FAILED
ESP32 station wps fails in enrollee mode

WIFI_EVENT_STA_WPS_ER_TIMEOUT
ESP32 station wps timeout in enrollee mode

WIFI_EVENT_STA_WPS_ER_PIN
ESP32 station wps pin code in enrollee mode

WIFI_EVENT_STA_WPS_ER_PBC_OVERLAP
ESP32 station wps overlap in enrollee mode

WIFI_EVENT_AP_START

ESP32 soft-AP start

WIFI_EVENT_AP_STOP

ESP32 soft-AP stop

WIFI_EVENT_AP_STACONNECTED

a station connected to ESP32 soft-AP

WIFI_EVENT_AP_STADISCONNECTED

a station disconnected from ESP32 soft-AP

WIFI_EVENT_AP_PROBEREQRCVD

Receive probe request packet in soft-AP interface

WIFI_EVENT_FTM_REPORT

Receive report of FTM procedure

WIFI_EVENT_STA_BSS_RSSI_LOW

AP' s RSSI crossed configured threshold

WIFI_EVENT_ACTION_TX_STATUS

Status indication of Action Tx operation

WIFI_EVENT_ROC_DONE

Remain-on-Channel operation complete

WIFI_EVENT_STA_BEACON_TIMEOUT

ESP32 station beacon timeout

WIFI_EVENT_MAX

Invalid WiFi event ID

enum wifi_event_sta_wps_fail_reason_t

Argument structure for WIFI_EVENT_STA_WPS_ER_FAILED event

*Values:***WPS_FAIL_REASON_NORMAL = 0**

ESP32 WPS normal fail reason

WPS_FAIL_REASON_RECV_M2D

ESP32 WPS receive M2D frame

WPS_FAIL_REASON_MAX**enum wifi_ftm_status_t**

FTM operation status types.

*Values:***FTM_STATUS_SUCCESS = 0**

FTM exchange is successful

FTM_STATUS_UNSUPPORTED

Peer does not support FTM

FTM_STATUS_CONF_REJECTED

Peer rejected FTM configuration in FTM Request

FTM_STATUS_NO_RESPONSE

Peer did not respond to FTM Requests

FTM_STATUS_FAIL

Unknown error during FTM exchange

SmartConfig

The SmartConfig™ is a provisioning technology developed by TI to connect a new Wi-Fi device to a Wi-Fi network. It uses a mobile app to broadcast the network credentials from a smartphone, or a tablet, to an un-provisioned Wi-Fi device.

The advantage of this technology is that the device does not need to directly know SSID or password of an Access Point (AP). This information is provided using the smartphone. This is particularly important to headless device and systems, due to their lack of a user interface.

If you are looking for other options to provision your ESP32-C3 devices, check [Provisioning API](#).

Application Example Connect ESP32-C3 to target AP using SmartConfig: [wifi/smart_config](#).

API Reference

Header File

- [esp_wifi/include/esp_smartconfig.h](#)

Functions

const char ***esp_smartconfig_get_version** (void)

Get the version of SmartConfig.

Return

- SmartConfig version const char.

esp_err_t **esp_smartconfig_start** (**const** *smartconfig_start_config_t* *config)

Start SmartConfig, config ESP device to connect AP. You need to broadcast information by phone APP. Device sniffer special packets from the air that containing SSID and password of target AP.

Attention 1. This API can be called in station or softAP-station mode.

Attention 2. Can not call `esp_smartconfig_start` twice before it finish, please call `esp_smartconfig_stop` first.

Return

- ESP_OK: succeed
- others: fail

Parameters

- config: pointer to smartconfig start configure structure

esp_err_t **esp_smartconfig_stop** (void)

Stop SmartConfig, free the buffer taken by `esp_smartconfig_start`.

Attention Whether connect to AP succeed or not, this API should be called to free memory taken by `smartconfig_start`.

Return

- ESP_OK: succeed
- others: fail

esp_err_t **esp_esptouch_set_timeout** (uint8_t time_s)

Set timeout of SmartConfig process.

Attention Timing starts from SC_STATUS_FIND_CHANNEL status. SmartConfig will restart if timeout.

Return

- ESP_OK: succeed
- others: fail

Parameters

- time_s: range 15s~255s, offset:45s.

esp_err_t **esp_smartconfig_set_type** (*smartconfig_type_t* type)

Set protocol type of SmartConfig.

Attention If users need to set the SmartConfig type, please set it before calling `esp_smartconfig_start`.

Return

- ESP_OK: succeed
- others: fail

Parameters

- type: Choose from the smartconfig_type_t.

esp_err_t **esp_smartconfig_fast_mode** (bool *enable*)

Set mode of SmartConfig. default normal mode.

Attention 1. Please call it before API esp_smartconfig_start.

Attention 2. Fast mode have corresponding APP(phone).

Attention 3. Two mode is compatible.

Return

- ESP_OK: succeed
- others: fail

Parameters

- enable: false-disable(default); true-enable;

esp_err_t **esp_smartconfig_get_rvd_data** (uint8_t **rvd_data*, uint8_t *len*)

Get reserved data of ESPTouch v2.

Return

- ESP_OK: succeed
- others: fail

Parameters

- rvd_data: reserved data
- len: length of reserved data

Structures

struct smartconfig_event_got_ssid_pswd_t

Argument structure for SC_EVENT_GOT_SSID_PSWD event

Public Members

uint8_t **ssid**[32]

SSID of the AP. Null terminated string.

uint8_t **password**[64]

Password of the AP. Null terminated string.

bool **bssid_set**

whether set MAC address of target AP or not.

uint8_t **bssid**[6]

MAC address of target AP.

smartconfig_type_t **type**

Type of smartconfig(ESPTouch or AirKiss).

uint8_t **token**

Token from cellphone which is used to send ACK to cellphone.

uint8_t **cellphone_ip**[4]

IP address of cellphone.

struct smartconfig_start_config_t

Configure structure for esp_smartconfig_start

Public Members

bool **enable_log**

Enable smartconfig logs.

```
bool esp_touch_v2_enable_crypt
    Enable ESPTouch v2 crypt.

char *esp_touch_v2_key
    ESPTouch v2 crypt key, len should be 16.
```

Macros

```
SMARTCONFIG_START_CONFIG_DEFAULT()
```

Enumerations

```
enum smartconfig_type_t
```

Values:

```
SC_TYPE_ESPTOUCH = 0
    protocol: ESPTouch
```

```
SC_TYPE_AIRKISS
    protocol: AirKiss
```

```
SC_TYPE_ESPTOUCH_AIRKISS
    protocol: ESPTouch and AirKiss
```

```
SC_TYPE_ESPTOUCH_V2
    protocol: ESPTouch v2
```

```
enum smartconfig_event_t
```

Smartconfig event declarations

Values:

```
SC_EVENT_SCAN_DONE
    ESP32 station smartconfig has finished to scan for APs
```

```
SC_EVENT_FOUND_CHANNEL
    ESP32 station smartconfig has found the channel of the target AP
```

```
SC_EVENT_GOT_SSID_PSWD
    ESP32 station smartconfig got the SSID and password
```

```
SC_EVENT_SEND_ACK_DONE
    ESP32 station smartconfig has sent ACK to cellphone
```

ESP-NOW

Overview ESP-NOW is a kind of connectionless Wi-Fi communication protocol that is defined by Espressif. In ESP-NOW, application data is encapsulated in a vendor-specific action frame and then transmitted from one Wi-Fi device to another without connection. CTR with CBC-MAC Protocol(CCMP) is used to protect the action frame for security. ESP-NOW is widely used in smart light, remote controlling, sensor, etc.

Frame Format ESP-NOW uses a vendor-specific action frame to transmit ESP-NOW data. The default ESP-NOW bit rate is 1 Mbps. The format of the vendor-specific action frame is as follows:

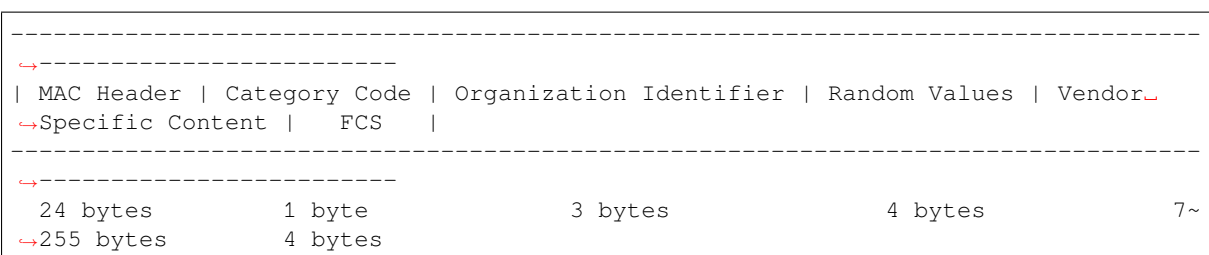

- Category Code: The Category Code field is set to the value(127) indicating the vendor-specific category.

- **Organization Identifier:** The Organization Identifier contains a unique identifier (0x18fe34), which is the first three bytes of MAC address applied by Espressif.
- **Random Value:** The Random Value field is used to prevent relay attacks.
- **Vendor Specific Content:** The Vendor Specific Content contains vendor-specific fields as follows:

Element ID	Length	Organization Identifier	Type	Version	Body
1 byte	1 byte	3 bytes	1 byte	1 byte	0~250 bytes

- **Element ID:** The Element ID field is set to the value (221), indicating the vendor-specific element.
- **Length:** The length is the total length of Organization Identifier, Type, Version and Body.
- **Organization Identifier:** The Organization Identifier contains a unique identifier(0x18fe34), which is the first three bytes of MAC address applied by Espressif.
- **Type:** The Type field is set to the value (4) indicating ESP-NOW.
- **Version:** The Version field is set to the version of ESP-NOW.
- **Body:** The Body contains the ESP-NOW data.

As ESP-NOW is connectionless, the MAC header is a little different from that of standard frames. The FromDS and ToDS bits of FrameControl field are both 0. The first address field is set to the destination address. The second address field is set to the source address. The third address field is set to broadcast address (0xff:0xff:0xff:0xff:0xff:0xff).

Security

ESP-NOW uses the CCMP method, which is described in IEEE Std. 802.11-2012, to protect the vendor-specific action frame

- PMK is used to encrypt LMK with the AES-128 algorithm. Call `esp_now_set_pmk()` to set PMK. If PMK is not set, a default PMK will be used.
- LMK of the paired device is used to encrypt the vendor-specific action frame with the CCMP method. The maximum number of different LMKs is six. If the LMK of the paired device is not set, the vendor-specific action frame will not be encrypted.

Encrypting multicast vendor-specific action frame is not supported.

Initialization and De-initialization Call `esp_now_init()` to initialize ESP-NOW and `esp_now_deinit()` to de-initialize ESP-NOW. ESP-NOW data must be transmitted after Wi-Fi is started, so it is recommended to start Wi-Fi before initializing ESP-NOW and stop Wi-Fi after de-initializing ESP-NOW. When `esp_now_deinit()` is called, all of the information of paired devices will be deleted.

Add Paired Device Call `esp_now_add_peer()` to add the device to the paired device list before you send data to this device. If security is enabled, the LMK must be set. You can send ESP-NOW data via both the Station and the SoftAP interface. Make sure that the interface is enabled before sending ESP-NOW data.

The maximum number of paired devices is 20, and the paired encryption devices are no more than 10, the default is 6.

A device with a broadcast MAC address must be added before sending broadcast data. The range of the channel of paired devices is from 0 to 14. If the channel is set to 0, data will be sent on the current channel. Otherwise, the channel must be set as the channel that the local device is on.

Send ESP-NOW Data Call `esp_now_send()` to send ESP-NOW data and `esp_now_register_send_cb()` to register sending callback function. It will return `ESP_NOW_SEND_SUCCESS` in sending callback function if the data is received successfully on the MAC layer. Otherwise, it will return `ESP_NOW_SEND_FAIL`. Several reasons can lead to ESP-NOW fails to send data. For example, the destination device doesn't exist; the channels of the devices are not the same; the action frame is lost when transmitting on the air, etc. It is not guaranteed that application layer can receive the data. If necessary, send back ack data when receiving ESP-NOW data. If receiving ack data timeouts, retransmit the ESP-NOW data. A sequence number can also be assigned to ESP-NOW data to drop the duplicate data.

If there is a lot of ESP-NOW data to send, call `esp_now_send()` to send less than or equal to 250 bytes of data once a time. Note that too short interval between sending two ESP-NOW data may lead to disorder of sending callback function. So, it is recommended that sending the next ESP-NOW data after the sending callback function of the previous sending has returned. The sending callback function runs from a high-priority Wi-Fi task. So, do not do lengthy operations in the callback function. Instead, post the necessary data to a queue and handle it from a lower priority task.

Receiving ESP-NOW Data Call `esp_now_register_recv_cb()` to register receiving callback function. Call the receiving callback function when receiving ESP-NOW. The receiving callback function also runs from the Wi-Fi task. So, do not do lengthy operations in the callback function. Instead, post the necessary data to a queue and handle it from a lower priority task.

Config ESP-NOW Rate Call `esp_wifi_config_espnow_rate()` to config ESPNOW rate of specified interface. Make sure that the interface is enabled before config rate. This API should be called after `esp_wifi_start()`.

API Reference

Header File

- `esp_wifi/include/esp_now.h`

Functions

`esp_err_t esp_now_init` (void)
Initialize ESPNOW function.

Return

- ESP_OK : succeed
- ESP_ERR_ESPNOW_INTERNAL : Internal error

`esp_err_t esp_now_deinit` (void)
De-initialize ESPNOW function.

Return

- ESP_OK : succeed

`esp_err_t esp_now_get_version` (uint32_t *version)
Get the version of ESPNOW.

Return

- ESP_OK : succeed
- ESP_ERR_ESPNOW_ARG : invalid argument

Parameters

- version: ESPNOW version

`esp_err_t esp_now_register_recv_cb` (`esp_now_recv_cb_t cb`)
Register callback function of receiving ESPNOW data.

Return

- ESP_OK : succeed
- ESP_ERR_ESPNOW_NOT_INIT : ESPNOW is not initialized
- ESP_ERR_ESPNOW_INTERNAL : internal error

Parameters

- cb: callback function of receiving ESPNOW data

`esp_err_t esp_now_unregister_recv_cb` (void)
Unregister callback function of receiving ESPNOW data.

Return

- ESP_OK : succeed

- `ESP_ERR_ESPNOW_NOT_INIT` : ESPNOW is not initialized

esp_err_t **esp_now_register_send_cb** (*esp_now_send_cb_t* cb)

Register callback function of sending ESPNOW data.

Return

- `ESP_OK` : succeed
- `ESP_ERR_ESPNOW_NOT_INIT` : ESPNOW is not initialized
- `ESP_ERR_ESPNOW_INTERNAL` : internal error

Parameters

- cb: callback function of sending ESPNOW data

esp_err_t **esp_now_unregister_send_cb** (void)

Unregister callback function of sending ESPNOW data.

Return

- `ESP_OK` : succeed
- `ESP_ERR_ESPNOW_NOT_INIT` : ESPNOW is not initialized

esp_err_t **esp_now_send** (const uint8_t *peer_addr, const uint8_t *data, size_t len)

Send ESPNOW data.

Attention 1. If peer_addr is not NULL, send data to the peer whose MAC address matches peer_addr

Attention 2. If peer_addr is NULL, send data to all of the peers that are added to the peer list

Attention 3. The maximum length of data must be less than `ESP_NOW_MAX_DATA_LEN`

Attention 4. The buffer pointed to by data argument does not need to be valid after esp_now_send returns

Return

- `ESP_OK` : succeed
- `ESP_ERR_ESPNOW_NOT_INIT` : ESPNOW is not initialized
- `ESP_ERR_ESPNOW_ARG` : invalid argument
- `ESP_ERR_ESPNOW_INTERNAL` : internal error
- `ESP_ERR_ESPNOW_NO_MEM` : out of memory, when this happens, you can delay a while before sending the next data
- `ESP_ERR_ESPNOW_NOT_FOUND` : peer is not found
- `ESP_ERR_ESPNOW_IF` : current WiFi interface doesn't match that of peer

Parameters

- peer_addr: peer MAC address
- data: data to send
- len: length of data

esp_err_t **esp_now_add_peer** (const *esp_now_peer_info_t* *peer)

Add a peer to peer list.

Return

- `ESP_OK` : succeed
- `ESP_ERR_ESPNOW_NOT_INIT` : ESPNOW is not initialized
- `ESP_ERR_ESPNOW_ARG` : invalid argument
- `ESP_ERR_ESPNOW_FULL` : peer list is full
- `ESP_ERR_ESPNOW_NO_MEM` : out of memory
- `ESP_ERR_ESPNOW_EXIST` : peer has existed

Parameters

- peer: peer information

esp_err_t **esp_now_del_peer** (const uint8_t *peer_addr)

Delete a peer from peer list.

Return

- `ESP_OK` : succeed
- `ESP_ERR_ESPNOW_NOT_INIT` : ESPNOW is not initialized
- `ESP_ERR_ESPNOW_ARG` : invalid argument
- `ESP_ERR_ESPNOW_NOT_FOUND` : peer is not found

Parameters

- peer_addr: peer MAC address

esp_err_t **esp_now_mod_peer** (*const esp_now_peer_info_t *peer*)

Modify a peer.

Return

- ESP_OK : succeed
- ESP_ERR_ESPNOW_NOT_INIT : ESPNOW is not initialized
- ESP_ERR_ESPNOW_ARG : invalid argument
- ESP_ERR_ESPNOW_FULL : peer list is full

Parameters

- peer: peer information

esp_err_t **esp_wifi_config_espnw_rate** (*wifi_interface_t ifx, wifi_phy_rate_t rate*)

Config ESPNOW rate of specified interface.

Attention 1. This API should be called after `esp_wifi_start()`.

Return

- ESP_OK: succeed
- others: failed

Parameters

- ifx: Interface to be configured.
- rate: Phy rate to be configured.

esp_err_t **esp_now_get_peer** (*const uint8_t *peer_addr, esp_now_peer_info_t *peer*)

Get a peer whose MAC address matches peer_addr from peer list.

Return

- ESP_OK : succeed
- ESP_ERR_ESPNOW_NOT_INIT : ESPNOW is not initialized
- ESP_ERR_ESPNOW_ARG : invalid argument
- ESP_ERR_ESPNOW_NOT_FOUND : peer is not found

Parameters

- peer_addr: peer MAC address
- peer: peer information

esp_err_t **esp_now_fetch_peer** (*bool from_head, esp_now_peer_info_t *peer*)

Fetch a peer from peer list. Only return the peer which address is unicast, for the multicast/broadcast address, the function will ignore and try to find the next in the peer list.

Return

- ESP_OK : succeed
- ESP_ERR_ESPNOW_NOT_INIT : ESPNOW is not initialized
- ESP_ERR_ESPNOW_ARG : invalid argument
- ESP_ERR_ESPNOW_NOT_FOUND : peer is not found

Parameters

- from_head: fetch from head of list or not
- peer: peer information

bool **esp_now_is_peer_exist** (*const uint8_t *peer_addr*)

Peer exists or not.

Return

- true : peer exists
- false : peer not exists

Parameters

- peer_addr: peer MAC address

esp_err_t **esp_now_get_peer_num** (*esp_now_peer_num_t *num*)

Get the number of peers.

Return

- ESP_OK : succeed
- ESP_ERR_ESPNOW_NOT_INIT : ESPNOW is not initialized
- ESP_ERR_ESPNOW_ARG : invalid argument

Parameters

- num: number of peers

esp_err_t **esp_now_set_pmk** (const uint8_t *pmk)

Set the primary master key.

Attention 1. primary master key is used to encrypt local master key

Return

- ESP_OK : succeed
- ESP_ERR_ESPNOW_NOT_INIT : ESPNOW is not initialized
- ESP_ERR_ESPNOW_ARG : invalid argument

Parameters

- pmk: primary master key

esp_err_t **esp_now_set_wake_window** (uint16_t window)

Set esp_now wake window for sta_disconnected power management.

Attention 1. Only when ESP_WIFI_STA_DISCONNECTED_PM_ENABLE is enabled, this configuration could work

Attention 2. This configuration only work for station mode and disconnected status

Attention 3. If more than one module has configured its wake_window, chip would choose the largest one to stay waked

Attention 4. If the gap between interval and window is smaller than 5ms, the chip would keep waked all the time

Attention 5. If never configured wake_window, the chip would keep waked at disconnected once it uses esp_now

Return

- ESP_OK : succeed
- ESP_ERR_ESPNOW_NOT_INIT : ESPNOW is not initialized

Parameters

- window: how much microsecond would the chip keep waked each interval, vary from 0 to 65535

Structures

struct esp_now_peer_info

ESPNOW peer information parameters.

Public Members

uint8_t **peer_addr**[ESP_NOW_ETH_ALEN]

ESPNOW peer MAC address that is also the MAC address of station or softap

uint8_t **lmk**[ESP_NOW_KEY_LEN]

ESPNOW peer local master key that is used to encrypt data

uint8_t **channel**

Wi-Fi channel that peer uses to send/receive ESPNOW data. If the value is 0, use the current channel which station or softap is on. Otherwise, it must be set as the channel that station or softap is on.

wifi_interface_t **ifidx**

Wi-Fi interface that peer uses to send/receive ESPNOW data

bool **encrypt**

ESPNOW data that this peer sends/receives is encrypted or not

void ***priv**

ESPNOW peer private data

struct esp_now_peer_num

Number of ESPNOW peers which exist currently.

Public Members

int **total_num**
Total number of ESPNOW peers, maximum value is `ESP_NOW_MAX_TOTAL_PEER_NUM`

int **encrypt_num**
Number of encrypted ESPNOW peers, maximum value is `ESP_NOW_MAX_ENCRYPT_PEER_NUM`

Macros

ESP_ERR_ESPNOW_BASE
ESPNOW error number base.

ESP_ERR_ESPNOW_NOT_INIT
ESPNOW is not initialized.

ESP_ERR_ESPNOW_ARG
Invalid argument

ESP_ERR_ESPNOW_NO_MEM
Out of memory

ESP_ERR_ESPNOW_FULL
ESPNOW peer list is full

ESP_ERR_ESPNOW_NOT_FOUND
ESPNOW peer is not found

ESP_ERR_ESPNOW_INTERNAL
Internal error

ESP_ERR_ESPNOW_EXIST
ESPNOW peer has existed

ESP_ERR_ESPNOW_IF
Interface error

ESP_NOW_ETH_ALEN
Length of ESPNOW peer MAC address

ESP_NOW_KEY_LEN
Length of ESPNOW peer local master key

ESP_NOW_MAX_TOTAL_PEER_NUM
Maximum number of ESPNOW total peers

ESP_NOW_MAX_ENCRYPT_PEER_NUM
Maximum number of ESPNOW encrypted peers

ESP_NOW_MAX_DATA_LEN
Maximum length of ESPNOW data which is sent very time

Type Definitions

typedef struct *esp_now_peer_info* esp_now_peer_info_t
ESPNOW peer information parameters.

typedef struct *esp_now_peer_num* esp_now_peer_num_t
Number of ESPNOW peers which exist currently.

typedef void (*esp_now_rcv_cb_t) (const uint8_t *mac_addr, const uint8_t *data, int data_len)
Callback function of receiving ESPNOW data.

Parameters

- `mac_addr`: peer MAC address
- `data`: received data
- `data_len`: length of received data

```
typedef void (*esp_now_send_cb_t) (const uint8_t *mac_addr, esp_now_send_status_t status)
```

Callback function of sending ESPNOW data.

Parameters

- `mac_addr`: peer MAC address
- `status`: status of sending ESPNOW data (succeed or fail)

Enumerations

```
enum esp_now_send_status_t
```

Status of sending ESPNOW data .

Values:

```
ESP_NOW_SEND_SUCCESS = 0
```

Send ESPNOW data successfully

```
ESP_NOW_SEND_FAIL
```

Send ESPNOW data fail

ESP-MESH Programming Guide

This is a programming guide for ESP-MESH, including the API reference and coding examples. This guide is split into the following parts:

1. [ESP-MESH Programming Model](#)
2. [Writing an ESP-MESH Application](#)
3. [Self Organized Networking](#)
4. [Application Examples](#)
5. [API Reference](#)

For documentation regarding the ESP-MESH protocol, please see the [ESP-MESH API Guide](#). For more information about ESP-MESH Development Framework, please see [ESP-MESH Development Framework](#).

ESP-MESH Programming Model

Software Stack The ESP-MESH software stack is built atop the Wi-Fi Driver/FreeRTOS and may use the LwIP Stack in some instances (i.e. the root node). The following diagram illustrates the ESP-MESH software stack.

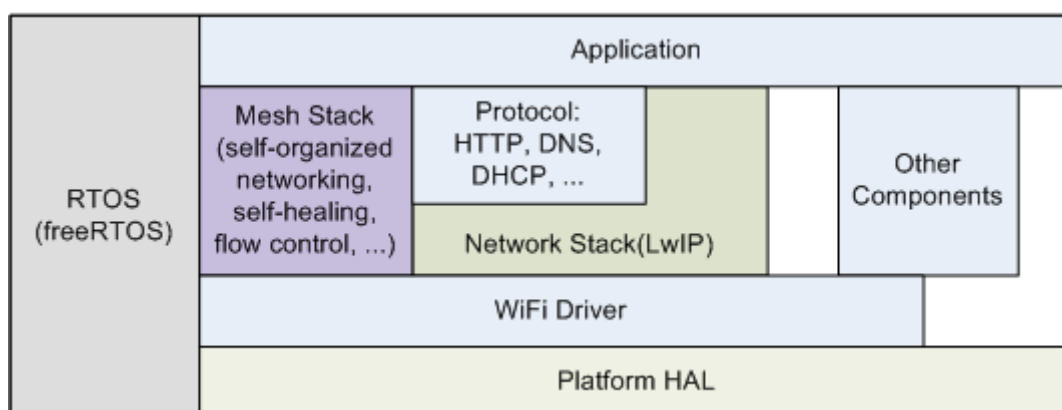

Fig. 2: ESP-MESH Software Stack

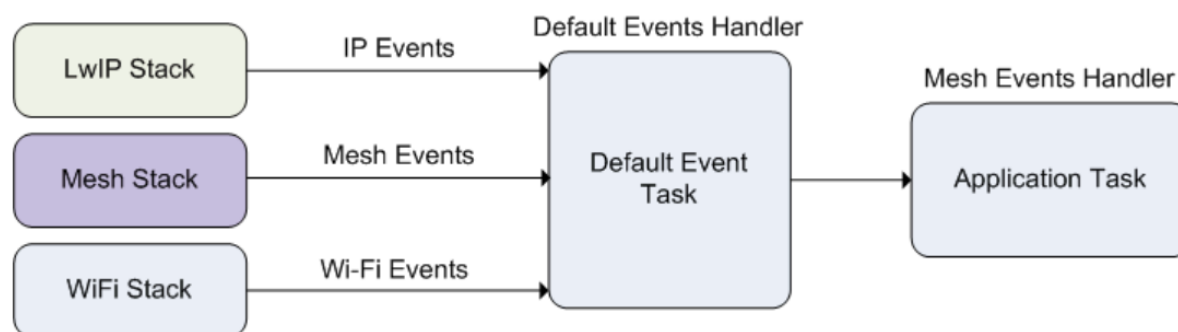

Fig. 3: ESP-MESH System Events Delivery

System Events An application interfaces with ESP-MESH via **ESP-MESH Events**. Since ESP-MESH is built atop the Wi-Fi stack, it is also possible for the application to interface with the Wi-Fi driver via the **Wi-Fi Event Task**. The following diagram illustrates the interfaces for the various System Events in an ESP-MESH application.

The `mesh_event_id_t` defines all possible ESP-MESH events and can indicate events such as the connection/disconnection of parent/child. Before ESP-MESH events can be used, the application must register a **Mesh Events handler** via `esp_event_handler_register()` to the default event task. The Mesh Events handler that is registered contain handlers for each ESP-MESH event relevant to the application.

Typical use cases of mesh events include using events such as `MESH_EVENT_PARENT_CONNECTED` and `MESH_EVENT_CHILD_CONNECTED` to indicate when a node can begin transmitting data upstream and downstream respectively. Likewise, `IP_EVENT_STA_GOT_IP` and `IP_EVENT_STA_LOST_IP` can be used to indicate when the root node can and cannot transmit data to the external IP network.

Warning: When using ESP-MESH under self-organized mode, users must ensure that no calls to Wi-Fi API are made. This is due to the fact that the self-organizing mode will internally make Wi-Fi API calls to connect/disconnect/scan etc. **Any Wi-Fi calls from the application (including calls from callbacks and handlers of Wi-Fi events) may interfere with ESP-MESH's self-organizing behavior.** Therefore, user's should not call Wi-Fi APIs after `esp_mesh_start()` is called, and before `esp_mesh_stop()` is called.

LwIP & ESP-MESH The application can access the ESP-MESH stack directly without having to go through the LwIP stack. The LwIP stack is only required by the root node to transmit/receive data to/from an external IP network. However, since every node can potentially become the root node (due to automatic root node selection), each node must still initialize the LwIP stack.

Each node is required to initialize LwIP by calling `tcpip_adapter_init()`. In order to prevent non-root node access to LwIP, the application should stop the following services after LwIP initialization:

- DHCP server service on the softAP interface.
- DHCP client service on the station interface.

The following code snippet demonstrates how to initialize LwIP for ESP-MESH applications.

```

/* tcpip initialization */
tcpip_adapter_init();
/*
 * for mesh
 * stop DHCP server on softAP interface by default
 * stop DHCP client on station interface by default
 */
ESP_ERROR_CHECK(tcpip_adapter_dhcps_stop(TCPIP_ADAPTER_IF_AP));
ESP_ERROR_CHECK(tcpip_adapter_dhpc_stop(TCPIP_ADAPTER_IF_STA));
  
```

Note: ESP-MESH requires a root node to be connected with a router. Therefore, in the event that a node becomes

the root, **the corresponding handler must start the DHCP client service and immediately obtain an IP address.** Doing so will allow other nodes to begin transmitting/receiving packets to/from the external IP network. However, this step is unnecessary if static IP settings are used.

Writing an ESP-MESH Application The prerequisites for starting ESP-MESH is to initialize LwIP and Wi-Fi. The following code snippet demonstrates the necessary prerequisite steps before ESP-MESH itself can be initialized.

```
tcpip_adapter_init();
/*
 * for mesh
 * stop DHCP server on softAP interface by default
 * stop DHCP client on station interface by default
 */
ESP_ERROR_CHECK(tcpip_adapter_dhcps_stop(TCPIP_ADAPTER_IF_AP));
ESP_ERROR_CHECK(tcpip_adapter_dhcpc_stop(TCPIP_ADAPTER_IF_STA));

/* event initialization */
ESP_ERROR_CHECK(esp_event_loop_create_default());

/* Wi-Fi initialization */
wifi_init_config_t config = WIFI_INIT_CONFIG_DEFAULT();
ESP_ERROR_CHECK(esp_wifi_init(&config));
/* register IP events handler */
ESP_ERROR_CHECK(esp_event_handler_register(IP_EVENT, IP_EVENT_STA_GOT_IP, &ip_
↪event_handler, NULL));
ESP_ERROR_CHECK(esp_wifi_set_storage(WIFI_STORAGE_FLASH));
ESP_ERROR_CHECK(esp_wifi_start());
```

After initializing LwIP and Wi-Fi, the process of getting an ESP-MESH network up and running can be summarized into the following three steps:

1. *Initialize Mesh*
2. *Configuring an ESP-MESH Network*
3. *Start Mesh*

Initialize Mesh The following code snippet demonstrates how to initialize ESP-MESH

```
/* mesh initialization */
ESP_ERROR_CHECK(esp_mesh_init());
/* register mesh events handler */
ESP_ERROR_CHECK(esp_event_handler_register(MESH_EVENT, ESP_EVENT_ANY_ID, &mesh_
↪event_handler, NULL));
```

Configuring an ESP-MESH Network ESP-MESH is configured via `esp_mesh_set_config()` which receives its arguments using the `mesh_cfg_t` structure. The structure contains the following parameters used to configure ESP-MESH:

Parameter	Description
Channel	Range from 1 to 14
Mesh ID	ID of ESP-MESH Network, see <code>mesh_addr_t</code>
Router	Router Configuration, see <code>mesh_router_t</code>
Mesh AP	Mesh AP Configuration, see <code>mesh_ap_cfg_t</code>
Crypto Functions	Crypto Functions for Mesh IE, see <code>mesh_crypto_funcs_t</code>

The following code snippet demonstrates how to configure ESP-MESH.

```

/* Enable the Mesh IE encryption by default */
mesh_cfg_t cfg = MESH_INIT_CONFIG_DEFAULT();
/* mesh ID */
memcpy((uint8_t *) &cfg.mesh_id, MESH_ID, 6);
/* channel (must match the router's channel) */
cfg.channel = CONFIG_MESH_CHANNEL;
/* router */
cfg.router.ssid_len = strlen(CONFIG_MESH_ROUTER_SSID);
memcpy((uint8_t *) &cfg.router.ssid, CONFIG_MESH_ROUTER_SSID, cfg.router.ssid_len);
memcpy((uint8_t *) &cfg.router.password, CONFIG_MESH_ROUTER_PASSWD,
        strlen(CONFIG_MESH_ROUTER_PASSWD));
/* mesh softAP */
cfg.mesh_ap.max_connection = CONFIG_MESH_AP_CONNECTIONS;
memcpy((uint8_t *) &cfg.mesh_ap.password, CONFIG_MESH_AP_PASSWD,
        strlen(CONFIG_MESH_AP_PASSWD));
ESP_ERROR_CHECK(esp_mesh_set_config(&cfg));

```

Start Mesh The following code snippet demonstrates how to start ESP-MESH.

```

/* mesh start */
ESP_ERROR_CHECK(esp_mesh_start());

```

After starting ESP-MESH, the application should check for ESP-MESH events to determine when it has connected to the network. After connecting, the application can start transmitting and receiving packets over the ESP-MESH network using `esp_mesh_send()` and `esp_mesh_recv()`.

Self Organized Networking Self organized networking is a feature of ESP-MESH where nodes can autonomously scan/select/connect/reconnect to other nodes and routers. This feature allows an ESP-MESH network to operate with high degree of autonomy by making the network robust to dynamic network topologies and conditions. With self organized networking enabled, nodes in an ESP-MESH network are able to carry out the following actions without autonomously:

- Selection or election of the root node (see **Automatic Root Node Selection** in *Building a Network*)
- Selection of a preferred parent node (see **Parent Node Selection** in *Building a Network*)
- Automatic reconnection upon detecting a disconnection (see **Intermediate Parent Node Failure** in *Managing a Network*)

When self organized networking is enabled, the ESP-MESH stack will internally make calls to Wi-Fi APIs. Therefore, **the application layer should not make any calls to Wi-Fi APIs whilst self organized networking is enabled as doing so would risk interfering with ESP-MESH.**

Toggling Self Organized Networking Self organized networking can be enabled or disabled by the application at runtime by calling the `esp_mesh_set_self_organized()` function. The function has the two following parameters:

- `bool enable` specifies whether to enable or disable self organized networking.
- `bool select_parent` specifies whether a new parent node should be selected when enabling self organized networking. Selecting a new parent has different effects depending the node type and the node's current state. This parameter is unused when disabling self organized networking.

Disabling Self Organized Networking The following code snippet demonstrates how to disable self organized networking.

```

//Disable self organized networking
esp_mesh_set_self_organized(false, false);

```

ESP-MESH will attempt to maintain the node's current Wi-Fi state when disabling self organized networking.

- If the node was previously connected to other nodes, it will remain connected.
- If the node was previously disconnected and was scanning for a parent node or router, it will stop scanning.
- If the node was previously attempting to reconnect to a parent node or router, it will stop reconnecting.

Enabling Self Organized Networking ESP-MESH will attempt to maintain the node's current Wi-Fi state when enabling self organized networking. However, depending on the node type and whether a new parent is selected, the Wi-Fi state of the node can change. The following table shows effects of enabling self organized networking.

Select Parent	Is Root Node	Effects
N	N	<ul style="list-style-type: none"> • Nodes already connected to a parent node will remain connected. • Nodes previously scanning for a parent nodes will stop scanning. Call <code>esp_mesh_connect ()</code> to restart.
	Y	<ul style="list-style-type: none"> • A root node already connected to router will stay connected. • A root node disconnected from router will need to call <code>esp_mesh_connect ()</code> to reconnect.
Y	N	<ul style="list-style-type: none"> • Nodes without a parent node will automatically select a preferred parent and connect. • Nodes already connected to a parent node will disconnect, reselect a preferred parent node, and connect.
	Y	<ul style="list-style-type: none"> • For a root node to connect to a parent node, it must give up its role as root. Therefore, a root node will disconnect from the router and all child nodes, select a preferred parent node, and connect.

The following code snippet demonstrates how to enable self organized networking.

```
//Enable self organized networking and select a new parent
esp_mesh_set_self_organized(true, true);

...

//Enable self organized networking and manually reconnect
esp_mesh_set_self_organized(true, false);
esp_mesh_connect ();
```

Calling Wi-Fi API There can be instances in which an application may want to directly call Wi-Fi API whilst using ESP-MESH. For example, an application may want to manually scan for neighboring APs. However, **self organized networking must be disabled before the application calls any Wi-Fi APIs**. This will prevent the ESP-MESH stack from attempting to call any Wi-Fi APIs and potentially interfering with the application's calls.

Therefore, application calls to Wi-Fi APIs should be placed in between calls of `esp_mesh_set_self_organized()` which disable and enable self organized networking. The following code snippet demonstrates how an application can safely call `esp_wifi_scan_start()` whilst using ESP-MESH.

```
//Disable self organized networking
esp_mesh_set_self_organized(0, 0);

//Stop any scans already in progress
esp_wifi_scan_stop();
//Manually start scan. Will automatically stop when run to completion
esp_wifi_scan_start();

//Process scan results

...

//Re-enable self organized networking if still connected
esp_mesh_set_self_organized(1, 0);

...

//Re-enable self organized networking if non-root and disconnected
esp_mesh_set_self_organized(1, 1);

...

//Re-enable self organized networking if root and disconnected
esp_mesh_set_self_organized(1, 0); //Don't select new parent
esp_mesh_connect(); //Manually reconnect to router
```

Application Examples ESP-IDF contains these ESP-MESH example projects:

[The Internal Communication Example](#) demonstrates how to set up a ESP-MESH network and have the root node send a data packet to every node within the network.

[The Manual Networking Example](#) demonstrates how to use ESP-MESH without the self-organizing features. This example shows how to program a node to manually scan for a list of potential parent nodes and select a parent node based on custom criteria.

API Reference

Header File

- [esp_wifi/include/esp_mesh.h](#)

Functions

`esp_err_t esp_mesh_init` (void)

Mesh initialization.

- Check whether Wi-Fi is started.
- Initialize mesh global variables with default values.

Attention This API shall be called after Wi-Fi is started.

Return

- ESP_OK
- ESP_FAIL

esp_err_t **esp_mesh_deinit** (void)

Mesh de-initialization.

- Release resources and stop the mesh

Return

- ESP_OK
- ESP_FAIL

esp_err_t **esp_mesh_start** (void)

Start mesh.

- Initialize mesh IE.
- Start mesh network management service.
- Create TX and RX queues according to the configuration.
- Register mesh packets receive callback.

Attention This API shall be called after mesh initialization and configuration.

Return

- ESP_OK
- ESP_FAIL
- ESP_ERR_MESH_NOT_INIT
- ESP_ERR_MESH_NOT_CONFIG
- ESP_ERR_MESH_NO_MEMORY

esp_err_t **esp_mesh_stop** (void)

Stop mesh.

- Deinitialize mesh IE.
- Disconnect with current parent.
- Disassociate all currently associated children.
- Stop mesh network management service.
- Unregister mesh packets receive callback.
- Delete TX and RX queues.
- Release resources.
- Restore Wi-Fi softAP to default settings if Wi-Fi dual mode is enabled.
- Set Wi-Fi Power Save type to WIFI_PS_NONE.

Return

- ESP_OK
- ESP_FAIL

esp_err_t **esp_mesh_send** (const *mesh_addr_t* *to, const *mesh_data_t* *data, int flag, const *mesh_opt_t* opt[], int opt_count)

Send a packet over the mesh network.

- Send a packet to any device in the mesh network.
- Send a packet to external IP network.

Attention This API is not reentrant.

Return

- ESP_OK
- ESP_FAIL
- ESP_ERR_MESH_ARGUMENT
- ESP_ERR_MESH_NOT_START
- ESP_ERR_MESH_DISCONNECTED
- ESP_ERR_MESH_OPT_UNKNOWN
- ESP_ERR_MESH_EXCEED_MTU
- ESP_ERR_MESH_NO_MEMORY
- ESP_ERR_MESH_TIMEOUT
- ESP_ERR_MESH_QUEUE_FULL
- ESP_ERR_MESH_NO_ROUTE_FOUND

- ESP_ERR_MESH_DISCARD

Parameters

- [in] `to`: the address of the final destination of the packet
 - If the packet is to the root, set this parameter to NULL.
 - If the packet is to an external IP network, set this parameter to the IPv4:PORT combination. This packet will be delivered to the root firstly, then the root will forward this packet to the final IP server address.
- [in] `data`: pointer to a sending mesh packet
 - Field size should not exceed MESH_MPS. Note that the size of one mesh packet should not exceed MESH_MTU.
 - Field proto should be set to data protocol in use (default is MESH_PROTO_BIN for binary).
 - Field tos should be set to transmission tos (type of service) in use (default is MESH_TOS_P2P for point-to-point reliable).
- [in] `flag`: bitmap for data sent
 - Speed up the route search
 - * If the packet is to the root and “to” parameter is NULL, set this parameter to 0.
 - * If the packet is to an internal device, MESH_DATA_P2P should be set.
 - * If the packet is to the root (“to” parameter isn’ t NULL) or to external IP network, MESH_DATA_TODS should be set.
 - * If the packet is from the root to an internal device, MESH_DATA_FROMDS should be set.
 - Specify whether this API is block or non-block, block by default
 - * If needs non-blocking, MESH_DATA_NONBLOCK should be set. Otherwise, may use `esp_mesh_send_block_time()` to specify a blocking time.
 - In the situation of the root change, MESH_DATA_DROP identifies this packet can be dropped by the new root for upstream data to external IP network, we try our best to avoid data loss caused by the root change, but there is a risk that the new root is running out of memory because most of memory is occupied by the pending data which isn’ t read out in time by `esp_mesh_rcv_toDS()`. Generally, we suggest `esp_mesh_rcv_toDS()` is called after a connection with IP network is created. Thus data outgoing to external IP network via socket is just from reading `esp_mesh_rcv_toDS()` which avoids unnecessary memory copy.
- [in] `opt`: options
 - In case of sending a packet to a certain group, MESH_OPT_SEND_GROUP is a good choice. In this option, the value field should be set to the target receiver addresses in this group.
 - Root sends a packet to an internal device, this packet is from external IP network in case the receiver device responds this packet, MESH_OPT_RECV_DS_ADDR is required to attach the target DS address.
- [in] `opt_count`: option count
 - Currently, this API only takes one option, so `opt_count` is only supported to be 1.

esp_err_t **esp_mesh_send_block_time** (uint32_t *time_ms*)

Set blocking time of `esp_mesh_send()`

Attention This API shall be called before mesh is started.

Return

- ESP_OK

Parameters

- [in] `time_ms`: blocking time of `esp_mesh_send()`, unit:ms

esp_err_t **esp_mesh_rcv** (*mesh_addr_t* **from*, *mesh_data_t* **data*, int *timeout_ms*, int **flag*, *mesh_opt_t* *opt*[], int *opt_count*)

Receive a packet targeted to self over the mesh network.

flag could be MESH_DATA_FROMDS or MESH_DATA_TODS.

Attention Mesh RX queue should be checked regularly to avoid running out of memory.

- Use `esp_mesh_get_rx_pending()` to check the number of packets available in the queue waiting to be received by applications.

Return

- ESP_OK
- ESP_ERR_MESH_ARGUMENT
- ESP_ERR_MESH_NOT_START

- ESP_ERR_MESH_TIMEOUT
- ESP_ERR_MESH_DISCARD

Parameters

- [out] *from*: the address of the original source of the packet
- [out] *data*: pointer to the received mesh packet
 - Field *proto* is the data protocol in use. Should follow it to parse the received data.
 - Field *tos* is the transmission tos (type of service) in use.
- [in] *timeout_ms*: wait time if a packet isn't immediately available (0:no wait, port-MAX_DELAY:wait forever)
- [out] *flag*: bitmap for data received
 - MESH_DATA_FROMDS represents data from external IP network
 - MESH_DATA_TODS represents data directed upward within the mesh network

Parameters

- [out] *opt*: options desired to receive
 - MESH_OPT_RECV_DS_ADDR attaches the DS address
- [in] *opt_count*: option count desired to receive
 - Currently, this API only takes one option, so *opt_count* is only supported to be 1.

*esp_err_t esp_mesh_recv_toDS(mesh_addr_t *from, mesh_addr_t *to, mesh_data_t *data, int timeout_ms, int *flag, mesh_opt_t opt[], int opt_count)*

Receive a packet targeted to external IP network.

- Root uses this API to receive packets destined to external IP network
- Root forwards the received packets to the final destination via socket.
- If no socket connection is ready to send out the received packets and this `esp_mesh_recv_toDS()` hasn't been called by applications, packets from the whole mesh network will be pending in toDS queue.

Use `esp_mesh_get_rx_pending()` to check the number of packets available in the queue waiting to be received by applications in case of running out of memory in the root.

Using `esp_mesh_set_xon_qsize()` users may configure the RX queue size, default:32. If this size is too large, and `esp_mesh_recv_toDS()` isn't called in time, there is a risk that a great deal of memory is occupied by the pending packets. If this size is too small, it will impact the efficiency on upstream. How to decide this value depends on the specific application scenarios.

flag could be MESH_DATA_TODS.

Attention This API is only called by the root.

Return

- ESP_OK
- ESP_ERR_MESH_ARGUMENT
- ESP_ERR_MESH_NOT_START
- ESP_ERR_MESH_TIMEOUT
- ESP_ERR_MESH_DISCARD
- ESP_ERR_MESH_RECV_RELEASE

Parameters

- [out] *from*: the address of the original source of the packet
- [out] *to*: the address contains remote IP address and port (IPv4:PORT)
- [out] *data*: pointer to the received packet
 - Contain the protocol and applications should follow it to parse the data.
- [in] *timeout_ms*: wait time if a packet isn't immediately available (0:no wait, port-MAX_DELAY:wait forever)
- [out] *flag*: bitmap for data received
 - MESH_DATA_TODS represents the received data target to external IP network. Root shall forward this data to external IP network via the association with router.

Parameters

- [out] *opt*: options desired to receive
- [in] *opt_count*: option count desired to receive

*esp_err_t esp_mesh_set_config(const mesh_cfg_t *config)*

Set mesh stack configuration.

- Use `MESH_INIT_CONFIG_DEFAULT()` to initialize the default values, mesh IE is encrypted by default.
- Mesh network is established on a fixed channel (1-14).
- Mesh event callback is mandatory.
- Mesh ID is an identifier of an MBSS. Nodes with the same mesh ID can communicate with each other.
- Regarding to the router configuration, if the router is hidden, BSSID field is mandatory.

If BSSID field isn't set and there exists more than one router with same SSID, there is a risk that more roots than one connected with different BSSID will appear. It means more than one mesh network is established with the same mesh ID.

Root conflict function could eliminate redundant roots connected with the same BSSID, but couldn't handle roots connected with different BSSID. Because users might have such requirements of setting up routers with same SSID for the future replacement. But in that case, if the above situations happen, please make sure applications implement forward functions on the root to guarantee devices in different mesh networks can communicate with each other. `max_connection` of mesh softAP is limited by the max number of Wi-Fi softAP supported (max:10).

Attention This API shall be called before mesh is started after mesh is initialized.

Return

- `ESP_OK`
- `ESP_ERR_MESH_ARGUMENT`
- `ESP_ERR_MESH_NOT_ALLOWED`

Parameters

- [in] `config`: pointer to mesh stack configuration

esp_err_t **esp_mesh_get_config** (*mesh_cfg_t* **config*)

Get mesh stack configuration.

Return

- `ESP_OK`
- `ESP_ERR_MESH_ARGUMENT`

Parameters

- [out] `config`: pointer to mesh stack configuration

esp_err_t **esp_mesh_set_router** (**const** *mesh_router_t* **router*)

Get router configuration.

Attention This API is used to dynamically modify the router configuration after mesh is configured.

Return

- `ESP_OK`
- `ESP_ERR_MESH_ARGUMENT`

Parameters

- [in] `router`: pointer to router configuration

esp_err_t **esp_mesh_get_router** (*mesh_router_t* **router*)

Get router configuration.

Return

- `ESP_OK`
- `ESP_ERR_MESH_ARGUMENT`

Parameters

- [out] `router`: pointer to router configuration

esp_err_t **esp_mesh_set_id** (**const** *mesh_addr_t* **id*)

Set mesh network ID.

Attention This API is used to dynamically modify the mesh network ID.

Return

- `ESP_OK`
- `ESP_ERR_MESH_ARGUMENT`: invalid argument

Parameters

- [in] `id`: pointer to mesh network ID

esp_err_t **esp_mesh_get_id** (*mesh_addr_t* *id)

Get mesh network ID.

Return

- ESP_OK
- ESP_ERR_MESH_ARGUMENT

Parameters

- [out] id: pointer to mesh network ID

esp_err_t **esp_mesh_set_type** (*mesh_type_t* type)

Designate device type over the mesh network.

- MESH_IDLE: designates a device as a self-organized node for a mesh network
- MESH_ROOT: designates the root node for a mesh network
- MESH_LEAF: designates a device as a standalone Wi-Fi station that connects to a parent
- MESH_STA: designates a device as a standalone Wi-Fi station that connects to a router

Return

- ESP_OK
- ESP_ERR_MESH_NOT_ALLOWED

Parameters

- [in] type: device type

mesh_type_t **esp_mesh_get_type** (void)

Get device type over mesh network.

Attention This API shall be called after having received the event MESH_EVENT_PARENT_CONNECTED.

Return mesh type

esp_err_t **esp_mesh_set_max_layer** (int max_layer)

Set network max layer value.

- for tree topology, the max is 25.
- for chain topology, the max is 1000.
- Network max layer limits the max hop count.

Attention This API shall be called before mesh is started.

Return

- ESP_OK
- ESP_ERR_MESH_ARGUMENT
- ESP_ERR_MESH_NOT_ALLOWED

Parameters

- [in] max_layer: max layer value

int **esp_mesh_get_max_layer** (void)

Get max layer value.

Return max layer value

esp_err_t **esp_mesh_set_ap_password** (const uint8_t *pwd, int len)

Set mesh softAP password.

Attention This API shall be called before mesh is started.

Return

- ESP_OK
- ESP_ERR_MESH_ARGUMENT
- ESP_ERR_MESH_NOT_ALLOWED

Parameters

- [in] pwd: pointer to the password
- [in] len: password length

esp_err_t **esp_mesh_set_ap_authmode** (*wifi_auth_mode_t* authmode)

Set mesh softAP authentication mode.

Attention This API shall be called before mesh is started.

Return

- ESP_OK
- ESP_ERR_MESH_ARGUMENT
- ESP_ERR_MESH_NOT_ALLOWED

Parameters

- [in] `authmode`: authentication mode

`wifi_auth_mode_t esp_mesh_get_ap_authmode` (void)

Get mesh softAP authentication mode.

Return authentication mode

`esp_err_t esp_mesh_set_ap_connections` (int *connections*)

Set mesh max connection value.

- Set mesh softAP max connection = mesh max connection + non-mesh max connection

Attention This API shall be called before mesh is started.

Return

- ESP_OK
- ESP_ERR_MESH_ARGUMENT

Parameters

- [in] `connections`: the number of max connections

int `esp_mesh_get_ap_connections` (void)

Get mesh max connection configuration.

Return the number of mesh max connections

int `esp_mesh_get_non_mesh_connections` (void)

Get non-mesh max connection configuration.

Return the number of non-mesh max connections

int `esp_mesh_get_layer` (void)

Get current layer value over the mesh network.

Attention This API shall be called after having received the event MESH_EVENT_PARENT_CONNECTED.

Return layer value

`esp_err_t esp_mesh_get_parent_bssid` (`mesh_addr_t *bssid`)

Get the parent BSSID.

Attention This API shall be called after having received the event MESH_EVENT_PARENT_CONNECTED.

Return

- ESP_OK
- ESP_FAIL

Parameters

- [out] `bssid`: pointer to parent BSSID

bool `esp_mesh_is_root` (void)

Return whether the device is the root node of the network.

Return true/false

`esp_err_t esp_mesh_set_self_organized` (bool *enable*, bool *select_parent*)

Enable/disable self-organized networking.

- Self-organized networking has three main functions: select the root node; find a preferred parent; initiate reconnection if a disconnection is detected.
- Self-organized networking is enabled by default.
- If self-organized is disabled, users should set a parent for the device via `esp_mesh_set_parent()`.

Attention This API is used to dynamically modify whether to enable the self organizing.

Return

- ESP_OK
- ESP_FAIL

Parameters

- [in] `enable`: enable or disable self-organized networking
- [in] `select_parent`: Only valid when self-organized networking is enabled.
 - if `select_parent` is set to true, the root will give up its mesh root status and search for a new parent like other non-root devices.

bool **esp_mesh_get_self_organized** (void)

Return whether enable self-organized networking or not.

Return true/false

esp_err_t **esp_mesh_waive_root** (const *mesh_vote_t* **vote*, int *reason*)

Cause the root device to give up (waive) its mesh root status.

- A device is elected root primarily based on RSSI from the external router.
- If external router conditions change, users can call this API to perform a root switch.
- In this API, users could specify a desired root address to replace itself or specify an attempts value to ask current root to initiate a new round of voting. During the voting, a better root candidate would be expected to find to replace the current one.
- If no desired root candidate, the vote will try a specified number of attempts (at least 15). If no better root candidate is found, keep the current one. If a better candidate is found, the new better one will send a root switch request to the current root, current root will respond with a root switch acknowledgment.
- After that, the new candidate will connect to the router to be a new root, the previous root will disconnect with the router and choose another parent instead.

Root switch is completed with minimal disruption to the whole mesh network.

Attention This API is only called by the root.

Return

- ESP_OK
- ESP_ERR_MESH_QUEUE_FULL
- ESP_ERR_MESH_DISCARD
- ESP_FAIL

Parameters

- [in] `vote`: vote configuration
 - If this parameter is set NULL, the vote will perform the default 15 times.
 - Field percentage threshold is 0.9 by default.
 - Field `is_rc_specified` shall be false.
 - Field `attempts` shall be at least 15 times.
- [in] `reason`: only accept MESH_VOTE_REASON_ROOT_INITIATED for now

esp_err_t **esp_mesh_set_vote_percentage** (float *percentage*)

Set vote percentage threshold for approval of being a root (default:0.9)

- During the networking, only obtaining vote percentage reaches this threshold, the device could be a root.

Attention This API shall be called before mesh is started.

Return

- ESP_OK
- ESP_FAIL

Parameters

- [in] `percentage`: vote percentage threshold

float **esp_mesh_get_vote_percentage** (void)

Get vote percentage threshold for approval of being a root.

Return percentage threshold

esp_err_t **esp_mesh_set_ap_assoc_expire** (int *seconds*)

Set mesh softAP associate expired time (default:10 seconds)

- If mesh softAP hasn't received any data from an associated child within this time, mesh softAP will take this child inactive and disassociate it.

- If mesh softAP is encrypted, this value should be set a greater value, such as 30 seconds.

Return

- ESP_OK
- ESP_FAIL

Parameters

- [in] seconds: the expired time

int **esp_mesh_get_ap_assoc_expire** (void)

Get mesh softAP associate expired time.

Return seconds

int **esp_mesh_get_total_node_num** (void)

Get total number of devices in current network (including the root)

Attention The returned value might be incorrect when the network is changing.

Return total number of devices (including the root)

int **esp_mesh_get_routing_table_size** (void)

Get the number of devices in this device' s sub-network (including self)

Return the number of devices over this device' s sub-network (including self)

esp_err_t **esp_mesh_get_routing_table** (*mesh_addr_t* *mac, int len, int *size)

Get routing table of this device' s sub-network (including itself)

Return

- ESP_OK
- ESP_ERR_MESH_ARGUMENT

Parameters

- [out] mac: pointer to routing table
- [in] len: routing table size(in bytes)
- [out] size: pointer to the number of devices in routing table (including itself)

esp_err_t **esp_mesh_post_toDS_state** (bool *reachable*)

Post the toDS state to the mesh stack.

Attention This API is only for the root.

Return

- ESP_OK
- ESP_FAIL

Parameters

- [in] reachable: this state represents whether the root is able to access external IP network

esp_err_t **esp_mesh_get_tx_pending** (*mesh_tx_pending_t* *pending)

Return the number of packets pending in the queue waiting to be sent by the mesh stack.

Return

- ESP_OK
- ESP_FAIL

Parameters

- [out] pending: pointer to the TX pending

esp_err_t **esp_mesh_get_rx_pending** (*mesh_rx_pending_t* *pending)

Return the number of packets available in the queue waiting to be received by applications.

Return

- ESP_OK
- ESP_FAIL

Parameters

- [out] pending: pointer to the RX pending

int **esp_mesh_available_txupQ_num** (const *mesh_addr_t* *addr, uint32_t *xseqno_in)

Return the number of packets could be accepted from the specified address.

Return the number of upQ for a certain address

Parameters

- [in] `addr`: self address or an associate children address
- [out] `xseqno_in`: sequence number of the last received packet from the specified address

esp_err_t **esp_mesh_set_xon_qsize** (int *qsize*)

Set the number of queue.

Attention This API shall be called before mesh is started.

Return

- ESP_OK
- ESP_FAIL

Parameters

- [in] `qsize`: default:32 (min:16)

int **esp_mesh_get_xon_qsize** (void)

Get queue size.

Return the number of queue

esp_err_t **esp_mesh_allow_root_conflicts** (bool *allowed*)

Set whether allow more than one root existing in one network.

Return

- ESP_OK
- ESP_WIFI_ERR_NOT_INIT
- ESP_WIFI_ERR_NOT_START

Parameters

- [in] `allowed`: allow or not

bool **esp_mesh_is_root_conflicts_allowed** (void)

Check whether allow more than one root to exist in one network.

Return true/false

esp_err_t **esp_mesh_set_group_id** (const *mesh_addr_t* **addr*, int *num*)

Set group ID addresses.

Return

- ESP_OK
- ESP_MESH_ERR_ARGUMENT

Parameters

- [in] `addr`: pointer to new group ID addresses
- [in] `num`: the number of group ID addresses

esp_err_t **esp_mesh_delete_group_id** (const *mesh_addr_t* **addr*, int *num*)

Delete group ID addresses.

Return

- ESP_OK
- ESP_MESH_ERR_ARGUMENT

Parameters

- [in] `addr`: pointer to deleted group ID address
- [in] `num`: the number of group ID addresses

int **esp_mesh_get_group_num** (void)

Get the number of group ID addresses.

Return the number of group ID addresses

esp_err_t **esp_mesh_get_group_list** (*mesh_addr_t* **addr*, int *num*)

Get group ID addresses.

Return

- ESP_OK
- ESP_MESH_ERR_ARGUMENT

Parameters

- [out] `addr`: pointer to group ID addresses
- [in] `num`: the number of group ID addresses

bool **esp_mesh_is_my_group** (const *mesh_addr_t* **addr*)

Check whether the specified group address is my group.

Return true/false

esp_err_t **esp_mesh_set_capacity_num** (int *num*)

Set mesh network capacity (max:1000, default:300)

Attention This API shall be called before mesh is started.

Return

- ESP_OK
- ESP_ERR_MESH_NOT_ALLOWED
- ESP_MESH_ERR_ARGUMENT

Parameters

- [in] `num`: mesh network capacity

int **esp_mesh_get_capacity_num** (void)

Get mesh network capacity.

Return mesh network capacity

esp_err_t **esp_mesh_set_ie_crypto_funcs** (const *mesh_crypto_funcs_t* **crypto_funcs*)

Set mesh IE crypto functions.

Attention This API can be called at any time after mesh is initialized.

Return

- ESP_OK

Parameters

- [in] `crypto_funcs`: crypto functions for mesh IE
 - If `crypto_funcs` is set to NULL, mesh IE is no longer encrypted.

esp_err_t **esp_mesh_set_ie_crypto_key** (const char **key*, int *len*)

Set mesh IE crypto key.

Attention This API can be called at any time after mesh is initialized.

Return

- ESP_OK
- ESP_MESH_ERR_ARGUMENT

Parameters

- [in] `key`: ASCII crypto key
- [in] `len`: length in bytes, range:8-64

esp_err_t **esp_mesh_get_ie_crypto_key** (char **key*, int *len*)

Get mesh IE crypto key.

Return

- ESP_OK
- ESP_MESH_ERR_ARGUMENT

Parameters

- [out] `key`: ASCII crypto key
- [in] `len`: length in bytes, range:8-64

esp_err_t **esp_mesh_set_root_healing_delay** (int *delay_ms*)

Set delay time before starting root healing.

Return

- ESP_OK

Parameters

- [in] `delay_ms`: delay time in milliseconds

int **esp_mesh_get_root_healing_delay** (void)

Get delay time before network starts root healing.

Return delay time in milliseconds

esp_err_t **esp_mesh_fix_root** (bool *enable*)

Enable network Fixed Root Setting.

- Enabling fixed root disables automatic election of the root node via voting.
- All devices in the network shall use the same Fixed Root Setting (enabled or disabled).
- If Fixed Root is enabled, users should make sure a root node is designated for the network.

Return

- ESP_OK

Parameters

- [in] *enable*: enable or not

bool **esp_mesh_is_root_fixed** (void)

Check whether network Fixed Root Setting is enabled.

- Enable/disable network Fixed Root Setting by API `esp_mesh_fix_root()`.
- Network Fixed Root Setting also changes with the “flag” value in parent networking IE.

Return true/false

esp_err_t **esp_mesh_set_parent** (const *wifi_config_t* **parent*, const *mesh_addr_t* **parent_mesh_id*, *mesh_type_t* *my_type*, int *my_layer*)

Set a specified parent for the device.

Attention This API can be called at any time after mesh is configured.

Return

- ESP_OK
- ESP_ERR_ARGUMENT
- ESP_ERR_MESH_NOT_CONFIG

Parameters

- [in] *parent*: parent configuration, the SSID and the channel of the parent are mandatory.
 - If the BSSID is set, make sure that the SSID and BSSID represent the same parent, otherwise the device will never find this specified parent.
- [in] *parent_mesh_id*: parent mesh ID,
 - If this value is not set, the original mesh ID is used.
- [in] *my_type*: mesh type
 - MESH_STA is not supported.
 - If the parent set for the device is the same as the router in the network configuration, then *my_type* shall set MESH_ROOT and *my_layer* shall set MESH_ROOT_LAYER.
- [in] *my_layer*: mesh layer
 - *my_layer* of the device may change after joining the network.
 - If *my_type* is set MESH_NODE, *my_layer* shall be greater than MESH_ROOT_LAYER.
 - If *my_type* is set MESH_LEAF, the device becomes a standalone Wi-Fi station and no longer has the ability to extend the network.

esp_err_t **esp_mesh_scan_get_ap_ie_len** (int **len*)

Get mesh networking IE length of one AP.

Return

- ESP_OK
- ESP_ERR_WIFI_NOT_INIT
- ESP_ERR_WIFI_ARG
- ESP_ERR_WIFI_FAIL

Parameters

- [out] *len*: mesh networking IE length

esp_err_t **esp_mesh_scan_get_ap_record** (*wifi_ap_record_t* **ap_record*, void **buffer*)

Get AP record.

Attention Different from `esp_wifi_scan_get_ap_records()`, this API only gets one of APs scanned each time. See “manual_networking” example.

Return

- ESP_OK
- ESP_ERR_WIFI_NOT_INIT
- ESP_ERR_WIFI_ARG
- ESP_ERR_WIFI_FAIL

Parameters

- [out] `ap_record`: pointer to one AP record
- [out] `buffer`: pointer to the mesh networking IE of this AP

esp_err_t **esp_mesh_flush_upstream_packets** (void)

Flush upstream packets pending in to_parent queue and to_parent_p2p queue.

Return

- ESP_OK

esp_err_t **esp_mesh_get_subnet_nodes_num** (const *mesh_addr_t* *`child_mac`, int *`nodes_num`)

Get the number of nodes in the subnet of a specific child.

Return

- ESP_OK
- ESP_ERR_MESH_NOT_START
- ESP_ERR_MESH_ARGUMENT

Parameters

- [in] `child_mac`: an associated child address of this device
- [out] `nodes_num`: pointer to the number of nodes in the subnet of a specific child

esp_err_t **esp_mesh_get_subnet_nodes_list** (const *mesh_addr_t* *`child_mac`, *mesh_addr_t* *`nodes`, int `nodes_num`)

Get nodes in the subnet of a specific child.

Return

- ESP_OK
- ESP_ERR_MESH_NOT_START
- ESP_ERR_MESH_ARGUMENT

Parameters

- [in] `child_mac`: an associated child address of this device
- [out] `nodes`: pointer to nodes in the subnet of a specific child
- [in] `nodes_num`: the number of nodes in the subnet of a specific child

esp_err_t **esp_mesh_disconnect** (void)

Disconnect from current parent.

Return

- ESP_OK

esp_err_t **esp_mesh_connect** (void)

Connect to current parent.

Return

- ESP_OK

esp_err_t **esp_mesh_flush_scan_result** (void)

Flush scan result.

Return

- ESP_OK

esp_err_t **esp_mesh_switch_channel** (const uint8_t *`new_bssid`, int `csa_newchan`, int `csa_count`)

Cause the root device to add Channel Switch Announcement Element (CSA IE) to beacon.

- Set the new channel
- Set how many beacons with CSA IE will be sent before changing a new channel
- Enable the channel switch function

Attention This API is only called by the root.

Return

- ESP_OK

Parameters

- [in] `new_bssid`: the new router BSSID if the router changes
- [in] `csa_newchan`: the new channel number to which the whole network is moving
- [in] `csa_count`: channel switch period (beacon count), unit is based on beacon interval of its softAP, the default value is 15.

esp_err_t **esp_mesh_get_router_bssid** (uint8_t **router_bssid*)

Get the router BSSID.

Return

- ESP_OK
- ESP_ERR_WIFI_NOT_INIT
- ESP_ERR_WIFI_ARG

Parameters

- [out] `router_bssid`: pointer to the router BSSID

int64_t **esp_mesh_get_tsf_time** (void)

Get the TSF time.

Return the TSF time

esp_err_t **esp_mesh_set_topology** (*esp_mesh_topology_t* *topo*)

Set mesh topology. The default value is MESH_TOPO_TREE.

- MESH_TOPO_CHAIN supports up to 1000 layers

Attention This API shall be called before mesh is started.

Return

- ESP_OK
- ESP_MESH_ERR_ARGUMENT
- ESP_ERR_MESH_NOT_ALLOWED

Parameters

- [in] `topo`: MESH_TOPO_TREE or MESH_TOPO_CHAIN

esp_mesh_topology_t **esp_mesh_get_topology** (void)

Get mesh topology.

Return MESH_TOPO_TREE or MESH_TOPO_CHAIN

esp_err_t **esp_mesh_enable_ps** (void)

Enable mesh Power Save function.

Attention This API shall be called before mesh is started.

Return

- ESP_OK
- ESP_ERR_WIFI_NOT_INIT
- ESP_ERR_MESH_NOT_ALLOWED

esp_err_t **esp_mesh_disable_ps** (void)

Disable mesh Power Save function.

Attention This API shall be called before mesh is started.

Return

- ESP_OK
- ESP_ERR_WIFI_NOT_INIT
- ESP_ERR_MESH_NOT_ALLOWED

bool **esp_mesh_is_ps_enabled** (void)

Check whether the mesh Power Save function is enabled.

Return true/false

bool **esp_mesh_is_device_active** (void)

Check whether the device is in active state.

- If the device is not in active state, it will neither transmit nor receive frames.

Return true/false

esp_err_t **esp_mesh_set_active_duty_cycle** (int *dev_duty*, int *dev_duty_type*)

Set the device duty cycle and type.

- The range of *dev_duty* values is 1 to 100. The default value is 10.
- *dev_duty* = 100, the PS will be stopped.
- *dev_duty* is better to not less than 5.
- *dev_duty_type* could be MESH_PS_DEVICE_DUTY_REQUEST or MESH_PS_DEVICE_DUTY_DEMAND.
- If *dev_duty_type* is set to MESH_PS_DEVICE_DUTY_REQUEST, the device will use a *nwk_duty* provided by the network.
- If *dev_duty_type* is set to MESH_PS_DEVICE_DUTY_DEMAND, the device will use the specified *dev_duty*.

Attention This API can be called at any time after mesh is started.

Return

- ESP_OK
- ESP_FAIL

Parameters

- [in] *dev_duty*: device duty cycle
- [in] *dev_duty_type*: device PS duty cycle type, not accept MESH_PS_NETWORK_DUTY_MASTER

esp_err_t **esp_mesh_get_active_duty_cycle** (int **dev_duty*, int **dev_duty_type*)

Get device duty cycle and type.

Return

- ESP_OK

Parameters

- [out] *dev_duty*: device duty cycle
- [out] *dev_duty_type*: device PS duty cycle type

esp_err_t **esp_mesh_set_network_duty_cycle** (int *nwk_duty*, int *duration_mins*, int *applied_rule*)

Set the network duty cycle, duration and rule.

- The range of *nwk_duty* values is 1 to 100. The default value is 10.
- *nwk_duty* is the network duty cycle the entire network or the up-link path will use. A device that successfully sets the *nwk_duty* is known as a NWK-DUTY-MASTER.
- *duration_mins* specifies how long the specified *nwk_duty* will be used. Once *duration_mins* expires, the root will take over as the NWK-DUTY-MASTER. If an existing NWK-DUTY-MASTER leaves the network, the root will take over as the NWK-DUTY-MASTER again.
- *duration_mins* = (-1) represents *nwk_duty* will be used until a new NWK-DUTY-MASTER with a different *nwk_duty* appears.
- Only the root can set *duration_mins* to (-1).
- If *applied_rule* is set to MESH_PS_NETWORK_DUTY_APPLIED_ENTIRE, the *nwk_duty* will be used by the entire network.
- If *applied_rule* is set to MESH_PS_NETWORK_DUTY_APPLIED_UPLINK, the *nwk_duty* will only be used by the up-link path nodes.
- The root does not accept MESH_PS_NETWORK_DUTY_APPLIED_UPLINK.
- A *nwk_duty* with *duration_mins*(-1) set by the root is the default network duty cycle used by the entire network.

Attention This API can be called at any time after mesh is started.

- In self-organized network, if this API is called before mesh is started in all devices, (1)*nwk_duty* shall be set to the same value for all devices; (2)*duration_mins* shall be set to (-1); (3)*applied_rule* shall be set to MESH_PS_NETWORK_DUTY_APPLIED_ENTIRE; after the voted root appears, the root will become the NWK-DUTY-MASTER and broadcast the *nwk_duty* and its identity of NWK-DUTY-MASTER.
- If the root is specified (FIXED-ROOT), call this API in the root to provide a default *nwk_duty* for the entire network.

- After joins the network, any device can call this API to change the `nwk_duty`, `duration_mins` or `applied_rule`.

Return

- ESP_OK
- ESP_FAIL

Parameters

- [in] `nwk_duty`: network duty cycle
- [in] `duration_mins`: duration (unit: minutes)
- [in] `applied_rule`: only support MESH_PS_NETWORK_DUTY_APPLIED_ENTIRE

esp_err_t **esp_mesh_get_network_duty_cycle** (int **nwk_duty*, int **duration_mins*, int **dev_duty_type*, int **applied_rule*)

Get the network duty cycle, duration, type and rule.

Return

- ESP_OK

Parameters

- [out] `nwk_duty`: current network duty cycle
- [out] `duration_mins`: the duration of current `nwk_duty`
- [out] `dev_duty_type`: if it includes MESH_PS_DEVICE_DUTY_MASTER, this device is the current NWK-DUTY-MASTER.
- [out] `applied_rule`: MESH_PS_NETWORK_DUTY_APPLIED_ENTIRE

int **esp_mesh_get_running_active_duty_cycle** (void)

Get the running active duty cycle.

- The running active duty cycle of the root is 100.
- If duty type is set to MESH_PS_DEVICE_DUTY_REQUEST, the running active duty cycle is `nwk_duty` provided by the network.
- If duty type is set to MESH_PS_DEVICE_DUTY_DEMAND, the running active duty cycle is `dev_duty` specified by the users.
- In a mesh network, devices are typically working with a certain duty-cycle (transmitting, receiving and sleep) to reduce the power consumption. The running active duty cycle decides the amount of awake time within a beacon interval. At each start of beacon interval, all devices wake up, broadcast beacons, and transmit packets if they do have pending packets for their parents or for their children. Note that Low-duty-cycle means devices may not be active in most of the time, the latency of data transmission might be greater.

Return the running active duty cycle

esp_err_t **esp_mesh_ps_duty_signaling** (int *fwd_times*)

Duty signaling.

Return

- ESP_OK

Parameters

- [in] `fwd_times`: the times of forwarding duty signaling packets

Unions

union mesh_addr_t

#include <esp_mesh.h> Mesh address.

Public Members

uint8_t **addr**[6]
mac address

mip_t **mip**
mip address

union mesh_event_info_t

#include <esp_mesh.h> Mesh event information.

Public Members

mesh_event_channel_switch_t **channel_switch**
channel switch

mesh_event_child_connected_t **child_connected**
child connected

mesh_event_child_disconnected_t **child_disconnected**
child disconnected

mesh_event_routing_table_change_t **routing_table**
routing table change

mesh_event_connected_t **connected**
parent connected

mesh_event_disconnected_t **disconnected**
parent disconnected

mesh_event_no_parent_found_t **no_parent**
no parent found

mesh_event_layer_change_t **layer_change**
layer change

mesh_event_toDS_state_t **toDS_state**
toDS state, devices shall check this state firstly before trying to send packets to external IP network. This state indicates right now whether the root is capable of sending packets out. If not, devices had better to wait until this state changes to be MESH_TODS_REACHABLE.

mesh_event_vote_started_t **vote_started**
vote started

mesh_event_root_address_t **root_addr**
root address

mesh_event_root_switch_req_t **switch_req**
root switch request

mesh_event_root_conflict_t **root_conflict**
other powerful root

mesh_event_root_fixed_t **root_fixed**
fixed root

mesh_event_scan_done_t **scan_done**
scan done

mesh_event_network_state_t **network_state**
network state, such as whether current mesh network has a root.

mesh_event_find_network_t **find_network**
network found that can join

mesh_event_router_switch_t **router_switch**
new router information

mesh_event_ps_duty_t **ps_duty**
PS duty information

union mesh_rc_config_t
#include <esp_mesh.h> Vote address configuration.

Public Members

int **attempts**

max vote attempts before a new root is elected automatically by mesh network. (min:15, 15 by default)

mesh_addr_t **rc_addr**

a new root address specified by users for API esp_mesh_waive_root()

Structures

struct mip_t

IP address and port.

Public Members

ip4_addr_t **ip4**

IP address

uint16_t **port**

port

struct mesh_event_channel_switch_t

Channel switch information.

Public Members

uint8_t **channel**

new channel

struct mesh_event_connected_t

Parent connected information.

Public Members

wifi_event_sta_connected_t **connected**

parent information, same as Wi-Fi event SYSTEM_EVENT_STA_CONNECTED does

uint16_t **self_layer**

layer

uint8_t **duty**

parent duty

struct mesh_event_no_parent_found_t

No parent found information.

Public Members

int **scan_times**

scan times being through

struct mesh_event_layer_change_t

Layer change information.

Public Members

uint16_t **new_layer**

new layer

struct mesh_event_vote_started_t
vote started information

Public Members

int **reason**
vote reason, vote could be initiated by children or by the root itself

int **attempts**
max vote attempts before stopped

mesh_addr_t **rc_addr**
root address specified by users via API `esp_mesh_waive_root()`

struct mesh_event_find_network_t
find a mesh network that this device can join

Public Members

uint8_t **channel**
channel number of the new found network

uint8_t **router_bssid**[6]
router BSSID

struct mesh_event_root_switch_req_t
Root switch request information.

Public Members

int **reason**
root switch reason, generally root switch is initialized by users via API `esp_mesh_waive_root()`

mesh_addr_t **rc_addr**
the address of root switch requester

struct mesh_event_root_conflict_t
Other powerful root address.

Public Members

int8_t **rsssi**
rssi with router

uint16_t **capacity**
the number of devices in current network

uint8_t **addr**[6]
other powerful root address

struct mesh_event_routing_table_change_t
Routing table change.

Public Members

uint16_t **rt_size_new**
the new value

uint16_t **rt_size_change**
the changed value

struct mesh_event_root_fixed_t
Root fixed.

Public Members

bool **is_fixed**
status

struct mesh_event_scan_done_t
Scan done event information.

Public Members

uint8_t **number**
the number of APs scanned

struct mesh_event_network_state_t
Network state information.

Public Members

bool **is_rootless**
whether current mesh network has a root

struct mesh_event_ps_duty_t
PS duty information.

Public Members

uint8_t **duty**
parent or child duty

[*mesh_event_child_connected_t*](#) **child_connected**
child info

struct mesh_opt_t
Mesh option.

Public Members

uint8_t **type**
option type

uint16_t **len**
option length

uint8_t ***val**
option value

struct mesh_data_t
Mesh data for esp_mesh_send() and esp_mesh_rcv()

Public Members

uint8_t ***data**
data

uint16_t size
data size

mesh_proto_t **proto**
data protocol

mesh_tos_t **tos**
data type of service

struct mesh_router_t
Router configuration.

Public Members

uint8_t ssid[32]
SSID

uint8_t ssid_len
length of SSID

uint8_t bssid[6]
BSSID, if this value is specified, users should also specify “allow_router_switch” .

uint8_t password[64]
password

bool allow_router_switch
if the BSSID is specified and this value is also set, when the router of this specified BSSID fails to be found after “fail” (mesh_attempts_t) times, the whole network is allowed to switch to another router with the same SSID. The new router might also be on a different channel. The default value is false. There is a risk that if the password is different between the new switched router and the previous one, the mesh network could be established but the root will never connect to the new switched router.

struct mesh_ap_cfg_t
Mesh softAP configuration.

Public Members

uint8_t password[64]
mesh softAP password

uint8_t max_connection
max number of stations allowed to connect in, default 6, max 10 = max_connection + non-mesh_max_connectionmax mesh connections

uint8_t nonmesh_max_connection
max non-mesh connections

struct mesh_cfg_t
Mesh initialization configuration.

Public Members

uint8_t channel
channel, the mesh network on

bool allow_channel_switch
if this value is set, when “fail” (mesh_attempts_t) times is reached, device will change to a full channel scan for a network that could join. The default value is false.

mesh_addr_t **mesh_id**
mesh network identification

mesh_router_t **router**
router configuration

mesh_ap_cfg_t **mesh_ap**
mesh softAP configuration

const *mesh_crypto_funcs_t* ***crypto_funcs**
crypto functions

struct mesh_vote_t
Vote.

Public Members

float **percentage**
vote percentage threshold for approval of being a root

bool **is_rc_specified**
if true, rc_addr shall be specified (Unimplemented). if false, attempts value shall be specified to make network start root election.

mesh_rc_config_t **config**
vote address configuration

struct mesh_tx_pending_t
The number of packets pending in the queue waiting to be sent by the mesh stack.

Public Members

int **to_parent**
to parent queue

int **to_parent_p2p**
to parent (P2P) queue

int **to_child**
to child queue

int **to_child_p2p**
to child (P2P) queue

int **mgmt**
management queue

int **broadcast**
broadcast and multicast queue

struct mesh_rx_pending_t
The number of packets available in the queue waiting to be received by applications.

Public Members

int **toDS**
to external DS

int **toSelf**
to self

Macros**MESH_ROOT_LAYER**

root layer value

MESH_MTU

max transmit unit(in bytes)

MESH_MPS

max payload size(in bytes)

ESP_ERR_MESH_WIFI_NOT_START

Mesh error code definition.

Wi-Fi isn't started

ESP_ERR_MESH_NOT_INIT

mesh isn't initialized

ESP_ERR_MESH_NOT_CONFIG

mesh isn't configured

ESP_ERR_MESH_NOT_START

mesh isn't started

ESP_ERR_MESH_NOT_SUPPORT

not supported yet

ESP_ERR_MESH_NOT_ALLOWED

operation is not allowed

ESP_ERR_MESH_NO_MEMORY

out of memory

ESP_ERR_MESH_ARGUMENT

illegal argument

ESP_ERR_MESH_EXCEED_MTU

packet size exceeds MTU

ESP_ERR_MESH_TIMEOUT

timeout

ESP_ERR_MESH_DISCONNECTED

disconnected with parent on station interface

ESP_ERR_MESH_QUEUE_FAIL

queue fail

ESP_ERR_MESH_QUEUE_FULL

queue full

ESP_ERR_MESH_NO_PARENT_FOUND

no parent found to join the mesh network

ESP_ERR_MESH_NO_ROUTE_FOUND

no route found to forward the packet

ESP_ERR_MESH_OPTION_NULL

no option found

ESP_ERR_MESH_OPTION_UNKNOWN

unknown option

ESP_ERR_MESH_XON_NO_WINDOW

no window for software flow control on upstream

ESP_ERR_MESH_INTERFACE

low-level Wi-Fi interface error

ESP_ERR_MESH_DISCARD_DUPLICATE

discard the packet due to the duplicate sequence number

ESP_ERR_MESH_DISCARD

discard the packet

ESP_ERR_MESH_VOTING

vote in progress

ESP_ERR_MESH_XMIT

XMIT

ESP_ERR_MESH_QUEUE_READ

error in reading queue

ESP_ERR_MESH_PS

mesh PS is not specified as enable or disable

ESP_ERR_MESH_RECV_RELEASE

release esp_mesh_rcv_toDS

MESH_DATA_ENC

Flags bitmap for esp_mesh_send() and esp_mesh_rcv()

data encrypted (Unimplemented)

MESH_DATA_P2P

point-to-point delivery over the mesh network

MESH_DATA_FROMDS

receive from external IP network

MESH_DATA_TODS

identify this packet is target to external IP network

MESH_DATA_NONBLOCK

esp_mesh_send() non-block

MESH_DATA_DROP

in the situation of the root having been changed, identify this packet can be dropped by new root

MESH_DATA_GROUP

identify this packet is target to a group address

MESH_OPT_SEND_GROUP

Option definitions for esp_mesh_send() and esp_mesh_rcv()

data transmission by group; used with esp_mesh_send() and shall have payload

MESH_OPT_RECV_DS_ADDR

return a remote IP address; used with esp_mesh_send() and esp_mesh_rcv()

MESH_ASSOC_FLAG_VOTE_IN_PROGRESS

Flag of mesh networking IE.

vote in progress

MESH_ASSOC_FLAG_NETWORK_FREE

no root in current network

MESH_ASSOC_FLAG_ROOTS_FOUND

root conflict is found

MESH_ASSOC_FLAG_ROOT_FIXED

fixed root

MESH_PS_DEVICE_DUTY_REQUEST

Mesh PS (Power Save) duty cycle type.

requests to join a network PS without specifying a device duty cycle. After the device joins the network, a network duty cycle will be provided by the network

MESH_PS_DEVICE_DUTY_DEMAND

requests to join a network PS and specifies a demanded device duty cycle

MESH_PS_NETWORK_DUTY_MASTER

indicates the device is the NWK-DUTY-MASTER (network duty cycle master)

MESH_PS_NETWORK_DUTY_APPLIED_ENTIRE

Mesh PS (Power Save) duty cycle applied rule.

MESH_PS_NETWORK_DUTY_APPLIED_UPLINK**MESH_INIT_CONFIG_DEFAULT ()****Type Definitions**

typedef *mesh_addr_t* **mesh_event_root_address_t**

Root address.

typedef *wifi_event_sta_disconnected_t* **mesh_event_disconnected_t**

Parent disconnected information.

typedef *wifi_event_ap_staconnected_t* **mesh_event_child_connected_t**

Child connected information.

typedef *wifi_event_ap_stadisconnected_t* **mesh_event_child_disconnected_t**

Child disconnected information.

typedef *wifi_event_sta_connected_t* **mesh_event_router_switch_t**

New router information.

Enumerations

enum **mesh_event_id_t**

Enumerated list of mesh event id.

Values:

MESH_EVENT_STARTED

mesh is started

MESH_EVENT_STOPPED

mesh is stopped

MESH_EVENT_CHANNEL_SWITCH

channel switch

MESH_EVENT_CHILD_CONNECTED

a child is connected on softAP interface

MESH_EVENT_CHILD_DISCONNECTED

a child is disconnected on softAP interface

MESH_EVENT_ROUTING_TABLE_ADD

routing table is changed by adding newly joined children

MESH_EVENT_ROUTING_TABLE_REMOVE

routing table is changed by removing leave children

MESH_EVENT_PARENT_CONNECTED

parent is connected on station interface

MESH_EVENT_PARENT_DISCONNECTED

parent is disconnected on station interface

MESH_EVENT_NO_PARENT_FOUND

no parent found

MESH_EVENT_LAYER_CHANGE

layer changes over the mesh network

MESH_EVENT_TODS_STATE

state represents whether the root is able to access external IP network

MESH_EVENT_VOTE_STARTED

the process of voting a new root is started either by children or by the root

MESH_EVENT_VOTE_STOPPED

the process of voting a new root is stopped

MESH_EVENT_ROOT_ADDRESS

the root address is obtained. It is posted by mesh stack automatically.

MESH_EVENT_ROOT_SWITCH_REQ

root switch request sent from a new voted root candidate

MESH_EVENT_ROOT_SWITCH_ACK

root switch acknowledgment responds the above request sent from current root

MESH_EVENT_ROOT_ASKED_YIELD

the root is asked yield by a more powerful existing root. If self organized is disabled and this device is specified to be a root by users, users should set a new parent for this device. if self organized is enabled, this device will find a new parent by itself, users could ignore this event.

MESH_EVENT_ROOT_FIXED

when devices join a network, if the setting of Fixed Root for one device is different from that of its parent, the device will update the setting the same as its parent's. Fixed Root Setting of each device is variable as that setting changes of the root.

MESH_EVENT_SCAN_DONE

if self-organized networking is disabled, user can call `esp_wifi_scan_start()` to trigger this event, and add the corresponding scan done handler in this event.

MESH_EVENT_NETWORK_STATE

network state, such as whether current mesh network has a root.

MESH_EVENT_STOP_RECONNECTION

the root stops reconnecting to the router and non-root devices stop reconnecting to their parents.

MESH_EVENT_FIND_NETWORK

when the channel field in mesh configuration is set to zero, mesh stack will perform a full channel scan to find a mesh network that can join, and return the channel value after finding it.

MESH_EVENT_ROUTER_SWITCH

if users specify BSSID of the router in mesh configuration, when the root connects to another router with the same SSID, this event will be posted and the new router information is attached.

MESH_EVENT_PS_PARENT_DUTY

parent duty

MESH_EVENT_PS_CHILD_DUTY

child duty

MESH_EVENT_PS_DEVICE_DUTY

device duty

MESH_EVENT_MAX

`enum mesh_type_t`

Device type.

Values:

MESH_IDLE

hasn't joined the mesh network yet

MESH_ROOT

the only sink of the mesh network. Has the ability to access external IP network

MESH_NODE

intermediate device. Has the ability to forward packets over the mesh network

MESH_LEAF

has no forwarding ability

MESH_STA

connect to router with a standalone Wi-Fi station mode, no network expansion capability

enum mesh_proto_t

Protocol of transmitted application data.

Values:

MESH_PROTO_BIN

binary

MESH_PROTO_HTTP

HTTP protocol

MESH_PROTO_JSON

JSON format

MESH_PROTO_MQTT

MQTT protocol

MESH_PROTO_AP

IP network mesh communication of node's AP interface

MESH_PROTO_STA

IP network mesh communication of node's STA interface

enum mesh_tos_t

For reliable transmission, mesh stack provides three type of services.

Values:

MESH_TOS_P2P

provide P2P (point-to-point) retransmission on mesh stack by default

MESH_TOS_E2E

provide E2E (end-to-end) retransmission on mesh stack (Unimplemented)

MESH_TOS_DEF

no retransmission on mesh stack

enum mesh_vote_reason_t

Vote reason.

Values:

MESH_VOTE_REASON_ROOT_INITIATED = 1

vote is initiated by the root

MESH_VOTE_REASON_CHILD_INITIATED

vote is initiated by children

enum mesh_disconnect_reason_t

Mesh disconnect reason code.

Values:

MESH_REASON_CYCLIC = 100

cyclic is detected

MESH_REASON_PARENT_IDLE

parent is idle

MESH_REASON_LEAF

the connected device is changed to a leaf

MESH_REASON_DIFF_ID

in different mesh ID

MESH_REASON_ROOTS

root conflict is detected

MESH_REASON_PARENT_STOPPED

parent has stopped the mesh

MESH_REASON_SCAN_FAIL

scan fail

MESH_REASON_IE_UNKNOWN

unknown IE

MESH_REASON_WAIVE_ROOT

waive root

MESH_REASON_PARENT_WORSE

parent with very poor RSSI

MESH_REASON_EMPTY_PASSWORD

use an empty password to connect to an encrypted parent

MESH_REASON_PARENT_UNENCRYPTED

connect to an unencrypted parent/router

enum esp_mesh_topology_t

Mesh topology.

Values:

MESH_TOPO_TREE

tree topology

MESH_TOPO_CHAIN

chain topology

enum mesh_event_toDS_state_t

The reachability of the root to a DS (distribute system)

Values:

MESH_TODS_UNREACHABLE

the root isn't able to access external IP network

MESH_TODS_REACHABLE

the root is able to access external IP network

Wi-Fi Easy Connect™ (DPP)

Wi-Fi Easy Connect™, also known as Device Provisioning Protocol (DPP) or Easy Connect, is a provisioning protocol certified by Wi-Fi Alliance. It is a secure and standardized provisioning protocol for configuration of Wi-Fi Devices. With Easy Connect adding a new device to a network is as simple as scanning a QR Code. This reduces complexity and enhances user experience while onboarding devices without UI like Smart Home and IoT products. Unlike old protocols like WiFi Protected Setup (WPS), Wi-Fi Easy Connect incorporates strong encryption through public key cryptography to ensure networks remain secure as new devices are added. Easy Connect brings many benefits in the User Experience:

- Simple and intuitive to use; no lengthy instructions to follow for new device setup
- No need to remember and enter passwords into the device being provisioned
- Works with electronic or printed QR codes, or human-readable strings
- Supports both WPA2 and WPA3 networks

Please refer to Wi-Fi Alliance's official page on [Easy Connect](#) for more information.

ESP32-C3 supports Enrollee mode of Easy Connect with QR Code as the provisioning method. A display is required to display this QR Code. Users can scan this QR Code using their capable device and provision the ESP32-C3 to their Wi-Fi network. The provisioning device needs to be connected to the AP which need not support Wi-Fi Easy Connect™. Easy Connect is still an evolving protocol. Of known platforms that support the QR Code method are some Android smartphones with Android 10 or higher. To use Easy Connect no additional App needs to be installed on the supported smartphone.

Application Example Example on how to provision ESP32-C3 using a supported smartphone: [wifi/wifi_easy_connect/dpp-enrollee](#).

API Reference

Header File

- `wpa_supplicant/include/esp_supplicant/esp_dpp.h`

Functions

esp_err_t **esp_supp_dpp_init** (*esp_supp_dpp_event_cb_t* evt_cb)

Initialize DPP Supplicant.

Starts DPP Supplicant and initializes related Data Structures.

return

- ESP_OK: Success
- ESP_FAIL: Failure

Parameters

- evt_cb: Callback function to receive DPP related events

void **esp_supp_dpp_deinit** (void)

De-initialize DPP Supplicant.

Frees memory from DPP Supplicant Data Structures.

esp_err_t **esp_supp_dpp_bootstrap_gen** (const char *chan_list, *esp_supp_dpp_bootstrap_t* type, const char *key, const char *info)

Generates Bootstrap Information as an Enrollee.

Generates Out Of Band Bootstrap information as an Enrollee which can be used by a DPP Configurator to provision the Enrollee.

Return

- ESP_OK: Success
- ESP_FAIL: Failure

Parameters

- chan_list: List of channels device will be available on for listening
- type: Bootstrap method type, only QR Code method is supported for now.
- key: (Optional) Private Key used to generate a Bootstrapping Public Key
- info: (Optional) Ancilliary Device Information like Serial Number

esp_err_t **esp_supp_dpp_start_listen** (void)

Start listening on Channels provided during esp_supp_dpp_bootstrap_gen.

Listens on every Channel from Channel List for a pre-defined wait time.

Return

- ESP_OK: Success
- ESP_FAIL: Generic Failure
- ESP_ERR_INVALID_STATE: ROC attempted before WiFi is started
- ESP_ERR_NO_MEM: Memory allocation failed while posting ROC request

void **esp_supp_dpp_stop_listen** (void)

Stop listening on Channels.

Stops listening on Channels and cancels ongoing listen operation.

Macros

ESP_ERR_DPP_FAILURE

Generic failure during DPP Operation

ESP_ERR_DPP_TX_FAILURE

DPP Frame Tx failed OR not Acked

ESP_ERR_DPP_INVALID_ATTR

Encountered invalid DPP Attribute

Type Definitions

typedef enum *dpp_bootstrap_type* esp_supp_dpp_bootstrap_t

Types of Bootstrap Methods for DPP.

typedef void (*esp_supp_dpp_event_cb_t) (*esp_supp_dpp_event_t* evt, void *data)

Callback function for receiving DPP Events from Supplicant.

Callback function will be called with DPP related information.

Parameters

- *evt*: DPP event ID
- *data*: Event data payload

Enumerations

enum dpp_bootstrap_type

Types of Bootstrap Methods for DPP.

Values:

DPP_BOOTSTRAP_QR_CODE

QR Code Method

DPP_BOOTSTRAP_PKEX

Proof of Knowledge Method

DPP_BOOTSTRAP_NFC_URI

NFC URI record Method

enum esp_supp_dpp_event_t

Types of Callback Events received from DPP Supplicant.

Values:

ESP_SUPP_DPP_URI_READY

URI is ready through Bootstrapping

ESP_SUPP_DPP_CFG_RECVD

Config received via DPP Authentication

ESP_SUPP_DPP_FAIL

DPP Authentication failure

Code examples for the Wi-Fi API are provided in the [wifi](#) directory of ESP-IDF examples.

Code examples for ESP-MESH are provided in the [mesh](#) directory of ESP-IDF examples.

2.2.2 Ethernet

Ethernet

Overview ESP-IDF provides a set of consistent and flexible APIs to support both internal Ethernet MAC (EMAC) controller and external SPI-Ethernet modules.

This programming guide is split into the following sections:

1. *Basic Ethernet Concepts*
2. *Configure MAC and PHY*
3. *Connect Driver to TCP/IP Stack*
4. *Misc control of Ethernet driver*

Basic Ethernet Concepts Ethernet is an asynchronous Carrier Sense Multiple Access with Collision Detect (CSMA/CD) protocol/interface. It is generally not well suited for low power applications. However, with ubiquitous deployment, internet connectivity, high data rates and limitless range expandability, Ethernet can accommodate nearly all wired communications.

Normal IEEE 802.3 compliant Ethernet frames are between 64 and 1518 bytes in length. They are made up of five or six different fields: a destination MAC address (DA), a source MAC address (SA), a type/length field, data payload, an optional padding field and a Cyclic Redundancy Check (CRC). Additionally, when transmitted on the Ethernet medium, a 7-byte preamble field and Start-of-Frame (SOF) delimiter byte are appended to the beginning of the Ethernet packet.

Thus the traffic on the twist-pair cabling will appear as shown below:

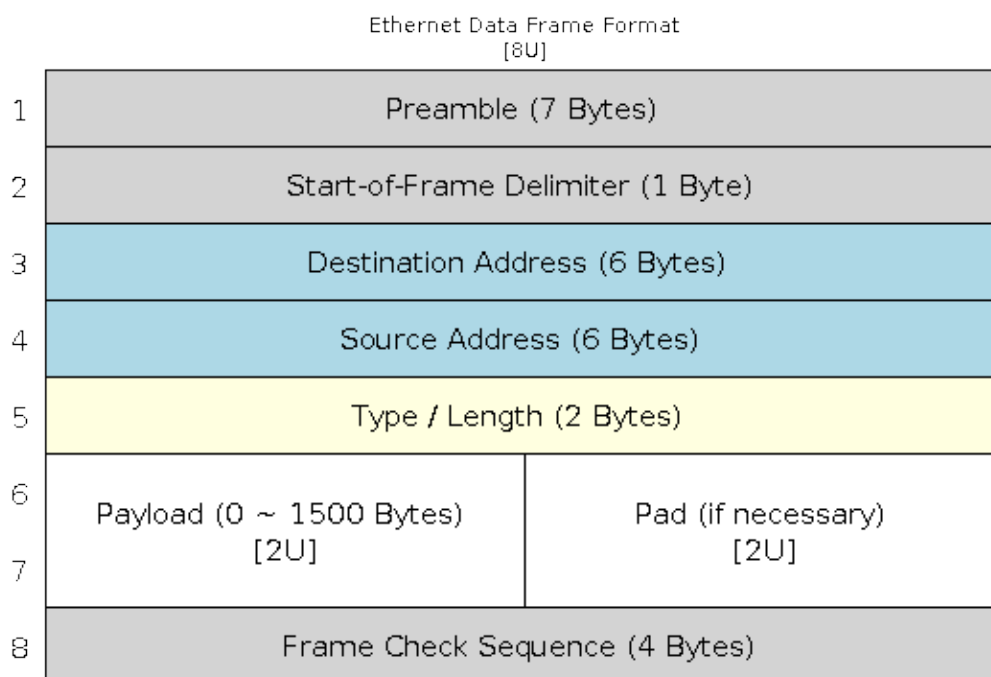

Fig. 4: Ethernet Data Frame Format

Preamble and Start-of-Frame Delimiter The preamble contains seven bytes of 55H, it allows the receiver to lock onto the stream of data before the actual frame arrives. The Start-of-Frame Delimiter (SFD) is a binary sequence 10101011 (as seen on the physical medium). It is sometimes considered to be part of the preamble.

When transmitting and receiving data, the preamble and SFD bytes will automatically be generated or stripped from the packets.

Destination Address The destination address field contains a 6-byte length MAC address of the device that the packet is directed to. If the Least Significant bit in the first byte of the MAC address is set, the address is a multi-cast destination. For example, 01-00-00-00-F0-00 and 33-45-67-89-AB-CD are multi-cast addresses, while 00-00-00-00-F0-00 and 32-45-67-89-AB-CD are not. Packets with multi-cast destination addresses are designed to arrive and be important to a selected group of Ethernet nodes. If the destination address field is the reserved multi-cast address, i.e. FF-FF-FF-FF-FF-FF, the packet is a broadcast packet and it will be directed to everyone sharing the network. If the Least Significant bit in the first byte of the MAC address is clear, the address is a uni-cast address and will be designed for usage by only the addressed node.

Normally the EMAC controller incorporates receive filters which can be used to discard or accept packets with multi-cast, broadcast and/or uni-cast destination addresses. When transmitting packets, the host controller is responsible for writing the desired destination address into the transmit buffer.

Source Address The source address field contains a 6-byte length MAC address of the node which created the Ethernet packet. Users of Ethernet must generate a unique MAC address for each controller used. MAC addresses consist of two portions. The first three bytes are known as the Organizationally Unique Identifier (OUI). OUIs are distributed by the IEEE. The last three bytes are address bytes at the discretion of the company that purchased the OUI. More information about MAC Address used in ESP-IDF, please see [MAC Address Allocation](#).

When transmitting packets, the assigned source MAC address must be written into the transmit buffer by the host controller.

Type / Length The type/length field is a 2-byte field, if the value in this field is ≤ 1500 (decimal), it is considered a length field and it specifies the amount of non-padding data which follows in the data field. If the value is ≥ 1536 , it represents the protocol the following packet data belongs to. The following are the most common type values:

- IPv4 = 0800H
- IPv6 = 86DDH
- ARP = 0806H

Users implementing proprietary networks may choose to treat this field as a length field, while applications implementing protocols such as the Internet Protocol (IP) or Address Resolution Protocol (ARP), should program this field with the appropriate type defined by the protocol's specification when transmitting packets.

Payload The payload field is a variable length field, anywhere from 0 to 1500 bytes. Larger data packets will violate Ethernet standards and will be dropped by most Ethernet nodes. This field contains the client data, such as an IP datagram.

Padding and FCS The padding field is a variable length field added to meet IEEE 802.3 specification requirements when small data payloads are used. The DA, SA, type, payload and padding of an Ethernet packet must be no smaller than 60 bytes. Adding the required 4-byte FCS field, packets must be no smaller than 64 bytes. If the data field is less than 46 bytes long, a padding field is required.

The FCS field is a 4-byte field which contains an industry standard 32-bit CRC calculated with the data from the DA, SA, type, payload and padding fields. Given the complexity of calculating a CRC, the hardware normally will automatically generate a valid CRC and transmit it. Otherwise, the host controller must generate the CRC and place it in the transmit buffer.

Normally, the host controller does not need to concern itself with padding and the CRC which the hardware EMAC will also be able to automatically generate when transmitting and verify when receiving. However, the padding and CRC fields will be written into the receive buffer when packets arrive, so they may be evaluated by the host controller if needed.

Note: Besides the basic data frame described above, there're two other common frame types in 10/100 Mbps Ethernet: control frames and VLAN tagged frames. They're not supported in ESP-IDF.

Configure MAC and PHY Ethernet driver is composed of two parts: MAC and PHY. The communication between MAC and PHY can have diverse choices: **MII** (Media Independent Interface), **RMI** (Reduced Media Independent Interface) and etc.

We need to setup necessary parameters for MAC and PHY respectively based on your Ethernet board design and then combine the two together, completing the driver installation.

Configuration for MAC is described in `eth_mac_config_t`, including:

- `sw_reset_timeout_ms`: software reset timeout value, in milliseconds, typically MAC reset should be finished within 100ms.
- `rx_task_stack_size` and `rx_task_prio`: the MAC driver creates a dedicated task to process incoming packets, these two parameters are used to set the stack size and priority of the task.
- `smi_mdc_gpio_num` and `smi_mdio_gpio_num`: the GPIO number used to connect the SMI signals.
- `flags`: specifying extra features that the MAC driver should have, it could be useful in some special situations. The value of this field can be OR' d with macros prefixed with `ETH_MAC_FLAG_`. For example, if the MAC driver should work when cache is disabled, then you should configure this field with `ETH_MAC_FLAG_WORK_WITH_CACHE_DISABLE`.

Configuration for PHY is described in `eth_phy_config_t`, including:

- `phy_addr`: multiple PHY device can share the same SMI bus, so each PHY needs a unique address. Usually this address is configured during hardware design by pulling up/down some PHY strapping pins. You can set the value from 0 to 15 based on your Ethernet board. Especially, if the SMI bus is shared by only one PHY device, setting this value to -1 can enable the driver to detect the PHY address automatically.
- `reset_timeout_ms`: reset timeout value, in milliseconds, typically PHY reset should be finished within 100ms.
- `autonego_timeout_ms`: auto-negotiation timeout value, in milliseconds. Ethernet driver will start negotiation with the peer Ethernet node automatically, to determine to duplex and speed mode. This value usually depends on the ability of the PHY device on your board.
- `reset_gpio_num`: if your board also connect the PHY reset pin to one of the GPIO, then set it here. Otherwise, set this field to -1.

ESP-IDF provides a default configuration for MAC and PHY in macro `ETH_MAC_DEFAULT_CONFIG` and `ETH_PHY_DEFAULT_CONFIG`.

Create MAC and PHY Instance Ethernet driver is implemented in an Object-Oriented style. Any operation on MAC and PHY should be based on the instance of them two.

```
eth_mac_config_t mac_config = ETH_MAC_DEFAULT_CONFIG(); // apply default MAC_
↳configuration
mac_config.smi_mdc_gpio_num = 23; // alter the GPIO used for MDC signal
mac_config.smi_mdio_gpio_num = 18; // alter the GPIO used for MDIO signal
esp_eth_mac_t *mac = esp_eth_mac_new_esp32(&mac_config); // create MAC instance

eth_phy_config_t phy_config = ETH_PHY_DEFAULT_CONFIG(); // apply default PHY_
↳configuration
phy_config.phy_addr = 1; // alter the PHY address according to your board_
↳design
phy_config.reset_gpio_num = 5; // alter the GPIO used for PHY reset
esp_eth_phy_t *phy = esp_eth_phy_new_ip101(&phy_config); // create PHY instance
// ESP-IDF officially supports several different Ethernet PHY
// esp_eth_phy_t *phy = esp_eth_phy_new_rtl8201(&phy_config);
// esp_eth_phy_t *phy = esp_eth_phy_new_lan8720(&phy_config);
// esp_eth_phy_t *phy = esp_eth_phy_new_dp83848(&phy_config);
```

Note: Care should be taken, when creating MAC and PHY instance for SPI-Ethernet modules (e.g. DM9051), the constructor function must have the same suffix (e.g. `esp_eth_mac_new_dm9051` and `esp_eth_phy_new_dm9051`). This is because we don't have other choices but the integrated PHY. Besides that, we have to create an SPI device handle firstly and then pass it to the MAC constructor function. More instructions on creating SPI device handle,

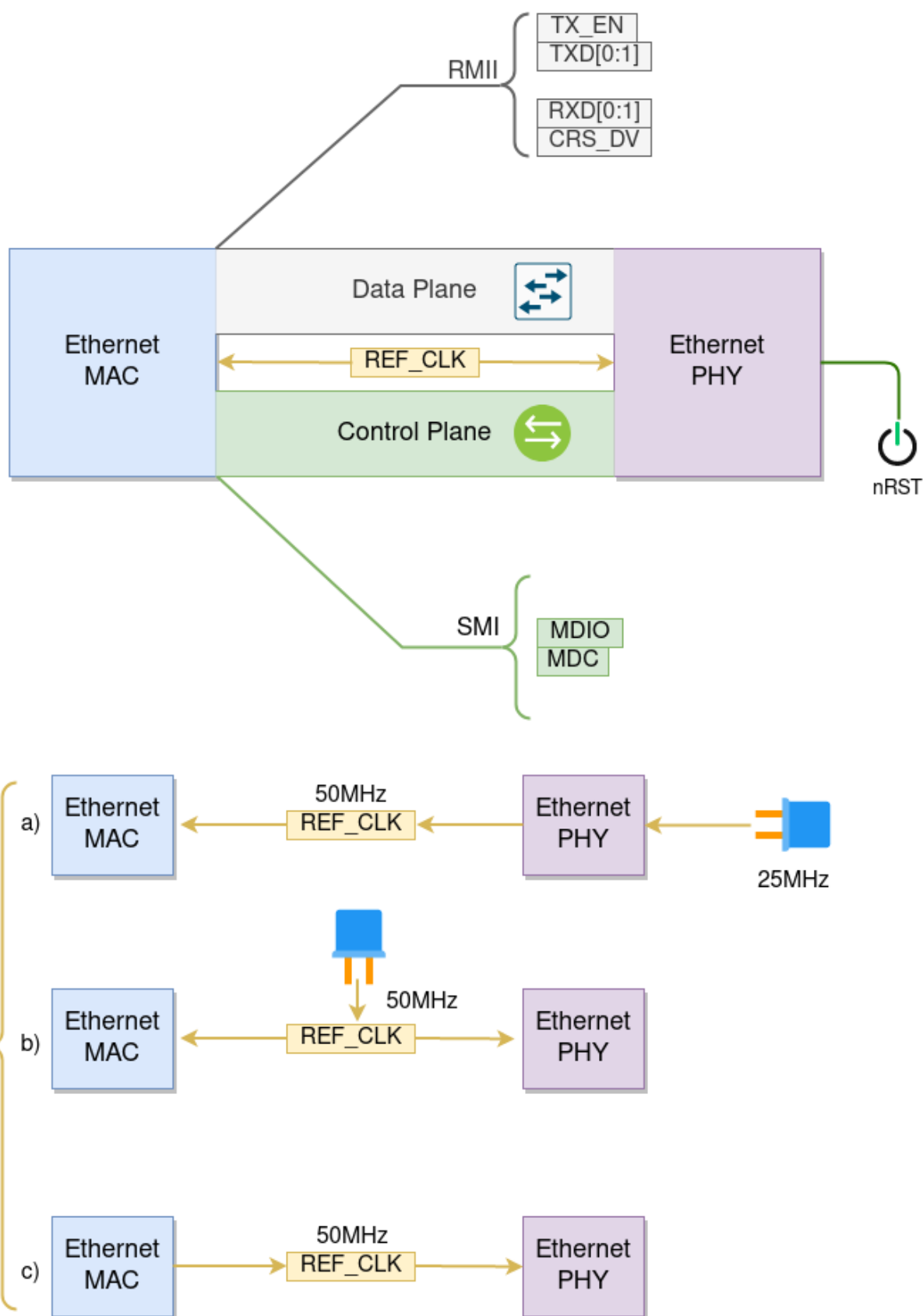

Fig. 5: Ethernet RMI Interface

please refer to *SPI Master*.

Install Driver Ethernet driver also includes event-driven model, which will send useful and important event to user space. We need to initialize the event loop before installing the Ethernet driver. For more information about event-driven programming, please refer to *ESP Event*.

```

/** Event handler for Ethernet events */
static void eth_event_handler(void *arg, esp_event_base_t event_base,
                              int32_t event_id, void *event_data)
{
    uint8_t mac_addr[6] = {0};
    /* we can get the ethernet driver handle from event data */
    esp_eth_handle_t eth_handle = *(esp_eth_handle_t *)event_data;

    switch (event_id) {
        case ETHERNET_EVENT_CONNECTED:
            esp_eth_ioctl(eth_handle, ETH_CMD_G_MAC_ADDR, mac_addr);
            ESP_LOGI(TAG, "Ethernet Link Up");
            ESP_LOGI(TAG, "Ethernet HW Addr %02x:%02x:%02x:%02x:%02x:%02x",
                    mac_addr[0], mac_addr[1], mac_addr[2], mac_addr[3], mac_addr[4],
↪mac_addr[5]);
            break;
        case ETHERNET_EVENT_DISCONNECTED:
            ESP_LOGI(TAG, "Ethernet Link Down");
            break;
        case ETHERNET_EVENT_START:
            ESP_LOGI(TAG, "Ethernet Started");
            break;
        case ETHERNET_EVENT_STOP:
            ESP_LOGI(TAG, "Ethernet Stopped");
            break;
        default:
            break;
    }
}

esp_event_loop_create_default(); // create a default event loop that running in
↪background
esp_event_handler_register(ETH_EVENT, ESP_EVENT_ANY_ID, &eth_event_handler, NULL);
↪// register Ethernet event handler (to deal with user specific stuffs when event
↪like link up/down happened)

```

To install the Ethernet driver, we need to combine the instance of MAC and PHY and set some additional high-level configurations (i.e. not specific to either MAC or PHY) in *esp_eth_config_t*:

- *mac*: instance that created from MAC generator (e.g. *esp_eth_mac_new_esp32()*).
- *phy*: instance that created from PHY generator (e.g. *esp_eth_phy_new_ip101()*).
- *check_link_period_ms*: Ethernet driver starts an OS timer to check the link status periodically, this field is used to set the interval, in milliseconds.
- *stack_input*: In most of Ethernet IoT applications, any Ethernet frame that received by driver should be passed to upper layer (e.g. TCP/IP stack). This field is set to a function which is responsible to deal with the incoming frames. You can even update this field at runtime via function *esp_eth_update_input_path()* after driver installation.
- *on_lowlevel_init_done* and *on_lowlevel_deinit_done*: These two fields are used to specify the hooks which get invoked when low level hardware has been initialized or de-initialized.

ESP-IDF provides a default configuration for driver installation in macro *ETH_DEFAULT_CONFIG*.

```

esp_eth_config_t config = ETH_DEFAULT_CONFIG(mac, phy); // apply default driver
↪configuration

```

(continues on next page)

(continued from previous page)

```
esp_eth_handle_t eth_handle = NULL; // after driver installed, we will get the
↳handle of the driver
esp_eth_driver_install(&config, &eth_handle); // install driver
```

Start Ethernet Driver After driver installation, we can start Ethernet immediately.

```
esp_eth_start(eth_handle); // start Ethernet driver state machine
```

Connect Driver to TCP/IP Stack Up until now, we have installed the Ethernet driver. From the view of OSI (Open System Interconnection), we're still on level 2 (i.e. Data Link Layer). We can detect link up and down event, we can gain MAC address in user space, but we can't obtain IP address, let alone send HTTP request. The TCP/IP stack used in ESP-IDF is called LwIP, for more information about it, please refer to [LwIP](#).

To connect Ethernet driver to TCP/IP stack, these three steps need to follow:

1. Create network interface for Ethernet driver
2. Register IP event handlers
3. Attach the network interface to Ethernet driver

More information about network interface, please refer to [Network Interface](#).

```
/** Event handler for IP_EVENT_ETH_GOT_IP */
static void got_ip_event_handler(void *arg, esp_event_base_t event_base,
                                int32_t event_id, void *event_data)
{
    ip_event_got_ip_t *event = (ip_event_got_ip_t *) event_data;
    const esp_netif_ip_info_t *ip_info = &event->ip_info;

    ESP_LOGI(TAG, "Ethernet Got IP Address");
    ESP_LOGI(TAG, "~~~~~");
    ESP_LOGI(TAG, "ETHIP:" IPSTR, IP2STR(&ip_info->ip));
    ESP_LOGI(TAG, "ETHMASK:" IPSTR, IP2STR(&ip_info->netmask));
    ESP_LOGI(TAG, "ETHGW:" IPSTR, IP2STR(&ip_info->gw));
    ESP_LOGI(TAG, "~~~~~");
}

esp_netif_init(); // Initialize TCP/IP network interface (should be called only
↳once in application)
esp_netif_config_t cfg = ESP_NETIF_DEFAULT_ETH(); // apply default network
↳interface configuration for Ethernet
esp_netif_t *eth_netif = esp_netif_new(&cfg); // create network interface for
↳Ethernet driver
esp_eth_set_default_handlers(eth_netif); // set default handlers to process TCP/IP
↳stuffs
esp_event_handler_register(IP_EVENT, IP_EVENT_ETH_GOT_IP, &got_ip_event_handler,
↳NULL); // register user defined IP event handlers

esp_netif_attach(eth_netif, esp_eth_new_netif_glue(eth_handle)); // attach
↳Ethernet driver to TCP/IP stack
esp_eth_start(eth_handle); // start Ethernet driver state machine
```

Warning: User's Ethernet/IP event handlers need to be registered after registration of default handlers (i.e. after [esp_eth_set_default_handlers\(\)](#)). General recommendation is to fully initialize Ethernet driver and network interface prior registering user's Ethernet/IP event handlers, i.e. register the user event handlers as the last thing prior starting the Ethernet driver. Such approach ensures that Ethernet/IP events get executed first by the Ethernet driver or network interface and so the system is in expected state when executing user's handlers.

Misc control of Ethernet driver The following functions should only be invoked after the Ethernet driver has been installed.

- Stop Ethernet driver: [esp_eth_stop\(\)](#)
- Update Ethernet data input path: [esp_eth_update_input_path\(\)](#)
- Misc get/set of Ethernet driver attributes: [esp_eth_ioctl\(\)](#)

```

/* get MAC address */
uint8_t mac_addr[6];
memset(mac_addr, 0, sizeof(mac_addr));
esp_eth_ioctl(eth_handle, ETH_CMD_G_MAC_ADDR, mac_addr);
ESP_LOGI(TAG, "Ethernet MAC Address: %02x:%02x:%02x:%02x:%02x:%02x",
          mac_addr[0], mac_addr[1], mac_addr[2], mac_addr[3], mac_addr[4], mac_
↪addr[5]);

/* get PHY address */
int phy_addr = -1;
esp_eth_ioctl(eth_handle, ETH_CMD_G_PHY_ADDR, &phy_addr);
ESP_LOGI(TAG, "Ethernet PHY Address: %d", phy_addr);

```

Flow control Ethernet on MCU usually has a limitation in the number of frames it can handle during network congestion, because of the limitation in RAM size. A sending station might be transmitting data faster than the peer end can accept it. Ethernet flow control mechanism allows the receiving node to signal the sender requesting suspension of transmissions until the receiver catches up. The magic behind that is the pause frame, which was defined in IEEE 802.3x.

Pause frame is a special Ethernet frame used to carry the pause command, whose EtherType field is 0x8808, with the Control opcode set to 0x0001. Only stations configured for full-duplex operation may send pause frames. When a station wishes to pause the other end of a link, it sends a pause frame to the 48-bit reserved multicast address of 01-80-C2-00-00-01. The pause frame also includes the period of pause time being requested, in the form of a two-byte integer, ranging from 0 to 65535.

After Ethernet driver installation, the flow control feature is disabled by default. You can enable it by invoking [esp_eth_ioctl\(eth_handle, ETH_CMD_S_FLOW_CTRL, true\)](#);: One thing should be kept in mind, is that the pause frame ability will be advertised to peer end by PHY during auto negotiation. Ethernet driver sends pause frame only when both sides of the link support it.

Application Example

- Ethernet basic example: [ethernet/basic](#).
- Ethernet iperf example: [ethernet/iperf](#).
- Ethernet to Wi-Fi AP “router” : [ethernet/eth2ap](#).
- Most of protocol examples should also work for Ethernet: [protocols](#).

API Reference

Header File

- [esp_eth/include/esp_eth.h](#)

Functions

esp_err_t esp_eth_driver_install(const esp_eth_config_t *config, esp_eth_handle_t *out_hdl)
Install Ethernet driver.

Return

- ESP_OK: install esp_eth driver successfully
- ESP_ERR_INVALID_ARG: install esp_eth driver failed because of some invalid argument
- ESP_ERR_NO_MEM: install esp_eth driver failed because there's no memory for driver

- ESP_FAIL: install esp_eth driver failed because some other error occurred

Parameters

- [in] config: configuration of the Ethernet driver
- [out] out_hdl: handle of Ethernet driver

esp_err_t **esp_eth_driver_uninstall** (*esp_eth_handle_t* hdl)

Uninstall Ethernet driver.

Note It's not recommended to uninstall Ethernet driver unless it won't get used any more in application code. To uninstall Ethernet driver, you have to make sure, all references to the driver are released. Ethernet driver can only be uninstalled successfully when reference counter equals to one.

Return

- ESP_OK: uninstall esp_eth driver successfully
- ESP_ERR_INVALID_ARG: uninstall esp_eth driver failed because of some invalid argument
- ESP_ERR_INVALID_STATE: uninstall esp_eth driver failed because it has more than one reference
- ESP_FAIL: uninstall esp_eth driver failed because some other error occurred

Parameters

- [in] hdl: handle of Ethernet driver

esp_err_t **esp_eth_start** (*esp_eth_handle_t* hdl)

Start Ethernet driver **ONLY** in standalone mode (i.e. without TCP/IP stack)

Note This API will start driver state machine and internal software timer (for checking link status).

Return

- ESP_OK: start esp_eth driver successfully
- ESP_ERR_INVALID_ARG: start esp_eth driver failed because of some invalid argument
- ESP_ERR_INVALID_STATE: start esp_eth driver failed because driver has started already
- ESP_FAIL: start esp_eth driver failed because some other error occurred

Parameters

- [in] hdl: handle of Ethernet driver

esp_err_t **esp_eth_stop** (*esp_eth_handle_t* hdl)

Stop Ethernet driver.

Note This function does the oppsite operation of esp_eth_start.

Return

- ESP_OK: stop esp_eth driver successfully
- ESP_ERR_INVALID_ARG: stop esp_eth driver failed because of some invalid argument
- ESP_ERR_INVALID_STATE: stop esp_eth driver failed because driver has not started yet
- ESP_FAIL: stop esp_eth driver failed because some other error occurred

Parameters

- [in] hdl: handle of Ethernet driver

esp_err_t **esp_eth_update_input_path** (*esp_eth_handle_t* hdl, *esp_err_t* (*stack_input)) *esp_eth_handle_t* hdl, uint8_t *buffer, uint32_t length, void *priv

, void *priv Update Ethernet data input path (i.e. specify where to pass the input buffer)

Note After install driver, Ethernet still don't know where to deliver the input buffer. In fact, this API registers a callback function which get invoked when Ethernet received new packets.

Return

- ESP_OK: update input path successfully
- ESP_ERR_INVALID_ARG: update input path failed because of some invalid argument
- ESP_FAIL: update input path failed because some other error occurred

Parameters

- [in] hdl: handle of Ethernet driver
- [in] stack_input: function pointer, which does the actual process on incoming packets
- [in] priv: private resource, which gets passed to stack_input callback without any modification

esp_err_t **esp_eth_transmit** (*esp_eth_handle_t* hdl, void *buf, size_t length)

General Transmit.

Return

- ESP_OK: transmit frame buffer successfully
- ESP_ERR_INVALID_ARG: transmit frame buffer failed because of some invalid argument
- ESP_FAIL: transmit frame buffer failed because some other error occurred

Parameters

- [in] hdl: handle of Ethernet driver
- [in] buf: buffer of the packet to transfer
- [in] length: length of the buffer to transfer

*esp_err_t esp_eth_receive(esp_eth_handle_t hdl, uint8_t *buf, uint32_t *length)*

General Receive is deprecated and shall not be accessed from app code, as polling is not supported by Ethernet.

Note Before this function got invoked, the value of “length” should set by user, equals the size of buffer. After the function returned, the value of “length” means the real length of received data.

Note This API was exposed by accident, users should not use this API in their applications. Ethernet driver is interrupt driven, and doesn't support polling mode. Instead, users should register input callback with esp_eth_update_input_path.

Return

- ESP_OK: receive frame buffer successfully
- ESP_ERR_INVALID_ARG: receive frame buffer failed because of some invalid argument
- ESP_ERR_INVALID_SIZE: input buffer size is not enough to hold the incoming data. in this case, value of returned “length” indicates the real size of incoming data.
- ESP_FAIL: receive frame buffer failed because some other error occurred

Parameters

- [in] hdl: handle of Ethernet driver
- [out] buf: buffer to preserve the received packet
- [out] length: length of the received packet

*esp_err_t esp_eth_ioctl(esp_eth_handle_t hdl, esp_eth_io_cmd_t cmd, void *data)*

Misc IO function of Ethernet driver.

Return

- ESP_OK: process io command successfully
- ESP_ERR_INVALID_ARG: process io command failed because of some invalid argument
- ESP_FAIL: process io command failed because some other error occurred

Parameters

- [in] hdl: handle of Ethernet driver
- [in] cmd: IO control command
- [in] data: specified data for command

esp_err_t esp_eth_increase_reference(esp_eth_handle_t hdl)

Increase Ethernet driver reference.

Note Ethernet driver handle can be obtained by os timer, netif, etc. It's dangerous when thread A is using Ethernet but thread B uninstall the driver. Using reference counter can prevent such risk, but care should be taken, when you obtain Ethernet driver, this API must be invoked so that the driver won't be uninstalled during your using time.

Return

- ESP_OK: increase reference successfully
- ESP_ERR_INVALID_ARG: increase reference failed because of some invalid argument

Parameters

- [in] hdl: handle of Ethernet driver

esp_err_t esp_eth_decrease_reference(esp_eth_handle_t hdl)

Decrease Ethernet driver reference.

Return

- ESP_OK: increase reference successfully
- ESP_ERR_INVALID_ARG: increase reference failed because of some invalid argument

Parameters

- [in] hdl: handle of Ethernet driver

Structures

struct esp_eth_config_t

Configuration of Ethernet driver.

Public Members

esp_eth_mac_t ***mac**

Ethernet MAC object.

esp_eth_phy_t ***phy**

Ethernet PHY object.

uint32_t **check_link_period_ms**

Period time of checking Ethernet link status.

esp_err_t (***stack_input**)(*esp_eth_handle_t* eth_handle, uint8_t *buffer, uint32_t length, void *priv)

Input frame buffer to user's stack.

Return

- ESP_OK: input frame buffer to upper stack successfully
- ESP_FAIL: error occurred when inputting buffer to upper stack

Parameters

- [in] eth_handle: handle of Ethernet driver
- [in] buffer: frame buffer that will get input to upper stack
- [in] length: length of the frame buffer

esp_err_t (***on_lowlevel_init_done**)(*esp_eth_handle_t* eth_handle)

Callback function invoked when lowlevel initialization is finished.

Return

- ESP_OK: process extra lowlevel initialization successfully
- ESP_FAIL: error occurred when processing extra lowlevel initialization

Parameters

- [in] eth_handle: handle of Ethernet driver

esp_err_t (***on_lowlevel_deinit_done**)(*esp_eth_handle_t* eth_handle)

Callback function invoked when lowlevel deinitialization is finished.

Return

- ESP_OK: process extra lowlevel deinitialization successfully
- ESP_FAIL: error occurred when processing extra lowlevel deinitialization

Parameters

- [in] eth_handle: handle of Ethernet driver

Macros

ETH_DEFAULT_CONFIG(emac, ephy)

Default configuration for Ethernet driver.

Type Definitions

typedef void ***esp_eth_handle_t**

Handle of Ethernet driver.

Header File

- [esp_eth/include/esp_eth_com.h](#)

Functions

esp_err_t **esp_eth_detect_phy_addr** (*esp_eth_mediator_t* *eth, int *detected_addr)

Detect PHY address.

Return

- ESP_OK: detect phy address successfully
- ESP_ERR_INVALID_ARG: invalid parameter
- ESP_ERR_NOT_FOUND: can't detect any PHY device
- ESP_FAIL: detect phy address failed because some error occurred

Parameters

- [in] eth: mediator of Ethernet driver
- [out] detected_addr: a valid address after detection

Structures

struct esp_eth_mediator_s

Ethernet mediator.

Public Members

esp_err_t (**phy_reg_read**) (*esp_eth_mediator_t* *eth, uint32_t phy_addr, uint32_t phy_reg, uint32_t *reg_value)

Read PHY register.

Return

- ESP_OK: read PHY register successfully
- ESP_FAIL: read PHY register failed because some error occurred

Parameters

- [in] eth: mediator of Ethernet driver
- [in] phy_addr: PHY Chip address (0~31)
- [in] phy_reg: PHY register index code
- [out] reg_value: PHY register value

esp_err_t (**phy_reg_write**) (*esp_eth_mediator_t* *eth, uint32_t phy_addr, uint32_t phy_reg, uint32_t reg_value)

Write PHY register.

Return

- ESP_OK: write PHY register successfully
- ESP_FAIL: write PHY register failed because some error occurred

Parameters

- [in] eth: mediator of Ethernet driver
- [in] phy_addr: PHY Chip address (0~31)
- [in] phy_reg: PHY register index code
- [in] reg_value: PHY register value

esp_err_t (**stack_input**) (*esp_eth_mediator_t* *eth, uint8_t *buffer, uint32_t length)

Deliver packet to upper stack.

Return

- ESP_OK: deliver packet to upper stack successfully
- ESP_FAIL: deliver packet failed because some error occurred

Parameters

- [in] eth: mediator of Ethernet driver
- [in] buffer: packet buffer
- [in] length: length of the packet

esp_err_t (**on_state_changed**) (*esp_eth_mediator_t* *eth, *esp_eth_state_t* state, void *args)

Callback on Ethernet state changed.

Return

- ESP_OK: process the new state successfully

- `ESP_FAIL`: process the new state failed because some error occurred

Parameters

- `[in] eth`: mediator of Ethernet driver
- `[in] state`: new state
- `[in] args`: optional argument for the new state

Macros

`ETH_MAX_PAYLOAD_LEN`

Maximum Ethernet payload size.

`ETH_MIN_PAYLOAD_LEN`

Minimum Ethernet payload size.

`ETH_HEADER_LEN`

Ethernet frame header size: Dest addr(6 Bytes) + Src addr(6 Bytes) + length/type(2 Bytes)

`ETH_CRC_LEN`

Ethernet frame CRC length.

`ETH_VLAN_TAG_LEN`

Optional 802.1q VLAN Tag length.

`ETH_JUMBO_FRAME_PAYLOAD_LEN`

Jumbo frame payload size.

`ETH_MAX_PACKET_SIZE`

Maximum frame size (1522 Bytes)

`ETH_MIN_PACKET_SIZE`

Minimum frame size (64 Bytes)

Type Definitions

```
typedef struct esp_eth_mediator_s esp_eth_mediator_t
```

Ethernet mediator.

Enumerations

```
enum esp_eth_state_t
```

Ethernet driver state.

Values:

```
ETH_STATE_LLINIT
```

Lowlevel init done

```
ETH_STATE_DEINIT
```

Deinit done

```
ETH_STATE_LINK
```

Link status changed

```
ETH_STATE_SPEED
```

Speed updated

```
ETH_STATE_DUPLEX
```

Duplex updated

```
ETH_STATE_PAUSE
```

Pause ability updated

```
enum esp_eth_io_cmd_t
```

Command list for ioctl API.

Values:

```
ETH_CMD_G_MAC_ADDR
```

Get MAC address

ETH_CMD_S_MAC_ADDR
Set MAC address

ETH_CMD_G_PHY_ADDR
Get PHY address

ETH_CMD_S_PHY_ADDR
Set PHY address

ETH_CMD_G_SPEED
Get Speed

ETH_CMD_S_PROMISCUOUS
Set promiscuous mode

ETH_CMD_S_FLOW_CTRL
Set flow control

ETH_CMD_G_DUPLEX_MODE
Get Duplex mode

enum eth_link_t
Ethernet link status.

Values:

ETH_LINK_UP
Ethernet link is up

ETH_LINK_DOWN
Ethernet link is down

enum eth_speed_t
Ethernet speed.

Values:

ETH_SPEED_10M
Ethernet speed is 10Mbps

ETH_SPEED_100M
Ethernet speed is 100Mbps

enum eth_duplex_t
Ethernet duplex mode.

Values:

ETH_DUPLEX_HALF
Ethernet is in half duplex

ETH_DUPLEX_FULL
Ethernet is in full duplex

enum eth_event_t
Ethernet event declarations.

Values:

ETHERNET_EVENT_START
Ethernet driver start

ETHERNET_EVENT_STOP
Ethernet driver stop

ETHERNET_EVENT_CONNECTED
Ethernet got a valid link

ETHERNET_EVENT_DISCONNECTED
Ethernet lost a valid link

Header File

- `esp_eth/include/esp_eth_mac.h`

Structures

struct esp_eth_mac_s
Ethernet MAC.

Public Members

esp_err_t (***set_mediator**) (*esp_eth_mac_t* *mac, *esp_eth_mediator_t* *eth)
Set mediator for Ethernet MAC.

Return

- ESP_OK: set mediator for Ethernet MAC successfully
- ESP_ERR_INVALID_ARG: set mediator for Ethernet MAC failed because of invalid argument

Parameters

- [in] mac: Ethernet MAC instance
- [in] eth: Ethernet mediator

esp_err_t (***init**) (*esp_eth_mac_t* *mac)
Initialize Ethernet MAC.

Return

- ESP_OK: initialize Ethernet MAC successfully
- ESP_ERR_TIMEOUT: initialize Ethernet MAC failed because of timeout
- ESP_FAIL: initialize Ethernet MAC failed because some other error occurred

Parameters

- [in] mac: Ethernet MAC instance

esp_err_t (***deinit**) (*esp_eth_mac_t* *mac)
Deinitialize Ethernet MAC.

Return

- ESP_OK: deinitialize Ethernet MAC successfully
- ESP_FAIL: deinitialize Ethernet MAC failed because some error occurred

Parameters

- [in] mac: Ethernet MAC instance

esp_err_t (***start**) (*esp_eth_mac_t* *mac)
Start Ethernet MAC.

Return

- ESP_OK: start Ethernet MAC successfully
- ESP_FAIL: start Ethernet MAC failed because some other error occurred

Parameters

- [in] mac: Ethernet MAC instance

esp_err_t (***stop**) (*esp_eth_mac_t* *mac)
Stop Ethernet MAC.

Return

- ESP_OK: stop Ethernet MAC successfully
- ESP_FAIL: stop Ethernet MAC failed because some error occurred

Parameters

- [in] mac: Ethernet MAC instance

esp_err_t (***transmit**) (*esp_eth_mac_t* *mac, *uint8_t* *buf, *uint32_t* length)
Transmit packet from Ethernet MAC.

Return

- ESP_OK: transmit packet successfully

- ESP_ERR_INVALID_ARG: transmit packet failed because of invalid argument
- ESP_ERR_INVALID_STATE: transmit packet failed because of wrong state of MAC
- ESP_FAIL: transmit packet failed because some other error occurred

Parameters

- [in] mac: Ethernet MAC instance
- [in] buf: packet buffer to transmit
- [in] length: length of packet

esp_err_t (***receive**) (*esp_eth_mac_t* *mac, uint8_t *buf, uint32_t *length)

Receive packet from Ethernet MAC.

Note Memory of buf is allocated in the Layer2, make sure it get free after process.

Note Before this function got invoked, the value of “length” should set by user, equals the size of buffer.

After the function returned, the value of “length” means the real length of received data.

Return

- ESP_OK: receive packet successfully
- ESP_ERR_INVALID_ARG: receive packet failed because of invalid argument
- ESP_ERR_INVALID_SIZE: input buffer size is not enough to hold the incoming data. in this case, value of returned “length” indicates the real size of incoming data.
- ESP_FAIL: receive packet failed because some other error occurred

Parameters

- [in] mac: Ethernet MAC instance
- [out] buf: packet buffer which will preserve the received frame
- [out] length: length of the received packet

esp_err_t (***read_phy_reg**) (*esp_eth_mac_t* *mac, uint32_t phy_addr, uint32_t phy_reg, uint32_t *reg_value)

Read PHY register.

Return

- ESP_OK: read PHY register successfully
- ESP_ERR_INVALID_ARG: read PHY register failed because of invalid argument
- ESP_ERR_INVALID_STATE: read PHY register failed because of wrong state of MAC
- ESP_ERR_TIMEOUT: read PHY register failed because of timeout
- ESP_FAIL: read PHY register failed because some other error occurred

Parameters

- [in] mac: Ethernet MAC instance
- [in] phy_addr: PHY chip address (0~31)
- [in] phy_reg: PHY register index code
- [out] reg_value: PHY register value

esp_err_t (***write_phy_reg**) (*esp_eth_mac_t* *mac, uint32_t phy_addr, uint32_t phy_reg, uint32_t reg_value)

Write PHY register.

Return

- ESP_OK: write PHY register successfully
- ESP_ERR_INVALID_STATE: write PHY register failed because of wrong state of MAC
- ESP_ERR_TIMEOUT: write PHY register failed because of timeout
- ESP_FAIL: write PHY register failed because some other error occurred

Parameters

- [in] mac: Ethernet MAC instance
- [in] phy_addr: PHY chip address (0~31)
- [in] phy_reg: PHY register index code
- [in] reg_value: PHY register value

esp_err_t (***set_addr**) (*esp_eth_mac_t* *mac, uint8_t *addr)

Set MAC address.

Return

- ESP_OK: set MAC address successfully
- ESP_ERR_INVALID_ARG: set MAC address failed because of invalid argument

- ESP_FAIL: set MAC address failed because some other error occurred

Parameters

- [in] mac: Ethernet MAC instance
- [in] addr: MAC address

esp_err_t (***get_addr**) (*esp_eth_mac_t* *mac, uint8_t *addr)

Get MAC address.

Return

- ESP_OK: get MAC address successfully
- ESP_ERR_INVALID_ARG: get MAC address failed because of invalid argument
- ESP_FAIL: get MAC address failed because some other error occurred

Parameters

- [in] mac: Ethernet MAC instance
- [out] addr: MAC address

esp_err_t (***set_speed**) (*esp_eth_mac_t* *mac, *eth_speed_t* speed)

Set speed of MAC.

Return

- ESP_OK: set MAC speed successfully
- ESP_ERR_INVALID_ARG: set MAC speed failed because of invalid argument
- ESP_FAIL: set MAC speed failed because some other error occurred

Parameters

- [in] mac: Ethernet MAC instance
- [in] speed: MAC speed

esp_err_t (***set_duplex**) (*esp_eth_mac_t* *mac, *eth_duplex_t* duplex)

Set duplex mode of MAC.

Return

- ESP_OK: set MAC duplex mode successfully
- ESP_ERR_INVALID_ARG: set MAC duplex failed because of invalid argument
- ESP_FAIL: set MAC duplex failed because some other error occurred

Parameters

- [in] mac: Ethernet MAC instance
- [in] duplex: MAC duplex

esp_err_t (***set_link**) (*esp_eth_mac_t* *mac, *eth_link_t* link)

Set link status of MAC.

Return

- ESP_OK: set link status successfully
- ESP_ERR_INVALID_ARG: set link status failed because of invalid argument
- ESP_FAIL: set link status failed because some other error occurred

Parameters

- [in] mac: Ethernet MAC instance
- [in] link: Link status

esp_err_t (***set_promiscuous**) (*esp_eth_mac_t* *mac, bool enable)

Set promiscuous of MAC.

Return

- ESP_OK: set promiscuous mode successfully
- ESP_FAIL: set promiscuous mode failed because some error occurred

Parameters

- [in] mac: Ethernet MAC instance
- [in] enable: set true to enable promiscuous mode; set false to disable promiscuous mode

esp_err_t (***enable_flow_ctrl**) (*esp_eth_mac_t* *mac, bool enable)

Enable flow control on MAC layer or not.

Return

- ESP_OK: set flow control successfully

- `ESP_FAIL`: set flow control failed because some error occurred

Parameters

- `[in] mac`: Ethernet MAC instance
- `[in] enable`: set true to enable flow control; set false to disable flow control

`esp_err_t (*set_peer_pause_ability)(esp_eth_mac_t *mac, uint32_t ability)`

Set the PAUSE ability of peer node.

Return

- `ESP_OK`: set peer pause ability successfully
- `ESP_FAIL`: set peer pause ability failed because some error occurred

Parameters

- `[in] mac`: Ethernet MAC instance
- `[in] ability`: zero indicates that pause function is supported by link partner; non-zero indicates that pause function is not supported by link partner

`esp_err_t (*del)(esp_eth_mac_t *mac)`

Free memory of Ethernet MAC.

Return

- `ESP_OK`: free Ethernet MAC instance successfully
- `ESP_FAIL`: free Ethernet MAC instance failed because some error occurred

Parameters

- `[in] mac`: Ethernet MAC instance

struct eth_mac_config_t

Configuration of Ethernet MAC object.

Public Members

`uint32_t sw_reset_timeout_ms`

Software reset timeout value (Unit: ms)

`uint32_t rx_task_stack_size`

Stack size of the receive task

`uint32_t rx_task_prio`

Priority of the receive task

`int smi_mdc_gpio_num`

SMI MDC GPIO number, set to -1 could bypass the SMI GPIO configuration

`int smi_mdio_gpio_num`

SMI MDIO GPIO number, set to -1 could bypass the SMI GPIO configuration

`uint32_t flags`

Flags that specify extra capability for mac driver

Macros

`ETH_MAC_FLAG_WORK_WITH_CACHE_DISABLE`

MAC driver can work when cache is disabled

`ETH_MAC_FLAG_PIN_TO_CORE`

Pin MAC task to the CPU core where driver installation happened

`ETH_MAC_DEFAULT_CONFIG()`

Default configuration for Ethernet MAC object.

Type Definitions

`typedef struct esp_eth_mac_s esp_eth_mac_t`

Ethernet MAC.

Header File

- `esp_eth/include/esp_eth_phy.h`

Functions

`esp_eth_phy_t *esp_eth_phy_new_ip101 (const eth_phy_config_t *config)`

Create a PHY instance of IP101.

Return

- instance: create PHY instance successfully
- NULL: create PHY instance failed because some error occurred

Parameters

- [in] config: configuration of PHY

`esp_eth_phy_t *esp_eth_phy_new_rt18201 (const eth_phy_config_t *config)`

Create a PHY instance of RTL8201.

Return

- instance: create PHY instance successfully
- NULL: create PHY instance failed because some error occurred

Parameters

- [in] config: configuration of PHY

`esp_eth_phy_t *esp_eth_phy_new_lan8720 (const eth_phy_config_t *config)`

Create a PHY instance of LAN8720.

Return

- instance: create PHY instance successfully
- NULL: create PHY instance failed because some error occurred

Parameters

- [in] config: configuration of PHY

`esp_eth_phy_t *esp_eth_phy_new_dp83848 (const eth_phy_config_t *config)`

Create a PHY instance of DP83848.

Return

- instance: create PHY instance successfully
- NULL: create PHY instance failed because some error occurred

Parameters

- [in] config: configuration of PHY

`esp_eth_phy_t *esp_eth_phy_new_ksz8041 (const eth_phy_config_t *config)`

Create a PHY instance of KSZ8041.

Return

- instance: create PHY instance successfully
- NULL: create PHY instance failed because some error occurred

Parameters

- [in] config: configuration of PHY

Structures

`struct esp_eth_phy_s`

Ethernet PHY.

Public Members

`esp_err_t (*set_mediator) (esp_eth_phy_t *phy, esp_eth_mediator_t *mediator)`

Set mediator for PHY.

Return

- ESP_OK: set mediator for Ethernet PHY instance successfully

- `ESP_ERR_INVALID_ARG`: set mediator for Ethernet PHY instance failed because of some invalid arguments

Parameters

- `[in] phy`: Ethernet PHY instance
- `[in] mediator`: mediator of Ethernet driver

`esp_err_t (*reset)(esp_eth_phy_t *phy)`

Software Reset Ethernet PHY.

Return

- `ESP_OK`: reset Ethernet PHY successfully
- `ESP_FAIL`: reset Ethernet PHY failed because some error occurred

Parameters

- `[in] phy`: Ethernet PHY instance

`esp_err_t (*reset_hw)(esp_eth_phy_t *phy)`

Hardware Reset Ethernet PHY.

Note Hardware reset is mostly done by pull down and up PHY's nRST pin

Return

- `ESP_OK`: reset Ethernet PHY successfully
- `ESP_FAIL`: reset Ethernet PHY failed because some error occurred

Parameters

- `[in] phy`: Ethernet PHY instance

`esp_err_t (*init)(esp_eth_phy_t *phy)`

Initialize Ethernet PHY.

Return

- `ESP_OK`: initialize Ethernet PHY successfully
- `ESP_FAIL`: initialize Ethernet PHY failed because some error occurred

Parameters

- `[in] phy`: Ethernet PHY instance

`esp_err_t (*deinit)(esp_eth_phy_t *phy)`

Deinitialize Ethernet PHY.

Return

- `ESP_OK`: deinitialize Ethernet PHY successfully
- `ESP_FAIL`: deinitialize Ethernet PHY failed because some error occurred

Parameters

- `[in] phyL`: Ethernet PHY instance

`esp_err_t (*negotiate)(esp_eth_phy_t *phy)`

Start auto negotiation.

Return

- `ESP_OK`: restart auto negotiation successfully
- `ESP_FAIL`: restart auto negotiation failed because some error occurred

Parameters

- `[in] phy`: Ethernet PHY instance

`esp_err_t (*get_link)(esp_eth_phy_t *phy)`

Get Ethernet PHY link status.

Return

- `ESP_OK`: get Ethernet PHY link status successfully
- `ESP_FAIL`: get Ethernet PHY link status failed because some error occurred

Parameters

- `[in] phy`: Ethernet PHY instance

`esp_err_t (*pwrctl)(esp_eth_phy_t *phy, bool enable)`

Power control of Ethernet PHY.

Return

- ESP_OK: control Ethernet PHY power successfully
- ESP_FAIL: control Ethernet PHY power failed because some error occurred

Parameters

- [in] `phy`: Ethernet PHY instance
- [in] `enable`: set true to power on Ethernet PHY; set false to power off Ethernet PHY

`esp_err_t (*set_addr) (esp_eth_phy_t *phy, uint32_t addr)`

Set PHY chip address.

Return

- ESP_OK: set Ethernet PHY address successfully
- ESP_FAIL: set Ethernet PHY address failed because some error occurred

Parameters

- [in] `phy`: Ethernet PHY instance
- [in] `addr`: PHY chip address

`esp_err_t (*get_addr) (esp_eth_phy_t *phy, uint32_t *addr)`

Get PHY chip address.

Return

- ESP_OK: get Ethernet PHY address successfully
- ESP_ERR_INVALID_ARG: get Ethernet PHY address failed because of invalid argument

Parameters

- [in] `phy`: Ethernet PHY instance
- [out] `addr`: PHY chip address

`esp_err_t (*advertise_pause_ability) (esp_eth_phy_t *phy, uint32_t ability)`

Advertise pause function supported by MAC layer.

Return

- ESP_OK: Advertise pause ability successfully
- ESP_ERR_INVALID_ARG: Advertise pause ability failed because of invalid argument

Parameters

- [in] `phy`: Ethernet PHY instance
- [out] `addr`: Pause ability

`esp_err_t (*del) (esp_eth_phy_t *phy)`

Free memory of Ethernet PHY instance.

Return

- ESP_OK: free PHY instance successfully
- ESP_FAIL: free PHY instance failed because some error occurred

Parameters

- [in] `phy`: Ethernet PHY instance

struct eth_phy_config_t

Ethernet PHY configuration.

Public Members

`int32_t phy_addr`

PHY address, set -1 to enable PHY address detection at initialization stage

`uint32_t reset_timeout_ms`

Reset timeout value (Unit: ms)

`uint32_t autonego_timeout_ms`

Auto-negotiation timeout value (Unit: ms)

`int reset_gpio_num`

Reset GPIO number, -1 means no hardware reset

Macros

ESP_ETH_PHY_ADDR_AUTO

ETH_PHY_DEFAULT_CONFIG()

Default configuration for Ethernet PHY object.

Type Definitions

typedef struct *esp_eth_phy_s* esp_eth_phy_t

Ethernet PHY.

Header File

- [esp_eth/include/esp_eth_netif_glue.h](#)

Functions

void *esp_eth_new_netif_glue (*esp_eth_handle_t eth_hdl*)

Create a netif glue for Ethernet driver.

Note netif glue is used to attach io driver to TCP/IP netif

Return glue object, which inherits esp_netif_driver_base_t

Parameters

- eth_hdl: Ethernet driver handle

esp_err_t esp_eth_del_netif_glue (void **glue*)

Delete netif glue of Ethernet driver.

Return -ESP_OK: delete netif glue successfully

Parameters

- glue: netif glue

esp_err_t esp_eth_set_default_handlers (void **esp_netif*)

Register default IP layer handlers for Ethernet.

Note : Ethernet handle might not yet properly initialized when setting up these default handlers

Return

- ESP_ERR_INVALID_ARG: invalid parameter (esp_netif is NULL)
- ESP_OK: set default IP layer handlers successfully
- others: other failure occurred during register esp_event handler

Parameters

- [in] esp_netif: esp network interface handle created for Ethernet driver

esp_err_t esp_eth_clear_default_handlers (void **esp_netif*)

Unregister default IP layer handlers for Ethernet.

Return

- ESP_ERR_INVALID_ARG: invalid parameter (esp_netif is NULL)
- ESP_OK: clear default IP layer handlers successfully
- others: other failure occurred during unregister esp_event handler

Parameters

- [in] esp_netif: esp network interface handle created for Ethernet driver

Code examples for the Ethernet API are provided in the [ethernet](#) directory of ESP-IDF examples.

2.2.3 IP Network Layer

ESP-NETIF

The purpose of ESP-NETIF library is twofold:

- It provides an abstraction layer for the application on top of the TCP/IP stack. This will allow applications to choose between IP stacks in the future.

- The APIs it provides are thread safe, even if the underlying TCP/IP stack APIs are not.

ESP-IDF currently implements ESP-NETIF for the lwIP TCP/IP stack only. However, the adapter itself is TCP/IP implementation agnostic and different implementations are possible.

Some ESP-NETIF API functions are intended to be called by application code, for example to get/set interface IP addresses, configure DHCP. Other functions are intended for internal ESP-IDF use by the network driver layer.

In many cases, applications do not need to call ESP-NETIF APIs directly as they are called from the default network event handlers.

ESP-NETIF component is a successor of the tcpip_adapter, former network interface abstraction, which has become deprecated since IDF v4.1. Please refer to the *TCP/IP Adapter Migration Guide* section in case existing applications to be ported to use the esp-netif API instead.

ESP-NETIF architecture

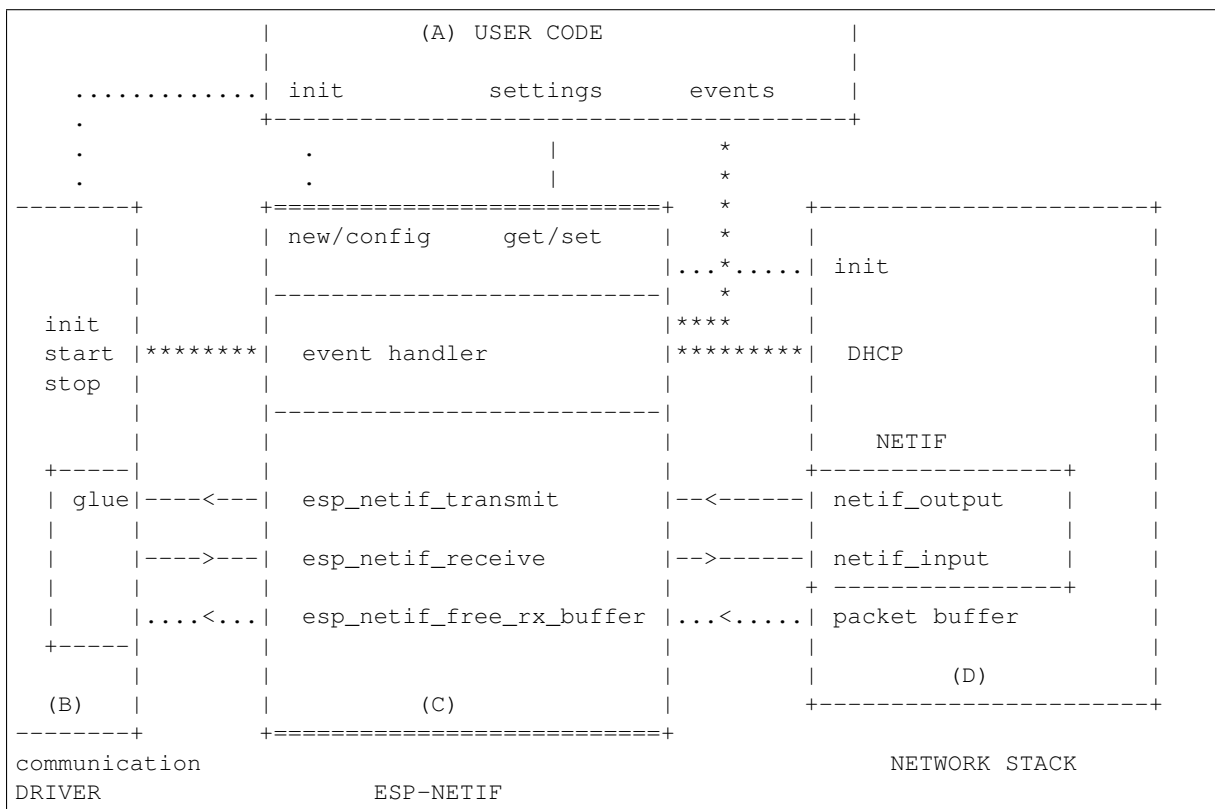

Data and event flow in the diagram

- Initialization line from user code to ESP-NETIF and communication driver
- ---<--->--- Data packets going from communication media to TCP/IP stack and back
- ***** Events aggregated in ESP-NETIF propagates to driver, user code and network stack
- | User settings and runtime configuration

ESP-NETIF interaction

A) User code, boiler plate Overall application interaction with a specific IO driver for communication media and configured TCP/IP network stack is abstracted using ESP-NETIF APIs and outlined as below:

- A) Initialization code
- 1) Initializes IO driver
 - 2) Creates a new instance of ESP-NETIF and configure with

- ESP-NETIF specific options (flags, behaviour, name)
 - Network stack options (netif init and input functions, not publicly available)
 - IO driver specific options (transmit, free rx buffer functions, IO driver handle)
- 3) Attaches the IO driver handle to the ESP-NETIF instance created in the above steps
 - 4) Configures event handlers
 - use default handlers for common interfaces defined in IO drivers; or define a specific handlers for customised behaviour/new interfaces
 - register handlers for app related events (such as IP lost/acquired)

B) Interaction with network interfaces using ESP-NETIF API

- Getting and setting TCP/IP related parameters (DHCP, IP, etc)
- Receiving IP events (connect/disconnect)
- Controlling application lifecycle (set interface up/down)

B) Communication driver, IO driver, media driver Communication driver plays these two important roles in relation with ESP-NETIF:

- 1) Event handlers: Define behaviour patterns of interaction with ESP-NETIF (for example: ethernet link-up -> turn netif on)
- 2) Glue IO layer: Adapts the input/output functions to use ESP-NETIF transmit, receive and free receive buffer
 - Installs driver_transmit to appropriate ESP-NETIF object, so that outgoing packets from network stack are passed to the IO driver
 - Calls `esp_netif_receive()` to pass incoming data to network stack

C) ESP-NETIF, former tcpip_adapter ESP-NETIF is an intermediary between an IO driver and a network stack, connecting packet data path between these two. As that it provides a set of interfaces for attaching a driver to ESP-NETIF object (runtime) and configuring a network stack (compile time). In addition to that a set of API is provided to control network interface lifecycle and its TCP/IP properties. As an overview, the ESP-NETIF public interface could be divided into these 6 groups:

- 1) Initialization APIs (to create and configure ESP-NETIF instance)
- 2) Input/Output API (for passing data between IO driver and network stack)
- 3) Event or Action API
 - Used for network interface lifecycle management
 - ESP-NETIF provides building blocks for designing event handlers
- 4) Setters and Getters for basic network interface properties
- 5) Network stack abstraction: enabling user interaction with TCP/IP stack
 - Set interface up or down
 - DHCP server and client API
 - DNS API
- 6) Driver conversion utilities

D) Network stack Network stack has no public interaction with application code with regard to public interfaces and shall be fully abstracted by ESP-NETIF API.

ESP-NETIF programmer' s manual Please refer to the example section for basic initialization of default interfaces:

- WiFi Station: [wifi/getting_started/station/main/station_example_main.c](#)
- WiFi Access Point: [wifi/getting_started/softAP/main/softap_example_main.c](#)
- Ethernet: [ethernet/basic/main/ethernet_example_main.c](#)

For more specific cases please consult this guide: [ESP-NETIF Custom I/O Driver](#).

WiFi default initialization The initialization code as well as registering event handlers for default interfaces, such as softAP and station, are provided in two separate APIs to facilitate simple startup code for most applications:

- `esp_netif_create_default_wifi_ap()`
- `esp_netif_create_default_wifi_sta()`

Please note that these functions return the `esp_netif` handle, i.e. a pointer to a network interface object allocated and configured with default settings, which as a consequence, means that:

- The created object has to be destroyed if a network de-initialization is provided by an application.
- These *default* interfaces must not be created multiple times, unless the created handle is deleted using `esp_netif_destroy()`.
- When using Wifi in AP+STA mode, both these interfaces has to be created.

API Reference

Header File

- `esp_netif/include/esp_netif.h`

Functions

`esp_err_t esp_netif_init` (void)

Initialize the underlying TCP/IP stack.

Return

- ESP_OK on success
- ESP_FAIL if initializing failed

Note This function should be called exactly once from application code, when the application starts up.

`esp_err_t esp_netif_deinit` (void)

Deinitialize the esp-netif component (and the underlying TCP/IP stack)

Note: Deinitialization is not supported yet

Return

- ESP_ERR_INVALID_STATE if esp_netif not initialized
- ESP_ERR_NOT_SUPPORTED otherwise

`esp_netif_t *esp_netif_new` (const esp_netif_config_t *esp_netif_config)

Creates an instance of new esp-netif object based on provided config.

Return

- pointer to esp-netif object on success
- NULL otherwise

Parameters

- [in] esp_netif_config: pointer esp-netif configuration

void `esp_netif_destroy` (esp_netif_t *esp_netif)

Destroys the esp_netif object.

Parameters

- [in] esp_netif: pointer to the object to be deleted

`esp_err_t esp_netif_set_driver_config` (esp_netif_t *esp_netif, const esp_netif_driver_ifconfig_t *driver_config)

Configures driver related options of esp_netif object.

Return

- ESP_OK on success
- ESP_ERR_ESP_NETIF_INVALID_PARAMS if invalid parameters provided

Parameters

- [inout] esp_netif: pointer to the object to be configured
- [in] driver_config: pointer esp-netif io driver related configuration

esp_err_t **esp_netif_attach** (*esp_netif_t *esp_netif*, *esp_netif_iedriver_handle driver_handle*)

Attaches *esp_netif* instance to the io driver handle.

Calling this function enables connecting specific *esp_netif* object with already initialized io driver to update *esp_netif* object with driver specific configuration (i.e. calls *post_attach* callback, which typically sets io driver callbacks to *esp_netif* instance and starts the driver)

Return

- ESP_OK on success
- ESP_ERR_ESP_NETIF_DRIVER_ATTACH_FAILED if driver's *post_attach* callback failed

Parameters

- [inout] *esp_netif*: pointer to *esp_netif* object to be attached
- [in] *driver_handle*: pointer to the driver handle

esp_err_t **esp_netif_receive** (*esp_netif_t *esp_netif*, *void *buffer*, *size_t len*, *void *eb*)

Passes the raw packets from communication media to the appropriate TCP/IP stack.

This function is called from the configured (peripheral) driver layer. The data are then forwarded as frames to the TCP/IP stack.

Return

- ESP_OK

Parameters

- [in] *esp_netif*: Handle to *esp-netif* instance
- [in] *buffer*: Received data
- [in] *len*: Length of the data frame
- [in] *eb*: Pointer to internal buffer (used in Wi-Fi driver)

void **esp_netif_action_start** (*void *esp_netif*, *esp_event_base_t base*, *int32_t event_id*, *void *data*)

Default building block for network interface action upon IO driver start event Creates network interface, if AUTOUP enabled turns the interface on, if DHCP enabled starts dhcp server.

Note This API can be directly used as event handler

Parameters

- [in] *esp_netif*: Handle to *esp-netif* instance
- *base*:
- *event_id*:
- *data*:

void **esp_netif_action_stop** (*void *esp_netif*, *esp_event_base_t base*, *int32_t event_id*, *void *data*)

Default building block for network interface action upon IO driver stop event.

Note This API can be directly used as event handler

Parameters

- [in] *esp_netif*: Handle to *esp-netif* instance
- *base*:
- *event_id*:
- *data*:

void **esp_netif_action_connected** (*void *esp_netif*, *esp_event_base_t base*, *int32_t event_id*, *void *data*)

Default building block for network interface action upon IO driver connected event.

Note This API can be directly used as event handler

Parameters

- [in] *esp_netif*: Handle to *esp-netif* instance
- *base*:
- *event_id*:
- *data*:

void **esp_netif_action_disconnected** (*void *esp_netif*, *esp_event_base_t base*, *int32_t event_id*, *void *data*)

Default building block for network interface action upon IO driver disconnected event.

Note This API can be directly used as event handler

Parameters

- [in] `esp_netif`: Handle to esp-netif instance
- `base`:
- `event_id`:
- `data`:

void **esp_netif_action_got_ip**(void **esp_netif*, *esp_event_base_t* *base*, int32_t *event_id*, void **data*)

Default building block for network interface action upon network got IP event.

Note This API can be directly used as event handler

Parameters

- [in] `esp_netif`: Handle to esp-netif instance
- `base`:
- `event_id`:
- `data`:

esp_err_t **esp_netif_set_mac**(*esp_netif_t* **esp_netif*, uint8_t *mac*[])

Set the mac address for the interface instance.

Return

- `ESP_OK` - success
- `ESP_ERR_ESP_NETIF_IF_NOT_READY` - interface status error
- `ESP_ERR_NOT_SUPPORTED` - mac not supported on this interface

Parameters

- [in] `esp_netif`: Handle to esp-netif instance
- [in] `mac`: Desired mac address for the related network interface

esp_err_t **esp_netif_get_mac**(*esp_netif_t* **esp_netif*, uint8_t *mac*[])

Get the mac address for the interface instance.

Return

- `ESP_OK` - success
- `ESP_ERR_ESP_NETIF_IF_NOT_READY` - interface status error
- `ESP_ERR_NOT_SUPPORTED` - mac not supported on this interface

Parameters

- [in] `esp_netif`: Handle to esp-netif instance
- [out] `mac`: Resultant mac address for the related network interface

esp_err_t **esp_netif_set_hostname**(*esp_netif_t* **esp_netif*, const char **hostname*)

Set the hostname of an interface.

The configured hostname overrides the default configuration value `CONFIG_LWIP_LOCAL_HOSTNAME`. Please note that when the hostname is altered after interface started/connected the changes would only be reflected once the interface restarts/reconnects

Return

- `ESP_OK` - success
- `ESP_ERR_ESP_NETIF_IF_NOT_READY` - interface status error
- `ESP_ERR_ESP_NETIF_INVALID_PARAMS` - parameter error

Parameters

- [in] `esp_netif`: Handle to esp-netif instance
- [in] `hostname`: New hostname for the interface. Maximum length 32 bytes.

esp_err_t **esp_netif_get_hostname**(*esp_netif_t* **esp_netif*, const char ***hostname*)

Get interface hostname.

Return

- `ESP_OK` - success
- `ESP_ERR_ESP_NETIF_IF_NOT_READY` - interface status error
- `ESP_ERR_ESP_NETIF_INVALID_PARAMS` - parameter error

Parameters

- [in] `esp_netif`: Handle to esp-netif instance

- [out] `hostname`: Returns a pointer to the hostname. May be NULL if no hostname is set. If set non-NULL, pointer remains valid (and string may change if the hostname changes).

bool **esp_netif_is_netif_up** (esp_netif_t **esp_netif*)

Test if supplied interface is up or down.

Return

- true - Interface is up
- false - Interface is down

Parameters

- [in] `esp_netif`: Handle to esp-netif instance

esp_err_t **esp_netif_get_ip_info** (esp_netif_t **esp_netif*, esp_netif_ip_info_t **ip_info*)

Get interface's IP address information.

If the interface is up, IP information is read directly from the TCP/IP stack. If the interface is down, IP information is read from a copy kept in the ESP-NETIF instance

Return

- ESP_OK
- ESP_ERR_ESP_NETIF_INVALID_PARAMS

Parameters

- [in] `esp_netif`: Handle to esp-netif instance
- [out] `ip_info`: If successful, IP information will be returned in this argument.

esp_err_t **esp_netif_get_old_ip_info** (esp_netif_t **esp_netif*, esp_netif_ip_info_t **ip_info*)

Get interface's old IP information.

Returns an "old" IP address previously stored for the interface when the valid IP changed.

If the IP lost timer has expired (meaning the interface was down for longer than the configured interval) then the old IP information will be zero.

Return

- ESP_OK
- ESP_ERR_ESP_NETIF_INVALID_PARAMS

Parameters

- [in] `esp_netif`: Handle to esp-netif instance
- [out] `ip_info`: If successful, IP information will be returned in this argument.

esp_err_t **esp_netif_set_ip_info** (esp_netif_t **esp_netif*, **const** esp_netif_ip_info_t **ip_info*)

Set interface's IP address information.

This function is mainly used to set a static IP on an interface.

If the interface is up, the new IP information is set directly in the TCP/IP stack.

The copy of IP information kept in the ESP-NETIF instance is also updated (this copy is returned if the IP is queried while the interface is still down.)

Note DHCP client/server must be stopped (if enabled for this interface) before setting new IP information.

Note Calling this interface for may generate a SYSTEM_EVENT_STA_GOT_IP or SYSTEM_EVENT_ETH_GOT_IP event.

Return

- ESP_OK
- ESP_ERR_ESP_NETIF_INVALID_PARAMS
- ESP_ERR_ESP_NETIF_DHCP_NOT_STOPPED If DHCP server or client is still running

Parameters

- [in] `esp_netif`: Handle to esp-netif instance
- [in] `ip_info`: IP information to set on the specified interface

esp_err_t **esp_netif_set_old_ip_info** (esp_netif_t **esp_netif*, **const** esp_netif_ip_info_t **ip_info*)

Set interface old IP information.

This function is called from the DHCP client (if enabled), before a new IP is set. It is also called from the default handlers for the `SYSTEM_EVENT_STA_CONNECTED` and `SYSTEM_EVENT_ETH_CONNECTED` events.

Calling this function stores the previously configured IP, which can be used to determine if the IP changes in the future.

If the interface is disconnected or down for too long, the “IP lost timer” will expire (after the configured interval) and set the old IP information to zero.

Return

- `ESP_OK`
- `ESP_ERR_ESP_NETIF_INVALID_PARAMS`

Parameters

- [in] `esp_netif`: Handle to esp-netif instance
- [in] `ip_info`: Store the old IP information for the specified interface

int `esp_netif_get_netif_impl_index` (`esp_netif_t *esp_netif`)

Get net interface index from network stack implementation.

Note This index could be used in `setsockopt` () to bind socket with multicast interface

Return implementation specific index of interface represented with supplied `esp_netif`

Parameters

- [in] `esp_netif`: Handle to esp-netif instance

esp_err_t `esp_netif_get_netif_impl_name` (`esp_netif_t *esp_netif`, char **name*)

Get net interface name from network stack implementation.

Note This name could be used in `setsockopt` () to bind socket with appropriate interface

Return

- `ESP_OK`
- `ESP_ERR_ESP_NETIF_INVALID_PARAMS`

Parameters

- [in] `esp_netif`: Handle to esp-netif instance
- [out] `name`: Interface name as specified in underlying TCP/IP stack. Note that the actual name will be copied to the specified buffer, which must be allocated to hold maximum interface name size (6 characters for lwIP)

esp_err_t `esp_netif_dhcps_option` (`esp_netif_t *esp_netif`, `esp_netif_dhcp_option_mode_t opt_op`, `esp_netif_dhcp_option_id_t opt_id`, void **opt_val*, `uint32_t opt_len`)

Set or Get DHCP server option.

Return

- `ESP_OK`
- `ESP_ERR_ESP_NETIF_INVALID_PARAMS`
- `ESP_ERR_ESP_NETIF_DHCP_ALREADY_STOPPED`
- `ESP_ERR_ESP_NETIF_DHCP_ALREADY_STARTED`

Parameters

- [in] `esp_netif`: Handle to esp-netif instance
- [in] `opt_op`: `ESP_NETIF_OP_SET` to set an option, `ESP_NETIF_OP_GET` to get an option.
- [in] `opt_id`: Option index to get or set, must be one of the supported enum values.
- [inout] `opt_val`: Pointer to the option parameter.
- [in] `opt_len`: Length of the option parameter.

esp_err_t `esp_netif_dhcpc_option` (`esp_netif_t *esp_netif`, `esp_netif_dhcp_option_mode_t opt_op`, `esp_netif_dhcp_option_id_t opt_id`, void **opt_val*, `uint32_t opt_len`)

Set or Get DHCP client option.

Return

- `ESP_OK`
- `ESP_ERR_ESP_NETIF_INVALID_PARAMS`
- `ESP_ERR_ESP_NETIF_DHCP_ALREADY_STOPPED`

- ESP_ERR_ESP_NETIF_DHCP_ALREADY_STARTED

Parameters

- [in] `esp_netif`: Handle to esp-netif instance
- [in] `opt_op`: ESP_NETIF_OP_SET to set an option, ESP_NETIF_OP_GET to get an option.
- [in] `opt_id`: Option index to get or set, must be one of the supported enum values.
- [inout] `opt_val`: Pointer to the option parameter.
- [in] `opt_len`: Length of the option parameter.

esp_err_t **esp_netif_dhcpc_start** (*esp_netif_t *esp_netif*)

Start DHCP client (only if enabled in interface object)

Note The default event handlers for the SYSTEM_EVENT_STA_CONNECTED and SYSTEM_EVENT_ETH_CONNECTED events call this function.

Return

- ESP_OK
- ESP_ERR_ESP_NETIF_INVALID_PARAMS
- ESP_ERR_ESP_NETIF_DHCP_ALREADY_STARTED
- ESP_ERR_ESP_NETIF_DHCPC_START_FAILED

Parameters

- [in] `esp_netif`: Handle to esp-netif instance

esp_err_t **esp_netif_dhcpc_stop** (*esp_netif_t *esp_netif*)

Stop DHCP client (only if enabled in interface object)

Note Calling `action_netif_stop()` will also stop the DHCP Client if it is running.

Return

- ESP_OK
- ESP_ERR_ESP_NETIF_INVALID_PARAMS
- ESP_ERR_ESP_NETIF_DHCP_ALREADY_STOPPED
- ESP_ERR_ESP_NETIF_IF_NOT_READY

Parameters

- [in] `esp_netif`: Handle to esp-netif instance

esp_err_t **esp_netif_dhcpc_get_status** (*esp_netif_t *esp_netif*, *esp_netif_dhcp_status_t *status*)

Get DHCP client status.

Return

- ESP_OK

Parameters

- [in] `esp_netif`: Handle to esp-netif instance
- [out] `status`: If successful, the status of DHCP client will be returned in this argument.

esp_err_t **esp_netif_dhcps_get_status** (*esp_netif_t *esp_netif*, *esp_netif_dhcp_status_t *status*)

Get DHCP Server status.

Return

- ESP_OK

Parameters

- [in] `esp_netif`: Handle to esp-netif instance
- [out] `status`: If successful, the status of the DHCP server will be returned in this argument.

esp_err_t **esp_netif_dhcps_start** (*esp_netif_t *esp_netif*)

Start DHCP server (only if enabled in interface object)

Return

- ESP_OK
- ESP_ERR_ESP_NETIF_INVALID_PARAMS
- ESP_ERR_ESP_NETIF_DHCP_ALREADY_STARTED

Parameters

- [in] `esp_netif`: Handle to esp-netif instance

esp_err_t **esp_netif_dhcps_stop** (*esp_netif_t *esp_netif*)

Stop DHCP server (only if enabled in interface object)

Return

- ESP_OK
- ESP_ERR_ESP_NETIF_INVALID_PARAMS
- ESP_ERR_ESP_NETIF_DHCP_ALREADY_STOPPED
- ESP_ERR_ESP_NETIF_IF_NOT_READY

Parameters

- [in] `esp_netif`: Handle to esp-netif instance

esp_err_t **esp_netif_set_dns_info** (`esp_netif_t *esp_netif`, `esp_netif_dns_type_t type`, `esp_netif_dns_info_t *dns`)

Set DNS Server information.

This function behaves differently if DHCP server or client is enabled

If DHCP client is enabled, main and backup DNS servers will be updated automatically from the DHCP lease if the relevant DHCP options are set. Fallback DNS Server is never updated from the DHCP lease and is designed to be set via this API. If DHCP client is disabled, all DNS server types can be set via this API only.

If DHCP server is enabled, the Main DNS Server setting is used by the DHCP server to provide a DNS Server option to DHCP clients (Wi-Fi stations).

- The default Main DNS server is typically the IP of the DHCP server itself.
- This function can override it by setting server type ESP_NETIF_DNS_MAIN.
- Other DNS Server types are not supported for the DHCP server.
- To propagate the DNS info to client, please stop the DHCP server before using this API.

Return

- ESP_OK on success
- ESP_ERR_ESP_NETIF_INVALID_PARAMS invalid params

Parameters

- [in] `esp_netif`: Handle to esp-netif instance
- [in] `type`: Type of DNS Server to set: ESP_NETIF_DNS_MAIN, ESP_NETIF_DNS_BACKUP, ESP_NETIF_DNS_FALLBACK
- [in] `dns`: DNS Server address to set

esp_err_t **esp_netif_get_dns_info** (`esp_netif_t *esp_netif`, `esp_netif_dns_type_t type`, `esp_netif_dns_info_t *dns`)

Get DNS Server information.

Return the currently configured DNS Server address for the specified interface and Server type.

This may be result of a previous call to `esp_netif_set_dns_info()`. If the interface's DHCP client is enabled, the Main or Backup DNS Server may be set by the current DHCP lease.

Return

- ESP_OK on success
- ESP_ERR_ESP_NETIF_INVALID_PARAMS invalid params

Parameters

- [in] `esp_netif`: Handle to esp-netif instance
- [in] `type`: Type of DNS Server to get: ESP_NETIF_DNS_MAIN, ESP_NETIF_DNS_BACKUP, ESP_NETIF_DNS_FALLBACK
- [out] `dns`: DNS Server result is written here on success

esp_err_t **esp_netif_create_ip6_linklocal** (`esp_netif_t *esp_netif`)

Create interface link-local IPv6 address.

Cause the TCP/IP stack to create a link-local IPv6 address for the specified interface.

This function also registers a callback for the specified interface, so that if the link-local address becomes verified as the preferred address then a SYSTEM_EVENT_GOT_IP6 event will be sent.

Return

- ESP_OK
- ESP_ERR_ESP_NETIF_INVALID_PARAMS

Parameters

- [in] `esp_netif`: Handle to esp-netif instance

esp_err_t **esp_netif_get_ip6_linklocal** (*esp_netif_t *esp_netif*, *esp_ip6_addr_t *if_ip6*)

Get interface link-local IPv6 address.

If the specified interface is up and a preferred link-local IPv6 address has been created for the interface, return a copy of it.

Return

- ESP_OK
- ESP_FAIL If interface is down, does not have a link-local IPv6 address, or the link-local IPv6 address is not a preferred address.

Parameters

- [in] `esp_netif`: Handle to esp-netif instance
- [out] `if_ip6`: IPv6 information will be returned in this argument if successful.

esp_err_t **esp_netif_get_ip6_global** (*esp_netif_t *esp_netif*, *esp_ip6_addr_t *if_ip6*)

Get interface global IPv6 address.

If the specified interface is up and a preferred global IPv6 address has been created for the interface, return a copy of it.

Return

- ESP_OK
- ESP_FAIL If interface is down, does not have a global IPv6 address, or the global IPv6 address is not a preferred address.

Parameters

- [in] `esp_netif`: Handle to esp-netif instance
- [out] `if_ip6`: IPv6 information will be returned in this argument if successful.

int **esp_netif_get_all_ip6** (*esp_netif_t *esp_netif*, *esp_ip6_addr_t if_ip6[]*)

Get all IPv6 addresses of the specified interface.

Return number of returned IPv6 addresses

Parameters

- [in] `esp_netif`: Handle to esp-netif instance
- [out] `if_ip6`: Array of IPv6 addresses will be copied to the argument

void **esp_netif_set_ip4_addr** (*esp_ip4_addr_t *addr*, *uint8_t a*, *uint8_t b*, *uint8_t c*, *uint8_t d*)

Sets IPv4 address to the specified octets.

Parameters

- [out] `addr`: IP address to be set
- `a`: the first octet (127 for IP 127.0.0.1)
- `b`:
- `c`:
- `d`:

char* **esp_ip4addr_ntoa** (**const** *esp_ip4_addr_t *addr*, *char *buf*, *int buflen*)

Converts numeric IP address into decimal dotted ASCII representation.

Return either pointer to `buf` which now holds the ASCII representation of `addr` or NULL if `buf` was too small

Parameters

- `addr`: ip address in network order to convert
- `buf`: target buffer where the string is stored
- `buflen`: length of `buf`

uint32_t **esp_ip4addr_aton** (**const** *char *addr*)

Ascii internet address interpretation routine The value returned is in network order.

Return ip address in network order

Parameters

- `addr`: IP address in ascii representation (e.g. "127.0.0.1")

esp_err_t **esp_netif_str_to_ip4** (**const** *char *src*, *esp_ip4_addr_t *dst*)

Converts Ascii internet IPv4 address into `esp_ip4_addr_t`.

Return

- ESP_OK on success
- ESP_FAIL if conversion failed
- ESP_ERR_INVALID_ARG if invalid parameter is passed into

Parameters

- [in] *src*: IPv4 address in ascii representation (e.g. “127.0.0.1”)
- [out] *dst*: Address of the target `esp_ip4_addr_t` structure to receive converted address

`esp_err_t esp_netif_str_to_ip6 (const char *src, esp_ip6_addr_t *dst)`

Converts Ascii internet IPv6 address into `esp_ip4_addr_t` Zeros in the IP address can be stripped or completely omitted: “2001:db8:85a3:0:0:2:1” or “2001:db8::2:1”)

Return

- ESP_OK on success
- ESP_FAIL if conversion failed
- ESP_ERR_INVALID_ARG if invalid parameter is passed into

Parameters

- [in] *src*: IPv6 address in ascii representation (e.g. “2001:0db8:85a3:0000:0000:0002:0001”)
- [out] *dst*: Address of the target `esp_ip6_addr_t` structure to receive converted address

`esp_netif_iodriver_handle esp_netif_get_io_driver (esp_netif_t *esp_netif)`

Gets media driver handle for this esp-netif instance.

Return opaque pointer of related IO driver

Parameters

- [in] *esp_netif*: Handle to esp-netif instance

`esp_netif_t *esp_netif_get_handle_from_ifkey (const char *if_key)`

Searches over a list of created objects to find an instance with supplied if key.

Return Handle to esp-netif instance

Parameters

- *if_key*: Textual description of network interface

`esp_netif_flags_t esp_netif_get_flags (esp_netif_t *esp_netif)`

Returns configured flags for this interface.

Return Configuration flags

Parameters

- [in] *esp_netif*: Handle to esp-netif instance

`const char *esp_netif_get_ifkey (esp_netif_t *esp_netif)`

Returns configured interface key for this esp-netif instance.

Return Textual description of related interface

Parameters

- [in] *esp_netif*: Handle to esp-netif instance

`const char *esp_netif_get_desc (esp_netif_t *esp_netif)`

Returns configured interface type for this esp-netif instance.

Return Enumerated type of this interface, such as station, AP, ethernet

Parameters

- [in] *esp_netif*: Handle to esp-netif instance

`int esp_netif_get_route_prio (esp_netif_t *esp_netif)`

Returns configured routing priority number.

Return Integer representing the instance’ s route-prio, or -1 if invalid paramters

Parameters

- [in] *esp_netif*: Handle to esp-netif instance

`int32_t esp_netif_get_event_id (esp_netif_t *esp_netif, esp_netif_ip_event_type_t event_type)`

Returns configured event for this esp-netif instance and supplied event type.

Return specific event id which is configured to be raised if the interface lost or acquired IP address -1 if supplied event_type is not known

Parameters

- [in] esp_netif: Handle to esp-netif instance
- event_type: (either get or lost IP)

esp_netif_t ***esp_netif_next** (esp_netif_t *esp_netif)

Iterates over list of interfaces. Returns first netif if NULL given as parameter.

Return First netif from the list if supplied parameter is NULL, next one otherwise

Parameters

- [in] esp_netif: Handle to esp-netif instance

size_t **esp_netif_get_nr_of_ifs** (void)

Returns number of registered esp_netif objects.

Return Number of esp_netifs

void **esp_netif_netstack_buf_ref** (void *netstack_buf)

increase the reference counter of net stack buffer

Parameters

- [in] netstack_buf: the net stack buffer

void **esp_netif_netstack_buf_free** (void *netstack_buf)

free the netstack buffer

Parameters

- [in] netstack_buf: the net stack buffer

Macros

`_ESP_NETIF_SUPPRESS_LEGACY_WARNING_`

WiFi default API reference

Header File

- [esp_wifi/include/esp_wifi_default.h](#)

Functions

esp_err_t **esp_netif_attach_wifi_station** (esp_netif_t *esp_netif)

Attaches wifi station interface to supplied netif.

Return

- ESP_OK on success
- ESP_FAIL if attach failed

Parameters

- esp_netif: instance to attach the wifi station to

esp_err_t **esp_netif_attach_wifi_ap** (esp_netif_t *esp_netif)

Attaches wifi soft AP interface to supplied netif.

Return

- ESP_OK on success
- ESP_FAIL if attach failed

Parameters

- esp_netif: instance to attach the wifi AP to

esp_err_t **esp_wifi_set_default_wifi_sta_handlers** (void)

Sets default wifi event handlers for STA interface.

Return

- ESP_OK on success, error returned from esp_event_handler_register if failed

esp_err_t **esp_wifi_set_default_wifi_ap_handlers** (void)

Sets default wifi event handlers for AP interface.

Return

- ESP_OK on success, error returned from esp_event_handler_register if failed

esp_err_t **esp_wifi_clear_default_wifi_driver_and_handlers** (void **esp_netif*)

Clears default wifi event handlers for supplied network interface.

Return

- ESP_OK on success, error returned from esp_event_handler_register if failed

Parameters

- *esp_netif*: instance of corresponding if object

esp_netif_t ***esp_netif_create_default_wifi_ap** (void)

Creates default WIFI AP. In case of any init error this API aborts.

Return pointer to esp-netif instance

esp_netif_t ***esp_netif_create_default_wifi_sta** (void)

Creates default WIFI STA. In case of any init error this API aborts.

Return pointer to esp-netif instance

esp_netif_t ***esp_netif_create_wifi** (*wifi_interface_t* *wifi_if*, *esp_netif_inherent_config_t* **esp_netif_config*)

Creates esp_netif WiFi object based on the custom configuration.

Attention This API DOES NOT register default handlers!

Return pointer to esp-netif instance

Parameters

- [in] *wifi_if*: type of wifi interface
- [in] *esp_netif_config*: inherent esp-netif configuration pointer

esp_err_t **esp_netif_create_default_wifi_mesh_netifs** (*esp_netif_t* **p_netif_sta*, *esp_netif_t* **p_netif_ap*)

Creates default STA and AP network interfaces for esp-mesh.

Both netifs are almost identical to the default station and softAP, but with DHCP client and server disabled. Please note that the DHCP client is typically enabled only if the device is promoted to a root node.

Returns created interfaces which could be ignored setting parameters to NULL if an application code does not need to save the interface instances for further processing.

Return ESP_OK on success

Parameters

- [out] *p_netif_sta*: pointer where the resultant STA interface is saved (if non NULL)
- [out] *p_netif_ap*: pointer where the resultant AP interface is saved (if non NULL)

TCP/IP Adapter Migration Guide

TCP/IP Adapter is a network interface abstraction component used in IDF prior to v4.1. This page outlines migration from tcpip_adapter API to its successor *ESP-NETIF*.

Updating network connection code

Network stack initialization Simply replace `tcpip_adapter_init()` with `esp_netif_init()`. Please note that the *ESP-NETIF* initialization API returns standard error code and the `esp_netif_deinit()` for un-initialization is available.

Also replace `#include "tcpip_adapter.h"` with `#include "esp_netif.h"`.

Network interface creation TCP/IP Adapter defined these three interfaces statically:

- WiFi Station
- WiFi Access Point
- Ethernet

Network interface instance shall be explicitly constructed for the *ESP-NETIF* to enable its connection to the TCP/IP stack. For example initialization code for WiFi has to explicitly call `esp_netif_create_default_wifi_sta()`; or `esp_netif_create_default_wifi_ap()`; after the TCP/IP stack and the event loop have been initialized. Please consult an example initialization code for these three interfaces:

- WiFi Station: [wifi/getting_started/station/main/station_example_main.c](#)
- WiFi Access Point: [wifi/getting_started/softAP/main/softap_example_main.c](#)
- Ethernet: [ethernet/basic/main/ethernet_example_main.c](#)

Replacing other tcpip_adapter API All the `tcpip_adapter` functions have their `esp-netif` counter-part. Please refer to the `esp_netif.h` grouped into these sections:

- [Setters/Getters](#)
- [DHCP](#)
- [DNS](#)
- [IP address](#)

Default event handlers Event handlers are moved from `tcpip_adapter` to appropriate driver code. There is no change from application code perspective, all events shall be handled in the same way. Please note that within IP related event handlers, application code usually receives IP addresses in a form of `esp-netif` specific struct (not the LwIP structs, but binary compatible). This is the preferred way of printing the address:

```
ESP_LOGI(TAG, "got ip:" IPSTR "\n", IP2STR(&event->ip_info.ip));
```

Instead of

```
ESP_LOGI(TAG, "got ip:%s\n", ip4addr_ntoa(&event->ip_info.ip));
```

Since `ip4addr_ntoa()` is a LwIP API, the `esp-netif` provides `esp_ip4addr_ntoa()` as a replacement, but the above method is generally preferred.

IP addresses It is preferred to use `esp-netif` defined IP structures. Please note that the LwIP structs will still work when default compatibility enabled. * [esp-netif IP address definitions](#)

Next steps Additional step in porting an application to fully benefit from the *ESP-NETIF* is to disable the `tcpip_adapter` compatibility layer in the component configuration: `ESP NETIF Adapter -> Enable backward compatible tcpip_adapter interface` and check if the project compiles. TCP/IP adapter brings many include dependencies and this step might help in decoupling the application from using specific TCP/IP stack API directly.

ESP-NETIF Custom I/O Driver

This section outlines implementing a new I/O driver with `esp-netif` connection capabilities. By convention the I/O driver has to register itself as an `esp-netif` driver and thus holds a dependency on `esp-netif` component and is responsible for providing data path functions, post-attach callback and in most cases also default event handlers to define network interface actions based on driver's lifecycle transitions.

Packet input/output As shown in the diagram, the following three API functions for the packet data path must be defined for connecting with esp-netif:

- `esp_netif_transmit()`
- `esp_netif_free_rx_buffer()`
- `esp_netif_receive()`

The first two functions for transmitting and freeing the rx buffer are provided as callbacks, i.e. they get called from esp-netif (and its underlying TCP/IP stack) and I/O driver provides their implementation.

The receiving function on the other hand gets called from the I/O driver, so that the driver's code simply calls `esp_netif_receive()` on a new data received event.

Post attach callback A final part of the network interface initialization consists of attaching the esp-netif instance to the I/O driver, by means of calling the following API:

```
esp_err_t esp_netif_attach(esp_netif_t *esp_netif, esp_netif_iodriver_handle_t
↳driver_handle);
```

It is assumed that the `esp_netif_iodriver_handle` is a pointer to driver's object, a struct derived from `struct esp_netif_driver_base_s`, so that the first member of I/O driver structure must be this base structure with pointers to

- post-attach function callback
- related esp-netif instance

As a consequence the I/O driver has to create an instance of the struct per below:

```
typedef struct my_netif_driver_s {
    esp_netif_driver_base_t base;           /*!< base structure reserved as_
↳esp-netif driver */
    driver_impl_t *h;                       /*!< handle of driver_
↳implementation */
} my_netif_driver_t;
```

with actual values of `my_netif_driver_t::base.post_attach` and the actual drivers handle `my_netif_driver_t::h`. So when the `esp_netif_attach()` gets called from the initialization code, the post-attach callback from I/O driver's code gets executed to mutually register callbacks between esp-netif and I/O driver instances. Typically the driver is started as well in the post-attach callback. An example of a simple post-attach callback is outlined below:

```
static esp_err_t my_post_attach_start(esp_netif_t * esp_netif, void * args)
{
    my_netif_driver_t *driver = args;
    const esp_netif_driver_ifconfig_t driver_ifconfig = {
        .driver_free_rx_buffer = my_free_rx_buf,
        .transmit = my_transmit,
        .handle = driver->driver_impl
    };
    driver->base.netif = esp_netif;
    ESP_ERROR_CHECK(esp_netif_set_driver_config(esp_netif, &driver_ifconfig));
    my_driver_start(driver->driver_impl);
    return ESP_OK;
}
```

Default handlers I/O drivers also typically provide default definitions of lifecycle behaviour of related network interfaces based on state transitions of I/O drivers. For example `driver start -> network start`, etc. An example of such a default handler is provided below:

```

esp_err_t my_driver_netif_set_default_handlers(my_netif_driver_t *driver, esp_
↪netif_t * esp_netif)
{
    driver_set_event_handler(driver->driver_impl, esp_netif_action_start, MY_DRV_
↪EVENT_START, esp_netif);
    driver_set_event_handler(driver->driver_impl, esp_netif_action_stop, MY_DRV_
↪EVENT_STOP, esp_netif);
    return ESP_OK;
}

```

Network stack connection The packet data path functions for transmitting and freeing the rx buffer (defined in the I/O driver) are called from the esp-netif, specifically from its TCP/IP stack connecting layer. The following API reference outlines these network stack interaction with the esp-netif.

Header File

- [esp_netif/include/esp_netif_net_stack.h](#)

Functions

`esp_netif_t *esp_netif_get_handle_from_netif_impl (void *dev)`

Returns esp-netif handle.

Return handle to related esp-netif instance

Parameters

- [in] dev: opaque ptr to network interface of specific TCP/IP stack

`void *esp_netif_get_netif_impl (esp_netif_t *esp_netif)`

Returns network stack specific implementation handle (if supported)

Note that it is not supported to acquire PPP netif impl pointer and this function will return NULL for esp_netif instances configured to PPP mode

Return handle to related network stack netif handle

Parameters

- [in] esp_netif: Handle to esp-netif instance

`esp_err_t esp_netif_transmit (esp_netif_t *esp_netif, void *data, size_t len)`

Outputs packets from the TCP/IP stack to the media to be transmitted.

This function gets called from network stack to output packets to IO driver.

Return ESP_OK on success, an error passed from the I/O driver otherwise

Parameters

- [in] esp_netif: Handle to esp-netif instance
- [in] data: Data to be transmitted
- [in] len: Length of the data frame

`esp_err_t esp_netif_transmit_wrap (esp_netif_t *esp_netif, void *data, size_t len, void *netstack_buf)`

Outputs packets from the TCP/IP stack to the media to be transmitted.

This function gets called from network stack to output packets to IO driver.

Return ESP_OK on success, an error passed from the I/O driver otherwise

Parameters

- [in] esp_netif: Handle to esp-netif instance
- [in] data: Data to be transmitted
- [in] len: Length of the data frame
- [in] netstack_buf: net stack buffer

`void esp_netif_free_rx_buffer (void *esp_netif, void *buffer)`

Free the rx buffer allocated by the media driver.

This function gets called from network stack when the rx buffer to be freed in IO driver context, i.e. to deallocate a buffer owned by io driver (when data packets were passed to higher levels to avoid copying)

Parameters

- [in] `esp_netif`: Handle to esp-netif instance
- [in] `buffer`: Rx buffer pointer

Code examples for TCP/IP socket APIs are provided in the [protocols/sockets](#) directory of ESP-IDF examples.

The TCP/IP Adapter (legacy network interface library) has been deprecated, please consult the [TCP/IP Adapter Migration Guide](#) to update existing IDF applications.

2.2.4 Application Layer

Documentation for Application layer network protocols (above the IP Network layer) are provided in [Application Protocols](#).

2.3 Peripherals API

2.3.1 Analog to Digital Converter

Overview

The ESP32-C3 integrates two 12-bit SAR (Successive Approximation Register) ADCs, supporting a total of 6 measurement channels (analog enabled pins).

These channels are supported:

ADC1:

- 5 channels: GPIO0 - GPIO4

ADC2:

- 1 channels: GPIO5

ADC Limitations

Note:

- Since the ADC2 module is also used by the Wi-Fi, reading operation of `adc2_get_raw()` may fail between `esp_wifi_start()` and `esp_wifi_stop()`. Use the return code to see whether the reading is successful.
 - A specific ADC module can only work under one operating mode at any one time, either Continuous Read Mode or Single Read Mode.
 - ADC1 and ADC2 can not work under Single Read Mode simultaneously. One of them will get blocked until another one finishes.
 - For continuous (DMA) read mode, the ADC sampling frequency (the `sample_freq_hz` member of `adc_digi_config_t`) should be within `SOC_ADC_SAMPLE_FREQ_THRES_LOW` and `SOC_ADC_SAMPLE_FREQ_THRES_HIGH`.
-

Driver Usage

Each ADC unit supports two work modes, ADC single read mode and ADC continuous (DMA) mode. ADC single read mode is suitable for low-frequency sampling operations. ADC continuous (DMA) read mode is suitable for high-frequency continuous sampling actions.

Note: ADC readings from a pin not connected to any signal are random.

ADC Continuous (DMA) Read mode Please use the ADC continuous read mode driver as the following steps:

- Initialize the ADC driver by calling the function `adc_digi_initialize()`.
- Initialize the ADC controller by calling the function `adc_digi_controller_config()`.
- Start the ADC continuous reading by calling the function `adc_digi_start()`.
- After starting the ADC, you can get the ADC reading result by calling the function `adc_digi_read_bytes()`. Before stopping the ADC (by calling `adc_digi_stop()`), the driver will keep converting the analog data to digital data.
- Stop the ADC reading by calling the function `adc_digi_stop()`.
- Deinitialize the ADC driver by calling the function `adc_digi_deinitialize()`.

Note: See [ADC Limitations](#) for the limitation of using ADC continuous (DMA) read mode.

ADC Single Read mode The ADC should be configured before reading is taken.

- For ADC1, configure desired precision and attenuation by calling functions `adc1_config_width()` and `adc1_config_channel_atten()`.
- For ADC2, configure the attenuation by `adc2_config_channel_atten()`. The reading width of ADC2 is configured every time you take the reading.

Attenuation configuration is done per channel, see `adc1_channel_t` and `adc2_channel_t`, set as a parameter of above functions.

Then it is possible to read ADC conversion result with `adc1_get_raw()` and `adc2_get_raw()`. Reading width of ADC2 should be set as a parameter of `adc2_get_raw()` instead of in the configuration functions.

Note: See [ADC Limitations](#) for the limitation of using ADC single read mode.

Application Example

The code example for using ADC single read mode and ADC continuous (DMA) read mode can be found in the [peripherals/adc/esp32c3](#) directory of ESP-IDF examples.

GPIO Lookup Macros

There are macros available to specify the GPIO number of a ADC channel, or vice versa. e.g.

1. `ADC1_CHANNEL_0_GPIO_NUM` is the GPIO number of ADC1 channel 0.
2. `ADC1_GPIOn_CHANNEL` is the ADC1 channel number of GPIO n.

API Reference

This reference covers three components:

- [ADC driver](#)
- [ADC Calibration](#)
- [GPIO Lookup Macros](#)

ADC driver

Header File

- [driver/esp32c3/include/driver/adc.h](#)

Functions

esp_err_t **adc_digi_filter_reset** (*adc_digi_filter_idx_t* idx)

Reset adc digital controller filter.

Return

- ESP_OK Success

Parameters

- idx: Filter index.

esp_err_t **adc_digi_filter_set_config** (*adc_digi_filter_idx_t* idx, *adc_digi_filter_t* *config)

Set adc digital controller filter configuration.

Return

- ESP_OK Success

Parameters

- idx: Filter index.
- config: See [adc_digi_filter_t](#).

esp_err_t **adc_digi_filter_get_config** (*adc_digi_filter_idx_t* idx, *adc_digi_filter_t* *config)

Get adc digital controller filter configuration.

Return

- ESP_OK Success

Parameters

- idx: Filter index.
- config: See [adc_digi_filter_t](#).

esp_err_t **adc_digi_filter_enable** (*adc_digi_filter_idx_t* idx, bool enable)

Enable/disable adc digital controller filter. Filtering the ADC data to obtain smooth data at higher sampling rates.

Return

- ESP_OK Success

Parameters

- idx: Filter index.
- enable: Enable/Disable filter.

esp_err_t **adc_digi_monitor_set_config** (*adc_digi_monitor_idx_t* idx, *adc_digi_monitor_t* *config)

Config monitor of adc digital controller.

Return

- ESP_OK Success

Parameters

- idx: Monitor index.
- config: See [adc_digi_monitor_t](#).

esp_err_t **adc_digi_monitor_enable** (*adc_digi_monitor_idx_t* idx, bool enable)

Enable/disable monitor of adc digital controller.

Return

- ESP_OK Success

Parameters

- idx: Monitor index.
- enable: True or false enable monitor.

Header File

- [hal/include/hal/adc_types.h](#)

Structures

struct adc_digi_pattern_table_t

ADC digital controller (DMA mode) conversion rules setting.

Public Members

uint8_t **atten** : 2

ADC sampling voltage attenuation configuration. Modification of attenuation affects the range of measurements. 0: measurement range 0 - 800mV, 1: measurement range 0 - 1100mV, 2: measurement range 0 - 1350mV, 3: measurement range 0 - 2600mV.

uint8_t **channel** : 3

ADC channel index.

uint8_t **unit** : 1

ADC unit index.

uint8_t **reserved** : 2

reserved0

uint8_t **val**

Raw data value

struct adc_digi_output_data_t

ADC digital controller (DMA mode) output data format. Used to analyze the acquired ADC (DMA) data.

Public Members

uint32_t **data** : 12

ADC real output data info. Resolution: 12 bit.

uint32_t **reserved12** : 1

Reserved12.

uint32_t **channel** : 3

ADC channel index info. If (channel < ADC_CHANNEL_MAX), The data is valid. If (channel > ADC_CHANNEL_MAX), The data is invalid.

uint32_t **unit** : 1

ADC unit index info. 0: ADC1; 1: ADC2.

uint32_t **reserved17_31** : 15

Reserved17.

struct adc_digi_output_data_t::[anonymous]::[anonymous] type2

When the configured output format is 12bit. ADC_DIGI_FORMAT_11BIT

uint32_t **val**

Raw data value

struct adc_digi_clk_t

ADC digital controller (DMA mode) clock system setting. Calculation formula: controller_clk = (APLL or APB) / (div_num + div_a / div_b + 1).

Note : The clocks of the DAC digital controller use the ADC digital controller clock divider.

Public Members

bool **use_apll**

true: use APLL clock; false: use APB clock.

uint32_t **div_num**

Division factor. Range: 0 ~ 255. Note: When a higher frequency clock is used (the division factor is less than 9), the ADC reading value will be slightly offset.

uint32_t **div_b**

Division factor. Range: 1 ~ 63.

uint32_t **div_a**

Division factor. Range: 0 ~ 63.

struct adc_digi_config_t

CONFIG_IDF_TARGET_ESP32.

ADC digital controller (DMA mode) configuration parameters.

Example setting: When using ADC1 channel0 to measure voltage, the sampling rate is required to be 1 kHz:

sample rate	1 kHz	1 kHz	1 kHz
conv_mode	single	both	alter
adc1_pattern_len	1	1	1
dig_clk.use_apll	0	0	0
dig_clk.div_num	99	99	99
dig_clk.div_b	0	0	0
dig_clk.div_a	0	0	0
interval	400	400	200
`trigger_meas_freq`	1 kHz	1 kHz	2 kHz

Explanation of the relationship between `conv_limit_num`, `dma_eof_num` and the number of DMA outputs:

conv_mode	single	both	alter
trigger meas times	1	1	1
conv_limit_num	+1	+1	+1
dma_eof_num	+1	+2	+1
dma output (byte)	+2	+4	+2

Public Members

bool **conv_limit_en**

Enable the function of limiting ADC conversion times. If the number of ADC conversion trigger count is equal to the `limit_num`, the conversion is stopped.

uint32_t **conv_limit_num**

Set the upper limit of the number of ADC conversion triggers. Range: 1 ~ 255.

uint32_t **adc_pattern_len**

Pattern table length for digital controller. Range: 0 ~ 7 (0: Don't change the pattern table setting). The pattern table that defines the conversion rules for each SAR ADC. Each table has 7 items, in which channel selection, resolution and attenuation are stored. When the conversion is started, the controller reads conversion rules from the pattern table one by one. For each controller the scan sequence has at most 16 different rules before repeating itself.

[adc_digi_pattern_table_t](#) ***adc_pattern**

Pointer to pattern table for digital controller. The table size defined by `adc_pattern_len`.

uint32_t sample_freq_hz

The expected ADC sampling frequency in Hz. Range: 611Hz ~ 83333Hz $F_s = F_d / \text{interval} / 2$ F_s : sampling frequency; F_d : digital controller frequency, no larger than 5M for better performance interval: interval between 2 measurement trigger signal, the smallest interval should not be smaller than the ADC measurement period, the largest interval should not be larger than 4095

struct adc_arbiter_t

ADC arbiter work mode and priority setting.

Note ESP32-S2: Only ADC2 support arbiter.

Public Members*adc_arbiter_mode_t* **mode**

Refer to *adc_arbiter_mode_t*. Note: only support ADC2.

uint8_t rtc_pri

RTC controller priority. Range: 0 ~ 2.

uint8_t dig_pri

Digital controller priority. Range: 0 ~ 2.

uint8_t pwdet_pri

Wi-Fi controller priority. Range: 0 ~ 2.

struct adc_digi_filter_t

ADC digital controller (DMA mode) filter configuration.

Note For ESP32-S2, The filter object of the ADC is fixed.

Note For ESP32-S2, The filter object is always all enabled channels.

Public Members*adc_unit_t* **adc_unit**

Set adc unit number for filter. For ESP32-S2, Filter IDX0/IDX1 can only be used to filter all enabled channels of ADC1/ADC2 unit at the same time.

adc_channel_t **channel**

Set adc channel number for filter. For ESP32-S2, it' s always ADC_CHANNEL_MAX

adc_digi_filter_mode_t **mode**

Set adc filter mode for filter. See *adc_digi_filter_mode_t*.

struct adc_digi_monitor_t

ADC digital controller (DMA mode) monitor configuration.

Note For ESP32-S2, The monitor object of the ADC is fixed.

Note For ESP32-S2, The monitor object is always all enabled channels.

Public Members*adc_unit_t* **adc_unit**

Set adc unit number for monitor. For ESP32-S2, monitor IDX0/IDX1 can only be used to monitor all enabled channels of ADC1/ADC2 unit at the same time.

adc_channel_t **channel**

Set adc channel number for monitor. For ESP32-S2, it' s always ADC_CHANNEL_MAX

adc_digi_monitor_mode_t **mode**

Set adc monitor mode. See *adc_digi_monitor_mode_t*.

uint32_t h_threshold

Set monitor threshold of adc digital controller.

`uint32_t l_threshold`

Set monitor threshold of adc digital controller.

Macros

`ADC_ARBITER_CONFIG_DEFAULT()`

ADC arbiter default configuration.

Note ESP32S2: Only ADC2 supports (needs) an arbiter.

Enumerations

`enum adc_unit_t`

ADC unit enumeration.

Note For ADC digital controller (DMA mode), ESP32 doesn't support `ADC_UNIT_2`, `ADC_UNIT_BOTH`, `ADC_UNIT_ALTER`.

Values:

`ADC_UNIT_1 = 1`

SAR ADC 1.

`ADC_UNIT_2 = 2`

SAR ADC 2.

`ADC_UNIT_BOTH = 3`

SAR ADC 1 and 2.

`ADC_UNIT_ALTER = 7`

SAR ADC 1 and 2 alternative mode.

`ADC_UNIT_MAX`

`enum adc_channel_t`

ADC channels handle. See `adc1_channel_t`, `adc2_channel_t`.

Note For ESP32 ADC1, don't use `ADC_CHANNEL_8`, `ADC_CHANNEL_9`. See `adc1_channel_t`.

Values:

`ADC_CHANNEL_0 = 0`

ADC channel

`ADC_CHANNEL_1`

ADC channel

`ADC_CHANNEL_2`

ADC channel

`ADC_CHANNEL_3`

ADC channel

`ADC_CHANNEL_4`

ADC channel

`ADC_CHANNEL_5`

ADC channel

`ADC_CHANNEL_6`

ADC channel

`ADC_CHANNEL_7`

ADC channel

`ADC_CHANNEL_8`

ADC channel

`ADC_CHANNEL_9`

ADC channel

ADC_CHANNEL_MAX**enum adc_atten_t**

ADC attenuation parameter. Different parameters determine the range of the ADC. See `adc1_config_channel_atten`.

Values:

ADC_ATTEN_DB_0 = 0

No input attenuation, ADC can measure up to approx. 800 mV.

ADC_ATTEN_DB_2_5 = 1

The input voltage of ADC will be attenuated, extending the range of measurement to up to approx. 1100 mV.

ADC_ATTEN_DB_6 = 2

The input voltage of ADC will be attenuated, extending the range of measurement to up to approx. 1350 mV.

ADC_ATTEN_DB_11 = 3

The input voltage of ADC will be attenuated, extending the range of measurement to up to approx. 2600 mV.

ADC_ATTEN_MAX**enum adc_i2s_source_t**

ESP32 ADC DMA source selection.

Values:

ADC_I2S_DATA_SRC_IO_SIG = 0

I2S data from GPIO matrix signal

ADC_I2S_DATA_SRC_ADC = 1

I2S data from ADC

ADC_I2S_DATA_SRC_MAX**enum adc_bits_width_t**

ADC resolution setting option.

Values:

ADC_WIDTH_BIT_12 = 3

ADC capture width is 12Bit.

ADC_WIDTH_MAX**enum adc_digi_convert_mode_t**

ADC digital controller (DMA mode) work mode.

Note The conversion mode affects the sampling frequency: `SINGLE_UNIT_1`: When the measurement is triggered, only ADC1 is sampled once. `SINGLE_UNIT_2`: When the measurement is triggered, only ADC2 is sampled once. `BOTH_UNIT`: When the measurement is triggered, ADC1 and ADC2 are sampled at the same time. `ALTER_UNIT`: When the measurement is triggered, ADC1 or ADC2 samples alternately.

Values:

ADC_CONV_SINGLE_UNIT_1 = 1

SAR ADC 1.

ADC_CONV_SINGLE_UNIT_2 = 2

SAR ADC 2.

ADC_CONV_BOTH_UNIT = 3

SAR ADC 1 and 2.

ADC_CONV_ALTER_UNIT = 7

SAR ADC 1 and 2 alternative mode.

ADC_CONV_UNIT_MAX**enum adc_digi_output_format_t**

ADC digital controller (DMA mode) output data format option.

Values:

ADC_DIGI_FORMAT_12BIT

ADC to DMA data format, [15:12]-channel, [11: 0]-12 bits ADC data (*adc_digi_output_data_t*). Note: For single convert mode.

ADC_DIGI_FORMAT_11BIT

ADC to DMA data format, [15]-adc unit, [14:11]-channel, [10: 0]-11 bits ADC data (*adc_digi_output_data_t*). Note: For multi or alter convert mode.

ADC_DIGI_FORMAT_MAX**enum adc_arbiter_mode_t**

ADC arbiter work mode option.

Note ESP32-S2: Only ADC2 support arbiter.

Values:

ADC_ARB_MODE_SHIELD

Force shield arbiter, Select the highest priority controller to work.

ADC_ARB_MODE_FIX

Fixed priority switch controller mode.

ADC_ARB_MODE_LOOP

Loop priority switch controller mode. Each controller has the same priority, and the arbiter will switch to the next controller after the measurement is completed.

enum adc_digi_filter_idx_t

ADC digital controller (DMA mode) filter index options.

Note For ESP32-S2, The filter object of the ADC is fixed.

Values:

ADC_DIGI_FILTER_IDX0 = 0

The filter index 0. For ESP32-S2, It can only be used to filter all enabled channels of ADC1 unit at the same time.

ADC_DIGI_FILTER_IDX1

The filter index 1. For ESP32-S2, It can only be used to filter all enabled channels of ADC2 unit at the same time.

ADC_DIGI_FILTER_IDX_MAX**enum adc_digi_filter_mode_t**

ADC digital controller (DMA mode) filter type options. Expression: $\text{filter_data} = (k-1)/k * \text{last_data} + \text{new_data} / k$.

Values:

ADC_DIGI_FILTER_DIS = -1

Disable filter

ADC_DIGI_FILTER_IIR_2 = 0

The filter mode is first-order IIR filter. The coefficient is 2.

ADC_DIGI_FILTER_IIR_4

The filter mode is first-order IIR filter. The coefficient is 4.

ADC_DIGI_FILTER_IIR_8

The filter mode is first-order IIR filter. The coefficient is 8.

ADC_DIGI_FILTER_IIR_16

The filter mode is first-order IIR filter. The coefficient is 16.

ADC_DIGI_FILTER_IIR_64

The filter mode is first-order IIR filter. The coefficient is 64.

ADC_DIGI_FILTER_IIR_MAX**enum adc_digi_monitor_idx_t**

ADC digital controller (DMA mode) monitor index options.

Note For ESP32-S2, The monitor object of the ADC is fixed.

Values:

ADC_DIGI_MONITOR_IDX0 = 0

The monitor index 0. For ESP32-S2, It can only be used to monitor all enabled channels of ADC1 unit at the same time.

ADC_DIGI_MONITOR_IDX1

The monitor index 1. For ESP32-S2, It can only be used to monitor all enabled channels of ADC2 unit at the same time.

ADC_DIGI_MONITOR_IDX_MAX**enum adc_digi_monitor_mode_t**

Set monitor mode of adc digital controller. MONITOR_HIGH: If ADC_OUT > threshold, Generates monitor interrupt. MONITOR_LOW: If ADC_OUT < threshold, Generates monitor interrupt.

Values:

ADC_DIGI_MONITOR_DIS = 0

Disable monitor.

ADC_DIGI_MONITOR_EN

If ADC_OUT < threshold, Generates monitor interrupt. If ADC_OUT > threshold, Generates monitor interrupt.

ADC_DIGI_MONITOR_MAX**Header File**

- [driver/include/driver/adc_common.h](#)

Functions

void **adc_power_on** (void)

Enable ADC power.

void **adc_power_off** (void)

Power off SAR ADC.

void **adc_power_acquire** (void)

Increment the usage counter for ADC module. ADC will stay powered on while the counter is greater than 0. Call `adc_power_release` when done using the ADC.

void **adc_power_release** (void)

Decrement the usage counter for ADC module. ADC will stay powered on while the counter is greater than 0. Call this function when done using the ADC.

esp_err_t **adc1_pad_get_io_num** (*adc1_channel_t* channel, *gpio_num_t* *gpio_num)

Get the GPIO number of a specific ADC1 channel.

Return

- ESP_OK if success
- ESP_ERR_INVALID_ARG if channel not valid

Parameters

- `channel`: Channel to get the GPIO number

- `gpio_num`: output buffer to hold the GPIO number

`esp_err_t adc1_config_channel_atten(adc1_channel_t channel, adc_atten_t atten)`

Set the attenuation of a particular channel on ADC1, and configure its associated GPIO pin mux.

The default ADC voltage is for attenuation 0 dB and listed in the table below. By setting higher attenuation it is possible to read higher voltages.

Due to ADC characteristics, most accurate results are obtained within the “suggested range” shown in the following table.

SoC	attenuation (dB)	suggested range (mV)
ESP32	0	100 ~ 950
	2.5	100 ~ 1250
	6	150 ~ 1750
	11	150 ~ 2450
ESP32-S2	0	0 ~ 750
	2.5	0 ~ 1050
	6	0 ~ 1300
	11	0 ~ 2500

For maximum accuracy, use the ADC calibration APIs and measure voltages within these recommended ranges.

Note For any given channel, this function must be called before the first time `adc1_get_raw()` is called for that channel.

Note This function can be called multiple times to configure multiple ADC channels simultaneously. You may call `adc1_get_raw()` only after configuring a channel.

Return

- ESP_OK success
- ESP_ERR_INVALID_ARG Parameter error

Parameters

- `channel`: ADC1 channel to configure
- `atten`: Attenuation level

`esp_err_t adc1_config_width(adc_bits_width_t width_bit)`

Configure ADC1 capture width, meanwhile enable output invert for ADC1. The configuration is for all channels of ADC1.

Return

- ESP_OK success
- ESP_ERR_INVALID_ARG Parameter error

Parameters

- `width_bit`: Bit capture width for ADC1

`int adc1_get_raw(adc1_channel_t channel)`

Take an ADC1 reading from a single channel.

Note ESP32: When the power switch of SARADC1, SARADC2, HALL sensor and AMP sensor is turned on, the input of GPIO36 and GPIO39 will be pulled down for about 80ns. When enabling power for any of these peripherals, ignore input from GPIO36 and GPIO39. Please refer to section 3.11 of ‘ECO_and_Workarounds_for_Bugs_in_ESP32’ for the description of this issue. As a workaround, call

`adc_power_acquire()` in the app. This will result in higher power consumption (by ~1mA), but will remove the glitches on GPIO36 and GPIO39.

Note Call `adc1_config_width()` before the first time this function is called.

Note For any given channel, `adc1_config_channel_atten(channel)` must be called before the first time this function is called. Configuring a new channel does not prevent a previously configured channel from being read.

Return

- -1: Parameter error
- Other: ADC1 channel reading.

Parameters

- `channel`: ADC1 channel to read

esp_err_t `adc2_pad_get_io_num(adc2_channel_t channel, gpio_num_t *gpio_num)`

Get the GPIO number of a specific ADC2 channel.

Return

- ESP_OK if success
- ESP_ERR_INVALID_ARG if channel not valid

Parameters

- `channel`: Channel to get the GPIO number
- `gpio_num`: output buffer to hold the GPIO number

esp_err_t `adc2_config_channel_atten(adc2_channel_t channel, adc_atten_t atten)`

Configure the ADC2 channel, including setting attenuation.

The default ADC voltage is for attenuation 0 dB and listed in the table below. By setting higher attenuation it is possible to read higher voltages.

Due to ADC characteristics, most accurate results are obtained within the “suggested range” shown in the following table.

SoC	attenuation (dB)	suggested range (mV)
ESP32	0	100 ~ 950
	2.5	100 ~ 1250
	6	150 ~ 1750
	11	150 ~ 2450
ESP32-S2	0	0 ~ 750
	2.5	0 ~ 1050
	6	0 ~ 1300
	11	0 ~ 2500

For maximum accuracy, use the ADC calibration APIs and measure voltages within these recommended ranges.

Note This function also configures the input GPIO pin mux to connect it to the ADC2 channel. It must be called before calling `adc2_get_raw()` for this channel.

Note For any given channel, this function must be called before the first time `adc2_get_raw()` is called for that channel.

Return

- ESP_OK success
- ESP_ERR_INVALID_ARG Parameter error

Parameters

- `channel`: ADC2 channel to configure
- `atten`: Attenuation level

esp_err_t `adc2_get_raw` (*adc_channel_t* channel, *adc_bits_width_t* width_bit, int *raw_out)

Take an ADC2 reading on a single channel.

Note ESP32: When the power switch of SARADC1, SARADC2, HALL sensor and AMP sensor is turned on, the input of GPIO36 and GPIO39 will be pulled down for about 80ns. When enabling power for any of these peripherals, ignore input from GPIO36 and GPIO39. Please refer to section 3.11 of ‘ECO_and_Workarounds_for_Bugs_in_ESP32’ for the description of this issue. As a workaround, call `adc_power_acquire()` in the app. This will result in higher power consumption (by ~1mA), but will remove the glitches on GPIO36 and GPIO39.

Note ESP32: For a given channel, `adc2_config_channel_atten()` must be called before the first time this function is called. If Wi-Fi is started via `esp_wifi_start()`, this function will always fail with `ESP_ERR_TIMEOUT`.

Note ESP32-S2: ADC2 support hardware arbiter. The arbiter is to improve the use efficiency of ADC2. After the control right is robbed by the high priority, the low priority controller will read the invalid ADC2 data. Default priority: Wi-Fi > RTC > Digital;

Return

- `ESP_OK` if success
- `ESP_ERR_TIMEOUT` ADC2 is being used by other controller and the request timed out.
- `ESP_ERR_INVALID_STATE` The controller status is invalid. Please try again.

Parameters

- `channel`: ADC2 channel to read
- `width_bit`: Bit capture width for ADC2
- `raw_out`: the variable to hold the output data.

esp_err_t `adc_vref_to_gpio` (*adc_unit_t* adc_unit, *gpio_num_t* gpio)

Output ADC1 or ADC2’ s reference voltage to `adc2_channe_t’ s` IO.

This function routes the internal reference voltage of ADCn to one of ADC2’ s channels. This reference voltage can then be manually measured for calibration purposes.

Note ESP32 only supports output of ADC2’ s internal reference voltage.

Return

- `ESP_OK`: v_ref successfully routed to selected GPIO
- `ESP_ERR_INVALID_ARG`: Unsupported GPIO

Parameters

- [in] `adc_unit`: ADC unit index
- [in] `gpio`: GPIO number (Only ADC2’ s channels IO are supported)

esp_err_t `adc2_vref_to_gpio` (*gpio_num_t* gpio)

Output ADC2 reference voltage to `adc2_channe_t’ s` IO.

This function routes the internal reference voltage of ADCn to one of ADC2’ s channels. This reference voltage can then be manually measured for calibration purposes.

Return

- `ESP_OK`: v_ref successfully routed to selected GPIO
- `ESP_ERR_INVALID_ARG`: Unsupported GPIO

Parameters

- [in] `gpio`: GPIO number (ADC2’ s channels are supported)

esp_err_t `adc_digi_controller_config` (const *adc_digi_config_t* *config)

Setting the digital controller.

Return

- `ESP_ERR_INVALID_STATE` Driver state is invalid.
- `ESP_ERR_INVALID_ARG` If the combination of arguments is invalid.
- `ESP_OK` On success

Parameters

- `config`: Pointer to digital controller paramter. Refer to `adc_digi_config_t`.

esp_err_t **adc_digi_initialize** (const *adc_digi_init_config_t* **init_config*)

Initialize the Digital ADC.

Return

- ESP_ERR_INVALID_ARG If the combination of arguments is invalid.
- ESP_ERR_NOT_FOUND No free interrupt found with the specified flags
- ESP_ERR_NO_MEM If out of memory
- ESP_OK On success

Parameters

- *init_config*: Pointer to Digital ADC initialization config. Refer to *adc_digi_init_config_t*.

esp_err_t **adc_digi_start** (void)

Start the Digital ADC and DMA peripherals. After this, the hardware starts working.

Return

- ESP_ERR_INVALID_STATE Driver state is invalid.
- ESP_OK On success

esp_err_t **adc_digi_stop** (void)

Stop the Digital ADC and DMA peripherals. After this, the hardware stops working.

Return

- ESP_ERR_INVALID_STATE Driver state is invalid.
- ESP_OK On success

esp_err_t **adc_digi_read_bytes** (uint8_t **buf*, uint32_t *length_max*, uint32_t **out_length*, uint32_t *timeout_ms*)

Read bytes from Digital ADC through DMA.

Return

- ESP_ERR_INVALID_STATE Driver state is invalid. Usually it means the ADC sampling rate is faster than the task processing rate.
- ESP_ERR_TIMEOUT Operation timed out
- ESP_OK On success

Parameters

- [out] *buf*: Buffer to read from ADC.
- [in] *length_max*: Expected length of data read from the ADC.
- [out] *out_length*: Real length of data read from the ADC via this API.
- [in] *timeout_ms*: Time to wait for data via this API, in millisecond.

esp_err_t **adc_digi_deinitialize** (void)

Deinitialize the Digital ADC.

Return

- ESP_ERR_INVALID_STATE Driver state is invalid.
- ESP_OK On success

Structures

struct *adc_digi_init_config_s*

Digital ADC DMA configuration.

Public Members

uint32_t **max_store_buf_size**

Max length of the converted data that driver can store before they are processed.

uint32_t **conv_num_each_intr**

Bytes of data that can be converted in 1 interrupt.

uint32_t **adc1_chan_mask**

Channel list of ADC1 to be initialized.

`uint32_t adc2_chan_mask`
Channel list of ADC2 to be initialized.

Macros

ADC_ATTEN_0db

ADC rtc controller attenuation option.

Note This definitions are only for being back-compatible

ADC_ATTEN_2_5db

ADC_ATTEN_6db

ADC_ATTEN_11db

ADC_WIDTH_BIT_DEFAULT

The default (max) bit width of the ADC of current version. You can also get the maximum bitwidth by `SOC_ADC_MAX_BITWIDTH` defined in `soc_caps.h`.

ADC_WIDTH_9Bit

ADC_WIDTH_10Bit

ADC_WIDTH_11Bit

ADC_WIDTH_12Bit

ADC_MAX_DELAY

Digital ADC DMA read max timeout value, it may make the `adc_digi_read_bytes` block forever if the OS supports.

Type Definitions

typedef struct *adc_digi_init_config_s* adc_digi_init_config_t

Digital ADC DMA configuration.

Enumerations

enum adc1_channel_t

Values:

ADC1_CHANNEL_0 = 0

ADC1 channel 0 is GPIO0

ADC1_CHANNEL_1

ADC1 channel 1 is GPIO1

ADC1_CHANNEL_2

ADC1 channel 2 is GPIO2

ADC1_CHANNEL_3

ADC1 channel 3 is GPIO3

ADC1_CHANNEL_4

ADC1 channel 4 is GPIO4

ADC1_CHANNEL_MAX

enum adc2_channel_t

Values:

ADC2_CHANNEL_0 = 0

ADC2 channel 0 is GPIO5

ADC2_CHANNEL_MAX

enum adc_i2s_encode_t

ADC digital controller encode option.

Values:

ADC_ENCODE_12BIT

ADC to DMA data format, [15:12]-channel [11:0]-12 bits ADC data

ADC_ENCODE_11BIT

ADC to DMA data format, [15]-unit, [14:11]-channel [10:0]-11 bits ADC data

ADC_ENCODE_MAX**ADC Calibration****Header File**

- [esp_adc_cal/include/esp_adc_cal.h](#)

Functions

esp_err_t **esp_adc_cal_check_efuse** (*esp_adc_cal_value_t* value_type)

Checks if ADC calibration values are burned into eFuse.

This function checks if ADC reference voltage or Two Point values have been burned to the eFuse of the current ESP32

Note in ESP32S2, only ESP_ADC_CAL_VAL_EFUSE_TP is supported. Some old ESP32S2s do not support this, either. In which case you have to calibrate it manually, possibly by performing your own two-point calibration on the chip.

Return

- ESP_OK: The calibration mode is supported in eFuse
- ESP_ERR_NOT_SUPPORTED: Error, eFuse values are not burned
- ESP_ERR_INVALID_ARG: Error, invalid argument (ESP_ADC_CAL_VAL_DEFAULT_VREF)

Parameters

- value_type: Type of calibration value (ESP_ADC_CAL_VAL_EFUSE_VREF or ESP_ADC_CAL_VAL_EFUSE_TP)

esp_adc_cal_value_t **esp_adc_cal_characterize** (*adc_unit_t* adc_num, *adc_atten_t* atten, *adc_bits_width_t* bit_width, *uint32_t* default_vref, *esp_adc_cal_characteristics_t* *chars)

Characterize an ADC at a particular attenuation.

This function will characterize the ADC at a particular attenuation and generate the ADC-Voltage curve in the form of $[y = \text{coeff_a} * x + \text{coeff_b}]$. Characterization can be based on Two Point values, eFuse Vref, or default Vref and the calibration values will be prioritized in that order.

Note For ESP32, Two Point values and eFuse Vref calibration can be enabled/disabled using menuconfig. For ESP32s2, only Two Point values calibration and only ADC_WIDTH_BIT_13 is supported. The parameter default_vref is unused.

Return

- ESP_ADC_CAL_VAL_EFUSE_VREF: eFuse Vref used for characterization
- ESP_ADC_CAL_VAL_EFUSE_TP: Two Point value used for characterization (only in Linear Mode)
- ESP_ADC_CAL_VAL_DEFAULT_VREF: Default Vref used for characterization

Parameters

- [in] adc_num: ADC to characterize (ADC_UNIT_1 or ADC_UNIT_2)
- [in] atten: Attenuation to characterize
- [in] bit_width: Bit width configuration of ADC
- [in] default_vref: Default ADC reference voltage in mV (Only in ESP32, used if eFuse values is not available)
- [out] chars: Pointer to empty structure used to store ADC characteristics

uint32_t **esp_adc_cal_raw_to_voltage** (*uint32_t* adc_reading, *const* *esp_adc_cal_characteristics_t* *chars)

Convert an ADC reading to voltage in mV.

This function converts an ADC reading to a voltage in mV based on the ADC's characteristics.

Note Characteristics structure must be initialized before this function is called (call `esp_adc_cal_characterize()`)

Return Voltage in mV

Parameters

- [in] `adc_reading`: ADC reading
- [in] `chars`: Pointer to initialized structure containing ADC characteristics

esp_err_t **esp_adc_cal_get_voltage** (*adc_channel_t* channel, const *esp_adc_cal_characteristics_t* *chars, uint32_t *voltage)

Reads an ADC and converts the reading to a voltage in mV.

This function reads an ADC then converts the raw reading to a voltage in mV based on the characteristics provided. The ADC that is read is also determined by the characteristics.

Note The Characteristics structure must be initialized before this function is called (call `esp_adc_cal_characterize()`)

Return

- ESP_OK: ADC read and converted to mV
- ESP_ERR_TIMEOUT: Error, timed out attempting to read ADC
- ESP_ERR_INVALID_ARG: Error due to invalid arguments

Parameters

- [in] `channel`: ADC Channel to read
- [in] `chars`: Pointer to initialized ADC characteristics structure
- [out] `voltage`: Pointer to store converted voltage

Structures

struct esp_adc_cal_characteristics_t

Structure storing characteristics of an ADC.

Note Call `esp_adc_cal_characterize()` to initialize the structure

Public Members

adc_unit_t **adc_num**

ADC number

adc_atten_t **atten**

ADC attenuation

adc_bits_width_t **bit_width**

ADC bit width

uint32_t **coeff_a**

Gradient of ADC-Voltage curve

uint32_t **coeff_b**

Offset of ADC-Voltage curve

uint32_t **vref**

Vref used by lookup table

const uint32_t ***low_curve**

Pointer to low Vref curve of lookup table (NULL if unused)

const uint32_t ***high_curve**

Pointer to high Vref curve of lookup table (NULL if unused)

Enumerations

enum esp_adc_cal_value_t

Type of calibration value used in characterization.

Values:

ESP_ADC_CAL_VAL_EFUSE_VREF = 0
Characterization based on reference voltage stored in eFuse

ESP_ADC_CAL_VAL_EFUSE_TP = 1
Characterization based on Two Point values stored in eFuse

ESP_ADC_CAL_VAL_DEFAULT_VREF = 2
Characterization based on default reference voltage

ESP_ADC_CAL_VAL_MAX

ESP_ADC_CAL_VAL_NOT_SUPPORTED = [ESP_ADC_CAL_VAL_MAX](#)

GPIO Lookup Macros

Header File

- [soc/esp32c3/include/soc/adc_channel.h](#)

Macros

ADC1_GPIO1_CHANNEL
ADC1_CHANNEL_0_GPIO_NUM

ADC1_GPIO2_CHANNEL
ADC1_CHANNEL_1_GPIO_NUM

ADC1_GPIO3_CHANNEL
ADC1_CHANNEL_2_GPIO_NUM

ADC1_GPIO4_CHANNEL
ADC1_CHANNEL_3_GPIO_NUM

ADC1_GPIO5_CHANNEL
ADC1_CHANNEL_4_GPIO_NUM

ADC2_GPIO5_CHANNEL
ADC2_CHANNEL_0_GPIO_NUM

2.3.2 General Purpose Timer

Introduction

The ESP32-C3 chip contains two hardware timer groups. Each group has two general-purpose hardware timers. They are all 54-bit generic timers based on 16-bit pre-scalers and 54-bit up / down counters which are capable of being auto-reloaded.

Functional Overview

The following sections of this document cover the typical steps to configure and operate a timer:

- [Timer Initialization](#) - covers which parameters should be set up to get the timer working, and also what specific functionality is provided depending on the timer configuration.
- [Timer Control](#) - describes how to read a timer's value, pause or start a timer, and change how it operates.
- [Alarms](#) - shows how to set and use alarms.
- [Interrupts](#) - explains how to use interrupt callbacks.

Timer Initialization The two ESP32-C3 timer groups, with two timers in each, provide the total of four individual timers for use. An ESP32-C3 timer group should be identified using `timer_group_t`. An individual timer in a group should be identified with `timer_idx_t`.

First of all, the timer should be initialized by calling the function `timer_init()` and passing a structure `timer_config_t` to it to define how the timer should operate. In particular, the following timer parameters can be set:

- **Clock Source:** Select the clock source, which together with the **Divider** define the resolution of the working timer. By default the clock source is APB_CLK (typically 80 MHz).
- **Divider:** Sets how quickly the timer's counter is "ticking". The setting `divider` is used as a divisor of the clock source.
- **Mode:** Sets if the counter should be incrementing or decrementing. It can be defined using `counter_dir` by selecting one of the values from `timer_count_dir_t`.
- **Counter Enable:** If the counter is enabled, it will start incrementing / decrementing immediately after calling `timer_init()`. You can change the behavior with `counter_en` by selecting one of the values from `timer_start_t`.
- **Alarm Enable:** Can be set using `alarm_en`.
- **Auto Reload:** Sets if the counter should `auto_reload` the initial counter value on the timer's alarm or continue incrementing or decrementing.

To get the current values of the timer's settings, use the function `timer_get_config()`.

Timer Control Once the timer is enabled, its counter starts running. To enable the timer, call the function `timer_init()` with `counter_en` set to `true`, or call `timer_start()`. You can specify the timer's initial counter value by calling `timer_set_counter_value()`. To check the timer's current value, call `timer_get_counter_value()` or `timer_get_counter_time_sec()`.

To pause the timer at any time, call `timer_pause()`. To resume it, call `timer_start()`.

To reconfigure the timer, you can call `timer_init()`. This function is described in Section [Timer Initialization](#).

You can also reconfigure the timer by using dedicated functions to change individual settings:

Setting	Dedicated Function	Description
Divider	<code>timer_set_divider()</code>	Change the rate of ticking. To avoid unpredictable results, the timer should be paused when changing the divider. If the timer is running, <code>timer_set_divider()</code> pauses it, change the setting, and start the timer again.
Mode	<code>timer_set_counter_dir()</code>	Set if the counter should be incrementing or decrementing
Auto Reload	<code>timer_set_auto_reload()</code>	Set if the initial counter value should be reloaded on the timer's alarm

Alarms To set an alarm, call the function `timer_set_alarm_value()` and then enable the alarm using `timer_set_alarm()`. The alarm can also be enabled during the timer initialization stage, when `timer_init()` is called.

After the alarm is enabled, and the timer reaches the alarm value, the following two actions can occur depending on the configuration:

- An interrupt will be triggered if previously configured. See Section [Interrupts](#) on how to configure interrupts.
- When `auto_reload` is enabled, the timer's counter will automatically be reloaded to start counting again from a previously configured value. This value should be set in advance with `timer_set_counter_value()`.

Note:

- If an alarm value is set and the timer has already reached this value, the alarm is triggered immediately.
- Once triggered, the alarm is disabled automatically and needs to be re-enabled to trigger again.

To check the specified alarm value, call `timer_get_alarm_value()`.

Interrupts Registration of an interrupt callback for a specific timer can be done by calling `timer_isr_callback_add()` and passing in the group ID, timer ID, callback handler and user data. The callback handler will be invoked in ISR context, so user shouldn't put any blocking API in the callback function. The benefit of using interrupt callback instead of precessing interrupt from scratch is, you don't have to deal with interrupt status check and clean stuffs, they are all addressed before the callback got run in driver's default interrupt handler.

For more information on how to use interrupts, please see the application example below.

Application Example

The 54-bit hardware timer example: [peripherals/timer_group](#).

API Reference

Header File

- [driver/include/driver/timer.h](#)

Functions

`esp_err_t timer_get_counter_value(timer_group_t group_num, timer_idx_t timer_num, uint64_t *timer_val)`

Read the counter value of hardware timer.

Return

- ESP_OK Success
- ESP_ERR_INVALID_ARG Parameter error

Parameters

- group_num: Timer group, 0 for TIMERG0 or 1 for TIMERG1
- timer_num: Timer index, 0 for hw_timer[0] & 1 for hw_timer[1]
- timer_val: Pointer to accept timer counter value.

`esp_err_t timer_get_counter_time_sec(timer_group_t group_num, timer_idx_t timer_num, double *time)`

Read the counter value of hardware timer, in unit of a given scale.

Return

- ESP_OK Success
- ESP_ERR_INVALID_ARG Parameter error

Parameters

- group_num: Timer group, 0 for TIMERG0 or 1 for TIMERG1
- timer_num: Timer index, 0 for hw_timer[0] & 1 for hw_timer[1]
- time: Pointer, type of double*, to accept timer counter value, in seconds.

`esp_err_t timer_set_counter_value(timer_group_t group_num, timer_idx_t timer_num, uint64_t load_val)`

Set counter value to hardware timer.

Return

- ESP_OK Success
- ESP_ERR_INVALID_ARG Parameter error

Parameters

- group_num: Timer group, 0 for TIMERG0 or 1 for TIMERG1
- timer_num: Timer index, 0 for hw_timer[0] & 1 for hw_timer[1]
- load_val: Counter value to write to the hardware timer.

esp_err_t **timer_start** (*timer_group_t* group_num, *timer_idx_t* timer_num)

Start the counter of hardware timer.

Return

- ESP_OK Success
- ESP_ERR_INVALID_ARG Parameter error

Parameters

- group_num: Timer group number, 0 for TIMERG0 or 1 for TIMERG1
- timer_num: Timer index, 0 for hw_timer[0] & 1 for hw_timer[1]

esp_err_t **timer_pause** (*timer_group_t* group_num, *timer_idx_t* timer_num)

Pause the counter of hardware timer.

Return

- ESP_OK Success
- ESP_ERR_INVALID_ARG Parameter error

Parameters

- group_num: Timer group number, 0 for TIMERG0 or 1 for TIMERG1
- timer_num: Timer index, 0 for hw_timer[0] & 1 for hw_timer[1]

esp_err_t **timer_set_counter_mode** (*timer_group_t* group_num, *timer_idx_t* timer_num, *timer_count_dir_t* counter_dir)

Set counting mode for hardware timer.

Return

- ESP_OK Success
- ESP_ERR_INVALID_ARG Parameter error

Parameters

- group_num: Timer group number, 0 for TIMERG0 or 1 for TIMERG1
- timer_num: Timer index, 0 for hw_timer[0] & 1 for hw_timer[1]
- counter_dir: Counting direction of timer, count-up or count-down

esp_err_t **timer_set_auto_reload** (*timer_group_t* group_num, *timer_idx_t* timer_num, *timer_autoreload_t* reload)

Enable or disable counter reload function when alarm event occurs.

Return

- ESP_OK Success
- ESP_ERR_INVALID_ARG Parameter error

Parameters

- group_num: Timer group number, 0 for TIMERG0 or 1 for TIMERG1
- timer_num: Timer index, 0 for hw_timer[0] & 1 for hw_timer[1]
- reload: Counter reload mode.

esp_err_t **timer_set_divider** (*timer_group_t* group_num, *timer_idx_t* timer_num, uint32_t divider)

Set hardware timer source clock divider. Timer groups clock are divider from APB clock.

Return

- ESP_OK Success
- ESP_ERR_INVALID_ARG Parameter error

Parameters

- group_num: Timer group number, 0 for TIMERG0 or 1 for TIMERG1
- timer_num: Timer index, 0 for hw_timer[0] & 1 for hw_timer[1]
- divider: Timer clock divider value. The divider's range is from 2 to 65536.

esp_err_t **timer_set_alarm_value** (*timer_group_t* group_num, *timer_idx_t* timer_num, uint64_t alarm_value)

Set timer alarm value.

Return

- ESP_OK Success
- ESP_ERR_INVALID_ARG Parameter error

Parameters

- group_num: Timer group, 0 for TIMERG0 or 1 for TIMERG1

- `timer_num`: Timer index, 0 for `hw_timer[0]` & 1 for `hw_timer[1]`
- `alarm_value`: A 64-bit value to set the alarm value.

`esp_err_t timer_get_alarm_value(timer_group_t group_num, timer_idx_t timer_num, uint64_t *alarm_value)`

Get timer alarm value.

Return

- `ESP_OK` Success
- `ESP_ERR_INVALID_ARG` Parameter error

Parameters

- `group_num`: Timer group, 0 for `TIMERG0` or 1 for `TIMERG1`
- `timer_num`: Timer index, 0 for `hw_timer[0]` & 1 for `hw_timer[1]`
- `alarm_value`: Pointer of A 64-bit value to accept the alarm value.

`esp_err_t timer_set_alarm(timer_group_t group_num, timer_idx_t timer_num, timer_alarm_t alarm_en)`

Enable or disable generation of timer alarm events.

Return

- `ESP_OK` Success
- `ESP_ERR_INVALID_ARG` Parameter error

Parameters

- `group_num`: Timer group, 0 for `TIMERG0` or 1 for `TIMERG1`
- `timer_num`: Timer index, 0 for `hw_timer[0]` & 1 for `hw_timer[1]`
- `alarm_en`: To enable or disable timer alarm function.

`esp_err_t timer_isr_callback_add(timer_group_t group_num, timer_idx_t timer_num, timer_isr_t isr_handler, void *arg, int intr_alloc_flags)`

Add ISR handle callback for the corresponding timer.

The callback should return a bool value to determine whether need to do `YIELD` at the end of the ISR.

Note This ISR handler will be called from an ISR. This ISR handler do not need to handle interrupt status, and should be kept short. If you want to realize some specific applications or write the whole ISR, you can call `timer_isr_register(...)` to register ISR.

Parameters

- `group_num`: Timer group number
- `timer_num`: Timer index of timer group
- `isr_handler`: Interrupt handler function, it is a callback function.
- `arg`: Parameter for handler function
- `intr_alloc_flags`: Flags used to allocate the interrupt. One or multiple (`OR`red) `ESP_INTR_FLAG_*` values. See `esp_intr_alloc.h` for more info.

If the `intr_alloc_flags` value `ESP_INTR_FLAG_IRAM` is set, the handler function must be declared with `IRAM_ATTR` attribute and can only call functions in `IRAM` or `ROM`. It cannot call other timer APIs.

Return

- `ESP_OK` Success
- `ESP_ERR_INVALID_ARG` Parameter error

`esp_err_t timer_isr_callback_remove(timer_group_t group_num, timer_idx_t timer_num)`

Remove ISR handle callback for the corresponding timer.

Return

- `ESP_OK` Success
- `ESP_ERR_INVALID_ARG` Parameter error

Parameters

- `group_num`: Timer group number
- `timer_num`: Timer index of timer group

`esp_err_t timer_isr_register(timer_group_t group_num, timer_idx_t timer_num, void (*fn) void *, void *arg, int intr_alloc_flags, timer_isr_handle_t *handle)` Register Timer interrupt handler, the handler is an ISR. The handler will be attached to the same CPU core that this function is running on.

If the `intr_alloc_flags` value `ESP_INTR_FLAG_IRAM` is set, the handler function must be declared with `IRAM_ATTR` attribute and can only call functions in IRAM or ROM. It cannot call other timer APIs. Use direct register access to configure timers from inside the ISR in this case.

Note If use this function to register ISR, you need to write the whole ISR. In the interrupt handler, you need to call `timer_spinlock_take(..)` before your handling, and call `timer_spinlock_give(...)` after your handling.

Parameters

- `group_num`: Timer group number
- `timer_num`: Timer index of timer group
- `fn`: Interrupt handler function.
- `arg`: Parameter for handler function
- `intr_alloc_flags`: Flags used to allocate the interrupt. One or multiple (ORred) `ESP_INTR_FLAG_*` values. See `esp_intr_alloc.h` for more info.
- `handle`: Pointer to return handle. If non-NULL, a handle for the interrupt will be returned here.

Return

- `ESP_OK` Success
- `ESP_ERR_INVALID_ARG` Parameter error

`esp_err_t timer_init(timer_group_t group_num, timer_idx_t timer_num, const timer_config_t *config)`

Initializes and configure the timer.

Return

- `ESP_OK` Success
- `ESP_ERR_INVALID_ARG` Parameter error

Parameters

- `group_num`: Timer group number, 0 for `TIMERG0` or 1 for `TIMERG1`
- `timer_num`: Timer index, 0 for `hw_timer[0]` & 1 for `hw_timer[1]`
- `config`: Pointer to timer initialization parameters.

`esp_err_t timer_deinit(timer_group_t group_num, timer_idx_t timer_num)`

Deinitializes the timer.

Return

- `ESP_OK` Success
- `ESP_ERR_INVALID_ARG` Parameter error

Parameters

- `group_num`: Timer group number, 0 for `TIMERG0` or 1 for `TIMERG1`
- `timer_num`: Timer index, 0 for `hw_timer[0]` & 1 for `hw_timer[1]`

`esp_err_t timer_get_config(timer_group_t group_num, timer_idx_t timer_num, timer_config_t *config)`

Get timer configure value.

Return

- `ESP_OK` Success
- `ESP_ERR_INVALID_ARG` Parameter error

Parameters

- `group_num`: Timer group number, 0 for `TIMERG0` or 1 for `TIMERG1`
- `timer_num`: Timer index, 0 for `hw_timer[0]` & 1 for `hw_timer[1]`
- `config`: Pointer of struct to accept timer parameters.

`esp_err_t timer_group_intr_enable(timer_group_t group_num, timer_intr_t intr_mask)`

Enable timer group interrupt, by enable mask.

Return

- `ESP_OK` Success
- `ESP_ERR_INVALID_ARG` Parameter error

Parameters

- `group_num`: Timer group number, 0 for `TIMERG0` or 1 for `TIMERG1`
- `intr_mask`: Timer interrupt enable mask.
 - `TIMER_INTR_T0`: t0 interrupt
 - `TIMER_INTR_T1`: t1 interrupt

- TIMER_INTR_WDT: watchdog interrupt

esp_err_t **timer_group_intr_disable** (*timer_group_t* group_num, *timer_intr_t* intr_mask)

Disable timer group interrupt, by disable mask.

Return

- ESP_OK Success
- ESP_ERR_INVALID_ARG Parameter error

Parameters

- group_num: Timer group number, 0 for TIMERG0 or 1 for TIMERG1
- intr_mask: Timer interrupt disable mask.
 - TIMER_INTR_T0: t0 interrupt
 - TIMER_INTR_T1: t1 interrupt
 - TIMER_INTR_WDT: watchdog interrupt

esp_err_t **timer_enable_intr** (*timer_group_t* group_num, *timer_idx_t* timer_num)

Enable timer interrupt.

Return

- ESP_OK Success
- ESP_ERR_INVALID_ARG Parameter error

Parameters

- group_num: Timer group number, 0 for TIMERG0 or 1 for TIMERG1
- timer_num: Timer index.

esp_err_t **timer_disable_intr** (*timer_group_t* group_num, *timer_idx_t* timer_num)

Disable timer interrupt.

Return

- ESP_OK Success
- ESP_ERR_INVALID_ARG Parameter error

Parameters

- group_num: Timer group number, 0 for TIMERG0 or 1 for TIMERG1
- timer_num: Timer index.

void **timer_group_intr_clr_in_isr** (*timer_group_t* group_num, *timer_idx_t* timer_num)

Clear timer interrupt status, just used in ISR.

Parameters

- group_num: Timer group number, 0 for TIMERG0 or 1 for TIMERG1
- timer_num: Timer index.

void **timer_group_clr_intr_status_in_isr** (*timer_group_t* group_num, *timer_idx_t* timer_num)

Clear timer interrupt status, just used in ISR.

Parameters

- group_num: Timer group number, 0 for TIMERG0 or 1 for TIMERG1
- timer_num: Timer index.

void **timer_group_enable_alarm_in_isr** (*timer_group_t* group_num, *timer_idx_t* timer_num)

Enable alarm interrupt, just used in ISR.

Parameters

- group_num: Timer group number, 0 for TIMERG0 or 1 for TIMERG1
- timer_num: Timer index.

uint64_t **timer_group_get_counter_value_in_isr** (*timer_group_t* group_num, *timer_idx_t* timer_num)

Get the current counter value, just used in ISR.

Return

- Counter value

Parameters

- group_num: Timer group number, 0 for TIMERG0 or 1 for TIMERG1
- timer_num: Timer index.

void **timer_group_set_alarm_value_in_isr** (*timer_group_t* group_num, *timer_idx_t* timer_num, *uint64_t* alarm_val)

Set the alarm threshold for the timer, just used in ISR.

Parameters

- group_num: Timer group number, 0 for TIMERG0 or 1 for TIMERG1
- timer_num: Timer index.
- alarm_val: Alarm threshold.

void **timer_group_set_counter_enable_in_isr** (*timer_group_t* group_num, *timer_idx_t* timer_num, *timer_start_t* counter_en)

Enable/disable a counter, just used in ISR.

Parameters

- group_num: Timer group number, 0 for TIMERG0 or 1 for TIMERG1
- timer_num: Timer index.
- counter_en: Enable/disable.

timer_intr_t **timer_group_intr_get_in_isr** (*timer_group_t* group_num)

Get the masked interrupt status, just used in ISR.

Return

- Interrupt status

Parameters

- group_num: Timer group number, 0 for TIMERG0 or 1 for TIMERG1

uint32_t **timer_group_get_intr_status_in_isr** (*timer_group_t* group_num)

Get interrupt status, just used in ISR.

Return

- Interrupt status

Parameters

- group_num: Timer group number, 0 for TIMERG0 or 1 for TIMERG1

void **timer_group_clr_intr_sta_in_isr** (*timer_group_t* group_num, *timer_intr_t* intr_mask)

Clear the masked interrupt status, just used in ISR.

Parameters

- group_num: Timer group number, 0 for TIMERG0 or 1 for TIMERG1
- intr_mask: Masked interrupt.

bool **timer_group_get_auto_reload_in_isr** (*timer_group_t* group_num, *timer_idx_t* timer_num)

Get auto reload enable status, just used in ISR.

Return

- True Auto reload enabled
- False Auto reload disabled

Parameters

- group_num: Timer group number, 0 for TIMERG0 or 1 for TIMERG1
- timer_num: Timer index

esp_err_t **timer_spinlock_take** (*timer_group_t* group_num)

Take timer spinlock to enter critical protect.

Return

- ESP_OK Success
- ESP_ERR_INVALID_ARG Parameter error

Parameters

- group_num: Timer group number, 0 for TIMERG0 or 1 for TIMERG1

esp_err_t **timer_spinlock_give** (*timer_group_t* group_num)

Give timer spinlock to exit critical protect.

Return

- ESP_OK Success

- `ESP_ERR_INVALID_ARG` Parameter error

Parameters

- `group_num`: Timer group number, 0 for `TIMERG0` or 1 for `TIMERG1`

Macros

`TIMER_BASE_CLK`

Frequency of the clock on the input of the timer groups

Type Definitions

`typedef bool (*timer_isr_t) (void *)`

Interrupt handle callback function. User need to retrun a bool value in callback.

Return

- True Do task yield at the end of ISR
- False Not do task yield at the end of ISR

Note If you called FreeRTOS functions in callback, you need to return true or false based on the retrun value of argument `pxHigherPriorityTaskWoken`. For example, `xQueueSendFromISR` is called in callback, if the return value `pxHigherPriorityTaskWoken` of any FreeRTOS calls is `pdTRUE`, return true; otherwise return false.

`typedef intr_handle_t timer_isr_handle_t`

Interrupt handle, used in order to free the isr after use. Aliases to an int handle for now.

Header File

- [hal/include/hal/timer_types.h](#)

Structures

`struct timer_config_t`

Data structure with timer' s configuration settings.

Public Members

`timer_alarm_t alarm_en`

Timer alarm enable

`timer_start_t counter_en`

Counter enable

`timer_intr_mode_t intr_type`

Interrupt mode

`timer_count_dir_t counter_dir`

Counter direction

`timer_autoreload_t auto_reload`

Timer auto-reload

`uint32_t divider`

Counter clock divider. The divider' s range is from from 2 to 65536.

`timer_src_clk_t clk_src`

Use XTAL as source clock.

Enumerations

`enum timer_group_t`

Selects a Timer-Group out of 2 available groups.

Values:

TIMER_GROUP_0 = 0
Hw timer group 0

TIMER_GROUP_1 = 1
Hw timer group 1

TIMER_GROUP_MAX

enum timer_idx_t
Select a hardware timer from timer groups.

Values:

TIMER_0 = 0
Select timer0 of GROUPx

TIMER_MAX

enum timer_count_dir_t
Decides the direction of counter.

Values:

TIMER_COUNT_DOWN = 0
Descending Count from cnt.hightcnt.low

TIMER_COUNT_UP = 1
Ascending Count from Zero

TIMER_COUNT_MAX

enum timer_start_t
Decides whether timer is on or paused.

Values:

TIMER_PAUSE = 0
Pause timer counter

TIMER_START = 1
Start timer counter

enum timer_intr_t
Interrupt types of the timer.

Values:

TIMER_INTR_T0 = BIT(0)
interrupt of timer 0

TIMER_INTR_WDT = BIT(1)
interrupt of watchdog

TIMER_INTR_NONE = 0

enum timer_alarm_t
Decides whether to enable alarm mode.

Values:

TIMER_ALARM_DIS = 0
Disable timer alarm

TIMER_ALARM_EN = 1
Enable timer alarm

TIMER_ALARM_MAX

enum timer_intr_mode_t
Select interrupt type if running in alarm mode.

Values:

TIMER_INTR_LEVEL = 0

Interrupt mode: level mode

TIMER_INTR_MAX

enum timer_autoreload_t

Select if Alarm needs to be loaded by software or automatically reload by hardware.

Values:

TIMER_AUTORELOAD_DIS = 0

Disable auto-reload: hardware will not load counter value after an alarm event

TIMER_AUTORELOAD_EN = 1

Enable auto-reload: hardware will load counter value after an alarm event

TIMER_AUTORELOAD_MAX

enum timer_src_clk_t

Select timer source clock.

Values:

TIMER_SRC_CLK_APB = 0

Select APB as the source clock

TIMER_SRC_CLK_XTAL = 1

Select XTAL as the source clock

2.3.3 GPIO & RTC GPIO

Overview

The ESP32-C3 chip features 22 physical GPIO pads. Some GPIO pads cannot be used or do not have the corresponding pin on the chip package. For more details, see *ESP32-C3 Technical Reference Manual > IO MUX and GPIO Matrix (GPIO, IO_MUX)* [PDF]. Each pad can be used as a general purpose I/O or can be connected to an internal peripheral signal.

- Note that GPIO12-17 are usually used for SPI flash.
- Note that GPIO 18 and 19 are used by USB-JTAG by default. In order to use them as GPIOs, USB-JTAG will be disabled by the drivers.
- ESP32-C3 doesn't have separate "RTC GPIO" support. However, GPIO0-5 keep the rtc feature, which can be used for power-management and analog subsystem.

Application Example

GPIO output and input interrupt example: [peripherals/gpio/generic_gpio](#).

API Reference - Normal GPIO

Header File

- [driver/include/driver/gpio.h](#)

Functions

esp_err_t **gpio_config** (**const** *gpio_config_t* *pGPIOConfig)

GPIO common configuration.

Configure GPIO's Mode, pull-up, PullDown, IntrType

Return

- ESP_OK success

- ESP_ERR_INVALID_ARG Parameter error

Parameters

- pGPIOConfig: Pointer to GPIO configure struct

esp_err_t gpio_reset_pin (gpio_num_t gpio_num)

Reset an gpio to default state (select gpio function, enable pullup and disable input and output).

Note This function also configures the IOMUX for this pin to the GPIO function, and disconnects any other peripheral output configured via GPIO Matrix.

Return Always return ESP_OK.

Parameters

- gpio_num: GPIO number.

esp_err_t gpio_set_intr_type (gpio_num_t gpio_num, gpio_int_type_t intr_type)

GPIO set interrupt trigger type.

Return

- ESP_OK Success
- ESP_ERR_INVALID_ARG Parameter error

Parameters

- gpio_num: GPIO number. If you want to set the trigger type of e.g. of GPIO16, gpio_num should be GPIO_NUM_16 (16);
- intr_type: Interrupt type, select from gpio_int_type_t

esp_err_t gpio_intr_enable (gpio_num_t gpio_num)

Enable GPIO module interrupt signal.

Note Please do not use the interrupt of GPIO36 and GPIO39 when using ADC or Wi-Fi and Bluetooth with sleep mode enabled. Please refer to the comments of `adc1_get_raw`. Please refer to section 3.11 of ‘ECO_and_Workarounds_for_Bugs_in_ESP32’ for the description of this issue. As a workaround, call `adc_power_acquire()` in the app. This will result in higher power consumption (by ~1mA), but will remove the glitches on GPIO36 and GPIO39.

Return

- ESP_OK Success
- ESP_ERR_INVALID_ARG Parameter error

Parameters

- gpio_num: GPIO number. If you want to enable an interrupt on e.g. GPIO16, gpio_num should be GPIO_NUM_16 (16);

esp_err_t gpio_intr_disable (gpio_num_t gpio_num)

Disable GPIO module interrupt signal.

Return

- ESP_OK success
- ESP_ERR_INVALID_ARG Parameter error

Parameters

- gpio_num: GPIO number. If you want to disable the interrupt of e.g. GPIO16, gpio_num should be GPIO_NUM_16 (16);

esp_err_t gpio_set_level (gpio_num_t gpio_num, uint32_t level)

GPIO set output level.

Return

- ESP_OK Success
- ESP_ERR_INVALID_ARG GPIO number error

Parameters

- gpio_num: GPIO number. If you want to set the output level of e.g. GPIO16, gpio_num should be GPIO_NUM_16 (16);
- level: Output level. 0: low ; 1: high

int gpio_get_level (gpio_num_t gpio_num)

GPIO get input level.

Warning If the pad is not configured for input (or input and output) the returned value is always 0.

Return

- 0 the GPIO input level is 0
- 1 the GPIO input level is 1

Parameters

- `gpio_num`: GPIO number. If you want to get the logic level of e.g. pin GPIO16, `gpio_num` should be `GPIO_NUM_16` (16);

esp_err_t **gpio_set_direction** (*gpio_num_t* `gpio_num`, *gpio_mode_t* `mode`)

GPIO set direction.

Configure GPIO direction, such as `output_only`, `input_only`, `output_and_input`

Return

- `ESP_OK` Success
- `ESP_ERR_INVALID_ARG` GPIO error

Parameters

- `gpio_num`: Configure GPIO pins number, it should be GPIO number. If you want to set direction of e.g. GPIO16, `gpio_num` should be `GPIO_NUM_16` (16);
- `mode`: GPIO direction

esp_err_t **gpio_set_pull_mode** (*gpio_num_t* `gpio_num`, *gpio_pull_mode_t* `pull`)

Configure GPIO pull-up/pull-down resistors.

Only pins that support both input & output have integrated pull-up and pull-down resistors. Input-only GPIOs 34-39 do not.

Return

- `ESP_OK` Success
- `ESP_ERR_INVALID_ARG` : Parameter error

Parameters

- `gpio_num`: GPIO number. If you want to set pull up or down mode for e.g. GPIO16, `gpio_num` should be `GPIO_NUM_16` (16);
- `pull`: GPIO pull up/down mode.

esp_err_t **gpio_wakeup_enable** (*gpio_num_t* `gpio_num`, *gpio_int_type_t* `intr_type`)

Enable GPIO wake-up function.

Return

- `ESP_OK` Success
- `ESP_ERR_INVALID_ARG` Parameter error

Parameters

- `gpio_num`: GPIO number.
- `intr_type`: GPIO wake-up type. Only `GPIO_INTR_LOW_LEVEL` or `GPIO_INTR_HIGH_LEVEL` can be used.

esp_err_t **gpio_wakeup_disable** (*gpio_num_t* `gpio_num`)

Disable GPIO wake-up function.

Return

- `ESP_OK` Success
- `ESP_ERR_INVALID_ARG` Parameter error

Parameters

- `gpio_num`: GPIO number

esp_err_t **gpio_isr_register** (void (*fn)) void *

, void *arg, int intr_alloc_flags, *gpio_isr_handle_t* *handle Register GPIO interrupt handler, the handler is an ISR. The handler will be attached to the same CPU core that this function is running on.

This ISR function is called whenever any GPIO interrupt occurs. See the alternative `gpio_install_isr_service()` and `gpio_isr_handler_add()` API in order to have the driver support per-GPIO ISRs.

To disable or remove the ISR, pass the returned handle to the *interrupt allocation functions*.

Parameters

- `fn`: Interrupt handler function.

- `intr_alloc_flags`: Flags used to allocate the interrupt. One or multiple (ORred) `ESP_INTR_FLAG_*` values. See `esp_intr_alloc.h` for more info.
- `arg`: Parameter for handler function
- `handle`: Pointer to return handle. If non-NULL, a handle for the interrupt will be returned here.

Return

- `ESP_OK` Success ;
- `ESP_ERR_INVALID_ARG` GPIO error
- `ESP_ERR_NOT_FOUND` No free interrupt found with the specified flags

esp_err_t **gpio_pullup_en** (*gpio_num_t* *gpio_num*)

Enable pull-up on GPIO.

Return

- `ESP_OK` Success
- `ESP_ERR_INVALID_ARG` Parameter error

Parameters

- `gpio_num`: GPIO number

esp_err_t **gpio_pullup_dis** (*gpio_num_t* *gpio_num*)

Disable pull-up on GPIO.

Return

- `ESP_OK` Success
- `ESP_ERR_INVALID_ARG` Parameter error

Parameters

- `gpio_num`: GPIO number

esp_err_t **gpio_pulldown_en** (*gpio_num_t* *gpio_num*)

Enable pull-down on GPIO.

Return

- `ESP_OK` Success
- `ESP_ERR_INVALID_ARG` Parameter error

Parameters

- `gpio_num`: GPIO number

esp_err_t **gpio_pulldown_dis** (*gpio_num_t* *gpio_num*)

Disable pull-down on GPIO.

Return

- `ESP_OK` Success
- `ESP_ERR_INVALID_ARG` Parameter error

Parameters

- `gpio_num`: GPIO number

esp_err_t **gpio_install_isr_service** (int *intr_alloc_flags*)

Install the driver's GPIO ISR handler service, which allows per-pin GPIO interrupt handlers.

This function is incompatible with `gpio_isr_register()` - if that function is used, a single global ISR is registered for all GPIO interrupts. If this function is used, the ISR service provides a global GPIO ISR and individual pin handlers are registered via the `gpio_isr_handler_add()` function.

Return

- `ESP_OK` Success
- `ESP_ERR_NO_MEM` No memory to install this service
- `ESP_ERR_INVALID_STATE` ISR service already installed.
- `ESP_ERR_NOT_FOUND` No free interrupt found with the specified flags
- `ESP_ERR_INVALID_ARG` GPIO error

Parameters

- `intr_alloc_flags`: Flags used to allocate the interrupt. One or multiple (ORred) `ESP_INTR_FLAG_*` values. See `esp_intr_alloc.h` for more info.

void **gpio_uninstall_isr_service** (void)

Uninstall the driver's GPIO ISR service, freeing related resources.

esp_err_t **gpio_isr_handler_add** (*gpio_num_t* gpio_num, *gpio_isr_t* isr_handler, void *args)

Add ISR handler for the corresponding GPIO pin.

Call this function after using `gpio_install_isr_service()` to install the driver's GPIO ISR handler service.

The pin ISR handlers no longer need to be declared with `IRAM_ATTR`, unless you pass the `ESP_INTR_FLAG_IRAM` flag when allocating the ISR in `gpio_install_isr_service()`.

This ISR handler will be called from an ISR. So there is a stack size limit (configurable as “ISR stack size” in menuconfig). This limit is smaller compared to a global GPIO interrupt handler due to the additional level of indirection.

Return

- `ESP_OK` Success
- `ESP_ERR_INVALID_STATE` Wrong state, the ISR service has not been initialized.
- `ESP_ERR_INVALID_ARG` Parameter error

Parameters

- `gpio_num`: GPIO number
- `isr_handler`: ISR handler function for the corresponding GPIO number.
- `args`: parameter for ISR handler.

esp_err_t **gpio_isr_handler_remove** (*gpio_num_t* gpio_num)

Remove ISR handler for the corresponding GPIO pin.

Return

- `ESP_OK` Success
- `ESP_ERR_INVALID_STATE` Wrong state, the ISR service has not been initialized.
- `ESP_ERR_INVALID_ARG` Parameter error

Parameters

- `gpio_num`: GPIO number

esp_err_t **gpio_set_drive_capability** (*gpio_num_t* gpio_num, *gpio_drive_cap_t* strength)

Set GPIO pad drive capability.

Return

- `ESP_OK` Success
- `ESP_ERR_INVALID_ARG` Parameter error

Parameters

- `gpio_num`: GPIO number, only support output GPIOs
- `strength`: Drive capability of the pad

esp_err_t **gpio_get_drive_capability** (*gpio_num_t* gpio_num, *gpio_drive_cap_t* *strength)

Get GPIO pad drive capability.

Return

- `ESP_OK` Success
- `ESP_ERR_INVALID_ARG` Parameter error

Parameters

- `gpio_num`: GPIO number, only support output GPIOs
- `strength`: Pointer to accept drive capability of the pad

esp_err_t **gpio_hold_en** (*gpio_num_t* gpio_num)

Enable gpio pad hold function.

The gpio pad hold function works in both input and output modes, but must be output-capable gpios. If pad hold enabled: in output mode: the output level of the pad will be force locked and can not be changed. in input mode: the input value read will not change, regardless the changes of input signal.

The state of digital gpio cannot be held during Deep-sleep, and it will resume the hold function when the chip wakes up from Deep-sleep. If the digital gpio also needs to be held during Deep-sleep, `gpio_deep_sleep_hold_en` should also be called.

Power down or call `gpio_hold_dis` will disable this function.

Return

- `ESP_OK` Success

- ESP_ERR_NOT_SUPPORTED Not support pad hold function

Parameters

- `gpio_num`: GPIO number, only support output-capable GPIOs

esp_err_t **gpio_hold_dis** (*gpio_num_t* *gpio_num*)

Disable gpio pad hold function.

When the chip is woken up from Deep-sleep, the gpio will be set to the default mode, so, the gpio will output the default level if this function is called. If you don't want the level changes, the gpio should be configured to a known state before this function is called. e.g. If you hold gpio18 high during Deep-sleep, after the chip is woken up and `gpio_hold_dis` is called, gpio18 will output low level (because gpio18 is input mode by default). If you don't want this behavior, you should configure gpio18 as output mode and set it to high level before calling `gpio_hold_dis`.

Return

- ESP_OK Success
- ESP_ERR_NOT_SUPPORTED Not support pad hold function

Parameters

- `gpio_num`: GPIO number, only support output-capable GPIOs

void **gpio_deep_sleep_hold_en** (void)

Enable all digital gpio pad hold function during Deep-sleep.

When the chip is in Deep-sleep mode, all digital gpio will hold the state before sleep, and when the chip is woken up, the status of digital gpio will not be held. Note that the pad hold feature only works when the chip is in Deep-sleep mode, when not in sleep mode, the digital gpio state can be changed even you have called this function.

Power down or call `gpio_hold_dis` will disable this function, otherwise, the digital gpio hold feature works as long as the chip enter Deep-sleep.

void **gpio_deep_sleep_hold_dis** (void)

Disable all digital gpio pad hold function during Deep-sleep.

void **gpio_iomux_in** (uint32_t *gpio_num*, uint32_t *signal_idx*)

Set pad input to a peripheral signal through the IOMUX.

Parameters

- `gpio_num`: GPIO number of the pad.
- `signal_idx`: Peripheral signal id to input. One of the *_IN_IDX signals in `soc/gpio_sig_map.h`.

void **gpio_iomux_out** (uint8_t *gpio_num*, int *func*, bool *oen_inv*)

Set peripheral output to an GPIO pad through the IOMUX.

Parameters

- `gpio_num`: `gpio_num` GPIO number of the pad.
- `func`: The function number of the peripheral pin to output pin. One of the FUNC_X_* of specified pin (X) in `soc/io_mux_reg.h`.
- `oen_inv`: True if the output enable needs to be inverted, otherwise False.

esp_err_t **gpio_force_hold_all** (void)

Force hold digital and rtc gpio pad.

Note GPIO force hold, whether the chip in sleep mode or wakeup mode.

esp_err_t **gpio_force_unhold_all** (void)

Force unhold digital and rtc gpio pad.

Note GPIO force unhold, whether the chip in sleep mode or wakeup mode.

esp_err_t **gpio_sleep_sel_en** (*gpio_num_t* *gpio_num*)

Enable SLP_SEL to change GPIO status automatically in lightsleep.

Return

- ESP_OK Success

Parameters

- `gpio_num`: GPIO number of the pad.

esp_err_t `gpio_sleep_sel_dis` (*gpio_num_t* `gpio_num`)

Disable SLP_SEL to change GPIO status automatically in lightsleep.

Return

- ESP_OK Success

Parameters

- `gpio_num`: GPIO number of the pad.

esp_err_t `gpio_sleep_set_direction` (*gpio_num_t* `gpio_num`, *gpio_mode_t* `mode`)

GPIO set direction at sleep.

Configure GPIO direction, such as output_only, input_only, output_and_input

Return

- ESP_OK Success
- ESP_ERR_INVALID_ARG GPIO error

Parameters

- `gpio_num`: Configure GPIO pins number, it should be GPIO number. If you want to set direction of e.g. GPIO16, `gpio_num` should be GPIO_NUM_16 (16);
- `mode`: GPIO direction

esp_err_t `gpio_sleep_set_pull_mode` (*gpio_num_t* `gpio_num`, *gpio_pull_mode_t* `pull`)

Configure GPIO pull-up/pull-down resistors at sleep.

Only pins that support both input & output have integrated pull-up and pull-down resistors. Input-only GPIOs 34-39 do not.

Return

- ESP_OK Success
- ESP_ERR_INVALID_ARG : Parameter error

Parameters

- `gpio_num`: GPIO number. If you want to set pull up or down mode for e.g. GPIO16, `gpio_num` should be GPIO_NUM_16 (16);
- `pull`: GPIO pull up/down mode.

esp_err_t `gpio_deep_sleep_wakeup_enable` (*gpio_num_t* `gpio_num`, *gpio_int_type_t* `intr_type`)

Enable GPIO deep-sleep wake-up function.

Note Called by the SDK. User shouldn't call this directly in the APP.

Return

- ESP_OK Success
- ESP_ERR_INVALID_ARG Parameter error

Parameters

- `gpio_num`: GPIO number.
- `intr_type`: GPIO wake-up type. Only GPIO_INTR_LOW_LEVEL or GPIO_INTR_HIGH_LEVEL can be used.

esp_err_t `gpio_deep_sleep_wakeup_disable` (*gpio_num_t* `gpio_num`)

Disable GPIO deep-sleep wake-up function.

Return

- ESP_OK Success
- ESP_ERR_INVALID_ARG Parameter error

Parameters

- `gpio_num`: GPIO number

Macros

`GPIO_PIN_COUNT`

`GPIO_IS_VALID_GPIO` (`gpio_num`)

Check whether it is a valid GPIO number.

GPIO_IS_VALID_OUTPUT_GPIO (gpio_num)

Check whether it can be a valid GPIO number of output mode.

GPIO_IS_DEEP_SLEEP_WAKEUP_VALID_GPIO (gpio_num)

Type Definitions

```
typedef intr_handle_t gpio_isr_handle_t
```

Header File

- [hal/include/hal/gpio_types.h](#)

Structures

struct gpio_config_t

Configuration parameters of GPIO pad for gpio_config function.

Public Members

uint64_t **pin_bit_mask**

GPIO pin: set with bit mask, each bit maps to a GPIO

gpio_mode_t **mode**

GPIO mode: set input/output mode

gpio_pullup_t **pull_up_en**

GPIO pull-up

gpio_pulldown_t **pull_down_en**

GPIO pull-down

gpio_int_type_t **intr_type**

GPIO interrupt type

Macros

GPIO_SEL_0

Pin 0 selected

GPIO_SEL_1

Pin 1 selected

GPIO_SEL_2

Pin 2 selected

GPIO_SEL_3

Pin 3 selected

GPIO_SEL_4

Pin 4 selected

GPIO_SEL_5

Pin 5 selected

GPIO_SEL_6

Pin 6 selected

GPIO_SEL_7

Pin 7 selected

GPIO_SEL_8

Pin 8 selected

GPIO_SEL_9

Pin 9 selected

GPIO_SEL_10
Pin 10 selected

GPIO_SEL_11
Pin 11 selected

GPIO_SEL_12
Pin 12 selected

GPIO_SEL_13
Pin 13 selected

GPIO_SEL_14
Pin 14 selected

GPIO_SEL_15
Pin 15 selected

GPIO_SEL_16
Pin 16 selected

GPIO_SEL_17
Pin 17 selected

GPIO_SEL_18
Pin 18 selected

GPIO_SEL_19
Pin 19 selected

GPIO_SEL_20
Pin 20 selected

GPIO_SEL_21
Pin 21 selected

GPIO_SEL_26
Pin 26 selected

GPIO_SEL_27
Pin 27 selected

GPIO_SEL_28
Pin 28 selected

GPIO_SEL_29
Pin 29 selected

GPIO_SEL_30
Pin 30 selected

GPIO_SEL_31
Pin 31 selected

GPIO_SEL_32
Pin 32 selected

GPIO_SEL_33
Pin 33 selected

GPIO_SEL_34
Pin 34 selected

GPIO_SEL_35
Pin 35 selected

GPIO_SEL_36
Pin 36 selected

GPIO_SEL_37
Pin 37 selected

GPIO_SEL_38
Pin 38 selected

GPIO_SEL_39
Pin 39 selected

GPIO_PIN_REG_0

GPIO_PIN_REG_1

GPIO_PIN_REG_2

GPIO_PIN_REG_3

GPIO_PIN_REG_4

GPIO_PIN_REG_5

GPIO_PIN_REG_6

GPIO_PIN_REG_7

GPIO_PIN_REG_8

GPIO_PIN_REG_9

GPIO_PIN_REG_10

GPIO_PIN_REG_11

GPIO_PIN_REG_12

GPIO_PIN_REG_13

GPIO_PIN_REG_14

GPIO_PIN_REG_15

GPIO_PIN_REG_16

GPIO_PIN_REG_17

GPIO_PIN_REG_18

GPIO_PIN_REG_19

GPIO_PIN_REG_20

GPIO_PIN_REG_21

GPIO_PIN_REG_22

GPIO_PIN_REG_23

GPIO_PIN_REG_24

GPIO_PIN_REG_25

GPIO_PIN_REG_26

GPIO_PIN_REG_27

GPIO_PIN_REG_28

GPIO_PIN_REG_29

GPIO_PIN_REG_30

GPIO_PIN_REG_31

GPIO_PIN_REG_32

GPIO_PIN_REG_33

GPIO_PIN_REG_34
GPIO_PIN_REG_35
GPIO_PIN_REG_36
GPIO_PIN_REG_37
GPIO_PIN_REG_38
GPIO_PIN_REG_39
GPIO_PIN_REG_40
GPIO_PIN_REG_41
GPIO_PIN_REG_42
GPIO_PIN_REG_43
GPIO_PIN_REG_44
GPIO_PIN_REG_45
GPIO_PIN_REG_46

Type Definitions

typedef void (***gpio_isr_t**) (void *)

Enumerations

enum **gpio_port_t**

Values:

GPIO_PORT_0 = 0

GPIO_PORT_MAX

enum **gpio_num_t**

Values:

GPIO_NUM_NC = -1

Use to signal not connected to S/W

GPIO_NUM_0 = 0

GPIO0, input and output

GPIO_NUM_1 = 1

GPIO1, input and output

GPIO_NUM_2 = 2

GPIO2, input and output

GPIO_NUM_3 = 3

GPIO3, input and output

GPIO_NUM_4 = 4

GPIO4, input and output

GPIO_NUM_5 = 5

GPIO5, input and output

GPIO_NUM_6 = 6

GPIO6, input and output

GPIO_NUM_7 = 7

GPIO7, input and output

GPIO_NUM_8 = 8

GPIO8, input and output

GPIO_NUM_9 = 9
GPIO9, input and output

GPIO_NUM_10 = 10
GPIO10, input and output

GPIO_NUM_11 = 11
GPIO11, input and output

GPIO_NUM_12 = 12
GPIO12, input and output

GPIO_NUM_13 = 13
GPIO13, input and output

GPIO_NUM_14 = 14
GPIO14, input and output

GPIO_NUM_15 = 15
GPIO15, input and output

GPIO_NUM_16 = 16
GPIO16, input and output

GPIO_NUM_17 = 17
GPIO17, input and output

GPIO_NUM_18 = 18
GPIO18, input and output

GPIO_NUM_19 = 19
GPIO19, input and output

GPIO_NUM_20 = 20
GPIO20, input and output

GPIO_NUM_21 = 21
GPIO21, input and output

GPIO_NUM_MAX

enum gpio_int_type_t

Values:

GPIO_INTR_DISABLE = 0
Disable GPIO interrupt

GPIO_INTR_POSEDGE = 1
GPIO interrupt type : rising edge

GPIO_INTR_NEGEDGE = 2
GPIO interrupt type : falling edge

GPIO_INTR_ANYEDGE = 3
GPIO interrupt type : both rising and falling edge

GPIO_INTR_LOW_LEVEL = 4
GPIO interrupt type : input low level trigger

GPIO_INTR_HIGH_LEVEL = 5
GPIO interrupt type : input high level trigger

GPIO_INTR_MAX

enum gpio_mode_t

Values:

GPIO_MODE_DISABLE = GPIO_MODE_DEF_DISABLE
GPIO mode : disable input and output

GPIO_MODE_INPUT = GPIO_MODE_DEF_INPUT

GPIO mode : input only

GPIO_MODE_OUTPUT = GPIO_MODE_DEF_OUTPUT

GPIO mode : output only mode

GPIO_MODE_OUTPUT_OD = ((GPIO_MODE_DEF_OUTPUT) | (GPIO_MODE_DEF_OD))

GPIO mode : output only with open-drain mode

GPIO_MODE_INPUT_OUTPUT_OD = ((GPIO_MODE_DEF_INPUT) | (GPIO_MODE_DEF_OUTPUT) | (GPIO_MODE_DEF_OD))

GPIO mode : output and input with open-drain mode

GPIO_MODE_INPUT_OUTPUT = ((GPIO_MODE_DEF_INPUT) | (GPIO_MODE_DEF_OUTPUT))

GPIO mode : output and input mode

enum gpio_pullup_t

Values:

GPIO_PULLUP_DISABLE = 0x0

Disable GPIO pull-up resistor

GPIO_PULLUP_ENABLE = 0x1

Enable GPIO pull-up resistor

enum gpio_pulldown_t

Values:

GPIO_PULLDOWN_DISABLE = 0x0

Disable GPIO pull-down resistor

GPIO_PULLDOWN_ENABLE = 0x1

Enable GPIO pull-down resistor

enum gpio_pull_mode_t

Values:

GPIO_PULLUP_ONLY

Pad pull up

GPIO_PULLDOWN_ONLY

Pad pull down

GPIO_PULLUP_PULLDOWN

Pad pull up + pull down

GPIO_FLOATING

Pad floating

enum gpio_drive_cap_t

Values:

GPIO_DRIVE_CAP_0 = 0

Pad drive capability: weak

GPIO_DRIVE_CAP_1 = 1

Pad drive capability: stronger

GPIO_DRIVE_CAP_2 = 2

Pad drive capability: medium

GPIO_DRIVE_CAP_DEFAULT = 2

Pad drive capability: medium

GPIO_DRIVE_CAP_3 = 3

Pad drive capability: strongest

GPIO_DRIVE_CAP_MAX

2.3.4 HMAC

The HMAC (Hash-based Message Authentication Code) module provides hardware acceleration for SHA256-HMAC generation using a key burned into an eFuse block. HMACs work with pre-shared secret keys and provide authenticity and integrity to a message.

For more detailed information on the application workflow and the HMAC calculation process, see *ESP32-C3 Technical Reference Manual > HMAC Accelerator (HMAC)* [PDF].

Generalized Application Scheme

Let there be two parties, A and B. They want to verify the authenticity and integrity of messages sent between each other. Before they can start sending messages, they need to exchange the secret key via a secure channel. To verify A's messages, B can do the following:

- A calculates the HMAC of the message it wants to send.
- A sends the message and the HMAC to B.
- B calculates HMAC of the received message itself.
- B checks whether the received and calculated HMACs match. If they do match, the message is authentic.

However, the HMAC itself isn't bound to this use case. It can also be used for challenge-response protocols supporting HMAC or as a key input for further security modules (see below), etc.

HMAC on the ESP32-C3

On the ESP32-C3, the HMAC module works with a secret key burnt into the eFuses. This eFuse key can be made completely inaccessible for any resources outside the cryptographic modules, thus avoiding key leakage.

Furthermore, the ESP32-C3 has three different application scenarios for its HMAC module:

1. HMAC is generated for software use
2. HMAC is used as a key for the Digital Signature (DS) module
3. HMAC is used for enabling the soft-disabled JTAG interface

The first mode is also called *Upstream* mode, while the last two modes are also called *Downstream* modes.

eFuse Keys for HMAC Six physical eFuse blocks can be used as keys for the HMAC module: block 4 up to block 9. The enum `hmac_key_id_t` in the API maps them to `HMAC_KEY0` ... `HMAC_KEY5`. Each key has a corresponding eFuse parameter `key_purpose` determining for which of the three HMAC application scenarios (see below) the key may be used:

Key Purpose	Application Scenario
8	HMAC generated for software use
7	HMAC used as a key for the Digital Signature (DS) module
6	HMAC used for enabling the soft-disabled JTAG interface
5	HMAC both as a key for the DS module and for enabling JTAG

This is to prevent the usage of a key for a different function than originally intended.

To calculate an HMAC, the software has to provide the ID of the key block containing the secret key as well as the `key_purpose` (see *ESP32-C3 Technical Reference Manual > eFuse Controller (eFuse)* [PDF]). Before the HMAC key calculation, the HMAC module looks up the purpose of the provided key block. The calculation only proceeds if the provided key purpose matches the purpose stored in the eFuses of the key block provided by the ID.

HMAC Generation for Software Key Purpose value: 8

In this case, the HMAC is given out to the software (e.g. to authenticate a message).

The API to calculate the HMAC is `esp_hmac_calculate()`. Only the message, message length and the eFuse key block ID have to be provided to that function. The rest, like setting the key purpose, is done automatically.

HMAC for Digital Signature Key Purpose values: 7, 5

The HMAC can be used as a key derivation function to decrypt private key parameters which are used by the Digital Signature module. A standard message is used by the hardware in that case. The user only needs to provide the eFuse key block and purpose on the HMAC side (additional parameters are required for the Digital Signature component in that case). Neither the key nor the actual HMAC are ever exposed to outside the HMAC module and DS component. The calculation of the HMAC and its hand-over to the DS component happen internally.

For more details, see *ESP32-C3 Technical Reference Manual > Digital Signature (DS)* [PDF].

HMAC for Enabling JTAG Key Purpose values: 6, 5

The third application is using the HMAC as a key to enable JTAG if it was soft-disabled before. Following is the procedure to re-enable the JTAG

Setup

1. Generate a 256-bit HMAC secret key to use for JTAG re-enable.
2. Write the key to an eFuse block with key purpose `HMAC_DOWN_ALL` (5) or `HMAC_DOWN_JTAG` (6). This can be done using the `ets_efuse_write_key()` function in the firmware or using `espefuse.py` from the host.
3. Configure the eFuse key block to be read protected using the `esp_efuse_set_read_protect()`, so that software cannot read back the value.
4. Burn the “soft JTAG disable” bit by `esp_efuse_write_field_bit(ESP_EFUSE_SOFT_DIS_JTAG)`. This will permanently disable JTAG unless the correct key value is provided by software.

JTAG enable

1. The key to re-enable JTAG is the output of the HMAC-SHA256 function using the secret key in eFuse and 32 0x00 bytes as the message.
2. Pass this key value when calling the `esp_hmac_jtag_enable()` function from the firmware.
3. To re-disable JTAG in the firmware, reset the system or call `esp_hmac_jtag_disable()`.

For more details, see *ESP32-C3 Technical Reference Manual > HMAC Accelerator (HMAC)* [PDF].

Application Outline

Following code is an outline of how to set an eFuse key and then use it to calculate an HMAC for software usage. We use `ets_efuse_write_key` to set physical key block 4 in the eFuse for the HMAC module together with its purpose. `ETS_EFUSE_KEY_PURPOSE_HMAC_UP` (8) means that this key can only be used for HMAC generation for software usage:

```
#include "esp32c3/rom/efuse.h"

const uint8_t key_data[32] = { ... };

int ets_status = ets_efuse_write_key(ETS_EFUSE_BLOCK_KEY4,
    ETS_EFUSE_KEY_PURPOSE_HMAC_UP,
    key_data, sizeof(key_data));

if (ets_status == ESP_OK) {
    // written key
} else {
    // writing key failed, maybe written already
}
```

Now we can use the saved key to calculate an HMAC for software usage.

```

#include "esp_hmac.h"

uint8_t hmac[32];

const char *message = "Hello, HMAC!";
const size_t msg_len = 12;

esp_err_t result = esp_hmac_calculate(HMAC_KEY4, message, msg_len, hmac);

if (result == ESP_OK) {
    // HMAC written to hmac now
} else {
    // failure calculating HMAC
}

```

API Reference

Header File

- [esp32c3/include/esp_hmac.h](#)

Functions

esp_err_t esp_hmac_calculate (*hmac_key_id_t* key_id, **const** void *message, size_t message_len, uint8_t *hmac)

Calculate the HMAC of a given message.

Calculate the HMAC hmac of a given message message with length message_len. SHA256 is used for the calculation (fixed on ESP32S2).

Note Uses the HMAC peripheral in “upstream” mode.

Return

- ESP_OK, if the calculation was successful,
- ESP_FAIL, if the hmac calculation failed

Parameters

- key_id: Determines which of the 6 key blocks in the efuses should be used for the HMAC calculation. The corresponding purpose field of the key block in the efuse must be set to the HMAC upstream purpose value.
- message: the message for which to calculate the HMAC
- message_len: message length return ESP_ERR_INVALID_STATE if unsuccessful
- [out] hmac: the hmac result; the buffer behind the provided pointer must be 32 bytes long

esp_err_t esp_hmac_jtag_enable (*hmac_key_id_t* key_id, **const** uint8_t *token)

Use HMAC peripheral in Downstream mode to re-enable the JTAG, if it is not permanently disabled by HW. In downstream mode, HMAC calculations performed by peripheral are used internally and not provided back to user.

Return

- ESP_OK, if the calculation was successful, if the calculated HMAC value matches with provided token, JTAG will be re-enable otherwise JTAG will remain disabled. Return value does not indicate the JTAG status.
- ESP_FAIL, if the hmac calculation failed or JTAG is permanently disabled by EFUSE_HARD_DIS_JTAG eFuse parameter.
- ESP_ERR_INVALID_ARG, invalid input arguments

Parameters

- key_id: Determines which of the 6 key blocks in the efuses should be used for the HMAC calculation. The corresponding purpose field of the key block in the efuse must be set to HMAC downstream purpose.
- token: Pre calculated HMAC value of the 32-byte 0x00 using SHA-256 and the known private HMAC key. The key is already programmed to a eFuse key block. The key block number is provided as the first parameter to this function.

`esp_err_t esp_hmac_jtag_disable` (void)

Disable the JTAG which might be enabled using the HMAC downstream mode. This function just clears the result generated by calling `esp_hmac_jtag_enable`() API.

Return

- ESP_OK return ESP_OK after writing the HMAC_SET_INVALIDATE_JTAG_REG with value 1.

Enumerations

`enum hmac_key_id_t`

The possible efuse keys for the HMAC peripheral

Values:

`HMAC_KEY0 = 0`

`HMAC_KEY1`

`HMAC_KEY2`

`HMAC_KEY3`

`HMAC_KEY4`

`HMAC_KEY5`

`HMAC_KEY_MAX`

2.3.5 Digital Signature

The Digital Signature (DS) module provides hardware acceleration of signing messages based on RSA. It uses pre-encrypted parameters to calculate a signature. The parameters are encrypted using HMAC as a key-derivation function. In turn, the HMAC uses eFuses as input key. The whole process happens in hardware so that neither the decryption key for the RSA parameters nor the input key for the HMAC key derivation function can be seen by the software while calculating the signature.

For more detailed information on the hardware involved in signature calculation and the registers used, see *ESP32-C3 Technical Reference Manual > Digital Signature (DS)* [PDF].

Private Key Parameters

The private key parameters for the RSA signature are stored in flash. To prevent unauthorized access, they are AES-encrypted. The HMAC module is used as a key-derivation function to calculate the AES encryption key for the private key parameters. In turn, the HMAC module uses a key from the eFuses key block which can be read-protected to prevent unauthorized access as well.

Upon signature calculation invocation, the software only specifies which eFuse key to use, the corresponding eFuse key purpose, the location of the encrypted RSA parameters and the message.

Key Generation

Both the HMAC key and the RSA private key have to be created and stored before the DS peripheral can be used. This needs to be done in software on the ESP32-C3 or alternatively on a host. For this context, the IDF provides `esp_efuse_write_block()` to set the HMAC key and `esp_hmac_calculate()` to encrypt the private RSA key parameters.

You can find instructions on how to calculate and assemble the private key parameters in *ESP32-C3 Technical Reference Manual > Digital Signature (DS)* [PDF].

Signature Calculation with IDF

For more detailed information on the workflow and the registers used, see *ESP32-C3 Technical Reference Manual > Digital Signature (DS)* [PDF].

Three parameters need to be prepared to calculate the digital signature:

1. the eFuse key block ID which is used as key for the HMAC,
2. the location of the encrypted private key parameters,
3. and the message to be signed.

Since the signature calculation takes some time, there are two possible API versions to use in IDF. The first one is `esp_ds_sign()` and simply blocks until the calculation is finished. If software needs to do something else during the calculation, `esp_ds_start_sign()` can be called, followed by periodic calls to `esp_ds_is_busy()` to check when the calculation has finished. Once the calculation has finished, `esp_ds_finish_sign()` can be called to get the resulting signature.

Note: Note that this is only the basic DS building block, the message length is fixed. To create signatures of arbitrary messages, the input is normally a hash of the actual message, padded up to the required length. An API to do this is planned in the future.

Configure the DS peripheral for a TLS connection

The DS peripheral on ESP32-C3 chip must be configured before it can be used for a TLS connection. The configuration involves the following steps -

- 1) Randomly generate a 256 bit value called the *Initialization Vector (IV)*.
- 2) Randomly generate a 256 bit value called the *HMAC_KEY*.
- 3) Calculate the encrypted private key parameters from the client private key (RSA) and the parameters generated in the above steps.
- 4) Then burn the 256 bit *HMAC_KEY* on the efuse, which can only be read by the DS peripheral.

For more details, see *ESP32-C3 Technical Reference Manual > Digital Signature (DS)* [PDF].

To configure the DS peripheral for development purposes, you can use the python script `configure_ds.py`. More details about the `configure_ds.py` script can be found at [mqtt example README](#).

The encrypted private key parameters obtained after the DS peripheral configuration are then to be kept in flash. Furthermore, they are to be passed to the DS peripheral which makes use of those parameters for the Digital Signature operation. *Non Volatile Storage* can be used to store the encrypted private key parameters in flash. The script `configure_ds.py` creates an NVS partition for the encrypted private key parameters. Then the script flashes this partition onto the ESP32-C3. The application then needs to read the DS data from NVS, which can be done with the function `esp_read_ds_data_from_nvs` in file `ssl_mutual_auth/main/app_main.c`

The process of initializing the DS peripheral and then performing the Digital Signature operation is done internally with help of *ESP-TLS*. Please refer to *Digital Signature with ESP-TLS* in *ESP-TLS* for more details. As mentioned in the *ESP-TLS* documentation, the application only needs to provide the encrypted private key parameters to the `esp_tls` context (as `ds_data`), which internally performs all necessary operations for initializing the DS peripheral and then performing the DS operation.

Example for SSL Mutual Authentication using DS

The example `ssl_ds` shows how to use the DS peripheral for mutual authentication. The example uses `mqtt_client` (Implemented through *ESP-MQTT*) to connect to broker `test.mosquitto.org` using `ssl` transport with mutual authentication. The `ssl` part is internally performed with *ESP-TLS*. See [example README](#) for more details.

API Reference

Header File

- `esp32s2/include/esp_ds.h`

Functions

`esp_err_t esp_ds_sign(const void *message, const esp_ds_data_t *data, hmac_key_id_t key_id, void *signature)`

Sign the message.

This function is a wrapper around `esp_ds_finish_sign()` and `esp_ds_start_sign()`, so do not use them in parallel. It blocks until the signing is finished and then returns the signature.

Note This function locks the HMAC, SHA, AES and RSA components during its entire execution time.

Return

- `ESP_OK` if successful, the signature was written to the parameter `signature`.
- `ESP_ERR_INVALID_ARG` if one of the parameters is `NULL` or `data->rsa_length` is too long or 0
- `ESP_ERR_HW_CRYPTODS_HMAC_FAIL` if there was an HMAC failure during retrieval of the decryption key
- `ESP_ERR_NO_MEM` if there hasn't been enough memory to allocate the context object
- `ESP_ERR_HW_CRYPTODS_INVALID_KEY` if there's a problem with passing the HMAC key to the DS component
- `ESP_ERR_HW_CRYPTODS_INVALID_DIGEST` if the message digest didn't match; the signature is invalid.
- `ESP_ERR_HW_CRYPTODS_INVALID_PADDING` if the message padding is incorrect, the signature can be read though since the message digest matches.

Parameters

- `message`: the message to be signed; its length is determined by `data->rsa_length`
- `data`: the encrypted signing key data (AES encrypted RSA key + IV)
- `key_id`: the HMAC key ID determining the HMAC key of the HMAC which will be used to decrypt the signing key data
- `signature`: the destination of the signature, should be $(data->rsa_length + 1) * 4$ bytes long

`esp_err_t esp_ds_start_sign(const void *message, const esp_ds_data_t *data, hmac_key_id_t key_id, esp_ds_context_t **esp_ds_ctx)`

Start the signing process.

This function yields a context object which needs to be passed to `esp_ds_finish_sign()` to finish the signing process.

Note This function locks the HMAC, SHA, AES and RSA components, so the user has to ensure to call `esp_ds_finish_sign()` in a timely manner.

Return

- `ESP_OK` if successful, the ds operation was started now and has to be finished with `esp_ds_finish_sign()`
- `ESP_ERR_INVALID_ARG` if one of the parameters is `NULL` or `data->rsa_length` is too long or 0
- `ESP_ERR_HW_CRYPTODS_HMAC_FAIL` if there was an HMAC failure during retrieval of the decryption key
- `ESP_ERR_NO_MEM` if there hasn't been enough memory to allocate the context object
- `ESP_ERR_HW_CRYPTODS_INVALID_KEY` if there's a problem with passing the HMAC key to the DS component

Parameters

- `message`: the message to be signed; its length is determined by `data->rsa_length`
- `data`: the encrypted signing key data (AES encrypted RSA key + IV)
- `key_id`: the HMAC key ID determining the HMAC key of the HMAC which will be used to decrypt the signing key data
- `esp_ds_ctx`: the context object which is needed for finishing the signing process later

bool `esp_ds_is_busy`(void)

Return true if the DS peripheral is busy, otherwise false.

Note Only valid if `esp_ds_start_sign()` was called before.

esp_err_t **esp_ds_finish_sign** (void *signature, *esp_ds_context_t* *esp_ds_ctx)

Finish the signing process.

Return

- ESP_OK if successful, the ds operation has been finished and the result is written to signature.
- ESP_ERR_INVALID_ARG if one of the parameters is NULL
- ESP_ERR_HW_CRYPTODS_INVALID_DIGEST if the message digest didn't match; the signature is invalid.
- ESP_ERR_HW_CRYPTODS_INVALID_PADDING if the message padding is incorrect, the signature can be read though since the message digest matches.

Parameters

- signature: the destination of the signature, should be $(data->rsa_length + 1) * 4$ bytes long
- esp_ds_ctx: the context object retrieved by `esp_ds_start_sign()`

esp_err_t **esp_ds_encrypt_params** (*esp_ds_data_t* *data, const void *iv, const *esp_ds_p_data_t* *p_data, const void *key)

Encrypt the private key parameters.

Return

- ESP_OK if successful, the ds operation has been finished and the result is written to signature.
- ESP_ERR_INVALID_ARG if one of the parameters is NULL or `p_data->rsa_length` is too long

Parameters

- data: Output buffer to store encrypted data, suitable for later use generating signatures. The allocated memory must be in internal memory and word aligned since it's filled by DMA. Both is asserted at run time.
- iv: Pointer to 16 byte IV buffer, will be copied into 'data'. Should be randomly generated bytes each time.
- p_data: Pointer to input plaintext key data. The expectation is this data will be deleted after this process is done and 'data' is stored.
- key: Pointer to 32 bytes of key data. Type determined by `key_type` parameter. The expectation is the corresponding HMAC key will be stored to efuse and then permanently erased.

Structures

struct **esp_digital_signature_data**

Encrypted private key data. Recommended to store in flash in this format.

Note This struct has to match to one from the ROM code! This documentation is mostly taken from there.

Public Members

esp_digital_signature_length_t **rsa_length**

RSA LENGTH register parameters (number of words in RSA key & operands, minus one).

Max value 127 (for RSA 4096).

This value must match the length field encrypted and stored in 'c', or invalid results will be returned. (The DS peripheral will always use the value in 'c', not this value, so an attacker can't alter the DS peripheral results this way, it will just truncate or extend the message and the resulting signature in software.)

Note In IDF, the enum type `length` is the same as of type `unsigned`, so they can be used interchangeably. See the ROM code for the original declaration of `struct ets_ds_data_t`.

`uint8_t` **iv**[ESP_DS_IV_LEN]

IV value used to encrypt 'c'

`uint8_t` **c**[ESP_DS_C_LEN]

Encrypted Digital Signature parameters. Result of AES-CBC encryption of plaintext values. Includes an encrypted message digest.

struct esp_ds_p_data_t

Plaintext parameters used by Digital Signature.

Not used for signing with DS peripheral, but can be encrypted in-device by calling `esp_ds_encrypt_params()`

Note This documentation is mostly taken from the ROM code.

Public Members

uint32_t **Y**[4096 / 32]

RSA exponent.

uint32_t **M**[4096 / 32]

RSA modulus.

uint32_t **Rb**[4096 / 32]

RSA r inverse operand.

uint32_t **M_prime**

RSA M prime operand.

esp_digital_signature_length_t **length**

RSA length.

Macros

ESP_ERR_HW_CRYPTODS_HMAC_FAIL

HMAC peripheral problem

ESP_ERR_HW_CRYPTODS_INVALID_KEY

given HMAC key isn't correct, HMAC peripheral problem

ESP_ERR_HW_CRYPTODS_INVALID_DIGEST

message digest check failed, result is invalid

ESP_ERR_HW_CRYPTODS_INVALID_PADDING

padding check failed, but result is produced anyway and can be read

ESP_DS_IV_LEN

ESP_DS_C_LEN

Type Definitions

typedef struct esp_ds_context esp_ds_context_t

typedef struct esp_digital_signature_data esp_ds_data_t

Encrypted private key data. Recommended to store in flash in this format.

Note This struct has to match to one from the ROM code! This documentation is mostly taken from there.

Enumerations

enum esp_digital_signature_length_t

Values:

ESP_DS_RSA_1024 = (1024 / 32) - 1

ESP_DS_RSA_2048 = (2048 / 32) - 1

ESP_DS_RSA_3072 = (3072 / 32) - 1

ESP_DS_RSA_4096 = (4096 / 32) - 1

2.3.6 I2C Driver

Warning: This document is not updated for ESP32-C3 yet.

Overview

I2C is a serial, synchronous, half-duplex communication protocol that allows co-existence of multiple masters and slaves on the same bus. The I2C bus consists of two lines: serial data line (SDA) and serial clock (SCL). Both lines require pull-up resistors.

With such advantages as simplicity and low manufacturing cost, I2C is mostly used for communication of low-speed peripheral devices over short distances (within one foot).

ESP32-C3 has only one I2C controller (also referred to as port) which is responsible for handling communications on I2C bus. The I2C controller can operate as master or slave.

Driver Features

I2C driver governs communications of devices over the I2C bus. The driver supports the following features:

- Reading and writing bytes in Master mode
- Slave mode
- Reading and writing to registers which are in turn read/written by the master

Driver Usage

The following sections describe typical steps of configuring and operating the I2C driver:

1. *Configuration* - set the initialization parameters (master or slave mode, GPIO pins for SDA and SCL, clock speed, etc.)
2. *Install Driver*- activate the driver on one of the two I2C controllers as a master or slave
3. Depending on whether you configure the driver for a master or slave, choose the appropriate item
 - a) *Communication as Master* - handle communications (master)
 - b) *Communication as Slave* - respond to messages from the master (slave)
4. *Interrupt Handling* - configure and service I2C interrupts
5. *Customized Configuration* - adjust default I2C communication parameters (timings, bit order, etc.)
6. *Error Handling* - how to recognize and handle driver configuration and communication errors
7. *Delete Driver*- release resources used by the I2C driver when communication ends

Configuration To establish I2C communication, start by configuring the driver. This is done by setting the parameters of the structure `i2c_config_t`:

- Set I2C **mode of operation** - slave or master from `i2c_mode_t`
- Configure **communication pins**
 - Assign GPIO pins for SDA and SCL signals
 - Set whether to enable ESP32-C3's internal pull-ups
- (Master only) Set I2C **clock speed**
- (Slave only) Configure the following
 - Whether to enable **10 bit address mode**
 - Define **slave address**

After that, initialize the configuration for a given I2C port. For this, call the function `i2c_param_config()` and pass to it the port number and the structure `i2c_config_t`.

Configuration example (master):

```

int i2c_master_port = 0;
i2c_config_t conf = {
    .mode = I2C_MODE_MASTER,
    .sda_io_num = I2C_MASTER_SDA_IO,           // select GPIO specific to your_
↪project
    .sda_pullup_en = GPIO_PULLUP_ENABLE,
    .scl_io_num = I2C_MASTER_SCL_IO,           // select GPIO specific to your_
↪project
    .scl_pullup_en = GPIO_PULLUP_ENABLE,
    .master.clk_speed = I2C_MASTER_FREQ_HZ,    // select frequency specific to your_
↪project
    // .clk_flags = 0,                          /*!< Optional, you can use I2C_SCLK_SRC_FLAG_*_
↪flags to choose i2c source clock here. */
};

```

Configuration example (slave):

```

int i2c_slave_port = I2C_SLAVE_NUM;
i2c_config_t conf_slave = {
    .sda_io_num = I2C_SLAVE_SDA_IO,           // select GPIO specific to your_
↪project
    .sda_pullup_en = GPIO_PULLUP_ENABLE,
    .scl_io_num = I2C_SLAVE_SCL_IO,           // select GPIO specific to your_
↪project
    .scl_pullup_en = GPIO_PULLUP_ENABLE,
    .mode = I2C_MODE_SLAVE,
    .slave.addr_10bit_en = 0,
    .slave.slave_addr = ESP_SLAVE_ADDR,       // address of your project
};

```

At this stage, `i2c_param_config()` also sets a few other I2C configuration parameters to default values that are defined by the I2C specification. For more details on the values and how to modify them, see [Customized Configuration](#).

Source Clock Configuration Clock sources allocator is added for supporting different clock sources (Master only). The clock allocator will choose one clock source that meets all the requirements of frequency and capability (as requested in `i2c_config_t::clk_flags`).

When `i2c_config_t::clk_flags` is 0, the clock allocator will select only according to the desired frequency. If no special capabilities are needed, such as APB, you can configure the clock allocator to select the source clock only according to the desired frequency. For this, set `i2c_config_t::clk_flags` to 0. For clock characteristics, see the table below.

Note: A clock is not a valid option, if it doesn't meet the requested capabilities, i.e. any bit of requested capabilities (`clk_flags`) is 0 in the clock's capabilities.

Table 1: Characteristics of ESP32-C3 clock sources

Clock name	MAX freq for SCL frequency	Clock capabilities
XTAL0 clock	2 MHz	/
RTC0 clock	1 MHz	<code>I2C_SCLK_SRC_FLAG_AWARE_DFS</code> , <code>I2C_SCLK_SRC_FLAG_LIGHT_SLEEP</code>

Explanations for `i2c_config_t::clk_flags` are as follows:

1. `I2C_SCLK_SRC_FLAG_AWARE_DFS`: Clock's baud rate will not change while APB clock is changing.

2. `I2C_SCLK_SRC_FLAG_LIGHT_SLEEP`: It supports Light-sleep mode, which APB clock cannot do.
3. Some flags may not be supported on ESP32-C3, reading technical reference manual before using it.

Note: The clock frequency of SCL in master mode should not be larger than max frequency for SCL mentioned in the table above.

Install Driver After the I2C driver is configured, install it by calling the function `i2c_driver_install()` with the following parameters:

- Port number, one of the two port numbers from `i2c_port_t`
- Master or slave, selected from `i2c_mode_t`
- (Slave only) Size of buffers to allocate for sending and receiving data. As I2C is a master-centric bus, data can only go from the slave to the master at the master's request. Therefore, the slave will usually have a send buffer where the slave application writes data. The data remains in the send buffer to be read by the master at the master's own discretion.
- Flags for allocating the interrupt (see `ESP_INTR_FLAG_*` values in `esp_system/include/esp_intr_alloc.h`)

Communication as Master After installing the I2C driver, ESP32-C3 is ready to communicate with other I2C devices.

ESP32-C3's I2C controller operating as master is responsible for establishing communication with I2C slave devices and sending commands to trigger a slave to action, for example, to take a measurement and send the readings back to the master.

For better process organization, the driver provides a container, called a “command link”, that should be populated with a sequence of commands and then passed to the I2C controller for execution.

Master Write The example below shows how to build a command link for an I2C master to send n bytes to a slave.

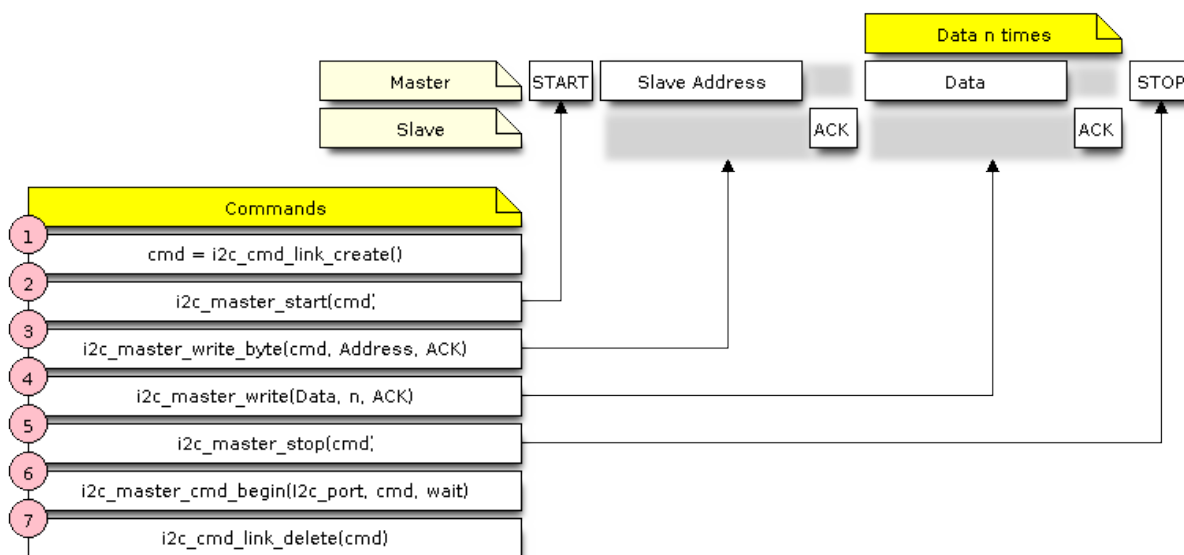

Fig. 6: I2C command link - master write example

The following describes how a command link for a “master write” is set up and what comes inside:

1. Create a command link with `i2c_cmd_link_create()`.
Then, populate it with the series of data to be sent to the slave:
 - a) **Start bit** - `i2c_master_start()`
 - b) **Slave address** - `i2c_master_write_byte()`. The single byte address is provided as an argument of this function call.

c) **Data** - One or more bytes as an argument of `i2c_master_write()`

d) **Stop bit** - `i2c_master_stop()`

Both functions `i2c_master_write_byte()` and `i2c_master_write()` have an additional argument specifying whether the master should ensure that it has received the ACK bit.

2. Trigger the execution of the command link by I2C controller by calling `i2c_master_cmd_begin()`. Once the execution is triggered, the command link cannot be modified.
3. After the commands are transmitted, release the resources used by the command link by calling `i2c_cmd_link_delete()`.

Master Read The example below shows how to build a command link for an I2C master to read n bytes from a slave.

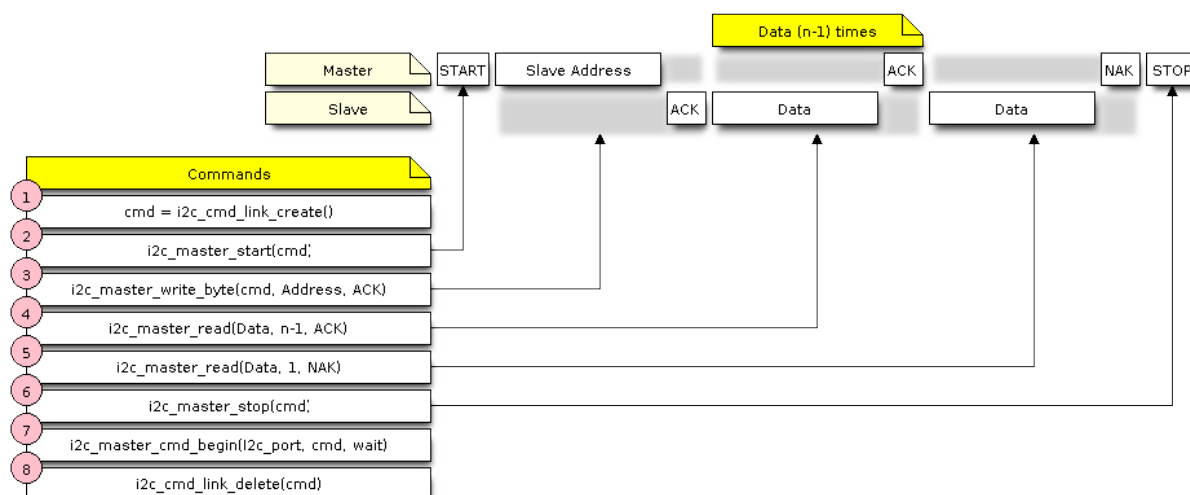

Fig. 7: I2C command link - master read example

Compared to writing data, the command link is populated in Step 4 not with `i2c_master_write...` functions but with `i2c_master_read_byte()` and / or `i2c_master_read()`. Also, the last read in Step 5 is configured so that the master does not provide the ACK bit.

Indicating Write or Read After sending a slave address (see Step 3 on both diagrams above), the master either writes or reads from the slave.

The information on what the master will actually do is hidden in the least significant bit of the slave's address.

For this reason, the command link sent by the master to write data to the slave contains the address `(ESP_SLAVE_ADDR << 1) | I2C_MASTER_WRITE` and looks as follows:

```
i2c_master_write_byte(cmd, (ESP_SLAVE_ADDR << 1) | I2C_MASTER_WRITE, ACK_EN);
```

Likewise, the command link to read from the slave looks as follows:

```
i2c_master_write_byte(cmd, (ESP_SLAVE_ADDR << 1) | I2C_MASTER_READ, ACK_EN);
```

Communication as Slave After installing the I2C driver, ESP32-C3 is ready to communicate with other I2C devices.

The API provides the following functions for slaves

- `i2c_slave_read_buffer()`

Whenever the master writes data to the slave, the slave will automatically store it in the receive buffer. This allows the slave application to call the function `i2c_slave_read_buffer()` at its own discretion. This function also has a parameter to specify block time if no data is in the

receive buffer. This will allow the slave application to wait with a specified timeout for data to arrive to the buffer.

- `i2c_slave_write_buffer()`

The send buffer is used to store all the data that the slave wants to send to the master in FIFO order. The data stays there until the master requests for it. The function `i2c_slave_write_buffer()` has a parameter to specify block time if the send buffer is full. This will allow the slave application to wait with a specified timeout for the adequate amount of space to become available in the send buffer.

A code example showing how to use these functions can be found in [peripherals/i2c](#).

Interrupt Handling During driver installation, an interrupt handler is installed by default. However, you can register your own interrupt handler instead of the default one by calling the function `i2c_isr_register()`. When implementing your own interrupt handler, refer to *ESP32-C3 Technical Reference Manual > I2C Controller (I2C) > Interrupts* [PDF] for the description of interrupts triggered by the I2C controller.

To delete an interrupt handler, call `i2c_isr_free()`.

Customized Configuration As mentioned at the end of Section [Configuration](#), when the function `i2c_param_config()` initializes the driver configuration for an I2C port, it also sets several I2C communication parameters to default values defined in the [I2C specification](#). Some other related parameters are pre-configured in registers of the I2C controller.

All these parameters can be changed to user-defined values by calling dedicated functions given in the table below. Please note that the timing values are defined in APB clock cycles. The frequency of APB is specified in `I2C_APB_CLK_FREQ`.

Table 2: Other Configurable I2C Communication Parameters

Parameters to Change	Function
High time and low time for SCL pulses	<code>i2c_set_period()</code>
SCL and SDA signal timing used during generation of start signals	<code>i2c_set_start_timing()</code>
SCL and SDA signal timing used during generation of stop signals	<code>i2c_set_stop_timing()</code>
Timing relationship between SCL and SDA signals when slave samples, as well as when master toggles	<code>i2c_set_data_timing()</code>
I2C timeout	<code>i2c_set_timeout()</code>
Choice between transmitting / receiving the LSB or MSB first, choose one of the modes defined in <code>i2c_trans_mode_t</code>	<code>i2c_set_data_mode()</code>

Each of the above functions has a `_get_` counterpart to check the currently set value. For example, to check the I2C timeout value, call `i2c_get_timeout()`.

To check the default parameter values which are set during the driver configuration process, please refer to the file [driver/i2c.c](#) and look for defines with the suffix `_DEFAULT`.

You can also select different pins for SDA and SCL signals and alter the configuration of pull-ups with the function `i2c_set_pin()`. If you want to modify already entered values, use the function `i2c_param_config()`.

Note: ESP32-C3's internal pull-ups are in the range of tens of kOhm, which is, in most cases, insufficient for use as I2C pull-ups. Users are advised to use external pull-ups with values described in the [I2C specification](#).

Error Handling The majority of I2C driver functions either return `ESP_OK` on successful completion or a specific error code on failure. It is a good practice to always check the returned values and implement error handling. The driver also prints out log messages that contain error details, e.g., when checking the validity of entered configuration. For details please refer to the file [driver/i2c.c](#) and look for defines with the suffix `_ERR_STR`.

Use dedicated interrupts to capture communication failures. For instance, if a slave stretches the clock for too long while preparing the data to send back to master, the interrupt `I2C_TIME_OUT_INT` will be triggered. For detailed information, see [Interrupt Handling](#).

In case of a communication failure, you can reset the internal hardware buffers by calling the functions `i2c_reset_tx_fifo()` and `i2c_reset_rx_fifo()` for the send and receive buffers respectively.

Delete Driver When the I2C communication is established with the function `i2c_driver_install()` and is not required for some substantial amount of time, the driver may be deinitialized to release allocated resources by calling `i2c_driver_delete()`.

Before calling `i2c_driver_delete()` to remove i2c driver, please make sure that all threads have stopped using the driver in any way, because this function does not guarantee thread safety.

Application Example

I2C master and slave example: [peripherals/i2c](#).

API Reference

Header File

- `driver/include/driver/i2c.h`

Functions

`esp_err_t i2c_driver_install(i2c_port_t i2c_num, i2c_mode_t mode, size_t slv_rx_buf_len, size_t slv_tx_buf_len, int intr_alloc_flags)`

I2C driver install.

Note Only slave mode will use this value, driver will ignore this value in master mode.

Note Only slave mode will use this value, driver will ignore this value in master mode.

Note In master mode, if the cache is likely to be disabled (such as write flash) and the slave is time-sensitive, `ESP_INTR_FLAG_IRAM` is suggested to be used. In this case, please use the memory allocated from internal RAM in i2c read and write function, because we can not access the psram (if psram is enabled) in interrupt handle function when cache is disabled.

Return

- `ESP_OK` Success
- `ESP_ERR_INVALID_ARG` Parameter error
- `ESP_FAIL` Driver install error

Parameters

- `i2c_num`: I2C port number
- `mode`: I2C mode (master or slave)
- `slv_rx_buf_len`: receiving buffer size for slave mode

Parameters

- `slv_tx_buf_len`: sending buffer size for slave mode

Parameters

- `intr_alloc_flags`: Flags used to allocate the interrupt. One or multiple (ORred) `ESP_INTR_FLAG_*` values. See `esp_intr_alloc.h` for more info.

`esp_err_t i2c_driver_delete(i2c_port_t i2c_num)`

I2C driver delete.

Note This function does not guarantee thread safety. Please make sure that no thread will continuously hold semaphores before calling the delete function.

Return

- `ESP_OK` Success
- `ESP_ERR_INVALID_ARG` Parameter error

Parameters

- `i2c_num`: I2C port number

esp_err_t **i2c_param_config** (*i2c_port_t* *i2c_num*, const *i2c_config_t* **i2c_conf*)

I2C parameter initialization.

Return

- ESP_OK Success
- ESP_ERR_INVALID_ARG Parameter error

Parameters

- *i2c_num*: I2C port number
- *i2c_conf*: pointer to I2C parameter settings

esp_err_t **i2c_reset_tx_fifo** (*i2c_port_t* *i2c_num*)

reset I2C tx hardware fifo

Return

- ESP_OK Success
- ESP_ERR_INVALID_ARG Parameter error

Parameters

- *i2c_num*: I2C port number

esp_err_t **i2c_reset_rx_fifo** (*i2c_port_t* *i2c_num*)

reset I2C rx fifo

Return

- ESP_OK Success
- ESP_ERR_INVALID_ARG Parameter error

Parameters

- *i2c_num*: I2C port number

esp_err_t **i2c_isr_register** (*i2c_port_t* *i2c_num*, void (**fn*)) void *

, void **arg*, int *intr_alloc_flags*, *intr_handle_t* **handle* I2C isr handler register.

Return

- ESP_OK Success
- ESP_ERR_INVALID_ARG Parameter error

Parameters

- *i2c_num*: I2C port number
- *fn*: isr handler function
- *arg*: parameter for isr handler function
- *intr_alloc_flags*: Flags used to allocate the interrupt. One or multiple (ORred) ESP_INTR_FLAG_* values. See esp_intr_alloc.h for more info.
- *handle*: handle return from esp_intr_alloc.

esp_err_t **i2c_isr_free** (*intr_handle_t* *handle*)

to delete and free I2C isr.

Return

- ESP_OK Success
- ESP_ERR_INVALID_ARG Parameter error

Parameters

- *handle*: handle of isr.

esp_err_t **i2c_set_pin** (*i2c_port_t* *i2c_num*, int *sda_io_num*, int *scl_io_num*, bool *sda_pullup_en*, bool *scl_pullup_en*, *i2c_mode_t* *mode*)

Configure GPIO signal for I2C sck and sda.

Return

- ESP_OK Success
- ESP_ERR_INVALID_ARG Parameter error

Parameters

- *i2c_num*: I2C port number
- *sda_io_num*: GPIO number for I2C sda signal
- *scl_io_num*: GPIO number for I2C scl signal
- *sda_pullup_en*: Whether to enable the internal pullup for sda pin
- *scl_pullup_en*: Whether to enable the internal pullup for scl pin

- mode: I2C mode

esp_err_t **i2c_cmd_link_create**(void)

Create and init I2C command link.

Note Before we build I2C command link, we need to call `i2c_cmd_link_create()` to create a command link. After we finish sending the commands, we need to call `i2c_cmd_link_delete()` to release and return the resources.

Return i2c command link handler

void **i2c_cmd_link_delete**(*i2c_cmd_handle_t* cmd_handle)

Free I2C command link.

Note Before we build I2C command link, we need to call `i2c_cmd_link_create()` to create a command link. After we finish sending the commands, we need to call `i2c_cmd_link_delete()` to release and return the resources.

Parameters

- cmd_handle: I2C command handle

esp_err_t **i2c_master_start**(*i2c_cmd_handle_t* cmd_handle)

Queue command for I2C master to generate a start signal.

Note Only call this function in I2C master mode Call `i2c_master_cmd_begin()` to send all queued commands

Return

- ESP_OK Success
- ESP_ERR_INVALID_ARG Parameter error

Parameters

- cmd_handle: I2C cmd link

esp_err_t **i2c_master_write_byte**(*i2c_cmd_handle_t* cmd_handle, uint8_t data, bool ack_en)

Queue command for I2C master to write one byte to I2C bus.

Note Only call this function in I2C master mode Call `i2c_master_cmd_begin()` to send all queued commands

Return

- ESP_OK Success
- ESP_ERR_INVALID_ARG Parameter error

Parameters

- cmd_handle: I2C cmd link
- data: I2C one byte command to write to bus
- ack_en: enable ack check for master

esp_err_t **i2c_master_write**(*i2c_cmd_handle_t* cmd_handle, const uint8_t *data, size_t data_len, bool ack_en)

Queue command for I2C master to write buffer to I2C bus.

Note Only call this function in I2C master mode Call `i2c_master_cmd_begin()` to send all queued commands

Note If the psram is enabled and `intr_flag` is `ESP_INTR_FLAG_IRAM`, please use the memory allocated from internal RAM.

Return

- ESP_OK Success
- ESP_ERR_INVALID_ARG Parameter error

Parameters

- cmd_handle: I2C cmd link
- data: data to send

Parameters

- data_len: data length
- ack_en: enable ack check for master

esp_err_t **i2c_master_read_byte**(*i2c_cmd_handle_t* cmd_handle, uint8_t *data, *i2c_ack_type_t* ack)

Queue command for I2C master to read one byte from I2C bus.

Note Only call this function in I2C master mode Call `i2c_master_cmd_begin()` to send all queued commands

Note If the psram is enabled and `intr_flag` is `ESP_INTR_FLAG_IRAM`, please use the memory allocated from internal RAM.

Return

- ESP_OK Success
- ESP_ERR_INVALID_ARG Parameter error

Parameters

- `cmd_handle`: I2C cmd link
- `data`: pointer accept the data byte

Parameters

- `ack`: ack value for read command

`esp_err_t i2c_master_read(i2c_cmd_handle_t cmd_handle, uint8_t *data, size_t data_len, i2c_ack_type_t ack)`

Queue command for I2C master to read data from I2C bus.

Note Only call this function in I2C master mode Call `i2c_master_cmd_begin()` to send all queued commands

Note If the psram is enabled and `intr_flag` is `ESP_INTR_FLAG_IRAM`, please use the memory allocated from internal RAM.

Return

- ESP_OK Success
- ESP_ERR_INVALID_ARG Parameter error

Parameters

- `cmd_handle`: I2C cmd link
- `data`: data buffer to accept the data from bus

Parameters

- `data_len`: read data length
- `ack`: ack value for read command

`esp_err_t i2c_master_stop(i2c_cmd_handle_t cmd_handle)`

Queue command for I2C master to generate a stop signal.

Note Only call this function in I2C master mode Call `i2c_master_cmd_begin()` to send all queued commands

Return

- ESP_OK Success
- ESP_ERR_INVALID_ARG Parameter error

Parameters

- `cmd_handle`: I2C cmd link

`esp_err_t i2c_master_cmd_begin(i2c_port_t i2c_num, i2c_cmd_handle_t cmd_handle, TickType_t ticks_to_wait)`

I2C master send queued commands. This function will trigger sending all queued commands. The task will be blocked until all the commands have been sent out. The I2C APIs are not thread-safe, if you want to use one I2C port in different tasks, you need to take care of the multi-thread issue.

Note Only call this function in I2C master mode

Return

- ESP_OK Success
- ESP_ERR_INVALID_ARG Parameter error
- ESP_FAIL Sending command error, slave doesn't ACK the transfer.
- ESP_ERR_INVALID_STATE I2C driver not installed or not in master mode.
- ESP_ERR_TIMEOUT Operation timeout because the bus is busy.

Parameters

- `i2c_num`: I2C port number
- `cmd_handle`: I2C command handler
- `ticks_to_wait`: maximum wait ticks.

`int i2c_slave_write_buffer(i2c_port_t i2c_num, const uint8_t *data, int size, TickType_t ticks_to_wait)`

I2C slave write data to internal ringbuffer, when tx fifo empty, isr will fill the hardware fifo from the internal ringbuffer.

Note Only call this function in I2C slave mode

Return

- ESP_FAIL(-1) Parameter error
- Others(>=0) The number of data bytes that pushed to the I2C slave buffer.

Parameters

- `i2c_num`: I2C port number
- `data`: data pointer to write into internal buffer
- `size`: data size
- `ticks_to_wait`: Maximum waiting ticks

int **`i2c_slave_read_buffer`** (*`i2c_port_t i2c_num`, `uint8_t *data`, `size_t max_size`, `TickType_t ticks_to_wait`)*

I2C slave read data from internal buffer. When I2C slave receive data, isr will copy received data from hardware rx fifo to internal ringbuffer. Then users can read from internal ringbuffer.

Note Only call this function in I2C slave mode

Return

- `ESP_FAIL`(-1) Parameter error
- Others(≥ 0) The number of data bytes that read from I2C slave buffer.

Parameters

- `i2c_num`: I2C port number
- `data`: data pointer to accept data from internal buffer
- `max_size`: Maximum data size to read
- `ticks_to_wait`: Maximum waiting ticks

`esp_err_t i2c_set_period` (*`i2c_port_t i2c_num`, `int high_period`, `int low_period`)*
set I2C master clock period

Return

- `ESP_OK` Success
- `ESP_ERR_INVALID_ARG` Parameter error

Parameters

- `i2c_num`: I2C port number
- `high_period`: clock cycle number during SCL is high level, `high_period` is a 14 bit value
- `low_period`: clock cycle number during SCL is low level, `low_period` is a 14 bit value

`esp_err_t i2c_get_period` (*`i2c_port_t i2c_num`, `int *high_period`, `int *low_period`)*
get I2C master clock period

Return

- `ESP_OK` Success
- `ESP_ERR_INVALID_ARG` Parameter error

Parameters

- `i2c_num`: I2C port number
- `high_period`: pointer to get clock cycle number during SCL is high level, will get a 14 bit value
- `low_period`: pointer to get clock cycle number during SCL is low level, will get a 14 bit value

`esp_err_t i2c_filter_enable` (*`i2c_port_t i2c_num`, `uint8_t cyc_num`)*

enable hardware filter on I2C bus Sometimes the I2C bus is disturbed by high frequency noise(about 20ns), or the rising edge of the SCL clock is very slow, these may cause the master state machine broken. enable hardware filter can filter out high frequency interference and make the master more stable.

Note Enable filter will slow the SCL clock.

Return

- `ESP_OK` Success
- `ESP_ERR_INVALID_ARG` Parameter error

Parameters

- `i2c_num`: I2C port number
- `cyc_num`: the APB cycles need to be filtered($0 \leq cyc_num \leq 7$). When the period of a pulse is less than `cyc_num * APB_cycle`, the I2C controller will ignore this pulse.

`esp_err_t i2c_filter_disable` (*`i2c_port_t i2c_num`)*
disable filter on I2C bus

Return

- `ESP_OK` Success
- `ESP_ERR_INVALID_ARG` Parameter error

Parameters

- `i2c_num`: I2C port number

esp_err_t **i2c_set_start_timing** (*i2c_port_t* *i2c_num*, int *setup_time*, int *hold_time*)

set I2C master start signal timing

Return

- `ESP_OK` Success
- `ESP_ERR_INVALID_ARG` Parameter error

Parameters

- `i2c_num`: I2C port number
- `setup_time`: clock number between the falling-edge of SDA and rising-edge of SCL for start mark, it' s a 10-bit value.
- `hold_time`: clock num between the falling-edge of SDA and falling-edge of SCL for start mark, it' s a 10-bit value.

esp_err_t **i2c_get_start_timing** (*i2c_port_t* *i2c_num*, int **setup_time*, int **hold_time*)

get I2C master start signal timing

Return

- `ESP_OK` Success
- `ESP_ERR_INVALID_ARG` Parameter error

Parameters

- `i2c_num`: I2C port number
- `setup_time`: pointer to get setup time
- `hold_time`: pointer to get hold time

esp_err_t **i2c_set_stop_timing** (*i2c_port_t* *i2c_num*, int *setup_time*, int *hold_time*)

set I2C master stop signal timing

Return

- `ESP_OK` Success
- `ESP_ERR_INVALID_ARG` Parameter error

Parameters

- `i2c_num`: I2C port number
- `setup_time`: clock num between the rising-edge of SCL and the rising-edge of SDA, it' s a 10-bit value.
- `hold_time`: clock number after the STOP bit' s rising-edge, it' s a 14-bit value.

esp_err_t **i2c_get_stop_timing** (*i2c_port_t* *i2c_num*, int **setup_time*, int **hold_time*)

get I2C master stop signal timing

Return

- `ESP_OK` Success
- `ESP_ERR_INVALID_ARG` Parameter error

Parameters

- `i2c_num`: I2C port number
- `setup_time`: pointer to get setup time.
- `hold_time`: pointer to get hold time.

esp_err_t **i2c_set_data_timing** (*i2c_port_t* *i2c_num*, int *sample_time*, int *hold_time*)

set I2C data signal timing

Return

- `ESP_OK` Success
- `ESP_ERR_INVALID_ARG` Parameter error

Parameters

- `i2c_num`: I2C port number
- `sample_time`: clock number I2C used to sample data on SDA after the rising-edge of SCL, it' s a 10-bit value
- `hold_time`: clock number I2C used to hold the data after the falling-edge of SCL, it' s a 10-bit value

esp_err_t **i2c_get_data_timing** (*i2c_port_t* *i2c_num*, int **sample_time*, int **hold_time*)
get I2C data signal timing

Return

- ESP_OK Success
- ESP_ERR_INVALID_ARG Parameter error

Parameters

- *i2c_num*: I2C port number
- *sample_time*: pointer to get sample time
- *hold_time*: pointer to get hold time

esp_err_t **i2c_set_timeout** (*i2c_port_t* *i2c_num*, int *timeout*)
set I2C timeout value

Return

- ESP_OK Success
- ESP_ERR_INVALID_ARG Parameter error

Parameters

- *i2c_num*: I2C port number
- *timeout*: timeout value for I2C bus (unit: APB 80Mhz clock cycle)

esp_err_t **i2c_get_timeout** (*i2c_port_t* *i2c_num*, int **timeout*)
get I2C timeout value

Return

- ESP_OK Success
- ESP_ERR_INVALID_ARG Parameter error

Parameters

- *i2c_num*: I2C port number
- *timeout*: pointer to get timeout value

esp_err_t **i2c_set_data_mode** (*i2c_port_t* *i2c_num*, *i2c_trans_mode_t* *tx_trans_mode*,
i2c_trans_mode_t *rx_trans_mode*)
set I2C data transfer mode

Return

- ESP_OK Success
- ESP_ERR_INVALID_ARG Parameter error

Parameters

- *i2c_num*: I2C port number
- *tx_trans_mode*: I2C sending data mode
- *rx_trans_mode*: I2C receiving data mode

esp_err_t **i2c_get_data_mode** (*i2c_port_t* *i2c_num*, *i2c_trans_mode_t* **tx_trans_mode*,
i2c_trans_mode_t **rx_trans_mode*)
get I2C data transfer mode

Return

- ESP_OK Success
- ESP_ERR_INVALID_ARG Parameter error

Parameters

- *i2c_num*: I2C port number
- *tx_trans_mode*: pointer to get I2C sending data mode
- *rx_trans_mode*: pointer to get I2C receiving data mode

Macros**I2C_APB_CLK_FREQ**

I2C source clock is APB clock, 80MHz

I2C_NUM_0

I2C port 0

I2C_NUM_1

I2C port 1

I2C_NUM_MAX
I2C port max

Type Definitions

typedef void ***i2c_cmd_handle_t**
I2C command handle

Header File

- [hal/include/hal/i2c_types.h](#)

Structures

struct i2c_config_t
I2C initialization parameters.

Public Members

i2c_mode_t **mode**
I2C mode

int **sda_io_num**
GPIO number for I2C sda signal

int **scl_io_num**
GPIO number for I2C scl signal

bool **sda_pullup_en**
Internal GPIO pull mode for I2C sda signal

bool **scl_pullup_en**
Internal GPIO pull mode for I2C scl signal

uint32_t **clk_speed**
I2C clock frequency for master mode, (no higher than 1MHz for now)

struct i2c_config_t::[anonymous]::[anonymous] master
I2C master config

uint8_t **addr_10bit_en**
I2C 10bit address mode enable for slave mode

uint16_t **slave_addr**
I2C address for slave mode

struct i2c_config_t::[anonymous]::[anonymous] slave
I2C slave config

uint32_t **clk_flags**
Bitwise of I2C_SCLK_SRC_FLAG_**FOR_DFS** for clk source choice

Macros

I2C_SCLK_SRC_FLAG_FOR_NOMAL
Any one clock source that is available for the specified frequency may be choosen

I2C_SCLK_SRC_FLAG_AWARE_DFS
For REF tick clock, it won't change with APB.

I2C_SCLK_SRC_FLAG_LIGHT_SLEEP
For light sleep mode.

I2C_CLK_FREQ_MAX
Use the highest speed that is available for the clock source picked by clk_flags.

Type Definitions

```
typedef int i2c_port_t
    I2C port number, can be I2C_NUM_0 ~ (I2C_NUM_MAX-1).
```

Enumerations

```
enum i2c_mode_t
```

Values:

```
I2C_MODE_SLAVE = 0
```

I2C slave mode

```
I2C_MODE_MASTER
```

I2C master mode

```
I2C_MODE_MAX
```

```
enum i2c_rw_t
```

Values:

```
I2C_MASTER_WRITE = 0
```

I2C write data

```
I2C_MASTER_READ
```

I2C read data

```
enum i2c_trans_mode_t
```

Values:

```
I2C_DATA_MODE_MSB_FIRST = 0
```

I2C data msb first

```
I2C_DATA_MODE_LSB_FIRST = 1
```

I2C data lsb first

```
I2C_DATA_MODE_MAX
```

```
enum i2c_addr_mode_t
```

Values:

```
I2C_ADDR_BIT_7 = 0
```

I2C 7bit address for slave mode

```
I2C_ADDR_BIT_10
```

I2C 10bit address for slave mode

```
I2C_ADDR_BIT_MAX
```

```
enum i2c_ack_type_t
```

Values:

```
I2C_MASTER_ACK = 0x0
```

I2C ack for each byte read

```
I2C_MASTER_NACK = 0x1
```

I2C nack for each byte read

```
I2C_MASTER_LAST_NACK = 0x2
```

I2C nack for the last byte

```
I2C_MASTER_ACK_MAX
```

```
enum i2c_sclk_t
```

I2C clock source, sorting from smallest to largest, place them in order. This can be expanded in the future use.

Values:

```
I2C_SCLK_DEFAULT = 0
```

I2C source clock not selected

I2C_SCLK_XTAL

I2C source clock from XTAL, 40M

I2C_SCLK_RTC

I2C source clock from 8M RTC, 8M

I2C_SCLK_MAX

2.3.7 I2S

Warning: This document is not updated for ESP32-C3 yet.

Overview

I2S (Inter-IC Sound) is a serial, synchronous communication protocol that is usually used for transmitting audio data between two digital audio devices.

An I2S bus consists of the following lines:

- Bit clock line
- Channel select line
- Serial data line

Each I2S controller has the following features that can be configured using the I2S driver:

- Operation as system master or slave
- Capable of acting as transmitter or receiver
- Dedicated DMA controller that allows for streaming sample data without requiring the CPU to copy each data sample

Each controller can operate in half-duplex communication mode. Thus, the two controllers can be combined to establish full-duplex communication.

I2S0 output can be routed directly to the digital-to-analog converter's (DAC) output channels (GPIO 25 & GPIO 26) to produce direct analog output without involving any external I2S codecs. I2S0 can also be used for transmitting PDM (Pulse-density modulation) signals.

The I2S peripherals also support LCD mode for communicating data over a parallel bus, as used by some LCD displays and camera modules. LCD mode has the following operational modes:

- LCD master transmitting mode
- Camera slave receiving mode
- ADC/DAC mode

Note: For high accuracy clock applications, use the APLL_CLK clock source, which has the frequency range of 16 ~ 128 MHz. You can enable the APLL_CLK clock source by setting `i2s_config_t::use_apll` to TRUE.

If `i2s_config_t::use_apll` = TRUE and `i2s_config_t::fixed_mclk` > 0, then the master clock output frequency for I2S will be equal to the value of `i2s_config_t::fixed_mclk`, which means that the mclk frequency is provided by the user, instead of being calculated by the driver.

The clock rate of the word select line, which is called audio left-right clock rate (LRCK) here, is always the divisor of the master clock output frequency and for which the following is always true: $0 < \text{MCLK/LRCK/channels/bits_per_sample} < 64$.

Functional Overview

Installing the Driver Install the I2S driver by calling the function `i2s_driver_install()` and passing the following arguments:

- Port number
- The structure `i2s_config_t` with defined communication parameters
- Event queue size and handle

Configuration example:

```
static const int i2s_num = 0; // i2s port number

static const i2s_config_t i2s_config = {
    .mode = I2S_MODE_MASTER | I2S_MODE_TX,
    .sample_rate = 44100,
    .bits_per_sample = I2S_BITS_PER_SAMPLE_16BIT,
    .channel_format = I2S_CHANNEL_FMT_RIGHT_LEFT,
    .communication_format = I2S_COMM_FORMAT_STAND_I2S,
    .intr_alloc_flags = 0, // default interrupt priority
    .dma_buf_count = 8,
    .dma_buf_len = 64,
    .use_apll = false
};

i2s_driver_install(I2S_NUM, &i2s_config, 0, NULL);
```

Setting Communication Pins Once the driver is installed, configure physical GPIO pins to which signals will be routed. For this, call the function `i2s_set_pin()` and pass the following arguments to it:

- Port number
- The structure `i2s_pin_config_t` defining the GPIO pin numbers to which the driver should route the BCK, WS, DATA out, and DATA in signals. If you want to keep a currently allocated pin number for a specific signal, or if this signal is unused, then pass the macro `I2S_PIN_NO_CHANGE`. See the example below.

```
static const i2s_pin_config_t pin_config = {
    .bck_io_num = 26,
    .ws_io_num = 25,
    .data_out_num = 22,
    .data_in_num = I2S_PIN_NO_CHANGE
};

i2s_set_pin(i2s_num, &pin_config);
```

Running I2S Communication To perform a transmission:

- Prepare the data for sending
- Call the function `i2s_write()` and pass the data buffer address and data length to it

The function will write the data to the I2S DMA Tx buffer, and then the data will be transmitted automatically.

```
i2s_write(I2S_NUM, samples_data, ((bits+8)/16)*SAMPLE_PER_CYCLE*4, &i2s_bytes_
↵write, 100);
```

To retrieve received data, use the function `i2s_read()`. It will retrieve the data from the I2S DMA Rx buffer, once the data is received by the I2S controller.

You can temporarily stop the I2S driver by calling the function `i2s_stop()`, which will disable the I2S Tx/Rx units until the function `i2s_start()` is called. If the function `i2s_driver_install()` is used, the driver will start up automatically eliminating the need to call `i2s_start()`.

Deleting the Driver If the established communication is no longer required, the driver can be removed to free allocated resources by calling `i2s_driver_uninstall()`.

Application Example

A code example for the I2S driver can be found in the directory [peripherals/i2s](#).

In addition, there are two short configuration examples for the I2S driver.

I2S configuration

```
#include "driver/i2s.h"
#include "freertos/queue.h"

static const int i2s_num = 0; // i2s port number

static const i2s_config_t i2s_config = {
    .mode = I2S_MODE_MASTER | I2S_MODE_TX,
    .sample_rate = 44100,
    .bits_per_sample = I2S_BITS_PER_SAMPLE_16BIT,
    .channel_format = I2S_CHANNEL_FMT_RIGHT_LEFT,
    .communication_format = I2S_COMM_FORMAT_STAND_I2S,
    .intr_alloc_flags = 0, // default interrupt priority
    .dma_buf_count = 8,
    .dma_buf_len = 64,
    .use_apll = false
};

static const i2s_pin_config_t pin_config = {
    .bck_io_num = 26,
    .ws_io_num = 25,
    .data_out_num = 22,
    .data_in_num = I2S_PIN_NO_CHANGE
};

...

i2s_driver_install(i2s_num, &i2s_config, 0, NULL); //install and start i2s_
↳driver

i2s_set_pin(i2s_num, &pin_config);

i2s_set_sample_rates(i2s_num, 22050); //set sample rates

i2s_driver_uninstall(i2s_num); //stop & destroy i2s driver
```

Configuring I2S to use internal DAC for analog output

```
#include "driver/i2s.h"
#include "freertos/queue.h"

static const int i2s_num = 0; // i2s port number

static const i2s_config_t i2s_config = {
    .mode = I2S_MODE_MASTER | I2S_MODE_TX | I2S_MODE_DAC_BUILT_IN,
    .sample_rate = 44100,
    .bits_per_sample = I2S_BITS_PER_SAMPLE_16BIT, /* the DAC module will only take_
↳the 8bits from MSB */
    .channel_format = I2S_CHANNEL_FMT_RIGHT_LEFT,
    .intr_alloc_flags = 0, // default interrupt priority
    .dma_buf_count = 8,
    .dma_buf_len = 64,
    .use_apll = false
};
```

(continues on next page)

```

...

    i2s_driver_install(i2s_num, &i2s_config, 0, NULL); //install and start i2s_
↳driver

    i2s_set_pin(i2s_num, NULL); //for internal DAC, this will enable both of the_
↳internal channels

    //You can call i2s_set_dac_mode to set built-in DAC output mode.
    //i2s_set_dac_mode(I2S_DAC_CHANNEL_BOTH_EN);

    i2s_set_sample_rates(i2s_num, 22050); //set sample rates

    i2s_driver_uninstall(i2s_num); //stop & destroy i2s driver

```

API Reference

Header File

- `driver/include/driver/i2s.h`

Functions

`esp_err_t i2s_set_pin(i2s_port_t i2s_num, const i2s_pin_config_t *pin)`

Set I2S pin number.

Inside the pin configuration structure, set `I2S_PIN_NO_CHANGE` for any pin where the current configuration should not be changed.

Note The I2S peripheral output signals can be connected to multiple GPIO pads. However, the I2S peripheral input signal can only be connected to one GPIO pad.

Parameters

- `i2s_num`: `I2S_NUM_0` or `I2S_NUM_1`
- `pin`: I2S Pin structure, or `NULL` to set 2-channel 8-bit internal DAC pin configuration (GPIO25 & GPIO26)

Note if `*pin` is set as `NULL`, this function will initialize both of the built-in DAC channels by default. if you don't want this to happen and you want to initialize only one of the DAC channels, you can call `i2s_set_dac_mode` instead.

Return

- `ESP_OK` Success
- `ESP_ERR_INVALID_ARG` Parameter error
- `ESP_FAIL` IO error

`esp_err_t i2s_set_dac_mode(i2s_dac_mode_t dac_mode)`

Set I2S dac mode, I2S built-in DAC is disabled by default.

Note Built-in DAC functions are only supported on I2S0 for current ESP32 chip. If either of the built-in DAC channel are enabled, the other one can not be used as RTC DAC function at the same time.

Return

- `ESP_OK` Success
- `ESP_ERR_INVALID_ARG` Parameter error

Parameters

- `dac_mode`: DAC mode configurations - see `i2s_dac_mode_t`

`esp_err_t i2s_driver_install(i2s_port_t i2s_num, const i2s_config_t *i2s_config, int queue_size, void *i2s_queue)`

Install and start I2S driver.

This function must be called before any I2S driver read/write operations.

Parameters

- `i2s_num`: I2S_NUM_0, I2S_NUM_1
- `i2s_config`: I2S configurations - see [i2s_config_t](#) struct
- `queue_size`: I2S event queue size/depth.
- `i2s_queue`: I2S event queue handle, if set NULL, driver will not use an event queue.

Return

- ESP_OK Success
- ESP_ERR_INVALID_ARG Parameter error
- ESP_ERR_NO_MEM Out of memory

esp_err_t **i2s_driver_uninstall** (*i2s_port_t* `i2s_num`)
Uninstall I2S driver.

Return

- ESP_OK Success
- ESP_ERR_INVALID_ARG Parameter error

Parameters

- `i2s_num`: I2S_NUM_0, I2S_NUM_1

esp_err_t **i2s_write** (*i2s_port_t* `i2s_num`, **const** void *`src`, *size_t* `size`, *size_t* *`bytes_written`, *TickType_t* `ticks_to_wait`)
Write data to I2S DMA transmit buffer.

Return

- ESP_OK Success
- ESP_ERR_INVALID_ARG Parameter error

Parameters

- `i2s_num`: I2S_NUM_0, I2S_NUM_1
- `src`: Source address to write from
- `size`: Size of data in bytes
- [out] `bytes_written`: Number of bytes written, if timeout, the result will be less than the size passed in.
- `ticks_to_wait`: TX buffer wait timeout in RTOS ticks. If this many ticks pass without space becoming available in the DMA transmit buffer, then the function will return (note that if the data is written to the DMA buffer in pieces, the overall operation may still take longer than this timeout.) Pass `portMAX_DELAY` for no timeout.

esp_err_t **i2s_write_expand** (*i2s_port_t* `i2s_num`, **const** void *`src`, *size_t* `size`, *size_t* `src_bits`, *size_t* `aim_bits`, *size_t* *`bytes_written`, *TickType_t* `ticks_to_wait`)
Write data to I2S DMA transmit buffer while expanding the number of bits per sample. For example, expanding 16-bit PCM to 32-bit PCM.

Format of the data in source buffer is determined by the I2S configuration (see [i2s_config_t](#)).

Parameters

- `i2s_num`: I2S_NUM_0, I2S_NUM_1
- `src`: Source address to write from
- `size`: Size of data in bytes
- `src_bits`: Source audio bit
- `aim_bits`: Bit wanted, no more than 32, and must be greater than `src_bits`
- [out] `bytes_written`: Number of bytes written, if timeout, the result will be less than the size passed in.
- `ticks_to_wait`: TX buffer wait timeout in RTOS ticks. If this many ticks pass without space becoming available in the DMA transmit buffer, then the function will return (note that if the data is written to the DMA buffer in pieces, the overall operation may still take longer than this timeout.) Pass `portMAX_DELAY` for no timeout.

Return

- ESP_OK Success
- ESP_ERR_INVALID_ARG Parameter error

esp_err_t **i2s_read** (*i2s_port_t* `i2s_num`, void *`dest`, *size_t* `size`, *size_t* *`bytes_read`, *TickType_t* `ticks_to_wait`)

Read data from I2S DMA receive buffer.

Note If the built-in ADC mode is enabled, we should call `i2s_adc_enable` and `i2s_adc_disable` around the whole reading process, to prevent the data getting corrupted.

Return

- ESP_OK Success
- ESP_ERR_INVALID_ARG Parameter error

Parameters

- `i2s_num`: I2S_NUM_0, I2S_NUM_1
- `dest`: Destination address to read into
- `size`: Size of data in bytes
- `[out] bytes_read`: Number of bytes read, if timeout, bytes read will be less than the size passed in.
- `ticks_to_wait`: RX buffer wait timeout in RTOS ticks. If this many ticks pass without bytes becoming available in the DMA receive buffer, then the function will return (note that if data is read from the DMA buffer in pieces, the overall operation may still take longer than this timeout.) Pass `portMAX_DELAY` for no timeout.

esp_err_t i2s_set_sample_rates (*i2s_port_t i2s_num*, *uint32_t rate*)

Set sample rate used for I2S RX and TX.

The bit clock rate is determined by the sample rate and `i2s_config_t` configuration parameters (number of channels, `bits_per_sample`).

```
bit_clock = rate * (number of channels) * bits_per_sample
```

Return

- ESP_OK Success
- ESP_ERR_INVALID_ARG Parameter error
- ESP_ERR_NO_MEM Out of memory

Parameters

- `i2s_num`: I2S_NUM_0, I2S_NUM_1
- `rate`: I2S sample rate (ex: 8000, 44100...)

esp_err_t i2s_stop (*i2s_port_t i2s_num*)

Stop I2S driver.

There is no need to call `i2s_stop()` before calling `i2s_driver_uninstall()`.

Disables I2S TX/RX, until `i2s_start()` is called.

Return

- ESP_OK Success
- ESP_ERR_INVALID_ARG Parameter error

Parameters

- `i2s_num`: I2S_NUM_0, I2S_NUM_1

esp_err_t i2s_start (*i2s_port_t i2s_num*)

Start I2S driver.

It is not necessary to call this function after `i2s_driver_install()` (it is started automatically), however it is necessary to call it after `i2s_stop()`.

Return

- ESP_OK Success
- ESP_ERR_INVALID_ARG Parameter error

Parameters

- `i2s_num`: I2S_NUM_0, I2S_NUM_1

esp_err_t i2s_zero_dma_buffer (*i2s_port_t i2s_num*)

Zero the contents of the TX DMA buffer.

Pushes zero-byte samples into the TX DMA buffer, until it is full.

Return

- ESP_OK Success

- `ESP_ERR_INVALID_ARG` Parameter error

Parameters

- `i2s_num`: `I2S_NUM_0`, `I2S_NUM_1`

`esp_err_t i2s_set_clk` (*`i2s_port_t` `i2s_num`, `uint32_t` `rate`, *`i2s_bits_per_sample_t`* `bits`, *`i2s_channel_t`* `ch`)*

Set clock & bit width used for I2S RX and TX.

Similar to `i2s_set_sample_rates()`, but also sets bit width.

Return

- `ESP_OK` Success
- `ESP_ERR_INVALID_ARG` Parameter error
- `ESP_ERR_NO_MEM` Out of memory

Parameters

- `i2s_num`: `I2S_NUM_0`, `I2S_NUM_1`
- `rate`: I2S sample rate (ex: 8000, 44100...)
- `bits`: I2S bit width (`I2S_BITS_PER_SAMPLE_16BIT`, `I2S_BITS_PER_SAMPLE_24BIT`, `I2S_BITS_PER_SAMPLE_32BIT`)
- `ch`: I2S channel, (`I2S_CHANNEL_MONO`, `I2S_CHANNEL_STEREO`)

float `i2s_get_clk` (*`i2s_port_t` `i2s_num`*)

get clock set on particular port number.

Return

- actual clock set by i2s driver

Parameters

- `i2s_num`: `I2S_NUM_0`, `I2S_NUM_1`

Macros**`I2S_PIN_NO_CHANGE`**

Use in *`i2s_pin_config_t`* for pins which should not be changed

Type Definitions

`typedef` *`intr_handle_t`* `i2s_isr_handle_t`

Header File

- `hal/include/hal/i2s_types.h`

Structures

`struct` `i2s_config_t`

I2S configuration parameters for `i2s_param_config` function.

Public Members

`i2s_mode_t` `mode`

I2S work mode

int `sample_rate`

I2S sample rate

`i2s_bits_per_sample_t` `bits_per_sample`

I2S bits per sample

`i2s_channel_fmt_t` `channel_format`

I2S channel format

`i2s_comm_format_t` `communication_format`

I2S communication format

int **intr_alloc_flags**

Flags used to allocate the interrupt. One or multiple (ORred) ESP_INTR_FLAG_* values. See esp_intr_alloc.h for more info

int **dma_buf_count**

I2S DMA Buffer Count

int **dma_buf_len**

I2S DMA Buffer Length

bool **use_apll**

I2S using APLL as main I2S clock, enable it to get accurate clock

bool **tx_desc_auto_clear**

I2S auto clear tx descriptor if there is underflow condition (helps in avoiding noise in case of data unavailability)

int **fixed_mclk**

I2S using fixed MCLK output. If use_apll = true and fixed_mclk > 0, then the clock output for i2s is fixed and equal to the fixed_mclk value.

struct **i2s_event_t**

Event structure used in I2S event queue.

Public Members

i2s_event_type_t **type**

I2S event type

size_t **size**

I2S data size for I2S_DATA event

struct **i2s_pin_config_t**

I2S pin number for i2s_set_pin.

Public Members

int **bck_io_num**

BCK in out pin

int **ws_io_num**

WS in out pin

int **data_out_num**

DATA out pin

int **data_in_num**

DATA in pin

Enumerations

enum **i2s_port_t**

I2S port number, the max port number is (I2S_NUM_MAX -1).

Values:

I2S_NUM_0 = 0

I2S port 0

I2S_NUM_MAX

I2S port max

enum **i2s_bits_per_sample_t**

I2S bit width per sample.

Values:

I2S_BITS_PER_SAMPLE_8BIT = 8

I2S bits per sample: 8-bits

I2S_BITS_PER_SAMPLE_16BIT = 16

I2S bits per sample: 16-bits

I2S_BITS_PER_SAMPLE_24BIT = 24

I2S bits per sample: 24-bits

I2S_BITS_PER_SAMPLE_32BIT = 32

I2S bits per sample: 32-bits

enum i2s_channel_t

I2S channel.

Values:

I2S_CHANNEL_MONO = 1

I2S 1 channel (mono)

I2S_CHANNEL_STEREO = 2

I2S 2 channel (stereo)

enum i2s_comm_format_t

I2S communication standard format.

Values:

I2S_COMM_FORMAT_STAND_I2S = 0X01

I2S communication I2S Philips standard, data launch at second BCK

I2S_COMM_FORMAT_STAND_MSB = 0X02

I2S communication MSB alignment standard, data launch at first BCK

I2S_COMM_FORMAT_STAND_PCM_SHORT = 0x04

PCM Short standard, also known as DSP mode. The period of synchronization signal (WS) is 1 bck cycle.

I2S_COMM_FORMAT_STAND_PCM_LONG = 0x0C

PCM Long standard. The period of synchronization signal (WS) is channel_bit*bck cycles.

I2S_COMM_FORMAT_STAND_MAX

standard max

I2S_COMM_FORMAT_I2S = 0x01

I2S communication format I2S, correspond to **I2S_COMM_FORMAT_STAND_I2S**

I2S_COMM_FORMAT_I2S_MSB = 0x01

I2S format MSB, (**I2S_COMM_FORMAT_I2S** | **I2S_COMM_FORMAT_I2S_MSB**) correspond to **I2S_COMM_FORMAT_STAND_I2S**

I2S_COMM_FORMAT_I2S_LSB = 0x02

I2S format LSB, (**I2S_COMM_FORMAT_I2S** | **I2S_COMM_FORMAT_I2S_LSB**) correspond to **I2S_COMM_FORMAT_STAND_MSB**

I2S_COMM_FORMAT_PCM = 0x04

I2S communication format PCM, correspond to **I2S_COMM_FORMAT_STAND_PCM_SHORT**

I2S_COMM_FORMAT_PCM_SHORT = 0x04

PCM Short, (**I2S_COMM_FORMAT_PCM** | **I2S_COMM_FORMAT_PCM_SHORT**) correspond to **I2S_COMM_FORMAT_STAND_PCM_SHORT**

I2S_COMM_FORMAT_PCM_LONG = 0x08

PCM Long, (**I2S_COMM_FORMAT_PCM** | **I2S_COMM_FORMAT_PCM_LONG**) correspond to **I2S_COMM_FORMAT_STAND_PCM_LONG**

enum i2s_channel_fmt_t

I2S channel format type.

Values:

I2S_CHANNEL_FMT_RIGHT_LEFT = 0x00

I2S_CHANNEL_FMT_ALL_RIGHT

I2S_CHANNEL_FMT_ALL_LEFT

I2S_CHANNEL_FMT_ONLY_RIGHT

I2S_CHANNEL_FMT_ONLY_LEFT

enum i2s_mode_t

I2S Mode, default is I2S_MODE_MASTER | I2S_MODE_TX.

Note PDM and built-in DAC functions are only supported on I2S0 for current ESP32 chip.

Values:

I2S_MODE_MASTER = 1
Master mode

I2S_MODE_SLAVE = 2
Slave mode

I2S_MODE_TX = 4
TX mode

I2S_MODE_RX = 8
RX mode

enum i2s_clock_src_t

I2S source clock.

Values:

I2S_CLK_D2CLK = 0
Clock from PLL_D2_CLK(160M)

I2S_CLK_APLL
Clock from APLL

enum i2s_event_type_t

I2S event types.

Values:

I2S_EVENT_DMA_ERROR

I2S_EVENT_TX_DONE
I2S DMA finish sent 1 buffer

I2S_EVENT_RX_DONE
I2S DMA finish received 1 buffer

I2S_EVENT_MAX
I2S event max index

enum i2s_dac_mode_t

I2S DAC mode for i2s_set_dac_mode.

Note PDM and built-in DAC functions are only supported on I2S0 for current ESP32 chip.

Values:

I2S_DAC_CHANNEL_DISABLE = 0
Disable I2S built-in DAC signals

I2S_DAC_CHANNEL_RIGHT_EN = 1
Enable I2S built-in DAC right channel, maps to DAC channel 1 on GPIO25

```
I2S_DAC_CHANNEL_LEFT_EN = 2
```

Enable I2S built-in DAC left channel, maps to DAC channel 2 on GPIO26

```
I2S_DAC_CHANNEL_BOTH_EN = 0x3
```

Enable both of the I2S built-in DAC channels.

```
I2S_DAC_CHANNEL_MAX = 0x4
```

I2S built-in DAC mode max index

2.3.8 LED Control

Introduction

The LED control (LEDC) peripheral is primarily designed to control the intensity of LEDs, although it can also be used to generate PWM signals for other purposes. It has 6 channels which can generate independent waveforms that can be used, for example, to drive RGB LED devices.

The PWM controller can automatically increase or decrease the duty cycle gradually, allowing for fades without any processor interference.

Functionality Overview

Setting up a channel of the LEDC is done in three steps. Note that unlike ESP32, ESP32-C3 only supports configuring channels in “low speed” mode.

1. *Timer Configuration* by specifying the PWM signal’s frequency and duty cycle resolution.
2. *Channel Configuration* by associating it with the timer and GPIO to output the PWM signal.
3. *Change PWM Signal* that drives the output in order to change LED’s intensity. This can be done under the full control of software or with hardware fading functions.

As an optional step, it is also possible to set up an interrupt on fade end.

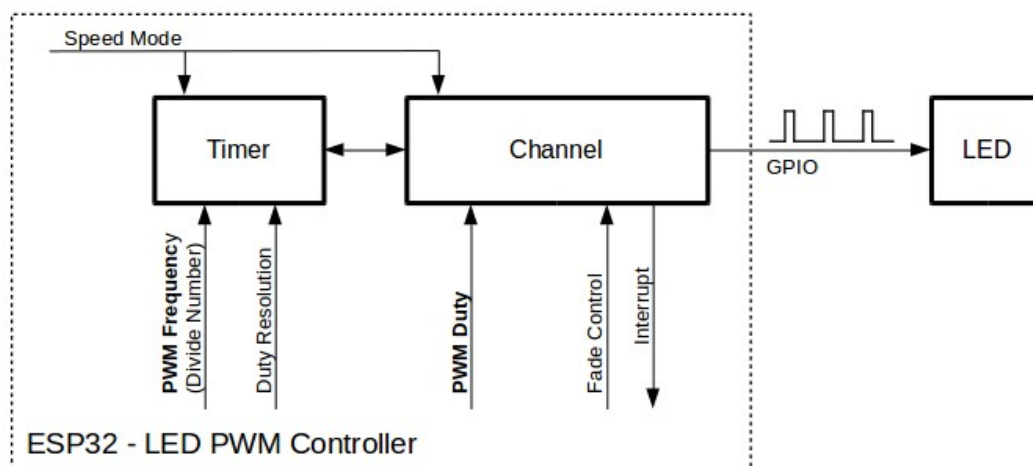

Fig. 8: Key Settings of LED PWM Controller’s API

Timer Configuration Setting the timer is done by calling the function `ledc_timer_config()` and passing the data structure `ledc_timer_config_t` that contains the following configuration settings:

- Speed mode (value must be `LEDC_LOW_SPEED_MODE`)

- Timer number `ledc_timer_t`
- PWM signal frequency
- Resolution of PWM duty

The frequency and the duty resolution are interdependent. The higher the PWM frequency, the lower the duty resolution which is available, and vice versa. This relationship might be important if you are planning to use this API for purposes other than changing the intensity of LEDs. For more details, see Section [Supported Range of Frequency and Duty Resolutions](#).

Channel Configuration When the timer is set up, configure the desired channel (one out of `ledc_channel_t`). This is done by calling the function `ledc_channel_config()`.

Similar to the timer configuration, the channel setup function should be passed a structure `ledc_channel_config_t` that contains the channel's configuration parameters.

At this point, the channel should start operating and generating the PWM signal on the selected GPIO, as configured in `ledc_channel_config_t`, with the frequency specified in the timer settings and the given duty cycle. The channel operation (signal generation) can be suspended at any time by calling the function `ledc_stop()`.

Change PWM Signal Once the channel starts operating and generating the PWM signal with the constant duty cycle and frequency, there are a couple of ways to change this signal. When driving LEDs, primarily the duty cycle is changed to vary the light intensity.

The following two sections describe how to change the duty cycle using software and hardware fading. If required, the signal's frequency can also be changed; it is covered in Section [Change PWM Frequency](#).

Note: All the timers and channels in the ESP32-C3's LED PWM Controller only support low speed mode. Any change of PWM settings must be explicitly triggered by software (see below).

Change PWM Duty Cycle Using Software To set the duty cycle, use the dedicated function `ledc_set_duty()`. After that, call `ledc_update_duty()` to activate the changes. To check the currently set value, use the corresponding `_get_` function `ledc_get_duty()`.

Another way to set the duty cycle, as well as some other channel parameters, is by calling `ledc_channel_config()` covered in Section [Channel Configuration](#).

The range of the duty cycle values passed to functions depends on selected `duty_resolution` and should be from 0 to $(2^{**} \text{duty_resolution}) - 1$. For example, if the selected duty resolution is 10, then the duty cycle values can range from 0 to 1023. This provides the resolution of ~0.1%.

Change PWM Duty Cycle using Hardware The LEDC hardware provides the means to gradually transition from one duty cycle value to another. To use this functionality, enable fading with `ledc_fade_func_install()` and then configure it by calling one of the available fading functions:

- `ledc_set_fade_with_time()`
- `ledc_set_fade_with_step()`
- `ledc_set_fade()`

Finally start fading with `ledc_fade_start()`.

If not required anymore, fading and an associated interrupt can be disabled with `ledc_fade_func_uninstall()`.

Change PWM Frequency The LEDC API provides several ways to change the PWM frequency “on the fly” :

- Set the frequency by calling `ledc_set_freq()`. There is a corresponding function `ledc_get_freq()` to check the current frequency.

- Change the frequency and the duty resolution by calling `ledc_bind_channel_timer()` to bind some other timer to the channel.
- Change the channel's timer by calling `ledc_channel_config()`.

More Control Over PWM There are several lower level timer-specific functions that can be used to change PWM settings:

- `ledc_timer_set()`
- `ledc_timer_rst()`
- `ledc_timer_pause()`
- `ledc_timer_resume()`

The first two functions are called “behind the scenes” by `ledc_channel_config()` to provide a startup of a timer after it is configured.

Use Interrupts When configuring an LEDC channel, one of the parameters selected within `ledc_channel_config_t` is `ledc_intr_type_t` which triggers an interrupt on fade completion.

For registration of a handler to address this interrupt, call `ledc_isr_register()`.

Supported Range of Frequency and Duty Resolutions

The LED PWM Controller is designed primarily to drive LEDs. It provides a large flexibility of PWM duty cycle settings. For instance, the PWM frequency of 5 kHz can have the maximum duty resolution of 13 bits. This means that the duty can be set anywhere from 0 to 100% with a resolution of ~0.012% ($2^{13} = 8192$ discrete levels of the LED intensity). Note, however, that these parameters depend on the clock signal clocking the LED PWM Controller timer which in turn clocks the channel (see [timer configuration](#) and the *ESP32-C3 Technical Reference Manual > LED PWM Controller (LEDC) [PDF]*).

The LEDC can be used for generating signals at much higher frequencies that are sufficient enough to clock other devices, e.g., a digital camera module. In this case, the maximum available frequency is 40 MHz with duty resolution of 1 bit. This means that the duty cycle is fixed at 50% and cannot be adjusted.

The LEDC API is designed to report an error when trying to set a frequency and a duty resolution that exceed the range of LEDC's hardware. For example, an attempt to set the frequency to 20 MHz and the duty resolution to 3 bits will result in the following error reported on a serial monitor:

```
E (196) ledc: requested frequency and duty resolution cannot be achieved, try_
↔reducing freq_hz or duty_resolution. div_param=128
```

In such a situation, either the duty resolution or the frequency must be reduced. For example, setting the duty resolution to 2 will resolve this issue and will make it possible to set the duty cycle at 25% steps, i.e., at 25%, 50% or 75%.

The LEDC driver will also capture and report attempts to configure frequency / duty resolution combinations that are below the supported minimum, e.g.:

```
E (196) ledc: requested frequency and duty resolution cannot be achieved, try_
↔increasing freq_hz or duty_resolution. div_param=128000000
```

The duty resolution is normally set using `ledc_timer_bit_t`. This enumeration covers the range from 10 to 15 bits. If a smaller duty resolution is required (from 10 down to 1), enter the equivalent numeric values directly.

Application Example

The LEDC change duty cycle and fading control example: [peripherals/ledc](#).

API Reference

Header File

- [driver/include/driver/ledc.h](#)

Functions

esp_err_t **ledc_channel_config**(const *ledc_channel_config_t* *ledc_conf)

LEDC channel configuration Configure LEDC channel with the given channel/output gpio_num/interrupt/source timer/frequency(Hz)/LEDC duty resolution.

Return

- ESP_OK Success
- ESP_ERR_INVALID_ARG Parameter error

Parameters

- ledc_conf: Pointer of LEDC channel configure struct

esp_err_t **ledc_timer_config**(const *ledc_timer_config_t* *timer_conf)

LEDC timer configuration Configure LEDC timer with the given source timer/frequency(Hz)/duty_resolution.

Return

- ESP_OK Success
- ESP_ERR_INVALID_ARG Parameter error
- ESP_FAIL Can not find a proper pre-divider number base on the given frequency and the current duty_resolution.

Parameters

- timer_conf: Pointer of LEDC timer configure struct

esp_err_t **ledc_update_duty**(*ledc_mode_t* speed_mode, *ledc_channel_t* channel)

LEDC update channel parameters.

Note Call this function to activate the LEDC updated parameters. After `ledc_set_duty`, we need to call this function to update the settings. And the new LEDC parameters don't take effect until the next PWM cycle.

Note `ledc_set_duty`, `ledc_set_duty_with_hpoint` and `ledc_update_duty` are not thread-safe, do not call these functions to control one LEDC channel in different tasks at the same time. A thread-safe version of API is `ledc_set_duty_and_update`

Return

- ESP_OK Success
- ESP_ERR_INVALID_ARG Parameter error

Parameters

- speed_mode: Select the LEDC channel group with specified speed mode. Note that not all targets support high speed mode.
- channel: LEDC channel (0-7), select from `ledc_channel_t`

esp_err_t **ledc_set_pin**(int *gpio_num*, *ledc_mode_t* speed_mode, *ledc_channel_t* ledc_channel)

Set LEDC output gpio.

Return

- ESP_OK Success
- ESP_ERR_INVALID_ARG Parameter error

Parameters

- *gpio_num*: The LEDC output gpio
- speed_mode: Select the LEDC channel group with specified speed mode. Note that not all targets support high speed mode.
- ledc_channel: LEDC channel (0-7), select from `ledc_channel_t`

esp_err_t **ledc_stop**(*ledc_mode_t* speed_mode, *ledc_channel_t* channel, *uint32_t* idle_level)

LEDC stop. Disable LEDC output, and set idle level.

Return

- ESP_OK Success
- ESP_ERR_INVALID_ARG Parameter error

Parameters

- `speed_mode`: Select the LEDC channel group with specified speed mode. Note that not all targets support high speed mode.
- `channel`: LEDC channel (0-7), select from `ledc_channel_t`
- `idle_level`: Set output idle level after LEDC stops.

esp_err_t **ledc_set_freq** (*ledc_mode_t* speed_mode, *ledc_timer_t* timer_num, uint32_t freq_hz)

LEDC set channel frequency (Hz)

Return

- `ESP_OK` Success
- `ESP_ERR_INVALID_ARG` Parameter error
- `ESP_FAIL` Can not find a proper pre-divider number base on the given frequency and the current duty_resolution.

Parameters

- `speed_mode`: Select the LEDC channel group with specified speed mode. Note that not all targets support high speed mode.
- `timer_num`: LEDC timer index (0-3), select from `ledc_timer_t`
- `freq_hz`: Set the LEDC frequency

uint32_t **ledc_get_freq** (*ledc_mode_t* speed_mode, *ledc_timer_t* timer_num)

LEDC get channel frequency (Hz)

Return

- 0 error
- Others Current LEDC frequency

Parameters

- `speed_mode`: Select the LEDC channel group with specified speed mode. Note that not all targets support high speed mode.
- `timer_num`: LEDC timer index (0-3), select from `ledc_timer_t`

esp_err_t **ledc_set_duty_with_hpoint** (*ledc_mode_t* speed_mode, *ledc_channel_t* channel, uint32_t duty, uint32_t hpoint)

LEDC set duty and hpoint value Only after calling `ledc_update_duty` will the duty update.

Note `ledc_set_duty`, `ledc_set_duty_with_hpoint` and `ledc_update_duty` are not thread-safe, do not call these functions to control one LEDC channel in different tasks at the same time. A thread-safe version of API is `ledc_set_duty_and_update`

Note If a fade operation is running in progress on that channel, the driver would not allow it to be stopped. Other duty operations will have to wait until the fade operation has finished.

Return

- `ESP_OK` Success
- `ESP_ERR_INVALID_ARG` Parameter error

Parameters

- `speed_mode`: Select the LEDC channel group with specified speed mode. Note that not all targets support high speed mode.
- `channel`: LEDC channel (0-7), select from `ledc_channel_t`
- `duty`: Set the LEDC duty, the range of duty setting is [0, (2**duty_resolution)]
- `hpoint`: Set the LEDC hpoint value(max: 0xffff)

int **ledc_get_hpoint** (*ledc_mode_t* speed_mode, *ledc_channel_t* channel)

LEDC get hpoint value, the counter value when the output is set high level.

Return

- `LEDC_ERR_VAL` if parameter error
- Others Current hpoint value of LEDC channel

Parameters

- `speed_mode`: Select the LEDC channel group with specified speed mode. Note that not all targets support high speed mode.
- `channel`: LEDC channel (0-7), select from `ledc_channel_t`

esp_err_t **ledc_set_duty** (*ledc_mode_t* speed_mode, *ledc_channel_t* channel, uint32_t duty)

LEDC set duty This function do not change the hpoint value of this channel. if needed, please call

`ledc_set_duty_with_hpoint`. only after calling `ledc_update_duty` will the duty update.

Note `ledc_set_duty`, `ledc_set_duty_with_hpoint` and `ledc_update_duty` are not thread-safe, do not call these functions to control one LEDC channel in different tasks at the same time. A thread-safe version of API is `ledc_set_duty_and_update`.

Note If a fade operation is running in progress on that channel, the driver would not allow it to be stopped. Other duty operations will have to wait until the fade operation has finished.

Return

- ESP_OK Success
- ESP_ERR_INVALID_ARG Parameter error

Parameters

- `speed_mode`: Select the LEDC channel group with specified speed mode. Note that not all targets support high speed mode.
- `channel`: LEDC channel (0-7), select from `ledc_channel_t`
- `duty`: Set the LEDC duty, the range of duty setting is $[0, (2^{**}duty_resolution)]$

`uint32_t ledc_get_duty` (*`ledc_mode_t speed_mode, ledc_channel_t channel`*)

LEDC get duty This function returns the duty at the present PWM cycle. You shouldn't expect the function to return the new duty in the same cycle of calling `ledc_update_duty`, because duty update doesn't take effect until the next cycle.

Return

- LEDC_ERR_DUTY if parameter error
- Others Current LEDC duty

Parameters

- `speed_mode`: Select the LEDC channel group with specified speed mode. Note that not all targets support high speed mode.
- `channel`: LEDC channel (0-7), select from `ledc_channel_t`

`esp_err_t ledc_set_fade` (*`ledc_mode_t speed_mode, ledc_channel_t channel, uint32_t duty, ledc_duty_direction_t fade_direction, uint32_t step_num, uint32_t duty_cycle_num, uint32_t duty_scale`*)

LEDC set gradient Set LEDC gradient, After the function calls the `ledc_update_duty` function, the function can take effect.

Note If a fade operation is running in progress on that channel, the driver would not allow it to be stopped. Other duty operations will have to wait until the fade operation has finished.

Return

- ESP_OK Success
- ESP_ERR_INVALID_ARG Parameter error

Parameters

- `speed_mode`: Select the LEDC channel group with specified speed mode. Note that not all targets support high speed mode.
- `channel`: LEDC channel (0-7), select from `ledc_channel_t`
- `duty`: Set the start of the gradient duty, the range of duty setting is $[0, (2^{**}duty_resolution)]$
- `fade_direction`: Set the direction of the gradient
- `step_num`: Set the number of the gradient
- `duty_cycle_num`: Set how many LEDC tick each time the gradient lasts
- `duty_scale`: Set gradient change amplitude

`esp_err_t ledc_isr_register` (*`void (*fn)`*) *`void *`*, *`void *arg, int intr_alloc_flags, ledc_isr_handle_t *handle`* Register LEDC interrupt handler, the handler is an ISR. The handler will be attached to the same CPU core that this function is running on.

Return

- ESP_OK Success
- ESP_ERR_INVALID_ARG Function pointer error.

Parameters

- `fn`: Interrupt handler function.
- `arg`: User-supplied argument passed to the handler function.
- `intr_alloc_flags`: Flags used to allocate the interrupt. One or multiple (ORred) ESP_INTR_FLAG_* values. See `esp_intr_alloc.h` for more info.

- `handle`: Pointer to return handle. If non-NULL, a handle for the interrupt will be returned here.

`esp_err_t ledc_timer_set` (*ledc_mode_t* speed_mode, *ledc_timer_t* timer_sel, uint32_t clock_divider, uint32_t duty_resolution, *ledc_clk_src_t* clk_src)

Configure LEDC settings.

Return

- (-1) Parameter error
- Other Current LEDC duty

Parameters

- `speed_mode`: Select the LEDC channel group with specified speed mode. Note that not all targets support high speed mode.
- `timer_sel`: Timer index (0-3), there are 4 timers in LEDC module
- `clock_divider`: Timer clock divide value, the timer clock is divided from the selected clock source
- `duty_resolution`: Resolution of duty setting in number of bits. The range of duty values is [0, (2**duty_resolution)]
- `clk_src`: Select LEDC source clock.

`esp_err_t ledc_timer_rst` (*ledc_mode_t* speed_mode, *ledc_timer_t* timer_sel)

Reset LEDC timer.

Return

- `ESP_ERR_INVALID_ARG` Parameter error
- `ESP_OK` Success

Parameters

- `speed_mode`: Select the LEDC channel group with specified speed mode. Note that not all targets support high speed mode.
- `timer_sel`: LEDC timer index (0-3), select from `ledc_timer_t`

`esp_err_t ledc_timer_pause` (*ledc_mode_t* speed_mode, *ledc_timer_t* timer_sel)

Pause LEDC timer counter.

Return

- `ESP_ERR_INVALID_ARG` Parameter error
- `ESP_OK` Success

Parameters

- `speed_mode`: Select the LEDC channel group with specified speed mode. Note that not all targets support high speed mode.
- `timer_sel`: LEDC timer index (0-3), select from `ledc_timer_t`

`esp_err_t ledc_timer_resume` (*ledc_mode_t* speed_mode, *ledc_timer_t* timer_sel)

Resume LEDC timer.

Return

- `ESP_ERR_INVALID_ARG` Parameter error
- `ESP_OK` Success

Parameters

- `speed_mode`: Select the LEDC channel group with specified speed mode. Note that not all targets support high speed mode.
- `timer_sel`: LEDC timer index (0-3), select from `ledc_timer_t`

`esp_err_t ledc_bind_channel_timer` (*ledc_mode_t* speed_mode, *ledc_channel_t* channel, *ledc_timer_t* timer_sel)

Bind LEDC channel with the selected timer.

Return

- `ESP_ERR_INVALID_ARG` Parameter error
- `ESP_OK` Success

Parameters

- `speed_mode`: Select the LEDC channel group with specified speed mode. Note that not all targets support high speed mode.
- `channel`: LEDC channel index (0-7), select from `ledc_channel_t`

- `timer_sel`: LEDC timer index (0-3), select from `ledc_timer_t`

esp_err_t **ledc_set_fade_with_step** (*ledc_mode_t* speed_mode, *ledc_channel_t* channel, uint32_t target_duty, uint32_t scale, uint32_t cycle_num)

Set LEDC fade function.

Note Call `ledc_fade_func_install()` once before calling this function. Call `ledc_fade_start()` after this to start fading.

Note `ledc_set_fade_with_step`, `ledc_set_fade_with_time` and `ledc_fade_start` are not thread-safe, do not call these functions to control one LEDC channel in different tasks at the same time. A thread-safe version of API is `ledc_set_fade_step_and_start`

Note If a fade operation is running in progress on that channel, the driver would not allow it to be stopped. Other duty operations will have to wait until the fade operation has finished.

Return

- `ESP_ERR_INVALID_ARG` Parameter error
- `ESP_OK` Success
- `ESP_ERR_INVALID_STATE` Fade function not installed.
- `ESP_FAIL` Fade function init error

Parameters

- `speed_mode`: Select the LEDC channel group with specified speed mode. Note that not all targets support high speed mode. ,
- `channel`: LEDC channel index (0-7), select from `ledc_channel_t`
- `target_duty`: Target duty of fading $[0, (2^{**}duty_resolution) - 1]$
- `scale`: Controls the increase or decrease step scale.
- `cycle_num`: increase or decrease the duty every `cycle_num` cycles

esp_err_t **ledc_set_fade_with_time** (*ledc_mode_t* speed_mode, *ledc_channel_t* channel, uint32_t target_duty, int max_fade_time_ms)

Set LEDC fade function, with a limited time.

Note Call `ledc_fade_func_install()` once before calling this function. Call `ledc_fade_start()` after this to start fading.

Note `ledc_set_fade_with_step`, `ledc_set_fade_with_time` and `ledc_fade_start` are not thread-safe, do not call these functions to control one LEDC channel in different tasks at the same time. A thread-safe version of API is `ledc_set_fade_step_and_start`

Note If a fade operation is running in progress on that channel, the driver would not allow it to be stopped. Other duty operations will have to wait until the fade operation has finished.

Return

- `ESP_ERR_INVALID_ARG` Parameter error
- `ESP_OK` Success
- `ESP_ERR_INVALID_STATE` Fade function not installed.
- `ESP_FAIL` Fade function init error

Parameters

- `speed_mode`: Select the LEDC channel group with specified speed mode. Note that not all targets support high speed mode. ,
- `channel`: LEDC channel index (0-7), select from `ledc_channel_t`
- `target_duty`: Target duty of fading. $(0 - (2^{**}duty_resolution - 1))$
- `max_fade_time_ms`: The maximum time of the fading (ms).

esp_err_t **ledc_fade_func_install** (int intr_alloc_flags)

Install LEDC fade function. This function will occupy interrupt of LEDC module.

Return

- `ESP_OK` Success
- `ESP_ERR_INVALID_STATE` Fade function already installed.

Parameters

- `intr_alloc_flags`: Flags used to allocate the interrupt. One or multiple (ORred) `ESP_INTR_FLAG_*` values. See `esp_intr_alloc.h` for more info.

void **ledc_fade_func_uninstall** (void)

Uninstall LEDC fade function.

esp_err_t **ledc_fade_start** (*ledc_mode_t* speed_mode, *ledc_channel_t* channel, *ledc_fade_mode_t* fade_mode)

Start LEDC fading.

Note Call `ledc_fade_func_install()` once before calling this function. Call this API right after `ledc_set_fade_with_time` or `ledc_set_fade_with_step` before to start fading.

Note If a fade operation is running in progress on that channel, the driver would not allow it to be stopped. Other duty operations will have to wait until the fade operation has finished.

Return

- ESP_OK Success
- ESP_ERR_INVALID_STATE Fade function not installed.
- ESP_ERR_INVALID_ARG Parameter error.

Parameters

- speed_mode: Select the LEDC channel group with specified speed mode. Note that not all targets support high speed mode.
- channel: LEDC channel number
- fade_mode: Whether to block until fading done. See `ledc_types.h` `ledc_fade_mode_t` for more info. Note that this function will not return until fading to the target duty if `LEDC_FADE_WAIT_DONE` mode is selected.

esp_err_t **ledc_set_duty_and_update** (*ledc_mode_t* speed_mode, *ledc_channel_t* channel, *uint32_t* duty, *uint32_t* hpoint)

A thread-safe API to set duty for LEDC channel and return when duty updated.

Note If a fade operation is running in progress on that channel, the driver would not allow it to be stopped. Other duty operations will have to wait until the fade operation has finished.

Parameters

- speed_mode: Select the LEDC channel group with specified speed mode. Note that not all targets support high speed mode.
- channel: LEDC channel (0-7), select from `ledc_channel_t`
- duty: Set the LEDC duty, the range of duty setting is $[0, (2^{**}duty_resolution)]$
- hpoint: Set the LEDC hpoint value(max: 0xffff)

esp_err_t **ledc_set_fade_time_and_start** (*ledc_mode_t* speed_mode, *ledc_channel_t* channel, *uint32_t* target_duty, *uint32_t* max_fade_time_ms, *ledc_fade_mode_t* fade_mode)

A thread-safe API to set and start LEDC fade function, with a limited time.

Note Call `ledc_fade_func_install()` once, before calling this function.

Note If a fade operation is running in progress on that channel, the driver would not allow it to be stopped. Other duty operations will have to wait until the fade operation has finished.

Return

- ESP_ERR_INVALID_ARG Parameter error
- ESP_OK Success
- ESP_ERR_INVALID_STATE Fade function not installed.
- ESP_FAIL Fade function init error

Parameters

- speed_mode: Select the LEDC channel group with specified speed mode. Note that not all targets support high speed mode.
- channel: LEDC channel index (0-7), select from `ledc_channel_t`
- target_duty: Target duty of fading. $(0 - (2^{**} duty_resolution - 1))$
- max_fade_time_ms: The maximum time of the fading (ms).
- fade_mode: choose blocking or non-blocking mode

esp_err_t **ledc_set_fade_step_and_start** (*ledc_mode_t* speed_mode, *ledc_channel_t* channel, *uint32_t* target_duty, *uint32_t* scale, *uint32_t* cycle_num, *ledc_fade_mode_t* fade_mode)

A thread-safe API to set and start LEDC fade function.

Note Call `ledc_fade_func_install()` once before calling this function.

Note If a fade operation is running in progress on that channel, the driver would not allow it to be stopped. Other duty operations will have to wait until the fade operation has finished.

Return

- ESP_ERR_INVALID_ARG Parameter error
- ESP_OK Success
- ESP_ERR_INVALID_STATE Fade function not installed.
- ESP_FAIL Fade function init error

Parameters

- `speed_mode`: Select the LEDC channel group with specified speed mode. Note that not all targets support high speed mode.
- `channel`: LEDC channel index (0-7), select from `ledc_channel_t`
- `target_duty`: Target duty of fading [0, (2**duty_resolution) - 1]
- `scale`: Controls the increase or decrease step scale.
- `cycle_num`: increase or decrease the duty every `cycle_num` cycles
- `fade_mode`: choose blocking or non-blocking mode

Macros`LEDC_APB_CLK_HZ``LEDC_REF_CLK_HZ``LEDC_ERR_DUTY``LEDC_ERR_VAL`**Type Definitions**`typedef intr_handle_t ledc_isr_handle_t`**Header File**

- [hal/include/hal/ledc_types.h](#)

Structures`struct ledc_channel_config_t`Configuration parameters of LEDC channel for `ledc_channel_config` function.**Public Members**`int gpio_num`the LEDC output `gpio_num`, if you want to use `gpio16`, `gpio_num = 16``ledc_mode_t speed_mode`LEDC speed `speed_mode`, high-speed mode or low-speed mode`ledc_channel_t channel`

LEDC channel (0 - 7)

`ledc_intr_type_t intr_type`

configure interrupt, Fade interrupt enable or Fade interrupt disable

`ledc_timer_t timer_sel`

Select the timer source of channel (0 - 3)

`uint32_t duty`

LEDC channel duty, the range of duty setting is [0, (2**duty_resolution)]

`int hpoint`LEDC channel `hpoint` value, the max value is 0xffff`struct ledc_timer_config_t`Configuration parameters of LEDC Timer `timer` for `ledc_timer_config` function.

Public Members

`ledc_mode_t` `speed_mode`

LEDC speed `speed_mode`, high-speed mode or low-speed mode

`ledc_timer_bit_t` `duty_resolution`

LEDC channel duty resolution

`ledc_timer_bit_t` `bit_num`

Deprecated in ESP-IDF 3.0. This is an alias to ‘`duty_resolution`’ for backward compatibility with ESP-IDF 2.1

`ledc_timer_t` `timer_num`

The timer source of channel (0 - 3)

`uint32_t` `freq_hz`

LEDC timer frequency (Hz)

`ledc_clk_cfg_t` `clk_cfg`

Configure LEDC source clock. For low speed channels and high speed channels, you can specify the source clock using `LEDC_USE_REF_TICK`, `LEDC_USE_APB_CLK` or `LEDC_AUTO_CLK`. For low speed channels, you can also specify the source clock using `LEDC_USE_RTC8M_CLK`, in this case, all low speed channel’s source clock must be `RTC8M_CLK`

Enumerations

`enum ledc_mode_t`

Values:

`LEDC_LOW_SPEED_MODE`

LEDC low speed `speed_mode`

`LEDC_SPEED_MODE_MAX`

LEDC speed limit

`enum ledc_intr_type_t`

Values:

`LEDC_INTR_DISABLE = 0`

Disable LEDC interrupt

`LEDC_INTR_FADE_END`

Enable LEDC interrupt

`LEDC_INTR_MAX`

`enum ledc_duty_direction_t`

Values:

`LEDC_DUTY_DIR_DECREASE = 0`

LEDC duty decrease direction

`LEDC_DUTY_DIR_INCREASE = 1`

LEDC duty increase direction

`LEDC_DUTY_DIR_MAX`

`enum ledc_slow_clk_sel_t`

Values:

`LEDC_SLOW_CLK_RTC8M = 0`

LEDC low speed timer clock source is 8MHz RTC clock

`LEDC_SLOW_CLK_APB`

LEDC low speed timer clock source is 80MHz APB clock

`LEDC_SLOW_CLK_XTAL`

LEDC low speed timer clock source XTAL clock

enum ledc_clk_cfg_t*Values:***LEDC_AUTO_CLK = 0**

The driver will automatically select the source clock(REF_TICK or APB) based on the giving resolution and duty parameter when init the timer

LEDC_USE_REF_TICK

LEDC timer select REF_TICK clock as source clock

LEDC_USE_APB_CLK

LEDC timer select APB clock as source clock

LEDC_USE_RTC8M_CLK

LEDC timer select RTC8M_CLK as source clock. Only for low speed channels and this parameter must be the same for all low speed channels

LEDC_USE_XTAL_CLK

LEDC timer select XTAL clock as source clock

enum ledc_clk_src_t*Values:***LEDC_REF_TICK = [LEDC_USE_REF_TICK](#)**

LEDC timer clock divided from reference tick (1Mhz)

LEDC_APB_CLK = [LEDC_USE_APB_CLK](#)

LEDC timer clock divided from APB clock (80Mhz)

enum ledc_timer_t*Values:***LEDC_TIMER_0 = 0**

LEDC timer 0

LEDC_TIMER_1

LEDC timer 1

LEDC_TIMER_2

LEDC timer 2

LEDC_TIMER_3

LEDC timer 3

LEDC_TIMER_MAX**enum ledc_channel_t***Values:***LEDC_CHANNEL_0 = 0**

LEDC channel 0

LEDC_CHANNEL_1

LEDC channel 1

LEDC_CHANNEL_2

LEDC channel 2

LEDC_CHANNEL_3

LEDC channel 3

LEDC_CHANNEL_4

LEDC channel 4

LEDC_CHANNEL_5

LEDC channel 5

LEDC_CHANNEL_MAX

enum ledc_timer_bit_t

Values:

LEDC_TIMER_1_BIT = 1
LEDC PWM duty resolution of 1 bits

LEDC_TIMER_2_BIT
LEDC PWM duty resolution of 2 bits

LEDC_TIMER_3_BIT
LEDC PWM duty resolution of 3 bits

LEDC_TIMER_4_BIT
LEDC PWM duty resolution of 4 bits

LEDC_TIMER_5_BIT
LEDC PWM duty resolution of 5 bits

LEDC_TIMER_6_BIT
LEDC PWM duty resolution of 6 bits

LEDC_TIMER_7_BIT
LEDC PWM duty resolution of 7 bits

LEDC_TIMER_8_BIT
LEDC PWM duty resolution of 8 bits

LEDC_TIMER_9_BIT
LEDC PWM duty resolution of 9 bits

LEDC_TIMER_10_BIT
LEDC PWM duty resolution of 10 bits

LEDC_TIMER_11_BIT
LEDC PWM duty resolution of 11 bits

LEDC_TIMER_12_BIT
LEDC PWM duty resolution of 12 bits

LEDC_TIMER_13_BIT
LEDC PWM duty resolution of 13 bits

LEDC_TIMER_14_BIT
LEDC PWM duty resolution of 14 bits

LEDC_TIMER_BIT_MAX

enum ledc_fade_mode_t

Values:

LEDC_FADE_NO_WAIT = 0
LEDC fade function will return immediately

LEDC_FADE_WAIT_DONE
LEDC fade function will block until fading to the target duty

LEDC_FADE_MAX

2.3.9 RMT

The RMT (Remote Control) module driver can be used to send and receive infrared remote control signals. Due to flexibility of RMT module, the driver can also be used to generate or receive many other types of signals.

The signal, which consists of a series of pulses, is generated by RMT's transmitter based on a list of values. The values define the pulse duration and a binary level, see below. The transmitter can also provide a carrier and modulate it with provided pulses.

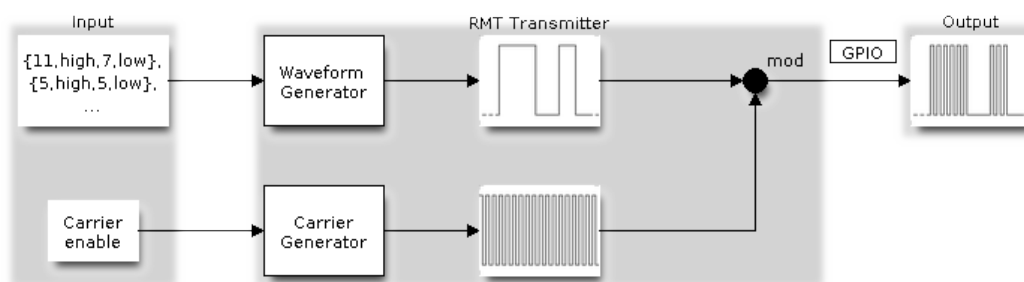

Fig. 9: RMT Transmitter Overview

The reverse operation is performed by the receiver, where a series of pulses is decoded into a list of values containing the pulse duration and binary level. A filter may be applied to remove high frequency noise from the input signal.

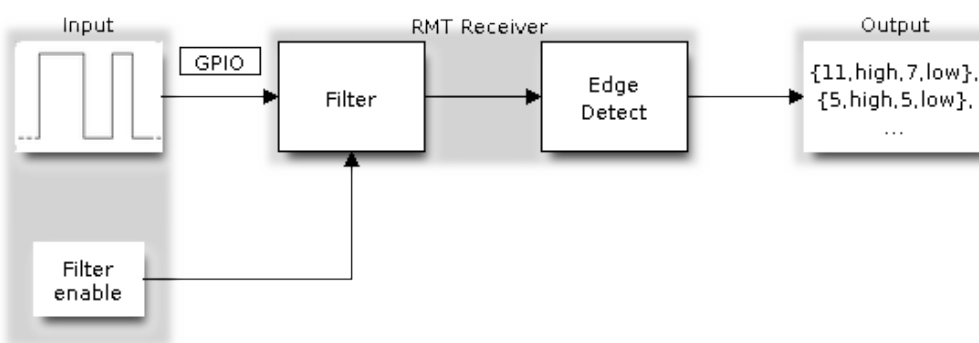

Fig. 10: RMT Receiver Overview

There couple of typical steps to setup and operate the RMT and they are discussed in the following sections:

1. *Configure Driver*
2. *Transmit Data or Receive Data*
3. *Change Operation Parameters*
4. *Use Interrupts*

The RMT has four channels numbered from zero to three. The first half (i.e. Channel 0 ~ 1) channels can only be configured for transmitting, and the other half (i.e. Channel 2 ~ 3) channels can only be configured for receiving. They are referred to using indexes defined in structure `rmt_channel_t`.

Configure Driver

There are several parameters that define how particular channel operates. Most of these parameters are configured by setting specific members of `rmt_config_t` structure. Some of the parameters are common to both transmit or receive mode, and some are mode specific. They are all discussed below.

Common Parameters

- The **channel** to be configured, select one from the `rmt_channel_t` enumerator.
- The RMT **operation mode** - whether this channel is used to transmit or receive data, selected by setting a **rmt_mode** members to one of the values from `rmt_mode_t`.
- What is the **pin number** to transmit or receive RMT signals, selected by setting **gpio_num**.
- How many **memory blocks** will be used by the channel, set with **mem_block_num**.

- Extra miscellaneous parameters for the channel can be set in the **flags**.
 - When **RMT_CHANNEL_FLAGS_AWARE_DFS** is set, RMT channel will take REF_TICK or XTAL as source clock. The benefit is, RMT channel can continue work even when APB clock is changing. See [power_management](#) for more information.
- A **clock divider**, that will determine the range of pulse length generated by the RMT transmitter or discriminated by the receiver. Selected by setting **clk_div** to a value within [1 .. 255] range. The RMT source clock is typically APB CLK, 80Mhz by default. But when **RMT_CHANNEL_FLAGS_AWARE_DFS** is set in **flags**, RMT source clock is changed to REF_TICK or XTAL.

Note: The period of a square wave after the clock divider is called a ‘tick’ . The length of the pulses generated by the RMT transmitter or discriminated by the receiver is configured in number of ‘ticks’ .

There are also couple of specific parameters that should be set up depending if selected channel is configured in [Transmit Mode](#) or [Receive Mode](#):

Transmit Mode When configuring channel in transmit mode, set **tx_config** and the following members of `rmt_tx_config_t`:

- Transmit the currently configured data items in a loop - **loop_en**
- Enable the RMT carrier signal - **carrier_en**
- Frequency of the carrier in Hz - **carrier_freq_hz**
- Duty cycle of the carrier signal in percent (%) - **carrier_duty_percent**
- Level of the RMT output, when the carrier is applied - **carrier_level**
- Enable the RMT output if idle - **idle_output_en**
- Set the signal level on the RMT output if idle - **idle_level**

Receive Mode In receive mode, set **rx_config** and the following members of `rmt_rx_config_t`:

- Enable a filter on the input of the RMT receiver - **filter_en**
- A threshold of the filter, set in the number of ticks - **filter_ticks_thresh**. Pulses shorter than this setting will be filtered out. Note, that the range of entered tick values is [0..255].
- A pulse length threshold that will turn the RMT receiver idle, set in number of ticks - **idle_threshold**. The receiver will ignore pulses longer than this setting.

Finalize Configuration Once the `rmt_config_t` structure is populated with parameters, it should be then invoked with `rmt_config()` to make the configuration effective.

The last configuration step is installation of the driver in memory by calling `rmt_driver_install()`. If `rx_buf_size` parameter of this function is > 0, then a ring buffer for incoming data will be allocated. A default ISR handler will be installed, see a note in [Use Interrupts](#).

Now, depending on how the channel is configured, we are ready to either [Transmit Data](#) or [Receive Data](#). This is described in next two sections.

Transmit Data

Before being able to transmit some RMT pulses, we need to define the pulse pattern. The minimum pattern recognized by the RMT controller, later called an ‘item’ , is provided in a structure `rmt_item32_t`. Each item consists of two pairs of two values. The first value in a pair describes the signal duration in ticks and is 15 bits long, the second provides the signal level (high or low) and is contained in a single bit. A block of couple of items and the structure of an item is presented below.

For a simple example how to define a block of items see [peripherals/rmt/morse_code](#).

The items are provided to the RMT controller by calling function `rmt_write_items()`. This function also automatically triggers start of transmission. It may be called to wait for transmission completion or exit just after transmission start. In such case you can wait for the transmission end by calling `rmt_wait_tx_done()`. This

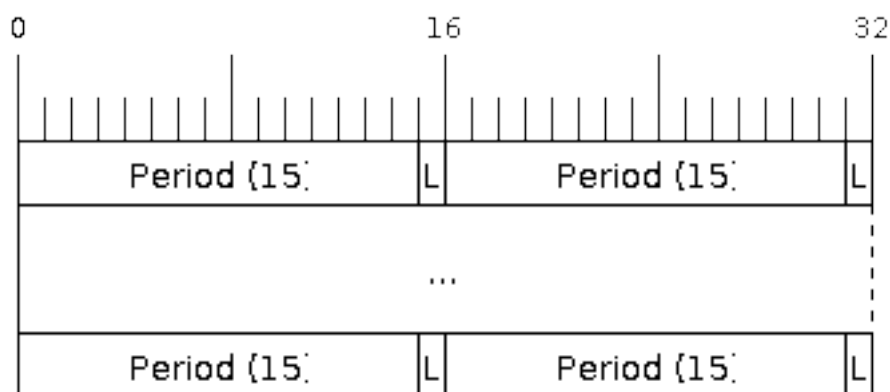

Fig. 11: Structure of RMT items (L - signal level)

function does not limit the number of data items to transmit. It is using an interrupt to successively copy the new data chunks to RMT's internal memory as previously provided data are sent out.

Another way to provide data for transmission is by calling `rmt_fill_tx_items()`. In this case transmission is not started automatically. To control the transmission process use `rmt_tx_start()` and `rmt_tx_stop()`. The number of items to sent is restricted by the size of memory blocks allocated in the RMT controller's internal memory, see `rmt_set_mem_block_num()`.

Receive Data

Before starting the receiver we need some storage for incoming items. The RMT controller has 192 x 32-bits of internal RAM shared between all four channels.

In typical scenarios it is not enough as an ultimate storage for all incoming (and outgoing) items. Therefore this API supports retrieval of incoming items on the fly to save them in a ring buffer of a size defined by the user. The size is provided when calling `rmt_driver_install()` discussed above. To get a handle to this buffer call `rmt_get_ringbuf_handle()`.

With the above steps complete we can start the receiver by calling `rmt_rx_start()` and then move to checking what's inside the buffer. To do so, you can use common FreeRTOS functions that interact with the ring buffer. Please see an example how to do it in [peripherals/rmt/ir_protocols](#).

To stop the receiver, call `rmt_rx_stop()`.

Change Operation Parameters

Previously described function `rmt_config()` provides a convenient way to set several configuration parameters in one shot. This is usually done on application start. Then, when the application is running, the API provides an alternate way to update individual parameters by calling dedicated functions. Each function refers to the specific RMT channel provided as the first input parameter. Most of the functions have `_get_` counterpart to read back the currently configured value.

Parameters Common to Transmit and Receive Mode

- Selection of a GPIO pin number on the input or output of the RMT - `rmt_set_pin()`
- Number of memory blocks allocated for the incoming or outgoing data - `rmt_set_mem_pd()`
- Setting of the clock divider - `rmt_set_clk_div()`

- Selection of the clock source, note that currently one clock source is supported, the APB clock which is 80Mhz - `rmt_set_source_clk()`

Transmit Mode Parameters

- Enable or disable the loop back mode for the transmitter - `rmt_set_tx_loop_mode()`
- Binary level on the output to apply the carrier - `rmt_set_tx_carrier()`, selected from `rmt_carrier_level_t`
- Determines the binary level on the output when transmitter is idle - `rmt_set_idle_level()`, selected from `rmt_idle_level_t`

Receive Mode Parameters

- The filter setting - `rmt_set_rx_filter()`
- The receiver threshold setting - `rmt_set_rx_idle_thresh()`
- Whether the transmitter or receiver is entitled to access RMT's memory - `rmt_set_memory_owner()`, selection is from `rmt_mem_owner_t`.

Use Interrupts

Registering of an interrupt handler for the RMT controller is done by calling `rmt_isr_register()`.

Note: When calling `rmt_driver_install()` to use the system RMT driver, a default ISR is being installed. In such a case you cannot register a generic ISR handler with `rmt_isr_register()`.

The RMT controller triggers interrupts on four specific events described below. To enable interrupts on these events, the following functions are provided:

- The RMT receiver has finished receiving a signal - `rmt_set_rx_intr_en()`
- The RMT transmitter has finished transmitting the signal - `rmt_set_tx_intr_en()`
- The number of events the transmitter has sent matches a threshold value `rmt_set_tx_thr_intr_en()`
- Ownership to the RMT memory block has been violated - `rmt_set_err_intr_en()`

Setting or clearing an interrupt enable mask for specific channels and events may be also done by calling `rmt_set_intr_enable_mask()` or `rmt_clr_intr_enable_mask()`.

When servicing an interrupt within an ISR, the interrupt need to explicitly cleared. To do so, set specific bits described as `RMT.int_clr.val.chN_event_name` and defined as a volatile struct in `soc/esp32c3/include/soc/rmt_struct.h`, where N is the RMT channel number [0, n] and the event_name is one of four events described above.

If you do not need an ISR anymore, you can deregister it by calling a function `rmt_isr_deregister()`.

Warning: It's not recommended for users to register an interrupt handler in their applications. RMT driver is highly dependent on interrupt, especially when doing transaction in a ping-pong way, so the driver itself has registered a default handler called `rmt_driver_isr_default`. Instead, if what you want is to get a notification when transaction is done, go ahead with `rmt_register_tx_end_callback()`.

Uninstall Driver

If the RMT driver has been installed with `rmt_driver_install()` for some specific period of time and then not required, the driver may be removed to free allocated resources by calling `rmt_driver_uninstall()`.

Application Examples

- Using RMT to send morse code: [peripherals/rmt/morse_code](#).
- Using RMT to drive RGB LED strip: [peripherals/rmt/led_strip](#).
- NEC remote control TX and RX example: [peripherals/rmt/ir_protocols](#).
- Musical buzzer example: [peripherals/rmt/musical_buzzer](#).

API Reference

Header File

- [driver/include/driver/rmt.h](#)

Functions

esp_err_t **rmt_set_clk_div**(*rmt_channel_t* channel, uint8_t div_cnt)

Set RMT clock divider, channel clock is divided from source clock.

Return

- ESP_ERR_INVALID_ARG Parameter error
- ESP_OK Success

Parameters

- channel: RMT channel
- div_cnt: RMT counter clock divider

esp_err_t **rmt_get_clk_div**(*rmt_channel_t* channel, uint8_t *div_cnt)

Get RMT clock divider, channel clock is divided from source clock.

Return

- ESP_ERR_INVALID_ARG Parameter error
- ESP_OK Success

Parameters

- channel: RMT channel
- div_cnt: pointer to accept RMT counter divider

esp_err_t **rmt_set_rx_idle_thresh**(*rmt_channel_t* channel, uint16_t thresh)

Set RMT RX idle threshold value.

In receive mode, when no edge is detected on the input signal for longer than idle_thresh channel clock cycles, the receive process is finished.

Return

- ESP_ERR_INVALID_ARG Parameter error
- ESP_OK Success

Parameters

- channel: RMT channel
- thresh: RMT RX idle threshold

esp_err_t **rmt_get_rx_idle_thresh**(*rmt_channel_t* channel, uint16_t *thresh)

Get RMT idle threshold value.

In receive mode, when no edge is detected on the input signal for longer than idle_thresh channel clock cycles, the receive process is finished.

Return

- ESP_ERR_INVALID_ARG Parameter error
- ESP_OK Success

Parameters

- channel: RMT channel
- thresh: pointer to accept RMT RX idle threshold value

esp_err_t **rmt_set_mem_block_num**(*rmt_channel_t* channel, uint8_t rmt_mem_num)

Set RMT memory block number for RMT channel.

This function is used to configure the amount of memory blocks allocated to channel *n*. The 8 channels share a 512x32-bit RAM block which can be read and written by the processor cores over the APB bus, as well as read by the transmitters and written by the receivers.

The RAM address range for channel *n* is `start_addr_CHn` to `end_addr_CHn`, which are defined by: Memory block start address is `RMT_CHANNEL_MEM(n)` (in `soc/rmt_reg.h`), that is, `start_addr_chn = RMT base address + 0x800 + 64 * 4 * n`, and `end_addr_chn = RMT base address + 0x800 + 64 * 4 * n + 64 * 4 * RMT_MEM_SIZE_CHn mod 512 * 4`.

Note If memory block number of one channel is set to a value greater than 1, this channel will occupy the memory block of the next channel. Channel 0 can use at most 8 blocks of memory, accordingly channel 7 can only use one memory block.

Return

- `ESP_ERR_INVALID_ARG` Parameter error
- `ESP_OK` Success

Parameters

- `channel`: RMT channel
- `rmt_mem_num`: RMT RX memory block number, one block has $64 * 32$ bits.

`esp_err_t rmt_get_mem_block_num(rmt_channel_t channel, uint8_t *rmt_mem_num)`
Get RMT memory block number.

Return

- `ESP_ERR_INVALID_ARG` Parameter error
- `ESP_OK` Success

Parameters

- `channel`: RMT channel
- `rmt_mem_num`: Pointer to accept RMT RX memory block number

`esp_err_t rmt_set_tx_carrier(rmt_channel_t channel, bool carrier_en, uint16_t high_level, uint16_t low_level, rmt_carrier_level_t carrier_level)`
Configure RMT carrier for TX signal.

Set different values for `carrier_high` and `carrier_low` to set different frequency of carrier. The unit of `carrier_high/low` is the source clock tick, not the divided channel counter clock.

Return

- `ESP_ERR_INVALID_ARG` Parameter error
- `ESP_OK` Success

Parameters

- `channel`: RMT channel
- `carrier_en`: Whether to enable output carrier.
- `high_level`: High level duration of carrier
- `low_level`: Low level duration of carrier.
- `carrier_level`: Configure the way carrier wave is modulated for channel.
 - 1' b1:transmit on low output level
 - 1' b0:transmit on high output level

`esp_err_t rmt_set_mem_pd(rmt_channel_t channel, bool pd_en)`
Set RMT memory in low power mode.

Reduce power consumed by memory. 1:memory is in low power state.

Return

- `ESP_ERR_INVALID_ARG` Parameter error
- `ESP_OK` Success

Parameters

- `channel`: RMT channel
- `pd_en`: RMT memory low power enable.

`esp_err_t rmt_get_mem_pd(rmt_channel_t channel, bool *pd_en)`
Get RMT memory low power mode.

Return

- ESP_ERR_INVALID_ARG Parameter error
- ESP_OK Success

Parameters

- `channel`: RMT channel
- `pd_en`: Pointer to accept RMT memory low power mode.

esp_err_t **rmt_tx_start** (*rmt_channel_t* channel, bool tx_idx_rst)

Set RMT start sending data from memory.

Return

- ESP_ERR_INVALID_ARG Parameter error
- ESP_OK Success

Parameters

- `channel`: RMT channel
- `tx_idx_rst`: Set true to reset memory index for TX. Otherwise, transmitter will continue sending from the last index in memory.

esp_err_t **rmt_tx_stop** (*rmt_channel_t* channel)

Set RMT stop sending.

Return

- ESP_ERR_INVALID_ARG Parameter error
- ESP_OK Success

Parameters

- `channel`: RMT channel

esp_err_t **rmt_rx_start** (*rmt_channel_t* channel, bool rx_idx_rst)

Set RMT start receiving data.

Return

- ESP_ERR_INVALID_ARG Parameter error
- ESP_OK Success

Parameters

- `channel`: RMT channel
- `rx_idx_rst`: Set true to reset memory index for receiver. Otherwise, receiver will continue receiving data to the last index in memory.

esp_err_t **rmt_rx_stop** (*rmt_channel_t* channel)

Set RMT stop receiving data.

Return

- ESP_ERR_INVALID_ARG Parameter error
- ESP_OK Success

Parameters

- `channel`: RMT channel

esp_err_t **rmt_tx_memory_reset** (*rmt_channel_t* channel)

Reset RMT TX memory.

Return

- ESP_ERR_INVALID_ARG Parameter error
- ESP_OK Success

Parameters

- `channel`: RMT channel

esp_err_t **rmt_rx_memory_reset** (*rmt_channel_t* channel)

Reset RMT RX memory.

Return

- ESP_ERR_INVALID_ARG Parameter error
- ESP_OK Success

Parameters

- `channel`: RMT channel

esp_err_t **rmt_set_memory_owner** (*rmt_channel_t* channel, *rmt_mem_owner_t* owner)

Set RMT memory owner.

Return

- ESP_ERR_INVALID_ARG Parameter error
- ESP_OK Success

Parameters

- channel: RMT channel
- owner: To set when the transmitter or receiver can process the memory of channel.

esp_err_t **rmt_get_memory_owner** (*rmt_channel_t* channel, *rmt_mem_owner_t* *owner)

Get RMT memory owner.

Return

- ESP_ERR_INVALID_ARG Parameter error
- ESP_OK Success

Parameters

- channel: RMT channel
- owner: Pointer to get memory owner.

esp_err_t **rmt_set_tx_loop_mode** (*rmt_channel_t* channel, bool loop_en)

Set RMT tx loop mode.

Return

- ESP_ERR_INVALID_ARG Parameter error
- ESP_OK Success

Parameters

- channel: RMT channel
- loop_en: Enable RMT transmitter loop sending mode. If set true, transmitter will continue sending from the first data to the last data in channel over and over again in a loop.

esp_err_t **rmt_get_tx_loop_mode** (*rmt_channel_t* channel, bool *loop_en)

Get RMT tx loop mode.

Return

- ESP_ERR_INVALID_ARG Parameter error
- ESP_OK Success

Parameters

- channel: RMT channel
- loop_en: Pointer to accept RMT transmitter loop sending mode.

esp_err_t **rmt_set_rx_filter** (*rmt_channel_t* channel, bool rx_filter_en, uint8_t thresh)

Set RMT RX filter.

In receive mode, channel will ignore input pulse when the pulse width is smaller than threshold. Counted in source clock, not divided counter clock.

Return

- ESP_ERR_INVALID_ARG Parameter error
- ESP_OK Success

Parameters

- channel: RMT channel
- rx_filter_en: To enable RMT receiver filter.
- thresh: Threshold of pulse width for receiver.

esp_err_t **rmt_set_source_clk** (*rmt_channel_t* channel, *rmt_source_clk_t* base_clk)

Set RMT source clock.

RMT module has two clock sources:

1. APB clock which is 80Mhz
2. REF tick clock, which would be 1Mhz (not supported in this version).

Return

- ESP_ERR_INVALID_ARG Parameter error

- ESP_OK Success

Parameters

- `channel`: RMT channel
- `base_clk`: To choose source clock for RMT module.

esp_err_t `rmt_get_source_clk` (*rmt_channel_t* channel, *rmt_source_clk_t* *src_clk)

Get RMT source clock.

RMT module has two clock sources:

1. APB clock which is 80Mhz
2. REF tick clock, which would be 1Mhz (not supported in this version).

Return

- ESP_ERR_INVALID_ARG Parameter error
- ESP_OK Success

Parameters

- `channel`: RMT channel
- `src_clk`: Pointer to accept source clock for RMT module.

esp_err_t `rmt_set_idle_level` (*rmt_channel_t* channel, bool *idle_out_en*, *rmt_idle_level_t* level)

Set RMT idle output level for transmitter.

Return

- ESP_ERR_INVALID_ARG Parameter error
- ESP_OK Success

Parameters

- `channel`: RMT channel
- `idle_out_en`: To enable idle level output.
- `level`: To set the output signal's level for channel in idle state.

esp_err_t `rmt_get_idle_level` (*rmt_channel_t* channel, bool **idle_out_en*, *rmt_idle_level_t* *level)

Get RMT idle output level for transmitter.

Return

- ESP_ERR_INVALID_ARG Parameter error
- ESP_OK Success

Parameters

- `channel`: RMT channel
- `idle_out_en`: Pointer to accept value of enable idle.
- `level`: Pointer to accept value of output signal's level in idle state for specified channel.

esp_err_t `rmt_get_status` (*rmt_channel_t* channel, uint32_t **status*)

Get RMT status.

Return

- ESP_ERR_INVALID_ARG Parameter error
- ESP_OK Success

Parameters

- `channel`: RMT channel
- `status`: Pointer to accept channel status. Please refer to RMT_CHnSTATUS_REG(n=0~7) in `rmt_reg.h` for more details of each field.

esp_err_t `rmt_set_rx_intr_en` (*rmt_channel_t* channel, bool *en*)

Set RMT RX interrupt enable.

Return

- ESP_ERR_INVALID_ARG Parameter error
- ESP_OK Success

Parameters

- `channel`: RMT channel
- `en`: enable or disable RX interrupt.

esp_err_t `rmt_set_err_intr_en` (*rmt_channel_t* channel, bool *en*)

Set RMT RX error interrupt enable.

Return

- ESP_ERR_INVALID_ARG Parameter error
- ESP_OK Success

Parameters

- `channel`: RMT channel
- `en`: enable or disable RX err interrupt.

esp_err_t `rmt_set_tx_intr_en` (*rmt_channel_t* `channel`, bool `en`)

Set RMT TX interrupt enable.

Return

- ESP_ERR_INVALID_ARG Parameter error
- ESP_OK Success

Parameters

- `channel`: RMT channel
- `en`: enable or disable TX interrupt.

esp_err_t `rmt_set_tx_thr_intr_en` (*rmt_channel_t* `channel`, bool `en`, uint16_t `evt_thresh`)

Set RMT TX threshold event interrupt enable.

An interrupt will be triggered when the number of transmitted items reaches the threshold value

Return

- ESP_ERR_INVALID_ARG Parameter error
- ESP_OK Success

Parameters

- `channel`: RMT channel
- `en`: enable or disable TX event interrupt.
- `evt_thresh`: RMT event interrupt threshold value

esp_err_t `rmt_set_pin` (*rmt_channel_t* `channel`, *rmt_mode_t* `mode`, *gpio_num_t* `gpio_num`)

Set RMT pin.

Return

- ESP_ERR_INVALID_ARG Parameter error
- ESP_OK Success

Parameters

- `channel`: RMT channel
- `mode`: TX or RX mode for RMT
- `gpio_num`: GPIO number to transmit or receive the signal.

esp_err_t `rmt_config` (`const` *rmt_config_t* `*rmt_param`)

Configure RMT parameters.

Return

- ESP_ERR_INVALID_ARG Parameter error
- ESP_OK Success

Parameters

- `rmt_param`: RMT parameter struct

esp_err_t `rmt_isr_register` (void (*`fn`)) void *

, void `*arg`, int `intr_alloc_flags`, *rmt_isr_handle_t* `*handle` Register RMT interrupt handler, the handler is an ISR.

The handler will be attached to the same CPU core that this function is running on.

Note If you already called `rmt_driver_install` to use system RMT driver, please do not register ISR handler again.

Return

- ESP_OK Success
- ESP_ERR_INVALID_ARG Function pointer error.
- ESP_FAIL System driver installed, can not register ISR handler for RMT

Parameters

- `fn`: Interrupt handler function.

- `arg`: Parameter for the handler function
- `intr_alloc_flags`: Flags used to allocate the interrupt. One or multiple (ORred) `ESP_INTR_FLAG_*` values. See `esp_intr_alloc.h` for more info.
- `handle`: If non-zero, a handle to later clean up the ISR gets stored here.

esp_err_t **rmt_isr_deregister** (*rmt_isr_handle_t* handle)

Deregister previously registered RMT interrupt handler.

Return

- `ESP_OK` Success
- `ESP_ERR_INVALID_ARG` Handle invalid

Parameters

- `handle`: Handle obtained from `rmt_isr_register`

esp_err_t **rmt_fill_tx_items** (*rmt_channel_t* channel, **const** *rmt_item32_t* *item, *uint16_t* item_num, *uint16_t* mem_offset)

Fill memory data of channel with given RMT items.

Return

- `ESP_ERR_INVALID_ARG` Parameter error
- `ESP_OK` Success

Parameters

- `channel`: RMT channel
- `item`: Pointer of items.
- `item_num`: RMT sending items number.
- `mem_offset`: Index offset of memory.

esp_err_t **rmt_driver_install** (*rmt_channel_t* channel, *size_t* rx_buf_size, *int* intr_alloc_flags)

Initialize RMT driver.

Return

- `ESP_ERR_INVALID_STATE` Driver is already installed, call `rmt_driver_uninstall` first.
- `ESP_ERR_NO_MEM` Memory allocation failure
- `ESP_ERR_INVALID_ARG` Parameter error
- `ESP_OK` Success

Parameters

- `channel`: RMT channel
- `rx_buf_size`: Size of RMT RX ringbuffer. Can be 0 if the RX ringbuffer is not used.
- `intr_alloc_flags`: Flags for the RMT driver interrupt handler. Pass 0 for default flags. See `esp_intr_alloc.h` for details. If `ESP_INTR_FLAG_IRAM` is used, please do not use the memory allocated from psram when calling `rmt_write_items`.

esp_err_t **rmt_driver_uninstall** (*rmt_channel_t* channel)

Uninstall RMT driver.

Return

- `ESP_ERR_INVALID_ARG` Parameter error
- `ESP_OK` Success

Parameters

- `channel`: RMT channel

esp_err_t **rmt_get_channel_status** (*rmt_channel_status_result_t* *channel_status)

Get the current status of eight channels.

Note Do not call this function if it is possible that `rmt_driver_uninstall` will be called at the same time.

Return

- `ESP_ERR_INVALID_ARG` Parameter is NULL
- `ESP_OK` Success

Parameters

- [out] `channel_status`: store the current status of each channel

esp_err_t **rmt_get_counter_clock** (*rmt_channel_t* channel, *uint32_t* *clock_hz)

Get speed of channel' s internal counter clock.

Return

- ESP_ERR_INVALID_ARG Parameter is NULL
- ESP_OK Success

Parameters

- `channel`: RMT channel
- `[out] clock_hz`: counter clock speed, in hz

esp_err_t **rmt_write_items** (*rmt_channel_t* `channel`, **const** *rmt_item32_t* *`rmt_item`, *int* `item_num`, *bool* `wait_tx_done`)

RMT send waveform from `rmt_item` array.

This API allows user to send waveform with any length.

Note This function will not copy data, instead, it will point to the original items, and send the waveform items. If `wait_tx_done` is set to true, this function will block and will not return until all items have been sent out. If `wait_tx_done` is set to false, this function will return immediately, and the driver interrupt will continue sending the items. We must make sure the item data will not be damaged when the driver is still sending items in driver interrupt.

Return

- ESP_ERR_INVALID_ARG Parameter error
- ESP_OK Success

Parameters

- `channel`: RMT channel
- `rmt_item`: head point of RMT items array. If ESP_INTR_FLAG_IRAM is used, please do not use the memory allocated from psram when calling `rmt_write_items`.
- `item_num`: RMT data item number.
- `wait_tx_done`:
 - If set 1, it will block the task and wait for sending done.
 - If set 0, it will not wait and return immediately.

esp_err_t **rmt_wait_tx_done** (*rmt_channel_t* `channel`, *TickType_t* `wait_time`)

Wait RMT TX finished.

Return

- ESP_OK RMT Tx done successfully
- ESP_ERR_TIMEOUT Exceeded the 'wait_time' given
- ESP_ERR_INVALID_ARG Parameter error
- ESP_FAIL Driver not installed

Parameters

- `channel`: RMT channel
- `wait_time`: Maximum time in ticks to wait for transmission to be complete. If set 0, return immediately with ESP_ERR_TIMEOUT if TX is busy (polling).

esp_err_t **rmt_get_ringbuf_handle** (*rmt_channel_t* `channel`, *RingbufHandle_t* *`buf_handle`)

Get ringbuffer from RMT.

Users can get the RMT RX ringbuffer handle, and process the RX data.

Return

- ESP_ERR_INVALID_ARG Parameter error
- ESP_OK Success

Parameters

- `channel`: RMT channel
- `buf_handle`: Pointer to buffer handle to accept RX ringbuffer handle.

esp_err_t **rmt_translator_init** (*rmt_channel_t* `channel`, *sample_to_rmt_t* `fn`)

Init rmt translator and register user callback. The callback will convert the raw data that needs to be sent to rmt format. If a channel is initialized more than once, the user callback will be replaced by the later.

Return

- ESP_FAIL Init fail.
- ESP_OK Init success.

Parameters

- `channel`: RMT channel .
- `fn`: Point to the data conversion function.

esp_err_t **rmt_translator_set_context** (*rmt_channel_t* channel, void *context)

Set user context for the translator of specific channel.

Return

- ESP_FAIL Set context fail
- ESP_OK Set context success

Parameters

- `channel`: RMT channel number
- `context`: User context

esp_err_t **rmt_translator_get_context** (const size_t *item_num, void **context)

Get the user context set by 'rmt_translator_set_context' .

Note This API must be invoked in the RMT translator callback function, and the first argument must be the actual parameter 'item_num' you got in that callback function.

Return

- ESP_FAIL Get context fail
- ESP_OK Get context success

Parameters

- `item_num`: Address of the memory which contains the number of translated items (It' s from driver' s internal memroy)
- `context`: Returned User context

esp_err_t **rmt_write_sample** (*rmt_channel_t* channel, const uint8_t *src, size_t src_size, bool wait_tx_done)

Translate uint8_t type of data into rmt format and send it out. Requires rmt_translator_init to init the translator first.

Return

- ESP_FAIL Send fail
- ESP_OK Send success

Parameters

- `channel`: RMT channel .
- `src`: Pointer to the raw data.
- `src_size`: The size of the raw data.
- `wait_tx_done`: Set true to wait all data send done.

rmt_tx_end_callback_t **rmt_register_tx_end_callback** (*rmt_tx_end_fn_t* function, void *arg)

Registers a callback that will be called when transmission ends.

Called by rmt_driver_isr_default in interrupt context.

Note Requires rmt_driver_install to install the default ISR handler.

Return the previous callback settings (members will be set to NULL if there was none)

Parameters

- `function`: Function to be called from the default interrupt handler or NULL.
- `arg`: Argument which will be provided to the callback when it is called.

esp_err_t **rmt_set_rx_thr_intr_en** (*rmt_channel_t* channel, bool en, uint16_t evt_thresh)

Set RMT RX threshold event interrupt enable.

An interrupt will be triggered when the number of received items reaches the threshold value

Return

- ESP_ERR_INVALID_ARG Parameter error
- ESP_OK Success

Parameters

- `channel`: RMT channel
- `en`: enable or disable RX event interrupt.
- `evt_thresh`: RMT event interrupt threshold value

esp_err_t **rmt_add_channel_to_group** (*rmt_channel_t* channel)

Add channel into a group (channels in the same group will transmit simultaneously)

Return

- ESP_ERR_INVALID_ARG Parameter error
- ESP_OK Success

Parameters

- channel: RMT channel

esp_err_t **rmt_remove_channel_from_group** (*rmt_channel_t* channel)

Remove channel out of a group.

Return

- ESP_ERR_INVALID_ARG Parameter error
- ESP_OK Success

Parameters

- channel: RMT channel

esp_err_t **rmt_set_tx_loop_count** (*rmt_channel_t* channel, *uint32_t* count)

Set loop count for RMT TX channel.

Return

- ESP_ERR_INVALID_ARG Parameter error
- ESP_OK Success

Parameters

- channel: RMT channel
- count: loop count

esp_err_t **rmt_memory_rw_rst** (*rmt_channel_t* channel)

Reset RMT TX/RX memory index.

Return

- ESP_ERR_INVALID_ARG Parameter error
- ESP_OK Success

Parameters

- channel: RMT channel

void **rmt_set_intr_enable_mask** (*uint32_t* mask)

Set mask value to RMT interrupt enable register.

Parameters

- mask: Bit mask to set to the register

void **rmt_clr_intr_enable_mask** (*uint32_t* mask)

Clear mask value to RMT interrupt enable register.

Parameters

- mask: Bit mask to clear the register

Structures

struct rmt_tx_config_t

Data struct of RMT TX configure parameters.

Public Members

uint32_t **carrier_freq_hz**

RMT carrier frequency

rmt_carrier_level_t **carrier_level**

Level of the RMT output, when the carrier is applied

rmt_idle_level_t **idle_level**

RMT idle level

`uint8_t carrier_duty_percent`
RMT carrier duty (%)

`uint32_t loop_count`
Maximum loop count

`bool carrier_en`
RMT carrier enable

`bool loop_en`
Enable sending RMT items in a loop

`bool idle_output_en`
RMT idle level output enable

`struct rmt_rx_config_t`
Data struct of RMT RX configure parameters.

Public Members

`uint16_t idle_threshold`
RMT RX idle threshold

`uint8_t filter_ticks_thresh`
RMT filter tick number

`bool filter_en`
RMT receiver filter enable

`bool rm_carrier`
RMT receiver remove carrier enable

`uint32_t carrier_freq_hz`
RMT carrier frequency

`uint8_t carrier_duty_percent`
RMT carrier duty (%)

`rmt_carrier_level_t carrier_level`
The level to remove the carrier

`struct rmt_config_t`
Data struct of RMT configure parameters.

Public Members

`rmt_mode_t rmt_mode`
RMT mode: transmitter or receiver

`rmt_channel_t channel`
RMT channel

`gpio_num_t gpio_num`
RMT GPIO number

`uint8_t clk_div`
RMT channel counter divider

`uint8_t mem_block_num`
RMT memory block number

`uint32_t flags`
RMT channel extra configurations, OR' d with RMT_CHANNEL_FLAGS_[*]

`rmt_tx_config_t tx_config`
RMT TX parameter

rmt_rx_config_t rx_config

RMT RX parameter

struct rmt_tx_end_callback_t

Structure encapsulating a RMT TX end callback.

Public Members

rmt_tx_end_fn_t function

Function which is called on RMT TX end

void *arg

Optional argument passed to function

Macros

RMT_CHANNEL_FLAGS_AWARE_DFS

Channel can work during APB clock scaling

RMT_MEM_ITEM_NUM

Define memory space of each RMT channel (in words = 4 bytes)

RMT_DEFAULT_CONFIG_TX (gpio, channel_id)

Default configuration for Tx channel.

RMT_DEFAULT_CONFIG_RX (gpio, channel_id)

Default configuration for RX channel.

Type Definitions

typedef intr_handle_t rmt_isr_handle_t

RMT interrupt handle.

typedef void (*rmt_tx_end_fn_t) (rmt_channel_t channel, void *arg)

Type of RMT Tx End callback function.

typedef void (*sample_to_rmt_t) (const void *src, rmt_item32_t *dest, size_t src_size, size_t wanted_num, size_t *translated_size, size_t *item_num)

User callback function to convert uint8_t type data to rmt format(rmt_item32_t).

This function may be called from an ISR, so, the code should be short and efficient.

Note In fact, item_num should be a multiple of translated_size, e.g. : When we convert each byte of uint8_t type data to rmt format data, the relation between item_num and translated_size should be $item_num = translated_size * 8$.

Parameters

- **src**: Pointer to the buffer storing the raw data that needs to be converted to rmt format.
- **[out] dest**: Pointer to the buffer storing the rmt format data.
- **src_size**: The raw data size.
- **wanted_num**: The number of rmt format data that wanted to get.
- **[out] translated_size**: The size of the raw data that has been converted to rmt format, it should return 0 if no data is converted in user callback.
- **[out] item_num**: The number of the rmt format data that actually converted to, it can be less than wanted_num if there is not enough raw data, but cannot exceed wanted_num. it should return 0 if no data was converted.

Header File

- [hal/include/hal/rmt_types.h](#)

Structures

struct rmt_channel_status_result_t

Data struct of RMT channel status.

Public Members

`rmt_channel_status_t status[RMT_CHANNEL_MAX]`
Store the current status of each channel

Enumerations

`enum rmt_channel_t`
RMT channel ID.

Values:

`RMT_CHANNEL_0`
RMT channel number 0

`RMT_CHANNEL_1`
RMT channel number 1

`RMT_CHANNEL_2`
RMT channel number 2

`RMT_CHANNEL_3`
RMT channel number 3

`RMT_CHANNEL_MAX`
Number of RMT channels

`enum rmt_mem_owner_t`
RMT Internal Memory Owner.

Values:

`RMT_MEM_OWNER_TX`
RMT RX mode, RMT transmitter owns the memory block

`RMT_MEM_OWNER_RX`
RMT RX mode, RMT receiver owns the memory block

`RMT_MEM_OWNER_MAX`

`enum rmt_source_clk_t`
Clock Source of RMT Channel.

Values:

`RMT_BASECLK_APB = 1`
RMT source clock is APB CLK, 80Mhz by default

`RMT_BASECLK_XTAL = 3`
RMT source clock is XTAL clock, 40Mhz by default

`RMT_BASECLK_MAX`

`enum rmt_data_mode_t`
RMT Data Mode.

Note We highly recommended to use MEM mode not FIFO mode since there will be some gotcha in FIFO mode.

Values:

`RMT_DATA_MODE_FIFO`

`RMT_DATA_MODE_MEM`

`RMT_DATA_MODE_MAX`

`enum rmt_mode_t`
RMT Channel Working Mode (TX or RX)

Values:

RMT_MODE_TX
RMT TX mode

RMT_MODE_RX
RMT RX mode

RMT_MODE_MAX

enum rmt_idle_level_t
RMT Idle Level.

Values:

RMT_IDLE_LEVEL_LOW
RMT TX idle level: low Level

RMT_IDLE_LEVEL_HIGH
RMT TX idle level: high Level

RMT_IDLE_LEVEL_MAX

enum rmt_carrier_level_t
RMT Carrier Level.

Values:

RMT_CARRIER_LEVEL_LOW
RMT carrier wave is modulated for low Level output

RMT_CARRIER_LEVEL_HIGH
RMT carrier wave is modulated for high Level output

RMT_CARRIER_LEVEL_MAX

enum rmt_channel_status_t
RMT Channel Status.

Values:

RMT_CHANNEL_UNINIT
RMT channel uninitialized

RMT_CHANNEL_IDLE
RMT channel status idle

RMT_CHANNEL_BUSY
RMT channel status busy

2.3.10 SD SPI Host Driver

Overview

The SD SPI host driver allows communicating with one or more SD cards by the SPI Master driver which makes use of the SPI host. Each card is accessed through an SD SPI device represented by an *sdspi_dev_handle_t spi_handle* returned when attaching the device to an SPI bus by calling *sdspi_host_init_device*. The bus should be already initialized before (by *spi_bus_initialize*).

With the help of *SPI Master driver* based on, the SPI bus can be shared among SD cards and other SPI devices. The SPI Master driver will handle exclusive access from different tasks.

The SD SPI driver uses software-controlled CS signal.

How to Use

Firstly, use the macro `SDSPI_DEVICE_CONFIG_DEFAULT` to initialize a structure `sdmmc_slot_config_t`, which is used to initialize an SD SPI device. This macro will also fill in the default pin mappings, which is same as the pin mappings of SDMMC host driver. Modify the host and pins of the structure to desired value. Then call `sdspi_host_init_device` to initialize the SD SPI device and attach to its bus.

Then use `SDSPI_HOST_DEFAULT` macro to initialize a `sdmmc_host_t` structure, which is used to store the state and configurations of upper layer (SD/SDIO/MMC driver). Modify the `slot` parameter of the structure to the SD SPI device `spi_handle` just returned from `sdspi_host_init_device`. Call `sdmmc_card_init` with the `sdmmc_host_t` to probe and initialize the SD card.

Now you can use SD/SDIO/MMC driver functions to access your card!

Other Details

Only the following driver's API functions are normally used by most applications:

- `sdspi_host_init()`
- `sdspi_host_init_device()`
- `sdspi_host_remove_device()`
- `sdspi_host_deinit()`

Other functions are mostly used by the protocol level SD/SDIO/MMC driver via function pointers in the `sdmmc_host_t` structure. For more details, see [the SD/SDIO/MMC Driver](#).

Note: SD over SPI does not support speeds above `SDMMC_FREQ_DEFAULT` due to the limitations of the SPI driver.

API Reference

Header File

- `driver/include/driver/sdspi_host.h`

Functions

`esp_err_t sds_pi_host_init` (void)
Initialize SD SPI driver.

Note This function is not thread safe

Return

- `ESP_OK` on success
- other error codes may be returned in future versions

`esp_err_t sds_pi_host_init_device` (const `sdspi_device_config_t` *`dev_config`, `sdspi_dev_handle_t` *`out_handle`)
Attach and initialize an SD SPI device on the specific SPI bus.

Note This function is not thread safe

Note Initialize the SPI bus by `spi_bus_initialize()` before calling this function.

Note The SDIO over `sdspi` needs an extra interrupt line. Call `gpio_install_isr_service()` before this function.

Return

- `ESP_OK` on success
- `ESP_ERR_INVALID_ARG` if `sdspi_host_init_device` has invalid arguments
- `ESP_ERR_NO_MEM` if memory can not be allocated
- other errors from the underlying `spi_master` and `gpio` drivers

Parameters

- `dev_config`: pointer to device configuration structure

- `out_handle`: Output of the handle to the sdspi device.

esp_err_t **sdspi_host_remove_device** (*sdspi_dev_handle_t* handle)

Remove an SD SPI device.

Return Always ESP_OK

Parameters

- `handle`: Handle of the SD SPI device

esp_err_t **sdspi_host_do_transaction** (*sdspi_dev_handle_t* handle, *sdmmc_command_t* *cmdinfo)

Send command to the card and get response.

This function returns when command is sent and response is received, or data is transferred, or timeout occurs.

Note This function is not thread safe w.r.t. `init/deinit` functions, and bus width/clock speed configuration functions. Multiple tasks can call `sdspi_host_do_transaction` as long as other `sdspi_host_*` functions are not called.

Return

- ESP_OK on success
- ESP_ERR_TIMEOUT if response or data transfer has timed out
- ESP_ERR_INVALID_CRC if response or data transfer CRC check has failed
- ESP_ERR_INVALID_RESPONSE if the card has sent an invalid response

Parameters

- `handle`: Handle of the sdspi device
- `cmdinfo`: pointer to structure describing command and data to transfer

esp_err_t **sdspi_host_set_card_clk** (*sdspi_dev_handle_t* host, *uint32_t* freq_khz)

Set card clock frequency.

Currently only integer fractions of 40MHz clock can be used. For High Speed cards, 40MHz can be used. For Default Speed cards, 20MHz can be used.

Note This function is not thread safe

Return

- ESP_OK on success
- other error codes may be returned in the future

Parameters

- `host`: Handle of the sdspi device
- `freq_khz`: card clock frequency, in kHz

esp_err_t **sdspi_host_deinit** (void)

Release resources allocated using `sdspi_host_init`.

Note This function is not thread safe

Return

- ESP_OK on success
- ESP_ERR_INVALID_STATE if `sdspi_host_init` function has not been called

esp_err_t **sdspi_host_io_int_enable** (*sdspi_dev_handle_t* handle)

Enable SDIO interrupt.

Return

- ESP_OK on success

Parameters

- `handle`: Handle of the sdspi device

esp_err_t **sdspi_host_io_int_wait** (*sdspi_dev_handle_t* handle, *TickType_t* timeout_ticks)

Wait for SDIO interrupt until timeout.

Return

- ESP_OK on success

Parameters

- `handle`: Handle of the sdspi device
- `timeout_ticks`: Ticks to wait before timeout.

esp_err_t **sdspi_host_init_slot** (int *slot*, const *sdspi_slot_config_t* **slot_config*)

Initialize SD SPI driver for the specific SPI controller.

Note This function is not thread safe

Note The SDIO over sdspi needs an extra interrupt line. Call `gpio_install_isr_service()` before this function.

Parameters

- *slot*: SPI controller to use (SPI2_HOST or SPI3_HOST)
- *slot_config*: pointer to slot configuration structure

Return

- ESP_OK on success
- ESP_ERR_INVALID_ARG if `sdspi_init_slot` has invalid arguments
- ESP_ERR_NO_MEM if memory can not be allocated
- other errors from the underlying `spi_master` and `gpio` drivers

Structures

struct *sdspi_device_config_t*

Extra configuration for SD SPI device.

Public Members

spi_host_device_t **host_id**

SPI host to use, SPIx_HOST (see `spi_types.h`).

gpio_num_t **gpio_cs**

GPIO number of CS signal.

gpio_num_t **gpio_cd**

GPIO number of card detect signal.

gpio_num_t **gpio_wp**

GPIO number of write protect signal.

gpio_num_t **gpio_int**

GPIO number of interrupt line (input) for SDIO card.

struct *sdspi_slot_config_t*

Extra configuration for SPI host.

Public Members

gpio_num_t **gpio_cs**

GPIO number of CS signal.

gpio_num_t **gpio_cd**

GPIO number of card detect signal.

gpio_num_t **gpio_wp**

GPIO number of write protect signal.

gpio_num_t **gpio_int**

GPIO number of interrupt line (input) for SDIO card.

gpio_num_t **gpio_miso**

GPIO number of MISO signal.

gpio_num_t **gpio_mosi**

GPIO number of MOSI signal.

gpio_num_t **gpio_sck**

GPIO number of SCK signal.

int **dma_channel**
DMA channel to be used by SPI driver (1 or 2).

Macros

SDSPI_DEFAULT_HOST

SDSPI_HOST_DEFAULT ()

Default *sdmmc_host_t* structure initializer for SD over SPI driver.

Uses SPI mode and max frequency set to 20MHz

‘slot’ should be set to an *sdspi* device initialized by *sdspi_host_init_device()*.

SDSPI_SLOT_NO_CD

indicates that card detect line is not used

SDSPI_SLOT_NO_WP

indicates that write protect line is not used

SDSPI_SLOT_NO_INT

indicates that interrupt line is not used

SDSPI_DEVICE_CONFIG_DEFAULT ()

Macro defining default configuration of SD SPI device.

SDSPI_SLOT_CONFIG_DEFAULT ()

Macro defining default configuration of SPI host

Type Definitions

typedef int sdspi_dev_handle_t

Handle representing an SD SPI device.

2.3.11 Sigma-delta Modulation

Introduction

ESP32-C3 has a second-order sigma-delta modulation module. This driver configures the channels of the sigma-delta module.

Functionality Overview

There are four independent sigma-delta modulation channels identified with *sigmadelta_channel_t*. Each channel is capable to output the binary, hardware generated signal with the sigma-delta modulation.

Selected channel should be set up by providing configuration parameters in *sigmadelta_config_t* and then applying this configuration with *sigmadelta_config()*.

Another option is to call individual functions, that will configure all required parameters one by one:

- **Prescaler** of the sigma-delta generator - *sigmadelta_set_prescale()*
- **Duty** of the output signal - *sigmadelta_set_duty()*
- **GPIO pin** to output modulated signal - *sigmadelta_set_pin()*

The range of the ‘duty’ input parameter of *sigmadelta_set_duty()* is from -128 to 127 (eight bit signed integer). If zero value is set, then the output signal’s duty will be about 50%, see description of *sigmadelta_set_duty()*.

Convert to analog signal (Optional)

Typically, if the sigma-delta signal is connected to an LED, you don't have to add any filter between them (because our eyes are a low pass filter naturally). However, if you want to check the real voltage or watch the analog waveform, you need to design an analog low pass filter. Also, it is recommended to use an active filter instead of a passive filter to gain better isolation and not lose too much voltage.

For example, you can take the following [Sallen-Key topology Low Pass Filter](#) as a reference.

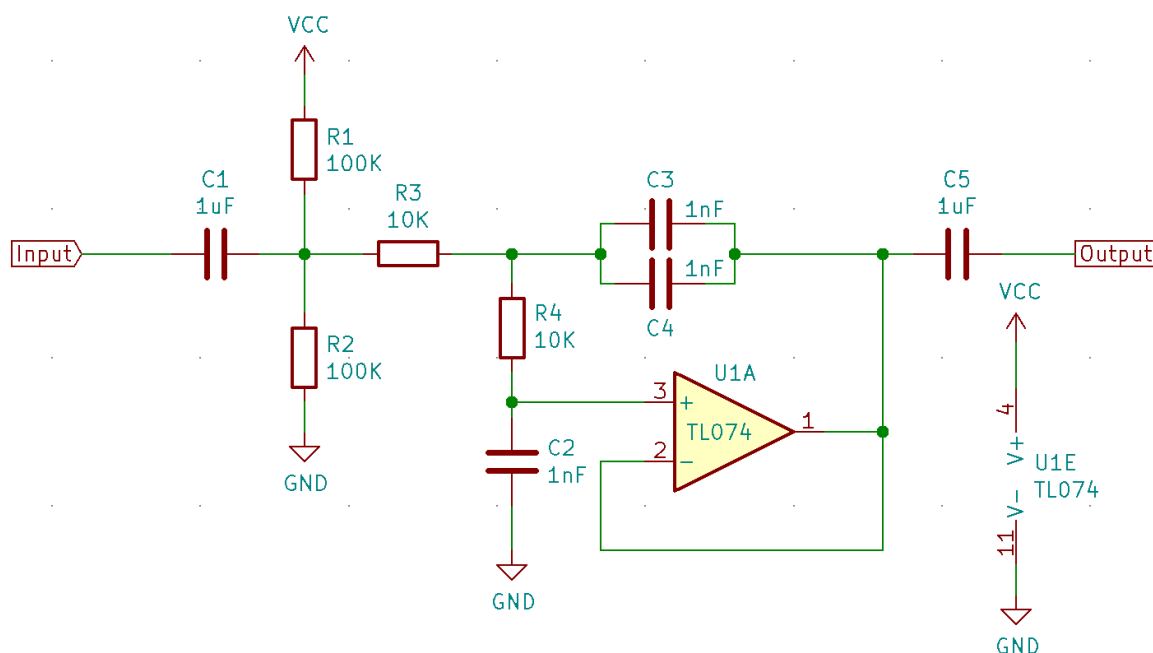

Fig. 12: Sallen-Key Low Pass Filter

Application Example

Sigma-delta Modulation example: [peripherals/sigmadelta](#).

API Reference

Header File

- [driver/include/driver/sigmadelta.h](#)

Functions

`esp_err_t sigmadelta_config(const sigmadelta_config_t *config)`

Configure Sigma-delta channel.

Return

- ESP_OK Success
- ESP_ERR_INVALID_STATE sigmadelta driver already initialized
- ESP_ERR_INVALID_ARG Parameter error

Parameters

- config: Pointer of Sigma-delta channel configuration struct

`esp_err_t sigmadelta_set_duty(sigmadelta_channel_t channel, int8_t duty)`

Set Sigma-delta channel duty.

This function is used to set Sigma-delta channel duty, If you add a capacitor between the output pin and ground, the average output voltage will be $V_{dc} = V_{DDIO} / 256 * duty + V_{DDIO}/2$, where VDDIO is the power supply voltage.

Return

- ESP_OK Success
- ESP_ERR_INVALID_STATE sigmadelta driver has not been initialized
- ESP_ERR_INVALID_ARG Parameter error

Parameters

- `channel`: Sigma-delta channel number
- `duty`: Sigma-delta duty of one channel, the value ranges from -128 to 127, recommended range is -90 ~ 90. The waveform is more like a random one in this range.

esp_err_t sigmadelta_set_prescale (*sigmadelta_channel_t channel*, *uint8_t prescale*)

Set Sigma-delta channel's clock pre-scale value. The source clock is APP_CLK, 80MHz. The clock frequency of the sigma-delta channel is APP_CLK / pre_scale.

Return

- ESP_OK Success
- ESP_ERR_INVALID_STATE sigmadelta driver has not been initialized
- ESP_ERR_INVALID_ARG Parameter error

Parameters

- `channel`: Sigma-delta channel number
- `prescale`: The divider of source clock, ranges from 0 to 255

esp_err_t sigmadelta_set_pin (*sigmadelta_channel_t channel*, *gpio_num_t gpio_num*)

Set Sigma-delta signal output pin.

Return

- ESP_OK Success
- ESP_ERR_INVALID_STATE sigmadelta driver has not been initialized
- ESP_ERR_INVALID_ARG Parameter error

Parameters

- `channel`: Sigma-delta channel number
- `gpio_num`: GPIO number of output pin.

Header File

- [hal/include/hal/sigmadelta_types.h](#)

Structures

struct sigmadelta_config_t

Sigma-delta configure struct.

Public Members

sigmadelta_channel_t channel

Sigma-delta channel number

int8_t sigmadelta_duty

Sigma-delta duty, duty ranges from -128 to 127.

uint8_t sigmadelta_prescale

Sigma-delta prescale, prescale ranges from 0 to 255.

uint8_t sigmadelta_gpio

Sigma-delta output io number, refer to gpio.h for more details.

Enumerations

enum sigmadelta_port_t

SIGMADELTA port number, the max port number is (SIGMADELTA_NUM_MAX -1).

Values:

SIGMADELTA_PORT_0

SIGMADELTA port 0

SIGMADELTA_PORT_MAX

SIGMADELTA port max

enum sigmadelta_channel_t

Sigma-delta channel list.

Values:

SIGMADELTA_CHANNEL_0

Sigma-delta channel 0

SIGMADELTA_CHANNEL_1

Sigma-delta channel 1

SIGMADELTA_CHANNEL_2

Sigma-delta channel 2

SIGMADELTA_CHANNEL_3

Sigma-delta channel 3

SIGMADELTA_CHANNEL_MAX

Sigma-delta channel max

2.3.12 SPI Master Driver

SPI Master driver is a program that controls ESP32-C3's SPI peripherals while they function as masters.

Overview of ESP32-C3's SPI peripherals

ESP32-C3 integrates 3 SPI peripherals.

- SPI0 and SPI1 are used internally to access the ESP32-C3's attached flash memory. Both controllers share the same SPI bus signals, and there is an arbiter to determine which can access the bus. Currently, SPI Master driver does not support SPI1 bus.
- SPI2 is a general purpose SPI controller. It has an independent signal bus with the same name. The bus has 6 CS lines to drive up to 6 SPI slaves.

Terminology

The terms used in relation to the SPI master driver are given in the table below.

Term	Definition
Host	The SPI controller peripheral inside ESP32-C3 that initiates SPI transmissions over the bus, and acts as an SPI Master.
Device	SPI slave device. An SPI bus may be connected to one or more Devices. Each Device shares the MOSI, MISO and SCLK signals but is only active on the bus when the Host asserts the Device's individual CS line.
Bus	A signal bus, common to all Devices connected to one Host. In general, a bus includes the following lines: MISO, MOSI, SCLK, one or more CS lines, and, optionally, QUADWP and QUADHD. So Devices are connected to the same lines, with the exception that each Device has its own CS line. Several Devices can also share one CS line if connected in the daisy-chain manner.
MISO	Master In, Slave Out, a.k.a. Q. Data transmission from a Device to Host.
MOSI	Master Out, Slave In, a.k.a. D. Data transmission from a Host to Device.
SCLK	Serial Clock. Oscillating signal generated by a Host that keeps the transmission of data bits in sync.
CS	Chip Select. Allows a Host to select individual Device(s) connected to the bus in order to send or receive data.
QUADWP	Write Protect signal. Only used for 4-bit (qio/qout) transactions.
QUADHD	Hold signal. Only used for 4-bit (qio/qout) transactions.
Assertion	The action of activating a line.
De-assertion	The action of returning the line back to inactive (back to idle) status.
Transaction	One instance of a Host asserting a CS line, transferring data to and from a Device, and de-asserting the CS line. Transactions are atomic, which means they can never be interrupted by another transaction.
Launch edge	Edge of the clock at which the source register <i>launches</i> the signal onto the line.
Latch edge	Edge of the clock at which the destination register <i>latches in</i> the signal.

Driver Features

The SPI master driver governs communications of Hosts with Devices. The driver supports the following features:

- Multi-threaded environments
- Transparent handling of DMA transfers while reading and writing data
- Automatic time-division multiplexing of data coming from different Devices on the same signal bus, see [SPI Bus Lock](#).

Warning: The SPI master driver has the concept of multiple Devices connected to a single bus (sharing a single ESP32-C3 SPI peripheral). As long as each Device is accessed by only one task, the driver is thread safe. However, if multiple tasks try to access the same SPI Device, the driver is **not thread-safe**. In this case, it is recommended to either:

- Refactor your application so that each SPI peripheral is only accessed by a single task at a time.
- Add a mutex lock around the shared Device using `xSemaphoreCreateMutex`.

SPI Features

SPI Master

SPI Bus Lock To realize the multiplexing of different devices from different drivers (SPI Master, SPI Flash, etc.), an SPI bus lock is applied on each SPI bus. Drivers can attach their devices onto the bus with the arbitration of the

lock.

Each bus lock are initialized with a BG (background) service registered, all devices request to do transactions on the bus should wait until the BG to be successfully disabled.

- For SPI1 bus, the BG is the cache, the bus lock will help to disable the cache before device operations starts, and enable it again after device releasing the lock. No devices on SPI1 is allowed using ISR (it' s meaningless for the task to yield to other tasks when the cache is disabled).
- For other buses, the driver may register its ISR as the BG. The bus lock will block a device task when it requests for exclusive use of the bus, try to disable the ISR, and unblock the device task allowed to exclusively use the bus when the ISR is successfully disabled. When the task releases the lock, the lock will also try to resume the ISR if there are pending transactions to be done in the ISR.

SPI Transactions

An SPI bus transaction consists of five phases which can be found in the table below. Any of these phases can be skipped.

Phase	Description
Com-mand	In this phase, a command (0-16 bit) is written to the bus by the Host.
Ad-dress	In this phase, an address (0-32 bit) is transmitted over the bus by the Host.
Write	Host sends data to a Device. This data follows the optional command and address phases and is indistinguishable from them at the electrical level.
Dummy	This phase is configurable and is used to meet the timing requirements.
Read	Device sends data to its Host.

The attributes of a transaction are determined by the bus configuration structure `spi_bus_config_t`, device configuration structure `spi_device_interface_config_t`, and transaction configuration structure `spi_transaction_t`.

An SPI Host can send full-duplex transactions, during which the read and write phases occur simultaneously. The total transaction length is determined by the sum of the following members:

- `spi_device_interface_config_t::command_bits`
- `spi_device_interface_config_t::address_bits`
- `spi_transaction_t::length`

While the member `spi_transaction_t::rxlength` only determines the length of data received into the buffer.

In half-duplex transactions, the read and write phases are not simultaneous (one direction at a time). The lengths of the write and read phases are determined by `length` and `rxlength` members of the struct `spi_transaction_t` respectively.

The command and address phases are optional, as not every SPI device requires a command and/or address. This is reflected in the Device' s configuration: if `command_bits` and/or `address_bits` are set to zero, no command or address phase will occur.

The read and write phases can also be optional, as not every transaction requires both writing and reading data. If `rx_buffer` is NULL and `SPI_TRANS_USE_RXDATA` is not set, the read phase is skipped. If `tx_buffer` is NULL and `SPI_TRANS_USE_TXDATA` is not set, the write phase is skipped.

The driver supports two types of transactions: the interrupt transactions and polling transactions. The programmer can choose to use a different transaction type per Device. If your Device requires both transaction types, see *Notes on Sending Mixed Transactions to the Same Device*.

Interrupt Transactions Interrupt transactions will block the transaction routine until the transaction completes, thus allowing the CPU to run other tasks.

An application task can queue multiple transactions, and the driver will automatically handle them one-by-one in the interrupt service routine (ISR). It allows the task to switch to other procedures until all the transactions complete.

Polling Transactions Polling transactions do not use interrupts. The routine keeps polling the SPI Host's status bit until the transaction is finished.

All the tasks that use interrupt transactions can be blocked by the queue. At this point, they will need to wait for the ISR to run twice before the transaction is finished. Polling transactions save time otherwise spent on queue handling and context switching, which results in smaller transaction duration. The disadvantage is that the CPU is busy while these transactions are in progress.

The `spi_device_polling_end()` routine needs an overhead of at least 1 us to unblock other tasks when the transaction is finished. It is strongly recommended to wrap a series of polling transactions using the functions `spi_device_acquire_bus()` and `spi_device_release_bus()` to avoid the overhead. For more information, see *Bus Acquiring*.

Command and Address Phases During the command and address phases, the members `cmd` and `addr` in the struct `spi_transaction_t` are sent to the bus, nothing is read at this time. The default lengths of the command and address phases are set in `spi_device_interface_config_t` by calling `spi_bus_add_device()`. If the flags `SPI_TRANS_VARIABLE_CMD` and `SPI_TRANS_VARIABLE_ADDR` in the member `spi_transaction_t::flags` are not set, the driver automatically sets the length of these phases to default values during Device initialization.

If the lengths of the command and address phases need to be variable, declare the struct `spi_transaction_ext_t`, set the flags `SPI_TRANS_VARIABLE_CMD` and/or `SPI_TRANS_VARIABLE_ADDR` in the member `spi_transaction_ext_t::base` and configure the rest of `base` as usual. Then the length of each phase will be equal to `command_bits` and `address_bits` set in the struct `spi_transaction_ext_t`.

Write and Read Phases Normally, the data that needs to be transferred to or from a Device will be read from or written to a chunk of memory indicated by the members `rx_buffer` and `tx_buffer` of the structure `spi_transaction_t`. If DMA is enabled for transfers, the buffers are required to be:

1. Allocated in DMA-capable internal memory. If *external PSRAM is enabled*, this means using `pvPortMallocCaps(size, MALLOC_CAP_DMA)`.
2. 32-bit aligned (starting from a 32-bit boundary and having a length of multiples of 4 bytes).

If these requirements are not satisfied, the transaction efficiency will be affected due to the allocation and copying of temporary buffers.

Note: Half-duplex transactions with both read and write phases are not supported. Please use full duplex mode.

Bus Acquiring Sometimes you might want to send SPI transactions exclusively and continuously so that it takes as little time as possible. For this, you can use bus acquiring, which helps to suspend transactions (both polling or interrupt) to other devices until the bus is released. To acquire and release a bus, use the functions `spi_device_acquire_bus()` and `spi_device_release_bus()`.

Driver Usage

- Initialize an SPI bus by calling the function `spi_bus_initialize()`. Make sure to set the correct I/O pins in the struct `spi_bus_config_t`. Set the signals that are not needed to `-1`.
- Register a Device connected to the bus with the driver by calling the function `spi_bus_add_device()`. Make sure to configure any timing requirements the device might need with the parameter `dev_config`. You should now have obtained the Device's handle which will be used when sending a transaction to it.
- To interact with the Device, fill one or more `spi_transaction_t` structs with any transaction parameters required. Then send the structs either using a polling transaction or an interrupt transaction:

- **Interrupt** Either queue all transactions by calling the function `spi_device_queue_trans()` and, at a later time, query the result using the function `spi_device_get_trans_result()`, or handle all requests synchronously by feeding them into `spi_device_transmit()`.
- **Polling** Call the function `spi_device_polling_transmit()` to send polling transactions. Alternatively, if you want to insert something in between, send the transactions by using `spi_device_polling_start()` and `spi_device_polling_end()`.
- (Optional) To perform back-to-back transactions with a Device, call the function `spi_device_acquire_bus()` before sending transactions and `spi_device_release_bus()` after the transactions have been sent.
- (Optional) To unload the driver for a certain Device, call `spi_bus_remove_device()` with the Device handle as an argument.
- (Optional) To remove the driver for a bus, make sure no more drivers are attached and call `spi_bus_free()`.

The example code for the SPI master driver can be found in the [peripherals/spi_master](#) directory of ESP-IDF examples.

Transactions with Data Not Exceeding 32 Bits When the transaction data size is equal to or less than 32 bits, it will be sub-optimal to allocate a buffer for the data. The data can be directly stored in the transaction struct instead. For transmitted data, it can be achieved by using the `tx_data` member and setting the `SPI_TRANS_USE_TXDATA` flag on the transmission. For received data, use `rx_data` and set `SPI_TRANS_USE_RXDATA`. In both cases, do not touch the `tx_buffer` or `rx_buffer` members, because they use the same memory locations as `tx_data` and `rx_data`.

Transactions with Integers Other Than `uint8_t` An SPI Host reads and writes data into memory byte by byte. By default, data is sent with the most significant bit (MSB) first, as LSB first used in rare cases. If a value less than 8 bits needs to be sent, the bits should be written into memory in the MSB first manner.

For example, if `0b00010` needs to be sent, it should be written into a `uint8_t` variable, and the length for reading should be set to 5 bits. The Device will still receive 8 bits with 3 additional “random” bits, so the reading must be performed correctly.

On top of that, ESP32-C3 is a little-endian chip, which means that the least significant byte of `uint16_t` and `uint32_t` variables is stored at the smallest address. Hence, if `uint16_t` is stored in memory, bits [7:0] are sent first, followed by bits [15:8].

For cases when the data to be transmitted has the size differing from `uint8_t` arrays, the following macros can be used to transform data to the format that can be sent by the SPI driver directly:

- `SPI_SWAP_DATA_TX` for data to be transmitted
- `SPI_SWAP_DATA_RX` for data received

Notes on Sending Mixed Transactions to the Same Device To reduce coding complexity, send only one type of transactions (interrupt or polling) to one Device. However, you still can send both interrupt and polling transactions alternately. The notes below explain how to do this.

The polling transactions should be initiated only after all the polling and interrupt transactions are finished.

Since an unfinished polling transaction blocks other transactions, please do not forget to call the function `spi_device_polling_end()` after `spi_device_polling_start()` to allow other transactions or to allow other Devices to use the bus. Remember that if there is no need to switch to other tasks during your polling transaction, you can initiate a transaction with `spi_device_polling_transmit()` so that it will be ended automatically.

In-flight polling transactions are disturbed by the ISR operation to accommodate interrupt transactions. Always make sure that all the interrupt transactions sent to the ISR are finished before you call `spi_device_polling_start()`. To do that, you can keep calling `spi_device_get_trans_result()` until all the transactions are returned.

To have better control of the calling sequence of functions, send mixed transactions to the same Device only within a single task.

Transfer Speed Considerations

There are three factors limiting the transfer speed:

- Transaction interval
- SPI clock frequency
- Cache miss of SPI functions, including callbacks

The main parameter that determines the transfer speed for large transactions is clock frequency. For multiple small transactions, the transfer speed is mostly determined by the length of transaction intervals.

Transaction Duration Transaction duration includes setting up SPI peripheral registers, copying data to FIFOs or setting up DMA links, and the time for SPI transaction.

Interrupt transactions allow appending extra overhead to accommodate the cost of FreeRTOS queues and the time needed for switching between tasks and the ISR.

For **interrupt transactions**, the CPU can switch to other tasks when a transaction is in progress. This saves the CPU time but increases the transaction duration. See [Interrupt Transactions](#). For **polling transactions**, it does not block the task but allows to do polling when the transaction is in progress. For more information, see [Polling Transactions](#).

If DMA is enabled, setting up the linked list requires about 2 us per transaction. When a master is transferring data, it automatically reads the data from the linked list. If DMA is not enabled, the CPU has to write and read each byte from the FIFO by itself. Usually, this is faster than 2 us, but the transaction length is limited to 64 bytes for both write and read.

Typical transaction duration for one byte of data are given below.

- Interrupt Transaction via DMA: 28 μs.
- Interrupt Transaction via CPU: 27 μs.
- Polling Transaction via DMA: 10 μs.
- Polling Transaction via CPU: 9 μs.

SPI Clock Frequency Transferring each byte takes eight times the clock period $8/f_{spi}$.

Cache Miss The default config puts only the ISR into the IRAM. Other SPI related functions, including the driver itself and the callback, might suffer from cache misses and will need to wait until the code is read from flash. Select [CONFIG_SPI_MASTER_IN_IRAM](#) to put the whole SPI driver into IRAM and put the entire callback(s) and its callee functions into IRAM to prevent cache misses.

For an interrupt transaction, the overall cost is $20+8n/F_{spi}[MHz]$ [us] for n bytes transferred in one transaction. Hence, the transferring speed is: $n/(20+8n/F_{spi})$. An example of transferring speed at 8 MHz clock speed is given in the following table.

Frequency (MHz)	Transaction Interval (us)	Transaction Length (bytes)	Total Time (us)	Total Speed (KBps)
8	25	1	26	38.5
8	25	8	33	242.4
8	25	16	41	490.2
8	25	64	89	719.1
8	25	128	153	836.6

When a transaction length is short, the cost of transaction interval is high. If possible, try to squash several short transactions into one transaction to achieve a higher transfer speed.

Please note that the ISR is disabled during flash operation by default. To keep sending transactions during flash operations, enable [CONFIG_SPI_MASTER_ISR_IN_IRAM](#) and set `ESP_INTR_FLAG_IRAM` in the member `spi_bus_config_t::intr_flags`. In this case, all the transactions queued before starting flash operations will be handled by the ISR in parallel. Also note that the callback of each Device and their callee functions should be in IRAM, or your callback will crash due to cache miss. For more details, see [IRAM-Safe Interrupt Handlers](#).

Application Example

The code example for displaying graphics on an ESP32-WROVER-KIT's 320x240 LCD screen can be found in the [peripherals/spi_master](#) directory of ESP-IDF examples.

API Reference - SPI Common

Header File

- [hal/include/hal/spi_types.h](#)

Enumerations

enum spi_host_device_t

Enum with the three SPI peripherals that are software-accessible in it.

Values:

SPI1_HOST = 0
SPI1.

SPI2_HOST = 1
SPI2.

SPI3_HOST = 2
SPI3.

enum spi_event_t

SPI Events.

Values:

SPI_EV_BUF_TX = BIT(0)
The buffer has sent data to master.

SPI_EV_BUF_RX = BIT(1)
The buffer has received data from master.

SPI_EV_SEND_DMA_READY = BIT(2)
Slave has loaded its TX data buffer to the hardware (DMA).

SPI_EV_SEND = BIT(3)
Master has received certain number of the data, the number is determined by Master.

SPI_EV_RECV_DMA_READY = BIT(4)
Slave has loaded its RX data buffer to the hardware (DMA).

SPI_EV_RECV = BIT(5)
Slave has received certain number of data from master, the number is determined by Master.

SPI_EV_CMD9 = BIT(6)
Received CMD9 from master.

SPI_EV_CMDA = BIT(7)
Received CMDA from master.

SPI_EV_TRANS = BIT(8)
A transaction has done.

Header File

- [driver/include/driver/spi_common.h](#)

Functions

`esp_err_t spi_bus_initialize(spi_host_device_t host_id, const spi_bus_config_t *bus_config, spi_dma_chan_t dma_chan)`

Initialize a SPI bus.

Warning SPI0/1 is not supported

Warning If a DMA channel is selected, any transmit and receive buffer used should be allocated in DMA-capable memory.

Warning The ISR of SPI is always executed on the core which calls this function. Never starve the ISR on this core or the SPI transactions will not be handled.

Return

- ESP_ERR_INVALID_ARG if configuration is invalid
- ESP_ERR_INVALID_STATE if host already is in use
- ESP_ERR_NOT_FOUND if there is no available DMA channel
- ESP_ERR_NO_MEM if out of memory
- ESP_OK on success

Parameters

- `host_id`: SPI peripheral that controls this bus
- `bus_config`: Pointer to a `spi_bus_config_t` struct specifying how the host should be initialized
- `dma_chan`: - Selecting a DMA channel for an SPI bus allows transactions on the bus with size only limited by the amount of internal memory.
 - Selecting SPI_DMA_DISABLED limits the size of transactions.
 - Set to SPI_DMA_DISABLED if only the SPI flash uses this bus.
 - Set to SPI_DMA_CH_AUTO to let the driver to allocate the DMA channel.

`esp_err_t spi_bus_free(spi_host_device_t host_id)`

Free a SPI bus.

Warning In order for this to succeed, all devices have to be removed first.

Return

- ESP_ERR_INVALID_ARG if parameter is invalid
- ESP_ERR_INVALID_STATE if bus hasn't been initialized before, or not all devices on the bus are freed
- ESP_OK on success

Parameters

- `host_id`: SPI peripheral to free

Structures

`struct spi_bus_config_t`

This is a configuration structure for a SPI bus.

You can use this structure to specify the GPIO pins of the bus. Normally, the driver will use the GPIO matrix to route the signals. An exception is made when all signals either can be routed through the IO_MUX or are -1. In that case, the IO_MUX is used, allowing for >40MHz speeds.

Note Be advised that the slave driver does not use the quadwp/quadhd lines and fields in `spi_bus_config_t` referring to these lines will be ignored and can thus safely be left uninitialized.

Public Members

int `mosi_io_num`

GPIO pin for Master Out Slave In (=spi_d) signal, or -1 if not used.

int `miso_io_num`

GPIO pin for Master In Slave Out (=spi_q) signal, or -1 if not used.

int `sclk_io_num`

GPIO pin for Spi CLocK signal, or -1 if not used.

int `quadwp_io_num`

GPIO pin for WP (Write Protect) signal which is used as D2 in 4-bit communication modes, or -1 if not

used.

int **quadhd_io_num**

GPIO pin for HD (HOLD) signal which is used as D3 in 4-bit communication modes, or -1 if not used.

int **max_transfer_sz**

Maximum transfer size, in bytes. Defaults to 4092 if 0 when DMA enabled, or to `SOC_SPI_MAXIMUM_BUFFER_SIZE` if DMA is disabled.

uint32_t **flags**

Abilities of bus to be checked by the driver. Or-ed value of `SPICOMMON_BUSFLAG_*` flags.

int **intr_flags**

Interrupt flag for the bus to set the priority, and IRAM attribute, see `esp_intr_alloc.h`. Note that the `EDGE`, `INTRDISABLED` attribute are ignored by the driver. Note that if `ESP_INTR_FLAG_IRAM` is set, ALL the callbacks of the driver, and their callee functions, should be put in the IRAM.

Macros

SPI_MAX_DMA_LEN

SPI_SWAP_DATA_TX (DATA, LEN)

Transform unsigned integer of length ≤ 32 bits to the format which can be sent by the SPI driver directly.

E.g. to send 9 bits of data, you can:

```
uint16_t data = SPI_SWAP_DATA_TX(0x145, 9);
```

Then points `tx_buffer` to `&data`.

Parameters

- **DATA**: Data to be sent, can be `uint8_t`, `uint16_t` or `uint32_t`.
- **LEN**: Length of data to be sent, since the SPI peripheral sends from the MSB, this helps to shift the data to the MSB.

SPI_SWAP_DATA_RX (DATA, LEN)

Transform received data of length ≤ 32 bits to the format of an unsigned integer.

E.g. to transform the data of 15 bits placed in a 4-byte array to integer:

```
uint16_t data = SPI_SWAP_DATA_RX(*(uint32_t*)t->rx_data, 15);
```

Parameters

- **DATA**: Data to be rearranged, can be `uint8_t`, `uint16_t` or `uint32_t`.
- **LEN**: Length of data received, since the SPI peripheral writes from the MSB, this helps to shift the data to the LSB.

SPICOMMON_BUSFLAG_SLAVE

Initialize I/O in slave mode.

SPICOMMON_BUSFLAG_MASTER

Initialize I/O in master mode.

SPICOMMON_BUSFLAG_IOMUX_PINS

Check using iomux pins. Or indicates the pins are configured through the IO mux rather than GPIO matrix.

SPICOMMON_BUSFLAG_GPIO_PINS

Force the signals to be routed through GPIO matrix. Or indicates the pins are routed through the GPIO matrix.

SPICOMMON_BUSFLAG_SCLK

Check existing of SCLK pin. Or indicates CLK line initialized.

SPICOMMON_BUSFLAG_MISO

Check existing of MISO pin. Or indicates MISO line initialized.

SPICOMMON_BUSFLAG_MOSI

Check existing of MOSI pin. Or indicates MOSI line initialized.

SPICOMMON_BUSFLAG_DUAL

Check MOSI and MISO pins can output. Or indicates bus able to work under DIO mode.

SPICOMMON_BUSFLAG_WPHD

Check existing of WP and HD pins. Or indicates WP & HD pins initialized.

SPICOMMON_BUSFLAG_QUAD

Check existing of MOSI/MISO/WP/HD pins as output. Or indicates bus able to work under QIO mode.

SPICOMMON_BUSFLAG_NATIVE_PINS**Type Definitions**

```
typedef spi_common_dma_t spi_dma_chan_t
```

Enumerations

```
enum spi_common_dma_t
```

SPI DMA channels.

Values:

```
SPI_DMA_DISABLED = 0
```

Do not enable DMA for SPI.

```
SPI_DMA_CH_AUTO = 3
```

Enable DMA, channel is automatically selected by driver.

API Reference - SPI Master**Header File**

- [driver/include/driver/spi_master.h](#)

Functions

```
esp_err_t spi_bus_add_device (spi_host_device_t host_id, const spi_device_interface_config_t  
*dev_config, spi_device_handle_t *handle)
```

Allocate a device on a SPI bus.

This initializes the internal structures for a device, plus allocates a CS pin on the indicated SPI master peripheral and routes it to the indicated GPIO. All SPI master devices have three CS pins and can thus control up to three devices.

Note While in general, speeds up to 80MHz on the dedicated SPI pins and 40MHz on GPIO-matrix-routed pins are supported, full-duplex transfers routed over the GPIO matrix only support speeds up to 26MHz.

Return

- ESP_ERR_INVALID_ARG if parameter is invalid
- ESP_ERR_NOT_FOUND if host doesn't have any free CS slots
- ESP_ERR_NO_MEM if out of memory
- ESP_OK on success

Parameters

- host_id: SPI peripheral to allocate device on
- dev_config: SPI interface protocol config for the device
- handle: Pointer to variable to hold the device handle

```
esp_err_t spi_bus_remove_device (spi_device_handle_t handle)
```

Remove a device from the SPI bus.

Return

- ESP_ERR_INVALID_ARG if parameter is invalid
- ESP_ERR_INVALID_STATE if device already is freed
- ESP_OK on success

Parameters

- `handle`: Device handle to free

esp_err_t **spi_device_queue_trans** (*spi_device_handle_t* `handle`, *spi_transaction_t* *`trans_desc`, TickType_t `ticks_to_wait`)

Queue a SPI transaction for interrupt transaction execution. Get the result by `spi_device_get_trans_result`.

Note Normally a device cannot start (queue) polling and interrupt transactions simultaneously.

Return

- `ESP_ERR_INVALID_ARG` if parameter is invalid
- `ESP_ERR_TIMEOUT` if there was no room in the queue before `ticks_to_wait` expired
- `ESP_ERR_NO_MEM` if allocating DMA-capable temporary buffer failed
- `ESP_ERR_INVALID_STATE` if previous transactions are not finished
- `ESP_OK` on success

Parameters

- `handle`: Device handle obtained using `spi_host_add_dev`
- `trans_desc`: Description of transaction to execute
- `ticks_to_wait`: Ticks to wait until there's room in the queue; use `portMAX_DELAY` to never time out.

esp_err_t **spi_device_get_trans_result** (*spi_device_handle_t* `handle`, *spi_transaction_t* **`trans_desc`, TickType_t `ticks_to_wait`)

Get the result of a SPI transaction queued earlier by `spi_device_queue_trans`.

This routine will wait until a transaction to the given device successfully completed. It will then return the description of the completed transaction so software can inspect the result and e.g. free the memory or re-use the buffers.

Return

- `ESP_ERR_INVALID_ARG` if parameter is invalid
- `ESP_ERR_TIMEOUT` if there was no completed transaction before `ticks_to_wait` expired
- `ESP_OK` on success

Parameters

- `handle`: Device handle obtained using `spi_host_add_dev`
- `trans_desc`: Pointer to variable able to contain a pointer to the description of the transaction that is executed. The descriptor should not be modified until the descriptor is returned by `spi_device_get_trans_result`.
- `ticks_to_wait`: Ticks to wait until there's a returned item; use `portMAX_DELAY` to never time out.

esp_err_t **spi_device_transmit** (*spi_device_handle_t* `handle`, *spi_transaction_t* *`trans_desc`)

Send a SPI transaction, wait for it to complete, and return the result.

This function is the equivalent of calling `spi_device_queue_trans()` followed by `spi_device_get_trans_result()`. Do not use this when there is still a transaction separately queued (started) from `spi_device_queue_trans()` or `polling_start/transmit` that hasn't been finalized.

Note This function is not thread safe when multiple tasks access the same SPI device. Normally a device cannot start (queue) polling and interrupt transactions simultaneously.

Return

- `ESP_ERR_INVALID_ARG` if parameter is invalid
- `ESP_OK` on success

Parameters

- `handle`: Device handle obtained using `spi_host_add_dev`
- `trans_desc`: Description of transaction to execute

esp_err_t **spi_device_polling_start** (*spi_device_handle_t* `handle`, *spi_transaction_t* *`trans_desc`, TickType_t `ticks_to_wait`)

Immediately start a polling transaction.

Note Normally a device cannot start (queue) polling and interrupt transactions simultaneously. Moreover, a device cannot start a new polling transaction if another polling transaction is not finished.

Return

- `ESP_ERR_INVALID_ARG` if parameter is invalid

- `ESP_ERR_TIMEOUT` if the device cannot get control of the bus before `ticks_to_wait` expired
- `ESP_ERR_NO_MEM` if allocating DMA-capable temporary buffer failed
- `ESP_ERR_INVALID_STATE` if previous transactions are not finished
- `ESP_OK` on success

Parameters

- `handle`: Device handle obtained using `spi_host_add_dev`
- `trans_desc`: Description of transaction to execute
- `ticks_to_wait`: Ticks to wait until there's room in the queue; currently only `portMAX_DELAY` is supported.

`esp_err_t spi_device_polling_end` (`spi_device_handle_t handle`, `TickType_t ticks_to_wait`)

Poll until the polling transaction ends.

This routine will not return until the transaction to the given device has successfully completed. The task is not blocked, but actively busy-spins for the transaction to be completed.

Return

- `ESP_ERR_INVALID_ARG` if parameter is invalid
- `ESP_ERR_TIMEOUT` if the transaction cannot finish before `ticks_to_wait` expired
- `ESP_OK` on success

Parameters

- `handle`: Device handle obtained using `spi_host_add_dev`
- `ticks_to_wait`: Ticks to wait until there's a returned item; use `portMAX_DELAY` to never time out.

`esp_err_t spi_device_polling_transmit` (`spi_device_handle_t handle`, `spi_transaction_t *trans_desc`)

Send a polling transaction, wait for it to complete, and return the result.

This function is the equivalent of calling `spi_device_polling_start()` followed by `spi_device_polling_end()`. Do not use this when there is still a transaction that hasn't been finalized.

Note This function is not thread safe when multiple tasks access the same SPI device. Normally a device cannot start (queue) polling and interrupt transactions simultaneously.

Return

- `ESP_ERR_INVALID_ARG` if parameter is invalid
- `ESP_OK` on success

Parameters

- `handle`: Device handle obtained using `spi_host_add_dev`
- `trans_desc`: Description of transaction to execute

`esp_err_t spi_device_acquire_bus` (`spi_device_handle_t device`, `TickType_t wait`)

Occupy the SPI bus for a device to do continuous transactions.

Transactions to all other devices will be put off until `spi_device_release_bus` is called.

Note The function will wait until all the existing transactions have been sent.

Return

- `ESP_ERR_INVALID_ARG` : `wait` is not set to `portMAX_DELAY`.
- `ESP_OK` : Success.

Parameters

- `device`: The device to occupy the bus.
- `wait`: Time to wait before the the bus is occupied by the device. Currently MUST set to `portMAX_DELAY`.

void `spi_device_release_bus` (`spi_device_handle_t dev`)

Release the SPI bus occupied by the device. All other devices can start sending transactions.

Parameters

- `dev`: The device to release the bus.

int `spi_cal_clock` (int `fapb`, int `hz`, int `duty_cycle`, uint32_t *`reg_o`)

Calculate the working frequency that is most close to desired frequency, and also the register value.

Parameters

- `fapb`: The frequency of apb clock, should be `APB_CLK_FREQ`.
- `hz`: Desired working frequency
- `duty_cycle`: Duty cycle of the spi clock
- `reg_o`: Output of value to be set in clock register, or NULL if not needed.

Return Actual working frequency that most fit.

int **spi_get_actual_clock** (int *fapb*, int *hz*, int *duty_cycle*)

Calculate the working frequency that is most close to desired frequency.

Return Actual working frequency that most fit.

Parameters

- `fapb`: The frequency of apb clock, should be `APB_CLK_FREQ`.
- `hz`: Desired working frequency
- `duty_cycle`: Duty cycle of the spi clock

void **spi_get_timing** (bool *gpio_is_used*, int *input_delay_ns*, int *eff_clk*, int **dummy_o*, int **cycles_remain_o*)

Calculate the timing settings of specified frequency and settings.

Note If ***dummy_o** is not zero, it means dummy bits should be applied in half duplex mode, and full duplex mode may not work.

Parameters

- `gpio_is_used`: True if using GPIO matrix, or False if iomux pins are used.
- `input_delay_ns`: Input delay from SCLK launch edge to MISO data valid.
- `eff_clk`: Effective clock frequency (in Hz) from `spi_cal_clock`.
- `dummy_o`: Address of dummy bits used output. Set to NULL if not needed.
- `cycles_remain_o`: Address of cycles remaining (after dummy bits are used) output.
 - -1 If too many cycles remaining, suggest to compensate half a clock.
 - 0 If no remaining cycles or dummy bits are not used.
 - positive value: cycles suggest to compensate.

int **spi_get_freq_limit** (bool *gpio_is_used*, int *input_delay_ns*)

Get the frequency limit of current configurations. SPI master working at this limit is OK, while above the limit, full duplex mode and DMA will not work, and dummy bits will be applied in the half duplex mode.

Return Frequency limit of current configurations.

Parameters

- `gpio_is_used`: True if using GPIO matrix, or False if native pins are used.
- `input_delay_ns`: Input delay from SCLK launch edge to MISO data valid.

Structures

struct spi_device_interface_config_t

This is a configuration for a SPI slave device that is connected to one of the SPI buses.

Public Members

uint8_t **command_bits**

Default amount of bits in command phase (0-16), used when `SPI_TRANS_VARIABLE_CMD` is not used, otherwise ignored.

uint8_t **address_bits**

Default amount of bits in address phase (0-64), used when `SPI_TRANS_VARIABLE_ADDR` is not used, otherwise ignored.

uint8_t **dummy_bits**

Amount of dummy bits to insert between address and data phase.

uint8_t **mode**

SPI mode, representing a pair of (CPOL, CPHA) configuration:

- 0: (0, 0)

- 1: (0, 1)
- 2: (1, 0)
- 3: (1, 1)

uint16_t duty_cycle_pos

Duty cycle of positive clock, in 1/256th increments (128 = 50%/50% duty). Setting this to 0 (=not setting it) is equivalent to setting this to 128.

uint16_t cs_ena_pretrans

Amount of SPI bit-cycles the cs should be activated before the transmission (0-16). This only works on half-duplex transactions.

uint8_t cs_ena_posttrans

Amount of SPI bit-cycles the cs should stay active after the transmission (0-16)

int clock_speed_hz

Clock speed, divisors of 80MHz, in Hz. See `SPI_MASTER_FREQ_*`.

int input_delay_ns

Maximum data valid time of slave. The time required between SCLK and MISO valid, including the possible clock delay from slave to master. The driver uses this value to give an extra delay before the MISO is ready on the line. Leave at 0 unless you know you need a delay. For better timing performance at high frequency (over 8MHz), it's suggested to have the right value.

int spics_io_num

CS GPIO pin for this device, or -1 if not used.

uint32_t flags

Bitwise OR of `SPI_DEVICE_*` flags.

int queue_size

Transaction queue size. This sets how many transactions can be 'in the air' (queued using `spi_device_queue_trans` but not yet finished using `spi_device_get_trans_result`) at the same time.

***transaction_cb_t* pre_cb**

Callback to be called before a transmission is started.

This callback is called within interrupt context should be in IRAM for best performance, see "Transferring Speed" section in the SPI Master documentation for full details. If not, the callback may crash during flash operation when the driver is initialized with `ESP_INTR_FLAG_IRAM`.

***transaction_cb_t* post_cb**

Callback to be called after a transmission has completed.

This callback is called within interrupt context should be in IRAM for best performance, see "Transferring Speed" section in the SPI Master documentation for full details. If not, the callback may crash during flash operation when the driver is initialized with `ESP_INTR_FLAG_IRAM`.

struct spi_transaction_t

This structure describes one SPI transaction. The descriptor should not be modified until the transaction finishes.

Public Members**uint32_t flags**

Bitwise OR of `SPI_TRANS_*` flags.

uint16_t cmd

Command data, of which the length is set in the `command_bits` of `spi_device_interface_config_t`.

NOTE: this field, used to be "command" in ESP-IDF 2.1 and before, is re-written to be used in a new way in ESP-IDF 3.0.

Example: write 0x0123 and `command_bits=12` to send command 0x12, 0x3_ (in previous version, you may have to write 0x3_12).

`uint64_t addr`

Address data, of which the length is set in the `address_bits` of *spi_device_interface_config_t*.

NOTE: this field, used to be “address” in ESP-IDF 2.1 and before, is re-written to be used in a new way in ESP-IDF3.0.

Example: write 0x123400 and `address_bits=24` to send address of 0x12, 0x34, 0x00 (in previous version, you may have to write 0x12340000).

`size_t length`

Total data length, in bits.

`size_t rxlength`

Total data length received, should be not greater than `length` in full-duplex mode (0 defaults this to the value of `length`).

`void *user`

User-defined variable. Can be used to store eg transaction ID.

`const void *tx_buffer`

Pointer to transmit buffer, or NULL for no MOSI phase.

`uint8_t tx_data[4]`

If `SPI_TRANS_USE_TXDATA` is set, data set here is sent directly from this variable.

`void *rx_buffer`

Pointer to receive buffer, or NULL for no MISO phase. Written by 4 bytes-unit if DMA is used.

`uint8_t rx_data[4]`

If `SPI_TRANS_USE_RXDATA` is set, data is received directly to this variable.

`struct spi_transaction_ext_t`

This struct is for SPI transactions which may change their address and command length. Please do set the flags in base to `SPI_TRANS_VARIABLE_CMD_ADR` to use the bit length here.

Public Members

`struct spi_transaction_t base`

Transaction data, so that pointer to *spi_transaction_t* can be converted into *spi_transaction_ext_t*.

`uint8_t command_bits`

The command length in this transaction, in bits.

`uint8_t address_bits`

The address length in this transaction, in bits.

`uint8_t dummy_bits`

The dummy length in this transaction, in bits.

Macros

`SPI_MASTER_FREQ_8M`

SPI master clock is divided by 80MHz apb clock. Below defines are example frequencies, and are accurate. Be free to specify a random frequency, it will be rounded to closest frequency (to macros below if above 8MHz).
8MHz

`SPI_MASTER_FREQ_9M`

8.89MHz

`SPI_MASTER_FREQ_10M`

10MHz

`SPI_MASTER_FREQ_11M`

11.43MHz

`SPI_MASTER_FREQ_13M`

13.33MHz

SPI_MASTER_FREQ_16M
16MHz

SPI_MASTER_FREQ_20M
20MHz

SPI_MASTER_FREQ_26M
26.67MHz

SPI_MASTER_FREQ_40M
40MHz

SPI_MASTER_FREQ_80M
80MHz

SPI_DEVICE_TXBIT_LSBFIRST
Transmit command/address/data LSB first instead of the default MSB first.

SPI_DEVICE_RXBIT_LSBFIRST
Receive data LSB first instead of the default MSB first.

SPI_DEVICE_BIT_LSBFIRST
Transmit and receive LSB first.

SPI_DEVICE_3WIRE
Use MOSI (=spid) for both sending and receiving data.

SPI_DEVICE_POSITIVE_CS
Make CS positive during a transaction instead of negative.

SPI_DEVICE_HALFDUPLEX
Transmit data before receiving it, instead of simultaneously.

SPI_DEVICE_CLK_AS_CS
Output clock on CS line if CS is active.

SPI_DEVICE_NO_DUMMY
There are timing issue when reading at high frequency (the frequency is related to whether iomux pins are used, valid time after slave sees the clock).

- In half-duplex mode, the driver automatically inserts dummy bits before reading phase to fix the timing issue. Set this flag to disable this feature.
- In full-duplex mode, however, the hardware cannot use dummy bits, so there is no way to prevent data being read from getting corrupted. Set this flag to confirm that you're going to work with output only, or read without dummy bits at your own risk.

SPI_DEVICE_DDRCLK

SPI_TRANS_MODE_DIO
Transmit/receive data in 2-bit mode.

SPI_TRANS_MODE_QIO
Transmit/receive data in 4-bit mode.

SPI_TRANS_USE_RXDATA
Receive into rx_data member of *spi_transaction_t* instead into memory at rx_buffer.

SPI_TRANS_USE_TXDATA
Transmit tx_data member of *spi_transaction_t* instead of data at tx_buffer. Do not set tx_buffer when using this.

SPI_TRANS_MODE_DIOQIO_ADDR
Also transmit address in mode selected by SPI_MODE_DIO/SPI_MODE_QIO.

SPI_TRANS_VARIABLE_CMD
Use the command_bits in *spi_transaction_ext_t* rather than default value in *spi_device_interface_config_t*.

SPI_TRANS_VARIABLE_ADDR

Use the `address_bits` in `spi_transaction_ext_t` rather than default value in `spi_device_interface_config_t`.

SPI_TRANS_VARIABLE_DUMMY

Use the `dummy_bits` in `spi_transaction_ext_t` rather than default value in `spi_device_interface_config_t`.

Type Definitions

```
typedef struct spi_transaction_t spi_transaction_t
typedef void (*transaction_cb_t) (spi_transaction_t *trans)
```

```
typedef struct spi_device_t *spi_device_handle_t
```

Handle for a device on a SPI bus.

2.3.13 SPI Slave Driver

SPI Slave driver is a program that controls ESP32-C3's SPI peripherals while they function as slaves.

Overview of ESP32-C3's SPI peripherals

ESP32-C3 integrates one general purpose SPI controller which can be used as slave node driven by an off-chip SPI master. The controller is called SPI2 and has an independent signal bus with the same name.

Terminology

The terms used in relation to the SPI slave driver are given in the table below.

Term	Definition
Host	The SPI controller peripheral external to ESP32-C3 that initiates SPI transmissions over the bus, and acts as an SPI Master.
Device	SPI slave device (general purpose SPI controller). Each Device shares the MOSI, MISO and SCLK signals but is only active on the bus when the Host asserts the Device's individual CS line.
Bus	A signal bus, common to all Devices connected to one Host. In general, a bus includes the following lines: MISO, MOSI, SCLK, one or more CS lines, and, optionally, QUADWP and QUADHD. So Devices are connected to the same lines, with the exception that each Device has its own CS line. Several Devices can also share one CS line if connected in the daisy-chain manner.
• MISO	Master In, Slave Out, a.k.a. Q. Data transmission from a Device to Host.
• MOSI	Master Out, Slave in, a.k.a. D. Data transmission from a Host to Device.
• SCLK	Serial Clock. Oscillating signal generated by a Host that keeps the transmission of data bits in sync.
• CS	Chip Select. Allows a Host to select individual Device(s) connected to the bus in order to send or receive data.
• QUADWP	Write Protect signal. Only used for 4-bit (qio/qout) transactions.
• QUADHD	Hold signal. Only used for 4-bit (qio/qout) transactions.
• Assertion	The action of activating a line. The opposite action of returning the line back to inactive (back to idle) is called <i>de-assertion</i> .
Transaction	One instance of a Host asserting a CS line, transferring data to and from a Device, and de-asserting the CS line. Transactions are atomic, which means they can never be interrupted by another transaction.
Launch edge	Edge of the clock at which the source register <i>launches</i> the signal onto the line.
Latch edge	Edge of the clock at which the destination register <i>latches in</i> the signal.

Driver Features

The SPI slave driver allows using the SPI peripherals as full-duplex Devices. The driver can send/receive transactions up to 64 bytes in length, or utilize DMA to send/receive longer transactions. However, there are some *known issues* related to DMA.

SPI Transactions

A full-duplex SPI transaction begins when the Host asserts the CS line and starts sending out clock pulses on the SCLK line. Every clock pulse, a data bit is shifted from the Host to the Device on the MOSI line and back on the MISO line at the same time. At the end of the transaction, the Host de-asserts the CS line.

The attributes of a transaction are determined by the configuration structure for an SPI host acting as a slave device `spi_slave_interface_config_t`, and transaction configuration structure `spi_slave_transaction_t`.

As not every transaction requires both writing and reading data, you have a choice to configure the `spi_transaction_t` structure for TX only, RX only, or TX and RX transactions. If `spi_slave_transaction_t::rx_buffer` is set to NULL, the read phase will be skipped. If `spi_slave_transaction_t::tx_buffer` is set to NULL, the write phase will be skipped.

Note: A Host should not start a transaction before its Device is ready for receiving data. It is recommended to use another GPIO pin for a handshake signal to sync the Devices. For more details, see [Transaction Interval](#).

Driver Usage

- Initialize an SPI peripheral as a Device by calling the function `cpp:func:spi_slave_initialize`. Make sure to set the correct I/O pins in the struct `bus_config`. Set the unused signals to `-1`.
- Before initiating transactions, fill one or more `spi_slave_transaction_t` structs with the transaction parameters required. Either queue all transactions by calling the function `spi_slave_queue_trans()` and, at a later time, query the result by using the function `spi_slave_get_trans_result()`, or handle all requests individually by feeding them into `spi_slave_transmit()`. The latter two functions will be blocked until the Host has initiated and finished a transaction, causing the queued data to be sent and received.
- (Optional) To unload the SPI slave driver, call `spi_slave_free()`.

Transaction Data and Master/Slave Length Mismatches

Normally, the data that needs to be transferred to or from a Device is read or written to a chunk of memory indicated by the `rx_buffer` and `tx_buffer` members of the `spi_transaction_t` structure. The SPI driver can be configured to use DMA for transfers, in which case these buffers must be allocated in DMA-capable memory using `pvPortMallocCaps(size, MALLOC_CAP_DMA)`.

The amount of data that the driver can read or write to the buffers is limited by the member `spi_transaction_t::length`. However, this member does not define the actual length of an SPI transaction. A transaction's length is determined by a Host which drives the clock and CS lines. The actual length of the transmission can be read only after a transaction is finished from the member `spi_slave_transaction_t::trans_len`.

If the length of the transmission is greater than the buffer length, only the initial number of bits specified in the `length` member will be sent and received. In this case, `trans_len` is set to `length` instead of the actual transaction length. To meet the actual transaction length requirements, set `length` to a value greater than the maximum `trans_len` expected. If the transmission length is shorter than the buffer length, only the data equal to the length of the buffer will be transmitted.

Speed and Timing Considerations

Transaction Interval The ESP32-C3 SPI slave peripherals are designed as general purpose Devices controlled by a CPU. As opposed to dedicated slaves, CPU-based SPI Devices have a limited number of pre-defined registers. All transactions must be handled by the CPU, which means that the transfers and responses are not real-time, and there might be noticeable latency.

As a solution, a Device's response rate can be doubled by using the functions `spi_slave_queue_trans()` and then `spi_slave_get_trans_result()` instead of using `spi_slave_transmit()`.

You can also configure a GPIO pin through which the Device will signal to the Host when it is ready for a new transaction. A code example of this can be found in [peripherals/spi_slave](#).

SCLK Frequency Requirements The SPI slaves are designed to operate at up to 60 MHz. The data cannot be recognized or received correctly if the clock is too fast or does not have a 50% duty cycle.

Restrictions and Known Issues

1. If DMA is enabled, the rx buffer should be word-aligned (starting from a 32-bit boundary and having a length of multiples of 4 bytes). Otherwise, DMA may write incorrectly or not in a boundary aligned manner. The driver reports an error if this condition is not satisfied.
Also, a Host should write lengths that are multiples of 4 bytes. The data with inappropriate lengths will be discarded.

Application Example

The code example for Device/Host communication can be found in the [peripherals/spi_slave](#) directory of ESP-IDF examples.

API Reference

Header File

- [driver/include/driver/spi_slave.h](#)

Functions

```
esp_err_t spi_slave_initialize(spi_host_device_t host, const spi_bus_config_t *bus_config,
                               const spi_slave_interface_config_t *slave_config,
                               spi_dma_chan_t dma_chan)
```

Initialize a SPI bus as a slave interface.

Warning SPI0/1 is not supported

Warning If a DMA channel is selected, any transmit and receive buffer used should be allocated in DMA-capable memory.

Warning The ISR of SPI is always executed on the core which calls this function. Never starve the ISR on this core or the SPI transactions will not be handled.

Return

- ESP_ERR_INVALID_ARG if configuration is invalid
- ESP_ERR_INVALID_STATE if host already is in use
- ESP_ERR_NOT_FOUND if there is no available DMA channel
- ESP_ERR_NO_MEM if out of memory
- ESP_OK on success

Parameters

- *host*: SPI peripheral to use as a SPI slave interface
- *bus_config*: Pointer to a *spi_bus_config_t* struct specifying how the host should be initialized
- *slave_config*: Pointer to a *spi_slave_interface_config_t* struct specifying the details for the slave interface
- *dma_chan*: - Selecting a DMA channel for an SPI bus allows transactions on the bus with size only limited by the amount of internal memory.
 - Selecting SPI_DMA_DISABLED limits the size of transactions.
 - Set to SPI_DMA_DISABLED if only the SPI flash uses this bus.
 - Set to SPI_DMA_CH_AUTO to let the driver to allocate the DMA channel.

```
esp_err_t spi_slave_free(spi_host_device_t host)
```

Free a SPI bus claimed as a SPI slave interface.

Return

- ESP_ERR_INVALID_ARG if parameter is invalid
- ESP_ERR_INVALID_STATE if not all devices on the bus are freed
- ESP_OK on success

Parameters

- `host`: SPI peripheral to free

```
esp_err_t spi_slave_queue_trans (spi_host_device_t host, const spi_slave_transaction_t
                                **trans_desc, TickType_t ticks_to_wait)
```

Queue a SPI transaction for execution.

Queues a SPI transaction to be executed by this slave device. (The transaction queue size was specified when the slave device was initialised via `spi_slave_initialize`.) This function may block if the queue is full (depending on the `ticks_to_wait` parameter). No SPI operation is directly initiated by this function, the next queued transaction will happen when the master initiates a SPI transaction by pulling down CS and sending out clock signals.

This function hands over ownership of the buffers in `trans_desc` to the SPI slave driver; the application is not to access this memory until `spi_slave_queue_trans` is called to hand ownership back to the application.

Return

- `ESP_ERR_INVALID_ARG` if parameter is invalid
- `ESP_OK` on success

Parameters

- `host`: SPI peripheral that is acting as a slave
- `trans_desc`: Description of transaction to execute. Not const because we may want to write status back into the transaction description.
- `ticks_to_wait`: Ticks to wait until there's room in the queue; use `portMAX_DELAY` to never time out.

```
esp_err_t spi_slave_get_trans_result (spi_host_device_t host, spi_slave_transaction_t
                                     **trans_desc, TickType_t ticks_to_wait)
```

Get the result of a SPI transaction queued earlier.

This routine will wait until a transaction to the given device (queued earlier with `spi_slave_queue_trans`) has successfully completed. It will then return the description of the completed transaction so software can inspect the result and e.g. free the memory or re-use the buffers.

It is mandatory to eventually use this function for any transaction queued by `spi_slave_queue_trans`.

Return

- `ESP_ERR_INVALID_ARG` if parameter is invalid
- `ESP_OK` on success

Parameters

- `host`: SPI peripheral to that is acting as a slave
- `[out] trans_desc`: Pointer to variable able to contain a pointer to the description of the transaction that is executed
- `ticks_to_wait`: Ticks to wait until there's a returned item; use `portMAX_DELAY` to never time out.

```
esp_err_t spi_slave_transmit (spi_host_device_t host, spi_slave_transaction_t *trans_desc, Tick-
                              Type_t ticks_to_wait)
```

Do a SPI transaction.

Essentially does the same as `spi_slave_queue_trans` followed by `spi_slave_get_trans_result`. Do not use this when there is still a transaction queued that hasn't been finalized using `spi_slave_get_trans_result`.

Return

- `ESP_ERR_INVALID_ARG` if parameter is invalid
- `ESP_OK` on success

Parameters

- `host`: SPI peripheral to that is acting as a slave
- `trans_desc`: Pointer to variable able to contain a pointer to the description of the transaction that is executed. Not const because we may want to write status back into the transaction description.
- `ticks_to_wait`: Ticks to wait until there's a returned item; use `portMAX_DELAY` to never time out.

Structures

struct spi_slave_interface_config_t

This is a configuration for a SPI host acting as a slave device.

Public Members**int spics_io_num**

CS GPIO pin for this device.

uint32_t flags

Bitwise OR of SPI_SLAVE_* flags.

int queue_size

Transaction queue size. This sets how many transactions can be ‘in the air’ (queued using spi_slave_queue_trans but not yet finished using spi_slave_get_trans_result) at the same time.

uint8_t mode

SPI mode, representing a pair of (CPOL, CPHA) configuration:

- 0: (0, 0)
- 1: (0, 1)
- 2: (1, 0)
- 3: (1, 1)

***slave_transaction_cb_t* post_setup_cb**

Callback called after the SPI registers are loaded with new data.

This callback is called within interrupt context should be in IRAM for best performance, see “Transferring Speed” section in the SPI Master documentation for full details. If not, the callback may crash during flash operation when the driver is initialized with ESP_INTR_FLAG_IRAM.

***slave_transaction_cb_t* post_trans_cb**

Callback called after a transaction is done.

This callback is called within interrupt context should be in IRAM for best performance, see “Transferring Speed” section in the SPI Master documentation for full details. If not, the callback may crash during flash operation when the driver is initialized with ESP_INTR_FLAG_IRAM.

struct spi_slave_transaction_t

This structure describes one SPI transaction

Public Members**size_t length**

Total data length, in bits.

size_t trans_len

Transaction data length, in bits.

const void *tx_buffer

Pointer to transmit buffer, or NULL for no MOSI phase.

void *rx_buffer

Pointer to receive buffer, or NULL for no MISO phase. When the DMA is enabled, must start at WORD boundary (`rx_buffer%4==0`), and has length of a multiple of 4 bytes.

void *user

User-defined variable. Can be used to store eg transaction ID.

Macros**SPI_SLAVE_TXBIT_LSBFIRST**

Transmit command/address/data LSB first instead of the default MSB first.

SPI_SLAVE_RXBIT_LSBFIRST

Receive data LSB first instead of the default MSB first.

SPI_SLAVE_BIT_LSBFIRST

Transmit and receive LSB first.

Type Definitions

```
typedef struct spi_slave_transaction_t spi_slave_transaction_t
typedef void (*slave_transaction_cb_t) (spi_slave_transaction_t *trans)
```

2.3.14 TWAI**Overview**

The Two-Wire Automotive Interface (TWAI) is a real-time serial communication protocol suited for automotive and industrial applications. It is compatible with ISO11898-1 Classical frames, thus can support Standard Frame Format (11-bit ID) and Extended Frame Format (29-bit ID). The ESP32-C3's peripherals contains a TWAI controller that can be configured to communicate on a TWAI bus via an external transceiver.

Warning: The TWAI controller is not compatible with ISO11898-1 FD Format frames, and will interpret such frames as errors.

This programming guide is split into the following sections:

1. *TWAI Protocol Summary*
2. *Signals Lines and Transceiver*
3. *Driver Configuration*
4. *Driver Operation*
5. *Examples*

TWAI Protocol Summary

The TWAI is a multi-master, multi-cast, asynchronous, serial communication protocol. TWAI also supports error detection and signalling, and inbuilt message prioritization.

Multi-master: Any node on the bus can initiate the transfer of a message.

Multi-cast: When a node transmits a message, all nodes on the bus will receive the message (i.e., broadcast) thus ensuring data consistency across all nodes. However, some nodes can selectively choose which messages to accept via the use of acceptance filtering (multi-cast).

Asynchronous: The bus does not contain a clock signal. All nodes on the bus operate at the same bit rate and synchronize using the edges of the bits transmitted on the bus.

Error Detection and Signalling: Every node will constantly monitor the bus. When any node detects an error, it will signal the detection by transmitting an error frame. Other nodes will receive the error frame and transmit their own error frames in response. This will result in an error detection being propagated to all nodes on the bus.

Message Priorities: Messages contain an ID field. If two or more nodes attempt to transmit simultaneously, the node transmitting the message with the lower ID value will win arbitration of the bus. All other nodes will become receivers ensuring that there is at most one transmitter at any time.

TWAI Messages TWAI Messages are split into Data Frames and Remote Frames. Data Frames are used to deliver a data payload to other nodes, whereas a Remote Frame is used to request a Data Frame from other nodes (other nodes can optionally respond with a Data Frame). Data and Remote Frames have two frame formats known as **Extended Frame** and **Standard Frame** which contain a 29-bit ID and an 11-bit ID respectively. A TWAI message consists of the following fields:

- 29-bit or 11-bit ID: Determines the priority of the message (lower value has higher priority).

- Data Length Code (DLC) between 0 to 8: Indicates the size (in bytes) of the data payload for a Data Frame, or the amount of data to request for a Remote Frame.
- Up to 8 bytes of data for a Data Frame (should match DLC).

Error States and Counters The TWAI protocol implements a feature known as “fault confinement” where a persistently erroneous node will eventually eliminate itself from the bus. This is implemented by requiring every node to maintain two internal error counters known as the **Transmit Error Counter (TEC)** and the **Receive Error Counter (REC)**. The two error counters are incremented and decremented according to a set of rules (where the counters increase on an error, and decrease on a successful message transmission/reception). The values of the counters are used to determine a node’s **error state**, namely **Error Active**, **Error Passive**, and **Bus-Off**.

Error Active: A node is Error Active when **both TEC and REC are less than 128** and indicates that the node is operating normally. Error Active nodes are allowed to participate in bus communications, and will actively signal the detection of any errors by automatically transmitting an **Active Error Flag** over the bus.

Error Passive: A node is Error Passive when **either the TEC or REC becomes greater than or equal to 128**. Error Passive nodes are still able to take part in bus communications, but will instead transmit a **Passive Error Flag** upon detection of an error.

Bus-Off: A node becomes Bus-Off when the **TEC becomes greater than or equal to 256**. A Bus-Off node is unable to influence the bus in any manner (essentially disconnected from the bus) thus eliminating itself from the bus. A node will remain in the Bus-Off state until it undergoes bus-off recovery.

Signals Lines and Transceiver

The TWAI controller does not contain an integrated transceiver. Therefore, to connect the TWAI controller to a TWAI bus, **an external transceiver is required**. The type of external transceiver used should depend on the application’s physical layer specification (e.g. using SN65HVD23x transceivers for ISO 11898-2 compatibility).

The TWAI controller’s interface consists of 4 signal lines known as **TX**, **RX**, **BUS-OFF**, and **CLKOUT**. These four signal lines can be routed through the GPIO Matrix to the ESP32-C3’s GPIO pads.

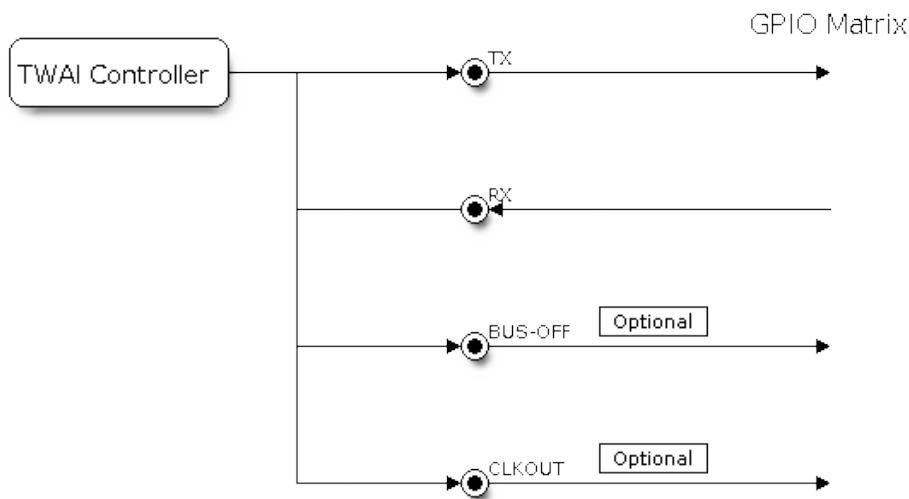

Fig. 13: Signal lines of the TWAI controller

TX and RX: The TX and RX signal lines are required to interface with an external transceiver. Both signal lines represent/interpret a dominant bit as a low logic level (0V), and a recessive bit as a high logic level (3.3V).

BUS-OFF: The BUS-OFF signal line is **optional** and is set to a low logic level (0V) whenever the TWAI controller reaches a bus-off state. The BUS-OFF signal line is set to a high logic level (3.3V) otherwise.

CLKOUT: The CLKOUT signal line is **optional** and outputs a prescaled version of the controller's source clock (APB Clock).

Note: An external transceiver **must internally loopback the TX to RX** such that a change in logic level to the TX signal line can be observed on the RX line. Failing to do so will cause the TWAI controller to interpret differences in logic levels between the two signal lines as a loss in arbitration or a bit error.

Driver Configuration

This section covers how to configure the TWAI driver.

Operating Modes The TWAI driver supports the following modes of operations:

Normal Mode: The normal operating mode allows the TWAI controller to take part in bus activities such as transmitting and receiving messages/error frames. Acknowledgement from another node is required when transmitting a message.

No Ack Mode: The No Acknowledgement mode is similar to normal mode, however acknowledgements are not required for a message transmission to be considered successful. This mode is useful when self testing the TWAI controller (loopback of transmissions).

Listen Only Mode: This mode will prevent the TWAI controller from influencing the bus. Therefore, transmission of messages/acknowledgement/error frames will be disabled. However the TWAI controller will still be able to receive messages but will not acknowledge the message. This mode is suited for bus monitor applications.

Alerts The TWAI driver contains an alert feature that is used to notify the application layer of certain TWAI controller or TWAI bus events. Alerts are selectively enabled when the TWAI driver is installed, but can be reconfigured during runtime by calling `twai_reconfigure_alerts()`. The application can then wait for any enabled alerts to occur by calling `twai_read_alerts()`. The TWAI driver supports the following alerts:

Table 3: TWAI Driver Alerts

Alert Flag	Description
TWAI_ALERT_TX_IDLE	No more messages queued for transmission
TWAI_ALERT_TX_SUCCESS	The previous transmission was successful
TWAI_ALERT_BELOW_ERR_WARN	Both error counters have dropped below error warning limit
TWAI_ALERT_ERR_ACTIVE	TWAI controller has become error active
TWAI_ALERT_RECOVERY_IN_PROGRESS	TWAI controller is undergoing bus recovery
TWAI_ALERT_BUS_RECOVERED	TWAI controller has successfully completed bus recovery
TWAI_ALERT_ARB_LOST	The previous transmission lost arbitration
TWAI_ALERT_ABOVE_ERR_WARN	One of the error counters have exceeded the error warning limit
TWAI_ALERT_BUS_ERROR	A (Bit, Stuff, CRC, Form, ACK) error has occurred on the bus
TWAI_ALERT_TX_FAILED	The previous transmission has failed
TWAI_ALERT_RX_QUEUE_FULL	The RX queue is full causing a received frame to be lost
TWAI_ALERT_ERR_PASS	TWAI controller has become error passive
TWAI_ALERT_BUS_OFF	Bus-off condition occurred. TWAI controller can no longer influence bus

Note: The TWAI controller's **error warning limit** is used to preemptively warn the application of bus errors before the error passive state is reached. By default, the TWAI driver sets the **error warning limit** to **96**. The TWAI_ALERT_ABOVE_ERR_WARN is raised when the TEC or REC becomes larger than or equal to the error warning limit. The TWAI_ALERT_BELOW_ERR_WARN is raised when both TEC and REC return back to values below **96**.

Note: When enabling alerts, the `TWAI_ALERT_AND_LOG` flag can be used to cause the TWAI driver to log any raised alerts to UART. However, alert logging is disabled and `TWAI_ALERT_AND_LOG` if the `CONFIG_TWAI_ISR_IN_IRAM` option is enabled (see *Placing ISR into IRAM*).

Note: The `TWAI_ALERT_ALL` and `TWAI_ALERT_NONE` macros can also be used to enable/disable all alerts during configuration/reconfiguration.

Bit Timing The operating bit rate of the TWAI driver is configured using the `twai_timing_config_t` structure. The period of each bit is made up of multiple **time quanta**, and the period of a **time quanta** is determined by a prescaled version of the TWAI controller's source clock. A single bit contains the following segments in the following order:

1. The **Synchronization Segment** consists of a single time quanta
2. **Timing Segment 1** consists of 1 to 16 time quanta before sample point
3. **Timing Segment 2** consists of 1 to 8 time quanta after sample point

The **Baudrate Prescaler** is used to determine the period of each time quanta by dividing the TWAI controller's source clock (80 MHz APB clock). On the ESP32-C3, the `brp` can be **any even number from 2 to 16384**.

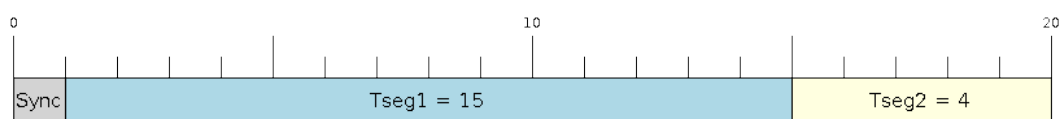

Fig. 14: Bit timing configuration for 500kbit/s given BRP = 8

The sample point of a bit is located on the intersection of Timing Segment 1 and 2. Enabling **Triple Sampling** will cause 3 time quanta to be sampled per bit instead of 1 (extra samples are located at the tail end of Timing Segment 1).

The **Synchronization Jump Width** is used to determine the maximum number of time quanta a single bit time can be lengthened/shortened for synchronization purposes. `sjw` can **range from 1 to 4**.

Note: Multiple combinations of `brp`, `tseg_1`, `tseg_2`, and `sjw` can achieve the same bit rate. Users should tune these values to the physical characteristics of their bus by taking into account factors such as **propagation delay, node information processing time, and phase errors**.

Bit timing **macro initializers** are also available for commonly used bit rates. The following macro initializers are provided by the TWAI driver.

- `TWAI_TIMING_CONFIG_1MBITS()`
- `TWAI_TIMING_CONFIG_800KBITS()`
- `TWAI_TIMING_CONFIG_500KBITS()`
- `TWAI_TIMING_CONFIG_250KBITS()`
- `TWAI_TIMING_CONFIG_125KBITS()`
- `TWAI_TIMING_CONFIG_100KBITS()`
- `TWAI_TIMING_CONFIG_50KBITS()`
- `TWAI_TIMING_CONFIG_25KBITS()`
- `TWAI_TIMING_CONFIG_20KBITS()`
- `TWAI_TIMING_CONFIG_16KBITS()`
- `TWAI_TIMING_CONFIG_12_5KBITS()`
- `TWAI_TIMING_CONFIG_10KBITS()`
- `TWAI_TIMING_CONFIG_5KBITS()`

- `TWAI_TIMING_CONFIG_1KBITS()`

Acceptance Filter The TWAI controller contains a hardware acceptance filter which can be used to filter messages of a particular ID. A node that filters out a message **will not receive the message, but will still acknowledge it**. Acceptance filters can make a node more efficient by filtering out messages sent over the bus that are irrelevant to the node. The acceptance filter is configured using two 32-bit values within `twai_filter_config_t` known as the **acceptance code** and the **acceptance mask**.

The **acceptance code** specifies the bit sequence which a message's ID, RTR, and data bytes must match in order for the message to be received by the TWAI controller. The **acceptance mask** is a bit sequence specifying which bits of the acceptance code can be ignored. This allows for a messages of different IDs to be accepted by a single acceptance code.

The acceptance filter can be used under **Single or Dual Filter Mode**. Single Filter Mode will use the acceptance code and mask to define a single filter. This allows for the first two data bytes of a standard frame to be filtered, or the entirety of an extended frame's 29-bit ID. The following diagram illustrates how the 32-bit acceptance code and mask will be interpreted under Single Filter Mode (Note: The yellow and blue fields represent standard and extended frame formats respectively).

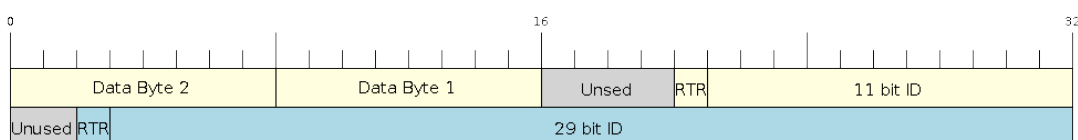

Fig. 15: Bit layout of single filter mode (Right side MSBit)

Dual Filter Mode will use the acceptance code and mask to define two separate filters allowing for increased flexibility of ID's to accept, but does not allow for all 29-bits of an extended ID to be filtered. The following diagram illustrates how the 32-bit acceptance code and mask will be interpreted under **Dual Filter Mode** (Note: The yellow and blue fields represent standard and extended frame formats respectively).

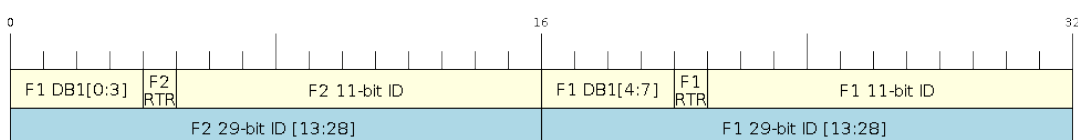

Fig. 16: Bit layout of dual filter mode (Right side MSBit)

Disabling TX Queue The TX queue can be disabled during configuration by setting the `tx_queue_len` member of `twai_general_config_t` to 0. This will allow applications that do not require message transmission to save a small amount of memory when using the TWAI driver.

Placing ISR into IRAM The TWAI driver's ISR (Interrupt Service Routine) can be placed into IRAM so that the ISR can still run whilst the cache is disabled. Placing the ISR into IRAM may be necessary to maintain the TWAI driver's functionality during lengthy cache disabling operations (such as SPI Flash writes, OTA updates etc). Whilst the cache is disabled, the ISR will continue to:

- Read received messages from the RX buffer and place them into the driver's RX queue.
- Load messages pending transmission from the driver's TX queue and write them into the TX buffer.

To place the TWAI driver's ISR, users must do the following:

- Enable the `CONFIG_TWAI_ISR_IN_IRAM` option using `idf.py menuconfig`.

- When calling `twai_driver_install()`, the `intr_flags` member of `twai_general_config_t` should set the `ESP_INTR_FLAG_IRAM` set.

Note: When the `CONFIG_TWAI_ISR_IN_IRAM` option is enabled, the TWAI driver will no longer log any alerts (i.e., the `TWAI_ALERT_AND_LOG` flag will not have any effect).

Driver Operation

The TWAI driver is designed with distinct states and strict rules regarding the functions or conditions that trigger a state transition. The following diagram illustrates the various states and their transitions.

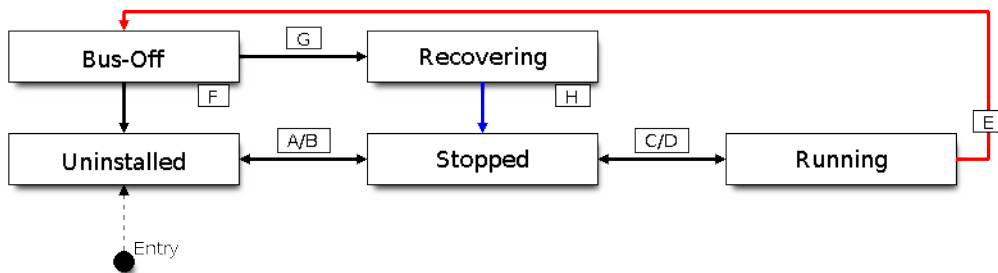

Fig. 17: State transition diagram of the TWAI driver (see table below)

Label	Transition	Action/Condition
A	Uninstalled -> Stopped	<code>twai_driver_install()</code>
B	Stopped -> Uninstalled	<code>twai_driver_uninstall()</code>
C	Stopped -> Running	<code>twai_start()</code>
D	Running -> Stopped	<code>twai_stop()</code>
E	Running -> Bus-Off	Transmit Error Counter \geq 256
F	Bus-Off -> Uninstalled	<code>twai_driver_uninstall()</code>
G	Bus-Off -> Recovering	<code>twai_initiate_recovery()</code>
H	Recovering -> Stopped	128 occurrences of 11 consecutive recessive bits.

Driver States Uninstalled: In the uninstalled state, no memory is allocated for the driver and the TWAI controller is powered OFF.

Stopped: In this state, the TWAI controller is powered ON and the TWAI driver has been installed. However the TWAI controller will be unable to take part in any bus activities such as transmitting, receiving, or acknowledging messages.

Running: In the running state, the TWAI controller is able to take part in bus activities. Therefore messages can be transmitted/received/acknowledged. Furthermore the TWAI controller will be able to transmit error frames upon detection of errors on the bus.

Bus-Off: The bus-off state is automatically entered when the TWAI controller's Transmit Error Counter becomes greater than or equal to 256. The bus-off state indicates the occurrence of severe errors on the bus or in the TWAI controller. Whilst in the bus-off state, the TWAI controller will be unable to take part in any bus activities. To exit the bus-off state, the TWAI controller must undergo the bus recovery process.

Recovering: The recovering state is entered when the TWAI controller undergoes bus recovery. The TWAI controller/TWAI driver will remain in the recovering state until the 128 occurrences of 11 consecutive recessive bits is observed on the bus.

Message Fields and Flags The TWAI driver distinguishes different types of messages by using the various bit field members of the `twai_message_t` structure. These bit field members determine whether a message is in standard or extended format, a remote frame, and the type of transmission to use when transmitting such a message.

These bit field members can also be toggled using the the `flags` member of `twai_message_t` and the following message flags:

Message Flag	Description
TWAI_MSG_FLAG_EXTD	Message is in Extended Frame Format (29bit ID)
TWAI_MSG_FLAG_RTR	Message is a Remote Frame (Remote Transmission Request)
TWAI_MSG_FLAG_SS	Transmit message using Single Shot Transmission (Message will not be retransmitted upon error or loss of arbitration). Unused for received message.
TWAI_MSG_FLAG_SELF	Transmit message using Self Reception Request (Transmitted message will also be received by the same node). Unused for received message.
TWAI_MSG_FLAG_DLC_NON	Message's Data length code is larger than 8. This will break compliance with TWAI
TWAI_MSG_FLAG_NONE	Clears all bit fields. Equivalent to a Standard Frame Format (11bit ID) Data Frame.

Examples

Configuration & Installation The following code snippet demonstrates how to configure, install, and start the TWAI driver via the use of the various configuration structures, macro initializers, the `twai_driver_install()` function, and the `twai_start()` function.

```
#include "driver/gpio.h"
#include "driver/twai.h"

void app_main()
{
    //Initialize configuration structures using macro initializers
    twai_general_config_t g_config = TWAI_GENERAL_CONFIG_DEFAULT(GPIO_NUM_21, GPIO_
    ↪NUM_22, TWAI_MODE_NORMAL);
    twai_timing_config_t t_config = TWAI_TIMING_CONFIG_500KBITS();
    twai_filter_config_t f_config = TWAI_FILTER_CONFIG_ACCEPT_ALL();

    //Install TWAI driver
    if (twai_driver_install(&g_config, &t_config, &f_config) == ESP_OK) {
        printf("Driver installed\n");
    } else {
        printf("Failed to install driver\n");
        return;
    }

    //Start TWAI driver
    if (twai_start() == ESP_OK) {
        printf("Driver started\n");
    } else {
        printf("Failed to start driver\n");
        return;
    }

    ...
}
```

The usage of macro initializers is not mandatory and each of the configuration structures can be manually.

Message Transmission The following code snippet demonstrates how to transmit a message via the usage of the `twai_message_t` type and `twai_transmit()` function.

```
#include "driver/twai.h"

...

//Configure message to transmit
twai_message_t message;
message.identifier = 0xAAAA;
message.extd = 1;
message.data_length_code = 4;
for (int i = 0; i < 4; i++) {
    message.data[i] = 0;
}

//Queue message for transmission
if (twai_transmit(&message, pdMS_TO_TICKS(1000)) == ESP_OK) {
    printf("Message queued for transmission\n");
} else {
    printf("Failed to queue message for transmission\n");
}
```

Message Reception The following code snippet demonstrates how to receive a message via the usage of the `twai_message_t` type and `twai_receive()` function.

```
#include "driver/twai.h"

...

//Wait for message to be received
twai_message_t message;
if (twai_receive(&message, pdMS_TO_TICKS(10000)) == ESP_OK) {
    printf("Message received\n");
} else {
    printf("Failed to receive message\n");
    return;
}

//Process received message
if (message.extd) {
    printf("Message is in Extended Format\n");
} else {
    printf("Message is in Standard Format\n");
}
printf("ID is %d\n", message.identifier);
if (!(message.rtr)) {
    for (int i = 0; i < message.data_length_code; i++) {
        printf("Data byte %d = %d\n", i, message.data[i]);
    }
}
```

Reconfiguring and Reading Alerts The following code snippet demonstrates how to reconfigure and read TWAI driver alerts via the use of the `twai_reconfigure_alerts()` and `twai_read_alerts()` functions.

```
#include "driver/twai.h"

...

//Reconfigure alerts to detect Error Passive and Bus-Off error states
```

(continues on next page)

(continued from previous page)

```

uint32_t alerts_to_enable = TWAI_ALERT_ERR_PASS | TWAI_ALERT_BUS_OFF;
if (twai_reconfigure_alerts(alerts_to_enable, NULL) == ESP_OK) {
    printf("Alerts reconfigured\n");
} else {
    printf("Failed to reconfigure alerts");
}

//Block indefinitely until an alert occurs
uint32_t alerts_triggered;
twai_read_alerts(&alerts_triggered, portMAX_DELAY);

```

Stop and Uninstall The following code demonstrates how to stop and uninstall the TWAI driver via the use of the `twai_stop()` and `twai_driver_uninstall()` functions.

```

#include "driver/twai.h"

...

//Stop the TWAI driver
if (twai_stop() == ESP_OK) {
    printf("Driver stopped\n");
} else {
    printf("Failed to stop driver\n");
    return;
}

//Uninstall the TWAI driver
if (twai_driver_uninstall() == ESP_OK) {
    printf("Driver uninstalled\n");
} else {
    printf("Failed to uninstall driver\n");
    return;
}

```

Multiple ID Filter Configuration The acceptance mask in `twai_filter_config_t` can be configured such that two or more IDs will be accepted for a single filter. For a particular filter to accept multiple IDs, the conflicting bit positions amongst the IDs must be set in the acceptance mask. The acceptance code can be set to any one of the IDs.

The following example shows how to calculate the acceptance mask given multiple IDs:

```

ID1 = 11'b101 1010 0000
ID2 = 11'b101 1010 0001
ID3 = 11'b101 1010 0100
ID4 = 11'b101 1010 1000
//Acceptance Mask
MASK = 11'b000 0000 1101

```

Application Examples **Network Example:** The TWAI Network example demonstrates communication between two ESP32-C3s using the TWAI driver API. One TWAI node acts as a network master that initiates and ceases the transfer of a data from another node acting as a network slave. The example can be found via [peripherals/twai/twai_network](#).

Alert and Recovery Example: This example demonstrates how to use the TWAI driver's alert and bus-off recovery API. The example purposely introduces errors on the bus to put the TWAI controller into the Bus-Off state. An alert is used to detect the Bus-Off state and trigger the bus recovery process. The example can be found via [peripherals/twai/twai_alert_and_recovery](#).

Self Test Example: This example uses the No Acknowledge Mode and Self Reception Request to cause the TWAI controller to send and simultaneously receive a series of messages. This example can be used to verify if the connections between the TWAI controller and the external transceiver are working correctly. The example can be found via [peripherals/twai/twai_self_test](#).

API Reference

Header File

- [hal/include/hal/twai_types.h](#)

Structures

struct twai_message_t

Structure to store a TWAI message.

Note The flags member is deprecated

Public Members

uint32_t **extd** : 1

Extended Frame Format (29bit ID)

uint32_t **rtr** : 1

Message is a Remote Frame

uint32_t **ss** : 1

Transmit as a Single Shot Transmission. Unused for received.

uint32_t **self** : 1

Transmit as a Self Reception Request. Unused for received.

uint32_t **dlc_non_comp** : 1

Message's Data length code is larger than 8. This will break compliance with ISO 11898-1

uint32_t **reserved** : 27

Reserved bits

uint32_t **flags**

Deprecated: Alternate way to set bits using message flags

uint32_t **identifier**

11 or 29 bit identifier

uint8_t **data_length_code**

Data length code

uint8_t **data**[**TWAI_FRAME_MAX_DLC**]

Data bytes (not relevant in RTR frame)

struct twai_timing_config_t

Structure for bit timing configuration of the TWAI driver.

Note Macro initializers are available for this structure

Public Members

uint32_t **brp**

Baudrate prescaler (i.e., APB clock divider). Any even number from 2 to 128 for ESP32, 2 to 32768 for ESP32S2. For ESP32 Rev 2 or later, multiples of 4 from 132 to 256 are also supported

uint8_t **tseg_1**

Timing segment 1 (Number of time quanta, between 1 to 16)

uint8_t **tseg_2**

Timing segment 2 (Number of time quanta, 1 to 8)

uint8_t **sjw**

Synchronization Jump Width (Max time quanta jump for synchronize from 1 to 4)

bool **triple_sampling**

Enables triple sampling when the TWAI controller samples a bit

struct twai_filter_config_t

Structure for acceptance filter configuration of the TWAI driver (see documentation)

Note Macro initializers are available for this structure

Public Members

uint32_t **acceptance_code**

32-bit acceptance code

uint32_t **acceptance_mask**

32-bit acceptance mask

bool **single_filter**

Use Single Filter Mode (see documentation)

Macros

TWAI_EXTD_ID_MASK

TWAI Constants.

Bit mask for 29 bit Extended Frame Format ID

TWAI_STD_ID_MASK

Bit mask for 11 bit Standard Frame Format ID

TWAI_FRAME_MAX_DLC

Max data bytes allowed in TWAI

TWAI_FRAME_EXTD_ID_LEN_BYTES

EFF ID requires 4 bytes (29bit)

TWAI_FRAME_STD_ID_LEN_BYTES

SFF ID requires 2 bytes (11bit)

TWAI_ERR_PASS_THRESH

Error counter threshold for error passive

Enumerations

enum twai_mode_t

TWAI Controller operating modes.

Values:

TWAI_MODE_NORMAL

Normal operating mode where TWAI controller can send/receive/acknowledge messages

TWAI_MODE_NO_ACK

Transmission does not require acknowledgment. Use this mode for self testing

TWAI_MODE_LISTEN_ONLY

The TWAI controller will not influence the bus (No transmissions or acknowledgments) but can receive messages

Header File

- [driver/include/driver/twai.h](#)

Functions

esp_err_t **twai_driver_install** (**const** *twai_general_config_t* *g_config, **const** *twai_timing_config_t* *t_config, **const** *twai_filter_config_t* *f_config)

Install TWAI driver.

This function installs the TWAI driver using three configuration structures. The required memory is allocated and the TWAI driver is placed in the stopped state after running this function.

Note Macro initializers are available for the configuration structures (see documentation)

Note To reinstall the TWAI driver, call `twai_driver_uninstall()` first

Return

- ESP_OK: Successfully installed TWAI driver
- ESP_ERR_INVALID_ARG: Arguments are invalid
- ESP_ERR_NO_MEM: Insufficient memory
- ESP_ERR_INVALID_STATE: Driver is already installed

Parameters

- [in] g_config: General configuration structure
- [in] t_config: Timing configuration structure
- [in] f_config: Filter configuration structure

esp_err_t **twai_driver_uninstall** (void)

Uninstall the TWAI driver.

This function uninstalls the TWAI driver, freeing the memory utilized by the driver. This function can only be called when the driver is in the stopped state or the bus-off state.

Warning The application must ensure that no tasks are blocked on TX/RX queues or alerts when this function is called.

Return

- ESP_OK: Successfully uninstalled TWAI driver
- ESP_ERR_INVALID_STATE: Driver is not in stopped/bus-off state, or is not installed

esp_err_t **twai_start** (void)

Start the TWAI driver.

This function starts the TWAI driver, putting the TWAI driver into the running state. This allows the TWAI driver to participate in TWAI bus activities such as transmitting/receiving messages. The TX and RX queue are reset in this function, clearing any messages that are unread or pending transmission. This function can only be called when the TWAI driver is in the stopped state.

Return

- ESP_OK: TWAI driver is now running
- ESP_ERR_INVALID_STATE: Driver is not in stopped state, or is not installed

esp_err_t **twai_stop** (void)

Stop the TWAI driver.

This function stops the TWAI driver, preventing any further message from being transmitted or received until `twai_start()` is called. Any messages in the TX queue are cleared. Any messages in the RX queue should be read by the application after this function is called. This function can only be called when the TWAI driver is in the running state.

Warning A message currently being transmitted/received on the TWAI bus will be ceased immediately. This may lead to other TWAI nodes interpreting the unfinished message as an error.

Return

- ESP_OK: TWAI driver is now Stopped
- ESP_ERR_INVALID_STATE: Driver is not in running state, or is not installed

esp_err_t **twai_transmit** (**const** *twai_message_t* *message, TickType_t ticks_to_wait)

Transmit a TWAI message.

This function queues a TWAI message for transmission. Transmission will start immediately if no other messages are queued for transmission. If the TX queue is full, this function will block until more space becomes available or until it times out. If the TX queue is disabled (TX queue length = 0 in configuration), this function will return immediately if another message is undergoing transmission. This function can only be called when the TWAI driver is in the running state and cannot be called under Listen Only Mode.

Note This function does not guarantee that the transmission is successful. The TX_SUCCESS/TX_FAILED alert can be enabled to alert the application upon the success/failure of a transmission.

Note The TX_IDLE alert can be used to alert the application when no other messages are awaiting transmission.

Return

- ESP_OK: Transmission successfully queued/initiated
- ESP_ERR_INVALID_ARG: Arguments are invalid
- ESP_ERR_TIMEOUT: Timed out waiting for space on TX queue
- ESP_FAIL: TX queue is disabled and another message is currently transmitting
- ESP_ERR_INVALID_STATE: TWAI driver is not in running state, or is not installed
- ESP_ERR_NOT_SUPPORTED: Listen Only Mode does not support transmissions

Parameters

- [in] message: Message to transmit
- [in] ticks_to_wait: Number of FreeRTOS ticks to block on the TX queue

*esp_err_t twai_receive (twai_message_t *message, TickType_t ticks_to_wait)*

Receive a TWAI message.

This function receives a message from the RX queue. The flags field of the message structure will indicate the type of message received. This function will block if there are no messages in the RX queue

Warning The flags field of the received message should be checked to determine if the received message contains any data bytes.

Return

- ESP_OK: Message successfully received from RX queue
- ESP_ERR_TIMEOUT: Timed out waiting for message
- ESP_ERR_INVALID_ARG: Arguments are invalid
- ESP_ERR_INVALID_STATE: TWAI driver is not installed

Parameters

- [out] message: Received message
- [in] ticks_to_wait: Number of FreeRTOS ticks to block on RX queue

*esp_err_t twai_read_alerts (uint32_t *alerts, TickType_t ticks_to_wait)*

Read TWAI driver alerts.

This function will read the alerts raised by the TWAI driver. If no alert has been issued when this function is called, this function will block until an alert occurs or until it timeouts.

Note Multiple alerts can be raised simultaneously. The application should check for all alerts that have been enabled.

Return

- ESP_OK: Alerts read
- ESP_ERR_TIMEOUT: Timed out waiting for alerts
- ESP_ERR_INVALID_ARG: Arguments are invalid
- ESP_ERR_INVALID_STATE: TWAI driver is not installed

Parameters

- [out] alerts: Bit field of raised alerts (see documentation for alert flags)
- [in] ticks_to_wait: Number of FreeRTOS ticks to block for alert

*esp_err_t twai_reconfigure_alerts (uint32_t alerts_enabled, uint32_t *current_alerts)*

Reconfigure which alerts are enabled.

This function reconfigures which alerts are enabled. If there are alerts which have not been read whilst reconfiguring, this function can read those alerts.

Return

- ESP_OK: Alerts reconfigured

- `ESP_ERR_INVALID_STATE`: TWAI driver is not installed

Parameters

- `[in] alerts_enabled`: Bit field of alerts to enable (see documentation for alert flags)
- `[out] current_alerts`: Bit field of currently raised alerts. Set to `NULL` if unused

esp_err_t **twai_initiate_recovery** (void)

Start the bus recovery process.

This function initiates the bus recovery process when the TWAI driver is in the bus-off state. Once initiated, the TWAI driver will enter the recovering state and wait for 128 occurrences of the bus-free signal on the TWAI bus before returning to the stopped state. This function will reset the TX queue, clearing any messages pending transmission.

Note The `BUS_RECOVERED` alert can be enabled to alert the application when the bus recovery process completes.

Return

- `ESP_OK`: Bus recovery started
- `ESP_ERR_INVALID_STATE`: TWAI driver is not in the bus-off state, or is not installed

esp_err_t **twai_get_status_info** (*twai_status_info_t* **status_info*)

Get current status information of the TWAI driver.

Return

- `ESP_OK`: Status information retrieved
- `ESP_ERR_INVALID_ARG`: Arguments are invalid
- `ESP_ERR_INVALID_STATE`: TWAI driver is not installed

Parameters

- `[out] status_info`: Status information

esp_err_t **twai_clear_transmit_queue** (void)

Clear the transmit queue.

This function will clear the transmit queue of all messages.

Note The transmit queue is automatically cleared when `twai_stop()` or `twai_initiate_recovery()` is called.

Return

- `ESP_OK`: Transmit queue cleared
- `ESP_ERR_INVALID_STATE`: TWAI driver is not installed or TX queue is disabled

esp_err_t **twai_clear_receive_queue** (void)

Clear the receive queue.

This function will clear the receive queue of all messages.

Note The receive queue is automatically cleared when `twai_start()` is called.

Return

- `ESP_OK`: Transmit queue cleared
- `ESP_ERR_INVALID_STATE`: TWAI driver is not installed

Structures

struct twai_general_config_t

Structure for general configuration of the TWAI driver.

Note Macro initializers are available for this structure

Public Members

twai_mode_t **mode**

Mode of TWAI controller

gpio_num_t **tx_io**

Transmit GPIO number

gpio_num_t **rx_io**
Receive GPIO number

gpio_num_t **clkout_io**
CLKOUT GPIO number (optional, set to -1 if unused)

gpio_num_t **bus_off_io**
Bus off indicator GPIO number (optional, set to -1 if unused)

uint32_t **tx_queue_len**
Number of messages TX queue can hold (set to 0 to disable TX Queue)

uint32_t **rx_queue_len**
Number of messages RX queue can hold

uint32_t **alerts_enabled**
Bit field of alerts to enable (see documentation)

uint32_t **clkout_divider**
CLKOUT divider. Can be 1 or any even number from 2 to 14 (optional, set to 0 if unused)

int **intr_flags**
Interrupt flags to set the priority of the driver's ISR. Note that to use the ESP_INTR_FLAG_IRAM, the CONFIG_TWAI_ISR_IN_IRAM option should be enabled first.

struct twai_status_info_t
Structure to store status information of TWAI driver.

Public Members

twai_state_t **state**
Current state of TWAI controller (Stopped/Running/Bus-Off/Recovery)

uint32_t **msgs_to_tx**
Number of messages queued for transmission or awaiting transmission completion

uint32_t **msgs_to_rx**
Number of messages in RX queue waiting to be read

uint32_t **tx_error_counter**
Current value of Transmit Error Counter

uint32_t **rx_error_counter**
Current value of Receive Error Counter

uint32_t **tx_failed_count**
Number of messages that failed transmissions

uint32_t **rx_missed_count**
Number of messages that were lost due to a full RX queue (or errata workaround if enabled)

uint32_t **rx_overrun_count**
Number of messages that were lost due to a RX FIFO overrun

uint32_t **arb_lost_count**
Number of instances arbitration was lost

uint32_t **bus_error_count**
Number of instances a bus error has occurred

Macros

TWAI_IO_UNUSED
Marks GPIO as unused in TWAI configuration

Enumerations

enum twai_state_t

TWAI driver states.

Values:

TWAI_STATE_STOPPED

Stopped state. The TWAI controller will not participate in any TWAI bus activities

TWAI_STATE_RUNNING

Running state. The TWAI controller can transmit and receive messages

TWAI_STATE_BUS_OFF

Bus-off state. The TWAI controller cannot participate in bus activities until it has recovered

TWAI_STATE_RECOVERING

Recovering state. The TWAI controller is undergoing bus recovery

2.3.15 UART

Overview

A Universal Asynchronous Receiver/Transmitter (UART) is a hardware feature that handles communication (i.e., timing requirements and data framing) using widely-adapted asynchronous serial communication interfaces, such as RS232, RS422, RS485. A UART provides a widely adopted and cheap method to realize full-duplex or half-duplex data exchange among different devices.

The ESP32-C3 chip has two UART controllers (UART0 and UART1) that feature an identical set of registers for ease of programming and flexibility.

Each UART controller is independently configurable with parameters such as baud rate, data bit length, bit ordering, number of stop bits, parity bit etc. All the controllers are compatible with UART-enabled devices from various manufacturers and can also support Infrared Data Association protocols (IrDA).

Functional Overview

The following overview describes how to establish communication between an ESP32-C3 and other UART devices using the functions and data types of the UART driver. The overview reflects a typical programming workflow and is broken down into the sections provided below:

1. *Setting Communication Parameters* - Setting baud rate, data bits, stop bits, etc.
2. *Setting Communication Pins* - Assigning pins for connection to a device.
3. *Driver Installation* - Allocating ESP32-C3's resources for the UART driver.
4. *Running UART Communication* - Sending / receiving data
5. *Using Interrupts* - Triggering interrupts on specific communication events
6. *Deleting a Driver* - Freeing allocated resources if a UART communication is no longer required

Steps 1 to 3 comprise the configuration stage. Step 4 is where the UART starts operating. Steps 5 and 6 are optional.

The UART driver's functions identify each of the UART controllers using `uart_port_t`. This identification is needed for all the following function calls.

Setting Communication Parameters UART communication parameters can be configured all in a single step or individually in multiple steps.

Single Step Call the function `uart_param_config()` and pass to it a `uart_config_t` structure. The `uart_config_t` structure should contain all the required parameters. See the example below.

```

const int uart_num = UART_NUM_1;
uart_config_t uart_config = {
    .baud_rate = 115200,
    .data_bits = UART_DATA_8_BITS,
    .parity = UART_PARITY_DISABLE,
    .stop_bits = UART_STOP_BITS_1,
    .flow_ctrl = UART_HW_FLOWCTRL_CTS_RTS,
    .rx_flow_ctrl_thresh = 122,
};
// Configure UART parameters
ESP_ERROR_CHECK(uart_param_config(uart_num, &uart_config));

```

Multiple Steps Configure specific parameters individually by calling a dedicated function from the table given below. These functions are also useful if re-configuring a single parameter.

Table 4: Functions for Configuring specific parameters individually

Parameter to Configure	Function
Baud rate	<code>uart_set_baudrate()</code>
Number of transmitted bits	<code>uart_set_word_length()</code> selected out of <code>uart_word_length_t</code>
Parity control	<code>uart_set_parity()</code> selected out of <code>uart_parity_t</code>
Number of stop bits	<code>uart_set_stop_bits()</code> selected out of <code>uart_stop_bits_t</code>
Hardware flow control mode	<code>uart_set_hw_flow_ctrl()</code> selected out of <code>uart_hw_flowcontrol_t</code>
Communication mode	<code>uart_set_mode()</code> selected out of <code>uart_mode_t</code>

Each of the above functions has a `_get_` counterpart to check the currently set value. For example, to check the current baud rate value, call `uart_get_baudrate()`.

Setting Communication Pins After setting communication parameters, configure the physical GPIO pins to which the other UART device will be connected. For this, call the function `uart_set_pin()` and specify the GPIO pin numbers to which the driver should route the Tx, Rx, RTS, and CTS signals. If you want to keep a currently allocated pin number for a specific signal, pass the macro `UART_PIN_NO_CHANGE`.

The same macro should be specified for pins that will not be used.

```

// Set UART pins (TX: IO4, RX: IO5, RTS: IO19, CTS: IO20)
ESP_ERROR_CHECK(uart_set_pin(UART_NUM_1, 4, 5, 19, 20));

```

Driver Installation Once the communication pins are set, install the driver by calling `uart_driver_install()` and specify the following parameters:

- Size of Tx ring buffer
- Size of Rx ring buffer
- Event queue handle and size
- Flags to allocate an interrupt

The function will allocate the required internal resources for the UART driver.

```

// Setup UART buffered IO with event queue
const int uart_buffer_size = (1024 * 2);
QueueHandle_t uart_queue;
// Install UART driver using an event queue here
ESP_ERROR_CHECK(uart_driver_install(UART_NUM_1, uart_buffer_size, \
                                   uart_buffer_size, 10, &uart_queue, 0));

```

Once this step is complete, you can connect the external UART device and check the communication.

Running UART Communication Serial communication is controlled by each UART controller's finite state machine (FSM).

The process of sending data involves the following steps:

1. Write data into Tx FIFO buffer
2. FSM serializes the data
3. FSM sends the data out

The process of receiving data is similar, but the steps are reversed:

1. FSM processes an incoming serial stream and parallelizes it
2. FSM writes the data into Rx FIFO buffer
3. Read the data from Rx FIFO buffer

Therefore, an application will be limited to writing and reading data from a respective buffer using `uart_write_bytes()` and `uart_read_bytes()` respectively, and the FSM will do the rest.

Transmitting After preparing the data for transmission, call the function `uart_write_bytes()` and pass the data buffer's address and data length to it. The function will copy the data to the Tx ring buffer (either immediately or after enough space is available), and then exit. When there is free space in the Tx FIFO buffer, an interrupt service routine (ISR) moves the data from the Tx ring buffer to the Tx FIFO buffer in the background. The code below demonstrates the use of this function.

```
// Write data to UART.
char* test_str = "This is a test string.\n";
uart_write_bytes(uart_num, (const char*)test_str, strlen(test_str));
```

The function `uart_write_bytes_with_break()` is similar to `uart_write_bytes()` but adds a serial break signal at the end of the transmission. A 'serial break signal' means holding the Tx line low for a period longer than one data frame.

```
// Write data to UART, end with a break signal.
uart_write_bytes_with_break(uart_num, "test break\n", strlen("test break\n"), 100);
```

Another function for writing data to the Tx FIFO buffer is `uart_tx_chars()`. Unlike `uart_write_bytes()`, this function will not block until space is available. Instead, it will write all data which can immediately fit into the hardware Tx FIFO, and then return the number of bytes that were written.

There is a 'companion' function `uart_wait_tx_done()` that monitors the status of the Tx FIFO buffer and returns once it is empty.

```
// Wait for packet to be sent
const int uart_num = UART_NUM_1;
ESP_ERROR_CHECK(uart_wait_tx_done(uart_num, 100)); // wait timeout is 100 RTOS_
↳ticks (TickType_t)
```

Receiving Once the data is received by the UART and saved in the Rx FIFO buffer, it needs to be retrieved using the function `uart_read_bytes()`. Before reading data, you can check the number of bytes available in the Rx FIFO buffer by calling `uart_get_buffered_data_len()`. An example of using these functions is given below.

```
// Read data from UART.
const int uart_num = UART_NUM_1;
uint8_t data[128];
int length = 0;
ESP_ERROR_CHECK(uart_get_buffered_data_len(uart_num, (size_t*)&length));
length = uart_read_bytes(uart_num, data, length, 100);
```

If the data in the Rx FIFO buffer is no longer needed, you can clear the buffer by calling `uart_flush()`.

Software Flow Control If the hardware flow control is disabled, you can manually set the RTS and DTR signal levels by using the functions `uart_set_rts()` and `uart_set_dtr()` respectively.

Communication Mode Selection The UART controller supports a number of communication modes. A mode can be selected using the function `uart_set_mode()`. Once a specific mode is selected, the UART driver will handle the behavior of a connected UART device accordingly. As an example, it can control the RS485 driver chip using the RTS line to allow half-duplex RS485 communication.

```
// Setup UART in rs485 half duplex mode
ESP_ERROR_CHECK(uart_set_mode(uart_num, UART_MODE_RS485_HALF_DUPLEX));
```

Using Interrupts There are many interrupts that can be generated following specific UART states or detected errors. The full list of available interrupts is provided in *ESP32-C3 Technical Reference Manual > UART Controller (UART) > UART Interrupts* and *UHCI Interrupts* [PDF]. You can enable or disable specific interrupts by calling `uart_enable_intr_mask()` or `uart_disable_intr_mask()` respectively. The mask of all interrupts is available as `UART_INTR_MASK`.

By default, the `uart_driver_install()` function installs the driver's internal interrupt handler to manage the Tx and Rx ring buffers and provides high-level API functions like events (see below). It is also possible to register a lower level interrupt handler instead using `uart_isr_register()`, and to free it again using `uart_isr_free()`. Some UART driver functions which use the Tx and Rx ring buffers, events, etc. will not automatically work in this case - it is necessary to handle the interrupts directly in the ISR. Inside the custom handler implementation, clear the interrupt status bits using `uart_clear_intr_status()`.

The API provides a convenient way to handle specific interrupts discussed in this document by wrapping them into dedicated functions:

- **Event detection:** There are several events defined in `uart_event_type_t` that may be reported to a user application using the FreeRTOS queue functionality. You can enable this functionality when calling `uart_driver_install()` described in *Driver Installation*. An example of using Event detection can be found in [peripherals/uart/uart_events](#).
- **FIFO space threshold or transmission timeout reached:** The Tx and Rx FIFO buffers can trigger an interrupt when they are filled with a specific number of characters, or on a timeout of sending or receiving data. To use these interrupts, do the following:
 - Configure respective threshold values of the buffer length and timeout by entering them in the structure `uart_intr_config_t` and calling `uart_intr_config()`
 - Enable the interrupts using the functions `uart_enable_tx_intr()` and `uart_enable_rx_intr()`
 - Disable these interrupts using the corresponding functions `uart_disable_tx_intr()` or `uart_disable_rx_intr()`
- **Pattern detection:** An interrupt triggered on detecting a 'pattern' of the same character being received/sent repeatedly for a number of times. This functionality is demonstrated in the example [peripherals/uart/uart_events](#). It can be used, e.g., to detect a command string followed by a specific number of identical characters (the 'pattern') added at the end of the command string. The following functions are available:
 - Configure and enable this interrupt using `uart_enable_pattern_det_intr()`
 - Disable the interrupt using `uart_disable_pattern_det_intr()`

Macros The API also defines several macros. For example, `UART_FIFO_LEN` defines the length of hardware FIFO buffers; `UART_BITRATE_MAX` gives the maximum baud rate supported by the UART controllers, etc.

Deleting a Driver If the communication established with `uart_driver_install()` is no longer required, the driver can be removed to free allocated resources by calling `uart_driver_delete()`.

Overview of RS485 specific communication options

Note: The following section will use `[UART_REGISTER_NAME].[UART_FIELD_BIT]` to refer to UART register fields/bits. For more information on a specific option bit, see *ESP32-C3 Technical Reference Manual > UART Controller (UART) > Register Summary* [PDF]. Use the register name to navigate to the register description and then find the field/bit.

- `UART_RS485_CONF_REG.UART_RS485_EN`: setting this bit enables RS485 communication mode support.
- `UART_RS485_CONF_REG.UART_RS485TX_RX_EN`: if this bit is set, the transmitter's output signal loops back to the receiver's input signal.
- `UART_RS485_CONF_REG.UART_RS485RXBY_TX_EN`: if this bit is set, the transmitter will still be sending data if the receiver is busy (remove collisions automatically by hardware).

The ESP32-C3's RS485 UART hardware can detect signal collisions during transmission of a datagram and generate the interrupt `UART_RS485_CLASH_INT` if this interrupt is enabled. The term collision means that a transmitted datagram is not equal to the one received on the other end. Data collisions are usually associated with the presence of other active devices on the bus or might occur due to bus errors.

The collision detection feature allows handling collisions when their interrupts are activated and triggered. The interrupts `UART_RS485_FRM_ERR_INT` and `UART_RS485_PARITY_ERR_INT` can be used with the collision detection feature to control frame errors and parity bit errors accordingly in RS485 mode. This functionality is supported in the UART driver and can be used by selecting the `UART_MODE_RS485_APP_CTRL` mode (see the function `uart_set_mode()`).

The collision detection feature can work with circuit A and circuit C (see Section *Interface Connection Options*). In the case of using circuit A or B, the RTS pin connected to the DE pin of the bus driver should be controlled by the user application. Use the function `uart_get_collision_flag()` to check if the collision detection flag has been raised.

The ESP32-C3 UART controllers themselves do not support half-duplex communication as they cannot provide automatic control of the RTS pin connected to the \sim RE/DE input of RS485 bus driver. However, half-duplex communication can be achieved via software control of the RTS pin by the UART driver. This can be enabled by selecting the `UART_MODE_RS485_HALF_DUPLEX` mode when calling `uart_set_mode()`.

Once the host starts writing data to the Tx FIFO buffer, the UART driver automatically asserts the RTS pin (logic 1); once the last bit of the data has been transmitted, the driver de-asserts the RTS pin (logic 0). To use this mode, the software would have to disable the hardware flow control function. This mode works with all the used circuits shown below.

Interface Connection Options This section provides example schematics to demonstrate the basic aspects of ESP32-C3's RS485 interface connection.

Note:

- The schematics below do **not** necessarily contain **all required elements**.
- The **analog devices** ADM483 & ADM2483 are examples of common RS485 transceivers and **can be replaced** with other similar transceivers.

Circuit A: Collision Detection Circuit

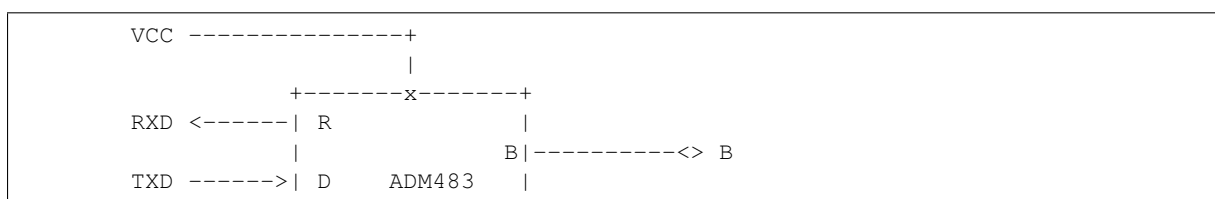

(continues on next page)

(continued from previous page)

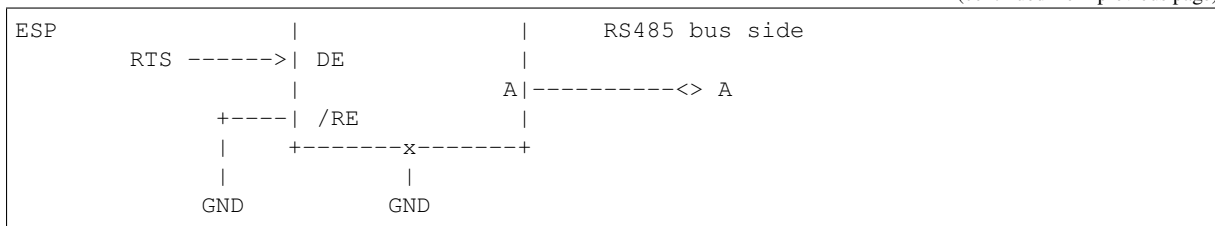

This circuit is preferable because it allows for collision detection and is quite simple at the same time. The receiver in the line driver is constantly enabled, which allows the UART to monitor the RS485 bus. Echo suppression is performed by the UART peripheral when the bit `UART_RS485_CONF_REG.UART_RS485TX_RX_EN` is enabled.

Circuit B: Manual Switching Transmitter/Receiver Without Collision Detection

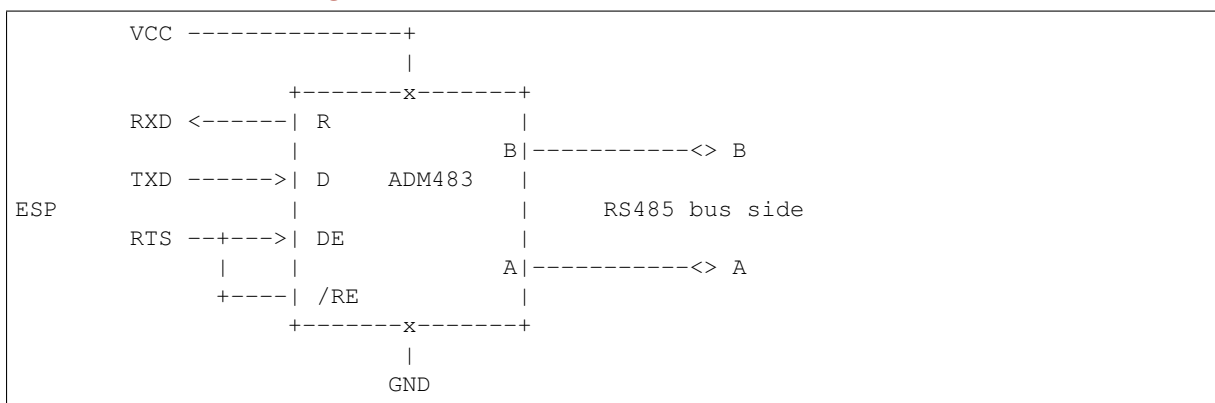

This circuit does not allow for collision detection. It suppresses the null bytes that the hardware receives when the bit `UART_RS485_CONF_REG.UART_RS485TX_RX_EN` is set. The bit `UART_RS485_CONF_REG.UART_RS485RXBY_TX_EN` is not applicable in this case.

Circuit C: Auto Switching Transmitter/Receiver

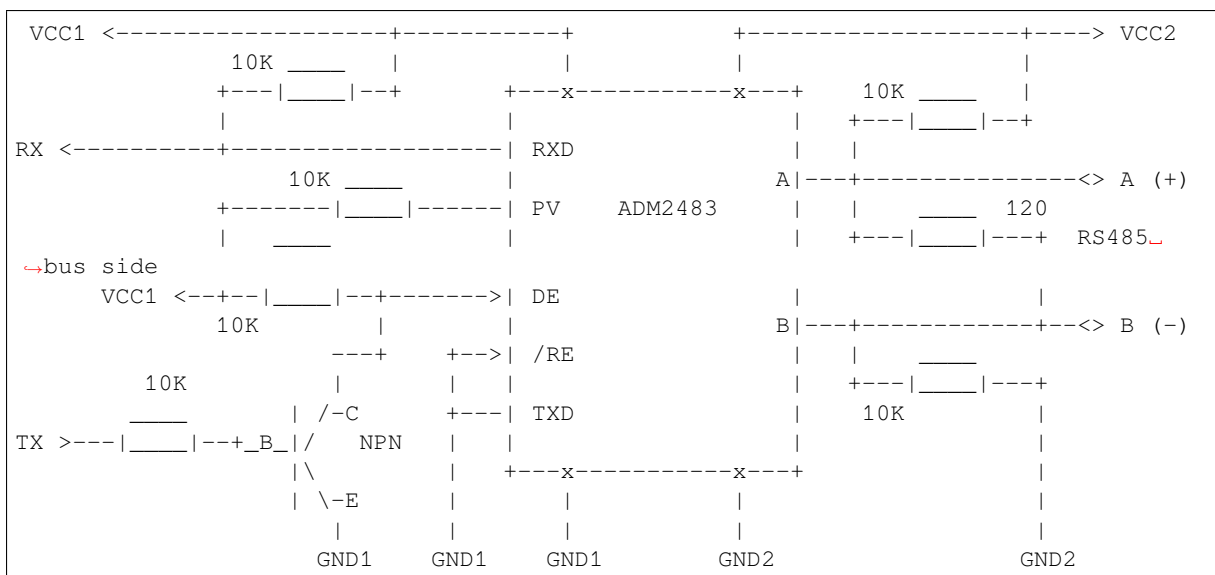

This galvanically isolated circuit does not require RTS pin control by a software application or driver because it controls the transceiver direction automatically. However, it requires suppressing null bytes during transmission by setting `UART_RS485_CONF_REG.UART_RS485RXBY_TX_EN` to 1 and `UART_RS485_CONF_REG.UART_RS485TX_RX_EN` to 0. This setup can work in any RS485 UART mode or even in `UART_MODE_UART`.

Application Examples

The table below describes the code examples available in the directory [peripherals/uart/](#).

Code Example	Description
peripherals/uart/uart_echo	Configuring UART settings, installing the UART driver, and reading/writing over the UART1 interface.
peripherals/uart/uart_events	Reporting various communication events, using pattern detection interrupts.
peripherals/uart/uart_async_rxtxtasks	Transmitting and receiving data in two separate FreeRTOS tasks over the same UART.
peripherals/uart/uart_select	Using synchronous I/O multiplexing for UART file descriptors.
peripherals/uart/uart_echo_rs485	Setting up UART driver to communicate over RS485 interface in half-duplex mode. This example is similar to peripherals/uart/uart_echo but allows communication through an RS485 interface chip connected to ESP32-C3 pins.
peripherals/uart/nmea0183_parser	Obtaining GPS information by parsing NMEA0183 statements received from GPS via the UART peripheral.

API Reference

Header File

- [driver/include/driver/uart.h](#)

Functions

`esp_err_t uart_driver_install(uart_port_t uart_num, int rx_buffer_size, int tx_buffer_size, int queue_size, QueueHandle_t *uart_queue, int intr_alloc_flags)`

Install UART driver and set the UART to the default configuration.

UART ISR handler will be attached to the same CPU core that this function is running on.

Note Rx_buffer_size should be greater than UART_FIFO_LEN. Tx_buffer_size should be either zero or greater than UART_FIFO_LEN.

Return

- ESP_OK Success
- ESP_FAIL Parameter error

Parameters

- `uart_num`: UART port number, the max port number is (UART_NUM_MAX - 1).
- `rx_buffer_size`: UART RX ring buffer size.
- `tx_buffer_size`: UART TX ring buffer size. If set to zero, driver will not use TX buffer, TX function will block task until all data have been sent out.
- `queue_size`: UART event queue size/depth.
- `uart_queue`: UART event queue handle (out param). On success, a new queue handle is written here to provide access to UART events. If set to NULL, driver will not use an event queue.
- `intr_alloc_flags`: Flags used to allocate the interrupt. One or multiple (ORred) ESP_INTR_FLAG_* values. See `esp_intr_alloc.h` for more info. Do not set ESP_INTR_FLAG_IRAM here (the driver's ISR handler is not located in IRAM)

`esp_err_t uart_driver_delete(uart_port_t uart_num)`

Uninstall UART driver.

Return

- ESP_OK Success
- ESP_FAIL Parameter error

Parameters

- `uart_num`: UART port number, the max port number is (UART_NUM_MAX - 1).

`bool uart_is_driver_installed(uart_port_t uart_num)`

Checks whether the driver is installed or not.

Return

- true driver is installed
- false driver is not installed

Parameters

- `uart_num`: UART port number, the max port number is (UART_NUM_MAX -1).

esp_err_t **uart_set_word_length** (*uart_port_t* `uart_num`, *uart_word_length_t* `data_bit`)

Set UART data bits.

Return

- ESP_OK Success
- ESP_FAIL Parameter error

Parameters

- `uart_num`: UART port number, the max port number is (UART_NUM_MAX -1).
- `data_bit`: UART data bits

esp_err_t **uart_get_word_length** (*uart_port_t* `uart_num`, *uart_word_length_t* `*data_bit`)

Get the UART data bit configuration.

Return

- ESP_FAIL Parameter error
- ESP_OK Success, result will be put in (`*data_bit`)

Parameters

- `uart_num`: UART port number, the max port number is (UART_NUM_MAX -1).
- `data_bit`: Pointer to accept value of UART data bits.

esp_err_t **uart_set_stop_bits** (*uart_port_t* `uart_num`, *uart_stop_bits_t* `stop_bits`)

Set UART stop bits.

Return

- ESP_OK Success
- ESP_FAIL Fail

Parameters

- `uart_num`: UART port number, the max port number is (UART_NUM_MAX -1).
- `stop_bits`: UART stop bits

esp_err_t **uart_get_stop_bits** (*uart_port_t* `uart_num`, *uart_stop_bits_t* `*stop_bits`)

Get the UART stop bit configuration.

Return

- ESP_FAIL Parameter error
- ESP_OK Success, result will be put in (`*stop_bit`)

Parameters

- `uart_num`: UART port number, the max port number is (UART_NUM_MAX -1).
- `stop_bits`: Pointer to accept value of UART stop bits.

esp_err_t **uart_set_parity** (*uart_port_t* `uart_num`, *uart_parity_t* `parity_mode`)

Set UART parity mode.

Return

- ESP_FAIL Parameter error
- ESP_OK Success

Parameters

- `uart_num`: UART port number, the max port number is (UART_NUM_MAX -1).
- `parity_mode`: the enum of uart parity configuration

esp_err_t **uart_get_parity** (*uart_port_t* `uart_num`, *uart_parity_t* `*parity_mode`)

Get the UART parity mode configuration.

Return

- ESP_FAIL Parameter error
- ESP_OK Success, result will be put in (`*parity_mode`)

Parameters

- `uart_num`: UART port number, the max port number is (UART_NUM_MAX -1).

- `parity_mode`: Pointer to accept value of UART parity mode.

esp_err_t **uart_set_baudrate** (*uart_port_t* *uart_num*, *uint32_t* *baudrate*)

Set UART baud rate.

Return

- `ESP_FAIL` Parameter error
- `ESP_OK` Success

Parameters

- `uart_num`: UART port number, the max port number is (`UART_NUM_MAX - 1`).
- `baudrate`: UART baud rate.

esp_err_t **uart_get_baudrate** (*uart_port_t* *uart_num*, *uint32_t* **baudrate*)

Get the UART baud rate configuration.

Return

- `ESP_FAIL` Parameter error
- `ESP_OK` Success, result will be put in (**baudrate*)

Parameters

- `uart_num`: UART port number, the max port number is (`UART_NUM_MAX - 1`).
- `baudrate`: Pointer to accept value of UART baud rate

esp_err_t **uart_set_line_inverse** (*uart_port_t* *uart_num*, *uint32_t* *inverse_mask*)

Set UART line inverse mode.

Return

- `ESP_OK` Success
- `ESP_FAIL` Parameter error

Parameters

- `uart_num`: UART port number, the max port number is (`UART_NUM_MAX - 1`).
- `inverse_mask`: Choose the wires that need to be inverted. Using the ORred mask of `uart_signal_inv_t`

esp_err_t **uart_set_hw_flow_ctrl** (*uart_port_t* *uart_num*, *uart_hw_flowcontrol_t* *flow_ctrl*, *uint8_t* *rx_thresh*)

Set hardware flow control.

Return

- `ESP_OK` Success
- `ESP_FAIL` Parameter error

Parameters

- `uart_num`: UART port number, the max port number is (`UART_NUM_MAX - 1`).
- `flow_ctrl`: Hardware flow control mode
- `rx_thresh`: Threshold of Hardware RX flow control (0 ~ `UART_FIFO_LEN`). Only when `UART_HW_FLOWCTRL_RTS` is set, will the `rx_thresh` value be set.

esp_err_t **uart_set_sw_flow_ctrl** (*uart_port_t* *uart_num*, *bool* *enable*, *uint8_t* *rx_thresh_xon*, *uint8_t* *rx_thresh_xoff*)

Set software flow control.

Return

- `ESP_OK` Success
- `ESP_FAIL` Parameter error

Parameters

- `uart_num`: `UART_NUM_0`, `UART_NUM_1` or `UART_NUM_2`
- `enable`: switch on or off
- `rx_thresh_xon`: low water mark
- `rx_thresh_xoff`: high water mark

esp_err_t **uart_get_hw_flow_ctrl** (*uart_port_t* *uart_num*, *uart_hw_flowcontrol_t* **flow_ctrl*)

Get the UART hardware flow control configuration.

Return

- `ESP_FAIL` Parameter error

- ESP_OK Success, result will be put in (*flow_ctrl)

Parameters

- `uart_num`: UART port number, the max port number is (UART_NUM_MAX -1).
- `flow_ctrl`: Option for different flow control mode.

esp_err_t `uart_clear_intr_status` (*uart_port_t* `uart_num`, *uint32_t* `clr_mask`)

Clear UART interrupt status.

Return

- ESP_OK Success
- ESP_FAIL Parameter error

Parameters

- `uart_num`: UART port number, the max port number is (UART_NUM_MAX -1).
- `clr_mask`: Bit mask of the interrupt status to be cleared.

esp_err_t `uart_enable_intr_mask` (*uart_port_t* `uart_num`, *uint32_t* `enable_mask`)

Set UART interrupt enable.

Return

- ESP_OK Success
- ESP_FAIL Parameter error

Parameters

- `uart_num`: UART port number, the max port number is (UART_NUM_MAX -1).
- `enable_mask`: Bit mask of the enable bits.

esp_err_t `uart_disable_intr_mask` (*uart_port_t* `uart_num`, *uint32_t* `disable_mask`)

Clear UART interrupt enable bits.

Return

- ESP_OK Success
- ESP_FAIL Parameter error

Parameters

- `uart_num`: UART port number, the max port number is (UART_NUM_MAX -1).
- `disable_mask`: Bit mask of the disable bits.

esp_err_t `uart_enable_rx_intr` (*uart_port_t* `uart_num`)

Enable UART RX interrupt (RX_FULL & RX_TIMEOUT INTERRUPT)

Return

- ESP_OK Success
- ESP_FAIL Parameter error

Parameters

- `uart_num`: UART port number, the max port number is (UART_NUM_MAX -1).

esp_err_t `uart_disable_rx_intr` (*uart_port_t* `uart_num`)

Disable UART RX interrupt (RX_FULL & RX_TIMEOUT INTERRUPT)

Return

- ESP_OK Success
- ESP_FAIL Parameter error

Parameters

- `uart_num`: UART port number, the max port number is (UART_NUM_MAX -1).

esp_err_t `uart_disable_tx_intr` (*uart_port_t* `uart_num`)

Disable UART TX interrupt (TXFIFO_EMPTY INTERRUPT)

Return

- ESP_OK Success
- ESP_FAIL Parameter error

Parameters

- `uart_num`: UART port number

esp_err_t `uart_enable_tx_intr` (*uart_port_t* `uart_num`, *int* `enable`, *int* `thresh`)

Enable UART TX interrupt (TXFIFO_EMPTY INTERRUPT)

Return

- ESP_OK Success
- ESP_FAIL Parameter error

Parameters

- `uart_num`: UART port number, the max port number is (UART_NUM_MAX -1).
- `enable`: 1: enable; 0: disable
- `thresh`: Threshold of TX interrupt, 0 ~ UART_FIFO_LEN

esp_err_t **uart_isr_register** (*uart_port_t* `uart_num`, void (**fn*)) void *
arg, int *intr_alloc_flags*, *uart_isr_handle_t* **handle*) Register UART interrupt handler (ISR).

Note UART ISR handler will be attached to the same CPU core that this function is running on.

Return

- ESP_OK Success
- ESP_FAIL Parameter error

Parameters

- `uart_num`: UART port number, the max port number is (UART_NUM_MAX -1).
- `fn`: Interrupt handler function.
- `arg`: parameter for handler function
- `intr_alloc_flags`: Flags used to allocate the interrupt. One or multiple (ORred) ESP_INTR_FLAG_* values. See `esp_intr_alloc.h` for more info.
- `handle`: Pointer to return handle. If non-NULL, a handle for the interrupt will be returned here.

esp_err_t **uart_isr_free** (*uart_port_t* `uart_num`)

Free UART interrupt handler registered by `uart_isr_register`. Must be called on the same core as `uart_isr_register` was called.

Return

- ESP_OK Success
- ESP_FAIL Parameter error

Parameters

- `uart_num`: UART port number, the max port number is (UART_NUM_MAX -1).

esp_err_t **uart_set_pin** (*uart_port_t* `uart_num`, int `tx_io_num`, int `rx_io_num`, int `rts_io_num`, int
`cts_io_num`)

Set UART pin number.

Note Internal signal can be output to multiple GPIO pads. Only one GPIO pad can connect with input signal.

Note Instead of GPIO number a macro 'UART_PIN_NO_CHANGE' may be provided to keep the currently allocated pin.

Return

- ESP_OK Success
- ESP_FAIL Parameter error

Parameters

- `uart_num`: UART port number, the max port number is (UART_NUM_MAX -1).
- `tx_io_num`: UART TX pin GPIO number.
- `rx_io_num`: UART RX pin GPIO number.
- `rts_io_num`: UART RTS pin GPIO number.
- `cts_io_num`: UART CTS pin GPIO number.

esp_err_t **uart_set_rts** (*uart_port_t* `uart_num`, int `level`)

Manually set the UART RTS pin level.

Note UART must be configured with hardware flow control disabled.

Return

- ESP_OK Success
- ESP_FAIL Parameter error

Parameters

- `uart_num`: UART port number, the max port number is (UART_NUM_MAX -1).
- `level`: 1: RTS output low (active); 0: RTS output high (block)

esp_err_t **uart_set_dtr** (*uart_port_t* `uart_num`, int `level`)

Manually set the UART DTR pin level.

Return

- ESP_OK Success
- ESP_FAIL Parameter error

Parameters

- `uart_num`: UART port number, the max port number is (UART_NUM_MAX -1).
- `level`: 1: DTR output low; 0: DTR output high

esp_err_t `uart_set_tx_idle_num` (*uart_port_t* `uart_num`, *uint16_t* `idle_num`)

Set UART idle interval after tx FIFO is empty.

Return

- ESP_OK Success
- ESP_FAIL Parameter error

Parameters

- `uart_num`: UART port number, the max port number is (UART_NUM_MAX -1).
- `idle_num`: idle interval after tx FIFO is empty(unit: the time it takes to send one bit under current baudrate)

esp_err_t `uart_param_config` (*uart_port_t* `uart_num`, **const** *uart_config_t* *`uart_config`)

Set UART configuration parameters.

Return

- ESP_OK Success
- ESP_FAIL Parameter error

Parameters

- `uart_num`: UART port number, the max port number is (UART_NUM_MAX -1).
- `uart_config`: UART parameter settings

esp_err_t `uart_intr_config` (*uart_port_t* `uart_num`, **const** *uart_intr_config_t* *`intr_conf`)

Configure UART interrupts.

Return

- ESP_OK Success
- ESP_FAIL Parameter error

Parameters

- `uart_num`: UART port number, the max port number is (UART_NUM_MAX -1).
- `intr_conf`: UART interrupt settings

esp_err_t `uart_wait_tx_done` (*uart_port_t* `uart_num`, *TickType_t* `ticks_to_wait`)

Wait until UART TX FIFO is empty.

Return

- ESP_OK Success
- ESP_FAIL Parameter error
- ESP_ERR_TIMEOUT Timeout

Parameters

- `uart_num`: UART port number, the max port number is (UART_NUM_MAX -1).
- `ticks_to_wait`: Timeout, count in RTOS ticks

int `uart_tx_chars` (*uart_port_t* `uart_num`, **const** *char* *`buffer`, *uint32_t* `len`)

Send data to the UART port from a given buffer and length.

This function will not wait for enough space in TX FIFO. It will just fill the available TX FIFO and return when the FIFO is full.

Note This function should only be used when UART TX buffer is not enabled.

Return

- (-1) Parameter error
- OTHERS (>=0) The number of bytes pushed to the TX FIFO

Parameters

- `uart_num`: UART port number, the max port number is (UART_NUM_MAX -1).
- `buffer`: data buffer address
- `len`: data length to send

int **uart_write_bytes** (*uart_port_t* *uart_num*, const void **src*, size_t *size*)

Send data to the UART port from a given buffer and length,.

If the UART driver's parameter 'tx_buffer_size' is set to zero: This function will not return until all the data have been sent out, or at least pushed into TX FIFO.

Otherwise, if the 'tx_buffer_size' > 0, this function will return after copying all the data to tx ring buffer, UART ISR will then move data from the ring buffer to TX FIFO gradually.

Return

- (-1) Parameter error
- OTHERS (>=0) The number of bytes pushed to the TX FIFO

Parameters

- *uart_num*: UART port number, the max port number is (UART_NUM_MAX -1).
- *src*: data buffer address
- *size*: data length to send

int **uart_write_bytes_with_break** (*uart_port_t* *uart_num*, const void **src*, size_t *size*, int *brk_len*)

Send data to the UART port from a given buffer and length,.

If the UART driver's parameter 'tx_buffer_size' is set to zero: This function will not return until all the data and the break signal have been sent out. After all data is sent out, send a break signal.

Otherwise, if the 'tx_buffer_size' > 0, this function will return after copying all the data to tx ring buffer, UART ISR will then move data from the ring buffer to TX FIFO gradually. After all data sent out, send a break signal.

Return

- (-1) Parameter error
- OTHERS (>=0) The number of bytes pushed to the TX FIFO

Parameters

- *uart_num*: UART port number, the max port number is (UART_NUM_MAX -1).
- *src*: data buffer address
- *size*: data length to send
- *brk_len*: break signal duration(unit: the time it takes to send one bit at current baudrate)

int **uart_read_bytes** (*uart_port_t* *uart_num*, void **buf*, uint32_t *length*, TickType_t *ticks_to_wait*)

UART read bytes from UART buffer.

Return

- (-1) Error
- OTHERS (>=0) The number of bytes read from UART FIFO

Parameters

- *uart_num*: UART port number, the max port number is (UART_NUM_MAX -1).
- *buf*: pointer to the buffer.
- *length*: data length
- *ticks_to_wait*: sTimeout, count in RTOS ticks

esp_err_t **uart_flush** (*uart_port_t* *uart_num*)

Alias of `uart_flush_input`. UART ring buffer flush. This will discard all data in the UART RX buffer.

Note Instead of waiting the data sent out, this function will clear UART rx buffer. In order to send all the data in tx FIFO, we can use `uart_wait_tx_done` function.

Return

- ESP_OK Success
- ESP_FAIL Parameter error

Parameters

- *uart_num*: UART port number, the max port number is (UART_NUM_MAX -1).

esp_err_t **uart_flush_input** (*uart_port_t* *uart_num*)

Clear input buffer, discard all the data is in the ring-buffer.

Note In order to send all the data in tx FIFO, we can use `uart_wait_tx_done` function.

Return

- ESP_OK Success
- ESP_FAIL Parameter error

Parameters

- `uart_num`: UART port number, the max port number is (UART_NUM_MAX -1).

`esp_err_t uart_get_buffered_data_len (uart_port_t uart_num, size_t *size)`

UART get RX ring buffer cached data length.

Return

- ESP_OK Success
- ESP_FAIL Parameter error

Parameters

- `uart_num`: UART port number, the max port number is (UART_NUM_MAX -1).
- `size`: Pointer of `size_t` to accept cached data length

`esp_err_t uart_disable_pattern_det_intr (uart_port_t uart_num)`

UART disable pattern detect function. Designed for applications like ‘AT commands’ . When the hardware detects a series of one same character, the interrupt will be triggered.

Return

- ESP_OK Success
- ESP_FAIL Parameter error

Parameters

- `uart_num`: UART port number, the max port number is (UART_NUM_MAX -1).

`esp_err_t uart_enable_pattern_det_baud_intr (uart_port_t uart_num, char pattern_chr, uint8_t chr_num, int chr_tout, int post_idle, int pre_idle)`

UART enable pattern detect function. Designed for applications like ‘AT commands’ . When the hardware detect a series of one same character, the interrupt will be triggered.

Return

- ESP_OK Success
- ESP_FAIL Parameter error

Parameters

- `uart_num`: UART port number.
- `pattern_chr`: character of the pattern.
- `chr_num`: number of the character, 8bit value.
- `chr_tout`: timeout of the interval between each pattern characters, 16bit value, unit is the baud-rate cycle you configured. When the duration is more than this value, it will not take this data as `at_cmd` char.
- `post_idle`: idle time after the last pattern character, 16bit value, unit is the baud-rate cycle you configured. When the duration is less than this value, it will not take the previous data as the last `at_cmd` char
- `pre_idle`: idle time before the first pattern character, 16bit value, unit is the baud-rate cycle you configured. When the duration is less than this value, it will not take this data as the first `at_cmd` char.

`int uart_pattern_pop_pos (uart_port_t uart_num)`

Return the nearest detected pattern position in buffer. The positions of the detected pattern are saved in a queue, this function will dequeue the first pattern position and move the pointer to next pattern position.

The following APIs will modify the pattern position info: `uart_flush_input`, `uart_read_bytes`, `uart_driver_delete`, `uart_pop_pattern_pos` It is the application’s responsibility to ensure atomic access to the pattern queue and the rx data buffer when using pattern detect feature.

Note If the RX buffer is full and flow control is not enabled, the detected pattern may not be found in the rx buffer due to overflow.

Return

- (-1) No pattern found for current index or parameter error
- others the pattern position in rx buffer.

Parameters

- `uart_num`: UART port number, the max port number is (`UART_NUM_MAX - 1`).

int `uart_pattern_get_pos` (*uart_port_t* *uart_num*)

Return the nearest detected pattern position in buffer. The positions of the detected pattern are saved in a queue, This function do nothing to the queue.

The following APIs will modify the pattern position info: `uart_flush_input`, `uart_read_bytes`, `uart_driver_delete`, `uart_pop_pattern_pos` It is the application' s responsibility to ensure atomic access to the pattern queue and the rx data buffer when using pattern detect feature.

Note If the RX buffer is full and flow control is not enabled, the detected pattern may not be found in the rx buffer due to overflow.

Return

- (-1) No pattern found for current index or parameter error
- others the pattern position in rx buffer.

Parameters

- `uart_num`: UART port number, the max port number is (`UART_NUM_MAX - 1`).

esp_err_t `uart_pattern_queue_reset` (*uart_port_t* *uart_num*, int *queue_length*)

Allocate a new memory with the given length to save record the detected pattern position in rx buffer.

Return

- `ESP_ERR_NO_MEM` No enough memory
- `ESP_ERR_INVALID_STATE` Driver not installed
- `ESP_FAIL` Parameter error
- `ESP_OK` Success

Parameters

- `uart_num`: UART port number, the max port number is (`UART_NUM_MAX - 1`).
- `queue_length`: Max queue length for the detected pattern. If the queue length is not large enough, some pattern positions might be lost. Set this value to the maximum number of patterns that could be saved in data buffer at the same time.

esp_err_t `uart_set_mode` (*uart_port_t* *uart_num*, *uart_mode_t* *mode*)

UART set communication mode.

Note This function must be executed after `uart_driver_install()`, when the driver object is initialized.

Return

- `ESP_OK` Success
- `ESP_ERR_INVALID_ARG` Parameter error

Parameters

- `uart_num`: Uart number to configure, the max port number is (`UART_NUM_MAX - 1`).
- `mode`: UART UART mode to set

esp_err_t `uart_set_rx_full_threshold` (*uart_port_t* *uart_num*, int *threshold*)

Set uart threshold value for RX fifo full.

Note If application is using higher baudrate and it is observed that bytes in hardware RX fifo are overwritten then this threshold can be reduced

Return

- `ESP_OK` Success
- `ESP_ERR_INVALID_ARG` Parameter error
- `ESP_ERR_INVALID_STATE` Driver is not installed

Parameters

- `uart_num`: `UART_NUM_0`, `UART_NUM_1` or `UART_NUM_2`
- `threshold`: Threshold value above which RX fifo full interrupt is generated

esp_err_t `uart_set_tx_empty_threshold` (*uart_port_t* *uart_num*, int *threshold*)

Set uart threshold values for TX fifo empty.

Return

- `ESP_OK` Success
- `ESP_ERR_INVALID_ARG` Parameter error
- `ESP_ERR_INVALID_STATE` Driver is not installed

Parameters

- `uart_num`: UART_NUM_0, UART_NUM_1 or UART_NUM_2
- `threshold`: Threshold value below which TX fifo empty interrupt is generated

esp_err_t **uart_set_rx_timeout** (*uart_port_t* *uart_num*, **const** *uint8_t* *tout_thresh*)

UART set threshold timeout for TOUT feature.

Return

- ESP_OK Success
- ESP_ERR_INVALID_ARG Parameter error
- ESP_ERR_INVALID_STATE Driver is not installed

Parameters

- `uart_num`: Uart number to configure, the max port number is (UART_NUM_MAX -1).
- `tout_thresh`: This parameter defines timeout threshold in uart symbol periods. The maximum value of threshold is 126. `tout_thresh = 1`, defines TOUT interrupt timeout equal to transmission time of one symbol (~11 bit) on current baudrate. If the time is expired the UART_RXFIFO_TOUT_INT interrupt is triggered. If `tout_thresh == 0`, the TOUT feature is disabled.

esp_err_t **uart_get_collision_flag** (*uart_port_t* *uart_num*, **bool** **collision_flag*)

Returns collision detection flag for RS485 mode Function returns the collision detection flag into variable pointed by `collision_flag`. *`collision_flag` = true, if collision detected else it is equal to false. This function should be executed when actual transmission is completed (after `uart_write_bytes()`).

Return

- ESP_OK Success
- ESP_ERR_INVALID_ARG Parameter error

Parameters

- `uart_num`: Uart number to configure the max port number is (UART_NUM_MAX -1).
- `collision_flag`: Pointer to variable of type `bool` to return collision flag.

esp_err_t **uart_set_wakeup_threshold** (*uart_port_t* *uart_num*, **int** *wakeup_threshold*)

Set the number of RX pin signal edges for light sleep wakeup.

UART can be used to wake up the system from light sleep. This feature works by counting the number of positive edges on RX pin and comparing the count to the threshold. When the count exceeds the threshold, system is woken up from light sleep. This function allows setting the threshold value.

Stop bit and parity bits (if enabled) also contribute to the number of edges. For example, letter 'a' with ASCII code 97 is encoded as 0100001101 on the wire (with 8n1 configuration), start and stop bits included. This sequence has 3 positive edges (transitions from 0 to 1). Therefore, to wake up the system when 'a' is sent, set `wakeup_threshold=3`.

The character that triggers wakeup is not received by UART (i.e. it can not be obtained from UART FIFO). Depending on the baud rate, a few characters after that will also not be received. Note that when the chip enters and exits light sleep mode, APB frequency will be changing. To make sure that UART has correct baud rate all the time, select REF_TICK as UART clock source, by setting `use_ref_tick` field in `uart_config_t` to true.

Note in ESP32, the wakeup signal can only be input via IO_MUX (i.e. GPIO3 should be configured as `function_1` to wake up UART0, GPIO9 should be configured as `function_5` to wake up UART1), UART2 does not support light sleep wakeup feature.

Return

- ESP_OK on success
- ESP_ERR_INVALID_ARG if `uart_num` is incorrect or `wakeup_threshold` is outside of [3, 0x3ff] range.

Parameters

- `uart_num`: UART number, the max port number is (UART_NUM_MAX -1).
- `wakeup_threshold`: number of RX edges for light sleep wakeup, value is 3 .. 0x3ff.

esp_err_t **uart_get_wakeup_threshold** (*uart_port_t* *uart_num*, **int** **out_wakeup_threshold*)

Get the number of RX pin signal edges for light sleep wakeup.

See description of `uart_set_wakeup_threshold` for the explanation of UART wakeup feature.

Return

- ESP_OK on success
- ESP_ERR_INVALID_ARG if out_wakeup_threshold is NULL

Parameters

- `uart_num`: UART number, the max port number is (UART_NUM_MAX -1).
- `[out] out_wakeup_threshold`: output, set to the current value of wakeup threshold for the given UART.

esp_err_t **uart_wait_tx_idle_polling** (*uart_port_t* *uart_num*)

Wait until UART tx memory empty and the last char send ok (polling mode).

- **Return**

- ESP_OK on success
- ESP_ERR_INVALID_ARG Parameter error
- ESP_FAIL Driver not installed

Parameters

- `uart_num`: UART number

esp_err_t **uart_set_loop_back** (*uart_port_t* *uart_num*, bool *loop_back_en*)

Configure TX signal loop back to RX module, just for the test usage.

- **Return**

- ESP_OK on success
- ESP_ERR_INVALID_ARG Parameter error
- ESP_FAIL Driver not installed

Parameters

- `uart_num`: UART number
- `loop_back_en`: Set ture to enable the loop back function, else set it false.

void **uart_set_always_rx_timeout** (*uart_port_t* *uart_num*, bool *always_rx_timeout_en*)

Configure behavior of UART RX timeout interrupt.

When `always_rx_timeout` is true, timeout interrupt is triggered even if FIFO is full. This function can cause extra timeout interrupts triggered only to send the timeout event. Call this function only if you want to ensure timeout interrupt will always happen after a byte stream.

Parameters

- `uart_num`: UART number
- `always_rx_timeout_en`: Set to false enable the default behavior of timeout interrupt, set it to true to always trigger timeout interrupt.

Structures

struct `uart_intr_config_t`

UART interrupt configuration parameters for `uart_intr_config` function.

Public Members

`uint32_t` **intr_enable_mask**

UART interrupt enable mask, choose from `UART_XXXX_INT_ENA_M` under `UART_INT_ENA_REG(i)`, connect with bit-or operator

`uint8_t` **rx_timeout_thresh**

UART timeout interrupt threshold (unit: time of sending one byte)

`uint8_t` **txfifo_empty_intr_thresh**

UART TX empty interrupt threshold.

`uint8_t` **rxfifo_full_thresh**

UART RX full interrupt threshold.

struct `uart_event_t`

Event structure used in UART event queue.

Public Members

`uart_event_type_t` **type**

UART event type

`size_t` **size**

UART data size for UART_DATA event

`bool` **timeout_flag**

UART data read timeout flag for UART_DATA event (no new data received during configured RX TOUT) If the event is caused by FIFO-full interrupt, then there will be no event with the timeout flag before the next byte coming.

Macros

UART_NUM_0

UART port 0

UART_NUM_1

UART port 1

UART_NUM_MAX

UART port max

UART_PIN_NO_CHANGE

Constant for `uart_set_pin` function which indicates that UART pin should not be changed

UART_FIFO_LEN

Length of the UART HW FIFO.

UART_BITRATE_MAX

Maximum configurable bitrate.

Type Definitions

`typedef intr_handle_t` **uart_isr_handle_t**

Enumerations

`enum` **uart_event_type_t**

UART event types used in the ring buffer.

Values:

UART_DATA

UART data event

UART_BREAK

UART break event

UART_BUFFER_FULL

UART RX buffer full event

UART_FIFO_OVF

UART FIFO overflow event

UART_FRAME_ERR

UART RX frame error event

UART_PARITY_ERR

UART RX parity event

UART_DATA_BREAK

UART TX data and break event

UART_PATTERN_DET

UART pattern detected

UART_EVENT_MAX
UART event max index

Header File

- [hal/include/hal/uart_types.h](#)

Structures

struct uart_at_cmd_t

UART AT cmd char configuration parameters Note that this function may different on different chip. Please refer to the TRM at configuration.

Public Members

uint8_t cmd_char
UART AT cmd char

uint8_t char_num
AT cmd char repeat number

uint32_t gap_tout
gap time(in baud-rate) between AT cmd char

uint32_t pre_idle
the idle time(in baud-rate) between the non AT char and first AT char

uint32_t post_idle
the idle time(in baud-rate) between the last AT char and the none AT char

struct uart_sw_flowctrl_t

UART software flow control configuration parameters.

Public Members

uint8_t xon_char
Xon flow control char

uint8_t xoff_char
Xoff flow control char

uint8_t xon_thrd
If the software flow control is enabled and the data amount in rxfifo is less than xon_thrd, an xon_char will be sent

uint8_t xoff_thrd
If the software flow control is enabled and the data amount in rxfifo is more than xoff_thrd, an xoff_char will be sent

struct uart_config_t

UART configuration parameters for uart_param_config function.

Public Members

int baud_rate
UART baud rate

uart_word_length_t data_bits
UART byte size

uart_parity_t parity
UART parity mode

uart_stop_bits_t **stop_bits**

UART stop bits

uart_hw_flowcontrol_t **flow_ctrl**

UART HW flow control mode (cts/rts)

uint8_t **rx_flow_ctrl_thresh**

UART HW RTS threshold

uart_sclk_t **source_clk**

UART source clock selection

bool **use_ref_tick**

Deprecated method to select ref tick clock source, set `source_clk` field instead

Type Definitions

typedef int uart_port_t

UART port number, can be `UART_NUM_0 ~ (UART_NUM_MAX - 1)`.

Enumerations

enum uart_mode_t

UART mode selection.

Values:

UART_MODE_UART = 0x00

mode: regular UART mode

UART_MODE_RS485_HALF_DUPLEX = 0x01

mode: half duplex RS485 UART mode control by RTS pin

UART_MODE_IRDA = 0x02

mode: IRDA UART mode

UART_MODE_RS485_COLLISION_DETECT = 0x03

mode: RS485 collision detection UART mode (used for test purposes)

UART_MODE_RS485_APP_CTRL = 0x04

mode: application control RS485 UART mode (used for test purposes)

enum uart_word_length_t

UART word length constants.

Values:

UART_DATA_5_BITS = 0x0

word length: 5bits

UART_DATA_6_BITS = 0x1

word length: 6bits

UART_DATA_7_BITS = 0x2

word length: 7bits

UART_DATA_8_BITS = 0x3

word length: 8bits

UART_DATA_BITS_MAX = 0x4

enum uart_stop_bits_t

UART stop bits number.

Values:

UART_STOP_BITS_1 = 0x1

stop bit: 1bit

UART_STOP_BITS_1_5 = 0x2
stop bit: 1.5bits

UART_STOP_BITS_2 = 0x3
stop bit: 2bits

UART_STOP_BITS_MAX = 0x4

enum uart_parity_t

UART parity constants.

Values:

UART_PARITY_DISABLE = 0x0
Disable UART parity

UART_PARITY_EVEN = 0x2
Enable UART even parity

UART_PARITY_ODD = 0x3
Enable UART odd parity

enum uart_hw_flowcontrol_t

UART hardware flow control modes.

Values:

UART_HW_FLOWCTRL_DISABLE = 0x0
disable hardware flow control

UART_HW_FLOWCTRL_RTS = 0x1
enable RX hardware flow control (rts)

UART_HW_FLOWCTRL_CTS = 0x2
enable TX hardware flow control (cts)

UART_HW_FLOWCTRL_CTS_RTS = 0x3
enable hardware flow control

UART_HW_FLOWCTRL_MAX = 0x4

enum uart_signal_inv_t

UART signal bit map.

Values:

UART_SIGNAL_INV_DISABLE = 0
Disable UART signal inverse

UART_SIGNAL_IRDA_TX_INV = (0x1 << 0)
inverse the UART irda_tx signal

UART_SIGNAL_IRDA_RX_INV = (0x1 << 1)
inverse the UART irda_rx signal

UART_SIGNAL_RXD_INV = (0x1 << 2)
inverse the UART rxd signal

UART_SIGNAL_CTS_INV = (0x1 << 3)
inverse the UART cts signal

UART_SIGNAL_DSR_INV = (0x1 << 4)
inverse the UART dsr signal

UART_SIGNAL_TXD_INV = (0x1 << 5)
inverse the UART txd signal

UART_SIGNAL_RTS_INV = (0x1 << 6)
inverse the UART rts signal

```
UART_SIGNAL_DTR_INV = (0x1 << 7)
    inverse the UART dtr signal
```

```
enum uart_sclk_t
    UART source clock.
```

Values:

```
UART_SCLK_APB = 0x0
    UART source clock from APB
```

```
UART_SCLK_RTC = 0x1
    UART source clock from RTC
```

```
UART_SCLK_XTAL = 0x2
    UART source clock from XTAL
```

GPIO Lookup Macros The UART peripherals have dedicated IO_MUX pins to which they are connected directly. However, signals can also be routed to other pins using the less direct GPIO matrix. To use direct routes, you need to know which pin is a dedicated IO_MUX pin for a UART channel. GPIO Lookup Macros simplify the process of finding and assigning IO_MUX pins. You choose a macro based on either the IO_MUX pin number, or a required UART channel name, and the macro will return the matching counterpart for you. See some examples below.

Note: These macros are useful if you need very high UART baud rates (over 40 MHz), which means you will have to use IO_MUX pins only. In other cases, these macros can be ignored, and you can use the GPIO Matrix as it allows you to configure any GPIO pin for any UART function.

1. `UART_NUM_2_TXD_DIRECT_GPIO_NUM` returns the IO_MUX pin number of UART channel 2 TXD pin (pin 17)
2. `UART_GPIO19_DIRECT_CHANNEL` returns the UART number of GPIO 19 when connected to the UART peripheral via IO_MUX (this is `UART_NUM_0`)
3. `UART_CTS_GPIO19_DIRECT_CHANNEL` returns the UART number of GPIO 19 when used as the UART CTS pin via IO_MUX (this is `UART_NUM_0`). Similar to the above macro but specifies the pin function which is also part of the IO_MUX assignment.

Header File

- [soc/esp32c3/include/soc/uart_channel.h](#)

Macros

```
UART_GPIO21_DIRECT_CHANNEL
UART_NUM_0_TXD_DIRECT_GPIO_NUM
UART_GPIO20_DIRECT_CHANNEL
UART_NUM_0_RXD_DIRECT_GPIO_NUM
UART_TXD_GPIO21_DIRECT_CHANNEL
UART_RXD_GPIO20_DIRECT_CHANNEL
```

Code examples for this API section are provided in the [peripherals](#) directory of ESP-IDF examples.

2.4 Application Protocols

2.4.1 ASIO port

Overview

Asio is a cross-platform C++ library, see <https://think-async.com>. It provides a consistent asynchronous model using a modern C++ approach.

ASIO documentation Please refer to the original asio documentation at <https://think-async.com/Asio/Documentation>. Asio also comes with a number of examples which could be find under Documentation/Examples on that web site.

Supported features ESP platform port currently supports only network asynchronous socket operations; does not support serial port. SSL/TLS support is disabled by default and could be enabled in component configuration menu by choosing TLS library from

- mbedTLS with OpenSSL translation layer (default option)
- wolfSSL

SSL support is very basic at this stage and it does include following features:

- Verification callbacks
- DH property files
- Certificates/private keys file APIs

Internal asio settings for ESP include

- EXCEPTIONS are enabled in ASIO if enabled in menuconfig
- TYPEID is enabled in ASIO if enabled in menuconfig

Application Example

ESP examples are based on standard asio [protocols/asio](#):

- [protocols/asio/udp_echo_server](#)
- [protocols/asio/tcp_echo_server](#)
- [protocols/asio/chat_client](#)
- [protocols/asio/chat_server](#)
- [protocols/asio/ssl_client_server](#)

Please refer to the specific example README.md for details

2.4.2 ESP-MQTT

Overview

ESP-MQTT is an implementation of MQTT protocol client (MQTT is a lightweight publish/subscribe messaging protocol).

Features

- Supports MQTT over TCP, SSL with mbedtls, MQTT over Websocket, MQTT over Websocket Secure.
- Easy to setup with URI
- Multiple instances (Multiple clients in one application)
- Support subscribing, publishing, authentication, last will messages, keep alive pings and all 3 QoS levels (it should be a fully functional client).

Application Example

- [protocols/mqtt/tcp](#): MQTT over tcp, default port 1883
- [protocols/mqtt/ssl](#): MQTT over tcp, default port 8883
- [protocols/mqtt/ssl_psk](#): MQTT over tcp using pre-shared keys for authentication, default port 8883
- [protocols/mqtt/ws](#): MQTT over Websocket, default port 80
- [protocols/mqtt/wss](#): MQTT over Websocket Secure, default port 443

Configuration

URI

- Currently support `mqtt`, `mqtt`s, `ws`, `wss` schemes
- MQTT over TCP samples:
 - `mqtt://mqtt.eclipseprojects.io`: MQTT over TCP, default port 1883:
 - `mqtt://mqtt.eclipseprojects.io:1884` MQTT over TCP, port 1884:
 - `mqtt://username:password@mqtt.eclipseprojects.io:1884` MQTT over TCP, port 1884, with username and password
- MQTT over SSL samples:
 - `mqtt://mqtt.eclipseprojects.io`: MQTT over SSL, port 8883
 - `mqtt://mqtt.eclipseprojects.io:8884`: MQTT over SSL, port 8884
- MQTT over Websocket samples:
 - `ws://mqtt.eclipseprojects.io:80/mqtt`
- MQTT over Websocket Secure samples:
 - `wss://mqtt.eclipseprojects.io:443/mqtt`
- Minimal configurations:

```
const esp_mqtt_client_config_t mqtt_cfg = {
    .uri = "mqtt://mqtt.eclipseprojects.io",
    // .user_context = (void *)your_context
};
esp_mqtt_client_handle_t client = esp_mqtt_client_init(&mqtt_cfg);
esp_mqtt_client_register_event(client, ESP_EVENT_ANY_ID, mqtt_event_handler,
↪client);
esp_mqtt_client_start(client);
```

- Note: By default mqtt client uses event loop library to post related mqtt events (connected, subscribed, published, etc.)

SSL

- Get certificate from server, example: `mqtt.eclipseprojects.io openssl s_client -showcerts -connect mqtt.eclipseprojects.io:8883 </dev/null 2>/dev/null|openssl x509 -outform PEM >mqtt_eclipse_org.pem`
- Check the sample application: `examples/mqtt_ssl`
- Configuration:

```
const esp_mqtt_client_config_t mqtt_cfg = {
    .uri = "mqtts://mqtt.eclipseprojects.io:8883",
    .event_handle = mqtt_event_handler,
    .cert_pem = (const char *)mqtt_eclipse_org_pem_start,
};
```

If the certificate is not null-terminated then `cert_len` should also be set. Other SSL related configuration parameters are:

- `use_global_ca_store`: use the global certificate store to verify server certificate, see `esp-tls.h` for more information
- `client_cert_pem`: pointer to certificate data in PEM or DER format for SSL mutual authentication, default is NULL, not required if mutual authentication is not needed.

- `client_cert_len`: length of the buffer pointed to by `client_cert_pem`. May be 0 for null-terminated pem.
- `client_key_pem`: pointer to private key data in PEM or DER format for SSL mutual authentication, default is NULL, not required if mutual authentication is not needed.
- `client_key_len`: length of the buffer pointed to by `client_key_pem`. May be 0 for null-terminated pem.
- `psk_hint_key`: pointer to PSK struct defined in `esp_tls.h` to enable PSK authentication (as alternative to certificate verification). If not NULL and server/client certificates are NULL, PSK is enabled
- `alpn_protos`: NULL-terminated list of protocols to be used for ALPN.

Last Will and Testament MQTT allows for a last will and testament (LWT) message to notify other clients when a client ungracefully disconnects. This is configured by the following fields in the `esp_mqtt_client_config_t` struct.

- `lwt_topic`: pointer to the LWT message topic
- `lwt_msg`: pointer to the LWT message
- `lwt_msg_len`: length of the LWT message, required if `lwt_msg` is not null-terminated
- `lwt_qos`: quality of service for the LWT message
- `lwt_retain`: specifies the retain flag of the LWT message

Other Configuration Parameters

- `disable_clean_session`: determines the clean session flag for the connect message, defaults to a clean session
- `keepalive`: determines how many seconds the client will wait for a ping response before disconnecting, default is 120 seconds.
- `disable_auto_reconnect`: enable to stop the client from reconnecting to server after errors or disconnects
- `user_context`: custom context that will be passed to the event handler
- `task_prio`: MQTT task priority, defaults to 5
- `task_stack`: MQTT task stack size, defaults to 6144 bytes, setting this will override setting from `menuconfig`
- `buffer_size`: size of MQTT send/receive buffer, default is 1024 bytes
- `username`: pointer to the username used for connecting to the broker
- `password`: pointer to the password used for connecting to the broker
- `client_id`: pointer to the client id, defaults to `ESP32_%CHIPID%` where `%CHIPID%` are the last 3 bytes of MAC address in hex format
- `host`: MQTT broker domain (ipv4 as string), setting the uri will override this
- `port`: MQTT broker port, specifying the port in the uri will override this
- `transport`: sets the transport protocol, setting the uri will override this
- `refresh_connection_after_ms`: refresh connection after this value (in milliseconds)
- `event_handle`: handle for MQTT events as a callback in legacy mode
- `event_loop_handle`: handle for MQTT event loop library

For more options on `esp_mqtt_client_config_t`, please refer to API reference below

Change settings in Project Configuration Menu The settings for MQTT can be found using `idf.py menuconfig`, under Component config -> ESP-MQTT Configuration

The following settings are available:

- `CONFIG_MQTT_PROTOCOL_311`: Enables 3.1.1 version of MQTT protocol
- `CONFIG_MQTT_TRANSPORT_SSL`, `CONFIG_MQTT_TRANSPORT_WEBSOCKET`: Enables specific MQTT transport layer, such as SSL, WEBSOCKET, WEBSOCKET_SECURE
- `CONFIG_MQTT_CUSTOM_OUTBOX`: Disables default implementation of `mqtt_outbox`, so a specific implementation can be supplied

Events

The following events may be posted by the MQTT client:

- `MQTT_EVENT_BEFORE_CONNECT`: The client is initialized and about to start connecting to the broker.
- `MQTT_EVENT_CONNECTED`: The client has successfully established a connection to the broker. The client is now ready to send and receive data.
- `MQTT_EVENT_DISCONNECTED`: The client has aborted the connection due to being unable to read or write data, e.g. because the server is unavailable.
- `MQTT_EVENT_SUBSCRIBED`: The broker has acknowledged the client's subscribe request. The event data will contain the message ID of the subscribe message.
- `MQTT_EVENT_UNSUBSCRIBED`: The broker has acknowledged the client's unsubscribe request. The event data will contain the message ID of the unsubscribe message.
- `MQTT_EVENT_PUBLISHED`: The broker has acknowledged the client's publish message. This will only be posted for Quality of Service level 1 and 2, as level 0 does not use acknowledgements. The event data will contain the message ID of the publish message.
- `MQTT_EVENT_DATA`: The client has received a publish message. The event data contains: message ID, name of the topic it was published to, received data and its length. For data that exceeds the internal buffer multiple `MQTT_EVENT_DATA` will be posted and `current_data_offset` and `total_data_len` from event data updated to keep track of the fragmented message.
- `MQTT_EVENT_ERROR`: The client has encountered an error. `esp_mqtt_error_type_t` from `error_handle` in the event data can be used to further determine the type of the error. The type of error will determine which parts of the `error_handle` struct is filled.

API Reference

Header File

- `mqtt/esp-mqtt/include/mqtt_client.h`

Functions

`esp_mqtt_client_handle_t esp_mqtt_client_init (const esp_mqtt_client_config_t *config)`
Creates mqtt client handle based on the configuration.

Return `mqtt_client_handle` if successfully created, `NULL` on error

Parameters

- `config`: mqtt configuration structure

`esp_err_t esp_mqtt_client_set_uri (esp_mqtt_client_handle_t client, const char *uri)`
Sets mqtt connection URI. This API is usually used to overrides the URI configured in `esp_mqtt_client_init`.

Return `ESP_FAIL` if URI parse error, `ESP_OK` on success

Parameters

- `client`: mqtt client handle
- `uri`:

`esp_err_t esp_mqtt_client_start (esp_mqtt_client_handle_t client)`
Starts mqtt client with already created client handle.

Return `ESP_OK` on success `ESP_ERR_INVALID_ARG` on wrong initialization `ESP_FAIL` on other error

Parameters

- `client`: mqtt client handle

`esp_err_t esp_mqtt_client_reconnect (esp_mqtt_client_handle_t client)`
This api is typically used to force reconnection upon a specific event.

Return `ESP_OK` on success `ESP_ERR_INVALID_ARG` on wrong initialization `ESP_FAIL` if client is in invalid state

Parameters

- `client`: mqtt client handle

`esp_err_t esp_mqtt_client_disconnect (esp_mqtt_client_handle_t client)`
This api is typically used to force disconnection from the broker.

Return `ESP_OK` on success `ESP_ERR_INVALID_ARG` on wrong initialization

Parameters

- `client`: mqtt client handle

`esp_err_t esp_mqtt_client_stop(esp_mqtt_client_handle_t client)`

Stops mqtt client tasks.

- Notes:
- Cannot be called from the mqtt event handler

Return ESP_OK on success ESP_ERR_INVALID_ARG on wrong initialization ESP_FAIL if client is in invalid state

Parameters

- `client`: mqtt client handle

int `esp_mqtt_client_subscribe(esp_mqtt_client_handle_t client, const char *topic, int qos)`

Subscribe the client to defined topic with defined qos.

Notes:

- Client must be connected to send subscribe message
- This API is could be executed from a user task or from a mqtt event callback i.e. internal mqtt task (API is protected by internal mutex, so it might block if a longer data receive operation is in progress.

Return message_id of the subscribe message on success -1 on failure

Parameters

- `client`: mqtt client handle
- `topic`:
- `qos`:

int `esp_mqtt_client_unsubscribe(esp_mqtt_client_handle_t client, const char *topic)`

Unsubscribe the client from defined topic.

Notes:

- Client must be connected to send unsubscribe message
- It is thread safe, please refer to `esp_mqtt_client_subscribe` for details

Return message_id of the subscribe message on success -1 on failure

Parameters

- `client`: mqtt client handle
- `topic`:

int `esp_mqtt_client_publish(esp_mqtt_client_handle_t client, const char *topic, const char *data, int len, int qos, int retain)`

Client to send a publish message to the broker.

Notes:

- This API might block for several seconds, either due to network timeout (10s) or if publishing payloads longer than internal buffer (due to message fragmentation)
- Client doesn't have to be connected for this API to work, enqueueing the messages with qos>1 (returning -1 for all the qos=0 messages if disconnected). If MQTT_SKIP_PUBLISH_IF_DISCONNECTED is enabled, this API will not attempt to publish when the client is not connected and will always return -1.
- It is thread safe, please refer to `esp_mqtt_client_subscribe` for details

Return message_id of the publish message (for QoS 0 message_id will always be zero) on success. -1 on failure.

Parameters

- `client`: mqtt client handle
- `topic`: topic string
- `data`: payload string (set to NULL, sending empty payload message)
- `len`: data length, if set to 0, length is calculated from payload string
- `qos`: qos of publish message
- `retain`: retain flag

int **esp_mqtt_client_enqueue** (*esp_mqtt_client_handle_t* client, const char *topic, const char *data, int len, int qos, int retain, bool store)

Enqueue a message to the outbox, to be sent later. Typically used for messages with qos>0, but could be also used for qos=0 messages if store=true.

This API generates and stores the publish message into the internal outbox and the actual sending to the network is performed in the mqtt-task context (in contrast to the esp_mqtt_client_publish() which sends the publish message immediately in the user task's context). Thus, it could be used as a non blocking version of esp_mqtt_client_publish().

Return message_id if queued successfully, -1 otherwise

Parameters

- client: mqtt client handle
- topic: topic string
- data: payload string (set to NULL, sending empty payload message)
- len: data length, if set to 0, length is calculated from payload string
- qos: qos of publish message
- retain: retain flag
- store: if true, all messages are enqueued; otherwise only qos1 and qos 2 are enqueued

esp_err_t **esp_mqtt_client_destroy** (*esp_mqtt_client_handle_t* client)

Destroys the client handle.

Notes:

- Cannot be called from the mqtt event handler

Return ESP_OK ESP_ERR_INVALID_ARG on wrong initialization

Parameters

- client: mqtt client handle

esp_err_t **esp_mqtt_set_config** (*esp_mqtt_client_handle_t* client, const *esp_mqtt_client_config_t* *config)

Set configuration structure, typically used when updating the config (i.e. on “before_connect” event).

Return ESP_ERR_NO_MEM if failed to allocate ESP_ERR_INVALID_ARG if conflicts on transport configuration. ESP_OK on success

Parameters

- client: mqtt client handle
- config: mqtt configuration structure

esp_err_t **esp_mqtt_client_register_event** (*esp_mqtt_client_handle_t* client, *esp_mqtt_event_id_t* event, *esp_event_handler_t* event_handler, void *event_handler_arg)

Registers mqtt event.

Return ESP_ERR_NO_MEM if failed to allocate ESP_ERR_INVALID_ARG on wrong initialization
ESP_OK on success

Parameters

- client: mqtt client handle
- event: event type
- event_handler: handler callback
- event_handler_arg: handlers context

int **esp_mqtt_client_get_outbox_size** (*esp_mqtt_client_handle_t* client)

Get outbox size.

Return outbox size 0 on wrong initialization

Parameters

- client: mqtt client handle

Structures

struct esp_mqtt_error_codes

MQTT error code structure to be passed as a contextual information into ERROR event.

Important: This structure extends `esp_tls_last_error` error structure and is backward compatible with it (so might be down-casted and treated as `esp_tls_last_error` error, but recommended to update applications if used this way previously)

Use this structure directly checking `error_type` first and then appropriate error code depending on the source of the error:

| `error_type` | related member variables | note | | `MQTT_ERROR_TYPE_TCP_TRANSPORT` | `esp_tls_last_esp_err`, `esp_tls_stack_err`, `esp_tls_cert_verify_flags`, `sock_errno` | Error reported from tcp_transport/esp-tls | | `MQTT_ERROR_TYPE_CONNECTION_REFUSED` | `connect_return_code` | Internal error reported from MQTT broker on connection |

Public Members

`esp_err_t esp_tls_last_esp_err`

last esp_err code reported from esp-tls component

int `esp_tls_stack_err`

tls specific error code reported from underlying tls stack

int `esp_tls_cert_verify_flags`

tls flags reported from underlying tls stack during certificate verification

`esp_mqtt_error_type_t error_type`

error type referring to the source of the error

`esp_mqtt_connect_return_code_t connect_return_code`

connection refused error code reported from MQTT broker on connection

int `esp_transport_sock_errno`

errno from the underlying socket

struct `esp_mqtt_event_t`

MQTT event configuration structure

Public Members

`esp_mqtt_event_id_t event_id`

MQTT event type

`esp_mqtt_client_handle_t client`

MQTT client handle for this event

void `*user_context`

User context passed from MQTT client config

char `*data`

Data associated with this event

int `data_len`

Length of the data for this event

int `total_data_len`

Total length of the data (longer data are supplied with multiple events)

int `current_data_offset`

Actual offset for the data associated with this event

char `*topic`

Topic associated with this event

int `topic_len`

Length of the topic for this event associated with this event

int `msg_id`

MQTT message id of message

int **session_present**
MQTT session_present flag for connection event

esp_mqtt_error_codes_t ***error_handle**
esp-mqtt error handle including esp-tls errors as well as internal mqtt errors

bool **retain**
Retained flag of the message associated with this event

int **qos**
qos of the messages associated with this event

bool **dup**
dup flag of the message associated with this event

struct esp_mqtt_client_config_t
MQTT client configuration structure

Public Members

mqtt_event_callback_t **event_handle**
handle for MQTT events as a callback in legacy mode

esp_event_loop_handle_t **event_loop_handle**
handle for MQTT event loop library

const char ***host**
MQTT server domain (ipv4 as string)

const char ***uri**
Complete MQTT broker URI

uint32_t **port**
MQTT server port

bool **set_null_client_id**
Selects a NULL client id

const char ***client_id**
Set client id. Ignored if set_null_client_id == true If NULL set the default client id. Default client id is ESP32_CHIPID% where CHIPID% are last 3 bytes of MAC address in hex format

const char ***username**
MQTT username

const char ***password**
MQTT password

const char ***lwt_topic**
LWT (Last Will and Testament) message topic (NULL by default)

const char ***lwt_msg**
LWT message (NULL by default)

int **lwt_qos**
LWT message qos

int **lwt_retain**
LWT retained message flag

int **lwt_msg_len**
LWT message length

int **disable_clean_session**
mqtt clean session, default clean_session is true

int keepalive
mqtt keepalive, default is 120 seconds

bool disable_auto_reconnect
this mqtt client will reconnect to server (when errors/disconnect). Set `disable_auto_reconnect=true` to disable

void *user_context
pass user context to this option, then can receive that context in `event->user_context`

int task_prio
MQTT task priority, default is 5, can be changed in `make menuconfig`

int task_stack
MQTT task stack size, default is 6144 bytes, can be changed in `make menuconfig`

int buffer_size
size of MQTT send/receive buffer, default is 1024 (only receive buffer size if `out_buffer_size` defined)

const char *cert_pem
Pointer to certificate data in PEM or DER format for server verify (with SSL), default is NULL, not required to verify the server. PEM-format must have a terminating NULL-character. DER-format requires the length to be passed in `cert_len`.

size_t cert_len
Length of the buffer pointed to by `cert_pem`. May be 0 for null-terminated pem

const char *client_cert_pem
Pointer to certificate data in PEM or DER format for SSL mutual authentication, default is NULL, not required if mutual authentication is not needed. If it is not NULL, also `client_key_pem` has to be provided. PEM-format must have a terminating NULL-character. DER-format requires the length to be passed in `client_cert_len`.

size_t client_cert_len
Length of the buffer pointed to by `client_cert_pem`. May be 0 for null-terminated pem

const char *client_key_pem
Pointer to private key data in PEM or DER format for SSL mutual authentication, default is NULL, not required if mutual authentication is not needed. If it is not NULL, also `client_cert_pem` has to be provided. PEM-format must have a terminating NULL-character. DER-format requires the length to be passed in `client_key_len`

size_t client_key_len
Length of the buffer pointed to by `client_key_pem`. May be 0 for null-terminated pem

***esp_mqtt_transport_t* transport**
overrides URI transport

int refresh_connection_after_ms
Refresh connection after this value (in milliseconds)

const struct *psk_key_hint* *psk_hint_key
Pointer to PSK struct defined in `esp_tls.h` to enable PSK authentication (as alternative to certificate verification). If not NULL and server/client certificates are NULL, PSK is enabled

bool use_global_ca_store
Use a global `ca_store` for all the connections in which this bool is set.

***esp_err_t* (**crt_bundle_attach*) (void *conf)**
Pointer to ESP x509 Certificate Bundle attach function for the usage of certification bundles in `mqttps`

int reconnect_timeout_ms
Reconnect to the broker after this value in milliseconds if auto reconnect is not disabled (defaults to 10s)

const char **alpn_protos
NULL-terminated list of supported application protocols to be used for ALPN

const char *clientkey_password
Client key decryption password string

int clientkey_password_len
String length of the password pointed to by `clientkey_password`

esp_mqtt_protocol_ver_t protocol_ver
MQTT protocol version used for connection, defaults to value from `menuconfig`

int out_buffer_size
size of MQTT output buffer. If not defined, both output and input buffers have the same size defined as `buffer_size`

bool skip_cert_common_name_check
Skip any validation of server certificate CN field, this reduces the security of TLS and makes the mqtt client susceptible to MITM attacks

bool use_secure_element
enable secure element for enabling SSL connection

void *ds_data
carrier of handle for digital signature parameters

int network_timeout_ms
Abort network operation if it is not completed after this value, in milliseconds (defaults to 10s)

bool disable_keepalive
Set `disable_keepalive=true` to turn off keep-alive mechanism, false by default (keepalive is active by default). Note: setting the config value `keepalive` to 0 doesn't disable keepalive feature, but uses a default keepalive period

const char *path
Path in the URI

int message_retransmit_timeout
timeout for retransmit of failed packet

Macros

MQTT_ERROR_TYPE_ESP_TLS

`MQTT_ERROR_TYPE_TCP_TRANSPORT` error type hold all sorts of transport layer errors, including ESP-TLS error, but in the past only the errors from `MQTT_ERROR_TYPE_ESP_TLS` layer were reported, so the ESP-TLS error type is re-defined here for backward compatibility

Type Definitions

typedef struct esp_mqtt_client *esp_mqtt_client_handle_t

typedef struct esp_mqtt_error_codes esp_mqtt_error_codes_t

MQTT error code structure to be passed as a contextual information into ERROR event.

Important: This structure extends `esp_tls_last_error` error structure and is backward compatible with it (so might be down-casted and treated as `esp_tls_last_error` error, but recommended to update applications if used this way previously)

Use this structure directly checking `error_type` first and then appropriate error code depending on the source of the error:

error_type	related member variables	note
<code>MQTT_ERROR_TYPE_TCP_TRANSPORT</code>	<code>esp_tls_last_esp_err</code> , <code>esp_tls_stack_err</code> , <code>esp_tls_cert_verify_flags</code> , <code>sock_errno</code>	Error reported from tcp_transport/esp-tls
<code>MQTT_ERROR_TYPE_CONNECTION_REFUSED</code>	<code>connect_return_code</code>	Internal error reported from MQTT broker on connection

typedef esp_mqtt_event_t *esp_mqtt_event_handle_t

typedef esp_err_t (*mqtt_event_callback_t)(esp_mqtt_event_handle_t event)

Enumerations

enum esp_mqtt_event_id_t

MQTT event types.

User event handler receives context data in `esp_mqtt_event_t` structure with

- `user_context` - user data from `esp_mqtt_client_config_t`
- `client` - mqtt client handle
- various other data depending on event type

Values:

MQTT_EVENT_ANY = -1

MQTT_EVENT_ERROR = 0

on error event, additional context: connection return code, error handle from `esp_tls` (if supported)

MQTT_EVENT_CONNECTED

connected event, additional context: `session_present` flag

MQTT_EVENT_DISCONNECTED

disconnected event

MQTT_EVENT_SUBSCRIBED

subscribed event, additional context:

- `msg_id` message id
- data pointer to the received data
- `data_len` length of the data for this event

MQTT_EVENT_UNSUBSCRIBED

unsubscribed event

MQTT_EVENT_PUBLISHED

published event, additional context: `msg_id`

MQTT_EVENT_DATA

data event, additional context:

- `msg_id` message id
- topic pointer to the received topic
- `topic_len` length of the topic
- data pointer to the received data
- `data_len` length of the data for this event
- `current_data_offset` offset of the current data for this event
- `total_data_len` total length of the data received
- retain retain flag of the message
- qos qos level of the message
- dup dup flag of the message Note: Multiple `MQTT_EVENT_DATA` could be fired for one message, if it is longer than internal buffer. In that case only first event contains topic pointer and length, other contain data only with current data length and current data offset updating.

MQTT_EVENT_BEFORE_CONNECT

The event occurs before connecting

MQTT_EVENT_DELETED

Notification on delete of one message from the internal outbox, if the message couldn't have been sent and acknowledged before expiring defined in `OUTBOX_EXPIRED_TIMEOUT_MS`. (events are not posted upon deletion of successfully acknowledged messages)

- This event id is posted only if `MQTT_REPORT_DELETED_MESSAGES==1`
- Additional context: `msg_id` (id of the deleted message).

enum esp_mqtt_connect_return_code_t

MQTT connection error codes propagated via ERROR event

Values:

MQTT_CONNECTION_ACCEPTED = 0

Connection accepted

MQTT_CONNECTION_REFUSE_PROTOCOL

MQTT connection refused reason: Wrong protocol

MQTT_CONNECTION_REFUSE_ID_REJECTED

MQTT connection refused reason: ID rejected

MQTT_CONNECTION_REFUSE_SERVER_UNAVAILABLE

MQTT connection refused reason: Server unavailable

MQTT_CONNECTION_REFUSE_BAD_USERNAME

MQTT connection refused reason: Wrong user

MQTT_CONNECTION_REFUSE_NOT_AUTHORIZED

MQTT connection refused reason: Wrong username or password

enum esp_mqtt_error_type_t

MQTT connection error codes propagated via ERROR event

Values:

MQTT_ERROR_TYPE_NONE = 0

MQTT_ERROR_TYPE_TCP_TRANSPORT

MQTT_ERROR_TYPE_CONNECTION_REFUSED

enum esp_mqtt_transport_t

Values:

MQTT_TRANSPORT_UNKNOWN = 0x0

MQTT_TRANSPORT_OVER_TCP

MQTT over TCP, using scheme: mqtt

MQTT_TRANSPORT_OVER_SSL

MQTT over SSL, using scheme: mqttssl

MQTT_TRANSPORT_OVER_WS

MQTT over Websocket, using scheme: ws

MQTT_TRANSPORT_OVER_WSS

MQTT over Websocket Secure, using scheme: wss

enum esp_mqtt_protocol_ver_t

MQTT protocol version used for connection

Values:

MQTT_PROTOCOL_UNDEFINED = 0

MQTT_PROTOCOL_V_3_1

MQTT_PROTOCOL_V_3_1_1

2.4.3 ESP-TLS

Overview

The ESP-TLS component provides a simplified API interface for accessing the commonly used TLS functionality. It supports common scenarios like CA certification validation, SNI, ALPN negotiation, non-blocking connection among others. All the configuration can be specified in the `esp_tls_cfg_t` data structure. Once done, TLS communication can be conducted using the following APIs:

- `esp_tls_conn_new()`: for opening a new TLS connection.
- `esp_tls_conn_read()`: for reading from the connection.

- `esp_tls_conn_write()`: for writing into the connection.
- `esp_tls_conn_delete()`: for freeing up the connection.

Any application layer protocol like HTTP1, HTTP2 etc can be executed on top of this layer.

Application Example

Simple HTTPS example that uses ESP-TLS to establish a secure socket connection: [protocols/https_request](#).

Tree structure for ESP-TLS component



The ESP-TLS component has a file `esp-tls/esp_tls.h` which contain the public API headers for the component. Internally ESP-TLS component uses one of the two SSL/TLS Libraries between `mbedtls` and `wolfssl` for its operation. API specific to `mbedtls` are present in `esp-tls/private_include/esp_tls_mbedtls.h` and API specific to `wolfssl` are present in `esp-tls/private_include/esp_tls_wolfssl.h`.

TLS Server verification

The ESP-TLS provides multiple options for TLS server verification on the client side. The ESP-TLS client can verify the server by validating the peer's server certificate or with the help of pre-shared keys. The user should select only one of the following options in the `esp_tls_cfg_t` structure for TLS server verification. If no option is selected then client will return a fatal error by default at the time of the TLS connection setup.

- **cacert_buf** and **cacert_bytes**: The CA certificate can be provided in a buffer to the `esp_tls_cfg_t` structure. The ESP-TLS will use the CA certificate present in the buffer to verify the server. The following variables in `esp_tls_cfg_t` structure must be set.
 - `cacert_buf` - pointer to the buffer which contains the CA cert.
 - `cacert_bytes` - size of the CA certificate in bytes.
- **use_global_ca_store**: The `global_ca_store` can be initialized and set at once. Then it can be used to verify the server for all the ESP-TLS connections which have set `use_global_ca_store = true` in their respective `esp_tls_cfg_t` structure. See API Reference section below on information regarding different API used for initializing and setting up the `global_ca_store`.
- **cert_bundle_attach**: The ESP x509 Certificate Bundle API provides an easy way to include a bundle of custom x509 root certificates for TLS server verification. More details can be found at [ESP x509 Certificate Bundle](#)
- **psk_hint_key**: To use pre-shared keys for server verification, `CONFIG_ESP_TLS_PSK_VERIFICATION` should be enabled in the ESP-TLS menuconfig. Then the pointer to PSK hint and key should be provided to the `esp_tls_cfg_t` structure. The ESP-TLS will use the PSK for server verification only when no other option regarding the server verification is selected.
- **skip server verification**: This is an insecure option provided in the ESP-TLS for testing purpose. The option can be set by enabling `CONFIG_ESP_TLS_INSECURE` and `CONFIG_ESP_TLS_SKIP_SERVER_CERT_VERIFY` in the ESP-TLS menuconfig. When this option is enabled the ESP-TLS will skip server verification by default when no other options for server verification are selected in the `esp_tls_cfg_t` structure. *WARNING:Enabling this option comes with a potential risk of establishing a TLS connection with a server which has a fake identity, provided that the server certificate is not provided either through API or other mechanism like ca_store etc.*

Underlying SSL/TLS Library Options

The ESP-TLS component has an option to use mbedtls or wolfssl as their underlying SSL/TLS library. By default only mbedtls is available and is used, wolfssl SSL/TLS library is available publicly at <https://github.com/espressif/esp-wolfssl>. The repository provides wolfssl component in binary format, it also provides few examples which are useful for understanding the API. Please refer the repository README.md for information on licensing and other options. Please see below option for using wolfssl in your project.

Note: *As the library options are internal to ESP-TLS, switching the libraries will not change ESP-TLS specific code for a project.*

How to use wolfssl with ESP-IDF

There are two ways to use wolfssl in your project

- 1) Directly add wolfssl as a component in your project with following three commands.:

```
(First change directory (cd) to your project directory)
mkdir components
cd components
git clone https://github.com/espressif/esp-wolfssl.git
```

- 2) Add wolfssl as an extra component in your project.

- Download wolfssl with:

```
git clone https://github.com/espressif/esp-wolfssl.git
```

- Include esp-wolfssl in ESP-IDF with setting EXTRA_COMPONENT_DIRS in CMakeLists.txt/Makefile of your project as done in [wolfssl/examples](#). For reference see Optional Project variables in [build-system](#).

After above steps, you will have option to choose wolfssl as underlying SSL/TLS library in configuration menu of your project as follows:

```
idf.py/make menuconfig -> ESP-TLS -> choose SSL/TLS Library -> mbedtls/wolfssl
```

Comparison between mbedtls and wolfssl

The following table shows a typical comparison between wolfssl and mbedtls when [protocols/https_request](#) example (which has server authentication) was run with both SSL/TLS libraries and with all respective configurations set to default. (mbedtls IN_CONTENT length and OUT_CONTENT length were set to 16384 bytes and 4096 bytes respectively)

Property	Wolfssl	Mbedtls
Total Heap Consumed	~19 Kb	~37 Kb
Task Stack Used	~2.2 Kb	~3.6 Kb
Bin size	~858 Kb	~736 Kb

Note: *These values are subject to change with change in configuration options and version of respective libraries.*

Digital Signature with ESP-TLS

ESP-TLS provides support for using the Digital Signature (DS) with ESP32-C3. Use of the DS for TLS is supported only when ESP-TLS is used with mbedTLS (default stack) as its underlying SSL/TLS stack. For more details on Digital Signature, please refer to the [Digital Signature Documentation](#). The technical details of Digital Signature such

as how to calculate private key parameters can be found in *ESP32-C3 Technical Reference Manual > Digital Signature (DS)* [PDF]. The DS peripheral must be configured before it can be used to perform Digital Signature, see *Configure the DS Peripheral* in *Digital Signature*.

The DS peripheral must be initialized with the required encrypted private key parameters (obtained when the DS peripheral is configured). ESP-TLS internally initializes the DS peripheral when provided with the required DS context (DS parameters). Please see the below code snippet for passing the DS context to esp-tls context. The DS context passed to the esp-tls context should not be freed till the TLS connection is deleted.

```
#include "esp_tls.h"
esp_ds_data_ctx_t *ds_ctx;
/* initialize ds_ctx with encrypted private key parameters, which can be read from
↳the nvs or
provided through the application code */
esp_tls_cfg_t cfg = {
    .clientcert_buf = /* the client cert */,
    .clientcert_bytes = /* length of the client cert */,
    /* other configurations options */
    .ds_data = (void *)ds_ctx,
};
```

Note: When using Digital Signature for the TLS connection, along with the other required params, only the client cert (*clientcert_buf*) and the DS params (*ds_data*) are required and the client key (*clientkey_buf*) can be set to NULL.

- An example of mutual authentication with the DS peripheral can be found at [ssl mutual auth](#) which internally uses (ESP-TLS) for the TLS connection.

API Reference

Header File

- [esp-tls/esp_tls.h](#)

Functions

esp_tls_t ***esp_tls_init** (void)

Create TLS connection.

This function allocates and initializes esp-tls structure handle.

Return *tls* Pointer to esp-tls as esp-tls handle if successfully initialized, NULL if allocation error

esp_tls_t ***esp_tls_conn_new** (const char *hostname, int hostlen, int port, const *esp_tls_cfg_t* *cfg)

Create a new blocking TLS/SSL connection.

This function establishes a TLS/SSL connection with the specified host in blocking manner.

Note: This API is present for backward compatibility reasons. Alternative function with the same functionality is *esp_tls_conn_new_sync* (and its asynchronous version *esp_tls_conn_new_async*)

Return pointer to *esp_tls_t*, or NULL if connection couldn't be opened.

Parameters

- [in] hostname: Hostname of the host.
- [in] hostlen: Length of hostname.
- [in] port: Port number of the host.
- [in] cfg: TLS configuration as *esp_tls_cfg_t*. If you wish to open non-TLS connection, keep this NULL. For TLS connection, a pass pointer to *esp_tls_cfg_t*. At a minimum, this structure should be zero-initialized.

int **esp_tls_conn_new_sync** (const char *hostname, int hostlen, int port, const *esp_tls_cfg_t* *cfg, *esp_tls_t* *tls)

Create a new blocking TLS/SSL connection.

This function establishes a TLS/SSL connection with the specified host in blocking manner.

Return

- -1 If connection establishment fails.
- 1 If connection establishment is successful.
- 0 If connection state is in progress.

Parameters

- [in] *hostname*: Hostname of the host.
- [in] *hostlen*: Length of hostname.
- [in] *port*: Port number of the host.
- [in] *cfg*: TLS configuration as `esp_tls_cfg_t`. If you wish to open non-TLS connection, keep this NULL. For TLS connection, a pass pointer to `esp_tls_cfg_t`. At a minimum, this structure should be zero-initialized.
- [in] *tls*: Pointer to esp-tls as esp-tls handle.

`esp_tls_t *esp_tls_conn_http_new(const char *url, const esp_tls_cfg_t *cfg)`

Create a new blocking TLS/SSL connection with a given “HTTP” url.

The behaviour is same as `esp_tls_conn_new()` API. However this API accepts host’s url.

Return pointer to `esp_tls_t`, or NULL if connection couldn’t be opened.

Parameters

- [in] *url*: url of host.
- [in] *cfg*: TLS configuration as `esp_tls_cfg_t`. If you wish to open non-TLS connection, keep this NULL. For TLS connection, a pass pointer to ‘`esp_tls_cfg_t`’. At a minimum, this structure should be zero-initialized.

int `esp_tls_conn_new_async(const char *hostname, int hostlen, int port, const esp_tls_cfg_t *cfg, esp_tls_t *tls)`

Create a new non-blocking TLS/SSL connection.

This function initiates a non-blocking TLS/SSL connection with the specified host, but due to its non-blocking nature, it doesn’t wait for the connection to get established.

Return

- -1 If connection establishment fails.
- 0 If connection establishment is in progress.
- 1 If connection establishment is successful.

Parameters

- [in] *hostname*: Hostname of the host.
- [in] *hostlen*: Length of hostname.
- [in] *port*: Port number of the host.
- [in] *cfg*: TLS configuration as `esp_tls_cfg_t`. `non_block` member of this structure should be set to be true.
- [in] *tls*: pointer to esp-tls as esp-tls handle.

int `esp_tls_conn_http_new_async(const char *url, const esp_tls_cfg_t *cfg, esp_tls_t *tls)`

Create a new non-blocking TLS/SSL connection with a given “HTTP” url.

The behaviour is same as `esp_tls_conn_new()` API. However this API accepts host’s url.

Return

- -1 If connection establishment fails.
- 0 If connection establishment is in progress.
- 1 If connection establishment is successful.

Parameters

- [in] *url*: url of host.
- [in] *cfg*: TLS configuration as `esp_tls_cfg_t`.
- [in] *tls*: pointer to esp-tls as esp-tls handle.

static ssize_t `esp_tls_conn_write(esp_tls_t *tls, const void *data, size_t datalen)`

Write from buffer ‘data’ into specified tls connection.

Return

- ≥ 0 if write operation was successful, the return value is the number of bytes actually written to the TLS/SSL connection.
- < 0 if write operation was not successful, because either an error occurred or an action must be taken by the calling process.
- `ESP_TLS_ERR_SSL_WANT_READ/ESP_TLS_ERR_SSL_WANT_WRITE`. if the handshake is incomplete and waiting for data to be available for reading. In this case this functions needs to be called again when the underlying transport is ready for operation.

Parameters

- [in] `tls`: pointer to esp-tls as esp-tls handle.
- [in] `data`: Buffer from which data will be written.
- [in] `datalen`: Length of data buffer.

static ssize_t `esp_tls_conn_read` (*esp_tls_t* *`tls`, void *`data`, size_t `datalen`)

Read from specified tls connection into the buffer 'data' .

Return

- > 0 if read operation was successful, the return value is the number of bytes actually read from the TLS/SSL connection.
- 0 if read operation was not successful. The underlying connection was closed.
- < 0 if read operation was not successful, because either an error occurred or an action must be taken by the calling process.

Parameters

- [in] `tls`: pointer to esp-tls as esp-tls handle.
- [in] `data`: Buffer to hold read data.
- [in] `datalen`: Length of data buffer.

void `esp_tls_conn_delete` (*esp_tls_t* *`tls`)

Compatible version of `esp_tls_conn_destroy()` to close the TLS/SSL connection.

Note This API will be removed in IDFv5.0

Parameters

- [in] `tls`: pointer to esp-tls as esp-tls handle.

int `esp_tls_conn_destroy` (*esp_tls_t* *`tls`)

Close the TLS/SSL connection and free any allocated resources.

This function should be called to close each tls connection opened with `esp_tls_conn_new()` or `esp_tls_conn_http_new()` APIs.

Return - 0 on success

- -1 if socket error or an invalid argument

Parameters

- [in] `tls`: pointer to esp-tls as esp-tls handle.

ssize_t `esp_tls_get_bytes_avail` (*esp_tls_t* *`tls`)

Return the number of application data bytes remaining to be read from the current record.

This API is a wrapper over mbedtls's `mbedtls_ssl_get_bytes_avail()` API.

Return

- -1 in case of invalid arg
- bytes available in the application data record read buffer

Parameters

- [in] `tls`: pointer to esp-tls as esp-tls handle.

esp_err_t `esp_tls_get_conn_sockfd` (*esp_tls_t* *`tls`, int *`sockfd`)

Returns the connection socket file descriptor from *esp_tls* session.

Return - `ESP_OK` on success and value of `sockfd` will be updated with socket file descriptor for connection

- `ESP_ERR_INVALID_ARG` if (`tls == NULL` || `sockfd == NULL`)

Parameters

- [in] `tls`: handle to *esp_tls* context
- [out] `sockfd`: int pointer to sockfd value.

esp_err_t **esp_tls_init_global_ca_store** (void)

Create a global CA store, initially empty.

This function should be called if the application wants to use the same CA store for multiple connections. This function initialises the global CA store which can be then set by calling `esp_tls_set_global_ca_store()`. To be effective, this function must be called before any call to `esp_tls_set_global_ca_store()`.

Return

- ESP_OK if creating global CA store was successful.
- ESP_ERR_NO_MEM if an error occurred when allocating the mbedTLS resources.

esp_err_t **esp_tls_set_global_ca_store** (const unsigned char *cacert_pem_buf, const unsigned int cacert_pem_bytes)

Set the global CA store with the buffer provided in pem format.

This function should be called if the application wants to set the global CA store for multiple connections i.e. to add the certificates in the provided buffer to the certificate chain. This function implicitly calls `esp_tls_init_global_ca_store()` if it has not already been called. The application must call this function before calling `esp_tls_conn_new()`.

Return

- ESP_OK if adding certificates was successful.
- Other if an error occurred or an action must be taken by the calling process.

Parameters

- [in] cacert_pem_buf: Buffer which has certificates in pem format. This buffer is used for creating a global CA store, which can be used by other tls connections.
- [in] cacert_pem_bytes: Length of the buffer.

void **esp_tls_free_global_ca_store** (void)

Free the global CA store currently being used.

The memory being used by the global CA store to store all the parsed certificates is freed up. The application can call this API if it no longer needs the global CA store.

esp_err_t **esp_tls_get_and_clear_last_error** (*esp_tls_error_handle_t* h, int *esp_tls_code, int *esp_tls_flags)

Returns last error in *esp_tls* with detailed mbedtls related error codes. The error information is cleared internally upon return.

Return

- ESP_ERR_INVALID_STATE if invalid parameters
- ESP_OK (0) if no error occurred
- specific error code (based on ESP_ERR_ESP_TLS_BASE) otherwise

Parameters

- [in] h: esp-tls error handle.
- [out] esp_tls_code: last error code returned from mbedtls api (set to zero if none) This pointer could be NULL if caller does not care about esp_tls_code
- [out] esp_tls_flags: last certification verification flags (set to zero if none) This pointer could be NULL if caller does not care about esp_tls_code

esp_err_t **esp_tls_get_and_clear_error_type** (*esp_tls_error_handle_t* h, *esp_tls_error_type_t* err_type, int *error_code)

Returns the last error captured in *esp_tls* of a specific type The error information is cleared internally upon return.

Return

- ESP_ERR_INVALID_STATE if invalid parameters
- ESP_OK if a valid error returned and was cleared

Parameters

- [in] h: esp-tls error handle.
- [in] err_type: specific error type
- [out] error_code: last error code returned from mbedtls api (set to zero if none) This pointer could be NULL if caller does not care about esp_tls_code

`mbedtls_x509_crt *esp_tls_get_global_ca_store` (void)

Get the pointer to the global CA store currently being used.

The application must first call `esp_tls_set_global_ca_store()`. Then the same CA store could be used by the application for APIs other than `esp_tls`.

Note Modifying the pointer might cause a failure in verifying the certificates.

Return

- Pointer to the global CA store currently being used if successful.
- NULL if there is no global CA store set.

Structures

struct esp_tls_last_error

Error structure containing relevant errors in case tls error occurred.

Public Members

`esp_err_t last_error`

error code (based on `ESP_ERR_ESP_TLS_BASE`) of the last occurred error

int `esp_tls_error_code`

`esp_tls` error code from last `esp_tls` failed api

int `esp_tls_flags`

last certification verification flags

struct psk_key_hint

ESP-TLS preshared key and hint structure.

Public Members

const uint8_t *`key`

key in PSK authentication mode in binary format

const size_t `key_size`

length of the key

const char *`hint`

hint in PSK authentication mode in string format

struct tls_keep_alive_cfg

Keep alive parameters structure.

Public Members

bool `keep_alive_enable`

Enable keep-alive timeout

int `keep_alive_idle`

Keep-alive idle time (second)

int `keep_alive_interval`

Keep-alive interval time (second)

int `keep_alive_count`

Keep-alive packet retry send count

struct esp_tls_cfg

ESP-TLS configuration parameters.

Note Note about format of certificates:

- This structure includes certificates of a Certificate Authority, of client or server as well as private keys, which may be of PEM or DER format. In case of PEM format, the buffer must be NULL terminated (with NULL character included in certificate size).
- Certificate Authority's certificate may be a chain of certificates in case of PEM format, but could be only one certificate in case of DER format
- Variables names of certificates and private key buffers and sizes are defined as unions providing backward compatibility for legacy *_pem_buf and *_pem_bytes names which suggested only PEM format was supported. It is encouraged to use generic names such as cacert_buf and cacert_bytes.

Public Members

const char ****alpn_protos**

Application protocols required for HTTP2. If HTTP2/ALPN support is required, a list of protocols that should be negotiated. The format is length followed by protocol name. For the most common cases the following is ok: const char **alpn_protos = { "h2" , NULL };

- where 'h2' is the protocol name

const unsigned char ***cacert_buf**

Certificate Authority's certificate in a buffer. Format may be PEM or DER, depending on mbedtls-support This buffer should be NULL terminated in case of PEM

const unsigned char ***cacert_pem_buf**

CA certificate buffer legacy name

unsigned int **cacert_bytes**

Size of Certificate Authority certificate pointed to by cacert_buf (including NULL-terminator in case of PEM format)

unsigned int **cacert_pem_bytes**

Size of Certificate Authority certificate legacy name

const unsigned char ***clientcert_buf**

Client certificate in a buffer Format may be PEM or DER, depending on mbedtls-support This buffer should be NULL terminated in case of PEM

const unsigned char ***clientcert_pem_buf**

Client certificate legacy name

unsigned int **clientcert_bytes**

Size of client certificate pointed to by clientcert_pem_buf (including NULL-terminator in case of PEM format)

unsigned int **clientcert_pem_bytes**

Size of client certificate legacy name

const unsigned char ***clientkey_buf**

Client key in a buffer Format may be PEM or DER, depending on mbedtls-support This buffer should be NULL terminated in case of PEM

const unsigned char ***clientkey_pem_buf**

Client key legacy name

unsigned int **clientkey_bytes**

Size of client key pointed to by clientkey_pem_buf (including NULL-terminator in case of PEM format)

unsigned int **clientkey_pem_bytes**

Size of client key legacy name

const unsigned char ***clientkey_password**

Client key decryption password string

unsigned int **clientkey_password_len**

String length of the password pointed to by clientkey_password

bool **non_block**
Configure non-blocking mode. If set to true the underneath socket will be configured in non blocking mode after tls session is established

bool **use_secure_element**
Enable this option to use secure element or atec608a chip (Integrated with ESP32-WROOM-32SE)

int **timeout_ms**
Network timeout in milliseconds

bool **use_global_ca_store**
Use a global ca_store for all the connections in which this bool is set.

const char ***common_name**
If non-NULL, server certificate CN must match this name. If NULL, server certificate CN must match hostname.

bool **skip_common_name**
Skip any validation of server certificate CN field

tls_keep_alive_cfg_t ***keep_alive_cfg**
Enable TCP keep-alive timeout for SSL connection

const *psk_hint_key_t* ***psk_hint_key**
Pointer to PSK hint and key. if not NULL (and certificates are NULL) then PSK authentication is enabled with configured setup. Important note: the pointer must be valid for connection

esp_err_t (***crt_bundle_attach**) (void *conf)
Function pointer to esp_cert_bundle_attach. Enables the use of certification bundle for server verification, must be enabled in menuconfig

void ***ds_data**
Pointer for digital signature peripheral context

struct esp_tls
ESP-TLS Connection Handle.

Public Members

mbedtls_ssl_context **ssl**
TLS/SSL context

mbedtls_entropy_context **entropy**
mbedtls entropy context structure

mbedtls_ctr_drbg_context **ctr_drbg**
mbedtls ctr drbg context structure. CTR_DRBG is deterministic random bit generation based on AES-256

mbedtls_ssl_config **conf**
TLS/SSL configuration to be shared between mbedtls_ssl_context structures

mbedtls_net_context **server_fd**
mbedtls wrapper type for sockets

mbedtls_x509_crt **cacert**
Container for the X.509 CA certificate

mbedtls_x509_crt ***cacert_ptr**
Pointer to the cacert being used.

mbedtls_x509_crt **clientcert**
Container for the X.509 client certificate

mbedtls_pk_context **clientkey**
Container for the private key of the client certificate

int **sockfd**

Underlying socket file descriptor.

ssize_t (***read**) (**struct esp_tls** *tls, char *data, size_t datalen)

Callback function for reading data from TLS/SSL connection.

ssize_t (***write**) (**struct esp_tls** *tls, **const** char *data, size_t datalen)

Callback function for writing data to TLS/SSL connection.

esp_tls_conn_state_t **conn_state**

ESP-TLS Connection state

fd_set **rset**

read file descriptors

fd_set **wset**

write file descriptors

bool **is_tls**

indicates connection type (TLS or NON-TLS)

esp_tls_role_t **role**

esp-tls role

- ESP_TLS_CLIENT
- ESP_TLS_SERVER

esp_tls_error_handle_t **error_handle**

handle to error descriptor

Macros

ESP_ERR_ESP_TLS_BASE

Starting number of ESP-TLS error codes

ESP_ERR_ESP_TLS_CANNOT_RESOLVE_HOSTNAME

Error if hostname couldn't be resolved upon tls connection

ESP_ERR_ESP_TLS_CANNOT_CREATE_SOCKET

Failed to create socket

ESP_ERR_ESP_TLS_UNSUPPORTED_PROTOCOL_FAMILY

Unsupported protocol family

ESP_ERR_ESP_TLS_FAILED_CONNECT_TO_HOST

Failed to connect to host

ESP_ERR_ESP_TLS_SOCKET_SETOPT_FAILED

failed to set socket option

ESP_ERR_MBEDTLS_CERT_PARTLY_OK

mbedtls parse certificates was partly successful

ESP_ERR_MBEDTLS_CTR_DRBG_SEED_FAILED

mbedtls api returned error

ESP_ERR_MBEDTLS_SSL_SET_HOSTNAME_FAILED

mbedtls api returned error

ESP_ERR_MBEDTLS_SSL_CONFIG_DEFAULTS_FAILED

mbedtls api returned error

ESP_ERR_MBEDTLS_SSL_CONF_ALPN_PROTOCOLS_FAILED

mbedtls api returned error

ESP_ERR_MBEDTLS_X509_CRT_PARSE_FAILED

mbedtls api returned error

ESP_ERR_MBEDTLS_SSL_CONF_OWN_CERT_FAILED

mbedtls api returned error

ESP_ERR_MBEDTLS_SSL_SETUP_FAILED

mbedtls api returned error

ESP_ERR_MBEDTLS_SSL_WRITE_FAILED

mbedtls api returned error

ESP_ERR_MBEDTLS_PK_PARSE_KEY_FAILED

mbedtls api returned failed

ESP_ERR_MBEDTLS_SSL_HANDSHAKE_FAILED

mbedtls api returned failed

ESP_ERR_MBEDTLS_SSL_CONF_PSK_FAILED

mbedtls api returned failed

ESP_ERR_ESP_TLS_CONNECTION_TIMEOUT

new connection in esp_tls_low_level_conn connection timeouted

ESP_ERR_WOLFSSL_SSL_SET_HOSTNAME_FAILED

wolfSSL api returned error

ESP_ERR_WOLFSSL_SSL_CONF_ALPN_PROTOCOLS_FAILED

wolfSSL api returned error

ESP_ERR_WOLFSSL_CERT_VERIFY_SETUP_FAILED

wolfSSL api returned error

ESP_ERR_WOLFSSL_KEY_VERIFY_SETUP_FAILED

wolfSSL api returned error

ESP_ERR_WOLFSSL_SSL_HANDSHAKE_FAILED

wolfSSL api returned failed

ESP_ERR_WOLFSSL_CTX_SETUP_FAILED

wolfSSL api returned failed

ESP_ERR_WOLFSSL_SSL_SETUP_FAILED

wolfSSL api returned failed

ESP_ERR_WOLFSSL_SSL_WRITE_FAILED

wolfSSL api returned failed

ESP_ERR_ESP_TLS_SE_FAILED

ESP_TLS_ERR_SSL_WANT_READ

ESP_TLS_ERR_SSL_WANT_WRITE

ESP_TLS_ERR_SSL_TIMEOUT

Type Definitions

typedef struct esp_tls_last_error *esp_tls_error_handle_t

typedef struct esp_tls_last_error esp_tls_last_error_t

Error structure containing relevant errors in case tls error occurred.

typedef enum esp_tls_conn_state esp_tls_conn_state_t

ESP-TLS Connection State.

typedef enum esp_tls_role esp_tls_role_t

typedef struct psk_key_hint psk_hint_key_t

ESP-TLS preshared key and hint structure.

typedef struct tls_keep_alive_cfg tls_keep_alive_cfg_t

Keep alive parameters structure.

typedef struct *esp_tls_cfg* esp_tls_cfg_t

ESP-TLS configuration parameters.

Note Note about format of certificates:

- This structure includes certificates of a Certificate Authority, of client or server as well as private keys, which may be of PEM or DER format. In case of PEM format, the buffer must be NULL terminated (with NULL character included in certificate size).
- Certificate Authority's certificate may be a chain of certificates in case of PEM format, but could be only one certificate in case of DER format
- Variables names of certificates and private key buffers and sizes are defined as unions providing backward compatibility for legacy *_pem_buf and *_pem_bytes names which suggested only PEM format was supported. It is encouraged to use generic names such as cacert_buf and cacert_bytes.

typedef struct *esp_tls* esp_tls_t

ESP-TLS Connection Handle.

Enumerations

enum esp_tls_error_type_t

Definition of different types/sources of error codes reported from different components

Values:

ESP_TLS_ERR_TYPE_UNKNOWN = 0

ESP_TLS_ERR_TYPE_SYSTEM

System error errno

ESP_TLS_ERR_TYPE_MBEDTLS

Error code from mbedTLS library

ESP_TLS_ERR_TYPE_MBEDTLS_CERT_FLAGS

Certificate flags defined in mbedTLS

ESP_TLS_ERR_TYPE_ESP

ESP-IDF error type esp_err_t

ESP_TLS_ERR_TYPE_WOLFSSL

Error code from wolfSSL library

ESP_TLS_ERR_TYPE_WOLFSSL_CERT_FLAGS

Certificate flags defined in wolfSSL

ESP_TLS_ERR_TYPE_MAX

Last err type invalid entry

enum esp_tls_conn_state

ESP-TLS Connection State.

Values:

ESP_TLS_INIT = 0

ESP_TLS_CONNECTING

ESP_TLS_HANDSHAKE

ESP_TLS_FAIL

ESP_TLS_DONE

enum esp_tls_role

Values:

ESP_TLS_CLIENT = 0

ESP_TLS_SERVER

2.4.4 ESP HTTP Client

Overview

`esp_http_client` provides an API for making HTTP/S requests from ESP-IDF programs. The steps to use this API for an HTTP request are:

- `esp_http_client_init()`: To use the HTTP client, the first thing we must do is create an `esp_http_client` by pass into this function with the `esp_http_client_config_t` configurations. Which configuration values we do not define, the library will use default.
- `esp_http_client_perform()`: The `esp_http_client` argument created from the init function is needed. This function performs all operations of the `esp_http_client`, from opening the connection, sending data, downloading data and closing the connection if necessary. All related events will be invoked in the `event_handle` (defined by `esp_http_client_config_t`). This function performs its job and blocks the current task until it' s done
- `esp_http_client_cleanup()`: After completing our `esp_http_client`' s task, this is the last function to be called. It will close the connection (if any) and free up all the memory allocated to the HTTP client

Application Example

```

esp_err_t _http_event_handle(esp_http_client_event_t *evt)
{
    switch(evt->event_id) {
        case HTTP_EVENT_ERROR:
            ESP_LOGI(TAG, "HTTP_EVENT_ERROR");
            break;
        case HTTP_EVENT_ON_CONNECTED:
            ESP_LOGI(TAG, "HTTP_EVENT_ON_CONNECTED");
            break;
        case HTTP_EVENT_HEADER_SENT:
            ESP_LOGI(TAG, "HTTP_EVENT_HEADER_SENT");
            break;
        case HTTP_EVENT_ON_HEADER:
            ESP_LOGI(TAG, "HTTP_EVENT_ON_HEADER");
            printf("*.s", evt->data_len, (char*)evt->data);
            break;
        case HTTP_EVENT_ON_DATA:
            ESP_LOGI(TAG, "HTTP_EVENT_ON_DATA, len=%d", evt->data_len);
            if (!esp_http_client_is_chunked_response(evt->client)) {
                printf("*.s", evt->data_len, (char*)evt->data);
            }

            break;
        case HTTP_EVENT_ON_FINISH:
            ESP_LOGI(TAG, "HTTP_EVENT_ON_FINISH");
            break;
        case HTTP_EVENT_DISCONNECTED:
            ESP_LOGI(TAG, "HTTP_EVENT_DISCONNECTED");
            break;
    }
    return ESP_OK;
}

esp_http_client_config_t config = {
    .url = "http://httpbin.org/redirect/2",
    .event_handler = _http_event_handle,
};
esp_http_client_handle_t client = esp_http_client_init(&config);
esp_err_t err = esp_http_client_perform(client);

```

(continues on next page)

(continued from previous page)

```

if (err == ESP_OK) {
    ESP_LOGI(TAG, "Status = %d, content_length = %d",
              esp_http_client_get_status_code(client),
              esp_http_client_get_content_length(client));
}
esp_http_client_cleanup(client);

```

Persistent Connections

Persistent connections means that the HTTP client can re-use the same connection for several transfers. If the server does not request to close the connection with the `Connection: close` header, the new transfer with same ip address, port, and protocol.

To allow the HTTP client to take full advantage of persistent connections, you should do as many of your file transfers as possible using the same handle.

Persistent Connections example

```

esp_err_t err;
esp_http_client_config_t config = {
    .url = "http://httpbin.org/get",
};
esp_http_client_handle_t client = esp_http_client_init(&config);
// first request
err = esp_http_client_perform(client);

// second request
esp_http_client_set_url(client, "http://httpbin.org/anything")
esp_http_client_set_method(client, HTTP_METHOD_DELETE);
esp_http_client_set_header(client, "HeaderKey", "HeaderValue");
err = esp_http_client_perform(client);

esp_http_client_cleanup(client);

```

HTTPS

The HTTP client supports SSL connections using **mbedtls**, with the `url` configuration starting with `https` scheme (or `transport_type = HTTP_TRANSPORT_OVER_SSL`). HTTPS support can be configured via [CONFIG_ESP_HTTP_CLIENT_ENABLE_HTTPS](#) (enabled by default).

Note: By providing information using HTTPS, the library will use the SSL transport type to connect to the server. If you want to verify server, then need to provide additional certificate in PEM format, and provide to `cert_pem` in `esp_http_client_config_t`

HTTPS example

```

static void https()
{
    esp_http_client_config_t config = {
        .url = "https://www.howsmyssl.com",
        .cert_pem = howsmyssl_com_root_cert_pem_start,
    };
    esp_http_client_handle_t client = esp_http_client_init(&config);
    esp_err_t err = esp_http_client_perform(client);
}

```

(continues on next page)

(continued from previous page)

```

if (err == ESP_OK) {
    ESP_LOGI(TAG, "Status = %d, content_length = %d",
             esp_http_client_get_status_code(client),
             esp_http_client_get_content_length(client));
}
esp_http_client_cleanup(client);
}

```

HTTP Stream

Some applications need to open the connection and control the reading of the data in an active manner. the HTTP client supports some functions to make this easier, of course, once you use these functions you should not use the `esp_http_client_perform()` function with that handle, and `esp_http_client_init()` always to be called first to get the handle. Perform that functions in the order below:

- `esp_http_client_init()`: to create and handle
- `esp_http_client_set_*` or `esp_http_client_delete_*`: to modify the http connection information (optional)
- `esp_http_client_open()`: Open the http connection with `write_len` parameter, `write_len=0` if we only need read
- `esp_http_client_write()`: Upload data, max length equal to `write_len` of `esp_http_client_open()` function. We may not need to call it if `write_len=0`
- `esp_http_client_fetch_headers()`: After sending the headers and write data (if any) to the server, this function will read the HTTP Server response headers. Calling this function will return the `content-length` from the Server, and we can call `esp_http_client_get_status_code()` for the HTTP status of the connection.
- `esp_http_client_read()`: Now, we can read the HTTP stream by this function.
- `esp_http_client_close()`: We should the connection after finish
- `esp_http_client_cleanup()`: And release the resources

Perform HTTP request as Stream reader Check the example function `http_perform_as_stream_reader` at [protocols/esp_http_client](#).

HTTP Authentication

The HTTP client supports both **Basic** and **Digest** Authentication. By providing usernames and passwords in `url` or in the `username`, `password` of config entry. And with `auth_type = HTTP_AUTH_TYPE_BASIC`, the HTTP client takes only 1 perform to pass the authentication process. If `auth_type = HTTP_AUTH_TYPE_NONE`, but there are `username` and `password` in the configuration, the HTTP client takes 2 performs. The first time it connects to the server and receives the UNAUTHORIZED header. Based on this information, it will know which authentication method to choose, and perform it on the second.

Config authentication example with URI

```

esp_http_client_config_t config = {
    .url = "http://user:passwd@httpbin.org/basic-auth/user/passwd",
    .auth_type = HTTP_AUTH_TYPE_BASIC,
};

```

Config authentication example with username, password entry

```

esp_http_client_config_t config = {
    .url = "http://httpbin.org/basic-auth/user/passwd",
    .username = "user",

```

(continues on next page)

```
.password = "passwd",
.auth_type = HTTP_AUTH_TYPE_BASIC,
};
```

HTTP Client example: [protocols/esp_http_client](#).

API Reference

Header File

- [esp_http_client/include/esp_http_client.h](#)

Functions

esp_http_client_handle_t **esp_http_client_init** (**const** *esp_http_client_config_t* **config*)

Start a HTTP session This function must be the first function to call, and it returns a *esp_http_client_handle_t* that you must use as input to other functions in the interface. This call MUST have a corresponding call to *esp_http_client_cleanup* when the operation is complete.

Return

- *esp_http_client_handle_t*
- NULL if any errors

Parameters

- [in] *config*: The configurations, see *http_client_config_t*

esp_err_t **esp_http_client_perform** (*esp_http_client_handle_t* *client*)

Invoke this function after *esp_http_client_init* and all the options calls are made, and will perform the transfer as described in the options. It must be called with the same *esp_http_client_handle_t* as input as the *esp_http_client_init* call returned. *esp_http_client_perform* performs the entire request in either blocking or non-blocking manner. By default, the API performs request in a blocking manner and returns when done, or if it failed, and in non-blocking manner, it returns if EAGAIN/EWOULDBLOCK or EINPROGRESS is encountered, or if it failed. And in case of non-blocking request, the user may call this API multiple times unless request & response is complete or there is a failure. To enable non-blocking *esp_http_client_perform()*, *is_async* member of *esp_http_client_config_t* must be set while making a call to *esp_http_client_init()* API. You can do any amount of calls to *esp_http_client_perform* while using the same *esp_http_client_handle_t*. The underlying connection may be kept open if the server allows it. If you intend to transfer more than one file, you are even encouraged to do so. *esp_http_client* will then attempt to re-use the same connection for the following transfers, thus making the operations faster, less CPU intense and using less network resources. Just note that you will have to use *esp_http_client_set_** between the invokes to set options for the following *esp_http_client_perform*.

Note You must never call this function simultaneously from two places using the same client handle.

Let the function return first before invoking it another time. If you want parallel transfers, you must use several *esp_http_client_handle_t*. This function include *esp_http_client_open* -> *esp_http_client_write* -> *esp_http_client_fetch_headers* -> *esp_http_client_read* (and option) *esp_http_client_close*.

Return

- ESP_OK on successful
- ESP_FAIL on error

Parameters

- *client*: The *esp_http_client* handle

esp_err_t **esp_http_client_set_url** (*esp_http_client_handle_t* *client*, **const** char **url*)

Set URL for client, when performing this behavior, the options in the URL will replace the old ones.

Return

- ESP_OK
- ESP_FAIL

Parameters

- [in] *client*: The *esp_http_client* handle

- [in] url: The url

esp_err_t **esp_http_client_set_post_field**(*esp_http_client_handle_t* client, const char *data, int len)

Set post data, this function must be called before `esp_http_client_perform`. Note: The data parameter passed to this function is a pointer and this function will not copy the data.

Return

- ESP_OK
- ESP_FAIL

Parameters

- [in] client: The `esp_http_client` handle
- [in] data: post data pointer
- [in] len: post length

int **esp_http_client_get_post_field**(*esp_http_client_handle_t* client, char **data)

Get current post field information.

Return Size of post data

Parameters

- [in] client: The client
- [out] data: Point to post data pointer

esp_err_t **esp_http_client_set_header**(*esp_http_client_handle_t* client, const char *key, const char *value)

Set http request header, this function must be called after `esp_http_client_init` and before any perform function.

Return

- ESP_OK
- ESP_FAIL

Parameters

- [in] client: The `esp_http_client` handle
- [in] key: The header key
- [in] value: The header value

esp_err_t **esp_http_client_get_header**(*esp_http_client_handle_t* client, const char *key, char **value)

Get http request header. The value parameter will be set to NULL if there is no header which is same as the key specified, otherwise the address of header value will be assigned to value parameter. This function must be called after `esp_http_client_init`.

Return

- ESP_OK
- ESP_FAIL

Parameters

- [in] client: The `esp_http_client` handle
- [in] key: The header key
- [out] value: The header value

esp_err_t **esp_http_client_get_username**(*esp_http_client_handle_t* client, char **value)

Get http request username. The address of username buffer will be assigned to value parameter. This function must be called after `esp_http_client_init`.

Return

- ESP_OK
- ESP_ERR_INVALID_ARG

Parameters

- [in] client: The `esp_http_client` handle
- [out] value: The username value

esp_err_t **esp_http_client_set_username**(*esp_http_client_handle_t* client, const char *username)

Set http request username. The value of username parameter will be assigned to username buffer. If the username parameter is NULL then username buffer will be freed.

Return

- ESP_OK
- ESP_ERR_INVALID_ARG

Parameters

- [in] `client`: The `esp_http_client` handle
- [in] `username`: The username value

esp_err_t **esp_http_client_get_password** (*esp_http_client_handle_t* `client`, char ***value*)

Get http request password. The address of password buffer will be assigned to value parameter. This function must be called after `esp_http_client_init`.

Return

- ESP_OK
- ESP_ERR_INVALID_ARG

Parameters

- [in] `client`: The `esp_http_client` handle
- [out] `value`: The password value

esp_err_t **esp_http_client_set_password** (*esp_http_client_handle_t* `client`, char **password*)

Set http request password. The value of password parameter will be assigned to password buffer. If the password parameter is NULL then password buffer will be freed.

Return

- ESP_OK
- ESP_ERR_INVALID_ARG

Parameters

- [in] `client`: The `esp_http_client` handle
- [in] `password`: The password value

esp_err_t **esp_http_client_set_auth_type** (*esp_http_client_handle_t* `client`, *esp_http_client_auth_type_t* `auth_type`)

Set http request `auth_type`.

Return

- ESP_OK
- ESP_ERR_INVALID_ARG

Parameters

- [in] `client`: The `esp_http_client` handle
- [in] `auth_type`: The `esp_http_client` auth type

esp_err_t **esp_http_client_set_method** (*esp_http_client_handle_t* `client`, *esp_http_client_method_t* `method`)

Set http request method.

Return

- ESP_OK
- ESP_ERR_INVALID_ARG

Parameters

- [in] `client`: The `esp_http_client` handle
- [in] `method`: The method

esp_err_t **esp_http_client_delete_header** (*esp_http_client_handle_t* `client`, const char **key*)

Delete http request header.

Return

- ESP_OK
- ESP_FAIL

Parameters

- [in] `client`: The `esp_http_client` handle
- [in] `key`: The key

esp_err_t **esp_http_client_open** (*esp_http_client_handle_t* `client`, int `write_len`)

This function will be open the connection, write all header strings and return.

Return

- ESP_OK
- ESP_FAIL

Parameters

- [in] *client*: The `esp_http_client` handle
- [in] *write_len*: HTTP Content length need to write to the server

int `esp_http_client_write` (*esp_http_client_handle_t client*, const char **buffer*, int *len*)
This function will write data to the HTTP connection previously opened by `esp_http_client_open()`

Return

- (-1) if any errors
- Length of data written

Parameters

- [in] *client*: The `esp_http_client` handle
- *buffer*: The buffer
- [in] *len*: This value must not be larger than the *write_len* parameter provided to `esp_http_client_open()`

int `esp_http_client_fetch_headers` (*esp_http_client_handle_t client*)
This function need to call after `esp_http_client_open`, it will read from http stream, process all receive headers.

Return

- (0) if stream doesn't contain content-length header, or chunked encoding (checked by `esp_http_client_is_chunked_response`)
- (-1: ESP_FAIL) if any errors
- Download data length defined by content-length header

Parameters

- [in] *client*: The `esp_http_client` handle

bool `esp_http_client_is_chunked_response` (*esp_http_client_handle_t client*)
Check response data is chunked.

Return true or false

Parameters

- [in] *client*: The `esp_http_client` handle

int `esp_http_client_read` (*esp_http_client_handle_t client*, char **buffer*, int *len*)
Read data from http stream.

Return

- (-1) if any errors
- Length of data was read

Parameters

- [in] *client*: The `esp_http_client` handle
- *buffer*: The buffer
- [in] *len*: The length

int `esp_http_client_get_status_code` (*esp_http_client_handle_t client*)
Get http response status code, the valid value if this function invoke after `esp_http_client_perform`

Return Status code

Parameters

- [in] *client*: The `esp_http_client` handle

int `esp_http_client_get_content_length` (*esp_http_client_handle_t client*)
Get http response content length (from header Content-Length) the valid value if this function invoke after `esp_http_client_perform`

Return

- (-1) Chunked transfer
- Content-Length value as bytes

Parameters

- [in] *client*: The `esp_http_client` handle

esp_err_t **esp_http_client_close** (*esp_http_client_handle_t* client)

Close http connection, still kept all http request resources.

Return

- ESP_OK
- ESP_FAIL

Parameters

- [in] client: The esp_http_client handle

esp_err_t **esp_http_client_cleanup** (*esp_http_client_handle_t* client)

This function must be the last function to call for an session. It is the opposite of the esp_http_client_init function and must be called with the same handle as input that a esp_http_client_init call returned. This might close all connections this handle has used and possibly has kept open until now. Don't call this function if you intend to transfer more files, re-using handles is a key to good performance with esp_http_client.

Return

- ESP_OK
- ESP_FAIL

Parameters

- [in] client: The esp_http_client handle

esp_http_client_transport_t **esp_http_client_get_transport_type** (*esp_http_client_handle_t* client)

Get transport type.

Return

- HTTP_TRANSPORT_UNKNOWN
- HTTP_TRANSPORT_OVER_TCP
- HTTP_TRANSPORT_OVER_SSL

Parameters

- [in] client: The esp_http_client handle

esp_err_t **esp_http_client_set_redirection** (*esp_http_client_handle_t* client)

Set redirection URL. When received the 30x code from the server, the client stores the redirect URL provided by the server. This function will set the current URL to redirect to enable client to execute the redirection request.

Return

- ESP_OK
- ESP_FAIL

Parameters

- [in] client: The esp_http_client handle

void **esp_http_client_add_auth** (*esp_http_client_handle_t* client)

On receiving HTTP Status code 401, this API can be invoked to add authorization information.

Note There is a possibility of receiving body message with redirection status codes, thus make sure to flush off body data after calling this API.

Parameters

- [in] client: The esp_http_client handle

bool **esp_http_client_is_complete_data_received** (*esp_http_client_handle_t* client)

Checks if entire data in the response has been read without any error.

Return

- true
- false

Parameters

- [in] client: The esp_http_client handle

int **esp_http_client_read_response** (*esp_http_client_handle_t* client, char *buffer, int len)

Helper API to read larger data chunks This is a helper API which internally calls esp_http_client_read multiple times till the end of data is reached or till the buffer gets full.

Return

- Length of data was read

Parameters

- [in] `client`: The `esp_http_client` handle
- `buffer`: The buffer
- [in] `len`: The buffer length

esp_err_t **esp_http_client_flush_response** (*esp_http_client_handle_t* `client`, int **len*)

Process all remaining response data. This uses an internal buffer to repeatedly receive, parse, and discard response data until complete data is processed. As no additional user-supplied buffer is required, this may be preferable to `esp_http_client_read_response` in situations where the content of the response may be ignored.

Return

- `ESP_OK` If successful, `len` will have discarded length
- `ESP_FAIL` If failed to read response
- `ESP_ERR_INVALID_ARG` If the client is `NULL`

Parameters

- [in] `client`: The `esp_http_client` handle
- `len`: Length of data discarded

esp_err_t **esp_http_client_get_url** (*esp_http_client_handle_t* `client`, char **url*, const int *len*)

Get URL from client.

Return

- `ESP_OK`
- `ESP_FAIL`

Parameters

- [in] `client`: The `esp_http_client` handle
- [inout] `url`: The buffer to store URL
- [in] `len`: The buffer length

esp_err_t **esp_http_client_get_chunk_length** (*esp_http_client_handle_t* `client`, int **len*)

Get Chunk-Length from client.

Return

- `ESP_OK` If successful, `len` will have length of current chunk
- `ESP_FAIL` If the server is not a chunked server
- `ESP_ERR_INVALID_ARG` If the client or `len` are `NULL`

Parameters

- [in] `client`: The `esp_http_client` handle
- [out] `len`: Variable to store length

Structures

struct esp_http_client_event

HTTP Client events data.

Public Members

esp_http_client_event_id_t **event_id**

event_id, to know the cause of the event

esp_http_client_handle_t **client**

`esp_http_client_handle_t` context

void ***data**

data of the event

int **data_len**

data length of data

void ***user_data**

user_data context, from *esp_http_client_config_t* `user_data`

char *header_key
For HTTP_EVENT_ON_HEADER event_id, it' s store current http header key

char *header_value
For HTTP_EVENT_ON_HEADER event_id, it' s store current http header value

struct esp_http_client_config_t
HTTP configuration.

Public Members

const char *url
HTTP URL, the information on the URL is most important, it overrides the other fields below, if any

const char *host
Domain or IP as string

int port
Port to connect, default depend on esp_http_client_transport_t (80 or 443)

const char *username
Using for Http authentication

const char *password
Using for Http authentication

esp_http_client_auth_type_t **auth_type**
Http authentication type, see esp_http_client_auth_type_t

const char *path
HTTP Path, if not set, default is /

const char *query
HTTP query

const char *cert_pem
SSL server certification, PEM format as string, if the client requires to verify server

const char *client_cert_pem
SSL client certification, PEM format as string, if the server requires to verify client

const char *client_key_pem
SSL client key, PEM format as string, if the server requires to verify client

const char *client_key_password
Client key decryption password string

size_t client_key_password_len
String length of the password pointed to by client_key_password

const char *user_agent
The User Agent string to send with HTTP requests

esp_http_client_method_t **method**
HTTP Method

int timeout_ms
Network timeout in milliseconds

bool disable_auto_redirect
Disable HTTP automatic redirects

int max_redirection_count
Max number of redirections on receiving HTTP redirect status code, using default value if zero

int max_authorization_retries
Max connection retries on receiving HTTP unauthorized status code, using default value if zero. Disables authorization retry if -1

http_event_handle_cb **event_handler**

HTTP Event Handle

esp_http_client_transport_t **transport_type**

HTTP transport type, see `esp_http_client_transport_t`

int **buffer_size**

HTTP receive buffer size

int **buffer_size_tx**

HTTP transmit buffer size

void ***user_data**

HTTP user_data context

bool **is_async**

Set asynchronous mode, only supported with HTTPS for now

bool **use_global_ca_store**

Use a global ca_store for all the connections in which this bool is set.

bool **skip_cert_common_name_check**

Skip any validation of server certificate CN field

esp_err_t (***crt_bundle_attach**) (void *conf)

Function pointer to `esp_cert_bundle_attach`. Enables the use of certification bundle for server verification, must be enabled in menuconfig

bool **keep_alive_enable**

Enable keep-alive timeout

int **keep_alive_idle**

Keep-alive idle time. Default is 5 (second)

int **keep_alive_interval**

Keep-alive interval time. Default is 5 (second)

int **keep_alive_count**

Keep-alive packet retry send count. Default is 3 counts

Macros

DEFAULT_HTTP_BUF_SIZE

ESP_ERR_HTTP_BASE

Starting number of HTTP error codes

ESP_ERR_HTTP_MAX_REDIRECT

The error exceeds the number of HTTP redirects

ESP_ERR_HTTP_CONNECT

Error open the HTTP connection

ESP_ERR_HTTP_WRITE_DATA

Error write HTTP data

ESP_ERR_HTTP_FETCH_HEADER

Error read HTTP header from server

ESP_ERR_HTTP_INVALID_TRANSPORT

There are no transport support for the input scheme

ESP_ERR_HTTP_CONNECTING

HTTP connection hasn't been established yet

ESP_ERR_HTTP_EAGAIN

Mapping of errno EAGAIN to `esp_err_t`

Type Definitions

```
typedef struct esp_http_client *esp_http_client_handle_t
typedef struct esp_http_client_event *esp_http_client_event_handle_t

typedef struct esp_http_client_event esp_http_client_event_t
    HTTP Client events data.

typedef esp_err_t (*http_event_handle_cb)(esp_http_client_event_t *evt)
```

Enumerations

```
enum esp_http_client_event_id_t
```

HTTP Client events id.

Values:

```
HTTP_EVENT_ERROR = 0
```

This event occurs when there are any errors during execution

```
HTTP_EVENT_ON_CONNECTED
```

Once the HTTP has been connected to the server, no data exchange has been performed

```
HTTP_EVENT_HEADERS_SENT
```

After sending all the headers to the server

```
HTTP_EVENT_HEADER_SENT = HTTP_EVENT_HEADERS_SENT
```

This header has been kept for backward compatability and will be deprecated in future versions esp-idf

```
HTTP_EVENT_ON_HEADER
```

Occurs when receiving each header sent from the server

```
HTTP_EVENT_ON_DATA
```

Occurs when receiving data from the server, possibly multiple portions of the packet

```
HTTP_EVENT_ON_FINISH
```

Occurs when finish a HTTP session

```
HTTP_EVENT_DISCONNECTED
```

The connection has been disconnected

```
enum esp_http_client_transport_t
```

HTTP Client transport.

Values:

```
HTTP_TRANSPORT_UNKNOWN = 0x0
```

Unknown

```
HTTP_TRANSPORT_OVER_TCP
```

Transport over tcp

```
HTTP_TRANSPORT_OVER_SSL
```

Transport over ssl

```
enum esp_http_client_method_t
```

HTTP method.

Values:

```
HTTP_METHOD_GET = 0
```

HTTP GET Method

```
HTTP_METHOD_POST
```

HTTP POST Method

```
HTTP_METHOD_PUT
```

HTTP PUT Method

```
HTTP_METHOD_PATCH
```

HTTP PATCH Method

HTTP_METHOD_DELETE
HTTP DELETE Method

HTTP_METHOD_HEAD
HTTP HEAD Method

HTTP_METHOD_NOTIFY
HTTP NOTIFY Method

HTTP_METHOD_SUBSCRIBE
HTTP SUBSCRIBE Method

HTTP_METHOD_UNSUBSCRIBE
HTTP UNSUBSCRIBE Method

HTTP_METHOD_OPTIONS
HTTP OPTIONS Method

HTTP_METHOD_COPY
HTTP COPY Method

HTTP_METHOD_MOVE
HTTP MOVE Method

HTTP_METHOD_LOCK
HTTP LOCK Method

HTTP_METHOD_UNLOCK
HTTP UNLOCK Method

HTTP_METHOD_PROPFIND
HTTP PROPFIND Method

HTTP_METHOD_PROPPATCH
HTTP PROPPATCH Method

HTTP_METHOD_MKCOL
HTTP MKCOL Method

HTTP_METHOD_MAX

enum esp_http_client_auth_type_t
HTTP Authentication type.

Values:

HTTP_AUTH_TYPE_NONE = 0
No authentication

HTTP_AUTH_TYPE_BASIC
HTTP Basic authentication

HTTP_AUTH_TYPE_DIGEST
HTTP Digest authentication

enum HttpStatus_Code
Enum for the HTTP status codes.

Values:

HttpStatus_Ok = 200

HttpStatus_MultipleChoices = 300

HttpStatus_MovedPermanently = 301

HttpStatus_Found = 302

HttpStatus_SeeOther = 303

HttpStatus_TemporaryRedirect = 307

```

HttpStatus_PermanentRedirect = 308
HttpStatus_BadRequest = 400
HttpStatus_Unauthorized = 401
HttpStatus_Forbidden = 403
HttpStatus_NotFound = 404
HttpStatus_InternalError = 500

```

2.4.5 HTTP Server

Overview

The HTTP Server component provides an ability for running a lightweight web server on ESP32-C3. Following are detailed steps to use the API exposed by HTTP Server:

- `httpd_start()`: Creates an instance of HTTP server, allocate memory/resources for it depending upon the specified configuration and outputs a handle to the server instance. The server has both, a listening socket (TCP) for HTTP traffic, and a control socket (UDP) for control signals, which are selected in a round robin fashion in the server task loop. The task priority and stack size are configurable during server instance creation by passing `httpd_config_t` structure to `httpd_start()`. TCP traffic is parsed as HTTP requests and, depending on the requested URI, user registered handlers are invoked which are supposed to send back HTTP response packets.
- `httpd_stop()`: This stops the server with the provided handle and frees up any associated memory/resources. This is a blocking function that first signals a halt to the server task and then waits for the task to terminate. While stopping, the task will close all open connections, remove registered URI handlers and reset all session context data to empty.
- `httpd_register_uri_handler()`: A URI handler is registered by passing object of type `httpd_uri_t` structure which has members including uri name, method type (eg. HTTPD_GET/HTTPD_POST/HTTPD_PUT etc.), function pointer of type `esp_err_t *handler (httpd_req_t *req)` and `user_ctx` pointer to user context data.

Application Example

```

/* Our URI handler function to be called during GET /uri request */
esp_err_t get_handler(httpd_req_t *req)
{
    /* Send a simple response */
    const char resp[] = "URI GET Response";
    httpd_resp_send(req, resp, HTTPD_RESP_USE_STRLEN);
    return ESP_OK;
}

/* Our URI handler function to be called during POST /uri request */
esp_err_t post_handler(httpd_req_t *req)
{
    /* Destination buffer for content of HTTP POST request.
     * httpd_req_recv() accepts char* only, but content could
     * as well be any binary data (needs type casting).
     * In case of string data, null termination will be absent, and
     * content length would give length of string */
    char content[100];

    /* Truncate if content length larger than the buffer */
    size_t rcv_size = MIN(req->content_len, sizeof(content));

    int ret = httpd_req_recv(req, content, rcv_size);

```

(continues on next page)

(continued from previous page)

```

if (ret <= 0) { /* 0 return value indicates connection closed */
    /* Check if timeout occurred */
    if (ret == HTTPD_SOCK_ERR_TIMEOUT) {
        /* In case of timeout one can choose to retry calling
         * httpd_req_recv(), but to keep it simple, here we
         * respond with an HTTP 408 (Request Timeout) error */
        httpd_resp_send_408(req);
    }
    /* In case of error, returning ESP_FAIL will
     * ensure that the underlying socket is closed */
    return ESP_FAIL;
}

/* Send a simple response */
const char resp[] = "URI POST Response";
httpd_resp_send(req, resp, HTTPD_RESP_USE_STRLEN);
return ESP_OK;
}

/* URI handler structure for GET /uri */
httpd_uri_t uri_get = {
    .uri      = "/uri",
    .method   = HTTP_GET,
    .handler  = get_handler,
    .user_ctx = NULL
};

/* URI handler structure for POST /uri */
httpd_uri_t uri_post = {
    .uri      = "/uri",
    .method   = HTTP_POST,
    .handler  = post_handler,
    .user_ctx = NULL
};

/* Function for starting the webserver */
httpd_handle_t start_webserver(void)
{
    /* Generate default configuration */
    httpd_config_t config = HTTPD_DEFAULT_CONFIG();

    /* Empty handle to esp_http_server */
    httpd_handle_t server = NULL;

    /* Start the httpd server */
    if (httpd_start(&server, &config) == ESP_OK) {
        /* Register URI handlers */
        httpd_register_uri_handler(server, &uri_get);
        httpd_register_uri_handler(server, &uri_post);
    }
    /* If server failed to start, handle will be NULL */
    return server;
}

/* Function for stopping the webserver */
void stop_webserver(httpd_handle_t server)
{
    if (server) {
        /* Stop the httpd server */
        httpd_stop(server);
    }
}

```

(continues on next page)

```
}

```

Simple HTTP server example Check HTTP server example under [protocols/http_server/simple](#) where handling of arbitrary content lengths, reading request headers and URL query parameters, and setting response headers is demonstrated.

Persistent Connections

HTTP server features persistent connections, allowing for the re-use of the same connection (session) for several transfers, all the while maintaining context specific data for the session. Context data may be allocated dynamically by the handler in which case a custom function may need to be specified for freeing this data when the connection/session is closed.

Persistent Connections Example

```
/* Custom function to free context */
void free_ctx_func(void *ctx)
{
    /* Could be something other than free */
    free(ctx);
}

esp_err_t adder_post_handler(httpd_req_t *req)
{
    /* Create session's context if not already available */
    if (! req->sess_ctx) {
        req->sess_ctx = malloc(sizeof(ANY_DATA_TYPE)); /*!< Pointer to context_
↪data */
        req->free_ctx = free_ctx_func; /*!< Function to free_
↪context data */
    }

    /* Access context data */
    ANY_DATA_TYPE *ctx_data = (ANY_DATA_TYPE *) req->sess_ctx;

    /* Respond */
    .....
    .....
    .....

    return ESP_OK;
}

```

Check the example under [protocols/http_server/persistent_sockets](#).

Websocket server

HTTP server provides a simple websocket support if the feature is enabled in menuconfig, please see [CONFIG_HTTPD_WS_SUPPORT](#). Please check the example under [protocols/http_server/ws_echo_server](#)

API Reference

Header File

- [esp_http_server/include/esp_http_server.h](#)

Functions

esp_err_t **httpd_register_uri_handler** (*httpd_handle_t* handle, **const** *httpd_uri_t**uri_handler)

Registers a URI handler.

Example usage:

```
esp_err_t my_uri_handler(httpd_req_t* req)
{
    // Recv , Process and Send
    ....
    ....
    ....

    // Fail condition
    if (....) {
        // Return fail to close session //
        return ESP_FAIL;
    }

    // On success
    return ESP_OK;
}

// URI handler structure
httpd_uri_t my_uri {
    .uri      = "/my_uri/path/xyz",
    .method   = HTTPD_GET,
    .handler  = my_uri_handler,
    .user_ctx = NULL
};

// Register handler
if (httpd_register_uri_handler(server_handle, &my_uri) != ESP_OK) {
    // If failed to register handler
    ....
}
```

Note URI handlers can be registered in real time as long as the server handle is valid.

Return

- **ESP_OK** : On successfully registering the handler
- **ESP_ERR_INVALID_ARG** : Null arguments
- **ESP_ERR_HTTPD_HANDLERS_FULL** : If no slots left for new handler
- **ESP_ERR_HTTPD_HANDLER_EXISTS** : If handler with same URI and method is already registered

Parameters

- [in] handle: handle to HTTPD server instance
- [in] uri_handler: pointer to handler that needs to be registered

esp_err_t **httpd_unregister_uri_handler** (*httpd_handle_t* handle, **const** char *uri, *httpd_method_t* method)

Unregister a URI handler.

Return

- **ESP_OK** : On successfully deregistering the handler
- **ESP_ERR_INVALID_ARG** : Null arguments
- **ESP_ERR_NOT_FOUND** : Handler with specified URI and method not found

Parameters

- [in] handle: handle to HTTPD server instance
- [in] uri: URI string
- [in] method: HTTP method

esp_err_t **httpd_unregister_uri** (*httpd_handle_t* handle, **const** char *uri)

Unregister all URI handlers with the specified uri string.

Return

- ESP_OK : On successfully deregistering all such handlers
- ESP_ERR_INVALID_ARG : Null arguments
- ESP_ERR_NOT_FOUND : No handler registered with specified uri string

Parameters

- [in] handle: handle to HTTPD server instance
- [in] uri: uri string specifying all handlers that need to be deregistered

esp_err_t **httpd_sess_set_recv_override** (*httpd_handle_t* hd, int sockfd, *httpd_recv_func_t* recv_func)

Override web server' s receive function (by session FD)

This function overrides the web server' s receive function. This same function is used to read HTTP request packets.

Note This API is supposed to be called either from the context of

- an http session APIs where sockfd is a valid parameter
- a URI handler where sockfd is obtained using httpd_req_to_sockfd()

Return

- ESP_OK : On successfully registering override
- ESP_ERR_INVALID_ARG : Null arguments

Parameters

- [in] hd: HTTPD instance handle
- [in] sockfd: Session socket FD
- [in] recv_func: The receive function to be set for this session

esp_err_t **httpd_sess_set_send_override** (*httpd_handle_t* hd, int sockfd, *httpd_send_func_t* send_func)

Override web server' s send function (by session FD)

This function overrides the web server' s send function. This same function is used to send out any response to any HTTP request.

Note This API is supposed to be called either from the context of

- an http session APIs where sockfd is a valid parameter
- a URI handler where sockfd is obtained using httpd_req_to_sockfd()

Return

- ESP_OK : On successfully registering override
- ESP_ERR_INVALID_ARG : Null arguments

Parameters

- [in] hd: HTTPD instance handle
- [in] sockfd: Session socket FD
- [in] send_func: The send function to be set for this session

esp_err_t **httpd_sess_set_pending_override** (*httpd_handle_t* hd, int sockfd, *httpd_pending_func_t* pending_func)

Override web server' s pending function (by session FD)

This function overrides the web server' s pending function. This function is used to test for pending bytes in a socket.

Note This API is supposed to be called either from the context of

- an http session APIs where sockfd is a valid parameter
- a URI handler where sockfd is obtained using httpd_req_to_sockfd()

Return

- ESP_OK : On successfully registering override
- ESP_ERR_INVALID_ARG : Null arguments

Parameters

- [in] hd: HTTPD instance handle
- [in] sockfd: Session socket FD
- [in] pending_func: The receive function to be set for this session

int **httpd_req_to_sockfd** (*httpd_req_t* *r)

Get the Socket Descriptor from the HTTP request.

This API will return the socket descriptor of the session for which URI handler was executed on reception of HTTP request. This is useful when user wants to call functions that require session socket fd, from within a URI handler, ie. : `httpd_sess_get_ctx()`, `httpd_sess_trigger_close()`, `httpd_sess_update_lru_counter()`.

Note This API is supposed to be called only from the context of a URI handler where `httpd_req_t*` request pointer is valid.

Return

- Socket descriptor : The socket descriptor for this request
- -1 : Invalid/NULL request pointer

Parameters

- [in] `r`: The request whose socket descriptor should be found

int `httpd_req_recv` (`httpd_req_t` **r*, char **buf*, size_t *buf_len*)

API to read content data from the HTTP request.

This API will read HTTP content data from the HTTP request into provided buffer. Use `content_len` provided in `httpd_req_t` structure to know the length of data to be fetched. If `content_len` is too large for the buffer then user may have to make multiple calls to this function, each time fetching ‘`buf_len`’ number of bytes, while the pointer to content data is incremented internally by the same number.

Note

- This API is supposed to be called only from the context of a URI handler where `httpd_req_t*` request pointer is valid.
- If an error is returned, the URI handler must further return an error. This will ensure that the erroneous socket is closed and cleaned up by the web server.
- Presently Chunked Encoding is not supported

Return

- Bytes : Number of bytes read into the buffer successfully
- 0 : Buffer length parameter is zero / connection closed by peer
- `HTTPD_SOCK_ERR_INVALID` : Invalid arguments
- `HTTPD_SOCK_ERR_TIMEOUT` : Timeout/interrupted while calling `socket recv()`
- `HTTPD_SOCK_ERR_FAIL` : Unrecoverable error while calling `socket recv()`

Parameters

- [in] `r`: The request being responded to
- [in] `buf`: Pointer to a buffer that the data will be read into
- [in] `buf_len`: Length of the buffer

size_t `httpd_req_get_hdr_value_len` (`httpd_req_t` **r*, const char **field*)

Search for a field in request headers and return the string length of it’ s value.

Note

- This API is supposed to be called only from the context of a URI handler where `httpd_req_t*` request pointer is valid.
- Once `httpd_resp_send()` API is called all request headers are purged, so request headers need be copied into separate buffers if they are required later.

Return

- Length : If field is found in the request URL
- Zero : Field not found / Invalid request / Null arguments

Parameters

- [in] `r`: The request being responded to
- [in] `field`: The header field to be searched in the request

`esp_err_t` `httpd_req_get_hdr_value_str` (`httpd_req_t` **r*, const char **field*, char **val*, size_t *val_size*)

Get the value string of a field from the request headers.

Note

- This API is supposed to be called only from the context of a URI handler where `httpd_req_t*` request pointer is valid.
- Once `httpd_resp_send()` API is called all request headers are purged, so request headers need be copied into separate buffers if they are required later.

- If output size is greater than input, then the value is truncated, accompanied by truncation error as return value.
- Use `httpd_req_get_hdr_value_len()` to know the right buffer length

Return

- `ESP_OK` : Field found in the request header and value string copied
- `ESP_ERR_NOT_FOUND` : Key not found
- `ESP_ERR_INVALID_ARG` : Null arguments
- `ESP_ERR_HTTPD_INVALID_REQ` : Invalid HTTP request pointer
- `ESP_ERR_HTTPD_RESULT_TRUNC` : Value string truncated

Parameters

- `[in]` `r`: The request being responded to
- `[in]` `field`: The field to be searched in the header
- `[out]` `val`: Pointer to the buffer into which the value will be copied if the field is found
- `[in]` `val_size`: Size of the user buffer “val”

`size_t httpd_req_get_url_query_len` (`httpd_req_t *r`)

Get Query string length from the request URL.

Note This API is supposed to be called only from the context of a URI handler where `httpd_req_t*` request pointer is valid

Return

- Length : Query is found in the request URL
- Zero : Query not found / Null arguments / Invalid request

Parameters

- `[in]` `r`: The request being responded to

`esp_err_t httpd_req_get_url_query_str` (`httpd_req_t *r`, `char *buf`, `size_t buf_len`)

Get Query string from the request URL.

Note

- Presently, the user can fetch the full URL query string, but decoding will have to be performed by the user. Request headers can be read using `httpd_req_get_hdr_value_str()` to know the ‘Content-Type’ (eg. Content-Type: application/x-www-form-urlencoded) and then the appropriate decoding algorithm needs to be applied.
- This API is supposed to be called only from the context of a URI handler where `httpd_req_t*` request pointer is valid
- If output size is greater than input, then the value is truncated, accompanied by truncation error as return value
- Prior to calling this function, one can use `httpd_req_get_url_query_len()` to know the query string length beforehand and hence allocate the buffer of right size (usually query string length + 1 for null termination) for storing the query string

Return

- `ESP_OK` : Query is found in the request URL and copied to buffer
- `ESP_ERR_NOT_FOUND` : Query not found
- `ESP_ERR_INVALID_ARG` : Null arguments
- `ESP_ERR_HTTPD_INVALID_REQ` : Invalid HTTP request pointer
- `ESP_ERR_HTTPD_RESULT_TRUNC` : Query string truncated

Parameters

- `[in]` `r`: The request being responded to
- `[out]` `buf`: Pointer to the buffer into which the query string will be copied (if found)
- `[in]` `buf_len`: Length of output buffer

`esp_err_t httpd_query_key_value` (`const char *qry`, `const char *key`, `char *val`, `size_t val_size`)

Helper function to get a URL query tag from a query string of the type `param1=val1¶m2=val2`.

Note

- The components of URL query string (keys and values) are not URLdecoded. The user must check for ‘Content-Type’ field in the request headers and then depending upon the specified encoding (URLencoded or otherwise) apply the appropriate decoding algorithm.
- If actual value size is greater than `val_size`, then the value is truncated, accompanied by truncation error as return value.

Return

- ESP_OK : Key is found in the URL query string and copied to buffer
- ESP_ERR_NOT_FOUND : Key not found
- ESP_ERR_INVALID_ARG : Null arguments
- ESP_ERR_HTTPD_RESULT_TRUNC : Value string truncated

Parameters

- [in] qry: Pointer to query string
- [in] key: The key to be searched in the query string
- [out] val: Pointer to the buffer into which the value will be copied if the key is found
- [in] val_size: Size of the user buffer “val”

bool **httpd_uri_match_wildcard**(const char *uri_template, const char *uri_to_match, size_t match_upto)

Test if a URI matches the given wildcard template.

Template may end with “?” to make the previous character optional (typically a slash), “*” for a wildcard match, and “?*” to make the previous character optional, and if present, allow anything to follow.

Example:

- * matches everything
- /foo/? matches /foo and /foo/
- /foo/* (sans the backslash) matches /foo/ and /foo/bar, but not /foo or /fo
- /foo/?* or /foo/*? (sans the backslash) matches /foo/, /foo/bar, and also /foo, but not /foox or /fo

The special characters “?” and “*” anywhere else in the template will be taken literally.

Return true if a match was found

Parameters

- [in] uri_template: URI template (pattern)
- [in] uri_to_match: URI to be matched
- [in] match_upto: how many characters of the URI buffer to test (there may be trailing query string etc.)

esp_err_t **httpd_resp_send**(*httpd_req_t* *r, const char *buf, ssize_t buf_len)

API to send a complete HTTP response.

This API will send the data as an HTTP response to the request. This assumes that you have the entire response ready in a single buffer. If you wish to send response in incremental chunks use `httpd_resp_send_chunk()` instead.

If no status code and content-type were set, by default this will send 200 OK status code and content type as text/html. You may call the following functions before this API to configure the response headers : `httpd_resp_set_status()` - for setting the HTTP status string, `httpd_resp_set_type()` - for setting the Content Type, `httpd_resp_set_hdr()` - for appending any additional field value entries in the response header

Note

- This API is supposed to be called only from the context of a URI handler where `httpd_req_t*` request pointer is valid.
- Once this API is called, the request has been responded to.
- No additional data can then be sent for the request.
- Once this API is called, all request headers are purged, so request headers need be copied into separate buffers if they are required later.

Return

- ESP_OK : On successfully sending the response packet
- ESP_ERR_INVALID_ARG : Null request pointer
- ESP_ERR_HTTPD_RESP_HDR : Essential headers are too large for internal buffer
- ESP_ERR_HTTPD_RESP_SEND : Error in raw send
- ESP_ERR_HTTPD_INVALID_REQ : Invalid request

Parameters

- [in] r: The request being responded to
- [in] buf: Buffer from where the content is to be fetched
- [in] buf_len: Length of the buffer, `HTTPD_RESP_USE_STRLEN` to use `strlen()`

esp_err_t **httpd_resp_send_chunk** (*httpd_req_t* **r*, **const** char **buf*, *ssize_t* *buf_len*)

API to send one HTTP chunk.

This API will send the data as an HTTP response to the request. This API will use chunked-encoding and send the response in the form of chunks. If you have the entire response contained in a single buffer, please use `httpd_resp_send()` instead.

If no status code and content-type were set, by default this will send 200 OK status code and content type as text/html. You may call the following functions before this API to configure the response headers `httpd_resp_set_status()` - for setting the HTTP status string, `httpd_resp_set_type()` - for setting the Content Type, `httpd_resp_set_hdr()` - for appending any additional field value entries in the response header

Note

- This API is supposed to be called only from the context of a URI handler where `httpd_req_t*` request pointer is valid.
- When you are finished sending all your chunks, you must call this function with `buf_len` as 0.
- Once this API is called, all request headers are purged, so request headers need be copied into separate buffers if they are required later.

Return

- `ESP_OK` : On successfully sending the response packet chunk
- `ESP_ERR_INVALID_ARG` : Null request pointer
- `ESP_ERR_HTTPD_RESP_HDR` : Essential headers are too large for internal buffer
- `ESP_ERR_HTTPD_RESP_SEND` : Error in raw send
- `ESP_ERR_HTTPD_INVALID_REQ` : Invalid request pointer

Parameters

- [*in*] *r*: The request being responded to
- [*in*] *buf*: Pointer to a buffer that stores the data
- [*in*] *buf_len*: Length of the buffer, `HTTPD_RESP_USE_STRLEN` to use `strlen()`

static *esp_err_t* **httpd_resp_sendstr** (*httpd_req_t* **r*, **const** char **str*)

API to send a complete string as HTTP response.

This API simply calls `httpd_resp_send` with buffer length set to string length assuming the buffer contains a null terminated string

Return

- `ESP_OK` : On successfully sending the response packet
- `ESP_ERR_INVALID_ARG` : Null request pointer
- `ESP_ERR_HTTPD_RESP_HDR` : Essential headers are too large for internal buffer
- `ESP_ERR_HTTPD_RESP_SEND` : Error in raw send
- `ESP_ERR_HTTPD_INVALID_REQ` : Invalid request

Parameters

- [*in*] *r*: The request being responded to
- [*in*] *str*: String to be sent as response body

static *esp_err_t* **httpd_resp_sendstr_chunk** (*httpd_req_t* **r*, **const** char **str*)

API to send a string as an HTTP response chunk.

This API simply calls `httpd_resp_send_chunk` with buffer length set to string length assuming the buffer contains a null terminated string

Return

- `ESP_OK` : On successfully sending the response packet
- `ESP_ERR_INVALID_ARG` : Null request pointer
- `ESP_ERR_HTTPD_RESP_HDR` : Essential headers are too large for internal buffer
- `ESP_ERR_HTTPD_RESP_SEND` : Error in raw send
- `ESP_ERR_HTTPD_INVALID_REQ` : Invalid request

Parameters

- [*in*] *r*: The request being responded to
- [*in*] *str*: String to be sent as response body (NULL to finish response packet)

esp_err_t **httpd_resp_set_status** (*httpd_req_t* **r*, **const** char **status*)

API to set the HTTP status code.

This API sets the status of the HTTP response to the value specified. By default, the ‘200 OK’ response is sent as the response.

Note

- This API is supposed to be called only from the context of a URI handler where `httpd_req_t*` request pointer is valid.
- This API only sets the status to this value. The status isn’t sent out until any of the send APIs is executed.
- Make sure that the lifetime of the status string is valid till send function is called.

Return

- `ESP_OK` : On success
- `ESP_ERR_INVALID_ARG` : Null arguments
- `ESP_ERR_HTTPD_INVALID_REQ` : Invalid request pointer

Parameters

- `[in] r`: The request being responded to
- `[in] status`: The HTTP status code of this response

`esp_err_t httpd_resp_set_type (httpd_req_t *r, const char *type)`

API to set the HTTP content type.

This API sets the ‘Content Type’ field of the response. The default content type is ‘text/html’.

Note

- This API is supposed to be called only from the context of a URI handler where `httpd_req_t*` request pointer is valid.
- This API only sets the content type to this value. The type isn’t sent out until any of the send APIs is executed.
- Make sure that the lifetime of the type string is valid till send function is called.

Return

- `ESP_OK` : On success
- `ESP_ERR_INVALID_ARG` : Null arguments
- `ESP_ERR_HTTPD_INVALID_REQ` : Invalid request pointer

Parameters

- `[in] r`: The request being responded to
- `[in] type`: The Content Type of the response

`esp_err_t httpd_resp_set_hdr (httpd_req_t *r, const char *field, const char *value)`

API to append any additional headers.

This API sets any additional header fields that need to be sent in the response.

Note

- This API is supposed to be called only from the context of a URI handler where `httpd_req_t*` request pointer is valid.
- The header isn’t sent out until any of the send APIs is executed.
- The maximum allowed number of additional headers is limited to value of `max_resp_headers` in config structure.
- Make sure that the lifetime of the field value strings are valid till send function is called.

Return

- `ESP_OK` : On successfully appending new header
- `ESP_ERR_INVALID_ARG` : Null arguments
- `ESP_ERR_HTTPD_RESP_HDR` : Total additional headers exceed max allowed
- `ESP_ERR_HTTPD_INVALID_REQ` : Invalid request pointer

Parameters

- `[in] r`: The request being responded to
- `[in] field`: The field name of the HTTP header
- `[in] value`: The value of this HTTP header

`esp_err_t httpd_resp_send_err (httpd_req_t *req, httpd_err_code_t error, const char *msg)`

For sending out error code in response to HTTP request.

Note

- This API is supposed to be called only from the context of a URI handler where `httpd_req_t*` request pointer is valid.
- Once this API is called, all request headers are purged, so request headers need be copied into separate buffers if they are required later.
- If you wish to send additional data in the body of the response, please use the lower-level functions directly.

Return

- `ESP_OK` : On successfully sending the response packet
- `ESP_ERR_INVALID_ARG` : Null arguments
- `ESP_ERR_HTTPD_RESP_SEND` : Error in raw send
- `ESP_ERR_HTTPD_INVALID_REQ` : Invalid request pointer

Parameters

- `[in] req`: Pointer to the HTTP request for which the response needs to be sent
- `[in] error`: Error type to send
- `[in] msg`: Error message string (pass NULL for default message)

static *esp_err_t* `httpd_resp_send_404` (*httpd_req_t* *r)

Helper function for HTTP 404.

Send HTTP 404 message. If you wish to send additional data in the body of the response, please use the lower-level functions directly.

Note

- This API is supposed to be called only from the context of a URI handler where `httpd_req_t*` request pointer is valid.
- Once this API is called, all request headers are purged, so request headers need be copied into separate buffers if they are required later.

Return

- `ESP_OK` : On successfully sending the response packet
- `ESP_ERR_INVALID_ARG` : Null arguments
- `ESP_ERR_HTTPD_RESP_SEND` : Error in raw send
- `ESP_ERR_HTTPD_INVALID_REQ` : Invalid request pointer

Parameters

- `[in] r`: The request being responded to

static *esp_err_t* `httpd_resp_send_408` (*httpd_req_t* *r)

Helper function for HTTP 408.

Send HTTP 408 message. If you wish to send additional data in the body of the response, please use the lower-level functions directly.

Note

- This API is supposed to be called only from the context of a URI handler where `httpd_req_t*` request pointer is valid.
- Once this API is called, all request headers are purged, so request headers need be copied into separate buffers if they are required later.

Return

- `ESP_OK` : On successfully sending the response packet
- `ESP_ERR_INVALID_ARG` : Null arguments
- `ESP_ERR_HTTPD_RESP_SEND` : Error in raw send
- `ESP_ERR_HTTPD_INVALID_REQ` : Invalid request pointer

Parameters

- `[in] r`: The request being responded to

static *esp_err_t* `httpd_resp_send_500` (*httpd_req_t* *r)

Helper function for HTTP 500.

Send HTTP 500 message. If you wish to send additional data in the body of the response, please use the lower-level functions directly.

Note

- This API is supposed to be called only from the context of a URI handler where `httpd_req_t*` request pointer is valid.

- Once this API is called, all request headers are purged, so request headers need be copied into separate buffers if they are required later.

Return

- `ESP_OK` : On successfully sending the response packet
- `ESP_ERR_INVALID_ARG` : Null arguments
- `ESP_ERR_HTTPD_RESP_SEND` : Error in raw send
- `ESP_ERR_HTTPD_INVALID_REQ` : Invalid request pointer

Parameters

- `[in] r`: The request being responded to

int `httpd_send` (`httpd_req_t *r`, `const char *buf`, `size_t buf_len`)

Raw HTTP send.

Call this API if you wish to construct your custom response packet. When using this, all essential header, eg. HTTP version, Status Code, Content Type and Length, Encoding, etc. will have to be constructed manually, and HTTP delimiters (CRLF) will need to be placed correctly for separating sub-sections of the HTTP response packet.

If the send override function is set, this API will end up calling that function eventually to send data out.

Note

- This API is supposed to be called only from the context of a URI handler where `httpd_req_t*` request pointer is valid.
- Unless the response has the correct HTTP structure (which the user must now ensure) it is not guaranteed that it will be recognized by the client. For most cases, you wouldn't have to call this API, but you would rather use either of : `httpd_resp_send()`, `httpd_resp_send_chunk()`

Return

- `Bytes` : Number of bytes that were sent successfully
- `HTTPD_SOCK_ERR_INVALID` : Invalid arguments
- `HTTPD_SOCK_ERR_TIMEOUT` : Timeout/interrupted while calling socket send()
- `HTTPD_SOCK_ERR_FAIL` : Unrecoverable error while calling socket send()

Parameters

- `[in] r`: The request being responded to
- `[in] buf`: Buffer from where the fully constructed packet is to be read
- `[in] buf_len`: Length of the buffer

int `httpd_socket_send` (`httpd_handle_t hd`, `int sockfd`, `const char *buf`, `size_t buf_len`, `int flags`)

A low level API to send data on a given socket

This internally calls the default send function, or the function registered by `httpd_sess_set_send_override()`.

Note This API is not recommended to be used in any request handler. Use this only for advanced use cases, wherein some asynchronous data is to be sent over a socket.

Return

- `Bytes` : The number of bytes sent successfully
- `HTTPD_SOCK_ERR_INVALID` : Invalid arguments
- `HTTPD_SOCK_ERR_TIMEOUT` : Timeout/interrupted while calling socket send()
- `HTTPD_SOCK_ERR_FAIL` : Unrecoverable error while calling socket send()

Parameters

- `[in] hd`: server instance
- `[in] sockfd`: session socket file descriptor
- `[in] buf`: buffer with bytes to send
- `[in] buf_len`: data size
- `[in] flags`: flags for the send() function

int `httpd_socket_recv` (`httpd_handle_t hd`, `int sockfd`, `char *buf`, `size_t buf_len`, `int flags`)

A low level API to receive data from a given socket

This internally calls the default recv function, or the function registered by `httpd_sess_set_recv_override()`.

Note This API is not recommended to be used in any request handler. Use this only for advanced use cases, wherein some asynchronous communication is required.

Return

- Bytes : The number of bytes received successfully
- 0 : Buffer length parameter is zero / connection closed by peer
- HTTPD_SOCK_ERR_INVALID : Invalid arguments
- HTTPD_SOCK_ERR_TIMEOUT : Timeout/interrupted while calling socket recv()
- HTTPD_SOCK_ERR_FAIL : Unrecoverable error while calling socket recv()

Parameters

- [in] hd: server instance
- [in] sockfd: session socket file descriptor
- [in] buf: buffer with bytes to send
- [in] buf_len: data size
- [in] flags: flags for the send() function

esp_err_t **httpd_register_err_handler** (*httpd_handle_t* handle, *httpd_err_code_t* error, *httpd_err_handler_func_t* handler_fn)

Function for registering HTTP error handlers.

This function maps a handler function to any supported error code given by `httpd_err_code_t`. See prototype `httpd_err_handler_func_t` above for details.

Return

- ESP_OK : handler registered successfully
- ESP_ERR_INVALID_ARG : invalid error code or server handle

Parameters

- [in] handle: HTTP server handle
- [in] error: Error type
- [in] handler_fn: User implemented handler function (Pass NULL to unset any previously set handler)

esp_err_t **httpd_start** (*httpd_handle_t* *handle, **const** *httpd_config_t* *config)

Starts the web server.

Create an instance of HTTP server and allocate memory/resources for it depending upon the specified configuration.

Example usage:

```
//Function for starting the webserver
httpd_handle_t start_webserver(void)
{
    // Generate default configuration
    httpd_config_t config = HTTPD_DEFAULT_CONFIG();

    // Empty handle to http_server
    httpd_handle_t server = NULL;

    // Start the httpd server
    if (httpd_start(&server, &config) == ESP_OK) {
        // Register URI handlers
        httpd_register_uri_handler(server, &uri_get);
        httpd_register_uri_handler(server, &uri_post);
    }
    // If server failed to start, handle will be NULL
    return server;
}
```

Return

- ESP_OK : Instance created successfully
- ESP_ERR_INVALID_ARG : Null argument(s)
- ESP_ERR_HTTPD_ALLOC_MEM : Failed to allocate memory for instance
- ESP_ERR_HTTPD_TASK : Failed to launch server task

Parameters

- [in] config: Configuration for new instance of the server

- [out] handle: Handle to newly created instance of the server. NULL on error

esp_err_t **httpd_stop**(*httpd_handle_t* handle)

Stops the web server.

Deallocates memory/resources used by an HTTP server instance and deletes it. Once deleted the handle can no longer be used for accessing the instance.

Example usage:

```
// Function for stopping the webserver
void stop_webserver(httpd_handle_t server)
{
    // Ensure handle is non NULL
    if (server != NULL) {
        // Stop the httpd server
        httpd_stop(server);
    }
}
```

Return

- ESP_OK : Server stopped successfully
- ESP_ERR_INVALID_ARG : Handle argument is Null

Parameters

- [in] handle: Handle to server returned by httpd_start

esp_err_t **httpd_queue_work**(*httpd_handle_t* handle, *httpd_work_fn_t* work, void *arg)

Queue execution of a function in HTTPD' s context.

This API queues a work function for asynchronous execution

Note Some protocols require that the web server generate some asynchronous data and send it to the persistently opened connection. This facility is for use by such protocols.

Return

- ESP_OK : On successfully queueing the work
- ESP_FAIL : Failure in ctrl socket
- ESP_ERR_INVALID_ARG : Null arguments

Parameters

- [in] handle: Handle to server returned by httpd_start
- [in] work: Pointer to the function to be executed in the HTTPD' s context
- [in] arg: Pointer to the arguments that should be passed to this function

void ***httpd_sess_get_ctx**(*httpd_handle_t* handle, int sockfd)

Get session context from socket descriptor.

Typically if a session context is created, it is available to URI handlers through the httpd_req_t structure. But, there are cases where the web server' s send/receive functions may require the context (for example, for accessing keying information etc). Since the send/receive function only have the socket descriptor at their disposal, this API provides them with a way to retrieve the session context.

Return

- void* : Pointer to the context associated with this session
- NULL : Empty context / Invalid handle / Invalid socket fd

Parameters

- [in] handle: Handle to server returned by httpd_start
- [in] sockfd: The socket descriptor for which the context should be extracted.

void **httpd_sess_set_ctx**(*httpd_handle_t* handle, int sockfd, void *ctx, *httpd_free_ctx_fn_t* free_fn)

Set session context by socket descriptor.

Parameters

- [in] handle: Handle to server returned by httpd_start
- [in] sockfd: The socket descriptor for which the context should be extracted.
- [in] ctx: Context object to assign to the session
- [in] free_fn: Function that should be called to free the context

void **httpd_sess_get_transport_ctx** (*httpd_handle_t* handle, int sockfd)
Get session ‘transport’ context by socket descriptor.

This context is used by the send/receive functions, for example to manage SSL context.

See `httpd_sess_get_ctx()`

Return

- void* : Pointer to the transport context associated with this session
- NULL : Empty context / Invalid handle / Invalid socket fd

Parameters

- [in] handle: Handle to server returned by `httpd_start`
- [in] sockfd: The socket descriptor for which the context should be extracted.

void **httpd_sess_set_transport_ctx** (*httpd_handle_t* handle, int sockfd, void *ctx, *httpd_free_ctx_fn_t* free_fn)

Set session ‘transport’ context by socket descriptor.

See `httpd_sess_set_ctx()`

Parameters

- [in] handle: Handle to server returned by `httpd_start`
- [in] sockfd: The socket descriptor for which the context should be extracted.
- [in] ctx: Transport context object to assign to the session
- [in] free_fn: Function that should be called to free the transport context

void **httpd_get_global_user_ctx** (*httpd_handle_t* handle)
Get HTTPD global user context (it was set in the server config struct)

Return global user context

Parameters

- [in] handle: Handle to server returned by `httpd_start`

void **httpd_get_global_transport_ctx** (*httpd_handle_t* handle)
Get HTTPD global transport context (it was set in the server config struct)

Return global transport context

Parameters

- [in] handle: Handle to server returned by `httpd_start`

esp_err_t **httpd_sess_trigger_close** (*httpd_handle_t* handle, int sockfd)
Trigger an httpd session close externally.

Note Calling this API is only required in special circumstances wherein some application requires to close an httpd client session asynchronously.

Return

- ESP_OK : On successfully initiating closure
- ESP_FAIL : Failure to queue work
- ESP_ERR_NOT_FOUND : Socket fd not found
- ESP_ERR_INVALID_ARG : Null arguments

Parameters

- [in] handle: Handle to server returned by `httpd_start`
- [in] sockfd: The socket descriptor of the session to be closed

esp_err_t **httpd_sess_update_lru_counter** (*httpd_handle_t* handle, int sockfd)
Update LRU counter for a given socket.

LRU Counters are internally associated with each session to monitor how recently a session exchanged traffic. When LRU purge is enabled, if a client is requesting for connection but maximum number of sockets/sessions is reached, then the session having the earliest LRU counter is closed automatically.

Updating the LRU counter manually prevents the socket from being purged due to the Least Recently Used (LRU) logic, even though it might not have received traffic for some time. This is useful when all open sockets/session are frequently exchanging traffic but the user specifically wants one of the sessions to be kept open, irrespective of when it last exchanged a packet.

Note Calling this API is only necessary if the LRU Purge Enable option is enabled.

Return

- ESP_OK : Socket found and LRU counter updated
- ESP_ERR_NOT_FOUND : Socket not found
- ESP_ERR_INVALID_ARG : Null arguments

Parameters

- [in] handle: Handle to server returned by `httpd_start`
- [in] sockfd: The socket descriptor of the session for which LRU counter is to be updated

esp_err_t **httpd_get_client_list** (*httpd_handle_t* handle, size_t *fds, int *client_fds)

Returns list of current socket descriptors of active sessions.

Return

- ESP_OK : Successfully retrieved session list
- ESP_ERR_INVALID_ARG : Wrong arguments or list is longer than allocated

Parameters

- [in] handle: Handle to server returned by `httpd_start`
- [inout] fds: In: Number of fds allocated in the supplied structure client_fds Out: Number of valid client fds returned in client_fds,
- [out] client_fds: Array of client fds

Structures**struct httpd_config**

HTTP Server Configuration Structure.

Note Use `HTTPD_DEFAULT_CONFIG()` to initialize the configuration to a default value and then modify only those fields that are specifically determined by the use case.

Public Members

unsigned **task_priority**

Priority of FreeRTOS task which runs the server

size_t **stack_size**

The maximum stack size allowed for the server task

BaseType_t **core_id**

The core the HTTP server task will run on

uint16_t **server_port**

TCP Port number for receiving and transmitting HTTP traffic

uint16_t **ctrl_port**

UDP Port number for asynchronously exchanging control signals between various components of the server

uint16_t **max_open_sockets**

Max number of sockets/clients connected at any time

uint16_t **max_uri_handlers**

Maximum allowed uri handlers

uint16_t **max_resp_headers**

Maximum allowed additional headers in HTTP response

uint16_t **backlog_conn**

Number of backlog connections

bool **lru_purge_enable**

Purge “Least Recently Used” connection

uint16_t **recv_wait_timeout**

Timeout for recv function (in seconds)

`uint16_t send_wait_timeout`

Timeout for send function (in seconds)

`void *global_user_ctx`

Global user context.

This field can be used to store arbitrary user data within the server context. The value can be retrieved using the server handle, available e.g. in the `httpd_req_t` struct.

When shutting down, the server frees up the user context by calling `free()` on the `global_user_ctx` field. If you wish to use a custom function for freeing the global user context, please specify that here.

[*httpd_free_ctx_fn_t*](#) `global_user_ctx_free_fn`

Free function for global user context

`void *global_transport_ctx`

Global transport context.

Similar to `global_user_ctx`, but used for session encoding or encryption (e.g. to hold the SSL context). It will be freed using `free()`, unless `global_transport_ctx_free_fn` is specified.

[*httpd_free_ctx_fn_t*](#) `global_transport_ctx_free_fn`

Free function for global transport context

[*httpd_open_func_t*](#) `open_fn`

Custom session opening callback.

Called on a new session socket just after `accept()`, but before reading any data.

This is an opportunity to set up e.g. SSL encryption using `global_transport_ctx` and the `send/recv/pending` session overrides.

If a context needs to be maintained between these functions, store it in the session using `httpd_sess_set_transport_ctx()` and retrieve it later with `httpd_sess_get_transport_ctx()`

Returning a value other than `ESP_OK` will immediately close the new socket.

[*httpd_close_func_t*](#) `close_fn`

Custom session closing callback.

Called when a session is deleted, before freeing user and transport contexts and before closing the socket. This is a place for custom de-init code common to all sockets.

Set the user or transport context to `NULL` if it was freed here, so the server does not try to free it again.

This function is run for all terminated sessions, including sessions where the socket was closed by the network stack - that is, the file descriptor may not be valid anymore.

[*httpd_uri_match_func_t*](#) `uri_match_fn`

URI matcher function.

Called when searching for a matching URI: 1) whose request handler is to be executed right after an HTTP request is successfully parsed 2) in order to prevent duplication while registering a new URI handler using `httpd_register_uri_handler()`

Available options are: 1) `NULL` : Internally do basic matching using `strcmp()` 2) `httpd_uri_match_wildcard()` : URI wildcard matcher

Users can implement their own matching functions (See description of the `httpd_uri_match_func_t` function prototype)

struct httpd_req

HTTP Request Data Structure.

Public Members

[*httpd_handle_t*](#) `handle`

Handle to server instance

int method

The type of HTTP request, -1 if unsupported method

const char uri[HTTPD_MAX_URI_LEN + 1]

The URI of this request (1 byte extra for null termination)

size_t content_len

Length of the request body

void *aux

Internally used members

void *user_ctx

User context pointer passed during URI registration.

void *sess_ctx

Session Context Pointer

A session context. Contexts are maintained across ‘sessions’ for a given open TCP connection. One session could have multiple request responses. The web server will ensure that the context persists across all these request and responses.

By default, this is NULL. URI Handlers can set this to any meaningful value.

If the underlying socket gets closed, and this pointer is non-NULL, the web server will free up the context by calling free(), unless free_ctx function is set.

***httpd_free_ctx_fn_t* free_ctx**

Pointer to free context hook

Function to free session context

If the web server’s socket closes, it frees up the session context by calling free() on the sess_ctx member. If you wish to use a custom function for freeing the session context, please specify that here.

bool ignore_sess_ctx_changes

Flag indicating if Session Context changes should be ignored

By default, if you change the sess_ctx in some URI handler, the http server will internally free the earlier context (if non NULL), after the URI handler returns. If you want to manage the allocation/reallocation/freeing of sess_ctx yourself, set this flag to true, so that the server will not perform any checks on it. The context will be cleared by the server (by calling free_ctx or free()) only if the socket gets closed.

struct httpd_uri

Structure for URI handler.

Public Members

const char *uri

The URI to handle

***httpd_method_t* method**

Method supported by the URI

***esp_err_t* (*handler) (*httpd_req_t* *r)**

Handler to call for supported request method. This must return ESP_OK, or else the underlying socket will be closed.

void *user_ctx

Pointer to user context data which will be available to handler

Macros

HTTPD_MAX_REQ_HDR_LEN

HTTPD_MAX_URI_LEN

HTTPD SOCK_ERR_FAIL

HTTPD SOCK_ERR_INVALID

HTTPD SOCK_ERR_TIMEOUT

HTTPD_200

HTTP Response 200

HTTPD_204

HTTP Response 204

HTTPD_207

HTTP Response 207

HTTPD_400

HTTP Response 400

HTTPD_404

HTTP Response 404

HTTPD_408

HTTP Response 408

HTTPD_500

HTTP Response 500

HTTPD_TYPE_JSON

HTTP Content type JSON

HTTPD_TYPE_TEXT

HTTP Content type text/HTML

HTTPD_TYPE_OCTET

HTTP Content type octext-stream

HTTPD_DEFAULT_CONFIG ()

ESP_ERR_HTTPD_BASE

Starting number of HTTPD error codes

ESP_ERR_HTTPD_HANDLERS_FULL

All slots for registering URI handlers have been consumed

ESP_ERR_HTTPD_HANDLER_EXISTS

URI handler with same method and target URI already registered

ESP_ERR_HTTPD_INVALID_REQ

Invalid request pointer

ESP_ERR_HTTPD_RESULT_TRUNC

Result string truncated

ESP_ERR_HTTPD_RESP_HDR

Response header field larger than supported

ESP_ERR_HTTPD_RESP_SEND

Error occurred while sending response packet

ESP_ERR_HTTPD_ALLOC_MEM

Failed to dynamically allocate memory for resource

ESP_ERR_HTTPD_TASK

Failed to launch server task/thread

HTTPD_RESP_USE_STRLEN

Type Definitions

typedef struct *httpd_req* httpd_req_t

HTTP Request Data Structure.

typedef struct *httpd_uri* httpd_uri_t

Structure for URI handler.

typedef int (*httpd_send_func_t) (*httpd_handle_t* hd, int sockfd, const char *buf, size_t buf_len, int flags)

Prototype for HTTPDs low-level send function.

Note User specified send function must handle errors internally, depending upon the set value of `errno`, and return specific `HTTPD_SOCKET_ERR_` codes, which will eventually be conveyed as return value of `httpd_send()` function

Return

- Bytes : The number of bytes sent successfully
- `HTTPD_SOCKET_ERR_INVALID` : Invalid arguments
- `HTTPD_SOCKET_ERR_TIMEOUT` : Timeout/interrupted while calling socket `send()`
- `HTTPD_SOCKET_ERR_FAIL` : Unrecoverable error while calling socket `send()`

Parameters

- [in] `hd`: server instance
- [in] `sockfd`: session socket file descriptor
- [in] `buf`: buffer with bytes to send
- [in] `buf_len`: data size
- [in] `flags`: flags for the `send()` function

typedef int (*httpd_recv_func_t) (*httpd_handle_t* hd, int sockfd, char *buf, size_t buf_len, int flags)

Prototype for HTTPDs low-level recv function.

Note User specified recv function must handle errors internally, depending upon the set value of `errno`, and return specific `HTTPD_SOCKET_ERR_` codes, which will eventually be conveyed as return value of `httpd_req_recv()` function

Return

- Bytes : The number of bytes received successfully
- 0 : Buffer length parameter is zero / connection closed by peer
- `HTTPD_SOCKET_ERR_INVALID` : Invalid arguments
- `HTTPD_SOCKET_ERR_TIMEOUT` : Timeout/interrupted while calling socket `recv()`
- `HTTPD_SOCKET_ERR_FAIL` : Unrecoverable error while calling socket `recv()`

Parameters

- [in] `hd`: server instance
- [in] `sockfd`: session socket file descriptor
- [in] `buf`: buffer with bytes to send
- [in] `buf_len`: data size
- [in] `flags`: flags for the `send()` function

typedef int (*httpd_pending_func_t) (*httpd_handle_t* hd, int sockfd)

Prototype for HTTPDs low-level “get pending bytes” function.

Note User specified pending function must handle errors internally, depending upon the set value of `errno`, and return specific `HTTPD_SOCKET_ERR_` codes, which will be handled accordingly in the server task.

Return

- Bytes : The number of bytes waiting to be received
- `HTTPD_SOCKET_ERR_INVALID` : Invalid arguments
- `HTTPD_SOCKET_ERR_TIMEOUT` : Timeout/interrupted while calling socket `pending()`
- `HTTPD_SOCKET_ERR_FAIL` : Unrecoverable error while calling socket `pending()`

Parameters

- [in] `hd`: server instance
- [in] `sockfd`: session socket file descriptor

typedef *esp_err_t* (*httpd_err_handler_func_t) (*httpd_req_t* *req, *httpd_err_code_t* error)

Function prototype for HTTP error handling.

This function is executed upon HTTP errors generated during internal processing of an HTTP request. This is used to override the default behavior on error, which is to send HTTP error response and close the underlying socket.

Note

- If implemented, the server will not automatically send out HTTP error response codes, therefore, `httpd_resp_send_err()` must be invoked inside this function if user wishes to generate HTTP error responses.
- When invoked, the validity of `uri`, `method`, `content_len` and `user_ctx` fields of the `httpd_req_t` parameter is not guaranteed as the HTTP request may be partially received/parsed.
- The function must return `ESP_OK` if underlying socket needs to be kept open. Any other value will ensure that the socket is closed. The return value is ignored when error is of type `HTTPD_500_INTERNAL_SERVER_ERROR` and the socket closed anyway.

Return

- `ESP_OK` : error handled successful
- `ESP_FAIL` : failure indicates that the underlying socket needs to be closed

Parameters

- `[in]` `req`: HTTP request for which the error needs to be handled
- `[in]` `error`: Error type

```
typedef void *httpd_handle_t  
HTTP Server Instance Handle.
```

Every instance of the server will have a unique handle.

```
typedef enum http_method httpd_method_t  
HTTP Method Type wrapper over “enum http_method” available in “http_parser” library.
```

```
typedef void (*httpd_free_ctx_fn_t) (void *ctx)  
Prototype for freeing context data (if any)
```

Parameters

- `[in]` `ctx`: object to free

```
typedef esp_err_t (*httpd_open_func_t) (httpd_handle_t hd, int sockfd)  
Function prototype for opening a session.
```

Called immediately after the socket was opened to set up the send/rcv functions and other parameters of the socket.

Return

- `ESP_OK` : On success
- Any value other than `ESP_OK` will signal the server to close the socket immediately

Parameters

- `[in]` `hd`: server instance
- `[in]` `sockfd`: session socket file descriptor

```
typedef void (*httpd_close_func_t) (httpd_handle_t hd, int sockfd)  
Function prototype for closing a session.
```

Note It's possible that the socket descriptor is invalid at this point, the function is called for all terminated sessions. Ensure proper handling of return codes.

Parameters

- `[in]` `hd`: server instance
- `[in]` `sockfd`: session socket file descriptor

```
typedef bool (*httpd_uri_match_func_t) (const char *reference_uri, const char  
*uri_to_match, size_t match_upto)
```

Function prototype for URI matching.

Return true on match

Parameters

- `[in]` `reference_uri`: URI/template with respect to which the other URI is matched
- `[in]` `uri_to_match`: URI/template being matched to the reference URI/template

- [in] `match_upto`: For specifying the actual length of `uri_to_match` up to which the matching algorithm is to be applied (The maximum value is `strlen(uri_to_match)`, independent of the length of `reference_uri`)

typedef struct *httpd_config* httpd_config_t

HTTP Server Configuration Structure.

Note Use `HTTPD_DEFAULT_CONFIG()` to initialize the configuration to a default value and then modify only those fields that are specifically determined by the use case.

typedef void (*httpd_work_fn_t) (void *arg)

Prototype of the HTTPD work function Please refer to `httpd_queue_work()` for more details.

Parameters

- [in] `arg`: The arguments for this work function

Enumerations

enum httpd_err_code_t

Error codes sent as HTTP response in case of errors encountered during processing of an HTTP request.

Values:

`HTTPD_500_INTERNAL_SERVER_ERROR = 0`

`HTTPD_501_METHOD_NOT_IMPLEMENTED`

`HTTPD_505_VERSION_NOT_SUPPORTED`

`HTTPD_400_BAD_REQUEST`

`HTTPD_401_UNAUTHORIZED`

`HTTPD_403_FORBIDDEN`

`HTTPD_404_NOT_FOUND`

`HTTPD_405_METHOD_NOT_ALLOWED`

`HTTPD_408_REQ_TIMEOUT`

`HTTPD_411_LENGTH_REQUIRED`

`HTTPD_414_URI_TOO_LONG`

`HTTPD_431_REQ_HDR_FIELDS_TOO_LARGE`

`HTTPD_ERR_CODE_MAX`

2.4.6 HTTPS server

Overview

This component is built on top of `esp_http_server`. The HTTPS server takes advantage of hooks and function overrides in the regular HTTP server to provide encryption using OpenSSL.

All documentation for `esp_http_server` applies also to a server you create this way.

Used APIs

The following API of `esp_http_server` should not be used with `esp_https_server`, as they are used internally to handle secure sessions and to maintain internal state:

- “send”, “receive” and “pending” function overrides - secure socket handling
 - `httpd_sess_set_send_override()`
 - `httpd_sess_set_rcv_override()`
 - `httpd_sess_set_pending_override()`

- “transport context” - both global and session
 - `httpd_sess_get_transport_ctx()` - returns SSL used for the session
 - `httpd_sess_set_transport_ctx()`
 - `httpd_get_global_transport_ctx()` - returns the shared SSL context
 - `httpd_config_t.global_transport_ctx`
 - `httpd_config_t.global_transport_ctx_free_fn`
 - `httpd_config_t.open_fn` - used to set up secure sockets

Everything else can be used without limitations.

Usage

Please see the example [protocols/https_server](#) to learn how to set up a secure server.

Basically all you need is to generate a certificate, embed it in the firmware, and provide its pointers and lengths to the start function via the init struct.

The server can be started with or without SSL by changing a flag in the init struct - `httpd_ssl_config.transport_mode`. This could be used e.g. for testing or in trusted environments where you prefer speed over security.

Performance

The initial session setup can take about two seconds, or more with slower clock speeds or more verbose logging. Subsequent requests through the open secure socket are much faster (down to under 100 ms).

API Reference

Header File

- [esp_https_server/include/esp_https_server.h](#)

Functions

`esp_err_t httpd_ssl_start(http_handle_t *handle, httpd_ssl_config_t *config)`

Create a SSL capable HTTP server (secure mode may be disabled in config)

Return success

Parameters

- [inout] `config`: - server config, must not be const. Does not have to stay valid after calling this function.
- [out] `handle`: - storage for the server handle, must be a valid pointer

`void httpd_ssl_stop(http_handle_t handle)`

Stop the server. Blocks until the server is shut down.

Parameters

- [in] `handle`:

Structures

`struct httpd_ssl_config`

HTTPS server config struct

Please use `HTTPD_SSL_CONFIG_DEFAULT()` to initialize it.

Public Members

httpd_config_t **httpd**

Underlying HTTPD server config

Parameters like task stack size and priority can be adjusted here.

const uint8_t ***cacert_pem**

CA certificate (here it is treated as server cert) Todo: Fix this change in release/v5.0 as it would be a breaking change i.e. Rename the nomenclature of variables holding different certs in https_server component as well as example 1)The cacert variable should hold the CA which is used to authenticate clients (should inherit current role of client_verify_cert_pem var) 2)There should be another variable servercert which would hold servers own certificate (should inherit current role of cacert var)

size_t **cacert_len**

CA certificate byte length

const uint8_t ***client_verify_cert_pem**

Client verify authority certificate (CA used to sign clients, or client cert itself

size_t **client_verify_cert_len**

Client verify authority cert len

const uint8_t ***prvtkey_pem**

Private key

size_t **prvtkey_len**

Private key byte length

httpd_ssl_transport_mode_t **transport_mode**

Transport Mode (default secure)

uint16_t **port_secure**

Port used when transport mode is secure (default 443)

uint16_t **port_insecure**

Port used when transport mode is insecure (default 80)

Macros

HTTPD_SSL_CONFIG_DEFAULT ()

Default config struct init

(http_server default config had to be copied for customization)

Notes:

- port is set when starting the server, according to 'transport_mode'
- one socket uses ~ 40kB RAM with SSL, we reduce the default socket count to 4
- SSL sockets are usually long-lived, closing LRU prevents pool exhaustion DOS
- Stack size may need adjustments depending on the user application

Type Definitions

```
typedef struct httpd_ssl_config httpd_ssl_config_t
```

Enumerations

```
enum httpd_ssl_transport_mode_t
```

Values:

```
HTTPD_SSL_TRANSPORT_SECURE
```

```
HTTPD_SSL_TRANSPORT_INSECURE
```

2.4.7 ICMP Echo

Overview

ICMP (Internet Control Message Protocol) is used for diagnostic or control purposes or generated in response to errors in IP operations. The common network util `ping` is implemented based on the ICMP packets with the type field value of 0, also called Echo Reply.

During a ping session, the source host firstly sends out an ICMP echo request packet and wait for an ICMP echo reply with specific times. In this way, it also measures the round-trip time for the messages. After receiving a valid ICMP echo reply, the source host will generate statistics about the IP link layer (e.g. packet loss, elapsed time, etc).

It is common that IoT device needs to check whether a remote server is alive or not. The device should show the warnings to users when it got offline. It can be achieved by creating a ping session and sending/parsing ICMP echo packets periodically.

To make this internal procedure much easier for users, ESP-IDF provides some out-of-box APIs.

Create a new ping session To create a ping session, you need to fill in the `esp_ping_config_t` configuration structure firstly, specifying target IP address, interval times, and etc. Optionally, you can also register some callback functions with the `esp_ping_callbacks_t` structure.

Example method to create a new ping session and register callbacks:

```
static void test_on_ping_success(esp_ping_handle_t hdl, void *args)
{
    // optionally, get callback arguments
    // const char* str = (const char*) args;
    // printf("%s\r\n", str); // "foo"
    uint8_t ttl;
    uint16_t seqno;
    uint32_t elapsed_time, recv_len;
    ip_addr_t target_addr;
    esp_ping_get_profile(hdl, ESP_PING_PROF_SEQNO, &seqno, sizeof(seqno));
    esp_ping_get_profile(hdl, ESP_PING_PROF_TTL, &ttl, sizeof(ttl));
    esp_ping_get_profile(hdl, ESP_PING_PROF_IPADDR, &target_addr, sizeof(target_
↪addr));
    esp_ping_get_profile(hdl, ESP_PING_PROF_SIZE, &recv_len, sizeof(recv_len));
    esp_ping_get_profile(hdl, ESP_PING_PROF_TIMEGAP, &elapsed_time, sizeof(elapsed_
↪time));
    printf("%d bytes from %s icmp_seq=%d ttl=%d time=%d ms\n",
           recv_len, inet_ntoa(target_addr.u_addr.ip4), seqno, ttl, elapsed_time);
}

static void test_on_ping_timeout(esp_ping_handle_t hdl, void *args)
{
    uint16_t seqno;
    ip_addr_t target_addr;
    esp_ping_get_profile(hdl, ESP_PING_PROF_SEQNO, &seqno, sizeof(seqno));
    esp_ping_get_profile(hdl, ESP_PING_PROF_IPADDR, &target_addr, sizeof(target_
↪addr));
    printf("From %s icmp_seq=%d timeout\n", inet_ntoa(target_addr.u_addr.ip4), ↪
↪seqno);
}

static void test_on_ping_end(esp_ping_handle_t hdl, void *args)
{
    uint32_t transmitted;
    uint32_t received;
    uint32_t total_time_ms;

    esp_ping_get_profile(hdl, ESP_PING_PROF_REQUEST, &transmitted, ↪
↪sizeof(transmitted));
```

(continues on next page)

(continued from previous page)

```

    esp_ping_get_profile(hdl, ESP_PING_PROF_REPLY, &received, sizeof(received));
    esp_ping_get_profile(hdl, ESP_PING_PROF_DURATION, &total_time_ms, sizeof(total_
↪time_ms));
    printf("%d packets transmitted, %d received, time %dms\n", transmitted,
↪received, total_time_ms);
}

void initialize_ping()
{
    /* convert URL to IP address */
    ip_addr_t target_addr;
    struct addrinfo hint;
    struct addrinfo *res = NULL;
    memset(&hint, 0, sizeof(hint));
    memset(&target_addr, 0, sizeof(target_addr));
    getaddrinfo("www.espressif.com", NULL, &hint, &res);
    struct in_addr addr4 = ((struct sockaddr_in *) (res->ai_addr))->sin_addr;
    inet_addr_to_ip4addr(ip_2_ip4(&target_addr), &addr4);
    freeaddrinfo(res);

    esp_ping_config_t ping_config = ESP_PING_DEFAULT_CONFIG();
    ping_config.target_addr = target_addr;           // target IP address
    ping_config.count = ESP_PING_COUNT_INFINITE;    // ping in infinite mode, esp_
↪ping_stop can stop it

    /* set callback functions */
    esp_ping_callbacks_t cbs;
    cbs.on_ping_success = test_on_ping_success;
    cbs.on_ping_timeout = test_on_ping_timeout;
    cbs.on_ping_end = test_on_ping_end;
    cbs.cb_args = "foo"; // arguments that will feed to all callback functions,
↪can be NULL
    cbs.cb_args = eth_event_group;

    esp_ping_handle_t ping;
    esp_ping_new_session(&ping_config, &cbs, &ping);
}

```

Start and Stop ping session You can start and stop ping session with the handle returned by `esp_ping_new_session`. Note that, the ping session won't start automatically after creation. If the ping session is stopped, and restart again, the sequence number in ICMP packets will recount from zero again.

Delete a ping session If a ping session won't be used any more, you can delete it with `esp_ping_delete_session`. Please make sure the ping session is in stop state (i.e. you have called `esp_ping_stop` before or the ping session has finished all the procedures) when you call this function.

Get runtime statistics As the example code above, you can call `esp_ping_get_profile` to get different runtime statistics of ping session in the callback function.

Application Example

ICMP echo example: [protocols/icmp_echo](#)

API Reference

Header File

- [lwip/include/apps/ping/ping_sock.h](#)

Functions

esp_err_t **esp_ping_new_session**(**const** *esp_ping_config_t* **config*, **const** *esp_ping_callbacks_t* **cbs*, *esp_ping_handle_t* **hdl_out*)

Create a ping session.

Return

- ESP_ERR_INVALID_ARG: invalid parameters (e.g. configuration is null, etc)
- ESP_ERR_NO_MEM: out of memory
- ESP_FAIL: other internal error (e.g. socket error)
- ESP_OK: create ping session successfully, user can take the ping handle to do follow-on jobs

Parameters

- *config*: ping configuration
- *cbs*: a bunch of callback functions invoked by internal ping task
- *hdl_out*: handle of ping session

esp_err_t **esp_ping_delete_session**(*esp_ping_handle_t* *hdl*)

Delete a ping session.

Return

- ESP_ERR_INVALID_ARG: invalid parameters (e.g. ping handle is null, etc)
- ESP_OK: delete ping session successfully

Parameters

- *hdl*: handle of ping session

esp_err_t **esp_ping_start**(*esp_ping_handle_t* *hdl*)

Start the ping session.

Return

- ESP_ERR_INVALID_ARG: invalid parameters (e.g. ping handle is null, etc)
- ESP_OK: start ping session successfully

Parameters

- *hdl*: handle of ping session

esp_err_t **esp_ping_stop**(*esp_ping_handle_t* *hdl*)

Stop the ping session.

Return

- ESP_ERR_INVALID_ARG: invalid parameters (e.g. ping handle is null, etc)
- ESP_OK: stop ping session successfully

Parameters

- *hdl*: handle of ping session

esp_err_t **esp_ping_get_profile**(*esp_ping_handle_t* *hdl*, *esp_ping_profile_t* *profile*, void **data*, uint32_t *size*)

Get runtime profile of ping session.

Return

- ESP_ERR_INVALID_ARG: invalid parameters (e.g. ping handle is null, etc)
- ESP_ERR_INVALID_SIZE: the actual profile data size doesn't match the "size" parameter
- ESP_OK: get profile successfully

Parameters

- *hdl*: handle of ping session
- *profile*: type of profile
- *data*: profile data
- *size*: profile data size

Structures

struct esp_ping_callbacks_t

Type of "ping" callback functions.

Public Members

void ***cb_args**

arguments for callback functions

void (***on_ping_success**) (*esp_ping_handle_t* hdl, void *args)

Invoked by internal ping thread when received ICMP echo reply packet.

void (***on_ping_timeout**) (*esp_ping_handle_t* hdl, void *args)

Invoked by internal ping thread when receive ICMP echo reply packet timeout.

void (***on_ping_end**) (*esp_ping_handle_t* hdl, void *args)

Invoked by internal ping thread when a ping session is finished.

struct esp_ping_config_t

Type of “ping” configuration.

Public Members

uint32_t **count**

A “ping” session contains count procedures

uint32_t **interval_ms**

Milliseconds between each ping procedure

uint32_t **timeout_ms**

Timeout value (in milliseconds) of each ping procedure

uint32_t **data_size**

Size of the data next to ICMP packet header

int **tos**

Type of Service, a field specified in the IP header

int **ttl**

Time to Live, a field specified in the IP header

ip_addr_t **target_addr**

Target IP address, either IPv4 or IPv6

uint32_t **task_stack_size**

Stack size of internal ping task

uint32_t **task_prio**

Priority of internal ping task

uint32_t **interface**

Netif index, interface=0 means NETIF_NO_INDEX

Macros

ESP_PING_DEFAULT_CONFIG ()

Default ping configuration.

ESP_PING_COUNT_INFINITE

Set ping count to zero will ping target infinitely

Type Definitions

typedef void ***esp_ping_handle_t**

Type of “ping” session handle.

Enumerations**enum esp_ping_profile_t**

Profile of ping session.

*Values:***ESP_PING_PROF_SEQNO**

Sequence number of a ping procedure

ESP_PING_PROF_TOS

Type of service of a ping procedure

ESP_PING_PROF_TTL

Time to live of a ping procedure

ESP_PING_PROF_REQUEST

Number of request packets sent out

ESP_PING_PROF_REPLY

Number of reply packets received

ESP_PING_PROF_IPADDR

IP address of replied target

ESP_PING_PROF_SIZE

Size of received packet

ESP_PING_PROF_TIMEGAP

Elapsed time between request and reply packet

ESP_PING_PROF_DURATION

Elapsed time of the whole ping session

2.4.8 ESP Local Control**Overview**

ESP Local Control (**esp_local_ctrl**) component in ESP-IDF provides capability to control an ESP device over Wi-Fi + HTTPS or BLE. It provides access to application defined **properties** that are available for reading / writing via a set of configurable handlers.

Initialization of the **esp_local_ctrl** service over BLE transport is performed as follows:

```

esp_local_ctrl_config_t config = {
    .transport = ESP_LOCAL_CTRL_TRANSPORT_BLE,
    .transport_config = {
        .ble = &(protocomm_ble_config_t) {
            .device_name = SERVICE_NAME,
            .service_uuid = {
                /* LSB <-----
                * -----> MSB */
                0x21, 0xd5, 0x3b, 0x8d, 0xbd, 0x75, 0x68, 0x8a,
                0xb4, 0x42, 0xeb, 0x31, 0x4a, 0x1e, 0x98, 0x3d
            }
        }
    },
    .proto_sec = {
        .version = PROTOCOM_SEC0,
        .custom_handle = NULL,
        .pop = NULL,
    },
    .handlers = {
        /* User defined handler functions */
        .get_prop_values = get_property_values,
    }
};

```

(continues on next page)

(continued from previous page)

```

        .set_prop_values = set_property_values,
        .usr_ctx         = NULL,
        .usr_ctx_free_fn = NULL
    },
    /* Maximum number of properties that may be set */
    .max_properties = 10
};

/* Start esp_local_ctrl service */
ESP_ERROR_CHECK(esp_local_ctrl_start(&config));

```

Similarly for HTTPS transport:

```

/* Set the configuration */
httpd_ssl_config_t https_conf = HTTPD_SSL_CONFIG_DEFAULT();

/* Load server certificate */
extern const unsigned char cacert_pem_start[] asm("_binary_cacert_pem_
↪start");
extern const unsigned char cacert_pem_end[]   asm("_binary_cacert_pem_end
↪");
https_conf.cacert_pem = cacert_pem_start;
https_conf.cacert_len = cacert_pem_end - cacert_pem_start;

/* Load server private key */
extern const unsigned char prvtkey_pem_start[] asm("_binary_prvtkey_pem_
↪start");
extern const unsigned char prvtkey_pem_end[]   asm("_binary_prvtkey_pem_
↪end");
https_conf.prvtkey_pem = prvtkey_pem_start;
https_conf.prvtkey_len = prvtkey_pem_end - prvtkey_pem_start;

esp_local_ctrl_config_t config = {
    .transport = ESP_LOCAL_CTRL_TRANSPORT_HTTPD,
    .transport_config = {
        .httpd = &https_conf
    },
    .proto_sec = {
        .version = PROTOCOM_SEC0,
        .custom_handle = NULL,
        .pop = NULL,
    },
    .handlers = {
        /* User defined handler functions */
        .get_prop_values = get_property_values,
        .set_prop_values = set_property_values,
        .usr_ctx         = NULL,
        .usr_ctx_free_fn = NULL
    },
    /* Maximum number of properties that may be set */
    .max_properties = 10
};

/* Start esp_local_ctrl service */
ESP_ERROR_CHECK(esp_local_ctrl_start(&config));

```

You may set security for transport in ESP local control using following options:

1. *PROTOCOM_SEC1*: specifies that end to end encryption is used.
2. *PROTOCOM_SEC0*: specifies that data will be exchanged as a plain text.
3. *PROTOCOM_SEC_CUSTOM*: you can define your own security requirement. Please note that you will also have to provide *custom_handle* of type *protocomm_security_t ** in this context.

Creating a property

Now that we know how to start the `esp_local_ctrl` service, let's add a property to it. Each property must have a unique *name* (string), a *type* (e.g. enum), *flags* (bit fields) and *size*.

The *size* is to be kept 0, if we want our property value to be of variable length (e.g. if its a string or bytestream). For fixed length property value data-types, like int, float, etc., setting the *size* field to the right value, helps `esp_local_ctrl` to perform internal checks on arguments received with write requests.

The interpretation of *type* and *flags* fields is totally upto the application, hence they may be used as enumerations, bit-fields, or even simple integers. One way is to use *type* values to classify properties, while *flags* to specify characteristics of a property.

Here is an example property which is function as a timestamp. It is assumed that the application defines `TYPE_TIMESTAMP` and `READONLY`, which are used for setting the *type* and *flags* fields here.

```
/* Create a timestamp property */
esp_local_ctrl_prop_t timestamp = {
    .name      = "timestamp",
    .type      = TYPE_TIMESTAMP,
    .size      = sizeof(int32_t),
    .flags     = READONLY,
    .ctx       = func_get_time,
    .ctx_free_fn = NULL
};

/* Now register the property */
esp_local_ctrl_add_property(&timestamp);
```

Also notice that there is a `ctx` field, which is set to point to some custom `func_get_time()`. This can be used inside the property get / set handlers to retrieve timestamp.

Here is an example of `get_prop_values()` handler, which is used for retrieving the timestamp.

```
static esp_err_t get_property_values(size_t props_count,
                                     const esp_local_ctrl_prop_t *props,
                                     esp_local_ctrl_prop_val_t *prop_
                                     ↪values,
                                     void *usr_ctx)
{
    for (uint32_t i = 0; i < props_count; i++) {
        ESP_LOGI(TAG, "Reading %s", props[i].name);
        if (props[i].type == TYPE_TIMESTAMP) {
            /* Obtain the timer function from ctx */
            int32_t (*func_get_time)(void) = props[i].ctx;

            /* Use static variable for saving the value.
             * This is essential because the value has to be
             * valid even after this function returns.
             * Alternative is to use dynamic allocation
             * and set the free_fn field */
            static int32_t ts = func_get_time();
            prop_values[i].data = &ts;
        }
    }
    return ESP_OK;
}
```

Here is an example of `set_prop_values()` handler. Notice how we restrict from writing to read-only properties.

```
static esp_err_t set_property_values(size_t props_count,
                                     const esp_local_ctrl_prop_t *props,
                                     const esp_local_ctrl_prop_val_t_
                                     ↪*prop_values,
```

(continues on next page)

(continued from previous page)

```

                                void *usr_ctx)
{
    for (uint32_t i = 0; i < props_count; i++) {
        if (props[i].flags & READONLY) {
            ESP_LOGE(TAG, "Cannot write to read-only property %s",
↳props[i].name);
            return ESP_ERR_INVALID_ARG;
        } else {
            ESP_LOGI(TAG, "Setting %s", props[i].name);

            /* For keeping it simple, lets only log the incoming data */
            ESP_LOG_BUFFER_HEX_LEVEL(TAG, prop_values[i].data,
                                    prop_values[i].size, ESP_LOG_INFO);
        }
    }
    return ESP_OK;
}

```

For complete example see [protocols/esp_local_ctrl](#)

Client Side Implementation

The client side implementation will have establish a protocomm session with the device first, over the supported mode of transport, and then send and receive protobuf messages understood by the **esp_local_ctrl** service. The service will translate these messages into requests and then call the appropriate handlers (set / get). Then, the generated response for each handler is again packed into a protobuf message and transmitted back to the client.

See below the various protobuf messages understood by the **esp_local_ctrl** service:

1. *get_prop_count* : This should simply return the total number of properties supported by the service
2. *get_prop_values* : This accepts an array of indices and should return the information (name, type, flags) and values of the properties corresponding to those indices
3. *set_prop_values* : This accepts an array of indices and an array of new values, which are used for setting the values of the properties corresponding to the indices

Note that indices may or may not be the same for a property, across multiple sessions. Therefore, the client must only use the names of the properties to uniquely identify them. So, every time a new session is established, the client should first call *get_prop_count* and then *get_prop_values*, hence form an index to name mapping for all properties. Now when calling *set_prop_values* for a set of properties, it must first convert the names to indexes, using the created mapping. As emphasized earlier, the client must refresh the index to name mapping every time a new session is established with the same device.

The various protocomm endpoints provided by **esp_local_ctrl** are listed below:

Table 5: Endpoints provided by ESP Local Control

Endpoint Name (BLE + GATT Server)	URI (HTTPS Server + mDNS)	Description
esp_local_ctrl/version	https://<hostname>.local/esp_local_ctrl/version	Endpoint used for retrieving version string
esp_local_ctrl/control	https://<hostname>.local/esp_local_ctrl/control	Endpoint used for sending / receiving control messages

API Reference

Header File

- [esp_local_ctrl/include/esp_local_ctrl.h](#)

Functions

const *esp_local_ctrl_transport_t* ***esp_local_ctrl_get_transport_ble** (void)

Function for obtaining BLE transport mode.

const *esp_local_ctrl_transport_t* ***esp_local_ctrl_get_transport_httpd** (void)

Function for obtaining HTTPD transport mode.

esp_err_t **esp_local_ctrl_start** (const *esp_local_ctrl_config_t* *config)

Start local control service.

Return

- ESP_OK : Success
- ESP_FAIL : Failure

Parameters

- [in] config: Pointer to configuration structure

esp_err_t **esp_local_ctrl_stop** (void)

Stop local control service.

esp_err_t **esp_local_ctrl_add_property** (const *esp_local_ctrl_prop_t* *prop)

Add a new property.

This adds a new property and allocates internal resources for it. The total number of properties that could be added is limited by configuration option `max_properties`

Return

- ESP_OK : Success
- ESP_FAIL : Failure

Parameters

- [in] prop: Property description structure

esp_err_t **esp_local_ctrl_remove_property** (const char *name)

Remove a property.

This finds a property by name, and releases the internal resources which are associated with it.

Return

- ESP_OK : Success
- ESP_ERR_NOT_FOUND : Failure

Parameters

- [in] name: Name of the property to remove

const *esp_local_ctrl_prop_t* ***esp_local_ctrl_get_property** (const char *name)

Get property description structure by name.

This API may be used to get a property's context structure `esp_local_ctrl_prop_t` when its name is known

Return

- Pointer to property
- NULL if not found

Parameters

- [in] name: Name of the property to find

esp_err_t **esp_local_ctrl_set_handler** (const char *ep_name, *protocomm_req_handler_t* handler, void *user_ctx)

Register protocomm handler for a custom endpoint.

This API can be called by the application to register a protocomm handler for an endpoint after the local control service has started.

Note In case of BLE transport the names and uuids of all custom endpoints must be provided beforehand as a part of the `protocomm_ble_config_t` structure set in `esp_local_ctrl_config_t`, and passed to `esp_local_ctrl_start()`.

Return

- ESP_OK : Success
- ESP_FAIL : Failure

Parameters

- [in] ep_name: Name of the endpoint
- [in] handler: Endpoint handler function
- [in] user_ctx: User data

Unions**union esp_local_ctrl_transport_config_t**

#include <esp_local_ctrl.h> Transport mode (BLE / HTTPD) configuration.

Public Members*esp_local_ctrl_transport_config_ble_t* *ble

This is same as `protocomm_ble_config_t`. See `protocomm_ble.h` for available configuration parameters.

esp_local_ctrl_transport_config_httpd_t *httpd

This is same as `httpd_ssl_config_t`. See `esp_https_server.h` for available configuration parameters.

Structures**struct esp_local_ctrl_prop**

Property description data structure, which is to be populated and passed to the `esp_local_ctrl_add_property()` function.

Once a property is added, its structure is available for read-only access inside `get_prop_values()` and `set_prop_values()` handlers.

Public Members

char *name

Unique name of property

uint32_t type

Type of property. This may be set to application defined enums

size_t size

Size of the property value, which:

- if zero, the property can have values of variable size
- if non-zero, the property can have values of fixed size only, therefore, checks are performed internally by `esp_local_ctrl` when setting the value of such a property

uint32_t flags

Flags set for this property. This could be a bit field. A flag may indicate property behavior, e.g. read-only / constant

void *ctx

Pointer to some context data relevant for this property. This will be available for use inside the `get_prop_values` and `set_prop_values` handlers as a part of this property structure. When set, this is valid throughout the lifetime of a property, till either the property is removed or the `esp_local_ctrl` service is stopped.

void (*ctx_free_fn) (void *ctx)

Function used by `esp_local_ctrl` to internally free the property context when `esp_local_ctrl_remove_property()` or `esp_local_ctrl_stop()` is called.

struct esp_local_ctrl_prop_val

Property value data structure. This gets passed to the `get_prop_values()` and `set_prop_values()` handlers for the purpose of retrieving or setting the present value of a property.

Public Members

void *data

Pointer to memory holding property value

size_t size

Size of property value

void (*free_fn)(void *data)

This may be set by the application in `get_prop_values()` handler to tell `esp_local_ctrl` to call this function on the data pointer above, for freeing its resources after sending the `get_prop_values` response.

struct esp_local_ctrl_handlers

Handlers for receiving and responding to local control commands for getting and setting properties.

Public Members

esp_err_t (***get_prop_values**)(size_t props_count, **const** *esp_local_ctrl_prop_t* props[],
esp_local_ctrl_prop_val_t prop_values[], void *usr_ctx)

Handler function to be implemented for retrieving current values of properties.

Note If any of the properties have fixed sizes, the size field of corresponding element in `prop_values` need to be set

Return Returning different error codes will convey the corresponding protocol level errors to the client :

- `ESP_OK` : Success
- `ESP_ERR_INVALID_ARG` : InvalidArgument
- `ESP_ERR_INVALID_STATE` : InvalidProto
- All other error codes : InternalError

Parameters

- [in] `props_count`: Total elements in the props array
- [in] `props`: Array of properties, the current values for which have been requested by the client
- [out] `prop_values`: Array of empty property values, the elements of which need to be populated with the current values of those properties specified by props argument
- [in] `usr_ctx`: This provides value of the `usr_ctx` field of `esp_local_ctrl_handlers_t` structure

esp_err_t (***set_prop_values**)(size_t props_count, **const** *esp_local_ctrl_prop_t* props[], **const**
esp_local_ctrl_prop_val_t prop_values[], void *usr_ctx)

Handler function to be implemented for changing values of properties.

Note If any of the properties have variable sizes, the size field of the corresponding element in `prop_values` must be checked explicitly before making any assumptions on the size.

Return Returning different error codes will convey the corresponding protocol level errors to the client :

- `ESP_OK` : Success
- `ESP_ERR_INVALID_ARG` : InvalidArgument
- `ESP_ERR_INVALID_STATE` : InvalidProto
- All other error codes : InternalError

Parameters

- [in] `props_count`: Total elements in the props array
- [in] `props`: Array of properties, the values for which the client requests to change
- [in] `prop_values`: Array of property values, the elements of which need to be used for updating those properties specified by props argument

- [in] `usr_ctx`: This provides value of the `usr_ctx` field of `esp_local_ctrl_handlers_t` structure

void ***usr_ctx**

Context pointer to be passed to above handler functions upon invocation. This is different from the property level context, as this is valid throughout the lifetime of the `esp_local_ctrl` service, and freed only when the service is stopped.

void (***usr_ctx_free_fn**) (void *usr_ctx)

Pointer to function which will be internally invoked on `usr_ctx` for freeing the context resources when `esp_local_ctrl_stop()` is called.

struct esp_local_ctrl_proto_sec_cfg

Protocom security configs

Public Members

esp_local_ctrl_proto_sec_t **version**

This sets protocom security version, `sec0/sec1` or custom. If custom, user must provide handle via `proto_sec_custom_handle` below

void ***custom_handle**

Custom security handle if security is set custom via `proto_sec` above. This handle must follow `protocomm_security_t` signature

void ***pop**

Proof of possession to be used for local control. Could be NULL.

struct esp_local_ctrl_config

Configuration structure to pass to `esp_local_ctrl_start()`

Public Members

const esp_local_ctrl_transport_t *transport

Transport layer over which service will be provided

esp_local_ctrl_transport_config_t **transport_config**

Transport layer over which service will be provided

esp_local_ctrl_proto_sec_cfg_t **proto_sec**

Security version and POP

esp_local_ctrl_handlers_t **handlers**

Register handlers for responding to get/set requests on properties

size_t **max_properties**

This limits the number of properties that are available at a time

Macros

ESP_LOCAL_CTRL_TRANSPORT_BLE

ESP_LOCAL_CTRL_TRANSPORT_HTTPD

Type Definitions

typedef struct esp_local_ctrl_prop esp_local_ctrl_prop_t

Property description data structure, which is to be populated and passed to the `esp_local_ctrl_add_property()` function.

Once a property is added, its structure is available for read-only access inside `get_prop_values()` and `set_prop_values()` handlers.

typedef struct *esp_local_ctrl_prop_val* esp_local_ctrl_prop_val_t
Property value data structure. This gets passed to the `get_prop_values()` and `set_prop_values()` handlers for the purpose of retrieving or setting the present value of a property.

typedef struct *esp_local_ctrl_handlers* esp_local_ctrl_handlers_t
Handlers for receiving and responding to local control commands for getting and setting properties.

typedef struct esp_local_ctrl_transport esp_local_ctrl_transport_t
Transport mode (BLE / HTTPD) over which the service will be provided.

This is forward declaration of a private structure, implemented internally by `esp_local_ctrl`.

typedef struct *protocomm_ble_config* esp_local_ctrl_transport_config_ble_t
Configuration for transport mode BLE.

This is a forward declaration for `protocomm_ble_config_t`. To use this, application must set `CONFIG_BT_BLUEDROID_ENABLED` and include `protocomm_ble.h`.

typedef struct *httpd_ssl_config* esp_local_ctrl_transport_config_httpd_t
Configuration for transport mode HTTPD.

This is a forward declaration for `httpd_ssl_config_t`. To use this, application must set `CONFIG_ESP_HTTPS_SERVER_ENABLE` and include `esp_https_server.h`.

typedef enum *esp_local_ctrl_proto_sec* esp_local_ctrl_proto_sec_t
Security types for `esp_local_control`.

typedef struct *esp_local_ctrl_proto_sec_cfg* esp_local_ctrl_proto_sec_cfg_t
Protocom security configs

typedef struct *esp_local_ctrl_config* esp_local_ctrl_config_t
Configuration structure to pass to `esp_local_ctrl_start()`

Enumerations

enum esp_local_ctrl_proto_sec
Security types for `esp_local_control`.

Values:

PROTCOM_SEC0 = 0

PROTCOM_SEC1

PROTCOM_SEC_CUSTOM

2.4.9 mDNS Service

Overview

mDNS is a multicast UDP service that is used to provide local network service and host discovery.

mDNS is installed by default on most operating systems or is available as separate package. On Mac OS it is installed by default and is called `Bonjour`. Apple releases an installer for Windows that can be found on [Apple's support page](#). On Linux, mDNS is provided by `avahi` and is usually installed by default.

mDNS Properties

- `hostname`: the hostname that the device will respond to. If not set, the `hostname` will be read from the interface. Example: `my-esp32c3` will resolve to `my-esp32c3.local`
- `default_instance`: friendly name for your device, like `Jhon's ESP32-C3 Thing`. If not set, `hostname` will be used.

Example method to start mDNS for the STA interface and set `hostname` and `default_instance`:

```

void start_mdns_service()
{
    //initialize mDNS service
    esp_err_t err = mdns_init();
    if (err) {
        printf("MDNS Init failed: %d\n", err);
        return;
    }

    //set hostname
    mdns_hostname_set("my-esp32c3");
    //set default instance
    mdns_instance_name_set("Jhon's ESP32-C3 Thing");
}

```

mDNS Services mDNS can advertise information about network services that your device offers. Each service is defined by a few properties.

- `instance_name`: friendly name for your service, like Jhon's EESP32-C3 Web Server. If not defined, `default_instance` will be used.
- `service_type`: (required) service type, prepended with underscore. Some common types can be found [here](#).
- `proto`: (required) protocol that the service runs on, prepended with underscore. Example: `_tcp` or `_udp`
- `port`: (required) network port that the service runs on
- `txt`: {var, val} array of strings, used to define properties for your service

Example method to add a few services and different properties:

```

void add_mdns_services()
{
    //add our services
    mdns_service_add(NULL, "_http", "_tcp", 80, NULL, 0);
    mdns_service_add(NULL, "_arduino", "_tcp", 3232, NULL, 0);
    mdns_service_add(NULL, "_myservice", "_udp", 1234, NULL, 0);

    //NOTE: services must be added before their properties can be set
    //use custom instance for the web server
    mdns_service_instance_name_set("_http", "_tcp", "Jhon's ESP32-C3 Web Server");

    mdns_txt_item_t serviceTxtData[3] = {
        {"board", "{esp32c3}"},
        {"u", "user"},
        {"p", "password"}
    };
    //set txt data for service (will free and replace current data)
    mdns_service_txt_set("_http", "_tcp", serviceTxtData, 3);

    //change service port
    mdns_service_port_set("_myservice", "_udp", 4321);
}

```

mDNS Query mDNS provides methods for browsing for services and resolving host's IP/IPv6 addresses.

Results for services are returned as a linked list of `mdns_result_t` objects.

Example method to resolve host IPs:

```

void resolve_mdns_host(const char * host_name)
{
    printf("Query A: %s.local", host_name);
}

```

(continues on next page)

(continued from previous page)

```

struct ip4_addr addr;
addr.addr = 0;

esp_err_t err = mdns_query_a(host_name, 2000, &addr);
if(err){
    if(err == ESP_ERR_NOT_FOUND){
        printf("Host was not found!");
        return;
    }
    printf("Query Failed");
    return;
}

printf(IPSTR, IP2STR(&addr));
}

```

Example method to resolve local services:

```

static const char * if_str[] = {"STA", "AP", "ETH", "MAX"};
static const char * ip_protocol_str[] = {"V4", "V6", "MAX"};

void mdns_print_results(mdns_result_t * results){
    mdns_result_t * r = results;
    mdns_ip_addr_t * a = NULL;
    int i = 1, t;
    while(r){
        printf("%d: Interface: %s, Type: %s\n", i++, if_str[r->tcpip_if], ip_
        ↪protocol_str[r->ip_protocol]);
        if(r->instance_name){
            printf(" PTR : %s\n", r->instance_name);
        }
        if(r->hostname){
            printf(" SRV : %s.local:%u\n", r->hostname, r->port);
        }
        if(r->txt_count){
            printf(" TXT : [%u] ", r->txt_count);
            for(t=0; t<r->txt_count; t++){
                printf("%s=%s; ", r->txt[t].key, r->txt[t].value);
            }
            printf("\n");
        }
        a = r->addr;
        while(a){
            if(a->addr.type == IPADDR_TYPE_V6){
                printf(" AAAA: " IPV6STR "\n", IPV62STR(a->addr.u_addr.ip6));
            } else {
                printf(" A : " IPSTR "\n", IP2STR(&(a->addr.u_addr.ip4)));
            }
            a = a->next;
        }
        r = r->next;
    }
}

void find_mdns_service(const char * service_name, const char * proto)
{
    ESP_LOGI(TAG, "Query PTR: %s.%s.local", service_name, proto);

    mdns_result_t * results = NULL;

```

(continues on next page)

(continued from previous page)

```

esp_err_t err = mdns_query_ptr(service_name, proto, 3000, 20, &results);
if(err){
    ESP_LOGE(TAG, "Query Failed");
    return;
}
if(!results){
    ESP_LOGW(TAG, "No results found!");
    return;
}

mdns_print_results(results);
mdns_query_results_free(results);
}

```

Example of using the methods above:

```

void my_app_some_method(){
    //search for esp32c3-mdns.local
    resolve_mdns_host("esp32c3-mdns");

    //search for HTTP servers
    find_mdns_service("_http", "_tcp");
    //or file servers
    find_mdns_service("_smb", "_tcp"); //windows sharing
    find_mdns_service("_afpovertcp", "_tcp"); //apple sharing
    find_mdns_service("_nfs", "_tcp"); //NFS server
    find_mdns_service("_ftp", "_tcp"); //FTP server
    //or networked printer
    find_mdns_service("_printer", "_tcp");
    find_mdns_service("_ipp", "_tcp");
}

```

Application Example

mDNS server/scanner example: [protocols/mdns](#).

API Reference

Header File

- [mdns/include/mdns.h](#)

Functions

esp_err_t **mdns_init** (void)

Initialize mDNS on given interface.

Return

- ESP_OK on success
- ESP_ERR_INVALID_STATE when failed to register event handler
- ESP_ERR_NO_MEM on memory error
- ESP_FAIL when failed to start mdns task

void **mdns_free** (void)

Stop and free mDNS server.

esp_err_t **mdns_hostname_set** (const char *hostname)

Set the hostname for mDNS server required if you want to advertise services.

Return

- ESP_OK success

- ESP_ERR_INVALID_ARG Parameter error
- ESP_ERR_NO_MEM memory error

Parameters

- `hostname`: Hostname to set

esp_err_t **mdns_instance_name_set** (**const** char **instance_name*)

Set the default instance name for mDNS server.

Return

- ESP_OK success
- ESP_ERR_INVALID_ARG Parameter error
- ESP_ERR_NO_MEM memory error

Parameters

- `instance_name`: Instance name to set

esp_err_t **mdns_service_add** (**const** char **instance_name*, **const** char **service_type*, **const** char **proto*, **uint16_t** *port*, *mdns_txt_item_t* *txt*[], **size_t** *num_items*)

Add service to mDNS server.

Return

- ESP_OK success
- ESP_ERR_INVALID_ARG Parameter error
- ESP_ERR_NO_MEM memory error
- ESP_FAIL failed to add service

Parameters

- `instance_name`: instance name to set. If NULL, global instance name or hostname will be used
- `service_type`: service type (`_http`, `_ftp`, etc)
- `proto`: service protocol (`_tcp`, `_udp`)
- `port`: service port
- `txt`: string array of TXT data (eg. {{ "var" ," val" },{ "other" ," 2" }})
- `num_items`: number of items in TXT data

esp_err_t **mdns_service_remove** (**const** char **service_type*, **const** char **proto*)

Remove service from mDNS server.

Return

- ESP_OK success
- ESP_ERR_INVALID_ARG Parameter error
- ESP_ERR_NOT_FOUND Service not found
- ESP_ERR_NO_MEM memory error

Parameters

- `service_type`: service type (`_http`, `_ftp`, etc)
- `proto`: service protocol (`_tcp`, `_udp`)

esp_err_t **mdns_service_instance_name_set** (**const** char **service_type*, **const** char **proto*, **const** char **instance_name*)

Set instance name for service.

Return

- ESP_OK success
- ESP_ERR_INVALID_ARG Parameter error
- ESP_ERR_NOT_FOUND Service not found
- ESP_ERR_NO_MEM memory error

Parameters

- `service_type`: service type (`_http`, `_ftp`, etc)
- `proto`: service protocol (`_tcp`, `_udp`)
- `instance_name`: instance name to set

esp_err_t **mdns_service_port_set** (**const** char **service_type*, **const** char **proto*, **uint16_t** *port*)

Set service port.

Return

- ESP_OK success

- ESP_ERR_INVALID_ARG Parameter error
- ESP_ERR_NOT_FOUND Service not found
- ESP_ERR_NO_MEM memory error

Parameters

- *service_type*: service type (`_http`, `_ftp`, etc)
- *proto*: service protocol (`_tcp`, `_udp`)
- *port*: service port

esp_err_t **mdns_service_txt_set** (**const** char *service_type*, **const** char *proto*, *mdns_txt_item_t* *txt*[], **uint8_t** *num_items*)

Replace all TXT items for service.

Return

- ESP_OK success
- ESP_ERR_INVALID_ARG Parameter error
- ESP_ERR_NOT_FOUND Service not found
- ESP_ERR_NO_MEM memory error

Parameters

- *service_type*: service type (`_http`, `_ftp`, etc)
- *proto*: service protocol (`_tcp`, `_udp`)
- *txt*: array of TXT data (eg. {{ "var" , " val" }, { "other" , " 2" }})
- *num_items*: number of items in TXT data

esp_err_t **mdns_service_txt_item_set** (**const** char *service_type*, **const** char *proto*, **const** char *key*, **const** char *value*)

Set/Add TXT item for service TXT record.

Return

- ESP_OK success
- ESP_ERR_INVALID_ARG Parameter error
- ESP_ERR_NOT_FOUND Service not found
- ESP_ERR_NO_MEM memory error

Parameters

- *service_type*: service type (`_http`, `_ftp`, etc)
- *proto*: service protocol (`_tcp`, `_udp`)
- *key*: the key that you want to add/update
- *value*: the new value of the key

esp_err_t **mdns_service_txt_item_remove** (**const** char *service_type*, **const** char *proto*, **const** char *key*)

Remove TXT item for service TXT record.

Return

- ESP_OK success
- ESP_ERR_INVALID_ARG Parameter error
- ESP_ERR_NOT_FOUND Service not found
- ESP_ERR_NO_MEM memory error

Parameters

- *service_type*: service type (`_http`, `_ftp`, etc)
- *proto*: service protocol (`_tcp`, `_udp`)
- *key*: the key that you want to remove

esp_err_t **mdns_service_remove_all** (**void**)

Remove and free all services from mDNS server.

Return

- ESP_OK success
- ESP_ERR_INVALID_ARG Parameter error

esp_err_t **mdns_query** (**const** char *name*, **const** char *service_type*, **const** char *proto*, **uint16_t** *type*, **uint32_t** *timeout*, **size_t** *max_results*, *mdns_result_t* ***results*)

Query mDNS for host or service All following query methods are derived from this one.

Return

- ESP_OK success
- ESP_ERR_INVALID_STATE mDNS is not running
- ESP_ERR_NO_MEM memory error
- ESP_ERR_INVALID_ARG timeout was not given

Parameters

- name: service instance or host name (NULL for PTR queries)
- service_type: service type (`_http`, `_arduino`, `_ftp` etc.) (NULL for host queries)
- proto: service protocol (`_tcp`, `_udp`, etc.) (NULL for host queries)
- type: type of query (`MDNS_TYPE_*`)
- timeout: time in milliseconds to wait for answers.
- max_results: maximum results to be collected
- results: pointer to the results of the query results must be freed using `mdns_query_results_free` below

void `mdns_query_results_free` (*mdns_result_t* *results)

Free query results.

Parameters

- results: linked list of results to be freed

esp_err_t `mdns_query_ptr` (**const** char *service_type, **const** char *proto, uint32_t timeout, size_t max_results, *mdns_result_t* **results)

Query mDNS for service.

Return

- ESP_OK success
- ESP_ERR_INVALID_STATE mDNS is not running
- ESP_ERR_NO_MEM memory error
- ESP_ERR_INVALID_ARG parameter error

Parameters

- service_type: service type (`_http`, `_arduino`, `_ftp` etc.)
- proto: service protocol (`_tcp`, `_udp`, etc.)
- timeout: time in milliseconds to wait for answer.
- max_results: maximum results to be collected
- results: pointer to the results of the query

esp_err_t `mdns_query_srv` (**const** char *instance_name, **const** char *service_type, **const** char *proto, uint32_t timeout, *mdns_result_t* **result)

Query mDNS for SRV record.

Return

- ESP_OK success
- ESP_ERR_INVALID_STATE mDNS is not running
- ESP_ERR_NO_MEM memory error
- ESP_ERR_INVALID_ARG parameter error

Parameters

- instance_name: service instance name
- service_type: service type (`_http`, `_arduino`, `_ftp` etc.)
- proto: service protocol (`_tcp`, `_udp`, etc.)
- timeout: time in milliseconds to wait for answer.
- result: pointer to the result of the query

esp_err_t `mdns_query_txt` (**const** char *instance_name, **const** char *service_type, **const** char *proto, uint32_t timeout, *mdns_result_t* **result)

Query mDNS for TXT record.

Return

- ESP_OK success
- ESP_ERR_INVALID_STATE mDNS is not running
- ESP_ERR_NO_MEM memory error
- ESP_ERR_INVALID_ARG parameter error

Parameters

- instance_name: service instance name

- `service_type`: service type (`_http`, `_arduino`, `_ftp` etc.)
- `proto`: service protocol (`_tcp`, `_udp`, etc.)
- `timeout`: time in milliseconds to wait for answer.
- `result`: pointer to the result of the query

`esp_err_t mdns_query_a (const char *host_name, uint32_t timeout, esp_ip4_addr_t *addr)`
Query mDNS for A record.

Return

- `ESP_OK` success
- `ESP_ERR_INVALID_STATE` mDNS is not running
- `ESP_ERR_NO_MEM` memory error
- `ESP_ERR_INVALID_ARG` parameter error

Parameters

- `host_name`: host name to look for
- `timeout`: time in milliseconds to wait for answer.
- `addr`: pointer to the resulting IP4 address

`esp_err_t mdns_query_aaaa (const char *host_name, uint32_t timeout, esp_ip6_addr_t *addr)`
Query mDNS for AAAA record.

Return

- `ESP_OK` success
- `ESP_ERR_INVALID_STATE` mDNS is not running
- `ESP_ERR_NO_MEM` memory error
- `ESP_ERR_INVALID_ARG` parameter error

Parameters

- `host_name`: host name to look for
- `timeout`: time in milliseconds to wait for answer. If 0, `max_results` needs to be defined
- `addr`: pointer to the resulting IP6 address

`esp_err_t mdns_handle_system_event (void *ctx, system_event_t *event)`

System event handler This method controls the service state on all active interfaces and applications are required to call it from the system event handler for normal operation of mDNS service.

Parameters

- `ctx`: The system event context
- `event`: The system event

Structures

`struct mdns_txt_item_t`

mDNS basic text item structure Used in `mdns_service_add()`

Public Members

`const char *key`
item key name

`const char *value`
item value string

`struct mdns_ip_addr_s`

mDNS query linked list IP item

Public Members

`esp_ip_addr_t addr`
IP address

`struct mdns_ip_addr_s *next`
next IP, or NULL for the last IP in the list

struct mdns_result_s
mDNS query result structure

Public Members

struct mdns_result_s *next
next result, or NULL for the last result in the list

mdns_if_t tcpip_if
interface index

mdns_ip_protocol_t ip_protocol
ip_protocol type of the interface (v4/v6)

char *instance_name
instance name

char *hostname
hostname

uint16_t port
service port

mdns_txt_item_t *txt
txt record

size_t txt_count
number of txt items

mdns_ip_addr_t *addr
linked list of IP addresses found

Macros

MDNS_TYPE_A

MDNS_TYPE_PTR

MDNS_TYPE_TXT

MDNS_TYPE_AAAA

MDNS_TYPE_SRV

MDNS_TYPE_OPT

MDNS_TYPE_NSEC

MDNS_TYPE_ANY

Type Definitions

typedef struct mdns_ip_addr_s mdns_ip_addr_t
mDNS query linked list IP item

typedef enum mdns_if_internal mdns_if_t

typedef struct mdns_result_s mdns_result_t
mDNS query result structure

Enumerations

enum mdns_ip_protocol_t
mDNS enum to specify the ip_protocol type

Values:

MDNS_IP_PROTOCOL_V4

```
MDNS_IP_PROTOCOL_V6
MDNS_IP_PROTOCOL_MAX
enum mdns_if_internal
Values:
MDNS_IF_STA = 0
MDNS_IF_AP = 1
MDNS_IF_ETH = 2
MDNS_IF_MAX
```

2.4.10 ESP-Modbus

Overview

The Modbus serial communication protocol is de facto standard protocol widely used to connect industrial electronic devices. Modbus allows communication among many devices connected to the same network, for example, a system that measures temperature and humidity and communicates the results to a computer. The Modbus protocol uses several types of data: Holding Registers, Input Registers, Coils (single bit output), Discrete Inputs. Versions of the Modbus protocol exist for serial port and for Ethernet and other protocols that support the Internet protocol suite. There are many variants of Modbus protocols, some of them are:

- `Modbus RTU` —This is used in serial communication and makes use of a compact, binary representation of the data for protocol communication. The RTU format follows the commands/data with a cyclic redundancy check checksum as an error check mechanism to ensure the reliability of data. Modbus RTU is the most common implementation available for Modbus. A Modbus RTU message must be transmitted continuously without inter-character hesitations. Modbus messages are framed (separated) by idle (silent) periods. The RS-485 interface communication is usually used for this type.
- `Modbus ASCII` —This is used in serial communication and makes use of ASCII characters for protocol communication. The ASCII format uses a longitudinal redundancy check checksum. Modbus ASCII messages are framed by leading colon (“:”) and trailing newline (CR/LF).
- `Modbus TCP/IP` or `Modbus TCP` —This is a Modbus variant used for communications over TCP/IP networks, connecting over port 502. It does not require a checksum calculation, as lower layers already provide checksum protection.

Modbus port specific API overview ESP-IDF supports Modbus Serial/TCP slave and master protocol stacks (port) and provides Modbus controller interface API to interact with user application.

The functions below are used to create and then initialize actual Modbus controller interface for Serial/TCP port accordingly:

`esp_err_t mbc_slave_init` (mb_port_type_t *port_type*, void ***handler*)

Initialize Modbus Slave controller and stack for Serial port.

Return

- `ESP_OK` Success
- `ESP_ERR_NO_MEM` Parameter error
- `ESP_ERR_NOT_SUPPORTED` Port type not supported
- `ESP_ERR_INVALID_STATE` Initialization failure

Parameters

- [out] *handler*: handler(pointer) to master data structure
- [in] *port_type*: the type of port

`esp_err_t mbc_master_init` (mb_port_type_t *port_type*, void ***handler*)

Initialize Modbus Master controller and stack for Serial port.

Return

- `ESP_OK` Success
- `ESP_ERR_NO_MEM` Parameter error

- ESP_ERR_NOT_SUPPORTED Port type not supported
- ESP_ERR_INVALID_STATE Initialization failure

Parameters

- [out] `handler`: handler(pointer) to master data structure
- [in] `port_type`: type of stack

esp_err_t **mbc_slave_init_tcp**(void ***handler*)

Initialize Modbus Slave controller and stack for TCP port.

Return

- ESP_OK Success
- ESP_ERR_NO_MEM Parameter error
- ESP_ERR_NOT_SUPPORTED Port type not supported
- ESP_ERR_INVALID_STATE Initialization failure

Parameters

- [out] `handler`: handler(pointer) to master data structure

esp_err_t **mbc_master_init_tcp**(void ***handler*)

Initialize Modbus controller and stack for TCP port.

Return

- ESP_OK Success
- ESP_ERR_NO_MEM Parameter error
- ESP_ERR_NOT_SUPPORTED Port type not supported
- ESP_ERR_INVALID_STATE Initialization failure

Parameters

- [out] `handler`: handler(pointer) to master data structure

Modbus common interface API overview The function initializes the Modbus controller interface and its active context (tasks, RTOS objects and other resources).

esp_err_t **mbc_slave_setup**(void **comm_info*)

Set Modbus communication parameters for the controller.

Return

- ESP_OK Success
- ESP_ERR_INVALID_ARG Incorrect parameter data

Parameters

- `comm_info`: Communication parameters structure.

esp_err_t **mbc_master_setup**(void **comm_info*)

Set Modbus communication parameters for the controller.

Return

- ESP_OK Success
- ESP_ERR_INVALID_ARG Incorrect parameter data

Parameters

- `comm_info`: Communication parameters structure.

The function is used to setup communication parameters of the Modbus stack. See the Modbus controller API documentation for more information. Note: The communication structure provided as a parameter is different for serial and TCP communication mode.

mbc_slave_set_descriptor(): Initialization of slave descriptor.

mbc_master_set_descriptor(): Initialization of master descriptor.

The Modbus stack uses parameter description tables (descriptors) for communication. These are different for master and slave implementation of stack and should be assigned by the API call before start of communication.

esp_err_t **mbc_slave_start**(void)

Start Modbus communication stack.

Return

- ESP_OK Success
- ESP_ERR_INVALID_ARG Modbus stack start error

esp_err_t **mbc_master_start** (void)

Start Modbus communication stack.

Return

- ESP_OK Success
- ESP_ERR_INVALID_ARG Modbus stack start error

Modbus controller start function. Starts stack and interface and allows communication.

esp_err_t **mbc_slave_destroy** (void)

Destroy Modbus controller and stack.

Return

- ESP_OK Success
- ESP_ERR_INVALID_STATE Parameter error

esp_err_t **mbc_master_destroy** (void)

Destroy Modbus controller and stack.

Return

- ESP_OK Success
- ESP_ERR_INVALID_STATE Parameter error

This function stops Modbus communication stack and destroys controller interface.

There are some configurable parameters of modbus_controller interface and Modbus stack that can be configured using KConfig values in “Modbus configuration” menu. The most important option in KConfig menu is “Enable Modbus stack support ..” for appropriate communication mode that allows to select master or slave stack for implementation. See the examples for more information about how to use these API functions.

Modbus slave interface API overview The slave stack requires the user defined structures which represent Modbus parameters accessed by stack. These structures should be prepared by user and be assigned to the modbus_controller interface using *mbc_slave_set_descriptor()* API call before start of communication. The interface API functions below are used for Modbus slave application:

esp_err_t **mbc_slave_set_descriptor** (mb_register_area_descriptor_t *descr_data*)

Set Modbus area descriptor.

Return

- ESP_OK: The appropriate descriptor is set
- ESP_ERR_INVALID_ARG: The argument is incorrect

Parameters

- *descr_data*: Modbus registers area descriptor structure

The function initializes Modbus communication descriptors for each type of Modbus register area (Holding Registers, Input Registers, Coils (single bit output), Discrete Inputs). Once areas are initialized and the *mbc_slave_start()* API is called the Modbus stack can access the data in user data structures by request from master. See the *mb_register_area_descriptor_t* and example for more information.

mb_event_group_t **mbc_slave_check_event** (*mb_event_group_t* *group*)

Wait for specific event on parameter change.

Return

- *mb_event_group_t* event bits triggered

Parameters

- *group*: Group event bit mask to wait for change

The blocking call to function waits for event specified in the input parameter as event mask. Once master access the parameter and event mask matches the parameter the application task will be unblocked and function will return ESP_OK. See the *mb_event_group_t* for more information about Modbus event masks.

esp_err_t **mbc_slave_get_param_info** (mb_param_info_t *reg_info, uint32_t timeout)

Get parameter information.

Return

- ESP_OK Success
- ESP_ERR_TIMEOUT Can not get data from parameter queue or queue overflow

Parameters

- [out] reg_info: parameter info structure
- timeout: Timeout in milliseconds to read information from parameter queue

The function gets information about accessed parameters from modbus controller event queue. The KConfig ‘CONFIG_FMB_CONTROLLER_NOTIFY_QUEUE_SIZE’ key can be used to configure the notification queue size. The timeout parameter allows to specify timeout for waiting notification. The mb_param_info_t structure contain information about accessed parameter.

Modbus master interface API overview The Modbus master implementation requires parameter description table be defined before start of stack. This table describes characteristics (physical parameters like temperature, humidity, etc.) and links them to Modbus registers in specific slave device in the Modbus segment. The table has to be assigned to the modbus_controller interface using *mbc_master_set_descriptor()* API call before start of communication.

Below are the interface API functions that are used to setup and use Modbus master stack from user application and can be executed in next order:

esp_err_t **mbc_master_set_descriptor** (const mb_parameter_descriptor_t *descriptor, const uint16_t num_elements)

Assign parameter description table for Modbus controller interface.

Return

- esp_err_t ESP_OK - set descriptor successfully
- esp_err_t ESP_ERR_INVALID_ARG - invalid argument in function call

Parameters

- [in] descriptor: pointer to parameter description table
- num_elements: number of elements in the table

Assigns parameter description table for Modbus controller interface. The table has to be prepared by user according to particular implementation. Note: TCP communication stack requires to setup additional information about modbus slaves that corresponds to each address(index) used in description table. This information with IP addresses of the slaves is assigned using communication structure and interface setup call.

esp_err_t **mbc_master_send_request** (mb_param_request_t *request, void *data_ptr)

Send data request as defined in parameter request, waits response from slave and returns status of command execution. This function provides standard way for read/write access to Modbus devices in the network.

Return

- esp_err_t ESP_OK - request was successful
- esp_err_t ESP_ERR_INVALID_ARG - invalid argument of function
- esp_err_t ESP_ERR_INVALID_RESPONSE - an invalid response from slave
- esp_err_t ESP_ERR_TIMEOUT - operation timeout or no response from slave
- esp_err_t ESP_ERR_NOT_SUPPORTED - the request command is not supported by slave
- esp_err_t ESP_FAIL - slave returned an exception or other failure

Parameters

- [in] request: pointer to request structure of type mb_param_request_t
- [in] data_ptr: pointer to data buffer to send or received data (dependent of command field in request)

This function sends data request as defined in parameter request, waits response from corresponded slave and returns status of command execution. This function provides a standard way for read/write access to Modbus devices in the network.

esp_err_t **mbc_master_get_cid_info** (uint16_t cid, const mb_parameter_descriptor_t **param_info)

Get information about supported characteristic defined as cid. Uses parameter description table to get this

information. The function will check if characteristic defined as a cid parameter is supported and returns its description in param_info. Returns ESP_ERR_NOT_FOUND if characteristic is not supported.

Return

- esp_err_t ESP_OK - request was successful and buffer contains the supported characteristic name
- esp_err_t ESP_ERR_INVALID_ARG - invalid argument of function
- esp_err_t ESP_ERR_NOT_FOUND - the characteristic (cid) not found
- esp_err_t ESP_FAIL - unknown error during lookup table processing

Parameters

- [in] cid: characteristic id
- param_info: pointer to pointer of characteristic data.

The function gets information about supported characteristic defined as cid. It will check if characteristic is supported and returns its description.

esp_err_t mbc_master_get_parameter (uint16_t cid, char *name, uint8_t *value, uint8_t *type)

Read parameter from modbus slave device whose name is defined by name and has cid. The additional data for request is taken from parameter description (lookup) table.

Return

- esp_err_t ESP_OK - request was successful and value buffer contains representation of actual parameter data from slave
- esp_err_t ESP_ERR_INVALID_ARG - invalid argument of function or parameter descriptor
- esp_err_t ESP_ERR_INVALID_RESPONSE - an invalid response from slave
- esp_err_t ESP_ERR_INVALID_STATE - invalid state during data processing or allocation failure
- esp_err_t ESP_ERR_TIMEOUT - operation timed out and no response from slave
- esp_err_t ESP_ERR_NOT_SUPPORTED - the request command is not supported by slave
- esp_err_t ESP_ERR_NOT_FOUND - the parameter is not found in the parameter description table
- esp_err_t ESP_FAIL - slave returned an exception or other failure

Parameters

- [in] cid: id of the characteristic for parameter
- [in] name: pointer into string name (key) of parameter (null terminated)
- [out] value: pointer to data buffer of parameter
- [out] type: parameter type associated with the name returned from parameter description table.

The function reads data of characteristic defined in parameters from Modbus slave device and returns its data. The additional data for request is taken from parameter description table.

esp_err_t mbc_master_set_parameter (uint16_t cid, char *name, uint8_t *value, uint8_t *type)

Set characteristic's value defined as a name and cid parameter. The additional data for cid parameter request is taken from master parameter lookup table.

Return

- esp_err_t ESP_OK - request was successful and value was saved in the slave device registers
- esp_err_t ESP_ERR_INVALID_ARG - invalid argument of function or parameter descriptor
- esp_err_t ESP_ERR_INVALID_RESPONSE - an invalid response from slave during processing of parameter
- esp_err_t ESP_ERR_INVALID_STATE - invalid state during data processing or allocation failure
- esp_err_t ESP_ERR_TIMEOUT - operation timed out and no response from slave
- esp_err_t ESP_ERR_NOT_SUPPORTED - the request command is not supported by slave
- esp_err_t ESP_FAIL - slave returned an exception or other failure

Parameters

- [in] cid: id of the characteristic for parameter
- [in] name: pointer into string name (key) of parameter (null terminated)
- [out] value: pointer to data buffer of parameter (actual representation of json value field in binary form)
- [out] type: pointer to parameter type associated with the name returned from parameter lookup table.

The function writes characteristic's value defined as a name and cid parameter in corresponded slave device. The additional data for parameter request is taken from master parameter description table.

Application Example

The examples below use the FreeModbus library port for serial TCP slave and master implementations accordingly. The selection of stack is performed through KConfig menu option “Enable Modbus stack support ...” for appropriate communication mode and related configuration keys.

[protocols/modbus/serial/mb_slave](#)

[protocols/modbus/serial/mb_master](#)

[protocols/modbus/tcp/mb_tcp_slave](#)

[protocols/modbus/tcp/mb_tcp_master](#)

Please refer to the specific example README.md for details.

2.4.11 ESP WebSocket Client

Overview

The ESP WebSocket client is an implementation of [WebSocket protocol client](#) for ESP32-C3

Features

- Supports WebSocket over TCP, TLS with mbedtls
- Easy to setup with URI
- Multiple instances (Multiple clients in one application)

Configuration

URI

- Supports `ws`, `wss` schemes
- WebSocket samples:
 - `ws://echo.websocket.org`: WebSocket over TCP, default port 80
 - `wss://echo.websocket.org`: WebSocket over SSL, default port 443

Minimal configurations:

```
const esp_websocket_client_config_t ws_cfg = {
    .uri = "ws://echo.websocket.org",
};
```

The WebSocket client supports the use of both path and query in the URI. Sample:

```
const esp_websocket_client_config_t ws_cfg = {
    .uri = "ws://echo.websocket.org/connectionhandler?id=104",
};
```

If there are any options related to the URI in `esp_websocket_client_config_t`, the option defined by the URI will be overridden. Sample:

```
const esp_websocket_client_config_t ws_cfg = {
    .uri = "ws://echo.websocket.org:123",
    .port = 4567,
};
//WebSocket client will connect to websocket.org using port 4567
```

TLS Configuration:

```
const esp_websocket_client_config_t ws_cfg = {
    .uri = "wss://echo.websocket.org",
    .cert_pem = (const char *)websocket_org_pem_start,
};
```

Note: If you want to verify the server, then you need to provide a certificate in PEM format, and provide to `cert_pem` in `websocket_client_config_t`. If no certificate is provided then the TLS connection will to default not requiring verification.

PEM certificate for this example could be extracted from an `openssl s_client` command connecting to `websocket.org`. In case a host operating system has `openssl` and `sed` packages installed, one could execute the following command to download and save the root or intermediate root certificate to a file (Note for Windows users: Both Linux like environment or Windows native packages may be used). `` echo "" | openssl s_client -showcerts -connect websocket.org:443 | sed -n "1,/Root/d; /BEGIN/,/END/p" | openssl x509 -outform PEM >websocket_org.pem ``

This command will extract the second certificate in the chain and save it as a pem-file.

Subprotocol The subprotocol field in the config struct can be used to request a subprotocol

```
const esp_websocket_client_config_t ws_cfg = {
    .uri = "ws://websocket.org",
    .subprotocol = "soap",
};
```

Note: The client is indifferent to the subprotocol field in the server response and will accept the connection no matter what the server replies.

For more options on `esp_websocket_client_config_t`, please refer to API reference below

Events

- **WEBSOCKET_EVENT_CONNECTED:** The client has successfully established a connection to the server. The client is now ready to send and receive data. Contains no event data.
- **WEBSOCKET_EVENT_DISCONNECTED:** The client has aborted the connection due to the transport layer failing to read data, e.g. because the server is unavailable. Contains no event data.
- **WEBSOCKET_EVENT_DATA:** The client has successfully received and parsed a WebSocket frame. The event data contains a pointer to the payload data, the length of the payload data as well as the opcode of the received frame. A message may be fragmented into multiple events if the length exceeds the buffer size. This event will also be posted for non-payload frames, e.g. pong or connection close frames.
- **WEBSOCKET_EVENT_ERROR:** Not used in the current implementation of the client.

If the client handle is needed in the event handler it can be accessed through the pointer passed to the event handler:

```
esp_websocket_client_handle_t client = (esp_websocket_client_handle_t)handler_args;
```

Limitations and Known Issues

- The client is able to request the use of a subprotocol from the server during the handshake, but does not do any subprotocol related checks on the response from the server.

Application Example

A simple WebSocket example that uses `esp_websocket_client` to establish a websocket connection and send/receive data with the websocket.org server can be found here: protocols/websocket.

Sending Text Data The WebSocket client supports sending data as a text data frame, which informs the application layer that the payload data is text data encoded as UTF-8. Example:

```
esp_websocket_client_send_text(client, data, len, portMAX_DELAY);
```

API Reference

Header File

- [esp_websocket_client/include/esp_websocket_client.h](#)

Functions

`esp_websocket_client_handle_t esp_websocket_client_init (const esp_websocket_client_config_t *config)`

Start a WebSocket session This function must be the first function to call, and it returns a `esp_websocket_client_handle_t` that you must use as input to other functions in the interface. This call MUST have a corresponding call to `esp_websocket_client_destroy` when the operation is complete.

Return

- `esp_websocket_client_handle_t`
- NULL if any errors

Parameters

- [in] `config`: The configuration

`esp_err_t esp_websocket_client_set_uri (esp_websocket_client_handle_t client, const char *uri)`

Set URL for client, when performing this behavior, the options in the URL will replace the old ones Must stop the WebSocket client before set URI if the client has been connected.

Return `esp_err_t`

Parameters

- [in] `client`: The client
- [in] `uri`: The uri

`esp_err_t esp_websocket_client_start (esp_websocket_client_handle_t client)`

Open the WebSocket connection.

Return `esp_err_t`

Parameters

- [in] `client`: The client

`esp_err_t esp_websocket_client_stop (esp_websocket_client_handle_t client)`

Stops the WebSocket connection without websocket closing handshake.

This API stops ws client and closes TCP connection directly without sending close frames. It is a good practice to close the connection in a clean way using `esp_websocket_client_close()`.

Notes:

- Cannot be called from the websocket event handler

Return `esp_err_t`

Parameters

- [in] `client`: The client

`esp_err_t esp_websocket_client_destroy (esp_websocket_client_handle_t client)`

Destroy the WebSocket connection and free all resources. This function must be the last function to call for an

session. It is the opposite of the `esp_websocket_client_init` function and must be called with the same handle as input that a `esp_websocket_client_init` call returned. This might close all connections this handle has used.

Notes:

- Cannot be called from the websocket event handler

Return `esp_err_t`

Parameters

- [in] `client`: The client

int `esp_websocket_client_send` (*esp_websocket_client_handle_t* `client`, const char *`data`, int `len`, TickType_t `timeout`)

Generic write data to the WebSocket connection; defaults to binary send.

Return

- Number of data was sent
- (-1) if any errors

Parameters

- [in] `client`: The client
- [in] `data`: The data
- [in] `len`: The length
- [in] `timeout`: Write data timeout in RTOS ticks

int `esp_websocket_client_send_bin` (*esp_websocket_client_handle_t* `client`, const char *`data`, int `len`, TickType_t `timeout`)

Write binary data to the WebSocket connection (data send with WS OPCODE=02, i.e. binary)

Return

- Number of data was sent
- (-1) if any errors

Parameters

- [in] `client`: The client
- [in] `data`: The data
- [in] `len`: The length
- [in] `timeout`: Write data timeout in RTOS ticks

int `esp_websocket_client_send_text` (*esp_websocket_client_handle_t* `client`, const char *`data`, int `len`, TickType_t `timeout`)

Write textual data to the WebSocket connection (data send with WS OPCODE=01, i.e. text)

Return

- Number of data was sent
- (-1) if any errors

Parameters

- [in] `client`: The client
- [in] `data`: The data
- [in] `len`: The length
- [in] `timeout`: Write data timeout in RTOS ticks

esp_err_t `esp_websocket_client_close` (*esp_websocket_client_handle_t* `client`, TickType_t `timeout`)

Close the WebSocket connection in a clean way.

Sequence of clean close initiated by client:

- Client sends CLOSE frame
- Client waits until server echos the CLOSE frame
- Client waits until server closes the connection
- Client is stopped the same way as by the `esp_websocket_client_stop()`

Notes:

- Cannot be called from the websocket event handler

Return `esp_err_t`

Parameters

- [in] `client`: The client
- [in] `timeout`: Timeout in RTOS ticks for waiting

`esp_err_t esp_websocket_client_close_with_code` (`esp_websocket_client_handle_t client`, `int code`, `const char *data`, `int len`, `TickType_t timeout`)

Close the WebSocket connection in a clean way with custom code/data. Closing sequence is the same as for `esp_websocket_client_close()`.

Notes:

- Cannot be called from the websocket event handler

Return `esp_err_t`

Parameters

- [in] `client`: The client
- [in] `code`: Close status code as defined in RFC6455 section-7.4
- [in] `data`: Additional data to closing message
- [in] `len`: The length of the additional data
- [in] `timeout`: Timeout in RTOS ticks for waiting

`bool esp_websocket_client_is_connected` (`esp_websocket_client_handle_t client`)

Check the WebSocket client connection state.

Return

- `true`
- `false`

Parameters

- [in] `client`: The client handle

`esp_err_t esp_websocket_register_events` (`esp_websocket_client_handle_t client`, `esp_websocket_event_id_t event`, `esp_event_handler_t event_handler`, `void *event_handler_arg`)

Register the Websocket Events.

Return `esp_err_t`

Parameters

- `client`: The client handle
- `event`: The event id
- `event_handler`: The callback function
- `event_handler_arg`: User context

Structures

`struct esp_websocket_event_data_t`

Websocket event data.

Public Members

`const char *data_ptr`

Data pointer

`int data_len`

Data length

`uint8_t op_code`

Received opcode

`esp_websocket_client_handle_t client`

`esp_websocket_client_handle_t` context

`void *user_context`

`user_data` context, from `esp_websocket_client_config_t user_data`

int payload_len

Total payload length, payloads exceeding buffer will be posted through multiple events

int payload_offset

Actual offset for the data associated with this event

struct esp_websocket_client_config_t

Websocket client setup configuration.

Public Members

const char *uri

Websocket URI, the information on the URI can be overrides the other fields below, if any

const char *host

Domain or IP as string

int port

Port to connect, default depend on esp_websocket_transport_t (80 or 443)

const char *username

Using for Http authentication - Not supported for now

const char *password

Using for Http authentication - Not supported for now

const char *path

HTTP Path, if not set, default is /

bool disable_auto_reconnect

Disable the automatic reconnect function when disconnected

void *user_context

HTTP user data context

int task_prio

Websocket task priority

int task_stack

Websocket task stack

int buffer_size

Websocket buffer size

const char *cert_pem

Pointer to certificate data in PEM or DER format for server verify (with SSL), default is NULL, not required to verify the server. PEM-format must have a terminating NULL-character. DER-format requires the length to be passed in cert_len.

size_t cert_len

Length of the buffer pointed to by cert_pem. May be 0 for null-terminated pem

const char *client_cert

Pointer to certificate data in PEM or DER format for SSL mutual authentication, default is NULL, not required if mutual authentication is not needed. If it is not NULL, also client_key has to be provided. PEM-format must have a terminating NULL-character. DER-format requires the length to be passed in client_cert_len.

size_t client_cert_len

Length of the buffer pointed to by client_cert. May be 0 for null-terminated pem

const char *client_key

Pointer to private key data in PEM or DER format for SSL mutual authentication, default is NULL, not required if mutual authentication is not needed. If it is not NULL, also client_cert has to be provided. PEM-format must have a terminating NULL-character. DER-format requires the length to be passed in client_key_len

`size_t client_key_len`
Length of the buffer pointed to by `client_key_pem`. May be 0 for null-terminated pem

`esp_websocket_transport_t transport`
Websocket transport type, see `esp_websocket_transport_t`

char *`subprotocol`
Websocket subprotocol

char *`user_agent`
Websocket user-agent

char *`headers`
Websocket additional headers

int `pingpong_timeout_sec`
Period before connection is aborted due to no PONGs received

bool `disable_pingpong_discon`
Disable auto-disconnect due to no PONG received within `pingpong_timeout_sec`

bool `use_global_ca_store`
Use a global `ca_store` for all the connections in which this bool is set.

bool `skip_cert_common_name_check`
Skip any validation of server certificate CN field

bool `keep_alive_enable`
Enable keep-alive timeout

int `keep_alive_idle`
Keep-alive idle time. Default is 5 (second)

int `keep_alive_interval`
Keep-alive interval time. Default is 5 (second)

int `keep_alive_count`
Keep-alive packet retry send count. Default is 3 counts

size_t `ping_interval_sec`
Websocket ping interval, defaults to 10 seconds if not set

Type Definitions

```
typedef struct esp_websocket_client *esp_websocket_client_handle_t
```

Enumerations

```
enum esp_websocket_event_id_t
```

Websocket Client events id.

Values:

`WEBSOCKET_EVENT_ANY` = -1

`WEBSOCKET_EVENT_ERROR` = 0

This event occurs when there are any errors during execution

`WEBSOCKET_EVENT_CONNECTED`

Once the Websocket has been connected to the server, no data exchange has been performed

`WEBSOCKET_EVENT_DISCONNECTED`

The connection has been disconnected

`WEBSOCKET_EVENT_DATA`

When receiving data from the server, possibly multiple portions of the packet

`WEBSOCKET_EVENT_CLOSED`

The connection has been closed cleanly

```
WEBSOCKET_EVENT_MAX
enum esp_websocket_transport_t
    Websocket Client transport.
```

Values:

```
WEBSOCKET_TRANSPORT_UNKNOWN = 0x0
    Transport unknown
```

```
WEBSOCKET_TRANSPORT_OVER_TCP
    Transport over tcp
```

```
WEBSOCKET_TRANSPORT_OVER_SSL
    Transport over ssl
```

2.4.12 ESP Serial Slave Link

Overview

Espressif provides several chips that can work as slaves. These slave devices rely on some common buses, and have their own communication protocols over those buses. The *esp_serial_slave_link* component is designed for the master to communicate with ESP slave devices through those protocols over the bus drivers.

After an *esp_serial_slave_link* device is initialized properly, the application can use it to communicate with the ESP slave devices conveniently.

Espressif Device protocols

For more details about Espressif device protocols, see the following documents.

ESP SPI Slave HD (Half Duplex) Mode Protocol

SPI Slave Capabilities of Espressif chips

	ESP32	ESP32-S2	ESP32-C3
SPI Slave HD	N	Y (v2)	Y (v2)
Tohost intr		N	N
Frhost intr		2 *	2 *
TX DMA		Y	Y
RX DMA		Y	Y
Shared registers		72	64

Introduction In the half duplex mode, the master has to use the protocol defined by the slave to communicate with the slave. Each transaction may consists of the following phases (list by the order they should exist):

- Command: 8-bit, master to slave
This phase determines the rest phases of the transactions. See *Supported Commands*.
- Address: 8-bit, master to slave, optional
For some commands (WRBUF, RDBUF), this phase specifies the address of shared buffer to write to/read from. For other commands with this phase, they are meaningless, but still have to exist in the transaction.
- Dummy: 8-bit, floating, optional
This phase is the turn around time between the master and the slave on the bus, and also provides enough time for the slave to prepare the data to send to master.
- Data: variable length, the direction is also determined by the command.
This may be a data OUT phase, in which the direction is slave to master, or a data IN phase, in which the direction is master to slave.

The *direction* means which side (master or slave) controls the MOSI, MISO, WP and HD pins.

Data IO Modes In some IO modes, more data wires can be used to send the data. As a result, the SPI clock cycles required for the same amount of data will be less than in 1-bit mode. For example, in QIO mode, address and data (IN and OUT) should be sent on all 4 data wires (MOSI, MISO, WP, and HD). Here's the modes supported by ESP32-S2 SPI slave and the wire number used in corresponding modes.

Mode	command WN	address WN	dummy cycles	data WN
1-bit	1	1	1	1
DOUT	1	1	4	2
DIO	1	2	4	2
QOUT	1	1	4	4
QIO	1	4	4	4
QPI	4	4	4	4

Normally, which mode is used is determined by the command sent by the master (See [Supported Commands](#)), except from the QPI mode.

QPI Mode The QPI mode is a special state of the SPI Slave. The master can send ENQPI command to put the slave into the QPI mode state. In the QPI mode, the command is also sent in 4-bit, thus it's not compatible with the normal modes. The master should only send QPI commands when the slave is in the QPI mode. To exit from the QPI mode, master can send EXQPI command.

Supported Commands

Note: The command name are in a master-oriented direction. For example, WRBUF means master writes the buffer of slave.

Name	Description	Command	Address	Data
WRBUF	Write buffer	0x01	Buf addr	master to slave, no longer than buffer size
RDBUF	Read buffer	0x02	Buf addr	slave to master, no longer than buffer size
WRDMA	Write DMA	0x03	8 bits	master to slave, no longer than length provided by slave
RDDMA	Read DMA	0x04	8 bits	slave to master, no longer than length provided by slave
SEG_DONE	Segments done	0x05	•	•
ENQPI	Enter QPI mode	0x06	•	•
WR_DONE	Write segments done	0x07	•	•
CMD8	Interrupt	0x08	•	•
CMD9	Interrupt	0x09	•	•
CMDA	Interrupt	0x0A	•	•
EXQPI	Exit QPI mode	0xDD	•	•

Moreover, WRBUF, RDBUF, WRDMA, RDDMA commands have their 2-bit and 4-bit version. To do transactions in 2-bit or 4-bit mode, send the original command ORed by the corresponding command mask below. For example, command 0xA1 means WRBUF in QIO mode.

Mode	Mask
1-bit	0x00
DOUT	0x10
DIO	0x50
QOUT	0x20
QIO	0xA0
QPI	0xA0

Segment Transaction Mode Segment transaction mode is the only mode supported by the SPI Slave HD driver for now. In this mode, for a transaction the slave load onto the DMA, the master is allowed to read or write in segments. This way the master doesn't have to prepare large buffer as the size of data provided by the slave. After the master finish reading/writing a buffer, it has to send corresponding termination command to the slave as a synchronization signal. The slave driver will update new data (if exist) onto the DMA upon seeing the termination command.

The termination command is WR_DONE (0x07) for the WRDMA, and CMD8 (0x08) for the RDDMA.

Here's an example for the flow the master read data from the slave DMA:

1. The slave loads 4092 bytes of data onto the RDDMA
2. The master do seven RDDMA transactions, each of them are 512 bytes long, and reads the first 3584 bytes from the slave
3. The master do the last RDDMA transaction of 512 bytes (equal, longer or shorter than the total length loaded by the slave are all allowed). The first 508 bytes are valid data from the slave, while the last 4 bytes are meaningless bytes.
4. The master sends CMD8 to the slave
5. The slave loads another 4092 bytes of data onto the RDDMA
6. The master can start new reading transactions after it sends the CMD8

Terminology

- ESSL: Abbreviation for ESP Serial Slave Link, the component described by this document.
- Master: The device running the *esp_serial_slave_link* component.
- ESSL device: a virtual device on the master associated with an ESP slave device. The device context has the knowledge of the slave protocol above the bus, relying on some bus drivers to communicate with the slave.
- ESSL device handle: a handle to ESSL device context containing the configuration, status and data required by the ESSL component. The context stores the driver configurations, communication state, data shared by master and slave, etc.
The context should be initialized before it is used, and get deinitialized if not used any more. The master application operates on the ESSL device through this handle.
- ESP slave: the slave device connected to the bus, which ESSL component is designed to communicate with.
- Bus: The bus over which the master and the slave communicate with each other.
- Slave protocol: The special communication protocol specified by Espressif HW/SW over the bus.
- TX buffer num: a counter, which is on the slave and can be read by the master, indicates the accumulated buffer numbers that the slave has loaded to the hardware to receive data from the master.
- RX data size: a counter, which is on the slave and can be read by the master, indicates the accumulated data size that the slave has loaded to the hardware to send to the master.

Services provided by ESP slave

There are some common services provided by the Espressif slaves:

1. Tohost Interrupts: The slave can inform the master about certain events by the interrupt line. (optional)
2. Frhost Interrupts: The master can inform the slave about certain events.

3. Tx FIFO (master to slave): the slave can send data in stream to the master. The SDIO slave can also indicate it has new data to send to master by the interrupt line.
The slave updates the TX buffer num to inform the master how much data it can receive, and the master then read the TX buffer num, and take off the used buffer number to know how many buffers are remaining.
4. Rx FIFO (slave to master): the slave can receive data from the master in units of receiving buffers.
The slave updates the RX data size to inform the master how much data it has prepared to send, and then the master read the data size, and take off the data length it has already received to know how many data is remaining.
5. Shared registers: the master can read some part of the registers on the slave, and also write these registers to let the slave read.

The services provided by the slave depends on the slave's model. See *SPI Slave Capabilities of Espressif chips* for more details.

Initialization of ESP Serial Slave Link

ESP SDIO Slave The ESP SDIO slave link (ESSL SDIO) devices relies on the sdmmc component. It includes the usage of communicating with ESP SDIO Slave device via SDSPI feature. The ESSL device should be initialized as below:

1. Initialize a sdmmc card (see `Document of SDMMC driver` structure).
2. Call `sdmmc_card_init()` to initialize the card.
3. Initialize the ESSL device with `essl_sdio_config_t`. The `card` member should be the `sdmmc_card_t` got in step 2, and the `recv_buffer_size` member should be filled correctly according to pre-negotiated value.
4. Call `essl_init()` to do initialization of the SDIO part.
5. Call `essl_wait_for_ready()` to wait for the slave to be ready.

ESP SPI Slave

Note: If you are communicating with the ESP SDIO Slave device through SPI interface, you should use the *SDIO interface* instead.

Hasn't been supported yet.

APIs

After the initialization process above is performed, you can call the APIs below to make use of the services provided by the slave:

Tohost Interrupts (optional)

1. Call `essl_get_intr_ena()` to know which events will trigger the interrupts to the master.
2. Call `essl_set_intr_ena()` to set the events that will trigger interrupts to the master.
3. Call `essl_wait_int()` to wait until interrupt from the slave, or timeout.
4. When interrupt is triggered, call `essl_get_intr()` to know which events are active, and call `essl_clear_intr()` to clear them.

Frhost Interrupts

1. Call `essl_send_slave_intr()` to trigger general purpose interrupt of the slave.

TX FIFO

1. Call `essl_get_tx_buffer_num()` to know how many buffers the slave has prepared to receive data from the master. This is optional. The master will poll `tx_buffer_num` when it try to send packets to the slave, until the slave has enough buffer or timeout.

2. Call `essl_send_paket ()` to send data to the slave.

RX FIFO

1. Call `essl_get_rx_data_size ()` to know how many data the slave has prepared to send to the master. This is optional. When the master tries to receive data from the slave, it will update the `rx_data_size` for once, if the current `rx_data_size` is shorter than the buffer size the master prepared to receive. And it may poll the `rx_data_size` if the `rx_data_size` keeps 0, until timeout.
2. Call `essl_get_packet ()` to receive data from the slave.

Reset counters (Optional) Call `essl_reset_cnt ()` to reset the internal counter if you find the slave has reset its counter.

Application Example

The example below shows how ESP32 SDIO host and slave communicate with each other. The host use the ESSL SDIO.

[peripherals/sdio](#).

Please refer to the specific example README.md for details.

API Reference

Header File

- [esp_serial_slave_link/include/esp_serial_slave_link/essl.h](#)

Functions

`esp_err_t` **essl_init** (*essl_handle_t* handle, uint32_t wait_ms)

Initialize the slave.

Return

- ESP_OK: If success
- ESP_ERR_NOT_SUPPORTED: Current device does not support this function.
- Other value returned from lower layer `init`.

Parameters

- handle: Handle of a `essl` device.
- wait_ms: Millisecond to wait before timeout, will not wait at all if set to 0-9.

`esp_err_t` **essl_wait_for_ready** (*essl_handle_t* handle, uint32_t wait_ms)

Wait for interrupt of an ESSL slave device.

Return

- ESP_OK: If success
- ESP_ERR_NOT_SUPPORTED: Current device does not support this function.
- One of the error codes from SDMMC host controller

Parameters

- handle: Handle of a `essl` device.
- wait_ms: Millisecond to wait before timeout, will not wait at all if set to 0-9.

`esp_err_t` **essl_get_tx_buffer_num** (*essl_handle_t* handle, uint32_t *out_tx_num, uint32_t wait_ms)

Get buffer num for the host to send data to the slave. The buffers are size of `buffer_size`.

Return

- ESP_OK: Success
- ESP_ERR_NOT_SUPPORTED: This API is not supported in this mode
- One of the error codes from SDMMC/SPI host controller

Parameters

- `handle`: Handle of an ESSL device.
- `out_tx_num`: Output of buffer num that host can send data to ESSL slave.
- `wait_ms`: Millisecond to wait before timeout, will not wait at all if set to 0-9.

esp_err_t **essl_get_rx_data_size** (*essl_handle_t* handle, uint32_t *out_rx_size, uint32_t wait_ms)

Get the size, in bytes, of the data that the ESSL slave is ready to send

Return

- `ESP_OK`: Success
- `ESP_ERR_NOT_SUPPORTED`: This API is not supported in this mode
- One of the error codes from SDMMC/SPI host controller

Parameters

- `handle`: Handle of an ESSL device.
- `out_rx_size`: Output of data size to read from slave, in bytes
- `wait_ms`: Millisecond to wait before timeout, will not wait at all if set to 0-9.

esp_err_t **essl_reset_cnt** (*essl_handle_t* handle)

Reset the counters of this component. Usually you don't need to do this unless you know the slave is reset.

Return

- `ESP_OK`: Success
- `ESP_ERR_NOT_SUPPORTED`: This API is not supported in this mode
- `ESP_ERR_INVALID_ARG`: Invalid argument, handle is not init.

Parameters

- `handle`: Handle of an ESSL device.

esp_err_t **essl_send_packet** (*essl_handle_t* handle, const void *start, size_t length, uint32_t wait_ms)

Send a packet to the ESSL Slave. The Slave receives the packet into buffers whose size is `buffer_size` (configured during initialization).

Return

- `ESP_OK` Success
- `ESP_ERR_INVALID_ARG`: Invalid argument, handle is not init or other argument is not valid.
- `ESP_ERR_TIMEOUT`: No buffer to use, or error from SDMMC host controller.
- `ESP_ERR_NOT_FOUND`: Slave is not ready for receiving.
- `ESP_ERR_NOT_SUPPORTED`: This API is not supported in this mode
- One of the error codes from SDMMC/SPI host controller.

Parameters

- `handle`: Handle of a `essl` device.
- `start`: Start address of the packet to send
- `length`: Length of data to send, if the packet is over-size, the it will be divided into blocks and hold into different buffers automatically.
- `wait_ms`: Millisecond to wait before timeout, will not wait at all if set to 0-9.

esp_err_t **essl_get_packet** (*essl_handle_t* handle, void *out_data, size_t size, size_t *out_length, uint32_t wait_ms)

Get a packet from ESSL slave.

Return

- `ESP_OK` Success: All the data has been read from the slave.
- `ESP_ERR_INVALID_ARG`: Invalid argument, The handle is not initialized or the other arguments are invalid.
- `ESP_ERR_NOT_FINISHED`: Read was successful, but there is still data remaining.
- `ESP_ERR_NOT_FOUND`: Slave is not ready to send data.
- `ESP_ERR_NOT_SUPPORTED`: This API is not supported in this mode
- One of the error codes from SDMMC/SPI host controller.

Parameters

- `handle`: Handle of a `essl` device.
- [out] `out_data`: Data output address
- `size`: The size of the output buffer, if the buffer is smaller than the size of data to receive from slave, the driver returns `ESP_ERR_NOT_FINISHED`
- [out] `out_length`: Output of length the data actually received from slave.

- `wait_ms`: Millisecond to wait before timeout, will not wait at all if set to 0-9.

`esp_err_t essl_write_reg(essl_handle_t handle, uint8_t addr, uint8_t value, uint8_t *value_o, uint32_t wait_ms)`

Write general purpose R/W registers (8-bit) of ESSL slave.

Note sdio 28-31 are reserved, the lower API helps to skip.

Return

- `ESP_OK` Success
- One of the error codes from SDMMC/SPI host controller

Parameters

- `handle`: Handle of an ESSL device.
- `addr`: Address of register to write. For SDIO, valid address: 0-59. For SPI, see `essl_spi.h`
- `value`: Value to write to the register.
- `value_o`: Output of the returned written value.
- `wait_ms`: Millisecond to wait before timeout, will not wait at all if set to 0-9.

`esp_err_t essl_read_reg(essl_handle_t handle, uint8_t addr, uint8_t *value_o, uint32_t wait_ms)`

Read general purpose R/W registers (8-bit) of ESSL slave.

Return

- `ESP_OK` Success
- One of the error codes from SDMMC/SPI host controller

Parameters

- `handle`: Handle of a `essl` device.
- `addr`: Address of register to read. For SDIO, Valid address: 0-27, 32-63 (28-31 reserved, return interrupt bits on read). For SPI, see `essl_spi.h`
- `value_o`: Output value read from the register.
- `wait_ms`: Millisecond to wait before timeout, will not wait at all if set to 0-9.

`esp_err_t essl_wait_int(essl_handle_t handle, uint32_t wait_ms)`

wait for an interrupt of the slave

Return

- `ESP_OK`: If interrupt is triggered.
- `ESP_ERR_NOT_SUPPORTED`: Current device does not support this function.
- `ESP_ERR_TIMEOUT`: No interrupts before timeout.

Parameters

- `handle`: Handle of a `essl` device.
- `wait_ms`: Millisecond to wait before timeout, will not wait at all if set to 0-9.

`esp_err_t essl_clear_intr(essl_handle_t handle, uint32_t intr_mask, uint32_t wait_ms)`

Clear interrupt bits of ESSL slave. All the bits set in the mask will be cleared, while other bits will stay the same.

Return

- `ESP_OK`: Success
- `ESP_ERR_NOT_SUPPORTED`: Current device does not support this function.
- One of the error codes from SDMMC host controller

Parameters

- `handle`: Handle of a `essl` device.
- `intr_mask`: Mask of interrupt bits to clear.
- `wait_ms`: Millisecond to wait before timeout, will not wait at all if set to 0-9.

`esp_err_t essl_get_intr(essl_handle_t handle, uint32_t *intr_raw, uint32_t *intr_st, uint32_t wait_ms)`

Get interrupt bits of ESSL slave.

Return

- `ESP_OK`: Success
- `ESP_INVALID_ARG`: If both `intr_raw` and `intr_st` are NULL.
- `ESP_ERR_NOT_SUPPORTED`: Current device does not support this function.
- One of the error codes from SDMMC host controller

Parameters

- `handle`: Handle of a `essl` device.
- `intr_raw`: Output of the raw interrupt bits. Set to NULL if only masked bits are read.
- `intr_st`: Output of the masked interrupt bits. set to NULL if only raw bits are read.
- `wait_ms`: Millisecond to wait before timeout, will not wait at all if set to 0-9.

`esp_err_t` **essl_set_intr_ena** (*essl_handle_t* handle, uint32_t *ena_mask*, uint32_t *wait_ms*)

Set interrupt enable bits of ESSL slave. The slave only sends interrupt on the line when there is a bit both the raw status and the enable are set.

Return

- `ESP_OK`: Success
- `ESP_ERR_NOT_SUPPORTED`: Current device does not support this function.
- One of the error codes from SDMMC host controller

Parameters

- `handle`: Handle of a `essl` device.
- `ena_mask`: Mask of the interrupt bits to enable.
- `wait_ms`: Millisecond to wait before timeout, will not wait at all if set to 0-9.

`esp_err_t` **essl_get_intr_ena** (*essl_handle_t* handle, uint32_t **ena_mask_o*, uint32_t *wait_ms*)

Get interrupt enable bits of ESSL slave.

Return

- `ESP_OK` Success
- One of the error codes from SDMMC host controller

Parameters

- `handle`: Handle of a `essl` device.
- `ena_mask_o`: Output of interrupt bit enable mask.
- `wait_ms`: Millisecond to wait before timeout, will not wait at all if set to 0-9.

`esp_err_t` **essl_send_slave_intr** (*essl_handle_t* handle, uint32_t *intr_mask*, uint32_t *wait_ms*)

Send interrupts to slave. Each bit of the interrupt will be triggered.

Return

- `ESP_OK`: Success
- `ESP_ERR_NOT_SUPPORTED`: Current device does not support this function.
- One of the error codes from SDMMC host controller

Parameters

- `handle`: Handle of a `essl` device.
- `intr_mask`: Mask of interrupt bits to send to slave.
- `wait_ms`: Millisecond to wait before timeout, will not wait at all if set to 0-9.

Macros

ESP_ERR_NOT_FINISHED

There is still remaining data.

Type Definitions

typedef struct `essl_dev_t` ***essl_handle_t**

Handle of an ESSL device.

Header File

- `esp_serial_slave_link/include/esp_serial_slave_link/essl_sdio.h`

Functions

`esp_err_t` **essl_sdio_init_dev** (*essl_handle_t* **out_handle*, **const** *essl_sdio_config_t* **config*)

Initialize the ESSL SDIO device and get its handle.

Return

- `ESP_OK`: on success

- ESP_ERR_NO_MEM: memory exhausted.

Parameters

- out_handle: Output of the handle.
- config: Configuration for the ESSL SDIO device.

esp_err_t **essl_sdio_deinit_dev** (*essl_handle_t* handle)

Deinitialize and free the space used by the ESSL SDIO device.

Return

- ESP_OK: on success
- ESP_ERR_INVALID_ARG: wrong handle passed

Parameters

- handle: Handle of the ESSL SDIO device to deinit.

Structures

struct **essl_sdio_config_t**

Configuration for the essl SDIO device.

Public Members

sdmnc_card_t *card

The initialized sdmnc card pointer of the slave.

int **rcv_buffer_size**

The pre-negotiated rcv buffer size used by both the host and the slave.

Header File

- esp_serial_slave_link/include/esp_serial_slave_link/essl_spi.h

Functions

esp_err_t **essl_spi_init_dev** (*essl_handle_t* *out_handle, **const** *essl_spi_config_t* *init_config)

Initialize the ESSL SPI device function list and get its handle.

Return

- ESP_OK: On success
- ESP_ERR_NO_MEM: Memory exhausted
- ESP_ERR_INVALID_STATE: SPI driver is not initialized
- ESP_ERR_INVALID_ARG: Wrong register ID

Parameters

- [out] out_handle: Output of the handle
- init_config: Configuration for the ESSL SPI device

esp_err_t **essl_spi_deinit_dev** (*essl_handle_t* handle)

Deinitialize the ESSL SPI device and free the memory used by the device.

Return

- ESP_OK: On success
- ESP_ERR_INVALID_STATE: ESSL SPI is not in use

Parameters

- handle: Handle of the ESSL SPI device

esp_err_t **essl_spi_read_reg** (void *arg, uint8_t addr, uint8_t *out_value, uint32_t wait_ms)

Read from the shared registers.

Note The registers for Master/Slave synchronization are reserved. Do not use them. (see rx_sync_reg in *essl_spi_config_t*)

Return

- ESP_OK: success
- ESP_ERR_INVALID_STATE: ESSL SPI has not been initialized.
- ESP_ERR_INVALID_ARG: The address argument is not valid. See note 1.

- or other return value from `:cpp:func:spi_device_transmit`.

Parameters

- `arg`: Context of the component. (Member `arg` from `essl_handle_t`)
- `addr`: Address of the shared registers. (Valid: 0 ~ `SOC_SPI_MAXIMUM_BUFFER_SIZE`, registers for M/S sync are reserved, see note1).
- `[out] out_value`: Read buffer for the shared registers.
- `wait_ms`: Time to wait before timeout (reserved for future use, user should set this to 0).

esp_err_t **essl_spi_get_packet** (void *arg, void *out_data, size_t size, uint32_t wait_ms)

Get a packet from Slave.

Return

- `ESP_OK`: On Success
- `ESP_ERR_INVALID_STATE`: ESSL SPI has not been initialized.
- `ESP_ERR_INVALID_ARG`: The output data address is neither DMA capable nor 4 byte-aligned
- `ESP_ERR_INVALID_SIZE`: Master requires `size` bytes of data but Slave did not load enough bytes.

Parameters

- `arg`: Context of the component. (Member `arg` from `essl_handle_t`)
- `[out] out_data`: Output data address
- `size`: The size of the output data.
- `wait_ms`: Time to wait before timeout (reserved for future use, user should set this to 0).

esp_err_t **essl_spi_write_reg** (void *arg, uint8_t addr, uint8_t value, uint8_t *out_value, uint32_t wait_ms)

Write to the shared registers.

Note The registers for Master/Slave synchronization are reserved. Do not use them. (see `tx_sync_reg` in [essl_spi_config_t](#))

Note Feature of checking the actual written value (`out_value`) is not supported.

Return

- `ESP_OK`: success
- `ESP_ERR_INVALID_STATE`: ESSL SPI has not been initialized.
- `ESP_ERR_INVALID_ARG`: The address argument is not valid. See note 1.
- `ESP_ERR_NOT_SUPPORTED`: Should set `out_value` to `NULL`. See note 2.
- or other return value from `:cpp:func:spi_device_transmit`.

Parameters

- `arg`: Context of the component. (Member `arg` from `essl_handle_t`)
- `addr`: Address of the shared registers. (Valid: 0 ~ `SOC_SPI_MAXIMUM_BUFFER_SIZE`, registers for M/S sync are reserved, see note1)
- `value`: Buffer for data to send, should be align to 4.
- `[out] out_value`: Not supported, should be set to `NULL`.
- `wait_ms`: Time to wait before timeout (reserved for future use, user should set this to 0).

esp_err_t **essl_spi_send_packet** (void *arg, const void *data, size_t size, uint32_t wait_ms)

Send a packet to Slave.

Return

- `ESP_OK`: On success
- `ESP_ERR_INVALID_STATE`: ESSL SPI has not been initialized.
- `ESP_ERR_INVALID_ARG`: The data address is not DMA capable
- `ESP_ERR_INVALID_SIZE`: Master will send `size` bytes of data but Slave did not load enough RX buffer

Parameters

- `arg`: Context of the component. (Member `arg` from `essl_handle_t`)
- `data`: Address of the data to send
- `size`: Size of the data to send.
- `wait_ms`: Time to wait before timeout (reserved for future use, user should set this to 0).

void **essl_spi_reset_cnt** (void *arg)

Reset the counter in Master context.

Note Shall only be called if the slave has reset its counter. Else, Slave and Master would be desynchronized

Parameters

- `arg`: Context of the component. (Member `arg` from `essl_handle_t`)

esp_err_t `essl_spi_rdbuf` (*spi_device_handle_t* `spi`, `uint8_t *out_data`, `int addr`, `int len`, `uint32_t flags`)

Read the shared buffer from the slave in ISR way.

Note The slave's HW doesn't guarantee the data in one SPI transaction is consistent. It sends data in unit of byte. In other words, if the slave SW attempts to update the shared register when a `rdbuf` SPI transaction is in-flight, the data got by the master will be the combination of bytes of different writes of slave SW.

Note `out_data` should be prepared in words and in the DRAM. The buffer may be written in words by the DMA. When a byte is written, the remaining bytes in the same word will also be overwritten, even the `len` is shorter than a word.

Return

- `ESP_OK`: on success
- or other return value from `:cpp:func:spi_device_transmit`.

Parameters

- `spi`: SPI device handle representing the slave
- [out] `out_data`: Buffer for read data, strongly suggested to be in the DRAM and aligned to 4
- `addr`: Address of the slave shared buffer
- `len`: Length to read
- `flags`: `SPI_TRANS_*` flags to control the transaction mode of the transaction to send.

esp_err_t `essl_spi_rdbuf_polling` (*spi_device_handle_t* `spi`, `uint8_t *out_data`, `int addr`, `int len`, `uint32_t flags`)

Read the shared buffer from the slave in polling way.

Note `out_data` should be prepared in words and in the DRAM. The buffer may be written in words by the DMA. When a byte is written, the remaining bytes in the same word will also be overwritten, even the `len` is shorter than a word.

Return

- `ESP_OK`: on success
- or other return value from `:cpp:func:spi_device_transmit`.

Parameters

- `spi`: SPI device handle representing the slave
- [out] `out_data`: Buffer for read data, strongly suggested to be in the DRAM and aligned to 4
- `addr`: Address of the slave shared buffer
- `len`: Length to read
- `flags`: `SPI_TRANS_*` flags to control the transaction mode of the transaction to send.

esp_err_t `essl_spi_wrbuf` (*spi_device_handle_t* `spi`, `const uint8_t *data`, `int addr`, `int len`, `uint32_t flags`)

Write the shared buffer of the slave in ISR way.

Note `out_data` should be prepared in words and in the DRAM. The buffer may be written in words by the DMA. When a byte is written, the remaining bytes in the same word will also be overwritten, even the `len` is shorter than a word.

Return

- `ESP_OK`: success
- or other return value from `:cpp:func:spi_device_transmit`.

Parameters

- `spi`: SPI device handle representing the slave
- `data`: Buffer for data to send, strongly suggested to be in the DRAM
- `addr`: Address of the slave shared buffer,
- `len`: Length to write
- `flags`: `SPI_TRANS_*` flags to control the transaction mode of the transaction to send.

esp_err_t `essl_spi_wrbuf_polling` (*spi_device_handle_t* `spi`, `const uint8_t *data`, `int addr`, `int len`, `uint32_t flags`)

Write the shared buffer of the slave in polling way.

Note `out_data` should be prepared in words and in the DRAM. The buffer may be written in words by the DMA. When a byte is written, the remaining bytes in the same word will also be overwritten, even the

len is shorter than a word.

Return

- ESP_OK: success
- or other return value from :cpp:func:spi_device_polling_transmit.

Parameters

- spi: SPI device handle representing the slave
- data: Buffer for data to send, strongly suggested to be in the DRAM
- addr: Address of the slave shared buffer,
- len: Length to write
- flags: SPI_TRANS_* flags to control the transaction mode of the transaction to send.

esp_err_t **essl_spi_rddma** (*spi_device_handle_t* spi, uint8_t *out_data, int len, int seg_len, uint32_t flags)

Receive long buffer in segments from the slave through its DMA.

Note This function combines several :cpp:func:essl_spi_rddma_seg and one :cpp:func:essl_spi_rddma_done at the end. Used when the slave is working in segment mode.

Return

- ESP_OK: success
- or other return value from :cpp:func:spi_device_transmit.

Parameters

- spi: SPI device handle representing the slave
- [out] out_data: Buffer to hold the received data, strongly suggested to be in the DRAM and aligned to 4
- len: Total length of data to receive.
- seg_len: Length of each segment, which is not larger than the maximum transaction length allowed for the spi device. Suggested to be multiples of 4. When set < 0, means send all data in one segment (the rddma_done will still be sent.)
- flags: SPI_TRANS_* flags to control the transaction mode of the transaction to send.

esp_err_t **essl_spi_rddma_seg** (*spi_device_handle_t* spi, uint8_t *out_data, int seg_len, uint32_t flags)

Read one data segment from the slave through its DMA.

Note To read long buffer, call :cpp:func:essl_spi_rddma instead.

Return

- ESP_OK: success
- or other return value from :cpp:func:spi_device_transmit.

Parameters

- spi: SPI device handle representing the slave
- [out] out_data: Buffer to hold the received data. strongly suggested to be in the DRAM and aligned to 4
- seg_len: Length of this segment
- flags: SPI_TRANS_* flags to control the transaction mode of the transaction to send.

esp_err_t **essl_spi_rddma_done** (*spi_device_handle_t* spi, uint32_t flags)

Send the rddma_done command to the slave. Upon receiving this command, the slave will stop sending the current buffer even there are data unsent, and maybe prepare the next buffer to send.

Note This is required only when the slave is working in segment mode.

Return

- ESP_OK: success
- or other return value from :cpp:func:spi_device_transmit.

Parameters

- spi: SPI device handle representing the slave
- flags: SPI_TRANS_* flags to control the transaction mode of the transaction to send.

esp_err_t **essl_spi_wrdma** (*spi_device_handle_t* spi, const uint8_t *data, int len, int seg_len, uint32_t flags)

Send long buffer in segments to the slave through its DMA.

Note This function combines several :cpp:func:essl_spi_wrdma_seg and one

:cpp:func:essl_spi_wrdma_done at the end. Used when the slave is working in segment mode.

Return

- ESP_OK: success
- or other return value from :cpp:func:spi_device_transmit.

Parameters

- spi: SPI device handle representing the slave
- data: Buffer for data to send, strongly suggested to be in the DRAM
- len: Total length of data to send.
- seg_len: Length of each segment, which is not larger than the maximum transaction length allowed for the spi device. Suggested to be multiples of 4. When set < 0, means send all data in one segment (the wrdma_done will still be sent.)
- flags: SPI_TRANS_* flags to control the transaction mode of the transaction to send.

esp_err_t **essl_spi_wrdma_seg** (*spi_device_handle_t* spi, const uint8_t *data, int seg_len, uint32_t flags)

Send one data segment to the slave through its DMA.

Note To send long buffer, call :cpp:func:essl_spi_wrdma instead.

Return

- ESP_OK: success
- or other return value from :cpp:func:spi_device_transmit.

Parameters

- spi: SPI device handle representing the slave
- data: Buffer for data to send, strongly suggested to be in the DRAM
- seg_len: Length of this segment
- flags: SPI_TRANS_* flags to control the transaction mode of the transaction to send.

esp_err_t **essl_spi_wrdma_done** (*spi_device_handle_t* spi, uint32_t flags)

Send the wrdma_done command to the slave. Upon receiving this command, the slave will stop receiving, process the received data, and maybe prepare the next buffer to receive.

Note This is required only when the slave is working in segment mode.

Return

- ESP_OK: success
- or other return value from :cpp:func:spi_device_transmit.

Parameters

- spi: SPI device handle representing the slave
- flags: SPI_TRANS_* flags to control the transaction mode of the transaction to send.

Structures

struct **essl_spi_config_t**

Configuration of ESSL SPI device.

Public Members

spi_device_handle_t *spi

Pointer to SPI device handle.

uint32_t tx_buf_size

The pre-negotiated Master TX buffer size used by both the host and the slave.

uint8_t tx_sync_reg

The pre-negotiated register ID for Master-TX-SLAVE-RX synchronization. 1 word (4 Bytes) will be reserved for the synchronization.

uint8_t rx_sync_reg

The pre-negotiated register ID for Master-RX-Slave-TX synchronization. 1 word (4 Bytes) will be reserved for the synchronization.

2.4.13 ESP x509 Certificate Bundle

Overview

The ESP x509 Certificate Bundle API provides an easy way to include a bundle of custom x509 root certificates for TLS server verification.

Note: The bundle is currently not available when using WolfSSL.

The bundle comes with the complete list of root certificates from Mozilla's NSS root certificate store. Using the `gen_cert_bundle.py` python utility the certificates' subject name and public key are stored in a file and embedded in the ESP32-C3 binary.

When generating the bundle you may choose between:

- The full root certificate bundle from Mozilla, containing more than 130 certificates. The current bundle was updated Tue Apr 26 03:12:05 2022 GMT.
- A pre-selected filter list of the name of the most commonly used root certificates, reducing the amount of certificates to around 35 while still having around 90 % coverage according to market share statistics.

In addition it is possible to specify a path to a certificate file or a directory containing certificates which then will be added to the generated bundle.

Note: Trusting all root certificates means the list will have to be updated if any of the certificates are retracted. This includes removing them from `ca.crt_all.pem`.

Configuration

Most configuration is done through `menuconfig`. `Make` and `CMake` will generate the bundle according to the configuration and embed it.

- `CONFIG_MBEDTLS_CERTIFICATE_BUNDLE`: automatically build and attach the bundle.
- `CONFIG_MBEDTLS_DEFAULT_CERTIFICATE_BUNDLE`: decide which certificates to include from the complete root list.
- `CONFIG_MBEDTLS_CUSTOM_CERTIFICATE_BUNDLE_PATH`: specify the path of any additional certificates to embed in the bundle.

To enable the bundle when using ESP-TLS simply pass the function pointer to the bundle attach function:

```
esp_tls_cfg_t cfg = {
    .cert_bundle_attach = esp_cert_bundle_attach,
};
```

This is done to avoid embedding the certificate bundle unless activated by the user.

If using mbedTLS directly then the bundle may be activated by directly calling the attach function during the setup process:

```
mbedtls_ssl_config conf;
mbedtls_ssl_config_init(&conf);

esp_cert_bundle_attach(&conf);
```

Generating the List of Root Certificates

The list of root certificates comes from Mozilla's NSS root certificate store, which can be found [here](#). The list can be downloaded and created by running the script `mk-ca-bundle.pl` that is distributed as a part of [curl](#). Another

alternative would be to download the finished list directly from the curl website: [CA certificates extracted from Mozilla](#)

The common certificates bundle were made by selecting the authorities with a market share of more than 1 % from w3tech' s [SSL Survey](#). These authorities were then used to pick the names of the certificates for the filter list, *cmn_cert_authorities.csv*, from [this list](#) provided by Mozilla.

Updating the Certificate Bundle

The bundle is embedded into the app and can be updated along with the app by an OTA update. If you want to include a more up-to-date bundle than the bundle currently included in IDF, then the certificate list can be downloaded from Mozilla as described in [Updating the Certificate Bundle](#).

Application Example

Simple HTTPS example that uses ESP-TLS to establish a secure socket connection using the certificate bundle with two custom certificates added for verification: [protocols/https_x509_bundle](#).

HTTPS example that uses ESP-TLS and the default bundle: [protocols/https_request](#).

HTTPS example that uses mbedTLS and the default bundle: [protocols/https_mbedtls](#).

API Reference

Header File

- [mbedtls/esp_cert_bundle/include/esp_cert_bundle.h](#)

Functions

esp_err_t **esp_cert_bundle_attach** (void **conf*)

Attach and enable use of a bundle for certificate verification.

Attach and enable use of a bundle for certificate verification through a verification callback. If no specific bundle has been set through `esp_cert_bundle_set()` it will default to the bundle defined in menuconfig and embedded in the binary.

Return

- ESP_OK if adding certificates was successful.
- Other if an error occurred or an action must be taken by the calling process.

Parameters

- [in] *conf*: The config struct for the SSL connection.

void **esp_cert_bundle_detach** (mbedtls_ssl_config **conf*)

Disable and deallocate the certification bundle.

Removes the certificate verification callback and deallocates used resources

Parameters

- [in] *conf*: The config struct for the SSL connection.

esp_err_t **esp_cert_bundle_set** (const uint8_t **x509_bundle*, size_t *bundle_size*)

Set the default certificate bundle used for verification.

Overrides the default certificate bundle only in case of successful initialization. In most use cases the bundle should be set through menuconfig. The bundle needs to be sorted by subject name since binary search is used to find certificates.

Return

- ESP_OK if adding certificates was successful.
- Other if an error occurred or an action must be taken by the calling process.

Parameters

- [in] *x509_bundle*: A pointer to the certificate bundle.

- [in] bundle_size: Size of the certificate bundle in bytes.

Code examples for this API section are provided in the [protocols](#) directory of ESP-IDF examples.

2.4.14 IP Network Layer

Documentation for IP Network Layer protocols (below the Application Protocol layer) are provided in [Networking APIs](#).

2.5 Provisioning API

2.5.1 Protocol Communication

Overview

Protocol Communication (protocomm) component manages secure sessions and provides framework for multiple transports. The application can also use protocomm layer directly to have application specific extensions for the provisioning (or non-provisioning) use cases.

Following features are available for provisioning :

- **Communication security at application level -**
 - protocomm_security0 (no security)
 - protocomm_security1 (curve25519 key exchange + AES-CTR encryption)
- Proof-of-possession (support with protocomm_security1 only)

Protocomm internally uses protobuf (protocol buffers) for secure session establishment. Though users can implement their own security (even without using protobuf). One can even use protocomm without any security layer.

Protocomm provides framework for various transports - WiFi (SoftAP+HTTPD), BLE, console - in which case the handler invocation is automatically taken care of on the device side (see Transport Examples below for code snippets).

Note that the client still needs to establish session (only for protocomm_security1) by performing the two way handshake. See [Unified Provisioning](#) for more details about the secure handshake logic.

Transport Example (SoftAP + HTTP) with Security 1

For complete example see [provisioning/legacy/softap_prov](#)

```

/* Endpoint handler to be registered with protocomm.
 * This simply echoes back the received data. */
esp_err_t echo_req_handler (uint32_t session_id,
                            const uint8_t *inbuf, ssize_t inlen,
                            uint8_t **outbuf, ssize_t *outlen,
                            void *priv_data)
{
    /* Session ID may be used for persistence */
    printf("Session ID : %d", session_id);

    /* Echo back the received data */
    *outlen = inlen;          /* Output data length updated */
    *outbuf = malloc(inlen); /* This will be deallocated outside */
    memcpy(*outbuf, inbuf, inlen);

    /* Private data that was passed at the time of endpoint creation */
    uint32_t *priv = (uint32_t *) priv_data;
    if (priv) {
        printf("Private data : %d", *priv);
    }
}

```

(continues on next page)

(continued from previous page)

```

    return ESP_OK;
}

/* Example function for launching a protocomm instance over HTTP */
protocomm_t *start_pc(const char *pop_string)
{
    protocomm_t *pc = protocomm_new();

    /* Config for protocomm_httpd_start() */
    protocomm_httpd_config_t pc_config = {
        .data = {
            .config = PROTOCOMM_HTTPD_DEFAULT_CONFIG()
        }
    };

    /* Start protocomm server on top of HTTP */
    protocomm_httpd_start(pc, &pc_config);

    /* Create Proof of Possession object from pop_string. It must be valid
     * throughout the scope of protocomm endpoint. This need not be
     ↪static,
     * ie. could be dynamically allocated and freed at the time of
     ↪endpoint
     * removal */
    const static protocomm_security_pop_t pop_obj = {
        .data = (const uint8_t *) strdup(pop_string),
        .len = strlen(pop_string)
    };

    /* Set security for communication at application level. Just like for
     * request handlers, setting security creates an endpoint and
     ↪registers
     * the handler provided by protocomm_security1. One can similarly use
     * protocomm_security0. Only one type of security can be set for a
     * protocomm instance at a time. */
    protocomm_set_security(pc, "security_endpoint", &protocomm_security1,
    ↪&pop_obj);

    /* Private data passed to the endpoint must be valid throughout the
     ↪scope
     * of protocomm endpoint. This need not be static, ie. could be
     ↪dynamically
     * allocated and freed at the time of endpoint removal */
    static uint32_t priv_data = 1234;

    /* Add a new endpoint for the protocomm instance, identified by a
     ↪unique name
     * and register a handler function along with private data to be
     ↪passed at the
     * time of handler execution. Multiple endpoints can be added as long
     ↪as they
     * are identified by unique names */
    protocomm_add_endpoint(pc, "echo_req_endpoint",
                          echo_req_handler, (void *) &priv_data);

    return pc;
}

/* Example function for stopping a protocomm instance */
void stop_pc(protocomm_t *pc)

```

(continues on next page)

(continued from previous page)

```

{
    /* Remove endpoint identified by it's unique name */
    protocomm_remove_endpoint(pc, "echo_req_endpoint");

    /* Remove security endpoint identified by it's name */
    protocomm_unset_security(pc, "security_endpoint");

    /* Stop HTTP server */
    protocomm_httpd_stop(pc);

    /* Delete (deallocate) the protocomm instance */
    protocomm_delete(pc);
}

```

Transport Example (BLE) with Security 0

For complete example see [provisioning/legacy/ble_prov](#)

```

/* Example function for launching a secure protocomm instance over BLE */
protocomm_t *start_pc()
{
    protocomm_t *pc = protocomm_new();

    /* Endpoint UUIDs */
    protocomm_ble_name_uuid_t nu_lookup_table[] = {
        {"security_endpoint", 0xFF51},
        {"echo_req_endpoint", 0xFF52}
    };

    /* Config for protocomm_ble_start() */
    protocomm_ble_config_t config = {
        .service_uuid = {
            /* LSB <-----> MSB */
            0xfb, 0x34, 0x9b, 0x5f, 0x80, 0x00, 0x00, 0x80,
            0x00, 0x10, 0x00, 0x00, 0xFF, 0xFF, 0x00, 0x00,
        },
        .nu_lookup_count = sizeof(nu_lookup_table)/sizeof(nu_lookup_
→table[0]),
        .nu_lookup = nu_lookup_table
    };

    /* Start protocomm layer on top of BLE */
    protocomm_ble_start(pc, &config);

    /* For protocomm_security0, Proof of Possession is not used, and can
→be kept NULL */
    protocomm_set_security(pc, "security_endpoint", &protocomm_security0,
→NULL);
    protocomm_add_endpoint(pc, "echo_req_endpoint", echo_req_handler,
→NULL);
    return pc;
}

/* Example function for stopping a protocomm instance */
void stop_pc(protocomm_t *pc)
{
    protocomm_remove_endpoint(pc, "echo_req_endpoint");
    protocomm_unset_security(pc, "security_endpoint");
}

```

(continues on next page)

(continued from previous page)

```

/* Stop BLE protocomm service */
protocomm_ble_stop(pc);

protocomm_delete(pc);
}

```

API Reference

Header File

- [protocomm/include/common/protocomm.h](#)

Functions

protocomm_t ***protocomm_new** (void)

Create a new protocomm instance.

This API will return a new dynamically allocated protocomm instance with all elements of the *protocomm_t* structure initialized to NULL.

Return

- *protocomm_t** : On success
- NULL : No memory for allocating new instance

void **protocomm_delete** (*protocomm_t* *pc)

Delete a protocomm instance.

This API will deallocate a protocomm instance that was created using *protocomm_new* ().

Parameters

- [in] pc: Pointer to the protocomm instance to be deleted

esp_err_t **protocomm_add_endpoint** (*protocomm_t* *pc, const char *ep_name, *protocomm_req_handler_t* h, void *priv_data)

Add endpoint request handler for a protocomm instance.

This API will bind an endpoint handler function to the specified endpoint name, along with any private data that needs to be pass to the handler at the time of call.

Note

- An endpoint must be bound to a valid protocomm instance, created using *protocomm_new* ().
- This function internally calls the registered *add_endpoint* () function of the selected transport which is a member of the *protocomm_t* instance structure.

Return

- ESP_OK : Success
- ESP_FAIL : Error adding endpoint / Endpoint with this name already exists
- ESP_ERR_NO_MEM : Error allocating endpoint resource
- ESP_ERR_INVALID_ARG : Null instance/name/handler arguments

Parameters

- [in] pc: Pointer to the protocomm instance
- [in] ep_name: Endpoint identifier(name) string
- [in] h: Endpoint handler function
- [in] priv_data: Pointer to private data to be passed as a parameter to the handler function on call. Pass NULL if not needed.

esp_err_t **protocomm_remove_endpoint** (*protocomm_t* *pc, const char *ep_name)

Remove endpoint request handler for a protocomm instance.

This API will remove a registered endpoint handler identified by an endpoint name.

Note

- This function internally calls the registered *remove_endpoint* () function which is a member of the *protocomm_t* instance structure.

Return

- ESP_OK : Success
- ESP_ERR_NOT_FOUND : Endpoint with specified name doesn't exist
- ESP_ERR_INVALID_ARG : Null instance/name arguments

Parameters

- [in] pc: Pointer to the protocomm instance
- [in] ep_name: Endpoint identifier(name) string

esp_err_t **protocomm_open_session** (*protocomm_t* *pc, uint32_t session_id)

Allocates internal resources for new transport session.

Note

- An endpoint must be bound to a valid protocomm instance, created using `protocomm_new()`.

Return

- ESP_OK : Request handled successfully
- ESP_ERR_NO_MEM : Error allocating internal resource
- ESP_ERR_INVALID_ARG : Null instance/name arguments

Parameters

- [in] pc: Pointer to the protocomm instance
- [in] session_id: Unique ID for a communication session

esp_err_t **protocomm_close_session** (*protocomm_t* *pc, uint32_t session_id)

Frees internal resources used by a transport session.

Note

- An endpoint must be bound to a valid protocomm instance, created using `protocomm_new()`.

Return

- ESP_OK : Request handled successfully
- ESP_ERR_INVALID_ARG : Null instance/name arguments

Parameters

- [in] pc: Pointer to the protocomm instance
- [in] session_id: Unique ID for a communication session

esp_err_t **protocomm_req_handle** (*protocomm_t* *pc, const char *ep_name, uint32_t session_id, const uint8_t *inbuf, ssize_t inlen, uint8_t **outbuf, ssize_t *outlen)

Calls the registered handler of an endpoint session for processing incoming data and generating the response.

Note

- An endpoint must be bound to a valid protocomm instance, created using `protocomm_new()`.
- Resulting output buffer must be deallocated by the caller.

Return

- ESP_OK : Request handled successfully
- ESP_FAIL : Internal error in execution of registered handler
- ESP_ERR_NO_MEM : Error allocating internal resource
- ESP_ERR_NOT_FOUND : Endpoint with specified name doesn't exist
- ESP_ERR_INVALID_ARG : Null instance/name arguments

Parameters

- [in] pc: Pointer to the protocomm instance
- [in] ep_name: Endpoint identifier(name) string
- [in] session_id: Unique ID for a communication session
- [in] inbuf: Input buffer contains input request data which is to be processed by the registered handler
- [in] inlen: Length of the input buffer
- [out] outbuf: Pointer to internally allocated output buffer, where the resulting response data output from the registered handler is to be stored
- [out] outlen: Buffer length of the allocated output buffer

esp_err_t **protocomm_set_security** (*protocomm_t* *pc, const char *ep_name, const *protocomm_security_t* *sec, const *protocomm_security_pop_t* *pop)

Add endpoint security for a protocomm instance.

This API will bind a security session establisher to the specified endpoint name, along with any proof of possession that may be required for authenticating a session client.

Note

- An endpoint must be bound to a valid `protocomm` instance, created using `protocomm_new()`.
- The choice of security can be any `protocomm_security_t` instance. Choices `protocomm_security0` and `protocomm_security1` are readily available.

Return

- `ESP_OK` : Success
- `ESP_FAIL` : Error adding endpoint / Endpoint with this name already exists
- `ESP_ERR_INVALID_STATE` : Security endpoint already set
- `ESP_ERR_NO_MEM` : Error allocating endpoint resource
- `ESP_ERR_INVALID_ARG` : Null instance/name/handler arguments

Parameters

- `[in] pc`: Pointer to the `protocomm` instance
- `[in] ep_name`: Endpoint identifier(name) string
- `[in] sec`: Pointer to endpoint security instance
- `[in] pop`: Pointer to proof of possession for authenticating a client

esp_err_t **protocomm_unset_security** (*protocomm_t* *pc, **const** char *ep_name)

Remove endpoint security for a `protocomm` instance.

This API will remove a registered security endpoint identified by an endpoint name.

Return

- `ESP_OK` : Success
- `ESP_ERR_NOT_FOUND` : Endpoint with specified name doesn't exist
- `ESP_ERR_INVALID_ARG` : Null instance/name arguments

Parameters

- `[in] pc`: Pointer to the `protocomm` instance
- `[in] ep_name`: Endpoint identifier(name) string

esp_err_t **protocomm_set_version** (*protocomm_t* *pc, **const** char *ep_name, **const** char *version)

Set endpoint for version verification.

This API can be used for setting an application specific protocol version which can be verified by clients through the endpoint.

Note

- An endpoint must be bound to a valid `protocomm` instance, created using `protocomm_new()`.

Return

- `ESP_OK` : Success
- `ESP_FAIL` : Error adding endpoint / Endpoint with this name already exists
- `ESP_ERR_INVALID_STATE` : Version endpoint already set
- `ESP_ERR_NO_MEM` : Error allocating endpoint resource
- `ESP_ERR_INVALID_ARG` : Null instance/name/handler arguments

Parameters

- `[in] pc`: Pointer to the `protocomm` instance
- `[in] ep_name`: Endpoint identifier(name) string
- `[in] version`: Version identifier(name) string

esp_err_t **protocomm_unset_version** (*protocomm_t* *pc, **const** char *ep_name)

Remove version verification endpoint from a `protocomm` instance.

This API will remove a registered version endpoint identified by an endpoint name.

Return

- `ESP_OK` : Success
- `ESP_ERR_NOT_FOUND` : Endpoint with specified name doesn't exist
- `ESP_ERR_INVALID_ARG` : Null instance/name arguments

Parameters

- `[in] pc`: Pointer to the `protocomm` instance
- `[in] ep_name`: Endpoint identifier(name) string

Type Definitions

```
typedef esp_err_t (*protocomm_req_handler_t) (uint32_t session_id, const uint8_t *inbuf,
                                             ssize_t inlen, uint8_t **outbuf, ssize_t *outlen,
                                             void *priv_data)
```

Function prototype for protocomm endpoint handler.

```
typedef struct protocomm protocomm_t
```

This structure corresponds to a unique instance of protocomm returned when the API `protocomm_new()` is called. The remaining Protocomm APIs require this object as the first parameter.

Note Structure of the protocomm object is kept private

Header File

- [protocomm/include/security/protocomm_security.h](#)

Structures

```
struct protocomm_security_pop
```

Proof Of Possession for authenticating a secure session.

Public Members

```
const uint8_t *data
```

Pointer to buffer containing the proof of possession data

```
uint16_t len
```

Length (in bytes) of the proof of possession data

```
struct protocomm_security
```

Protocomm security object structure.

The member functions are used for implementing secure protocomm sessions.

Note This structure should not have any dynamic members to allow re-entrancy

Public Members

```
int ver
```

Unique version number of security implementation

```
esp_err_t (*init) (protocomm_security_handle_t *handle)
```

Function for initializing/allocating security infrastructure

```
esp_err_t (*cleanup) (protocomm_security_handle_t handle)
```

Function for deallocating security infrastructure

```
esp_err_t (*new_transport_session) (protocomm_security_handle_t handle, uint32_t session_id)
```

Starts new secure transport session with specified ID

```
esp_err_t (*close_transport_session) (protocomm_security_handle_t handle, uint32_t session_id)
```

Closes a secure transport session with specified ID

```
esp_err_t (*security_req_handler) (protocomm_security_handle_t handle, const protocomm_security_pop_t *pop, uint32_t session_id, const uint8_t *inbuf,
                                     ssize_t inlen, uint8_t **outbuf, ssize_t *outlen, void *priv_data)
```

Handler function for authenticating connection request and establishing secure session

```
esp_err_t (*encrypt) (protocomm_security_handle_t handle, uint32_t session_id, const uint8_t *inbuf,
                                     ssize_t inlen, uint8_t *outbuf, ssize_t *outlen)
```

Function which implements the encryption algorithm

esp_err_t (***decrypt**) (*protocomm_security_handle_t* handle, uint32_t session_id, **const** uint8_t *inbuf, ssize_t inlen, uint8_t *outbuf, ssize_t *outlen)
Function which implements the decryption algorithm

Type Definitions

typedef struct *protocomm_security_pop* **protocomm_security_pop_t**

Proof Of Possession for authenticating a secure session.

typedef void ***protocomm_security_handle_t**

typedef struct *protocomm_security* **protocomm_security_t**

Protocomm security object structure.

The member functions are used for implementing secure protocomm sessions.

Note This structure should not have any dynamic members to allow re-entrancy

Header File

- [protocomm/include/security/protocomm_security0.h](#)

Header File

- [protocomm/include/security/protocomm_security1.h](#)

Header File

- [protocomm/include/transports/protocomm_httpd.h](#)

Functions

esp_err_t **protocomm_httpd_start** (*protocomm_t* *pc, **const** *protocomm_httpd_config_t* *config)

Start HTTPD protocomm transport.

This API internally creates a framework to allow endpoint registration and security configuration for the protocomm.

Note This is a singleton. ie. Protocomm can have multiple instances, but only one instance can be bound to an HTTP transport layer.

Return

- **ESP_OK** : Success
- **ESP_ERR_INVALID_ARG** : Null arguments
- **ESP_ERR_NOT_SUPPORTED** : Transport layer bound to another protocomm instance
- **ESP_ERR_INVALID_STATE** : Transport layer already bound to this protocomm instance
- **ESP_ERR_NO_MEM** : Memory allocation for server resource failed
- **ESP_ERR_HTTPD_*** : HTTP server error on start

Parameters

- [*in*] pc: Protocomm instance pointer obtained from `protocomm_new()`
- [*in*] config: Pointer to config structure for initializing HTTP server

esp_err_t **protocomm_httpd_stop** (*protocomm_t* *pc)

Stop HTTPD protocomm transport.

This API cleans up the HTTPD transport protocomm and frees all the handlers registered with the protocomm.

Return

- **ESP_OK** : Success
- **ESP_ERR_INVALID_ARG** : Null / incorrect protocomm instance pointer

Parameters

- [*in*] pc: Same protocomm instance that was passed to `protocomm_httpd_start()`

Unions

union `protocomm_httpd_config_data_t`
#include <protocomm_httpd.h> Protocomm HTTPD Configuration Data

Public Members

`void *handle`
HTTP Server Handle, if `ext_handle_provided` is set to true

protocomm_http_server_config_t `config`
HTTP Server Configuration, if a server is not already active

Structures

struct `protocomm_http_server_config_t`
Config parameters for protocomm HTTP server.

Public Members

`uint16_t port`
Port on which the HTTP server will listen

`size_t stack_size`
Stack size of server task, adjusted depending upon stack usage of endpoint handler

`unsigned task_priority`
Priority of server task

struct `protocomm_httpd_config_t`
Config parameters for protocomm HTTP server.

Public Members

`bool ext_handle_provided`
Flag to indicate of an external HTTP Server Handle has been provided. In such as case, protocomm will use the same HTTP Server and not start a new one internally.

protocomm_httpd_config_data_t `data`
Protocomm HTTPD Configuration Data

Macros

`PROTOCOLM_HTTPD_DEFAULT_CONFIG ()`

Header File

- [protocomm/include/transport/protocomm_ble.h](#)

Functions

esp_err_t `protocomm_ble_start` (*protocomm_t* *pc, **const** *protocomm_ble_config_t* *config)
Start Bluetooth Low Energy based transport layer for provisioning.

Initialize and start required BLE service for provisioning. This includes the initialization for characteristics/service for BLE.

Return

- `ESP_OK` : Success
- `ESP_FAIL` : Simple BLE start error
- `ESP_ERR_NO_MEM` : Error allocating memory for internal resources

- `ESP_ERR_INVALID_STATE` : Error in ble config
- `ESP_ERR_INVALID_ARG` : Null arguments

Parameters

- `[in] pc`: Protocomm instance pointer obtained from `protocomm_new()`
- `[in] config`: Pointer to config structure for initializing BLE

`esp_err_t` **protocomm_ble_stop** (*protocomm_t* *pc)

Stop Bluetooth Low Energy based transport layer for provisioning.

Stops service/task responsible for BLE based interactions for provisioning

Note You might want to optionally reclaim memory from Bluetooth. Refer to the documentation of `esp_bt_mem_release` in that case.

Return

- `ESP_OK` : Success
- `ESP_FAIL` : Simple BLE stop error
- `ESP_ERR_INVALID_ARG` : Null / incorrect protocomm instance

Parameters

- `[in] pc`: Same protocomm instance that was passed to `protocomm_ble_start()`

Structures**struct name_uuid**

This structure maps handler required by protocomm layer to UUIDs which are used to uniquely identify BLE characteristics from a smartphone or a similar client device.

Public Members

const char *name

Name of the handler, which is passed to protocomm layer

uint16_t uuid

UUID to be assigned to the BLE characteristic which is mapped to the handler

struct protocomm_ble_config

Config parameters for protocomm BLE service.

Public Members

char device_name[`MAX_BLE_DEVNAME_LEN`]

BLE device name being broadcast at the time of provisioning

uint8_t service_uuid[`BLE_UUID128_VAL_LENGTH`]

128 bit UUID of the provisioning service

uint8_t *manufacturer_data

BLE device manufacturer data pointer in advertisement

ssize_t manufacturer_data_len

BLE device manufacturer data length in advertisement

ssize_t nu_lookup_count

Number of entries in the Name-UUID lookup table

protocomm_ble_name_uuid_t ***nu_lookup**

Pointer to the Name-UUID lookup table

unsigned ble_bonding : 1

BLE bonding

unsigned ble_sm_sc : 1

BLE security flag

Macros

MAX_BLE_DEVNAME_LEN

BLE device name cannot be larger than this value 31 bytes (max scan response size) - 1 byte (length) - 1 byte (type) = 29 bytes

BLE_UUID128_VAL_LENGTH

MAX_BLE_MANUFACTURER_DATA_LEN

Theoretically, the limit for max manufacturer length remains same as BLE device name i.e. 31 bytes (max scan response size) - 1 byte (length) - 1 byte (type) = 29 bytes However, manufacturer data goes along with BLE device name in scan response. So, it is important to understand the actual length should be smaller than (29 - (BLE device name length) - 2).

Type Definitions

```
typedef struct name_uuid protocomm_ble_name_uuid_t
```

This structure maps handler required by protocomm layer to UUIDs which are used to uniquely identify BLE characteristics from a smartphone or a similar client device.

```
typedef struct protocomm_ble_config protocomm_ble_config_t
```

Config parameters for protocomm BLE service.

2.5.2 Unified Provisioning

Overview

Unified provisioning support in the ESP-IDF provides an extensible mechanism to the developers to configure the device with the Wi-Fi credentials and/or other custom configuration using various transports and different security schemes. Depending on the use-case it provides a complete and ready solution for Wi-Fi network provisioning along with example iOS and Android applications. Or developers can extend the device-side and phone-app side implementations to accommodate their requirements for sending additional configuration data. Following are the important features of this implementation.

1. *Extensible Protocol*: The protocol is completely flexible and it offers the ability for the developers to send custom configuration in the provisioning process. The data representation too is left to the application to decide.
2. *Transport Flexibility*: The protocol can work on Wi-Fi (SoftAP + HTTP server) or on BLE as a transport protocol. The framework provides an ability to add support for any other transport easily as long as command-response behaviour can be supported on the transport.
3. *Security Scheme Flexibility*: It's understood that each use-case may require different security scheme to secure the data that is exchanged in the provisioning process. Some applications may work with SoftAP that's WPA2 protected or BLE with "just-works" security. Or the applications may consider the transport to be insecure and may want application level security. The unified provisioning framework allows application to choose the security as deemed suitable.
4. *Compact Data Representation*: The protocol uses [Google Protobufs](#) as a data representation for session setup and Wi-Fi provisioning. They provide a compact data representation and ability to parse the data in multiple programming languages in native format. Please note that this data representation is not forced on application specific data and the developers may choose the representation of their choice.

Typical Provisioning Process

Deciding on Transport

Unified provisioning subsystem supports Wi-Fi (SoftAP+HTTP server) and BLE (GATT based) transport schemes. Following points need to be considered while selecting the best possible transport for provisioning.

1. BLE based transport has an advantage that in the provisioning process, the BLE communication channel stays intact between the device and the client. That provides reliable provisioning feedback.
2. BLE based provisioning implementation makes the user-experience better from the phone apps as on Android and iOS both, the phone app can discover and connect to the device without requiring user to go out of the phone app

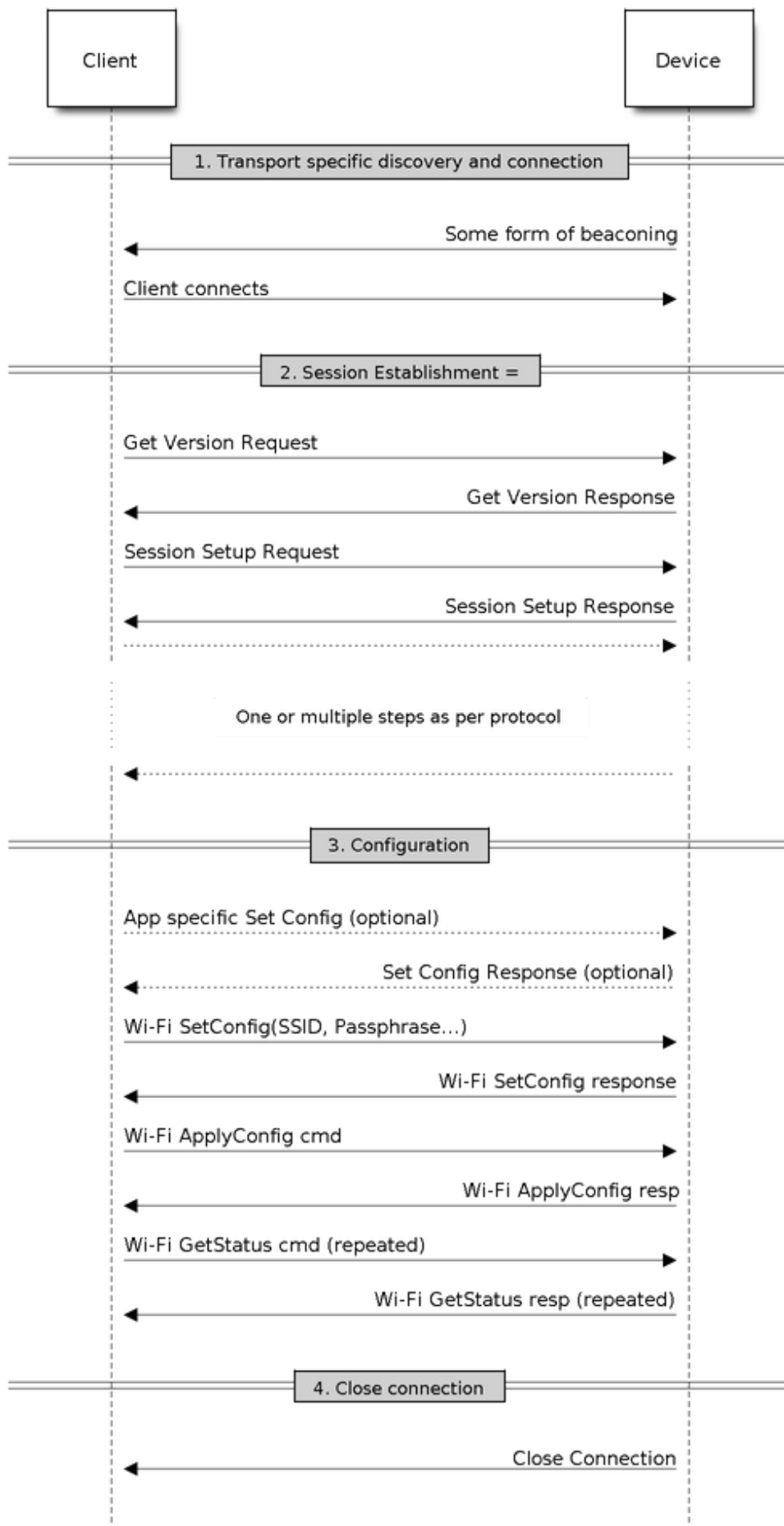

Fig. 18: Typical Provisioning Process

3. BLE transport however consumes ~110KB memory at runtime. If the product does not use the BLE or BT functionality after provisioning is done, almost all the memory can be reclaimed back and can be added into the heap.
4. SoftAP based transport is highly interoperable; however as the same radio is shared between SoftAP and Station interface, the transport is not reliable in the phase when the Wi-Fi connection to external AP is attempted. Also, the client may roam back to different network when the SoftAP changes the channel at the time of Station connection.
5. SoftAP transport does not require much additional memory for the Wi-Fi use-cases
6. SoftAP based provisioning requires the phone app user to go to “System Settings” to connect to Wi-Fi network hosted by the device in case of iOS. The discovery (scanning) as well as connection API is not available for the iOS applications.

Deciding on Security

Depending on the transport and other constraints the security scheme needs to be selected by the application developers. Following considerations need to be given from the provisioning security perspective: 1. The configuration data sent from the client to the device and the response has to be secured. 2. The client should authenticate the device it is connected to. 3. The device manufacturer may choose proof-of-possession - a unique per device secret to be entered on the provisioning client as a security measure to make sure that the user can provision the device in the possession.

There are two levels of security schemes. The developer may select one or combination depending on requirements.

1. *Transport Security*: SoftAP provisioning may choose WPA2 protected security with unique per-device passphrase. Per-device unique passphrase can also act as a proof-of-possession. For BLE, “just-works” security can be used as a transport level security after understanding the level of security it provides.
2. *Application Security*: The unified provisioning subsystem provides application level security (*security1*) that provides data protection and authentication (through proof-of-possession) if the application does not use the transport level security or if the transport level security is not sufficient for the use-case.

Device Discovery

The advertisement and device discovery is left to the application and depending on the protocol chosen, the phone apps and device firmware application can choose appropriate method to advertise and discovery.

For the SoftAP+HTTP transport, typically the SSID (network name) of the AP hosted by the device can be used for discovery.

For the BLE transport device name or primary service included in the advertisement or combination of both can be used for discovery.

Architecture

The below diagram shows architecture of unified provisioning.

It relies on the base layer called *Protocol Communication* (Protocol Communication) which provides a framework for security schemes and transport mechanisms. Wi-Fi Provisioning layer uses Protocomm to provide simple callbacks to the application for setting the configuration and getting the Wi-Fi status. The application has control over implementation of these callbacks. In addition application can directly use protocomm to register custom handlers.

Application creates a protocomm instance which is mapped to a specific transport and specific security scheme. Each transport in the protocomm has a concept of an “end-point” which corresponds to logical channel for communication for specific type of information. For example security handshake happens on a different endpoint than the Wi-Fi configuration endpoint. Each end-point is identified using a string and depending on the transport internal representation of the end-point changes. In case of SoftAP+HTTP transport the end-point corresponds to URI whereas in case of BLE the end-point corresponds to GATT characteristic with specific UUID. Developers can create custom end-points and implement handler for the data that is received or sent over the same end-point.

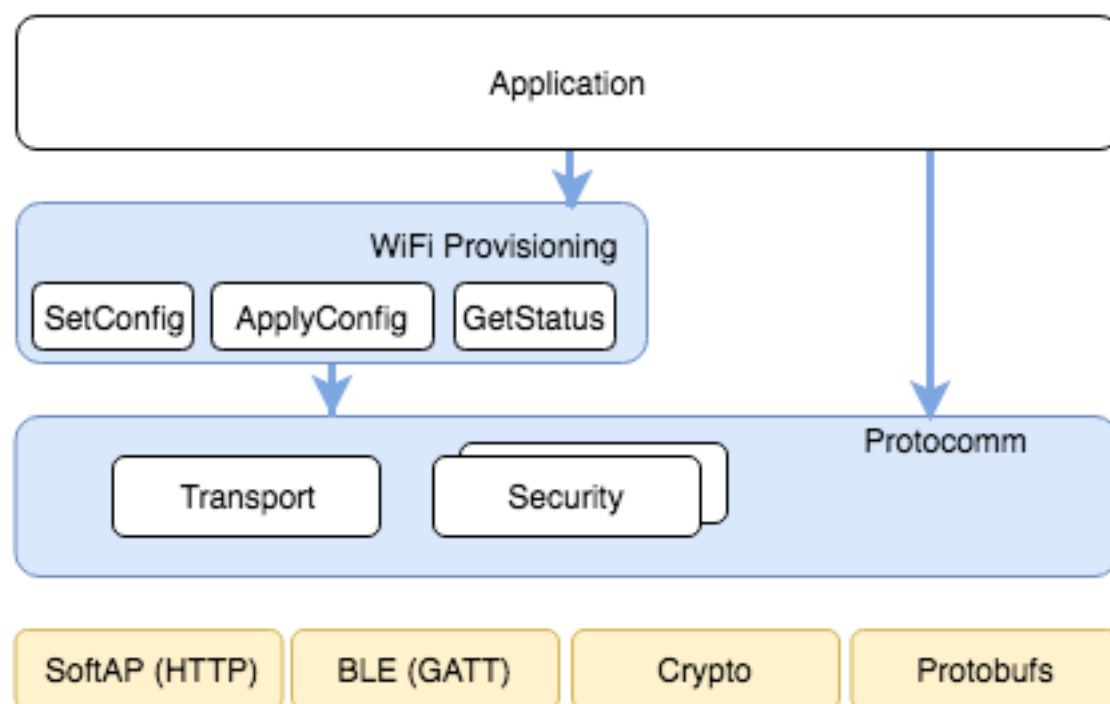

Fig. 19: Unified Provisioning Architecture

Security Schemes

At present unified provisioning supports two security schemes: 1. Security0 - No security (No encryption) 2. Security1 - Curve25519 based key exchange, shared key derivation and AES256-CTR mode encryption of the data. It supports two modes :

- a. Authorized - Proof of Possession (PoP) string used to authorize session and derive shared key
- b. No Auth (Null PoP) - Shared key derived through key exchange only

Security1 scheme details are shown in the below sequence diagram

Sample Code

Please refer to [Protocol Communication](#) and [Wi-Fi Provisioning](#) for API guides and code snippets on example usage.

Application implementation can be found as an example under [provisioning](#).

Provisioning Tools

Provisioning applications are available for various platforms, along with source code:

- **Android:**
 - [BLE Provisioning app on Play Store](#).
 - [SoftAP Provisioning app on Play Store](#).
 - Source code on GitHub: [esp-idf-provisioning-android](#).
- **iOS:**
 - [BLE Provisioning app on app store](#).
 - [SoftAP Provisioning app on app Store](#).
 - Source code on GitHub: [esp-idf-provisioning-ios](#).
- Linux/MacOS/Windows : [tools/esp_prov](#) (a python based command line tool for provisioning)

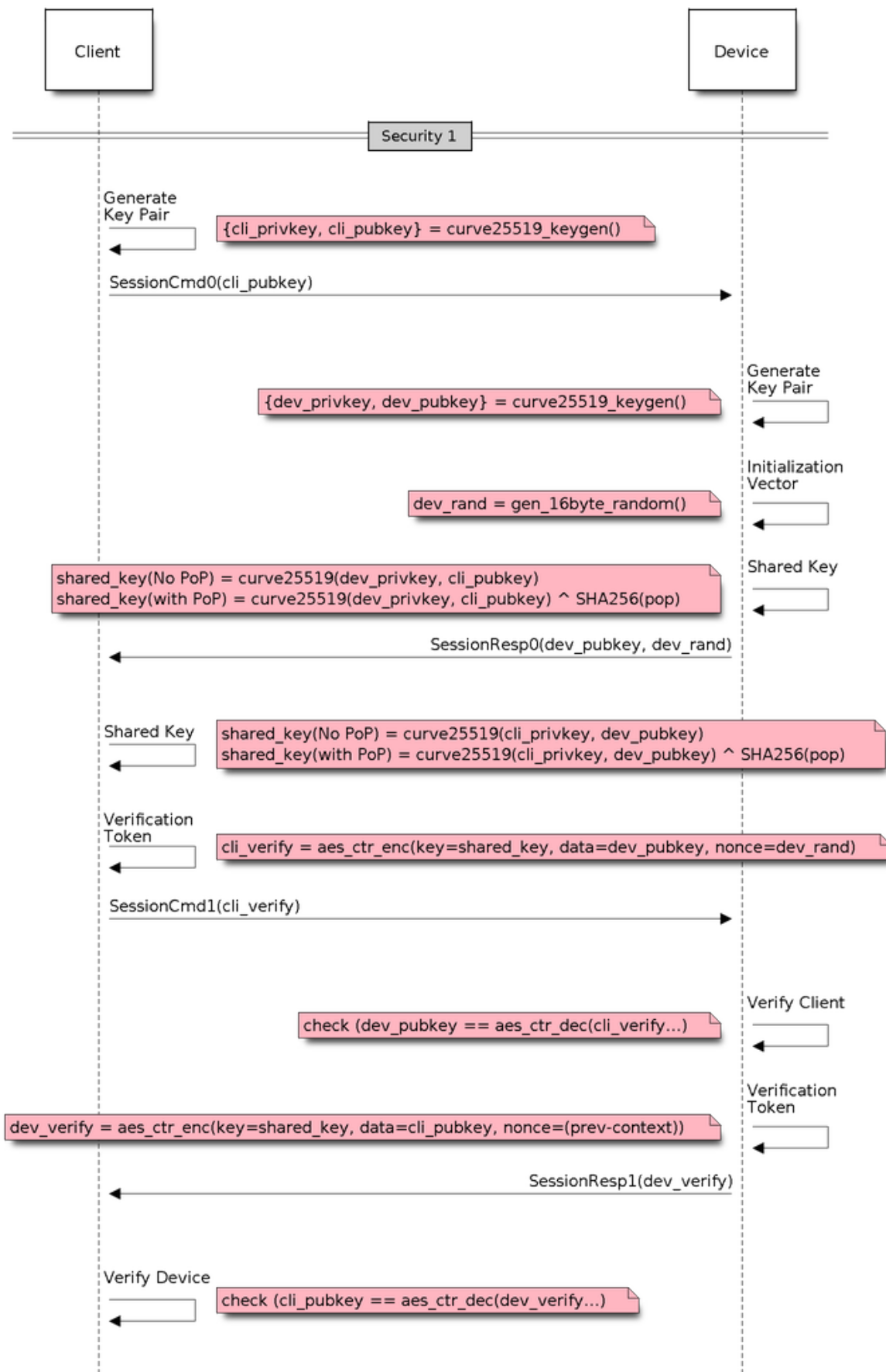

Fig. 20: Security1

The phone applications offer simple UI and thus more user centric, while the command line application is useful as a debugging tool for developers.

2.5.3 Wi-Fi Provisioning

Overview

This component provides APIs that control Wi-Fi provisioning service for receiving and configuring Wi-Fi credentials over SoftAP or BLE transport via secure *Protocol Communication (protocomm)* sessions. The set of `wifi_prov_mgr_` APIs help in quickly implementing a provisioning service having necessary features with minimal amount of code and sufficient flexibility.

Initialization `wifi_prov_mgr_init()` is called to configure and initialize the provisioning manager and thus this must be called prior to invoking any other `wifi_prov_mgr_` APIs. Note that the manager relies on other components of IDF, namely NVS, TCP/IP, Event Loop and Wi-Fi (and optionally mDNS), hence these must be initialized beforehand. The manager can be de-initialized at any moment by making a call to `wifi_prov_mgr_deinit()`.

```
wifi_prov_mgr_config_t config = {
    .scheme = wifi_prov_scheme_ble,
    .scheme_event_handler = WIFI_PROV_SCHEME_BLE_EVENT_HANDLER_FREE_BTDM
};

ESP_ERR_CHECK( wifi_prov_mgr_init(config) );
```

The configuration structure `wifi_prov_mgr_config_t` has a few fields to specify the behavior desired of the manager :

- *scheme* : This is used to specify the provisioning scheme. Each scheme corresponds to one of the modes of transport supported by *protocomm*. Hence, we have three options :
 - `wifi_prov_scheme_ble` : BLE transport and GATT Server for handling provisioning commands
 - `wifi_prov_scheme_softap` : Wi-Fi SoftAP transport and HTTP Server for handling provisioning commands
 - `wifi_prov_scheme_console` : Serial transport and console for handling provisioning commands
- *scheme_event_handler* : An event handler defined along with scheme. Choosing appropriate scheme specific event handler allows the manager to take care of certain matters automatically. Presently this is not used for either SoftAP or Console based provisioning, but is very convenient for BLE. To understand how, we must recall that Bluetooth requires quite some amount of memory to function and once provisioning is finished, the main application may want to reclaim back this memory (or part of it, if it needs to use either BLE or classic BT). Also, upon every future re-boot of a provisioned device, this reclamation of memory needs to be performed again. To reduce this complication in using `wifi_prov_scheme_ble`, the scheme specific handlers have been defined, and depending upon the chosen handler, the BLE / classic BT / BTDM memory will be freed automatically when the provisioning manager is de-initialized. The available options are:
 - `WIFI_PROV_SCHEME_BLE_EVENT_HANDLER_FREE_BTDM` - Free both classic BT and BLE (BTDM) memory. Used when main application doesn't require Bluetooth at all.
 - `WIFI_PROV_SCHEME_BLE_EVENT_HANDLER_FREE_BLE` - Free only BLE memory. Used when main application requires classic BT.
 - `WIFI_PROV_SCHEME_BLE_EVENT_HANDLER_FREE_BT` - Free only classic BT. Used when main application requires BLE. In this case freeing happens right when the manager is initialized.
 - `WIFI_PROV_EVENT_HANDLER_NONE` - Don't use any scheme specific handler. Used when provisioning scheme is not BLE (i.e. SoftAP or Console), or when main application wants to handle the memory reclaiming on its own, or needs both BLE and classic BT to function.
- *app_event_handler* (Deprecated) : It is now recommended to catch `WIFI_PROV_EVENT` `s` that are emitted to the default event loop handler. See definition

of `wifi_prov_cb_event_t` for the list of events that are generated by the provisioning service. Here is an excerpt showing some of the provisioning events:

```
static void event_handler(void* arg, esp_event_base_t event_base,
                          int event_id, void* event_data)
{
    if (event_base == WIFI_PROV_EVENT) {
        switch (event_id) {
            case WIFI_PROV_START:
                ESP_LOGI(TAG, "Provisioning started");
                break;
            case WIFI_PROV_CRED_RECV: {
                wifi_sta_config_t *wifi_sta_cfg = (wifi_sta_config_t_
→*)event_data;
                ESP_LOGI(TAG, "Received Wi-Fi credentials"
"\n\tSSID      : %s\n\tPassword : %s",
                (const char *) wifi_sta_cfg->ssid,
                (const char *) wifi_sta_cfg->password);
                break;
            }
            case WIFI_PROV_CRED_FAIL: {
                wifi_prov_sta_fail_reason_t *reason = (wifi_prov_sta_fail_
→reason_t *)event_data;
                ESP_LOGE(TAG, "Provisioning failed!\n\tReason : %s"
"\n\tPlease reset to factory and retry_
→provisioning",
                (*reason == WIFI_PROV_STA_AUTH_ERROR) ?
                "Wi-Fi station authentication failed" : "Wi-Fi_
→access-point not found");
                break;
            }
            case WIFI_PROV_CRED_SUCCESS:
                ESP_LOGI(TAG, "Provisioning successful");
                break;
            case WIFI_PROV_END:
                /* De-initialize manager once provisioning is finished */
                wifi_prov_mgr_deinit();
                break;
            default:
                break;
        }
    }
}
```

The manager can be de-initialized at any moment by making a call to `wifi_prov_mgr_deinit()`.

Check Provisioning State Whether device is provisioned or not can be checked at runtime by calling `wifi_prov_mgr_is_provisioned()`. This internally checks if the Wi-Fi credentials are stored in NVS.

Note that presently manager does not have its own NVS namespace for storage of Wi-Fi credentials, instead it relies on the `esp_wifi_` APIs to set and get the credentials stored in NVS from the default location.

If provisioning state needs to be reset, any of the following approaches may be taken :

- the associated part of NVS partition has to be erased manually
- main application must implement some logic to call `esp_wifi_` APIs for erasing the credentials at runtime
- main application must implement some logic to force start the provisioning irrespective of the provisioning state

```
bool provisioned = false;
ESP_ERR_CHECK( wifi_prov_mgr_is_provisioned(&provisioned) );
```

Start Provisioning Service At the time of starting provisioning we need to specify a service name and the corresponding key. These translate to :

- Wi-Fi SoftAP SSID and passphrase, respectively, when scheme is `wifi_prov_scheme_softap`
- BLE Device name (service key is ignored) when scheme is `wifi_prov_scheme_ble`

Also, since internally the manager uses *protocomm*, we have the option of choosing one of the security features provided by it :

- Security 1 is secure communication which consists of a prior handshake involving X25519 key exchange along with authentication using a proof of possession (*pop*), followed by AES-CTR for encryption/decryption of subsequent messages
- Security 0 is simply plain text communication. In this case the *pop* is simply ignored

See [Provisioning](#) for details about the security features.

```
const char *service_name = "my_device";
const char *service_key = "password";

wifi_prov_security_t security = WIFI_PROV_SECURITY_1;
const char *pop = "abcd1234";

ESP_ERR_CHECK( wifi_prov_mgr_start_provisioning(security, pop, service_
↪name, service_key) );
```

The provisioning service will automatically finish only if it receives valid Wi-Fi AP credentials followed by successfully connection of device to the AP (IP obtained). Regardless of that, the provisioning service can be stopped at any moment by making a call to `wifi_prov_mgr_stop_provisioning()`.

Note: If the device fails to connect with the provided credentials, it won't accept new credentials anymore, but the provisioning service will keep on running (only to convey failure to the client), until the device is restarted. Upon restart the provisioning state will turn out to be true this time (as credentials will be found in NVS), but device will again fail to connect with those same credentials (unless an AP with the matching credentials somehow does become available). This situation can be fixed by resetting the credentials in NVS or force starting the provisioning service. This has been explained above in [Check Provisioning State](#).

Waiting For Completion Typically, the main application will wait for the provisioning to finish, then de-initialize the manager to free up resources and finally start executing its own logic.

There are two ways for making this possible. The simpler way is to use a blocking call to `wifi_prov_mgr_wait()`.

```
// Start provisioning service
ESP_ERR_CHECK( wifi_prov_mgr_start_provisioning(security, pop, service_
↪name, service_key) );

// Wait for service to complete
wifi_prov_mgr_wait();

// Finally de-initialize the manager
wifi_prov_mgr_deinit();
```

The other way is to use the default event loop handler to catch `WIFI_PROV_EVENT`s` and call `:cpp:func:`wifi_prov_mgr_deinit()`` when event ID is `WIFI_PROV_END`:

```
static void event_handler(void* arg, esp_event_base_t event_base,
                          int event_id, void* event_data)
{
    if (event_base == WIFI_PROV_EVENT && event_id == WIFI_PROV_END) {
        /* De-initialize manager once provisioning is finished */
```

(continues on next page)

(continued from previous page)

```

        wifi_prov_mgr_deinit();
    }
}

```

User Side Implementation When the service is started, the device to be provisioned is identified by the advertised service name which, depending upon the selected transport, is either the BLE device name or the SoftAP SSID.

When using SoftAP transport, for allowing service discovery, mDNS must be initialized before starting provisioning. In this case the hostname set by the main application is used, and the service type is internally set to `_esp_wifi_prov`.

When using BLE transport, a custom 128 bit UUID should be set using `wifi_prov_scheme_ble_set_service_uuid()`. This UUID will be included in the BLE advertisement and will correspond to the primary GATT service that provides provisioning endpoints as GATT characteristics. Each GATT characteristic will be formed using the primary service UUID as base, with different auto assigned 12th and 13th bytes (assume counting starts from 0th byte). Since, an endpoint characteristic UUID is auto assigned, it shouldn't be used to identify the endpoint. Instead, client side applications should identify the endpoints by reading the User Characteristic Description (0x2901) descriptor for each characteristic, which contains the endpoint name of the characteristic. For example, if the service UUID is set to `55cc035e-fb27-4f80-be02-3c60828b7451`, each endpoint characteristic will be assigned a UUID like `55cc____-fb27-4f80-be02-3c60828b7451`, with unique values at the 12th and 13th bytes.

Once connected to the device, the provisioning related protocomm endpoints can be identified as follows :

Table 6: Endpoints provided by Provisioning Service

Endpoint Name (BLE + GATT Server)	URI (SoftAP + HTTP Server + mDNS)	Description
prov-session	<a href="http://<mdns-hostname>.local/prov-session">http://<mdns-hostname>.local/prov-session	Security endpoint used for session establishment
prov-scan	http://wifi-prov.local/prov-scan	Endpoint used for starting Wi-Fi scan and receiving scan results
prov-config	<a href="http://<mdns-hostname>.local/prov-config">http://<mdns-hostname>.local/prov-config	Endpoint used for configuring Wi-Fi credentials on device
proto-ver	<a href="http://<mdns-hostname>.local/proto-ver">http://<mdns-hostname>.local/proto-ver	Endpoint for retrieving version info

Immediately after connecting, the client application may fetch the version / capabilities information from the `proto-ver` endpoint. All communications to this endpoint are un-encrypted, hence necessary information (that may be relevant for deciding compatibility) can be retrieved before establishing a secure session. The response is in JSON format and looks like `:prov: { ver: v1.1, cap: [no_pop] }, my_app: { ver: 1.345, cap: [cloud, local_ctrl] }, ...`. Here label `prov` provides provisioning service version (`ver`) and capabilities (`cap`). For now, only `no_pop` capability is supported, which indicates that the service doesn't require proof of possession for authentication. Any application related version / capabilities will be given by other labels (like `my_app` in this example). These additional fields are set using `wifi_prov_mgr_set_app_info()`.

User side applications need to implement the signature handshaking required for establishing and authenticating secure protocomm sessions as per the security scheme configured for use (this is not needed when manager is configured to use protocomm security 0).

See Unified Provisioning for more details about the secure handshake and encryption used. Applications must use the `.proto` files found under `protocomm/proto`, which define the Protobuf message structures supported by `prov-session` endpoint.

Once a session is established, Wi-Fi credentials are configured using the following set of `wifi_config` commands, serialized as Protobuf messages (the corresponding `.proto` files can be found under `wifi_provisioning/proto`) :

- *get_status* - For querying the Wi-Fi connection status. The device will respond with a status which will be one of connecting / connected / disconnected. If status is disconnected, a disconnection reason will also be included in the status response.
- *set_config* - For setting the Wi-Fi connection credentials
- *apply_config* - For applying the credentials saved during *set_config* and start the Wi-Fi station

After session establishment, client can also request Wi-Fi scan results from the device. The results returned is a list of AP SSIDs, sorted in descending order of signal strength. This allows client applications to display APs nearby to the device at the time of provisioning, and users can select one of the SSIDs and provide the password which is then sent using the *wifi_config* commands described above. The *wifi_scan* endpoint supports the following protobuf commands :

- *scan_start* - For starting Wi-Fi scan with various options :
 - *blocking* (input) - If true, the command returns only when the scanning is finished
 - *passive* (input) - If true scan is started in passive mode (this may be slower) instead of active mode
 - *group_channels* (input) - This specifies whether to scan all channels in one go (when zero) or perform scanning of channels in groups, with 120ms delay between scanning of consecutive groups, and the value of this parameter sets the number of channels in each group. This is useful when transport mode is SoftAP, where scanning all channels in one go may not give the Wi-Fi driver enough time to send out beacons, and hence may cause disconnection with any connected stations. When scanning in groups, the manager will wait for atleast 120ms after completing scan on a group of channels, and thus allow the driver to send out the beacons. For example, given that the total number of Wi-Fi channels is 14, then setting *group_channels* to 4, will create 5 groups, with each group having 3 channels, except the last one which will have $14 \% 3 = 2$ channels. So, when scan is started, the first 3 channels will be scanned, followed by a 120ms delay, and then the next 3 channels, and so on, until all the 14 channels have been scanned. One may need to adjust this parameter as having only few channels in a group may slow down the overall scan time, while having too many may again cause disconnection. Usually a value of 4 should work for most cases. Note that for any other mode of transport, e.g. BLE, this can be safely set to 0, and hence achieve the fastest overall scanning time.
 - *period_ms* (input) - Scan parameter specifying how long to wait on each channel
- *scan_status* - Gives the status of scanning process :
 - *scan_finished* (output) - When scan has finished this returns true
 - *result_count* (output) - This gives the total number of results obtained till now. If scan is yet happening this number will keep on updating
- *scan_result* - For fetching scan results. This can be called even if scan is still on going
 - *start_index* (input) - Starting index from where to fetch the entries from the results list
 - *count* (input) - Number of entries to fetch from the starting index
 - *entries* (output) - List of entries returned. Each entry consists of *ssid*, *channel* and *rsni* information

Additional Endpoints In case users want to have some additional protocomm endpoints customized to their requirements, this is done in two steps. First is creation of an endpoint with a specific name, and the second step is the registration of a handler for this endpoint. See [protocomm](#) for the function signature of an endpoint handler. A custom endpoint must be created after initialization and before starting the provisioning service. Whereas, the protocomm handler is registered for this endpoint only after starting the provisioning service.

```
wifi_prov_mgr_init(config);
wifi_prov_mgr_endpoint_create("custom-endpoint");
wifi_prov_mgr_start_provisioning(security, pop, service_name, service_
↳key);
wifi_prov_mgr_endpoint_register("custom-endpoint", custom_ep_handler,
↳custom_ep_data);
```

When the provisioning service stops, the endpoint is unregistered automatically.

One can also choose to call *wifi_prov_mgr_endpoint_unregister()* to manually deactivate an endpoint at runtime. This can also be used to deactivate the internal endpoints used by the provisioning service.

When / How To Stop Provisioning Service? The default behavior is that once the device successfully connects using the Wi-Fi credentials set by the *apply_config* command, the provisioning service will be stopped (and BLE

/ SoftAP turned off) automatically after responding to the next `get_status` command. If `get_status` command is not received by the device, the service will be stopped after a 30s timeout.

On the other hand, if device was not able to connect using the provided Wi-Fi credentials, due to incorrect SSID / passphrase, the service will keep running, and `get_status` will keep responding with disconnected status and reason for disconnection. Any further attempts to provide another set of Wi-Fi credentials, will be rejected. These credentials will be preserved, unless the provisioning service is force started, or NVS erased.

If this default behavior is not desired, it can be disabled by calling `wifi_prov_mgr_disable_auto_stop()`. Now the provisioning service will only be stopped after an explicit call to `wifi_prov_mgr_stop_provisioning()`, which returns immediately after scheduling a task for stopping the service. The service stops after a certain delay and WIFI_PROV_END event gets emitted. This delay is specified by the argument to `wifi_prov_mgr_disable_auto_stop()`.

The customized behavior is useful for applications which want the provisioning service to be stopped some time after the Wi-Fi connection is successfully established. For example, if the application requires the device to connect to some cloud service and obtain another set of credentials, and exchange this credentials over a custom protocomm endpoint, then after successfully doing so stop the provisioning service by calling `wifi_prov_mgr_stop_provisioning()` inside the protocomm handler itself. The right amount of delay ensures that the transport resources are freed only after the response from the protocomm handler reaches the client side application.

Application Examples

For complete example implementation see [provisioning/wifi_prov_mgr](#)

Provisioning Tools

Provisioning applications are available for various platforms, along with source code:

- **Android:**
 - [BLE Provisioning app on Play Store](#).
 - [SoftAP Provisioning app on Play Store](#).
 - Source code on GitHub: [esp-idf-provisioning-android](#).
- **iOS:**
 - [BLE Provisioning app on app store](#).
 - [SoftAP Provisioning app on app Store](#).
 - Source code on GitHub: [esp-idf-provisioning-ios](#).
- Linux/MacOS/Windows : [tools/esp_prov](#) (a python based command line tool for provisioning)

The phone applications offer simple UI and thus more user centric, while the command line application is useful as a debugging tool for developers.

API Reference

Header File

- [wifi_provisioning/include/wifi_provisioning/manager.h](#)

Functions

`esp_err_t wifi_prov_mgr_init (wifi_prov_mgr_config_t config)`

Initialize provisioning manager instance.

Configures the manager and allocates internal resources

Configuration specifies the provisioning scheme (transport) and event handlers

Event WIFI_PROV_INIT is emitted right after initialization is complete

Return

- ESP_OK : Success
- ESP_FAIL : Fail

Parameters

- [in] config: Configuration structure

void **wifi_prov_mgr_deinit** (void)

Stop provisioning (if running) and release resource used by the manager.

Event WIFI_PROV_DEINIT is emitted right after de-initialization is finished

If provisioning service is still active when this API is called, it first stops the service, hence emitting WIFI_PROV_END, and then performs the de-initialization

esp_err_t **wifi_prov_mgr_is_provisioned** (bool *provisioned)

Checks if device is provisioned.

This checks if Wi-Fi credentials are present on the NVS

The Wi-Fi credentials are assumed to be kept in the same NVS namespace as used by esp_wifi component

If one were to call esp_wifi_set_config() directly instead of going through the provisioning process, this function will still yield true (i.e. device will be found to be provisioned)

Note Calling wifi_prov_mgr_start_provisioning() automatically resets the provision state, irrespective of what the state was prior to making the call.

Return

- ESP_OK : Retrieved provision state successfully
- ESP_FAIL : Wi-Fi not initialized
- ESP_ERR_INVALID_ARG : Null argument supplied
- ESP_ERR_INVALID_STATE : Manager not initialized

Parameters

- [out] provisioned: True if provisioned, else false

esp_err_t **wifi_prov_mgr_start_provisioning** (*wifi_prov_security_t* security, const char *pop, const char *service_name, const char *service_key)

Start provisioning service.

This starts the provisioning service according to the scheme configured at the time of initialization. For scheme :

- wifi_prov_scheme_ble : This starts protocomm_ble, which internally initializes BLE transport and starts GATT server for handling provisioning requests
- wifi_prov_scheme_softap : This activates SoftAP mode of Wi-Fi and starts protocomm_httpd, which internally starts an HTTP server for handling provisioning requests (If mDNS is active it also starts advertising service with type _esp_wifi_prov._tcp)

Event WIFI_PROV_START is emitted right after provisioning starts without failure

Note This API will start provisioning service even if device is found to be already provisioned, i.e. wifi_prov_mgr_is_provisioned() yields true

Return

- ESP_OK : Provisioning started successfully
- ESP_FAIL : Failed to start provisioning service
- ESP_ERR_INVALID_STATE : Provisioning manager not initialized or already started

Parameters

- [in] security: Specify which protocomm security scheme to use :
 - WIFI_PROV_SECURITY_0 : For no security
 - WIFI_PROV_SECURITY_1 : x25519 secure handshake for session establishment followed by AES-CTR encryption of provisioning messages
- [in] pop: Pointer to proof of possession string (NULL if not needed). This is relevant only for protocomm security 1, in which case it is used for authenticating secure session
- [in] service_name: Unique name of the service. This translates to:
 - Wi-Fi SSID when provisioning mode is softAP
 - Device name when provisioning mode is BLE

- [in] `service_key`: Key required by client to access the service (NULL if not needed). This translates to:
 - Wi-Fi password when provisioning mode is softAP
 - ignored when provisioning mode is BLE

void **wifi_prov_mgr_stop_provisioning** (void)

Stop provisioning service.

If provisioning service is active, this API will initiate a process to stop the service and return. Once the service actually stops, the event `WIFI_PROV_END` will be emitted.

If `wifi_prov_mgr_deinit()` is called without calling this API first, it will automatically stop the provisioning service and emit the `WIFI_PROV_END`, followed by `WIFI_PROV_DEINIT`, before returning.

This API will generally be used along with `wifi_prov_mgr_disable_auto_stop()` in the scenario when the main application has registered its own endpoints, and wishes that the provisioning service is stopped only when some protocomm command from the client side application is received.

Calling this API inside an endpoint handler, with sufficient `cleanup_delay`, will allow the response / acknowledgment to be sent successfully before the underlying protocomm service is stopped.

`Cleanup_delay` is set when calling `wifi_prov_mgr_disable_auto_stop()`. If not specified, it defaults to 1000ms.

For straightforward cases, using this API is usually not necessary as provisioning is stopped automatically once `WIFI_PROV_CRED_SUCCESS` is emitted. Stopping is delayed (maximum 30 seconds) thus allowing the client side application to query for Wi-Fi state, i.e. after receiving the first query and sending `Wi-Fi state connected` response the service is stopped immediately.

void **wifi_prov_mgr_wait** (void)

Wait for provisioning service to finish.

Calling this API will block until provisioning service is stopped i.e. till event `WIFI_PROV_END` is emitted.

This will not block if provisioning is not started or not initialized.

esp_err_t **wifi_prov_mgr_disable_auto_stop** (uint32_t *cleanup_delay*)

Disable auto stopping of provisioning service upon completion.

By default, once provisioning is complete, the provisioning service is automatically stopped, and all endpoints (along with those registered by main application) are deactivated.

This API is useful in the case when main application wishes to close provisioning service only after it receives some protocomm command from the client side app. For example, after connecting to Wi-Fi, the device may want to connect to the cloud, and only once that is successfully, the device is said to be fully configured. But, then it is upto the main application to explicitly call `wifi_prov_mgr_stop_provisioning()` later when the device is fully configured and the provisioning service is no longer required.

Note This must be called before executing `wifi_prov_mgr_start_provisioning()`

Return

- `ESP_OK` : Success
- `ESP_ERR_INVALID_STATE` : Manager not initialized or provisioning service already started

Parameters

- [in] `cleanup_delay`: Sets the delay after which the actual cleanup of transport related resources is done after a call to `wifi_prov_mgr_stop_provisioning()` returns. Minimum allowed value is 100ms. If not specified, this will default to 1000ms.

esp_err_t **wifi_prov_mgr_set_app_info** (const char **label*, const char **version*, const char ***capabilities*, size_t *total_capabilities*)

Set application version and capabilities in the JSON data returned by proto-ver endpoint.

This function can be called multiple times, to specify information about the various application specific services running on the device, identified by unique labels.

The provisioning service itself registers an entry in the JSON data, by the label “prov”, containing only provisioning service version and capabilities. Application services should use a label other than “prov” so as not to overwrite this.

Note This must be called before executing `wifi_prov_mgr_start_provisioning()`

Return

- `ESP_OK` : Success
- `ESP_ERR_INVALID_STATE` : Manager not initialized or provisioning service already started
- `ESP_ERR_NO_MEM` : Failed to allocate memory for version string
- `ESP_ERR_INVALID_ARG` : Null argument

Parameters

- `[in] label`: String indicating the application name.
- `[in] version`: String indicating the application version. There is no constraint on format.
- `[in] capabilities`: Array of strings with capabilities. These could be used by the client side app to know the application registered endpoint capabilities
- `[in] total_capabilities`: Size of capabilities array

`esp_err_t wifi_prov_mgr_endpoint_create (const char *ep_name)`

Create an additional endpoint and allocate internal resources for it.

This API is to be called by the application if it wants to create an additional endpoint. All additional endpoints will be assigned UUIDs starting from 0xFF54 and so on in the order of execution.

protocomm handler for the created endpoint is to be registered later using `wifi_prov_mgr_endpoint_register()` after provisioning has started.

Note This API can only be called BEFORE provisioning is started

Note Additional endpoints can be used for configuring client provided parameters other than Wi-Fi credentials, that are necessary for the main application and hence must be set prior to starting the application

Note After session establishment, the additional endpoints must be targeted first by the client side application before sending Wi-Fi configuration, because once Wi-Fi configuration finishes the provisioning service is stopped and hence all endpoints are unregistered

Return

- `ESP_OK` : Success
- `ESP_FAIL` : Failure

Parameters

- `[in] ep_name`: unique name of the endpoint

`esp_err_t wifi_prov_mgr_endpoint_register (const char *ep_name, proto-comm_req_handler_t handler, void *user_ctx)`

Register a handler for the previously created endpoint.

This API can be called by the application to register a protocomm handler to any endpoint that was created using `wifi_prov_mgr_endpoint_create()`.

Note This API can only be called AFTER provisioning has started

Note Additional endpoints can be used for configuring client provided parameters other than Wi-Fi credentials, that are necessary for the main application and hence must be set prior to starting the application

Note After session establishment, the additional endpoints must be targeted first by the client side application before sending Wi-Fi configuration, because once Wi-Fi configuration finishes the provisioning service is stopped and hence all endpoints are unregistered

Return

- `ESP_OK` : Success
- `ESP_FAIL` : Failure

Parameters

- `[in] ep_name`: Name of the endpoint
- `[in] handler`: Endpoint handler function
- `[in] user_ctx`: User data

`void wifi_prov_mgr_endpoint_unregister (const char *ep_name)`

Unregister the handler for an endpoint.

This API can be called if the application wants to selectively unregister the handler of an endpoint while the provisioning is still in progress.

All the endpoint handlers are unregistered automatically when the provisioning stops.

Parameters

- [in] ep_name: Name of the endpoint

esp_err_t **wifi_prov_mgr_event_handler** (void *ctx, *system_event_t* *event)

Event handler for provisioning manager.

This is called from the main event handler and controls the provisioning manager's internal state machine depending on incoming Wi-Fi events

Note : This function is DEPRECATED, because events are now handled internally using the event loop library, esp_event. Calling this will do nothing and simply return ESP_OK.

Return

- ESP_OK : Event handled successfully

Parameters

- [in] ctx: Event context data
- [in] event: Event info

esp_err_t **wifi_prov_mgr_get_wifi_state** (*wifi_prov_sta_state_t* *state)

Get state of Wi-Fi Station during provisioning.

Return

- ESP_OK : Successfully retrieved Wi-Fi state
- ESP_FAIL : Provisioning app not running

Parameters

- [out] state: Pointer to wifi_prov_sta_state_t variable to be filled

esp_err_t **wifi_prov_mgr_get_wifi_disconnect_reason** (*wifi_prov_sta_fail_reason_t* *reason)

Get reason code in case of Wi-Fi station disconnection during provisioning.

Return

- ESP_OK : Successfully retrieved Wi-Fi disconnect reason
- ESP_FAIL : Provisioning app not running

Parameters

- [out] reason: Pointer to wifi_prov_sta_fail_reason_t variable to be filled

esp_err_t **wifi_prov_mgr_configure_sta** (*wifi_config_t* *wifi_cfg)

Runs Wi-Fi as Station with the supplied configuration.

Configures the Wi-Fi station mode to connect to the AP with SSID and password specified in config structure and sets Wi-Fi to run as station.

This is automatically called by provisioning service upon receiving new credentials.

If credentials are to be supplied to the manager via a different mode other than through protocomm, then this API needs to be called.

Event WIFI_PROV_CRED_RECV is emitted after credentials have been applied and Wi-Fi station started

Return

- ESP_OK : Wi-Fi configured and started successfully
- ESP_FAIL : Failed to set configuration

Parameters

- [in] wifi_cfg: Pointer to Wi-Fi configuration structure

esp_err_t **wifi_prov_mgr_reset_sm_state_on_failure** (void)

Reset internal state machine and clear provisioned credentials.

This API can be used to restart provisioning in case invalid credentials are entered.

Return

- ESP_OK : Reset provisioning state machine successfully
- ESP_FAIL : Failed to reset provisioning state machine
- ESP_ERR_INVALID_STATE : Manager not initialized

Structures

struct wifi_prov_event_handler_t

Event handler that is used by the manager while provisioning service is active.

Public Members

wifi_prov_cb_func_t **event_cb**

Callback function to be executed on provisioning events

void ***user_data**

User context data to pass as parameter to callback function

struct wifi_prov_scheme

Structure for specifying the provisioning scheme to be followed by the manager.

Note Ready to use schemes are available:

- `wifi_prov_scheme_ble` : for provisioning over BLE transport + GATT server
- `wifi_prov_scheme_softap` : for provisioning over SoftAP transport + HTTP server
- `wifi_prov_scheme_console` : for provisioning over Serial UART transport + Console (for debugging)

Public Members

esp_err_t (***prov_start**) (*protocomm_t* *pc, void *config)

Function which is to be called by the manager when it is to start the provisioning service associated with a protocomm instance and a scheme specific configuration

esp_err_t (***prov_stop**) (*protocomm_t* *pc)

Function which is to be called by the manager to stop the provisioning service previously associated with a protocomm instance

void (***new_config**) (void)

Function which is to be called by the manager to generate a new configuration for the provisioning service, that is to be passed to *prov_start()*

void (***delete_config**) (void *config)

Function which is to be called by the manager to delete a configuration generated using *new_config()*

esp_err_t (***set_config_service**) (void *config, **const** char *service_name, **const** char *service_key)

Function which is to be called by the manager to set the service name and key values in the configuration structure

esp_err_t (***set_config_endpoint**) (void *config, **const** char *endpoint_name, uint16_t uuid)

Function which is to be called by the manager to set a protocomm endpoint with an identifying name and UUID in the configuration structure

wifi_mode_t **wifi_mode**

Sets mode of operation of Wi-Fi during provisioning This is set to :

- `WIFI_MODE_APSTA` for SoftAP transport
- `WIFI_MODE_STA` for BLE transport

struct wifi_prov_mgr_config_t

Structure for specifying the manager configuration.

Public Members

wifi_prov_scheme_t **scheme**

Provisioning scheme to use. Following schemes are already available:

- `wifi_prov_scheme_ble` : for provisioning over BLE transport + GATT server

- `wifi_prov_scheme_softap` : for provisioning over SoftAP transport + HTTP server + mDNS (optional)
- `wifi_prov_scheme_console` : for provisioning over Serial UART transport + Console (for debugging)

`wifi_prov_event_handler_t` **scheme_event_handler**

Event handler required by the scheme for incorporating scheme specific behavior while provisioning manager is running. Various options may be provided by the scheme for setting this field. Use `WIFI_PROV_EVENT_HANDLER_NONE` when not used. When using scheme `wifi_prov_scheme_ble`, the following options are available:

- `WIFI_PROV_SCHEME_BLE_EVENT_HANDLER_FREE_BTDM`
- `WIFI_PROV_SCHEME_BLE_EVENT_HANDLER_FREE_BLE`
- `WIFI_PROV_SCHEME_BLE_EVENT_HANDLER_FREE_BT`

`wifi_prov_event_handler_t` **app_event_handler**

Event handler that can be set for the purpose of incorporating application specific behavior. Use `WIFI_PROV_EVENT_HANDLER_NONE` when not used.

Macros

`WIFI_PROV_EVENT_HANDLER_NONE`

Event handler can be set to none if not used.

Type Definitions

```
typedef void (*wifi_prov_cb_func_t) (void *user_data, wifi_prov_cb_event_t event, void
                                     *event_data)
```

```
typedef struct wifi_prov_scheme wifi_prov_scheme_t
```

Structure for specifying the provisioning scheme to be followed by the manager.

Note Ready to use schemes are available:

- `wifi_prov_scheme_ble` : for provisioning over BLE transport + GATT server
- `wifi_prov_scheme_softap` : for provisioning over SoftAP transport + HTTP server
- `wifi_prov_scheme_console` : for provisioning over Serial UART transport + Console (for debugging)

```
typedef enum wifi_prov_security wifi_prov_security_t
```

Security modes supported by the Provisioning Manager.

These are same as the security modes provided by protocomm

Enumerations

```
enum wifi_prov_cb_event_t
```

Events generated by manager.

These events are generated in order of declaration and, for the stretch of time between initialization and de-initialization of the manager, each event is signaled only once

Values:

```
WIFI_PROV_INIT
```

Emitted when the manager is initialized

```
WIFI_PROV_START
```

Indicates that provisioning has started

```
WIFI_PROV_CRED_RECV
```

Emitted when Wi-Fi AP credentials are received via `protocomm` endpoint `wifi_config`. The event data in this case is a pointer to the corresponding `wifi_sta_config_t` structure

```
WIFI_PROV_CRED_FAIL
```

Emitted when device fails to connect to the AP of which the credentials were received earlier on event `WIFI_PROV_CRED_RECV`. The event data in this case is a pointer to the disconnection reason code with type `wifi_prov_sta_fail_reason_t`

WIFI_PROV_CRED_SUCCESS

Emitted when device successfully connects to the AP of which the credentials were received earlier on event `WIFI_PROV_CRED_RECV`

WIFI_PROV_END

Signals that provisioning service has stopped

WIFI_PROV_DEINIT

Signals that manager has been de-initialized

enum wifi_prov_security

Security modes supported by the Provisioning Manager.

These are same as the security modes provided by protocomm

Values:

WIFI_PROV_SECURITY_0 = 0

No security (plain-text communication)

WIFI_PROV_SECURITY_1

This secure communication mode consists of X25519 key exchange

- proof of possession (pop) based authentication
- AES-CTR encryption

Header File

- [wifi_provisioning/include/wifi_provisioning/scheme_ble.h](#)

Functions

void `wifi_prov_scheme_ble_event_cb_free_btadm` (void **user_data*, [wifi_prov_cb_event_t](#) *event*, void **event_data*)

void `wifi_prov_scheme_ble_event_cb_free_ble` (void **user_data*, [wifi_prov_cb_event_t](#) *event*, void **event_data*)

void `wifi_prov_scheme_ble_event_cb_free_bt` (void **user_data*, [wifi_prov_cb_event_t](#) *event*, void **event_data*)

[esp_err_t](#) `wifi_prov_scheme_ble_set_service_uuid` (uint8_t **uuid128*)

Set the 128 bit GATT service UUID used for provisioning.

This API is used to override the default 128 bit provisioning service UUID, which is 0000ffff-0000-1000-8000-00805f9b34fb.

This must be called before starting provisioning, i.e. before making a call to `wifi_prov_mgr_start_provisioning()`, otherwise the default UUID will be used.

Note The data being pointed to by the argument must be valid atleast till provisioning is started. Upon start, the manager will store an internal copy of this UUID, and this data can be freed or invalidated afterwards.

Return

- `ESP_OK` : Success
- `ESP_ERR_INVALID_ARG` : Null argument

Parameters

- [in] `uuid128`: A custom 128 bit UUID

[esp_err_t](#) `wifi_prov_scheme_ble_set_mfg_data` (uint8_t **mfg_data*, `ssize_t` *mfg_data_len*)

Set manufacturer specific data in scan response.

This must be called before starting provisioning, i.e. before making a call to `wifi_prov_mgr_start_provisioning()`.

Note It is important to understand that length of custom manufacturer data should be within limits. The manufacturer data goes into scan response along with BLE device name. By default, BLE device name length is of 11 Bytes, however it can vary as per application use case. So, one has to honour the scan

response data size limits i.e. $(mfg_data_len + 2) < 31 - (device_name_length + 2)$. If the `mfg_data` length exceeds this limit, the length will be truncated.

Return

- `ESP_OK` : Success
- `ESP_ERR_INVALID_ARG` : Null argument

Parameters

- `[in] mfg_data`: Custom manufacturer data
- `[in] mfg_data_len`: Manufacturer data length

Macros

```
WIFI_PROV_SCHEME_BLE_EVENT_HANDLER_FREE_BTDM
```

```
WIFI_PROV_SCHEME_BLE_EVENT_HANDLER_FREE_BLE
```

```
WIFI_PROV_SCHEME_BLE_EVENT_HANDLER_FREE_BT
```

Header File

- [wifi_provisioning/include/wifi_provisioning/scheme_softap.h](#)

Functions

void `wifi_prov_scheme_softap_set_httpd_handle` (void **handle*)
Provide HTTPD Server handle externally.

Useful in cases wherein applications need the webserver for some different operations, and do not want the wifi provisioning component to start/stop a new instance.

Note This API should be called before `wifi_prov_mgr_start_provisioning()`

Parameters

- `[in] handle`: Handle to HTTPD server instance

Header File

- [wifi_provisioning/include/wifi_provisioning/scheme_console.h](#)

Header File

- [wifi_provisioning/include/wifi_provisioning/wifi_config.h](#)

Functions

`esp_err_t` `wifi_prov_config_data_handler` (uint32_t *session_id*, const uint8_t **inbuf*, ssize_t *inlen*, uint8_t ***outbuf*, ssize_t **outlen*, void **priv_data*)

Handler for receiving and responding to requests from master.

This is to be registered as the `wifi_config` endpoint handler (protocomm `protocomm_req_handler_t`) using `protocomm_add_endpoint()`

Structures

```
struct wifi_prov_sta_conn_info_t  
WiFi STA connected status information.
```

Public Members

```
char ip_addr[IP4ADDR_STRLEN_MAX]  
IP Address received by station
```

char **bssid**[6]
BSSID of the AP to which connection was established

char **ssid**[33]
SSID of the to which connection was established

uint8_t **channel**
Channel of the AP

uint8_t **auth_mode**
Authorization mode of the AP

struct wifi_prov_config_get_data_t
WiFi status data to be sent in response to `get_status` request from master.

Public Members

wifi_prov_sta_state_t **wifi_state**
WiFi state of the station

wifi_prov_sta_fail_reason_t **fail_reason**
Reason for disconnection (valid only when `wifi_state` is `WIFI_STATION_DISCONNECTED`)

wifi_prov_sta_conn_info_t **conn_info**
Connection information (valid only when `wifi_state` is `WIFI_STATION_CONNECTED`)

struct wifi_prov_config_set_data_t
WiFi config data received by slave during `set_config` request from master.

Public Members

char **ssid**[33]
SSID of the AP to which the slave is to be connected

char **password**[64]
Password of the AP

char **bssid**[6]
BSSID of the AP

uint8_t **channel**
Channel of the AP

struct wifi_prov_config_handlers
Internal handlers for receiving and responding to protocomm requests from master.

This is to be passed as `priv_data` for protocomm request handler (refer to `wifi_prov_config_data_handler()`) when calling `protocomm_add_endpoint()`.

Public Members

esp_err_t (***get_status_handler**) (*wifi_prov_config_get_data_t* *resp_data, *wifi_prov_ctx_t* **ctx)
Handler function called when connection status of the slave (in WiFi station mode) is requested

esp_err_t (***set_config_handler**) (**const** *wifi_prov_config_set_data_t* *req_data, *wifi_prov_ctx_t* **ctx)
Handler function called when WiFi connection configuration (eg. AP SSID, password, etc.) of the slave (in WiFi station mode) is to be set to user provided values

esp_err_t (***apply_config_handler**) (*wifi_prov_ctx_t* **ctx)
Handler function for applying the configuration that was set in `set_config_handler`. After applying the station may get connected to the AP or may fail to connect. The slave must be ready to convey the updated connection status information when `get_status_handler` is invoked again by the master.

`wifi_prov_ctx_t *ctx`

Context pointer to be passed to above handler functions upon invocation

Type Definitions

typedef struct wifi_prov_ctx **wifi_prov_ctx_t**

Type of context data passed to each get/set/apply handler function set in `wifi_prov_config_handlers` structure.

This is passed as an opaque pointer, thereby allowing it be defined later in application code as per requirements.

typedef struct *wifi_prov_config_handlers* **wifi_prov_config_handlers_t**

Internal handlers for receiving and responding to protocomm requests from master.

This is to be passed as `priv_data` for protocomm request handler (refer to `wifi_prov_config_data_handler()`) when calling `protocomm_add_endpoint()`.

Enumerations

enum wifi_prov_sta_state_t

WiFi STA status for conveying back to the provisioning master.

Values:

WIFI_PROV_STA_CONNECTING

WIFI_PROV_STA_CONNECTED

WIFI_PROV_STA_DISCONNECTED

enum wifi_prov_sta_fail_reason_t

WiFi STA connection fail reason.

Values:

WIFI_PROV_STA_AUTH_ERROR

WIFI_PROV_STA_AP_NOT_FOUND

Code examples for above API are provided in the [provisioning](#) directory of ESP-IDF examples.

Code example for above API is provided in [wifi/smart_config](#)

Code example for above API is provided in [wifi/wifi_easy_connect/dpp-enrollee](#)

2.6 Storage API

2.6.1 FAT Filesystem Support

ESP-IDF uses the [FatFs](#) library to work with FAT filesystems. FatFs resides in the `fatfs` component. Although the library can be used directly, many of its features can be accessed via VFS, using the C standard library and POSIX API functions.

Additionally, FatFs has been modified to support the runtime pluggable disk I/O layer. This allows mapping of FatFs drives to physical disks at runtime.

Using FatFs with VFS

The header file `fatfs/vfs/esp_vfs_fat.h` defines the functions for connecting FatFs and VFS.

The function `esp_vfs_fat_register()` allocates a FATFS structure and registers a given path prefix in VFS. Subsequent operations on files starting with this prefix are forwarded to FatFs APIs. The function `esp_vfs_fat_unregister_path()` deletes the registration with VFS, and frees the FATFS structure.

Most applications use the following workflow when working with `esp_vfs_fat_` functions:

1. Call `esp_vfs_fat_register()` to specify:
 - Path prefix where to mount the filesystem (e.g. `"/sdcard"`, `"/spiflash"`)
 - FatFs drive number
 - A variable which will receive the pointer to the FATFS structure
2. Call `ff_diskio_register()` to register the disk I/O driver for the drive number used in Step 1.
3. Call the FatFs function `f_mount`, and optionally `f_fdisk`, `f_mkfs`, to mount the filesystem using the same drive number which was passed to `esp_vfs_fat_register()`. For more information, see *FatFs documentation* <<http://www.elm-chan.org/fsw/ff/doc/mount.html>>.
4. Call the C standard library and POSIX API functions to perform such actions on files as open, read, write, erase, copy, etc. Use paths starting with the path prefix passed to `esp_vfs_register()` (for example, `"/sdcard/hello.txt"`).
5. Optionally, by enabling the option `CONFIG_FATFS_USE_FASTSEEK`, use the POSIX `lseek` function to perform it faster, the fast seek will not work for files in write mode, so to take advantage of fast seek, you should open (or close and then reopen) the file in read-only mode.
6. Optionally, call the FatFs library functions directly. In this case, use paths without a VFS prefix (for example, `"/hello.txt"`).
7. Close all open files.
8. Call the FatFs function `f_mount` for the same drive number, with `NULL` `FATFS*` argument, to unmount the filesystem.
9. Call the FatFs function `ff_diskio_register()` with `NULL` `ff_diskio_impl_t*` argument and the same drive number to unregister the disk I/O driver.
10. Call `esp_vfs_fat_unregister_path()` with the path where the file system is mounted to remove FatFs from VFS, and free the FATFS structure allocated in Step 1.

The convenience functions `esp_vfs_fat_sdmmc_mount`, `esp_vfs_fat_sdspi_mount` and `esp_vfs_fat_sdcard_unmount` wrap the steps described above and also handle SD card initialization. These two functions are described in the next section.

`esp_err_t esp_vfs_fat_register(const char *base_path, const char *fat_drive, size_t max_files, FATFS **out_fs)`

Register FATFS with VFS component.

This function registers given FAT drive in VFS, at the specified base path. If only one drive is used, `fat_drive` argument can be an empty string. Refer to FATFS library documentation on how to specify FAT drive. This function also allocates FATFS structure which should be used for `f_mount` call.

Note This function doesn't mount the drive into FATFS, it just connects POSIX and C standard library IO function with FATFS. You need to mount desired drive into FATFS separately.

Return

- `ESP_OK` on success
- `ESP_ERR_INVALID_STATE` if `esp_vfs_fat_register` was already called
- `ESP_ERR_NO_MEM` if not enough memory or too many VFSes already registered

Parameters

- `base_path`: path prefix where FATFS should be registered
- `fat_drive`: FATFS drive specification; if only one drive is used, can be an empty string
- `max_files`: maximum number of files which can be open at the same time
- `[out] out_fs`: pointer to FATFS structure which can be used for FATFS `f_mount` call is returned via this argument.

`esp_err_t esp_vfs_fat_unregister_path(const char *base_path)`

Un-register FATFS from VFS.

Note FATFS structure returned by `esp_vfs_fat_register` is destroyed after this call. Make sure to call `f_mount` function to unmount it before calling `esp_vfs_fat_unregister_path`. Difference between this function and the one above is that this one will release the correct drive, while the one above will release the last registered one

Return

- `ESP_OK` on success
- `ESP_ERR_INVALID_STATE` if FATFS is not registered in VFS

Parameters

- `base_path`: path prefix where FATFS is registered. This is the same used when

esp_vfs_fat_register was called

Using FatFs with VFS and SD cards

The header file `fatfs/vfs/esp_vfs_fat.h` defines convenience functions `esp_vfs_fat_sdmmc_mount()`, `esp_vfs_fat_sdspi_mount()` and `esp_vfs_fat_sdcard_unmount()`. These functions perform Steps 1–3 and 7–9 respectively and handle SD card initialization, but provide only limited error handling. Developers are encouraged to check its source code and incorporate more advanced features into production applications.

The convenience function `esp_vfs_fat_sdmmc_unmount()` unmounts the filesystem and releases the resources acquired by `esp_vfs_fat_sdmmc_mount()`.

```
esp_err_t esp_vfs_fat_sdmmc_mount (const char *base_path, const sdmmc_host_t *host_config,
                                   const void *slot_config, const esp_vfs_fat_mount_config_t
                                   *mount_config, sdmmc_card_t **out_card)
```

Convenience function to get FAT filesystem on SD card registered in VFS.

This is an all-in-one function which does the following:

- initializes SDMMC driver or SPI driver with configuration in `host_config`
- initializes SD card with configuration in `slot_config`
- mounts FAT partition on SD card using FATFS library, with configuration in `mount_config`
- registers FATFS library with VFS, with prefix given by `base_prefix` variable

This function is intended to make example code more compact. For real world applications, developers should implement the logic of probing SD card, locating and mounting partition, and registering FATFS in VFS, with proper error checking and handling of exceptional conditions.

Note Use this API to mount a card through SDSPI is deprecated. Please call `esp_vfs_fat_sdspi_mount()` instead for that case.

Return

- ESP_OK on success
- ESP_ERR_INVALID_STATE if `esp_vfs_fat_sdmmc_mount` was already called
- ESP_ERR_NO_MEM if memory can not be allocated
- ESP_FAIL if partition can not be mounted
- other error codes from SDMMC or SPI drivers, SDMMC protocol, or FATFS drivers

Parameters

- `base_path`: path where partition should be registered (e.g. `"/sdcard"`)
- `host_config`: Pointer to structure describing SDMMC host. When using SDMMC peripheral, this structure can be initialized using `SDMMC_HOST_DEFAULT()` macro. When using SPI peripheral, this structure can be initialized using `SDSPI_HOST_DEFAULT()` macro.
- `slot_config`: Pointer to structure with slot configuration. For SDMMC peripheral, pass a pointer to `sdmmc_slot_config_t` structure initialized using `SDMMC_SLOT_CONFIG_DEFAULT()`. (Deprecated) For SPI peripheral, pass a pointer to `sdspi_slot_config_t` structure initialized using `SDSPI_SLOT_CONFIG_DEFAULT()`.
- `mount_config`: pointer to structure with extra parameters for mounting FATFS
- `[out] out_card`: if not NULL, pointer to the card information structure will be returned via this argument

```
esp_err_t esp_vfs_fat_sdspi_mount (const char *base_path, const sdmmc_host_t
                                   *host_config_input, const sdspi_device_config_t *slot_config,
                                   const esp_vfs_fat_mount_config_t *mount_config, sd-
                                   mmc_card_t **out_card)
```

Convenience function to get FAT filesystem on SD card registered in VFS.

This is an all-in-one function which does the following:

- initializes an SPI Master device based on the SPI Master driver with configuration in `slot_config`, and attach it to an initialized SPI bus.
- initializes SD card with configuration in `host_config_input`
- mounts FAT partition on SD card using FATFS library, with configuration in `mount_config`
- registers FATFS library with VFS, with prefix given by `base_prefix` variable

This function is intended to make example code more compact. For real world applications, developers should implement the logic of probing SD card, locating and mounting partition, and registering FATFS in VFS, with proper error checking and handling of exceptional conditions.

Note This function try to attach the new SD SPI device to the bus specified in `host_config`. Make sure the SPI bus specified in `host_config->slot` have been initialized by `spi_bus_initialize()` before.

Return

- ESP_OK on success
- ESP_ERR_INVALID_STATE if `esp_vfs_fat_sdmmc_mount` was already called
- ESP_ERR_NO_MEM if memory can not be allocated
- ESP_FAIL if partition can not be mounted
- other error codes from SDMMC or SPI drivers, SDMMC protocol, or FATFS drivers

Parameters

- `base_path`: path where partition should be registered (e.g. `"/sdcard"`)
- `host_config_input`: Pointer to structure describing SDMMC host. This structure can be initialized using `SDSPI_HOST_DEFAULT()` macro.
- `slot_config`: Pointer to structure with slot configuration. For SPI peripheral, pass a pointer to `sdspi_device_config_t` structure initialized using `SDSPI_DEVICE_CONFIG_DEFAULT()`.
- `mount_config`: pointer to structure with extra parameters for mounting FATFS
- `[out] out_card`: If not NULL, pointer to the card information structure will be returned via this argument. It is suggested to hold this handle and use it to unmount the card later if needed. Otherwise it's not suggested to use more than one card at the same time and unmount one of them in your application.

struct esp_vfs_fat_mount_config_t

Configuration arguments for `esp_vfs_fat_sdmmc_mount` and `esp_vfs_fat_spiflash_mount` functions.

Public Members

bool `format_if_mount_failed`

If FAT partition can not be mounted, and this parameter is true, create partition table and format the filesystem.

int `max_files`

Max number of open files.

size_t `allocation_unit_size`

If `format_if_mount_failed` is set, and mount fails, format the card with given allocation unit size. Must be a power of 2, between sector size and $128 * \text{sector size}$. For SD cards, sector size is always 512 bytes. For wear_leveling, sector size is determined by `CONFIG_WL_SECTOR_SIZE` option.

Using larger allocation unit size will result in higher read/write performance and higher overhead when storing small files.

Setting this field to 0 will result in allocation unit set to the sector size.

esp_err_t `esp_vfs_fat_sdcard_unmount` (`const char *base_path, sdmmc_card_t *card`)

Unmount an SD card from the FAT filesystem and release resources acquired using `esp_vfs_fat_sdmmc_mount()` or `esp_vfs_fat_sdspi_mount()`

Return

- ESP_OK on success
- ESP_ERR_INVALID_ARG if the card argument is unregistered
- ESP_ERR_INVALID_STATE if `esp_vfs_fat_sdmmc_mount` hasn't been called

Using FatFs with VFS in read-only mode

The header file `fatfs/vfs/esp_vfs_fat.h` also defines the convenience functions `esp_vfs_fat_rawflash_mount()` and `esp_vfs_fat_rawflash_unmount()`. These functions perform Steps 1-3 and 7-9 respectively for read-only FAT partitions. These are particularly helpful for

data partitions written only once during factory provisioning which will not be changed by production application throughout the lifetime of the hardware.

```
esp_err_t esp_vfs_fat_rawflash_mount (const char *base_path, const char *partition_label,
                                     const esp_vfs_fat_mount_config_t *mount_config)
```

Convenience function to initialize read-only FAT filesystem and register it in VFS.

This is an all-in-one function which does the following:

- finds the partition with defined partition_label. Partition label should be configured in the partition table.
- mounts FAT partition using FATFS library
- registers FATFS library with VFS, with prefix given by base_prefix variable

Note Wear levelling is not used when FAT is mounted in read-only mode using this function.

Return

- ESP_OK on success
- ESP_ERR_NOT_FOUND if the partition table does not contain FATFS partition with given label
- ESP_ERR_INVALID_STATE if esp_vfs_fat_rawflash_mount was already called for the same partition
- ESP_ERR_NO_MEM if memory can not be allocated
- ESP_FAIL if partition can not be mounted
- other error codes from SPI flash driver, or FATFS drivers

Parameters

- base_path: path where FATFS partition should be mounted (e.g. “/spiflash”)
- partition_label: label of the partition which should be used
- mount_config: pointer to structure with extra parameters for mounting FATFS

```
esp_err_t esp_vfs_fat_rawflash_unmount (const char *base_path, const char
                                       *partition_label)
```

Unmount FAT filesystem and release resources acquired using esp_vfs_fat_rawflash_mount.

Return

- ESP_OK on success
- ESP_ERR_INVALID_STATE if esp_vfs_fat_spiflash_mount hasn't been called

Parameters

- base_path: path where partition should be registered (e.g. “/spiflash”)
- partition_label: label of partition to be unmounted

FatFS disk IO layer

FatFs has been extended with API functions that register the disk I/O driver at runtime.

They provide implementation of disk I/O functions for SD/MMC cards and can be registered for the given FatFs drive number using the function `ff_diskio_register_sdmmc()`.

```
void ff_diskio_register (BYTE pdrv, const ff_diskio_impl_t *discio_impl)
```

Register or unregister diskio driver for given drive number.

When FATFS library calls one of disk_xxx functions for driver number pdrv, corresponding function in discio_impl for given pdrv will be called.

Parameters

- pdrv: drive number
- discio_impl: pointer to `ff_diskio_impl_t` structure with diskio functions or NULL to unregister and free previously registered drive

```
struct ff_diskio_impl_t
```

Structure of pointers to disk IO driver functions.

See FatFs documentation for details about these functions

Public Members

DSTATUS (***init**) (unsigned char pdrv)
disk initialization function

DSTATUS (***status**) (unsigned char pdrv)
disk status check function

DRESULT (***read**) (unsigned char pdrv, unsigned char *buff, uint32_t sector, unsigned count)
sector read function

DRESULT (***write**) (unsigned char pdrv, **const** unsigned char *buff, uint32_t sector, unsigned count)
sector write function

DRESULT (***ioctl**) (unsigned char pdrv, unsigned char cmd, void *buff)
function to get info about disk and do some misc operations

void **ff_diskio_register_sdmmc** (unsigned char pdrv, *sdmmc_card_t* *card)
Register SD/MMC diskio driver

Parameters

- pdrv: drive number
- card: pointer to *sdmmc_card_t* structure describing a card; card should be initialized before calling `f_mount`.

esp_err_t **ff_diskio_register_wl_partition** (unsigned char pdrv, *wl_handle_t* flash_handle)
Register spi flash partition

Parameters

- pdrv: drive number
- flash_handle: handle of the wear levelling partition.

esp_err_t **ff_diskio_register_raw_partition** (unsigned char pdrv, **const** *esp_partition_t* *part_handle)
Register spi flash partition

Parameters

- pdrv: drive number
- part_handle: pointer to raw flash partition.

2.6.2 Manufacturing Utility

Introduction

This utility is designed to create instances of factory NVS partition images on a per-device basis for mass manufacturing purposes. The NVS partition images are created from CSV files containing user-provided configurations and values.

Please note that this utility only creates manufacturing binary images which then need to be flashed onto your devices using:

- [esptool.py](#).
- [Flash Download tool](#) (available on Windows only). Just download it, unzip, and follow the instructions inside the *doc* folder.
- Direct flash programming using custom production tools.

Prerequisites

This utility is dependent on `esp-idf`'s NVS partition utility.

- **Operating System requirements:**
 - Linux/macOS/Windows (standard distributions)

- **The following packages are needed to use this utility:**
 - Python

Note:**Before using this utility, please make sure that:**

- The path to Python is added to the PATH environment variable.
 - You have installed the packages from *requirement.txt*, the file in the root of the esp-idf directory.
-

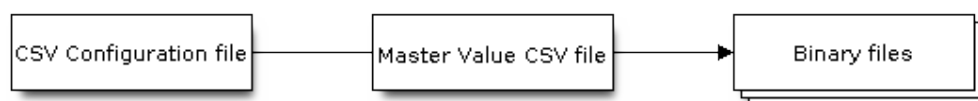
Workflow**CSV Configuration File**

This file contains the configuration of the device to be flashed.

The data in the configuration file has the following format (the *REPEAT* tag is optional):

```
name1,namespace,    <-- First entry should be of type "namespace"
key1,type1,encoding1
key2,type2,encoding2,REPEAT
name2,namespace,
key3,type3,encoding3
key4,type4,encoding4
```

Note: The first line in this file should always be the namespace entry.

Each line should have three parameters: *key*, *type*, *encoding*, separated by a comma. If the *REPEAT* tag is present, the value corresponding to this key in the master value CSV file will be the same for all devices.

Please refer to README of the NVS Partition Generator utility for detailed description of each parameter.

Below is a sample example of such a configuration file:

```
app,namespace,
firmware_key,data,hex2bin
serial_no,data,string,REPEAT
device_no,data,i32
```

Note:**Make sure there are no spaces:**

- before and after ‘,’
 - at the end of each line in a CSV file
-

Master Value CSV File

This file contains details of the devices to be flashed. Each line in this file corresponds to a device instance.

The data in the master value CSV file has the following format:

```
key1,key2,key3,....  
value1,value2,value3,....
```

Note: The first line in the file should always contain the `key` names. All the keys from the configuration file should be present here in the **same order**. This file can have additional columns (keys). The additional keys will be treated as metadata and would not be part of the final binary files.

Each line should contain the `value` of the corresponding keys, separated by a comma. If the key has the `REPEAT` tag, its corresponding value **must** be entered in the second line only. Keep the entry empty for this value in the following lines.

The description of this parameter is as follows:

value Data value

Data value is the value of data corresponding to the key.

Below is a sample example of a master value CSV file:

```
id,firmware_key,serial_no,device_no  
1,1a2b3c4d5e6faabb,A1,101  
2,1a2b3c4d5e6fccdd,,102  
3,1a2b3c4d5e6feeff,,103
```

Note: If the `'REPEAT'` tag is present, a new master value CSV file will be created in the same folder as the input Master CSV File with the values inserted at each line for the key with the `'REPEAT'` tag.

This utility creates intermediate CSV files which are used as input for the NVS partition utility to generate the binary files.

The format of this intermediate CSV file is as follows:

```
key,type,encoding,value  
key,namespace, ,  
key1,type1,encoding1,value1  
key2,type2,encoding2,value2
```

An instance of an intermediate CSV file will be created for each device on an individual basis.

Running the utility

Usage:

```
python mfg_gen.py [-h] {generate,generate-key} ...
```

Optional Arguments:

No.	Parameter	Description
1	-h, -help	show this help message and exit

Commands:

Run `mfg_gen.py {command} -h` for additional help

No.	Parameter	Description
1	generate	Generate NVS partition
2	generate-key	Generate keys for encryption

To generate factory images for each device (Default):

Usage:

```
python mfg_gen.py generate [-h] [--fileid FILEID] [--version {1,2}] [--keygen]
                          [--keyfile KEYFILE] [--inputkey INPUTKEY]
                          [--outdir OUTDIR]
                          conf values prefix size
```

Positional Arguments:

Parameter	Description
conf	Path to configuration csv file to parse
values	Path to values csv file to parse
prefix	Unique name for each output filename prefix
size	Size of NVS partition in bytes (must be multiple of 4096)

Optional Arguments:

Parameter	Description
-h, -help	show this help message and exit
-fileid FILEID	Unique file identifier(any key in values file) for each filename suffix (Default: numeric value(1,2,3...))
-version {1,2}	Set multipage blob version. Version 1 - Multipage blob support disabled. Version 2 - Multipage blob support enabled. Default: Version 2
-keygen	Generates key for encrypting NVS partition
-inputkey INPUTKEY	File having key for encrypting NVS partition
-outdir OUTDIR	Output directory to store files created (Default: current directory)

You can run the utility to generate factory images for each device using the command below. A sample CSV file is provided with the utility:

```
python mfg_gen.py generate samples/sample_config.csv samples/sample_values_
↪singlepage_blob.csv Sample 0x3000
```

The master value CSV file should have the path in the `file` type relative to the directory from which you are running the utility.

To generate encrypted factory images for each device:

You can run the utility to encrypt factory images for each device using the command below. A sample CSV file is provided with the utility:

- Encrypt by allowing the utility to generate encryption keys:

```
python mfg_gen.py generate samples/sample_config.csv samples/sample_values_
↪singlepage_blob.csv Sample 0x3000 --keygen
```

Note: Encryption key of the following format `<outdir>/keys/keys-<prefix>-<fileid>.bin` is created.

Note: This newly created file having encryption keys in `keys/` directory is compatible with NVS key-partition structure. Refer to [NVS key partition](#) for more details.

- Encrypt by providing the encryption keys as input binary file:

```
python mfg_gen.py generate samples/sample_config.csv samples/sample_values_
↪singlepage_blob.csv Sample 0x3000 --inputkey keys/sample_keys.bin
```

To generate only encryption keys:

Usage:

```
python mfg_gen.py generate-key [-h] [--keyfile KEYFILE] [--outdir OUTDIR]
```

Optional Arguments:

Parameter	Description
<code>-h, --help</code>	show this help message and exit
<code>--keyfile KEYFILE</code>	Path to output encryption keys file
<code>--outdir OUTDIR</code>	Output directory to store files created. (Default: current directory)

You can run the utility to generate only encryption keys using the command below:

```
python mfg_gen.py generate-key
```

Note: Encryption key of the following format `<outdir>/keys/keys-<timestamp>.bin` is created. Timestamp format is: `%m-%d_%H-%M`.

Note: To provide custom target filename use the `--keyfile` argument.

Generated encryption key binary file can further be used to encrypt factory images created on the per device basis.

The default numeric value: 1,2,3... of the `fileid` argument corresponds to each line bearing device instance values in the master value CSV file.

While running the manufacturing utility, the following folders will be created in the specified `outdir` directory:

- `bin/` for storing the generated binary files
- `csv/` for storing the generated intermediate CSV files
- `keys/` for storing encryption keys (when generating encrypted factory images)

2.6.3 Non-volatile storage library

Introduction

Non-volatile storage (NVS) library is designed to store key-value pairs in flash. This section introduces some concepts used by NVS.

Underlying storage Currently, NVS uses a portion of main flash memory through the *esp_partition* API. The library uses all the partitions with `data` type and `nvs` subtype. The application can choose to use the partition with the label `nvs` through the *nvs_open()* API function or any other partition by specifying its name using the *nvs_open_from_partition()* API function.

Future versions of this library may have other storage backends to keep data in another flash chip (SPI or I2C), RTC, FRAM, etc.

Note: if an NVS partition is truncated (for example, when the partition table layout is changed), its contents should be erased. ESP-IDF build system provides a `idf.py erase_flash` target to erase all contents of the flash chip.

Note: NVS works best for storing many small values, rather than a few large values of the type 'string' and 'blob'. If you need to store large blobs or strings, consider using the facilities provided by the FAT filesystem on top of the wear levelling library.

Keys and values NVS operates on key-value pairs. Keys are ASCII strings; the maximum key length is currently 15 characters. Values can have one of the following types:

- integer types: `uint8_t`, `int8_t`, `uint16_t`, `int16_t`, `uint32_t`, `int32_t`, `uint64_t`, `int64_t`
- zero-terminated string
- variable length binary data (blob)

Note: String values are currently limited to 4000 bytes. This includes the null terminator. Blob values are limited to 508000 bytes or 97.6% of the partition size - 4000 bytes, whichever is lower.

Additional types, such as `float` and `double` might be added later.

Keys are required to be unique. Assigning a new value to an existing key works as follows:

- if the new value is of the same type as the old one, value is updated
- if the new value has a different data type, an error is returned

Data type check is also performed when reading a value. An error is returned if the data type of the read operation does not match the data type of the value.

Namespaces To mitigate potential conflicts in key names between different components, NVS assigns each key-value pair to one of namespaces. Namespace names follow the same rules as key names, i.e., the maximum length is 15 characters. Namespace name is specified in the *nvs_open()* or *nvs_open_from_partition* call. This call returns an opaque handle, which is used in subsequent calls to the *nvs_get_**, *nvs_set_**, and *nvs_commit()* functions. This way, a handle is associated with a namespace, and key names will not collide with same names in other namespaces. Please note that the namespaces with the same name in different NVS partitions are considered as separate namespaces.

NVS iterators Iterators allow to list key-value pairs stored in NVS, based on specified partition name, namespace, and data type.

There are the following functions available:

- *nvs_entry_find()* returns an opaque handle, which is used in subsequent calls to the *nvs_entry_next()* and *nvs_entry_info()* functions.
- *nvs_entry_next()* returns iterator to the next key-value pair.
- *nvs_entry_info()* returns information about each key-value pair

If none or no other key-value pair was found for given criteria, `nvs_entry_find()` and `nvs_entry_next()` return NULL. In that case, the iterator does not have to be released. If the iterator is no longer needed, you can release it by using the function `nvs_release_iterator()`.

Security, tampering, and robustness NVS is not directly compatible with the ESP32-C3 flash encryption system. However, data can still be stored in encrypted form if NVS encryption is used together with ESP32-C3 flash encryption. Please refer to [NVS Encryption](#) for more details.

If NVS encryption is not used, it is possible for anyone with physical access to the flash chip to alter, erase, or add key-value pairs. With NVS encryption enabled, it is not possible to alter or add a key-value pair and get recognized as a valid pair without knowing corresponding NVS encryption keys. However, there is no tamper-resistance against the erase operation.

The library does try to recover from conditions when flash memory is in an inconsistent state. In particular, one should be able to power off the device at any point and time and then power it back on. This should not result in loss of data, except for the new key-value pair if it was being written at the moment of powering off. The library should also be able to initialize properly with any random data present in flash memory.

NVS Encryption

Data stored in NVS partitions can be encrypted using AES-XTS in the manner similar to the one mentioned in disk encryption standard IEEE P1619. For the purpose of encryption, each entry is treated as one *sector* and relative address of the entry (w.r.t. partition-start) is fed to the encryption algorithm as *sector-number*. The NVS Encryption can be enabled by enabling `CONFIG_NVS_ENCRYPTION`. The keys required for NVS encryption are stored in yet another partition, which is protected using [Flash Encryption](#). Therefore, enabling [Flash Encryption](#) is a prerequisite for NVS encryption.

The NVS Encryption is enabled by default when [Flash Encryption](#) is enabled. This is done because WiFi driver stores credentials (like SSID and passphrase) in the default NVS partition. It is important to encrypt them as default choice if platform level encryption is already enabled.

For using NVS encryption, the partition table must contain the [NVS key partition](#). Two partition tables containing the [NVS key partition](#) are provided for NVS encryption under the partition table option (menuconfig->Partition Table). They can be selected with the project configuration menu (`idf.py menuconfig`). Please refer to the example [security/flash_encryption](#) for how to configure and use NVS encryption feature.

NVS key partition

An application requiring NVS encryption support needs to be compiled with a key-partition of the type *data* and subtype *key*. This partition should be marked as *encrypted* and its size should be the minimum partition size (4KB). Refer to [Partition Tables](#) for more details. Two additional partition tables which contain the [NVS key partition](#) are provided under the partition table option (menuconfig->Partition Table). They can be directly used for [NVS Encryption](#). The structure of these partitions is depicted below.

-----+-----+-----+-----+-----
XTS encryption key (32)
-----+-----+-----+-----+-----
XTS tweak key (32)
-----+-----+-----+-----+-----
CRC32 (4)
-----+-----+-----+-----+-----

The XTS encryption keys in the [NVS key partition](#) can be generated in one of the following two ways.

1. Generate the keys on the ESP chip:

When NVS encryption is enabled the `nvs_flash_init()` API function can be used to initialize the encrypted default NVS partition. The API function internally generates the XTS encryption keys on the ESP chip. The API function finds the first [NVS key partition](#). Then the API function automatically generates and stores the nvs keys in that partition by making use of the `nvs_flash_generate_keys()` API function provided by `nvs_flash/include/nvs_flash.h`.

New keys are generated and stored only when the respective key partition is empty. The same key partition can then be used to read the security configurations for initializing a custom encrypted NVS partition with help of `nvs_flash_secure_init_partition()`.

The API functions `nvs_flash_secure_init()` and `nvs_flash_secure_init_partition()` do not generate the keys internally. When these API functions are used for initializing encrypted NVS partitions, the keys can be generated after startup using the `nvs_flash_generate_keys()` API function provided by `nvs_flash.h`. The API function will then write those keys onto the key-partition in encrypted form.

2. Use pre-generated key partition:

This option will be required by the user when keys in the *NVS key partition* are not generated by the application. The *NVS key partition* containing the XTS encryption keys can be generated with the help of *NVS Partition Generator Utility*. Then the user can store the pre generated key partition on the flash with help of the following two commands:

i) Build and flash the partition table

```
idf.py partition_table partition_table-flash
```

ii) Store the keys in the *NVS key partition* (on the flash) with the help of `parttool.py` (see Partition Tool section in *partition-tables* for more details)

```
parttool.py --port /dev/ttyUSB0 --partition-table-offset "nvs_key_  
↪partition offset" write_partition --partition-name="name of nvs_key_  
↪partition" --input "nvs_key partition"
```

Since the key partition is marked as *encrypted* and *Flash Encryption* is enabled, the bootloader will encrypt this partition using flash encryption key on the first boot.

It is possible for an application to use different keys for different NVS partitions and thereby have multiple key-partitions. However, it is a responsibility of the application to provide correct key-partition/keys for the purpose of encryption/decryption.

Encrypted Read/Write The same NVS API functions `nvs_get_*` or `nvs_set_*` can be used for reading of, and writing to an encrypted nvs partition as well.

Encrypt the default NVS partition: To enable encryption for the default NVS partition no additional steps are necessary. When *CONFIG_NVS_ENCRYPTION* is enabled, the `nvs_flash_init()` API function internally performs some additional steps using the first *NVS key partition* found to enable encryption for the default NVS partition (refer to the API documentation for more details). Alternatively, `nvs_flash_secure_init()` API function can also be used to enable encryption for the default NVS partition.

Encrypt a custom NVS partition: To enable encryption for a custom NVS partition, `nvs_flash_secure_init_partition()` API function is used instead of `nvs_flash_init_partition()`.

When `nvs_flash_secure_init()` and `nvs_flash_secure_init_partition()` API functions are used, the applications are expected to follow the steps below in order to perform NVS read/write operations with encryption enabled.

1. Find key partition and NVS data partition using `esp_partition_find*` API functions.
2. Populate the `nvs_sec_cfg_t` struct using the `nvs_flash_read_security_cfg()` or `nvs_flash_generate_keys()` API functions.
3. Initialise NVS flash partition using the `nvs_flash_secure_init()` or `nvs_flash_secure_init_partition()` API functions.
4. Open a namespace using the `nvs_open()` or `nvs_open_from_partition()` API functions.
5. Perform NVS read/write operations using `nvs_get_*` or `nvs_set_*`.
6. Deinitialise an NVS partition using `nvs_flash_deinit()`.

NVS Partition Generator Utility

This utility helps generate NVS partition binary files which can be flashed separately on a dedicated partition via a flashing utility. Key-value pairs to be flashed onto the partition can be provided via a CSV file. For more details,

please refer to [NVS Partition Generator Utility](#).

Application Example

You can find code examples in the [storage](#) directory of ESP-IDF examples:

[storage/nvs_rw_value](#)

Demonstrates how to read a single integer value from, and write it to NVS.

The value checked in this example holds the number of the ESP32-C3 module restarts. The value's function as a counter is only possible due to its storing in NVS.

The example also shows how to check if a read / write operation was successful, or if a certain value has not been initialized in NVS. The diagnostic procedure is provided in plain text to help you track the program flow and capture any issues on the way.

[storage/nvs_rw_blob](#)

Demonstrates how to read a single integer value and a blob (binary large object), and write them to NVS to preserve this value between ESP32-C3 module restarts.

- value - tracks the number of the ESP32-C3 module soft and hard restarts.
- blob - contains a table with module run times. The table is read from NVS to dynamically allocated RAM. A new run time is added to the table on each manually triggered soft restart, and then the added run time is written to NVS. Triggering is done by pulling down GPIO0.

The example also shows how to implement the diagnostic procedure to check if the read / write operation was successful.

[storage/nvs_rw_value_cxx](#)

This example does exactly the same as [storage/nvs_rw_value](#), except that it uses the C++ nvs handle class.

Internals

Log of key-value pairs NVS stores key-value pairs sequentially, with new key-value pairs being added at the end. When a value of any given key has to be updated, a new key-value pair is added at the end of the log and the old key-value pair is marked as erased.

Pages and entries NVS library uses two main entities in its operation: pages and entries. Page is a logical structure which stores a portion of the overall log. Logical page corresponds to one physical sector of flash memory. Pages which are in use have a *sequence number* associated with them. Sequence numbers impose an ordering on pages. Higher sequence numbers correspond to pages which were created later. Each page can be in one of the following states:

Empty/uninitialized Flash storage for the page is empty (all bytes are 0xff). Page is not used to store any data at this point and does not have a sequence number.

Active Flash storage is initialized, page header has been written to flash, page has a valid sequence number. Page has some empty entries and data can be written there. No more than one page can be in this state at any given moment.

Full Flash storage is in a consistent state and is filled with key-value pairs. Writing new key-value pairs into this page is not possible. It is still possible to mark some key-value pairs as erased.

Erasing Non-erased key-value pairs are being moved into another page so that the current page can be erased. This is a transient state, i.e., page should never stay in this state at the time when any API call returns. In case of a sudden power off, the move-and-erase process will be completed upon the next power-on.

Corrupted Page header contains invalid data, and further parsing of page data was canceled. Any items previously written into this page will not be accessible. The corresponding flash sector will not be erased immediately and will be kept along with sectors in *uninitialized* state for later use. This may be useful for debugging.

Mapping from flash sectors to logical pages does not have any particular order. The library will inspect sequence numbers of pages found in each flash sector and organize pages in a list based on these numbers.

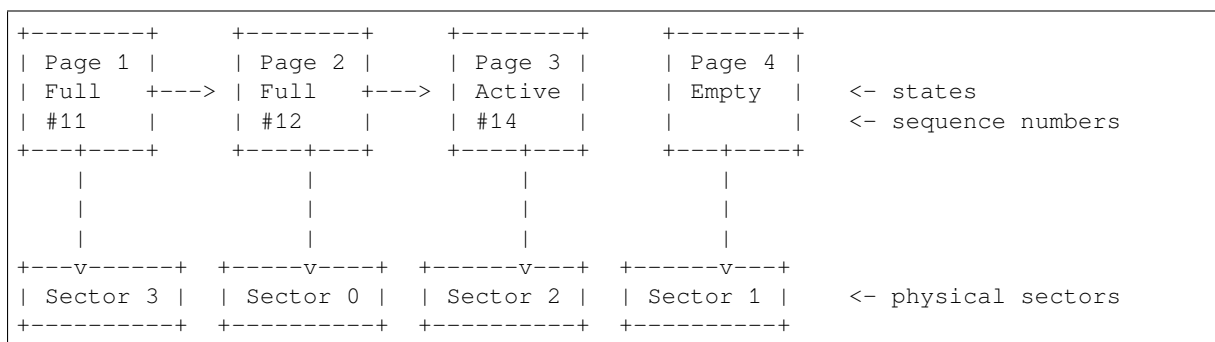

Structure of a page For now, we assume that flash sector size is 4096 bytes and that ESP32-C3 flash encryption hardware operates on 32-byte blocks. It is possible to introduce some settings configurable at compile-time (e.g., via menuconfig) to accommodate flash chips with different sector sizes (although it is not clear if other components in the system, e.g., SPI flash driver and SPI flash cache can support these other sizes).

Page consists of three parts: header, entry state bitmap, and entries themselves. To be compatible with ESP32-C3 flash encryption, the entry size is 32 bytes. For integer types, an entry holds one key-value pair. For strings and blobs, an entry holds part of key-value pair (more on that in the entry structure description).

The following diagram illustrates the page structure. Numbers in parentheses indicate the size of each part in bytes.

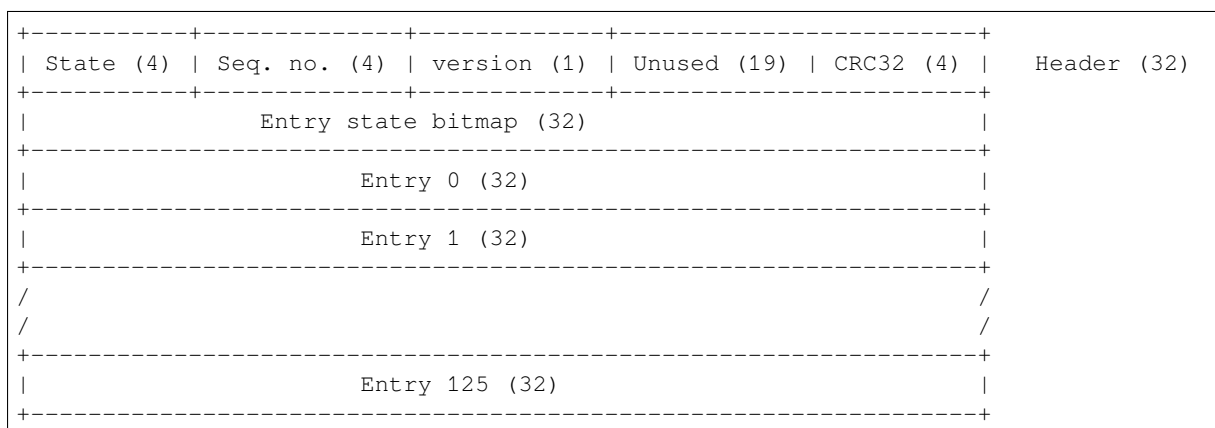

Page header and entry state bitmap are always written to flash unencrypted. Entries are encrypted if flash encryption feature of ESP32-C3 is used.

Page state values are defined in such a way that changing state is possible by writing 0 into some of the bits. Therefore it is not necessary to erase the page to change its state unless that is a change to the *erased* state.

The version field in the header reflects the NVS format version used. For backward compatibility reasons, it is decremented for every version upgrade starting at 0xff (i.e., 0xff for version-1, 0xfe for version-2 and so on).

CRC32 value in the header is calculated over the part which does not include a state value (bytes 4 to 28). The unused part is currently filled with 0xff bytes.

The following sections describe the structure of entry state bitmap and entry itself.

Entry and entry state bitmap Each entry can be in one of the following three states represented with two bits in the entry state bitmap. The final four bits in the bitmap (256 - 2 * 126) are not used.

Empty (2' b11) Nothing is written into the specific entry yet. It is in an uninitialized state (all bytes are 0xff).

Written (2' b10) A key-value pair (or part of key-value pair which spans multiple entries) has been written into the entry.

Erased (2' b00) A key-value pair in this entry has been discarded. Contents of this entry will not be parsed anymore.

Structure of entry For values of primitive types (currently integers from 1 to 8 bytes long), entry holds one key-value pair. For string and blob types, entry holds part of the whole key-value pair. For strings, in case when a key-value pair spans multiple entries, all entries are stored in the same page. Blobs are allowed to span over multiple pages by dividing them into smaller chunks. For tracking these chunks, an additional fixed length metadata entry is stored called “blob index”. Earlier formats of blobs are still supported (can be read and modified). However, once the blobs are modified, they are stored using the new format.

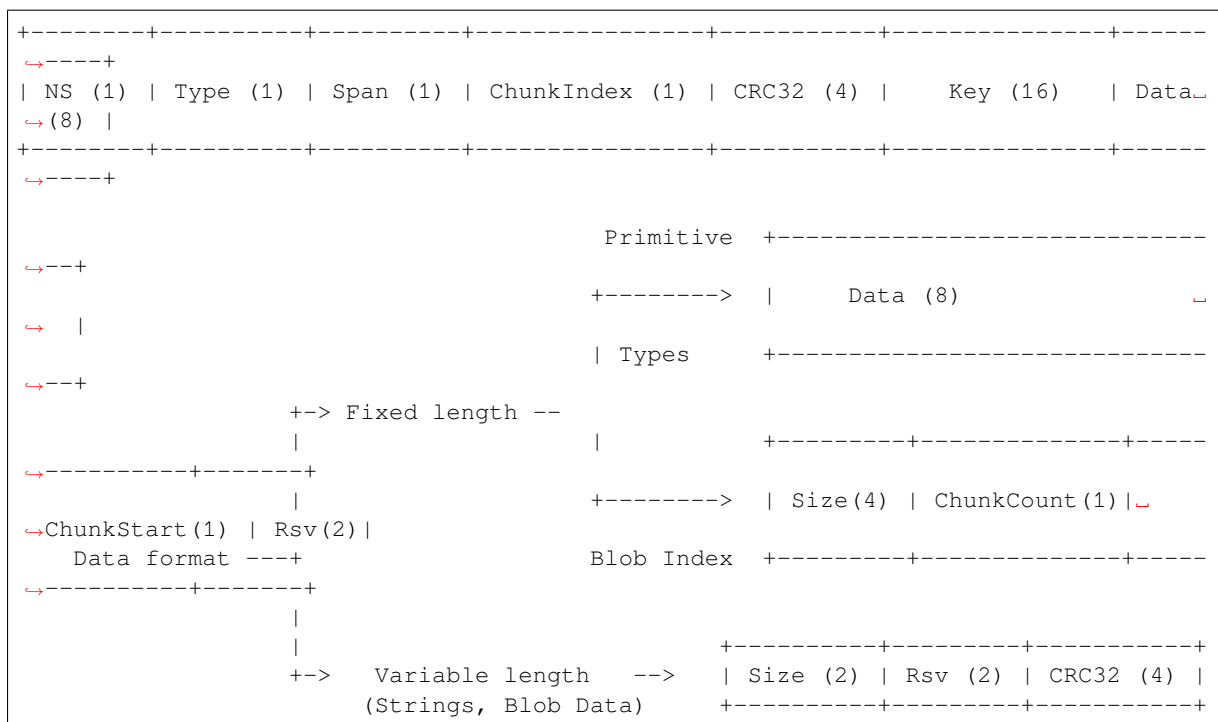

Individual fields in entry structure have the following meanings:

NS Namespace index for this entry. For more information on this value, see the section on namespaces implementation.

Type One byte indicating the value data type. See the `ItemType` enumeration in `nvs_flash/include/nvs_handle.hpp` for possible values.

Span Number of entries used by this key-value pair. For integer types, this is equal to 1. For strings and blobs, this depends on value length.

ChunkIndex Used to store the index of a blob-data chunk for blob types. For other types, this should be `0xff`.

CRC32 Checksum calculated over all the bytes in this entry, except for the CRC32 field itself.

Key Zero-terminated ASCII string containing a key name. Maximum string length is 15 bytes, excluding a zero terminator.

Data For integer types, this field contains the value itself. If the value itself is shorter than 8 bytes, it is padded to the right, with unused bytes filled with `0xff`.

For “blob index” entry, these 8 bytes hold the following information about data-chunks:

- **Size** (Only for blob index.) Size, in bytes, of complete blob data.
- **ChunkCount** (Only for blob index.) Total number of blob-data chunks into which the blob was divided during storage.
- **ChunkStart** (Only for blob index.) `ChunkIndex` of the first blob-data chunk of this blob. Subsequent chunks have `chunkIndex` incrementally allocated (step of 1).

For string and blob data chunks, these 8 bytes hold additional data about the value, which are described below:

- **Size** (Only for strings and blobs.) Size, in bytes, of actual data. For strings, this includes zero terminators.
- **CRC32** (Only for strings and blobs.) Checksum calculated over all bytes of data.

Variable length values (strings and blobs) are written into subsequent entries, 32 bytes per entry. The *Span* field of the first entry indicates how many entries are used.

Namespaces As mentioned above, each key-value pair belongs to one of the namespaces. Namespace identifiers (strings) are stored as keys of key-value pairs in namespace with index 0. Values corresponding to these keys are indexes of these namespaces.

+-----+ NS=0 Type=uint8_t Key="wifi" Value=1	Entry describing namespace "wifi"
+-----+ NS=1 Type=uint32_t Key="channel" Value=6	Key "channel" in namespace "wifi"
+-----+ NS=0 Type=uint8_t Key="pwm" Value=2	Entry describing namespace "pwm"
+-----+ NS=2 Type=uint16_t Key="channel" Value=20	Key "channel" in namespace "pwm"
+-----+	

Item hash list To reduce the number of reads from flash memory, each member of the Page class maintains a list of pairs: item index; item hash. This list makes searches much quicker. Instead of iterating over all entries, reading them from flash one at a time, *Page::findItem* first performs a search for the item hash in the hash list. This gives the item index within the page if such an item exists. Due to a hash collision, it is possible that a different item will be found. This is handled by falling back to iteration over items in flash.

Each node in the hash list contains a 24-bit hash and 8-bit item index. Hash is calculated based on item namespace, key name, and ChunkIndex. CRC32 is used for calculation; the result is truncated to 24 bits. To reduce the overhead for storing 32-bit entries in a linked list, the list is implemented as a double-linked list of arrays. Each array holds 29 entries, for the total size of 128 bytes, together with linked list pointers and a 32-bit count field. The minimum amount of extra RAM usage per page is therefore 128 bytes; maximum is 640 bytes.

API Reference

Header File

- [nvs_flash/include/nvs_flash.h](#)

Functions

esp_err_t **nvs_flash_init** (void)

Initialize the default NVS partition.

This API initialises the default NVS partition. The default NVS partition is the one that is labeled “nvs” in the partition table.

When “NVS_ENCRYPTION” is enabled in the menuconfig, this API enables the NVS encryption for the default NVS partition as follows

1. Read security configurations from the first NVS key partition listed in the partition table. (NVS key partition is any “data” type partition which has the subtype value set to “nvs_keys”)
2. If the NVS key partition obtained in the previous step is empty, generate and store new keys in that NVS key partition.
3. Internally call “nvs_flash_secure_init()” with the security configurations obtained/generated in the previous steps.

Post initialization NVS read/write APIs remain the same irrespective of NVS encryption.

Return

- ESP_OK if storage was successfully initialized.
- ESP_ERR_NVS_NO_FREE_PAGES if the NVS storage contains no empty pages (which may happen if NVS partition was truncated)
- ESP_ERR_NOT_FOUND if no partition with label “nvs” is found in the partition table
- ESP_ERR_NO_MEM in case memory could not be allocated for the internal structures
- one of the error codes from the underlying flash storage driver
- error codes from *nvs_flash_read_security_cfg* API (when “NVS_ENCRYPTION” is enabled).
- error codes from *nvs_flash_generate_keys* API (when “NVS_ENCRYPTION” is enabled).

• error codes from `nvs_flash_secure_init_partition` API (when “NVS_ENCRYPTION” is enabled).

`esp_err_t nvs_flash_init_partition(const char *partition_label)`
Initialize NVS flash storage for the specified partition.

Return

- `ESP_OK` if storage was successfully initialized.
- `ESP_ERR_NVS_NO_FREE_PAGES` if the NVS storage contains no empty pages (which may happen if NVS partition was truncated)
- `ESP_ERR_NOT_FOUND` if specified partition is not found in the partition table
- `ESP_ERR_NO_MEM` in case memory could not be allocated for the internal structures
- one of the error codes from the underlying flash storage driver

Parameters

- [in] `partition_label`: Label of the partition. Must be no longer than 16 characters.

`esp_err_t nvs_flash_init_partition_ptr(const esp_partition_t *partition)`

Initialize NVS flash storage for the partition specified by partition pointer.

Return

- `ESP_OK` if storage was successfully initialized
- `ESP_ERR_NVS_NO_FREE_PAGES` if the NVS storage contains no empty pages (which may happen if NVS partition was truncated)
- `ESP_ERR_INVALID_ARG` in case partition is `NULL`
- `ESP_ERR_NO_MEM` in case memory could not be allocated for the internal structures
- one of the error codes from the underlying flash storage driver

Parameters

- [in] `partition`: pointer to a partition obtained by the ESP partition API.

`esp_err_t nvs_flash_deinit(void)`

Deinitialize NVS storage for the default NVS partition.

Default NVS partition is the partition with “nvs” label in the partition table.

Return

- `ESP_OK` on success (storage was deinitialized)
- `ESP_ERR_NVS_NOT_INITIALIZED` if the storage was not initialized prior to this call

`esp_err_t nvs_flash_deinit_partition(const char *partition_label)`

Deinitialize NVS storage for the given NVS partition.

Return

- `ESP_OK` on success
- `ESP_ERR_NVS_NOT_INITIALIZED` if the storage for given partition was not initialized prior to this call

Parameters

- [in] `partition_label`: Label of the partition

`esp_err_t nvs_flash_erase(void)`

Erase the default NVS partition.

Erases all contents of the default NVS partition (one with label “nvs”).

Note If the partition is initialized, this function first de-initializes it. Afterwards, the partition has to be initialized again to be used.

Return

- `ESP_OK` on success
- `ESP_ERR_NOT_FOUND` if there is no NVS partition labeled “nvs” in the partition table
- different error in case de-initialization fails (shouldn't happen)

`esp_err_t nvs_flash_erase_partition(const char *part_name)`

Erase specified NVS partition.

Erase all content of a specified NVS partition

Note If the partition is initialized, this function first de-initializes it. Afterwards, the partition has to be initialized again to be used.

Return

- ESP_OK on success
- ESP_ERR_NOT_FOUND if there is no NVS partition with the specified name in the partition table
- different error in case de-initialization fails (shouldn't happen)

Parameters

- [in] `part_name`: Name (label) of the partition which should be erased

`esp_err_t nvs_flash_erase_partition_ptr (const esp_partition_t *partition)`

Erase custom partition.

Erase all content of specified custom partition.

Note If the partition is initialized, this function first de-initializes it. Afterwards, the partition has to be initialized again to be used.

Return

- ESP_OK on success
- ESP_ERR_NOT_FOUND if there is no partition with the specified parameters in the partition table
- ESP_ERR_INVALID_ARG in case partition is NULL
- one of the error codes from the underlying flash storage driver

Parameters

- [in] `partition`: pointer to a partition obtained by the ESP partition API.

`esp_err_t nvs_flash_secure_init (nvs_sec_cfg_t *cfg)`

Initialize the default NVS partition.

This API initialises the default NVS partition. The default NVS partition is the one that is labeled “nvs” in the partition table.

Return

- ESP_OK if storage was successfully initialized.
- ESP_ERR_NVS_NO_FREE_PAGES if the NVS storage contains no empty pages (which may happen if NVS partition was truncated)
- ESP_ERR_NOT_FOUND if no partition with label “nvs” is found in the partition table
- ESP_ERR_NO_MEM in case memory could not be allocated for the internal structures
- one of the error codes from the underlying flash storage driver

Parameters

- [in] `cfg`: Security configuration (keys) to be used for NVS encryption/decryption. If `cfg` is NULL, no encryption is used.

`esp_err_t nvs_flash_secure_init_partition (const char *partition_label, nvs_sec_cfg_t *cfg)`

Initialize NVS flash storage for the specified partition.

Return

- ESP_OK if storage was successfully initialized.
- ESP_ERR_NVS_NO_FREE_PAGES if the NVS storage contains no empty pages (which may happen if NVS partition was truncated)
- ESP_ERR_NOT_FOUND if specified partition is not found in the partition table
- ESP_ERR_NO_MEM in case memory could not be allocated for the internal structures
- one of the error codes from the underlying flash storage driver

Parameters

- [in] `partition_label`: Label of the partition. Note that internally a reference to passed value is kept and it should be accessible for future operations
- [in] `cfg`: Security configuration (keys) to be used for NVS encryption/decryption. If `cfg` is null, no encryption/decryption is used.

`esp_err_t nvs_flash_generate_keys (const esp_partition_t *partition, nvs_sec_cfg_t *cfg)`

Generate and store NVS keys in the provided esp partition.

Return -ESP_OK, if `cfg` was read successfully; -or error codes from `esp_partition_write/erase` APIs.

Parameters

- [in] `partition`: Pointer to partition structure obtained using `esp_partition_find_first` or `esp_partition_get`. Must be non-NULL.

- [out] `cfg`: Pointer to nvs security configuration structure. Pointer must be non-NULL. Generated keys will be populated in this structure.

`esp_err_t nvs_flash_read_security_cfg(const esp_partition_t *partition, nvs_sec_cfg_t *cfg)`

Read NVS security configuration from a partition.

Note Provided partition is assumed to be marked 'encrypted'.

Return -ESP_OK, if `cfg` was read successfully; -ESP_ERR_NVS_KEYS_NOT_INITIALIZED, if the partition is not yet written with keys. -ESP_ERR_NVS_CORRUPT_KEY_PART, if the partition containing keys is found to be corrupt -or error codes from `esp_partition_read` API.

Parameters

- [in] `partition`: Pointer to partition structure obtained using `esp_partition_find_first` or `esp_partition_get`. Must be non-NULL.
- [out] `cfg`: Pointer to nvs security configuration structure. Pointer must be non-NULL.

Structures

struct nvs_sec_cfg_t

Key for encryption and decryption.

Public Members

`uint8_t eky[NVS_KEY_SIZE]`
XTS encryption and decryption key

`uint8_t tky[NVS_KEY_SIZE]`
XTS tweak key

Macros

NVS_KEY_SIZE

Header File

- [nvs_flash/include/nvs.h](#)

Functions

`esp_err_t nvs_set_i8(nvs_handle_t handle, const char *key, int8_t value)`

set `int8_t` value for given key

Set value for the key, given its name. Note that the actual storage will not be updated until `nvs_commit` is called.

Return

- ESP_OK if value was set successfully
- ESP_ERR_NVS_INVALID_HANDLE if handle has been closed or is NULL
- ESP_ERR_NVS_READ_ONLY if storage handle was opened as read only
- ESP_ERR_NVS_INVALID_NAME if key name doesn't satisfy constraints
- ESP_ERR_NVS_NOT_ENOUGH_SPACE if there is not enough space in the underlying storage to save the value
- ESP_ERR_NVS_REMOVE_FAILED if the value wasn't updated because flash write operation has failed. The value was written however, and update will be finished after re-initialization of nvs, provided that flash operation doesn't fail again.

Parameters

- [in] `handle`: Handle obtained from `nvs_open` function. Handles that were opened read only cannot be used.
- [in] `key`: Key name. Maximal length is (NVS_KEY_NAME_MAX_SIZE-1) characters. Shouldn't be empty.
- [in] `value`: The value to set.

esp_err_t nvs_set_u8 (*nvs_handle_t* handle, **const** char *key, uint8_t value)
set uint8_t value for given key

This function is the same as `nvs_set_i8` except for the data type.

esp_err_t nvs_set_i16 (*nvs_handle_t* handle, **const** char *key, int16_t value)
set int16_t value for given key

This function is the same as `nvs_set_i8` except for the data type.

esp_err_t nvs_set_u16 (*nvs_handle_t* handle, **const** char *key, uint16_t value)
set uint16_t value for given key

This function is the same as `nvs_set_i8` except for the data type.

esp_err_t nvs_set_i32 (*nvs_handle_t* handle, **const** char *key, int32_t value)
set int32_t value for given key

This function is the same as `nvs_set_i8` except for the data type.

esp_err_t nvs_set_u32 (*nvs_handle_t* handle, **const** char *key, uint32_t value)
set uint32_t value for given key

This function is the same as `nvs_set_i8` except for the data type.

esp_err_t nvs_set_i64 (*nvs_handle_t* handle, **const** char *key, int64_t value)
set int64_t value for given key

This function is the same as `nvs_set_i8` except for the data type.

esp_err_t nvs_set_u64 (*nvs_handle_t* handle, **const** char *key, uint64_t value)
set uint64_t value for given key

This function is the same as `nvs_set_i8` except for the data type.

esp_err_t nvs_set_str (*nvs_handle_t* handle, **const** char *key, **const** char *value)
set string for given key

Set value for the key, given its name. Note that the actual storage will not be updated until `nvs_commit` is called.

Return

- `ESP_OK` if value was set successfully
- `ESP_ERR_NVS_INVALID_HANDLE` if handle has been closed or is `NULL`
- `ESP_ERR_NVS_READ_ONLY` if storage handle was opened as read only
- `ESP_ERR_NVS_INVALID_NAME` if key name doesn't satisfy constraints
- `ESP_ERR_NVS_NOT_ENOUGH_SPACE` if there is not enough space in the underlying storage to save the value
- `ESP_ERR_NVS_REMOVE_FAILED` if the value wasn't updated because flash write operation has failed. The value was written however, and update will be finished after re-initialization of `nvs`, provided that flash operation doesn't fail again.
- `ESP_ERR_NVS_VALUE_TOO_LONG` if the string value is too long

Parameters

- [in] handle: Handle obtained from `nvs_open` function. Handles that were opened read only cannot be used.
- [in] key: Key name. Maximal length is `(NVS_KEY_NAME_MAX_SIZE-1)` characters. Shouldn't be empty.
- [in] value: The value to set. For strings, the maximum length (including null character) is 4000 bytes, if there is one complete page free for writing. This decreases, however, if the free space is fragmented.

esp_err_t nvs_get_i8 (*nvs_handle_t* handle, **const** char *key, int8_t *out_value)
get int8_t value for given key

These functions retrieve value for the key, given its name. If `key` does not exist, or the requested variable type doesn't match the type which was used when setting a value, an error is returned.

In case of any error, `out_value` is not modified.

`out_value` has to be a pointer to an already allocated variable of the given type.

```
// Example of using nvs_get_i32:
int32_t max_buffer_size = 4096; // default value
esp_err_t err = nvs_get_i32(my_handle, "max_buffer_size", &max_buffer_size);
assert(err == ESP_OK || err == ESP_ERR_NVS_NOT_FOUND);
// if ESP_ERR_NVS_NOT_FOUND was returned, max_buffer_size will still
// have its default value.
```

Return

- `ESP_OK` if the value was retrieved successfully
- `ESP_ERR_NVS_NOT_FOUND` if the requested key doesn't exist
- `ESP_ERR_NVS_INVALID_HANDLE` if handle has been closed or is `NULL`
- `ESP_ERR_NVS_INVALID_NAME` if key name doesn't satisfy constraints
- `ESP_ERR_NVS_INVALID_LENGTH` if length is not sufficient to store data

Parameters

- `[in] handle`: Handle obtained from `nvs_open` function.
- `[in] key`: Key name. Maximal length is `(NVS_KEY_NAME_MAX_SIZE-1)` characters. Shouldn't be empty.
- `out_value`: Pointer to the output value. May be `NULL` for `nvs_get_str` and `nvs_get_blob`, in this case required length will be returned in length argument.

`esp_err_t nvs_get_u8` (*`nvs_handle_t handle`*, **`const char *key`**, *`uint8_t *out_value`*)
get `uint8_t` value for given key

This function is the same as `nvs_get_i8` except for the data type.

`esp_err_t nvs_get_i16` (*`nvs_handle_t handle`*, **`const char *key`**, *`int16_t *out_value`*)
get `int16_t` value for given key

This function is the same as `nvs_get_i8` except for the data type.

`esp_err_t nvs_get_u16` (*`nvs_handle_t handle`*, **`const char *key`**, *`uint16_t *out_value`*)
get `uint16_t` value for given key

This function is the same as `nvs_get_i8` except for the data type.

`esp_err_t nvs_get_i32` (*`nvs_handle_t handle`*, **`const char *key`**, *`int32_t *out_value`*)
get `int32_t` value for given key

This function is the same as `nvs_get_i8` except for the data type.

`esp_err_t nvs_get_u32` (*`nvs_handle_t handle`*, **`const char *key`**, *`uint32_t *out_value`*)
get `uint32_t` value for given key

This function is the same as `nvs_get_i8` except for the data type.

`esp_err_t nvs_get_i64` (*`nvs_handle_t handle`*, **`const char *key`**, *`int64_t *out_value`*)
get `int64_t` value for given key

This function is the same as `nvs_get_i8` except for the data type.

`esp_err_t nvs_get_u64` (*`nvs_handle_t handle`*, **`const char *key`**, *`uint64_t *out_value`*)
get `uint64_t` value for given key

This function is the same as `nvs_get_i8` except for the data type.

`esp_err_t nvs_get_str` (*`nvs_handle_t handle`*, **`const char *key`**, *`char *out_value`*, *`size_t *length`*)
get string value for given key

These functions retrieve the data of an entry, given its key. If key does not exist, or the requested variable type doesn't match the type which was used when setting a value, an error is returned.

In case of any error, `out_value` is not modified.

All functions expect `out_value` to be a pointer to an already allocated variable of the given type.

`nvs_get_str` and `nvs_get_blob` functions support WinAPI-style length queries. To get the size necessary to store the value, call `nvs_get_str` or `nvs_get_blob` with zero `out_value` and non-zero pointer to `length`. Variable pointed to by `length` argument will be set to the required length. For `nvs_get_str`, this length includes the zero terminator. When calling `nvs_get_str` and `nvs_get_blob` with non-zero `out_value`, `length` has to be non-zero and has to point to the length available in `out_value`. It is suggested that `nvs_get/set_str` is used for zero-terminated C strings, and `nvs_get/set_blob` used for arbitrary data structures.

```
// Example (without error checking) of using nvs_get_str to get a string into
↳dynamic array:
size_t required_size;
nvs_get_str(my_handle, "server_name", NULL, &required_size);
char* server_name = malloc(required_size);
nvs_get_str(my_handle, "server_name", server_name, &required_size);

// Example (without error checking) of using nvs_get_blob to get a binary data
into a static array:
uint8_t mac_addr[6];
size_t size = sizeof(mac_addr);
nvs_get_blob(my_handle, "dst_mac_addr", mac_addr, &size);
```

Return

- `ESP_OK` if the value was retrieved successfully
- `ESP_ERR_NVS_NOT_FOUND` if the requested key doesn't exist
- `ESP_ERR_NVS_INVALID_HANDLE` if handle has been closed or is `NULL`
- `ESP_ERR_NVS_INVALID_NAME` if key name doesn't satisfy constraints
- `ESP_ERR_NVS_INVALID_LENGTH` if `length` is not sufficient to store data

Parameters

- `[in]` `handle`: Handle obtained from `nvs_open` function.
- `[in]` `key`: Key name. Maximal length is `(NVS_KEY_NAME_MAX_SIZE-1)` characters. Shouldn't be empty.
- `[out]` `out_value`: Pointer to the output value. May be `NULL` for `nvs_get_str` and `nvs_get_blob`, in this case required length will be returned in `length` argument.
- `[inout]` `length`: A non-zero pointer to the variable holding the length of `out_value`. In case `out_value` a zero, will be set to the length required to hold the value. In case `out_value` is not zero, will be set to the actual length of the value written. For `nvs_get_str` this includes zero terminator.

esp_err_t `nvs_get_blob`(*nvs_handle_t* `handle`, `const` `char`*`key`, `void`*`out_value`, `size_t`*`length`)
get blob value for given key

This function behaves the same as `nvs_get_str`, except for the data type.

esp_err_t `nvs_open`(`const` `char`*`name`, *nvs_open_mode_t* `open_mode`, *nvs_handle_t**`out_handle`)
Open non-volatile storage with a given namespace from the default NVS partition.

Multiple internal ESP-IDF and third party application modules can store their key-value pairs in the NVS module. In order to reduce possible conflicts on key names, each module can use its own namespace. The default NVS partition is the one that is labelled "nvs" in the partition table.

Return

- `ESP_OK` if storage handle was opened successfully
- `ESP_ERR_NVS_NOT_INITIALIZED` if the storage driver is not initialized
- `ESP_ERR_NVS_PART_NOT_FOUND` if the partition with label "nvs" is not found
- `ESP_ERR_NVS_NOT_FOUND` id namespace doesn't exist yet and mode is `NVS_READONLY`
- `ESP_ERR_NVS_INVALID_NAME` if namespace name doesn't satisfy constraints
- `ESP_ERR_NO_MEM` in case memory could not be allocated for the internal structures
- other error codes from the underlying storage driver

Parameters

- `[in]` `name`: Namespace name. Maximal length is `(NVS_KEY_NAME_MAX_SIZE-1)` characters. Shouldn't be empty.
- `[in]` `open_mode`: `NVS_READWRITE` or `NVS_READONLY`. If `NVS_READONLY`, will open a handle for reading only. All write requests will be rejected for this handle.
- `[out]` `out_handle`: If successful (return code is zero), handle will be returned in this argument.

esp_err_t **nvs_open_from_partition**(const char *part_name, const char *name, *nvs_open_mode_t* open_mode, *nvs_handle_t* *out_handle)

Open non-volatile storage with a given namespace from specified partition.

The behaviour is same as `nvs_open()` API. However this API can operate on a specified NVS partition instead of default NVS partition. Note that the specified partition must be registered with NVS using `nvs_flash_init_partition()` API.

Return

- `ESP_OK` if storage handle was opened successfully
- `ESP_ERR_NVS_NOT_INITIALIZED` if the storage driver is not initialized
- `ESP_ERR_NVS_PART_NOT_FOUND` if the partition with specified name is not found
- `ESP_ERR_NVS_NOT_FOUND` id namespace doesn't exist yet and mode is `NVS_READONLY`
- `ESP_ERR_NVS_INVALID_NAME` if namespace name doesn't satisfy constraints
- `ESP_ERR_NO_MEM` in case memory could not be allocated for the internal structures
- other error codes from the underlying storage driver

Parameters

- [in] `part_name`: Label (name) of the partition of interest for object read/write/erase
- [in] `name`: Namespace name. Maximal length is `(NVS_KEY_NAME_MAX_SIZE-1)` characters. Shouldn't be empty.
- [in] `open_mode`: `NVS_READWRITE` or `NVS_READONLY`. If `NVS_READONLY`, will open a handle for reading only. All write requests will be rejected for this handle.
- [out] `out_handle`: If successful (return code is zero), handle will be returned in this argument.

esp_err_t **nvs_set_blob**(*nvs_handle_t* handle, const char *key, const void *value, *size_t* length)

set variable length binary value for given key

This family of functions set value for the key, given its name. Note that actual storage will not be updated until `nvs_commit` function is called.

Return

- `ESP_OK` if value was set successfully
- `ESP_ERR_NVS_INVALID_HANDLE` if handle has been closed or is `NULL`
- `ESP_ERR_NVS_READ_ONLY` if storage handle was opened as read only
- `ESP_ERR_NVS_INVALID_NAME` if key name doesn't satisfy constraints
- `ESP_ERR_NVS_NOT_ENOUGH_SPACE` if there is not enough space in the underlying storage to save the value
- `ESP_ERR_NVS_REMOVE_FAILED` if the value wasn't updated because flash write operation has failed. The value was written however, and update will be finished after re-initialization of nvs, provided that flash operation doesn't fail again.
- `ESP_ERR_NVS_VALUE_TOO_LONG` if the value is too long

Parameters

- [in] `handle`: Handle obtained from `nvs_open` function. Handles that were opened read only cannot be used.
- [in] `key`: Key name. Maximal length is `(NVS_KEY_NAME_MAX_SIZE-1)` characters. Shouldn't be empty.
- [in] `value`: The value to set.
- [in] `length`: length of binary value to set, in bytes; Maximum length is 508000 bytes or (97.6% of the partition size - 4000) bytes whichever is lower.

esp_err_t **nvs_erase_key**(*nvs_handle_t* handle, const char *key)

Erase key-value pair with given key name.

Note that actual storage may not be updated until `nvs_commit` function is called.

Return

- `ESP_OK` if erase operation was successful
- `ESP_ERR_NVS_INVALID_HANDLE` if handle has been closed or is `NULL`
- `ESP_ERR_NVS_READ_ONLY` if handle was opened as read only
- `ESP_ERR_NVS_NOT_FOUND` if the requested key doesn't exist
- other error codes from the underlying storage driver

Parameters

- [in] `handle`: Storage handle obtained with `nvs_open`. Handles that were opened read only cannot be used.
- [in] `key`: Key name. Maximal length is `(NVS_KEY_NAME_MAX_SIZE-1)` characters. Shouldn't be empty.

`esp_err_t nvs_erase_all(nvs_handle_t handle)`

Erase all key-value pairs in a namespace.

Note that actual storage may not be updated until `nvs_commit` function is called.

Return

- `ESP_OK` if erase operation was successful
- `ESP_ERR_NVS_INVALID_HANDLE` if handle has been closed or is `NULL`
- `ESP_ERR_NVS_READ_ONLY` if handle was opened as read only
- other error codes from the underlying storage driver

Parameters

- [in] `handle`: Storage handle obtained with `nvs_open`. Handles that were opened read only cannot be used.

`esp_err_t nvs_commit(nvs_handle_t handle)`

Write any pending changes to non-volatile storage.

After setting any values, `nvs_commit()` must be called to ensure changes are written to non-volatile storage. Individual implementations may write to storage at other times, but this is not guaranteed.

Return

- `ESP_OK` if the changes have been written successfully
- `ESP_ERR_NVS_INVALID_HANDLE` if handle has been closed or is `NULL`
- other error codes from the underlying storage driver

Parameters

- [in] `handle`: Storage handle obtained with `nvs_open`. Handles that were opened read only cannot be used.

void `nvs_close(nvs_handle_t handle)`

Close the storage handle and free any allocated resources.

This function should be called for each handle opened with `nvs_open` once the handle is not in use any more. Closing the handle may not automatically write the changes to nonvolatile storage. This has to be done explicitly using `nvs_commit` function. Once this function is called on a handle, the handle should no longer be used.

Parameters

- [in] `handle`: Storage handle to close

`esp_err_t nvs_get_stats(const char *part_name, nvs_stats_t *nvs_stats)`

Fill structure `nvs_stats_t`. It provides info about used memory the partition.

This function calculates to runtime the number of used entries, free entries, total entries, and amount namespace in partition.

```
// Example of nvs_get_stats() to get the number of used entries and free_
↪entries:
nvs_stats_t nvs_stats;
nvs_get_stats(NULL, &nvs_stats);
printf("Count: UsedEntries = (%d), FreeEntries = (%d), AllEntries = (%d)\n",
      nvs_stats.used_entries, nvs_stats.free_entries, nvs_stats.total_
↪entries);
```

Return

- `ESP_OK` if the changes have been written successfully. Return param `nvs_stats` will be filled.
- `ESP_ERR_NVS_PART_NOT_FOUND` if the partition with label "name" is not found. Return param `nvs_stats` will be filled 0.
- `ESP_ERR_NVS_NOT_INITIALIZED` if the storage driver is not initialized. Return param `nvs_stats` will be filled 0.
- `ESP_ERR_INVALID_ARG` if `nvs_stats` equal to `NULL`.

- `ESP_ERR_INVALID_STATE` if there is page with the status of `INVALID`. Return param `nvs_stats` will be filled not with correct values because not all pages will be counted. Counting will be interrupted at the first `INVALID` page.

Parameters

- [in] `part_name`: Partition name NVS in the partition table. If pass a `NULL` than will use `NVS_DEFAULT_PART_NAME` ("nvs").
- [out] `nvs_stats`: Returns filled structure `nvs_states_t`. It provides info about used memory the partition.

esp_err_t **nvs_get_used_entry_count** (*nvs_handle_t* handle, size_t *used_entries)

Calculate all entries in a namespace.

An entry represents the smallest storage unit in NVS. Strings and blobs may occupy more than one entry. Note that to find out the total number of entries occupied by the namespace, add one to the returned value `used_entries` (if `err` is equal to `ESP_OK`). Because the name space entry takes one entry.

```
// Example of nvs_get_used_entry_count() to get amount of all key-value pairs.
↳in one namespace:
nvs_handle_t handle;
nvs_open("namespace1", NVS_READWRITE, &handle);
...
size_t used_entries;
size_t total_entries_namespace;
if(nvs_get_used_entry_count(handle, &used_entries) == ESP_OK){
    // the total number of entries occupied by the namespace
    total_entries_namespace = used_entries + 1;
}
```

Return

- `ESP_OK` if the changes have been written successfully. Return param `used_entries` will be filled valid value.
- `ESP_ERR_NVS_NOT_INITIALIZED` if the storage driver is not initialized. Return param `used_entries` will be filled 0.
- `ESP_ERR_NVS_INVALID_HANDLE` if `handle` has been closed or is `NULL`. Return param `used_entries` will be filled 0.
- `ESP_ERR_INVALID_ARG` if `used_entries` equal to `NULL`.
- Other error codes from the underlying storage driver. Return param `used_entries` will be filled 0.

Parameters

- [in] `handle`: Handle obtained from `nvs_open` function.
- [out] `used_entries`: Returns amount of used entries from a namespace.

nvs_iterator_t **nvs_entry_find** (**const** char *part_name, **const** char *namespace_name, *nvs_type_t* type)

Create an iterator to enumerate NVS entries based on one or more parameters.

```
// Example of listing all the key-value pairs of any type under specified
↳partition and namespace
nvs_iterator_t it = nvs_entry_find(partition, namespace, NVS_TYPE_ANY);
while (it != NULL) {
    nvs_entry_info_t info;
    nvs_entry_info(it, &info);
    it = nvs_entry_next(it);
    printf("key '%s', type '%d' \n", info.key, info.type);
};
// Note: no need to release iterator obtained from nvs_entry_find function when
// nvs_entry_find or nvs_entry_next function return NULL, indicating no
↳other
// element for specified criteria was found.
}
```

Return Iterator used to enumerate all the entries found, or `NULL` if no entry satisfying criteria was found. Iterator obtained through this function has to be released using `nvs_release_iterator` when not used any

more.

Parameters

- [in] `part_name`: Partition name
- [in] `namespace_name`: Set this value if looking for entries with a specific namespace. Pass NULL otherwise.
- [in] `type`: One of `nvs_type_t` values.

`nvs_iterator_t nvs_entry_next (nvs_iterator_t iterator)`

Returns next item matching the iterator criteria, NULL if no such item exists.

Note that any copies of the iterator will be invalid after this call.

Return NULL if no entry was found, valid `nvs_iterator_t` otherwise.

Parameters

- [in] `iterator`: Iterator obtained from `nvs_entry_find` function. Must be non-NULL.

void `nvs_entry_info (nvs_iterator_t iterator, nvs_entry_info_t *out_info)`

Fills `nvs_entry_info_t` structure with information about entry pointed to by the iterator.

Parameters

- [in] `iterator`: Iterator obtained from `nvs_entry_find` or `nvs_entry_next` function. Must be non-NULL.
- [out] `out_info`: Structure to which entry information is copied.

void `nvs_release_iterator (nvs_iterator_t iterator)`

Release iterator.

Parameters

- [in] `iterator`: Release iterator obtained from `nvs_entry_find` function. NULL argument is allowed.

Structures

struct `nvs_entry_info_t`

information about entry obtained from `nvs_entry_info` function

Public Members

char `namespace_name`[16]

Namespace to which key-value belong

char `key`[`NVS_KEY_NAME_MAX_SIZE`]

Key of stored key-value pair

`nvs_type_t` `type`

Type of stored key-value pair

struct `nvs_stats_t`

Note Info about storage space NVS.

Public Members

size_t `used_entries`

Amount of used entries.

size_t `free_entries`

Amount of free entries.

size_t `total_entries`

Amount all available entries.

size_t `namespace_count`

Amount name space.

Macros**ESP_ERR_NVS_BASE**

Starting number of error codes

ESP_ERR_NVS_NOT_INITIALIZED

The storage driver is not initialized

ESP_ERR_NVS_NOT_FOUND

Id namespace doesn't exist yet and mode is NVS_READONLY

ESP_ERR_NVS_TYPE_MISMATCH

The type of set or get operation doesn't match the type of value stored in NVS

ESP_ERR_NVS_READ_ONLY

Storage handle was opened as read only

ESP_ERR_NVS_NOT_ENOUGH_SPACE

There is not enough space in the underlying storage to save the value

ESP_ERR_NVS_INVALID_NAME

Namespace name doesn't satisfy constraints

ESP_ERR_NVS_INVALID_HANDLE

Handle has been closed or is NULL

ESP_ERR_NVS_REMOVE_FAILED

The value wasn't updated because flash write operation has failed. The value was written however, and update will be finished after re-initialization of nvs, provided that flash operation doesn't fail again.

ESP_ERR_NVS_KEY_TOO_LONG

Key name is too long

ESP_ERR_NVS_PAGE_FULL

Internal error; never returned by nvs API functions

ESP_ERR_NVS_INVALID_STATE

NVS is in an inconsistent state due to a previous error. Call `nvs_flash_init` and `nvs_open` again, then retry.

ESP_ERR_NVS_INVALID_LENGTH

String or blob length is not sufficient to store data

ESP_ERR_NVS_NO_FREE_PAGES

NVS partition doesn't contain any empty pages. This may happen if NVS partition was truncated. Erase the whole partition and call `nvs_flash_init` again.

ESP_ERR_NVS_VALUE_TOO_LONG

String or blob length is longer than supported by the implementation

ESP_ERR_NVS_PART_NOT_FOUND

Partition with specified name is not found in the partition table

ESP_ERR_NVS_NEW_VERSION_FOUND

NVS partition contains data in new format and cannot be recognized by this version of code

ESP_ERR_NVS_XTS_ENCR_FAILED

XTS encryption failed while writing NVS entry

ESP_ERR_NVS_XTS_DECR_FAILED

XTS decryption failed while reading NVS entry

ESP_ERR_NVS_XTS_CFG_FAILED

XTS configuration setting failed

ESP_ERR_NVS_XTS_CFG_NOT_FOUND

XTS configuration not found

ESP_ERR_NVS_ENCR_NOT_SUPPORTED

NVS encryption is not supported in this version

ESP_ERR_NVS_KEYS_NOT_INITIALIZED

NVS key partition is uninitialized

ESP_ERR_NVS_CORRUPT_KEY_PART

NVS key partition is corrupt

ESP_ERR_NVS_WRONG_ENCRYPTION

NVS partition is marked as encrypted with generic flash encryption. This is forbidden since the NVS encryption works differently.

ESP_ERR_NVS_CONTENT_DIFFERS

Internal error; never returned by nvs API functions. NVS key is different in comparison

NVS_DEFAULT_PART_NAME

Default partition name of the NVS partition in the partition table

NVS_PART_NAME_MAX_SIZE

maximum length of partition name (excluding null terminator)

NVS_KEY_NAME_MAX_SIZE

Maximal length of NVS key name (including null terminator)

Type Definitions**typedef** uint32_t **nvs_handle_t**

Opaque pointer type representing non-volatile storage handle

typedef *nvs_handle_t* **nvs_handle****typedef** *nvs_open_mode_t* **nvs_open_mode****typedef** struct nvs_opaque_iterator_t ***nvs_iterator_t**

Opaque pointer type representing iterator to nvs entries

Enumerations**enum** **nvs_open_mode_t**

Mode of opening the non-volatile storage.

*Values:***NVS_READONLY**

Read only

NVS_READWRITE

Read and write

enum **nvs_type_t**

Types of variables.

*Values:***NVS_TYPE_U8** = 0x01

Type uint8_t

NVS_TYPE_I8 = 0x11

Type int8_t

NVS_TYPE_U16 = 0x02

Type uint16_t

NVS_TYPE_I16 = 0x12

Type int16_t

NVS_TYPE_U32 = 0x04

Type uint32_t

NVS_TYPE_I32 = 0x14

Type int32_t

NVS_TYPE_U64 = 0x08
Type uint64_t

NVS_TYPE_I64 = 0x18
Type int64_t

NVS_TYPE_STR = 0x21
Type string

NVS_TYPE_BLOB = 0x42
Type blob

NVS_TYPE_ANY = 0xff
Must be last

2.6.4 NVS Partition Generator Utility

Introduction

The utility `nvs_flash/nvs_partition_generator/nvs_partition_gen.py` creates a binary file based on key-value pairs provided in a CSV file. The binary file is compatible with NVS architecture defined in *Non-Volatile Storage*. This utility is ideally suited for generating a binary blob, containing data specific to ODM/OEM, which can be flashed externally at the time of device manufacturing. This allows manufacturers to generate many instances of the same application firmware with customized parameters for each device, such as a serial number.

Prerequisites

To use this utility in encryption mode, install the following packages:

- cryptography package

All the required packages are included in *requirements.txt* in the root of the esp-idf directory.

CSV file format

Each line of a .csv file should contain 4 parameters, separated by a comma. The table below provides the description for each of these parameters.

No.	Parameter	Description	Notes
1	Key	Key of the data. The data can be accessed later from an application using this key.	
2	Type	Supported values are <code>file</code> , <code>data</code> and <code>namespace</code> .	
3	Encoding	Supported values are: <code>u8</code> , <code>i8</code> , <code>u16</code> , <code>i16</code> , <code>u32</code> , <code>i32</code> , <code>u64</code> , <code>i64</code> , <code>string</code> , <code>hex2bin</code> , <code>base64</code> and <code>binary</code> . This specifies how actual data values are encoded in the resulting binary file. The difference between the <code>string</code> and <code>binary</code> encoding is that <code>string</code> data is terminated with a NULL character, whereas <code>binary</code> data is not.	As of now, for the <code>file</code> type, only <code>hex2bin</code> , <code>base64</code> , <code>string</code> , and <code>binary</code> encoding is supported.
4	Value	Data value.	Encoding and Value cells for the <code>namespace</code> field type should be empty. Encoding and Value of <code>namespace</code> is fixed and is not configurable. Any values in these cells are ignored.

Note: The first line of the CSV file should always be the column header and it is not configurable.

Below is an example dump of such a CSV file:

```
key,type,encoding,value      <-- column header
namespace_name,namespace,,  <-- First entry should be of type "namespace"
key1,data,u8,1
key2,file,string,/path/to/file
```

Note:

Make sure there are no spaces:

- before and after ‘,’
 - at the end of each line in a CSV file
-

NVS Entry and Namespace association

When a namespace entry is encountered in a CSV file, each following entry will be treated as part of that namespace until the next namespace entry is found. At this point, all the following entries will be treated as part of the new namespace.

Note: First entry in a CSV file should always be a namespace entry.

Multipage Blob Support

By default, binary blobs are allowed to span over multiple pages and are written in the format mentioned in Section [Structure of entry](#). If you intend to use an older format, the utility provides an option to disable this feature.

Encryption Support

The NVS Partition Generator utility also allows you to create an encrypted binary file. The utility uses the AES-XTS encryption. Please refer to [NVS Encryption](#) for more details.

Decryption Support

This utility allows you to decrypt an encrypted NVS binary file. The utility uses an NVS binary file encrypted using AES-XTS encryption. Please refer to [NVS Encryption](#) for more details.

Running the utility

Usage:

```
python nvs_partition_gen.py [-h] {generate,generate-key,encrypt,decrypt} ...
```

Optional Arguments:

No.	Parameter	Description

(continues on next page)

(continued from previous page)

```

| 1 | -h, --help | show this help message and exit
↵
+-----+
↵-----+

Commands:
    Run nvs_partition_gen.py {command} -h for additional help
+-----+
↵-----+
| No. | Parameter | Description
↵
+-----+
| 1 | generate | Generate NVS partition
↵
+-----+
↵-----+
| 2 | generate-key | Generate keys for encryption
↵
+-----+
↵-----+
| 3 | encrypt | Generate NVS encrypted partition
↵
+-----+
↵-----+
| 4 | decrypt | Decrypt NVS encrypted partition
↵
+-----+
↵-----+

```

To generate NVS partition (Default):**Usage:**

```

python nvs_partition_gen.py generate [-h] [--version {1,2}] [--outdir↵
↵OUTDIR]
                                input output size

Positional Arguments:
+-----+
↵-----+
| Parameter | Description
↵
+-----+
| input | Path to CSV file to parse
↵
+-----+
↵-----+
| output | Path to output NVS binary file
↵
+-----+
↵-----+
| size | Size of NVS partition in bytes (must be multiple↵
↵of 4096)
+-----+
↵-----+

Optional Arguments:
+-----+
↵-----+

```

(continues on next page)

(continued from previous page)

Parameter	Description
-h, --help	show this help message and exit
--version {1,2}	Set multipage blob version. Version 1 - Multipage blob support disabled. Version 2 - Multipage blob support enabled. Default: Version 2
--outdir OUTDIR	Output directory to store files created (Default: current directory)

You can run the utility to generate NVS partition using the command below: A sample CSV file is provided with the utility:

```
python nvs_partition_gen.py generate sample_singlepage_blob.csv sample.bin 0x3000
```

To generate only encryption keys:

Usage:

```
python nvs_partition_gen.py generate-key [-h] [--keyfile KEYFILE]
                                     [--outdir OUTDIR]
```

Optional Arguments:

Parameter	Description
-h, --help	show this help message and exit
--keyfile KEYFILE	Path to output encryption keys file
--outdir OUTDIR	Output directory to store files created. (Default: current directory)

You can run the utility to generate only encryption keys using the command below:

```
python nvs_partition_gen.py generate-key
```

To generate encrypted NVS partition:

Usage:

```
python nvs_partition_gen.py encrypt [-h] [--version {1,2}] [--keygen]
                                   [--keyfile KEYFILE] [--inputkey 
↳ INPUTKEY]
                                   [--outdir OUTDIR]
                                   input output size

Positional Arguments:
+-----+-----+
| Parameter | Description |
|-----|-----|
| input     | Path to CSV file to parse |
|-----|-----|
| output    | Path to output NVS binary file |
|-----|-----|
| size     | Size of NVS partition in bytes (must be multiple 
↳ of 4096) |
+-----+-----+

Optional Arguments:
+-----+-----+
| Parameter | Description | |
|---|---|---|
| -h, --help | show this help message and exit |
|-----|-----|
| --version {1,2} | Set multipage blob version. |
|-----|-----|
| | | Version 1 - Multipage blob support disabled. |
| | | Version 2 - Multipage blob support enabled. |
| | | Default: Version 2 |
|-----|-----|
| --keygen | Generates key for encrypting NVS partition |
|-----|-----|
| --keyfile KEYFILE | Path to output encryption keys file |
+-----+-----+
```

(continues on next page)

(continued from previous page)

--inputkey INPUTKEY	File having key for encrypting NVS partition	↵
↵		
+-----+	+-----+	
↵		
--outdir OUTDIR	Output directory to store files created	↵
↵		
	(Default: current directory)	↵
↵		
+-----+	+-----+	
↵		

You can run the utility to encrypt NVS partition using the command below: A sample CSV file is provided with the utility:

- Encrypt by allowing the utility to generate encryption keys:

```
python nvs_partition_gen.py encrypt sample_singlepage_blob.csv sample_encr.bin_
↵0x3000 --keygen
```

Note: Encryption key of the following format <outdir>/keys/keys-<timestamp>.bin is created.

- Encrypt by allowing the utility to generate encryption keys and store it in provided custom filename:

```
python nvs_partition_gen.py encrypt sample_singlepage_blob.csv sample_encr.bin_
↵0x3000 --keygen --keyfile sample_keys.bin
```

Note: Encryption key of the following format <outdir>/keys/sample_keys.bin is created.

Note: This newly created file having encryption keys in keys/ directory is compatible with NVS key-partition structure. Refer to [NVS key partition](#) for more details.

- Encrypt by providing the encryption keys as input binary file:

```
python nvs_partition_gen.py encrypt sample_singlepage_blob.csv sample_encr.bin_
↵0x3000 --inputkey sample_keys.bin
```

To decrypt encrypted NVS partition:

Usage:

```
python nvs_partition_gen.py decrypt [-h] [--outdir OUTDIR] input key_
↵output
```

Positional Arguments:

+-----+	+-----+	
↵		
Parameter	Description	↵
↵		
+-----+	+-----+	
input	Path to encrypted NVS partition file to parse	↵
↵		
+-----+	+-----+	
↵		
key	Path to file having keys for decryption	↵
↵		

(continues on next page)

(continued from previous page)

```

+-----+-----+
↪-----+
| output      |          Path to output decrypted binary file          ↪
↪          |
+-----+-----+
↪-----+

Optional Arguments:
+-----+-----+
↪-----+
| Parameter    |          Description          ↪
↪          |
+-----+-----+-----+-----+-----+-----+-----+-----+-----+
| -h, --help   |          show this help message and exit          ↪
↪          |
+-----+-----+-----+-----+-----+-----+-----+-----+-----+
↪-----+
| --outdir OUTDIR |          Output directory to store files created          ↪
↪          |          (Default: current directory)          ↪
↪          |
+-----+-----+-----+-----+-----+-----+-----+-----+-----+
↪-----+

```

You can run the utility to decrypt encrypted NVS partition using the command below:

```
python nvs_partition_gen.py decrypt sample_encr.bin sample_keys.bin sample_decr.bin
```

You can also provide the format version number:

- Multipage Blob Support Disabled (Version 1)
- Multipage Blob Support Enabled (Version 2)

Multipage Blob Support Disabled (Version 1): You can run the utility in this format by setting the version parameter to 1, as shown below. A sample CSV file is provided with the utility:

```
python nvs_partition_gen.py generate sample_singlepage_blob.csv sample.bin 0x3000 --
↪-version 1
```

Multipage Blob Support Enabled (Version 2): You can run the utility in this format by setting the version parameter to 2, as shown below. A sample CSV file is provided with the utility:

```
python nvs_partition_gen.py generate sample_multipage_blob.csv sample.bin 0x4000 --
↪version 2
```

Note: *Minimum NVS Partition Size needed is 0x3000 bytes.*

Note: *When flashing the binary onto the device, make sure it is consistent with the application's sdkconfig.*

Caveats

- Utility does not check for duplicate keys and will write data pertaining to both keys. You need to make sure that the keys are distinct.

- Once a new page is created, no data will be written in the space left on the previous page. Fields in the CSV file need to be ordered in such a way as to optimize memory.
- 64-bit datatype is not yet supported.

2.6.5 SD/SDIO/MMC Driver

Overview

The SD/SDIO/MMC driver currently supports SD memory, SDIO cards, and eMMC chips. This is a protocol level driver built on top of SDMMC and SD SPI host drivers.

SDMMC and SD SPI host drivers ([driver/include/driver/sdmmc_host.h](#) and [driver/include/driver/sdsp_i_host.h](#)) provide API functions for:

- Sending commands to slave devices
- Sending and receiving data
- Handling error conditions within the bus

For functions used to initialize and configure:

- SD SPI host, see [SD SPI Host API](#)

Application Example

An example which combines the SDMMC driver with the FATFS library is provided in the [storage/sd_card](#) directory of ESP-IDF examples. This example initializes the card, then writes and reads data from it using POSIX and C library APIs. See README.md file in the example directory for more information.

Combo (memory + IO) cards The driver does not support SD combo cards. Combo cards are treated as IO cards.

Thread safety Most applications need to use the protocol layer only in one task. For this reason, the protocol layer does not implement any kind of locking on the [sdmmc_card_t](#) structure, or when accessing SDMMC or SD SPI host drivers. Such locking is usually implemented on a higher layer, e.g., in the filesystem driver.

API Reference

Header File

- [sdmmc/include/sdmmc_cmd.h](#)

Functions

[esp_err_t](#) [sdmmc_card_init](#) ([const](#) [sdmmc_host_t](#) *host, [sdmmc_card_t](#) *out_card)

Probe and initialize SD/MMC card using given host

Note Only SD cards (SDSC and SDHC/SDXC) are supported now. Support for MMC/eMMC cards will be added later.

Return

- ESP_OK on success
- One of the error codes from SDMMC host controller

Parameters

- host: pointer to structure defining host controller
- out_card: pointer to structure which will receive information about the card when the function completes

void [sdmmc_card_print_info](#) (FILE *stream, [const](#) [sdmmc_card_t](#) *card)

Print information about the card to a stream.

Parameters

- `stream`: stream obtained using `fopen` or `fdopen`
- `card`: card information structure initialized using `sdmmc_card_init`

esp_err_t **sdmmc_write_sectors** (*sdmmc_card_t* **card*, **const** void **src*, size_t *start_sector*, size_t *sector_count*)

Write given number of sectors to SD/MMC card

Return

- ESP_OK on success
- One of the error codes from SDMMC host controller

Parameters

- `card`: pointer to card information structure previously initialized using `sdmmc_card_init`
- `src`: pointer to data buffer to read data from; data size must be equal to `sector_count * card->csd.sector_size`
- `start_sector`: sector where to start writing
- `sector_count`: number of sectors to write

esp_err_t **sdmmc_read_sectors** (*sdmmc_card_t* **card*, void **dst*, size_t *start_sector*, size_t *sector_count*)

Read given number of sectors from the SD/MMC card

Return

- ESP_OK on success
- One of the error codes from SDMMC host controller

Parameters

- `card`: pointer to card information structure previously initialized using `sdmmc_card_init`
- `dst`: pointer to data buffer to write into; buffer size must be at least `sector_count * card->csd.sector_size`
- `start_sector`: sector where to start reading
- `sector_count`: number of sectors to read

esp_err_t **sdmmc_io_read_byte** (*sdmmc_card_t* **card*, uint32_t *function*, uint32_t *reg*, uint8_t **out_byte*)

Read one byte from an SDIO card using IO_RW_DIRECT (CMD52)

Return

- ESP_OK on success
- One of the error codes from SDMMC host controller

Parameters

- `card`: pointer to card information structure previously initialized using `sdmmc_card_init`
- `function`: IO function number
- `reg`: byte address within IO function
- `[out] out_byte`: output, receives the value read from the card

esp_err_t **sdmmc_io_write_byte** (*sdmmc_card_t* **card*, uint32_t *function*, uint32_t *reg*, uint8_t *in_byte*, uint8_t **out_byte*)

Write one byte to an SDIO card using IO_RW_DIRECT (CMD52)

Return

- ESP_OK on success
- One of the error codes from SDMMC host controller

Parameters

- `card`: pointer to card information structure previously initialized using `sdmmc_card_init`
- `function`: IO function number
- `reg`: byte address within IO function
- `in_byte`: value to be written
- `[out] out_byte`: if not NULL, receives new byte value read from the card (read-after-write).

esp_err_t **sdmmc_io_read_bytes** (*sdmmc_card_t* **card*, uint32_t *function*, uint32_t *addr*, void **dst*, size_t *size*)

Read multiple bytes from an SDIO card using IO_RW_EXTENDED (CMD53)

This function performs read operation using CMD53 in byte mode. For block mode, see `sdmmc_io_read_blocks`.

Return

- ESP_OK on success
- ESP_ERR_INVALID_SIZE if size exceeds 512 bytes
- One of the error codes from SDMMC host controller

Parameters

- `card`: pointer to card information structure previously initialized using `sdmmc_card_init`
- `function`: IO function number
- `addr`: byte address within IO function where reading starts
- `dst`: buffer which receives the data read from card
- `size`: number of bytes to read

esp_err_t **sdmmc_io_write_bytes** (*sdmmc_card_t* **card*, uint32_t *function*, uint32_t *addr*, const void **src*, size_t *size*)

Write multiple bytes to an SDIO card using IO_RW_EXTENDED (CMD53)

This function performs write operation using CMD53 in byte mode. For block mode, see `sdmmc_io_write_blocks`.

Return

- ESP_OK on success
- ESP_ERR_INVALID_SIZE if size exceeds 512 bytes
- One of the error codes from SDMMC host controller

Parameters

- `card`: pointer to card information structure previously initialized using `sdmmc_card_init`
- `function`: IO function number
- `addr`: byte address within IO function where writing starts
- `src`: data to be written
- `size`: number of bytes to write

esp_err_t **sdmmc_io_read_blocks** (*sdmmc_card_t* **card*, uint32_t *function*, uint32_t *addr*, void **dst*, size_t *size*)

Read blocks of data from an SDIO card using IO_RW_EXTENDED (CMD53)

This function performs read operation using CMD53 in block mode. For byte mode, see `sdmmc_io_read_bytes`.

Return

- ESP_OK on success
- ESP_ERR_INVALID_SIZE if size is not divisible by 512 bytes
- One of the error codes from SDMMC host controller

Parameters

- `card`: pointer to card information structure previously initialized using `sdmmc_card_init`
- `function`: IO function number
- `addr`: byte address within IO function where writing starts
- `dst`: buffer which receives the data read from card
- `size`: number of bytes to read, must be divisible by the card block size.

esp_err_t **sdmmc_io_write_blocks** (*sdmmc_card_t* **card*, uint32_t *function*, uint32_t *addr*, const void **src*, size_t *size*)

Write blocks of data to an SDIO card using IO_RW_EXTENDED (CMD53)

This function performs write operation using CMD53 in block mode. For byte mode, see `sdmmc_io_write_bytes`.

Return

- ESP_OK on success
- ESP_ERR_INVALID_SIZE if size is not divisible by 512 bytes
- One of the error codes from SDMMC host controller

Parameters

- `card`: pointer to card information structure previously initialized using `sdmmc_card_init`
- `function`: IO function number
- `addr`: byte address within IO function where writing starts
- `src`: data to be written

- `size`: number of bytes to read, must be divisible by the card block size.

`esp_err_t sdmmc_io_enable_int (sdmmc_card_t *card)`

Enable SDIO interrupt in the SDMMC host

Return

- `ESP_OK` on success
- `ESP_ERR_NOT_SUPPORTED` if the host controller does not support IO interrupts

Parameters

- `card`: pointer to card information structure previously initialized using `sdmmc_card_init`

`esp_err_t sdmmc_io_wait_int (sdmmc_card_t *card, TickType_t timeout_ticks)`

Block until an SDIO interrupt is received

Slave uses D1 line to signal interrupt condition to the host. This function can be used to wait for the interrupt.

Return

- `ESP_OK` if the interrupt is received
- `ESP_ERR_NOT_SUPPORTED` if the host controller does not support IO interrupts
- `ESP_ERR_TIMEOUT` if the interrupt does not happen in `timeout_ticks`

Parameters

- `card`: pointer to card information structure previously initialized using `sdmmc_card_init`
- `timeout_ticks`: time to wait for the interrupt, in RTOS ticks

`esp_err_t sdmmc_io_get_cis_data (sdmmc_card_t *card, uint8_t *out_buffer, size_t buffer_size, size_t *inout_cis_size)`

Get the data of CIS region of a SDIO card.

You may provide a buffer not sufficient to store all the CIS data. In this case, this functions store as much data into your buffer as possible. Also, this function will try to get and return the size required for you.

Return

- `ESP_OK`: on success
- `ESP_ERR_INVALID_RESPONSE`: if the card does not (correctly) support CIS.
- `ESP_ERR_INVALID_SIZE`: `CIS_CODE_END` found, but `buffer_size` is less than required size, which is stored in the `inout_cis_size` then.
- `ESP_ERR_NOT_FOUND`: if the `CIS_CODE_END` not found. Increase input value of `inout_cis_size` or set it to 0, if you still want to search for the end; output value of `inout_cis_size` is invalid in this case.
- and other error code return from `sdmmc_io_read_bytes`

Parameters

- `card`: pointer to card information structure previously initialized using `sdmmc_card_init`
- `out_buffer`: Output buffer of the CIS data
- `buffer_size`: Size of the buffer.
- `inout_cis_size`: Mandatory, pointer to a size, input and output.
 - input: Limitation of maximum searching range, should be 0 or larger than `buffer_size`. The function searches for `CIS_CODE_END` until this range. Set to 0 to search infinitely.
 - output: The size required to store all the CIS data, if `CIS_CODE_END` is found.

`esp_err_t sdmmc_io_print_cis_info (uint8_t *buffer, size_t buffer_size, FILE *fp)`

Parse and print the CIS information of a SDIO card.

Note Not all the CIS codes and all kinds of tuples are supported. If you see some unresolved code, you can add the parsing of these code in `sdmmc_io.c` and contribute to the IDF through the Github repository.

```
using sdmmc_card_init
```

Return

- `ESP_OK`: on success
- `ESP_ERR_NOT_SUPPORTED`: if the value from the card is not supported to be parsed.
- `ESP_ERR_INVALID_SIZE`: if the CIS size fields are not correct.

Parameters

- `buffer`: Buffer to parse
- `buffer_size`: Size of the buffer.

- `fp`: File pointer to print to, set to `NULL` to print to `stdout`.

Header File

- [driver/include/driver/sdmmc_types.h](#)

Structures

struct sdmmc_csd_t

Decoded values from SD card Card Specific Data register

Public Members

int **csd_ver**

CSD structure format

int **mmc_ver**

MMC version (for CID format)

int **capacity**

total number of sectors

int **sector_size**

sector size in bytes

int **read_block_len**

block length for reads

int **card_command_class**

Card Command Class for SD

int **tr_speed**

Max transfer speed

struct sdmmc_cid_t

Decoded values from SD card Card IDentification register

Public Members

int **mfg_id**

manufacturer identification number

int **oem_id**

OEM/product identification number

char **name**[8]

product name (MMC v1 has the longest)

int **revision**

product revision

int **serial**

product serial number

int **date**

manufacturing date

struct sdmmc_scr_t

Decoded values from SD Configuration Register

Public Members

int **sd_spec**
SD Physical layer specification version, reported by card

int **bus_width**
bus widths supported by card: BIT(0) —1-bit bus, BIT(2) —4-bit bus

struct sdmmc_ext_csd_t
Decoded values of Extended Card Specific Data

Public Members

uint8_t **power_class**
Power class used by the card

struct sdmmc_switch_func_rsp_t
SD SWITCH_FUNC response buffer

Public Members

uint32_t **data**[512 / 8 / sizeof(uint32_t)]
response data

struct sdmmc_command_t
SD/MMC command information

Public Members

uint32_t **opcode**
SD or MMC command index

uint32_t **arg**
SD/MMC command argument

sdmmc_response_t **response**
response buffer

void ***data**
buffer to send or read into

size_t **datalen**
length of data buffer

size_t **blklen**
block length

int **flags**
see below

esp_err_t **error**
error returned from transfer

int **timeout_ms**
response timeout, in milliseconds

struct sdmmc_host_t
SD/MMC Host description

This structure defines properties of SD/MMC host and functions of SD/MMC host which can be used by upper layers.

Public Members

`uint32_t flags`

flags defining host properties

`int slot`

slot number, to be passed to host functions

`int max_freq_khz`

max frequency supported by the host

`float io_voltage`

I/O voltage used by the controller (voltage switching is not supported)

`esp_err_t (*init) (void)`

Host function to initialize the driver

`esp_err_t (*set_bus_width) (int slot, size_t width)`

host function to set bus width

`size_t (*get_bus_width) (int slot)`

host function to get bus width

`esp_err_t (*set_bus_ddr_mode) (int slot, bool ddr_enable)`

host function to set DDR mode

`esp_err_t (*set_card_clk) (int slot, uint32_t freq_khz)`

host function to set card clock frequency

`esp_err_t (*do_transaction) (int slot, sdmmc_command_t *cmdinfo)`

host function to do a transaction

`esp_err_t (*deinit) (void)`

host function to deinitialize the driver

`esp_err_t (*deinit_p) (int slot)`

host function to deinitialize the driver, called with the `slot`

`esp_err_t (*io_int_enable) (int slot)`

Host function to enable SDIO interrupt line

`esp_err_t (*io_int_wait) (int slot, TickType_t timeout_ticks)`

Host function to wait for SDIO interrupt line to be active

`int command_timeout_ms`

timeout, in milliseconds, of a single command. Set to 0 to use the default value.

`struct sdmmc_card_t`

SD/MMC card information structure

Public Members

`sdmmc_host_t host`

Host with which the card is associated

`uint32_t ocr`

OCR (Operation Conditions Register) value

`sdmmc_cid_t cid`

decoded CID (Card IDentification) register value

`sdmmc_response_t raw_cid`

raw CID of MMC card to be decoded after the CSD is fetched in the data transfer mode

`sdmmc_csd_t csd`

decoded CSD (Card-Specific Data) register value

sdmmc_scr_t scr

decoded SCR (SD card Configuration Register) value

sdmmc_ext_csd_t ext_csd

decoded EXT_CSD (Extended Card Specific Data) register value

uint16_t rca

RCA (Relative Card Address)

uint16_t max_freq_khz

Maximum frequency, in kHz, supported by the card

uint32_t is_mem : 1

Bit indicates if the card is a memory card

uint32_t is_sdio : 1

Bit indicates if the card is an IO card

uint32_t is_mmc : 1

Bit indicates if the card is MMC

uint32_t num_io_functions : 3

If is_sdio is 1, contains the number of IO functions on the card

uint32_t log_bus_width : 2log₂(bus width supported by card)**uint32_t is_ddr : 1**

Card supports DDR mode

uint32_t reserved : 23

Reserved for future expansion

Macros**SDMMC_HOST_FLAG_1BIT**

host supports 1-line SD and MMC protocol

SDMMC_HOST_FLAG_4BIT

host supports 4-line SD and MMC protocol

SDMMC_HOST_FLAG_8BIT

host supports 8-line MMC protocol

SDMMC_HOST_FLAG_SPI

host supports SPI protocol

SDMMC_HOST_FLAG_DDR

host supports DDR mode for SD/MMC

SDMMC_HOST_FLAG_DEINIT_ARGhost `deinit` function called with the slot argument**SDMMC_FREQ_DEFAULT**

SD/MMC Default speed (limited by clock divider)

SDMMC_FREQ_HIGHSPEED

SD High speed (limited by clock divider)

SDMMC_FREQ_PROBING

SD/MMC probing speed

SDMMC_FREQ_52M

MMC 52MHz speed

SDMMC_FREQ_26M

MMC 26MHz speed

Type Definitions

```
typedef uint32_t sdmmc_response_t[4]  
    SD/MMC command response buffer
```

2.6.6 SPI Flash API

Overview

The `spi_flash` component contains API functions related to reading, writing, erasing, memory mapping for data in the external flash. The `spi_flash` component also has higher-level API functions which work with partitions defined in the [partition table](#).

Different from the API before IDF v4.0, the functionality of `esp_flash_*` APIs is not limited to the “main” SPI flash chip (the same SPI flash chip from which program runs). With different chip pointers, you can access to external flashes chips connected to not only SPI0/1 but also other SPI buses like SPI2.

Note: Instead of through the cache connected to the SPI0 peripheral, most `esp_flash_*` APIs go through other SPI peripherals like SPI1, SPI2, etc.. This makes them able to access to not only the main flash, but also external flash.

However due to limitations of the cache, operations through the cache are limited to the main flash. The address range limitation for these operations are also on the cache side. The cache is not able to access external flash chips or address range above its capabilities. These cache operations include: mmap, encrypted read/write, executing code or access to variables in the flash.

Note: Flash APIs after IDF v4.0 are no longer *atomic*. A writing operation during another on-going read operation, on the overlapped flash address, may cause the return data from the read operation to be partly same as before, and partly updated as new written.

Kconfig option `CONFIG_SPI_FLASH_USE_LEGACY_IMPL` can be used to switch `spi_flash_*` functions back to the implementation before IDF v4.0. However, the code size may get bigger if you use the new API and the old API the same time.

Encrypted reads and writes use the old implementation, even if `CONFIG_SPI_FLASH_USE_LEGACY_IMPL` is not enabled. As such, encrypted flash operations are only supported with the main flash chip (and not with other flash chips, that is on SPI1 with different CS, or on other SPI buses). Reading through cache is only supported on the main flash, which is determined by the HW.

Support for features of flash chips

Flash features of different vendors are operated in different ways and need special support. The fast/slow read and Dual mode (DOUT/DIO) of almost all 24-bits address flash chips are supported, because they don't need any vendor-specific commands.

The Quad mode (QIO/QOUT) the following chip types are supported:

1. ISSI
2. GD
3. MXIC
4. FM
5. Winbond
6. XMC
7. BOYA

The 32-bit address range of following chip type is supported:

1. W25Q256
2. GD25Q256

Initializing a flash device

To use `esp_flash_*` APIs, you need to have a chip initialized on a certain SPI bus.

1. Call `spi_bus_initialize()` to properly initialize an SPI bus. This functions initialize the resources (I/O, DMA, interrupts) shared among devices attached to this bus.
2. Call `spi_bus_add_flash_device()` to attach the flash device onto the bus. This allocates memory, and fill the members for the `esp_flash_t` structure. The CS I/O is also initialized here.
3. Call `esp_flash_init()` to actually communicate with the chip. This will also detect the chip type, and influence the following operations.

Note: Multiple flash chips can be attached to the same bus now. However, using `esp_flash_*` devices and `spi_device_*` devices on the same SPI bus is not supported yet.

SPI flash access API

This is the set of API functions for working with data in flash:

- `esp_flash_read()` reads data from flash to RAM
- `esp_flash_write()` writes data from RAM to flash
- `esp_flash_erase_region()` erases specific region of flash
- `esp_flash_erase_chip()` erases the whole flash
- `esp_flash_get_chip_size()` returns flash chip size, in bytes, as configured in menuconfig

Generally, try to avoid using the raw SPI flash functions to the “main” SPI flash chip in favour of *partition-specific functions*.

SPI Flash Size

The SPI flash size is configured by writing a field in the software bootloader image header, flashed at offset 0x1000.

By default, the SPI flash size is detected by `esptool.py` when this bootloader is written to flash, and the header is updated with the correct size. Alternatively, it is possible to generate a fixed flash size by setting `CONFIG_ESPTOOLPY_FLASHSIZE` in project configuration.

If it is necessary to override the configured flash size at runtime, it is possible to set the `chip_size` member of the `g_rom_flashchip` structure. This size is used by `esp_flash_*` functions (in both software & ROM) to check the bounds.

Concurrency Constraints for flash on SPI1

Concurrency Constraints for flash on SPI1 The SPI0/1 bus is shared between the instruction & data cache (for firmware execution) and the SPI1 peripheral (controlled by the drivers including this SPI Flash driver). Hence, operations to SPI1 will cause significant influence to the whole system. This kind of operations include calling SPI Flash API or other drivers on SPI1 bus, any operations like read/write/erase or other user defined SPI operations, regardless to the main flash or other SPI slave devices.

On ESP32-C3, the config option `CONFIG_SPI_FLASH_AUTO_SUSPEND` (enabled by default) allows the cache to read flash & PSRAM concurrently with SPI1 operations. See *When auto suspend is enabled* for more details.

If this option is disabled, the caches must be disabled while reading/writing/erasing operations. There are some constraints using driver on the SPI1 bus, see *When the caches are disabled*. This constraints will cause more IRAM/DRAM usages.

When the caches are disabled This means that all CPUs must be running code from IRAM and must only be reading data from DRAM while flash write operations occur. If you use the API functions documented here, then the caches will be disabled automatically and transparently. However, note that it will have some performance impact on other tasks in the system.

There are no such constraints and impacts for flash chips on other SPI buses than SPI0/1.

For differences between IRAM, DRAM, and flash cache, please refer to the [application memory layout](#) documentation.

See also [OS functions](#), [SPI Bus Lock](#).

IRAM-Safe Interrupt Handlers If you have an interrupt handler that you want to execute while a flash operation is in progress (for example, for low latency operations), set the `ESP_INTR_FLAG_IRAM` flag when the [interrupt handler is registered](#).

You must ensure that all data and functions accessed by these interrupt handlers, including the ones that handlers call, are located in IRAM or DRAM. See [How to place code in IRAM](#).

If a function or symbol is not correctly put into IRAM/DRAM, and the interrupt handler reads from the flash cache during a flash operation, it will cause a crash due to Illegal Instruction exception (for code which should be in IRAM) or garbage data to be read (for constant data which should be in DRAM).

Note: When working with string in ISRs, it is not advised to use `printf` and other output functions. For debugging purposes, use `ESP_DRAM_LOGE()` and similar macros when logging from ISRs. Make sure that both `TAG` and format string are placed into DRAM in that case.

When auto suspend is enabled

Important: The flash chip you are using must have suspend/resume function, even then, and not all flash chips with suspend/resume support auto-suspend on ESP32-C3. If you use suspend feature on a unsupported chip, it may cause a severe crash. Therefore, we strongly suggest you reading the flash chip datasheets first. Ensure the flash chip satisfies the following conditions at minimum. Even then, thorough testing is recommended.

1. SUS bit in status registers should in SR2 bit7 (or SR bit15)(This is caused by the restriction of out software implementation).
 2. Suspend command is 75H, resume command is 7AH(This is caused by the restriction of out software implementation).
 3. When the flash is successfully suspended, all address of the flash, except from the section/block being erased, can be read correctly. And resume can be sent immediately at this state.
 4. When the flash is successfully resumed, another suspend can be sent immediately at this state.
-

When auto suspend is enabled, the cache will be kept enabled while accessing the SPI1 bus (e.g. erasing/writing/reading main flash). The hardware handles the arbitration between them.

If SPI1 operation is short (like reading operation), the CPU and the cache will wait until the SPI1 operation is done. However if it's an erasing, auto suspend will happen, interrupting the erasing, making the CPU able to read from cache in limited time.

This way some code/variables can be put into the flash/psram instead of IRAM/DRAM, while still able to be executed during flash erasing. This reduces the some usage of IRAM/DRAM.

Please note this feature has the overhead of the flash suspend/resume. The flash erasing can be extremely long if the erasing is interrupted too often. Use FreeRTOS task priorities to ensure that only real-time critical tasks are executed at higher priority than flash erase, to allow the flash erase to complete in reasonable time.

In other words, there are three kinds of code:

1. Critical code: inside IRAM/DRAM. This kind of code usually has high performance requirements, related to cache/flash/psram, or called very often.

2. Cached code: inside flash/psram. This kind of code has lower performance requirements or called less often. They will execute during erasing, with some overhead.
3. Low priority code: inside flash/psram and disabled during erasing. This kind of code should be forbidden from executed to avoid affecting the flash erasing, by setting a lower task priority than the erasing task.

Attention: The SPI0/1 bus is shared between the instruction & data cache (for firmware execution) and the SPI1 peripheral (controlled by the drivers including this SPI Flash driver). Hence, calling SPI Flash API on SPI1 bus (including the main flash) will cause significant influence to the whole system. See [Concurrency Constraints for flash on SPI1](#) for more details.

Partition table API

ESP-IDF projects use a partition table to maintain information about various regions of SPI flash memory (bootloader, various application binaries, data, filesystems). More information on partition tables can be found [here](#).

This component provides API functions to enumerate partitions found in the partition table and perform operations on them. These functions are declared in `esp_partition.h`:

- `esp_partition_find()` checks a partition table for entries with specific type, returns an opaque iterator.
- `esp_partition_get()` returns a structure describing the partition for a given iterator.
- `esp_partition_next()` shifts the iterator to the next found partition.
- `esp_partition_iterator_release()` releases iterator returned by `esp_partition_find`.
- `esp_partition_find_first()` - a convenience function which returns the structure describing the first partition found by `esp_partition_find`.
- `esp_partition_read()`, `esp_partition_write()`, `esp_partition_erase_range()` are equivalent to `spi_flash_read()`, `spi_flash_write()`, `spi_flash_erase_range()`, but operate within partition boundaries.

Note: Application code should mostly use these `esp_partition_*` API functions instead of lower level `esp_flash_*` API functions. Partition table API functions do bounds checking and calculate correct offsets in flash, based on data stored in a partition table.

SPI Flash Encryption

It is possible to encrypt the contents of SPI flash and have it transparently decrypted by hardware.

Refer to the [Flash Encryption documentation](#) for more details.

Memory mapping API

ESP32-C3 features memory hardware which allows regions of flash memory to be mapped into instruction and data address spaces. This mapping works only for read operations. It is not possible to modify contents of flash memory by writing to a mapped memory region.

Mapping happens in 64 KB pages. Memory mapping hardware can map flash into the data address space and the instruction address space. See the technical reference manual for more details and limitations about memory mapping hardware.

Note that some pages are used to map the application itself into memory, so the actual number of available pages may be less than the capability of the hardware.

Reading data from flash using a memory mapped region is the only way to decrypt contents of flash when [flash encryption](#) is enabled. Decryption is performed at the hardware level.

Memory mapping API are declared in `esp_spi_flash.h` and `esp_partition.h`:

- `spi_flash_mmap()` maps a region of physical flash addresses into instruction space or data space of the CPU.
- `spi_flash_munmap()` unmaps previously mapped region.
- `esp_partition_mmap()` maps part of a partition into the instruction space or data space of the CPU.

Differences between `spi_flash_mmap()` and `esp_partition_mmap()` are as follows:

- `spi_flash_mmap()` must be given a 64 KB aligned physical address.
- `esp_partition_mmap()` may be given any arbitrary offset within the partition, it will adjust the returned pointer to mapped memory as necessary

Note that since memory mapping happens in pages, it may be possible to read data outside of the partition provided to `esp_partition_mmap`, regardless of the partition boundary.

Note: `mmap` is supported by cache, so it can only be used on main flash.

SPI Flash Implementation

The `esp_flash_t` structure holds chip data as well as three important parts of this API:

1. The host driver, which provides the hardware support to access the chip;
2. The chip driver, which provides compatibility service to different chips;
3. The OS functions, provides support of some OS functions (e.g. lock, delay) in different stages (1st/2st boot, or the app).

Host driver The host driver relies on an interface (`spi_flash_host_driver_t`) defined in the `spi_flash_types.h` (in the `hal/include/hal` folder). This interface provides some common functions to communicate with the chip.

In other files of the SPI HAL, some of these functions are implemented with existing ESP32-C3 memory-spi functionalities. However due to the speed limitations of ESP32-C3, the HAL layer can't provide high-speed implementations to some reading commands (So we didn't do it at all). The files (`memspi_host_driver.h` and `.c`) implement the high-speed version of these commands with the `common_command` function provided in the HAL, and wrap these functions as `spi_flash_host_driver_t` for upper layer to use.

You can also implement your own host driver, even with the GPIO. As long as all the functions in the `spi_flash_host_driver_t` are implemented, the `esp_flash` API can access to the flash regardless of the low-level hardware.

Chip driver The chip driver, defined in `spi_flash_chip_driver.h`, wraps basic functions provided by the host driver for the API layer to use.

Some operations need some commands to be sent first, or read some status after. Some chips need different command or value, or need special communication ways.

There is a type of chip called `generic_chip` which stands for common chips. Other special chip drivers can be developed on the base of the generic chip.

The chip driver relies on the host driver.

OS functions Currently the OS function layer provides entries of a lock and delay.

The lock (see [SPI Bus Lock](#)) is used to resolve the conflicts among the access of devices on the same SPI bus, and the SPI Flash chip access. E.g.

1. On SPI1 bus, the cache (used to fetch the data (code) in the Flash and PSRAM) should be disabled when the flash chip on the SPI0/1 is being accessed.
2. On the other buses, the flash driver needs to disable the ISR registered by SPI Master driver, to avoid conflicts.

3. Some devices of SPI Master driver may requires to use the bus monopolized during a period. (especially when the device doesn't have CS wire, or the wire is controlled by the software like SDSPI driver).

The delay is used by some long operations which requires the master to wait or polling periodically.

The top API wraps these the chip driver and OS functions into an entire component, and also provides some argument checking.

See also

- [Partition Table documentation](#)
- [Over The Air Update \(OTA\) API](#) provides high-level API for updating app firmware stored in flash.
- [Non-Volatile Storage \(NVS\) API](#) provides a structured API for storing small pieces of data in SPI flash.

Implementation details

In order to perform some flash operations, it is necessary to make sure that both CPUs are not running any code from flash for the duration of the flash operation: - In a single-core setup, the SDK does it by disabling interrupts/scheduler before performing the flash operation. - In a dual-core setup, this is slightly more complicated as the SDK needs to make sure that the other CPU is not running any code from flash.

When SPI flash API is called on CPU A (can be PRO or APP), start the `spi_flash_op_block_func` function on CPU B using the `esp_ipc_call` API. This API wakes up a high priority task on CPU B and tells it to execute a given function, in this case, `spi_flash_op_block_func`. This function disables cache on CPU B and signals that the cache is disabled by setting the `s_flash_op_can_start` flag. Then the task on CPU A disables cache as well and proceeds to execute flash operation.

While a flash operation is running, interrupts can still run on CPUs A and B. It is assumed that all interrupt code is placed into RAM. Once the interrupt allocation API is added, a flag should be added to request the interrupt to be disabled for the duration of a flash operations.

Once the flash operation is complete, the function on CPU A sets another flag, `s_flash_op_complete`, to let the task on CPU B know that it can re-enable cache and release the CPU. Then the function on CPU A re-enables the cache on CPU A as well and returns control to the calling code.

Additionally, all API functions are protected with a mutex (`s_flash_op_mutex`).

In a single core environment (`CONFIG_FREERTOS_UNICORE` enabled), you need to disable both caches, so that no inter-CPU communication can take place.

API Reference - SPI Flash

Header File

- `spi_flash/include/esp_flash_spi_init.h`

Functions

```
esp_err_t spi_bus_add_flash_device(esp_flash_t *out_chip, const  
                                esp_flash_spi_device_config_t *config)
```

Add a SPI Flash device onto the SPI bus.

The bus should be already initialized by `spi_bus_initialization`.

Return

- `ESP_ERR_INVALID_ARG`: `out_chip` is NULL, or some field in the config is invalid.
- `ESP_ERR_NO_MEM`: failed to allocate memory for the chip structures.
- `ESP_OK`: success.

Parameters

- `out_chip`: Pointer to hold the initialized chip.
- `config`: Configuration of the chips to initialize.

esp_err_t **spi_bus_remove_flash_device** (*esp_flash_t* *chip)

Remove a SPI Flash device from the SPI bus.

Return

- ESP_ERR_INVALID_ARG: The chip is invalid.
- ESP_OK: success.

Parameters

- chip: The flash device to remove.

Structures

struct esp_flash_spi_device_config_t

Configurations for the SPI Flash to init.

Public Members

spi_host_device_t **host_id**

Bus to use.

int **cs_io_num**

GPIO pin to output the CS signal.

esp_flash_io_mode_t **io_mode**

IO mode to read from the Flash.

esp_flash_speed_t **speed**

Speed of the Flash clock.

int **input_delay_ns**

Input delay of the data pins, in ns. Set to 0 if unknown.

int **cs_id**

CS line ID, ignored when not `host_id` is not `SPI1_HOST`, or `CONFIG_SPI_FLASH_SHARE_SPI1_BUS` is enabled. In this case, the CS line used is automatically assigned by the SPI bus lock.

Header File

- `spi_flash/include/esp_flash.h`

Functions

esp_err_t **esp_flash_init** (*esp_flash_t* *chip)

Initialise SPI flash chip interface.

This function must be called before any other API functions are called for this chip.

Note Only the `host` and `read_mode` fields of the chip structure must be initialised before this function is called. Other fields may be auto-detected if left set to zero or NULL.

Note If the `chip->drv` pointer is NULL, `chip` `chip_drv` will be auto-detected based on its manufacturer & product IDs. See `esp_flash_registered_flash_drivers` pointer for details of this process.

Return ESP_OK on success, or a flash error code if initialisation fails.

Parameters

- chip: Pointer to SPI flash chip to use. If NULL, `esp_flash_default_chip` is substituted.

bool **esp_flash_chip_driver_initialized** (const *esp_flash_t* *chip)

Check if appropriate chip driver is set.

Return true if set, otherwise false.

Parameters

- chip: Pointer to SPI flash chip to use. If NULL, `esp_flash_default_chip` is substituted.

*esp_err_t esp_flash_read_id(esp_flash_t *chip, uint32_t *out_id)*

Read flash ID via the common “RDID” SPI flash command.

ID is a 24-bit value. Lower 16 bits of ‘id’ are the chip ID, upper 8 bits are the manufacturer ID.

Parameters

- *chip*: Pointer to identify flash chip. Must have been successfully initialised via *esp_flash_init()*
- [out] *out_id*: Pointer to receive ID value.

Return ESP_OK on success, or a flash error code if operation failed.

*esp_err_t esp_flash_get_size(esp_flash_t *chip, uint32_t *out_size)*

Detect flash size based on flash ID.

Note Most flash chips use a common format for flash ID, where the lower 4 bits specify the size as a power of 2. If the manufacturer doesn’t follow this convention, the size may be incorrectly detected.

Return ESP_OK on success, or a flash error code if operation failed.

Parameters

- *chip*: Pointer to identify flash chip. Must have been successfully initialised via *esp_flash_init()*
- [out] *out_size*: Detected size in bytes.

*esp_err_t esp_flash_erase_chip(esp_flash_t *chip)*

Erase flash chip contents.

Return

- ESP_OK on success,
- ESP_ERR_NOT_SUPPORTED if the chip is not able to perform the operation. This is indicated by WREN = 1 after the command is sent.
- Other flash error code if operation failed.

Parameters

- *chip*: Pointer to identify flash chip. Must have been successfully initialised via *esp_flash_init()*

*esp_err_t esp_flash_erase_region(esp_flash_t *chip, uint32_t start, uint32_t len)*

Erase a region of the flash chip.

Sector size is specified in *chip->drv->sector_size* field (typically 4096 bytes.) ESP_ERR_INVALID_ARG will be returned if the start & length are not a multiple of this size.

Parameters

- *chip*: Pointer to identify flash chip. Must have been successfully initialised via *esp_flash_init()*
- *start*: Address to start erasing flash. Must be sector aligned.
- *len*: Length of region to erase. Must also be sector aligned.

Erase is performed using block (multi-sector) erases where possible (block size is specified in *chip->drv->block_erase_size* field, typically 65536 bytes). Remaining sectors are erased using individual sector erase commands.

Return

- ESP_OK on success,
- ESP_ERR_NOT_SUPPORTED if the chip is not able to perform the operation. This is indicated by WREN = 1 after the command is sent.
- Other flash error code if operation failed.

*esp_err_t esp_flash_get_chip_write_protect(esp_flash_t *chip, bool *write_protected)*

Read if the entire chip is write protected.

Note A correct result for this flag depends on the SPI flash chip model and *chip_drv* in use (via the ‘*chip->drv*’ field).

Return ESP_OK on success, or a flash error code if operation failed.

Parameters

- *chip*: Pointer to identify flash chip. Must have been successfully initialised via *esp_flash_init()*
- [out] *write_protected*: Pointer to boolean, set to the value of the write protect flag.

*esp_err_t esp_flash_set_chip_write_protect(esp_flash_t *chip, bool write_protect)*

Set write protection for the SPI flash chip.

Some SPI flash chips may require a power cycle before write protect status can be cleared. Otherwise, write protection can be removed via a follow-up call to this function.

Note Correct behaviour of this function depends on the SPI flash chip model and `chip_drv` in use (via the `'chip->drv'` field).

Parameters

- `chip`: Pointer to identify flash chip. Must have been successfully initialised via `esp_flash_init()`
- `write_protect`: Boolean value for the write protect flag

Return `ESP_OK` on success, or a flash error code if operation failed.

```
esp_err_t esp_flash_get_protectable_regions(const esp_flash_t *chip, const
                                           esp_flash_region_t **out_regions, uint32_t
                                           *out_num_regions)
```

Read the list of individually protectable regions of this SPI flash chip.

Note Correct behaviour of this function depends on the SPI flash chip model and `chip_drv` in use (via the `'chip->drv'` field).

Return `ESP_OK` on success, or a flash error code if operation failed.

Parameters

- `chip`: Pointer to identify flash chip. Must have been successfully initialised via `esp_flash_init()`
- `[out] out_regions`: Pointer to receive a pointer to the array of protectable regions of the chip.
- `[out] out_num_regions`: Pointer to an integer receiving the count of protectable regions in the array returned in `'regions'` .

```
esp_err_t esp_flash_get_protected_region(esp_flash_t *chip, const esp_flash_region_t
                                          *region, bool *out_protected)
```

Detect if a region of the SPI flash chip is protected.

Note It is possible for this result to be false and write operations to still fail, if protection is enabled for the entire chip.

Note Correct behaviour of this function depends on the SPI flash chip model and `chip_drv` in use (via the `'chip->drv'` field).

Return `ESP_OK` on success, or a flash error code if operation failed.

Parameters

- `chip`: Pointer to identify flash chip. Must have been successfully initialised via `esp_flash_init()`
- `region`: Pointer to a struct describing a protected region. This must match one of the regions returned from `esp_flash_get_protectable_regions(...)`.
- `[out] out_protected`: Pointer to a flag which is set based on the protected status for this region.

```
esp_err_t esp_flash_set_protected_region(esp_flash_t *chip, const esp_flash_region_t
                                          *region, bool protect)
```

Update the protected status for a region of the SPI flash chip.

Note It is possible for the region protection flag to be cleared and write operations to still fail, if protection is enabled for the entire chip.

Note Correct behaviour of this function depends on the SPI flash chip model and `chip_drv` in use (via the `'chip->drv'` field).

Return `ESP_OK` on success, or a flash error code if operation failed.

Parameters

- `chip`: Pointer to identify flash chip. Must have been successfully initialised via `esp_flash_init()`
- `region`: Pointer to a struct describing a protected region. This must match one of the regions returned from `esp_flash_get_protectable_regions(...)`.
- `protect`: Write protection flag to set.

```
esp_err_t esp_flash_read(esp_flash_t *chip, void *buffer, uint32_t address, uint32_t length)
```

Read data from the SPI flash chip.

There are no alignment constraints on `buffer`, `address` or `length`.

Parameters

- `chip`: Pointer to identify flash chip. Must have been successfully initialised via `esp_flash_init()`

- `buffer`: Pointer to a buffer where the data will be read. To get better performance, this should be in the DRAM and word aligned.
- `address`: Address on flash to read from. Must be less than `chip->size` field.
- `length`: Length (in bytes) of data to read.

Note If on-chip flash encryption is used, this function returns raw (ie encrypted) data. Use the flash cache to transparently decrypt data.

Return

- `ESP_OK`: success
- `ESP_ERR_NO_MEM`: Buffer is in external PSRAM which cannot be concurrently accessed, and a temporary internal buffer could not be allocated.
- or a flash error code if operation failed.

`esp_err_t esp_flash_write(esp_flash_t *chip, const void *buffer, uint32_t address, uint32_t length)`

Write data to the SPI flash chip.

There are no alignment constraints on `buffer`, `address` or `length`.

Parameters

- `chip`: Pointer to identify flash chip. Must have been successfully initialised via `esp_flash_init()`
- `address`: Address on flash to write to. Must be previously erased (SPI NOR flash can only write bits 1->0).
- `buffer`: Pointer to a buffer with the data to write. To get better performance, this should be in the DRAM and word aligned.
- `length`: Length (in bytes) of data to write.

Return

- `ESP_OK` on success,
- `ESP_ERR_NOT_SUPPORTED` if the chip is not able to perform the operation. This is indicated by `WREN = 1` after the command is sent.
- Other flash error code if operation failed.

`esp_err_t esp_flash_write_encrypted(esp_flash_t *chip, uint32_t address, const void *buffer, uint32_t length)`

Encrypted and write data to the SPI flash chip using on-chip hardware flash encryption.

Note Both `address` & `length` must be 16 byte aligned, as this is the encryption block size

Return

- `ESP_OK`: on success
- `ESP_ERR_NOT_SUPPORTED`: encrypted write not supported for this chip.
- `ESP_ERR_INVALID_ARG`: Either the `address`, `buffer` or `length` is invalid.
- or other flash error code from `spi_flash_write_encrypted()`.

Parameters

- `chip`: Pointer to identify flash chip. Must be `NULL` (the main flash chip). For other chips, encrypted write is not supported.
- `address`: Address on flash to write to. 16 byte aligned. Must be previously erased (SPI NOR flash can only write bits 1->0).
- `buffer`: Pointer to a buffer with the data to write.
- `length`: Length (in bytes) of data to write. 16 byte aligned.

`esp_err_t esp_flash_read_encrypted(esp_flash_t *chip, uint32_t address, void *out_buffer, uint32_t length)`

Read and decrypt data from the SPI flash chip using on-chip hardware flash encryption.

Return

- `ESP_OK`: on success
- `ESP_ERR_NOT_SUPPORTED`: encrypted read not supported for this chip.
- or other flash error code from `spi_flash_read_encrypted()`.

Parameters

- `chip`: Pointer to identify flash chip. Must be `NULL` (the main flash chip). For other chips, encrypted read is not supported.
- `address`: Address on flash to read from.
- `out_buffer`: Pointer to a buffer for the data to read to.

- `length`: Length (in bytes) of data to read.

static bool `esp_flash_is_quad_mode` (const *esp_flash_t* *`chip`)

Returns true if chip is configured for Quad I/O or Quad Fast Read.

Return true if flash works in quad mode, otherwise false

Parameters

- `chip`: Pointer to SPI flash chip to use. If NULL, `esp_flash_default_chip` is substituted.

Structures

struct `esp_flash_region_t`

Structure for describing a region of flash.

Public Members

uint32_t `offset`

Start address of this region.

uint32_t `size`

Size of the region.

struct `esp_flash_os_functions_t`

OS-level integration hooks for accessing flash chips inside a running OS.

It's in the public header because some instances should be allocated statically in the startup code. May be updated according to hardware version and new flash chip feature requirements, shouldn't be treated as public API.

For advanced developers, you may replace some of them with your implementations at your own risk.

Public Members

esp_err_t (*`start`) (void *`arg`)

Called before commencing any flash operation. Does not need to be recursive (ie is called at most once for each call to '`end`').

esp_err_t (*`end`) (void *`arg`)

Called after completing any flash operation.

esp_err_t (*`region_protected`) (void *`arg`, size_t `start_addr`, size_t `size`)

Called before any erase/write operations to check whether the region is limited by the OS

esp_err_t (*`delay_us`) (void *`arg`, uint32_t `us`)

Delay for at least '`us`' microseconds. Called in between '`start`' and '`end`' .

void (*`get_temp_buffer`) (void *`arg`, size_t `request_size`, size_t *`out_size`)

Called for get temp buffer when buffer from application cannot be directly read into/write from.

void (*`release_temp_buffer`) (void *`arg`, void *`temp_buf`)

Called for release temp buffer.

esp_err_t (*`check_yield`) (void *`arg`, uint32_t `chip_status`, uint32_t *`out_request`)

Yield to other tasks. Called during erase operations.

Return ESP_OK means yield needs to be called (got an event to handle), while ESP_ERR_TIMEOUT means skip yield.

esp_err_t (*`yield`) (void *`arg`, uint32_t *`out_status`)

Yield to other tasks. Called during erase operations.

int64_t (*`get_system_time`) (void *`arg`)

Called for get system time.

struct esp_flash_t

Structure to describe a SPI flash chip connected to the system.

Structure must be initialized before use (passed to `esp_flash_init()`). It's in the public header because some instances should be allocated statically in the startup code. May be updated according to hardware version and new flash chip feature requirements, shouldn't be treated as public API.

For advanced developers, you may replace some of them with your implementations at your own risk.

Public Members

spi_flash_host_inst_t ***host**

Pointer to hardware-specific "host_driver" structure. Must be initialized before used.

const spi_flash_chip_t ***chip_drv**

Pointer to chip-model-specific "adapter" structure. If NULL, will be detected during initialisation.

const esp_flash_os_functions_t ***os_func**

Pointer to os-specific hook structure. Call `esp_flash_init_os_functions()` to setup this field, after the host is properly initialized.

void ***os_func_data**

Pointer to argument for os-specific hooks. Left NULL and will be initialized with `os_func`.

esp_flash_io_mode_t **read_mode**

Configured SPI flash read mode. Set before `esp_flash_init` is called.

uint32_t **size**

Size of SPI flash in bytes. If 0, size will be detected during initialisation.

uint32_t **chip_id**

Detected chip id.

uint32_t **busy** : 1

This flag is used to verify chip's status.

uint32_t **reserved_flags** : 31

reserved.

Macros

SPI_FLASH_YIELD_REQ_YIELD

SPI_FLASH_YIELD_REQ_SUSPEND

SPI_FLASH_YIELD_STA_RESUME

Type Definitions

typedef struct spi_flash_chip_t spi_flash_chip_t

typedef struct esp_flash_t esp_flash_t

Header File

- [hal/include/hal/spi_flash_types.h](#)

Structures

struct spi_flash_trans_t

Definition of a common transaction. Also holds the return value.

Public Members**uint8_t reserved**

Reserved, must be 0.

uint8_t mosi_len

Output data length, in bytes.

uint8_t miso_len

Input data length, in bytes.

uint8_t address_bitlen

Length of address in bits, set to 0 if command does not need an address.

uint32_t address

Address to perform operation on.

const uint8_t *mosi_data

Output data to salve.

uint8_t *miso_data

[out] Input data from slave, little endian

uint32_t flags

Flags for this transaction. Set to 0 for now.

uint16_t command

Command to send.

uint8_t dummy_bitlen

Basic dummy bits to use.

struct spi_flash_sus_cmd_conf

Configuration structure for the flash chip suspend feature.

Public Members**uint32_t sus_mask**

SUS/SUS1/SUS2 bit in flash register.

uint32_t cmd_rdsr : 8

Read flash status register(2) command.

uint32_t sus_cmd : 8

Flash suspend command.

uint32_t res_cmd : 8

Flash resume command.

uint32_t reserved : 8

Reserved, set to 0.

struct spi_flash_host_inst_t

SPI Flash Host driver instance

Public Members**const struct spi_flash_host_driver_s *driver**

Pointer to the implementation function table.

struct spi_flash_host_driver_s

Host driver configuration and context structure.

Public Members

esp_err_t (***dev_config**) (*spi_flash_host_inst_t* *host)
Configure the device-related register before transactions. This saves some time to re-configure those registers when we send continuously

esp_err_t (***common_command**) (*spi_flash_host_inst_t* *host, *spi_flash_trans_t* *t)
Send an user-defined spi transaction to the device.

esp_err_t (***read_id**) (*spi_flash_host_inst_t* *host, uint32_t *id)
Read flash ID.

void (***erase_chip**) (*spi_flash_host_inst_t* *host)
Erase whole flash chip.

void (***erase_sector**) (*spi_flash_host_inst_t* *host, uint32_t start_address)
Erase a specific sector by its start address.

void (***erase_block**) (*spi_flash_host_inst_t* *host, uint32_t start_address)
Erase a specific block by its start address.

esp_err_t (***read_status**) (*spi_flash_host_inst_t* *host, uint8_t *out_sr)
Read the status of the flash chip.

esp_err_t (***set_write_protect**) (*spi_flash_host_inst_t* *host, bool wp)
Disable write protection.

void (***program_page**) (*spi_flash_host_inst_t* *host, const void *buffer, uint32_t address, uint32_t length)
Program a page of the flash. Check `max_write_bytes` for the maximum allowed writing length.

bool (***supports_direct_write**) (*spi_flash_host_inst_t* *host, const void *p)
Check whether given buffer can be directly used to write

int (***write_data_slicer**) (*spi_flash_host_inst_t* *host, uint32_t address, uint32_t len, uint32_t *align_addr, uint32_t page_size)
Slicer for write data. The `program_page` should be called iteratively with the return value of this function.

Return Length that can be actually written in one `program_page` call

Parameters

- `address`: Beginning flash address to write
- `len`: Length request to write
- `align_addr`: Output of the aligned address to write to
- `page_size`: Physical page size of the flash chip

esp_err_t (***read**) (*spi_flash_host_inst_t* *host, void *buffer, uint32_t address, uint32_t read_len)
Read data from the flash. Check `max_read_bytes` for the maximum allowed reading length.

bool (***supports_direct_read**) (*spi_flash_host_inst_t* *host, const void *p)
Check whether given buffer can be directly used to read

int (***read_data_slicer**) (*spi_flash_host_inst_t* *host, uint32_t address, uint32_t len, uint32_t *align_addr, uint32_t page_size)
Slicer for read data. The `read` should be called iteratively with the return value of this function.

Return Length that can be actually read in one `read` call

Parameters

- `address`: Beginning flash address to read
- `len`: Length request to read
- `align_addr`: Output of the aligned address to read
- `page_size`: Physical page size of the flash chip

uint32_t (***host_status**) (*spi_flash_host_inst_t* *host)
Check the host status, 0:busy, 1:idle, 2:suspended.

```
esp_err_t (*configure_host_io_mode) (spi_flash_host_inst_t *host, uint32_t command,
                                     uint32_t addr_bitlen, int dummy_bitlen_base,
                                     esp_flash_io_mode_t io_mode)
```

Configure the host to work at different read mode. Responsible to compensate the timing and set IO mode.

```
void (*poll_cmd_done) (spi_flash_host_inst_t *host)
    Internal use, poll the HW until the last operation is done.
```

```
esp_err_t (*flush_cache) (spi_flash_host_inst_t *host, uint32_t addr, uint32_t size)
```

For some host (SPI1), they are shared with a cache. When the data is modified, the cache needs to be flushed. Left NULL if not supported.

```
void (*check_suspend) (spi_flash_host_inst_t *host)
```

Suspend check erase/program operation, reserved for ESP32-C3 and ESP32-S3 spi flash ROM IMPL.

```
void (*resume) (spi_flash_host_inst_t *host)
```

Resume flash from suspend manually

```
void (*suspend) (spi_flash_host_inst_t *host)
```

Set flash in suspend status manually

```
esp_err_t (*sus_setup) (spi_flash_host_inst_t *host, const spi_flash_sus_cmd_conf *sus_conf)
```

Suspend feature setup for setting cmd and status register mask.

Macros

SPI_FLASH_TRANS_FLAG_CMD16

Send command of 16 bits.

SPI_FLASH_TRANS_FLAG_IGNORE_BASEIO

Not applying the basic io mode configuration for this transaction.

SPI_FLASH_TRANS_FLAG_BYTE_SWAP

Used for DTR mode, to swap the bytes of a pair of rising/falling edge.

ESP_FLASH_SPEED_MIN

Lowest speed supported by the driver, currently 5 MHz.

SPI_FLASH_CONFIG_CONF_BITS

OR the *io_mode* with this mask, to enable the dummy output feature or replace the first several dummy bits into address to meet the requirements of conf bits. (Used in DIO/QIO/OIO mode)

SPI_FLASH_READ_MODE_MIN

Slowest io mode supported by ESP32, currently SlowRd.

Type Definitions

```
typedef struct spi_flash_host_driver_s spi_flash_host_driver_t
```

Enumerations

```
enum esp_flash_speed_t
```

SPI flash clock speed values, always refer to them by the enum rather than the actual value (more speed may be appended into the list).

A strategy to select the maximum allowed speed is to enumerate from the `ESP_FLASH_SPEED_MAX-1` or highest frequency supported by your flash, and decrease the speed until the probing success.

Values:

ESP_FLASH_5MHZ = 0

The flash runs under 5MHz.

ESP_FLASH_10MHZ

The flash runs under 10MHz.

ESP_FLASH_20MHZ

The flash runs under 20MHz.

ESP_FLASH_26MHZ

The flash runs under 26MHz.

ESP_FLASH_40MHZ

The flash runs under 40MHz.

ESP_FLASH_80MHZ

The flash runs under 80MHz.

ESP_FLASH_SPEED_MAX

The maximum frequency supported by the host is ESP_FLASH_SPEED_MAX-1.

enum esp_flash_io_mode_t

Mode used for reading from SPI flash.

Values:

SPI_FLASH_SLOWRD = 0

Data read using single I/O, some limits on speed.

SPI_FLASH_FASTRD

Data read using single I/O, no limit on speed.

SPI_FLASH_DOUT

Data read using dual I/O.

SPI_FLASH_DIO

Both address & data transferred using dual I/O.

SPI_FLASH_QOUT

Data read using quad I/O.

SPI_FLASH_QIO

Both address & data transferred using quad I/O.

SPI_FLASH_READ_MODE_MAX

The fastest io mode supported by the host is ESP_FLASH_READ_MODE_MAX-1.

API Reference - Partition Table

Header File

- [spi_flash/include/esp_partition.h](#)

Functions

esp_partition_iterator_t **esp_partition_find** (*esp_partition_type_t* type, *esp_partition_subtype_t* subtype, **const** char *label)

Find partition based on one or more parameters.

Return iterator which can be used to enumerate all the partitions found, or NULL if no partitions were found.

Iterator obtained through this function has to be released using `esp_partition_iterator_release` when not used any more.

Parameters

- *type*: Partition type, one of `esp_partition_type_t` values or an 8-bit unsigned integer
- *subtype*: Partition subtype, one of `esp_partition_subtype_t` values or an 8-bit unsigned integer. To find all partitions of given type, use `ESP_PARTITION_SUBTYPE_ANY`.
- *label*: (optional) Partition label. Set this value if looking for partition with a specific name. Pass NULL otherwise.

const *esp_partition_t* ***esp_partition_find_first** (*esp_partition_type_t* type, *esp_partition_subtype_t* subtype, **const** char *label)

Find first partition based on one or more parameters.

Return pointer to *esp_partition_t* structure, or NULL if no partition is found. This pointer is valid for the lifetime of the application.

Parameters

- *type*: Partition type, one of *esp_partition_type_t* values or an 8-bit unsigned integer
- *subtype*: Partition subtype, one of *esp_partition_subtype_t* values or an 8-bit unsigned integer To find all partitions of given type, use *ESP_PARTITION_SUBTYPE_ANY*.
- *label*: (optional) Partition label. Set this value if looking for partition with a specific name. Pass NULL otherwise.

const *esp_partition_t* ***esp_partition_get** (*esp_partition_iterator_t* iterator)

Get *esp_partition_t* structure for given partition.

Return pointer to *esp_partition_t* structure. This pointer is valid for the lifetime of the application.

Parameters

- *iterator*: Iterator obtained using *esp_partition_find*. Must be non-NULL.

esp_partition_iterator_t **esp_partition_next** (*esp_partition_iterator_t* iterator)

Move partition iterator to the next partition found.

Any copies of the iterator will be invalid after this call.

Return NULL if no partition was found, valid *esp_partition_iterator_t* otherwise.

Parameters

- *iterator*: Iterator obtained using *esp_partition_find*. Must be non-NULL.

void **esp_partition_iterator_release** (*esp_partition_iterator_t* iterator)

Release partition iterator.

Parameters

- *iterator*: Iterator obtained using *esp_partition_find*. Must be non-NULL.

const *esp_partition_t* ***esp_partition_verify** (**const** *esp_partition_t* *partition)

Verify partition data.

Given a pointer to partition data, verify this partition exists in the partition table (all fields match.)

This function is also useful to take partition data which may be in a RAM buffer and convert it to a pointer to the permanent partition data stored in flash.

Pointers returned from this function can be compared directly to the address of any pointer returned from *esp_partition_get()*, as a test for equality.

Return

- If partition not found, returns NULL.
- If found, returns a pointer to the *esp_partition_t* structure in flash. This pointer is always valid for the lifetime of the application.

Parameters

- *partition*: Pointer to partition data to verify. Must be non-NULL. All fields of this structure must match the partition table entry in flash for this function to return a successful match.

esp_err_t **esp_partition_read** (**const** *esp_partition_t* *partition, *size_t* src_offset, void *dst, *size_t* size)

Read data from the partition.

Partitions marked with an encryption flag will automatically be read and decrypted via a cache mapping.

Return *ESP_OK*, if data was read successfully; *ESP_ERR_INVALID_ARG*, if *src_offset* exceeds partition size; *ESP_ERR_INVALID_SIZE*, if read would go out of bounds of the partition; or one of error codes from lower-level flash driver.

Parameters

- *partition*: Pointer to partition structure obtained using *esp_partition_find_first* or *esp_partition_get*. Must be non-NULL.
- *dst*: Pointer to the buffer where data should be stored. Pointer must be non-NULL and buffer must be at least 'size' bytes long.
- *src_offset*: Address of the data to be read, relative to the beginning of the partition.
- *size*: Size of data to be read, in bytes.

esp_err_t **esp_partition_write** (**const** *esp_partition_t* *partition, size_t dst_offset, **const** void *src, size_t size)

Write data to the partition.

Before writing data to flash, corresponding region of flash needs to be erased. This can be done using `esp_partition_erase_range` function.

Partitions marked with an encryption flag will automatically be written via the `spi_flash_write_encrypted()` function. If writing to an encrypted partition, all write offsets and lengths must be multiples of 16 bytes. See the `spi_flash_write_encrypted()` function for more details. Unencrypted partitions do not have this restriction.

Note Prior to writing to flash memory, make sure it has been erased with `esp_partition_erase_range` call.

Return `ESP_OK`, if data was written successfully; `ESP_ERR_INVALID_ARG`, if `dst_offset` exceeds partition size; `ESP_ERR_INVALID_SIZE`, if write would go out of bounds of the partition; or one of error codes from lower-level flash driver.

Parameters

- `partition`: Pointer to partition structure obtained using `esp_partition_find_first` or `esp_partition_get`. Must be non-NULL.
- `dst_offset`: Address where the data should be written, relative to the beginning of the partition.
- `src`: Pointer to the source buffer. Pointer must be non-NULL and buffer must be at least 'size' bytes long.
- `size`: Size of data to be written, in bytes.

esp_err_t **esp_partition_read_raw** (**const** *esp_partition_t* *partition, size_t src_offset, void *dst, size_t size)

Read data from the partition without any transformation/decryption.

Note This function is essentially the same as `esp_partition_read()` above. It just never decrypts data but returns it as is.

Return `ESP_OK`, if data was read successfully; `ESP_ERR_INVALID_ARG`, if `src_offset` exceeds partition size; `ESP_ERR_INVALID_SIZE`, if read would go out of bounds of the partition; or one of error codes from lower-level flash driver.

Parameters

- `partition`: Pointer to partition structure obtained using `esp_partition_find_first` or `esp_partition_get`. Must be non-NULL.
- `dst`: Pointer to the buffer where data should be stored. Pointer must be non-NULL and buffer must be at least 'size' bytes long.
- `src_offset`: Address of the data to be read, relative to the beginning of the partition.
- `size`: Size of data to be read, in bytes.

esp_err_t **esp_partition_write_raw** (**const** *esp_partition_t* *partition, size_t dst_offset, **const** void *src, size_t size)

Write data to the partition without any transformation/encryption.

Before writing data to flash, corresponding region of flash needs to be erased. This can be done using `esp_partition_erase_range` function.

Note This function is essentially the same as `esp_partition_write()` above. It just never encrypts data but writes it as is.

Note Prior to writing to flash memory, make sure it has been erased with `esp_partition_erase_range` call.

Return `ESP_OK`, if data was written successfully; `ESP_ERR_INVALID_ARG`, if `dst_offset` exceeds partition size; `ESP_ERR_INVALID_SIZE`, if write would go out of bounds of the partition; or one of the error codes from lower-level flash driver.

Parameters

- `partition`: Pointer to partition structure obtained using `esp_partition_find_first` or `esp_partition_get`. Must be non-NULL.
- `dst_offset`: Address where the data should be written, relative to the beginning of the partition.
- `src`: Pointer to the source buffer. Pointer must be non-NULL and buffer must be at least 'size' bytes long.
- `size`: Size of data to be written, in bytes.

esp_err_t **esp_partition_erase_range** (**const** *esp_partition_t* *partition, size_t offset, size_t size)

Erase part of the partition.

Return ESP_OK, if the range was erased successfully; ESP_ERR_INVALID_ARG, if iterator or dst are NULL; ESP_ERR_INVALID_SIZE, if erase would go out of bounds of the partition; or one of error codes from lower-level flash driver.

Parameters

- `partition`: Pointer to partition structure obtained using `esp_partition_find_first` or `esp_partition_get`. Must be non-NULL.
- `offset`: Offset from the beginning of partition where erase operation should start. Must be aligned to 4 kilobytes.
- `size`: Size of the range which should be erased, in bytes. Must be divisible by 4 kilobytes.

```
esp_err_t esp_partition_mmap(const esp_partition_t *partition, size_t offset, size_t size,
                             spi_flash_mmap_memory_t memory, const void **out_ptr,
                             spi_flash_mmap_handle_t *out_handle)
```

Configure MMU to map partition into data memory.

Unlike `spi_flash_mmap` function, which requires a 64kB aligned base address, this function doesn't impose such a requirement. If offset results in a flash address which is not aligned to 64kB boundary, address will be rounded to the lower 64kB boundary, so that mapped region includes requested range. Pointer returned via `out_ptr` argument will be adjusted to point to the requested offset (not necessarily to the beginning of mmap-ed region).

To release mapped memory, pass handle returned via `out_handle` argument to `spi_flash_munmap` function.

Return ESP_OK, if successful

Parameters

- `partition`: Pointer to partition structure obtained using `esp_partition_find_first` or `esp_partition_get`. Must be non-NULL.
- `offset`: Offset from the beginning of partition where mapping should start.
- `size`: Size of the area to be mapped.
- `memory`: Memory space where the region should be mapped
- `out_ptr`: Output, pointer to the mapped memory region
- `out_handle`: Output, handle which should be used for `spi_flash_munmap` call

```
esp_err_t esp_partition_get_sha256(const esp_partition_t *partition, uint8_t *sha_256)
```

Get SHA-256 digest for required partition.

For apps with SHA-256 appended to the app image, the result is the appended SHA-256 value for the app image content. The hash is verified before returning, if app content is invalid then the function returns ESP_ERR_IMAGE_INVALID. For apps without SHA-256 appended to the image, the result is the SHA-256 of all bytes in the app image. For other partition types, the result is the SHA-256 of the entire partition.

Return

- ESP_OK: In case of successful operation.
- ESP_ERR_INVALID_ARG: The size was 0 or the sha_256 was NULL.
- ESP_ERR_NO_MEM: Cannot allocate memory for sha256 operation.
- ESP_ERR_IMAGE_INVALID: App partition doesn't contain a valid app image.
- ESP_FAIL: An allocation error occurred.

Parameters

- [in] `partition`: Pointer to info for partition containing app or data. (fields: address, size and type, are required to be filled).
- [out] `sha_256`: Returned SHA-256 digest for a given partition.

```
bool esp_partition_check_identity(const esp_partition_t *partition_1, const esp_partition_t
                                 *partition_2)
```

Check for the identity of two partitions by SHA-256 digest.

Return

- True: In case of the two firmware is equal.
- False: Otherwise

Parameters

- [in] `partition_1`: Pointer to info for partition 1 containing app or data. (fields: address, size and type, are required to be filled).

- [in] `partition_2`: Pointer to info for partition 2 containing app or data. (fields: address, size and type, are required to be filled).

```
esp_err_t esp_partition_register_external (esp_flash_t *flash_chip, size_t offset, size_t
size, const char *label, esp_partition_type_t
type, esp_partition_subtype_t subtype, const
esp_partition_t **out_partition)
```

Register a partition on an external flash chip.

This API allows designating certain areas of external flash chips (identified by the *esp_flash_t* structure) as partitions. This allows using them with components which access SPI flash through the `esp_partition` API.

Return

- ESP_OK on success
- ESP_ERR_NOT_SUPPORTED if CONFIG_CONFIG_SPI_FLASH_USE_LEGACY_IMPL is enabled
- ESP_ERR_NO_MEM if memory allocation has failed
- ESP_ERR_INVALID_ARG if the new partition overlaps another partition on the same flash chip
- ESP_ERR_INVALID_SIZE if the partition doesn't fit into the flash chip size

Parameters

- `flash_chip`: Pointer to the structure identifying the flash chip
- `offset`: Address in bytes, where the partition starts
- `size`: Size of the partition in bytes
- `label`: Partition name
- `type`: One of the partition types (ESP_PARTITION_TYPE_*), or an integer. Note that applications can not be booted from external flash chips, so using ESP_PARTITION_TYPE_APP is not supported.
- `subtype`: One of the partition subtypes (ESP_PARTITION_SUBTYPE_*), or an integer.
- [out] `out_partition`: Output, if non-NULL, receives the pointer to the resulting *esp_partition_t* structure

```
esp_err_t esp_partition_deregister_external (const esp_partition_t *partition)
```

Deregister the partition previously registered using `esp_partition_register_external`.

Return

- ESP_OK on success
- ESP_ERR_NOT_FOUND if the partition pointer is not found
- ESP_ERR_INVALID_ARG if the partition comes from the partition table
- ESP_ERR_INVALID_ARG if the partition was not registered using `esp_partition_register_external` function.

Parameters

- `partition`: pointer to the partition structure obtained from `esp_partition_register_external`,

Structures

```
struct esp_partition_t
partition information structure
```

This is not the format in flash, that format is `esp_partition_info_t`.

However, this is the format used by this API.

Public Members

```
esp_flash_t *flash_chip
SPI flash chip on which the partition resides
```

```
esp_partition_type_t type
partition type (app/data)
```

```
esp_partition_subtype_t subtype
partition subtype
```

`uint32_t address`
starting address of the partition in flash

`uint32_t size`
size of the partition, in bytes

char `label[17]`
partition label, zero-terminated ASCII string

bool `encrypted`
flag is set to true if partition is encrypted

Macros

ESP_PARTITION_SUBTYPE_OTA (i)
Convenience macro to get `esp_partition_subtype_t` value for the i-th OTA partition.

Type Definitions

typedef struct `esp_partition_iterator_opaque_*` **esp_partition_iterator_t**
Opaque partition iterator type.

Enumerations

enum `esp_partition_type_t`
Partition type.

Note Partition types with integer value 0x00-0x3F are reserved for partition types defined by ESP-IDF. Any other integer value 0x40-0xFE can be used by individual applications, without restriction.

Values:

ESP_PARTITION_TYPE_APP = 0x00
Application partition type.

ESP_PARTITION_TYPE_DATA = 0x01
Data partition type.

enum `esp_partition_subtype_t`
Partition subtype.

Application-defined partition types (0x40-0xFE) can set any numeric subtype value.

Note These ESP-IDF-defined partition subtypes apply to partitions of type `ESP_PARTITION_TYPE_APP` and `ESP_PARTITION_TYPE_DATA`.

Values:

ESP_PARTITION_SUBTYPE_APP_FACTORY = 0x00
Factory application partition.

ESP_PARTITION_SUBTYPE_APP_OTA_MIN = 0x10
Base for OTA partition subtypes.

ESP_PARTITION_SUBTYPE_APP_OTA_0 = `ESP_PARTITION_SUBTYPE_APP_OTA_MIN` + 0
OTA partition 0.

ESP_PARTITION_SUBTYPE_APP_OTA_1 = `ESP_PARTITION_SUBTYPE_APP_OTA_MIN` + 1
OTA partition 1.

ESP_PARTITION_SUBTYPE_APP_OTA_2 = `ESP_PARTITION_SUBTYPE_APP_OTA_MIN` + 2
OTA partition 2.

ESP_PARTITION_SUBTYPE_APP_OTA_3 = `ESP_PARTITION_SUBTYPE_APP_OTA_MIN` + 3
OTA partition 3.

ESP_PARTITION_SUBTYPE_APP_OTA_4 = `ESP_PARTITION_SUBTYPE_APP_OTA_MIN` + 4
OTA partition 4.

ESP_PARTITION_SUBTYPE_APP_OTA_5 = *ESP_PARTITION_SUBTYPE_APP_OTA_MIN* + 5
OTA partition 5.

ESP_PARTITION_SUBTYPE_APP_OTA_6 = *ESP_PARTITION_SUBTYPE_APP_OTA_MIN* + 6
OTA partition 6.

ESP_PARTITION_SUBTYPE_APP_OTA_7 = *ESP_PARTITION_SUBTYPE_APP_OTA_MIN* + 7
OTA partition 7.

ESP_PARTITION_SUBTYPE_APP_OTA_8 = *ESP_PARTITION_SUBTYPE_APP_OTA_MIN* + 8
OTA partition 8.

ESP_PARTITION_SUBTYPE_APP_OTA_9 = *ESP_PARTITION_SUBTYPE_APP_OTA_MIN* + 9
OTA partition 9.

ESP_PARTITION_SUBTYPE_APP_OTA_10 = *ESP_PARTITION_SUBTYPE_APP_OTA_MIN* + 10
OTA partition 10.

ESP_PARTITION_SUBTYPE_APP_OTA_11 = *ESP_PARTITION_SUBTYPE_APP_OTA_MIN* + 11
OTA partition 11.

ESP_PARTITION_SUBTYPE_APP_OTA_12 = *ESP_PARTITION_SUBTYPE_APP_OTA_MIN* + 12
OTA partition 12.

ESP_PARTITION_SUBTYPE_APP_OTA_13 = *ESP_PARTITION_SUBTYPE_APP_OTA_MIN* + 13
OTA partition 13.

ESP_PARTITION_SUBTYPE_APP_OTA_14 = *ESP_PARTITION_SUBTYPE_APP_OTA_MIN* + 14
OTA partition 14.

ESP_PARTITION_SUBTYPE_APP_OTA_15 = *ESP_PARTITION_SUBTYPE_APP_OTA_MIN* + 15
OTA partition 15.

ESP_PARTITION_SUBTYPE_APP_OTA_MAX = *ESP_PARTITION_SUBTYPE_APP_OTA_MIN* + 16
Max subtype of OTA partition.

ESP_PARTITION_SUBTYPE_APP_TEST = 0x20
Test application partition.

ESP_PARTITION_SUBTYPE_DATA_OTA = 0x00
OTA selection partition.

ESP_PARTITION_SUBTYPE_DATA_PHY = 0x01
PHY init data partition.

ESP_PARTITION_SUBTYPE_DATA_NVS = 0x02
NVS partition.

ESP_PARTITION_SUBTYPE_DATA_COREDUMP = 0x03
COREDUMP partition.

ESP_PARTITION_SUBTYPE_DATA_NVS_KEYS = 0x04
Partition for NVS keys.

ESP_PARTITION_SUBTYPE_DATA_EFUSE_EM = 0x05
Partition for emulate eFuse bits.

ESP_PARTITION_SUBTYPE_DATA_UNDEFINED = 0x06
Undefined (or unspecified) data partition.

ESP_PARTITION_SUBTYPE_DATA_ESPHTTPD = 0x80
ESPHTTPD partition.

ESP_PARTITION_SUBTYPE_DATA_FAT = 0x81
FAT partition.

ESP_PARTITION_SUBTYPE_DATA_SPIFFS = 0x82
SPIFFS partition.

ESP_PARTITION_SUBTYPE_ANY = 0xff

Used to search for partitions with any subtype.

API Reference - Flash Encrypt

Header File

- [bootloader_support/include/esp_flash_encrypt.h](#)

Functions

static bool esp_flash_encryption_enabled (void)

Is flash encryption currently enabled in hardware?

Flash encryption is enabled if the FLASH_CRYPT_CNT efuse has an odd number of bits set.

Return true if flash encryption is enabled.

esp_err_t **esp_flash_encrypt_check_and_update** (void)

esp_err_t **esp_flash_encrypt_region** (uint32_t *src_addr*, size_t *data_length*)

Encrypt-in-place a block of flash sectors.

Note This function resets RTC_WDT between operations with sectors.

Return ESP_OK if all operations succeeded, ESP_ERR_FLASH_OP_FAIL if SPI flash fails, ESP_ERR_FLASH_OP_TIMEOUT if flash times out.

Parameters

- *src_addr*: Source offset in flash. Should be multiple of 4096 bytes.
- *data_length*: Length of data to encrypt in bytes. Will be rounded up to next multiple of 4096 bytes.

void **esp_flash_write_protect_crypt_cnt** (void)

Write protect FLASH_CRYPT_CNT.

Intended to be called as a part of boot process if flash encryption is enabled but secure boot is not used. This should protect against serial re-flashing of an unauthorised code in absence of secure boot.

Note On ESP32 V3 only, write protecting FLASH_CRYPT_CNT will also prevent disabling UART Download Mode. If both are wanted, call `esp_efuse_disable_rom_download_mode()` before calling this function.

esp_flash_enc_mode_t **esp_get_flash_encryption_mode** (void)

Return the flash encryption mode.

The API is called during boot process but can also be called by application to check the current flash encryption mode of ESP32

Return

void **esp_flash_encryption_init_checks** (void)

Check the flash encryption mode during startup.

Verifies the flash encryption config during startup:

Note This function is called automatically during app startup, it doesn't need to be called from the app.

- Correct any insecure flash encryption settings if hardware Secure Boot is enabled.
- Log warnings if the efuse config doesn't match the project config in any way

Enumerations

enum **esp_flash_enc_mode_t**

Values:

ESP_FLASH_ENC_MODE_DISABLED

ESP_FLASH_ENC_MODE_DEVELOPMENT

ESP_FLASH_ENC_MODE_RELEASE

2.6.7 SPIFFS Filesystem

Overview

SPIFFS is a file system intended for SPI NOR flash devices on embedded targets. It supports wear levelling, file system consistency checks, and more.

Notes

- Currently, SPIFFS does not support directories, it produces a flat structure. If SPIFFS is mounted under `/spiffs`, then creating a file with the path `/spiffs/tmp/myfile.txt` will create a file called `/tmp/myfile.txt` in SPIFFS, instead of `myfile.txt` in the directory `/spiffs/tmp`.
- It is not a real-time stack. One write operation might take much longer than another.
- For now, it does not detect or handle bad blocks.

Tools

spiffsgen.py `spiffsgen.py` is a write-only Python SPIFFS implementation used to create filesystem images from the contents of a host folder. To use `spiffsgen.py`, open Terminal and run:

```
python spiffsgen.py <image_size> <base_dir> <output_file>
```

The required arguments are as follows:

- **image_size**: size of the partition onto which the created SPIFFS image will be flashed.
- **base_dir**: directory for which the SPIFFS image needs to be created.
- **output_file**: SPIFFS image output file.

There are also other arguments that control image generation. Documentation on these arguments can be found in the tool's help:

```
python spiffsgen.py --help
```

These optional arguments correspond to a possible SPIFFS build configuration. To generate the right image, please make sure that you use the same arguments/configuration as were used to build SPIFFS. As a guide, the help output indicates the SPIFFS build configuration to which the argument corresponds. In cases when these arguments are not specified, the default values shown in the help output will be used.

When the image is created, it can be flashed using `esptool.py` or `parttool.py`.

Aside from invoking the `spiffsgen.py` standalone by manually running it from the command line or a script, it is also possible to invoke `spiffsgen.py` directly from the build system by calling `spiffs_create_partition_image`.

Make:

```
SPIFFS_IMAGE_FLASH_IN_PROJECT := ...
SPIFFS_IMAGE_DEPENDS := ...
$(eval $(call spiffs_create_partition_image,<partition>,<base_dir>))
```

CMake:

```
spiffs_create_partition_image(<partition> <base_dir> [FLASH_IN_PROJECT] [DEPENDS_
↳dep dep dep...])
```

This is more convenient as the build configuration is automatically passed to the tool, ensuring that the generated image is valid for that build. An example of this is while the *image_size* is required for the standalone invocation, only the *partition* name is required when using `spiffs_create_partition_image` –the image size is automatically obtained from the project’s partition table.

Due to the differences in structure between Make and CMake, it is important to note that: - for Make `spiffs_create_partition_image` must be called from the project Makefile - for CMake `spiffs_create_partition_image` must be called from one of the component CMakeLists.txt files

Optionally, user can opt to have the image automatically flashed together with the app binaries, partition tables, etc. on `idf.py flash` or `make flash` by specifying `FLASH_IN_PROJECT`. For example,

in Make:

```
SPIFFS_IMAGE_FLASH_IN_PROJECT := 1
$(eval $(call spiffs_create_partition_image, <partition>, <base_dir>))
```

in CMake:

```
spiffs_create_partition_image(my_spiffs_partition my_folder FLASH_IN_PROJECT)
```

If `FLASH_IN_PROJECT/SPIFFS_IMAGE_FLASH_IN_PROJECT` is not specified, the image will still be generated, but you will have to flash it manually using `esptool.py`, `parttool.py`, or a custom build system target.

There are cases where the contents of the base directory itself is generated at build time. Users can use `DEPENDS/SPIFFS_IMAGE_DEPENDS` to specify targets that should be executed before generating the image.

in Make:

```
dep:
    ...

SPIFFS_IMAGE_DEPENDS := dep
$(eval $(call spiffs_create_partition_image, <partition>, <base_dir>))
```

in CMake:

```
add_custom_target(dep COMMAND ...)

spiffs_create_partition_image(my_spiffs_partition my_folder DEPENDS dep)
```

+For an example, see [storage/spiffsgen](#).

mkspiffs Another tool for creating SPIFFS partition images is `mkspiffs`. Similar to `spiffsgen.py`, it can be used to create an image from a given folder and then flash that image using `esptool.py`

For that, you need to obtain the following parameters:

- **Block Size:** 4096 (standard for SPI Flash)
- **Page Size:** 256 (standard for SPI Flash)
- **Image Size:** Size of the partition in bytes (can be obtained from a partition table)
- **Partition Offset:** Starting address of the partition (can be obtained from a partition table)

To pack a folder into a 1-Megabyte image, run:

```
mkspiffs -c [src_folder] -b 4096 -p 256 -s 0x100000 spiffs.bin
```

To flash the image onto ESP32-C3 at offset 0x110000, run:

```
python esptool.py --chip esp32c3 --port [port] --baud [baud] write_flash -z_
↪0x110000 spiffs.bin
```

Notes on which SPIFFS tool to use The two tools presented above offer very similar functionality. However, there are reasons to prefer one over the other, depending on the use case.

Use `spiffsgen.py` in the following cases: 1. If you want to simply generate a SPIFFS image during the build, `spiffsgen.py` makes it very convenient by providing functions/commands from the build system itself. 2. If the host has no C/C++ compiler available, because `spiffsgen.py` does not require compilation.

Use `mkspiffs` in the following cases: 1. If you need to unpack SPIFFS images in addition to image generation. For now, it is not possible with `spiffsgen.py`. 2. If you have an environment where a Python interpreter is not available, but a host compiler is available. Otherwise, a pre-compiled `mkspiffs` binary can do the job. However, there is no build system integration for `mkspiffs` and the user has to do the corresponding work: compiling `mkspiffs` during build (if a pre-compiled binary is not used), creating build rules/targets for the output files, passing proper parameters to the tool, etc.

See also

- [Partition Table documentation](#)

Application Example

An example of using SPIFFS is provided in the [storage/spiffs](#) directory. This example initializes and mounts a SPIFFS partition, then writes and reads data from it using POSIX and C library APIs. See the README.md file in the example directory for more information.

High-level API Reference

Header File

- [spiffs/include/esp_spiffs.h](#)

Functions

`esp_err_t esp_vfs_spiffs_register(const esp_vfs_spiffs_conf_t *conf)`

Register and mount SPIFFS to VFS with given path prefix.

Return

- ESP_OK if success
- ESP_ERR_NO_MEM if objects could not be allocated
- ESP_ERR_INVALID_STATE if already mounted or partition is encrypted
- ESP_ERR_NOT_FOUND if partition for SPIFFS was not found
- ESP_FAIL if mount or format fails

Parameters

- `conf`: Pointer to `esp_vfs_spiffs_conf_t` configuration structure

`esp_err_t esp_vfs_spiffs_unregister(const char *partition_label)`

Unregister and unmount SPIFFS from VFS

Return

- ESP_OK if successful
- ESP_ERR_INVALID_STATE already unregistered

Parameters

- `partition_label`: Same label as passed to `esp_vfs_spiffs_register`.

bool `esp_spiffs_mounted(const char *partition_label)`

Check if SPIFFS is mounted

Return

- true if mounted
- false if not mounted

Parameters

- `partition_label`: Optional, label of the partition to check. If not specified, first partition with `subtype=spiffs` is used.

esp_err_t **esp_spiffs_format** (**const** char **partition_label*)

Format the SPIFFS partition

Return

- `ESP_OK` if successful
- `ESP_FAIL` on error

Parameters

- `partition_label`: Same label as passed to `esp_vfs_spiffs_register`.

esp_err_t **esp_spiffs_info** (**const** char **partition_label*, **size_t** **total_bytes*, **size_t** **used_bytes*)

Get information for SPIFFS

Return

- `ESP_OK` if success
- `ESP_ERR_INVALID_STATE` if not mounted

Parameters

- `partition_label`: Same label as passed to `esp_vfs_spiffs_register`
- `[out] total_bytes`: Size of the file system
- `[out] used_bytes`: Current used bytes in the file system

Structures

struct esp_vfs_spiffs_conf_t

Configuration structure for `esp_vfs_spiffs_register`.

Public Members

const char ***base_path**

File path prefix associated with the filesystem.

const char ***partition_label**

Optional, label of SPIFFS partition to use. If set to `NULL`, first partition with `subtype=spiffs` will be used.

size_t **max_files**

Maximum files that could be open at the same time.

bool **format_if_mount_failed**

If true, it will format the file system if it fails to mount.

2.6.8 Virtual filesystem component

Overview

Virtual filesystem (VFS) component provides a unified interface for drivers which can perform operations on file-like objects. These can be real filesystems (FAT, SPIFFS, etc.) or device drivers which provide a file-like interface.

This component allows C library functions, such as `fopen` and `fprintf`, to work with FS drivers. At a high level, each FS driver is associated with some path prefix. When one of C library functions needs to open a file, the VFS component searches for the FS driver associated with the file path and forwards the call to that driver. VFS also forwards read, write, and other calls for the given file to the same FS driver.

For example, one can register a FAT filesystem driver with the `/fat` prefix and call `fopen("/fat/file.txt", "w")`. The VFS component will then call the function `open` of the FAT driver and pass the argument `/file.txt` to it together with appropriate mode flags. All subsequent calls to C library functions for the returned `FILE*` stream will also be forwarded to the FAT driver.

FS registration

To register an FS driver, an application needs to define an instance of the `esp_vfs_t` structure and populate it with function pointers to FS APIs:

```
esp_vfs_t myfs = {
    .flags = ESP_VFS_FLAG_DEFAULT,
    .write = &myfs_write,
    .open = &myfs_open,
    .fstat = &myfs_fstat,
    .close = &myfs_close,
    .read = &myfs_read,
};

ESP_ERROR_CHECK(esp_vfs_register("/data", &myfs, NULL));
```

Depending on the way how the FS driver declares its API functions, either `read`, `write`, etc., or `read_p`, `write_p`, etc., should be used.

Case 1: API functions are declared without an extra context pointer (the FS driver is a singleton):

```
ssize_t myfs_write(int fd, const void * data, size_t size);

// In definition of esp_vfs_t:
    .flags = ESP_VFS_FLAG_DEFAULT,
    .write = &myfs_write,
// ... other members initialized

// When registering FS, context pointer (third argument) is NULL:
ESP_ERROR_CHECK(esp_vfs_register("/data", &myfs, NULL));
```

Case 2: API functions are declared with an extra context pointer (the FS driver supports multiple instances):

```
ssize_t myfs_write(myfs_t* fs, int fd, const void * data, size_t size);

// In definition of esp_vfs_t:
    .flags = ESP_VFS_FLAG_CONTEXT_PTR,
    .write_p = &myfs_write,
// ... other members initialized

// When registering FS, pass the FS context pointer into the third argument
// (hypothetical myfs_mount function is used for illustrative purposes)
myfs_t* myfs_inst1 = myfs_mount(partition1->offset, partition1->size);
ESP_ERROR_CHECK(esp_vfs_register("/data1", &myfs, myfs_inst1));

// Can register another instance:
myfs_t* myfs_inst2 = myfs_mount(partition2->offset, partition2->size);
ESP_ERROR_CHECK(esp_vfs_register("/data2", &myfs, myfs_inst2));
```

Synchronous input/output multiplexing Synchronous input/output multiplexing by `select()` is supported in the VFS component. The implementation works in the following way.

1. `select()` is called with file descriptors which could belong to various VFS drivers.
2. The file descriptors are divided into groups each belonging to one VFS driver.
3. The file descriptors belonging to non-socket VFS drivers are handed over to the given VFS drivers by `start_select()` described later on this page. This function represents the driver-specific implementation of `select()` for the given driver. This should be a non-blocking call which means the function should immediately return after setting up the environment for checking events related to the given file descriptors.
4. The file descriptors belonging to the socket VFS driver are handed over to the socket driver by `socket_select()` described later on this page. This is a blocking call which means that it will return

- only if there is an event related to socket file descriptors or a non-socket driver signals `socket_select()` to exit.
5. Results are collected from each VFS driver and all drivers are stopped by deinitialization of the environment for checking events.
 6. The `select()` call ends and returns the appropriate results.

Non-socket VFS drivers If you want to use `select()` with a file descriptor belonging to a non-socket VFS driver then you need to register the driver with functions `start_select()` and `end_select()` similarly to the following example:

```
// In definition of esp_vfs_t:
    .start_select = &uart_start_select,
    .end_select = &uart_end_select,
// ... other members initialized
```

`start_select()` is called for setting up the environment for detection of read/write/error conditions on file descriptors belonging to the given VFS driver.

`end_select()` is called to stop/deinitialize/free the environment which was setup by `start_select()`.

Note: `end_select()` might be called without a previous `start_select()` call in some rare circumstances. `end_select()` should fail gracefully if this is the case.

Please refer to the reference implementation for the UART peripheral in [vfs/vfs_uart.c](#) and most particularly to the functions `esp_vfs_dev_uart_register()`, `uart_start_select()`, and `uart_end_select()` for more information.

Please check the following examples that demonstrate the use of `select()` with VFS file descriptors:

- [peripherals/uart/uart_select](#)
- [system/select](#)

Socket VFS drivers A socket VFS driver is using its own internal implementation of `select()` and non-socket VFS drivers notify it upon read/write/error conditions.

A socket VFS driver needs to be registered with the following functions defined:

```
// In definition of esp_vfs_t:
    .socket_select = &lwip_select,
    .get_socket_select_semaphore = &lwip_get_socket_select_semaphore,
    .stop_socket_select = &lwip_stop_socket_select,
    .stop_socket_select_isr = &lwip_stop_socket_select_isr,
// ... other members initialized
```

`socket_select()` is the internal implementation of `select()` for the socket driver. It works only with file descriptors belonging to the socket VFS.

`get_socket_select_semaphore()` returns the signalization object (semaphore) which will be used in non-socket drivers to stop the waiting in `socket_select()`.

`stop_socket_select()` call is used to stop the waiting in `socket_select()` by passing the object returned by `get_socket_select_semaphore()`.

`stop_socket_select_isr()` has the same functionality as `stop_socket_select()` but it can be used from ISR.

Please see [lwip/port/esp32/vfs_lwip.c](#) for a reference socket driver implementation using LWIP.

Note: If you use `select()` for socket file descriptors only then you can enable the `CONFIG_LWIP_USE_ONLY_LWIP_SELECT` option to reduce the code size and improve performance.

Note: Don't change the socket driver during an active `select()` call or you might experience some undefined behavior.

Paths

Each registered FS has a path prefix associated with it. This prefix can be considered as a “mount point” of this partition.

In case when mount points are nested, the mount point with the longest matching path prefix is used when opening the file. For instance, suppose that the following filesystems are registered in VFS:

- FS 1 on /data
- FS 2 on /data/static

Then:

- FS 1 will be used when opening a file called `/data/log.txt`
- FS 2 will be used when opening a file called `/data/static/index.html`
- Even if `/index.html` does not exist in FS 2, FS 1 will *not* be searched for `/static/index.html`.

As a general rule, mount point names must start with the path separator (`/`) and must contain at least one character after path separator. However, an empty mount point name is also supported and might be used in cases when an application needs to provide a “fallback” filesystem or to override VFS functionality altogether. Such filesystem will be used if no prefix matches the path given.

VFS does not handle dots (`.`) in path names in any special way. VFS does not treat `..` as a reference to the parent directory. In the above example, using a path `/data/static/./log.txt` will not result in a call to FS 1 to open `/log.txt`. Specific FS drivers (such as FATFS) might handle dots in file names differently.

When opening files, the FS driver receives only relative paths to files. For example:

1. The `myfs` driver is registered with `/data` as a path prefix.
2. The application calls `fopen("/data/config.json", ...)`.
3. The VFS component calls `myfs_open("/config.json", ...)`.
4. The `myfs` driver opens the `/config.json` file.

VFS does not impose any limit on total file path length, but it does limit the FS path prefix to `ESP_VFS_PATH_MAX` characters. Individual FS drivers may have their own filename length limitations.

File descriptors

File descriptors are small positive integers from 0 to `FD_SETSIZE - 1`, where `FD_SETSIZE` is defined in `newlib's sys/types.h`. The largest file descriptors (configured by `CONFIG_LWIP_MAX_SOCKETS`) are reserved for sockets. The VFS component contains a lookup-table called `s_fd_table` for mapping global file descriptors to VFS driver indexes registered in the `s_vfs` array.

Standard IO streams (stdin, stdout, stderr)

If the `menuconfig` option `UART` for console output is not set to `None`, then `stdin`, `stdout`, and `stderr` are configured to read from, and write to, a UART. It is possible to use `UART0` or `UART1` for standard IO. By default, `UART0` is used with 115200 baud rate; TX pin is `GPIO1`; RX pin is `GPIO3`. These parameters can be changed in `menuconfig`.

Writing to `stdout` or `stderr` will send characters to the UART transmit FIFO. Reading from `stdin` will retrieve characters from the UART receive FIFO.

By default, VFS uses simple functions for reading from and writing to UART. Writes busy-wait until all data is put into UART FIFO, and reads are non-blocking, returning only the data present in the FIFO. Due to this non-blocking read behavior, higher level C library calls, such as `fscanf("%d\n", &var);`, might not have desired results.

Applications which use the UART driver can instruct VFS to use the driver's interrupt driven, blocking read and write functions instead. This can be done using a call to the `esp_vfs_dev_uart_use_driver` function. It is also possible to revert to the basic non-blocking functions using a call to `esp_vfs_dev_uart_use_nonblocking`.

VFS also provides an optional newline conversion feature for input and output. Internally, most applications send and receive lines terminated by the LF (' ') character. Different terminal programs may require different line termination, such as CR or CRLF. Applications can configure this separately for input and output either via `menuconfig`, or by calls to the functions `esp_vfs_dev_uart_port_set_rx_line_endings` and `esp_vfs_dev_uart_port_set_tx_line_endings`.

Standard streams and FreeRTOS tasks FILE objects for `stdin`, `stdout`, and `stderr` are shared between all FreeRTOS tasks, but the pointers to these objects are stored in per-task `struct _reent`.

The following code is transferred to `fprintf(__getreent()->stderr, "42\n");` by the preprocessor:

```
fprintf(stderr, "42\n");
```

The `__getreent()` function returns a per-task pointer to `struct _reent` in `newlib libc`. This structure is allocated on the TCB of each task. When a task is initialized, `_stdin`, `_stdout`, and `_stderr` members of `struct _reent` are set to the values of `_stdin`, `_stdout`, and `_stderr` of `_GLOBAL_REENT` (i.e., the structure which is used before FreeRTOS is started).

Such a design has the following consequences:

- It is possible to set `stdin`, `stdout`, and `stderr` for any given task without affecting other tasks, e.g., by doing `stdin = fopen("/dev/uart/1", "r")`.
- Closing default `stdin`, `stdout`, or `stderr` using `fclose` will close the FILE stream object, which will affect all other tasks.
- To change the default `stdin`, `stdout`, `stderr` streams for new tasks, modify `_GLOBAL_REENT->_stdin(_stdout, _stderr)` before creating the task.

API Reference

Header File

- [vfs/include/esp_vfs.h](#)

Functions

`ssize_t esp_vfs_write (struct _reent *r, int fd, const void *data, size_t size)`

These functions are to be used in `newlib` syscall table. They will be called by `newlib` when it needs to use any of the syscalls.

`off_t esp_vfs_lseek (struct _reent *r, int fd, off_t size, int mode)`

`ssize_t esp_vfs_read (struct _reent *r, int fd, void *dst, size_t size)`

`int esp_vfs_open (struct _reent *r, const char *path, int flags, int mode)`

`int esp_vfs_close (struct _reent *r, int fd)`

`int esp_vfs_fstat (struct _reent *r, int fd, struct stat *st)`

`int esp_vfs_stat (struct _reent *r, const char *path, struct stat *st)`

`int esp_vfs_link (struct _reent *r, const char *n1, const char *n2)`

`int esp_vfs_unlink (struct _reent *r, const char *path)`

`int esp_vfs_rename (struct _reent *r, const char *src, const char *dst)`

`int esp_vfs_utime (const char *path, const struct utimbuf *times)`

`esp_err_t esp_vfs_register (const char *base_path, const esp_vfs_t *vfs, void *ctx)`

Register a virtual filesystem for given path prefix.

Return ESP_OK if successful, ESP_ERR_NO_MEM if too many VFSes are registered.

Parameters

- `base_path`: file path prefix associated with the filesystem. Must be a zero-terminated C string, may be empty. If not empty, must be up to ESP_VFS_PATH_MAX characters long, and at least 2 characters long. Name must start with a “/” and must not end with “/”. For example, “/data” or “/dev/spi” are valid. These VFSes would then be called to handle file paths such as “/data/myfile.txt” or “/dev/spi/0”. In the special case of an empty `base_path`, a “fallback” VFS is registered. Such VFS will handle paths which are not matched by any other registered VFS.
- `vfs`: Pointer to `esp_vfs_t`, a structure which maps syscalls to the filesystem driver functions. VFS component doesn't assume ownership of this pointer.
- `ctx`: If `vfs->flags` has ESP_VFS_FLAG_CONTEXT_PTR set, a pointer which should be passed to VFS functions. Otherwise, NULL.

esp_err_t **esp_vfs_register_fd_range** (const *esp_vfs_t* **vfs*, void **ctx*, int *min_fd*, int *max_fd*)

Special case function for registering a VFS that uses a method other than `open()` to open new file descriptors from the interval `<min_fd; max_fd)`.

This is a special-purpose function intended for registering LWIP sockets to VFS.

Return ESP_OK if successful, ESP_ERR_NO_MEM if too many VFSes are registered, ESP_ERR_INVALID_ARG if the file descriptor boundaries are incorrect.

Parameters

- `vfs`: Pointer to `esp_vfs_t`. Meaning is the same as for `esp_vfs_register()`.
- `ctx`: Pointer to context structure. Meaning is the same as for `esp_vfs_register()`.
- `min_fd`: The smallest file descriptor this VFS will use.
- `max_fd`: Upper boundary for file descriptors this VFS will use (the biggest file descriptor plus one).

esp_err_t **esp_vfs_register_with_id** (const *esp_vfs_t* **vfs*, void **ctx*, *esp_vfs_id_t* **vfs_id*)

Special case function for registering a VFS that uses a method other than `open()` to open new file descriptors. In comparison with `esp_vfs_register_fd_range`, this function doesn't pre-register an interval of file descriptors. File descriptors can be registered later, by using `esp_vfs_register_fd`.

Return ESP_OK if successful, ESP_ERR_NO_MEM if too many VFSes are registered, ESP_ERR_INVALID_ARG if the file descriptor boundaries are incorrect.

Parameters

- `vfs`: Pointer to `esp_vfs_t`. Meaning is the same as for `esp_vfs_register()`.
- `ctx`: Pointer to context structure. Meaning is the same as for `esp_vfs_register()`.
- `vfs_id`: Here will be written the VFS ID which can be passed to `esp_vfs_register_fd` for registering file descriptors.

esp_err_t **esp_vfs_unregister** (const char **base_path*)

Unregister a virtual filesystem for given path prefix

Return ESP_OK if successful, ESP_ERR_INVALID_STATE if VFS for given prefix hasn't been registered

Parameters

- `base_path`: file prefix previously used in `esp_vfs_register` call

esp_err_t **esp_vfs_register_fd** (*esp_vfs_id_t* *vfs_id*, int **fd*)

Special function for registering another file descriptor for a VFS registered by `esp_vfs_register_with_id`.

Return ESP_OK if the registration is successful, ESP_ERR_NO_MEM if too many file descriptors are registered, ESP_ERR_INVALID_ARG if the arguments are incorrect.

Parameters

- `vfs_id`: VFS identifier returned by `esp_vfs_register_with_id`.
- `fd`: The registered file descriptor will be written to this address.

esp_err_t **esp_vfs_unregister_fd** (*esp_vfs_id_t* *vfs_id*, int *fd*)

Special function for unregistering a file descriptor belonging to a VFS registered by `esp_vfs_register_with_id`.

Return ESP_OK if the registration is successful, ESP_ERR_INVALID_ARG if the arguments are incorrect.

Parameters

- `vfs_id`: VFS identifier returned by `esp_vfs_register_with_id`.
- `fd`: File descriptor which should be unregistered.

int **esp_vfs_select** (int *nfds*, fd_set **readfds*, fd_set **writefds*, fd_set **errorfds*, **struct** timeval **timeout*)

Synchronous I/O multiplexing which implements the functionality of POSIX select() for VFS.

Return The number of descriptors set in the descriptor sets, or -1 when an error (specified by errno) have occurred.

Parameters

- *nfds*: Specifies the range of descriptors which should be checked. The first *nfds* descriptors will be checked in each set.
- *readfds*: If not NULL, then points to a descriptor set that on input specifies which descriptors should be checked for being ready to read, and on output indicates which descriptors are ready to read.
- *writefds*: If not NULL, then points to a descriptor set that on input specifies which descriptors should be checked for being ready to write, and on output indicates which descriptors are ready to write.
- *errorfds*: If not NULL, then points to a descriptor set that on input specifies which descriptors should be checked for error conditions, and on output indicates which descriptors have error conditions.
- *timeout*: If not NULL, then points to timeval structure which specifies the time period after which the functions should time-out and return. If it is NULL, then the function will not time-out. Note that the timeout period is rounded up to the system tick and incremented by one.

void **esp_vfs_select_triggered** (*esp_vfs_select_sem_t sem*)

Notification from a VFS driver about a read/write/error condition.

This function is called when the VFS driver detects a read/write/error condition as it was requested by the previous call to start_select.

Parameters

- *sem*: semaphore structure which was passed to the driver by the start_select call

void **esp_vfs_select_triggered_isr** (*esp_vfs_select_sem_t sem*, BaseType_t **woken*)

Notification from a VFS driver about a read/write/error condition (ISR version)

This function is called when the VFS driver detects a read/write/error condition as it was requested by the previous call to start_select.

Parameters

- *sem*: semaphore structure which was passed to the driver by the start_select call
- *woken*: is set to pdTRUE if the function wakes up a task with higher priority

ssize_t **esp_vfs_pread** (int *fd*, void **dst*, size_t *size*, off_t *offset*)

Implements the VFS layer of POSIX pread()

Return A positive return value indicates the number of bytes read. -1 is return on failure and errno is set accordingly.

Parameters

- *fd*: File descriptor used for read
- *dst*: Pointer to the buffer where the output will be written
- *size*: Number of bytes to be read
- *offset*: Starting offset of the read

ssize_t **esp_vfs_pwrite** (int *fd*, const void **src*, size_t *size*, off_t *offset*)

Implements the VFS layer of POSIX pwrite()

Return A positive return value indicates the number of bytes written. -1 is return on failure and errno is set accordingly.

Parameters

- *fd*: File descriptor used for write
- *src*: Pointer to the buffer from where the output will be read
- *size*: Number of bytes to write
- *offset*: Starting offset of the write

Structures

struct esp_vfs_select_sem_t

VFS semaphore type for select()

Public Members

bool **is_sem_local**

type of “sem” is SemaphoreHandle_t when true, defined by socket driver otherwise

void ***sem**

semaphore instance

struct esp_vfs_t

VFS definition structure.

This structure should be filled with pointers to corresponding FS driver functions.

VFS component will translate all FDs so that the filesystem implementation sees them starting at zero. The caller sees a global FD which is prefixed with an pre-filesystem-implementation.

Some FS implementations expect some state (e.g. pointer to some structure) to be passed in as a first argument. For these implementations, populate the members of this structure which have `_p` suffix, set flags member to `ESP_VFS_FLAG_CONTEXT_PTR` and provide the context pointer to `esp_vfs_register` function. If the implementation doesn't use this extra argument, populate the members without `_p` suffix and set flags member to `ESP_VFS_FLAG_DEFAULT`.

If the FS driver doesn't provide some of the functions, set corresponding members to `NULL`.

Public Members

int **flags**

`ESP_VFS_FLAG_CONTEXT_PTR` or `ESP_VFS_FLAG_DEFAULT`

ssize_t (***write_p**) (void *p, int fd, const void *data, size_t size)

Write with context pointer

ssize_t (***write**) (int fd, const void *data, size_t size)

Write without context pointer

off_t (***lseek_p**) (void *p, int fd, off_t size, int mode)

Seek with context pointer

off_t (***lseek**) (int fd, off_t size, int mode)

Seek without context pointer

ssize_t (***read_p**) (void *ctx, int fd, void *dst, size_t size)

Read with context pointer

ssize_t (***read**) (int fd, void *dst, size_t size)

Read without context pointer

ssize_t (***pread_p**) (void *ctx, int fd, void *dst, size_t size, off_t offset)

pread with context pointer

ssize_t (***pread**) (int fd, void *dst, size_t size, off_t offset)

pread without context pointer

ssize_t (***pwrite_p**) (void *ctx, int fd, const void *src, size_t size, off_t offset)

pwrite with context pointer

ssize_t (***pwrite**) (int fd, const void *src, size_t size, off_t offset)

pwrite without context pointer

int (***open_p**) (void *ctx, const char *path, int flags, int mode)

open with context pointer

`int (*open) (const char *path, int flags, int mode)`
open without context pointer

`int (*close_p) (void *ctx, int fd)`
close with context pointer

`int (*close) (int fd)`
close without context pointer

`int (*fstat_p) (void *ctx, int fd, struct stat *st)`
fstat with context pointer

`int (*fstat) (int fd, struct stat *st)`
fstat without context pointer

`int (*stat_p) (void *ctx, const char *path, struct stat *st)`
stat with context pointer

`int (*stat) (const char *path, struct stat *st)`
stat without context pointer

`int (*link_p) (void *ctx, const char *n1, const char *n2)`
link with context pointer

`int (*link) (const char *n1, const char *n2)`
link without context pointer

`int (*unlink_p) (void *ctx, const char *path)`
unlink with context pointer

`int (*unlink) (const char *path)`
unlink without context pointer

`int (*rename_p) (void *ctx, const char *src, const char *dst)`
rename with context pointer

`int (*rename) (const char *src, const char *dst)`
rename without context pointer

`DIR *(*opendir_p) (void *ctx, const char *name)`
opendir with context pointer

`DIR *(*opendir) (const char *name)`
opendir without context pointer

`struct dirent *(*readdir_p) (void *ctx, DIR *pdir)`
readdir with context pointer

`struct dirent *(*readdir) (DIR *pdir)`
readdir without context pointer

`int (*readdir_r_p) (void *ctx, DIR *pdir, struct dirent *entry, struct dirent **out_dirent)`
readdir_r with context pointer

`int (*readdir_r) (DIR *pdir, struct dirent *entry, struct dirent **out_dirent)`
readdir_r without context pointer

`long (*telldir_p) (void *ctx, DIR *pdir)`
telldir with context pointer

`long (*telldir) (DIR *pdir)`
telldir without context pointer

`void (*seekdir_p) (void *ctx, DIR *pdir, long offset)`
seekdir with context pointer

`void (*seekdir) (DIR *pdir, long offset)`
seekdir without context pointer

`int (*closedir_p) (void *ctx, DIR *pdir)`
closedir with context pointer

`int (*closedir) (DIR *pdir)`
closedir without context pointer

`int (*mkdir_p) (void *ctx, const char *name, mode_t mode)`
mkdir with context pointer

`int (*mkdir) (const char *name, mode_t mode)`
mkdir without context pointer

`int (*rmdir_p) (void *ctx, const char *name)`
rmdir with context pointer

`int (*rmdir) (const char *name)`
rmdir without context pointer

`int (*fcntl_p) (void *ctx, int fd, int cmd, int arg)`
fcntl with context pointer

`int (*fcntl) (int fd, int cmd, int arg)`
fcntl without context pointer

`int (*ioctl_p) (void *ctx, int fd, int cmd, va_list args)`
ioctl with context pointer

`int (*ioctl) (int fd, int cmd, va_list args)`
ioctl without context pointer

`int (*fsync_p) (void *ctx, int fd)`
fsync with context pointer

`int (*fsync) (int fd)`
fsync without context pointer

`int (*access_p) (void *ctx, const char *path, int amode)`
access with context pointer

`int (*access) (const char *path, int amode)`
access without context pointer

`int (*truncate_p) (void *ctx, const char *path, off_t length)`
truncate with context pointer

`int (*truncate) (const char *path, off_t length)`
truncate without context pointer

`int (*utime_p) (void *ctx, const char *path, const struct utimbuf *times)`
utime with context pointer

`int (*utime) (const char *path, const struct utimbuf *times)`
utime without context pointer

`int (*tcsetattr_p) (void *ctx, int fd, int optional_actions, const struct termios *p)`
tcsetattr with context pointer

`int (*tcsetattr) (int fd, int optional_actions, const struct termios *p)`
tcsetattr without context pointer

`int (*tcgetattr_p) (void *ctx, int fd, struct termios *p)`
tcgetattr with context pointer

`int (*tcgetattr) (int fd, struct termios *p)`
tcgetattr without context pointer

`int (*tcdrain_p) (void *ctx, int fd)`
tcdrain with context pointer

`int (*tcdrain) (int fd)`
tcdrain without context pointer

`int (*tcflush_p) (void *ctx, int fd, int select)`
tcflush with context pointer

`int (*tcflush) (int fd, int select)`
tcflush without context pointer

`int (*tcflow_p) (void *ctx, int fd, int action)`
tcflow with context pointer

`int (*tcflow) (int fd, int action)`
tcflow without context pointer

`pid_t (*tcgetsid_p) (void *ctx, int fd)`
tcgetsid with context pointer

`pid_t (*tcgetsid) (int fd)`
tcgetsid without context pointer

`int (*tcsendbreak_p) (void *ctx, int fd, int duration)`
tcsendbreak with context pointer

`int (*tcsendbreak) (int fd, int duration)`
tcsendbreak without context pointer

`esp_err_t (*start_select) (int nfds, fd_set *readfds, fd_set *writefds, fd_set *exceptfds, esp_vfs_select_sem_t sem, void **end_select_args)`
start_select is called for setting up synchronous I/O multiplexing of the desired file descriptors in the given VFS

`int (*socket_select) (int nfds, fd_set *readfds, fd_set *writefds, fd_set *errorfds, struct timeval *timeout)`
socket select function for socket FDs with the functionality of POSIX select(); this should be set only for the socket VFS

`void (*stop_socket_select) (void *sem)`
called by VFS to interrupt the socket_select call when select is activated from a non-socket VFS driver; set only for the socket driver

`void (*stop_socket_select_isr) (void *sem, BaseType_t *woken)`
stop_socket_select which can be called from ISR; set only for the socket driver

`void (*get_socket_select_semaphore) (void)`
end_select is called to stop the I/O multiplexing and deinitialize the environment created by start_select for the given VFS

`esp_err_t (*end_select) (void *end_select_args)`
get_socket_select_semaphore returns semaphore allocated in the socket driver; set only for the socket driver

Macros

MAX_FDS

Maximum number of (global) file descriptors.

ESP_VFS_PATH_MAX

Maximum length of path prefix (not including zero terminator)

ESP_VFS_FLAG_DEFAULT

Default value of flags member in *esp_vfs_t* structure.

ESP_VFS_FLAG_CONTEXT_PTR

Flag which indicates that FS needs extra context pointer in syscalls.

Type Definitions

```
typedef int esp_vfs_id_t
```

Header File

- [vfs/include/esp_vfs_dev.h](#)

Functions

void **esp_vfs_dev_uart_register** (void)
add /dev/uart virtual filesystem driver

This function is called from startup code to enable serial output

void **esp_vfs_dev_uart_set_rx_line_endings** (esp_line_endings_t *mode*)
Set the line endings expected to be received on UART.

This specifies the conversion between line endings received on UART and newlines (‘ ’ , LF) passed into stdin:

- ESP_LINE_ENDINGS_CRLF: convert CRLF to LF
- ESP_LINE_ENDINGS_CR: convert CR to LF
- ESP_LINE_ENDINGS_LF: no modification

Note this function is not thread safe w.r.t. reading from UART

Parameters

- *mode*: line endings expected on UART

void **esp_vfs_dev_uart_set_tx_line_endings** (esp_line_endings_t *mode*)
Set the line endings to sent to UART.

This specifies the conversion between newlines (‘ ’ , LF) on stdout and line endings sent over UART:

- ESP_LINE_ENDINGS_CRLF: convert LF to CRLF
- ESP_LINE_ENDINGS_CR: convert LF to CR
- ESP_LINE_ENDINGS_LF: no modification

Note this function is not thread safe w.r.t. writing to UART

Parameters

- *mode*: line endings to send to UART

int **esp_vfs_dev_uart_port_set_rx_line_endings** (int *uart_num*, esp_line_endings_t *mode*)
Set the line endings expected to be received on specified UART.

This specifies the conversion between line endings received on UART and newlines (‘ ’ , LF) passed into stdin:

- ESP_LINE_ENDINGS_CRLF: convert CRLF to LF
- ESP_LINE_ENDINGS_CR: convert CR to LF
- ESP_LINE_ENDINGS_LF: no modification

Note this function is not thread safe w.r.t. reading from UART

Return 0 if succeeded, or -1 when an error (specified by *errno*) have occurred.

Parameters

- *uart_num*: the UART number
- *mode*: line endings to send to UART

int **esp_vfs_dev_uart_port_set_tx_line_endings** (int *uart_num*, esp_line_endings_t *mode*)
Set the line endings to sent to specified UART.

This specifies the conversion between newlines (‘ ’ , LF) on stdout and line endings sent over UART:

- ESP_LINE_ENDINGS_CRLF: convert LF to CRLF
- ESP_LINE_ENDINGS_CR: convert LF to CR
- ESP_LINE_ENDINGS_LF: no modification

Note this function is not thread safe w.r.t. writing to UART

Return 0 if succeeded, or -1 when an error (specified by `errno`) have occurred.

Parameters

- `uart_num`: the UART number
- `mode`: line endings to send to UART

void **esp_vfs_dev_uart_use_nonblocking** (int `uart_num`)

set VFS to use simple functions for reading and writing UART Read is non-blocking, write is busy waiting until TX FIFO has enough space. These functions are used by default.

Parameters

- `uart_num`: UART peripheral number

void **esp_vfs_dev_uart_use_driver** (int `uart_num`)

set VFS to use UART driver for reading and writing

Note application must configure UART driver before calling these functions With these functions, read and write are blocking and interrupt-driven.

Parameters

- `uart_num`: UART peripheral number

void **esp_vfs_usb_serial_jtag_use_driver** (void)

set VFS to use USB-SERIAL-JTAG driver for reading and writing

Note application must configure USB-SERIAL-JTAG driver before calling these functions With these functions, read and write are blocking and interrupt-driven.

void **esp_vfs_usb_serial_jtag_use_nonblocking** (void)

set VFS to use simple functions for reading and writing UART Read is non-blocking, write is busy waiting until TX FIFO has enough space. These functions are used by default.

2.6.9 Wear Levelling API

Overview

Most of flash memory and especially SPI flash that is used in ESP32-C3 has a sector-based organization and also has a limited number of erase/modification cycles per memory sector. The wear levelling component helps to distribute wear and tear among sectors more evenly without requiring any attention from the user.

The wear levelling component provides API functions related to reading, writing, erasing, and memory mapping of data in external SPI flash through the partition component. The component also has higher-level API functions which work with the FAT filesystem defined in *FAT filesystem*.

The wear levelling component, together with the FAT FS component, uses FAT FS sectors of 4096 bytes, which is a standard size for flash memory. With this size, the component shows the best performance but needs additional memory in RAM.

To save internal memory, the component has two additional modes which both use sectors of 512 bytes:

- **Performance mode.** Erase sector operation data is stored in RAM, the sector is erased, and then data is copied back to flash memory. However, if a device is powered off for any reason, all 4096 bytes of data is lost.
- **Safety mode.** The data is first saved to flash memory, and after the sector is erased, the data is saved back. If a device is powered off, the data can be recovered as soon as the device boots up.

The default settings are as follows: - Sector size is 512 bytes - Performance mode

You can change the settings through the configuration menu.

The wear levelling component does not cache data in RAM. The write and erase functions modify flash directly, and flash contents are consistent when the function returns.

Wear Levelling access API functions

This is the set of API functions for working with data in flash:

- `wl_mount` - initializes the wear levelling module and mounts the specified partition
- `wl_unmount` - unmounts the partition and deinitializes the wear levelling module
- `wl_erase_range` - erases a range of addresses in flash
- `wl_write` - writes data to a partition
- `wl_read` - reads data from a partition
- `wl_size` - returns the size of available memory in bytes
- `wl_sector_size` - returns the size of one sector

As a rule, try to avoid using raw wear levelling functions and use filesystem-specific functions instead.

Memory Size

The memory size is calculated in the wear levelling module based on partition parameters. The module uses some sectors of flash for internal data.

See also

- [FAT Filesystem](#)
- [Partition Table documentation](#)

Application Example

An example which combines the wear levelling driver with the FATFS library is provided in the [storage/wear_levelling](#) directory. This example initializes the wear levelling driver, mounts FATFS partition, as well as writes and reads data from it using POSIX and C library APIs. See the [storage/wear_levelling/README.md](#) file for more information.

High level API Reference

Header Files

- [fatfs/vfs/esp_vfs_fat.h](#)

Functions

`esp_err_t esp_vfs_fat_spiflash_mount` (`const` char **base_path*, `const` char **partition_label*,
`const` [esp_vfs_fat_mount_config_t](#) **mount_config*,
[wl_handle_t](#) **wl_handle*)

Convenience function to initialize FAT filesystem in SPI flash and register it in VFS.

This is an all-in-one function which does the following:

- finds the partition with defined `partition_label`. Partition label should be configured in the partition table.
- initializes flash wear levelling library on top of the given partition
- mounts FAT partition using FATFS library on top of flash wear levelling library
- registers FATFS library with VFS, with prefix given by `base_prefix` variable

This function is intended to make example code more compact.

Return

- `ESP_OK` on success
- `ESP_ERR_NOT_FOUND` if the partition table does not contain FATFS partition with given label
- `ESP_ERR_INVALID_STATE` if `esp_vfs_fat_spiflash_mount` was already called
- `ESP_ERR_NO_MEM` if memory can not be allocated
- `ESP_FAIL` if partition can not be mounted
- other error codes from wear levelling library, SPI flash driver, or FATFS drivers

Parameters

- `base_path`: path where FATFS partition should be mounted (e.g. “/spiflash”)
- `partition_label`: label of the partition which should be used
- `mount_config`: pointer to structure with extra parameters for mounting FATFS

- [out] `wl_handle`: wear levelling driver handle

struct esp_vfs_fat_mount_config_t

Configuration arguments for `esp_vfs_fat_sdmmc_mount` and `esp_vfs_fat_spiflash_mount` functions.

Public Members

bool **format_if_mount_failed**

If FAT partition can not be mounted, and this parameter is true, create partition table and format the filesystem.

int **max_files**

Max number of open files.

size_t **allocation_unit_size**

If `format_if_mount_failed` is set, and mount fails, format the card with given allocation unit size. Must be a power of 2, between sector size and $128 * \text{sector size}$. For SD cards, sector size is always 512 bytes. For wear levelling, sector size is determined by `CONFIG_WL_SECTOR_SIZE` option.

Using larger allocation unit size will result in higher read/write performance and higher overhead when storing small files.

Setting this field to 0 will result in allocation unit set to the sector size.

esp_err_t **esp_vfs_fat_spiflash_unmount** (**const** char **base_path*, *wl_handle_t* *wl_handle*)

Unmount FAT filesystem and release resources acquired using `esp_vfs_fat_spiflash_mount`.

Return

- `ESP_OK` on success
- `ESP_ERR_INVALID_STATE` if `esp_vfs_fat_spiflash_mount` hasn't been called

Parameters

- *base_path*: path where partition should be registered (e.g. `"/spiflash"`)
- *wl_handle*: wear levelling driver handle returned by `esp_vfs_fat_spiflash_mount`

Mid level API Reference

Header File

- [wear_levelling/include/wear_levelling.h](#)

Functions

esp_err_t **wl_mount** (**const** *esp_partition_t* **partition*, *wl_handle_t* **out_handle*)

Mount WL for defined partition.

Return

- `ESP_OK`, if the allocation was successfully;
- `ESP_ERR_INVALID_ARG`, if WL allocation was unsuccessful;
- `ESP_ERR_NO_MEM`, if there was no memory to allocate WL components;

Parameters

- *partition*: that will be used for access
- *out_handle*: handle of the WL instance

esp_err_t **wl_unmount** (*wl_handle_t* *handle*)

Unmount WL for defined partition.

Return

- `ESP_OK`, if the operation completed successfully;
- or one of error codes from lower-level flash driver.

Parameters

- *handle*: WL partition handle

esp_err_t **wl_erase_range** (*wl_handle_t* *handle*, size_t *start_addr*, size_t *size*)

Erase part of the WL storage.

Return

- ESP_OK, if the range was erased successfully;
- ESP_ERR_INVALID_ARG, if iterator or dst are NULL;
- ESP_ERR_INVALID_SIZE, if erase would go out of bounds of the partition;
- or one of error codes from lower-level flash driver.

Parameters

- *handle*: WL handle that are related to the partition
- *start_addr*: Address where erase operation should start. Must be aligned to the result of function `wl_sector_size(...)`.
- *size*: Size of the range which should be erased, in bytes. Must be divisible by result of function `wl_sector_size(...)`.

esp_err_t **wl_write** (*wl_handle_t* *handle*, *size_t* *dest_addr*, **const** void **src*, *size_t* *size*)

Write data to the WL storage.

Before writing data to flash, corresponding region of flash needs to be erased. This can be done using `wl_erase_range` function.

Note Prior to writing to WL storage, make sure it has been erased with `wl_erase_range` call.

Return

- ESP_OK, if data was written successfully;
- ESP_ERR_INVALID_ARG, if *dst_offset* exceeds partition size;
- ESP_ERR_INVALID_SIZE, if write would go out of bounds of the partition;
- or one of error codes from lower-level flash driver.

Parameters

- *handle*: WL handle that are related to the partition
- *dest_addr*: Address where the data should be written, relative to the beginning of the partition.
- *src*: Pointer to the source buffer. Pointer must be non-NULL and buffer must be at least 'size' bytes long.
- *size*: Size of data to be written, in bytes.

esp_err_t **wl_read** (*wl_handle_t* *handle*, *size_t* *src_addr*, void **dest*, *size_t* *size*)

Read data from the WL storage.

Return

- ESP_OK, if data was read successfully;
- ESP_ERR_INVALID_ARG, if *src_offset* exceeds partition size;
- ESP_ERR_INVALID_SIZE, if read would go out of bounds of the partition;
- or one of error codes from lower-level flash driver.

Parameters

- *handle*: WL module instance that was initialized before
- *dest*: Pointer to the buffer where data should be stored. Pointer must be non-NULL and buffer must be at least 'size' bytes long.
- *src_addr*: Address of the data to be read, relative to the beginning of the partition.
- *size*: Size of data to be read, in bytes.

size_t **wl_size** (*wl_handle_t* *handle*)

Get size of the WL storage.

Return usable size, in bytes

Parameters

- *handle*: WL module handle that was initialized before

size_t **wl_sector_size** (*wl_handle_t* *handle*)

Get sector size of the WL instance.

Return sector size, in bytes

Parameters

- *handle*: WL module handle that was initialized before

Macros

WL_INVALID_HANDLE

Type Definitions

```
typedef int32_t w1_handle_t
    wear levelling handle
```

Code examples for this API section are provided in the [storage](#) directory of ESP-IDF examples.

2.7 System API

2.7.1 App Image Format

An application image consists of the following structures:

1. The `esp_image_header_t` structure describes the mode of SPI flash and the count of memory segments.
2. The `esp_image_segment_header_t` structure describes each segment, its length, and its location in ESP32-C3's memory, followed by the data with a length of `data_len`. The data offset for each segment in the image is calculated in the following way:
 - offset for 0 Segment = `sizeof(esp_image_header_t) + sizeof(esp_image_segment_header_t)`.
 - offset for 1 Segment = offset for 0 Segment + length of 0 Segment + `sizeof(esp_image_segment_header_t)`.
 - offset for 2 Segment = offset for 1 Segment + length of 1 Segment + `sizeof(esp_image_segment_header_t)`.
 - ...

The count of each segment is defined in the `segment_count` field that is stored in `esp_image_header_t`. The count cannot be more than `ESP_IMAGE_MAX_SEGMENTS`.

To get the list of your image segments, please run the following command:

```
esptool.py --chip esp32c3 image_info build/app.bin
```

```
esptool.py v2.3.1
Image version: 1
Entry point: 40080ea4
13 segments
Segment 1: len 0x13ce0 load 0x3f400020 file_offs 0x00000018 SOC_DROM
Segment 2: len 0x00000 load 0x3ff80000 file_offs 0x00013d00 SOC_RTC_DRAM
Segment 3: len 0x00000 load 0x3ff80000 file_offs 0x00013d08 SOC_RTC_DRAM
Segment 4: len 0x028e0 load 0x3ffb0000 file_offs 0x00013d10 DRAM
Segment 5: len 0x00000 load 0x3ffb28e0 file_offs 0x000165f8 DRAM
Segment 6: len 0x00400 load 0x40080000 file_offs 0x00016600 SOC_IRAM
Segment 7: len 0x09600 load 0x40080400 file_offs 0x00016a08 SOC_IRAM
Segment 8: len 0x62e4c load 0x400d0018 file_offs 0x00020010 SOC_IROM
Segment 9: len 0x06cec load 0x40089a00 file_offs 0x00082e64 SOC_IROM
Segment 10: len 0x00000 load 0x400c0000 file_offs 0x00089b58 SOC_RTC_IRAM
Segment 11: len 0x00004 load 0x50000000 file_offs 0x00089b60 SOC_RTC_DATA
Segment 12: len 0x00000 load 0x50000004 file_offs 0x00089b6c SOC_RTC_DATA
Segment 13: len 0x00000 load 0x50000004 file_offs 0x00089b74 SOC_RTC_DATA
Checksum: e8 (valid) Validation Hash: ↵
↵407089ca0eae2bbf83b4120979d3354b1c938a49cb7a0c997f240474ef2ec76b (valid)
```

You can also see the information on segments in the IDF logs while your application is booting:

```
I (443) esp_image: segment 0: paddr=0x00020020 vaddr=0x3f400020 size=0x13ce0 (↵
↵81120) map
I (489) esp_image: segment 1: paddr=0x00033d08 vaddr=0x3ff80000 size=0x00000 ( 0) ↵
↵load
I (530) esp_image: segment 2: paddr=0x00033d10 vaddr=0x3ff80000 size=0x00000 ( 0) ↵
↵load
I (571) esp_image: segment 3: paddr=0x00033d18 vaddr=0x3ffb0000 size=0x028e0 (↵
↵10464) load
```

(continues on next page)

(continued from previous page)

```

I (612) esp_image: segment 4: paddr=0x00036600 vaddr=0x3ffb28e0 size=0x00000 ( 0) ↵
↪load
I (654) esp_image: segment 5: paddr=0x00036608 vaddr=0x40080000 size=0x00400 ( ↵
↪1024) load
I (695) esp_image: segment 6: paddr=0x00036a10 vaddr=0x40080400 size=0x09600 ( ↵
↪38400) load
I (737) esp_image: segment 7: paddr=0x00040018 vaddr=0x400d0018 size=0x62e4c ↵
↪(405068) map
I (847) esp_image: segment 8: paddr=0x000a2e6c vaddr=0x40089a00 size=0x06cec ( ↵
↪27884) load
I (888) esp_image: segment 9: paddr=0x000a9b60 vaddr=0x400c0000 size=0x00000 ( 0) ↵
↪load
I (929) esp_image: segment 10: paddr=0x000a9b68 vaddr=0x50000000 size=0x00004 ( 4) ↵
↪load
I (971) esp_image: segment 11: paddr=0x000a9b74 vaddr=0x50000004 size=0x00000 ( 0) ↵
↪load
I (1012) esp_image: segment 12: paddr=0x000a9b7c vaddr=0x50000004 size=0x00000 ( ↵
↪0) load

```

For more details on the type of memory segments and their address ranges, see *ESP32-C3 Technical Reference Manual > System and Memory > Internal Memory* [PDF].

3. The image has a single checksum byte after the last segment. This byte is written on a sixteen byte padded boundary, so the application image might need padding.
4. If the `hash_appended` field from `esp_image_header_t` is set then a SHA256 checksum will be appended. The value of SHA256 is calculated on the range from first byte and up to this field. The length of this field is 32 bytes.
5. If the options `CONFIG_SECURE_SIGNED_APPS_SCHEME` is set to ECDSA then the application image will have additional 68 bytes for an ECDSA signature, which includes:
 - version word (4 bytes),
 - signature data (64 bytes).

Application Description

The DROM segment starts with the `esp_app_desc_t` structure which carries specific fields describing the application:

- `secure_version` - see *Anti-rollback*.
- `version` - see *App version*. *
- `project_name` is filled from `PROJECT_NAME`. *
- `time and date` - compile time and date.
- `idf_ver` - version of ESP-IDF. *
- `app_elf_sha256` - contains sha256 for the elf application file.

* - The maximum length is 32 characters, including null-termination character. For example, if the length of `PROJECT_NAME` exceeds 32 characters, the excess characters will be disregarded.

This structure is useful for identification of images uploaded OTA because it has a fixed offset = `sizeof(esp_image_header_t) + sizeof(esp_image_segment_header_t)`. As soon as a device receives the first fragment containing this structure, it has all the information to determine whether the update should be continued or not.

Adding a Custom Structure to an Application

Customer also has the opportunity to have similar structure with a fixed offset relative to the beginning of the image. The following pattern can be used to add a custom structure to your image:

```
const __attribute__((section(".rodata_custom_desc"))) esp_custom_app_desc_t custom_
↪app_desc = { ... }
```

Offset for custom structure is `sizeof(esp_image_header_t) + sizeof(esp_image_segment_header_t) + sizeof(esp_app_desc_t)`.

To guarantee that the custom structure is located in the image even if it is not used, you need to add:

- For Make: add `COMPONENT_ADD_LDFLAGS += -u custom_app_desc` into `component.mk`
- For Cmake: add `target_link_libraries(${COMPONENT_TARGET} "-u custom_app_desc")` into `CMakeLists.txt`

API Reference

Header File

- [bootloader_support/include/esp_app_format.h](#)

Structures

struct esp_image_header_t

Main header of binary image.

Public Members

uint8_t magic

Magic word `ESP_IMAGE_HEADER_MAGIC`

uint8_t segment_count

Count of memory segments

uint8_t spi_mode

flash read mode (`esp_image_spi_mode_t` as `uint8_t`)

uint8_t spi_speed : 4

flash frequency (`esp_image_spi_freq_t` as `uint8_t`)

uint8_t spi_size : 4

flash chip size (`esp_image_flash_size_t` as `uint8_t`)

uint32_t entry_addr

Entry address

uint8_t wp_pin

WP pin when SPI pins set via efuse (read by ROM bootloader, the IDF bootloader uses software to configure the WP pin and sets this field to `0xEE`=disabled)

uint8_t spi_pin_drv[3]

Drive settings for the SPI flash pins (read by ROM bootloader)

esp_chip_id_t chip_id

Chip identification number

uint8_t min_chip_rev

Minimum chip revision supported by image

uint8_t reserved[8]

Reserved bytes in additional header space, currently unused

uint8_t hash_appended

If 1, a SHA256 digest “simple hash” (of the entire image) is appended after the checksum. Included in image length. This digest is separate to secure boot and only used for detecting corruption. For secure boot signed images, the signature is appended after this (and the simple hash is included in the signed data).

struct esp_image_segment_header_t

Header of binary image segment.

Public Members

uint32_t **load_addr**

Address of segment

uint32_t **data_len**

Length of data

struct esp_app_desc_t

Description about application.

Public Members

uint32_t **magic_word**

Magic word ESP_APP_DESC_MAGIC_WORD

uint32_t **secure_version**

Secure version

uint32_t **reserv1**[2]

reserv1

char **version**[32]

Application version

char **project_name**[32]

Project name

char **time**[16]

Compile time

char **date**[16]

Compile date

char **idf_ver**[32]

Version IDF

uint8_t **app_elf_sha256**[32]

sha256 of elf file

uint32_t **reserv2**[20]

reserv2

Macros

ESP_IMAGE_HEADER_MAGIC

The magic word for the *esp_image_header_t* structure.

ESP_IMAGE_MAX_SEGMENTS

Max count of segments in the image.

ESP_APP_DESC_MAGIC_WORD

The magic word for the *esp_app_desc* structure that is in DROM.

Enumerations

enum esp_chip_id_t

ESP chip ID.

Values:

ESP_CHIP_ID_ESP32 = 0x0000
chip ID: ESP32

ESP_CHIP_ID_ESP32S2 = 0x0002
chip ID: ESP32-S2

ESP_CHIP_ID_ESP32S3 = 0x0004
chip ID: ESP32-S3

ESP_CHIP_ID_ESP32C3 = 0x0005
chip ID: ESP32-C3

ESP_CHIP_ID_INVALID = 0xFFFF
Invalid chip ID (we defined it to make sure the `esp_chip_id_t` is 2 bytes size)

enum esp_image_spi_mode_t
SPI flash mode, used in [esp_image_header_t](#).

Values:

ESP_IMAGE_SPI_MODE_QIO
SPI mode QIO

ESP_IMAGE_SPI_MODE_QOUT
SPI mode QOUT

ESP_IMAGE_SPI_MODE_DIO
SPI mode DIO

ESP_IMAGE_SPI_MODE_DOUT
SPI mode DOUT

ESP_IMAGE_SPI_MODE_FAST_READ
SPI mode FAST_READ

ESP_IMAGE_SPI_MODE_SLOW_READ
SPI mode SLOW_READ

enum esp_image_spi_freq_t
SPI flash clock frequency.

Values:

ESP_IMAGE_SPI_SPEED_40M
SPI clock frequency 40 MHz

ESP_IMAGE_SPI_SPEED_26M
SPI clock frequency 26 MHz

ESP_IMAGE_SPI_SPEED_20M
SPI clock frequency 20 MHz

ESP_IMAGE_SPI_SPEED_80M = 0xF
SPI clock frequency 80 MHz

enum esp_image_flash_size_t
Supported SPI flash sizes.

Values:

ESP_IMAGE_FLASH_SIZE_1MB = 0
SPI flash size 1 MB

ESP_IMAGE_FLASH_SIZE_2MB
SPI flash size 2 MB

ESP_IMAGE_FLASH_SIZE_4MB
SPI flash size 4 MB

ESP_IMAGE_FLASH_SIZE_8MB
SPI flash size 8 MB

ESP_IMAGE_FLASH_SIZE_16MB
SPI flash size 16 MB

ESP_IMAGE_FLASH_SIZE_MAX
SPI flash size MAX

2.7.2 Application Level Tracing

Overview

IDF provides useful feature for program behaviour analysis: application level tracing. It is implemented in the corresponding library and can be enabled via menuconfig. This feature allows to transfer arbitrary data between host and ESP32-C3 via JTAG interface with small overhead on program execution. Developers can use this library to send application specific state of execution to the host and receive commands or other type of info in the opposite direction at runtime. The main use cases of this library are:

1. Collecting application specific data, see [Application Specific Tracing](#)
2. Lightweight logging to the host, see [Logging to Host](#)
3. System behaviour analysis, see [System Behavior Analysis with SEGGER SystemView](#)

API Reference

Header File

- [app_trace/include/esp_app_trace.h](#)

Functions

esp_err_t **esp_apptrace_init** (void)
Initializes application tracing module.

Note Should be called before any esp_apptrace_xxx call.

Return ESP_OK on success, otherwise see esp_err_t

void **esp_apptrace_down_buffer_config** (uint8_t *buf, uint32_t size)
Configures down buffer.

Note Needs to be called before initiating any data transfer using esp_apptrace_buffer_get and esp_apptrace_write. This function does not protect internal data by lock.

Parameters

- buf: Address of buffer to use for down channel (host to target) data.
- size: Size of the buffer.

uint8_t ***esp_apptrace_buffer_get** (*esp_apptrace_dest_t* dest, uint32_t size, uint32_t tmo)

Allocates buffer for trace data. After data in buffer are ready to be sent off esp_apptrace_buffer_put must be called to indicate it.

Return non-NULL on success, otherwise NULL.

Parameters

- dest: Indicates HW interface to send data.
- size: Size of data to write to trace buffer.
- tmo: Timeout for operation (in us). Use ESP_APPTRACE_TMO_INFINITE to wait indefinitely.

esp_err_t **esp_apptrace_buffer_put** (*esp_apptrace_dest_t* dest, uint8_t *ptr, uint32_t tmo)

Indicates that the data in buffer are ready to be sent off. This function is a counterpart of and must be preceded by esp_apptrace_buffer_get.

Return ESP_OK on success, otherwise see esp_err_t

Parameters

- dest: Indicates HW interface to send data. Should be identical to the same parameter in call to esp_apptrace_buffer_get.

- `ptr`: Address of trace buffer to release. Should be the value returned by call to `esp_appttrace_buffer_get`.
- `tmo`: Timeout for operation (in us). Use `ESP_APPTRACE_TMO_INFINITE` to wait indefinitely.

`esp_err_t esp_appttrace_write` (*esp_appttrace_dest_t* `dest`, **const** void **data*, `uint32_t` *size*, `uint32_t` *tmo*)

Writes data to trace buffer.

Return `ESP_OK` on success, otherwise see `esp_err_t`

Parameters

- `dest`: Indicates HW interface to send data.
- `data`: Address of data to write to trace buffer.
- `size`: Size of data to write to trace buffer.
- `tmo`: Timeout for operation (in us). Use `ESP_APPTRACE_TMO_INFINITE` to wait indefinitely.

`int esp_appttrace_vprintf_to` (*esp_appttrace_dest_t* `dest`, `uint32_t` *tmo*, **const** char **fmt*, *va_list ap*)
vprintf-like function to sent log messages to host via specified HW interface.

Return Number of bytes written.

Parameters

- `dest`: Indicates HW interface to send data.
- `tmo`: Timeout for operation (in us). Use `ESP_APPTRACE_TMO_INFINITE` to wait indefinitely.
- `fmt`: Address of format string.
- `ap`: List of arguments.

`int esp_appttrace_vprintf` (**const** char **fmt*, *va_list ap*)
vprintf-like function to sent log messages to host.

Return Number of bytes written.

Parameters

- `fmt`: Address of format string.
- `ap`: List of arguments.

`esp_err_t esp_appttrace_flush` (*esp_appttrace_dest_t* `dest`, `uint32_t` *tmo*)

Flushes remaining data in trace buffer to host.

Return `ESP_OK` on success, otherwise see `esp_err_t`

Parameters

- `dest`: Indicates HW interface to flush data on.
- `tmo`: Timeout for operation (in us). Use `ESP_APPTRACE_TMO_INFINITE` to wait indefinitely.

`esp_err_t esp_appttrace_flush_nolock` (*esp_appttrace_dest_t* `dest`, `uint32_t` *min_sz*, `uint32_t` *tmo*)

Flushes remaining data in trace buffer to host without locking internal data. This is special version of `esp_appttrace_flush` which should be called from panic handler.

Return `ESP_OK` on success, otherwise see `esp_err_t`

Parameters

- `dest`: Indicates HW interface to flush data on.
- `min_sz`: Threshold for flushing data. If current filling level is above this value, data will be flushed. TRAX destinations only.
- `tmo`: Timeout for operation (in us). Use `ESP_APPTRACE_TMO_INFINITE` to wait indefinitely.

`esp_err_t esp_appttrace_read` (*esp_appttrace_dest_t* `dest`, void **data*, `uint32_t` **size*, `uint32_t` *tmo*)

Reads host data from trace buffer.

Return `ESP_OK` on success, otherwise see `esp_err_t`

Parameters

- `dest`: Indicates HW interface to read the data on.
- `data`: Address of buffer to put data from trace buffer.
- `size`: Pointer to store size of read data. Before call to this function pointed memory must hold requested size of data
- `tmo`: Timeout for operation (in us). Use `ESP_APPTRACE_TMO_INFINITE` to wait indefinitely.

`uint8_t *esp_appttrace_down_buffer_get` (*esp_appttrace_dest_t* `dest`, `uint32_t` **size*, `uint32_t` *tmo*)

Retrieves incoming data buffer if any. After data in buffer are processed `esp_appttrace_down_buffer_put` must

be called to indicate it.

Return non-NULL on success, otherwise NULL.

Parameters

- *dest*: Indicates HW interface to receive data.
- *size*: Address to store size of available data in down buffer. Must be initialized with requested value.
- *tmo*: Timeout for operation (in us). Use ESP_APPTRACE_TMO_INFINITE to wait indefinitely.

esp_err_t **esp_appttrace_down_buffer_put** (*esp_appttrace_dest_t* *dest*, *uint8_t* **ptr*, *uint32_t* *tmo*)

Indicates that the data in down buffer are processed. This function is a counterpart of and must be preceded by `esp_appttrace_down_buffer_get`.

Return ESP_OK on success, otherwise see `esp_err_t`

Parameters

- *dest*: Indicates HW interface to receive data. Should be identical to the same parameter in call to `esp_appttrace_down_buffer_get`.
- *ptr*: Address of trace buffer to release. Should be the value returned by call to `esp_appttrace_down_buffer_get`.
- *tmo*: Timeout for operation (in us). Use ESP_APPTRACE_TMO_INFINITE to wait indefinitely.

bool **esp_appttrace_host_is_connected** (*esp_appttrace_dest_t* *dest*)

Checks whether host is connected.

Return true if host is connected, otherwise false

Parameters

- *dest*: Indicates HW interface to use.

void ***esp_appttrace_fopen** (*esp_appttrace_dest_t* *dest*, **const** *char* **path*, **const** *char* **mode*)

Opens file on host. This function has the same semantic as 'fopen' except for the first argument.

Return non zero file handle on success, otherwise 0

Parameters

- *dest*: Indicates HW interface to use.
- *path*: Path to file.
- *mode*: Mode string. See fopen for details.

int **esp_appttrace_fclose** (*esp_appttrace_dest_t* *dest*, *void* **stream*)

Closes file on host. This function has the same semantic as 'fclose' except for the first argument.

Return Zero on success, otherwise non-zero. See fclose for details.

Parameters

- *dest*: Indicates HW interface to use.
- *stream*: File handle returned by `esp_appttrace_fopen`.

size_t **esp_appttrace_fwrite** (*esp_appttrace_dest_t* *dest*, **const** *void* **ptr*, *size_t* *size*, *size_t* *nmemb*, *void* **stream*)

Writes to file on host. This function has the same semantic as 'fwrite' except for the first argument.

Return Number of written items. See fwrite for details.

Parameters

- *dest*: Indicates HW interface to use.
- *ptr*: Address of data to write.
- *size*: Size of an item.
- *nmemb*: Number of items to write.
- *stream*: File handle returned by `esp_appttrace_fopen`.

size_t **esp_appttrace_fread** (*esp_appttrace_dest_t* *dest*, *void* **ptr*, *size_t* *size*, *size_t* *nmemb*, *void* **stream*)

Read file on host. This function has the same semantic as 'fread' except for the first argument.

Return Number of read items. See fread for details.

Parameters

- *dest*: Indicates HW interface to use.
- *ptr*: Address to store read data.

- `size`: Size of an item.
- `nmemb`: Number of items to read.
- `stream`: File handle returned by `esp_appttrace_fopen`.

int **esp_appttrace_fseek** (*esp_appttrace_dest_t* *dest*, void **stream*, long *offset*, int *whence*)

Set position indicator in file on host. This function has the same semantic as ‘`fseek`’ except for the first argument.

Return Zero on success, otherwise non-zero. See `fseek` for details.

Parameters

- `dest`: Indicates HW interface to use.
- `stream`: File handle returned by `esp_appttrace_fopen`.
- `offset`: Offset. See `fseek` for details.
- `whence`: Position in file. See `fseek` for details.

int **esp_appttrace_ftell** (*esp_appttrace_dest_t* *dest*, void **stream*)

Get current position indicator for file on host. This function has the same semantic as ‘`ftell`’ except for the first argument.

Return Current position in file. See `ftell` for details.

Parameters

- `dest`: Indicates HW interface to use.
- `stream`: File handle returned by `esp_appttrace_fopen`.

int **esp_appttrace_fstop** (*esp_appttrace_dest_t* *dest*)

Indicates to the host that all file operations are completed. This function should be called after all file operations are finished and indicate to the host that it can perform cleanup operations (close open files etc.).

Return `ESP_OK` on success, otherwise see `esp_err_t`

Parameters

- `dest`: Indicates HW interface to use.

void **esp_gcov_dump** (void)

Triggers gcov info dump. This function waits for the host to connect to target before dumping data.

Enumerations

enum **esp_appttrace_dest_t**

Application trace data destinations bits.

Values:

ESP_APPTRACE_DEST_JTAG = 1
JTAG destination.

ESP_APPTRACE_DEST_TRAX = *ESP_APPTRACE_DEST_JTAG*
xxx_TRAX name is obsolete, use more common xxx_JTAG

ESP_APPTRACE_DEST_UART0
UART0 destination.

ESP_APPTRACE_DEST_MAX = *ESP_APPTRACE_DEST_UART0*

ESP_APPTRACE_DEST_NUM

Header File

- `app_trace/include/esp_sysview_trace.h`

Functions

static *esp_err_t* **esp_sysview_flush** (uint32_t *tmo*)

Flushes remaining data in SystemView trace buffer to host.

Return `ESP_OK`.

Parameters

- `tmo`: Timeout for operation (in us). Use `ESP_APPTRACE_TMO_INFINITE` to wait indefinitely.

int **`esp_sysview_vprintf`** (`const char *format, va_list args`)
vprintf-like function to sent log messages to the host.

Return Number of bytes written.

Parameters

- `format`: Address of format string.
- `args`: List of arguments.

esp_err_t **`esp_sysview_heap_trace_start`** (`uint32_t tmo`)
Starts SystemView heap tracing.

Return `ESP_OK` on success, `ESP_ERR_TIMEOUT` if operation has been timed out.

Parameters

- `tmo`: Timeout (in us) to wait for the host to be connected. Use -1 to wait forever.

esp_err_t **`esp_sysview_heap_trace_stop`** (`void`)
Stops SystemView heap tracing.

Return `ESP_OK`.

void **`esp_sysview_heap_trace_alloc`** (`void *addr, uint32_t size, const void *callers`)
Sends heap allocation event to the host.

Parameters

- `addr`: Address of allocated block.
- `size`: Size of allocated block.
- `callers`: Pointer to array with callstack addresses. Array size must be `CONFIG_HEAP_TRACING_STACK_DEPTH`.

void **`esp_sysview_heap_trace_free`** (`void *addr, const void *callers`)
Sends heap de-allocation event to the host.

Parameters

- `addr`: Address of de-allocated block.
- `callers`: Pointer to array with callstack addresses. Array size must be `CONFIG_HEAP_TRACING_STACK_DEPTH`.

2.7.3 The Async memcpy API

Overview

ESP32-C3 has a DMA engine which can help to offload internal memory copy operations from the CPU in a asynchronous way.

The async memcpy API wraps all DMA configurations and operations, the signature of `esp_async_memcpy()` is almost the same to the standard libc one.

Thanks to the benefit of the DMA, we don't have to wait for each memory copy to be done before we issue another memcpy request. By the way, it's still possible to know when memcpy is finished by listening in the memcpy callback function.

Configure and Install driver

`esp_async_memcpy_install()` is used to install the driver with user's configuration. Please note that async memcpy has to be called with the handle returned from `esp_async_memcpy_install()`.

Driver configuration is described in `async_memcpy_config_t`: `backlog`: This is used to configured the maximum number of DMA operation that can be working at the background at the same time. `flags`: This is used to enable some special driver features.

`ASYNC_MEMCPY_DEFAULT_CONFIG` provides a default configuration, which specifies the backlog to 8.

```

async_memcpy_config_t config = ASYNC_MEMCPY_DEFAULT_CONFIG();
// update the maximum data stream supported by underlying DMA engine
config.backlog = 16;
async_memcpy_t driver = NULL;
ESP_ERROR_CHECK(esp_async_memcpy_install(&config, &driver)); // install driver,
↳return driver handle

```

Send memory copy request

`esp_async_memcpy()` is the API to send memory copy request to DMA engine. It must be called after driver is installed successfully. This API is thread safe, so it can be called from different tasks.

Different from the libc version of `memcpy`, user should also pass a callback to `esp_async_memcpy()`, if it's necessary to be notified when the memory copy is done. The callback is executed in the ISR context, make sure you won't violate the restriction applied to ISR handler.

Besides that, the callback function should reside in IRAM space by applying `IRAM_ATTR` attribute. The prototype of the callback function is `async_memcpy_isr_cb_t`, please note that, the callback function should return true if it wakes up a high priority task by some API like `xSemaphoreGiveFromISR()`.

```

SemaphoreHandle_t semphr; //already initialized in somewhere

// Callback implementation, running in ISR context
static IRAM_ATTR bool my_async_memcpy_cb(async_memcpy_t mcp_hdl, async_memcpy_
↳event_t *event, void *cb_args)
{
    SemaphoreHandle_t sem = (SemaphoreHandle_t)cb_args;
    BaseType_t high_task_wakeup = pdFALSE;
    SemaphoreGiveInISR(semphr, &high_task_wakeup); // high_task_wakeup set to pdTRUE_
↳if some high priority task unblocked
    return high_task_wakeup == pdTRUE;
}

// Called from user's context
ESP_ERROR_CHECK(esp_async_memcpy(driver_handle, to, from, copy_len, my_async_
↳memcpy_cb, my_semaphore));
//Do something else here
SemaphoreTake(my_semaphore, ...); //wait until the buffer copy is done

```

Uninstall driver (optional)

`esp_async_memcpy_uninstall()` is used to uninstall asynchronous memcpy driver. It's not necessary to uninstall the driver after each memcpy operation. If you know your application won't use this driver anymore, then this API can recycle the memory for you.

API Reference

Header File

- `esp_system/include/esp_async_memcpy.h`

Functions

```

esp_err_t esp_async_memcpy_install(const async_memcpy_config_t *config, async_memcpy_t
↳asmcp)

```

Install async memcpy driver.

Return

- ESP_OK: Install async memcpy driver successfully

- `ESP_ERR_INVALID_ARG`: Install async memcpy driver failed because of invalid argument
- `ESP_ERR_NO_MEM`: Install async memcpy driver failed because out of memory
- `ESP_FAIL`: Install async memcpy driver failed because of other error

Parameters

- `[in] config`: Configuration of async memcpy
- `[out] asmcp`: Handle of async memcpy that returned from this API. If driver installation is failed, `asmcp` would be assigned to `NULL`.

esp_err_t **esp_async_memcpy_uninstall** (*async_memcpy_t* *asmcp*)

Uninstall async memcpy driver.

Return

- `ESP_OK`: Uninstall async memcpy driver successfully
- `ESP_ERR_INVALID_ARG`: Uninstall async memcpy driver failed because of invalid argument
- `ESP_FAIL`: Uninstall async memcpy driver failed because of other error

Parameters

- `[in] asmcp`: Handle of async memcpy driver that returned from `esp_async_memcpy_install`

esp_err_t **esp_async_memcpy** (*async_memcpy_t* *asmcp*, void **dst*, void **src*, size_t *n*, *async_memcpy_isr_cb_t* *cb_isr*, void **cb_args*)

Send an asynchronous memory copy request.

Return

- `ESP_OK`: Send memory copy request successfully
- `ESP_ERR_INVALID_ARG`: Send memory copy request failed because of invalid argument
- `ESP_FAIL`: Send memory copy request failed because of other error

Note The callback function is invoked in interrupt context, never do blocking jobs in the callback.

Parameters

- `[in] asmcp`: Handle of async memcpy driver that returned from `esp_async_memcpy_install`
- `[in] dst`: Destination address (copy to)
- `[in] src`: Source address (copy from)
- `[in] n`: Number of bytes to copy
- `[in] cb_isr`: Callback function, which got invoked in interrupt context. Set to `NULL` can bypass the callback.
- `[in] cb_args`: User defined argument to be passed to the callback function

Structures

struct `async_memcpy_event_t`

Type of async memcpy event object.

Public Members

void ***data**

Event data

struct `async_memcpy_config_t`

Type of async memcpy configuration.

Public Members

uint32_t **backlog**

Maximum number of streams that can be handled simultaneously

uint32_t **flags**

Extra flags to control async memcpy feature

Macros

ASYNC_MEMCPY_DEFAULT_CONFIG ()

Default configuration for async memcpy.

Type Definitions

typedef struct `async_memcpy_context_t` ***async_memcpy_t**

Type of async memcpy handle.

typedef bool (***async_memcpy_isr_cb_t**) (*async_memcpy_t* mcp_hdl, *async_memcpy_event_t* *event, void *cb_args)

Type of async memcpy interrupt callback function.

Return Whether a high priority task is woken up by the callback function

Note User can call OS primitives (semaphore, mutex, etc) in the callback function. Keep in mind, if any OS primitive wakes high priority task up, the callback should return true.

Parameters

- `mcp_hdl`: Handle of async memcpy
- `event`: Event object, which contains related data, reserved for future
- `cb_args`: User defined arguments, passed from `esp_async_memcpy` function

2.7.4 Console

ESP-IDF provides `console` component, which includes building blocks needed to develop an interactive console over serial port. This component includes following facilities:

- Line editing, provided by [linenoise](#) library. This includes handling of backspace and arrow keys, scrolling through command history, command auto-completion, and argument hints.
- Splitting of command line into arguments.
- Argument parsing, provided by [argtable3](#) library. This library includes APIs used for parsing GNU style command line arguments.
- Functions for registration and dispatching of commands.
- Functions to establish a basic REPL (Read-Evaluate-Print-Loop) environment.

Note: These facilities can be used together or independently. For example, it is possible to use line editing and command registration features, but use `getopt` or custom code for argument parsing, instead of [argtable3](#). Likewise, it is possible to use simpler means of command input (such as `fgets`) together with the rest of the means for command splitting and argument parsing.

Line editing

Line editing feature lets users compose commands by typing them, erasing symbols using ‘backspace’ key, navigating within the command using left/right keys, navigating to previously typed commands using up/down keys, and performing autocompletion using ‘tab’ key.

Note: This feature relies on ANSI escape sequence support in the terminal application. As such, serial monitors which display raw UART data can not be used together with the line editing library. If you see `[\b\n` or similar escape sequence when running [system/console](#) example instead of a command prompt (e.g. `esp>`), it means that the serial monitor does not support escape sequences. Programs which are known to work are GNU screen, minicom, and `idf_monitor.py` (which can be invoked using `idf.py monitor` from project directory).

Here is an overview of functions provided by [linenoise](#) library.

Configuration Linenoise library does not need explicit initialization. However, some configuration defaults may need to be changed before invoking the main line editing function.

```
linenoiseClearScreen()
```

Clear terminal screen using an escape sequence and position the cursor at the top left corner.

```
linenoiseSetMultiLine()
```

Switch between single line and multi line editing modes. In single line mode, if the length of the command exceeds the width of the terminal, the command text is scrolled within the line to show the end of the text. In this case the beginning of the text is hidden. Single line needs less data to be sent to refresh screen on each key press, so exhibits less glitching compared to the multi line mode. On the flip side, editing commands and copying command text from terminal in single line mode is harder. Default is single line mode.

```
linenoiseAllowEmpty()
```

Set whether linenoise library will return a zero-length string (if `true`) or `NULL` (if `false`) for empty lines. By default, zero-length strings are returned.

Main loop `linenoise()`

In most cases, console applications have some form of read/eval loop. `linenoise()` is the single function which handles user's key presses and returns completed line once 'enter' key is pressed. As such, it handles the 'read' part of the loop.

```
linenoiseFree()
```

This function must be called to release the command line buffer obtained from `linenoise()` function.

Hints and completions `linenoiseSetCompletionCallback()`

When user presses 'tab' key, linenoise library invokes completion callback. The callback should inspect the contents of the command typed so far and provide a list of possible completions using calls to `linenoiseAddCompletion()` function. `linenoiseSetCompletionCallback()` function should be called to register this completion callback, if completion feature is desired.

console component provides a ready made function to provide completions for registered commands, [`esp_console_get_completion\(\)`](#) (see below).

```
linenoiseAddCompletion()
```

Function to be called by completion callback to inform the library about possible completions of the currently typed command.

```
linenoiseSetHintsCallback()
```

Whenever user input changes, linenoise invokes hints callback. This callback can inspect the command line typed so far, and provide a string with hints (which can include list of command arguments, for example). The library then displays the hint text on the same line where editing happens, possibly with a different color.

```
linenoiseSetFreeHintsCallback()
```

If hint string returned by hints callback is dynamically allocated or needs to be otherwise recycled, the function which performs such cleanup should be registered via `linenoiseSetFreeHintsCallback()`.

History `linenoiseHistorySetMaxLen()`

This function sets the number of most recently typed commands to be kept in memory. Users can navigate the history using up/down arrows.

```
linenoiseHistoryAdd()
```

Linenoise does not automatically add commands to history. Instead, applications need to call this function to add command strings to the history.

```
linenoiseHistorySave()
```

Function saves command history from RAM to a text file, for example on an SD card or on a filesystem in flash memory.

`linenoiseHistoryLoad()`

Counterpart to `linenoiseHistorySave()`, loads history from a file.

`linenoiseHistoryFree()`

Releases memory used to store command history. Call this function when done working with linenoise library.

Splitting of command line into arguments

`console` component provides `esp_console_split_argv()` function to split command line string into arguments. The function returns the number of arguments found (`argc`) and fills an array of pointers which can be passed as `argv` argument to any function which accepts arguments in `argc, argv` format.

The command line is split into arguments according to the following rules:

- Arguments are separated by spaces
- If spaces within arguments are required, they can be escaped using `\` (backslash) character.
- Other escape sequences which are recognized are `\\` (which produces literal backslash) and `\"`, which produces a double quote.
- Arguments can be quoted using double quotes. Quotes may appear only in the beginning and at the end of the argument. Quotes within the argument must be escaped as mentioned above. Quotes surrounding the argument are stripped by `esp_console_split_argv` function.

Examples:

- `abc def 1 20 .3` → `[abc, def, 1, 20, .3]`
- `abc "123 456" def` → `[abc, 123 456, def]`
- ``a\ b\\c\"` → `[a b\c"]`

Argument parsing

For argument parsing, `console` component includes `argtable3` library. Please see [tutorial](#) for an introduction to `argtable3`. Github repository also includes [examples](#).

Command registration and dispatching

`console` component includes utility functions which handle registration of commands, matching commands typed by the user to registered ones, and calling these commands with the arguments given on the command line.

Application first initializes command registration module using a call to `esp_console_init()`, and calls `esp_console_cmd_register()` function to register command handlers.

For each command, application provides the following information (in the form of `esp_console_cmd_t` structure):

- Command name (string without spaces)
- Help text explaining what the command does
- Optional hint text listing the arguments of the command. If application uses `Argtable3` for argument parsing, hint text can be generated automatically by providing a pointer to `argtable` argument definitions structure instead.
- The command handler function.

A few other functions are provided by the command registration module:

`esp_console_run()`

This function takes the command line string, splits it into `argc/argv` argument list using `esp_console_split_argv()`, looks up the command in the list of registered components, and if it is found, executes its handler.

`esp_console_register_help_command()`

Adds `help` command to the list of registered commands. This command prints the list of all the registered commands, along with their arguments and help texts.

`esp_console_get_completion()`

Callback function to be used with `linenoiseSetCompletionCallback()` from `linenoise` library. Provides completions to `linenoise` based on the list of registered commands.

`esp_console_get_hint()`

Callback function to be used with `linenoiseSetHintsCallback()` from `linenoise` library. Provides argument hints for registered commands to `linenoise`.

Initialize console REPL environment

To establish a basic REPL environment, `console` component provides several useful APIs, combining those functions described above.

In a typical application, you only need to call `esp_console_new_repl_uart()` to initialize the REPL environment based on UART device, including driver install, basic console configuration, spawning a thread to do REPL task and register several useful commands (e.g. `help`).

After that, you can register your own commands with `esp_console_cmd_register()`. The REPL environment keeps in init state until you call `esp_console_start_repl()`.

Application Example

Example application illustrating usage of the `console` component is available in `system/console` directory. This example shows how to initialize UART and VFS functions, set up `linenoise` library, read and handle commands from UART, and store command history in Flash. See `README.md` in the example directory for more details.

Besides that, ESP-IDF contains several useful examples which based on `console` component and can be treated as “tools” when developing applications. For example, `peripherals/i2c/i2c_tools`, `wifi/iperf`.

API Reference

Header File

- `console/esp_console.h`

Functions

`esp_err_t esp_console_init(const esp_console_config_t *config)`
initialize console module

Note Call this once before using other console module features

Return

- `ESP_OK` on success
- `ESP_ERR_NO_MEM` if out of memory
- `ESP_ERR_INVALID_STATE` if already initialized
- `ESP_ERR_INVALID_ARG` if the configuration is invalid

Parameters

- `config`: console configuration

`esp_err_t esp_console_deinit(void)`
de-initialize console module

Note Call this once when done using console module functions

Return

- `ESP_OK` on success
- `ESP_ERR_INVALID_STATE` if not initialized yet

`esp_err_t esp_console_cmd_register (const esp_console_cmd_t *cmd)`

Register console command.

Return

- ESP_OK on success
- ESP_ERR_NO_MEM if out of memory
- ESP_ERR_INVALID_ARG if command description includes invalid arguments

Parameters

- cmd: pointer to the command description; can point to a temporary value

`esp_err_t esp_console_run (const char *cmdline, int *cmd_ret)`

Run command line.

Return

- ESP_OK, if command was run
- ESP_ERR_INVALID_ARG, if the command line is empty, or only contained whitespace
- ESP_ERR_NOT_FOUND, if command with given name wasn't registered
- ESP_ERR_INVALID_STATE, if esp_console_init wasn't called

Parameters

- cmdline: command line (command name followed by a number of arguments)
- [out] cmd_ret: return code from the command (set if command was run)

`size_t esp_console_split_argv (char *line, char **argv, size_t argv_size)`

Split command line into arguments in place.

```
* - This function finds whitespace-separated arguments in the given input line.
*
*   'abc def 1 20 .3' -> [ 'abc', 'def', '1', '20', '.3' ]
*
* - Argument which include spaces may be surrounded with quotes. In this case
*   spaces are preserved and quotes are stripped.
*
*   'abc "123 456" def' -> [ 'abc', '123 456', 'def' ]
*
* - Escape sequences may be used to produce backslash, double quote, and space:
*
*   'a\ b\\c\"' -> [ 'a b\c"' ]
*
```

Note Pointers to at most `argv_size - 1` arguments are returned in `argv` array. The pointer after the last one (i.e. `argv[argc]`) is set to NULL.

Return number of arguments found (`argc`)

Parameters

- line: pointer to buffer to parse; it is modified in place
- argv: array where the pointers to arguments are written
- argv_size: number of elements in `argv_array` (max. number of arguments)

`void esp_console_get_completion (const char *buf, linenoiseCompletions *lc)`

Callback which provides command completion for linenoise library.

When using linenoise for line editing, command completion support can be enabled like this:

```
linenoiseSetCompletionCallback(&esp_console_get_completion);
```

Parameters

- buf: the string typed by the user
- lc: linenoiseCompletions to be filled in

`const char *esp_console_get_hint (const char *buf, int *color, int *bold)`

Callback which provides command hints for linenoise library.

When using linenoise for line editing, hints support can be enabled as follows:

```
linenoiseSetHintsCallback((linenoiseHintsCallback*) &esp_console_get_hint);
```

The extra cast is needed because `linenoiseHintsCallback` is defined as returning a `char*` instead of `const char*`.

Return string containing the hint text. This string is persistent and should not be freed (i.e. `linenoiseSetFreeHintsCallback` should not be used).

Parameters

- `buf`: line typed by the user
- [out] `color`: ANSI color code to be used when displaying the hint
- [out] `bold`: set to 1 if hint has to be displayed in bold

esp_err_t `esp_console_register_help_command` (void)

Register a 'help' command.

Default 'help' command prints the list of registered commands along with hints and help strings.

Return

- `ESP_OK` on success
- `ESP_ERR_INVALID_STATE`, if `esp_console_init` wasn't called

esp_err_t `esp_console_new_repl_uart` (const *esp_console_dev_uart_config_t* **dev_config*,
const *esp_console_repl_config_t* **repl_config*,
esp_console_repl_t ***ret_repl*)

Establish a console REPL environment over UART driver.

Note This is a all-in-one function to establish the environment needed for REPL, includes:

- Install the UART driver on the console UART (8n1, 115200, REF_TICK clock source)
- Configures the stdin/stdout to go through the UART driver
- Initializes linenoise
- Spawn new thread to run REPL in the background

Attention This function is meant to be used in the examples to make the code more compact. Applications which use console functionality should be based on the underlying linenoise and `esp_console` functions.

Return

- `ESP_OK` on success
- `ESP_FAIL` Parameter error

Parameters

- [in] `dev_config`: UART device configuration
- [in] `repl_config`: REPL configuration
- [out] `ret_repl`: return REPL handle after initialization succeed, return NULL otherwise

esp_err_t `esp_console_new_repl_usb_cdc` (const *esp_console_dev_usb_cdc_config_t* **dev_config*, const *esp_console_repl_config_t* **repl_config*, *esp_console_repl_t* ***ret_repl*)

Establish a console REPL environment over USB CDC.

Note This is a all-in-one function to establish the environment needed for REPL, includes:

- Initializes linenoise
- Spawn new thread to run REPL in the background

Attention This function is meant to be used in the examples to make the code more compact. Applications which use console functionality should be based on the underlying linenoise and `esp_console` functions.

Return

- `ESP_OK` on success
- `ESP_FAIL` Parameter error

Parameters

- [in] `dev_config`: USB CDC configuration
- [in] `repl_config`: REPL configuration
- [out] `ret_repl`: return REPL handle after initialization succeed, return NULL otherwise

esp_err_t `esp_console_start_repl` (*esp_console_repl_t* **repl*)

Start REPL environment.

Note Once the REPL got started, it won't be stopped until user call `repl->del(repl)` to destroy the REPL environment.

Return

- `ESP_OK` on success

- `ESP_ERR_INVALID_STATE`, if repl has started already

Parameters

- `[in]` `repl`: REPL handle returned from `esp_console_new_repl_xxx`

Structures**struct esp_console_config_t**

Parameters for console initialization.

Public Members`size_t max_cmdline_length`

length of command line buffer, in bytes

`size_t max_cmdline_args`

maximum number of command line arguments to parse

`int hint_color`

ASCII color code of hint text.

`int hint_bold`

Set to 1 to print hint text in bold.

struct esp_console_repl_config_t

Parameters for console REPL (Read Eval Print Loop)

Public Members`uint32_t max_history_len`

maximum length for the history

`const char *history_save_path`

file path used to save history commands, set to NULL won't save to file system

`uint32_t task_stack_size`

repl task stack size

`uint32_t task_priority`

repl task priority

`const char *prompt`

prompt (NULL represents default: "esp> ")

struct esp_console_dev_uart_config_t

Parameters for console device: UART.

Public Members`int channel`

UART channel number (count from zero)

`int baud_rate`

Communication baud rate.

`int tx_gpio_num`

GPIO number for TX path, -1 means using default one.

`int rx_gpio_num`

GPIO number for RX path, -1 means using default one.

struct esp_console_dev_usb_cdc_config_t

Parameters for console device: USB CDC.

Note It's an empty structure for now, reserved for future

struct esp_console_cmd_t
Console command description.

Public Members

const char *command
Command name. Must not be NULL, must not contain spaces. The pointer must be valid until the call to `esp_console_deinit`.

const char *help
Help text for the command, shown by help command. If set, the pointer must be valid until the call to `esp_console_deinit`. If not set, the command will not be listed in ‘help’ output.

const char *hint
Hint text, usually lists possible arguments. If set to NULL, and ‘argtable’ field is non-NULL, hint will be generated automatically

esp_console_cmd_func_t **func**
Pointer to a function which implements the command.

void *argtable
Array or structure of pointers to `arg_xxx` structures, may be NULL. Used to generate hint text if ‘hint’ is set to NULL. Array/structure which this field points to must end with an `arg_end`. Only used for the duration of `esp_console_cmd_register` call.

struct esp_console_repl_s
Console REPL base structure.

Public Members

esp_err_t (***del**) (*esp_console_repl_t* *repl)
Delete console REPL environment.

Return

- ESP_OK on success
- ESP_FAIL on errors

Parameters

- [in] repl: REPL handle returned from `esp_console_new_repl_xxx`

Macros

ESP_CONSOLE_CONFIG_DEFAULT ()
Default console configuration value.

ESP_CONSOLE_REPL_CONFIG_DEFAULT ()
Default console repl configuration value.

ESP_CONSOLE_DEV_UART_CONFIG_DEFAULT ()

ESP_CONSOLE_DEV_CDC_CONFIG_DEFAULT ()

Type Definitions

typedef struct *linenoiseCompletions* linenoiseCompletions
typedef int (*esp_console_cmd_func_t) (int argc, char **argv)
Console command main function.

Return console command return code, 0 indicates “success”

Parameters

- argc: number of arguments
- argv: array with argc entries, each pointing to a zero-terminated string argument

```
typedef struct esp_console_repl_s esp_console_repl_t
```

Type defined for console REPL.

2.7.5 eFuse Manager

Introduction

The eFuse Manager library is designed to structure access to eFuse bits and make using these easy. This library operates eFuse bits by a structure name which is assigned in eFuse table. This sections introduces some concepts used by eFuse Manager.

Hardware description

The ESP32-C3 has a number of eFuses which can store system and user parameters. Each eFuse is a one-bit field which can be programmed to 1 after which it cannot be reverted back to 0. Some of system parameters are using these eFuse bits directly by hardware modules and have special place (for example EFUSE_BLK0).

For more details, see *ESP32-C3 Technical Reference Manual > eFuse Controller (eFuse)* [PDF]. Some eFuse bits are available for user applications.

ESP32-C3 has 11 eFuse blocks each of the size of 256 bits (not all bits are available):

- EFUSE_BLK0 is used entirely for system purposes;
- EFUSE_BLK1 is used entirely for system purposes;
- EFUSE_BLK2 is used entirely for system purposes;
- EFUSE_BLK3 or EFUSE_BLK_USER_DATA can be used for user purposes;
- EFUSE_BLK4 or EFUSE_BLK_KEY0 can be used as key (for secure_boot or flash_encryption) or for user purposes;
- EFUSE_BLK5 or EFUSE_BLK_KEY1 can be used as key (for secure_boot or flash_encryption) or for user purposes;
- EFUSE_BLK6 or EFUSE_BLK_KEY2 can be used as key (for secure_boot or flash_encryption) or for user purposes;
- EFUSE_BLK7 or EFUSE_BLK_KEY3 can be used as key (for secure_boot or flash_encryption) or for user purposes;
- EFUSE_BLK8 or EFUSE_BLK_KEY4 can be used as key (for secure_boot or flash_encryption) or for user purposes;
- EFUSE_BLK9 or EFUSE_BLK_KEY5 can be used as key (for secure_boot or flash_encryption) or for user purposes;
- EFUSE_BLK10 or EFUSE_BLK_SYS_DATA_PART2 is reserved for system purposes.

Each block is divided into 8 32-bits registers.

eFuse Manager component

The component has API functions for reading and writing fields. Access to the fields is carried out through the structures that describe the location of the eFuse bits in the blocks. The component provides the ability to form fields of any length and from any number of individual bits. The description of the fields is made in a CSV file in a table form. To generate from a tabular form (CSV file) in the C-source uses the tool *efuse_table_gen.py*. The tool checks the CSV file for uniqueness of field names and bit intersection, in case of using a *custom* file from the user's project directory, the utility will check with the *common* CSV file.

CSV files:

- *common* (*esp_efuse_table.csv*) - contains eFuse fields which are used inside the IDF. C-source generation should be done manually when changing this file (run command `idf.py efuse_common_table`). Note that changes in this file can lead to incorrect operation.
- *custom* - (optional and can be enabled by `CONFIG_EFUSE_CUSTOM_TABLE`) contains eFuse fields that are used by the user in their application. C-source generation should be done manually when changing this file and running `idf.py efuse_custom_table`.

Description CSV file

The CSV file contains a description of the eFuse fields. In the simple case, one field has one line of description. Table header:

```
# field_name, efuse_block(EFUSE_BLK0..EFUSE_BLK10), bit_start(0..255), bit_
↪count(1..256), comment
```

Individual params in CSV file the following meanings:

field_name Name of field. The prefix *ESP_EFUSE_* will be added to the name, and this field name will be available in the code. This name will be used to access the fields. The name must be unique for all fields. If the line has an empty name, then this line is combined with the previous field. This allows you to set an arbitrary order of bits in the field, and expand the field as well (see *MAC_FACTORY* field in the common table).

efuse_block Block number. It determines where the eFuse bits will be placed for this field. Available *EFUSE_BLK0..EFUSE_BLK10*.

bit_start Start bit number (0..255). The *bit_start* field can be omitted. In this case, it will be set to *bit_start + bit_count* from the previous record, if it has the same *efuse_block*. Otherwise (if *efuse_block* is different, or this is the first entry), an error will be generated.

bit_count The number of bits to use in this field (1..-). This parameter can not be omitted. This field also may be *MAX_BLK_LEN* in this case, the field length will have the maximum block length.

comment This param is using for comment field, it also move to C-header file. The comment field can be omitted.

If a non-sequential bit order is required to describe a field, then the field description in the following lines should be continued without specifying a name, this will indicate that it belongs to one field. For example two fields *MAC_FACTORY* and *MAC_FACTORY_CRC*:

```
# Factory MAC address #
#####
MAC_FACTORY,          EFUSE_BLK0,    72,    8,    Factory MAC addr [0]
,                    EFUSE_BLK0,    64,    8,    Factory MAC addr [1]
,                    EFUSE_BLK0,    56,    8,    Factory MAC addr [2]
,                    EFUSE_BLK0,    48,    8,    Factory MAC addr [3]
,                    EFUSE_BLK0,    40,    8,    Factory MAC addr [4]
,                    EFUSE_BLK0,    32,    8,    Factory MAC addr [5]
MAC_FACTORY_CRC,     EFUSE_BLK0,    80,    8,    CRC8 for factory MAC address
```

This field will available in code as *ESP_EFUSE_MAC_FACTORY* and *ESP_EFUSE_MAC_FACTORY_CRC*.

efuse_table_gen.py tool

The tool is designed to generate C-source files from CSV file and validate fields. First of all, the check is carried out on the uniqueness of the names and overlaps of the field bits. If an additional *custom* file is used, it will be checked with the existing *common* file (*esp_efuse_table.csv*). In case of errors, a message will be displayed and the string that caused the error. C-source files contain structures of type *esp_efuse_desc_t*.

To generate a *common* files, use the following command `idf.py efuse_common_table` or:

```
cd $IDF_PATH/components/efuse/
./efuse_table_gen.py esp32c3/esp_efuse_table.csv
```

After generation in the folder *\$IDF_PATH/components/efuse/esp32c3* create:

- *esp_efuse_table.c* file.
- In *include* folder *esp_efuse_table.c* file.

To generate a *custom* files, use the following command `idf.py efuse_custom_table` or:

```
cd $IDF_PATH/components/efuse/
./efuse_table_gen.py esp32c3/esp_efuse_table.csv PROJECT_PATH/main/esp_efuse_
↪custom_table.csv
```

After generation in the folder PROJECT_PATH/main create:

- `esp_efuse_custom_table.c` file.
- In `include` folder `esp_efuse_custom_table.c` file.

To use the generated fields, you need to include two files:

```
#include "esp_efuse.h"
#include "esp_efuse_table.h" or "esp_efuse_custom_table.h"
```

Supported coding scheme

Coding schemes are used to protect against data corruption. ESP32-C3 supports two coding schemes:

- None. EFUSE_BLK0 is stored with four backups, meaning each bit is stored four times. This backup scheme is automatically applied by the hardware and is not visible to software. EFUSE_BLK0 can be written many times.
- RS. EFUSE_BLK1 - EFUSE_BLK10 use Reed-Solomon coding scheme that supports up to 5 bytes of automatic error correction. Software will encode the 32-byte EFUSE_BLKx using RS (44, 32) to generate a 12-byte check code, and then burn the EFUSE_BLKx and the check code into eFuse at the same time. The eFuse Controller automatically decodes the RS encoding and applies error correction when reading back the eFuse block. Because the RS check codes are generated across the entire 256-bit eFuse block, each block can only be written to one time.

To write some fields into one block, or different blocks in one time, you need to use the `batch writing` mode. Firstly set this mode through `esp_efuse_batch_write_begin()` function then write some fields as usual using the `esp_efuse_write_...` functions. At the end to burn them, call the `esp_efuse_batch_write_commit()` function. It burns prepared data to the eFuse blocks and disables the batch recording mode.

eFuse API

Access to the fields is via a pointer to the description structure. API functions have some basic operation:

- `esp_efuse_read_field_blob()` - returns an array of read eFuse bits.
- `esp_efuse_read_field_cnt()` - returns the number of bits programmed as "1".
- `esp_efuse_write_field_blob()` - writes an array.
- `esp_efuse_write_field_cnt()` - writes a required count of bits as "1".
- `esp_efuse_get_field_size()` - returns the number of bits by the field name.
- `esp_efuse_read_reg()` - returns value of eFuse register.
- `esp_efuse_write_reg()` - writes value to eFuse register.
- `esp_efuse_get_coding_scheme()` - returns eFuse coding scheme for blocks.
- `esp_efuse_read_block()` - reads key to eFuse block starting at the offset and the required size.
- `esp_efuse_write_block()` - writes key to eFuse block starting at the offset and the required size.
- `esp_efuse_batch_write_begin()` - set the batch mode of writing fields.
- `esp_efuse_batch_write_commit()` - writes all prepared data for batch writing mode and reset the batch writing mode.
- `esp_efuse_batch_write_cancel()` - reset the batch writing mode and prepared data.

For frequently used fields, special functions are made, like this `esp_efuse_get_chip_ver()`, `esp_efuse_get_pkg_ver()`.

eFuse API for keys

EFUSE_BLK_KEY0 - EFUSE_BLK_KEY5 are intended to keep up to 6 keys with a length of 256-bits. Each key has an `ESP_EFUSE_KEY_PURPOSE_x` field which defines the purpose of these keys. The purpose field is described in `esp_efuse_purpose_t`.

The purposes like `ESP_EFUSE_KEY_PURPOSE_XTS_AES...` are used for flash encryption.

The purposes like `ESP_EFUSE_KEY_PURPOSE_SECURE_BOOT_DIGEST . . .` are used for secure boot.

There are some eFuse APIs useful to work with states of keys.

- `esp_efuse_get_purpose_field()` - Returns a pointer to a key purpose for an eFuse key block.
- `esp_efuse_get_key()` - Returns a pointer to a key block.
- `esp_efuse_get_key_dis_read()` - Returns a read protection for the key block.
- `esp_efuse_set_key_dis_read()` - Sets a read protection for the key block.
- `esp_efuse_get_key_dis_write()` - Returns a write protection for the key block.
- `esp_efuse_set_key_dis_write()` - Sets a write protection for the key block.
- `esp_efuse_get_key_purpose()` - Returns the current purpose set for an eFuse key block.
- `esp_efuse_set_key_purpose()` - Sets a key purpose for an eFuse key block.
- `esp_efuse_get_keypurpose_dis_write()` - Returns a write protection of the key purpose field for an eFuse key block.
- `esp_efuse_set_keypurpose_dis_write()` - Sets a write protection of the key purpose field for an eFuse key block.
- `esp_efuse_find_purpose()` - Finds a key block with the particular purpose set.
- `esp_efuse_find_unused_key_block()` - Search for an unused key block and return the first one found.
- `esp_efuse_count_unused_key_blocks()` - Returns the number of unused eFuse key blocks in the range `EFUSE_BLK_KEY0..EFUSE_BLK_KEY_MAX`
- `esp_efuse_key_block_unused()` - Returns true if the key block is unused, false otherwise.
- `esp_efuse_get_digest_revoke()` - Returns the status of the Secure Boot public key digest revocation bit.
- `esp_efuse_set_digest_revoke()` - Sets the Secure Boot public key digest revocation bit.
- `esp_efuse_get_write_protect_of_digest_revoke()` - Returns a write protection of the Secure Boot public key digest revocation bit.
- `esp_efuse_set_write_protect_of_digest_revoke()` - Sets a write protection of the Secure Boot public key digest revocation bit.
- `esp_efuse_write_key()` - Programs a block of key data to an eFuse block
- `esp_efuse_write_keys()` - Programs keys to unused eFuse blocks

How to add a new field

1. Find a free bits for field. Show `esp_efuse_table.csv` file or run `idf.py show_efuse_table` or the next command:

```
$ ./efuse_table_gen.py esp32c3/esp_efuse_table.csv --info
eFuse coding scheme: NONE
#      field_name                efuse_block    bit_start      bit_count
1      WR_DIS_FLASH_CRYPT_CNT     EFUSE_BLK0    2               1
2      WR_DIS_BLK1                 EFUSE_BLK0    7               1
3      WR_DIS_BLK2                 EFUSE_BLK0    8               1
4      WR_DIS_BLK3                 EFUSE_BLK0    9               1
5      RD_DIS_BLK1                 EFUSE_BLK0    16              1
6      RD_DIS_BLK2                 EFUSE_BLK0    17              1
7      RD_DIS_BLK3                 EFUSE_BLK0    18              1
8      FLASH_CRYPT_CNT            EFUSE_BLK0    20              7
9      MAC_FACTORY                 EFUSE_BLK0    32              8
10     MAC_FACTORY                 EFUSE_BLK0    40              8
11     MAC_FACTORY                 EFUSE_BLK0    48              8
12     MAC_FACTORY                 EFUSE_BLK0    56              8
13     MAC_FACTORY                 EFUSE_BLK0    64              8
14     MAC_FACTORY                 EFUSE_BLK0    72              8
15     MAC_FACTORY_CRC             EFUSE_BLK0    80              8
16     CHIP_VER_DIS_APP_CPU        EFUSE_BLK0    96              1
17     CHIP_VER_DIS_BT             EFUSE_BLK0    97              1
18     CHIP_VER_PKG                 EFUSE_BLK0    105             3
19     CHIP_CPU_FREQ_LOW           EFUSE_BLK0    108             1
20     CHIP_CPU_FREQ_RATED         EFUSE_BLK0    109             1
```

(continues on next page)

(continued from previous page)

21	CHIP_VER_REV1	EFUSE_BLK0	111	1
22	ADC_VREF_AND_SDIO_DREF	EFUSE_BLK0	136	6
23	XPD_SDIO_REG	EFUSE_BLK0	142	1
24	SDIO_TIEH	EFUSE_BLK0	143	1
25	SDIO_FORCE	EFUSE_BLK0	144	1
26	ENCRYPT_CONFIG	EFUSE_BLK0	188	4
27	CONSOLE_DEBUG_DISABLE	EFUSE_BLK0	194	1
28	ABS_DONE_0	EFUSE_BLK0	196	1
29	DISABLE_JTAG	EFUSE_BLK0	198	1
30	DISABLE_DL_ENCRYPT	EFUSE_BLK0	199	1
31	DISABLE_DL_DECRYPT	EFUSE_BLK0	200	1
32	DISABLE_DL_CACHE	EFUSE_BLK0	201	1
33	ENCRYPT_FLASH_KEY	EFUSE_BLK1	0	256
34	SECURE_BOOT_KEY	EFUSE_BLK2	0	256
35	MAC_CUSTOM_CRC	EFUSE_BLK3	0	8
36	MAC_CUSTOM	EFUSE_BLK3	8	48
37	ADC1_TP_LOW	EFUSE_BLK3	96	7
38	ADC1_TP_HIGH	EFUSE_BLK3	103	9
39	ADC2_TP_LOW	EFUSE_BLK3	112	7
40	ADC2_TP_HIGH	EFUSE_BLK3	119	9
41	SECURE_VERSION	EFUSE_BLK3	128	32
42	MAC_CUSTOM_VER	EFUSE_BLK3	184	8

Used bits in eFuse table:

EFUSE_BLK0

[2 2] [7 9] [16 18] [20 27] [32 87] [96 97] [105 109] [111 111] [136 144] [188-
 ↪191] [194 194] [196 196] [198 201]

EFUSE_BLK1

[0 255]

EFUSE_BLK2

[0 255]

EFUSE_BLK3

[0 55] [96 159] [184 191]

Note: Not printed ranges are free for using. (bits in EFUSE_BLK0 are reserved for
 ↪Espressif)

Parsing eFuse CSV input file \$IDF_PATH/components/efuse/esp32c3/esp_efuse_table.

↪csv ...

Verifying eFuse table...

The number of bits not included in square brackets is free (bits in EFUSE_BLK0 are reserved for Espressif). All fields are checked for overlapping.

2. Fill a line for field: field_name, efuse_block, bit_start, bit_count, comment.
3. Run a show_efuse_table command to check eFuse table. To generate source files run efuse_common_table or efuse_custom_table command.

Debug eFuse & Unit tests

Virtual eFuses The Kconfig option `CONFIG_EFUSE_VIRTUAL` will virtualize eFuse values inside the eFuse Manager, so writes are emulated and no eFuse values are permanently changed. This can be useful for debugging app and unit tests.

espefuse.py esptool includes a useful tool for reading/writing ESP32-C3 eFuse bits - `espefuse.py`.

```

espefuse.py -p PORT summary

    Connecting....
Detecting chip type... ESP32-C3
espefuse.py v3.1-dev
EFUSE_NAME (Block)                Description = [Meaningful_
↳Value] [Readable/Writeable] (Hex Value)
-----
↳-----
Config fuses:
DIS_ICACHE (BLOCK0)                Disables ICache                               ↳
↳                                = False R/W (0b0)
DIS_DOWNLOAD_ICACHE (BLOCK0)       Disables Icache when SoC is in_
↳Download mode                    = False R/W (0b0)
DIS_FORCE_DOWNLOAD (BLOCK0)        Disables forcing chip into_
↳Download mode                    = False R/W (0b0)
DIS_CAN (BLOCK0)                   Disables the TWAI Controller_
↳hardware                         = False R/W (0b0)
VDD_SPI_AS_GPIO (BLOCK0)           Set this bit to vdd spi pin_
↳function as gpio                = False R/W (0b0)
BTLC_GPIO_ENABLE (BLOCK0)          Enable btlc gpio                               ↳
↳                                = 0 R/W (0b00)
POWERGLITCH_EN (BLOCK0)            Set this bit to enable power_
↳glitch function                 = False R/W (0b0)
POWER_GLITCH_DSENSE (BLOCK0)       Sample delay configuration of_
↳power glitch                    = 0 R/W (0b00)
DIS_DIRECT_BOOT (BLOCK0)           Disables direct boot mode                     ↳
↳                                = False R/W (0b0)
DIS_USB_SERIAL_JTAG_ROM_PRINT (BLOCK0) Selects the default UART for_
↳printing boot msg              = UART0 R/W (0b0)
UART_PRINT_CONTROL (BLOCK0)        Sets the default UART boot_
↳message output mode            = Enabled R/W (0b00)
FORCE_SEND_RESUME (BLOCK0)         Force ROM code to send a resume_
↳command during SPI = False R/W (0b0)
                                bootduring SPI boot
BLOCK_USR_DATA (BLOCK3)            User data
= 00 00 00 00 00 00 00 00 00 00 00 00 00 00 00 00 00 00 00 00_
↳00 00 00 00 00 00 00 00 R/W

Efuse fuses:
WR_DIS (BLOCK0)                   Disables programming of_
↳individual eFuses              = 0 R/W (0x00000000)
RD_DIS (BLOCK0)                   Disables software reading from_
↳BLOCK4-10                      = 0 R/W (0b00000000)

Flash Config fuses:
FLASH_TPUW (BLOCK0)               Configures flash startup delay_
↳after SoC power-up, = 0 R/W (0x0)
                                unit is (ms/2). When the value is_
↳15, delay is 7.
                                5 ms
FLASH_ECC_MODE (BLOCK0)           Set this bit to set flsah ecc_
↳mode.
= flash ecc 16to18 byte mode R/W (0b0)
FLASH_TYPE (BLOCK0)               Selects SPI flash type                       ↳
↳                                = 4 data lines R/W (0b0)
FLASH_PAGE_SIZE (BLOCK0)          Flash page size                               ↳
↳                                = 0 R/W (0b00)
FLASH_ECC_EN (BLOCK0)             Enable ECC for flash boot                     ↳
↳                                = False R/W (0b0)

Identity fuses:

```

(continues on next page)

(continued from previous page)

SECURE_VERSION (BLOCK0)	Secure version (used by ESP-IDF)	
↳ anti-rollback feat = 0 R/W (0x0000)		
MAC (BLOCK1)	Factory MAC Address	
= 7c:df:a1:40:40:08: (OK) R/W		
WAFER_VERSION (BLOCK1)	WAFER version	
↳ = (revision 0) R/W (0b000)		
PKG_VERSION (BLOCK1)	Package version	
↳ = ESP32-C3 R/W (0x0)		
BLOCK1_VERSION (BLOCK1)	BLOCK1 efuse version	
↳ = 0 R/W (0b000)		
OPTIONAL_UNIQUE_ID (BLOCK2) (0 errors):	Optional unique 128-bit ID	
= 00 00 00 00 00 00 00 00 00 00 00 00 00 00 00 00 R/W		
BLOCK2_VERSION (BLOCK2)	Version of BLOCK2	
↳ = No calibration R/W (0b000)		
Jtag Config fuses:		
JTAG_SEL_ENABLE (BLOCK0)	Set this bit to enable selection	
↳ between usb_to_jt = False R/W (0b0)		
↳ strapping gpio10 when b	ag and pad_to_jtag through	
↳ pad_jtag are equa	oth reg_dis_usb_jtag and reg_dis_	
	l to 0.	
SOFT_DIS_JTAG (BLOCK0)	Software disables JTAG. When	
↳ software disabled, JT = 0 R/W (0b000)		
↳ by HMAC peripheral	AG can be activated temporarily	
DIS_PAD_JTAG (BLOCK0)	Permanently disable JTAG access	
↳ via pads. USB JTAG = False R/W (0b0)		
	is controlled separately.	
Security fuses:		
DIS_DOWNLOAD_MANUAL_ENCRYPT (BLOCK0)	Disables flash encryption when	
↳ in download boot mo = False R/W (0b0)		
	des	
SPI_BOOT_CRYPT_CNT (BLOCK0)	Enables encryption and	
↳ decryption, when an SPI boo = Disable R/W (0b000)		
↳ 3 bits are set, di	t mode is set. Enabled when 1 or	
	sabled otherwise	
SECURE_BOOT_KEY_REVOKE0 (BLOCK0)	If set, revokes use of secure	
↳ boot key digest 0 = False R/W (0b0)		
SECURE_BOOT_KEY_REVOKE1 (BLOCK0)	If set, revokes use of secure	
↳ boot key digest 1 = False R/W (0b0)		
SECURE_BOOT_KEY_REVOKE2 (BLOCK0)	If set, revokes use of secure	
↳ boot key digest 2 = False R/W (0b0)		
KEY_PURPOSE_0 (BLOCK0)	KEY0 purpose	
↳ = USER R/W (0x0)		
KEY_PURPOSE_1 (BLOCK0)	KEY1 purpose	
↳ = USER R/W (0x0)		
KEY_PURPOSE_2 (BLOCK0)	KEY2 purpose	
↳ = USER R/W (0x0)		
KEY_PURPOSE_3 (BLOCK0)	KEY3 purpose	
↳ = USER R/W (0x0)		
KEY_PURPOSE_4 (BLOCK0)	KEY4 purpose	
↳ = USER R/W (0x0)		
KEY_PURPOSE_5 (BLOCK0)	KEY5 purpose	
↳ = USER R/W (0x0)		
SECURE_BOOT_EN (BLOCK0)	Enables secure boot	
↳ = False R/W (0b0)		

(continues on next page)

(continued from previous page)

```

SECURE_BOOT_AGGRESSIVE_REVOKE (BLOCK0)    Enables aggressive secure boot
↳key revocation mode = False R/W (0b0)
DIS_DOWNLOAD_MODE (BLOCK0)                Disables all Download boot modes
↳                                = False R/W (0b0)
ENABLE_SECURITY_DOWNLOAD (BLOCK0)        Enables secure UART download
↳mode (read/write flas = False R/W (0b0)
                                         h only)

BLOCK_KEY0 (BLOCK4) (0 errors):
Purpose: USER
Encryption key0 or user data
= 00 00 00 00 00 00 00 00 00 00 00 00 00 00 00 00 00 00 00 00 00 00 00 00 00 00
↳00 00 00 00 00 00 00 00 R/W
BLOCK_KEY1 (BLOCK5) (0 errors):
Purpose: USER
Encryption key1 or user data
= 00 00 00 00 00 00 00 00 00 00 00 00 00 00 00 00 00 00 00 00 00 00 00 00 00 00
↳00 00 00 00 00 00 00 00 R/W
BLOCK_KEY2 (BLOCK6) (0 errors):
Purpose: USER
Encryption key2 or user data
= 00 00 00 00 00 00 00 00 00 00 00 00 00 00 00 00 00 00 00 00 00 00 00 00 00 00
↳00 00 00 00 00 00 00 00 R/W
BLOCK_KEY3 (BLOCK7) (0 errors):
Purpose: USER
Encryption key3 or user data
= 00 00 00 00 00 00 00 00 00 00 00 00 00 00 00 00 00 00 00 00 00 00 00 00 00 00
↳00 00 00 00 00 00 00 00 R/W
BLOCK_KEY4 (BLOCK8) (0 errors):
Purpose: USER
Encryption key4 or user data
= 00 00 00 00 00 00 00 00 00 00 00 00 00 00 00 00 00 00 00 00 00 00 00 00 00 00
↳00 00 00 00 00 00 00 00 R/W
BLOCK_KEY5 (BLOCK9) (0 errors):
Purpose: USER
Encryption key5 or user data
= 00 00 00 00 00 00 00 00 00 00 00 00 00 00 00 00 00 00 00 00 00 00 00 00 00 00
↳00 00 00 00 00 00 00 00 R/W
BLOCK_SYS_DATA2 (BLOCK10) (0 errors):      System data (part 2)
= 00 00 00 00 00 00 00 00 00 00 00 00 00 00 00 00 00 00 00 00 00 00 00 00 00 00
↳00 00 00 00 00 00 00 00 R/W

Spi_Pad_Config fuses:
SPI_PAD_CONFIG_CLK (BLOCK1)              SPI CLK pad
↳                                = 0 R/W (0b000000)
SPI_PAD_CONFIG_Q (BLOCK1)               SPI Q (D1) pad
↳                                = 0 R/W (0b000000)
SPI_PAD_CONFIG_D (BLOCK1)               SPI D (D0) pad
↳                                = 0 R/W (0b000000)
SPI_PAD_CONFIG_CS (BLOCK1)              SPI CS pad
↳                                = 0 R/W (0b000000)
SPI_PAD_CONFIG_HD (BLOCK1)              SPI HD (D3) pad
↳                                = 0 R/W (0b000000)
SPI_PAD_CONFIG_WP (BLOCK1)              SPI WP (D2) pad
↳                                = 0 R/W (0b000000)
SPI_PAD_CONFIG_DQS (BLOCK1)             SPI DQS pad
↳                                = 0 R/W (0b000000)
SPI_PAD_CONFIG_D4 (BLOCK1)              SPI D4 pad
↳                                = 0 R/W (0b000000)
SPI_PAD_CONFIG_D5 (BLOCK1)              SPI D5 pad
↳                                = 0 R/W (0b000000)
SPI_PAD_CONFIG_D6 (BLOCK1)              SPI D6 pad
↳                                = 0 R/W (0b000000)

```

(continues on next page)

(continued from previous page)

SPI_PAD_CONFIG_D7 (BLOCK1)	SPI D7 pad	↵
↵	= 0 R/W (0b000000)	
Usb Config fuses:		
DIS_USB_JTAG (BLOCK0)	Disables USB JTAG. JTAG access	↵
↵	via pads is control = False R/W (0b0)	
	led separately	
DIS_USB_DEVICE (BLOCK0)	Disables USB DEVICE	↵
↵	= False R/W (0b0)	
DIS_USB (BLOCK0)	Disables the USB OTG hardware	↵
↵	= False R/W (0b0)	
USB_EXCHG_PINS (BLOCK0)	Exchanges USB D+ and D- pins	↵
↵	= False R/W (0b0)	
DIS_USB_SERIAL_JTAG_DOWNLOAD_MODE (BLOCK0)	Disables download through USB-	
↵Serial-JTAG	= False R/W (0b0)	
Vdd_Spi Config fuses:		
PIN_POWER_SELECTION (BLOCK0)	GPIO33-GPIO37 power supply	↵
↵selection in ROM code	= VDD3P3_CPU R/W (0b0)	
Wdt Config fuses:		
WDT_DELAY_SEL (BLOCK0)	Selects RTC WDT timeout	↵
↵threshold at startup	= False R/W (0b0)	

To get a dump for all eFuse registers.

```

espefuse.py -p PORT dump

Connecting....
Detecting chip type... ESP32-C3
BLOCK0 ( ) [0 ] read_regs: 00000000 00000000↵
↵00000000 00000000 00000000 00000000
MAC_SPI_8M_0 (BLOCK1 ) [1 ] read_regs: a1404008 00007cdf↵
↵00000000 00000000 00000000 00000000
BLOCK_SYS_DATA (BLOCK2 ) [2 ] read_regs: 00000000 00000000↵
↵00000000 00000000 00000000 00000000 00000000 00000000
BLOCK_USR_DATA (BLOCK3 ) [3 ] read_regs: 00000000 00000000↵
↵00000000 00000000 00000000 00000000 00000000 00000000
BLOCK_KEY0 (BLOCK4 ) [4 ] read_regs: 00000000 00000000↵
↵00000000 00000000 00000000 00000000 00000000 00000000
BLOCK_KEY1 (BLOCK5 ) [5 ] read_regs: 00000000 00000000↵
↵00000000 00000000 00000000 00000000 00000000 00000000
BLOCK_KEY2 (BLOCK6 ) [6 ] read_regs: 00000000 00000000↵
↵00000000 00000000 00000000 00000000 00000000 00000000
BLOCK_KEY3 (BLOCK7 ) [7 ] read_regs: 00000000 00000000↵
↵00000000 00000000 00000000 00000000 00000000 00000000
BLOCK_KEY4 (BLOCK8 ) [8 ] read_regs: 00000000 00000000↵
↵00000000 00000000 00000000 00000000 00000000 00000000
BLOCK_KEY5 (BLOCK9 ) [9 ] read_regs: 00000000 00000000↵
↵00000000 00000000 00000000 00000000 00000000 00000000
BLOCK_SYS_DATA2 (BLOCK10 ) [10] read_regs: 00000000 00000000↵
↵00000000 00000000 00000000 00000000 00000000 00000000
espefuse.py v3.1-dev

```

Header File

- [efuse/include/esp_efuse.h](#)

Functions

esp_err_t **esp_efuse_read_field_blob**(const *esp_efuse_desc_t* *field[], void *dst, size_t dst_size_bits)

Reads bits from EFUSE field and writes it into an array.

The number of read bits will be limited to the minimum value from the description of the bits in “field” structure or “dst_size_bits” required size. Use “esp_efuse_get_field_size()” function to determine the length of the field.

Note Please note that reading in the batch mode does not show uncommitted changes.

Return

- ESP_OK: The operation was successfully completed.
- ESP_ERR_INVALID_ARG: Error in the passed arguments.

Parameters

- [in] field: A pointer to the structure describing the fields of efuse.
- [out] dst: A pointer to array that will contain the result of reading.
- [in] dst_size_bits: The number of bits required to read. If the requested number of bits is greater than the field, the number will be limited to the field size.

bool **esp_efuse_read_field_bit**(const *esp_efuse_desc_t* *field[])

Read a single bit eFuse field as a boolean value.

Note The value must exist and must be a single bit wide. If there is any possibility of an error in the provided arguments, call esp_efuse_read_field_blob() and check the returned value instead.

Note If assertions are enabled and the parameter is invalid, execution will abort

Note Please note that reading in the batch mode does not show uncommitted changes.

Return

- true: The field parameter is valid and the bit is set.
- false: The bit is not set, or the parameter is invalid and assertions are disabled.

Parameters

- [in] field: A pointer to the structure describing the fields of efuse.

esp_err_t **esp_efuse_read_field_cnt**(const *esp_efuse_desc_t* *field[], size_t *out_cnt)

Reads bits from EFUSE field and returns number of bits programmed as “1” .

If the bits are set not sequentially, they will still be counted.

Note Please note that reading in the batch mode does not show uncommitted changes.

Return

- ESP_OK: The operation was successfully completed.
- ESP_ERR_INVALID_ARG: Error in the passed arguments.

Parameters

- [in] field: A pointer to the structure describing the fields of efuse.
- [out] out_cnt: A pointer that will contain the number of programmed as “1” bits.

esp_err_t **esp_efuse_write_field_blob**(const *esp_efuse_desc_t* *field[], const void *src, size_t src_size_bits)

Writes array to EFUSE field.

The number of write bits will be limited to the minimum value from the description of the bits in “field” structure or “src_size_bits” required size. Use “esp_efuse_get_field_size()” function to determine the length of the field. After the function is completed, the writing registers are cleared.

Return

- ESP_OK: The operation was successfully completed.
- ESP_ERR_INVALID_ARG: Error in the passed arguments.
- ESP_ERR_EFUSE_REPEATED_PROG: Error repeated programming of programmed bits is strictly forbidden.
- ESP_ERR_CODING: Error range of data does not match the coding scheme.

Parameters

- [in] field: A pointer to the structure describing the fields of efuse.
- [in] src: A pointer to array that contains the data for writing.
- [in] src_size_bits: The number of bits required to write.

esp_err_t **esp_efuse_write_field_cnt**(const *esp_efuse_desc_t* *field[], size_t cnt)

Writes a required count of bits as “1” to EFUSE field.

If there are no free bits in the field to set the required number of bits to “1”, ESP_ERR_EFUSE_CNT_IS_FULL error is returned, the field will not be partially recorded. After the function is completed, the writing registers are cleared.

Return

- ESP_OK: The operation was successfully completed.
- ESP_ERR_INVALID_ARG: Error in the passed arguments.
- ESP_ERR_EFUSE_CNT_IS_FULL: Not all requested cnt bits is set.

Parameters

- [in] *field*: A pointer to the structure describing the fields of efuse.
- [in] *cnt*: Required number of programmed as “1” bits.

esp_err_t **esp_efuse_write_field_bit** (const *esp_efuse_desc_t* **field*[])

Write a single bit eFuse field to 1.

For use with eFuse fields that are a single bit. This function will write the bit to value 1 if it is not already set, or does nothing if the bit is already set.

This is equivalent to calling `esp_efuse_write_field_cnt()` with the `cnt` parameter equal to 1, except that it will return ESP_OK if the field is already set to 1.

Return

- ESP_OK: The operation was successfully completed, or the bit was already set to value 1.
- ESP_ERR_INVALID_ARG: Error in the passed arguments, including if the efuse field is not 1 bit wide.

Parameters

- [in] *field*: Pointer to the structure describing the efuse field.

esp_err_t **esp_efuse_set_write_protect** (*esp_efuse_block_t* *blk*)

Sets a write protection for the whole block.

After that, it is impossible to write to this block. The write protection does not apply to block 0.

Return

- ESP_OK: The operation was successfully completed.
- ESP_ERR_INVALID_ARG: Error in the passed arguments.
- ESP_ERR_EFUSE_CNT_IS_FULL: Not all requested cnt bits is set.
- ESP_ERR_NOT_SUPPORTED: The block does not support this command.

Parameters

- [in] *blk*: Block number of eFuse. (EFUSE_BLK1, EFUSE_BLK2 and EFUSE_BLK3)

esp_err_t **esp_efuse_set_read_protect** (*esp_efuse_block_t* *blk*)

Sets a read protection for the whole block.

After that, it is impossible to read from this block. The read protection does not apply to block 0.

Return

- ESP_OK: The operation was successfully completed.
- ESP_ERR_INVALID_ARG: Error in the passed arguments.
- ESP_ERR_EFUSE_CNT_IS_FULL: Not all requested cnt bits is set.
- ESP_ERR_NOT_SUPPORTED: The block does not support this command.

Parameters

- [in] *blk*: Block number of eFuse. (EFUSE_BLK1, EFUSE_BLK2 and EFUSE_BLK3)

int **esp_efuse_get_field_size** (const *esp_efuse_desc_t* **field*[])

Returns the number of bits used by field.

Return Returns the number of bits used by field.

Parameters

- [in] *field*: A pointer to the structure describing the fields of efuse.

uint32_t **esp_efuse_read_reg** (*esp_efuse_block_t* *blk*, unsigned int *num_reg*)

Returns value of efuse register.

This is a thread-safe implementation. Example: EFUSE_BLK2_RDATA3_REG where (blk=2, num_reg=3)

Note Please note that reading in the batch mode does not show uncommitted changes.

Return Value of register

Parameters

- [in] blk: Block number of eFuse.
- [in] num_reg: The register number in the block.

esp_err_t **esp_efuse_write_reg** (esp_efuse_block_t blk, unsigned int num_reg, uint32_t val)

Write value to efuse register.

Apply a coding scheme if necessary. This is a thread-safe implementation. Example: EFUSE_BLK3_WDATA0_REG where (blk=3, num_reg=0)

Return

- ESP_OK: The operation was successfully completed.
- ESP_ERR_EFUSE_REPEATED_PROG: Error repeated programming of programmed bits is strictly forbidden.

Parameters

- [in] blk: Block number of eFuse.
- [in] num_reg: The register number in the block.
- [in] val: Value to write.

esp_efuse_coding_scheme_t **esp_efuse_get_coding_scheme** (esp_efuse_block_t blk)

Return efuse coding scheme for blocks.

Note: The coding scheme is applicable only to 1, 2 and 3 blocks. For 0 block, the coding scheme is always NONE.

Return Return efuse coding scheme for blocks

Parameters

- [in] blk: Block number of eFuse.

esp_err_t **esp_efuse_read_block** (esp_efuse_block_t blk, void *dst_key, size_t offset_in_bits, size_t size_bits)

Read key to efuse block starting at the offset and the required size.

Note Please note that reading in the batch mode does not show uncommitted changes.

Return

- ESP_OK: The operation was successfully completed.
- ESP_ERR_INVALID_ARG: Error in the passed arguments.
- ESP_ERR_CODING: Error range of data does not match the coding scheme.

Parameters

- [in] blk: Block number of eFuse.
- [in] dst_key: A pointer to array that will contain the result of reading.
- [in] offset_in_bits: Start bit in block.
- [in] size_bits: The number of bits required to read.

esp_err_t **esp_efuse_write_block** (esp_efuse_block_t blk, const void *src_key, size_t offset_in_bits, size_t size_bits)

Write key to efuse block starting at the offset and the required size.

Return

- ESP_OK: The operation was successfully completed.
- ESP_ERR_INVALID_ARG: Error in the passed arguments.
- ESP_ERR_CODING: Error range of data does not match the coding scheme.
- ESP_ERR_EFUSE_REPEATED_PROG: Error repeated programming of programmed bits

Parameters

- [in] blk: Block number of eFuse.
- [in] src_key: A pointer to array that contains the key for writing.
- [in] offset_in_bits: Start bit in block.
- [in] size_bits: The number of bits required to write.

uint8_t **esp_efuse_get_chip_ver** (void)

Returns chip version from efuse.

Return chip version

uint32_t **esp_efuse_get_pkg_ver** (void)

Returns chip package from efuse.

Return chip package

void **esp_efuse_burn_new_values** (void)

Permanently update values written to the efuse write registers.

After updating EFUSE_BLKx_WDATAx_REG registers with new values to write, call this function to permanently write them to efuse.

After burning new efuses, the read registers are updated to match the new efuse values.

Note Setting bits in efuse is permanent, they cannot be unset.

Note Due to this restriction you don't need to copy values to Efuse write registers from the matching read registers, bits which are set in the read register but unset in the matching write register will be unchanged when new values are burned.

Note This function is not threadsafe, if calling code updates efuse values from multiple tasks then this is caller's responsibility to serialise.

void **esp_efuse_reset** (void)

Reset efuse write registers.

Efuse write registers are written to zero, to negate any changes that have been staged here.

Note This function is not threadsafe, if calling code updates efuse values from multiple tasks then this is caller's responsibility to serialise.

esp_err_t **esp_efuse_disable_rom_download_mode** (void)

Disable ROM Download Mode via eFuse.

Permanently disables the ROM Download Mode feature. Once disabled, if the SoC is booted with strapping pins set for ROM Download Mode then an error is printed instead.

Note Not all SoCs support this option. An error will be returned if called on an ESP32 with a silicon revision lower than 3, as these revisions do not support this option.

Note If ROM Download Mode is already disabled, this function does nothing and returns success.

Return

- ESP_OK If the eFuse was successfully burned, or had already been burned.
- ESP_ERR_NOT_SUPPORTED (ESP32 only) This SoC is not capable of disabling UART download mode
- ESP_ERR_INVALID_STATE (ESP32 only) This eFuse is write protected and cannot be written

esp_err_t **esp_efuse_enable_rom_secure_download_mode** (void)

Switch ROM Download Mode to Secure Download mode via eFuse.

Permanently enables Secure Download mode. This mode limits the use of ROM Download Mode functions to simple flash read, write and erase operations, plus a command to return a summary of currently enabled security features.

Note If Secure Download mode is already enabled, this function does nothing and returns success.

Note Disabling the ROM Download Mode also disables Secure Download Mode.

Return

- ESP_OK If the eFuse was successfully burned, or had already been burned.
- ESP_ERR_INVALID_STATE ROM Download Mode has been disabled via eFuse, so Secure Download mode is unavailable.

void **esp_efuse_write_random_key** (uint32_t *blk_wdata0_reg*)

Write random data to efuse key block write registers.

Note Caller is responsible for ensuring efuse block is empty and not write protected, before calling.

Note Behaviour depends on coding scheme: a 256-bit key is generated and written for Coding Scheme "None", a 192-bit key is generated, extended to 256-bits by the Coding Scheme, and then written for 3/4 Coding Scheme.

Note This function does not burn the new values, caller should call `esp_efuse_burn_new_values()` when ready to do this.

Parameters

- `blk_wdata0_reg`: Address of the first data write register in the block

`uint32_t esp_efuse_read_secure_version` (void)

Return `secure_version` from efuse field.

Return Secure version from efuse field

bool `esp_efuse_check_secure_version` (`uint32_t secure_version`)

Check `secure_version` from app and `secure_version` and from efuse field.

Return

- True: If version of app is equal or more then `secure_version` from efuse.

Parameters

- `secure_version`: Secure version from app.

esp_err_t `esp_efuse_update_secure_version` (`uint32_t secure_version`)

Write efuse field by `secure_version` value.

Update the `secure_version` value is available if the coding scheme is None. Note: Do not use this function in your applications. This function is called as part of the other API.

Return

- ESP_OK: Successful.
- ESP_FAIL: secure version of app cannot be set to efuse field.
- ESP_ERR_NOT_SUPPORTED: Anti rollback is not supported with the 3/4 and Repeat coding scheme.

Parameters

- [in] `secure_version`: Secure version from app.

void `esp_efuse_init` (`uint32_t offset`, `uint32_t size`)

Initializes variables: `offset` and `size` to simulate the work of an eFuse.

Note: To simulate the work of an eFuse need to set `CONFIG_BOOTLOADER_EFUSE_SECURE_VERSION_EMULATE` option and to add in the `partition.csv` file a line `efuse_em, data, efuse, , 0x2000,.`

Parameters

- [in] `offset`: The starting address of the partition where the eFuse data will be located.
- [in] `size`: The size of the partition.

esp_err_t `esp_efuse_batch_write_begin` (void)

Set the batch mode of writing fields.

This mode allows you to write the fields in the batch mode when need to burn several efuses at one time. To enable batch mode call `begin()` then perform as usually the necessary operations read and write and at the end call `commit()` to actually burn all written efuses. The batch mode can be used nested. The commit will be done by the last `commit()` function. The number of `begin()` functions should be equal to the number of `commit()` functions.

Note: If batch mode is enabled by the first task, at this time the second task cannot write/read efuses. The second task will wait for the first task to complete the batch operation.

Note Please note that reading in the batch mode does not show uncommitted changes.

```
// Example of using the batch writing mode.

// set the batch writing mode
esp_efuse_batch_write_begin();

// use any writing functions as usual
esp_efuse_write_field_blob(ESP_EFUSE...);
esp_efuse_write_field_cnt(ESP_EFUSE...);
esp_efuse_set_write_protect(EFUSE_BLKx);
esp_efuse_write_reg(EFUSE_BLKx, ...);
esp_efuse_write_block(EFUSE_BLKx, ...);
```

(continues on next page)

(continued from previous page)

```

esp_efuse_write(ESP_EFUSE_1, 3); // ESP_EFUSE_1 == 1, here we write a new
↳value = 3. The changes will be burn by the commit() function.
esp_efuse_read...(ESP_EFUSE_1); // this function returns ESP_EFUSE_1 == 1
↳because uncommitted changes are not readable, it will be available only
↳after commit.
...

// esp_efuse_batch_write APIs can be called recursively.
esp_efuse_batch_write_begin();
esp_efuse_set_write_protect(EFUSE_BLKx);
esp_efuse_batch_write_commit(); // the burn will be skipped here, it will be
↳done in the last commit().

...

// Write all of these fields to the efuse registers
esp_efuse_batch_write_commit();
esp_efuse_read...(ESP_EFUSE_1); // this function returns ESP_EFUSE_1 == 3.

```

Return

- ESP_OK: Successful.

esp_err_t **esp_efuse_batch_write_cancel**(void)

Reset the batch mode of writing fields.

It will reset the batch writing mode and any written changes.

Return

- ESP_OK: Successful.
- ESP_ERR_INVALID_STATE: The batch mode was not set.

esp_err_t **esp_efuse_batch_write_commit**(void)

Writes all prepared data for the batch mode.

Must be called to ensure changes are written to the efuse registers. After this the batch writing mode will be reset.

Return

- ESP_OK: Successful.
- ESP_ERR_INVALID_STATE: The deferred writing mode was not set.

const *esp_efuse_desc_t* ****esp_efuse_get_purpose_field**(*esp_efuse_block_t* block)

Returns a pointer to a key purpose for an efuse key block.

To get the value of this field use `esp_efuse_read_field_blob()` or `esp_efuse_get_key_purpose()`.

Parameters

- [in] block: A key block in the range EFUSE_BLK_KEY0..EFUSE_BLK_KEY_MAX

Return Pointer: If Successful returns a pointer to the corresponding efuse field otherwise NULL.

const *esp_efuse_desc_t* ****esp_efuse_get_key**(*esp_efuse_block_t* block)

Returns a pointer to a key block.

Return Pointer: If Successful returns a pointer to the corresponding efuse field otherwise NULL.

Parameters

- [in] block: A key block in the range EFUSE_BLK_KEY0..EFUSE_BLK_KEY_MAX

bool **esp_efuse_get_key_dis_read**(*esp_efuse_block_t* block)

Returns a read protection for the key block.

Return True: The key block is read protected False: The key block is readable.

Parameters

- [in] block: A key block in the range EFUSE_BLK_KEY0..EFUSE_BLK_KEY_MAX

esp_err_t **esp_efuse_set_key_dis_read** (*esp_efuse_block_t block*)

Sets a read protection for the key block.

Return

- ESP_OK: Successful.
- ESP_ERR_INVALID_ARG: Error in the passed arguments.
- ESP_ERR_EFUSE_REPEATED_PROG: Error repeated programming of programmed bits is strictly forbidden.
- ESP_ERR_CODING: Error range of data does not match the coding scheme.

Parameters

- [in] *block*: A key block in the range EFUSE_BLK_KEY0..EFUSE_BLK_KEY_MAX

bool **esp_efuse_get_key_dis_write** (*esp_efuse_block_t block*)

Returns a write protection for the key block.

Return True: The key block is write protected False: The key block is writeable.

Parameters

- [in] *block*: A key block in the range EFUSE_BLK_KEY0..EFUSE_BLK_KEY_MAX

esp_err_t **esp_efuse_set_key_dis_write** (*esp_efuse_block_t block*)

Sets a write protection for the key block.

Return

- ESP_OK: Successful.
- ESP_ERR_INVALID_ARG: Error in the passed arguments.
- ESP_ERR_EFUSE_REPEATED_PROG: Error repeated programming of programmed bits is strictly forbidden.
- ESP_ERR_CODING: Error range of data does not match the coding scheme.

Parameters

- [in] *block*: A key block in the range EFUSE_BLK_KEY0..EFUSE_BLK_KEY_MAX

esp_efuse_purpose_t **esp_efuse_get_key_purpose** (*esp_efuse_block_t block*)

Returns the current purpose set for an efuse key block.

Return

- Value: If Successful, it returns the value of the purpose related to the given key block.
- ESP_EFUSE_KEY_PURPOSE_MAX: Otherwise.

Parameters

- [in] *block*: A key block in the range EFUSE_BLK_KEY0..EFUSE_BLK_KEY_MAX

esp_err_t **esp_efuse_set_key_purpose** (*esp_efuse_block_t block*, *esp_efuse_purpose_t purpose*)

Sets a key purpose for an efuse key block.

Return

- ESP_OK: Successful.
- ESP_ERR_INVALID_ARG: Error in the passed arguments.
- ESP_ERR_EFUSE_REPEATED_PROG: Error repeated programming of programmed bits is strictly forbidden.
- ESP_ERR_CODING: Error range of data does not match the coding scheme.

Parameters

- [in] *block*: A key block in the range EFUSE_BLK_KEY0..EFUSE_BLK_KEY_MAX
- [in] *purpose*: Key purpose.

bool **esp_efuse_get_keypurpose_dis_write** (*esp_efuse_block_t block*)

Returns a write protection of the key purpose field for an efuse key block.

Return True: The key purpose is write protected. False: The key purpose is writeable.

Parameters

- [in] *block*: A key block in the range EFUSE_BLK_KEY0..EFUSE_BLK_KEY_MAX

esp_err_t **esp_efuse_set_keypurpose_dis_write** (*esp_efuse_block_t block*)

Sets a write protection of the key purpose field for an efuse key block.

Return

- ESP_OK: Successful.

- `ESP_ERR_INVALID_ARG`: Error in the passed arguments.
- `ESP_ERR_EFUSE_REPEATED_PROG`: Error repeated programming of programmed bits is strictly forbidden.
- `ESP_ERR_CODING`: Error range of data does not match the coding scheme.

Parameters

- `[in] block`: A key block in the range `EFUSE_BLK_KEY0..EFUSE_BLK_KEY_MAX`

bool **esp_efuse_find_purpose** (*esp_efuse_purpose_t purpose*, *esp_efuse_block_t *block*)

Find a key block with the particular purpose set.

Return

- True: If found,
- False: If not found (value at block pointer is unchanged).

Parameters

- `[in] purpose`: Purpose to search for.
- `[out] block`: Pointer in the range `EFUSE_BLK_KEY0..EFUSE_BLK_KEY_MAX` which will be set to the key block if found. Can be NULL, if only need to test the key block exists.

esp_efuse_block_t **esp_efuse_find_unused_key_block** (void)

Search for an unused key block and return the first one found.

See `esp_efuse_key_block_unused` for a description of an unused key block.

Return First unused key block, or `EFUSE_BLK_KEY_MAX` if no unused key block is found.

unsigned **esp_efuse_count_unused_key_blocks** (void)

Return the number of unused efuse key blocks in the range `EFUSE_BLK_KEY0..EFUSE_BLK_KEY_MAX`.

bool **esp_efuse_key_block_unused** (*esp_efuse_block_t block*)

Returns true if the key block is unused, false otherwise.

An unused key block is all zero content, not read or write protected, and has purpose 0 (`ESP_EFUSE_KEY_PURPOSE_USER`)

Return

- True if key block is unused,
- False if key block is used or the specified block index is not a key block.

Parameters

- `block`: key block to check.

bool **esp_efuse_get_digest_revoke** (unsigned *num_digest*)

Returns the status of the Secure Boot public key digest revocation bit.

Return

- True: If key digest is revoked,
- False: If key digest is not revoked.

Parameters

- `[in] num_digest`: The number of digest in range 0..2

esp_err_t **esp_efuse_set_digest_revoke** (unsigned *num_digest*)

Sets the Secure Boot public key digest revocation bit.

Return

- `ESP_OK`: Successful.
- `ESP_ERR_INVALID_ARG`: Error in the passed arguments.
- `ESP_ERR_EFUSE_REPEATED_PROG`: Error repeated programming of programmed bits is strictly forbidden.
- `ESP_ERR_CODING`: Error range of data does not match the coding scheme.

Parameters

- `[in] num_digest`: The number of digest in range 0..2

bool **esp_efuse_get_write_protect_of_digest_revoke** (unsigned *num_digest*)

Returns a write protection of the Secure Boot public key digest revocation bit.

Return True: The revocation bit is write protected. False: The revocation bit is writeable.

Parameters

- [in] num_digest: The number of digest in range 0..2

esp_err_t **esp_efuse_set_write_protect_of_digest_revoke** (unsigned num_digest)

Sets a write protection of the Secure Boot public key digest revocation bit.

Return

- ESP_OK: Successful.
- ESP_ERR_INVALID_ARG: Error in the passed arguments.
- ESP_ERR_EFUSE_REPEATED_PROG: Error repeated programming of programmed bits is strictly forbidden.
- ESP_ERR_CODING: Error range of data does not match the coding scheme.

Parameters

- [in] num_digest: The number of digest in range 0..2

esp_err_t **esp_efuse_write_key** (esp_efuse_block_t block, esp_efuse_purpose_t purpose, const void *key, size_t key_size_bytes)

Program a block of key data to an efuse block.

The burn of a key, protection bits, and a purpose happens in batch mode.

Return

- ESP_OK: Successful.
- ESP_ERR_INVALID_ARG: Error in the passed arguments.
- ESP_ERR_INVALID_STATE: Error in efuses state, unused block not found.
- ESP_ERR_EFUSE_REPEATED_PROG: Error repeated programming of programmed bits is strictly forbidden.
- ESP_ERR_CODING: Error range of data does not match the coding scheme.

Parameters

- [in] block: Block to read purpose for. Must be in range EFUSE_BLK_KEY0 to EFUSE_BLK_KEY_MAX. Key block must be unused (esp_efuse_key_block_unused).
- [in] purpose: Purpose to set for this key. Purpose must be already unset.
- [in] key: Pointer to data to write.
- [in] key_size_bytes: Bytes length of data to write.

esp_err_t **esp_efuse_write_keys** (esp_efuse_purpose_t purposes[], uint8_t keys[][32], unsigned number_of_keys)

Program keys to unused efuse blocks.

The burn of keys, protection bits, and purposes happens in batch mode.

Return

- ESP_OK: Successful.
- ESP_ERR_INVALID_ARG: Error in the passed arguments.
- ESP_ERR_INVALID_STATE: Error in efuses state, unused block not found.
- ESP_ERR_NOT_ENOUGH_UNUSED_KEY_BLOCKS: Error not enough unused key blocks available
- ESP_ERR_EFUSE_REPEATED_PROG: Error repeated programming of programmed bits is strictly forbidden.
- ESP_ERR_CODING: Error range of data does not match the coding scheme.

Parameters

- [in] purposes: Array of purposes (purpose[number_of_keys]).
- [in] keys: Array of keys (uint8_t keys[number_of_keys][32]). Each key is 32 bytes long.
- [in] number_of_keys: The number of keys to write (up to 6 keys).

esp_err_t **esp_efuse_check_errors** (void)

Checks eFuse errors in BLOCK0.

It does a BLOCK0 check if eFuse EFUSE_ERR_RST_ENABLE is set. If BLOCK0 has an error, it prints the error and returns ESP_FAIL, which should be treated as esp_restart.

Note Refers to ESP32-C3 only.

Return

- ESP_OK: No errors in BLOCK0.

- `ESP_FAIL`: Error in BLOCK0 requiring reboot.

Structures

struct esp_efuse_desc_t
Type definition for an eFuse field.

Public Members

`esp_efuse_block_t efuse_block` : 8
Block of eFuse

`uint8_t bit_start`
Start bit [0..255]

`uint16_t bit_count`
Length of bit field [1..-]

Macros

ESP_ERR_EFUSE
Base error code for efuse api.

ESP_OK_EFUSE_CNT
OK the required number of bits is set.

ESP_ERR_EFUSE_CNT_IS_FULL
Error field is full.

ESP_ERR_EFUSE_REPEATED_PROG
Error repeated programming of programmed bits is strictly forbidden.

ESP_ERR_CODING
Error while a encoding operation.

ESP_ERR_NOT_ENOUGH_UNUSED_KEY_BLOCKS
Error not enough unused key blocks available

Enumerations

enum esp_efuse_purpose_t
Type of key purpose.

Values:

`ESP_EFUSE_KEY_PURPOSE_USER` = 0

`ESP_EFUSE_KEY_PURPOSE_RESERVED` = 1

`ESP_EFUSE_KEY_PURPOSE_XTS_AES_256_KEY_1` = 2

`ESP_EFUSE_KEY_PURPOSE_XTS_AES_256_KEY_2` = 3

`ESP_EFUSE_KEY_PURPOSE_XTS_AES_128_KEY` = 4

`ESP_EFUSE_KEY_PURPOSE_HMAC_DOWN_ALL` = 5

`ESP_EFUSE_KEY_PURPOSE_HMAC_DOWN_JTAG` = 6

`ESP_EFUSE_KEY_PURPOSE_HMAC_DOWN_DIGITAL_SIGNATURE` = 7

`ESP_EFUSE_KEY_PURPOSE_HMAC_UP` = 8

`ESP_EFUSE_KEY_PURPOSE_SECURE_BOOT_DIGEST0` = 9

`ESP_EFUSE_KEY_PURPOSE_SECURE_BOOT_DIGEST1` = 10

`ESP_EFUSE_KEY_PURPOSE_SECURE_BOOT_DIGEST2` = 11

ESP_EFUSE_KEY_PURPOSE_MAX

2.7.6 Error Codes and Helper Functions

This section lists definitions of common ESP-IDF error codes and several helper functions related to error handling.

For general information about error codes in ESP-IDF, see [Error Handling](#).

For the full list of error codes defined in ESP-IDF, see [Error Code Reference](#).

API Reference

Header File

- [esp_common/include/esp_err.h](#)

Functions

const char ***esp_err_to_name** (*esp_err_t code*)

Returns string for esp_err_t error codes.

This function finds the error code in a pre-generated lookup-table and returns its string representation.

The function is generated by the Python script tools/gen_esp_err_to_name.py which should be run each time an esp_err_t error is modified, created or removed from the IDF project.

Return string error message

Parameters

- code: esp_err_t error code

const char ***esp_err_to_name_r** (*esp_err_t code*, char **buf*, size_t *buflen*)

Returns string for esp_err_t and system error codes.

This function finds the error code in a pre-generated lookup-table of esp_err_t errors and returns its string representation. If the error code is not found then it is attempted to be found among system errors.

The function is generated by the Python script tools/gen_esp_err_to_name.py which should be run each time an esp_err_t error is modified, created or removed from the IDF project.

Return buf containing the string error message

Parameters

- code: esp_err_t error code
- [out] buf: buffer where the error message should be written
- buflen: Size of buffer buf. At most buflen bytes are written into the buf buffer (including the terminating null byte).

Macros

ESP_OK

esp_err_t value indicating success (no error)

ESP_FAIL

Generic esp_err_t code indicating failure

ESP_ERR_NO_MEM

Out of memory

ESP_ERR_INVALID_ARG

Invalid argument

ESP_ERR_INVALID_STATE

Invalid state

ESP_ERR_INVALID_SIZE

Invalid size

ESP_ERR_NOT_FOUND

Requested resource not found

ESP_ERR_NOT_SUPPORTED

Operation or feature not supported

ESP_ERR_TIMEOUT

Operation timed out

ESP_ERR_INVALID_RESPONSE

Received response was invalid

ESP_ERR_INVALID_CRC

CRC or checksum was invalid

ESP_ERR_INVALID_VERSION

Version was invalid

ESP_ERR_INVALID_MAC

MAC address was invalid

ESP_ERR_WIFI_BASE

Starting number of WiFi error codes

ESP_ERR_MESH_BASE

Starting number of MESH error codes

ESP_ERR_FLASH_BASE

Starting number of flash error codes

ESP_ERR_HW_CRYPTO_BASE

Starting number of HW cryptography module error codes

ESP_ERROR_CHECK (x)

Macro which can be used to check the error code, and terminate the program in case the code is not ESP_OK. Prints the error code, error location, and the failed statement to serial output.

Disabled if assertions are disabled.

ESP_ERROR_CHECK_WITHOUT_ABORT (x)

Macro which can be used to check the error code. Prints the error code, error location, and the failed statement to serial output. In comparison with ESP_ERROR_CHECK(), this prints the same error message but isn't terminating the program.

Type Definitions

```
typedef int esp_err_t
```

2.7.7 ESP HTTPS OTA

Overview

esp_https_ota provides simplified APIs to perform firmware upgrades over HTTPS. It's an abstraction layer over existing OTA APIs.

Application Example

```
esp_err_t do_firmware_upgrade ()
{
    esp_http_client_config_t config = {
        .url = CONFIG_FIRMWARE_UPGRADE_URL,
        .cert_pem = (char *)server_cert_pem_start,
```

(continues on next page)

(continued from previous page)

```

};
esp_err_t ret = esp_https_ota(&config);
if (ret == ESP_OK) {
    esp_restart();
} else {
    return ESP_FAIL;
}
return ESP_OK;
}

```

Signature Verification

For additional security, signature of OTA firmware images can be verified. For that, refer [Secure OTA Updates Without Secure boot](#)

API Reference

Header File

- `esp_https_ota/include/esp_https_ota.h`

Functions

`esp_err_t esp_https_ota(const esp_http_client_config_t *config)`

HTTPS OTA Firmware upgrade.

This function allocates HTTPS OTA Firmware upgrade context, establishes HTTPS connection, reads image data from HTTP stream and writes it to OTA partition and finishes HTTPS OTA Firmware upgrade operation. This API supports URL redirection, but if CA cert of URLs differ then it should be appended to `cert_pem` member of `config`.

Note This API handles the entire OTA operation, so if this API is being used then no other APIs from `esp_https_ota` component should be called. If more information and control is needed during the HTTPS OTA process, then one can use `esp_https_ota_begin` and subsequent APIs. If this API returns successfully, `esp_restart()` must be called to boot from the new firmware image.

Return

- `ESP_OK`: OTA data updated, next reboot will use specified partition.
- `ESP_FAIL`: For generic failure.
- `ESP_ERR_INVALID_ARG`: Invalid argument
- `ESP_ERR_OTA_VALIDATE_FAILED`: Invalid app image
- `ESP_ERR_NO_MEM`: Cannot allocate memory for OTA operation.
- `ESP_ERR_FLASH_OP_TIMEOUT` or `ESP_ERR_FLASH_OP_FAIL`: Flash write failed.
- For other return codes, refer OTA documentation in esp-idf's `app_update` component.

Parameters

- [in] `config`: pointer to `esp_http_client_config_t` structure.

`esp_err_t esp_https_ota_begin(esp_https_ota_config_t *ota_config, esp_https_ota_handle_t *handle)`

Start HTTPS OTA Firmware upgrade.

This function initializes ESP HTTPS OTA context and establishes HTTPS connection. This function must be invoked first. If this function returns successfully, then `esp_https_ota_perform` should be called to continue with the OTA process and there should be a call to `esp_https_ota_finish` on completion of OTA operation or on failure in subsequent operations. This API supports URL redirection, but if CA cert of URLs differ then it should be appended to `cert_pem` member of `http_config`, which is a part of `ota_config`. In case of error, this API explicitly sets `handle` to `NULL`.

Note This API is blocking, so setting `is_async` member of `http_config` structure will result in an error.

Return

- `ESP_OK`: HTTPS OTA Firmware upgrade context initialised and HTTPS connection established

- ESP_FAIL: For generic failure.
- ESP_ERR_INVALID_ARG: Invalid argument (missing/incorrect config, certificate, etc.)
- For other return codes, refer documentation in app_update component and esp_http_client component in esp-idf.

Parameters

- [in] ota_config: pointer to *esp_https_ota_config_t* structure
- [out] handle: pointer to an allocated data of type *esp_https_ota_handle_t* which will be initialised in this function

esp_err_t **esp_https_ota_perform** (*esp_https_ota_handle_t* https_ota_handle)

Read image data from HTTP stream and write it to OTA partition.

This function reads image data from HTTP stream and writes it to OTA partition. This function must be called only if *esp_https_ota_begin*() returns successfully. This function must be called in a loop since it returns after every HTTP read operation thus giving you the flexibility to stop OTA operation midway.

Return

- ESP_ERR_HTTPS_OTA_IN_PROGRESS: OTA update is in progress, call this API again to continue.
- ESP_OK: OTA update was successful
- ESP_FAIL: OTA update failed
- ESP_ERR_INVALID_ARG: Invalid argument
- ESP_ERR_OTA_VALIDATE_FAILED: Invalid app image
- ESP_ERR_NO_MEM: Cannot allocate memory for OTA operation.
- ESP_ERR_FLASH_OP_TIMEOUT or ESP_ERR_FLASH_OP_FAIL: Flash write failed.
- For other return codes, refer OTA documentation in esp-idf's app_update component.

Parameters

- [in] https_ota_handle: pointer to *esp_https_ota_handle_t* structure

bool **esp_https_ota_is_complete_data_received** (*esp_https_ota_handle_t* https_ota_handle)

Checks if complete data was received or not.

Note This API can be called just before *esp_https_ota_finish*() to validate if the complete image was indeed received.

Return

- false
- true

Parameters

- [in] https_ota_handle: pointer to *esp_https_ota_handle_t* structure

esp_err_t **esp_https_ota_finish** (*esp_https_ota_handle_t* https_ota_handle)

Clean-up HTTPS OTA Firmware upgrade and close HTTPS connection.

This function closes the HTTP connection and frees the ESP HTTPS OTA context. This function switches the boot partition to the OTA partition containing the new firmware image.

Note If this API returns successfully, *esp_restart*() must be called to boot from the new firmware image
esp_https_ota_finish should not be called after calling *esp_https_ota_abort*

Return

- ESP_OK: Clean-up successful
- ESP_ERR_INVALID_STATE
- ESP_ERR_INVALID_ARG: Invalid argument
- ESP_ERR_OTA_VALIDATE_FAILED: Invalid app image

Parameters

- [in] https_ota_handle: pointer to *esp_https_ota_handle_t* structure

esp_err_t **esp_https_ota_abort** (*esp_https_ota_handle_t* https_ota_handle)

Clean-up HTTPS OTA Firmware upgrade and close HTTPS connection.

This function closes the HTTP connection and frees the ESP HTTPS OTA context.

Note *esp_https_ota_abort* should not be called after calling *esp_https_ota_finish*

Return

- ESP_OK: Clean-up successful

- `ESP_ERR_INVALID_STATE`: Invalid ESP HTTPS OTA state
- `ESP_FAIL`: OTA not started
- `ESP_ERR_NOT_FOUND`: OTA handle not found
- `ESP_ERR_INVALID_ARG`: Invalid argument

Parameters

- [in] `https_ota_handle`: pointer to `esp_https_ota_handle_t` structure

`esp_err_t esp_https_ota_get_img_desc` (`esp_https_ota_handle_t https_ota_handle, esp_app_desc_t *new_app_info`)

Reads app description from image header. The app description provides information like the “Firmware version” of the image.

Note This API can be called only after `esp_https_ota_begin()` and before `esp_https_ota_perform()`. Calling this API is not mandatory.

Return

- `ESP_ERR_INVALID_ARG`: Invalid arguments
- `ESP_FAIL`: Failed to read image descriptor
- `ESP_OK`: Successfully read image descriptor

Parameters

- [in] `https_ota_handle`: pointer to `esp_https_ota_handle_t` structure
- [out] `new_app_info`: pointer to an allocated `esp_app_desc_t` structure

int `esp_https_ota_get_image_len_read` (`esp_https_ota_handle_t https_ota_handle`)

This function returns OTA image data read so far.

Note This API should be called only if `esp_https_ota_perform()` has been called atleast once or if `esp_https_ota_get_img_desc` has been called before.

Return

- -1 On failure
- total bytes read so far

Parameters

- [in] `https_ota_handle`: pointer to `esp_https_ota_handle_t` structure

Structures

struct `esp_https_ota_config_t`
ESP HTTPS OTA configuration.

Public Members

const `esp_http_client_config_t *http_config`
ESP HTTP client configuration

`http_client_init_cb_t http_client_init_cb`
Callback after ESP HTTP client is initialised

bool `bulk_flash_erase`

Erase entire flash partition during initialization. By default flash partition is erased during write operation and in chunk of 4K sector size

Macros

`ESP_ERR_HTTPS_OTA_BASE`

`ESP_ERR_HTTPS_OTA_IN_PROGRESS`

Type Definitions

typedef void `*esp_https_ota_handle_t`

typedef `esp_err_t (*http_client_init_cb_t)(esp_http_client_handle_t)`

2.7.8 ESP-pthread

Overview

This module offers Espressif specific extensions to the pthread library that can be used to influence the behaviour of pthreads. Currently the following configuration can be tuned:

- Stack size of the pthreads
- Priority of the created pthreads
- Inheriting this configuration across threads
- Thread name
- Core affinity / core pinning.

Example to tune the stack size of the pthread:

```
void * thread_func(void * p)
{
    printf("In thread_func\n");
    return NULL;
}

void app_main(void)
{
    pthread_t t1;

    esp_pthread_cfg_t cfg = esp_create_default_pthread_config();
    cfg.stack_size = (4 * 1024);
    esp_pthread_set_cfg(&cfg);

    pthread_create(&t1, NULL, thread_func);
}
```

The API can also be used for inheriting the settings across threads. For example:

```
void * my_thread2(void * p)
{
    /* This thread will inherit the stack size of 4K */
    printf("In my_thread2\n");

    return NULL;
}

void * my_thread1(void * p)
{
    printf("In my_thread1\n");
    pthread_t t2;
    pthread_create(&t2, NULL, my_thread2);

    return NULL;
}

void app_main(void)
{
    pthread_t t1;

    esp_pthread_cfg_t cfg = esp_create_default_pthread_config();
    cfg.stack_size = (4 * 1024);
    cfg.inherit_cfg = true;
    esp_pthread_set_cfg(&cfg);

    pthread_create(&t1, NULL, my_thread1);
}
```

API Reference

Header File

- `pthread/include/esp_thread.h`

Functions

`esp_thread_cfg_t esp_thread_get_default_config` (void)

Creates a default pthread configuration based on the values set via menuconfig.

Return A default configuration structure.

`esp_err_t esp_thread_set_cfg` (const `esp_thread_cfg_t` *cfg)

Configure parameters for creating pthread.

This API allows you to configure how the subsequent `pthread_create()` call will behave. This call can be used to setup configuration parameters like stack size, priority, configuration inheritance etc.

If the ‘inherit’ flag in the configuration structure is enabled, then the same configuration is also inherited in the thread subtree.

Note Passing non-NULL attributes to `pthread_create()` will override the `stack_size` parameter set using this API

Return

- `ESP_OK` if configuration was successfully set
- `ESP_ERR_NO_MEM` if out of memory
- `ESP_ERR_INVALID_ARG` if `stack_size` is less than `PTHREAD_STACK_MIN`

Parameters

- `cfg`: The pthread config parameters

`esp_err_t esp_thread_get_cfg` (`esp_thread_cfg_t` *p)

Get current pthread creation configuration.

This will retrieve the current configuration that will be used for creating threads.

Return

- `ESP_OK` if the configuration was available
- `ESP_ERR_NOT_FOUND` if a configuration wasn't previously set

Parameters

- `p`: Pointer to the pthread config structure that will be updated with the currently configured parameters

`esp_err_t esp_thread_init` (void)

Initialize pthread library.

Structures

`struct esp_thread_cfg_t`

pthread configuration structure that influences pthread creation

Public Members

`size_t stack_size`

The stack size of the pthread.

`size_t prio`

The thread's priority.

`bool inherit_cfg`

Inherit this configuration further.

`const char *thread_name`

The thread name.

`int pin_to_core`

The core id to pin the thread to. Has the same value range as `xCoreId` argument of `xTaskCreatePinnedToCore`.

Macros

`PTHREAD_STACK_MIN`

2.7.9 Event Loop Library

Overview

The event loop library allows components to declare events to which other components can register handlers –code which will execute when those events occur. This allows loosely coupled components to attach desired behavior to changes in state of other components without application involvement. For instance, a high level connection handling library may subscribe to events produced by the wifi subsystem directly and act on those events. This also simplifies event processing by serializing and deferring code execution to another context.

Using `esp_event` APIs

There are two objects of concern for users of this library: events and event loops.

Events are occurrences of note. For example, for WiFi, a successful connection to the access point may be an event. Events are referenced using a two part identifier which are discussed more [here](#). Event loops are the vehicle by which events get posted by event sources and handled by event handler functions. These two appear prominently in the event loop library APIs.

Using this library roughly entails the following flow:

1. A user defines a function that should run when an event is posted to a loop. This function is referred to as the event handler. It should have the same signature as `esp_event_handler_t`.
2. An event loop is created using `esp_event_loop_create()`, which outputs a handle to the loop of type `esp_event_loop_handle_t`. Event loops created using this API are referred to as user event loops. There is, however, a special type of event loop called the default event loop which are discussed [here](#).
3. Components register event handlers to the loop using `esp_event_handler_register_with()`. Handlers can be registered with multiple loops, more on that [here](#).
4. Event sources post an event to the loop using `esp_event_post_to()`.
5. Components wanting to remove their handlers from being called can do so by unregistering from the loop using `esp_event_handler_unregister_with()`.
6. Event loops which are no longer needed can be deleted using `esp_event_loop_delete()`.

In code, the flow above may look like as follows:

```
// 1. Define the event handler
void run_on_event(void* handler_arg, esp_event_base_t base, int32_t id, void*_
↳event_data)
{
    // Event handler logic
}

void app_main()
{
    // 2. A configuration structure of type esp_event_loop_args_t is needed to_
↳specify the properties of the loop to be
    // created. A handle of type esp_event_loop_handle_t is obtained, which is_
↳needed by the other APIs to reference the loop
    // to perform their operations on.
    esp_event_loop_args_t loop_args = {
        .queue_size = ...,
```

(continues on next page)

```

        .task_name = ...
        .task_priority = ...,
        .task_stack_size = ...,
        .task_core_id = ...
    };

    esp_event_loop_handle_t loop_handle;

    esp_event_loop_create(&loop_args, &loop_handle);

    // 3. Register event handler defined in (1). MY_EVENT_BASE and MY_EVENT_ID
    ↪ specifies a hypothetical
    // event that handler run_on_event should execute on when it gets posted to
    ↪ the loop.
    esp_event_handler_register_with(loop_handle, MY_EVENT_BASE, MY_EVENT_ID, run_
    ↪ on_event, ...);

    ...

    // 4. Post events to the loop. This queues the event on the event loop. At
    ↪ some point in time
    // the event loop executes the event handler registered to the posted event,
    ↪ in this case run_on_event.
    // For simplicity sake this example calls esp_event_post_to from app_main, but
    ↪ posting can be done from
    // any other tasks (which is the more interesting use case).
    esp_event_post_to(loop_handle, MY_EVENT_BASE, MY_EVENT_ID, ...);

    ...

    // 5. Unregistering an unneeded handler
    esp_event_handler_unregister_with(loop_handle, MY_EVENT_BASE, MY_EVENT_ID, run_
    ↪ on_event);

    ...

    // 6. Deleting an unneeded event loop
    esp_event_loop_delete(loop_handle);
}

```

Declaring and defining events

As mentioned previously, events consists of two-part identifiers: the event base and the event ID. The event base identifies an independent group of events; the event ID identifies the event within that group. Think of the event base and event ID as a person's last name and first name, respectively. A last name identifies a family, and the first name identifies a person within that family.

The event loop library provides macros to declare and define the event base easily.

Event base declaration:

```
ESP_EVENT_DECLARE_BASE(EVENT_BASE)
```

Event base definition:

```
ESP_EVENT_DEFINE_BASE(EVENT_BASE)
```

Note: In IDF, the base identifiers for system events are uppercase and are postfixed with `_EVENT`. For example, the base for wifi events is declared and defined as `WIFI_EVENT`, the ethernet event base `ETHERNET_EVENT`, and

so on. The purpose is to have event bases look like constants (although they are global variables considering the definitions of macros `ESP_EVENT_DECLARE_BASE` and `ESP_EVENT_DEFINE_BASE`).

For event ID's, declaring them as enumerations is recommended. Once again, for visibility, these are typically placed in public header files.

Event ID:

```
enum {
    EVENT_ID_1,
    EVENT_ID_2,
    EVENT_ID_3,
    ...
}
```

Default Event Loop

The default event loop is a special type of loop used for system events (WiFi events, for example). The handle for this loop is hidden from the user. The creation, deletion, handler registration/unregistration and posting of events is done through a variant of the APIs for user event loops. The table below enumerates those variants, and the user event loops equivalent.

User Event Loops	Default Event Loops
<code>esp_event_loop_create()</code>	<code>esp_event_loop_create_default()</code>
<code>esp_event_loop_delete()</code>	<code>esp_event_loop_delete_default()</code>
<code>esp_event_handler_register_with()</code>	<code>esp_event_handler_register()</code>
<code>esp_event_handler_unregister_with()</code>	<code>esp_event_handler_unregister()</code>
<code>esp_event_post_to()</code>	<code>esp_event_post()</code>

If you compare the signatures for both, they are mostly similar except the for the lack of loop handle specification for the default event loop APIs.

Other than the API difference and the special designation to which system events are posted to, there is no difference to how default event loops and user event loops behave. It is even possible for users to post their own events to the default event loop, should the user opt to not create their own loops to save memory.

Notes on Handler Registration

It is possible to register a single handler to multiple events individually, i.e. using multiple calls to [`esp_event_handler_register_with\(\)`](#). For those multiple calls, the specific event base and event ID can be specified with which the handler should execute.

However, in some cases it is desirable for a handler to execute on (1) all events that get posted to a loop or (2) all events of a particular base identifier. This is possible using the special event base identifier `ESP_EVENT_ANY_BASE` and special event ID `ESP_EVENT_ANY_ID`. These special identifiers may be passed as the event base and event ID arguments for [`esp_event_handler_register_with\(\)`](#).

Therefore, the valid arguments to [`esp_event_handler_register_with\(\)`](#) are:

1. <event base>, <event ID> - handler executes when the event with base <event base> and event ID <event ID> gets posted to the loop
2. <event base>, `ESP_EVENT_ANY_ID` - handler executes when any event with base <event base> gets posted to the loop
3. `ESP_EVENT_ANY_BASE`, `ESP_EVENT_ANY_ID` - handler executes when any event gets posted to the loop

As an example, suppose the following handler registrations were performed:

```

esp_event_handler_register_with(loop_handle, MY_EVENT_BASE, MY_EVENT_ID, run_on_
↳event_1, ...);
esp_event_handler_register_with(loop_handle, MY_EVENT_BASE, ESP_EVENT_ANY_ID, run_
↳on_event_2, ...);
esp_event_handler_register_with(loop_handle, ESP_EVENT_ANY_BASE, ESP_EVENT_ANY_ID,
↳run_on_event_3, ...);

```

If the hypothetical event `MY_EVENT_BASE, MY_EVENT_ID` is posted, all three handlers `run_on_event_1`, `run_on_event_2`, and `run_on_event_3` would execute.

If the hypothetical event `MY_EVENT_BASE, MY_OTHER_EVENT_ID` is posted, only `run_on_event_2` and `run_on_event_3` would execute.

If the hypothetical event `MY_OTHER_EVENT_BASE, MY_OTHER_EVENT_ID` is posted, only `run_on_event_3` would execute.

Handler Registration and Handler Dispatch Order The general rule is that for handlers that match a certain posted event during dispatch, those which are registered first also gets executed first. The user can then control which handlers get executed first by registering them before other handlers, provided that all registrations are performed using a single task. If the user plans to take advantage of this behavior, caution must be exercised if there are multiple tasks registering handlers. While the ‘first registered, first executed’ behavior still holds true, the task which gets executed first will also get their handlers registered first. Handlers registered one after the other by a single task will still be dispatched in the order relative to each other, but if that task gets pre-empted in between registration by another task which also registers handlers; then during dispatch those handlers will also get executed in between.

Event loop profiling

A configuration option `CONFIG_ESP_EVENT_LOOP_PROFILING` can be enabled in order to activate statistics collection for all event loops created. The function `esp_event_dump()` can be used to output the collected statistics to a file stream. More details on the information included in the dump can be found in the `esp_event_dump()` API Reference.

Application Example

Examples on using the `esp_event` library can be found in `system/esp_event`. The examples cover event declaration, loop creation, handler registration and unregistration and event posting.

Other examples which also adopt `esp_event` library:

- [NMEA Parser](#), which will decode the statements received from GPS.

API Reference

Header File

- `esp_event/include/esp_event.h`

Functions

```

esp_err_t esp_event_loop_create(const esp_event_loop_args_t *event_loop_args,
                               esp_event_loop_handle_t *event_loop)

```

Create a new event loop.

Return

- `ESP_OK`: Success
- `ESP_ERR_INVALID_ARG`: `event_loop_args` or `event_loop` was `NULL`
- `ESP_ERR_NO_MEM`: Cannot allocate memory for event loops list
- `ESP_FAIL`: Failed to create task loop

- Others: Fail

Parameters

- [in] `event_loop_args`: configuration structure for the event loop to create
- [out] `event_loop`: handle to the created event loop

esp_err_t **esp_event_loop_delete** (*esp_event_loop_handle_t* *event_loop*)

Delete an existing event loop.

Return

- ESP_OK: Success
- Others: Fail

Parameters

- [in] `event_loop`: event loop to delete, must not be NULL

esp_err_t **esp_event_loop_create_default** (void)

Create default event loop.

Return

- ESP_OK: Success
- ESP_ERR_NO_MEM: Cannot allocate memory for event loops list
- ESP_FAIL: Failed to create task loop
- Others: Fail

esp_err_t **esp_event_loop_delete_default** (void)

Delete the default event loop.

Return

- ESP_OK: Success
- Others: Fail

esp_err_t **esp_event_loop_run** (*esp_event_loop_handle_t* *event_loop*, `TickType_t` *ticks_to_run*)

Dispatch events posted to an event loop.

This function is used to dispatch events posted to a loop with no dedicated task, i.e task name was set to NULL in `event_loop_args` argument during loop creation. This function includes an argument to limit the amount of time it runs, returning control to the caller when that time expires (or some time afterwards). There is no guarantee that a call to this function will exit at exactly the time of expiry. There is also no guarantee that events have been dispatched during the call, as the function might have spent all of the allotted time waiting on the event queue. Once an event has been unqueued, however, it is guaranteed to be dispatched. This guarantee contributes to not being able to exit exactly at time of expiry as (1) blocking on internal mutexes is necessary for dispatching the unqueued event, and (2) during dispatch of the unqueued event there is no way to control the time occupied by handler code execution. The guaranteed time of exit is therefore the allotted time + amount of time required to dispatch the last unqueued event.

In cases where waiting on the queue times out, ESP_OK is returned and not ESP_ERR_TIMEOUT, since it is normal behavior.

Note encountering an unknown event that has been posted to the loop will only generate a warning, not an error.

Return

- ESP_OK: Success
- Others: Fail

Parameters

- [in] `event_loop`: event loop to dispatch posted events from, must not be NULL
- [in] `ticks_to_run`: number of ticks to run the loop

esp_err_t **esp_event_handler_register** (*esp_event_base_t* *event_base*, `int32_t` *event_id*,
esp_event_handler_t *event_handler*, void
**event_handler_arg*)

Register an event handler to the system event loop (legacy).

This function can be used to register a handler for either: (1) specific events, (2) all events of a certain event base, or (3) all events known by the system event loop.

Note This function is obsolete and will be deprecated soon, please use `esp_event_handler_instance_register()` instead.

- specific events: specify exact `event_base` and `event_id`
- all events of a certain base: specify exact `event_base` and use `ESP_EVENT_ANY_ID` as the `event_id`
- all events known by the loop: use `ESP_EVENT_ANY_BASE` for `event_base` and `ESP_EVENT_ANY_ID` as the `event_id`

Registering multiple handlers to events is possible. Registering a single handler to multiple events is also possible. However, registering the same handler to the same event multiple times would cause the previous registrations to be overwritten.

Note the event loop library does not maintain a copy of `event_handler_arg`, therefore the user should ensure that `event_handler_arg` still points to a valid location by the time the handler gets called

Return

- `ESP_OK`: Success
- `ESP_ERR_NO_MEM`: Cannot allocate memory for the handler
- `ESP_ERR_INVALID_ARG`: Invalid combination of event base and event id
- Others: Fail

Parameters

- `[in] event_base`: the base id of the event to register the handler for
- `[in] event_id`: the id of the event to register the handler for
- `[in] event_handler`: the handler function which gets called when the event is dispatched
- `[in] event_handler_arg`: data, aside from event data, that is passed to the handler when it is called

```
esp_err_t esp_event_handler_register_with(esp_event_loop_handle_t event_loop,
                                         esp_event_base_t event_base, int32_t event_id,
                                         esp_event_handler_t event_handler, void
                                         *event_handler_arg)
```

Register an event handler to a specific loop (legacy).

This function behaves in the same manner as `esp_event_handler_register`, except the additional specification of the event loop to register the handler to.

Note This function is obsolete and will be deprecated soon, please use `esp_event_handler_instance_register_with()` instead.

Note the event loop library does not maintain a copy of `event_handler_arg`, therefore the user should ensure that `event_handler_arg` still points to a valid location by the time the handler gets called

Return

- `ESP_OK`: Success
- `ESP_ERR_NO_MEM`: Cannot allocate memory for the handler
- `ESP_ERR_INVALID_ARG`: Invalid combination of event base and event id
- Others: Fail

Parameters

- `[in] event_loop`: the event loop to register this handler function to, must not be NULL
- `[in] event_base`: the base id of the event to register the handler for
- `[in] event_id`: the id of the event to register the handler for
- `[in] event_handler`: the handler function which gets called when the event is dispatched
- `[in] event_handler_arg`: data, aside from event data, that is passed to the handler when it is called

```
esp_err_t esp_event_handler_instance_register_with(esp_event_loop_handle_t
                                                  event_loop, esp_event_base_t
                                                  event_base, int32_t event_id,
                                                  esp_event_handler_t event_handler,
                                                  void *event_handler_arg,
                                                  esp_event_handler_instance_t
                                                  *instance)
```

Register an instance of event handler to a specific loop.

This function can be used to register a handler for either: (1) specific events, (2) all events of a certain event

base, or (3) all events known by the system event loop.

- specific events: specify exact `event_base` and `event_id`
- all events of a certain base: specify exact `event_base` and use `ESP_EVENT_ANY_ID` as the `event_id`
- all events known by the loop: use `ESP_EVENT_ANY_BASE` for `event_base` and `ESP_EVENT_ANY_ID` as the `event_id`

Besides the error, the function returns an instance object as output parameter to identify each registration. This is necessary to remove (unregister) the registration before the event loop is deleted.

Registering multiple handlers to events, registering a single handler to multiple events as well as registering the same handler to the same event multiple times is possible. Each registration yields a distinct instance object which identifies it over the registration lifetime.

Note the event loop library does not maintain a copy of `event_handler_arg`, therefore the user should ensure that `event_handler_arg` still points to a valid location by the time the handler gets called

Return

- `ESP_OK`: Success
- `ESP_ERR_NO_MEM`: Cannot allocate memory for the handler
- `ESP_ERR_INVALID_ARG`: Invalid combination of event base and event id or instance is NULL
- Others: Fail

Parameters

- `[in] event_loop`: the event loop to register this handler function to, must not be NULL
- `[in] event_base`: the base id of the event to register the handler for
- `[in] event_id`: the id of the event to register the handler for
- `[in] event_handler`: the handler function which gets called when the event is dispatched
- `[in] event_handler_arg`: data, aside from event data, that is passed to the handler when it is called
- `[out] instance`: An event handler instance object related to the registered event handler and data, can be NULL. This needs to be kept if the specific callback instance should be unregistered before deleting the whole event loop. Registering the same event handler multiple times is possible and yields distinct instance objects. The data can be the same for all registrations. If no unregistration is needed but the handler should be deleted when the event loop is deleted, instance can be NULL.

```
esp_err_t esp_event_handler_instance_register(esp_event_base_t event_base, int32_t
                                             event_id, esp_event_handler_t
                                             event_handler, void *event_handler_arg,
                                             esp_event_handler_instance_t *instance)
```

Register an instance of event handler to the default loop.

This function does the same as `esp_event_handler_instance_register_with`, except that it registers the handler to the default event loop.

Note the event loop library does not maintain a copy of `event_handler_arg`, therefore the user should ensure that `event_handler_arg` still points to a valid location by the time the handler gets called

Return

- `ESP_OK`: Success
- `ESP_ERR_NO_MEM`: Cannot allocate memory for the handler
- `ESP_ERR_INVALID_ARG`: Invalid combination of event base and event id or instance is NULL
- Others: Fail

Parameters

- `[in] event_base`: the base id of the event to register the handler for
- `[in] event_id`: the id of the event to register the handler for
- `[in] event_handler`: the handler function which gets called when the event is dispatched
- `[in] event_handler_arg`: data, aside from event data, that is passed to the handler when it is called
- `[out] instance`: An event handler instance object related to the registered event handler and data, can be NULL. This needs to be kept if the specific callback instance should be unregistered before deleting the whole event loop. Registering the same event handler multiple times is possible and yields distinct instance objects. The data can be the same for all registrations. If no unregistration is needed but the handler should be deleted when the event loop is deleted, instance can be NULL.

esp_err_t **esp_event_handler_unregister** (*esp_event_base_t* event_base, int32_t event_id, *esp_event_handler_t* event_handler)

Unregister a handler with the system event loop (legacy).

Unregisters a handler so it will no longer be called during dispatch. Handlers can be unregistered for any combination of event_base and event_id which were previously registered. To unregister a handler, the event_base and event_id arguments must match exactly the arguments passed to esp_event_handler_register() when that handler was registered. Passing ESP_EVENT_ANY_BASE and/or ESP_EVENT_ANY_ID will only unregister handlers that were registered with the same wildcard arguments.

Note This function is obsolete and will be deprecated soon, please use esp_event_handler_instance_unregister() instead.

Note When using ESP_EVENT_ANY_ID, handlers registered to specific event IDs using the same base will not be unregistered. When using ESP_EVENT_ANY_BASE, events registered to specific bases will also not be unregistered. This avoids accidental unregistration of handlers registered by other users or components.

Return ESP_OK success

Return ESP_ERR_INVALID_ARG invalid combination of event base and event id

Return others fail

Parameters

- [in] event_base: the base of the event with which to unregister the handler
- [in] event_id: the id of the event with which to unregister the handler
- [in] event_handler: the handler to unregister

esp_err_t **esp_event_handler_unregister_with** (*esp_event_loop_handle_t* event_loop, *esp_event_base_t* event_base, int32_t event_id, *esp_event_handler_t* event_handler)

Unregister a handler from a specific event loop (legacy).

This function behaves in the same manner as esp_event_handler_unregister, except the additional specification of the event loop to unregister the handler with.

Note This function is obsolete and will be deprecated soon, please use esp_event_handler_instance_unregister_with() instead.

Return

- ESP_OK: Success
- ESP_ERR_INVALID_ARG: Invalid combination of event base and event id
- Others: Fail

Parameters

- [in] event_loop: the event loop with which to unregister this handler function, must not be NULL
- [in] event_base: the base of the event with which to unregister the handler
- [in] event_id: the id of the event with which to unregister the handler
- [in] event_handler: the handler to unregister

esp_err_t **esp_event_handler_instance_unregister_with** (*esp_event_loop_handle_t* event_loop, *esp_event_base_t* event_base, int32_t event_id, *esp_event_handler_instance_t* instance)

Unregister a handler instance from a specific event loop.

Unregisters a handler instance so it will no longer be called during dispatch. Handler instances can be unregistered for any combination of event_base and event_id which were previously registered. To unregister a handler instance, the event_base and event_id arguments must match exactly the arguments passed to esp_event_handler_instance_register() when that handler instance was registered. Passing ESP_EVENT_ANY_BASE and/or ESP_EVENT_ANY_ID will only unregister handler instances that were registered with the same wildcard arguments.

Note When using ESP_EVENT_ANY_ID, handlers registered to specific event IDs using the same base will not be unregistered. When using ESP_EVENT_ANY_BASE, events registered to specific bases will

also not be unregistered. This avoids accidental unregistration of handlers registered by other users or components.

Return

- ESP_OK: Success
- ESP_ERR_INVALID_ARG: Invalid combination of event base and event id
- Others: Fail

Parameters

- [in] `event_loop`: the event loop with which to unregister this handler function, must not be NULL
- [in] `event_base`: the base of the event with which to unregister the handler
- [in] `event_id`: the id of the event with which to unregister the handler
- [in] `instance`: the instance object of the registration to be unregistered

```
esp_err_t esp_event_handler_instance_unregister(esp_event_base_t event_base, int32_t
                                             event_id, esp_event_handler_instance_t
                                             instance)
```

Unregister a handler from the system event loop.

This function does the same as `esp_event_handler_instance_unregister_with`, except that it unregisters the handler instance from the default event loop.

Return

- ESP_OK: Success
- ESP_ERR_INVALID_ARG: Invalid combination of event base and event id
- Others: Fail

Parameters

- [in] `event_base`: the base of the event with which to unregister the handler
- [in] `event_id`: the id of the event with which to unregister the handler
- [in] `instance`: the instance object of the registration to be unregistered

```
esp_err_t esp_event_post(esp_event_base_t event_base, int32_t event_id, void *event_data, size_t
                          event_data_size, TickType_t ticks_to_wait)
```

Posts an event to the system default event loop. The event loop library keeps a copy of `event_data` and manages the copy's lifetime automatically (allocation + deletion); this ensures that the data the handler receives is always valid.

Return

- ESP_OK: Success
- ESP_ERR_TIMEOUT: Time to wait for event queue to unblock expired, queue full when posting from ISR
- ESP_ERR_INVALID_ARG: Invalid combination of event base and event id
- Others: Fail

Parameters

- [in] `event_base`: the event base that identifies the event
- [in] `event_id`: the event id that identifies the event
- [in] `event_data`: the data, specific to the event occurrence, that gets passed to the handler
- [in] `event_data_size`: the size of the event data
- [in] `ticks_to_wait`: number of ticks to block on a full event queue

```
esp_err_t esp_event_post_to(esp_event_loop_handle_t event_loop, esp_event_base_t event_base,
                             int32_t event_id, void *event_data, size_t event_data_size, TickType_t
                             ticks_to_wait)
```

Posts an event to the specified event loop. The event loop library keeps a copy of `event_data` and manages the copy's lifetime automatically (allocation + deletion); this ensures that the data the handler receives is always valid.

This function behaves in the same manner as `esp_event_post_to`, except the additional specification of the event loop to post the event to.

Return

- ESP_OK: Success
- ESP_ERR_TIMEOUT: Time to wait for event queue to unblock expired, queue full when posting from ISR

- ESP_ERR_INVALID_ARG: Invalid combination of event base and event id
- Others: Fail

Parameters

- [in] `event_loop`: the event loop to post to, must not be NULL
- [in] `event_base`: the event base that identifies the event
- [in] `event_id`: the event id that identifies the event
- [in] `event_data`: the data, specific to the event occurrence, that gets passed to the handler
- [in] `event_data_size`: the size of the event data
- [in] `ticks_to_wait`: number of ticks to block on a full event queue

esp_err_t **esp_event_isr_post** (*esp_event_base_t* `event_base`, *int32_t* `event_id`, *void** `event_data`, *size_t* `event_data_size`, *BaseType_t* `*task_unblocked`)

Special variant of `esp_event_post` for posting events from interrupt handlers.

Note this function is only available when `CONFIG_ESP_EVENT_POST_FROM_ISR` is enabled

Note when this function is called from an interrupt handler placed in IRAM, this function should be placed in IRAM as well by enabling `CONFIG_ESP_EVENT_POST_FROM_IRAM_ISR`

Return

- ESP_OK: Success
- ESP_FAIL: Event queue for the default event loop full
- ESP_ERR_INVALID_ARG: Invalid combination of event base and event id, data size of more than 4 bytes
- Others: Fail

Parameters

- [in] `event_base`: the event base that identifies the event
- [in] `event_id`: the event id that identifies the event
- [in] `event_data`: the data, specific to the event occurrence, that gets passed to the handler
- [in] `event_data_size`: the size of the event data; max is 4 bytes
- [out] `task_unblocked`: an optional parameter (can be NULL) which indicates that an event task with higher priority than currently running task has been unblocked by the posted event; a context switch should be requested before the interrupt is existed.

esp_err_t **esp_event_isr_post_to** (*esp_event_loop_handle_t* `event_loop`, *esp_event_base_t* `event_base`, *int32_t* `event_id`, *void** `event_data`, *size_t* `event_data_size`, *BaseType_t* `*task_unblocked`)

Special variant of `esp_event_post_to` for posting events from interrupt handlers.

Note this function is only available when `CONFIG_ESP_EVENT_POST_FROM_ISR` is enabled

Note when this function is called from an interrupt handler placed in IRAM, this function should be placed in IRAM as well by enabling `CONFIG_ESP_EVENT_POST_FROM_IRAM_ISR`

Return

- ESP_OK: Success
- ESP_FAIL: Event queue for the loop full
- ESP_ERR_INVALID_ARG: Invalid combination of event base and event id, data size of more than 4 bytes
- Others: Fail

Parameters

- [in] `event_loop`: the event loop to post to, must not be NULL
- [in] `event_base`: the event base that identifies the event
- [in] `event_id`: the event id that identifies the event
- [in] `event_data`: the data, specific to the event occurrence, that gets passed to the handler
- [in] `event_data_size`: the size of the event data
- [out] `task_unblocked`: an optional parameter (can be NULL) which indicates that an event task with higher priority than currently running task has been unblocked by the posted event; a context switch should be requested before the interrupt is existed.

esp_err_t **esp_event_dump** (*FILE** `file`)

Dumps statistics of all event loops.

Dumps event loop info in the format:

```

    event loop
        handler
        handler
        ...
    event loop
        handler
        handler
        ...

where:

event loop
    format: address,name rx:total_recieved dr:total_dropped
    where:
        address - memory address of the event loop
        name - name of the event loop, 'none' if no dedicated task
        total_recieved - number of successfully posted events
        total_dropped - number of events unsuccessfully posted due to queue_
↳being full

handler
    format: address ev:base,id inv:total_invoked run:total_runtime
    where:
        address - address of the handler function
        base,id - the event specified by event base and id this handler_
↳executes
        total_invoked - number of times this handler has been invoked
        total_runtime - total amount of time used for invoking this handler

```

Note this function is a noop when CONFIG_ESP_EVENT_LOOP_PROFILING is disabled

Return

- ESP_OK: Success
- ESP_ERR_NO_MEM: Cannot allocate memory for event loops list
- Others: Fail

Parameters

- [in] file: the file stream to output to

Structures

struct esp_event_loop_args_t

Configuration for creating event loops.

Public Members

int32_t queue_size

size of the event loop queue

const char *task_name

name of the event loop task; if NULL, a dedicated task is not created for event loop

UBaseType_t task_priority

priority of the event loop task, ignored if task name is NULL

uint32_t task_stack_size

stack size of the event loop task, ignored if task name is NULL

BaseType_t task_core_id

core to which the event loop task is pinned to, ignored if task name is NULL

Header File

- [esp_event/include/esp_event_base.h](#)

Macros

ESP_EVENT_DECLARE_BASE (id)

ESP_EVENT_DEFINE_BASE (id)

ESP_EVENT_ANY_BASE

register handler for any event base

ESP_EVENT_ANY_ID

register handler for any event id

Type Definitions

typedef const char ***esp_event_base_t**

unique pointer to a subsystem that exposes events

typedef void ***esp_event_loop_handle_t**

a number that identifies an event with respect to a base

typedef void (***esp_event_handler_t**) (void *event_handler_arg, *esp_event_base_t* event_base, int32_t event_id, void *event_data)

function called when an event is posted to the queue

typedef void ***esp_event_handler_instance_t**

context identifying an instance of a registered event handler

Related Documents

Legacy event loop

API Reference

Header File

- [esp_event/include/esp_event_legacy.h](#)

Functions

esp_err_t **esp_event_send** (*system_event_t* *event)

Send a event to event task.

Other task/modules, such as the tcpip_adapter, can call this API to send an event to event task

Note This API is part of the legacy event system. New code should use event library API in esp_event.h

Return ESP_OK : succeed

Return others : fail

Parameters

- event: Event to send

esp_err_t **esp_event_send_internal** (*esp_event_base_t* event_base, int32_t event_id, void *event_data, size_t event_data_size, TickType_t ticks_to_wait)

Send a event to event task.

Other task/modules, such as the tcpip_adapter, can call this API to send an event to event task

Note This API is used by WiFi Driver only.

Return ESP_OK : succeed

Return others : fail

Parameters

- [in] event_base: the event base that identifies the event

- [in] `event_id`: the event id that identifies the event
- [in] `event_data`: the data, specific to the event occurrence, that gets passed to the handler
- [in] `event_data_size`: the size of the event data
- [in] `ticks_to_wait`: number of ticks to block on a full event queue

esp_err_t **esp_event_process_default** (*system_event_t *event*)

Default event handler for system events.

This function performs default handling of system events. When using `esp_event_loop` APIs, it is called automatically before invoking the user-provided callback function.

Note This API is part of the legacy event system. New code should use event library API in `esp_event.h`

Applications which implement a custom event loop must call this function as part of event processing.

Return `ESP_OK` if an event was handled successfully

Parameters

- `event`: pointer to event to be handled

void **esp_event_set_default_eth_handlers** (void)

Install default event handlers for Ethernet interface.

Note This API is part of the legacy event system. New code should use event library API in `esp_event.h`

void **esp_event_set_default_wifi_handlers** (void)

Install default event handlers for Wi-Fi interfaces (station and AP)

Note This API is part of the legacy event system. New code should use event library API in `esp_event.h`

esp_err_t **esp_event_loop_init** (*system_event_cb_t cb*, void **ctx*)

Initialize event loop.

Create the event handler and task

Note This API is part of the legacy event system. New code should use event library API in `esp_event.h`

Return

- `ESP_OK`: succeed
- others: fail

Parameters

- `cb`: application specified event callback, it can be modified by call `esp_event_set_cb`
- `ctx`: reserved for user

system_event_cb_t **esp_event_loop_set_cb** (*system_event_cb_t cb*, void **ctx*)

Set application specified event callback function.

Note This API is part of the legacy event system. New code should use event library API in `esp_event.h`

Attention 1. If `cb` is `NULL`, means application don't need to handle If `cb` is not `NULL`, it will be call when an event is received, after the default event callback is completed

Return old callback

Parameters

- `cb`: application callback function
- `ctx`: argument to be passed to callback

Unions

union system_event_info_t

`#include <esp_event_legacy.h>` Union of all possible `system_event` argument structures

Public Members

system_event_sta_connected_t **connected**

ESP32 station connected to AP

system_event_sta_disconnected_t **disconnected**

ESP32 station disconnected to AP

system_event_sta_scan_done_t **scan_done**
ESP32 station scan (APs) done

system_event_sta_authmode_change_t **auth_change**
the auth mode of AP ESP32 station connected to changed

system_event_sta_got_ip_t **got_ip**
ESP32 station got IP, first time got IP or when IP is changed

system_event_sta_wps_er_pin_t **sta_er_pin**
ESP32 station WPS enrollee mode PIN code received

system_event_sta_wps_fail_reason_t **sta_er_fail_reason**
ESP32 station WPS enrollee mode failed reason code received

system_event_sta_wps_er_success_t **sta_er_success**
ESP32 station WPS enrollee success

system_event_ap_staconnected_t **sta_connected**
a station connected to ESP32 soft-AP

system_event_ap_stadisconnected_t **sta_disconnected**
a station disconnected to ESP32 soft-AP

system_event_ap_probe_req_rx_t **ap_probereqrecved**
ESP32 soft-AP receive probe request packet

system_event_ftm_report_t **ftm_report**
Report of FTM procedure

system_event_ap_staipassigned_t **ap_staipassigned**
ESP32 soft-AP assign an IP to the station

system_event_got_ip6_t **got_ip6**
ESP32 station or ap or ethernet ipv6 addr state change to preferred

Structures

struct system_event_t
Event, as a tagged enum

Public Members

system_event_id_t **event_id**
event ID

system_event_info_t **event_info**
event information

Macros

SYSTEM_EVENT_AP_STA_GOT_IP6

Type Definitions

typedef *wifi_event_sta_wps_fail_reason_t* **system_event_sta_wps_fail_reason_t**
Argument structure of SYSTEM_EVENT_STA_WPS_ER_FAILED event

typedef *wifi_event_sta_scan_done_t* **system_event_sta_scan_done_t**
Argument structure of SYSTEM_EVENT_SCAN_DONE event

typedef *wifi_event_sta_connected_t* **system_event_sta_connected_t**
Argument structure of SYSTEM_EVENT_STA_CONNECTED event

typedef *wifi_event_sta_disconnected_t* **system_event_sta_disconnected_t**
Argument structure of SYSTEM_EVENT_STA_DISCONNECTED event

```

typedef wifi_event_sta_authmode_change_t system_event_sta_authmode_change_t
    Argument structure of SYSTEM_EVENT_STA_AUTHMODE_CHANGE event

typedef wifi_event_sta_wps_er_pin_t system_event_sta_wps_er_pin_t
    Argument structure of SYSTEM_EVENT_STA_WPS_ER_PIN event

typedef wifi_event_sta_wps_er_success_t system_event_sta_wps_er_success_t
    Argument structure of SYSTEM_EVENT_STA_WPS_ER_PIN event

typedef wifi_event_ap_staconnected_t system_event_ap_staconnected_t
    Argument structure of event

typedef wifi_event_ap_stadisconnected_t system_event_ap_stadisconnected_t
    Argument structure of event

typedef wifi_event_ap_probe_req_rx_t system_event_ap_probe_req_rx_t
    Argument structure of event

typedef wifi_event_ftm_report_t system_event_ftm_report_t
    Argument structure of SYSTEM_EVENT_FTM_REPORT event

typedef ip_event_ap_staassigned_t system_event_ap_staassigned_t
    Argument structure of event

typedef ip_event_got_ip_t system_event_sta_got_ip_t
    Argument structure of event

typedef ip_event_got_ip6_t system_event_got_ip6_t
    Argument structure of event

typedef esp_err_t (*system_event_handler_t) (esp_event_base_t event_base, int32_t event_id,
    void *event_data, size_t event_data_size, Tick-
    Type_t ticks_to_wait)

    Event handler function type

typedef esp_err_t (*system_event_cb_t) (void *ctx, system_event_t *event)
    Application specified event callback function.

```

Note This API is part of the legacy event system. New code should use event library API in esp_event.h

Return

- ESP_OK: succeed
- others: fail

Parameters

- ctx: reserved for user
- event: event type defined in this file

Enumerations

```

enum system_event_id_t
    System event types enumeration

    Values:

    SYSTEM_EVENT_WIFI_READY = 0
        ESP32 WiFi ready

    SYSTEM_EVENT_SCAN_DONE
        ESP32 finish scanning AP

    SYSTEM_EVENT_STA_START
        ESP32 station start

    SYSTEM_EVENT_STA_STOP
        ESP32 station stop

    SYSTEM_EVENT_STA_CONNECTED
        ESP32 station connected to AP

```

SYSTEM_EVENT_STA_DISCONNECTED
ESP32 station disconnected from AP

SYSTEM_EVENT_STA_AUTHMODE_CHANGE
the auth mode of AP connected by ESP32 station changed

SYSTEM_EVENT_STA_GOT_IP
ESP32 station got IP from connected AP

SYSTEM_EVENT_STA_LOST_IP
ESP32 station lost IP and the IP is reset to 0

SYSTEM_EVENT_STA_BSS_RSSI_LOW
ESP32 station connected BSS rssi goes below threshold

SYSTEM_EVENT_STA_WPS_ER_SUCCESS
ESP32 station wps succeeds in enrollee mode

SYSTEM_EVENT_STA_WPS_ER_FAILED
ESP32 station wps fails in enrollee mode

SYSTEM_EVENT_STA_WPS_ER_TIMEOUT
ESP32 station wps timeout in enrollee mode

SYSTEM_EVENT_STA_WPS_ER_PIN
ESP32 station wps pin code in enrollee mode

SYSTEM_EVENT_STA_WPS_ER_PBC_OVERLAP
ESP32 station wps overlap in enrollee mode

SYSTEM_EVENT_AP_START
ESP32 soft-AP start

SYSTEM_EVENT_AP_STOP
ESP32 soft-AP stop

SYSTEM_EVENT_AP_STA_CONNECTED
a station connected to ESP32 soft-AP

SYSTEM_EVENT_AP_STA_DISCONNECTED
a station disconnected from ESP32 soft-AP

SYSTEM_EVENT_AP_STA_IP_ASSIGNED
ESP32 soft-AP assign an IP to a connected station

SYSTEM_EVENT_AP_PROBREQ_RECV
Receive probe request packet in soft-AP interface

SYSTEM_EVENT_ACTION_TX_STATUS
Receive status of Action frame transmitted

SYSTEM_EVENT_ROC_DONE
Indicates the completion of Remain-on-Channel operation status

SYSTEM_EVENT_STA_BEACON_TIMEOUT
ESP32 station beacon timeout

SYSTEM_EVENT_FTM_REPORT
Receive report of FTM procedure

SYSTEM_EVENT_GOT_IP6
ESP32 station or ap or ethernet interface v6IP addr is preferred

SYSTEM_EVENT_ETH_START
ESP32 ethernet start

SYSTEM_EVENT_ETH_STOP
ESP32 ethernet stop

SYSTEM_EVENT_ETH_CONNECTED

ESP32 ethernet phy link up

SYSTEM_EVENT_ETH_DISCONNECTED

ESP32 ethernet phy link down

SYSTEM_EVENT_ETH_GOT_IP

ESP32 ethernet got IP from connected AP

SYSTEM_EVENT_MAX

Number of members in this enum

2.7.10 FreeRTOS

Overview

This section contains documentation of FreeRTOS types, functions, and macros. It is automatically generated from FreeRTOS header files.

Note: ESP-IDF FreeRTOS is based on the Xtensa port of FreeRTOS v10.2.0,

For more information about FreeRTOS features specific to ESP-IDF, see [ESP-IDF FreeRTOS SMP Changes](#) and [ESP-IDF FreeRTOS Additions](#).

Task API

Header File

- [freertos/include/freertos/task.h](#)

Functions

BaseType_t **xTaskCreatePinnedToCore** (TaskFunction_t *pvTaskCode*, **const** char ***const** *pcName*, **const** uint32_t *usStackDepth*, void ***const** *pvParameters*, UBaseType_t *uxPriority*, *TaskHandle_t* ***const** *pvCreatedTask*, **const** BaseType_t *xCoreID*)

Create a new task with a specified affinity.

This function is similar to xTaskCreate, but allows setting task affinity in SMP system.

Return pdPASS if the task was successfully created and added to a ready list, otherwise an error code defined in the file projdefs.h

Parameters

- *pvTaskCode*: Pointer to the task entry function. Tasks must be implemented to never return (i.e. continuous loop), or should be terminated using vTaskDelete function.
- *pcName*: A descriptive name for the task. This is mainly used to facilitate debugging. Max length defined by configMAX_TASK_NAME_LEN - default is 16.
- *usStackDepth*: The size of the task stack specified as the number of bytes. Note that this differs from vanilla FreeRTOS.
- *pvParameters*: Pointer that will be used as the parameter for the task being created.
- *uxPriority*: The priority at which the task should run. Systems that include MPU support can optionally create tasks in a privileged (system) mode by setting bit portPRIVILEGE_BIT of the priority parameter. For example, to create a privileged task at priority 2 the uxPriority parameter should be set to (2 | portPRIVILEGE_BIT).
- *pvCreatedTask*: Used to pass back a handle by which the created task can be referenced.
- *xCoreID*: If the value is tskNO_AFFINITY, the created task is not pinned to any CPU, and the scheduler can run it on any core available. Values 0 or 1 indicate the index number of the CPU which the task should be pinned to. Specifying values larger than (portNUM_PROCESSORS - 1) will cause the function to fail.

```
static BaseType_t xTaskCreate (TaskFunction_t pvTaskCode, const char *const pcName, const
uint32_t usStackDepth, void *const pvParameters, UBaseType_t
uxPriority, TaskHandle_t *const pvCreatedTask)
```

Create a new task and add it to the list of tasks that are ready to run.

Internally, within the FreeRTOS implementation, tasks use two blocks of memory. The first block is used to hold the task's data structures. The second block is used by the task as its stack. If a task is created using `xTaskCreate()` then both blocks of memory are automatically dynamically allocated inside the `xTaskCreate()` function. (see <http://www.freertos.org/a00111.html>). If a task is created using `xTaskCreateStatic()` then the application writer must provide the required memory. `xTaskCreateStatic()` therefore allows a task to be created without using any dynamic memory allocation.

See `xTaskCreateStatic()` for a version that does not use any dynamic memory allocation.

`xTaskCreate()` can only be used to create a task that has unrestricted access to the entire microcontroller memory map. Systems that include MPU support can alternatively create an MPU constrained task using `xTaskCreateRestricted()`.

Example usage:

```
// Task to be created.
void vTaskCode( void * pvParameters )
{
    for ( ;; )
    {
        // Task code goes here.
    }
}

// Function that creates a task.
void vOtherFunction( void )
{
    static uint8_t ucParameterToPass;
    TaskHandle_t xHandle = NULL;

    // Create the task, storing the handle. Note that the passed parameter_
    ↪ucParameterToPass
    // must exist for the lifetime of the task, so in this case is declared_
    ↪static. If it was just an
    // an automatic stack variable it might no longer exist, or at least have_
    ↪been corrupted, by the time
    // the new task attempts to access it.
    xTaskCreate( vTaskCode, "NAME", STACK_SIZE, &ucParameterToPass, tskIDLE_
    ↪PRIORITY, &xHandle );
    configASSERT( xHandle );

    // Use the handle to delete the task.
    if( xHandle != NULL )
    {
        vTaskDelete( xHandle );
    }
}
```

Return `pdPASS` if the task was successfully created and added to a ready list, otherwise an error code defined in the file `projdefs.h`

Note If program uses thread local variables (ones specified with “`__thread`” keyword) then storage for them will be allocated on the task's stack.

Parameters

- `pvTaskCode`: Pointer to the task entry function. Tasks must be implemented to never return (i.e. continuous loop), or should be terminated using `vTaskDelete` function.
- `pcName`: A descriptive name for the task. This is mainly used to facilitate debugging. Max length defined by `configMAX_TASK_NAME_LEN` - default is 16.
- `usStackDepth`: The size of the task stack specified as the number of bytes. Note that this differs

from vanilla FreeRTOS.

- `pvParameters`: Pointer that will be used as the parameter for the task being created.
- `uxPriority`: The priority at which the task should run. Systems that include MPU support can optionally create tasks in a privileged (system) mode by setting bit `portPRIVILEGE_BIT` of the priority parameter. For example, to create a privileged task at priority 2 the `uxPriority` parameter should be set to `(2 | portPRIVILEGE_BIT)`.
- `pvCreatedTask`: Used to pass back a handle by which the created task can be referenced.

```
TaskHandle_t xTaskCreateStaticPinnedToCore (TaskFunction_t pvTaskCode, const char
                                           *const pcName, const uint32_t ulStackDepth, void *const pvParameters, UBaseType_t uxPriority, StackType_t *const pxStackBuffer, StaticTask_t *const pxTaskBuffer, const BaseType_t xCoreID)
```

Create a new task with a specified affinity.

This function is similar to `xTaskCreateStatic`, but allows specifying task affinity in an SMP system.

Return If neither `pxStackBuffer` or `pxTaskBuffer` are NULL, then the task will be created and `pdPASS` is returned. If either `pxStackBuffer` or `pxTaskBuffer` are NULL then the task will not be created and `errCOULD_NOT_ALLOCATE_REQUIRED_MEMORY` is returned.

Parameters

- `pvTaskCode`: Pointer to the task entry function. Tasks must be implemented to never return (i.e. continuous loop), or should be terminated using `vTaskDelete` function.
- `pcName`: A descriptive name for the task. This is mainly used to facilitate debugging. The maximum length of the string is defined by `configMAX_TASK_NAME_LEN` in `FreeRTOSConfig.h`.
- `ulStackDepth`: The size of the task stack specified as the number of bytes. Note that this differs from vanilla FreeRTOS.
- `pvParameters`: Pointer that will be used as the parameter for the task being created.
- `uxPriority`: The priority at which the task will run.
- `pxStackBuffer`: Must point to a `StackType_t` array that has at least `ulStackDepth` indexes - the array will then be used as the task's stack, removing the need for the stack to be allocated dynamically.
- `pxTaskBuffer`: Must point to a variable of type `StaticTask_t`, which will then be used to hold the task's data structures, removing the need for the memory to be allocated dynamically.
- `xCoreID`: If the value is `tskNO_AFFINITY`, the created task is not pinned to any CPU, and the scheduler can run it on any core available. Values 0 or 1 indicate the index number of the CPU which the task should be pinned to. Specifying values larger than `(portNUM_PROCESSORS - 1)` will cause the function to fail.

```
static TaskHandle_t xTaskCreateStatic (TaskFunction_t pvTaskCode, const char *const
                                       pcName, const uint32_t ulStackDepth, void *const
                                       pvParameters, UBaseType_t uxPriority, StackType_t
                                       *const pxStackBuffer, StaticTask_t *const pxTaskBuffer)
```

Create a new task and add it to the list of tasks that are ready to run.

Internally, within the FreeRTOS implementation, tasks use two blocks of memory. The first block is used to hold the task's data structures. The second block is used by the task as its stack. If a task is created using `xTaskCreate()` then both blocks of memory are automatically dynamically allocated inside the `xTaskCreate()` function. (see <http://www.freertos.org/a00111.html>). If a task is created using `xTaskCreateStatic()` then the application writer must provide the required memory. `xTaskCreateStatic()` therefore allows a task to be created without using any dynamic memory allocation.

Example usage:

```
// Dimensions the buffer that the task being created will use as its stack.
// NOTE: This is the number of bytes the stack will hold, not the number of
// words as found in vanilla FreeRTOS.
#define STACK_SIZE 200
```

(continues on next page)

(continued from previous page)

```

// Structure that will hold the TCB of the task being created.
StaticTask_t xTaskBuffer;

// Buffer that the task being created will use as its stack. Note this is
// an array of StackType_t variables. The size of StackType_t is dependent on
// the RTOS port.
StackType_t xStack[ STACK_SIZE ];

// Function that implements the task being created.
void vTaskCode( void * pvParameters )
{
    // The parameter value is expected to be 1 as 1 is passed in the
    // pvParameters value in the call to xTaskCreateStatic().
    configASSERT( ( uint32_t ) pvParameters == 1UL );

    for( ;; )
    {
        // Task code goes here.
    }
}

// Function that creates a task.
void vOtherFunction( void )
{
    TaskHandle_t xHandle = NULL;

    // Create the task without using any dynamic memory allocation.
    xHandle = xTaskCreateStatic(
        vTaskCode,          // Function that implements the task.
        "NAME",            // Text name for the task.
        STACK_SIZE,       // Stack size in bytes, not words.
        ( void * ) 1,     // Parameter passed into the task.
        tskIDLE_PRIORITY, // Priority at which the task is created.
        xStack,           // Array to use as the task's stack.
        &xTaskBuffer );  // Variable to hold the task's data_
↳structure.

    // puxStackBuffer and pxTaskBuffer were not NULL, so the task will have
    // been created, and xHandle will be the task's handle. Use the handle
    // to suspend the task.
    vTaskSuspend( xHandle );
}

```

Return If neither pxStackBuffer or pxTaskBuffer are NULL, then the task will be created and pdPASS is returned. If either pxStackBuffer or pxTaskBuffer are NULL then the task will not be created and errCOULD_NOT_ALLOCATE_REQUIRED_MEMORY is returned.

Note If program uses thread local variables (ones specified with “__thread” keyword) then storage for them will be allocated on the task’s stack.

Parameters

- pvTaskCode: Pointer to the task entry function. Tasks must be implemented to never return (i.e. continuous loop), or should be terminated using vTaskDelete function.
- pcName: A descriptive name for the task. This is mainly used to facilitate debugging. The maximum length of the string is defined by configMAX_TASK_NAME_LEN in FreeRTOSConfig.h.
- ulStackDepth: The size of the task stack specified as the number of bytes. Note that this differs from vanilla FreeRTOS.
- pvParameters: Pointer that will be used as the parameter for the task being created.
- uxPriority: The priority at which the task will run.
- pxStackBuffer: Must point to a StackType_t array that has at least ulStackDepth indexes - the array will then be used as the task’s stack, removing the need for the stack to be allocated dynamically.

- `pxTaskBuffer`: Must point to a variable of type `StaticTask_t`, which will then be used to hold the task's data structures, removing the need for the memory to be allocated dynamically.

void **vTaskAllocateMPURegions** (*TaskHandle_t* *xTask*, const MemoryRegion_t *const *pxRegions*)

void **vTaskDelete** (*TaskHandle_t* *xTaskToDelete*)

Remove a task from the RTOS real time kernel's management. The task being deleted will be removed from all ready, blocked, suspended and event lists.

`INCLUDE_vTaskDelete` must be defined as 1 for this function to be available. See the configuration section for more information.

NOTE: The idle task is responsible for freeing the kernel allocated memory from tasks that have been deleted. It is therefore important that the idle task is not starved of microcontroller processing time if your application makes any calls to `vTaskDelete()`. Memory allocated by the task code is not automatically freed, and should be freed before the task is deleted.

See the demo application file `death.c` for sample code that utilises `vTaskDelete()`.

Example usage:

```
void vOtherFunction( void )
{
    TaskHandle_t xHandle;

    // Create the task, storing the handle.
    xTaskCreate( vTaskCode, "NAME", STACK_SIZE, NULL, tskIDLE_PRIORITY, &
    ↪xHandle );

    // Use the handle to delete the task.
    vTaskDelete( xHandle );
}
```

Parameters

- `xTaskToDelete`: The handle of the task to be deleted. Passing `NULL` will cause the calling task to be deleted.

void **vTaskDelay** (const TickType_t *xTicksToDelay*)

Delay a task for a given number of ticks.

Delay a task for a given number of ticks. The actual time that the task remains blocked depends on the tick rate. The constant `portTICK_PERIOD_MS` can be used to calculate real time from the tick rate - with the resolution of one tick period.

`INCLUDE_vTaskDelay` must be defined as 1 for this function to be available. See the configuration section for more information.

`vTaskDelay()` specifies a time at which the task wishes to unblock relative to the time at which `vTaskDelay()` is called. For example, specifying a block period of 100 ticks will cause the task to unblock 100 ticks after `vTaskDelay()` is called. `vTaskDelay()` does not therefore provide a good method of controlling the frequency of a periodic task as the path taken through the code, as well as other task and interrupt activity, will effect the frequency at which `vTaskDelay()` gets called and therefore the time at which the task next executes. See `vTaskDelayUntil()` for an alternative API function designed to facilitate fixed frequency execution. It does this by specifying an absolute time (rather than a relative time) at which the calling task should unblock.

Example usage:

```
void vTaskFunction( void * pvParameters )
{
    // Block for 500ms.
    const TickType_t xDelay = 500 / portTICK_PERIOD_MS;

    for( ;; )
    {
```

(continues on next page)

(continued from previous page)

```

// Simply toggle the LED every 500ms, blocking between each toggle.
vToggleLED();
vTaskDelay( xDelay );
}
}

```

Parameters

- `xTicksToDelay`: The amount of time, in tick periods, that the calling task should block.

void **vTaskDelayUntil** (TickType_t ***const** *pxPreviousWakeTime*, **const** TickType_t *xTimeIncrement*)

Delay a task until a specified time.

INCLUDE_vTaskDelayUntil must be defined as 1 for this function to be available. See the configuration section for more information.

Delay a task until a specified time. This function can be used by periodic tasks to ensure a constant execution frequency.

This function differs from `vTaskDelay()` in one important aspect: `vTaskDelay()` will cause a task to block for the specified number of ticks from the time `vTaskDelay()` is called. It is therefore difficult to use `vTaskDelay()` by itself to generate a fixed execution frequency as the time between a task starting to execute and that task calling `vTaskDelay()` may not be fixed [the task may take a different path though the code between calls, or may get interrupted or preempted a different number of times each time it executes].

Whereas `vTaskDelay()` specifies a wake time relative to the time at which the function is called, `vTaskDelayUntil()` specifies the absolute (exact) time at which it wishes to unblock.

The constant `portTICK_PERIOD_MS` can be used to calculate real time from the tick rate - with the resolution of one tick period.

Example usage:

```

// Perform an action every 10 ticks.
void vTaskFunction( void * pvParameters )
{
TickType_t xLastWakeTime;
const TickType_t xFrequency = 10;

// Initialise the xLastWakeTime variable with the current time.
xLastWakeTime = xTaskGetTickCount ();
for ( ;; )
{
// Wait for the next cycle.
vTaskDelayUntil( &xLastWakeTime, xFrequency );

// Perform action here.
}
}

```

Parameters

- `pxPreviousWakeTime`: Pointer to a variable that holds the time at which the task was last unblocked. The variable must be initialised with the current time prior to its first use (see the example below). Following this the variable is automatically updated within `vTaskDelayUntil()`.
- `xTimeIncrement`: The cycle time period. The task will be unblocked at time `*pxPreviousWakeTime + xTimeIncrement`. Calling `vTaskDelayUntil` with the same `xTimeIncrement` parameter value will cause the task to execute with a fixed interface period.

BaseType_t **xTaskAbortDelay** (*TaskHandle_t xTask*)

UBaseType_t **uxTaskPriorityGet** (**const** *TaskHandle_t xTask*)

Obtain the priority of any task.

INCLUDE_uxTaskPriorityGet must be defined as 1 for this function to be available. See the configuration section for more information.

Example usage:

```
void vAFunction( void )
{
    TaskHandle_t xHandle;

    // Create a task, storing the handle.
    xTaskCreate( vTaskCode, "NAME", STACK_SIZE, NULL, tskIDLE_PRIORITY, &xHandle_
→);

    // ...

    // Use the handle to obtain the priority of the created task.
    // It was created with tskIDLE_PRIORITY, but may have changed
    // it itself.
    if( uxTaskPriorityGet( xHandle ) != tskIDLE_PRIORITY )
    {
        // The task has changed it's priority.
    }

    // ...

    // Is our priority higher than the created task?
    if( uxTaskPriorityGet( xHandle ) < uxTaskPriorityGet( NULL ) )
    {
        // Our priority (obtained using NULL handle) is higher.
    }
}
```

Return The priority of xTask.

Parameters

- xTask: Handle of the task to be queried. Passing a NULL handle results in the priority of the calling task being returned.

UBaseType_t **uxTaskPriorityGetFromISR**(const TaskHandle_t xTask)

A version of uxTaskPriorityGet() that can be used from an ISR.

eTaskState **eTaskGetState**(TaskHandle_t xTask)

Obtain the state of any task.

States are encoded by the eTaskState enumerated type.

INCLUDE_eTaskGetState must be defined as 1 for this function to be available. See the configuration section for more information.

Return The state of xTask at the time the function was called. Note the state of the task might change between the function being called, and the functions return value being tested by the calling task.

Parameters

- xTask: Handle of the task to be queried.

void **vTaskGetInfo**(TaskHandle_t xTask, TaskStatus_t *pxTaskStatus, BaseType_t xGetFreeStackSpace, eTaskState eState)

Populates a TaskStatus_t structure with information about a task.

configUSE_TRACE_FACILITY must be defined as 1 for this function to be available. See the configuration section for more information.

Example usage:

```
void vAFunction( void )
{
    TaskHandle_t xHandle;
```

(continues on next page)

(continued from previous page)

```

TaskStatus_t xTaskDetails;

// Obtain the handle of a task from its name.
xHandle = xTaskGetHandle( "Task_Name" );

// Check the handle is not NULL.
configASSERT( xHandle );

// Use the handle to obtain further information about the task.
vTaskGetInfo( xHandle,
              &xTaskDetails,
              pdTRUE, // Include the high water mark in xTaskDetails.
              eInvalid ); // Include the task state in xTaskDetails.
}

```

Parameters

- **xTask**: Handle of the task being queried. If xTask is NULL then information will be returned about the calling task.
- **pxTaskStatus**: A pointer to the TaskStatus_t structure that will be filled with information about the task referenced by the handle passed using the xTask parameter.
- **xGetFreeStackSize**: The TaskStatus_t structure contains a member to report the stack high water mark of the task being queried. Calculating the stack high water mark takes a relatively long time, and can make the system temporarily unresponsive - so the xGetFreeStackSize parameter is provided to allow the high water mark checking to be skipped. The high watermark value will only be written to the TaskStatus_t structure if xGetFreeStackSize is not set to pdFALSE;
- **eState**: The TaskStatus_t structure contains a member to report the state of the task being queried. Obtaining the task state is not as fast as a simple assignment - so the eState parameter is provided to allow the state information to be omitted from the TaskStatus_t structure. To obtain state information then set eState to eInvalid - otherwise the value passed in eState will be reported as the task state in the TaskStatus_t structure.

void **vTaskPrioritySet** (*TaskHandle_t* xTask, *UBaseType_t* uxNewPriority)

Set the priority of any task.

INCLUDE_vTaskPrioritySet must be defined as 1 for this function to be available. See the configuration section for more information.

A context switch will occur before the function returns if the priority being set is higher than the currently executing task.

Example usage:

```

void vAFunction( void )
{
    TaskHandle_t xHandle;

    // Create a task, storing the handle.
    xTaskCreate( vTaskCode, "NAME", STACK_SIZE, NULL, tskIDLE_PRIORITY, &xHandle_
    ↪ );

    // ...

    // Use the handle to raise the priority of the created task.
    vTaskPrioritySet( xHandle, tskIDLE_PRIORITY + 1 );

    // ...

    // Use a NULL handle to raise our priority to the same value.
    vTaskPrioritySet( NULL, tskIDLE_PRIORITY + 1 );
}

```

Parameters

- `xTask`: Handle to the task for which the priority is being set. Passing a NULL handle results in the priority of the calling task being set.
- `uxNewPriority`: The priority to which the task will be set.

void **vTaskSuspend** (*TaskHandle_t* xTaskToSuspend)

Suspend a task.

INCLUDE_vTaskSuspend must be defined as 1 for this function to be available. See the configuration section for more information.

Suspend any task. When suspended a task will never get any microcontroller processing time, no matter what its priority.

Calls to vTaskSuspend are not accumulative - i.e. calling vTaskSuspend () twice on the same task still only requires one call to vTaskResume () to ready the suspended task.

Example usage:

```
void vAFunction( void )
{
    TaskHandle_t xHandle;

    // Create a task, storing the handle.
    xTaskCreate( vTaskCode, "NAME", STACK_SIZE, NULL, tskIDLE_PRIORITY, &xHandle );

    // ...

    // Use the handle to suspend the created task.
    vTaskSuspend( xHandle );

    // ...

    // The created task will not run during this period, unless
    // another task calls vTaskResume( xHandle ).

    //...

    // Suspend ourselves.
    vTaskSuspend( NULL );

    // We cannot get here unless another task calls vTaskResume
    // with our handle as the parameter.
}
```

Parameters

- `xTaskToSuspend`: Handle to the task being suspended. Passing a NULL handle will cause the calling task to be suspended.

void **vTaskResume** (*TaskHandle_t* xTaskToResume)

Resumes a suspended task.

INCLUDE_vTaskSuspend must be defined as 1 for this function to be available. See the configuration section for more information.

A task that has been suspended by one or more calls to vTaskSuspend () will be made available for running again by a single call to vTaskResume ().

Example usage:

```
void vAFunction( void )
{
    TaskHandle_t xHandle;
```

(continues on next page)

(continued from previous page)

```

// Create a task, storing the handle.
xTaskCreate( vTaskCode, "NAME", STACK_SIZE, NULL, tskIDLE_PRIORITY, &xHandle_
→);

// ...

// Use the handle to suspend the created task.
vTaskSuspend( xHandle );

// ...

// The created task will not run during this period, unless
// another task calls vTaskResume( xHandle ).

//...

// Resume the suspended task ourselves.
vTaskResume( xHandle );

// The created task will once again get microcontroller processing
// time in accordance with its priority within the system.
}

```

Parameters

- xTaskToResume: Handle to the task being readied.

BaseType_t **xTaskResumeFromISR** (*TaskHandle_t* xTaskToResume)

An implementation of vTaskResume() that can be called from within an ISR.

INCLUDE_xTaskResumeFromISR must be defined as 1 for this function to be available. See the configuration section for more information.

A task that has been suspended by one or more calls to vTaskSuspend () will be made available for running again by a single call to xTaskResumeFromISR ().

xTaskResumeFromISR() should not be used to synchronise a task with an interrupt if there is a chance that the interrupt could arrive prior to the task being suspended - as this can lead to interrupts being missed. Use of a semaphore as a synchronisation mechanism would avoid this eventuality.

Return pdTRUE if resuming the task should result in a context switch, otherwise pdFALSE. This is used by the ISR to determine if a context switch may be required following the ISR.

Parameters

- xTaskToResume: Handle to the task being readied.

void **vTaskSuspendAll** (void)

Suspends the scheduler without disabling interrupts.

Context switches will not occur while the scheduler is suspended.

After calling vTaskSuspendAll () the calling task will continue to execute without risk of being swapped out until a call to xTaskResumeAll () has been made.

API functions that have the potential to cause a context switch (for example, vTaskDelayUntil(), xQueueSend(), etc.) must not be called while the scheduler is suspended.

Example usage:

```

void vTask1( void * pvParameters )
{
    for ( ;; )
    {
        // Task code goes here.
    }
}

```

(continues on next page)

(continued from previous page)

```

// ...

// At some point the task wants to perform a long operation during
// which it does not want to get swapped out. It cannot use
// taskENTER_CRITICAL ()/taskEXIT_CRITICAL () as the length of the
// operation may cause interrupts to be missed - including the
// ticks.

// Prevent the real time kernel swapping out the task.
vTaskSuspendAll ();

// Perform the operation here. There is no need to use critical
// sections as we have all the microcontroller processing time.
// During this time interrupts will still operate and the kernel
// tick count will be maintained.

// ...

// The operation is complete. Restart the kernel.
xTaskResumeAll ();
}
}

```

 BaseType_t xTaskResumeAll (void)

Resumes scheduler activity after it was suspended by a call to vTaskSuspendAll().

xTaskResumeAll() only resumes the scheduler. It does not unsuspend tasks that were previously suspended by a call to vTaskSuspend().

Example usage:

```

void vTask1( void * pvParameters )
{
    for( ;; )
    {
        // Task code goes here.

        // ...

        // At some point the task wants to perform a long operation during
        // which it does not want to get swapped out. It cannot use
        // taskENTER_CRITICAL ()/taskEXIT_CRITICAL () as the length of the
        // operation may cause interrupts to be missed - including the
        // ticks.

        // Prevent the real time kernel swapping out the task.
        vTaskSuspendAll ();

        // Perform the operation here. There is no need to use critical
        // sections as we have all the microcontroller processing time.
        // During this time interrupts will still operate and the real
        // time kernel tick count will be maintained.

        // ...

        // The operation is complete. Restart the kernel. We want to force
        // a context switch - but there is no point if resuming the scheduler
        // caused a context switch already.
        if( !xTaskResumeAll () )
        {
            taskYIELD ();
        }
    }
}

```

(continues on next page)

```

}
}

```

Return If resuming the scheduler caused a context switch then pdTRUE is returned, otherwise pdFALSE is returned.

TickType_t **xTaskGetTickCount** (void)

Get tick count

Return The count of ticks since vTaskStartScheduler was called.

TickType_t **xTaskGetTickCountFromISR** (void)

Get tick count from ISR

This is a version of xTaskGetTickCount() that is safe to be called from an ISR - provided that TickType_t is the natural word size of the microcontroller being used or interrupt nesting is either not supported or not being used.

Return The count of ticks since vTaskStartScheduler was called.

UBaseType_t **uxTaskGetNumberOfTasks** (void)

Get current number of tasks

Return The number of tasks that the real time kernel is currently managing. This includes all ready, blocked and suspended tasks. A task that has been deleted but not yet freed by the idle task will also be included in the count.

char ***pcTaskGetName** (*TaskHandle_t* xTaskToQuery)

Get task name

Return The text (human readable) name of the task referenced by the handle xTaskToQuery. A task can query its own name by either passing in its own handle, or by setting xTaskToQuery to NULL.

TaskHandle_t **xTaskGetHandle** (const char **pcNameToQuery*)

Note This function takes a relatively long time to complete and should be used sparingly.

Return The handle of the task that has the human readable name pcNameToQuery. NULL is returned if no matching name is found. INCLUDE_xTaskGetHandle must be set to 1 in FreeRTOSConfig.h for pcTaskGetHandle() to be available.

UBaseType_t **uxTaskGetStackHighWaterMark** (*TaskHandle_t* xTask)

Returns the high water mark of the stack associated with xTask.

INCLUDE_uxTaskGetStackHighWaterMark must be set to 1 in FreeRTOSConfig.h for this function to be available.

Returns the high water mark of the stack associated with xTask. That is, the minimum free stack space there has been (in bytes not words, unlike vanilla FreeRTOS) since the task started. The smaller the returned number the closer the task has come to overflowing its stack.

uxTaskGetStackHighWaterMark() and uxTaskGetStackHighWaterMark2() are the same except for their return type. Using configSTACK_DEPTH_TYPE allows the user to determine the return type. It gets around the problem of the value overflowing on 8-bit types without breaking backward compatibility for applications that expect an 8-bit return type.

Return The smallest amount of free stack space there has been (in bytes not words, unlike vanilla FreeRTOS) since the task referenced by xTask was created.

Parameters

- xTask: Handle of the task associated with the stack to be checked. Set xTask to NULL to check the stack of the calling task.

configSTACK_DEPTH_TYPE **uxTaskGetStackHighWaterMark2** (*TaskHandle_t* xTask)

Returns the start of the stack associated with xTask.

INCLUDE_uxTaskGetStackHighWaterMark2 must be set to 1 in FreeRTOSConfig.h for this function to be available.

Returns the high water mark of the stack associated with `xTask`. That is, the minimum free stack space there has been (in words, so on a 32 bit machine a value of 1 means 4 bytes) since the task started. The smaller the returned number the closer the task has come to overflowing its stack.

`uxTaskGetStackHighWaterMark()` and `uxTaskGetStackHighWaterMark2()` are the same except for their return type. Using `configSTACK_DEPTH_TYPE` allows the user to determine the return type. It gets around the problem of the value overflowing on 8-bit types without breaking backward compatibility for applications that expect an 8-bit return type.

Return The smallest amount of free stack space there has been (in words, so actual spaces on the stack rather than bytes) since the task referenced by `xTask` was created.

Parameters

- `xTask`: Handle of the task associated with the stack to be checked. Set `xTask` to `NULL` to check the stack of the calling task.

`uint8_t *pxTaskGetStackStart (TaskHandle_t xTask)`

Returns the start of the stack associated with `xTask`.

`INCLUDE_pxTaskGetStackStart` must be set to 1 in `FreeRTOSConfig.h` for this function to be available.

Returns the lowest stack memory address, regardless of whether the stack grows up or down.

Return A pointer to the start of the stack.

Parameters

- `xTask`: Handle of the task associated with the stack returned. Set `xTask` to `NULL` to return the stack of the calling task.

`void vTaskSetApplicationTaskTag (TaskHandle_t xTask, TaskHookFunction_t pxHookFunction)`

Sets `pxHookFunction` to be the task hook function used by the task `xTask`.

Parameters

- `xTask`: Handle of the task to set the hook function for. Passing `xTask` as `NULL` has the effect of setting the calling tasks hook function.
- `pxHookFunction`: Pointer to the hook function.

`TaskHookFunction_t xTaskGetApplicationTaskTag (TaskHandle_t xTask)`

Returns the `pxHookFunction` value assigned to the task `xTask`. Do not call from an interrupt service routine - call `xTaskGetApplicationTaskTagFromISR()` instead.

`TaskHookFunction_t xTaskGetApplicationTaskTagFromISR (TaskHandle_t xTask)`

Returns the `pxHookFunction` value assigned to the task `xTask`. Can be called from an interrupt service routine.

`void vTaskSetThreadLocalStoragePointer (TaskHandle_t xTaskToSet, BaseType_t xIndex, void *pvValue)`

Set local storage pointer specific to the given task.

Each task contains an array of pointers that is dimensioned by the `configNUM_THREAD_LOCAL_STORAGE_POINTERS` setting in `FreeRTOSConfig.h`. The kernel does not use the pointers itself, so the application writer can use the pointers for any purpose they wish.

Parameters

- `xTaskToSet`: Task to set thread local storage pointer for
- `xIndex`: The index of the pointer to set, from 0 to `configNUM_THREAD_LOCAL_STORAGE_POINTERS - 1`.
- `pvValue`: Pointer value to set.

`void *pvTaskGetThreadLocalStoragePointer (TaskHandle_t xTaskToQuery, BaseType_t xIndex)`

Get local storage pointer specific to the given task.

Each task contains an array of pointers that is dimensioned by the `configNUM_THREAD_LOCAL_STORAGE_POINTERS` setting in `FreeRTOSConfig.h`. The kernel does not use the pointers itself, so the application writer can use the pointers for any purpose they wish.

Return Pointer value

Parameters

- `xTaskToQuery`: Task to get thread local storage pointer for
- `xIndex`: The index of the pointer to get, from 0 to `configNUM_THREAD_LOCAL_STORAGE_POINTERS - 1`.

```
void vTaskSetThreadLocalStoragePointerAndDelCallback (TaskHandle_t xTaskToSet,
                                                    BaseType_t xIndex, void
                                                    *pvValue, TlsDeleteCallback-
                                                    Function_t pvDelCallback)
```

Set local storage pointer and deletion callback.

Each task contains an array of pointers that is dimensioned by the `configNUM_THREAD_LOCAL_STORAGE_POINTERS` setting in `FreeRTOSConfig.h`. The kernel does not use the pointers itself, so the application writer can use the pointers for any purpose they wish.

Local storage pointers set for a task can reference dynamically allocated resources. This function is similar to `vTaskSetThreadLocalStoragePointer`, but provides a way to release these resources when the task gets deleted. For each pointer, a callback function can be set. This function will be called when task is deleted, with the local storage pointer index and value as arguments.

Parameters

- `xTaskToSet`: Task to set thread local storage pointer for
- `xIndex`: The index of the pointer to set, from 0 to `configNUM_THREAD_LOCAL_STORAGE_POINTERS - 1`.
- `pvValue`: Pointer value to set.
- `pvDelCallback`: Function to call to dispose of the local storage pointer when the task is deleted.

```
BaseType_t xTaskCallApplicationTaskHook (TaskHandle_t xTask, void *pvParameter)
```

Calls the hook function associated with `xTask`. Passing `xTask` as `NULL` has the effect of calling the Running tasks (the calling task) hook function.

Parameters

- `xTask`: Handle of the task to call the hook for.
- `pvParameter`: Parameter passed to the hook function for the task to interpret as it wants. The return value is the value returned by the task hook function registered by the user.

```
TaskHandle_t xTaskGetIdleTaskHandle (void)
```

`xTaskGetIdleTaskHandle()` is only available if `INCLUDE_xTaskGetIdleTaskHandle` is set to 1 in `FreeRTOSConfig.h`.

Simply returns the handle of the idle task. It is not valid to call `xTaskGetIdleTaskHandle()` before the scheduler has been started.

```
UBaseType_t uxTaskGetSystemState (TaskStatus_t *const pxTaskStatusArray, const UBase-
                                Type_t uxArraySize, uint32_t *const pulTotalRunTime)
```

`configUSE_TRACE_FACILITY` must be defined as 1 in `FreeRTOSConfig.h` for `uxTaskGetSystemState()` to be available.

`uxTaskGetSystemState()` populates an `TaskStatus_t` structure for each task in the system. `TaskStatus_t` structures contain, among other things, members for the task handle, task name, task priority, task state, and total amount of run time consumed by the task. See the `TaskStatus_t` structure definition in this file for the full member list.

Example usage:

```
// This example demonstrates how a human readable table of run time stats
// information is generated from raw data provided by uxTaskGetSystemState().
// The human readable table is written to pcWriteBuffer
void vTaskGetRunTimeStats( char *pcWriteBuffer )
{
    TaskStatus_t *pxTaskStatusArray;
    volatile UBaseType_t uxArraySize, x;
    uint32_t ulTotalRunTime, ulStatsAsPercentage;

    // Make sure the write buffer does not contain a string.
```

(continues on next page)

(continued from previous page)

```

*pcWriteBuffer = 0x00;

// Take a snapshot of the number of tasks in case it changes while this
// function is executing.
uxArraySize = uxTaskGetNumberOfTasks();

// Allocate a TaskStatus_t structure for each task. An array could be
// allocated statically at compile time.
pxTaskStatusArray = pvPortMalloc( uxArraySize * sizeof( TaskStatus_t ) );

if( pxTaskStatusArray != NULL )
{
    // Generate raw status information about each task.
    uxArraySize = uxTaskGetSystemState( pxTaskStatusArray, uxArraySize, &
↳ulTotalRunTime );

    // For percentage calculations.
    ulTotalRunTime /= 100UL;

    // Avoid divide by zero errors.
    if( ulTotalRunTime > 0 )
    {
        // For each populated position in the pxTaskStatusArray array,
        // format the raw data as human readable ASCII data
        for( x = 0; x < uxArraySize; x++ )
        {
            // What percentage of the total run time has the task used?
            // This will always be rounded down to the nearest integer.
            // ulTotalRunTimeDiv100 has already been divided by 100.
            ulStatsAsPercentage = pxTaskStatusArray[ x ].ulRunTimeCounter /↳
↳ulTotalRunTime;

            if( ulStatsAsPercentage > 0UL )
            {
                sprintf( pcWriteBuffer, "%s\t\t%lu\t\t%lu%%\r\n",↳
↳pxTaskStatusArray[ x ].pcTaskName, pxTaskStatusArray[ x ].ulRunTimeCounter,↳
↳ulStatsAsPercentage );
            }
            else
            {
                // If the percentage is zero here then the task has
                // consumed less than 1% of the total run time.
                sprintf( pcWriteBuffer, "%s\t\t%lu\t\t<1%\r\n",↳
↳pxTaskStatusArray[ x ].pcTaskName, pxTaskStatusArray[ x ].ulRunTimeCounter );
            }

            pcWriteBuffer += strlen( ( char * ) pcWriteBuffer );
        }
    }

    // The array is no longer needed, free the memory it consumes.
    vPortFree( pxTaskStatusArray );
}
}

```

Note This function is intended for debugging use only as its use results in the scheduler remaining suspended for an extended period.

Return The number of TaskStatus_t structures that were populated by uxTaskGetSystemState(). This should equal the number returned by the uxTaskGetNumberOfTasks() API function, but will be zero if the value passed in the uxArraySize parameter was too small.

Parameters

- `pxTaskStatusArray`: A pointer to an array of `TaskStatus_t` structures. The array must contain at least one `TaskStatus_t` structure for each task that is under the control of the RTOS. The number of tasks under the control of the RTOS can be determined using the `uxTaskGetNumberOfTasks()` API function.
- `uxArraySize`: The size of the array pointed to by the `pxTaskStatusArray` parameter. The size is specified as the number of indexes in the array, or the number of `TaskStatus_t` structures contained in the array, not by the number of bytes in the array.
- `pulTotalRunTime`: If `configGENERATE_RUN_TIME_STATS` is set to 1 in `FreeRTOSConfig.h` then `*pulTotalRunTime` is set by `uxTaskGetSystemState()` to the total run time (as defined by the run time stats clock, see <http://www.freertos.org/rtos-run-time-stats.html>) since the target booted. `pulTotalRunTime` can be set to `NULL` to omit the total run time information.

void **vTaskList** (char *pcWriteBuffer)

List all the current tasks.

`configUSE_TRACE_FACILITY` and `configUSE_STATS_FORMATTING_FUNCTIONS` must both be defined as 1 for this function to be available. See the configuration section of the [FreeRTOS.org](http://www.freertos.org) website for more information.

Lists all the current tasks, along with their current state and stack usage high water mark.

Note This function will disable interrupts for its duration. It is not intended for normal application runtime use but as a debug aid.

Tasks are reported as blocked ('B'), ready ('R'), deleted ('D') or suspended ('S').

`vTaskList()` calls `uxTaskGetSystemState()`, then formats part of the `uxTaskGetSystemState()` output into a human readable table that displays task names, states and stack usage.

Note This function is provided for convenience only, and is used by many of the demo applications. Do not consider it to be part of the scheduler.

`vTaskList()` has a dependency on the `sprintf()` C library function that might bloat the code size, use a lot of stack, and provide different results on different platforms. An alternative, tiny, third party, and limited functionality implementation of `sprintf()` is provided in many of the `FreeRTOS/Demo` sub-directories in a file called `printf-stdarg.c` (note `printf-stdarg.c` does not provide a full `snprintf()` implementation!).

It is recommended that production systems call `uxTaskGetSystemState()` directly to get access to raw stats data, rather than indirectly through a call to `vTaskList()`.

Parameters

- `pcWriteBuffer`: A buffer into which the above mentioned details will be written, in ASCII form. This buffer is assumed to be large enough to contain the generated report. Approximately 40 bytes per task should be sufficient.

void **vTaskGetRunTimeStats** (char *pcWriteBuffer)

Get the state of running tasks as a string

`configGENERATE_RUN_TIME_STATS` and `configUSE_STATS_FORMATTING_FUNCTIONS` must both be defined as 1 for this function to be available. The application must also then provide definitions for `portCONFIGURE_TIMER_FOR_RUN_TIME_STATS()` and `portGET_RUN_TIME_COUNTER_VALUE()` to configure a peripheral timer/counter and return the timers current count value respectively. The counter should be at least 10 times the frequency of the tick count.

Setting `configGENERATE_RUN_TIME_STATS` to 1 will result in a total accumulated execution time being stored for each task. The resolution of the accumulated time value depends on the frequency of the timer configured by the `portCONFIGURE_TIMER_FOR_RUN_TIME_STATS()` macro. Calling `vTaskGetRunTimeStats()` writes the total execution time of each task into a buffer, both as an absolute count value and as a percentage of the total system execution time.

Note This function will disable interrupts for its duration. It is not intended for normal application runtime use but as a debug aid.

`vTaskGetRunTimeStats()` calls `uxTaskGetSystemState()`, then formats part of the `uxTaskGetSystemState()` output into a human readable table that displays the amount of time each task has spent in the Running state in both absolute and percentage terms.

Note This function is provided for convenience only, and is used by many of the demo applications. Do not consider it to be part of the scheduler.

`vTaskGetRunTimeStats()` has a dependency on the `sprintf()` C library function that might bloat the code size, use a lot of stack, and provide different results on different platforms. An alternative, tiny, third party, and limited functionality implementation of `sprintf()` is provided in many of the FreeRTOS/Demo sub-directories in a file called `printf-stdarg.c` (note `printf-stdarg.c` does not provide a full `snprintf()` implementation!).

It is recommended that production systems call `uxTaskGetSystemState()` directly to get access to raw stats data, rather than indirectly through a call to `vTaskGetRunTimeStats()`.

Parameters

- `pcWriteBuffer`: A buffer into which the execution times will be written, in ASCII form. This buffer is assumed to be large enough to contain the generated report. Approximately 40 bytes per task should be sufficient.

`uint32_t ulTaskGetIdleRunTimeCounter` (void)

`configGENERATE_RUN_TIME_STATS` and `configUSE_STATS_FORMATTING_FUNCTIONS` must both be defined as 1 for this function to be available. The application must also then provide definitions for `portCONFIGURE_TIMER_FOR_RUN_TIME_STATS()` and `portGET_RUN_TIME_COUNTER_VALUE()` to configure a peripheral timer/counter and return the timers current count value respectively. The counter should be at least 10 times the frequency of the tick count.

Setting `configGENERATE_RUN_TIME_STATS` to 1 will result in a total accumulated execution time being stored for each task. The resolution of the accumulated time value depends on the frequency of the timer configured by the `portCONFIGURE_TIMER_FOR_RUN_TIME_STATS()` macro. While `uxTaskGetSystemState()` and `vTaskGetRunTimeStats()` writes the total execution time of each task into a buffer, `ulTaskGetIdleRunTimeCounter()` returns the total execution time of just the idle task.

Return The total run time of the idle task. This is the amount of time the idle task has actually been executing. The unit of time is dependent on the frequency configured using the `portCONFIGURE_TIMER_FOR_RUN_TIME_STATS()` and `portGET_RUN_TIME_COUNTER_VALUE()` macros.

`BaseType_t xTaskGenericNotify` (*TaskHandle_t xTaskToNotify*, `uint32_t ulValue`, *eNotifyAction eAction*, *uint32_t *pulPreviousNotificationValue*)

`configUSE_TASK_NOTIFICATIONS` must be undefined or defined as 1 for this function to be available.

When `configUSE_TASK_NOTIFICATIONS` is set to one each task has its own private “notification value”, which is a 32-bit unsigned integer (`uint32_t`).

Events can be sent to a task using an intermediary object. Examples of such objects are queues, semaphores, mutexes and event groups. Task notifications are a method of sending an event directly to a task without the need for such an intermediary object.

A notification sent to a task can optionally perform an action, such as update, overwrite or increment the task’s notification value. In that way task notifications can be used to send data to a task, or be used as light weight and fast binary or counting semaphores.

A notification sent to a task will remain pending until it is cleared by the task calling `xTaskNotifyWait()` or `ulTaskNotifyTake()`. If the task was already in the Blocked state to wait for a notification when the notification arrives then the task will automatically be removed from the Blocked state (unblocked) and the notification cleared.

A task can use `xTaskNotifyWait()` to [optionally] block to wait for a notification to be pending, or `ulTaskNotifyTake()` to [optionally] block to wait for its notification value to have a non-zero value. The task does not consume any CPU time while it is in the Blocked state.

See <http://www.FreeRTOS.org/RTOS-task-notifications.html> for details.

`eSetBits` - The task’s notification value is bitwise ORed with `ulValue`. `xTaskNotify()` always returns `pdPASS` in this case.

Parameters

- `xTaskToNotify`: The handle of the task being notified. The handle to a task can be returned from the `xTaskCreate()` API function used to create the task, and the handle of the currently running task can be obtained by calling `xTaskGetCurrentTaskHandle()`.
- `ulValue`: Data that can be sent with the notification. How the data is used depends on the value of the `eAction` parameter.
- `eAction`: Specifies how the notification updates the task's notification value, if at all. Valid values for `eAction` are as follows:

`eIncrement` - The task's notification value is incremented. `ulValue` is not used and `xTaskNotify()` always returns `pdPASS` in this case.

`eSetValueWithOverwrite` - The task's notification value is set to the value of `ulValue`, even if the task being notified had not yet processed the previous notification (the task already had a notification pending). `xTaskNotify()` always returns `pdPASS` in this case.

`eSetValueWithoutOverwrite` - If the task being notified did not already have a notification pending then the task's notification value is set to `ulValue` and `xTaskNotify()` will return `pdPASS`. If the task being notified already had a notification pending then no action is performed and `pdFAIL` is returned.

`eNoAction` - The task receives a notification without its notification value being updated. `ulValue` is not used and `xTaskNotify()` always returns `pdPASS` in this case.

Return Dependent on the value of `eAction`. See the description of the `eAction` parameter.

Parameters

- `pulPreviousNotificationValue`: Can be used to pass out the subject task's notification value before any bits are modified by the notify function.

`BaseType_t xTaskGenericNotifyFromISR` (*TaskHandle_t xTaskToNotify*, *uint32_t ulValue*, *eNotifyAction eAction*, *uint32_t *pulPreviousNotificationValue*, *BaseType_t *pxHigherPriorityTaskWoken*)

Send task notification from an ISR.

`configUSE_TASK_NOTIFICATIONS` must be undefined or defined as 1 for this function to be available.

When `configUSE_TASK_NOTIFICATIONS` is set to one each task has its own private "notification value", which is a 32-bit unsigned integer (`uint32_t`).

A version of `xTaskNotify()` that can be used from an interrupt service routine (ISR).

Events can be sent to a task using an intermediary object. Examples of such objects are queues, semaphores, mutexes and event groups. Task notifications are a method of sending an event directly to a task without the need for such an intermediary object.

A notification sent to a task can optionally perform an action, such as update, overwrite or increment the task's notification value. In that way task notifications can be used to send data to a task, or be used as light weight and fast binary or counting semaphores.

A notification sent to a task will remain pending until it is cleared by the task calling `xTaskNotifyWait()` or `ulTaskNotifyTake()`. If the task was already in the Blocked state to wait for a notification when the notification arrives then the task will automatically be removed from the Blocked state (unblocked) and the notification cleared.

A task can use `xTaskNotifyWait()` to [optionally] block to wait for a notification to be pending, or `ulTaskNotifyTake()` to [optionally] block to wait for its notification value to have a non-zero value. The task does not consume any CPU time while it is in the Blocked state.

See <http://www.FreeRTOS.org/RTOS-task-notifications.html> for details.

`eSetBits` - The task's notification value is bitwise ORed with `ulValue`. `xTaskNotify()` always returns `pdPASS` in this case.

Parameters

- `xTaskToNotify`: The handle of the task being notified. The handle to a task can be returned from the `xTaskCreate()` API function used to create the task, and the handle of the currently running task can be obtained by calling `xTaskGetCurrentTaskHandle()`.

- `ulValue`: Data that can be sent with the notification. How the data is used depends on the value of the `eAction` parameter.
- `eAction`: Specifies how the notification updates the task's notification value, if at all. Valid values for `eAction` are as follows:

`eIncrement` - The task's notification value is incremented. `ulValue` is not used and `xTaskNotify()` always returns `pdPASS` in this case.

`eSetValueWithOverwrite` - The task's notification value is set to the value of `ulValue`, even if the task being notified had not yet processed the previous notification (the task already had a notification pending). `xTaskNotify()` always returns `pdPASS` in this case.

`eSetValueWithoutOverwrite` - If the task being notified did not already have a notification pending then the task's notification value is set to `ulValue` and `xTaskNotify()` will return `pdPASS`. If the task being notified already had a notification pending then no action is performed and `pdFAIL` is returned.

`eNoAction` - The task receives a notification without its notification value being updated. `ulValue` is not used and `xTaskNotify()` always returns `pdPASS` in this case.

Return Dependent on the value of `eAction`. See the description of the `eAction` parameter.

Parameters

- `pulPreviousNotificationValue`: Can be used to pass out the subject task's notification value before any bits are modified by the notify function.
- `pxHigherPriorityTaskWoken`: `xTaskNotifyFromISR()` will set `*pxHigherPriorityTaskWoken` to `pdTRUE` if sending the notification caused the task to which the notification was sent to leave the Blocked state, and the unblocked task has a priority higher than the currently running task. If `xTaskNotifyFromISR()` sets this value to `pdTRUE` then a context switch should be requested before the interrupt is exited. How a context switch is requested from an ISR is dependent on the port - see the documentation page for the port in use.

`BaseType_t xTaskNotifyWait` (`uint32_t ulBitsToClearOnEntry`, `uint32_t ulBitsToClearOnExit`, `uint32_t *pulNotificationValue`, `TickType_t xTicksToWait`)

Wait for task notification

`configUSE_TASK_NOTIFICATIONS` must be undefined or defined as 1 for this function to be available.

When `configUSE_TASK_NOTIFICATIONS` is set to one each task has its own private "notification value", which is a 32-bit unsigned integer (`uint32_t`).

Events can be sent to a task using an intermediary object. Examples of such objects are queues, semaphores, mutexes and event groups. Task notifications are a method of sending an event directly to a task without the need for such an intermediary object.

A notification sent to a task can optionally perform an action, such as update, overwrite or increment the task's notification value. In that way task notifications can be used to send data to a task, or be used as light weight and fast binary or counting semaphores.

A notification sent to a task will remain pending until it is cleared by the task calling `xTaskNotifyWait()` or `ulTaskNotifyTake()`. If the task was already in the Blocked state to wait for a notification when the notification arrives then the task will automatically be removed from the Blocked state (unblocked) and the notification cleared.

A task can use `xTaskNotifyWait()` to [optionally] block to wait for a notification to be pending, or `ulTaskNotifyTake()` to [optionally] block to wait for its notification value to have a non-zero value. The task does not consume any CPU time while it is in the Blocked state.

See <http://www.FreeRTOS.org/RTOS-task-notifications.html> for details.

Return If a notification was received (including notifications that were already pending when `xTaskNotifyWait` was called) then `pdPASS` is returned. Otherwise `pdFAIL` is returned.

Parameters

- `ulBitsToClearOnEntry`: Bits that are set in `ulBitsToClearOnEntry` value will be cleared in the calling task's notification value before the task checks to see if any notifications are pending, and optionally blocks if no notifications are pending. Setting `ulBitsToClearOnEntry` to `ULONG_MAX` (if `limits.h` is included) or `0xffffffffUL` (if `limits.h` is not included) will have the effect of resetting the

task's notification value to 0. Setting `ulBitsToClearOnEntry` to 0 will leave the task's notification value unchanged.

- `ulBitsToClearOnExit`: If a notification is pending or received before the calling task exits the `xTaskNotifyWait()` function then the task's notification value (see the `xTaskNotify()` API function) is passed out using the `pulNotificationValue` parameter. Then any bits that are set in `ulBitsToClearOnExit` will be cleared in the task's notification value (note `*pulNotificationValue` is set before any bits are cleared). Setting `ulBitsToClearOnExit` to `ULONG_MAX` (if `limits.h` is included) or `0xffffffffUL` (if `limits.h` is not included) will have the effect of resetting the task's notification value to 0 before the function exits. Setting `ulBitsToClearOnExit` to 0 will leave the task's notification value unchanged when the function exits (in which case the value passed out in `pulNotificationValue` will match the task's notification value).
- `pulNotificationValue`: Used to pass the task's notification value out of the function. Note the value passed out will not be effected by the clearing of any bits caused by `ulBitsToClearOnExit` being non-zero.
- `xTicksToWait`: The maximum amount of time that the task should wait in the Blocked state for a notification to be received, should a notification not already be pending when `xTaskNotifyWait()` was called. The task will not consume any processing time while it is in the Blocked state. This is specified in kernel ticks, the macro `pdMS_TO_TICKS(value_in_ms)` can be used to convert a time specified in milliseconds to a time specified in ticks.

```
void vTaskNotifyGiveFromISR (TaskHandle_t xTaskToNotify, BaseType_t
                             *pxHigherPriorityTaskWoken)
```

Simplified macro for sending task notification from ISR.

`configUSE_TASK_NOTIFICATIONS` must be undefined or defined as 1 for this macro to be available.

When `configUSE_TASK_NOTIFICATIONS` is set to one each task has its own private “notification value”, which is a 32-bit unsigned integer (`uint32_t`).

A version of `xTaskNotifyGive()` that can be called from an interrupt service routine (ISR).

Events can be sent to a task using an intermediary object. Examples of such objects are queues, semaphores, mutexes and event groups. Task notifications are a method of sending an event directly to a task without the need for such an intermediary object.

A notification sent to a task can optionally perform an action, such as update, overwrite or increment the task's notification value. In that way task notifications can be used to send data to a task, or be used as light weight and fast binary or counting semaphores.

`vTaskNotifyGiveFromISR()` is intended for use when task notifications are used as light weight and faster binary or counting semaphore equivalents. Actual FreeRTOS semaphores are given from an ISR using the `xSemaphoreGiveFromISR()` API function, the equivalent action that instead uses a task notification is `vTaskNotifyGiveFromISR()`.

When task notifications are being used as a binary or counting semaphore equivalent then the task being notified should wait for the notification using the `ulTaskNotificationTake()` API function rather than the `xTaskNotifyWait()` API function.

See <http://www.FreeRTOS.org/RTOS-task-notifications.html> for more details.

Parameters

- `xTaskToNotify`: The handle of the task being notified. The handle to a task can be returned from the `xTaskCreate()` API function used to create the task, and the handle of the currently running task can be obtained by calling `xTaskGetCurrentTaskHandle()`.
- `pxHigherPriorityTaskWoken`: `vTaskNotifyGiveFromISR()` will set `*pxHigherPriorityTaskWoken` to `pdTRUE` if sending the notification caused the task to which the notification was sent to leave the Blocked state, and the unblocked task has a priority higher than the currently running task. If `vTaskNotifyGiveFromISR()` sets this value to `pdTRUE` then a context switch should be requested before the interrupt is exited. How a context switch is requested from an ISR is dependent on the port - see the documentation page for the port in use.

```
uint32_t ulTaskNotifyTake (BaseType_t xClearCountOnExit, TickType_t xTicksToWait)
```

Simplified macro for receiving task notification.

`configUSE_TASK_NOTIFICATIONS` must be undefined or defined as 1 for this function to be available.

When `configUSE_TASK_NOTIFICATIONS` is set to one each task has its own private “notification value”, which is a 32-bit unsigned integer (`uint32_t`).

Events can be sent to a task using an intermediary object. Examples of such objects are queues, semaphores, mutexes and event groups. Task notifications are a method of sending an event directly to a task without the need for such an intermediary object.

A notification sent to a task can optionally perform an action, such as update, overwrite or increment the task’s notification value. In that way task notifications can be used to send data to a task, or be used as light weight and fast binary or counting semaphores.

`ulTaskNotifyTake()` is intended for use when a task notification is used as a faster and lighter weight binary or counting semaphore alternative. Actual FreeRTOS semaphores are taken using the `xSemaphoreTake()` API function, the equivalent action that instead uses a task notification is `ulTaskNotifyTake()`.

When a task is using its notification value as a binary or counting semaphore other tasks should send notifications to it using the `xTaskNotifyGive()` macro, or `xTaskNotify()` function with the `eAction` parameter set to `eIncrement`.

`ulTaskNotifyTake()` can either clear the task’s notification value to zero on exit, in which case the notification value acts like a binary semaphore, or decrement the task’s notification value on exit, in which case the notification value acts like a counting semaphore.

A task can use `ulTaskNotifyTake()` to [optionally] block to wait for a the task’s notification value to be non-zero. The task does not consume any CPU time while it is in the Blocked state.

Where as `xTaskNotifyWait()` will return when a notification is pending, `ulTaskNotifyTake()` will return when the task’s notification value is not zero.

See <http://www.FreeRTOS.org/RTOS-task-notifications.html> for details.

Return The task’s notification count before it is either cleared to zero or decremented (see the `xClearCountOnExit` parameter).

Parameters

- `xClearCountOnExit`: if `xClearCountOnExit` is `pdFALSE` then the task’s notification value is decremented when the function exits. In this way the notification value acts like a counting semaphore. If `xClearCountOnExit` is not `pdFALSE` then the task’s notification value is cleared to zero when the function exits. In this way the notification value acts like a binary semaphore.
- `xTicksToWait`: The maximum amount of time that the task should wait in the Blocked state for the task’s notification value to be greater than zero, should the count not already be greater than zero when `ulTaskNotifyTake()` was called. The task will not consume any processing time while it is in the Blocked state. This is specified in kernel ticks, the macro `pdMS_TO_TICKS(value_in_ms)` can be used to convert a time specified in milliseconds to a time specified in ticks.

BaseType_t **xTaskNotifyStateClear** (*TaskHandle_t xTask*)

If the notification state of the task referenced by the handle `xTask` is `eNotified`, then set the task’s notification state to `eNotWaitingNotification`. The task’s notification value is not altered. Set `xTask` to `NULL` to clear the notification state of the calling task.

Return `pdTRUE` if the task’s notification state was set to `eNotWaitingNotification`, otherwise `pdFALSE`.

Macros

`tskKERNEL_VERSION_NUMBER`

`tskKERNEL_VERSION_MAJOR`

`tskKERNEL_VERSION_MINOR`

`tskKERNEL_VERSION_BUILD`

`tskMPU_REGION_READ_ONLY`

`tskMPU_REGION_READ_WRITE`

`tskMPU_REGION_EXECUTE_NEVER`

taskMPU_REGION_NORMAL_MEMORY

taskMPU_REGION_DEVICE_MEMORY

taskNO_AFFINITY

taskIDLE_PRIORITY

Defines the priority used by the idle task. This must not be modified.

taskYIELD ()

Macro for forcing a context switch.

taskENTER_CRITICAL (x)

Macro to mark the start of a critical code region. Preemptive context switches cannot occur when in a critical region.

Note This may alter the stack (depending on the portable implementation) so must be used with care!

taskENTER_CRITICAL_FROM_ISR ()

taskENTER_CRITICAL_ISR (mux)

taskEXIT_CRITICAL (x)

Macro to mark the end of a critical code region. Preemptive context switches cannot occur when in a critical region.

Note This may alter the stack (depending on the portable implementation) so must be used with care!

taskEXIT_CRITICAL_FROM_ISR (x)

taskEXIT_CRITICAL_ISR (mux)

taskDISABLE_INTERRUPTS ()

Macro to disable all maskable interrupts.

taskENABLE_INTERRUPTS ()

Macro to enable microcontroller interrupts.

taskSCHEDULER_SUSPENDED

taskSCHEDULER_NOT_STARTED

taskSCHEDULER_RUNNING

xTaskNotify (xTaskToNotify, ulValue, eAction)

xTaskNotifyAndQuery (xTaskToNotify, ulValue, eAction, pulPreviousNotifyValue)

xTaskNotifyFromISR (xTaskToNotify, ulValue, eAction, pxHigherPriorityTaskWoken)

xTaskNotifyAndQueryFromISR (xTaskToNotify, ulValue, eAction, pulPreviousNotificationValue, pxHigherPriorityTaskWoken)

xTaskNotifyGive (xTaskToNotify)

Simplified macro for sending task notification.

configUSE_TASK_NOTIFICATIONS must be undefined or defined as 1 for this macro to be available.

When configUSE_TASK_NOTIFICATIONS is set to one each task has its own private “notification value”, which is a 32-bit unsigned integer (uint32_t).

Events can be sent to a task using an intermediary object. Examples of such objects are queues, semaphores, mutexes and event groups. Task notifications are a method of sending an event directly to a task without the need for such an intermediary object.

A notification sent to a task can optionally perform an action, such as update, overwrite or increment the task’s notification value. In that way task notifications can be used to send data to a task, or be used as light weight and fast binary or counting semaphores.

xTaskNotifyGive() is a helper macro intended for use when task notifications are used as light weight and faster binary or counting semaphore equivalents. Actual FreeRTOS semaphores are given using the xSemaphoreGive() API function, the equivalent action that instead uses a task notification is xTaskNotifyGive().

When task notifications are being used as a binary or counting semaphore equivalent then the task being notified should wait for the notification using the `ulTaskNotificationTake()` API function rather than the `xTaskNotifyWait()` API function.

See <http://www.FreeRTOS.org/RTOS-task-notifications.html> for more details.

Return `xTaskNotifyGive()` is a macro that calls `xTaskNotify()` with the `eAction` parameter set to `eIncrement` - so `pdPASS` is always returned.

Parameters

- `xTaskToNotify`: The handle of the task being notified. The handle to a task can be returned from the `xTaskCreate()` API function used to create the task, and the handle of the currently running task can be obtained by calling `xTaskGetCurrentTaskHandle()`.

Type Definitions

```
typedef void *TaskHandle_t
```

```
typedef BaseType_t (*TaskHookFunction_t) (void *)
```

Defines the prototype to which the application task hook function must conform.

```
typedef void (*TlsDeleteCallbackFunction_t) (int, void *)
```

Prototype of local storage pointer deletion callback.

Enumerations

```
enum eTaskState
```

Task states returned by `eTaskGetState`.

Values:

```
eRunning = 0
```

```
eReady
```

```
eBlocked
```

```
eSuspended
```

```
eDeleted
```

```
eInvalid
```

```
enum eNotifyAction
```

Values:

```
eNoAction = 0
```

```
eSetBits
```

```
eIncrement
```

```
eSetValueWithOverwrite
```

```
eSetValueWithoutOverwrite
```

```
enum eSleepModeStatus
```

Possible return values for `eTaskConfirmSleepModeStatus()`.

Values:

```
eAbortSleep = 0
```

```
eStandardSleep
```

```
eNoTasksWaitingTimeout
```

Queue API

Header File

- [freertos/include/freertos/queue.h](#)

Functions

BaseType_t **xQueueGenericSendFromISR** (*QueueHandle_t* xQueue, **const** void ***const** pvItemToQueue, BaseType_t ***const** pxHigherPriorityTaskWoken, **const** BaseType_t xCopyPosition)

It is preferred that the macros `xQueueSendFromISR()`, `xQueueSendToFrontFromISR()` and `xQueueSendToBackFromISR()` be used in place of calling this function directly. `xQueueGiveFromISR()` is an equivalent for use by semaphores that don't actually copy any data.

Post an item on a queue. It is safe to use this function from within an interrupt service routine.

Items are queued by copy not reference so it is preferable to only queue small items, especially when called from an ISR. In most cases it would be preferable to store a pointer to the item being queued.

Example usage for buffered IO (where the ISR can obtain more than one value per call):

```
void vBufferISR( void )
{
char cIn;
BaseType_t xHigherPriorityTaskWokenByPost;

// We have not woken a task at the start of the ISR.
xHigherPriorityTaskWokenByPost = pdFALSE;

// Loop until the buffer is empty.
do
{
// Obtain a byte from the buffer.
cIn = portINPUT_BYTE( RX_REGISTER_ADDRESS );

// Post each byte.
xQueueGenericSendFromISR( xRxQueue, &cIn, &
→xHigherPriorityTaskWokenByPost, queueSEND_TO_BACK );

} while( portINPUT_BYTE( BUFFER_COUNT ) );

// Now the buffer is empty we can switch context if necessary. Note that_
→the
// name of the yield function required is port specific.
if( xHigherPriorityTaskWokenByPost )
{
taskYIELD_YIELD_FROM_ISR();
}
}
```

Return `pdTRUE` if the data was successfully sent to the queue, otherwise `errQUEUE_FULL`.

Parameters

- `xQueue`: The handle to the queue on which the item is to be posted.
- `pvItemToQueue`: A pointer to the item that is to be placed on the queue. The size of the items the queue will hold was defined when the queue was created, so this many bytes will be copied from `pvItemToQueue` into the queue storage area.
- [out] `pxHigherPriorityTaskWoken`: `xQueueGenericSendFromISR()` will set `*pxHigherPriorityTaskWoken` to `pdTRUE` if sending to the queue caused a task to unblock, and the unblocked task has a priority higher than the currently running task. If `xQueueGenericSendFromISR()` sets this value to `pdTRUE` then a context switch should be requested before the interrupt is exited.
- `xCopyPosition`: Can take the value `queueSEND_TO_BACK` to place the item at the back of the queue, or `queueSEND_TO_FRONT` to place the item at the front of the queue (for high priority

messages).

BaseType_t **xQueueGiveFromISR** (*QueueHandle_t* xQueue, BaseType_t *const pxHigherPriorityTaskWoken)

BaseType_t **xQueueGenericSend** (*QueueHandle_t* xQueue, const void *const pvItemToQueue, TickType_t xTicksToWait, const BaseType_t xCopyPosition)

It is preferred that the macros xQueueSend(), xQueueSendToFront() and xQueueSendToBack() are used in place of calling this function directly.

Post an item on a queue. The item is queued by copy, not by reference. This function must not be called from an interrupt service routine. See xQueueSendFromISR () for an alternative which may be used in an ISR.

Example usage:

```

struct AMessage
{
    char ucMessageID;
    char ucData[ 20 ];
} xMessage;

uint32_t ulVar = 10UL;

void vATask( void *pvParameters )
{
    QueueHandle_t xQueue1, xQueue2;
    struct AMessage *pxMessage;

    // Create a queue capable of containing 10 uint32_t values.
    xQueue1 = xQueueCreate( 10, sizeof( uint32_t ) );

    // Create a queue capable of containing 10 pointers to AMessage structures.
    // These should be passed by pointer as they contain a lot of data.
    xQueue2 = xQueueCreate( 10, sizeof( struct AMessage * ) );

    // ...

    if( xQueue1 != 0 )
    {
        // Send an uint32_t. Wait for 10 ticks for space to become
        // available if necessary.
        if( xQueueGenericSend( xQueue1, ( void * ) &ulVar, ( TickType_t ) 10,
        ↪queueSEND_TO_BACK ) != pdPASS )
        {
            // Failed to post the message, even after 10 ticks.
        }
    }

    if( xQueue2 != 0 )
    {
        // Send a pointer to a struct AMessage object. Don't block if the
        // queue is already full.
        pxMessage = & xMessage;
        xQueueGenericSend( xQueue2, ( void * ) &pxMessage, ( TickType_t ) 0,
        ↪queueSEND_TO_BACK );
    }

    // ... Rest of task code.
}

```

Return pdTRUE if the item was successfully posted, otherwise errQUEUE_FULL.

Parameters

- xQueue: The handle to the queue on which the item is to be posted.
- pvItemToQueue: A pointer to the item that is to be placed on the queue. The size of the items the queue will hold was defined when the queue was created, so this many bytes will be copied from

pvItemToQueue into the queue storage area.

- `xTicksToWait`: The maximum amount of time the task should block waiting for space to become available on the queue, should it already be full. The call will return immediately if this is set to 0 and the queue is full. The time is defined in tick periods so the constant `portTICK_PERIOD_MS` should be used to convert to real time if this is required.
- `xCopyPosition`: Can take the value `queueSEND_TO_BACK` to place the item at the back of the queue, or `queueSEND_TO_FRONT` to place the item at the front of the queue (for high priority messages).

BaseType_t **xQueuePeek** (*QueueHandle_t* xQueue, void *const pvBuffer, TickType_t xTicksToWait)

Receive an item from a queue without removing the item from the queue. The item is received by copy so a buffer of adequate size must be provided. The number of bytes copied into the buffer was defined when the queue was created.

Successfully received items remain on the queue so will be returned again by the next call, or a call to `xQueueReceive()`.

This macro must not be used in an interrupt service routine. See `xQueuePeekFromISR()` for an alternative that can be called from an interrupt service routine.

Example usage:

```

struct AMessage
{
    char ucMessageID;
    char ucData[ 20 ];
} xMessage;

QueueHandle_t xQueue;

// Task to create a queue and post a value.
void vATask( void *pvParameters )
{
    struct AMessage *pxMessage;

    // Create a queue capable of containing 10 pointers to AMessage structures.
    // These should be passed by pointer as they contain a lot of data.
    xQueue = xQueueCreate( 10, sizeof( struct AMessage * ) );
    if( xQueue == 0 )
    {
        // Failed to create the queue.
    }

    // ...

    // Send a pointer to a struct AMessage object. Don't block if the
    // queue is already full.
    pxMessage = & xMessage;
    xQueueSend( xQueue, ( void * ) &pxMessage, ( TickType_t ) 0 );

    // ... Rest of task code.
}

// Task to peek the data from the queue.
void vADifferentTask( void *pvParameters )
{
    struct AMessage *pRxedMessage;

    if( xQueue != 0 )
    {
        // Peek a message on the created queue. Block for 10 ticks if a
        // message is not immediately available.
        if( xQueuePeek( xQueue, & pRxedMessage ), ( TickType_t ) 10 )

```

(continues on next page)

(continued from previous page)

```

    {
        // pcRxedMessage now points to the struct AMessage variable posted
        // by vATask, but the item still remains on the queue.
    }
}

// ... Rest of task code.
}

```

Return pdTRUE if an item was successfully received from the queue, otherwise pdFALSE.

Parameters

- `xQueue`: The handle to the queue from which the item is to be received.
- `pvBuffer`: Pointer to the buffer into which the received item will be copied.
- `xTicksToWait`: The maximum amount of time the task should block waiting for an item to receive should the queue be empty at the time of the call. The time is defined in tick periods so the constant `portTICK_PERIOD_MS` should be used to convert to real time if this is required. `xQueuePeek()` will return immediately if `xTicksToWait` is 0 and the queue is empty.

BaseType_t **xQueuePeekFromISR** (*QueueHandle_t* `xQueue`, void ***const** `pvBuffer`)

A version of `xQueuePeek()` that can be called from an interrupt service routine (ISR).

Receive an item from a queue without removing the item from the queue. The item is received by copy so a buffer of adequate size must be provided. The number of bytes copied into the buffer was defined when the queue was created.

Successfully received items remain on the queue so will be returned again by the next call, or a call to `xQueueReceive()`.

Return pdTRUE if an item was successfully received from the queue, otherwise pdFALSE.

Parameters

- `xQueue`: The handle to the queue from which the item is to be received.
- `pvBuffer`: Pointer to the buffer into which the received item will be copied.

BaseType_t **xQueueReceive** (*QueueHandle_t* `xQueue`, void ***const** `pvBuffer`, TickType_t `xTicksToWait`)

Receive an item from a queue. The item is received by copy so a buffer of adequate size must be provided. The number of bytes copied into the buffer was defined when the queue was created.

Successfully received items are removed from the queue.

This function must not be used in an interrupt service routine. See `xQueueReceiveFromISR` for an alternative that can.

Example usage:

```

struct AMessage
{
    char ucMessageID;
    char ucData[ 20 ];
} xMessage;

QueueHandle_t xQueue;

// Task to create a queue and post a value.
void vATask( void *pvParameters )
{
    struct AMessage *pxMessage;

    // Create a queue capable of containing 10 pointers to AMessage structures.
    // These should be passed by pointer as they contain a lot of data.
    xQueue = xQueueCreate( 10, sizeof( struct AMessage * ) );
    if( xQueue == 0 )
    {

```

(continues on next page)

(continued from previous page)

```

        // Failed to create the queue.
    }

    // ...

    // Send a pointer to a struct AMessage object. Don't block if the
    // queue is already full.
    pxMessage = & xMessage;
    xQueueSend( xQueue, ( void * ) &pxMessage, ( TickType_t ) 0 );

    // ... Rest of task code.
}

// Task to receive from the queue.
void vADifferentTask( void *pvParameters )
{
    struct AMessage *pxRxdMessage;

    if( xQueue != 0 )
    {
        // Receive a message on the created queue. Block for 10 ticks if a
        // message is not immediately available.
        if( xQueueReceive( xQueue, &( pxRxdMessage ), ( TickType_t ) 10 ) )
        {
            // pxRxdMessage now points to the struct AMessage variable posted
            // by vATask.
        }
    }

    // ... Rest of task code.
}

```

Return pdTRUE if an item was successfully received from the queue, otherwise pdFALSE.

Parameters

- xQueue: The handle to the queue from which the item is to be received.
- pvBuffer: Pointer to the buffer into which the received item will be copied.
- xTicksToWait: The maximum amount of time the task should block waiting for an item to receive should the queue be empty at the time of the call. xQueueReceive() will return immediately if xTicksToWait is zero and the queue is empty. The time is defined in tick periods so the constant portTICK_PERIOD_MS should be used to convert to real time if this is required.

UBaseType_t **uxQueueMessagesWaiting**(const [QueueHandle_t](#) xQueue)

Return the number of messages stored in a queue.

Return The number of messages available in the queue.

Parameters

- xQueue: A handle to the queue being queried.

UBaseType_t **uxQueueSpacesAvailable**(const [QueueHandle_t](#) xQueue)

Return the number of free spaces available in a queue. This is equal to the number of items that can be sent to the queue before the queue becomes full if no items are removed.

Return The number of spaces available in the queue.

Parameters

- xQueue: A handle to the queue being queried.

void **vQueueDelete**([QueueHandle_t](#) xQueue)

Delete a queue - freeing all the memory allocated for storing of items placed on the queue.

Parameters

- xQueue: A handle to the queue to be deleted.

BaseType_t **xQueueReceiveFromISR** (*QueueHandle_t* xQueue, void ***const** pvBuffer, BaseType_t ***const** pxHigherPriorityTaskWoken)

Receive an item from a queue. It is safe to use this function from within an interrupt service routine.

Example usage:

```
QueueHandle_t xQueue;

// Function to create a queue and post some values.
void vAFunction( void *pvParameters )
{
    char cValueToPost;
    const TickType_t xTicksToWait = ( TickType_t )0xff;

    // Create a queue capable of containing 10 characters.
    xQueue = xQueueCreate( 10, sizeof( char ) );
    if( xQueue == 0 )
    {
        // Failed to create the queue.
    }

    // ...

    // Post some characters that will be used within an ISR.  If the queue
    // is full then this task will block for xTicksToWait ticks.
    cValueToPost = 'a';
    xQueueSend( xQueue, ( void * ) &cValueToPost, xTicksToWait );
    cValueToPost = 'b';
    xQueueSend( xQueue, ( void * ) &cValueToPost, xTicksToWait );

    // ... keep posting characters ... this task may block when the queue
    // becomes full.

    cValueToPost = 'c';
    xQueueSend( xQueue, ( void * ) &cValueToPost, xTicksToWait );
}

// ISR that outputs all the characters received on the queue.
void vISR_Routine( void )
{
    BaseType_t xTaskWokenByReceive = pdFALSE;
    char cRxdChar;

    while( xQueueReceiveFromISR( xQueue, ( void * ) &cRxdChar, &
    ↪xTaskWokenByReceive) )
    {
        // A character was received.  Output the character now.
        vOutputCharacter( cRxdChar );

        // If removing the character from the queue woke the task that was
        // posting onto the queue cTaskWokenByReceive will have been set to
        // pdTRUE.  No matter how many times this loop iterates only one
        // task will be woken.
    }

    if( cTaskWokenByPost != ( char ) pdFALSE;
    {
        taskYIELD ();
    }
}
}
```

Return pdTRUE if an item was successfully received from the queue, otherwise pdFALSE.

Parameters

- `xQueue`: The handle to the queue from which the item is to be received.
- `pvBuffer`: Pointer to the buffer into which the received item will be copied.
- `[out] pxHigherPriorityTaskWoken`: A task may be blocked waiting for space to become available on the queue. If `xQueueReceiveFromISR` causes such a task to unblock `*pxTaskWoken` will get set to `pdTRUE`, otherwise `*pxTaskWoken` will remain unchanged.

`BaseType_t xQueueIsQueueEmptyFromISR (const QueueHandle_t xQueue)`

`BaseType_t xQueueIsQueueFullFromISR (const QueueHandle_t xQueue)`

`UBaseType_t uxQueueMessagesWaitingFromISR (const QueueHandle_t xQueue)`

`void vQueueAddToRegistry (QueueHandle_t xQueue, const char *pcQueueName)`

The registry is provided as a means for kernel aware debuggers to locate queues, semaphores and mutexes. Call `vQueueAddToRegistry()` add a queue, semaphore or mutex handle to the registry if you want the handle to be available to a kernel aware debugger. If you are not using a kernel aware debugger then this function can be ignored.

`configQUEUE_REGISTRY_SIZE` defines the maximum number of handles the registry can hold. `configQUEUE_REGISTRY_SIZE` must be greater than 0 within `FreeRTOSConfig.h` for the registry to be available. Its value does not effect the number of queues, semaphores and mutexes that can be created - just the number that the registry can hold.

Parameters

- `xQueue`: The handle of the queue being added to the registry. This is the handle returned by a call to `xQueueCreate()`. Semaphore and mutex handles can also be passed in here.
- `pcQueueName`: The name to be associated with the handle. This is the name that the kernel aware debugger will display. The queue registry only stores a pointer to the string - so the string must be persistent (global or preferably in ROM/Flash), not on the stack.

`void vQueueUnregisterQueue (QueueHandle_t xQueue)`

lint !e971 Unqualified char types are allowed for strings and single characters only. The registry is provided as a means for kernel aware debuggers to locate queues, semaphores and mutexes. Call `vQueueAddToRegistry()` add a queue, semaphore or mutex handle to the registry if you want the handle to be available to a kernel aware debugger, and `vQueueUnregisterQueue()` to remove the queue, semaphore or mutex from the register. If you are not using a kernel aware debugger then this function can be ignored.

Parameters

- `xQueue`: The handle of the queue being removed from the registry.

`const char *pcQueueGetName (QueueHandle_t xQueue)`

The queue registry is provided as a means for kernel aware debuggers to locate queues, semaphores and mutexes. Call `pcQueueGetName()` to look up and return the name of a queue in the queue registry from the queue's handle.

Return If the queue is in the registry then a pointer to the name of the queue is returned. If the queue is not in the registry then `NULL` is returned.

Parameters

- `xQueue`: The handle of the queue the name of which will be returned.

`QueueHandle_t xQueueGenericCreate (const UBaseType_t uxQueueLength, const UBaseType_t uxItemSize, const uint8_t ucQueueType)`

lint !e971 Unqualified char types are allowed for strings and single characters only. Generic version of the function used to create a queue using dynamic memory allocation. This is called by other functions and macros that create other RTOS objects that use the queue structure as their base.

`QueueHandle_t xQueueGenericCreateStatic (const UBaseType_t uxQueueLength, const UBaseType_t uxItemSize, uint8_t *pucQueueStorage, StaticQueue_t *pxStaticQueue, const uint8_t ucQueueType)`

Generic version of the function used to create a queue using dynamic memory allocation. This is called by other functions and macros that create other RTOS objects that use the queue structure as their base.

`QueueSetHandle_t xQueueCreateSet (const UBaseType_t uxEventQueueLength)`

Queue sets provide a mechanism to allow a task to block (pend) on a read operation from multiple queues or

semaphores simultaneously.

See FreeRTOS/Source/Demo/Common/Minimal/QueueSet.c for an example using this function.

A queue set must be explicitly created using a call to `xQueueCreateSet()` before it can be used. Once created, standard FreeRTOS queues and semaphores can be added to the set using calls to `xQueueAddToSet()`. `xQueueSelectFromSet()` is then used to determine which, if any, of the queues or semaphores contained in the set is in a state where a queue read or semaphore take operation would be successful.

Note 1: See the documentation on <http://www.FreeRTOS.org/RTOS-queue-sets.html> for reasons why queue sets are very rarely needed in practice as there are simpler methods of blocking on multiple objects.

Note 2: Blocking on a queue set that contains a mutex will not cause the mutex holder to inherit the priority of the blocked task.

Note 3: An additional 4 bytes of RAM is required for each space in a every queue added to a queue set. Therefore counting semaphores that have a high maximum count value should not be added to a queue set.

Note 4: A receive (in the case of a queue) or take (in the case of a semaphore) operation must not be performed on a member of a queue set unless a call to `xQueueSelectFromSet()` has first returned a handle to that set member.

Return If the queue set is created successfully then a handle to the created queue set is returned. Otherwise NULL is returned.

Parameters

- `uxEventQueueLength`: Queue sets store events that occur on the queues and semaphores contained in the set. `uxEventQueueLength` specifies the maximum number of events that can be queued at once. To be absolutely certain that events are not lost `uxEventQueueLength` should be set to the total sum of the length of the queues added to the set, where binary semaphores and mutexes have a length of 1, and counting semaphores have a length set by their maximum count value. Examples:
 - If a queue set is to hold a queue of length 5, another queue of length 12, and a binary semaphore, then `uxEventQueueLength` should be set to $(5 + 12 + 1)$, or 18.
 - If a queue set is to hold three binary semaphores then `uxEventQueueLength` should be set to $(1 + 1 + 1)$, or 3.
 - If a queue set is to hold a counting semaphore that has a maximum count of 5, and a counting semaphore that has a maximum count of 3, then `uxEventQueueLength` should be set to $(5 + 3)$, or 8.

BaseType_t **xQueueAddToSet** (*QueueSetMemberHandle_t* *xQueueOrSemaphore*, *QueueSetHandle_t* *xQueueSet*)

Adds a queue or semaphore to a queue set that was previously created by a call to `xQueueCreateSet()`.

See FreeRTOS/Source/Demo/Common/Minimal/QueueSet.c for an example using this function.

Note 1: A receive (in the case of a queue) or take (in the case of a semaphore) operation must not be performed on a member of a queue set unless a call to `xQueueSelectFromSet()` has first returned a handle to that set member.

Return If the queue or semaphore was successfully added to the queue set then `pdPASS` is returned. If the queue could not be successfully added to the queue set because it is already a member of a different queue set then `pdFAIL` is returned.

Parameters

- `xQueueOrSemaphore`: The handle of the queue or semaphore being added to the queue set (cast to an `QueueSetMemberHandle_t` type).
- `xQueueSet`: The handle of the queue set to which the queue or semaphore is being added.

BaseType_t **xQueueRemoveFromSet** (*QueueSetMemberHandle_t* *xQueueOrSemaphore*, *QueueSetHandle_t* *xQueueSet*)

Removes a queue or semaphore from a queue set. A queue or semaphore can only be removed from a set if the queue or semaphore is empty.

See FreeRTOS/Source/Demo/Common/Minimal/QueueSet.c for an example using this function.

Return If the queue or semaphore was successfully removed from the queue set then `pdPASS` is returned. If the queue was not in the queue set, or the queue (or semaphore) was not empty, then `pdFAIL` is returned.

Parameters

- `xQueueOrSemaphore`: The handle of the queue or semaphore being removed from the queue set (cast to an `QueueSetMemberHandle_t` type).
- `xQueueSet`: The handle of the queue set in which the queue or semaphore is included.

QueueSetMemberHandle_t **xQueueSelectFromSet** (*QueueSetHandle_t* *xQueueSet*, **const** *TickType_t* *xTicksToWait*)

`xQueueSelectFromSet()` selects from the members of a queue set a queue or semaphore that either contains data (in the case of a queue) or is available to take (in the case of a semaphore). `xQueueSelectFromSet()` effectively allows a task to block (pend) on a read operation on all the queues and semaphores in a queue set simultaneously.

See `FreeRTOS/Source/Demo/Common/Minimal/QueueSet.c` for an example using this function.

Note 1: See the documentation on <http://www.FreeRTOS.org/RTOS-queue-sets.html> for reasons why queue sets are very rarely needed in practice as there are simpler methods of blocking on multiple objects.

Note 2: Blocking on a queue set that contains a mutex will not cause the mutex holder to inherit the priority of the blocked task.

Note 3: A receive (in the case of a queue) or take (in the case of a semaphore) operation must not be performed on a member of a queue set unless a call to `xQueueSelectFromSet()` has first returned a handle to that set member.

Return `xQueueSelectFromSet()` will return the handle of a queue (cast to a `QueueSetMemberHandle_t` type) contained in the queue set that contains data, or the handle of a semaphore (cast to a `QueueSetMemberHandle_t` type) contained in the queue set that is available, or `NULL` if no such queue or semaphore exists before the specified block time expires.

Parameters

- `xQueueSet`: The queue set on which the task will (potentially) block.
- `xTicksToWait`: The maximum time, in ticks, that the calling task will remain in the Blocked state (with other tasks executing) to wait for a member of the queue set to be ready for a successful queue read or semaphore take operation.

QueueSetMemberHandle_t **xQueueSelectFromSetFromISR** (*QueueSetHandle_t* *xQueueSet*)

A version of `xQueueSelectFromSet()` that can be used from an ISR.

Macros

xQueueCreate (`uxQueueLength`, `uxItemSize`)

Creates a new queue instance. This allocates the storage required by the new queue and returns a handle for the queue.

Example usage:

```
struct AMessage
{
    char ucMessageID;
    char ucData[ 20 ];
};

void vATask( void *pvParameters )
{
    QueueHandle_t xQueue1, xQueue2;

    // Create a queue capable of containing 10 uint32_t values.
    xQueue1 = xQueueCreate( 10, sizeof( uint32_t ) );
    if( xQueue1 == 0 )
    {
        // Queue was not created and must not be used.
    }

    // Create a queue capable of containing 10 pointers to AMessage structures.
    // These should be passed by pointer as they contain a lot of data.
```

(continues on next page)

(continued from previous page)

```
xQueue2 = xQueueCreate( 10, sizeof( struct AMessage * ) );
if( xQueue2 == 0 )
{
    // Queue was not created and must not be used.
}

// ... Rest of task code.
}
```

Return If the queue is successfully create then a handle to the newly created queue is returned. If the queue cannot be created then 0 is returned.

Parameters

- `uxQueueLength`: The maximum number of items that the queue can contain.
- `uxItemSize`: The number of bytes each item in the queue will require. Items are queued by copy, not by reference, so this is the number of bytes that will be copied for each posted item. Each item on the queue must be the same size.

xQueueCreateStatic (`uxQueueLength`, `uxItemSize`, `pucQueueStorage`, `pxQueueBuffer`)

Creates a new queue instance, and returns a handle by which the new queue can be referenced.

Internally, within the FreeRTOS implementation, queues use two blocks of memory. The first block is used to hold the queue's data structures. The second block is used to hold items placed into the queue. If a queue is created using `xQueueCreate()` then both blocks of memory are automatically dynamically allocated inside the `xQueueCreate()` function. (see <http://www.freertos.org/a00111.html>). If a queue is created using `xQueueCreateStatic()` then the application writer must provide the memory that will get used by the queue. `xQueueCreateStatic()` therefore allows a queue to be created without using any dynamic memory allocation.

<http://www.FreeRTOS.org/Embedded-RTOS-Queues.html>

Example usage:

```
struct AMessage
{
    char ucMessageID;
    char ucData[ 20 ];
};

#define QUEUE_LENGTH 10
#define ITEM_SIZE sizeof( uint32_t )

// xQueueBuffer will hold the queue structure.
StaticQueue_t xQueueBuffer;

// ucQueueStorage will hold the items posted to the queue. Must be at least
// [(queue length) * ( queue item size)] bytes long.
uint8_t ucQueueStorage[ QUEUE_LENGTH * ITEM_SIZE ];

void vATask( void *pvParameters )
{
    QueueHandle_t xQueue1;

    // Create a queue capable of containing 10 uint32_t values.
    xQueue1 = xQueueCreate( QUEUE_LENGTH, // The number of items the queue can
    →hold.
                            ITEM_SIZE // The size of each item in the queue
    →hold the items in the queue.
                            &( ucQueueStorage[ 0 ] ), // The buffer that will
    →queue structure.
                            &xQueueBuffer ); // The buffer that will hold the

    // The queue is guaranteed to be created successfully as no dynamic memory
    // allocation is used. Therefore xQueue1 is now a handle to a valid queue.
```

(continues on next page)

(continued from previous page)

```
// ... Rest of task code.
}
```

Return If the queue is created then a handle to the created queue is returned. If `pxQueueBuffer` is `NULL` then `NULL` is returned.

Parameters

- `uxQueueLength`: The maximum number of items that the queue can contain.
- `uxItemSize`: The number of bytes each item in the queue will require. Items are queued by copy, not by reference, so this is the number of bytes that will be copied for each posted item. Each item on the queue must be the same size.
- `pucQueueStorage`: If `uxItemSize` is not zero then `pucQueueStorageBuffer` must point to a `uint8_t` array that is at least large enough to hold the maximum number of items that can be in the queue at any one time - which is $(uxQueueLength * uxItemSize)$ bytes. If `uxItemSize` is zero then `pucQueueStorageBuffer` can be `NULL`.
- `pxQueueBuffer`: Must point to a variable of type `StaticQueue_t`, which will be used to hold the queue's data structure.

xQueueSendToFront (xQueue, pvItemToQueue, xTicksToWait)

Post an item to the front of a queue. The item is queued by copy, not by reference. This function must not be called from an interrupt service routine. See `xQueueSendFromISR()` for an alternative which may be used in an ISR.

Example usage:

```
struct AMessage
{
char ucMessageID;
char ucData[ 20 ];
} xMessage;

uint32_t ulVar = 10UL;

void vATask( void *pvParameters )
{
QueueHandle_t xQueue1, xQueue2;
struct AMessage *pxMessage;

// Create a queue capable of containing 10 uint32_t values.
xQueue1 = xQueueCreate( 10, sizeof( uint32_t ) );

// Create a queue capable of containing 10 pointers to AMessage structures.
// These should be passed by pointer as they contain a lot of data.
xQueue2 = xQueueCreate( 10, sizeof( struct AMessage * ) );

// ...

if( xQueue1 != 0 )
{
// Send an uint32_t. Wait for 10 ticks for space to become
// available if necessary.
if( xQueueSendToFront( xQueue1, ( void * ) &ulVar, ( TickType_t ) 10 ) != pdPASS )
{
// Failed to post the message, even after 10 ticks.
}
}

if( xQueue2 != 0 )
{
```

(continues on next page)

(continued from previous page)

```

// Send a pointer to a struct AMessage object. Don't block if the
// queue is already full.
pxMessage = & xMessage;
xQueueSendToFront( xQueue2, ( void * ) &pxMessage, ( TickType_t ) 0 );
}

// ... Rest of task code.
}

```

Return pdTRUE if the item was successfully posted, otherwise errQUEUE_FULL.

Parameters

- **xQueue**: The handle to the queue on which the item is to be posted.
- **pvItemToQueue**: A pointer to the item that is to be placed on the queue. The size of the items the queue will hold was defined when the queue was created, so this many bytes will be copied from pvItemToQueue into the queue storage area.
- **xTicksToWait**: The maximum amount of time the task should block waiting for space to become available on the queue, should it already be full. The call will return immediately if this is set to 0 and the queue is full. The time is defined in tick periods so the constant portTICK_PERIOD_MS should be used to convert to real time if this is required.

xQueueSendToBack (xQueue, pvItemToQueue, xTicksToWait)

This is a macro that calls xQueueGenericSend().

Post an item to the back of a queue. The item is queued by copy, not by reference. This function must not be called from an interrupt service routine. See xQueueSendFromISR () for an alternative which may be used in an ISR.

Example usage:

```

struct AMessage
{
char ucMessageID;
char ucData[ 20 ];
} xMessage;

uint32_t ulVar = 10UL;

void vATask( void *pvParameters )
{
QueueHandle_t xQueue1, xQueue2;
struct AMessage *pxMessage;

// Create a queue capable of containing 10 uint32_t values.
xQueue1 = xQueueCreate( 10, sizeof( uint32_t ) );

// Create a queue capable of containing 10 pointers to AMessage structures.
// These should be passed by pointer as they contain a lot of data.
xQueue2 = xQueueCreate( 10, sizeof( struct AMessage * ) );

// ...

if( xQueue1 != 0 )
{
// Send an uint32_t. Wait for 10 ticks for space to become
// available if necessary.
if( xQueueSendToBack( xQueue1, ( void * ) &ulVar, ( TickType_t ) 10 ) != pdPASS )
{
// Failed to post the message, even after 10 ticks.
}
}
}

```

(continues on next page)

(continued from previous page)

```

if( xQueue2 != 0 )
{
    // Send a pointer to a struct AMessage object. Don't block if the
    // queue is already full.
    pxMessage = & xMessage;
    xQueueSendToBack( xQueue2, ( void * ) &pxMessage, ( TickType_t ) 0 );
}

// ... Rest of task code.
}

```

Return pdTRUE if the item was successfully posted, otherwise errQUEUE_FULL.

Parameters

- **xQueue**: The handle to the queue on which the item is to be posted.
- **pvItemToQueue**: A pointer to the item that is to be placed on the queue. The size of the items the queue will hold was defined when the queue was created, so this many bytes will be copied from pvItemToQueue into the queue storage area.
- **xTicksToWait**: The maximum amount of time the task should block waiting for space to become available on the queue, should it already be full. The call will return immediately if this is set to 0 and the queue is full. The time is defined in tick periods so the constant portTICK_PERIOD_MS should be used to convert to real time if this is required.

xQueueSend (xQueue, pvItemToQueue, xTicksToWait)

This is a macro that calls xQueueGenericSend(). It is included for backward compatibility with versions of FreeRTOS.org that did not include the xQueueSendToFront() and xQueueSendToBack() macros. It is equivalent to xQueueSendToBack().

Post an item on a queue. The item is queued by copy, not by reference. This function must not be called from an interrupt service routine. See xQueueSendFromISR () for an alternative which may be used in an ISR.

Example usage:

```

struct AMessage
{
    char ucMessageID;
    char ucData[ 20 ];
} xMessage;

uint32_t ulVar = 10UL;

void vATask( void *pvParameters )
{
    QueueHandle_t xQueue1, xQueue2;
    struct AMessage *pxMessage;

    // Create a queue capable of containing 10 uint32_t values.
    xQueue1 = xQueueCreate( 10, sizeof( uint32_t ) );

    // Create a queue capable of containing 10 pointers to AMessage structures.
    // These should be passed by pointer as they contain a lot of data.
    xQueue2 = xQueueCreate( 10, sizeof( struct AMessage * ) );

    // ...

    if( xQueue1 != 0 )
    {
        // Send an uint32_t. Wait for 10 ticks for space to become
        // available if necessary.
        if( xQueueSend( xQueue1, ( void * ) &ulVar, ( TickType_t ) 10 ) != pdPASS )
        {

```

(continues on next page)

(continued from previous page)

```

        // Failed to post the message, even after 10 ticks.
    }
}

if( xQueue2 != 0 )
{
    // Send a pointer to a struct AMessage object. Don't block if the
    // queue is already full.
    pxMessage = & xMessage;
    xQueueSend( xQueue2, ( void * ) &pxMessage, ( TickType_t ) 0 );
}

// ... Rest of task code.
}

```

Return pdTRUE if the item was successfully posted, otherwise errQUEUE_FULL.

Parameters

- **xQueue**: The handle to the queue on which the item is to be posted.
- **pvItemToQueue**: A pointer to the item that is to be placed on the queue. The size of the items the queue will hold was defined when the queue was created, so this many bytes will be copied from **pvItemToQueue** into the queue storage area.
- **xTicksToWait**: The maximum amount of time the task should block waiting for space to become available on the queue, should it already be full. The call will return immediately if this is set to 0 and the queue is full. The time is defined in tick periods so the constant portTICK_PERIOD_MS should be used to convert to real time if this is required.

xQueueOverwrite (xQueue, pvItemToQueue)

Only for use with queues that have a length of one - so the queue is either empty or full.

Post an item on a queue. If the queue is already full then overwrite the value held in the queue. The item is queued by copy, not by reference.

This function must not be called from an interrupt service routine. See **xQueueOverwriteFromISR** () for an alternative which may be used in an ISR.

Example usage:

```

void vFunction( void *pvParameters )
{
    QueueHandle_t xQueue;
    uint32_t ulVarToSend, ulValReceived;

    // Create a queue to hold one uint32_t value. It is strongly
    // recommended not to use xQueueOverwrite() on queues that can
    // contain more than one value, and doing so will trigger an assertion
    // if configASSERT() is defined.
    xQueue = xQueueCreate( 1, sizeof( uint32_t ) );

    // Write the value 10 to the queue using xQueueOverwrite().
    ulVarToSend = 10;
    xQueueOverwrite( xQueue, &ulVarToSend );

    // Peeking the queue should now return 10, but leave the value 10 in
    // the queue. A block time of zero is used as it is known that the
    // queue holds a value.
    ulValReceived = 0;
    xQueuePeek( xQueue, &ulValReceived, 0 );

    if( ulValReceived != 10 )
    {
        // Error unless the item was removed by a different task.
    }
}

```

(continues on next page)

(continued from previous page)

```

}

// The queue is still full. Use xQueueOverwrite() to overwrite the
// value held in the queue with 100.
ulVarToSend = 100;
xQueueOverwrite( xQueue, &ulVarToSend );

// This time read from the queue, leaving the queue empty once more.
// A block time of 0 is used again.
xQueueReceive( xQueue, &ulValReceived, 0 );

// The value read should be the last value written, even though the
// queue was already full when the value was written.
if( ulValReceived != 100 )
{
    // Error!
}

// ...
}

```

Return `xQueueOverwrite()` is a macro that calls `xQueueGenericSend()`, and therefore has the same return values as `xQueueSendToFront()`. However, `pdPASS` is the only value that can be returned because `xQueueOverwrite()` will write to the queue even when the queue is already full.

Parameters

- `xQueue`: The handle of the queue to which the data is being sent.
- `pvItemToQueue`: A pointer to the item that is to be placed on the queue. The size of the items the queue will hold was defined when the queue was created, so this many bytes will be copied from `pvItemToQueue` into the queue storage area.

xQueueSendToFrontFromISR (`xQueue`, `pvItemToQueue`, `pxHigherPriorityTaskWoken`)

This is a macro that calls `xQueueGenericSendFromISR()`.

Post an item to the front of a queue. It is safe to use this macro from within an interrupt service routine.

Items are queued by copy not reference so it is preferable to only queue small items, especially when called from an ISR. In most cases it would be preferable to store a pointer to the item being queued.

Example usage for buffered IO (where the ISR can obtain more than one value per call):

```

void vBufferISR( void )
{
    char cIn;
    BaseType_t xHigherPriorityTaskWoken;

    // We have not woken a task at the start of the ISR.
    xHigherPriorityTaskWoken = pdFALSE;

    // Loop until the buffer is empty.
    do
    {
        // Obtain a byte from the buffer.
        cIn = portINPUT_BYTE( RX_REGISTER_ADDRESS );

        // Post the byte.
        xQueueSendToFrontFromISR( xRxQueue, &cIn, &xHigherPriorityTaskWoken );

    } while( portINPUT_BYTE( BUFFER_COUNT ) );

    // Now the buffer is empty we can switch context if necessary.
    if( xHigherPriorityTaskWoken )
    {

```

(continues on next page)

(continued from previous page)

```

    portYIELD_FROM_ISR ();
}
}

```

Return pdTRUE if the data was successfully sent to the queue, otherwise errQUEUE_FULL.

Parameters

- xQueue: The handle to the queue on which the item is to be posted.
- pvItemToQueue: A pointer to the item that is to be placed on the queue. The size of the items the queue will hold was defined when the queue was created, so this many bytes will be copied from pvItemToQueue into the queue storage area.
- [out] pxHigherPriorityTaskWoken: xQueueSendToFrontFromISR() will set *pxHigherPriorityTaskWoken to pdTRUE if sending to the queue caused a task to unblock, and the unblocked task has a priority higher than the currently running task. If xQueueSendToFromFromISR() sets this value to pdTRUE then a context switch should be requested before the interrupt is exited.

xQueueSendToBackFromISR (xQueue, pvItemToQueue, pxHigherPriorityTaskWoken)

This is a macro that calls xQueueGenericSendFromISR().

Post an item to the back of a queue. It is safe to use this macro from within an interrupt service routine.

Items are queued by copy not reference so it is preferable to only queue small items, especially when called from an ISR. In most cases it would be preferable to store a pointer to the item being queued.

Example usage for buffered IO (where the ISR can obtain more than one value per call):

```

void vBufferISR( void )
{
    char cIn;
    BaseType_t xHigherPriorityTaskWoken;

    // We have not woken a task at the start of the ISR.
    xHigherPriorityTaskWoken = pdFALSE;

    // Loop until the buffer is empty.
    do
    {
        // Obtain a byte from the buffer.
        cIn = portINPUT_BYTE( RX_REGISTER_ADDRESS );

        // Post the byte.
        xQueueSendToBackFromISR( xRxQueue, &cIn, &xHigherPriorityTaskWoken );

    } while( portINPUT_BYTE( BUFFER_COUNT ) );

    // Now the buffer is empty we can switch context if necessary.
    if( xHigherPriorityTaskWoken )
    {
        portYIELD_FROM_ISR ();
    }
}

```

Return pdTRUE if the data was successfully sent to the queue, otherwise errQUEUE_FULL.

Parameters

- xQueue: The handle to the queue on which the item is to be posted.
- pvItemToQueue: A pointer to the item that is to be placed on the queue. The size of the items the queue will hold was defined when the queue was created, so this many bytes will be copied from pvItemToQueue into the queue storage area.
- [out] pxHigherPriorityTaskWoken: xQueueSendToBackFromISR() will set *pxHigherPriorityTaskWoken to pdTRUE if sending to the queue caused a task to unblock, and the unblocked task has a priority higher than the currently running task. If xQueueSendToBackFromISR() sets this value to pdTRUE then a context switch should be requested before the interrupt is exited.

xQueueOverwriteFromISR (xQueue, pvItemToQueue, pxHigherPriorityTaskWoken)

A version of xQueueOverwrite() that can be used in an interrupt service routine (ISR).

Only for use with queues that can hold a single item - so the queue is either empty or full.

Post an item on a queue. If the queue is already full then overwrite the value held in the queue. The item is queued by copy, not by reference.

Example usage:

```

QueueHandle_t xQueue;

void vFunction( void *pvParameters )
{
    // Create a queue to hold one uint32_t value. It is strongly
    // recommended *not* to use xQueueOverwriteFromISR() on queues that can
    // contain more than one value, and doing so will trigger an assertion
    // if configASSERT() is defined.
    xQueue = xQueueCreate( 1, sizeof( uint32_t ) );
}

void vAnInterruptHandler( void )
{
    // xHigherPriorityTaskWoken must be set to pdFALSE before it is used.
    BaseType_t xHigherPriorityTaskWoken = pdFALSE;
    uint32_t ulVarToSend, ulValReceived;

    // Write the value 10 to the queue using xQueueOverwriteFromISR().
    ulVarToSend = 10;
    xQueueOverwriteFromISR( xQueue, &ulVarToSend, &xHigherPriorityTaskWoken );

    // The queue is full, but calling xQueueOverwriteFromISR() again will still
    // pass because the value held in the queue will be overwritten with the
    // new value.
    ulVarToSend = 100;
    xQueueOverwriteFromISR( xQueue, &ulVarToSend, &xHigherPriorityTaskWoken );

    // Reading from the queue will now return 100.

    // ...

    if( xHigherPriorityTaskWoken == pdTRUE )
    {
        // Writing to the queue caused a task to unblock and the unblocked task
        // has a priority higher than or equal to the priority of the currently
        // executing task (the task this interrupt interrupted). Perform a
        →context
        // switch so this interrupt returns directly to the unblocked task.
        portYIELD_FROM_ISR(); // or portEND_SWITCHING_ISR() depending on the
        →port.
    }
}

```

Return xQueueOverwriteFromISR() is a macro that calls xQueueGenericSendFromISR(), and therefore has the same return values as xQueueSendToFrontFromISR(). However, pdPASS is the only value that can be returned because xQueueOverwriteFromISR() will write to the queue even when the queue is already full.

Parameters

- xQueue: The handle to the queue on which the item is to be posted.
- pvItemToQueue: A pointer to the item that is to be placed on the queue. The size of the items the queue will hold was defined when the queue was created, so this many bytes will be copied from pvItemToQueue into the queue storage area.
- [out] pxHigherPriorityTaskWoken: xQueueOverwriteFromISR() will set *pxHigher-

PriorityTaskWoken to pdTRUE if sending to the queue caused a task to unblock, and the unblocked task has a priority higher than the currently running task. If xQueueOverwriteFromISR() sets this value to pdTRUE then a context switch should be requested before the interrupt is exited.

xQueueSendFromISR (xQueue, pvItemToQueue, pxHigherPriorityTaskWoken)

This is a macro that calls xQueueGenericSendFromISR(). It is included for backward compatibility with versions of FreeRTOS.org that did not include the xQueueSendToBackFromISR() and xQueueSendToFrontFromISR() macros.

Post an item to the back of a queue. It is safe to use this function from within an interrupt service routine.

Items are queued by copy not reference so it is preferable to only queue small items, especially when called from an ISR. In most cases it would be preferable to store a pointer to the item being queued.

Example usage for buffered IO (where the ISR can obtain more than one value per call):

```
void vBufferISR( void )
{
    char cIn;
    BaseType_t xHigherPriorityTaskWoken;

    // We have not woken a task at the start of the ISR.
    xHigherPriorityTaskWoken = pdFALSE;

    // Loop until the buffer is empty.
    do
    {
        // Obtain a byte from the buffer.
        cIn = portINPUT_BYTE( RX_REGISTER_ADDRESS );

        // Post the byte.
        xQueueSendFromISR( xRxQueue, &cIn, &xHigherPriorityTaskWoken );

    } while( portINPUT_BYTE( BUFFER_COUNT ) );

    // Now the buffer is empty we can switch context if necessary.
    if( xHigherPriorityTaskWoken )
    {
        // Actual macro used here is port specific.
        portYIELD_FROM_ISR ();
    }
}
```

Return pdTRUE if the data was successfully sent to the queue, otherwise errQUEUE_FULL.

Parameters

- xQueue: The handle to the queue on which the item is to be posted.
- pvItemToQueue: A pointer to the item that is to be placed on the queue. The size of the items the queue will hold was defined when the queue was created, so this many bytes will be copied from pvItemToQueue into the queue storage area.
- [out] pxHigherPriorityTaskWoken: xQueueSendFromISR() will set *pxHigherPriorityTaskWoken to pdTRUE if sending to the queue caused a task to unblock, and the unblocked task has a priority higher than the currently running task. If xQueueSendFromISR() sets this value to pdTRUE then a context switch should be requested before the interrupt is exited.

xQueueReset (xQueue)

Reset a queue back to its original empty state. The return value is now obsolete and is always set to pdPASS.

Type Definitions

```
typedef struct QueueDefinition *QueueHandle_t
```

```
typedef struct QueueDefinition *QueueSetHandle_t
```

Type by which queue sets are referenced. For example, a call to xQueueCreateSet() returns an xQueueSet variable that can then be used as a parameter to xQueueSelectFromSet(), xQueueAddToSet(), etc.

typedef struct QueueDefinition *QueueSetMemberHandle_t

Queue sets can contain both queues and semaphores, so the QueueSetMemberHandle_t is defined as a type to be used where a parameter or return value can be either an QueueHandle_t or an SemaphoreHandle_t.

Semaphore API

Header File

- freertos/include/freertos/semphr.h

Macros

semBINARY_SEMAPHORE_QUEUE_LENGTH

semSEMAPHORE_QUEUE_ITEM_LENGTH

semGIVE_BLOCK_TIME

xSemaphoreCreateBinary()

Creates a new binary semaphore instance, and returns a handle by which the new semaphore can be referenced.

In many usage scenarios it is faster and more memory efficient to use a direct to task notification in place of a binary semaphore! <http://www.freertos.org/RTOS-task-notifications.html>

Internally, within the FreeRTOS implementation, binary semaphores use a block of memory, in which the semaphore structure is stored. If a binary semaphore is created using xSemaphoreCreateBinary() then the required memory is automatically dynamically allocated inside the xSemaphoreCreateBinary() function. (see <http://www.freertos.org/a00111.html>). If a binary semaphore is created using xSemaphoreCreateBinaryStatic() then the application writer must provide the memory. xSemaphoreCreateBinaryStatic() therefore allows a binary semaphore to be created without using any dynamic memory allocation.

The old vSemaphoreCreateBinary() macro is now deprecated in favour of this xSemaphoreCreateBinary() function. Note that binary semaphores created using the vSemaphoreCreateBinary() macro are created in a state such that the first call to ‘take’ the semaphore would pass, whereas binary semaphores created using xSemaphoreCreateBinary() are created in a state such that the the semaphore must first be ‘given’ before it can be ‘taken’.

This type of semaphore can be used for pure synchronisation between tasks or between an interrupt and a task. The semaphore need not be given back once obtained, so one task/interrupt can continuously ‘give’ the semaphore while another continuously ‘takes’ the semaphore. For this reason this type of semaphore does not use a priority inheritance mechanism. For an alternative that does use priority inheritance see xSemaphoreCreateMutex().

Example usage:

```
SemaphoreHandle_t xSemaphore = NULL;

void vATask( void * pvParameters )
{
    // Semaphore cannot be used before a call to vSemaphoreCreateBinary().
    // This is a macro so pass the variable in directly.
    xSemaphore = xSemaphoreCreateBinary();

    if( xSemaphore != NULL )
    {
        // The semaphore was created successfully.
        // The semaphore can now be used.
    }
}
```

Return Handle to the created semaphore, or NULL if the memory required to hold the semaphore’s data structures could not be allocated.

xSemaphoreCreateBinaryStatic (pxStaticSemaphore)

Creates a new binary semaphore instance, and returns a handle by which the new semaphore can be referenced.

NOTE: In many usage scenarios it is faster and more memory efficient to use a direct to task notification in place of a binary semaphore! <http://www.freertos.org/RTOS-task-notifications.html>

Internally, within the FreeRTOS implementation, binary semaphores use a block of memory, in which the semaphore structure is stored. If a binary semaphore is created using xSemaphoreCreateBinary() then the required memory is automatically dynamically allocated inside the xSemaphoreCreateBinary() function. (see <http://www.freertos.org/a00111.html>). If a binary semaphore is created using xSemaphoreCreateBinaryStatic() then the application writer must provide the memory. xSemaphoreCreateBinaryStatic() therefore allows a binary semaphore to be created without using any dynamic memory allocation.

This type of semaphore can be used for pure synchronisation between tasks or between an interrupt and a task. The semaphore need not be given back once obtained, so one task/interrupt can continuously 'give' the semaphore while another continuously 'takes' the semaphore. For this reason this type of semaphore does not use a priority inheritance mechanism. For an alternative that does use priority inheritance see xSemaphoreCreateMutex().

Example usage:

```
SemaphoreHandle_t xSemaphore = NULL;
StaticSemaphore_t xSemaphoreBuffer;

void vATask( void * pvParameters )
{
    // Semaphore cannot be used before a call to xSemaphoreCreateBinary() or
    // xSemaphoreCreateBinaryStatic().
    // The semaphore's data structures will be placed in the xSemaphoreBuffer
    // variable, the address of which is passed into the function. The
    // function's parameter is not NULL, so the function will not attempt any
    // dynamic memory allocation, and therefore the function will not return
    // return NULL.
    xSemaphore = xSemaphoreCreateBinaryStatic( &xSemaphoreBuffer );

    // Rest of task code goes here.
}
```

Return If the semaphore is created then a handle to the created semaphore is returned. If pxSemaphoreBuffer is NULL then NULL is returned.

Parameters

- pxStaticSemaphore: Must point to a variable of type StaticSemaphore_t, which will then be used to hold the semaphore's data structure, removing the need for the memory to be allocated dynamically.

xSemaphoreTake (xSemaphore, xBlockTime)

Macro to obtain a semaphore. The semaphore must have previously been created with a call to xSemaphoreCreateBinary(), xSemaphoreCreateMutex() or xSemaphoreCreateCounting().

Example usage:

```
SemaphoreHandle_t xSemaphore = NULL;

// A task that creates a semaphore.
void vATask( void * pvParameters )
{
    // Create the semaphore to guard a shared resource.
    vSemaphoreCreateBinary( xSemaphore );
}

// A task that uses the semaphore.
void vAnotherTask( void * pvParameters )
{
```

(continues on next page)

(continued from previous page)

```

// ... Do other things.

if( xSemaphore != NULL )
{
    // See if we can obtain the semaphore. If the semaphore is not
    →available
    // wait 10 ticks to see if it becomes free.
    if( xSemaphoreTake( xSemaphore, ( TickType_t ) 10 ) == pdTRUE )
    {
        // We were able to obtain the semaphore and can now access the
        // shared resource.

        // ...

        // We have finished accessing the shared resource. Release the
        // semaphore.
        xSemaphoreGive( xSemaphore );
    }
    else
    {
        // We could not obtain the semaphore and can therefore not access
        // the shared resource safely.
    }
}
}

```

Return pdTRUE if the semaphore was obtained. pdFALSE if xBlockTime expired without the semaphore becoming available.

Parameters

- xSemaphore: A handle to the semaphore being taken - obtained when the semaphore was created.
- xBlockTime: The time in ticks to wait for the semaphore to become available. The macro portTICK_PERIOD_MS can be used to convert this to a real time. A block time of zero can be used to poll the semaphore. A block time of portMAX_DELAY can be used to block indefinitely (provided INCLUDE_vTaskSuspend is set to 1 in FreeRTOSConfig.h).

xSemaphoreTakeRecursive (xMutex, xBlockTime)

Macro to recursively obtain, or ‘take’, a mutex type semaphore. The mutex must have previously been created using a call to xSemaphoreCreateRecursiveMutex();

configUSE_RECURSIVE_MUTEXES must be set to 1 in FreeRTOSConfig.h for this macro to be available.

This macro must not be used on mutexes created using xSemaphoreCreateMutex().

A mutex used recursively can be ‘taken’ repeatedly by the owner. The mutex doesn’t become available again until the owner has called xSemaphoreGiveRecursive() for each successful ‘take’ request. For example, if a task successfully ‘takes’ the same mutex 5 times then the mutex will not be available to any other task until it has also ‘given’ the mutex back exactly five times.

Example usage:

```

SemaphoreHandle_t xMutex = NULL;

// A task that creates a mutex.
void vATask( void * pvParameters )
{
    // Create the mutex to guard a shared resource.
    xMutex = xSemaphoreCreateRecursiveMutex();
}

// A task that uses the mutex.
void vAnotherTask( void * pvParameters )
{

```

(continues on next page)

(continued from previous page)

```

// ... Do other things.

if( xMutex != NULL )
{
    // See if we can obtain the mutex. If the mutex is not available
    // wait 10 ticks to see if it becomes free.
    if( xSemaphoreTakeRecursive( xSemaphore, ( TickType_t ) 10 ) == pdTRUE )
    {
        // We were able to obtain the mutex and can now access the
        // shared resource.

        // ...
        // For some reason due to the nature of the code further calls to
        // xSemaphoreTakeRecursive() are made on the same mutex. In real
        // code these would not be just sequential calls as this would make
        // no sense. Instead the calls are likely to be buried inside
        // a more complex call structure.
        xSemaphoreTakeRecursive( xMutex, ( TickType_t ) 10 );
        xSemaphoreTakeRecursive( xMutex, ( TickType_t ) 10 );

        // The mutex has now been 'taken' three times, so will not be
        // available to another task until it has also been given back
        // three times. Again it is unlikely that real code would have
        // these calls sequentially, but instead buried in a more complex
        // call structure. This is just for illustrative purposes.
        xSemaphoreGiveRecursive( xMutex );
        xSemaphoreGiveRecursive( xMutex );
        xSemaphoreGiveRecursive( xMutex );

        // Now the mutex can be taken by other tasks.
    }
    else
    {
        // We could not obtain the mutex and can therefore not access
        // the shared resource safely.
    }
}
}

```

Return pdTRUE if the semaphore was obtained. pdFALSE if xBlockTime expired without the semaphore becoming available.

Parameters

- **xMutex**: A handle to the mutex being obtained. This is the handle returned by xSemaphoreCreateRecursiveMutex();
- **xBlockTime**: The time in ticks to wait for the semaphore to become available. The macro portTICK_PERIOD_MS can be used to convert this to a real time. A block time of zero can be used to poll the semaphore. If the task already owns the semaphore then xSemaphoreTakeRecursive() will return immediately no matter what the value of xBlockTime.

xSemaphoreGive (xSemaphore)

Macro to release a semaphore. The semaphore must have previously been created with a call to xSemaphoreCreateBinary(), xSemaphoreCreateMutex() or xSemaphoreCreateCounting(). and obtained using sSemaphoreTake().

This macro must not be used from an ISR. See xSemaphoreGiveFromISR () for an alternative which can be used from an ISR.

This macro must also not be used on semaphores created using xSemaphoreCreateRecursiveMutex().

Example usage:

```

SemaphoreHandle_t xSemaphore = NULL;

void vATask( void * pvParameters )
{
    // Create the semaphore to guard a shared resource.
    vSemaphoreCreateBinary( xSemaphore );

    if( xSemaphore != NULL )
    {
        if( xSemaphoreGive( xSemaphore ) != pdTRUE )
        {
            // We would expect this call to fail because we cannot give
            // a semaphore without first "taking" it!
        }

        // Obtain the semaphore - don't block if the semaphore is not
        // immediately available.
        if( xSemaphoreTake( xSemaphore, ( TickType_t ) 0 ) )
        {
            // We now have the semaphore and can access the shared resource.

            // ...

            // We have finished accessing the shared resource so can free the
            // semaphore.
            if( xSemaphoreGive( xSemaphore ) != pdTRUE )
            {
                // We would not expect this call to fail because we must have
                // obtained the semaphore to get here.
            }
        }
    }
}

```

Return pdTRUE if the semaphore was released. pdFALSE if an error occurred. Semaphores are implemented using queues. An error can occur if there is no space on the queue to post a message - indicating that the semaphore was not first obtained correctly.

Parameters

- **xSemaphore**: A handle to the semaphore being released. This is the handle returned when the semaphore was created.

xSemaphoreGiveRecursive (xMutex)

semphr. h

Macro to recursively release, or ‘give’, a mutex type semaphore. The mutex must have previously been created using a call to xSemaphoreCreateRecursiveMutex();

configUSE_RECURSIVE_MUTEXES must be set to 1 in FreeRTOSConfig.h for this macro to be available.

This macro must not be used on mutexes created using xSemaphoreCreateMutex().

A mutex used recursively can be ‘taken’ repeatedly by the owner. The mutex doesn’t become available again until the owner has called xSemaphoreGiveRecursive() for each successful ‘take’ request. For example, if a task successfully ‘takes’ the same mutex 5 times then the mutex will not be available to any other task until it has also ‘given’ the mutex back exactly five times.

Example usage:

```

SemaphoreHandle_t xMutex = NULL;

// A task that creates a mutex.
void vATask( void * pvParameters )
{

```

(continues on next page)

```

// Create the mutex to guard a shared resource.
xMutex = xSemaphoreCreateRecursiveMutex();
}

// A task that uses the mutex.
void vAnotherTask( void * pvParameters )
{
    // ... Do other things.

    if( xMutex != NULL )
    {
        // See if we can obtain the mutex.  If the mutex is not available
        // wait 10 ticks to see if it becomes free.
        if( xSemaphoreTakeRecursive( xMutex, ( TickType_t ) 10 ) == pdTRUE )
        {
            // We were able to obtain the mutex and can now access the
            // shared resource.

            // ...
            // For some reason due to the nature of the code further calls to
            // xSemaphoreTakeRecursive() are made on the same mutex.  In real
            // code these would not be just sequential calls as this would make
            // no sense.  Instead the calls are likely to be buried inside
            // a more complex call structure.
            xSemaphoreTakeRecursive( xMutex, ( TickType_t ) 10 );
            xSemaphoreTakeRecursive( xMutex, ( TickType_t ) 10 );

            // The mutex has now been 'taken' three times, so will not be
            // available to another task until it has also been given back
            // three times.  Again it is unlikely that real code would have
            // these calls sequentially, it would be more likely that the calls
            // to xSemaphoreGiveRecursive() would be called as a call stack
            // unwound.  This is just for demonstrative purposes.
            xSemaphoreGiveRecursive( xMutex );
            xSemaphoreGiveRecursive( xMutex );
            xSemaphoreGiveRecursive( xMutex );

            // Now the mutex can be taken by other tasks.
        }
        else
        {
            // We could not obtain the mutex and can therefore not access
            // the shared resource safely.
        }
    }
}

```

Return pdTRUE if the semaphore was given.

Parameters

- xMutex: A handle to the mutex being released, or 'given'. This is the handle returned by xSemaphoreCreateMutex();

xSemaphoreGiveFromISR (xSemaphore, pxHigherPriorityTaskWoken)

Macro to release a semaphore. The semaphore must have previously been created with a call to xSemaphoreCreateBinary() or xSemaphoreCreateCounting().

Mutex type semaphores (those created using a call to xSemaphoreCreateMutex()) must not be used with this macro.

This macro can be used from an ISR.

Example usage:

```

#define LONG_TIME 0xffff
#define TICKS_TO_WAIT 10
SemaphoreHandle_t xSemaphore = NULL;

// Repetitive task.
void vATask( void * pvParameters )
{
    for( ;; )
    {
        // We want this task to run every 10 ticks of a timer.  The semaphore
        // was created before this task was started.

        // Block waiting for the semaphore to become available.
        if( xSemaphoreTake( xSemaphore, LONG_TIME ) == pdTRUE )
        {
            // It is time to execute.

            // ...

            // We have finished our task.  Return to the top of the loop where
            // we will block on the semaphore until it is time to execute
            // again.  Note when using the semaphore for synchronisation with an
            // ISR in this manner there is no need to 'give' the semaphore back.
        }
    }
}

// Timer ISR
void vTimerISR( void * pvParameters )
{
    static uint8_t ucLocalTickCount = 0;
    static BaseType_t xHigherPriorityTaskWoken;

    // A timer tick has occurred.

    // ... Do other time functions.

    // Is it time for vATask () to run?
    xHigherPriorityTaskWoken = pdFALSE;
    ucLocalTickCount++;
    if( ucLocalTickCount >= TICKS_TO_WAIT )
    {
        // Unblock the task by releasing the semaphore.
        xSemaphoreGiveFromISR( xSemaphore, &xHigherPriorityTaskWoken );

        // Reset the count so we release the semaphore again in 10 ticks time.
        ucLocalTickCount = 0;
    }

    if( xHigherPriorityTaskWoken != pdFALSE )
    {
        // We can force a context switch here.  Context switching from an
        // ISR uses port specific syntax.  Check the demo task for your port
        // to find the syntax required.
    }
}

```

Return pdTRUE if the semaphore was successfully given, otherwise errQUEUE_FULL.

Parameters

- xSemaphore: A handle to the semaphore being released. This is the handle returned when the semaphore was created.
- pxHigherPriorityTaskWoken: xSemaphoreGiveFromISR() will set *pxHigherPriority-

TaskWoken to pdTRUE if giving the semaphore caused a task to unblock, and the unblocked task has a priority higher than the currently running task. If xSemaphoreGiveFromISR() sets this value to pdTRUE then a context switch should be requested before the interrupt is exited.

xSemaphoreTakeFromISR (xSemaphore, pxHigherPriorityTaskWoken)

Macro to take a semaphore from an ISR. The semaphore must have previously been created with a call to xSemaphoreCreateBinary() or xSemaphoreCreateCounting().

Mutex type semaphores (those created using a call to xSemaphoreCreateMutex()) must not be used with this macro.

This macro can be used from an ISR, however taking a semaphore from an ISR is not a common operation. It is likely to only be useful when taking a counting semaphore when an interrupt is obtaining an object from a resource pool (when the semaphore count indicates the number of resources available).

Return pdTRUE if the semaphore was successfully taken, otherwise pdFALSE

Parameters

- xSemaphore: A handle to the semaphore being taken. This is the handle returned when the semaphore was created.
- [out] pxHigherPriorityTaskWoken: xSemaphoreTakeFromISR() will set *pxHigherPriorityTaskWoken to pdTRUE if taking the semaphore caused a task to unblock, and the unblocked task has a priority higher than the currently running task. If xSemaphoreTakeFromISR() sets this value to pdTRUE then a context switch should be requested before the interrupt is exited.

xSemaphoreCreateMutex ()

Macro that implements a mutex semaphore by using the existing queue mechanism.

Internally, within the FreeRTOS implementation, mutex semaphores use a block of memory, in which the mutex structure is stored. If a mutex is created using xSemaphoreCreateMutex() then the required memory is automatically dynamically allocated inside the xSemaphoreCreateMutex() function. (see <http://www.freertos.org/a00111.html>). If a mutex is created using xSemaphoreCreateMutexStatic() then the application writer must provide the memory. xSemaphoreCreateMutexStatic() therefore allows a mutex to be created without using any dynamic memory allocation.

Mutexes created using this function can be accessed using the xSemaphoreTake() and xSemaphoreGive() macros. The xSemaphoreTakeRecursive() and xSemaphoreGiveRecursive() macros must not be used.

This type of semaphore uses a priority inheritance mechanism so a task ‘taking’ a semaphore MUST ALWAYS ‘give’ the semaphore back once the semaphore it is no longer required.

Mutex type semaphores cannot be used from within interrupt service routines.

See xSemaphoreCreateBinary() for an alternative implementation that can be used for pure synchronisation (where one task or interrupt always ‘gives’ the semaphore and another always ‘takes’ the semaphore) and from within interrupt service routines.

Example usage:

```
SemaphoreHandle_t xSemaphore;

void vATask( void * pvParameters )
{
    // Semaphore cannot be used before a call to xSemaphoreCreateMutex().
    // This is a macro so pass the variable in directly.
    xSemaphore = xSemaphoreCreateMutex();

    if( xSemaphore != NULL )
    {
        // The semaphore was created successfully.
        // The semaphore can now be used.
    }
}
```

Return If the mutex was successfully created then a handle to the created semaphore is returned. If there was not enough heap to allocate the mutex data structures then NULL is returned.

xSemaphoreCreateMutexStatic (pxMutexBuffer)

Creates a new mutex type semaphore instance, and returns a handle by which the new mutex can be referenced.

Internally, within the FreeRTOS implementation, mutex semaphores use a block of memory, in which the mutex structure is stored. If a mutex is created using `xSemaphoreCreateMutex()` then the required memory is automatically dynamically allocated inside the `xSemaphoreCreateMutex()` function. (see <http://www.freertos.org/a00111.html>). If a mutex is created using `xSemaphoreCreateMutexStatic()` then the application writer must provide the memory. `xSemaphoreCreateMutexStatic()` therefore allows a mutex to be created without using any dynamic memory allocation.

Mutexes created using this function can be accessed using the `xSemaphoreTake()` and `xSemaphoreGive()` macros. The `xSemaphoreTakeRecursive()` and `xSemaphoreGiveRecursive()` macros must not be used.

This type of semaphore uses a priority inheritance mechanism so a task ‘taking’ a semaphore **MUST ALWAYS** ‘give’ the semaphore back once the semaphore it is no longer required.

Mutex type semaphores cannot be used from within interrupt service routines.

See `xSemaphoreCreateBinary()` for an alternative implementation that can be used for pure synchronisation (where one task or interrupt always ‘gives’ the semaphore and another always ‘takes’ the semaphore) and from within interrupt service routines.

Example usage:

```
SemaphoreHandle_t xSemaphore;
StaticSemaphore_t xMutexBuffer;

void vATask( void * pvParameters )
{
    // A mutex cannot be used before it has been created. xMutexBuffer is
    // into xSemaphoreCreateMutexStatic() so no dynamic memory allocation is
    // attempted.
    xSemaphore = xSemaphoreCreateMutexStatic( &xMutexBuffer );

    // As no dynamic memory allocation was performed, xSemaphore cannot be NULL,
    // so there is no need to check it.
}
```

Return If the mutex was successfully created then a handle to the created mutex is returned. If `pxMutexBuffer` was NULL then NULL is returned.

Parameters

- `pxMutexBuffer`: Must point to a variable of type `StaticSemaphore_t`, which will be used to hold the mutex’ s data structure, removing the need for the memory to be allocated dynamically.

xSemaphoreCreateRecursiveMutex ()

Creates a new recursive mutex type semaphore instance, and returns a handle by which the new recursive mutex can be referenced.

Internally, within the FreeRTOS implementation, recursive mutexes use a block of memory, in which the mutex structure is stored. If a recursive mutex is created using `xSemaphoreCreateRecursiveMutex()` then the required memory is automatically dynamically allocated inside the `xSemaphoreCreateRecursiveMutex()` function. (see <http://www.freertos.org/a00111.html>). If a recursive mutex is created using `xSemaphoreCreateRecursiveMutexStatic()` then the application writer must provide the memory that will get used by the mutex. `xSemaphoreCreateRecursiveMutexStatic()` therefore allows a recursive mutex to be created without using any dynamic memory allocation.

Mutexes created using this macro can be accessed using the `xSemaphoreTakeRecursive()` and `xSemaphoreGiveRecursive()` macros. The `xSemaphoreTake()` and `xSemaphoreGive()` macros must not be used.

A mutex used recursively can be ‘taken’ repeatedly by the owner. The mutex doesn’ t become available again until the owner has called `xSemaphoreGiveRecursive()` for each successful ‘take’ request. For example, if a task successfully ‘takes’ the same mutex 5 times then the mutex will not be available to any other task until it has also ‘given’ the mutex back exactly five times.

This type of semaphore uses a priority inheritance mechanism so a task ‘taking’ a semaphore MUST ALWAYS ‘give’ the semaphore back once the semaphore it is no longer required.

Mutex type semaphores cannot be used from within interrupt service routines.

See `vSemaphoreCreateBinary()` for an alternative implementation that can be used for pure synchronisation (where one task or interrupt always ‘gives’ the semaphore and another always ‘takes’ the semaphore) and from within interrupt service routines.

Example usage:

```
SemaphoreHandle_t xSemaphore;

void vATask( void * pvParameters )
{
    // Semaphore cannot be used before a call to xSemaphoreCreateMutex().
    // This is a macro so pass the variable in directly.
    xSemaphore = xSemaphoreCreateRecursiveMutex();

    if( xSemaphore != NULL )
    {
        // The semaphore was created successfully.
        // The semaphore can now be used.
    }
}
```

Return `xSemaphore` Handle to the created mutex semaphore. Should be of type `SemaphoreHandle_t`.

xSemaphoreCreateRecursiveMutexStatic (`pxStaticSemaphore`)

Creates a new recursive mutex type semaphore instance, and returns a handle by which the new recursive mutex can be referenced.

Internally, within the FreeRTOS implementation, recursive mutexes use a block of memory, in which the mutex structure is stored. If a recursive mutex is created using `xSemaphoreCreateRecursiveMutex()` then the required memory is automatically dynamically allocated inside the `xSemaphoreCreateRecursiveMutex()` function. (see <http://www.freertos.org/a00111.html>). If a recursive mutex is created using `xSemaphoreCreateRecursiveMutexStatic()` then the application writer must provide the memory that will get used by the mutex. `xSemaphoreCreateRecursiveMutexStatic()` therefore allows a recursive mutex to be created without using any dynamic memory allocation.

Mutexes created using this macro can be accessed using the `xSemaphoreTakeRecursive()` and `xSemaphoreGiveRecursive()` macros. The `xSemaphoreTake()` and `xSemaphoreGive()` macros must not be used.

A mutex used recursively can be ‘taken’ repeatedly by the owner. The mutex doesn’t become available again until the owner has called `xSemaphoreGiveRecursive()` for each successful ‘take’ request. For example, if a task successfully ‘takes’ the same mutex 5 times then the mutex will not be available to any other task until it has also ‘given’ the mutex back exactly five times.

This type of semaphore uses a priority inheritance mechanism so a task ‘taking’ a semaphore MUST ALWAYS ‘give’ the semaphore back once the semaphore it is no longer required.

Mutex type semaphores cannot be used from within interrupt service routines.

See `xSemaphoreCreateBinary()` for an alternative implementation that can be used for pure synchronisation (where one task or interrupt always ‘gives’ the semaphore and another always ‘takes’ the semaphore) and from within interrupt service routines.

Example usage:

```
SemaphoreHandle_t xSemaphore;
StaticSemaphore_t xMutexBuffer;

void vATask( void * pvParameters )
{
    // A recursive semaphore cannot be used before it is created. Here a
```

(continues on next page)

(continued from previous page)

```

// recursive mutex is created using xSemaphoreCreateRecursiveMutexStatic().
// The address of xMutexBuffer is passed into the function, and will hold
// the mutexes data structures - so no dynamic memory allocation will be
// attempted.
xSemaphore = xSemaphoreCreateRecursiveMutexStatic( &xMutexBuffer );

// As no dynamic memory allocation was performed, xSemaphore cannot be NULL,
// so there is no need to check it.
}

```

Return If the recursive mutex was successfully created then a handle to the created recursive mutex is returned. If pxMutexBuffer was NULL then NULL is returned.

Parameters

- pxStaticSemaphore: Must point to a variable of type StaticSemaphore_t, which will then be used to hold the recursive mutex's data structure, removing the need for the memory to be allocated dynamically.

xSemaphoreCreateCounting (uxMaxCount, uxInitialCount)

Creates a new counting semaphore instance, and returns a handle by which the new counting semaphore can be referenced.

In many usage scenarios it is faster and more memory efficient to use a direct to task notification in place of a counting semaphore! <http://www.freertos.org/RTOS-task-notifications.html>

Internally, within the FreeRTOS implementation, counting semaphores use a block of memory, in which the counting semaphore structure is stored. If a counting semaphore is created using xSemaphoreCreateCounting() then the required memory is automatically dynamically allocated inside the xSemaphoreCreateCounting() function. (see <http://www.freertos.org/a00111.html>). If a counting semaphore is created using xSemaphoreCreateCountingStatic() then the application writer can instead optionally provide the memory that will get used by the counting semaphore. xSemaphoreCreateCountingStatic() therefore allows a counting semaphore to be created without using any dynamic memory allocation.

Counting semaphores are typically used for two things:

1) Counting events.

In this usage scenario an event handler will 'give' a semaphore each time an event occurs (incrementing the semaphore count value), and a handler task will 'take' a semaphore each time it processes an event (decrementing the semaphore count value). The count value is therefore the difference between the number of events that have occurred and the number that have been processed. In this case it is desirable for the initial count value to be zero.

2) Resource management.

In this usage scenario the count value indicates the number of resources available. To obtain control of a resource a task must first obtain a semaphore - decrementing the semaphore count value. When the count value reaches zero there are no free resources. When a task finishes with the resource it 'gives' the semaphore back - incrementing the semaphore count value. In this case it is desirable for the initial count value to be equal to the maximum count value, indicating that all resources are free.

Example usage:

```

SemaphoreHandle_t xSemaphore;

void vATask( void * pvParameters )
{
    SemaphoreHandle_t xSemaphore = NULL;

    // Semaphore cannot be used before a call to xSemaphoreCreateCounting().
    // The max value to which the semaphore can count should be 10, and the
    // initial value assigned to the count should be 0.
    xSemaphore = xSemaphoreCreateCounting( 10, 0 );
}

```

(continues on next page)

(continued from previous page)

```

if( xSemaphore != NULL )
{
    // The semaphore was created successfully.
    // The semaphore can now be used.
}
}

```

Return Handle to the created semaphore. Null if the semaphore could not be created.

Parameters

- **uxMaxCount**: The maximum count value that can be reached. When the semaphore reaches this value it can no longer be ‘given’.
- **uxInitialCount**: The count value assigned to the semaphore when it is created.

xSemaphoreCreateCountingStatic (uxMaxCount, uxInitialCount, pxSemaphoreBuffer)

Creates a new counting semaphore instance, and returns a handle by which the new counting semaphore can be referenced.

In many usage scenarios it is faster and more memory efficient to use a direct to task notification in place of a counting semaphore! <http://www.freertos.org/RTOS-task-notifications.html>

Internally, within the FreeRTOS implementation, counting semaphores use a block of memory, in which the counting semaphore structure is stored. If a counting semaphore is created using `xSemaphoreCreateCounting()` then the required memory is automatically dynamically allocated inside the `xSemaphoreCreateCounting()` function. (see <http://www.freertos.org/a00111.html>). If a counting semaphore is created using `xSemaphoreCreateCountingStatic()` then the application writer must provide the memory. `xSemaphoreCreateCountingStatic()` therefore allows a counting semaphore to be created without using any dynamic memory allocation.

Counting semaphores are typically used for two things:

1) Counting events.

In this usage scenario an event handler will ‘give’ a semaphore each time an event occurs (incrementing the semaphore count value), and a handler task will ‘take’ a semaphore each time it processes an event (decrementing the semaphore count value). The count value is therefore the difference between the number of events that have occurred and the number that have been processed. In this case it is desirable for the initial count value to be zero.

2) Resource management.

In this usage scenario the count value indicates the number of resources available. To obtain control of a resource a task must first obtain a semaphore - decrementing the semaphore count value. When the count value reaches zero there are no free resources. When a task finishes with the resource it ‘gives’ the semaphore back - incrementing the semaphore count value. In this case it is desirable for the initial count value to be equal to the maximum count value, indicating that all resources are free.

Example usage:

```

SemaphoreHandle_t xSemaphore;
StaticSemaphore_t xSemaphoreBuffer;

void vATask( void * pvParameters )
{
    SemaphoreHandle_t xSemaphore = NULL;

    // Counting semaphore cannot be used before they have been created. Create
    // a counting semaphore using xSemaphoreCreateCountingStatic(). The max
    // value to which the semaphore can count is 10, and the initial value
    // assigned to the count will be 0. The address of xSemaphoreBuffer is
    // passed in and will be used to hold the semaphore structure, so no dynamic
    // memory allocation will be used.
}

```

(continues on next page)

(continued from previous page)

```

xSemaphore = xSemaphoreCreateCounting( 10, 0, &xSemaphoreBuffer );

// No memory allocation was attempted so xSemaphore cannot be NULL, so there
// is no need to check its value.
}

```

Return If the counting semaphore was successfully created then a handle to the created counting semaphore is returned. If pxSemaphoreBuffer was NULL then NULL is returned.

Parameters

- uxMaxCount: The maximum count value that can be reached. When the semaphore reaches this value it can no longer be ‘given’.
- uxInitialCount: The count value assigned to the semaphore when it is created.
- pxSemaphoreBuffer: Must point to a variable of type StaticSemaphore_t, which will then be used to hold the semaphore’s data structure, removing the need for the memory to be allocated dynamically.

vSemaphoreDelete (xSemaphore)

Delete a semaphore. This function must be used with care. For example, do not delete a mutex type semaphore if the mutex is held by a task.

Parameters

- xSemaphore: A handle to the semaphore to be deleted.

xSemaphoreGetMutexHolder (xSemaphore)

If xMutex is indeed a mutex type semaphore, return the current mutex holder. If xMutex is not a mutex type semaphore, or the mutex is available (not held by a task), return NULL.

Note: This is a good way of determining if the calling task is the mutex holder, but not a good way of determining the identity of the mutex holder as the holder may change between the function exiting and the returned value being tested.

xSemaphoreGetMutexHolderFromISR (xSemaphore)

If xMutex is indeed a mutex type semaphore, return the current mutex holder. If xMutex is not a mutex type semaphore, or the mutex is available (not held by a task), return NULL.

uxSemaphoreGetCount (xSemaphore)

semphr.h

If the semaphore is a counting semaphore then uxSemaphoreGetCount() returns its current count value. If the semaphore is a binary semaphore then uxSemaphoreGetCount() returns 1 if the semaphore is available, and 0 if the semaphore is not available.

Type Definitions

```
typedef QueueHandle_t SemaphoreHandle_t
```

Timer API

Header File

- freertos/include/freertos/timers.h

Functions

TimerHandle_t **xTimerCreate** (**const** char ***const** pcTimerName, **const** TickType_t xTimerPeriod, *InTicks*, **const** UBaseType_t uxAutoReload, void ***const** pvTimerID, *TimerCallbackFunction_t* pxCallbackFunction)

Creates a new software timer instance, and returns a handle by which the created software timer can be referenced.

Internally, within the FreeRTOS implementation, software timers use a block of memory, in which the timer data structure is stored. If a software timer is created using xTimerCreate() then the required memory is

automatically dynamically allocated inside the `xTimerCreate()` function. (see <http://www.freertos.org/a00111.html>). If a software timer is created using `xTimerCreateStatic()` then the application writer must provide the memory that will get used by the software timer. `xTimerCreateStatic()` therefore allows a software timer to be created without using any dynamic memory allocation.

Timers are created in the dormant state. The `xTimerStart()`, `xTimerReset()`, `xTimerStartFromISR()`, `xTimerResetFromISR()`, `xTimerChangePeriod()` and `xTimerChangePeriodFromISR()` API functions can all be used to transition a timer into the active state.

Example usage:

```
#define NUM_TIMERS 5

// An array to hold handles to the created timers.
TimerHandle_t xTimers[ NUM_TIMERS ];

// An array to hold a count of the number of times each timer expires.
int32_t lExpireCounters[ NUM_TIMERS ] = { 0 };

// Define a callback function that will be used by multiple timer instances.
// The callback function does nothing but count the number of times the
// associated timer expires, and stop the timer once the timer has expired
// 10 times.
void vTimerCallback( TimerHandle_t pxTimer )
{
    int32_t lArrayIndex;
    const int32_t xMaxExpiryCountBeforeStopping = 10;

    // Optionally do something if the pxTimer parameter is NULL.
    configASSERT( pxTimer );

    // Which timer expired?
    lArrayIndex = ( int32_t ) pvTimerGetTimerID( pxTimer );

    // Increment the number of times that pxTimer has expired.
    lExpireCounters[ lArrayIndex ] += 1;

    // If the timer has expired 10 times then stop it from running.
    if( lExpireCounters[ lArrayIndex ] == xMaxExpiryCountBeforeStopping )
    {
        // Do not use a block time if calling a timer API function from a
        // timer callback function, as doing so could cause a deadlock!
        xTimerStop( pxTimer, 0 );
    }
}

void main( void )
{
    int32_t x;

    // Create then start some timers. Starting the timers before the scheduler
    // has been started means the timers will start running immediately that
    // the scheduler starts.
    for( x = 0; x < NUM_TIMERS; x++ )
    {
        xTimers[ x ] = xTimerCreate( "Timer", // Just a text name,
        ↪not used by the kernel.
                                     ( 100 * x ), // The timer period in
        ↪ticks.
                                     pdTRUE, // The timers will auto-
        ↪reload themselves when they expire.
                                     ( void * ) x, // Assign each timer a
        ↪unique id equal to its array index.
```

(continues on next page)

(continued from previous page)

```

vTimerCallback // Each timer calls the
↳same callback when it expires.
        );

    if( xTimers[ x ] == NULL )
    {
        // The timer was not created.
    }
    else
    {
        // Start the timer. No block time is specified, and even if one
↳was
        // it would be ignored because the scheduler has not yet been
        // started.
        if( xTimerStart( xTimers[ x ], 0 ) != pdPASS )
        {
            // The timer could not be set into the Active state.
        }
    }
}

// ...
// Create tasks here.
// ...

// Starting the scheduler will start the timers running as they have
↳already
// been set into the active state.
vTaskStartScheduler();

// Should not reach here.
for( ;; );
}

```

Return If the timer is successfully created then a handle to the newly created timer is returned. If the timer cannot be created (because either there is insufficient FreeRTOS heap remaining to allocate the timer structures, or the timer period was set to 0) then NULL is returned.

Parameters

- **pcTimerName**: A text name that is assigned to the timer. This is done purely to assist debugging. The kernel itself only ever references a timer by its handle, and never by its name.
- **xTimerPeriodInTicks**: The timer period. The time is defined in tick periods so the constant `portTICK_PERIOD_MS` can be used to convert a time that has been specified in milliseconds. For example, if the timer must expire after 100 ticks, then `xTimerPeriodInTicks` should be set to 100. Alternatively, if the timer must expire after 500ms, then `xPeriod` can be set to $(500 / \text{portTICK_PERIOD_MS})$ provided `configTICK_RATE_HZ` is less than or equal to 1000.
- **uxAutoReload**: If `uxAutoReload` is set to `pdTRUE` then the timer will expire repeatedly with a frequency set by the `xTimerPeriodInTicks` parameter. If `uxAutoReload` is set to `pdFALSE` then the timer will be a one-shot timer and enter the dormant state after it expires.
- **pvTimerID**: An identifier that is assigned to the timer being created. Typically this would be used in the timer callback function to identify which timer expired when the same callback function is assigned to more than one timer.
- **pxCallbackFunction**: The function to call when the timer expires. Callback functions must have the prototype defined by `TimerCallbackFunction_t`, which is “void vCallbackFunction(TimerHandle_t xTimer);” .

TimerHandle_t xTimerCreateStatic(const char *const pcTimerName, const TickType_t xTimerPeriodInTicks, const UBaseType_t uxAutoReload, void *const pvTimerID, TimerCallbackFunction_t pxCallbackFunction, StaticTimer_t *pxTimerBuffer)

Creates a new software timer instance, and returns a handle by which the created software timer can be referenced.

Internally, within the FreeRTOS implementation, software timers use a block of memory, in which the timer data structure is stored. If a software timer is created using `xTimerCreate()` then the required memory is automatically dynamically allocated inside the `xTimerCreate()` function. (see <http://www.freertos.org/a00111.html>). If a software timer is created using `xTimerCreateStatic()` then the application writer must provide the memory that will get used by the software timer. `xTimerCreateStatic()` therefore allows a software timer to be created without using any dynamic memory allocation.

Timers are created in the dormant state. The `xTimerStart()`, `xTimerReset()`, `xTimerStartFromISR()`, `xTimerResetFromISR()`, `xTimerChangePeriod()` and `xTimerChangePeriodFromISR()` API functions can all be used to transition a timer into the active state.

Example usage:

```
// The buffer used to hold the software timer's data structure.
static StaticTimer_t xTimerBuffer;

// A variable that will be incremented by the software timer's callback
// function.
UBaseType_t uxVariableToIncrement = 0;

// A software timer callback function that increments a variable passed to
// it when the software timer was created. After the 5th increment the
// callback function stops the software timer.
static void prvTimerCallback( TimerHandle_t xExpiredTimer )
{
    UBaseType_t *puxVariableToIncrement;
    BaseType_t xReturned;

    // Obtain the address of the variable to increment from the timer ID.
    puxVariableToIncrement = ( UBaseType_t * ) pvTimerGetTimerID( &xExpiredTimer );

    // Increment the variable to show the timer callback has executed.
    ( *puxVariableToIncrement )++;

    // If this callback has executed the required number of times, stop the
    // timer.
    if( *puxVariableToIncrement == 5 )
    {
        // This is called from a timer callback so must not block.
        xTimerStop( xExpiredTimer, staticDONT_BLOCK );
    }
}

void main( void )
{
    // Create the software time. xTimerCreateStatic() has an extra parameter
    // than the normal xTimerCreate() API function. The parameter is a pointer
    // to the StaticTimer_t structure that will hold the software timer
    // structure. If the parameter is passed as NULL then the structure will
    // be
    // allocated dynamically, just as if xTimerCreate() had been called.
    xTimer = xTimerCreateStatic( "T1", // Text name for the task.
    // Helps debugging only. Not used by FreeRTOS.
    xTimerPeriod, // The period of the timer
    // in ticks.
    pdTRUE, // This is an auto-reload
    // timer.
    ( void * ) &uxVariableToIncrement, // A
    // variable incremented by the software timer's callback function
    prvTimerCallback, // The function to execute
    // when the timer expires.
```

(continues on next page)

(continued from previous page)

```

                                &xTimerBuffer ); // The buffer that will
↳hold the software timer structure.

    // The scheduler has not started yet so a block time is not used.
    xReturned = xTimerStart( xTimer, 0 );

    // ...
    // Create tasks here.
    // ...

    // Starting the scheduler will start the timers running as they have
↳already
    // been set into the active state.
    vTaskStartScheduler();

    // Should not reach here.
    for( ;; );
}

```

Return If the timer is created then a handle to the created timer is returned. If pxTimerBuffer was NULL then NULL is returned.

Parameters

- pcTimerName: A text name that is assigned to the timer. This is done purely to assist debugging. The kernel itself only ever references a timer by its handle, and never by its name.
- xTimerPeriodInTicks: The timer period. The time is defined in tick periods so the constant portTICK_PERIOD_MS can be used to convert a time that has been specified in milliseconds. For example, if the timer must expire after 100 ticks, then xTimerPeriodInTicks should be set to 100. Alternatively, if the timer must expire after 500ms, then xPeriod can be set to (500 / portTICK_PERIOD_MS) provided configTICK_RATE_HZ is less than or equal to 1000.
- uxAutoReload: If uxAutoReload is set to pdTRUE then the timer will expire repeatedly with a frequency set by the xTimerPeriodInTicks parameter. If uxAutoReload is set to pdFALSE then the timer will be a one-shot timer and enter the dormant state after it expires.
- pvTimerID: An identifier that is assigned to the timer being created. Typically this would be used in the timer callback function to identify which timer expired when the same callback function is assigned to more than one timer.
- pxCallbackFunction: The function to call when the timer expires. Callback functions must have the prototype defined by TimerCallbackFunction_t, which is “void vCallbackFunction(TimerHandle_t xTimer);” .
- pxTimerBuffer: Must point to a variable of type StaticTimer_t, which will be then be used to hold the software timer’ s data structures, removing the need for the memory to be allocated dynamically.

```

void *pvTimerGetTimerID ( const TimerHandle_t xTimer )
void *pvTimerGetTimerID( TimerHandle_t xTimer );

```

Returns the ID assigned to the timer.

IDs are assigned to timers using the pvTimerID parameter of the call to xTimerCreated() that was used to create the timer, and by calling the vTimerSetTimerID() API function.

If the same callback function is assigned to multiple timers then the timer ID can be used as time specific (timer local) storage.

Example usage:

Return The ID assigned to the timer being queried.

Parameters

- xTimer: The timer being queried.

See the xTimerCreate() API function example usage scenario.

```

void vTimerSetTimerID ( TimerHandle_t xTimer, void *pvNewID )

```

```
void vTimerSetTimerID( TimerHandle_t xTimer, void *pvNewID );
```

Sets the ID assigned to the timer.

IDs are assigned to timers using the `pvTimerID` parameter of the call to `xTimerCreated()` that was used to create the timer.

If the same callback function is assigned to multiple timers then the timer ID can be used as time specific (timer local) storage.

Example usage:

Parameters

- `xTimer`: The timer being updated.
- `pvNewID`: The ID to assign to the timer.

See the `xTimerCreate()` API function example usage scenario.

```
BaseType_t xTimerIsTimerActive (TimerHandle_t xTimer)
BaseType_t xTimerIsTimerActive( TimerHandle_t xTimer );
```

Queries a timer to see if it is active or dormant.

A timer will be dormant if: 1) It has been created but not started, or 2) It is an expired one-shot timer that has not been restarted.

Timers are created in the dormant state. The `xTimerStart()`, `xTimerReset()`, `xTimerStartFromISR()`, `xTimerResetFromISR()`, `xTimerChangePeriod()` and `xTimerChangePeriodFromISR()` API functions can all be used to transition a timer into the active state.

Example usage:

```
// This function assumes xTimer has already been created.
void vAFunction( TimerHandle_t xTimer )
{
    if( xTimerIsTimerActive( xTimer ) != pdFALSE ) // or more simply and
    →equivalently "if( xTimerIsTimerActive( xTimer ) )"
    {
        // xTimer is active, do something.
    }
    else
    {
        // xTimer is not active, do something else.
    }
}
```

Return `pdFALSE` will be returned if the timer is dormant. A value other than `pdFALSE` will be returned if the timer is active.

Parameters

- `xTimer`: The timer being queried.

```
TaskHandle_t xTimerGetTimerDaemonTaskHandle (void)
```

`xTimerGetTimerDaemonTaskHandle()` is only available if `INCLUDE_xTimerGetTimerDaemonTaskHandle` is set to 1 in `FreeRTOSConfig.h`.

Simply returns the handle of the timer service/daemon task. It is not valid to call `xTimerGetTimerDaemonTaskHandle()` before the scheduler has been started.

```
BaseType_t xTimerPendFunctionCallFromISR (PendedFunction_t xFunctionToPend, void
                                           *pvParameter1, uint32_t ulParameter2, BaseType_t *pxHigherPriorityTaskWoken)
```

Used from application interrupt service routines to defer the execution of a function to the RTOS daemon task (the timer service task, hence this function is implemented in `timers.c` and is prefixed with 'Timer').

Ideally an interrupt service routine (ISR) is kept as short as possible, but sometimes an ISR either has a lot of processing to do, or needs to perform processing that is not deterministic. In these cases `xTimerPendFunctionCallFromISR()` can be used to defer processing of a function to the RTOS daemon task.

A mechanism is provided that allows the interrupt to return directly to the task that will subsequently execute the pended callback function. This allows the callback function to execute contiguously in time with the interrupt - just as if the callback had executed in the interrupt itself.

Example usage:

```
// The callback function that will execute in the context of the daemon task.
// Note callback functions must all use this same prototype.
void vProcessInterface( void *pvParameter1, uint32_t ulParameter2 )
{
    BaseType_t xInterfaceToService;

    // The interface that requires servicing is passed in the second
    // parameter. The first parameter is not used in this case.
    xInterfaceToService = ( BaseType_t ) ulParameter2;

    // ...Perform the processing here...
}

// An ISR that receives data packets from multiple interfaces
void vAnISR( void )
{
    BaseType_t xInterfaceToService, xHigherPriorityTaskWoken;

    // Query the hardware to determine which interface needs processing.
    xInterfaceToService = prvCheckInterfaces();

    // The actual processing is to be deferred to a task. Request the
    // vProcessInterface() callback function is executed, passing in the
    // number of the interface that needs processing. The interface to
    // service is passed in the second parameter. The first parameter is
    // not used in this case.
    xHigherPriorityTaskWoken = pdFALSE;
    xTimerPendFunctionCallFromISR( vProcessInterface, NULL, ( uint32_t )
    ↪xInterfaceToService, &xHigherPriorityTaskWoken );

    // If xHigherPriorityTaskWoken is now set to pdTRUE then a context
    // switch should be requested. The macro used is port specific and will
    // be either portYIELD_FROM_ISR() or portEND_SWITCHING_ISR() - refer to
    // the documentation page for the port being used.
    portYIELD_FROM_ISR( xHigherPriorityTaskWoken );
}

```

Return pdPASS is returned if the message was successfully sent to the timer daemon task, otherwise pdFALSE is returned.

Parameters

- xFunctionToPend: The function to execute from the timer service/ daemon task. The function must conform to the PendedFunction_t prototype.
- pvParameter1: The value of the callback function's first parameter. The parameter has a void * type to allow it to be used to pass any type. For example, unsigned longs can be cast to a void *, or the void * can be used to point to a structure.
- ulParameter2: The value of the callback function's second parameter.
- pxHigherPriorityTaskWoken: As mentioned above, calling this function will result in a message being sent to the timer daemon task. If the priority of the timer daemon task (which is set using configTIMER_TASK_PRIORITY in FreeRTOSConfig.h) is higher than the priority of the currently running task (the task the interrupt interrupted) then *pxHigherPriorityTaskWoken will be set to pdTRUE within xTimerPendFunctionCallFromISR(), indicating that a context switch should be requested before the interrupt exits. For that reason *pxHigherPriorityTaskWoken must be initialised to pdFALSE. See the example code below.

```
BaseType_t xTimerPendFunctionCall( PendedFunction_t xFunctionToPend, void *pvParameter1,
    uint32_t ulParameter2, TickType_t xTicksToWait )
```

Used to defer the execution of a function to the RTOS daemon task (the timer service task, hence this function is implemented in `timers.c` and is prefixed with 'Timer').

Return `pdPASS` is returned if the message was successfully sent to the timer daemon task, otherwise `pdFALSE` is returned.

Parameters

- `xFunctionToPend`: The function to execute from the timer service/ daemon task. The function must conform to the `PendedFunction_t` prototype.
- `pvParameter1`: The value of the callback function's first parameter. The parameter has a void * type to allow it to be used to pass any type. For example, unsigned longs can be cast to a void *, or the void * can be used to point to a structure.
- `ulParameter2`: The value of the callback function's second parameter.
- `xTicksToWait`: Calling this function will result in a message being sent to the timer daemon task on a queue. `xTicksToWait` is the amount of time the calling task should remain in the Blocked state (so not using any processing time) for space to become available on the timer queue if the queue is found to be full.

```
const char *pcTimerGetName (TimerHandle_t xTimer)
const char * const pcTimerGetName( TimerHandle_t xTimer );
```

Returns the name that was assigned to a timer when the timer was created.

Return The name assigned to the timer specified by the `xTimer` parameter.

Parameters

- `xTimer`: The handle of the timer being queried.

```
void vTimerSetReloadMode (TimerHandle_t xTimer, const UBaseType_t uxAutoReload)
void vTimerSetReloadMode( TimerHandle_t xTimer, const UBaseType_t uxAutoReload );
```

Updates a timer to be either an autoreload timer, in which case the timer automatically resets itself each time it expires, or a one shot timer, in which case the timer will only expire once unless it is manually restarted.

Parameters

- `xTimer`: The handle of the timer being updated.
- `uxAutoReload`: If `uxAutoReload` is set to `pdTRUE` then the timer will expire repeatedly with a frequency set by the timer's period (see the `xTimerPeriodInTicks` parameter of the `xTimerCreate()` API function). If `uxAutoReload` is set to `pdFALSE` then the timer will be a one-shot timer and enter the dormant state after it expires.

```
TickType_t xTimerGetPeriod (TimerHandle_t xTimer)
TickType_t xTimerGetPeriod( TimerHandle_t xTimer );
```

Returns the period of a timer.

Return The period of the timer in ticks.

Parameters

- `xTimer`: The handle of the timer being queried.

```
TickType_t xTimerGetExpiryTime (TimerHandle_t xTimer)
TickType_t xTimerGetExpiryTime( TimerHandle_t xTimer );
```

Returns the time in ticks at which the timer will expire. If this is less than the current tick count then the expiry time has overflowed from the current time.

Return If the timer is running then the time in ticks at which the timer will next expire is returned. If the timer is not running then the return value is undefined.

Parameters

- `xTimer`: The handle of the timer being queried.

Macros

```
tmrCOMMAND_EXECUTE_CALLBACK_FROM_ISR
```

```
tmrCOMMAND_EXECUTE_CALLBACK
```

```
tmrCOMMAND_START_DONT_TRACE
```

tmrCOMMAND_START

tmrCOMMAND_RESET

tmrCOMMAND_STOP

tmrCOMMAND_CHANGE_PERIOD

tmrCOMMAND_DELETE

tmrFIRST_FROM_ISR_COMMAND

tmrCOMMAND_START_FROM_ISR

tmrCOMMAND_RESET_FROM_ISR

tmrCOMMAND_STOP_FROM_ISR

tmrCOMMAND_CHANGE_PERIOD_FROM_ISR

xTimerStart (xTimer, xTicksToWait)

BaseType_t xTimerStart(TimerHandle_t xTimer, TickType_t xTicksToWait);

Timer functionality is provided by a timer service/daemon task. Many of the public FreeRTOS timer API functions send commands to the timer service task through a queue called the timer command queue. The timer command queue is private to the kernel itself and is not directly accessible to application code. The length of the timer command queue is set by the configTIMER_QUEUE_LENGTH configuration constant.

xTimerStart() starts a timer that was previously created using the xTimerCreate() API function. If the timer had already been started and was already in the active state, then xTimerStart() has equivalent functionality to the xTimerReset() API function.

Starting a timer ensures the timer is in the active state. If the timer is not stopped, deleted, or reset in the mean time, the callback function associated with the timer will get called 'n' ticks after xTimerStart() was called, where 'n' is the timers defined period.

It is valid to call xTimerStart() before the scheduler has been started, but when this is done the timer will not actually start until the scheduler is started, and the timers expiry time will be relative to when the scheduler is started, not relative to when xTimerStart() was called.

The configUSE_TIMERS configuration constant must be set to 1 for xTimerStart() to be available.

Example usage:

Return pdFAIL will be returned if the start command could not be sent to the timer command queue even after xTicksToWait ticks had passed. pdPASS will be returned if the command was successfully sent to the timer command queue. When the command is actually processed will depend on the priority of the timer service/daemon task relative to other tasks in the system, although the timers expiry time is relative to when xTimerStart() is actually called. The timer service/daemon task priority is set by the configTIMER_TASK_PRIORITY configuration constant.

Parameters

- **xTimer**: The handle of the timer being started/restarted.
- **xTicksToWait**: Specifies the time, in ticks, that the calling task should be held in the Blocked state to wait for the start command to be successfully sent to the timer command queue, should the queue already be full when xTimerStart() was called. xTicksToWait is ignored if xTimerStart() is called before the scheduler is started.

See the xTimerCreate() API function example usage scenario.

xTimerStop (xTimer, xTicksToWait)

Timer functionality is provided by a timer service/daemon task. Many of the public FreeRTOS timer API functions send commands to the timer service task through a queue called the timer command queue. The timer command queue is private to the kernel itself and is not directly accessible to application code. The length of the timer command queue is set by the configTIMER_QUEUE_LENGTH configuration constant.

xTimerStop() stops a timer that was previously started using either of the The xTimerStart(), xTimerReset(), xTimerStartFromISR(), xTimerResetFromISR(), xTimerChangePeriod() or xTimerChangePeriodFromISR() API functions.

Stopping a timer ensures the timer is not in the active state.

The `configUSE_TIMERS` configuration constant must be set to 1 for `xTimerStop()` to be available.

Example usage:

Return `pdFAIL` will be returned if the stop command could not be sent to the timer command queue even after `xTicksToWait` ticks had passed. `pdPASS` will be returned if the command was successfully sent to the timer command queue. When the command is actually processed will depend on the priority of the timer service/daemon task relative to other tasks in the system. The timer service/daemon task priority is set by the `configTIMER_TASK_PRIORITY` configuration constant.

Parameters

- `xTimer`: The handle of the timer being stopped.
- `xTicksToWait`: Specifies the time, in ticks, that the calling task should be held in the Blocked state to wait for the stop command to be successfully sent to the timer command queue, should the queue already be full when `xTimerStop()` was called. `xTicksToWait` is ignored if `xTimerStop()` is called before the scheduler is started.

See the `xTimerCreate()` API function example usage scenario.

xTimerChangePeriod (`xTimer`, `xNewPeriod`, `xTicksToWait`)

Timer functionality is provided by a timer service/daemon task. Many of the public FreeRTOS timer API functions send commands to the timer service task through a queue called the timer command queue. The timer command queue is private to the kernel itself and is not directly accessible to application code. The length of the timer command queue is set by the `configTIMER_QUEUE_LENGTH` configuration constant.

`xTimerChangePeriod()` changes the period of a timer that was previously created using the `xTimerCreate()` API function.

`xTimerChangePeriod()` can be called to change the period of an active or dormant state timer.

The `configUSE_TIMERS` configuration constant must be set to 1 for `xTimerChangePeriod()` to be available.

Example usage:

```
// This function assumes xTimer has already been created. If the timer
// referenced by xTimer is already active when it is called, then the timer
// is deleted. If the timer referenced by xTimer is not active when it is
// called, then the period of the timer is set to 500ms and the timer is
// started.
void vAFunction( TimerHandle_t xTimer )
{
    if( xTimerIsTimerActive( xTimer ) != pdFALSE ) // or more simply and
    →equivalently "if( xTimerIsTimerActive( xTimer ) )"
    {
        // xTimer is already active - delete it.
        xTimerDelete( xTimer );
    }
    else
    {
        // xTimer is not active, change its period to 500ms. This will also
        // cause the timer to start. Block for a maximum of 100 ticks if the
        // change period command cannot immediately be sent to the timer
        // command queue.
        if( xTimerChangePeriod( xTimer, 500 / portTICK_PERIOD_MS, 100 ) ==
    →pdPASS )
        {
            // The command was successfully sent.
        }
        else
        {
            // The command could not be sent, even after waiting for 100 ticks
            // to pass. Take appropriate action here.
        }
    }
}
```

(continues on next page)

```

    }
}

```

Return pdFAIL will be returned if the change period command could not be sent to the timer command queue even after xTicksToWait ticks had passed. pdPASS will be returned if the command was successfully sent to the timer command queue. When the command is actually processed will depend on the priority of the timer service/daemon task relative to other tasks in the system. The timer service/daemon task priority is set by the configTIMER_TASK_PRIORITY configuration constant.

Parameters

- xTimer: The handle of the timer that is having its period changed.
- xNewPeriod: The new period for xTimer. Timer periods are specified in tick periods, so the constant portTICK_PERIOD_MS can be used to convert a time that has been specified in milliseconds. For example, if the timer must expire after 100 ticks, then xNewPeriod should be set to 100. Alternatively, if the timer must expire after 500ms, then xNewPeriod can be set to (500 / portTICK_PERIOD_MS) provided configTICK_RATE_HZ is less than or equal to 1000.
- xTicksToWait: Specifies the time, in ticks, that the calling task should be held in the Blocked state to wait for the change period command to be successfully sent to the timer command queue, should the queue already be full when xTimerChangePeriod() was called. xTicksToWait is ignored if xTimerChangePeriod() is called before the scheduler is started.

xTimerDelete (xTimer, xTicksToWait)

Timer functionality is provided by a timer service/daemon task. Many of the public FreeRTOS timer API functions send commands to the timer service task through a queue called the timer command queue. The timer command queue is private to the kernel itself and is not directly accessible to application code. The length of the timer command queue is set by the configTIMER_QUEUE_LENGTH configuration constant.

xTimerDelete() deletes a timer that was previously created using the xTimerCreate() API function.

The configUSE_TIMERS configuration constant must be set to 1 for xTimerDelete() to be available.

Example usage:

Return pdFAIL will be returned if the delete command could not be sent to the timer command queue even after xTicksToWait ticks had passed. pdPASS will be returned if the command was successfully sent to the timer command queue. When the command is actually processed will depend on the priority of the timer service/daemon task relative to other tasks in the system. The timer service/daemon task priority is set by the configTIMER_TASK_PRIORITY configuration constant.

Parameters

- xTimer: The handle of the timer being deleted.
- xTicksToWait: Specifies the time, in ticks, that the calling task should be held in the Blocked state to wait for the delete command to be successfully sent to the timer command queue, should the queue already be full when xTimerDelete() was called. xTicksToWait is ignored if xTimerDelete() is called before the scheduler is started.

See the xTimerChangePeriod() API function example usage scenario.

xTimerReset (xTimer, xTicksToWait)

Timer functionality is provided by a timer service/daemon task. Many of the public FreeRTOS timer API functions send commands to the timer service task through a queue called the timer command queue. The timer command queue is private to the kernel itself and is not directly accessible to application code. The length of the timer command queue is set by the configTIMER_QUEUE_LENGTH configuration constant.

xTimerReset() re-starts a timer that was previously created using the xTimerCreate() API function. If the timer had already been started and was already in the active state, then xTimerReset() will cause the timer to re-evaluate its expiry time so that it is relative to when xTimerReset() was called. If the timer was in the dormant state then xTimerReset() has equivalent functionality to the xTimerStart() API function.

Resetting a timer ensures the timer is in the active state. If the timer is not stopped, deleted, or reset in the mean time, the callback function associated with the timer will get called 'n' ticks after xTimerReset() was called, where 'n' is the timers defined period.

It is valid to call xTimerReset() before the scheduler has been started, but when this is done the timer will not

actually start until the scheduler is started, and the timers expiry time will be relative to when the scheduler is started, not relative to when `xTimerReset()` was called.

The `configUSE_TIMERS` configuration constant must be set to 1 for `xTimerReset()` to be available.

Example usage:

```
// When a key is pressed, an LCD back-light is switched on. If 5 seconds pass
// without a key being pressed, then the LCD back-light is switched off. In
// this case, the timer is a one-shot timer.

TimerHandle_t xBacklightTimer = NULL;

// The callback function assigned to the one-shot timer. In this case the
// parameter is not used.
void vBacklightTimerCallback( TimerHandle_t pxTimer )
{
    // The timer expired, therefore 5 seconds must have passed since a key
    // was pressed. Switch off the LCD back-light.
    vSetBacklightState( BACKLIGHT_OFF );
}

// The key press event handler.
void vKeyPressEventHandler( char cKey )
{
    // Ensure the LCD back-light is on, then reset the timer that is
    // responsible for turning the back-light off after 5 seconds of
    // key inactivity. Wait 10 ticks for the command to be successfully sent
    // if it cannot be sent immediately.
    vSetBacklightState( BACKLIGHT_ON );
    if( xTimerReset( xBacklightTimer, 100 ) != pdPASS )
    {
        // The reset command was not executed successfully. Take appropriate
        // action here.
    }

    // Perform the rest of the key processing here.
}

void main( void )
{
    int32_t x;

    // Create then start the one-shot timer that is responsible for turning
    // the back-light off if no keys are pressed within a 5 second period.
    xBacklightTimer = xTimerCreate( "BacklightTimer", // Just a text_
    ↪name, not used by the kernel. ( 5000 / portTICK_PERIOD_MS), // The timer_
    ↪period in ticks. pdFALSE, // The timer_
    ↪is a one-shot timer. 0, // The id is_
    ↪not used by the callback so can take any value. vBacklightTimerCallback // The_
    ↪callback function that switches the LCD back-light off. );

    if( xBacklightTimer == NULL )
    {
        // The timer was not created.
    }
    else
    {
```

(continues on next page)

(continued from previous page)

```

// Start the timer. No block time is specified, and even if one was
// it would be ignored because the scheduler has not yet been
// started.
if( xTimerStart( xBacklightTimer, 0 ) != pdPASS )
{
    // The timer could not be set into the Active state.
}
}

// ...
// Create tasks here.
// ...

// Starting the scheduler will start the timer running as it has already
// been set into the active state.
vTaskStartScheduler();

// Should not reach here.
for( ;; );
}

```

Return pdFAIL will be returned if the reset command could not be sent to the timer command queue even after xTicksToWait ticks had passed. pdPASS will be returned if the command was successfully sent to the timer command queue. When the command is actually processed will depend on the priority of the timer service/daemon task relative to other tasks in the system, although the timers expiry time is relative to when xTimerStart() is actually called. The timer service/daemon task priority is set by the configTIMER_TASK_PRIORITY configuration constant.

Parameters

- xTimer: The handle of the timer being reset/started/restarted.
- xTicksToWait: Specifies the time, in ticks, that the calling task should be held in the Blocked state to wait for the reset command to be successfully sent to the timer command queue, should the queue already be full when xTimerReset() was called. xTicksToWait is ignored if xTimerReset() is called before the scheduler is started.

xTimerStartFromISR (xTimer, pxHigherPriorityTaskWoken)

A version of xTimerStart() that can be called from an interrupt service routine.

Example usage:

```

// This scenario assumes xBacklightTimer has already been created. When a
// key is pressed, an LCD back-light is switched on. If 5 seconds pass
// without a key being pressed, then the LCD back-light is switched off. In
// this case, the timer is a one-shot timer, and unlike the example given for
// the xTimerReset() function, the key press event handler is an interrupt
// service routine.

// The callback function assigned to the one-shot timer. In this case the
// parameter is not used.
void vBacklightTimerCallback( TimerHandle_t pxTimer )
{
    // The timer expired, therefore 5 seconds must have passed since a key
    // was pressed. Switch off the LCD back-light.
    vSetBacklightState( BACKLIGHT_OFF );
}

// The key press interrupt service routine.
void vKeyPressEventInterruptHandler( void )
{
    BaseType_t xHigherPriorityTaskWoken = pdFALSE;

    // Ensure the LCD back-light is on, then restart the timer that is

```

(continues on next page)

(continued from previous page)

```

// responsible for turning the back-light off after 5 seconds of
// key inactivity. This is an interrupt service routine so can only
// call FreeRTOS API functions that end in "FromISR".
vSetBacklightState( BACKLIGHT_ON );

// xTimerStartFromISR() or xTimerResetFromISR() could be called here
// as both cause the timer to re-calculate its expiry time.
// xHigherPriorityTaskWoken was initialised to pdFALSE when it was
// declared (in this function).
if( xTimerStartFromISR( xBacklightTimer, &xHigherPriorityTaskWoken ) !=_
↳pdPASS )
{
    // The start command was not executed successfully. Take appropriate
    // action here.
}

// Perform the rest of the key processing here.

// If xHigherPriorityTaskWoken equals pdTRUE, then a context switch
// should be performed. The syntax required to perform a context switch
// from inside an ISR varies from port to port, and from compiler to
// compiler. Inspect the demos for the port you are using to find the
// actual syntax required.
if( xHigherPriorityTaskWoken != pdFALSE )
{
    // Call the interrupt safe yield function here (actual function
    // depends on the FreeRTOS port being used).
}
}

```

Return pdFAIL will be returned if the start command could not be sent to the timer command queue. pdPASS will be returned if the command was successfully sent to the timer command queue. When the command is actually processed will depend on the priority of the timer service/daemon task relative to other tasks in the system, although the timer expiry time is relative to when xTimerStartFromISR() is actually called. The timer service/daemon task priority is set by the configTIMER_TASK_PRIORITY configuration constant.

Parameters

- xTimer: The handle of the timer being started/restarted.
- pxHigherPriorityTaskWoken: The timer service/daemon task spends most of its time in the Blocked state, waiting for messages to arrive on the timer command queue. Calling xTimerStartFromISR() writes a message to the timer command queue, so has the potential to transition the timer service/daemon task out of the Blocked state. If calling xTimerStartFromISR() causes the timer service/daemon task to leave the Blocked state, and the timer service/daemon task has a priority equal to or greater than the currently executing task (the task that was interrupted), then *pxHigherPriorityTaskWoken will get set to pdTRUE internally within the xTimerStartFromISR() function. If xTimerStartFromISR() sets this value to pdTRUE then a context switch should be performed before the interrupt exits.

xTimerStopFromISR(xTimer, pxHigherPriorityTaskWoken)

A version of xTimerStop() that can be called from an interrupt service routine.

Example usage:

```

// This scenario assumes xTimer has already been created and started. When
// an interrupt occurs, the timer should be simply stopped.

// The interrupt service routine that stops the timer.
void vAnExampleInterruptServiceRoutine( void )
{
    BaseType_t xHigherPriorityTaskWoken = pdFALSE;

```

(continues on next page)

(continued from previous page)

```

// The interrupt has occurred - simply stop the timer.
// xHigherPriorityTaskWoken was set to pdFALSE where it was defined
// (within this function). As this is an interrupt service routine, only
// FreeRTOS API functions that end in "FromISR" can be used.
if( xTimerStopFromISR( xTimer, &xHigherPriorityTaskWoken ) != pdPASS )
{
    // The stop command was not executed successfully. Take appropriate
    // action here.
}

// If xHigherPriorityTaskWoken equals pdTRUE, then a context switch
// should be performed. The syntax required to perform a context switch
// from inside an ISR varies from port to port, and from compiler to
// compiler. Inspect the demos for the port you are using to find the
// actual syntax required.
if( xHigherPriorityTaskWoken != pdFALSE )
{
    // Call the interrupt safe yield function here (actual function
    // depends on the FreeRTOS port being used).
}
}

```

Return pdFAIL will be returned if the stop command could not be sent to the timer command queue. pdPASS will be returned if the command was successfully sent to the timer command queue. When the command is actually processed will depend on the priority of the timer service/daemon task relative to other tasks in the system. The timer service/daemon task priority is set by the configTIMER_TASK_PRIORITY configuration constant.

Parameters

- `xTimer`: The handle of the timer being stopped.
- `pxHigherPriorityTaskWoken`: The timer service/daemon task spends most of its time in the Blocked state, waiting for messages to arrive on the timer command queue. Calling `xTimerStopFromISR()` writes a message to the timer command queue, so has the potential to transition the timer service/daemon task out of the Blocked state. If calling `xTimerStopFromISR()` causes the timer service/daemon task to leave the Blocked state, and the timer service/ daemon task has a priority equal to or greater than the currently executing task (the task that was interrupted), then `*pxHigherPriorityTaskWoken` will get set to pdTRUE internally within the `xTimerStopFromISR()` function. If `xTimerStopFromISR()` sets this value to pdTRUE then a context switch should be performed before the interrupt exits.

`xTimerChangePeriodFromISR` (`xTimer`, `xNewPeriod`, `pxHigherPriorityTaskWoken`)

A version of `xTimerChangePeriod()` that can be called from an interrupt service routine.

Example usage:

```

// This scenario assumes xTimer has already been created and started. When
// an interrupt occurs, the period of xTimer should be changed to 500ms.

// The interrupt service routine that changes the period of xTimer.
void vAnExampleInterruptServiceRoutine( void )
{
    BaseType_t xHigherPriorityTaskWoken = pdFALSE;

    // The interrupt has occurred - change the period of xTimer to 500ms.
    // xHigherPriorityTaskWoken was set to pdFALSE where it was defined
    // (within this function). As this is an interrupt service routine, only
    // FreeRTOS API functions that end in "FromISR" can be used.
    if( xTimerChangePeriodFromISR( xTimer, &xHigherPriorityTaskWoken ) !=
    ↪pdPASS )
    {

```

(continues on next page)

(continued from previous page)

```

    // The command to change the timers period was not executed
    // successfully. Take appropriate action here.
}

// If xHigherPriorityTaskWoken equals pdTRUE, then a context switch
// should be performed. The syntax required to perform a context switch
// from inside an ISR varies from port to port, and from compiler to
// compiler. Inspect the demos for the port you are using to find the
// actual syntax required.
if( xHigherPriorityTaskWoken != pdFALSE )
{
    // Call the interrupt safe yield function here (actual function
    // depends on the FreeRTOS port being used).
}
}

```

Return pdFAIL will be returned if the command to change the timers period could not be sent to the timer command queue. pdPASS will be returned if the command was successfully sent to the timer command queue. When the command is actually processed will depend on the priority of the timer service/daemon task relative to other tasks in the system. The timer service/daemon task priority is set by the configTIMER_TASK_PRIORITY configuration constant.

Parameters

- xTimer: The handle of the timer that is having its period changed.
- xNewPeriod: The new period for xTimer. Timer periods are specified in tick periods, so the constant portTICK_PERIOD_MS can be used to convert a time that has been specified in milliseconds. For example, if the timer must expire after 100 ticks, then xNewPeriod should be set to 100. Alternatively, if the timer must expire after 500ms, then xNewPeriod can be set to (500 / portTICK_PERIOD_MS) provided configTICK_RATE_HZ is less than or equal to 1000.
- pxHigherPriorityTaskWoken: The timer service/daemon task spends most of its time in the Blocked state, waiting for messages to arrive on the timer command queue. Calling xTimerChangePeriodFromISR() writes a message to the timer command queue, so has the potential to transition the timer service/ daemon task out of the Blocked state. If calling xTimerChangePeriodFromISR() causes the timer service/daemon task to leave the Blocked state, and the timer service/daemon task has a priority equal to or greater than the currently executing task (the task that was interrupted), then *pxHigherPriorityTaskWoken will get set to pdTRUE internally within the xTimerChangePeriodFromISR() function. If xTimerChangePeriodFromISR() sets this value to pdTRUE then a context switch should be performed before the interrupt exits.

xTimerResetFromISR (xTimer, pxHigherPriorityTaskWoken)

A version of xTimerReset() that can be called from an interrupt service routine.

Example usage:

```

// This scenario assumes xBacklightTimer has already been created. When a
// key is pressed, an LCD back-light is switched on. If 5 seconds pass
// without a key being pressed, then the LCD back-light is switched off. In
// this case, the timer is a one-shot timer, and unlike the example given for
// the xTimerReset() function, the key press event handler is an interrupt
// service routine.

// The callback function assigned to the one-shot timer. In this case the
// parameter is not used.
void vBacklightTimerCallback( TimerHandle_t pxTimer )
{
    // The timer expired, therefore 5 seconds must have passed since a key
    // was pressed. Switch off the LCD back-light.
    vSetBacklightState( BACKLIGHT_OFF );
}

// The key press interrupt service routine.

```

(continues on next page)

(continued from previous page)

```

void vKeyPressEventInterruptHandler( void )
{
BaseType_t xHigherPriorityTaskWoken = pdFALSE;

    // Ensure the LCD back-light is on, then reset the timer that is
    // responsible for turning the back-light off after 5 seconds of
    // key inactivity. This is an interrupt service routine so can only
    // call FreeRTOS API functions that end in "FromISR".
    vSetBacklightState( BACKLIGHT_ON );

    // xTimerStartFromISR() or xTimerResetFromISR() could be called here
    // as both cause the timer to re-calculate its expiry time.
    // xHigherPriorityTaskWoken was initialised to pdFALSE when it was
    // declared (in this function).
    if( xTimerResetFromISR( xBacklightTimer, &xHigherPriorityTaskWoken ) !=
    ↪pdPASS )
    {
        // The reset command was not executed successfully. Take appropriate
        // action here.
    }

    // Perform the rest of the key processing here.

    // If xHigherPriorityTaskWoken equals pdTRUE, then a context switch
    // should be performed. The syntax required to perform a context switch
    // from inside an ISR varies from port to port, and from compiler to
    // compiler. Inspect the demos for the port you are using to find the
    // actual syntax required.
    if( xHigherPriorityTaskWoken != pdFALSE )
    {
        // Call the interrupt safe yield function here (actual function
        // depends on the FreeRTOS port being used).
    }
}

```

Return pdFAIL will be returned if the reset command could not be sent to the timer command queue. pdPASS will be returned if the command was successfully sent to the timer command queue. When the command is actually processed will depend on the priority of the timer service/daemon task relative to other tasks in the system, although the timers expiry time is relative to when xTimerResetFromISR() is actually called. The timer service/daemon task priority is set by the configTIMER_TASK_PRIORITY configuration constant.

Parameters

- xTimer: The handle of the timer that is to be started, reset, or restarted.
- pxHigherPriorityTaskWoken: The timer service/daemon task spends most of its time in the Blocked state, waiting for messages to arrive on the timer command queue. Calling xTimerResetFromISR() writes a message to the timer command queue, so has the potential to transition the timer service/daemon task out of the Blocked state. If calling xTimerResetFromISR() causes the timer service/daemon task to leave the Blocked state, and the timer service/ daemon task has a priority equal to or greater than the currently executing task (the task that was interrupted), then *pxHigherPriorityTaskWoken will get set to pdTRUE internally within the xTimerResetFromISR() function. If xTimerResetFromISR() sets this value to pdTRUE then a context switch should be performed before the interrupt exits.

Type Definitions

```

typedef void *TimerHandle_t
typedef void (*TimerCallbackFunction_t)(TimerHandle_t xTimer)
typedef void (*PendedFunction_t)(void *, uint32_t)

```

Event Group API

Header File

- `freertos/include/freertos/event_groups.h`

Functions

EventGroupHandle_t **xEventGroupCreate** (void)

Create a new event group.

Internally, within the FreeRTOS implementation, event groups use a [small] block of memory, in which the event group's structure is stored. If an event groups is created using `xEventGropuCreate()` then the required memory is automatically dynamically allocated inside the `xEventGroupCreate()` function. (see <http://www.freertos.org/a00111.html>). If an event group is created using `xEventGropuCreateStatic()` then the application writer must instead provide the memory that will get used by the event group. `xEventGroupCreateStatic()` therefore allows an event group to be created without using any dynamic memory allocation.

Although event groups are not related to ticks, for internal implementation reasons the number of bits available for use in an event group is dependent on the `configUSE_16_BIT_TICKS` setting in `FreeRTOSConfig.h`. If `configUSE_16_BIT_TICKS` is 1 then each event group contains 8 usable bits (bit 0 to bit 7). If `configUSE_16_BIT_TICKS` is set to 0 then each event group has 24 usable bits (bit 0 to bit 23). The `EventBits_t` type is used to store event bits within an event group.

Example usage:

```
// Declare a variable to hold the created event group.
EventGroupHandle_t xCreatedEventGroup;

// Attempt to create the event group.
xCreatedEventGroup = xEventGroupCreate();

// Was the event group created successfully?
if( xCreatedEventGroup == NULL )
{
    // The event group was not created because there was insufficient
    // FreeRTOS heap available.
}
else
{
    // The event group was created.
}
```

Return If the event group was created then a handle to the event group is returned. If there was insufficient FreeRTOS heap available to create the event group then `NULL` is returned. See <http://www.freertos.org/a00111.html>

EventGroupHandle_t **xEventGroupCreateStatic** (StaticEventGroup_t *pxEventGroupBuffer)

Create a new event group.

Internally, within the FreeRTOS implementation, event groups use a [small] block of memory, in which the event group's structure is stored. If an event groups is created using `xEventGropuCreate()` then the required memory is automatically dynamically allocated inside the `xEventGroupCreate()` function. (see <http://www.freertos.org/a00111.html>). If an event group is created using `xEventGropuCreateStatic()` then the application writer must instead provide the memory that will get used by the event group. `xEventGroupCreateStatic()` therefore allows an event group to be created without using any dynamic memory allocation.

Although event groups are not related to ticks, for internal implementation reasons the number of bits available for use in an event group is dependent on the `configUSE_16_BIT_TICKS` setting in `FreeRTOSConfig.h`. If `configUSE_16_BIT_TICKS` is 1 then each event group contains 8 usable bits (bit 0 to bit 7). If `configUSE_16_BIT_TICKS` is set to 0 then each event group has 24 usable bits (bit 0 to bit 23). The `EventBits_t` type is used to store event bits within an event group.

Example usage:

```

// StaticEventGroup_t is a publicly accessible structure that has the same
// size and alignment requirements as the real event group structure. It is
// provided as a mechanism for applications to know the size of the event
// group (which is dependent on the architecture and configuration file
// settings) without breaking the strict data hiding policy by exposing the
// real event group internals. This StaticEventGroup_t variable is passed
// into the xSemaphoreCreateEventGroupStatic() function and is used to store
// the event group's data structures
StaticEventGroup_t xEventGroupBuffer;

// Create the event group without dynamically allocating any memory.
xEventGroup = xEventGroupCreateStatic( &xEventGroupBuffer );

```

Return If the event group was created then a handle to the event group is returned. If pxEventGroupBuffer was NULL then NULL is returned.

Parameters

- pxEventGroupBuffer: pxEventGroupBuffer must point to a variable of type StaticEventGroup_t, which will be then be used to hold the event group's data structures, removing the need for the memory to be allocated dynamically.

EventBits_t xEventGroupWaitBits (*EventGroupHandle_t* xEventGroup, **const** *EventBits_t* uxBitsToWaitFor, **const** BaseType_t xClearOnExit, **const** BaseType_t xWaitForAllBits, TickType_t xTicksToWait)

[Potentially] block to wait for one or more bits to be set within a previously created event group.

This function cannot be called from an interrupt.

Example usage:

```

#define BIT_0    ( 1 << 0 )
#define BIT_4    ( 1 << 4 )

void aFunction( EventGroupHandle_t xEventGroup )
{
EventBits_t uxBits;
const TickType_t xTicksToWait = 100 / portTICK_PERIOD_MS;

    // Wait a maximum of 100ms for either bit 0 or bit 4 to be set within
    // the event group. Clear the bits before exiting.
    uxBits = xEventGroupWaitBits(
        xEventGroup,    // The event group being tested.
        BIT_0 | BIT_4, // The bits within the event group to wait_
→for.
        pdTRUE,        // BIT_0 and BIT_4 should be cleared before_
→returning.
        pdFALSE,      // Don't wait for both bits, either bit will_
→do.
        xTicksToWait ); // Wait a maximum of 100ms for either bit to_
→be set.

    if( ( uxBits & ( BIT_0 | BIT_4 ) ) == ( BIT_0 | BIT_4 ) )
    {
        // xEventGroupWaitBits() returned because both bits were set.
    }
    else if( ( uxBits & BIT_0 ) != 0 )
    {
        // xEventGroupWaitBits() returned because just BIT_0 was set.
    }
    else if( ( uxBits & BIT_4 ) != 0 )
    {
        // xEventGroupWaitBits() returned because just BIT_4 was set.
    }
}

```

(continues on next page)

(continued from previous page)

```

else
{
    // xEventGroupWaitBits() returned because xTicksToWait ticks passed
    // without either BIT_0 or BIT_4 becoming set.
}
}

```

{c}

Return The value of the event group at the time either the bits being waited for became set, or the block time expired. Test the return value to know which bits were set. If `xEventGroupWaitBits()` returned because its timeout expired then not all the bits being waited for will be set. If `xEventGroupWaitBits()` returned because the bits it was waiting for were set then the returned value is the event group value before any bits were automatically cleared in the case that `xClearOnExit` parameter was set to `pdTRUE`.

Parameters

- `xEventGroup`: The event group in which the bits are being tested. The event group must have previously been created using a call to `xEventGroupCreate()`.
- `uxBitsToWaitFor`: A bitwise value that indicates the bit or bits to test inside the event group. For example, to wait for bit 0 and/or bit 2 set `uxBitsToWaitFor` to `0x05`. To wait for bits 0 and/or bit 1 and/or bit 2 set `uxBitsToWaitFor` to `0x07`. Etc.
- `xClearOnExit`: If `xClearOnExit` is set to `pdTRUE` then any bits within `uxBitsToWaitFor` that are set within the event group will be cleared before `xEventGroupWaitBits()` returns if the wait condition was met (if the function returns for a reason other than a timeout). If `xClearOnExit` is set to `pdFALSE` then the bits set in the event group are not altered when the call to `xEventGroupWaitBits()` returns.
- `xWaitForAllBits`: If `xWaitForAllBits` is set to `pdTRUE` then `xEventGroupWaitBits()` will return when either all the bits in `uxBitsToWaitFor` are set or the specified block time expires. If `xWaitForAllBits` is set to `pdFALSE` then `xEventGroupWaitBits()` will return when any one of the bits set in `uxBitsToWaitFor` is set or the specified block time expires. The block time is specified by the `xTicksToWait` parameter.
- `xTicksToWait`: The maximum amount of time (specified in ‘ticks’) to wait for one/all (depending on the `xWaitForAllBits` value) of the bits specified by `uxBitsToWaitFor` to become set.

EventBits_t **xEventGroupClearBits** (*EventGroupHandle_t* *xEventGroup*, **const** *EventBits_t* *uxBitsToClear*)

Clear bits within an event group. This function cannot be called from an interrupt.

Example usage:

```

#define BIT_0    ( 1 << 0 )
#define BIT_4    ( 1 << 4 )

void aFunction( EventGroupHandle_t xEventGroup )
{
    EventBits_t uxBits;

    // Clear bit 0 and bit 4 in xEventGroup.
    uxBits = xEventGroupClearBits(
                xEventGroup,    // The event group being updated.
                BIT_0 | BIT_4 ); // The bits being cleared.

    if( ( uxBits & ( BIT_0 | BIT_4 ) ) == ( BIT_0 | BIT_4 ) )
    {
        // Both bit 0 and bit 4 were set before xEventGroupClearBits() was
        // called. Both will now be clear (not set).
    }
    else if( ( uxBits & BIT_0 ) != 0 )
    {
        // Bit 0 was set before xEventGroupClearBits() was called. It will
        // now be clear.
    }
}

```

(continues on next page)

(continued from previous page)

```

}
else if( ( uxBits & BIT_4 ) != 0 )
{
    // Bit 4 was set before xEventGroupClearBits() was called. It will
    // now be clear.
}
else
{
    // Neither bit 0 nor bit 4 were set in the first place.
}
}

```

Return The value of the event group before the specified bits were cleared.

Parameters

- `xEventGroup`: The event group in which the bits are to be cleared.
- `uxBitsToClear`: A bitwise value that indicates the bit or bits to clear in the event group. For example, to clear bit 3 only, set `uxBitsToClear` to `0x08`. To clear bit 3 and bit 0 set `uxBitsToClear` to `0x09`.

EventBits_t xEventGroupSetBits (*EventGroupHandle_t* xEventGroup, **const** *EventBits_t* uxBitsToSet)

Set bits within an event group. This function cannot be called from an interrupt. `xEventGroupSetBitsFromISR()` is a version that can be called from an interrupt.

Setting bits in an event group will automatically unblock tasks that are blocked waiting for the bits.

Example usage:

```

#define BIT_0    ( 1 << 0 )
#define BIT_4    ( 1 << 4 )

void aFunction( EventGroupHandle_t xEventGroup )
{
    EventBits_t uxBits;

    // Set bit 0 and bit 4 in xEventGroup.
    uxBits = xEventGroupSetBits(
                xEventGroup, // The event group being updated.
                BIT_0 | BIT_4 ); // The bits being set.

    if( ( uxBits & ( BIT_0 | BIT_4 ) ) == ( BIT_0 | BIT_4 ) )
    {
        // Both bit 0 and bit 4 remained set when the function returned.
    }
    else if( ( uxBits & BIT_0 ) != 0 )
    {
        // Bit 0 remained set when the function returned, but bit 4 was
        // cleared. It might be that bit 4 was cleared automatically as a
        // task that was waiting for bit 4 was removed from the Blocked
        // state.
    }
    else if( ( uxBits & BIT_4 ) != 0 )
    {
        // Bit 4 remained set when the function returned, but bit 0 was
        // cleared. It might be that bit 0 was cleared automatically as a
        // task that was waiting for bit 0 was removed from the Blocked
        // state.
    }
    else
    {
        // Neither bit 0 nor bit 4 remained set. It might be that a task
        // was waiting for both of the bits to be set, and the bits were
        // cleared as the task left the Blocked state.
    }
}

```

(continues on next page)

```

    }
}

```

{c}

Return The value of the event group at the time the call to `xEventGroupSetBits()` returns. There are two reasons why the returned value might have the bits specified by the `uxBitsToSet` parameter cleared. First, if setting a bit results in a task that was waiting for the bit leaving the blocked state then it is possible the bit will be cleared automatically (see the `xClearBitOnExit` parameter of `xEventGroupWaitBits()`). Second, any unblocked (or otherwise Ready state) task that has a priority above that of the task that called `xEventGroupSetBits()` will execute and may change the event group value before the call to `xEventGroupSetBits()` returns.

Parameters

- `xEventGroup`: The event group in which the bits are to be set.
- `uxBitsToSet`: A bitwise value that indicates the bit or bits to set. For example, to set bit 3 only, set `uxBitsToSet` to `0x08`. To set bit 3 and bit 0 set `uxBitsToSet` to `0x09`.

EventBits_t **xEventGroupSync** (*EventGroupHandle_t* `xEventGroup`, **const** *EventBits_t* `uxBitsToSet`, **const** *EventBits_t* `uxBitsToWaitFor`, *TickType_t* `xTicksToWait`)

Atomically set bits within an event group, then wait for a combination of bits to be set within the same event group. This functionality is typically used to synchronise multiple tasks, where each task has to wait for the other tasks to reach a synchronisation point before proceeding.

This function cannot be used from an interrupt.

The function will return before its block time expires if the bits specified by the `uxBitsToWait` parameter are set, or become set within that time. In this case all the bits specified by `uxBitsToWait` will be automatically cleared before the function returns.

Example usage:

```

// Bits used by the three tasks.
#define TASK_0_BIT    ( 1 << 0 )
#define TASK_1_BIT    ( 1 << 1 )
#define TASK_2_BIT    ( 1 << 2 )

#define ALL_SYNC_BITS ( TASK_0_BIT | TASK_1_BIT | TASK_2_BIT )

// Use an event group to synchronise three tasks. It is assumed this event
// group has already been created elsewhere.
EventGroupHandle_t xEventBits;

void vTask0( void *pvParameters )
{
    EventBits_t uxReturn;
    TickType_t xTicksToWait = 100 / portTICK_PERIOD_MS;

    for( ;; )
    {
        // Perform task functionality here.

        // Set bit 0 in the event flag to note this task has reached the
        // sync point. The other two tasks will set the other two bits defined
        // by ALL_SYNC_BITS. All three tasks have reached the synchronisation
        // point when all the ALL_SYNC_BITS are set. Wait a maximum of 100ms
        // for this to happen.
        uxReturn = xEventGroupSync( xEventBits, TASK_0_BIT, ALL_SYNC_BITS,
        ↪xTicksToWait );

        if( ( uxReturn & ALL_SYNC_BITS ) == ALL_SYNC_BITS )
        {
            // All three tasks reached the synchronisation point before the call

```

(continues on next page)

```

        // to xEventGroupSync() timed out.
    }
}

void vTask1( void *pvParameters )
{
    for( ;; )
    {
        // Perform task functionality here.

        // Set bit 1 in the event flag to note this task has reached the
        // synchronisation point. The other two tasks will set the other two
        // bits defined by ALL_SYNC_BITS. All three tasks have reached the
        // synchronisation point when all the ALL_SYNC_BITS are set. Wait
        // indefinitely for this to happen.
        xEventGroupSync( xEventBits, TASK_1_BIT, ALL_SYNC_BITS, portMAX_DELAY );

        // xEventGroupSync() was called with an indefinite block time, so
        // this task will only reach here if the synchronisation was made by all
        // three tasks, so there is no need to test the return value.
    }
}

void vTask2( void *pvParameters )
{
    for( ;; )
    {
        // Perform task functionality here.

        // Set bit 2 in the event flag to note this task has reached the
        // synchronisation point. The other two tasks will set the other two
        // bits defined by ALL_SYNC_BITS. All three tasks have reached the
        // synchronisation point when all the ALL_SYNC_BITS are set. Wait
        // indefinitely for this to happen.
        xEventGroupSync( xEventBits, TASK_2_BIT, ALL_SYNC_BITS, portMAX_DELAY );

        // xEventGroupSync() was called with an indefinite block time, so
        // this task will only reach here if the synchronisation was made by all
        // three tasks, so there is no need to test the return value.
    }
}

```

Return The value of the event group at the time either the bits being waited for became set, or the block time expired. Test the return value to know which bits were set. If `xEventGroupSync()` returned because its timeout expired then not all the bits being waited for will be set. If `xEventGroupSync()` returned because all the bits it was waiting for were set then the returned value is the event group value before any bits were automatically cleared.

Parameters

- `xEventGroup`: The event group in which the bits are being tested. The event group must have previously been created using a call to `xEventGroupCreate()`.
- `uxBitsToSet`: The bits to set in the event group before determining if, and possibly waiting for, all the bits specified by the `uxBitsToWait` parameter are set.
- `uxBitsToWaitFor`: A bitwise value that indicates the bit or bits to test inside the event group. For example, to wait for bit 0 and bit 2 set `uxBitsToWaitFor` to 0x05. To wait for bits 0 and bit 1 and bit 2 set `uxBitsToWaitFor` to 0x07. Etc.
- `xTicksToWait`: The maximum amount of time (specified in 'ticks') to wait for all of the bits specified by `uxBitsToWaitFor` to become set.

EventBits_t `xEventGroupGetBitsFromISR` (*EventGroupHandle_t* `xEventGroup`)

A version of `xEventGroupGetBits()` that can be called from an ISR.

Return The event group bits at the time `xEventGroupGetBitsFromISR()` was called.

Parameters

- `xEventGroup`: The event group being queried.

void **vEventGroupDelete** (*EventGroupHandle_t* `xEventGroup`)

Delete an event group that was previously created by a call to `xEventGroupCreate()`. Tasks that are blocked on the event group will be unblocked and obtain 0 as the event group's value.

Parameters

- `xEventGroup`: The event group being deleted.

Macros

xEventGroupClearBitsFromISR (`xEventGroup`, `uxBitsToClear`)

A version of `xEventGroupClearBits()` that can be called from an interrupt.

Setting bits in an event group is not a deterministic operation because there are an unknown number of tasks that may be waiting for the bit or bits being set. FreeRTOS does not allow nondeterministic operations to be performed while interrupts are disabled, so protects event groups that are accessed from tasks by suspending the scheduler rather than disabling interrupts. As a result event groups cannot be accessed directly from an interrupt service routine. Therefore `xEventGroupClearBitsFromISR()` sends a message to the timer task to have the clear operation performed in the context of the timer task.

Example usage:

```
#define BIT_0    ( 1 << 0 )
#define BIT_4    ( 1 << 4 )

// An event group which it is assumed has already been created by a call to
// xEventGroupCreate().
EventGroupHandle_t xEventGroup;

void anInterruptHandler( void )
{
    // Clear bit 0 and bit 4 in xEventGroup.
    xResult = xEventGroupClearBitsFromISR(
                xEventGroup, // The event group being updated.
                BIT_0 | BIT_4 ); // The bits being set.

    if( xResult == pdPASS )
    {
        // The message was posted successfully.
    }
}
```

Return If the request to execute the function was posted successfully then `pdPASS` is returned, otherwise `pdFALSE` is returned. `pdFALSE` will be returned if the timer service queue was full.

Parameters

- `xEventGroup`: The event group in which the bits are to be cleared.
- `uxBitsToClear`: A bitwise value that indicates the bit or bits to clear. For example, to clear bit 3 only, set `uxBitsToClear` to `0x08`. To clear bit 3 and bit 0 set `uxBitsToClear` to `0x09`.

xEventGroupSetBitsFromISR (`xEventGroup`, `uxBitsToSet`, `pxHigherPriorityTaskWoken`)

A version of `xEventGroupSetBits()` that can be called from an interrupt.

Setting bits in an event group is not a deterministic operation because there are an unknown number of tasks that may be waiting for the bit or bits being set. FreeRTOS does not allow nondeterministic operations to be performed in interrupts or from critical sections. Therefore `xEventGroupSetBitsFromISR()` sends a message to the timer task to have the set operation performed in the context of the timer task - where a scheduler lock is used in place of a critical section.

Example usage:

```

#define BIT_0    ( 1 << 0 )
#define BIT_4    ( 1 << 4 )

// An event group which it is assumed has already been created by a call to
// xEventGroupCreate().
EventGroupHandle_t xEventGroup;

void anInterruptHandler( void )
{
    BaseType_t xHigherPriorityTaskWoken, xResult;

    // xHigherPriorityTaskWoken must be initialised to pdFALSE.
    xHigherPriorityTaskWoken = pdFALSE;

    // Set bit 0 and bit 4 in xEventGroup.
    xResult = xEventGroupSetBitsFromISR(
                xEventGroup,    // The event group being updated.
                BIT_0 | BIT_4    // The bits being set.
                &xHigherPriorityTaskWoken );

    // Was the message posted successfully?
    if( xResult == pdPASS )
    {
        // If xHigherPriorityTaskWoken is now set to pdTRUE then a context
        // switch should be requested. The macro used is port specific and
        // will be either portYIELD_FROM_ISR() or portEND_SWITCHING_ISR() -
        // refer to the documentation page for the port being used.
        portYIELD_FROM_ISR( xHigherPriorityTaskWoken );
    }
}

```

Return If the request to execute the function was posted successfully then `pdPASS` is returned, otherwise `pdFALSE` is returned. `pdFALSE` will be returned if the timer service queue was full.

Parameters

- `xEventGroup`: The event group in which the bits are to be set.
- `uxBitsToSet`: A bitwise value that indicates the bit or bits to set. For example, to set bit 3 only, set `uxBitsToSet` to `0x08`. To set bit 3 and bit 0 set `uxBitsToSet` to `0x09`.
- `pxHigherPriorityTaskWoken`: As mentioned above, calling this function will result in a message being sent to the timer daemon task. If the priority of the timer daemon task is higher than the priority of the currently running task (the task the interrupt interrupted) then `*pxHigherPriorityTaskWoken` will be set to `pdTRUE` by `xEventGroupSetBitsFromISR()`, indicating that a context switch should be requested before the interrupt exits. For that reason `*pxHigherPriorityTaskWoken` must be initialised to `pdFALSE`. See the example code below.

xEventGroupGetBits (xEventGroup)

Returns the current value of the bits in an event group. This function cannot be used from an interrupt.

Return The event group bits at the time `xEventGroupGetBits()` was called.

Parameters

- `xEventGroup`: The event group being queried.

Type Definitions

```

typedef void *EventGroupHandle_t
typedef TickType_t EventBits_t

```

Stream Buffer API

Header File

- [freertos/include/freertos/stream_buffer.h](#)

Functions

size_t **xStreamBufferSend**(*StreamBufferHandle_t* xStreamBuffer, const void *pvTxData, size_t xDataLengthBytes, TickType_t xTicksToWait)

Sends bytes to a stream buffer. The bytes are copied into the stream buffer.

*****NOTE***:** Uniquely among FreeRTOS objects, the stream buffer implementation (so also the message buffer implementation, as message buffers are built on top of stream buffers) assumes there is only one task or interrupt that will write to the buffer (the writer), and only one task or interrupt that will read from the buffer (the reader). It is safe for the writer and reader to be different tasks or interrupts, but, unlike other FreeRTOS objects, it is not safe to have multiple different writers or multiple different readers. If there are to be multiple different writers then the application writer must place each call to a writing API function (such as xStreamBufferSend()) inside a critical section and set the send block time to 0. Likewise, if there are to be multiple different readers then the application writer must place each call to a reading API function (such as xStreamBufferRead()) inside a critical section and set the receive block time to 0.

Use xStreamBufferSend() to write to a stream buffer from a task. Use xStreamBufferSendFromISR() to write to a stream buffer from an interrupt service routine (ISR).

Example use:

```
void vAFunction( StreamBufferHandle_t xStreamBuffer )
{
    size_t xBytesSent;
    uint8_t ucArrayToSend[] = { 0, 1, 2, 3 };
    char *pcStringToSend = "String to send";
    const TickType_t x100ms = pdMS_TO_TICKS( 100 );

    // Send an array to the stream buffer, blocking for a maximum of 100ms to
    // wait for enough space to be available in the stream buffer.
    xBytesSent = xStreamBufferSend( xStreamBuffer, ( void * ) ucArrayToSend,
    ↪ sizeof( ucArrayToSend ), x100ms );

    if( xBytesSent != sizeof( ucArrayToSend ) )
    {
        // The call to xStreamBufferSend() times out before there was enough
        // space in the buffer for the data to be written, but it did
        // successfully write xBytesSent bytes.
    }

    // Send the string to the stream buffer. Return immediately if there is
    ↪ not
    // enough space in the buffer.
    xBytesSent = xStreamBufferSend( xStreamBuffer, ( void * ) pcStringToSend,
    ↪ strlen( pcStringToSend ), 0 );

    if( xBytesSent != strlen( pcStringToSend ) )
    {
        // The entire string could not be added to the stream buffer because
        // there was not enough free space in the buffer, but xBytesSent bytes
        // were sent. Could try again to send the remaining bytes.
    }
}
```

Return The number of bytes written to the stream buffer. If a task times out before it can write all xDataLengthBytes into the buffer it will still write as many bytes as possible.

Parameters

- xStreamBuffer: The handle of the stream buffer to which a stream is being sent.
- pvTxData: A pointer to the buffer that holds the bytes to be copied into the stream buffer.
- xDataLengthBytes: The maximum number of bytes to copy from pvTxData into the stream buffer.
- xTicksToWait: The maximum amount of time the task should remain in the Blocked state to wait for enough space to become available in the stream buffer, should the stream buffer contain too little space to hold the another xDataLengthBytes bytes. The block time is specified in tick periods, so

the absolute time it represents is dependent on the tick frequency. The macro `pdMS_TO_TICKS()` can be used to convert a time specified in milliseconds into a time specified in ticks. Setting `xTicksToWait` to `portMAX_DELAY` will cause the task to wait indefinitely (without timing out), provided `INCLUDE_vTaskSuspend` is set to 1 in `FreeRTOSConfig.h`. If a task times out before it can write all `xDataLengthBytes` into the buffer it will still write as many bytes as possible. A task does not use any CPU time when it is in the blocked state.

```
size_t xStreamBufferSendFromISR( StreamBufferHandle_t xStreamBuffer, const void *pvTxData,
                                size_t xDataLengthBytes, BaseType_t *const pxHigherPriorityTaskWoken )
```

Interrupt safe version of the API function that sends a stream of bytes to the stream buffer.

*****NOTE***:** Uniquely among FreeRTOS objects, the stream buffer implementation (so also the message buffer implementation, as message buffers are built on top of stream buffers) assumes there is only one task or interrupt that will write to the buffer (the writer), and only one task or interrupt that will read from the buffer (the reader). It is safe for the writer and reader to be different tasks or interrupts, but, unlike other FreeRTOS objects, it is not safe to have multiple different writers or multiple different readers. If there are to be multiple different writers then the application writer must place each call to a writing API function (such as `xStreamBufferSend()`) inside a critical section and set the send block time to 0. Likewise, if there are to be multiple different readers then the application writer must place each call to a reading API function (such as `xStreamBufferRead()`) inside a critical section and set the receive block time to 0.

Use `xStreamBufferSend()` to write to a stream buffer from a task. Use `xStreamBufferSendFromISR()` to write to a stream buffer from an interrupt service routine (ISR).

Example use:

```
//A stream buffer that has already been created.
StreamBufferHandle_t xStreamBuffer;

void vAnInterruptServiceRoutine( void )
{
    size_t xBytesSent;
    char *pcStringToSend = "String to send";
    BaseType_t xHigherPriorityTaskWoken = pdFALSE; // Initialised to pdFALSE.

    // Attempt to send the string to the stream buffer.
    xBytesSent = xStreamBufferSendFromISR( xStreamBuffer,
                                           ( void * ) pcStringToSend,
                                           strlen( pcStringToSend ),
                                           &xHigherPriorityTaskWoken );

    if( xBytesSent != strlen( pcStringToSend ) )
    {
        // There was not enough free space in the stream buffer for the entire
        // string to be written, ut xBytesSent bytes were written.
    }

    // If xHigherPriorityTaskWoken was set to pdTRUE inside
    // xStreamBufferSendFromISR() then a task that has a priority above the
    // priority of the currently executing task was unblocked and a context
    // switch should be performed to ensure the ISR returns to the unblocked
    // task. In most FreeRTOS ports this is done by simply passing
    // xHigherPriorityTaskWoken into taskYIELD_FROM_ISR(), which will test the
    // variables value, and perform the context switch if necessary. Check the
    // documentation for the port in use for port specific instructions.
    taskYIELD_FROM_ISR( xHigherPriorityTaskWoken );
}
```

Return The number of bytes actually written to the stream buffer, which will be less than `xDataLengthBytes` if the stream buffer didn't have enough free space for all the bytes to be written.

Parameters

- `xStreamBuffer`: The handle of the stream buffer to which a stream is being sent.
- `pvTxData`: A pointer to the data that is to be copied into the stream buffer.

- `xDataLengthBytes`: The maximum number of bytes to copy from `pvTxData` into the stream buffer.
- `pxHigherPriorityTaskWoken`: It is possible that a stream buffer will have a task blocked on it waiting for data. Calling `xStreamBufferSendFromISR()` can make data available, and so cause a task that was waiting for data to leave the Blocked state. If calling `xStreamBufferSendFromISR()` causes a task to leave the Blocked state, and the unblocked task has a priority higher than the currently executing task (the task that was interrupted), then, internally, `xStreamBufferSendFromISR()` will set `*pxHigherPriorityTaskWoken` to `pdTRUE`. If `xStreamBufferSendFromISR()` sets this value to `pdTRUE`, then normally a context switch should be performed before the interrupt is exited. This will ensure that the interrupt returns directly to the highest priority Ready state task. `*pxHigherPriorityTaskWoken` should be set to `pdFALSE` before it is passed into the function. See the example code below for an example.

`size_t xStreamBufferReceive` (*StreamBufferHandle_t* `xStreamBuffer`, `void *pvRxData`, `size_t xBufferLengthBytes`, `TickType_t xTicksToWait`)

Receives bytes from a stream buffer.

*****NOTE***:** Uniquely among FreeRTOS objects, the stream buffer implementation (so also the message buffer implementation, as message buffers are built on top of stream buffers) assumes there is only one task or interrupt that will write to the buffer (the writer), and only one task or interrupt that will read from the buffer (the reader). It is safe for the writer and reader to be different tasks or interrupts, but, unlike other FreeRTOS objects, it is not safe to have multiple different writers or multiple different readers. If there are to be multiple different writers then the application writer must place each call to a writing API function (such as `xStreamBufferSend()`) inside a critical section and set the send block time to 0. Likewise, if there are to be multiple different readers then the application writer must place each call to a reading API function (such as `xStreamBufferRead()`) inside a critical section and set the receive block time to 0.

Use `xStreamBufferReceive()` to read from a stream buffer from a task. Use `xStreamBufferReceiveFromISR()` to read from a stream buffer from an interrupt service routine (ISR).

Example use:

```
void vAFunction( StreamBuffer_t xStreamBuffer )
{
    uint8_t ucRxData[ 20 ];
    size_t xReceivedBytes;
    const TickType_t xBlockTime = pdMS_TO_TICKS( 20 );

    // Receive up to another sizeof( ucRxData ) bytes from the stream buffer.
    // Wait in the Blocked state (so not using any CPU processing time) for a
    // maximum of 100ms for the full sizeof( ucRxData ) number of bytes to be
    // available.
    xReceivedBytes = xStreamBufferReceive( xStreamBuffer,
                                          ( void * ) ucRxData,
                                          sizeof( ucRxData ),
                                          xBlockTime );

    if( xReceivedBytes > 0 )
    {
        // A ucRxData contains another xReceivedBytes bytes of data, which can
        // be processed here....
    }
}
```

Return The number of bytes actually read from the stream buffer, which will be less than `xBufferLengthBytes` if the call to `xStreamBufferReceive()` timed out before `xBufferLengthBytes` were available.

Parameters

- `xStreamBuffer`: The handle of the stream buffer from which bytes are to be received.
- `pvRxData`: A pointer to the buffer into which the received bytes will be copied.
- `xBufferLengthBytes`: The length of the buffer pointed to by the `pvRxData` parameter. This sets the maximum number of bytes to receive in one call. `xStreamBufferReceive` will return as many bytes as possible up to a maximum set by `xBufferLengthBytes`.

- `xTicksToWait`: The maximum amount of time the task should remain in the Blocked state to wait for data to become available if the stream buffer is empty. `xStreamBufferReceive()` will return immediately if `xTicksToWait` is zero. The block time is specified in tick periods, so the absolute time it represents is dependent on the tick frequency. The macro `pdMS_TO_TICKS()` can be used to convert a time specified in milliseconds into a time specified in ticks. Setting `xTicksToWait` to `portMAX_DELAY` will cause the task to wait indefinitely (without timing out), provided `INCLUDE_vTaskSuspend` is set to 1 in `FreeRTOSConfig.h`. A task does not use any CPU time when it is in the Blocked state.

```
size_t xStreamBufferReceiveFromISR( StreamBufferHandle_t xStreamBuffer, void *pvRxData,
                                   size_t xBufferLengthBytes, BaseType_t *const pxHigher-
                                   PriorityTask Woken )
```

An interrupt safe version of the API function that receives bytes from a stream buffer.

Use `xStreamBufferReceive()` to read bytes from a stream buffer from a task. Use `xStreamBufferReceiveFromISR()` to read bytes from a stream buffer from an interrupt service routine (ISR).

Example use:

```
// A stream buffer that has already been created.
StreamBuffer_t xStreamBuffer;

void vAnInterruptServiceRoutine( void )
{
    uint8_t ucRxData[ 20 ];
    size_t xReceivedBytes;
    BaseType_t xHigherPriorityTaskWoken = pdFALSE; // Initialised to pdFALSE.

    // Receive the next stream from the stream buffer.
    xReceivedBytes = xStreamBufferReceiveFromISR( xStreamBuffer,
                                                ( void * ) ucRxData,
                                                sizeof( ucRxData ),
                                                &xHigherPriorityTaskWoken );

    if( xReceivedBytes > 0 )
    {
        // ucRxData contains xReceivedBytes read from the stream buffer.
        // Process the stream here....
    }

    // If xHigherPriorityTaskWoken was set to pdTRUE inside
    // xStreamBufferReceiveFromISR() then a task that has a priority above the
    // priority of the currently executing task was unblocked and a context
    // switch should be performed to ensure the ISR returns to the unblocked
    // task. In most FreeRTOS ports this is done by simply passing
    // xHigherPriorityTaskWoken into taskYIELD_FROM_ISR(), which will test the
    // variables value, and perform the context switch if necessary. Check the
    // documentation for the port in use for port specific instructions.
    taskYIELD_FROM_ISR( xHigherPriorityTaskWoken );
}
```

Return The number of bytes read from the stream buffer, if any.

Parameters

- `xStreamBuffer`: The handle of the stream buffer from which a stream is being received.
- `pvRxData`: A pointer to the buffer into which the received bytes are copied.
- `xBufferLengthBytes`: The length of the buffer pointed to by the `pvRxData` parameter. This sets the maximum number of bytes to receive in one call. `xStreamBufferReceive` will return as many bytes as possible up to a maximum set by `xBufferLengthBytes`.
- `pxHigherPriorityTaskWoken`: It is possible that a stream buffer will have a task blocked on it waiting for space to become available. Calling `xStreamBufferReceiveFromISR()` can make space available, and so cause a task that is waiting for space to leave the Blocked state. If calling `xStreamBufferReceiveFromISR()` causes a task to leave the Blocked state, and the unblocked task has a priority higher than the currently executing task (the task that was interrupted), then,

internally, `xStreamBufferReceiveFromISR()` will set `*pxHigherPriorityTaskWoken` to `pdTRUE`. If `xStreamBufferReceiveFromISR()` sets this value to `pdTRUE`, then normally a context switch should be performed before the interrupt is exited. That will ensure the interrupt returns directly to the highest priority Ready state task. `*pxHigherPriorityTaskWoken` should be set to `pdFALSE` before it is passed into the function. See the code example below for an example.

void **xStreamBufferDelete** (*StreamBufferHandle_t* xStreamBuffer)

Deletes a stream buffer that was previously created using a call to `xStreamBufferCreate()` or `xStreamBufferCreateStatic()`. If the stream buffer was created using dynamic memory (that is, by `xStreamBufferCreate()`), then the allocated memory is freed.

A stream buffer handle must not be used after the stream buffer has been deleted.

Parameters

- `xStreamBuffer`: The handle of the stream buffer to be deleted.

BaseType_t **xStreamBufferIsFull** (*StreamBufferHandle_t* xStreamBuffer)

Queries a stream buffer to see if it is full. A stream buffer is full if it does not have any free space, and therefore cannot accept any more data.

Return If the stream buffer is full then `pdTRUE` is returned. Otherwise `pdFALSE` is returned.

Parameters

- `xStreamBuffer`: The handle of the stream buffer being queried.

BaseType_t **xStreamBufferIsEmpty** (*StreamBufferHandle_t* xStreamBuffer)

Queries a stream buffer to see if it is empty. A stream buffer is empty if it does not contain any data.

Return If the stream buffer is empty then `pdTRUE` is returned. Otherwise `pdFALSE` is returned.

Parameters

- `xStreamBuffer`: The handle of the stream buffer being queried.

BaseType_t **xStreamBufferReset** (*StreamBufferHandle_t* xStreamBuffer)

Resets a stream buffer to its initial, empty, state. Any data that was in the stream buffer is discarded. A stream buffer can only be reset if there are no tasks blocked waiting to either send to or receive from the stream buffer.

Return If the stream buffer is reset then `pdPASS` is returned. If there was a task blocked waiting to send to or read from the stream buffer then the stream buffer is not reset and `pdFAIL` is returned.

Parameters

- `xStreamBuffer`: The handle of the stream buffer being reset.

size_t **xStreamBufferSpacesAvailable** (*StreamBufferHandle_t* xStreamBuffer)

size_t **xStreamBufferBytesAvailable** (*StreamBufferHandle_t* xStreamBuffer)

BaseType_t **xStreamBufferSetTriggerLevel** (*StreamBufferHandle_t* xStreamBuffer, size_t xTriggerLevel)

A stream buffer's trigger level is the number of bytes that must be in the stream buffer before a task that is blocked on the stream buffer to wait for data is moved out of the blocked state. For example, if a task is blocked on a read of an empty stream buffer that has a trigger level of 1 then the task will be unblocked when a single byte is written to the buffer or the task's block time expires. As another example, if a task is blocked on a read of an empty stream buffer that has a trigger level of 10 then the task will not be unblocked until the stream buffer contains at least 10 bytes or the task's block time expires. If a reading task's block time expires before the trigger level is reached then the task will still receive however many bytes are actually available. Setting a trigger level of 0 will result in a trigger level of 1 being used. It is not valid to specify a trigger level that is greater than the buffer size.

A trigger level is set when the stream buffer is created, and can be modified using `xStreamBufferSetTriggerLevel()`.

Return If `xTriggerLevel` was less than or equal to the stream buffer's length then the trigger level will be updated and `pdTRUE` is returned. Otherwise `pdFALSE` is returned.

Parameters

- `xStreamBuffer`: The handle of the stream buffer being updated.
- `xTriggerLevel`: The new trigger level for the stream buffer.

BaseType_t **xStreamBufferSendCompletedFromISR** (*StreamBufferHandle_t* xStreamBuffer, BaseType_t *pxHigherPriorityTaskWoken)

For advanced users only.

The sbSEND_COMPLETED() macro is called from within the FreeRTOS APIs when data is sent to a message buffer or stream buffer. If there was a task that was blocked on the message or stream buffer waiting for data to arrive then the sbSEND_COMPLETED() macro sends a notification to the task to remove it from the Blocked state. xStreamBufferSendCompletedFromISR() does the same thing. It is provided to enable application writers to implement their own version of sbSEND_COMPLETED(), and **MUST NOT BE USED AT ANY OTHER TIME**.

See the example implemented in FreeRTOS/Demo/Minimal/MessageBufferAMP.c for additional information.

Return If a task was removed from the Blocked state then pdTRUE is returned. Otherwise pdFALSE is returned.

Parameters

- xStreamBuffer: The handle of the stream buffer to which data was written.
- pxHigherPriorityTaskWoken: *pxHigherPriorityTaskWoken should be initialised to pdFALSE before it is passed into xStreamBufferSendCompletedFromISR(). If calling xStreamBufferSendCompletedFromISR() removes a task from the Blocked state, and the task has a priority above the priority of the currently running task, then *pxHigherPriorityTaskWoken will get set to pdTRUE indicating that a context switch should be performed before exiting the ISR.

BaseType_t **xStreamBufferReceiveCompletedFromISR** (*StreamBufferHandle_t* xStreamBuffer, BaseType_t *pxHigherPriorityTaskWoken)

For advanced users only.

The sbRECEIVE_COMPLETED() macro is called from within the FreeRTOS APIs when data is read out of a message buffer or stream buffer. If there was a task that was blocked on the message or stream buffer waiting for data to arrive then the sbRECEIVE_COMPLETED() macro sends a notification to the task to remove it from the Blocked state. xStreamBufferReceiveCompletedFromISR() does the same thing. It is provided to enable application writers to implement their own version of sbRECEIVE_COMPLETED(), and **MUST NOT BE USED AT ANY OTHER TIME**.

See the example implemented in FreeRTOS/Demo/Minimal/MessageBufferAMP.c for additional information.

Return If a task was removed from the Blocked state then pdTRUE is returned. Otherwise pdFALSE is returned.

Parameters

- xStreamBuffer: The handle of the stream buffer from which data was read.
- pxHigherPriorityTaskWoken: *pxHigherPriorityTaskWoken should be initialised to pdFALSE before it is passed into xStreamBufferReceiveCompletedFromISR(). If calling xStreamBufferReceiveCompletedFromISR() removes a task from the Blocked state, and the task has a priority above the priority of the currently running task, then *pxHigherPriorityTaskWoken will get set to pdTRUE indicating that a context switch should be performed before exiting the ISR.

Macros

xStreamBufferCreate (xBufferSizeBytes, xTriggerLevelBytes)

Creates a new stream buffer using dynamically allocated memory. See xStreamBufferCreateStatic() for a version that uses statically allocated memory (memory that is allocated at compile time).

configSUPPORT_DYNAMIC_ALLOCATION must be set to 1 or left undefined in FreeRTOSConfig.h for xStreamBufferCreate() to be available.

Example use:

```
void vAFunction( void )
{
    StreamBufferHandle_t xStreamBuffer;
    const size_t xStreamBufferSizeBytes = 100, xTriggerLevel = 10;
```

(continues on next page)

(continued from previous page)

```

// Create a stream buffer that can hold 100 bytes. The memory used to
↪hold
// both the stream buffer structure and the data in the stream buffer.
↪is
// allocated dynamically.
xStreamBuffer = xStreamBufferCreate( xStreamBufferSizeBytes,
↪xTriggerLevel );

    if( xStreamBuffer == NULL )
    {
        // There was not enough heap memory space available to create the
        // stream buffer.
    }
    else
    {
        // The stream buffer was created successfully and can now be used.
    }
}

```

Return If NULL is returned, then the stream buffer cannot be created because there is insufficient heap memory available for FreeRTOS to allocate the stream buffer data structures and storage area. A non-NULL value being returned indicates that the stream buffer has been created successfully - the returned value should be stored as the handle to the created stream buffer.

Parameters

- **xBufferSizeBytes**: The total number of bytes the stream buffer will be able to hold at any one time.
- **xTriggerLevelBytes**: The number of bytes that must be in the stream buffer before a task that is blocked on the stream buffer to wait for data is moved out of the blocked state. For example, if a task is blocked on a read of an empty stream buffer that has a trigger level of 1 then the task will be unblocked when a single byte is written to the buffer or the task's block time expires. As another example, if a task is blocked on a read of an empty stream buffer that has a trigger level of 10 then the task will not be unblocked until the stream buffer contains at least 10 bytes or the task's block time expires. If a reading task's block time expires before the trigger level is reached then the task will still receive however many bytes are actually available. Setting a trigger level of 0 will result in a trigger level of 1 being used. It is not valid to specify a trigger level that is greater than the buffer size.

xStreamBufferCreateStatic (xBufferSizeBytes, xTriggerLevelBytes, pucStreamBufferStorageArea, pxStaticStreamBuffer)

Creates a new stream buffer using statically allocated memory. See xStreamBufferCreate() for a version that uses dynamically allocated memory.

configSUPPORT_STATIC_ALLOCATION must be set to 1 in FreeRTOSConfig.h for xStreamBufferCreateStatic() to be available.

Example use:

```

// Used to dimension the array used to hold the streams. The available space
// will actually be one less than this, so 999.
#define STORAGE_SIZE_BYTES 1000

// Defines the memory that will actually hold the streams within the stream
// buffer.
static uint8_t ucStorageBuffer[ STORAGE_SIZE_BYTES ];

// The variable used to hold the stream buffer structure.
StaticStreamBuffer_t xStreamBufferStruct;

void MyFunction( void )
{
    StreamBufferHandle_t xStreamBuffer;
}

```

(continues on next page)

(continued from previous page)

```

const size_t xTriggerLevel = 1;

    xStreamBuffer = xStreamBufferCreateStatic( sizeof( ucBufferStorage ),
                                              xTriggerLevel,
                                              ucBufferStorage,
                                              &xStreamBufferStruct );

// As neither the pucStreamBufferStorageArea or pxStaticStreamBuffer
// parameters were NULL, xStreamBuffer will not be NULL, and can be used to
// reference the created stream buffer in other stream buffer API calls.

// Other code that uses the stream buffer can go here.
}

```

Return If the stream buffer is created successfully then a handle to the created stream buffer is returned. If either pucStreamBufferStorageArea or pxStaticstreamBuffer are NULL then NULL is returned.

Parameters

- **xBufferSizeBytes**: The size, in bytes, of the buffer pointed to by the pucStreamBufferStorageArea parameter.
- **xTriggerLevelBytes**: The number of bytes that must be in the stream buffer before a task that is blocked on the stream buffer to wait for data is moved out of the blocked state. For example, if a task is blocked on a read of an empty stream buffer that has a trigger level of 1 then the task will be unblocked when a single byte is written to the buffer or the task's block time expires. As another example, if a task is blocked on a read of an empty stream buffer that has a trigger level of 10 then the task will not be unblocked until the stream buffer contains at least 10 bytes or the task's block time expires. If a reading task's block time expires before the trigger level is reached then the task will still receive however many bytes are actually available. Setting a trigger level of 0 will result in a trigger level of 1 being used. It is not valid to specify a trigger level that is greater than the buffer size.
- **pucStreamBufferStorageArea**: Must point to a uint8_t array that is at least xBufferSizeBytes + 1 big. This is the array to which streams are copied when they are written to the stream buffer.
- **pxStaticStreamBuffer**: Must point to a variable of type StaticStreamBuffer_t, which will be used to hold the stream buffer's data structure.

Type Definitions

```
typedef struct StreamBufferDef_t *StreamBufferHandle_t
```

Message Buffer API

Header File

- [freertos/include/freertos/message_buffer.h](#)

Macros

xMessageBufferCreate (xBufferSizeBytes)

Creates a new message buffer using dynamically allocated memory. See xMessageBufferCreateStatic() for a version that uses statically allocated memory (memory that is allocated at compile time).

configSUPPORT_DYNAMIC_ALLOCATION must be set to 1 or left undefined in FreeRTOSConfig.h for xMessageBufferCreate() to be available.

Example use:

```

void vAFunction( void )
{
    MessageBufferHandle_t xMessageBuffer;

```

(continues on next page)

(continued from previous page)

```

const size_t xMessageBufferSizeBytes = 100;

// Create a message buffer that can hold 100 bytes. The memory used to hold
// both the message buffer structure and the messages themselves is allocated
// dynamically. Each message added to the buffer consumes an additional 4
// bytes which are used to hold the length of the message.
xMessageBuffer = xMessageBufferCreate( xMessageBufferSizeBytes );

if( xMessageBuffer == NULL )
{
    // There was not enough heap memory space available to create the
    // message buffer.
}
else
{
    // The message buffer was created successfully and can now be used.
}

```

Return If NULL is returned, then the message buffer cannot be created because there is insufficient heap memory available for FreeRTOS to allocate the message buffer data structures and storage area. A non-NULL value being returned indicates that the message buffer has been created successfully - the returned value should be stored as the handle to the created message buffer.

Parameters

- **xBufferSizeBytes**: The total number of bytes (not messages) the message buffer will be able to hold at any one time. When a message is written to the message buffer an additional `sizeof(size_t)` bytes are also written to store the message's length. `sizeof(size_t)` is typically 4 bytes on a 32-bit architecture, so on most 32-bit architectures a 10 byte message will take up 14 bytes of message buffer space.

xMessageBufferCreateStatic (xBufferSizeBytes, pucMessageBufferStorageArea, pxStaticMessageBuffer)

Creates a new message buffer using statically allocated memory. See `xMessageBufferCreate()` for a version that uses dynamically allocated memory.

Example use:

```

// Used to dimension the array used to hold the messages. The available space
// will actually be one less than this, so 999.
#define STORAGE_SIZE_BYTES 1000

// Defines the memory that will actually hold the messages within the message
// buffer.
static uint8_t ucStorageBuffer[ STORAGE_SIZE_BYTES ];

// The variable used to hold the message buffer structure.
StaticMessageBuffer_t xMessageBufferStruct;

void MyFunction( void )
{
    MessageBufferHandle_t xMessageBuffer;

    xMessageBuffer = xMessageBufferCreateStatic( sizeof( ucBufferStorage ),
                                                ucBufferStorage,
                                                &xMessageBufferStruct );

    // As neither the pucMessageBufferStorageArea or pxStaticMessageBuffer
    // parameters were NULL, xMessageBuffer will not be NULL, and can be used to
    // reference the created message buffer in other message buffer API calls.

    // Other code that uses the message buffer can go here.
}

```

Return If the message buffer is created successfully then a handle to the created message buffer is returned. If either `pucMessageBufferStorageArea` or `pxStaticmessageBuffer` are NULL then NULL is returned.

Parameters

- `xBufferSizeBytes`: The size, in bytes, of the buffer pointed to by the `pucMessageBufferStorageArea` parameter. When a message is written to the message buffer an additional `sizeof(size_t)` bytes are also written to store the message's length. `sizeof(size_t)` is typically 4 bytes on a 32-bit architecture, so on most 32-bit architecture a 10 byte message will take up 14 bytes of message buffer space. The maximum number of bytes that can be stored in the message buffer is actually `(xBufferSizeBytes - 1)`.
- `pucMessageBufferStorageArea`: Must point to a `uint8_t` array that is at least `xBufferSizeBytes + 1` big. This is the array to which messages are copied when they are written to the message buffer.
- `pxStaticMessageBuffer`: Must point to a variable of type `StaticMessageBuffer_t`, which will be used to hold the message buffer's data structure.

xMessageBufferSend (`xMessageBuffer`, `pvTxData`, `xDataLengthBytes`, `xTicksToWait`)

Sends a discrete message to the message buffer. The message can be any length that fits within the buffer's free space, and is copied into the buffer.

NOTE: Uniquely among FreeRTOS objects, the stream buffer implementation (so also the message buffer implementation, as message buffers are built on top of stream buffers) assumes there is only one task or interrupt that will write to the buffer (the writer), and only one task or interrupt that will read from the buffer (the reader). It is safe for the writer and reader to be different tasks or interrupts, but, unlike other FreeRTOS objects, it is not safe to have multiple different writers or multiple different readers. If there are to be multiple different writers then the application writer must place each call to a writing API function (such as `xMessageBufferSend()`) inside a critical section and set the send block time to 0. Likewise, if there are to be multiple different readers then the application writer must place each call to a reading API function (such as `xMessageBufferRead()`) inside a critical section and set the receive block time to 0.

Use `xMessageBufferSend()` to write to a message buffer from a task. Use `xMessageBufferSendFromISR()` to write to a message buffer from an interrupt service routine (ISR).

Example use:

```
void vAFunction( MessageBufferHandle_t xMessageBuffer )
{
    size_t xBytesSent;
    uint8_t ucArrayToSend[] = { 0, 1, 2, 3 };
    char *pcStringToSend = "String to send";
    const TickType_t x100ms = pdMS_TO_TICKS( 100 );

    // Send an array to the message buffer, blocking for a maximum of 100ms to
    // wait for enough space to be available in the message buffer.
    xBytesSent = xMessageBufferSend( xMessageBuffer, ( void * ) ucArrayToSend,
    ↪ sizeof( ucArrayToSend ), x100ms );

    if( xBytesSent != sizeof( ucArrayToSend ) )
    {
        // The call to xMessageBufferSend() times out before there was enough
        // space in the buffer for the data to be written.
    }

    // Send the string to the message buffer. Return immediately if there is
    // not enough space in the buffer.
    xBytesSent = xMessageBufferSend( xMessageBuffer, ( void * ) pcStringToSend,
    ↪ strlen( pcStringToSend ), 0 );

    if( xBytesSent != strlen( pcStringToSend ) )
    {
        // The string could not be added to the message buffer because there was
        // not enough free space in the buffer.
    }
}
```

(continues on next page)

```
}

```

Return The number of bytes written to the message buffer. If the call to `xMessageBufferSend()` times out before there was enough space to write the message into the message buffer then zero is returned. If the call did not time out then `xDataLengthBytes` is returned.

Parameters

- `xMessageBuffer`: The handle of the message buffer to which a message is being sent.
- `pvTxData`: A pointer to the message that is to be copied into the message buffer.
- `xDataLengthBytes`: The length of the message. That is, the number of bytes to copy from `pvTxData` into the message buffer. When a message is written to the message buffer an additional `sizeof(size_t)` bytes are also written to store the message's length. `sizeof(size_t)` is typically 4 bytes on a 32-bit architecture, so on most 32-bit architecture setting `xDataLengthBytes` to 20 will reduce the free space in the message buffer by 24 bytes (20 bytes of message data and 4 bytes to hold the message length).
- `xTicksToWait`: The maximum amount of time the calling task should remain in the Blocked state to wait for enough space to become available in the message buffer, should the message buffer have insufficient space when `xMessageBufferSend()` is called. The calling task will never block if `xTicksToWait` is zero. The block time is specified in tick periods, so the absolute time it represents is dependent on the tick frequency. The macro `pdMS_TO_TICKS()` can be used to convert a time specified in milliseconds into a time specified in ticks. Setting `xTicksToWait` to `portMAX_DELAY` will cause the task to wait indefinitely (without timing out), provided `INCLUDE_vTaskSuspend` is set to 1 in `FreeRTOSConfig.h`. Tasks do not use any CPU time when they are in the Blocked state.

xMessageBufferSendFromISR (`xMessageBuffer`, `pvTxData`, `xDataLengthBytes`, `pxHigherPriorityTaskWoken`)

Interrupt safe version of the API function that sends a discrete message to the message buffer. The message can be any length that fits within the buffer's free space, and is copied into the buffer.

*****NOTE***:** Uniquely among FreeRTOS objects, the stream buffer implementation (so also the message buffer implementation, as message buffers are built on top of stream buffers) assumes there is only one task or interrupt that will write to the buffer (the writer), and only one task or interrupt that will read from the buffer (the reader). It is safe for the writer and reader to be different tasks or interrupts, but, unlike other FreeRTOS objects, it is not safe to have multiple different writers or multiple different readers. If there are to be multiple different writers then the application writer must place each call to a writing API function (such as `xMessageBufferSend()`) inside a critical section and set the send block time to 0. Likewise, if there are to be multiple different readers then the application writer must place each call to a reading API function (such as `xMessageBufferRead()`) inside a critical section and set the receive block time to 0.

Use `xMessageBufferSend()` to write to a message buffer from a task. Use `xMessageBufferSendFromISR()` to write to a message buffer from an interrupt service routine (ISR).

Example use:

```
// A message buffer that has already been created.
MessageBufferHandle_t xMessageBuffer;

void vAnInterruptServiceRoutine( void )
{
    size_t xBytesSent;
    char *pcStringToSend = "String to send";
    BaseType_t xHigherPriorityTaskWoken = pdFALSE; // Initialised to pdFALSE.

    // Attempt to send the string to the message buffer.
    xBytesSent = xMessageBufferSendFromISR( xMessageBuffer,
                                           ( void * ) pcStringToSend,
                                           strlen( pcStringToSend ),
                                           &xHigherPriorityTaskWoken );

    if( xBytesSent != strlen( pcStringToSend ) )
    {

```

(continues on next page)

(continued from previous page)

```

// The string could not be added to the message buffer because there was
// not enough free space in the buffer.
}

// If xHigherPriorityTaskWoken was set to pdTRUE inside
// xMessageBufferSendFromISR() then a task that has a priority above the
// priority of the currently executing task was unblocked and a context
// switch should be performed to ensure the ISR returns to the unblocked
// task. In most FreeRTOS ports this is done by simply passing
// xHigherPriorityTaskWoken into portYIELD_FROM_ISR(), which will test the
// variables value, and perform the context switch if necessary. Check the
// documentation for the port in use for port specific instructions.
portYIELD_FROM_ISR( xHigherPriorityTaskWoken );
}

```

Return The number of bytes actually written to the message buffer. If the message buffer didn't have enough free space for the message to be stored then 0 is returned, otherwise xDataLengthBytes is returned.

Parameters

- **xMessageBuffer**: The handle of the message buffer to which a message is being sent.
- **pvTxData**: A pointer to the message that is to be copied into the message buffer.
- **xDataLengthBytes**: The length of the message. That is, the number of bytes to copy from pvTxData into the message buffer. When a message is written to the message buffer an additional sizeof(size_t) bytes are also written to store the message's length. sizeof(size_t) is typically 4 bytes on a 32-bit architecture, so on most 32-bit architecture setting xDataLengthBytes to 20 will reduce the free space in the message buffer by 24 bytes (20 bytes of message data and 4 bytes to hold the message length).
- **pxHigherPriorityTaskWoken**: It is possible that a message buffer will have a task blocked on it waiting for data. Calling xMessageBufferSendFromISR() can make data available, and so cause a task that was waiting for data to leave the Blocked state. If calling xMessageBufferSendFromISR() causes a task to leave the Blocked state, and the unblocked task has a priority higher than the currently executing task (the task that was interrupted), then, internally, xMessageBufferSendFromISR() will set *pxHigherPriorityTaskWoken to pdTRUE. If xMessageBufferSendFromISR() sets this value to pdTRUE, then normally a context switch should be performed before the interrupt is exited. This will ensure that the interrupt returns directly to the highest priority Ready state task. *pxHigherPriorityTaskWoken should be set to pdFALSE before it is passed into the function. See the code example below for an example.

xMessageBufferReceive (xMessageBuffer, pvRxData, xBufferLengthBytes, xTicksToWait)

Receives a discrete message from a message buffer. Messages can be of variable length and are copied out of the buffer.

*****NOTE*****: Uniquely among FreeRTOS objects, the stream buffer implementation (so also the message buffer implementation, as message buffers are built on top of stream buffers) assumes there is only one task or interrupt that will write to the buffer (the writer), and only one task or interrupt that will read from the buffer (the reader). It is safe for the writer and reader to be different tasks or interrupts, but, unlike other FreeRTOS objects, it is not safe to have multiple different writers or multiple different readers. If there are to be multiple different writers then the application writer must place each call to a writing API function (such as xMessageBufferSend()) inside a critical section and set the send block time to 0. Likewise, if there are to be multiple different readers then the application writer must place each call to a reading API function (such as xMessageBufferRead()) inside a critical section and set the receive block time to 0.

Use xMessageBufferReceive() to read from a message buffer from a task. Use xMessageBufferReceiveFromISR() to read from a message buffer from an interrupt service routine (ISR).

Example use:

```

void vAFunction( MessageBuffer_t xMessageBuffer )
{
uint8_t ucRxData[ 20 ];
size_t xReceivedBytes;

```

(continues on next page)

(continued from previous page)

```

const TickType_t xBlockTime = pdMS_TO_TICKS( 20 );

// Receive the next message from the message buffer. Wait in the Blocked
// state (so not using any CPU processing time) for a maximum of 100ms for
// a message to become available.
xReceivedBytes = xMessageBufferReceive( xMessageBuffer,
                                        ( void * ) ucRxData,
                                        sizeof( ucRxData ),
                                        xBlockTime );

if( xReceivedBytes > 0 )
{
    // A ucRxData contains a message that is xReceivedBytes long. Process
    // the message here....
}
}

```

Return The length, in bytes, of the message read from the message buffer, if any. If `xMessageBufferReceive()` times out before a message became available then zero is returned. If the length of the message is greater than `xBufferLengthBytes` then the message will be left in the message buffer and zero is returned.

Parameters

- `xMessageBuffer`: The handle of the message buffer from which a message is being received.
- `pvRxData`: A pointer to the buffer into which the received message is to be copied.
- `xBufferLengthBytes`: The length of the buffer pointed to by the `pvRxData` parameter. This sets the maximum length of the message that can be received. If `xBufferLengthBytes` is too small to hold the next message then the message will be left in the message buffer and 0 will be returned.
- `xTicksToWait`: The maximum amount of time the task should remain in the Blocked state to wait for a message, should the message buffer be empty. `xMessageBufferReceive()` will return immediately if `xTicksToWait` is zero and the message buffer is empty. The block time is specified in tick periods, so the absolute time it represents is dependent on the tick frequency. The macro `pdMS_TO_TICKS()` can be used to convert a time specified in milliseconds into a time specified in ticks. Setting `xTicksToWait` to `portMAX_DELAY` will cause the task to wait indefinitely (without timing out), provided `INCLUDE_vTaskSuspend` is set to 1 in `FreeRTOSConfig.h`. Tasks do not use any CPU time when they are in the Blocked state.

xMessageBufferReceiveFromISR (`xMessageBuffer`, `pvRxData`, `xBufferLengthBytes`, `pxHigherPriorityTaskWoken`)

An interrupt safe version of the API function that receives a discrete message from a message buffer. Messages can be of variable length and are copied out of the buffer.

*****NOTE***:** Uniquely among FreeRTOS objects, the stream buffer implementation (so also the message buffer implementation, as message buffers are built on top of stream buffers) assumes there is only one task or interrupt that will write to the buffer (the writer), and only one task or interrupt that will read from the buffer (the reader). It is safe for the writer and reader to be different tasks or interrupts, but, unlike other FreeRTOS objects, it is not safe to have multiple different writers or multiple different readers. If there are to be multiple different writers then the application writer must place each call to a writing API function (such as `xMessageBufferSend()`) inside a critical section and set the send block time to 0. Likewise, if there are to be multiple different readers then the application writer must place each call to a reading API function (such as `xMessageBufferRead()`) inside a critical section and set the receive block time to 0.

Use `xMessageBufferReceive()` to read from a message buffer from a task. Use `xMessageBufferReceiveFromISR()` to read from a message buffer from an interrupt service routine (ISR).

Example use:

```

// A message buffer that has already been created.
MessageBuffer_t xMessageBuffer;

void vAnInterruptServiceRoutine( void )
{

```

(continues on next page)

(continued from previous page)

```

uint8_t ucRxData[ 20 ];
size_t xReceivedBytes;
 BaseType_t xHigherPriorityTaskWoken = pdFALSE; // Initialised to pdFALSE.

// Receive the next message from the message buffer.
xReceivedBytes = xMessageBufferReceiveFromISR( xMessageBuffer,
                                               ( void * ) ucRxData,
                                               sizeof( ucRxData ),
                                               &xHigherPriorityTaskWoken );

if( xReceivedBytes > 0 )
{
    // A ucRxData contains a message that is xReceivedBytes long. Process
    // the message here....
}

// If xHigherPriorityTaskWoken was set to pdTRUE inside
// xMessageBufferReceiveFromISR() then a task that has a priority above the
// priority of the currently executing task was unblocked and a context
// switch should be performed to ensure the ISR returns to the unblocked
// task. In most FreeRTOS ports this is done by simply passing
// xHigherPriorityTaskWoken into portYIELD_FROM_ISR(), which will test the
// variables value, and perform the context switch if necessary. Check the
// documentation for the port in use for port specific instructions.
portYIELD_FROM_ISR( xHigherPriorityTaskWoken );
}

```

Return The length, in bytes, of the message read from the message buffer, if any.

Parameters

- **xMessageBuffer**: The handle of the message buffer from which a message is being received.
- **pvRxData**: A pointer to the buffer into which the received message is to be copied.
- **xBufferLengthBytes**: The length of the buffer pointed to by the **pvRxData** parameter. This sets the maximum length of the message that can be received. If **xBufferLengthBytes** is too small to hold the next message then the message will be left in the message buffer and 0 will be returned.
- **pxHigherPriorityTaskWoken**: It is possible that a message buffer will have a task blocked on it waiting for space to become available. Calling **xMessageBufferReceiveFromISR()** can make space available, and so cause a task that is waiting for space to leave the Blocked state. If calling **xMessageBufferReceiveFromISR()** causes a task to leave the Blocked state, and the unblocked task has a priority higher than the currently executing task (the task that was interrupted), then, internally, **xMessageBufferReceiveFromISR()** will set ***pxHigherPriorityTaskWoken** to **pdTRUE**. If **xMessageBufferReceiveFromISR()** sets this value to **pdTRUE**, then normally a context switch should be performed before the interrupt is exited. That will ensure the interrupt returns directly to the highest priority Ready state task. ***pxHigherPriorityTaskWoken** should be set to **pdFALSE** before it is passed into the function. See the code example below for an example.

vMessageBufferDelete (xMessageBuffer)

Deletes a message buffer that was previously created using a call to **xMessageBufferCreate()** or **xMessageBufferCreateStatic()**. If the message buffer was created using dynamic memory (that is, by **xMessageBufferCreate()**), then the allocated memory is freed.

A message buffer handle must not be used after the message buffer has been deleted.

Parameters

- **xMessageBuffer**: The handle of the message buffer to be deleted.

xMessageBufferIsFull (xMessageBuffer)

Tests to see if a message buffer is full. A message buffer is full if it cannot accept any more messages, of any size, until space is made available by a message being removed from the message buffer.

Return If the message buffer referenced by **xMessageBuffer** is full then **pdTRUE** is returned. Otherwise **pdFALSE** is returned.

Parameters

- `xMessageBuffer`: The handle of the message buffer being queried.

xMessageBufferIsEmpty (`xMessageBuffer`)

Tests to see if a message buffer is empty (does not contain any messages).

Return If the message buffer referenced by `xMessageBuffer` is empty then `pdTRUE` is returned. Otherwise `pdFALSE` is returned.

Parameters

- `xMessageBuffer`: The handle of the message buffer being queried.

xMessageBufferReset (`xMessageBuffer`)

Resets a message buffer to its initial empty state, discarding any message it contained.

A message buffer can only be reset if there are no tasks blocked on it.

Return If the message buffer was reset then `pdPASS` is returned. If the message buffer could not be reset because either there was a task blocked on the message queue to wait for space to become available, or to wait for a message to be available, then `pdFAIL` is returned.

Parameters

- `xMessageBuffer`: The handle of the message buffer being reset.

xMessageBufferSpaceAvailable (`xMessageBuffer`)

Returns the number of bytes of free space in the message buffer.

Return The number of bytes that can be written to the message buffer before the message buffer would be full. When a message is written to the message buffer an additional `sizeof(size_t)` bytes are also written to store the message's length. `sizeof(size_t)` is typically 4 bytes on a 32-bit architecture, so if `xMessageBufferSpacesAvailable()` returns 10, then the size of the largest message that can be written to the message buffer is 6 bytes.

Parameters

- `xMessageBuffer`: The handle of the message buffer being queried.

xMessageBufferSpacesAvailable (`xMessageBuffer`)**xMessageBufferNextLengthBytes** (`xMessageBuffer`)

Returns the length (in bytes) of the next message in a message buffer. Useful if `xMessageBufferReceive()` returned 0 because the size of the buffer passed into `xMessageBufferReceive()` was too small to hold the next message.

Return The length (in bytes) of the next message in the message buffer, or 0 if the message buffer is empty.

Parameters

- `xMessageBuffer`: The handle of the message buffer being queried.

xMessageBufferSendCompletedFromISR (`xMessageBuffer`, `pxHigherPriorityTaskWoken`)

For advanced users only.

The `sbSEND_COMPLETED()` macro is called from within the FreeRTOS APIs when data is sent to a message buffer or stream buffer. If there was a task that was blocked on the message or stream buffer waiting for data to arrive then the `sbSEND_COMPLETED()` macro sends a notification to the task to remove it from the Blocked state. `xMessageBufferSendCompletedFromISR()` does the same thing. It is provided to enable application writers to implement their own version of `sbSEND_COMPLETED()`, and **MUST NOT BE USED AT ANY OTHER TIME**.

See the example implemented in `FreeRTOS/Demo/Minimal/MessageBufferAMP.c` for additional information.

Return If a task was removed from the Blocked state then `pdTRUE` is returned. Otherwise `pdFALSE` is returned.

Parameters

- `xMessageBuffer`: The handle of the stream buffer to which data was written.
- `pxHigherPriorityTaskWoken`: `*pxHigherPriorityTaskWoken` should be initialised to `pdFALSE` before it is passed into `xMessageBufferSendCompletedFromISR()`. If calling `xMessageBufferSendCompletedFromISR()` removes a task from the Blocked state, and the task has a priority above the priority of the currently running task, then `*pxHigherPriorityTaskWoken` will get set to `pdTRUE` indicating that a context switch should be performed before exiting the ISR.

xMessageBufferReceiveCompletedFromISR (xMessageBuffer, pxHigherPriorityTaskWoken)

For advanced users only.

The sbRECEIVE_COMPLETED() macro is called from within the FreeRTOS APIs when data is read out of a message buffer or stream buffer. If there was a task that was blocked on the message or stream buffer waiting for data to arrive then the sbRECEIVE_COMPLETED() macro sends a notification to the task to remove it from the Blocked state. xMessageBufferReceiveCompletedFromISR() does the same thing. It is provided to enable application writers to implement their own version of sbRECEIVE_COMPLETED(), and **MUST NOT BE USED AT ANY OTHER TIME**.

See the example implemented in FreeRTOS/Demo/Minimal/MessageBufferAMP.c for additional information.

Return If a task was removed from the Blocked state then pdTRUE is returned. Otherwise pdFALSE is returned.

Parameters

- xMessageBuffer: The handle of the stream buffer from which data was read.
- pxHigherPriorityTaskWoken: *pxHigherPriorityTaskWoken should be initialised to pdFALSE before it is passed into xMessageBufferReceiveCompletedFromISR(). If calling xMessageBufferReceiveCompletedFromISR() removes a task from the Blocked state, and the task has a priority above the priority of the currently running task, then *pxHigherPriorityTaskWoken will get set to pdTRUE indicating that a context switch should be performed before exiting the ISR.

Type Definitions

```
typedef void *MessageBufferHandle_t
```

Type by which message buffers are referenced. For example, a call to xMessageBufferCreate() returns an MessageBufferHandle_t variable that can then be used as a parameter to xMessageBufferSend(), xMessageBufferReceive(), etc.

2.7.11 FreeRTOS Additions

Overview

ESP-IDF FreeRTOS is based on the Xtensa port of FreeRTOS v10.2.0 with significant modifications for SMP compatibility (see *ESP-IDF FreeRTOS SMP Changes*). However various features specific to ESP-IDF FreeRTOS have been added. The features are as follows:

Ring Buffers: Ring buffers were added to provide a form of buffer that could accept entries of arbitrary lengths.

Hooks: ESP-IDF FreeRTOS hooks provides support for registering extra Idle and Tick hooks at run time. Moreover, the hooks can be asymmetric amongst both CPUs.

Component Specific Properties: Currently added only one component specific property *ORIG_INCLUDE_PATH*.

Ring Buffers

The ESP-IDF FreeRTOS ring buffer is a strictly FIFO buffer that supports arbitrarily sized items. Ring buffers are a more memory efficient alternative to FreeRTOS queues in situations where the size of items is variable. The capacity of a ring buffer is not measured by the number of items it can store, but rather by the amount of memory used for storing items. The ring buffer provides API to send an item, or to allocate space for an item in the ring buffer to be filled manually by the user. For efficiency reasons, **items are always retrieved from the ring buffer by reference**. As a result, all retrieved items *must also be returned* to the ring buffer by using *vRingbufferReturnItem()* or *vRingbufferReturnItemFromISR()*, in order for them to be removed from the ring buffer completely. The ring buffers are split into the three following types:

No-Split buffers will guarantee that an item is stored in contiguous memory and will not attempt to split an item under any circumstances. Use no-split buffers when items must occupy contiguous memory. *Only this buffer type allows you getting the data item address and writing to the item by yourself.*

Allow-Split buffers will allow an item to be split when wrapping around if doing so will allow the item to be stored. Allow-split buffers are more memory efficient than no-split buffers but can return an item in two parts when retrieving.

Byte buffers do not store data as separate items. All data is stored as a sequence of bytes, and any number of bytes can be sent or retrieved each time. Use byte buffers when separate items do not need to be maintained (e.g. a byte stream).

Note: No-split/allow-split buffers will always store items at 32-bit aligned addresses. Therefore when retrieving an item, the item pointer is guaranteed to be 32-bit aligned. This is useful especially when you need to send some data to the DMA.

Note: Each item stored in no-split/allow-split buffers will **require an additional 8 bytes for a header**. Item sizes will also be rounded up to a 32-bit aligned size (multiple of 4 bytes), however the true item size is recorded within the header. The sizes of no-split/allow-split buffers will also be rounded up when created.

Usage The following example demonstrates the usage of `xRingbufferCreate()` and `xRingbufferSend()` to create a ring buffer then send an item to it.

```
#include "freertos/ringbuf.h"
static char tx_item[] = "test_item";

...

//Create ring buffer
RingbufHandle_t buf_handle;
buf_handle = xRingbufferCreate(1028, RINGBUF_TYPE_NOSPLIT);
if (buf_handle == NULL) {
    printf("Failed to create ring buffer\n");
}

//Send an item
UBaseType_t res = xRingbufferSend(buf_handle, tx_item, sizeof(tx_item), pdMS_
↳TO_TICKS(1000));
if (res != pdTRUE) {
    printf("Failed to send item\n");
}
```

The following example demonstrates the usage of `xRingbufferSendAcquire()` and `xRingbufferSendComplete()` instead of `xRingbufferSend()` to apply for the memory on the ring buffer (of type `RINGBUF_TYPE_NOSPLIT`) and then send an item to it. This way adds one more step, but allows getting the address of the memory to write to, and writing to the memory yourself.

```
#include "freertos/ringbuf.h"
#include "soc/lldesc.h"

typedef struct {
    lldesc_t dma_desc;
    uint8_t buf[1];
} dma_item_t;

#define DMA_ITEM_SIZE(N) (sizeof(lldesc_t)+((N)+3)&(~3))

...

//Retrieve space for DMA descriptor and corresponding data buffer
//This has to be done with SendAcquire, or the address may be different when
↳copy
dma_item_t item;
UBaseType_t res = xRingbufferSendAcquire(buf_handle,
&item, DMA_ITEM_SIZE(buffer_size), pdMS_TO_TICKS(1000));
```

(continues on next page)

(continued from previous page)

```

if (res != pdTRUE) {
    printf("Failed to acquire memory for item\n");
}
item->dma_desc = (lldesc_t) {
    .size = buffer_size,
    .length = buffer_size,
    .eof = 0,
    .owner = 1,
    .buf = &item->buf,
};
//Actually send to the ring buffer for consumer to use
res = xRingbufferSendComplete(buf_handle, &item);
if (res != pdTRUE) {
    printf("Failed to send item\n");
}

```

The following example demonstrates retrieving and returning an item from a **no-split ring buffer** using `xRingbufferReceive()` and `vRingbufferReturnItem()`

```

...

//Receive an item from no-split ring buffer
size_t item_size;
char *item = (char *)xRingbufferReceive(buf_handle, &item_size, pdMS_TO_
↪TICKS(1000));

//Check received item
if (item != NULL) {
    //Print item
    for (int i = 0; i < item_size; i++) {
        printf("%c", item[i]);
    }
    printf("\n");
    //Return Item
    vRingbufferReturnItem(buf_handle, (void *)item);
} else {
    //Failed to receive item
    printf("Failed to receive item\n");
}

```

The following example demonstrates retrieving and returning an item from an **allow-split ring buffer** using `xRingbufferReceiveSplit()` and `vRingbufferReturnItem()`

```

...

//Receive an item from allow-split ring buffer
size_t item_size1, item_size2;
char *item1, *item2;
BaseType_t ret = xRingbufferReceiveSplit(buf_handle, (void **)&item1, (void_
↪*)&item2, &item_size1, &item_size2, pdMS_TO_TICKS(1000));

//Check received item
if (ret == pdTRUE && item1 != NULL) {
    for (int i = 0; i < item_size1; i++) {
        printf("%c", item1[i]);
    }
    vRingbufferReturnItem(buf_handle, (void *)item1);
    //Check if item was split
    if (item2 != NULL) {
        for (int i = 0; i < item_size2; i++) {
            printf("%c", item2[i]);
        }
    }
}

```

(continues on next page)

(continued from previous page)

```

    }
    vRingbufferReturnItem(buf_handle, (void *)item2);
}
printf("\n");
} else {
    //Failed to receive item
    printf("Failed to receive item\n");
}
}

```

The following example demonstrates retrieving and returning an item from a **byte buffer** using `xRingbufferReceiveUpTo()` and `vRingbufferReturnItem()`

```

...
//Receive data from byte buffer
size_t item_size;
char *item = (char *)xRingbufferReceiveUpTo(buf_handle, &item_size, pdMS_TO_
↪TICKS(1000), sizeof(tx_item));

//Check received data
if (item != NULL) {
    //Print item
    for (int i = 0; i < item_size; i++) {
        printf("%c", item[i]);
    }
    printf("\n");
    //Return Item
    vRingbufferReturnItem(buf_handle, (void *)item);
} else {
    //Failed to receive item
    printf("Failed to receive item\n");
}
}

```

For ISR safe versions of the functions used above, call `xRingbufferSendFromISR()`, `xRingbufferReceiveFromISR()`, `xRingbufferReceiveSplitFromISR()`, `xRingbufferReceiveUpToFromISR()`, and `vRingbufferReturnItemFromISR()`

Note: Two calls to `RingbufferReceive[UpTo][FromISR]()` are required if the bytes wraps around the end of the ring buffer.

Sending to Ring Buffer The following diagrams illustrate the differences between no-split/allow-split buffers and byte buffers with regards to sending items/data. The diagrams assume that three items of sizes **18, 3, and 27 bytes** are sent respectively to a **buffer of 128 bytes**.

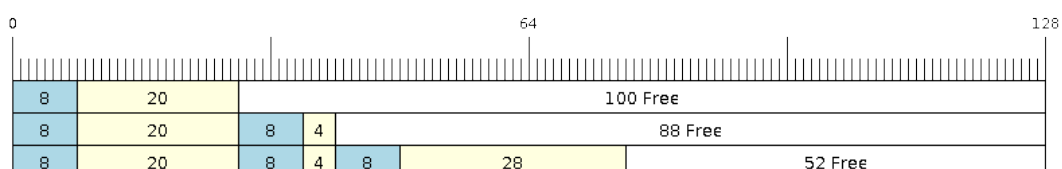

Fig. 21: Sending items to no-split/allow-split ring buffers

For no-split/allow-split buffers, a header of 8 bytes precedes every data item. Furthermore, the space occupied by each item is **rounded up to the nearest 32-bit aligned size** in order to maintain overall 32-bit alignment. However

the true size of the item is recorded inside the header which will be returned when the item is retrieved.

Referring to the diagram above, the 18, 3, and 27 byte items are **rounded up to 20, 4, and 28 bytes** respectively. An 8 byte header is then added in front of each item.

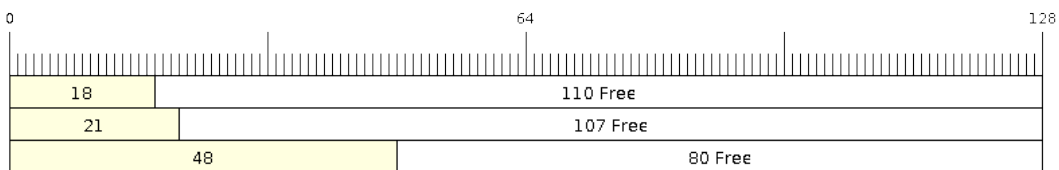

Fig. 22: Sending items to byte buffers

Byte buffers treat data as a sequence of bytes and does not incur any overhead (no headers). As a result, all data sent to a byte buffer is merged into a single item.

Referring to the diagram above, the 18, 3, and 27 byte items are sequentially written to the byte buffer and **merged into a single item of 48 bytes**.

Using SendAcquire and SendComplete Items in no-split buffers are acquired (by SendAcquire) in strict FIFO order and must be sent to the buffer by SendComplete for the data to be accessible by the consumer. Multiple items can be sent or acquired without calling SendComplete, and the items do not necessarily need to be completed in the order they were acquired. However the receiving of data items must occur in FIFO order, therefore not calling SendComplete the earliest acquired item will prevent the subsequent items from being received.

The following diagrams illustrate what will happen when SendAcquire/SendComplete don't happen in the same order. At the beginning, there is already an data item of 16 bytes sent to the ring buffer. Then SendAcquire is called to acquire space of 20, 8, 24 bytes on the ring buffer.

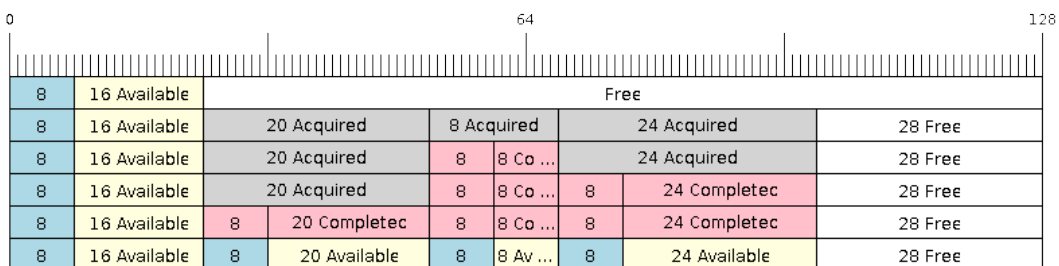

Fig. 23: SendAcquire/SendComplete items in no-split ring buffers

After that, we fill (use) the buffers, and send them to the ring buffer by SendComplete in the order of 8, 24, 20. When 8 bytes and 24 bytes data are sent, the consumer still can only get the 16 bytes data item. Due to the usage if 20 bytes item is not complete, it's not available, nor the following data items.

When the 20 bytes item is finally completed, all the 3 data items can be received now, in the order of 20, 8, 24 bytes, right after the 16 bytes item existing in the buffer at the beginning.

Allow-split/byte buffers do not allow using SendAcquire/SendComplete since acquired buffers are required to be complete (not wrapped).

Wrap around The following diagrams illustrate the differences between no-split, allow-split, and byte buffers when a sent item requires a wrap around. The diagrams assumes a buffer of **128 bytes with 56 bytes of free space that wraps around** and a sent item of **28 bytes**.

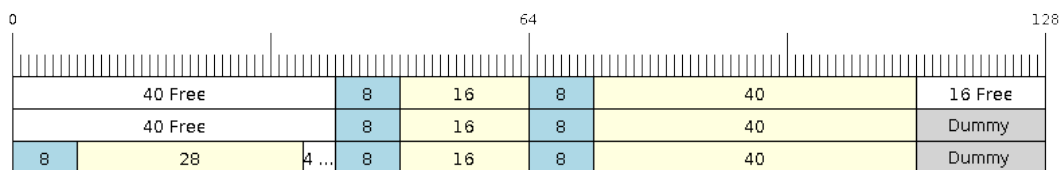

Fig. 24: Wrap around in no-split buffers

No-split buffers will **only store an item in continuous free space and will not split an item under any circumstances**. When the free space at the tail of the buffer is insufficient to completely store the item and its header, the free space at the tail will be **marked as dummy data**. The buffer will then wrap around and store the item in the free space at the head of the buffer.

Referring to the diagram above, the 16 bytes of free space at the tail of the buffer is insufficient to store the 28 byte item. Therefore the 16 bytes is marked as dummy data and the item is written to the free space at the head of the buffer instead.

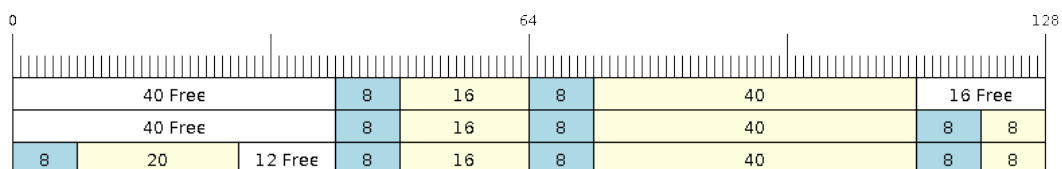

Fig. 25: Wrap around in allow-split buffers

Allow-split buffers will attempt to **split the item into two parts** when the free space at the tail of the buffer is insufficient to store the item data and its header. Both parts of the split item will have their own headers (therefore incurring an extra 8 bytes of overhead).

Referring to the diagram above, the 16 bytes of free space at the tail of the buffer is insufficient to store the 28 byte item. Therefore the item is split into two parts (8 and 20 bytes) and written as two parts to the buffer.

Note: Allow-split buffers treats the both parts of the split item as two separate items, therefore call `xRingbufferReceiveSplit()` instead of `xRingbufferReceive()` to receive both parts of a split item in a thread safe manner.

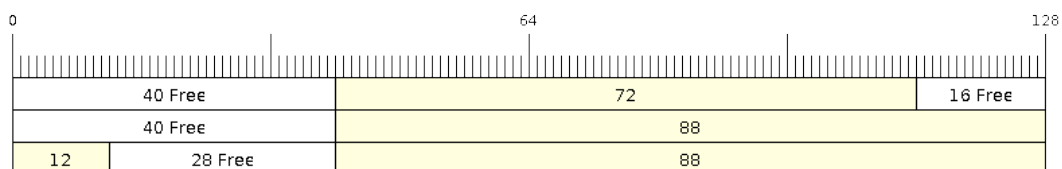

Fig. 26: Wrap around in byte buffers

Byte buffers will **store as much data as possible into the free space at the tail of buffer**. The remaining data will then be stored in the free space at the head of the buffer. No overhead is incurred when wrapping around in byte buffers.

Referring to the diagram above, the 16 bytes of free space at the tail of the buffer is insufficient to completely store the 28 bytes of data. Therefore the 16 bytes of free space is filled with data, and the remaining 12 bytes are written to the free space at the head of the buffer. The buffer now contains data in two separate continuous parts, and each part continuous will be treated as a separate item by the byte buffer.

Retrieving/Returning The following diagrams illustrates the differences between no-split/allow-split and byte buffers in retrieving and returning data.

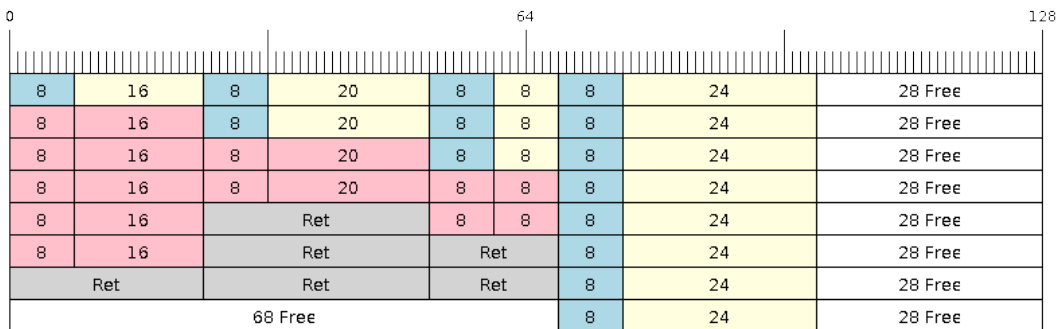

Fig. 27: Retrieving/Returning items in no-split/allow-split ring buffers

Items in no-split/allow-split buffers are **retrieved in strict FIFO order** and **must be returned** for the occupied space to be freed. Multiple items can be retrieved before returning, and the items do not necessarily need to be returned in the order they were retrieved. However the freeing of space must occur in FIFO order, therefore not returning the earliest retrieved item will prevent the space of subsequent items from being freed.

Referring to the diagram above, the **16, 20, and 8 byte items are retrieved in FIFO order**. However the items are not returned in they were retrieved (20, 8, 16). As such, the space is not freed until the first item (16 byte) is returned.

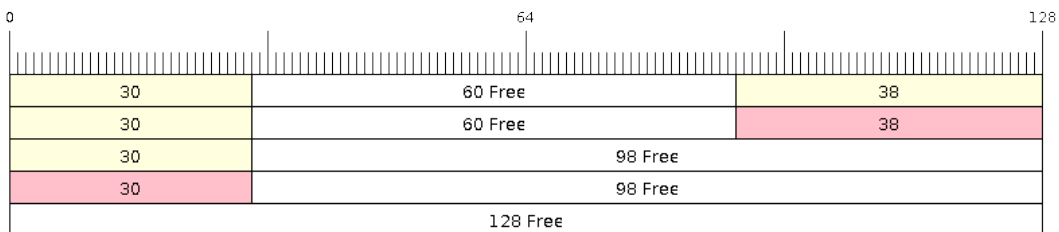

Fig. 28: Retrieving/Returning data in byte buffers

Byte buffers **do not allow multiple retrievals before returning** (every retrieval must be followed by a return before another retrieval is permitted). When using `xRingbufferReceive()` or `xRingbufferReceiveFromISR()`, all continuous stored data will be retrieved. `xRingbufferReceiveUpTo()` or `xRingbufferReceiveUpToFromISR()` can be used to restrict the maximum number of bytes retrieved. Since every retrieval must be followed by a return, the space will be freed as soon as the data is returned.

Referring to the diagram above, the 38 bytes of continuous stored data at the tail of the buffer is retrieved, returned, and freed. The next call to `xRingbufferReceive()` or `xRingbufferReceiveFromISR()` then wraps around and does the same to the 30 bytes of continuous stored data at the head of the buffer.

Ring Buffers with Queue Sets Ring buffers can be added to FreeRTOS queue sets using `xRingbufferAddToQueueSetRead()` such that every time a ring buffer receives an item or data, the queue set is notified. Once

added to a queue set, every attempt to retrieve an item from a ring buffer should be preceded by a call to `xQueueSelectFromSet()`. To check whether the selected queue set member is the ring buffer, call `xRingbufferCanRead()`.

The following example demonstrates queue set usage with ring buffers.

```
#include "freertos/queue.h"
#include "freertos/ringbuf.h"

...

//Create ring buffer and queue set
RingbufHandle_t buf_handle = xRingbufferCreate(1028, RINGBUF_TYPE_NOSPLIT);
QueueSetHandle_t queue_set = xQueueCreateSet(3);

//Add ring buffer to queue set
if (xRingbufferAddToQueueSetRead(buf_handle, queue_set) != pdTRUE) {
    printf("Failed to add to queue set\n");
}

...

//Block on queue set
xQueueSetMemberHandle member = xQueueSelectFromSet(queue_set, pdMS_TO_
↳TICKS(1000));

//Check if member is ring buffer
if (member != NULL && xRingbufferCanRead(buf_handle, member) == pdTRUE) {
    //Member is ring buffer, receive item from ring buffer
    size_t item_size;
    char *item = (char *)xRingbufferReceive(buf_handle, &item_size, 0);

    //Handle item
    ...
} else {
    ...
}
```

Ring Buffers with Static Allocation The `xRingbufferCreateStatic()` can be used to create ring buffers with specific memory requirements (such as a ring buffer being allocated in external RAM). All blocks of memory used by a ring buffer must be manually allocated beforehand then passed to the `xRingbufferCreateStatic()` to be initialized as a ring buffer. These blocks include the following:

- The ring buffer's data structure of type `StaticRingbuffer_t`
- The ring buffer's storage area of size `xBufferSize`. Note that `xBufferSize` must be 32-bit aligned for no-split/allow-split buffers.

The manner in which these blocks are allocated will depend on the users requirements (e.g. all blocks being statically declared, or dynamically allocated with specific capabilities such as external RAM).

Note: When deleting a ring buffer created via `xRingbufferCreateStatic()`, the function `vRingbufferDelete()` will not free any of the memory blocks. This must be done manually by the user after `vRingbufferDelete()` is called.

The code snippet below demonstrates a ring buffer being allocated entirely in external RAM.

```
#include "freertos/ringbuf.h"
#include "freertos/semphr.h"
#include "esp_heap_caps.h"
```

(continues on next page)

```

#define BUFFER_SIZE      400      //32-bit aligned size
#define BUFFER_TYPE      RINGBUF_TYPE_NOSPLIT
...

//Allocate ring buffer data structure and storage area into external RAM
StaticRingbuffer_t *buffer_struct = (StaticRingbuffer_t *)heap_caps_
↳malloc(sizeof(StaticRingbuffer_t), MALLOC_CAP_SPIRAM);
uint8_t *buffer_storage = (uint8_t *)heap_caps_malloc(sizeof(uint8_t)*BUFFER_SIZE,↳
↳MALLOC_CAP_SPIRAM);

//Create a ring buffer with manually allocated memory
RingbufHandle_t handle = xRingbufferCreateStatic(BUFFER_SIZE, BUFFER_TYPE, buffer_
↳storage, buffer_struct);

...

//Delete the ring buffer after used
vRingbufferDelete(handle);

//Manually free all blocks of memory
free(buffer_struct);
free(buffer_storage);

```

Ring Buffer API Reference

Note: Ideally, ring buffers can be used with multiple tasks in an SMP fashion where the **highest priority task will always be serviced first**. However due to the usage of binary semaphores in the ring buffer's underlying implementation, priority inversion may occur under very specific circumstances.

The ring buffer governs sending by a binary semaphore which is given whenever space is freed on the ring buffer. The highest priority task waiting to send will repeatedly take the semaphore until sufficient free space becomes available or until it times out. Ideally this should prevent any lower priority tasks from being serviced as the semaphore should always be given to the highest priority task.

However in between iterations of acquiring the semaphore, there is a **gap in the critical section** which may permit another task (on the other core or with an even higher priority) to free some space on the ring buffer and as a result give the semaphore. Therefore the semaphore will be given before the highest priority task can re-acquire the semaphore. This will result in the **semaphore being acquired by the second highest priority task** waiting to send, hence causing priority inversion.

This side effect will not affect ring buffer performance drastically given if the number of tasks using the ring buffer simultaneously is low, and the ring buffer is not operating near maximum capacity.

Header File

- `esp_ringbuf/include/freertos/ringbuf.h`

Functions

RingbufHandle_t **xRingbufferCreate** (*size_t* *xBufferSize*, *RingbufferType_t* *xBufferType*)

Create a ring buffer.

Note *xBufferSize* of no-split/allow-split buffers will be rounded up to the nearest 32-bit aligned size.

Return A handle to the created ring buffer, or NULL in case of error.

Parameters

- [*in*] *xBufferSize*: Size of the buffer in bytes. Note that items require space for overhead in no-split/allow-split buffers

- [in] `xBufferType`: Type of ring buffer, see documentation.

RingbufHandle_t **xRingbufferCreateNoSplit** (*size_t* *xItemSize*, *size_t* *xItemNum*)

Create a ring buffer of type RINGBUF_TYPE_NOSPLIT for a fixed *item_size*.

This API is similar to `xRingbufferCreate()`, but it will internally allocate additional space for the headers.

Return A `RingbufHandle_t` handle to the created ring buffer, or NULL in case of error.

Parameters

- [in] `xItemSize`: Size of each item to be put into the ring buffer
- [in] `xItemNum`: Maximum number of items the buffer needs to hold simultaneously

RingbufHandle_t **xRingbufferCreateStatic** (*size_t* *xBufferSize*, *RingbufferType_t* *xBufferType*, *uint8_t* **pucRingbufferStorage*, *StaticRingbuffer_t* **pxStaticRingbuffer*)

Create a ring buffer but manually provide the required memory.

Note `xBufferSize` of no-split/allow-split buffers MUST be 32-bit aligned.

Return A handle to the created ring buffer

Parameters

- [in] `xBufferSize`: Size of the buffer in bytes.
- [in] `xBufferType`: Type of ring buffer, see documentation
- [in] `pucRingbufferStorage`: Pointer to the ring buffer's storage area. Storage area must of the same size as specified by `xBufferSize`
- [in] `pxStaticRingbuffer`: Pointed to a struct of type `StaticRingbuffer_t` which will be used to hold the ring buffer's data structure

BaseType_t **xRingbufferSend** (*RingbufHandle_t* *xRingbuffer*, **const** *void* **pvItem*, *size_t* *xItemSize*, *TickType_t* *xTicksToWait*)

Insert an item into the ring buffer.

Attempt to insert an item into the ring buffer. This function will block until enough free space is available or until it times out.

Note For no-split/allow-split ring buffers, the actual size of memory that the item will occupy will be rounded up to the nearest 32-bit aligned size. This is done to ensure all items are always stored in 32-bit aligned fashion.

Return

- `pdTRUE` if succeeded
- `pdFALSE` on time-out or when the data is larger than the maximum permissible size of the buffer

Parameters

- [in] `xRingbuffer`: Ring buffer to insert the item into
- [in] `pvItem`: Pointer to data to insert. NULL is allowed if `xItemSize` is 0.
- [in] `xItemSize`: Size of data to insert.
- [in] `xTicksToWait`: Ticks to wait for room in the ring buffer.

BaseType_t **xRingbufferSendFromISR** (*RingbufHandle_t* *xRingbuffer*, **const** *void* **pvItem*, *size_t* *xItemSize*, *BaseType_t* **pxHigherPriorityTaskWoken*)

Insert an item into the ring buffer in an ISR.

Attempt to insert an item into the ring buffer from an ISR. This function will return immediately if there is insufficient free space in the buffer.

Note For no-split/allow-split ring buffers, the actual size of memory that the item will occupy will be rounded up to the nearest 32-bit aligned size. This is done to ensure all items are always stored in 32-bit aligned fashion.

Return

- `pdTRUE` if succeeded
- `pdFALSE` when the ring buffer does not have space.

Parameters

- [in] `xRingbuffer`: Ring buffer to insert the item into
- [in] `pvItem`: Pointer to data to insert. NULL is allowed if `xItemSize` is 0.
- [in] `xItemSize`: Size of data to insert.
- [out] `pxHigherPriorityTaskWoken`: Value pointed to will be set to `pdTRUE` if the function woke up a higher priority task.

BaseType_t **xRingbufferSendAcquire** (*RingbufHandle_t* xRingbuffer, void **ppvItem, size_t xItemSize, TickType_t xTicksToWait)

Acquire memory from the ring buffer to be written to by an external source and to be sent later.

Attempt to allocate buffer for an item to be sent into the ring buffer. This function will block until enough free space is available or until it timesout.

The item, as well as the following items `SendAcquire` or `Send` after it, will not be able to be read from the ring buffer until this item is actually sent into the ring buffer.

Note Only applicable for no-split ring buffers now, the actual size of memory that the item will occupy will be rounded up to the nearest 32-bit aligned size. This is done to ensure all items are always stored in 32-bit aligned fashion.

Return

- pdTRUE if succeeded
- pdFALSE on time-out or when the data is larger than the maximum permissible size of the buffer

Parameters

- [in] xRingbuffer: Ring buffer to allocate the memory
- [out] ppvItem: Double pointer to memory acquired (set to NULL if no memory were retrieved)
- [in] xItemSize: Size of item to acquire.
- [in] xTicksToWait: Ticks to wait for room in the ring buffer.

BaseType_t **xRingbufferSendComplete** (*RingbufHandle_t* xRingbuffer, void *pvItem)

Actually send an item into the ring buffer allocated before by `xRingbufferSendAcquire`.

Note Only applicable for no-split ring buffers. Only call for items allocated by `xRingbufferSendAcquire`.

Return

- pdTRUE if succeeded
- pdFALSE if fail for some reason.

Parameters

- [in] xRingbuffer: Ring buffer to insert the item into
- [in] pvItem: Pointer to item in allocated memory to insert.

void ***xRingbufferReceive** (*RingbufHandle_t* xRingbuffer, size_t *pxItemSize, TickType_t xTicksToWait)

Retrieve an item from the ring buffer.

Attempt to retrieve an item from the ring buffer. This function will block until an item is available or until it times out.

Note A call to `vRingbufferReturnItem()` is required after this to free the item retrieved.

Return

- Pointer to the retrieved item on success; *pxItemSize filled with the length of the item.
- NULL on timeout, *pxItemSize is untouched in that case.

Parameters

- [in] xRingbuffer: Ring buffer to retrieve the item from
- [out] pxItemSize: Pointer to a variable to which the size of the retrieved item will be written.
- [in] xTicksToWait: Ticks to wait for items in the ring buffer.

void ***xRingbufferReceiveFromISR** (*RingbufHandle_t* xRingbuffer, size_t *pxItemSize)

Retrieve an item from the ring buffer in an ISR.

Attempt to retrieve an item from the ring buffer. This function returns immediately if there are no items available for retrieval

Note A call to `vRingbufferReturnItemFromISR()` is required after this to free the item retrieved.

Note Byte buffers do not allow multiple retrievals before returning an item

Note Two calls to `RingbufferReceiveFromISR()` are required if the bytes wrap around the end of the ring buffer.

Return

- Pointer to the retrieved item on success; *pxItemSize filled with the length of the item.
- NULL when the ring buffer is empty, *pxItemSize is untouched in that case.

Parameters

- [in] `xRingbuffer`: Ring buffer to retrieve the item from
- [out] `pxItemSize`: Pointer to a variable to which the size of the retrieved item will be written.

BaseType_t **xRingbufferReceiveSplit** (*RingbufHandle_t* `xRingbuffer`, void ****ppvHeadItem**, void ****ppvTailItem**, size_t ***pxHeadItemSize**, size_t ***pxTailItemSize**, TickType_t `xTicksToWait`)

Retrieve a split item from an allow-split ring buffer.

Attempt to retrieve a split item from an allow-split ring buffer. If the item is not split, only a single item is retrieved. If the item is split, both parts will be retrieved. This function will block until an item is available or until it times out.

Note Call(s) to `vRingbufferReturnItem()` is required after this to free up the item(s) retrieved.

Note This function should only be called on allow-split buffers

Return

- pdTRUE if an item (split or unsplit) was retrieved
- pdFALSE when no item was retrieved

Parameters

- [in] `xRingbuffer`: Ring buffer to retrieve the item from
- [out] `ppvHeadItem`: Double pointer to first part (set to NULL if no items were retrieved)
- [out] `ppvTailItem`: Double pointer to second part (set to NULL if item is not split)
- [out] `pxHeadItemSize`: Pointer to size of first part (unmodified if no items were retrieved)
- [out] `pxTailItemSize`: Pointer to size of second part (unmodified if item is not split)
- [in] `xTicksToWait`: Ticks to wait for items in the ring buffer.

BaseType_t **xRingbufferReceiveSplitFromISR** (*RingbufHandle_t* `xRingbuffer`, void ****ppvHeadItem**, void ****ppvTailItem**, size_t ***pxHeadItemSize**, size_t ***pxTailItemSize**)

Retrieve a split item from an allow-split ring buffer in an ISR.

Attempt to retrieve a split item from an allow-split ring buffer. If the item is not split, only a single item is retrieved. If the item is split, both parts will be retrieved. This function returns immediately if there are no items available for retrieval

Note Calls to `vRingbufferReturnItemFromISR()` is required after this to free up the item(s) retrieved.

Note This function should only be called on allow-split buffers

Return

- pdTRUE if an item (split or unsplit) was retrieved
- pdFALSE when no item was retrieved

Parameters

- [in] `xRingbuffer`: Ring buffer to retrieve the item from
- [out] `ppvHeadItem`: Double pointer to first part (set to NULL if no items were retrieved)
- [out] `ppvTailItem`: Double pointer to second part (set to NULL if item is not split)
- [out] `pxHeadItemSize`: Pointer to size of first part (unmodified if no items were retrieved)
- [out] `pxTailItemSize`: Pointer to size of second part (unmodified if item is not split)

void ***xRingbufferReceiveUpTo** (*RingbufHandle_t* `xRingbuffer`, size_t ***pxItemSize**, TickType_t `xTicksToWait`, size_t `xMaxSize`)

Retrieve bytes from a byte buffer, specifying the maximum amount of bytes to retrieve.

Attempt to retrieve data from a byte buffer whilst specifying a maximum number of bytes to retrieve. This function will block until there is data available for retrieval or until it times out.

Note A call to `vRingbufferReturnItem()` is required after this to free up the data retrieved.

Note This function should only be called on byte buffers

Note Byte buffers do not allow multiple retrievals before returning an item

Note Two calls to `RingbufferReceiveUpTo()` are required if the bytes wrap around the end of the ring buffer.

Return

- Pointer to the retrieved item on success; `*pxItemSize` filled with the length of the item.
- NULL on timeout, `*pxItemSize` is untouched in that case.

Parameters

- [in] `xRingbuffer`: Ring buffer to retrieve the item from
- [out] `pxItemSize`: Pointer to a variable to which the size of the retrieved item will be written.

- [in] `xTicksToWait`: Ticks to wait for items in the ring buffer.
- [in] `xMaxSize`: Maximum number of bytes to return.

void ***xRingbufferReceiveUpToFromISR** (*RingbufHandle_t* `xRingbuffer`, size_t `*pxItemSize`, size_t `xMaxSize`)

Retrieve bytes from a byte buffer, specifying the maximum amount of bytes to retrieve. Call this from an ISR.

Attempt to retrieve bytes from a byte buffer whilst specifying a maximum number of bytes to retrieve. This function will return immediately if there is no data available for retrieval.

Note A call to `vRingbufferReturnItemFromISR()` is required after this to free up the data received.

Note This function should only be called on byte buffers

Note Byte buffers do not allow multiple retrievals before returning an item

Return

- Pointer to the retrieved item on success; `*pxItemSize` filled with the length of the item.
- NULL when the ring buffer is empty, `*pxItemSize` is untouched in that case.

Parameters

- [in] `xRingbuffer`: Ring buffer to retrieve the item from
- [out] `pxItemSize`: Pointer to a variable to which the size of the retrieved item will be written.
- [in] `xMaxSize`: Maximum number of bytes to return.

void **vRingbufferReturnItem** (*RingbufHandle_t* `xRingbuffer`, void `*pvItem`)

Return a previously-retrieved item to the ring buffer.

Note If a split item is retrieved, both parts should be returned by calling this function twice

Parameters

- [in] `xRingbuffer`: Ring buffer the item was retrieved from
- [in] `pvItem`: Item that was received earlier

void **vRingbufferReturnItemFromISR** (*RingbufHandle_t* `xRingbuffer`, void `*pvItem`, BaseType_t `*pxHigherPriorityTaskWoken`)

Return a previously-retrieved item to the ring buffer from an ISR.

Note If a split item is retrieved, both parts should be returned by calling this function twice

Parameters

- [in] `xRingbuffer`: Ring buffer the item was retrieved from
- [in] `pvItem`: Item that was received earlier
- [out] `pxHigherPriorityTaskWoken`: Value pointed to will be set to `pdTRUE` if the function woke up a higher priority task.

void **vRingbufferDelete** (*RingbufHandle_t* `xRingbuffer`)

Delete a ring buffer.

Note This function will not deallocate any memory if the ring buffer was created using `xRingbufferCreateStatic()`. Deallocation must be done manually by the user.

Parameters

- [in] `xRingbuffer`: Ring buffer to delete

size_t **xRingbufferGetMaxItemSize** (*RingbufHandle_t* `xRingbuffer`)

Get maximum size of an item that can be placed in the ring buffer.

This function returns the maximum size an item can have if it was placed in an empty ring buffer.

Note The max item size for a no-split buffer is limited to $((\text{buffer_size}/2) - \text{header_size})$. This limit is imposed so that an item of max item size can always be sent to the an empty no-split buffer regardless of the internal positions of the buffer's read/write/free pointers.

Return Maximum size, in bytes, of an item that can be placed in a ring buffer.

Parameters

- [in] `xRingbuffer`: Ring buffer to query

size_t **xRingbufferGetCurFreeSize** (*RingbufHandle_t* `xRingbuffer`)

Get current free size available for an item/data in the buffer.

This gives the real time free space available for an item/data in the ring buffer. This represents the maximum size an item/data can have if it was currently sent to the ring buffer.

Warning This API is not thread safe. So, if multiple threads are accessing the same ring buffer, it is the application's responsibility to ensure atomic access to this API and the subsequent Send

Note An empty no-split buffer has a max current free size for an item that is limited to ((buffer_size/2)-header_size). See API reference for xRingbufferGetMaxItemSize().

Return Current free size, in bytes, available for an entry

Parameters

- [in] xRingbuffer: Ring buffer to query

BaseType_t **xRingbufferAddToQueueSetRead** (*RingbufHandle_t* xRingbuffer, *QueueSetHandle_t* xQueueSet)

Add the ring buffer's read semaphore to a queue set.

The ring buffer's read semaphore indicates that data has been written to the ring buffer. This function adds the ring buffer's read semaphore to a queue set.

Return

- pdTRUE on success, pdFALSE otherwise

Parameters

- [in] xRingbuffer: Ring buffer to add to the queue set
- [in] xQueueSet: Queue set to add the ring buffer's read semaphore to

BaseType_t **xRingbufferCanRead** (*RingbufHandle_t* xRingbuffer, *QueueSetMemberHandle_t* xMember)

Check if the selected queue set member is the ring buffer's read semaphore.

This API checks if queue set member returned from xQueueSelectFromSet() is the read semaphore of this ring buffer. If so, this indicates the ring buffer has items waiting to be retrieved.

Return

- pdTRUE when semaphore belongs to ring buffer
- pdFALSE otherwise.

Parameters

- [in] xRingbuffer: Ring buffer which should be checked
- [in] xMember: Member returned from xQueueSelectFromSet

BaseType_t **xRingbufferRemoveFromQueueSetRead** (*RingbufHandle_t* xRingbuffer, *QueueSetHandle_t* xQueueSet)

Remove the ring buffer's read semaphore from a queue set.

This specifically removes a ring buffer's read semaphore from a queue set. The read semaphore is used to indicate when data has been written to the ring buffer

Return

- pdTRUE on success
- pdFALSE otherwise

Parameters

- [in] xRingbuffer: Ring buffer to remove from the queue set
- [in] xQueueSet: Queue set to remove the ring buffer's read semaphore from

void **vRingbufferGetInfo** (*RingbufHandle_t* xRingbuffer, UBaseType_t *uxFree, UBaseType_t *uxRead, UBaseType_t *uxWrite, UBaseType_t *uxAcquire, UBaseType_t *uxItemsWaiting)

Get information about ring buffer status.

Get information of the a ring buffer's current status such as free/read/write pointer positions, and number of items waiting to be retrieved. Arguments can be set to NULL if they are not required.

Parameters

- [in] xRingbuffer: Ring buffer to remove from the queue set
- [out] uxFree: Pointer use to store free pointer position
- [out] uxRead: Pointer use to store read pointer position
- [out] uxWrite: Pointer use to store write pointer position
- [out] uxAcquire: Pointer use to store acquire pointer position
- [out] uxItemsWaiting: Pointer use to store number of items (bytes for byte buffer) waiting to be retrieved

void **xRingbufferPrintInfo** (*RingbufHandle_t* xRingbuffer)

Debugging function to print the internal pointers in the ring buffer.

Parameters

- xRingbuffer: Ring buffer to show

Structures

struct xSTATIC_RINGBUFFER

Struct that is equivalent in size to the ring buffer's data structure.

The contents of this struct are not meant to be used directly. This structure is meant to be used when creating a statically allocated ring buffer where this struct is of the exact size required to store a ring buffer's control data structure.

Type Definitions

typedef void *RingbufHandle_t

Type by which ring buffers are referenced. For example, a call to xRingbufferCreate() returns a RingbufHandle_t variable that can then be used as a parameter to xRingbufferSend(), xRingbufferReceive(), etc.

typedef struct xSTATIC_RINGBUFFER StaticRingbuffer_t

Struct that is equivalent in size to the ring buffer's data structure.

The contents of this struct are not meant to be used directly. This structure is meant to be used when creating a statically allocated ring buffer where this struct is of the exact size required to store a ring buffer's control data structure.

Enumerations

enum RingbufferType_t

Values:

RINGBUF_TYPE_NOSPLIT = 0

No-split buffers will only store an item in contiguous memory and will never split an item. Each item requires an 8 byte overhead for a header and will always internally occupy a 32-bit aligned size of space.

RINGBUF_TYPE_ALLOWSPLIT

Allow-split buffers will split an item into two parts if necessary in order to store it. Each item requires an 8 byte overhead for a header, splitting incurs an extra header. Each item will always internally occupy a 32-bit aligned size of space.

RINGBUF_TYPE_BYTEBUF

Byte buffers store data as a sequence of bytes and do not maintain separate items, therefore byte buffers have no overhead. All data is stored as a sequence of byte and any number of bytes can be sent or retrieved each time.

RINGBUF_TYPE_MAX

Hooks

FreeRTOS consists of Idle Hooks and Tick Hooks which allow for application specific functionality to be added to the Idle Task and Tick Interrupt. ESP-IDF provides its own Idle and Tick Hook API in addition to the hooks provided by Vanilla FreeRTOS. ESP-IDF hooks have the added benefit of being run time configurable and asymmetrical.

Vanilla FreeRTOS Hooks Idle and Tick Hooks in vanilla FreeRTOS are implemented by the user defining the functions `vApplicationIdleHook()` and `vApplicationTickHook()` respectively somewhere in the application. Vanilla FreeRTOS will run the user defined Idle Hook and Tick Hook on every iteration of the Idle Task and Tick Interrupt respectively.

Vanilla FreeRTOS hooks are referred to as **Legacy Hooks** in ESP-IDF FreeRTOS. To enable legacy hooks, `CONFIG_FREERTOS_LEGACY_HOOKS` should be enabled in [project configuration menu](#).

Due to vanilla FreeRTOS being designed for single core, `vApplicationIdleHook()` and `vApplicationTickHook()` can only be defined once. However, the ESP32 is dual core in nature, therefore same Idle Hook and Tick Hook are used for both cores (in other words, the hooks are symmetrical for both cores).

In a dual core system, `vApplicationTickHook()` must be located in IRAM (for example by adding the `IRAM_ATTR` attribute).

ESP-IDF Idle and Tick Hooks Due to the the dual core nature of the ESP32, it may be necessary for some applications to have separate hooks for each core. Furthermore, it may be necessary for the Idle Tasks or Tick Interrupts to execute multiple hooks that are configurable at run time. Therefore the ESP-IDF provides it's own hooks API in addition to the legacy hooks provided by Vanilla FreeRTOS.

The ESP-IDF tick/idle hooks are registered at run time, and each tick/idle hook must be registered to a specific CPU. When the idle task runs/tick Interrupt occurs on a particular CPU, the CPU will run each of its registered idle/tick hooks in turn.

Hooks API Reference

Header File

- [esp_common/include/esp_freertos_hooks.h](#)

Functions

`esp_err_t esp_register_freertos_idle_hook_for_cpu(esp_freertos_idle_cb_t new_idle_cb, UBaseType_t cpuid)`

Register a callback to be called from the specified core's idle hook. The callback should return true if it should be called by the idle hook once per interrupt (or FreeRTOS tick), and return false if it should be called repeatedly as fast as possible by the idle hook.

Warning Idle callbacks MUST NOT, UNDER ANY CIRCUMSTANCES, CALL A FUNCTION THAT MIGHT BLOCK.

Return

- `ESP_OK`: Callback registered to the specified core's idle hook
- `ESP_ERR_NO_MEM`: No more space on the specified core's idle hook to register callback
- `ESP_ERR_INVALID_ARG`: cpuid is invalid

Parameters

- [in] `new_idle_cb`: Callback to be called
- [in] `cpuid`: id of the core

`esp_err_t esp_register_freertos_idle_hook(esp_freertos_idle_cb_t new_idle_cb)`

Register a callback to the idle hook of the core that calls this function. The callback should return true if it should be called by the idle hook once per interrupt (or FreeRTOS tick), and return false if it should be called repeatedly as fast as possible by the idle hook.

Warning Idle callbacks MUST NOT, UNDER ANY CIRCUMSTANCES, CALL A FUNCTION THAT MIGHT BLOCK.

Return

- `ESP_OK`: Callback registered to the calling core's idle hook
- `ESP_ERR_NO_MEM`: No more space on the calling core's idle hook to register callback

Parameters

- [in] `new_idle_cb`: Callback to be called

`esp_err_t esp_register_freertos_tick_hook_for_cpu(esp_freertos_tick_cb_t new_tick_cb, UBaseType_t cpuid)`

Register a callback to be called from the specified core's tick hook.

Return

- `ESP_OK`: Callback registered to specified core's tick hook
- `ESP_ERR_NO_MEM`: No more space on the specified core's tick hook to register the callback
- `ESP_ERR_INVALID_ARG`: cpuid is invalid

Parameters

- [in] `new_tick_cb`: Callback to be called
- [in] `cpuid`: id of the core

`esp_err_t esp_register_freertos_tick_hook(esp_freertos_tick_cb_t new_tick_cb)`

Register a callback to be called from the calling core's tick hook.

Return

- `ESP_OK`: Callback registered to the calling core's tick hook
- `ESP_ERR_NO_MEM`: No more space on the calling core's tick hook to register the callback

Parameters

- [in] `new_tick_cb`: Callback to be called

void `esp_deregister_freertos_idle_hook_for_cpu(esp_freertos_idle_cb_t old_idle_cb, UBaseType_t cpuid)`

Unregister an idle callback from the idle hook of the specified core.

Parameters

- [in] `old_idle_cb`: Callback to be unregistered
- [in] `cpuid`: id of the core

void `esp_deregister_freertos_idle_hook(esp_freertos_idle_cb_t old_idle_cb)`

Unregister an idle callback. If the idle callback is registered to the idle hooks of both cores, the idle hook will be unregistered from both cores.

Parameters

- [in] `old_idle_cb`: Callback to be unregistered

void `esp_deregister_freertos_tick_hook_for_cpu(esp_freertos_tick_cb_t old_tick_cb, UBaseType_t cpuid)`

Unregister a tick callback from the tick hook of the specified core.

Parameters

- [in] `old_tick_cb`: Callback to be unregistered
- [in] `cpuid`: id of the core

void `esp_deregister_freertos_tick_hook(esp_freertos_tick_cb_t old_tick_cb)`

Unregister a tick callback. If the tick callback is registered to the tick hooks of both cores, the tick hook will be unregistered from both cores.

Parameters

- [in] `old_tick_cb`: Callback to be unregistered

Type Definitions

```
typedef bool (*esp_freertos_idle_cb_t)(void)
```

```
typedef void (*esp_freertos_tick_cb_t)(void)
```

Component Specific Properties

Besides standard component variables that could be gotten with basic cmake build properties FreeRTOS component also provides an arguments (only one so far) for simpler integration with other modules:

- `ORIG_INCLUDE_PATH` - contains an absolute path to freertos root include folder. Thus instead of `#include "freertos/FreeRTOS.h"` you can refer to headers directly: `#include "FreeRTOS.h"`.

2.7.12 Heap Memory Allocation

Stack and Heap

ESP-IDF applications use the common computer architecture patterns of *stack* (dynamic memory allocated by program control flow) and *heap* (dynamic memory allocated by function calls), as well as statically allocated memory (allocated at compile time).

Because ESP-IDF is a multi-threaded RTOS environment, each RTOS task has its own stack. By default, each of these stacks is allocated from the heap when the task is created. (See `xTaskCreateStatic()` for the alternative where stacks are statically allocated.)

Because ESP32-C3 uses multiple types of RAM, it also contains multiple heaps with different capabilities. A capabilities-based memory allocator allows apps to make heap allocations for different purposes.

For most purposes, the standard `libc malloc()` and `free()` functions can be used for heap allocation without any special consideration.

However, in order to fully make use of all of the memory types and their characteristics, ESP-IDF also has a capabilities-based heap memory allocator. If you want to have memory with certain properties (for example, *DMA-Capable Memory* or executable-memory), you can create an OR-mask of the required capabilities and pass that to `heap_caps_malloc()`.

Memory Capabilities

The ESP32-C3 contains multiple types of RAM:

- DRAM (Data RAM) is memory used to hold data. This is the most common kind of memory accessed as heap.
- IRAM (Instruction RAM) usually holds executable data only. If accessed as generic memory, all accesses must be *32-bit aligned*.
- D/IRAM is RAM which can be used as either Instruction or Data RAM.

For more details on these internal memory types, see *Memory Types*.

DRAM uses capability `MALLOC_CAP_8BIT` (accessible in single byte reads and writes). When calling `malloc()`, the ESP-IDF `malloc()` implementation internally calls `heap_caps_malloc(size, MALLOC_CAP_8BIT)` in order to allocate DRAM that is byte-addressable. To test the free DRAM heap size at runtime, call `cpp:func:heap_caps_get_free_size(MALLOC_CAP_8BIT)`.

Because `malloc` uses the capabilities-based allocation system, memory allocated using `heap_caps_malloc()` can be freed by calling the standard `free()` function.

Available Heap

DRAM At startup, the DRAM heap contains all data memory which is not statically allocated by the app. Reducing statically allocated buffers will increase the amount of available free heap.

To find the amount of statically allocated memory, use the `idf.py size` command.

Note: At runtime, the available heap DRAM may be less than calculated at compile time, because at startup some memory is allocated from the heap before the FreeRTOS scheduler is started (including memory for the stacks of initial FreeRTOS tasks).

IRAM At startup, the IRAM heap contains all instruction memory which is not used by the app executable code.

The `idf.py size` command can be used to find the amount of IRAM used by the app.

D/IRAM Some memory in the ESP32-C3 is available as either DRAM or IRAM. If memory is allocated from a D/IRAM region, the free heap size for both types of memory will decrease.

Heap Sizes At startup, all ESP-IDF apps log a summary of all heap addresses (and sizes) at level Info:

```

I (252) heap_init: Initializing. RAM available for dynamic allocation:
I (259) heap_init: At 3FFAE6E0 len 00001920 (6 KiB): DRAM
I (265) heap_init: At 3FFB2EC8 len 0002D138 (180 KiB): DRAM
I (272) heap_init: At 3FFE0440 len 00003AE0 (14 KiB): D/IRAM
I (278) heap_init: At 3FFE4350 len 0001BCB0 (111 KiB): D/IRAM
I (284) heap_init: At 4008944C len 00016BB4 (90 KiB): IRAM

```

Finding available heap See [Heap Information](#).

Special Capabilities

DMA-Capable Memory Use the `MALLOC_CAP_DMA` flag to allocate memory which is suitable for use with hardware DMA engines (for example SPI and I2S). This capability flag excludes any external PSRAM.

32-Bit Accessible Memory If a certain memory structure is only addressed in 32-bit units, for example an array of ints or pointers, it can be useful to allocate it with the `MALLOC_CAP_32BIT` flag. This also allows the allocator to give out IRAM memory; something which it can't do for a normal `malloc()` call. This can help to use all the available memory in the ESP32-C3.

Memory allocated with `MALLOC_CAP_32BIT` can *only* be accessed via 32-bit reads and writes, any other type of access will generate a fatal `LoadStoreError` exception.

API Reference - Heap Allocation

Header File

- [heap/include/esp_heap_caps.h](#)

Functions

`esp_err_t heap_caps_register_failed_alloc_callback (esp_alloc_failed_hook_t callback)`
registers a callback function to be invoked if a memory allocation operation fails

Return `ESP_OK` if callback was registered.

Parameters

- `callback`: caller defined callback to be invoked

void *`heap_caps_malloc (size_t size, uint32_t caps)`

Allocate a chunk of memory which has the given capabilities.

Equivalent semantics to `libc malloc()`, for capability-aware memory.

In IDF, `malloc (p)` is equivalent to `heap_caps_malloc (p, MALLOC_CAP_8BIT)`.

Return A pointer to the memory allocated on success, `NULL` on failure

Parameters

- `size`: Size, in bytes, of the amount of memory to allocate
- `caps`: Bitwise OR of `MALLOC_CAP_*` flags indicating the type of memory to be returned

void `heap_caps_free (void *ptr)`

Free memory previously allocated via `heap_caps_malloc()` or `heap_caps_realloc()`.

Equivalent semantics to `libc free()`, for capability-aware memory.

In IDF, `free (p)` is equivalent to `heap_caps_free (p)`.

Parameters

- `ptr`: Pointer to memory previously returned from `heap_caps_malloc()` or `heap_caps_realloc()`. Can be `NULL`.

void ***heap_caps_realloc** (void **ptr*, size_t *size*, uint32_t *caps*)

Reallocate memory previously allocated via `heap_caps_malloc()` or `heap_caps_realloc()`.

Equivalent semantics to `libc realloc()`, for capability-aware memory.

In IDF, `realloc(p, s)` is equivalent to `heap_caps_realloc(p, s, MALLOC_CAP_8BIT)`.

'caps' parameter can be different to the capabilities that any original 'ptr' was allocated with. In this way, `realloc` can be used to "move" a buffer if necessary to ensure it meets a new set of capabilities.

Return Pointer to a new buffer of size 'size' with capabilities 'caps', or NULL if allocation failed.

Parameters

- *ptr*: Pointer to previously allocated memory, or NULL for a new allocation.
- *size*: Size of the new buffer requested, or 0 to free the buffer.
- *caps*: Bitwise OR of `MALLOC_CAP_*` flags indicating the type of memory desired for the new allocation.

void ***heap_caps_aligned_alloc** (size_t *alignment*, size_t *size*, uint32_t *caps*)

Allocate a aligned chunk of memory which has the given capabilities.

Equivalent semantics to `libc aligned_alloc()`, for capability-aware memory.

Return A pointer to the memory allocated on success, NULL on failure

Parameters

- *alignment*: How the pointer received needs to be aligned must be a power of two
- *size*: Size, in bytes, of the amount of memory to allocate
- *caps*: Bitwise OR of `MALLOC_CAP_*` flags indicating the type of memory to be returned

void **heap_caps_aligned_free** (void **ptr*)

Used to deallocate memory previously allocated with `heap_caps_aligned_alloc`.

Note This function is deprecated, please consider using `heap_caps_free()` instead

Parameters

- *ptr*: Pointer to the memory allocated

void ***heap_caps_aligned_calloc** (size_t *alignment*, size_t *n*, size_t *size*, uint32_t *caps*)

Allocate a aligned chunk of memory which has the given capabilities. The initialized value in the memory is set to zero.

Return A pointer to the memory allocated on success, NULL on failure

Parameters

- *alignment*: How the pointer received needs to be aligned must be a power of two
- *n*: Number of continuing chunks of memory to allocate
- *size*: Size, in bytes, of a chunk of memory to allocate
- *caps*: Bitwise OR of `MALLOC_CAP_*` flags indicating the type of memory to be returned

void ***heap_caps_calloc** (size_t *n*, size_t *size*, uint32_t *caps*)

Allocate a chunk of memory which has the given capabilities. The initialized value in the memory is set to zero.

Equivalent semantics to `libc calloc()`, for capability-aware memory.

In IDF, `calloc(p)` is equivalent to `heap_caps_calloc(p, MALLOC_CAP_8BIT)`.

Return A pointer to the memory allocated on success, NULL on failure

Parameters

- *n*: Number of continuing chunks of memory to allocate
- *size*: Size, in bytes, of a chunk of memory to allocate
- *caps*: Bitwise OR of `MALLOC_CAP_*` flags indicating the type of memory to be returned

size_t **heap_caps_get_total_size** (uint32_t *caps*)

Get the total size of all the regions that have the given capabilities.

This function takes all regions capable of having the given capabilities allocated in them and adds up the total space they have.

Return total size in bytes

Parameters

- `caps`: Bitwise OR of `MALLOC_CAP_*` flags indicating the type of memory

`size_t heap_caps_get_free_size (uint32_t caps)`

Get the total free size of all the regions that have the given capabilities.

This function takes all regions capable of having the given capabilities allocated in them and adds up the free space they have.

Note that because of heap fragmentation it is probably not possible to allocate a single block of memory of this size. Use `heap_caps_get_largest_free_block()` for this purpose.

Return Amount of free bytes in the regions

Parameters

- `caps`: Bitwise OR of `MALLOC_CAP_*` flags indicating the type of memory

`size_t heap_caps_get_minimum_free_size (uint32_t caps)`

Get the total minimum free memory of all regions with the given capabilities.

This adds all the low water marks of the regions capable of delivering the memory with the given capabilities.

Note the result may be less than the global all-time minimum available heap of this kind, as “low water marks” are tracked per-region. Individual regions’ heaps may have reached their “low water marks” at different points in time. However this result still gives a “worst case” indication for all-time minimum free heap.

Return Amount of free bytes in the regions

Parameters

- `caps`: Bitwise OR of `MALLOC_CAP_*` flags indicating the type of memory

`size_t heap_caps_get_largest_free_block (uint32_t caps)`

Get the largest free block of memory able to be allocated with the given capabilities.

Returns the largest value of `s` for which `heap_caps_malloc(s, caps)` will succeed.

Return Size of largest free block in bytes.

Parameters

- `caps`: Bitwise OR of `MALLOC_CAP_*` flags indicating the type of memory

`void heap_caps_get_info (multi_heap_info_t *info, uint32_t caps)`

Get heap info for all regions with the given capabilities.

Calls `multi_heap_info()` on all heaps which share the given capabilities. The information returned is an aggregate across all matching heaps. The meanings of fields are the same as defined for `multi_heap_info_t`, except that `minimum_free_bytes` has the same caveats described in `heap_caps_get_minimum_free_size()`.

Parameters

- `info`: Pointer to a structure which will be filled with relevant heap metadata.
- `caps`: Bitwise OR of `MALLOC_CAP_*` flags indicating the type of memory

`void heap_caps_print_heap_info (uint32_t caps)`

Print a summary of all memory with the given capabilities.

Calls `multi_heap_info` on all heaps which share the given capabilities, and prints a two-line summary for each, then a total summary.

Parameters

- `caps`: Bitwise OR of `MALLOC_CAP_*` flags indicating the type of memory

`bool heap_caps_check_integrity_all (bool print_errors)`

Check integrity of all heap memory in the system.

Calls `multi_heap_check` on all heaps. Optionally print errors if heaps are corrupt.

Calling this function is equivalent to calling `heap_caps_check_integrity` with the `caps` argument set to `MALLOC_CAP_INVALID`.

Return True if all heaps are valid, False if at least one heap is corrupt.

Parameters

- `print_errors`: Print specific errors if heap corruption is found.

bool **heap_caps_check_integrity** (uint32_t *caps*, bool *print_errors*)

Check integrity of all heaps with the given capabilities.

Calls `multi_heap_check` on all heaps which share the given capabilities. Optionally print errors if the heaps are corrupt.

See also `heap_caps_check_integrity_all` to check all heap memory in the system and `heap_caps_check_integrity_addr` to check memory around a single address.

Return True if all heaps are valid, False if at least one heap is corrupt.

Parameters

- *caps*: Bitwise OR of `MALLOC_CAP_*` flags indicating the type of memory
- *print_errors*: Print specific errors if heap corruption is found.

bool **heap_caps_check_integrity_addr** (intptr_t *addr*, bool *print_errors*)

Check integrity of heap memory around a given address.

This function can be used to check the integrity of a single region of heap memory, which contains the given address.

This can be useful if debugging heap integrity for corruption at a known address, as it has a lower overhead than checking all heap regions. Note that if the corrupt address moves around between runs (due to timing or other factors) then this approach won't work and you should call `heap_caps_check_integrity` or `heap_caps_check_integrity_all` instead.

Note The entire heap region around the address is checked, not only the adjacent heap blocks.

Return True if the heap containing the specified address is valid, False if at least one heap is corrupt or the address doesn't belong to a heap region.

Parameters

- *addr*: Address in memory. Check for corruption in region containing this address.
- *print_errors*: Print specific errors if heap corruption is found.

void **heap_caps_malloc_extmem_enable** (size_t *limit*)

Enable `malloc()` in external memory and set limit below which `malloc()` attempts are placed in internal memory.

When external memory is in use, the allocation strategy is to initially try to satisfy smaller allocation requests with internal memory and larger requests with external memory. This sets the limit between the two, as well as generally enabling allocation in external memory.

Parameters

- *limit*: Limit, in bytes.

void ***heap_caps_malloc_prefer** (size_t *size*, size_t *num*, ...)

Allocate a chunk of memory as preference in decreasing order.

Attention The variable parameters are bitwise OR of `MALLOC_CAP_*` flags indicating the type of memory. This API prefers to allocate memory with the first parameter. If failed, allocate memory with the next parameter. It will try in this order until allocating a chunk of memory successfully or fail to allocate memories with any of the parameters.

Return A pointer to the memory allocated on success, NULL on failure

Parameters

- *size*: Size, in bytes, of the amount of memory to allocate
- *num*: Number of variable parameters

void ***heap_caps_realloc_prefer** (void **ptr*, size_t *size*, size_t *num*, ...)

Allocate a chunk of memory as preference in decreasing order.

Return Pointer to a new buffer of size '*size*', or NULL if allocation failed.

Parameters

- *ptr*: Pointer to previously allocated memory, or NULL for a new allocation.
- *size*: Size of the new buffer requested, or 0 to free the buffer.
- *num*: Number of variable parameters

void ***heap_caps_calloc_prefer** (size_t *n*, size_t *size*, size_t *num*, ...)

Allocate a chunk of memory as preference in decreasing order.

Return A pointer to the memory allocated on success, NULL on failure

Parameters

- `n`: Number of continuing chunks of memory to allocate
- `size`: Size, in bytes, of a chunk of memory to allocate
- `num`: Number of variable paramters

void **heap_caps_dump** (uint32_t *caps*)

Dump the full structure of all heaps with matching capabilities.

Prints a large amount of output to serial (because of locking limitations, the output bypasses stdout/stderr). For each (variable sized) block in each matching heap, the following output is printed on a single line:

- Block address (the data buffer returned by malloc is 4 bytes after this if heap debugging is set to Basic, or 8 bytes otherwise).
- Data size (the data size may be larger than the size requested by malloc, either due to heap fragmentation or because of heap debugging level).
- Address of next block in the heap.
- If the block is free, the address of the next free block is also printed.

Parameters

- `caps`: Bitwise OR of MALLOC_CAP_* flags indicating the type of memory

void **heap_caps_dump_all** (void)

Dump the full structure of all heaps.

Covers all registered heaps. Prints a large amount of output to serial.

Output is the same as for heap_caps_dump.

size_t **heap_caps_get_allocated_size** (void **ptr*)

Return the size that a particular pointer was allocated with.

Note The app will crash with an assertion failure if the pointer is not valid.

Return Size of the memory allocated at this block.

Parameters

- `ptr`: Pointer to currently allocated heap memory. Must be a pointer value previously returned by heap_caps_malloc, malloc, calloc, etc. and not yet freed.

Macros

MALLOC_CAP_EXEC

Flags to indicate the capabilities of the various memory systems.

Memory must be able to run executable code

MALLOC_CAP_32BIT

Memory must allow for aligned 32-bit data accesses.

MALLOC_CAP_8BIT

Memory must allow for 8/16/...-bit data accesses.

MALLOC_CAP_DMA

Memory must be able to accessed by DMA.

MALLOC_CAP_PID2

Memory must be mapped to PID2 memory space (PIDs are not currently used)

MALLOC_CAP_PID3

Memory must be mapped to PID3 memory space (PIDs are not currently used)

MALLOC_CAP_PID4

Memory must be mapped to PID4 memory space (PIDs are not currently used)

MALLOC_CAP_PID5

Memory must be mapped to PID5 memory space (PIDs are not currently used)

MALLOC_CAP_PID6

Memory must be mapped to PID6 memory space (PIDs are not currently used)

MALLOC_CAP_PID7

Memory must be mapped to PID7 memory space (PIDs are not currently used)

MALLOC_CAP_SPIRAM

Memory must be in SPI RAM.

MALLOC_CAP_INTERNAL

Memory must be internal; specifically it should not disappear when flash/spiram cache is switched off.

MALLOC_CAP_DEFAULT

Memory can be returned in a non-capability-specific memory allocation (e.g. `malloc()`, `calloc()`) call.

MALLOC_CAP_IRAM_8BIT

Memory must be in IRAM and allow unaligned access.

MALLOC_CAP_RETENTION**MALLOC_CAP_INVALID**

Memory can't be used / list end marker.

Type Definitions

```
typedef void (*esp_alloc_failed_hook_t)(size_t size, uint32_t caps, const char *function_name)
        callback called when a allocation operation fails, if registered
```

Parameters

- `size`: in bytes of failed allocation
- `caps`: capabilities requested of failed allocation
- `function_name`: function which generated the failure

Thread Safety Heap functions are thread safe, meaning they can be called from different tasks simultaneously without any limitations.

It is technically possible to call `malloc`, `free`, and related functions from interrupt handler (ISR) context. However this is not recommended, as heap function calls may delay other interrupts. It is strongly recommended to refactor applications so that any buffers used by an ISR are pre-allocated outside of the ISR. Support for calling heap functions from ISRs may be removed in a future update.

Heap Tracing & Debugging

The following features are documented on the [Heap Memory Debugging](#) page:

- [Heap Information](#) (free space, etc.)
- [Heap Corruption Detection](#)
- [Heap Tracing](#) (memory leak detection, monitoring, etc.)

API Reference - Initialisation**Header File**

- [heap/include/esp_heap_caps_init.h](#)

Functions

void **heap_caps_init** (void)

Initialize the capability-aware heap allocator.

This is called once in the IDF startup code. Do not call it at other times.

void **heap_caps_enable_nonos_stack_heaps** (void)

Enable heap(s) in memory regions where the startup stacks are located.

On startup, the pro/app CPUs have a certain memory region they use as stack, so we cannot do allocations in the regions these stack frames are. When FreeRTOS is completely started, they do not use that memory anymore and heap(s) there can be enabled.

esp_err_t **heap_caps_add_region** (intptr_t *start*, intptr_t *end*)

Add a region of memory to the collection of heaps at runtime.

Most memory regions are defined in `soc_memory_layout.c` for the SoC, and are registered via `heap_caps_init()`. Some regions can't be used immediately and are later enabled via `heap_caps_enable_nonos_stack_heaps()`.

Call this function to add a region of memory to the heap at some later time.

This function does not consider any of the “reserved” regions or other data in `soc_memory_layout`, caller needs to consider this themselves.

All memory within the region specified by `start` & `end` parameters must be otherwise unused.

The capabilities of the newly registered memory will be determined by the start address, as looked up in the regions specified in `soc_memory_layout.c`.

Use `heap_caps_add_region_with_caps()` to register a region with custom capabilities.

Return `ESP_OK` on success, `ESP_ERR_INVALID_ARG` if a parameter is invalid, `ESP_ERR_NOT_FOUND` if the specified start address doesn't reside in a known region, or any error returned by `heap_caps_add_region_with_caps()`.

Parameters

- `start`: Start address of new region.
- `end`: End address of new region.

esp_err_t **heap_caps_add_region_with_caps** (const uint32_t *caps*[], intptr_t *start*, intptr_t *end*)

Add a region of memory to the collection of heaps at runtime, with custom capabilities.

Similar to `heap_caps_add_region()`, only custom memory capabilities are specified by the caller.

Return

- `ESP_OK` on success
- `ESP_ERR_INVALID_ARG` if a parameter is invalid
- `ESP_ERR_NO_MEM` if no memory to register new heap.
- `ESP_ERR_INVALID_SIZE` if the memory region is too small to fit a heap
- `ESP_FAIL` if region overlaps the start and/or end of an existing region

Parameters

- `caps`: Ordered array of capability masks for the new region, in order of priority. Must have length `SOC_MEMORY_TYPE_NO_PRIOS`. Does not need to remain valid after the call returns.
- `start`: Start address of new region.
- `end`: End address of new region.

Implementation Notes

Knowledge about the regions of memory in the chip comes from the “soc” component, which contains memory layout information for the chip, and the different capabilities of each region. Each region's capabilities are prioritised, so that (for example) dedicated DRAM and IRAM regions will be used for allocations ahead of the more versatile D/IRAM regions.

Each contiguous region of memory contains its own memory heap. The heaps are created using the `multi_heap` functionality. `multi_heap` allows any contiguous region of memory to be used as a heap.

The heap capabilities allocator uses knowledge of the memory regions to initialize each individual heap. Allocation functions in the heap capabilities API will find the most appropriate heap for the allocation (based on desired capabilities, available space, and preferences for each region's use) and then calling `multi_heap_malloc()` or `multi_heap_calloc()` for the heap situated in that particular region.

Calling `free()` involves finding the particular heap corresponding to the freed address, and then calling `multi_heap_free()` on that particular `multi_heap` instance.

API Reference - Multi Heap API

(Note: The multi heap API is used internally by the heap capabilities allocator. Most IDF programs will never need to call this API directly.)

Header File

- [heap/include/multi_heap.h](#)

Functions

void ***multi_heap_aligned_alloc** (*multi_heap_handle_t heap*, *size_t size*, *size_t alignment*)
allocate a chunk of memory with specific alignment

Return pointer to the memory allocated, NULL on failure

Parameters

- `heap`: Handle to a registered heap.
- `size`: size in bytes of memory chunk
- `alignment`: how the memory must be aligned

void ***multi_heap_malloc** (*multi_heap_handle_t heap*, *size_t size*)
`malloc()` a buffer in a given heap

Semantics are the same as standard `malloc()`, only the returned buffer will be allocated in the specified heap.

Return Pointer to new memory, or NULL if allocation fails.

Parameters

- `heap`: Handle to a registered heap.
- `size`: Size of desired buffer.

void **multi_heap_aligned_free** (*multi_heap_handle_t heap*, *void *p*)
`free()` a buffer aligned in a given heap.

Note This function is deprecated, consider using `multi_heap_free()` instead

Parameters

- `heap`: Handle to a registered heap.
- `p`: NULL, or a pointer previously returned from `multi_heap_aligned_alloc()` for the same heap.

void **multi_heap_free** (*multi_heap_handle_t heap*, *void *p*)
`free()` a buffer in a given heap.

Semantics are the same as standard `free()`, only the argument `'p'` must be NULL or have been allocated in the specified heap.

Parameters

- `heap`: Handle to a registered heap.
- `p`: NULL, or a pointer previously returned from `multi_heap_malloc()` or `multi_heap_realloc()` for the same heap.

void ***multi_heap_realloc** (*multi_heap_handle_t heap*, *void *p*, *size_t size*)
`realloc()` a buffer in a given heap.

Semantics are the same as standard `realloc()`, only the argument `'p'` must be NULL or have been allocated in the specified heap.

Return New buffer of `'size'` containing contents of `'p'`, or NULL if reallocation failed.

Parameters

- `heap`: Handle to a registered heap.
- `p`: NULL, or a pointer previously returned from `multi_heap_malloc()` or `multi_heap_realloc()` for the same heap.
- `size`: Desired new size for buffer.

`size_t multi_heap_get_allocated_size (multi_heap_handle_t heap, void *p)`

Return the size that a particular pointer was allocated with.

Return Size of the memory allocated at this block. May be more than the original size argument, due to padding and minimum block sizes.

Parameters

- `heap`: Handle to a registered heap.
- `p`: Pointer, must have been previously returned from `multi_heap_malloc()` or `multi_heap_realloc()` for the same heap.

`multi_heap_handle_t multi_heap_register (void *start, size_t size)`

Register a new heap for use.

This function initialises a heap at the specified address, and returns a handle for future heap operations.

There is no equivalent function for deregistering a heap - if all blocks in the heap are free, you can immediately start using the memory for other purposes.

Return Handle of a new heap ready for use, or NULL if the heap region was too small to be initialised.

Parameters

- `start`: Start address of the memory to use for a new heap.
- `size`: Size (in bytes) of the new heap.

`void multi_heap_set_lock (multi_heap_handle_t heap, void *lock)`

Associate a private lock pointer with a heap.

The lock argument is supplied to the `MULTI_HEAP_LOCK()` and `MULTI_HEAP_UNLOCK()` macros, defined in `multi_heap_platform.h`.

The lock in question must be recursive.

When the heap is first registered, the associated lock is NULL.

Parameters

- `heap`: Handle to a registered heap.
- `lock`: Optional pointer to a locking structure to associate with this heap.

`void multi_heap_dump (multi_heap_handle_t heap)`

Dump heap information to stdout.

For debugging purposes, this function dumps information about every block in the heap to stdout.

Parameters

- `heap`: Handle to a registered heap.

`bool multi_heap_check (multi_heap_handle_t heap, bool print_errors)`

Check heap integrity.

Walks the heap and checks all heap data structures are valid. If any errors are detected, an error-specific message can be optionally printed to stderr. Print behaviour can be overridden at compile time by defining `MULTI_CHECK_FAIL_PRINTF` in `multi_heap_platform.h`.

Return true if heap is valid, false otherwise.

Parameters

- `heap`: Handle to a registered heap.
- `print_errors`: If true, errors will be printed to stderr.

`size_t multi_heap_free_size (multi_heap_handle_t heap)`

Return free heap size.

Returns the number of bytes available in the heap.

Equivalent to the `total_free_bytes` member returned by `multi_heap_get_heap_info()`.

Note that the heap may be fragmented, so the actual maximum size for a single `malloc()` may be lower. To know this size, see the `largest_free_block` member returned by `multi_heap_get_heap_info()`.

Return Number of free bytes.

Parameters

- `heap`: Handle to a registered heap.

`size_t multi_heap_minimum_free_size (multi_heap_handle_t heap)`

Return the lifetime minimum free heap size.

Equivalent to the `minimum_free_bytes` member returned by `multi_heap_get_info()`.

Returns the lifetime “low water mark” of possible values returned from `multi_free_heap_size()`, for the specified heap.

Return Number of free bytes.

Parameters

- `heap`: Handle to a registered heap.

void `multi_heap_get_info (multi_heap_handle_t heap, multi_heap_info_t *info)`

Return metadata about a given heap.

Fills a `multi_heap_info_t` structure with information about the specified heap.

Parameters

- `heap`: Handle to a registered heap.
- `info`: Pointer to a structure to fill with heap metadata.

Structures

`struct multi_heap_info_t`

Structure to access heap metadata via `multi_heap_get_info`.

Public Members

`size_t total_free_bytes`

Total free bytes in the heap. Equivalent to `multi_free_heap_size()`.

`size_t total_allocated_bytes`

Total bytes allocated to data in the heap.

`size_t largest_free_block`

Size of largest free block in the heap. This is the largest malloc-able size.

`size_t minimum_free_bytes`

Lifetime minimum free heap size. Equivalent to `multi_minimum_free_heap_size()`.

`size_t allocated_blocks`

Number of (variable size) blocks allocated in the heap.

`size_t free_blocks`

Number of (variable size) free blocks in the heap.

`size_t total_blocks`

Total number of (variable size) blocks in the heap.

Type Definitions

`typedef struct multi_heap_info *multi_heap_handle_t`

Opaque handle to a registered heap.

2.7.13 Heap Memory Debugging

Overview

ESP-IDF integrates tools for requesting [heap information](#), [detecting heap corruption](#), and [tracing memory leaks](#). These can help track down memory-related bugs.

For general information about the heap memory allocator, see the [Heap Memory Allocation](#) page.

Heap Information

To obtain information about the state of the heap:

- `xPortGetFreeHeapSize()` is a FreeRTOS function which returns the number of free bytes in the (data memory) heap. This is equivalent to calling `heap_caps_get_free_size(MALLOC_CAP_8BIT)`.
- `heap_caps_get_free_size()` can also be used to return the current free memory for different memory capabilities.
- `heap_caps_get_largest_free_block()` can be used to return the largest free block in the heap. This is the largest single allocation which is currently possible. Tracking this value and comparing to total free heap allows you to detect heap fragmentation.
- `xPortGetMinimumEverFreeHeapSize()` and the related `heap_caps_get_minimum_free_size()` can be used to track the heap “low water mark” since boot.
- `heap_caps_get_info()` returns a `multi_heap_info_t` structure which contains the information from the above functions, plus some additional heap-specific data (number of allocations, etc.).
- `heap_caps_print_heap_info()` prints a summary to stdout of the information returned by `heap_caps_get_info()`.
- `heap_caps_dump()` and `heap_caps_dump_all()` will output detailed information about the structure of each block in the heap. Note that this can be large amount of output.

Heap Corruption Detection

Heap corruption detection allows you to detect various types of heap memory errors:

- Out of bounds writes & buffer overflow.
- Writes to freed memory.
- Reads from freed or uninitialized memory,

Assertions The heap implementation (`multi_heap.c`, etc.) includes a lot of assertions which will fail if the heap memory is corrupted. To detect heap corruption most effectively, ensure that assertions are enabled in the project configuration menu under `Compiler options` -> `CONFIG_COMPILER_OPTIMIZATION_ASSERTION_LEVEL`.

If a heap integrity assertion fails, a line will be printed like `CORRUPT HEAP: multi_heap.c:225 detected at 0x3ffbb71c`. The memory address which is printed is the address of the heap structure which has corrupt content.

It's also possible to manually check heap integrity by calling `heap_caps_check_integrity_all()` or related functions. This function checks all of requested heap memory for integrity, and can be used even if assertions are disabled. If the integrity check prints an error, it will also contain the address(es) of corrupt heap structures.

Memory Allocation Failed Hook Users can use `heap_caps_register_failed_alloc_callback()` to register a callback that will be invoked every time a allocation operation fails.

Additionally user can enable a generation of a system abort if allocation operation fails by following the steps below: - In the project configuration menu, navigate to `Component config` -> `Heap Memory Debugging` and select `Abort if memory allocation fails` option (see `CONFIG_HEAP_ABORT_WHEN_ALLOCATION_FAILS`).

The example below show how to register a allocation failure callback:

```
#include "esp_heap_caps.h"

void heap_caps_alloc_failed_hook(size_t requested_size, uint32_t caps, const char_
↳*function_name)
{
    printf("%s was called but failed to allocate %d bytes with 0x%X capabilities. \n
↳",function_name, requested_size, caps);
}
```

(continues on next page)

(continued from previous page)

```

void app_main()
{
    ...
    esp_err_t error = heap_caps_register_failed_alloc_callback(heap_caps_alloc_
↪failed_hook);
    ...
    void *ptr = heap_caps_malloc(allocation_size, MALLOC_CAP_DEFAULT);
    ...
}

```

Finding Heap Corruption Memory corruption can be one of the hardest classes of bugs to find and fix, as one area of memory can be corrupted from a totally different place. Some tips:

- A crash with a `CORRUPT HEAP` message will usually include a stack trace, but this stack trace is rarely useful. The crash is the symptom of memory corruption when the system realises the heap is corrupt, but usually the corruption happened elsewhere and earlier in time.
- Increasing the Heap memory debugging *Configuration* level to “Light impact” or “Comprehensive” can give you a more accurate message with the first corrupt memory address.
- Adding regular calls to `heap_caps_check_integrity_all()` or `heap_caps_check_integrity_addr()` in your code will help you pin down the exact time that the corruption happened. You can move these checks around to “close in on” the section of code that corrupted the heap.
- Based on the memory address which is being corrupted, you can use *JTAG debugging* to set a watchpoint on this address and have the CPU halt when it is written to.
- If you don’t have JTAG, but you do know roughly when the corruption happens, then you can set a watchpoint in software just beforehand via `esp_set_watchpoint()`. A fatal exception will occur when the watchpoint triggers. For example `esp_set_watchpoint(0, (void *)addr, 4, ESP_WATCHPOINT_STORE`. Note that watchpoints are per-CPU and are set on the current running CPU only, so if you don’t know which CPU is corrupting memory then you will need to call this function on both CPUs.
- For buffer overflows, *heap tracing* in `HEAP_TRACE_ALL` mode lets you see which callers are allocating which addresses from the heap. See *Heap Tracing To Find Heap Corruption* for more details. If you can find the function which allocates memory with an address immediately before the address which is corrupted, this will probably be the function which overflows the buffer.
- Calling `heap_caps_dump()` or `heap_caps_dump_all()` can give an indication of what heap blocks are surrounding the corrupted region and may have overflowed/underflowed/etc.

Configuration Temporarily increasing the heap corruption detection level can give more detailed information about heap corruption errors.

In the project configuration menu, under `Component config` there is a menu `Heap memory debugging`. The setting `CONFIG_HEAP_CORRUPTION_DETECTION` can be set to one of three levels:

Basic (no poisoning) This is the default level. No special heap corruption features are enabled, but provided assertions are enabled (the default configuration) then a heap corruption error will be printed if any of the heap’s internal data structures appear overwritten or corrupted. This usually indicates a buffer overrun or out of bounds write.

If assertions are enabled, an assertion will also trigger if a double-free occurs (the same memory is freed twice).

Calling `heap_caps_check_integrity()` in Basic mode will check the integrity of all heap structures, and print errors if any appear to be corrupted.

Light Impact At this level, heap memory is additionally “poisoned” with head and tail “canary bytes” before and after each block which is allocated. If an application writes outside the bounds of allocated buffers, the canary bytes will be corrupted and the integrity check will fail.

The head canary word is 0xABBA1234 (3412BAAB in byte order), and the tail canary word is 0xBAAD5678 (7856ADBA in byte order).

“Basic” heap corruption checks can also detect most out of bounds writes, but this setting is more precise as even a single byte overrun can be detected. With Basic heap checks, the number of overrun bytes before a failure is detected will depend on the properties of the heap.

Enabling “Light Impact” checking increases memory usage, each individual allocation will use 9 to 12 additional bytes of memory (depending on alignment).

Each time `free()` is called in Light Impact mode, the head and tail canary bytes of the buffer being freed are checked against the expected values.

When `heap_caps_check_integrity()` is called, all allocated blocks of heap memory have their canary bytes checked against the expected values.

In both cases, the check is that the first 4 bytes of an allocated block (before the buffer returned to the user) should be the word 0xABBA1234. Then the last 4 bytes of the allocated block (after the buffer returned to the user) should be the word 0xBAAD5678.

Different values usually indicate buffer underrun or overrun, respectively.

Comprehensive This level incorporates the “light impact” detection features plus additional checks for uninitialised-access and use-after-free bugs. In this mode, all freshly allocated memory is filled with the pattern 0xCE, and all freed memory is filled with the pattern 0xFE.

Enabling “Comprehensive” detection has a substantial runtime performance impact (as all memory needs to be set to the allocation patterns each time a malloc/free completes, and the memory also needs to be checked each time.) However it allows easier detection of memory corruption bugs which are much more subtle to find otherwise. It is recommended to only enable this mode when debugging, not in production.

Crashes in Comprehensive Mode If an application crashes reading/writing an address related to 0xCECECECE in Comprehensive mode, this indicates it has read uninitialized memory. The application should be changed to either use `calloc()` (which zeroes memory), or initialize the memory before using it. The value 0xCECECECE may also be seen in stack-allocated automatic variables, because in IDF most task stacks are originally allocated from the heap and in C stack memory is uninitialized by default.

If an application crashes and the exception register dump indicates that some addresses or values were 0xFEFEFEFE, this indicates it is reading heap memory after it has been freed (a “use after free bug” .) The application should be changed to not access heap memory after it has been freed.

If a call to `malloc()` or `realloc()` causes a crash because it expected to find the pattern 0xFEFEFEFE in free memory and a different pattern was found, then this indicates the app has a use-after-free bug where it is writing to memory which has already been freed.

Manual Heap Checks in Comprehensive Mode Calls to `heap_caps_check_integrity()` may print errors relating to 0xFEFEFEFE, 0xABBA1234 or 0xBAAD5678. In each case the checker is expecting to find a given pattern, and will error out if this is not found:

- For free heap blocks, the checker expects to find all bytes set to 0xFE. Any other values indicate a use-after-free bug where free memory has been incorrectly overwritten.
- For allocated heap blocks, the behaviour is the same as for *Light Impact* mode. The canary bytes 0xABBA1234 and 0xBAAD5678 are checked at the head and tail of each allocated buffer, and any variation indicates a buffer overrun/underrun.

Heap Task Tracking

Heap Task Tracking can be used to get per task info for heap memory allocation. Application has to specify the heap capabilities for which the heap allocation is to be tracked.

Example code is provided in [system/heap_task_tracking](#)

Heap Tracing

Heap Tracing allows tracing of code which allocates/frees memory. Two tracing modes are supported:

- **Standalone.** In this mode trace data are kept on-board, so the size of gathered information is limited by the buffer assigned for that purposes. Analysis is done by the on-board code. There are a couple of APIs available for accessing and dumping collected info.
- **Host-based.** This mode does not have the limitation of the standalone mode, because trace data are sent to the host over JTAG connection using `app_trace` library. Later on they can be analysed using special tools.

Heap tracing can perform two functions:

- **Leak checking:** find memory which is allocated and never freed.
- **Heap use analysis:** show all functions that are allocating/freeing memory while the trace is running.

How To Diagnose Memory Leaks If you suspect a memory leak, the first step is to figure out which part of the program is leaking memory. Use the `xPortGetFreeHeapSize()`, `heap_caps_get_free_size()`, or *related functions* to track memory use over the life of the application. Try to narrow the leak down to a single function or sequence of functions where free memory always decreases and never recovers.

Standalone Mode Once you've identified the code which you think is leaking:

- In the project configuration menu, navigate to Component settings -> Heap Memory Debugging -> Heap tracing and select Standalone option (see `CONFIG_HEAP_TRACING_DEST`).
- Call the function `heap_trace_init_standalone()` early in the program, to register a buffer which can be used to record the memory trace.
- Call the function `heap_trace_start()` to begin recording all mallocs/frees in the system. Call this immediately before the piece of code which you suspect is leaking memory.
- Call the function `heap_trace_stop()` to stop the trace once the suspect piece of code has finished executing.
- Call the function `heap_trace_dump()` to dump the results of the heap trace.

An example:

```
#include "esp_heap_trace.h"

#define NUM_RECORDS 100
static heap_trace_record_t trace_record[NUM_RECORDS]; // This buffer must be in
↳ internal RAM

...

void app_main()
{
    ...
    ESP_ERROR_CHECK( heap_trace_init_standalone(trace_record, NUM_RECORDS) );
    ...
}

void some_function()
{
    ESP_ERROR_CHECK( heap_trace_start(HEAP_TRACE_LEAKS) );

    do_something_you_suspect_is_leaking();

    ESP_ERROR_CHECK( heap_trace_stop() );
    heap_trace_dump();
    ...
}
```

The output from the heap trace will look something like this:

```

2 allocations trace (100 entry buffer)
32 bytes (@ 0x3ffaf214) allocated CPU 0 ccount 0x2e9b7384 caller
8 bytes (@ 0x3ffaf804) allocated CPU 0 ccount 0x2e9b79c0 caller
40 bytes 'leaked' in trace (2 allocations)
total allocations 2 total frees 0

```

(Above example output is using *IDF Monitor* to automatically decode PC addresses to their source files & line number.)

The first line indicates how many allocation entries are in the buffer, compared to its total size.

In `HEAP_TRACE_LEAKS` mode, for each traced memory allocation which has not already been freed a line is printed with:

- `XX bytes` is number of bytes allocated
- `@ 0x...` is the heap address returned from `malloc/calloc`.
- `CPU x` is the CPU (0 or 1) running when the allocation was made.
- `ccount 0x...` is the `CCOUNT` (CPU cycle count) register value when the allocation was made. Is different for CPU 0 vs CPU 1.

Finally, the total number of ‘leaked’ bytes (bytes allocated but not freed while trace was running) is printed, and the total number of allocations this represents.

A warning will be printed if the trace buffer was not large enough to hold all the allocations which happened. If you see this warning, consider either shortening the tracing period or increasing the number of records in the trace buffer.

Host-Based Mode Once you’ve identified the code which you think is leaking:

- In the project configuration menu, navigate to Component settings -> Heap Memory Debugging -> `CONFIG_HEAP_TRACING_DEST` and select Host-Based.
- In the project configuration menu, navigate to Component settings -> Application Level Tracing -> `CONFIG_APPTRACE_DESTINATION` and select Trace memory.
- In the project configuration menu, navigate to Component settings -> Application Level Tracing -> FreeRTOS SystemView Tracing and enable `CONFIG_APPTRACE_SV_ENABLE`.
- Call the function `heap_trace_init_tohost()` early in the program, to initialize JTAG heap tracing module.
- Call the function `heap_trace_start()` to begin recording all mallocs/frees in the system. Call this immediately before the piece of code which you suspect is leaking memory. In host-based mode argument to this function is ignored and heap tracing module behaves like `HEAP_TRACE_ALL` was passed: all allocations and deallocations are sent to the host.
- Call the function `heap_trace_stop()` to stop the trace once the suspect piece of code has finished executing.

An example:

```

#include "esp_heap_trace.h"

...

void app_main()
{
    ...
    ESP_ERROR_CHECK( heap_trace_init_tohost() );
    ...
}

void some_function()
{
    ESP_ERROR_CHECK( heap_trace_start(HEAP_TRACE_LEAKS) );

    do_something_you_suspect_is_leaking();

    ESP_ERROR_CHECK( heap_trace_stop() );
}

```

(continues on next page)

```

...
}

```

To gather and analyse heap trace do the following on the host:

1. Build the program and download it to the target as described in *Getting Started Guide*.
2. Run OpenOCD (see *JTAG Debugging*).

Note: In order to use this feature you need OpenOCD version *v0.10.0-esp32-20181105* or later.

3. You can use GDB to start and/or stop tracing automatically. To do this you need to prepare special gdbinit file:

```

target remote :3333

mon reset halt
flushregs

tb heap_trace_start
commands
mon esp sysview start file:///tmp/heap.svdat
c
end

tb heap_trace_stop
commands
mon esp sysview stop
end

c

```

Using this file GDB will connect to the target, reset it, and start tracing when program hits breakpoint at `heap_trace_start()`. Trace data will be saved to `/tmp/heap_log.svdat`. Tracing will be stopped when program hits breakpoint at `heap_trace_stop()`.

4. Run GDB using the following command `riscv32-esp-elf-gdb -x gdbinit </path/to/program/elf>`
5. Quit GDB when program stops at `heap_trace_stop()`. Trace data are saved in `/tmp/heap.svdat`
6. Run processing script `$IDF_PATH/tools/esp_app_trace/sysviewtrace_proc.py -p -b </path/to/program/elf> /tmp/heap_log.svdat`

The output from the heap trace will look something like this:

```

Parse trace from '/tmp/heap.svdat'...
Stop parsing trace. (Timeout 0.000000 sec while reading 1 bytes!)
Process events from '['/tmp/heap.svdat']'...
[0.002244575] HEAP: Allocated 1 bytes @ 0x3ffafd8 from task "alloc" on core 0 by:
/home/user/projects/esp/esp-idf/examples/system/sysview_tracing_heap_log/main/
↪sysview_heap_log.c:47
/home/user/projects/esp/esp-idf/components/freertos/port.c:355 (discriminator 1)

[0.002258425] HEAP: Allocated 2 bytes @ 0x3ffaffe0 from task "alloc" on core 0 by:
/home/user/projects/esp/esp-idf/examples/system/sysview_tracing_heap_log/main/
↪sysview_heap_log.c:48
/home/user/projects/esp/esp-idf/components/freertos/port.c:355 (discriminator 1)

[0.002563725] HEAP: Freed bytes @ 0x3ffaffe0 from task "free" on core 0 by:
/home/user/projects/esp/esp-idf/examples/system/sysview_tracing_heap_log/main/
↪sysview_heap_log.c:31 (discriminator 9)
/home/user/projects/esp/esp-idf/components/freertos/port.c:355 (discriminator 1)

```

(continues on next page)

(continued from previous page)

```
[0.002782950] HEAP: Freed bytes @ 0x3ffb40b8 from task "main" on core 0 by:
/home/user/projects/esp/esp-idf/components/freertos/tasks.c:4590
/home/user/projects/esp/esp-idf/components/freertos/tasks.c:4590

[0.002798700] HEAP: Freed bytes @ 0x3ffb50bc from task "main" on core 0 by:
/home/user/projects/esp/esp-idf/components/freertos/tasks.c:4590
/home/user/projects/esp/esp-idf/components/freertos/tasks.c:4590

[0.102436025] HEAP: Allocated 2 bytes @ 0x3ffa0000 from task "alloc" on core 0 by:
/home/user/projects/esp/esp-idf/examples/system/sysview_tracing_heap_log/main/
↪sysview_heap_log.c:47
/home/user/projects/esp/esp-idf/components/freertos/port.c:355 (discriminator 1)

[0.102449800] HEAP: Allocated 4 bytes @ 0x3ffa0008 from task "alloc" on core 0 by:
/home/user/projects/esp/esp-idf/examples/system/sysview_tracing_heap_log/main/
↪sysview_heap_log.c:48
/home/user/projects/esp/esp-idf/components/freertos/port.c:355 (discriminator 1)

[0.102666150] HEAP: Freed bytes @ 0x3ffa0008 from task "free" on core 0 by:
/home/user/projects/esp/esp-idf/examples/system/sysview_tracing_heap_log/main/
↪sysview_heap_log.c:31 (discriminator 9)
/home/user/projects/esp/esp-idf/components/freertos/port.c:355 (discriminator 1)

[0.202436200] HEAP: Allocated 3 bytes @ 0x3ffa0008 from task "alloc" on core 0 by:
/home/user/projects/esp/esp-idf/examples/system/sysview_tracing_heap_log/main/
↪sysview_heap_log.c:47
/home/user/projects/esp/esp-idf/components/freertos/port.c:355 (discriminator 1)

[0.202451725] HEAP: Allocated 6 bytes @ 0x3ffa0010 from task "alloc" on core 0 by:
/home/user/projects/esp/esp-idf/examples/system/sysview_tracing_heap_log/main/
↪sysview_heap_log.c:48
/home/user/projects/esp/esp-idf/components/freertos/port.c:355 (discriminator 1)

[0.202667075] HEAP: Freed bytes @ 0x3ffa0010 from task "free" on core 0 by:
/home/user/projects/esp/esp-idf/examples/system/sysview_tracing_heap_log/main/
↪sysview_heap_log.c:31 (discriminator 9)
/home/user/projects/esp/esp-idf/components/freertos/port.c:355 (discriminator 1)

[0.302436000] HEAP: Allocated 4 bytes @ 0x3ffa0010 from task "alloc" on core 0 by:
/home/user/projects/esp/esp-idf/examples/system/sysview_tracing_heap_log/main/
↪sysview_heap_log.c:47
/home/user/projects/esp/esp-idf/components/freertos/port.c:355 (discriminator 1)

[0.302451475] HEAP: Allocated 8 bytes @ 0x3ffb40b8 from task "alloc" on core 0 by:
/home/user/projects/esp/esp-idf/examples/system/sysview_tracing_heap_log/main/
↪sysview_heap_log.c:48
/home/user/projects/esp/esp-idf/components/freertos/port.c:355 (discriminator 1)

[0.302667500] HEAP: Freed bytes @ 0x3ffb40b8 from task "free" on core 0 by:
/home/user/projects/esp/esp-idf/examples/system/sysview_tracing_heap_log/main/
↪sysview_heap_log.c:31 (discriminator 9)
/home/user/projects/esp/esp-idf/components/freertos/port.c:355 (discriminator 1)

Processing completed.
Processed 1019 events
===== HEAP TRACE REPORT =====
Processed 14 heap events.
[0.002244575] HEAP: Allocated 1 bytes @ 0x3ffa00d8 from task "alloc" on core 0 by:
/home/user/projects/esp/esp-idf/examples/system/sysview_tracing_heap_log/main/
↪sysview_heap_log.c:47
```

(continues on next page)

(continued from previous page)

```

/home/user/projects/esp/esp-idf/components/freertos/port.c:355 (discriminator 1)

[0.102436025] HEAP: Allocated 2 bytes @ 0x3ffaffe0 from task "alloc" on core 0 by:
/home/user/projects/esp/esp-idf/examples/system/sysview_tracing_heap_log/main/
↪sysview_heap_log.c:47
/home/user/projects/esp/esp-idf/components/freertos/port.c:355 (discriminator 1)

[0.202436200] HEAP: Allocated 3 bytes @ 0x3ffaffe8 from task "alloc" on core 0 by:
/home/user/projects/esp/esp-idf/examples/system/sysview_tracing_heap_log/main/
↪sysview_heap_log.c:47
/home/user/projects/esp/esp-idf/components/freertos/port.c:355 (discriminator 1)

[0.302436000] HEAP: Allocated 4 bytes @ 0x3ffafff0 from task "alloc" on core 0 by:
/home/user/projects/esp/esp-idf/examples/system/sysview_tracing_heap_log/main/
↪sysview_heap_log.c:47
/home/user/projects/esp/esp-idf/components/freertos/port.c:355 (discriminator 1)

Found 10 leaked bytes in 4 blocks.
```

Heap Tracing To Find Heap Corruption Heap tracing can also be used to help track down heap corruption. When a region in heap is corrupted, it may be from some other part of the program which allocated memory at a nearby address.

If you have some idea at what time the corruption occurred, enabling heap tracing in `HEAP_TRACE_ALL` mode allows you to record all of the functions which allocated memory, and the addresses of the allocations.

Using heap tracing in this way is very similar to memory leak detection as described above. For memory which is allocated and not freed, the output is the same. However, records will also be shown for memory which has been freed.

Performance Impact Enabling heap tracing in menuconfig increases the code size of your program, and has a very small negative impact on performance of heap allocation/free operations even when heap tracing is not running.

When heap tracing is running, heap allocation/free operations are substantially slower than when heap tracing is stopped. Increasing the depth of stack frames recorded for each allocation (see above) will also increase this performance impact.

False-Positive Memory Leaks Not everything printed by `heap_trace_dump()` is necessarily a memory leak. Among things which may show up here, but are not memory leaks:

- Any memory which is allocated after `heap_trace_start()` but then freed after `heap_trace_stop()` will appear in the leak dump.
- Allocations may be made by other tasks in the system. Depending on the timing of these tasks, it's quite possible this memory is freed after `heap_trace_stop()` is called.
- The first time a task uses `stdio` - for example, when it calls `printf()` - a lock (RTOS mutex semaphore) is allocated by the `libc`. This allocation lasts until the task is deleted.
- Certain uses of `printf()`, such as printing floating point numbers, will allocate some memory from the heap on demand. These allocations last until the task is deleted.
- The Bluetooth, WiFi, and TCP/IP libraries will allocate heap memory buffers to handle incoming or outgoing data. These memory buffers are usually short lived, but some may be shown in the heap leak trace if the data was received/transmitted by the lower levels of the network while the leak trace was running.
- TCP connections will continue to use some memory after they are closed, because of the `TIME_WAIT` state. After the `TIME_WAIT` period has completed, this memory will be freed.

One way to differentiate between “real” and “false positive” memory leaks is to call the suspect code multiple times while tracing is running, and look for patterns (multiple matching allocations) in the heap trace output.

API Reference - Heap Tracing

Header File

- [heap/include/esp_heap_trace.h](#)

Functions

esp_err_t **heap_trace_init_standalone** (*heap_trace_record_t* **record_buffer*, *size_t* *num_records*)

Initialise heap tracing in standalone mode.

This function must be called before any other heap tracing functions.

To disable heap tracing and allow the buffer to be freed, stop tracing and then call `heap_trace_init_standalone(NULL, 0)`;

Return

- `ESP_ERR_NOT_SUPPORTED` Project was compiled without heap tracing enabled in menuconfig.
- `ESP_ERR_INVALID_STATE` Heap tracing is currently in progress.
- `ESP_OK` Heap tracing initialised successfully.

Parameters

- *record_buffer*: Provide a buffer to use for heap trace data. Must remain valid any time heap tracing is enabled, meaning it must be allocated from internal memory not in PSRAM.
- *num_records*: Size of the heap trace buffer, as number of record structures.

esp_err_t **heap_trace_init_tohost** (void)

Initialise heap tracing in host-based mode.

This function must be called before any other heap tracing functions.

Return

- `ESP_ERR_INVALID_STATE` Heap tracing is currently in progress.
- `ESP_OK` Heap tracing initialised successfully.

esp_err_t **heap_trace_start** (*heap_trace_mode_t* *mode*)

Start heap tracing. All heap allocations & frees will be traced, until `heap_trace_stop()` is called.

Note `heap_trace_init_standalone()` must be called to provide a valid buffer, before this function is called.

Note Calling this function while heap tracing is running will reset the heap trace state and continue tracing.

Return

- `ESP_ERR_NOT_SUPPORTED` Project was compiled without heap tracing enabled in menuconfig.
- `ESP_ERR_INVALID_STATE` A non-zero-length buffer has not been set via `heap_trace_init_standalone()`.
- `ESP_OK` Tracing is started.

Parameters

- *mode*: Mode for tracing.
 - `HEAP_TRACE_ALL` means all heap allocations and frees are traced.
 - `HEAP_TRACE_LEAKS` means only suspected memory leaks are traced. (When memory is freed, the record is removed from the trace buffer.)

esp_err_t **heap_trace_stop** (void)

Stop heap tracing.

Return

- `ESP_ERR_NOT_SUPPORTED` Project was compiled without heap tracing enabled in menuconfig.
- `ESP_ERR_INVALID_STATE` Heap tracing was not in progress.
- `ESP_OK` Heap tracing stopped..

esp_err_t **heap_trace_resume** (void)

Resume heap tracing which was previously stopped.

Unlike `heap_trace_start()`, this function does not clear the buffer of any pre-existing trace records.

The heap trace mode is the same as when `heap_trace_start()` was last called (or `HEAP_TRACE_ALL` if `heap_trace_start()` was never called).

Return

- `ESP_ERR_NOT_SUPPORTED` Project was compiled without heap tracing enabled in menuconfig.
- `ESP_ERR_INVALID_STATE` Heap tracing was already started.
- `ESP_OK` Heap tracing resumed.

`size_t heap_trace_get_count` (void)

Return number of records in the heap trace buffer.

It is safe to call this function while heap tracing is running.

`esp_err_t heap_trace_get` (size_t *index*, `heap_trace_record_t` **record*)

Return a raw record from the heap trace buffer.

Note It is safe to call this function while heap tracing is running, however in `HEAP_TRACE_LEAK` mode record indexing may skip entries unless heap tracing is stopped first.

Return

- `ESP_ERR_NOT_SUPPORTED` Project was compiled without heap tracing enabled in menuconfig.
- `ESP_ERR_INVALID_STATE` Heap tracing was not initialised.
- `ESP_ERR_INVALID_ARG` Index is out of bounds for current heap trace record count.
- `ESP_OK` Record returned successfully.

Parameters

- *index*: Index (zero-based) of the record to return.
- [*out*] *record*: Record where the heap trace record will be copied.

void `heap_trace_dump` (void)

Dump heap trace record data to stdout.

Note It is safe to call this function while heap tracing is running, however in `HEAP_TRACE_LEAK` mode the dump may skip entries unless heap tracing is stopped first.

Structures

`struct heap_trace_record_t`

Trace record data type. Stores information about an allocated region of memory.

Public Members

uint32_t `ccount`

CCOUNT of the CPU when the allocation was made. LSB (bit value 1) is the CPU number (0 or 1).

void *`address`

Address which was allocated.

size_t `size`

Size of the allocation.

void *`allocated_by`[`CONFIG_HEAP_TRACING_STACK_DEPTH`]

Call stack of the caller which allocated the memory.

void *`freed_by`[`CONFIG_HEAP_TRACING_STACK_DEPTH`]

Call stack of the caller which freed the memory (all zero if not freed.)

Macros

`CONFIG_HEAP_TRACING_STACK_DEPTH`

Enumerations

enum `heap_trace_mode_t`

Values:

`HEAP_TRACE_ALL`

`HEAP_TRACE_LEAKS`

2.7.14 High Resolution Timer

Overview

Although FreeRTOS provides software timers, these timers have a few limitations:

- Maximum resolution is equal to RTOS tick period
- Timer callbacks are dispatched from a low-priority task

Hardware timers are free from both of the limitations, but often they are less convenient to use. For example, application components may need timer events to fire at certain times in the future, but the hardware timer only contains one “compare” value used for interrupt generation. This means that some facility needs to be built on top of the hardware timer to manage the list of pending events can dispatch the callbacks for these events as corresponding hardware interrupts happen.

`esp_timer` set of APIs provides one-shot and periodic timers, microsecond time resolution, and 64-bit range.

Internally, `esp_timer` uses a 64-bit hardware timer, where the implementation depends on `CONFIG_ESP_TIMER_IMPL`. Available options are:

- SYSTIMER

`ESP_TIMER_TASK`. Timer callbacks are dispatched from a high-priority `esp_timer` task. Because all the callbacks are dispatched from the same task, it is recommended to only do the minimal possible amount of work from the callback itself, posting an event to a lower priority task using a queue instead.

If other tasks with priority higher than `esp_timer` are running, callback dispatching will be delayed until `esp_timer` task has a chance to run. For example, this will happen if a SPI Flash operation is in progress.

Creating and starting a timer, and dispatching the callback takes some time. Therefore there is a lower limit to the timeout value of one-shot `esp_timer`. If `esp_timer_start_once()` is called with a timeout value less than 20us, the callback will be dispatched only after approximately 20us.

Periodic `esp_timer` also imposes a 50us restriction on the minimal timer period. Periodic software timers with period of less than 50us are not practical since they would consume most of the CPU time. Consider using dedicated hardware peripherals or DMA features if you find that a timer with small period is required.

Using `esp_timer` APIs

Single timer is represented by `esp_timer_handle_t` type. Timer has a callback function associated with it. This callback function is called from the `esp_timer` task each time the timer elapses.

- To create a timer, call `esp_timer_create()`.
- To delete the timer when it is no longer needed, call `esp_timer_delete()`.

The timer can be started in one-shot mode or in periodic mode.

- To start the timer in one-shot mode, call `esp_timer_start_once()`, passing the time interval after which the callback should be called. When the callback gets called, the timer is considered to be stopped.
- To start the timer in periodic mode, call `esp_timer_start_periodic()`, passing the period with which the callback should be called. The timer keeps running until `esp_timer_stop()` is called.

Note that the timer must not be running when `esp_timer_start_once()` or `esp_timer_start_periodic()` is called. To restart a running timer, call `esp_timer_stop()` first, then call one of the start functions.

`esp_timer` during the light sleep

During light sleep, the `esp_timer` counter stops and no callback functions are called. Instead, the time is counted by the RTC counter. Upon waking up, the system gets the difference between the counters and calls a function that advances the `esp_timer` counter. Since the counter has been advanced, the system starts calling callbacks that were not called during sleep. The number of callbacks depends on the duration of the sleep and the period of the timers. It can lead to overflow of some queues. This only applies to periodic timers, one-shot timers will be called once.

This behavior can be changed by calling `esp_timer_stop()` before sleeping. In some cases, this can be inconvenient, and instead of the stop function, you can use the `skip_unhandled_events` option during `esp_timer_create()`. When the `skip_unhandled_events` is true, if a periodic timer expires one or more times during light sleep then only one callback is called on wake.

Handling callbacks

`esp_timer` is designed to achieve a high-resolution low latency timer and the ability to handle delayed events. If the timer is late then the callback will be called as soon as possible, it will not be lost. In the worst case, when the timer has not been processed for more than one period (for periodic timers), in this case the callbacks will be called one after the other without waiting for the set period. This can be bad for some applications, and the `skip_unhandled_events` option was introduced to eliminate this behavior. If `skip_unhandled_events` is set then a periodic timer that has expired multiple times without being able to call the callback will still result in only one callback event once processing is possible.

Obtaining Current Time

`esp_timer` also provides a convenience function to obtain the time passed since start-up, with microsecond precision: `esp_timer_get_time()`. This function returns the number of microseconds since `esp_timer` was initialized, which usually happens shortly before `app_main` function is called.

Unlike `gettimeofday` function, values returned by `esp_timer_get_time()`:

- Start from zero after the chip wakes up from deep sleep
- Do not have timezone or DST adjustments applied

Application Example

The following example illustrates usage of `esp_timer` APIs: [system/esp_timer](#).

API Reference

Header File

- [esp_timer/include/esp_timer.h](#)

Functions

`esp_err_t esp_timer_early_init` (void)

Minimal initialization of `esp_timer`.

This function can be called very early in startup process, after this call only `esp_timer_get_time` function can be used.

Note This function is called from startup code. Applications do not need to call this function before using other `esp_timer` APIs.

Return

- `ESP_OK` on success

`esp_err_t esp_timer_init` (void)

Initialize `esp_timer` library.

Note This function is called from startup code. Applications do not need to call this function before using other `esp_timer` APIs. Before calling this function, `esp_timer_early_init` must be called by the startup code.

Return

- `ESP_OK` on success
- `ESP_ERR_NO_MEM` if allocation has failed
- `ESP_ERR_INVALID_STATE` if already initialized

- other errors from interrupt allocator

esp_err_t **esp_timer_deinit** (void)

De-initialize esp_timer library.

Note Normally this function should not be called from applications

Return

- ESP_OK on success
- ESP_ERR_INVALID_STATE if not yet initialized

esp_err_t **esp_timer_create** (const *esp_timer_create_args_t* *create_args, *esp_timer_handle_t* *out_handle)

Create an esp_timer instance.

Note When done using the timer, delete it with esp_timer_delete function.

Return

- ESP_OK on success
- ESP_ERR_INVALID_ARG if some of the create_args are not valid
- ESP_ERR_INVALID_STATE if esp_timer library is not initialized yet
- ESP_ERR_NO_MEM if memory allocation fails

Parameters

- create_args: Pointer to a structure with timer creation arguments. Not saved by the library, can be allocated on the stack.
- [out] out_handle: Output, pointer to esp_timer_handle_t variable which will hold the created timer handle.

esp_err_t **esp_timer_start_once** (*esp_timer_handle_t* timer, uint64_t timeout_us)

Start one-shot timer.

Timer should not be running when this function is called.

Return

- ESP_OK on success
- ESP_ERR_INVALID_ARG if the handle is invalid
- ESP_ERR_INVALID_STATE if the timer is already running

Parameters

- timer: timer handle created using esp_timer_create
- timeout_us: timer timeout, in microseconds relative to the current moment

esp_err_t **esp_timer_start_periodic** (*esp_timer_handle_t* timer, uint64_t period)

Start a periodic timer.

Timer should not be running when this function is called. This function will start the timer which will trigger every 'period' microseconds.

Return

- ESP_OK on success
- ESP_ERR_INVALID_ARG if the handle is invalid
- ESP_ERR_INVALID_STATE if the timer is already running

Parameters

- timer: timer handle created using esp_timer_create
- period: timer period, in microseconds

esp_err_t **esp_timer_stop** (*esp_timer_handle_t* timer)

Stop the timer.

This function stops the timer previously started using esp_timer_start_once or esp_timer_start_periodic.

Return

- ESP_OK on success
- ESP_ERR_INVALID_STATE if the timer is not running

Parameters

- timer: timer handle created using esp_timer_create

esp_err_t **esp_timer_delete** (*esp_timer_handle_t* timer)

Delete an esp_timer instance.

The timer must be stopped before deleting. A one-shot timer which has expired does not need to be stopped.

Return

- ESP_OK on success
- ESP_ERR_INVALID_STATE if the timer is running

Parameters

- timer: timer handle allocated using esp_timer_create

int64_t **esp_timer_get_time** (void)

Get time in microseconds since boot.

Return number of microseconds since underlying timer has been started

int64_t **esp_timer_get_next_alarm** (void)

Get the timestamp when the next timeout is expected to occur.

Return Timestamp of the nearest timer event, in microseconds. The timebase is the same as for the values returned by esp_timer_get_time.

esp_err_t **esp_timer_dump** (FILE *stream)

Dump the list of timers to a stream.

If CONFIG_ESP_TIMER_PROFILING option is enabled, this prints the list of all the existing timers. Otherwise, only the list active timers is printed.

The format is:

name period alarm times_armed times_triggered total_callback_run_time

where:

name —timer name (if CONFIG_ESP_TIMER_PROFILING is defined), or timer pointer
period —period of timer, in microseconds, or 0 for one-shot timer
alarm - time of the next alarm, in microseconds since boot, or 0 if the timer is not started

The following fields are printed if CONFIG_ESP_TIMER_PROFILING is defined:

times_armed —number of times the timer was armed via esp_timer_start_X
times_triggered - number of times the callback was called
total_callback_run_time - total time taken by callback to execute, across all calls

Return

- ESP_OK on success
- ESP_ERR_NO_MEM if can not allocate temporary buffer for the output

Parameters

- stream: stream (such as stdout) to dump the information to

bool **esp_timer_is_active** (*esp_timer_handle_t* timer)

Returns status of a timer, active or not.

This function is used to identify if the timer is still active or not.

Return

- 1 if timer is still active
- 0 if timer is not active.

Parameters

- timer: timer handle created using esp_timer_create

Structures

struct **esp_timer_create_args_t**

Timer configuration passed to esp_timer_create.

Public Members

esp_timer_cb_t callback

Function to call when timer expires.

void ***arg**

Argument to pass to the callback.

esp_timer_dispatch_t dispatch_method

Call the callback from task or from ISR.

const char ***name**

Timer name, used in `esp_timer_dump` function.

bool **skip_unhandled_events**

Skip unhandled events for periodic timers.

Type Definitions

typedef struct esp_timer ***esp_timer_handle_t**

Opaque type representing a single `esp_timer`.

typedef void (***esp_timer_cb_t**)(void *arg)

Timer callback function type.

Parameters

- `arg`: pointer to opaque user-specific data

Enumerations

enum **esp_timer_dispatch_t**

Method for dispatching timer callback.

Values:

ESP_TIMER_TASK

Callback is called from timer task.

2.7.15 Call function with external stack

Overview

A given function can be executed with a user allocated stack space which is independent of current task stack, this mechanism can be used to save stack space wasted by tasks which call a common function with intensive stack usage such as `printf`. The given function can be called inside the shared stack space which is a callback function deferred by calling `esp_execute_shared_stack_function()`, passing that function as parameter

Usage

`esp_execute_shared_stack_function()` takes four arguments, a mutex object allocated by the caller, which is used to protect if the same function shares its allocated stack, a pointer to the top of stack used to that function, the size in bytes of stack and, a pointer to a user function where the shared stack space will reside, after calling the function, the user defined function will be deferred as a callback where functions can be called using the user allocated space without taking space from current task stack.

The usage may look like the code below:

```
void external_stack_function(void)
{
    printf("Executing this printf from external stack! \n");
}
```

(continues on next page)

(continued from previous page)

```

//Let's suppose we want to call printf using a separated stack space
//allowing app to reduce its stack size.
void app_main()
{
    //Allocate a stack buffer, from heap or as a static form:
    portSTACK_TYPE *shared_stack = malloc(8192 * sizeof(portSTACK_TYPE));
    assert(shared_stack != NULL);

    //Allocate a mutex to protect its usage:
    SemaphoreHandle_t printf_lock = xSemaphoreCreateMutex();
    assert(printf_lock != NULL);

    //Call the desired function using the macro helper:
    esp_execute_shared_stack_function(printf_lock,
                                     shared_stack,
                                     8192,
                                     external_stack_function);

    vSemaphoreDelete(printf_lock);
    free(shared_stack);
}

```

API Reference

Header File

- `esp_common/include/esp_expression_with_stack.h`

Functions

void **esp_execute_shared_stack_function** (*SemaphoreHandle_t lock*, void **stack*, size_t *stack_size*, *shared_stack_function function*)

Calls user defined shared stack space function.

Note if either lock, stack or stack size is invalid, the expression will be called using the current stack.

Parameters

- *lock*: Mutex object to protect in case of shared stack
- *stack*: Pointer to user allocated stack
- *stack_size*: Size of current stack in bytes
- *function*: pointer to the shared stack function to be executed

Macros

ESP_EXECUTE_EXPRESSION_WITH_STACK (*lock*, *stack*, *stack_size*, *expression*)

Type Definitions

typedef void (**shared_stack_function*) (void)

2.7.16 Interrupt allocation

Overview

The ESP32-C3 has one core, with 31 interrupts. Each interrupt has a programmable priority level.

Because there are more interrupt sources than interrupts, sometimes it makes sense to share an interrupt in multiple drivers. The `esp_intr_alloc()` abstraction exists to hide all these implementation details.

A driver can allocate an interrupt for a certain peripheral by calling `esp_intr_alloc()` (or `esp_intr_alloc_intrstatus()`). It can use the flags passed to this function to set the type of interrupt allocated, specifying a specific level or trigger method. The interrupt allocation code will then find an applicable interrupt, use the interrupt mux to hook it up to the peripheral, and install the given interrupt handler and ISR to it.

This code has two different types of interrupts it handles differently: Shared interrupts and non-shared interrupts. The simplest of the two are non-shared interrupts: a separate interrupt is allocated per `esp_intr_alloc` call and this interrupt is solely used for the peripheral attached to it, with only one ISR that will get called. Shared interrupts can have multiple peripherals triggering it, with multiple ISRs being called when one of the peripherals attached signals an interrupt. Thus, ISRs that are intended for shared interrupts should check the interrupt status of the peripheral they service in order to see if any action is required.

Non-shared interrupts can be either level- or edge-triggered. Shared interrupts can only be level interrupts (because of the chance of missed interrupts when edge interrupts are used.) (The logic behind this: DevA and DevB share an int. DevB signals an int. Int line goes high. ISR handler calls code for DevA -> does nothing. ISR handler calls code for DevB, but while doing that, DevA signals an int. ISR DevB is done, clears int for DevB, exits interrupt code. Now an interrupt for DevA is still pending, but because the int line never went low (DevA kept it high even when the int for DevB was cleared) the interrupt is never serviced.)

IRAM-Safe Interrupt Handlers

The `ESP_INTR_FLAG_IRAM` flag registers an interrupt handler that always runs from IRAM (and reads all its data from DRAM), and therefore does not need to be disabled during flash erase and write operations.

This is useful for interrupts which need a guaranteed minimum execution latency, as flash write and erase operations can be slow (erases can take tens or hundreds of milliseconds to complete).

It can also be useful to keep an interrupt handler in IRAM if it is called very frequently, to avoid flash cache misses.

Refer to the [SPI flash API documentation](#) for more details.

Multiple Handlers Sharing A Source

Several handlers can be assigned to a same source, given that all handlers are allocated using the `ESP_INTR_FLAG_SHARED` flag. They'll be all allocated to the interrupt, which the source is attached to, and called sequentially when the source is active. The handlers can be disabled and freed individually. The source is attached to the interrupt (enabled), if one or more handlers are enabled, otherwise detached. A handler will never be called when disabled, while **its source may still be triggered** if any one of its handler enabled.

Sources attached to non-shared interrupt do not support this feature.

Though the framework support this feature, you have to use it *very carefully*. There usually exist 2 ways to stop a interrupt from being triggered: *disable the source* or *mask peripheral interrupt status*. IDF only handles the enabling and disabling of the source itself, leaving status and mask bits to be handled by users. **Status bits should always be masked before the handler responsible for it is disabled, or the status should be handled in other enabled interrupt properly**. You may leave some status bits unhandled if you just disable one of all the handlers without masking the status bits, which causes the interrupt to trigger infinitely resulting in a system crash.

API Reference

Header File

- [esp_system/include/esp_intr_alloc.h](#)

Functions

`esp_err_t esp_intr_mark_shared(int intrno, int cpu, bool is_in_iram)`

Mark an interrupt as a shared interrupt.

This will mark a certain interrupt on the specified CPU as an interrupt that can be used to hook shared interrupt handlers to.

Return ESP_ERR_INVALID_ARG if cpu or intno is invalid ESP_OK otherwise

Parameters

- `intno`: The number of the interrupt (0-31)
- `cpu`: CPU on which the interrupt should be marked as shared (0 or 1)
- `is_in_iram`: Shared interrupt is for handlers that reside in IRAM and the int can be left enabled while the flash cache is disabled.

esp_err_t **esp_intr_reserve** (int *intno*, int *cpu*)

Reserve an interrupt to be used outside of this framework.

This will mark a certain interrupt on the specified CPU as reserved, not to be allocated for any reason.

Return ESP_ERR_INVALID_ARG if cpu or intno is invalid ESP_OK otherwise

Parameters

- `intno`: The number of the interrupt (0-31)
- `cpu`: CPU on which the interrupt should be marked as shared (0 or 1)

esp_err_t **esp_intr_alloc** (int *source*, int *flags*, *intr_handler_t* *handler*, void **arg*, *intr_handle_t* **ret_handle*)

Allocate an interrupt with the given parameters.

This finds an interrupt that matches the restrictions as given in the flags parameter, maps the given interrupt source to it and hooks up the given interrupt handler (with optional argument) as well. If needed, it can return a handle for the interrupt as well.

The interrupt will always be allocated on the core that runs this function.

If ESP_INTR_FLAG_IRAM flag is used, and handler address is not in IRAM or RTC_FAST_MEM, then ESP_ERR_INVALID_ARG is returned.

Return ESP_ERR_INVALID_ARG if the combination of arguments is invalid. ESP_ERR_NOT_FOUND

No free interrupt found with the specified flags ESP_OK otherwise

Parameters

- `source`: The interrupt source. One of the ETS_*_INTR_SOURCE interrupt mux sources, as defined in soc/soc.h, or one of the internal ETS_INTERNAL_*_INTR_SOURCE sources as defined in this header.
- `flags`: An ORred mask of the ESP_INTR_FLAG_* defines. These restrict the choice of interrupts that this routine can choose from. If this value is 0, it will default to allocating a non-shared interrupt of level 1, 2 or 3. If this is ESP_INTR_FLAG_SHARED, it will allocate a shared interrupt of level 1. Setting ESP_INTR_FLAG_INTRDISABLED will return from this function with the interrupt disabled.
- `handler`: The interrupt handler. Must be NULL when an interrupt of level >3 is requested, because these types of interrupts aren't C-callable.
- `arg`: Optional argument for passed to the interrupt handler
- `ret_handle`: Pointer to an *intr_handle_t* to store a handle that can later be used to request details or free the interrupt. Can be NULL if no handle is required.

esp_err_t **esp_intr_alloc_intrstatus** (int *source*, int *flags*, uint32_t *intrstatusreg*, uint32_t *intrstatusmask*, *intr_handler_t* *handler*, void **arg*, *intr_handle_t* **ret_handle*)

Allocate an interrupt with the given parameters.

This essentially does the same as `esp_intr_alloc`, but allows specifying a register and mask combo. For shared interrupts, the handler is only called if a read from the specified register, ANDed with the mask, returns non-zero. By passing an interrupt status register address and a fitting mask, this can be used to accelerate interrupt handling in the case a shared interrupt is triggered; by checking the interrupt statuses first, the code can decide which ISRs can be skipped

Return ESP_ERR_INVALID_ARG if the combination of arguments is invalid. ESP_ERR_NOT_FOUND

No free interrupt found with the specified flags ESP_OK otherwise

Parameters

- `source`: The interrupt source. One of the ETS_*_INTR_SOURCE interrupt mux sources, as defined in soc/soc.h, or one of the internal ETS_INTERNAL_*_INTR_SOURCE sources as defined in this header.

- `flags`: An ORred mask of the `ESP_INTR_FLAG_*` defines. These restrict the choice of interrupts that this routine can choose from. If this value is 0, it will default to allocating a non-shared interrupt of level 1, 2 or 3. If this is `ESP_INTR_FLAG_SHARED`, it will allocate a shared interrupt of level 1. Setting `ESP_INTR_FLAG_INTRDISABLED` will return from this function with the interrupt disabled.
- `intrstatusreg`: The address of an interrupt status register
- `intrstatusmask`: A mask. If a read of address `intrstatusreg` has any of the bits that are 1 in the mask set, the ISR will be called. If not, it will be skipped.
- `handler`: The interrupt handler. Must be NULL when an interrupt of level >3 is requested, because these types of interrupts aren't C-callable.
- `arg`: Optional argument for passed to the interrupt handler
- `ret_handle`: Pointer to an `intr_handle_t` to store a handle that can later be used to request details or free the interrupt. Can be NULL if no handle is required.

esp_err_t `esp_intr_free` (*intr_handle_t* handle)

Disable and free an interrupt.

Use an interrupt handle to disable the interrupt and release the resources associated with it. If the current core is not the core that registered this interrupt, this routine will be assigned to the core that allocated this interrupt, blocking and waiting until the resource is successfully released.

Note When the handler shares its source with other handlers, the interrupt status bits it's responsible for should be managed properly before freeing it. see `esp_intr_disable` for more details. Please do not call this function in `esp_ipc_call_blocking`.

Return `ESP_ERR_INVALID_ARG` the handle is NULL `ESP_FAIL` failed to release this handle `ESP_OK` otherwise

Parameters

- `handle`: The handle, as obtained by `esp_intr_alloc` or `esp_intr_alloc_intrstatus`

int `esp_intr_get_cpu` (*intr_handle_t* handle)

Get CPU number an interrupt is tied to.

Return The core number where the interrupt is allocated

Parameters

- `handle`: The handle, as obtained by `esp_intr_alloc` or `esp_intr_alloc_intrstatus`

int `esp_intr_get_intno` (*intr_handle_t* handle)

Get the allocated interrupt for a certain handle.

Return The interrupt number

Parameters

- `handle`: The handle, as obtained by `esp_intr_alloc` or `esp_intr_alloc_intrstatus`

esp_err_t `esp_intr_disable` (*intr_handle_t* handle)

Disable the interrupt associated with the handle.

Note

1. For local interrupts (`ESP_INTERNAL_*` sources), this function has to be called on the CPU the interrupt is allocated on. Other interrupts have no such restriction.
2. When several handlers sharing a same interrupt source, interrupt status bits, which are handled in the handler to be disabled, should be masked before the disabling, or handled in other enabled interrupts properly. Miss of interrupt status handling will cause infinite interrupt calls and finally system crash.

Return `ESP_ERR_INVALID_ARG` if the combination of arguments is invalid. `ESP_OK` otherwise

Parameters

- `handle`: The handle, as obtained by `esp_intr_alloc` or `esp_intr_alloc_intrstatus`

esp_err_t `esp_intr_enable` (*intr_handle_t* handle)

Enable the interrupt associated with the handle.

Note For local interrupts (`ESP_INTERNAL_*` sources), this function has to be called on the CPU the interrupt is allocated on. Other interrupts have no such restriction.

Return `ESP_ERR_INVALID_ARG` if the combination of arguments is invalid. `ESP_OK` otherwise

Parameters

- `handle`: The handle, as obtained by `esp_intr_alloc` or `esp_intr_alloc_intrstatus`

esp_err_t **esp_intr_set_in_iram** (*intr_handle_t* handle, bool *is_in_iram*)

Set the “in IRAM” status of the handler.

Note Does not work on shared interrupts.

Return ESP_ERR_INVALID_ARG if the combination of arguments is invalid. ESP_OK otherwise

Parameters

- *handle*: The handle, as obtained by `esp_intr_alloc` or `esp_intr_alloc_intrstatus`
- *is_in_iram*: Whether the handler associated with this handle resides in IRAM. Handlers residing in IRAM can be called when cache is disabled.

void **esp_intr_noniram_disable** (void)

Disable interrupts that aren't specifically marked as running from IRAM.

void **esp_intr_noniram_enable** (void)

Re-enable interrupts disabled by `esp_intr_noniram_disable`.

void **esp_intr_enable_source** (int *inum*)

enable the interrupt source based on its number

Parameters

- *inum*: interrupt number from 0 to 31

void **esp_intr_disable_source** (int *inum*)

disable the interrupt source based on its number

Parameters

- *inum*: interrupt number from 0 to 31

static int **esp_intr_flags_to_level** (int *flags*)

Get the lowest interrupt level from the flags.

Parameters

- *flags*: The same flags that pass to `esp_intr_alloc_intrstatus` API

Macros

ESP_INTR_FLAG_LEVEL1

Interrupt allocation flags.

These flags can be used to specify which interrupt qualities the code calling `esp_intr_alloc*` needs. Accept a Level 1 interrupt vector (lowest priority)

ESP_INTR_FLAG_LEVEL2

Accept a Level 2 interrupt vector.

ESP_INTR_FLAG_LEVEL3

Accept a Level 3 interrupt vector.

ESP_INTR_FLAG_LEVEL4

Accept a Level 4 interrupt vector.

ESP_INTR_FLAG_LEVEL5

Accept a Level 5 interrupt vector.

ESP_INTR_FLAG_LEVEL6

Accept a Level 6 interrupt vector.

ESP_INTR_FLAG_NMI

Accept a Level 7 interrupt vector (highest priority)

ESP_INTR_FLAG_SHARED

Interrupt can be shared between ISRs.

ESP_INTR_FLAG_EDGE

Edge-triggered interrupt.

ESP_INTR_FLAG_IRAM

ISR can be called if cache is disabled.

ESP_INTR_FLAG_INTRDISABLED

Return with this interrupt disabled.

ESP_INTR_FLAG_LOWMED

Low and medium prio interrupts. These can be handled in C.

ESP_INTR_FLAG_HIGH

High level interrupts. Need to be handled in assembly.

ESP_INTR_FLAG_LEVELMASK

Mask for all level flags.

ETS_INTERNAL_TIMER0_INTR_SOURCE

Platform timer 0 interrupt source.

The `esp_intr_alloc*` functions can allocate an int for all `ETS_*_INTR_SOURCE` interrupt sources that are routed through the interrupt mux. Apart from these sources, each core also has some internal sources that do not pass through the interrupt mux. To allocate an interrupt for these sources, pass these pseudo-sources to the functions.

ETS_INTERNAL_TIMER1_INTR_SOURCE

Platform timer 1 interrupt source.

ETS_INTERNAL_TIMER2_INTR_SOURCE

Platform timer 2 interrupt source.

ETS_INTERNAL_SW0_INTR_SOURCE

Software int source 1.

ETS_INTERNAL_SW1_INTR_SOURCE

Software int source 2.

ETS_INTERNAL_PROFILING_INTR_SOURCE

Int source for profiling.

ETS_INTERNAL_INTR_SOURCE_OFF

Provides SystemView with positive IRQ IDs, otherwise scheduler events are not shown properly

ESP_INTR_ENABLE (inum)

Enable interrupt by interrupt number

ESP_INTR_DISABLE (inum)

Disable interrupt by interrupt number

Type Definitions

```
typedef void (*intr_handler_t)(void *arg)
```

Function prototype for interrupt handler function

```
typedef struct intr_handle_data_t intr_handle_data_t
```

Interrupt handler associated data structure

```
typedef intr_handle_data_t*intr_handle_t
```

Handle to an interrupt handler

2.7.17 Logging library

Overview

The logging library provides two ways for setting log verbosity:

- **At compile time:** in menuconfig, set the verbosity level using the option `CONFIG_LOG_DEFAULT_LEVEL`. All logging statements for verbosity levels higher than `CONFIG_LOG_DEFAULT_LEVEL` will be removed by the preprocessor.

- **At runtime:** all logs for verbosity levels lower than `CONFIG_LOG_DEFAULT_LEVEL` are enabled by default. The function `esp_log_level_set()` can be used to set a logging level on a per module basis. Modules are identified by their tags, which are human-readable ASCII zero-terminated strings.

There are the following verbosity levels:

- Error (lowest)
- Warning
- Info
- Debug
- Verbose (highest)

Note: The function `esp_log_level_set()` cannot set logging levels higher than specified by `CONFIG_LOG_DEFAULT_LEVEL`. To increase log level for a specific file at compile time, use the macro `LOG_LOCAL_LEVEL` (see the details below).

How to use this library

In each C file that uses logging functionality, define the TAG variable as shown below:

```
static const char* TAG = "MyModule";
```

Then use one of logging macros to produce output, e.g:

```
ESP_LOGW(TAG, "Baud rate error %.1f%%. Requested: %d baud, actual: %d baud", error_
↪ * 100, baud_req, baud_real);
```

Several macros are available for different verbosity levels:

- `ESP_LOGE` - error (lowest)
- `ESP_LOGW` - warning
- `ESP_LOGI` - info
- `ESP_LOGD` - debug
- `ESP_LOGV` - verbose (highest)

Additionally, there are `ESP_EARLY_LOGx` versions for each of these macros, e.g., `ESP_EARLY_LOGE`. These versions have to be used explicitly in the early startup code only, before heap allocator and syscalls have been initialized. Normal `ESP_LOGx` macros can also be used while compiling the bootloader, but they will fall back to the same implementation as `ESP_EARLY_LOGx` macros.

To override default verbosity level at file or component scope, define the `LOG_LOCAL_LEVEL` macro.

At file scope, define it before including `esp_log.h`, e.g.:

```
#define LOG_LOCAL_LEVEL ESP_LOG_VERBOSE
#include "esp_log.h"
```

At component scope, define it in the component makefile:

```
CFLAGS += -D LOG_LOCAL_LEVEL=ESP_LOG_DEBUG
```

To configure logging output per module at runtime, add calls to the function `esp_log_level_set()` as follows:

```
esp_log_level_set("", ESP_LOG_ERROR); // set all components to ERROR level
esp_log_level_set("wifi", ESP_LOG_WARN); // enable WARN logs from WiFi stack
esp_log_level_set("dhcpc", ESP_LOG_INFO); // enable INFO logs from DHCP client
```

Logging to Host via JTAG By default, the logging library uses the `vprintf`-like function to write formatted output to the dedicated UART. By calling a simple API, all log output may be routed to JTAG instead, making logging several times faster. For details, please refer to Section [Logging to Host](#).

Application Example

The logging library is commonly used by most esp-idf components and examples. For demonstration of log functionality, check ESP-IDF's [examples](#) directory. The most relevant examples that deal with logging are the following:

- [system/ota](#)
- [storage/sd_card](#)
- [protocols/https_request](#)

API Reference

Header File

- [log/include/esp_log.h](#)

Functions

void **esp_log_level_set** (**const** char *tag, *esp_log_level_t* level)

Set log level for given tag.

If logging for given component has already been enabled, changes previous setting.

Note that this function can not raise log level above the level set using CONFIG_LOG_DEFAULT_LEVEL setting in menuconfig.

To raise log level above the default one for a given file, define LOG_LOCAL_LEVEL to one of the ESP_LOG_* values, before including esp_log.h in this file.

Parameters

- tag: Tag of the log entries to enable. Must be a non-NULL zero terminated string. Value "*" resets log level for all tags to the given value.
- level: Selects log level to enable. Only logs at this and lower verbosity levels will be shown.

vprintf_like_t **esp_log_set_vprintf** (*vprintf_like_t* func)

Set function used to output log entries.

By default, log output goes to UART0. This function can be used to redirect log output to some other destination, such as file or network. Returns the original log handler, which may be necessary to return output to the previous destination.

Return func old Function used for output.

Parameters

- func: new Function used for output. Must have same signature as vprintf.

uint32_t **esp_log_timestamp** (void)

Function which returns timestamp to be used in log output.

This function is used in expansion of ESP_LOGx macros. In the 2nd stage bootloader, and at early application startup stage this function uses CPU cycle counter as time source. Later when FreeRTOS scheduler start running, it switches to FreeRTOS tick count.

For now, we ignore millisecond counter overflow.

Return timestamp, in milliseconds

char ***esp_log_system_timestamp** (void)

Function which returns system timestamp to be used in log output.

This function is used in expansion of ESP_LOGx macros to print the system time as "HH:MM:SS.sss". The system time is initialized to 0 on startup, this can be set to the correct time with an SNTP sync, or manually with standard POSIX time functions.

Currently this will not get used in logging from binary blobs (i.e WiFi & Bluetooth libraries), these will still print the RTOS tick time.

Return timestamp, in "HH:MM:SS.sss"

`uint32_t esp_log_early_timestamp` (void)

Function which returns timestamp to be used in log output.

This function uses HW cycle counter and does not depend on OS, so it can be safely used after application crash.

Return timestamp, in milliseconds

void `esp_log_write` (`esp_log_level_t level`, `const char *tag`, `const char *format`, ...)

Write message into the log.

This function is not intended to be used directly. Instead, use one of `ESP_LOGE`, `ESP_LOGW`, `ESP_LOGI`, `ESP_LOGD`, `ESP_LOGV` macros.

This function or these macros should not be used from an interrupt.

void `esp_log_writew` (`esp_log_level_t level`, `const char *tag`, `const char *format`, `va_list args`)

Write message into the log, `va_list` variant.

This function is provided to ease integration toward other logging framework, so that `esp_log` can be used as a log sink.

See `esp_log_write()`

Macros

ESP_LOG_BUFFER_HEX_LEVEL (`tag`, `buffer`, `buff_len`, `level`)

Log a buffer of hex bytes at specified level, separated into 16 bytes each line.

Parameters

- `tag`: description tag
- `buffer`: Pointer to the buffer array
- `buff_len`: length of buffer in bytes
- `level`: level of the log

ESP_LOG_BUFFER_CHAR_LEVEL (`tag`, `buffer`, `buff_len`, `level`)

Log a buffer of characters at specified level, separated into 16 bytes each line. Buffer should contain only printable characters.

Parameters

- `tag`: description tag
- `buffer`: Pointer to the buffer array
- `buff_len`: length of buffer in bytes
- `level`: level of the log

ESP_LOG_BUFFER_HEXDUMP (`tag`, `buffer`, `buff_len`, `level`)

Dump a buffer to the log at specified level.

The dump log shows just like the one below:

```

W (195) log_example: 0x3ffb4280  45 53 50 33 32 20 69 73  20 67 72 65 61 74_
↪2c 20 |ESP32 is great, |
W (195) log_example: 0x3ffb4290  77 6f 72 6b 69 6e 67 20  61 6c 6f 6e 67 20_
↪77 69 |working along wi|
W (205) log_example: 0x3ffb42a0  74 68 20 74 68 65 20 49  44 46 2e 00      _
↪      |th the IDF..|

```

It is highly recommend to use terminals with over 102 text width.

Parameters

- `tag`: description tag
- `buffer`: Pointer to the buffer array
- `buff_len`: length of buffer in bytes
- `level`: level of the log

ESP_LOG_BUFFER_HEX (`tag`, `buffer`, `buff_len`)

Log a buffer of hex bytes at Info level.

See `esp_log_buffer_hex_level`

Parameters

- `tag`: description tag
- `buffer`: Pointer to the buffer array
- `buff_len`: length of buffer in bytes

ESP_LOG_BUFFER_CHAR (`tag`, `buffer`, `buff_len`)

Log a buffer of characters at Info level. Buffer should contain only printable characters.

See `esp_log_buffer_char_level`

Parameters

- `tag`: description tag
- `buffer`: Pointer to the buffer array
- `buff_len`: length of buffer in bytes

ESP_EARLY_LOGE (`tag`, `format`, ...)

macro to output logs in startup code, before heap allocator and syscalls have been initialized. log at `ESP_LOG_ERROR` level.

See `printf,ESP_LOGE`

ESP_EARLY_LOGW (`tag`, `format`, ...)

macro to output logs in startup code at `ESP_LOG_WARN` level.

See `ESP_EARLY_LOGE,ESP_LOGE,printf`

ESP_EARLY_LOGI (`tag`, `format`, ...)

macro to output logs in startup code at `ESP_LOG_INFO` level.

See `ESP_EARLY_LOGE,ESP_LOGE,printf`

ESP_EARLY_LOGD (`tag`, `format`, ...)

macro to output logs in startup code at `ESP_LOG_DEBUG` level.

See `ESP_EARLY_LOGE,ESP_LOGE,printf`

ESP_EARLY_LOGV (`tag`, `format`, ...)

macro to output logs in startup code at `ESP_LOG_VERBOSE` level.

See `ESP_EARLY_LOGE,ESP_LOGE,printf`

ESP_LOG_EARLY_IMPL (`tag`, `format`, `log_level`, `log_tag_letter`, ...)

ESP_LOGE (`tag`, `format`, ...)

ESP_LOGW (`tag`, `format`, ...)

ESP_LOGI (`tag`, `format`, ...)

ESP_LOGD (`tag`, `format`, ...)

ESP_LOGV (`tag`, `format`, ...)

ESP_LOG_LEVEL (`level`, `tag`, `format`, ...)

runtime macro to output logs at a specified level.

See `printf`

Parameters

- `tag`: tag of the log, which can be used to change the log level by `esp_log_level_set` at runtime.
- `level`: level of the output log.
- `format`: format of the output log. see `printf`
- `...`: variables to be replaced into the log. see `printf`

ESP_LOG_LEVEL_LOCAL (`level`, `tag`, `format`, ...)

runtime macro to output logs at a specified level. Also check the level with `LOG_LOCAL_LEVEL`.

See `printf,ESP_LOG_LEVEL`

ESP_DRAM_LOGE (tag, format, ...)

Macro to output logs when the cache is disabled. log at ESP_LOG_ERROR level.

Similar to ESP_EARLY_LOGE, the log level cannot be changed by esp_log_level_set.

Usage: ESP_DRAM_LOGE(DRAM_STR("my_tag"), "format", or ESP_DRAM_LOGE(TAG, "format", ...)\, where TAG is a char* that points to a str in the DRAM.

Note Placing log strings in DRAM reduces available DRAM, so only use when absolutely essential.

See esp_rom_printf,ESP_LOGE

ESP_DRAM_LOGW (tag, format, ...)

macro to output logs when the cache is disabled at ESP_LOG_WARN level.

See ESP_DRAM_LOGW,ESP_LOGW, esp_rom_printf

ESP_DRAM_LOGI (tag, format, ...)

macro to output logs when the cache is disabled at ESP_LOG_INFO level.

See ESP_DRAM_LOGI,ESP_LOGI, esp_rom_printf

ESP_DRAM_LOGD (tag, format, ...)

macro to output logs when the cache is disabled at ESP_LOG_DEBUG level.

See ESP_DRAM_LOGD,ESP_LOGD, esp_rom_printf

ESP_DRAM_LOGV (tag, format, ...)

macro to output logs when the cache is disabled at ESP_LOG_VERBOSE level.

See ESP_DRAM_LOGV,ESP_LOGV, esp_rom_printf

Type Definitions

```
typedef int (*vprintf_like_t) (const char *, va_list)
```

Enumerations

```
enum esp_log_level_t
```

Log level.

Values:

ESP_LOG_NONE

No log output

ESP_LOG_ERROR

Critical errors, software module can not recover on its own

ESP_LOG_WARN

Error conditions from which recovery measures have been taken

ESP_LOG_INFO

Information messages which describe normal flow of events

ESP_LOG_DEBUG

Extra information which is not necessary for normal use (values, pointers, sizes, etc).

ESP_LOG_VERBOSE

Bigger chunks of debugging information, or frequent messages which can potentially flood the output.

2.7.18 Miscellaneous System APIs

Software reset

To perform software reset of the chip, `esp_restart()` function is provided. When the function is called, execution of the program will stop, both CPUs will be reset, application will be loaded by the bootloader and started again.

Additionally, `esp_register_shutdown_handler()` function is provided to register a routine which needs to be called prior to restart (when done by `esp_restart()`). This is similar to the functionality of `atexit` POSIX function.

Reset reason

ESP-IDF application can be started or restarted due to a variety of reasons. To get the last reset reason, call `esp_reset_reason()` function. See description of `esp_reset_reason_t` for the list of possible reset reasons.

Heap memory

Two heap memory related functions are provided:

- `esp_get_free_heap_size()` returns the current size of free heap memory
- `esp_get_minimum_free_heap_size()` returns the minimum size of free heap memory that was available during program execution.

Note that ESP-IDF supports multiple heaps with different capabilities. Functions mentioned in this section return the size of heap memory which can be allocated using `malloc` family of functions. For further information about heap memory see [Heap Memory Allocation](#).

Random number generation

ESP32-C3 contains a hardware random number generator, values from it can be obtained using `esp_random()`.

When Wi-Fi or Bluetooth are enabled, numbers returned by hardware random number generator (RNG) can be considered true random numbers. Without Wi-Fi or Bluetooth enabled, hardware RNG is a pseudo-random number generator. At startup, ESP-IDF bootloader seeds the hardware RNG with entropy, but care must be taken when reading random values between the start of `app_main` and initialization of Wi-Fi or Bluetooth drivers.

MAC Address

These APIs allow querying and customizing MAC addresses for different network interfaces that supported (e.g. Wi-Fi, Bluetooth, Ethernet).

In ESP-IDF these addresses are calculated from *Base MAC address*. Base MAC address can be initialized with factory-programmed value from internal eFuse, or with a user-defined value. In addition to setting the base MAC address, applications can specify the way in which MAC addresses are allocated to devices. See [Number of universally administered MAC address](#) section for more details.

Base MAC address To fetch MAC address for a specific interface (e.g. Wi-Fi, Bluetooth, Ethernet), you can simply use `esp_read_mac()` function.

By default, this function takes the eFuse value burned at a pre-defined block (e.g. BLK0 for ESP32, BLK1 for ESP32-S2) as the base MAC address. Per-interface MAC addresses will be calculated according to the table above.

Applications who want to customize base MAC address (not the one provided by Espressif) should call `esp_base_mac_addr_set()` before `esp_read_mac()`. The customized MAC address can be stored in any supported storage device (e.g. Flash, NVS, etc).

Note that, calls to `esp_base_mac_addr_set()` should take place before the initialization of network stack, for example, early in `app_main`.

Custom MAC address in eFuse To facilitate the usage of custom MAC addresses, ESP-IDF provides `esp_efuse_mac_get_custom()` function, which loads MAC address from internal pre-defined eFuse block (e.g. BLK3 for ESP32). This function assumes that custom MAC address is stored in the following format:

Field	# of bits	Range of bits	Notes
Version	8	191:184	0: invalid, others — valid
Reserved	128	183:56	
MAC address	48	55:8	
MAC address CRC	8	7:0	CRC-8-CCITT, polynomial 0x07

Once MAC address has been obtained using `esp_efuse_mac_get_custom()`, call `esp_base_mac_addr_set()` to set this MAC address as base MAC address.

Number of universally administered MAC address Several MAC addresses (universally administered by IEEE) are uniquely assigned to the networking interfaces (Wi-Fi/BT/Ethernet). The final octet of each universally administered MAC address increases by one. Only the first one of them (which is called base MAC address) is stored in eFuse or external storage, the others are generated from it. Here, ‘generate’ means adding 0, 1, 2 and 3 (respectively) to the final octet of the base MAC address.

If the universally administered MAC addresses are not enough for all of the networking interfaces, locally administered MAC addresses which are derived from universally administered MAC addresses are assigned to the rest of networking interfaces.

See [this article](#) for the definition of local and universally administered MAC addresses.

Chip version

`esp_chip_info()` function fills `esp_chip_info_t` structure with information about the chip. This includes the chip revision, number of CPU cores, and a bit mask of features enabled in the chip.

SDK version

`esp_get_idf_version()` returns a string describing the IDF version which was used to compile the application. This is the same value as the one available through `IDF_VER` variable of the build system. The version string generally has the format of `git describe` output.

To get the version at build time, additional version macros are provided. They can be used to enable or disable parts of the program depending on IDF version.

- `ESP_IDF_VERSION_MAJOR`, `ESP_IDF_VERSION_MINOR`, `ESP_IDF_VERSION_PATCH` are defined to integers representing major, minor, and patch version.
- `ESP_IDF_VERSION_VAL` and `ESP_IDF_VERSION` can be used when implementing version checks:

```
#include "esp_idf_version.h"

#if ESP_IDF_VERSION >= ESP_IDF_VERSION_VAL(4, 0, 0)
    // enable functionality present in IDF v4.0
#endif
```

App version

Application version is stored in `esp_app_desc_t` structure. It is located in DROM sector and has a fixed offset from the beginning of the binary file. The structure is located after `esp_image_header_t` and `esp_image_segment_header_t` structures. The field version has string type and max length 32 chars.

To set version in your project manually you need to set `PROJECT_VER` variable in your project CMakeLists.txt/Makefile:

- In application CMakeLists.txt put `set (PROJECT_VER "0.1.0.1")` before including `project.cmake`.

(For legacy GNU Make build system: in application Makefile put `PROJECT_VER = "0.1.0.1"` before including `project.mk`.)

If `CONFIG_APP_PROJECT_VER_FROM_CONFIG` option is set, the value of `CONFIG_APP_PROJECT_VER` will be used. Otherwise if `PROJECT_VER` variable is not set in the project then it will be retrieved from either `$(PROJECT_PATH)/version.txt` file (if present) else using git command `git describe`. If neither is available then `PROJECT_VER` will be set to "1". Application can make use of this by calling `esp_ota_get_app_description()` or `esp_ota_get_partition_description()` functions.

API Reference

Header File

- `esp_system/include/esp_system.h`

Functions

`esp_err_t esp_register_shutdown_handler (shutdown_handler_t handle)`

Register shutdown handler.

This function allows you to register a handler that gets invoked before the application is restarted using `esp_restart` function.

Return

- `ESP_OK` on success
- `ESP_ERR_INVALID_STATE` if the handler has already been registered
- `ESP_ERR_NO_MEM` if no more shutdown handler slots are available

Parameters

- `handle`: function to execute on restart

`esp_err_t esp_unregister_shutdown_handler (shutdown_handler_t handle)`

Unregister shutdown handler.

This function allows you to unregister a handler which was previously registered using `esp_register_shutdown_handler` function.

- `ESP_OK` on success
- `ESP_ERR_INVALID_STATE` if the given handler hasn't been registered before

void `esp_restart` (void)

Restart PRO and APP CPUs.

This function can be called both from PRO and APP CPUs. After successful restart, CPU reset reason will be `SW_CPU_RESET`. Peripherals (except for WiFi, BT, UART0, SPI1, and legacy timers) are not reset. This function does not return.

`esp_reset_reason_t esp_reset_reason` (void)

Get reason of last reset.

Return See description of `esp_reset_reason_t` for explanation of each value.

uint32_t `esp_get_free_heap_size` (void)

Get the size of available heap.

Note that the returned value may be larger than the maximum contiguous block which can be allocated.

Return Available heap size, in bytes.

uint32_t `esp_get_free_internal_heap_size` (void)

Get the size of available internal heap.

Note that the returned value may be larger than the maximum contiguous block which can be allocated.

Return Available internal heap size, in bytes.

`uint32_t esp_get_minimum_free_heap_size` (void)

Get the minimum heap that has ever been available.

Return Minimum free heap ever available

`uint32_t esp_random` (void)

Get one random 32-bit word from hardware RNG.

The hardware RNG is fully functional whenever an RF subsystem is running (ie Bluetooth or WiFi is enabled). For random values, call this function after WiFi or Bluetooth are started.

If the RF subsystem is not used by the program, the function `bootloader_random_enable()` can be called to enable an entropy source. `bootloader_random_disable()` must be called before RF subsystem or I2S peripheral are used. See these functions' documentation for more details.

Any time the app is running without an RF subsystem (or `bootloader_random`) enabled, RNG hardware should be considered a PRNG. A very small amount of entropy is available due to pre-seeding while the IDF bootloader is running, but this should not be relied upon for any use.

Return Random value between 0 and `UINT32_MAX`

void `esp_fill_random` (void **buf*, size_t *len*)

Fill a buffer with random bytes from hardware RNG.

Note This function has the same restrictions regarding available entropy as `esp_random()`

Parameters

- *buf*: Pointer to buffer to fill with random numbers.
- *len*: Length of buffer in bytes

`esp_err_t esp_base_mac_addr_set` (const uint8_t **mac*)

Set base MAC address with the MAC address which is stored in BLK3 of EFUSE or external storage e.g. flash and EEPROM.

Base MAC address is used to generate the MAC addresses used by the networking interfaces. If using base MAC address stored in BLK3 of EFUSE or external storage, call this API to set base MAC address with the MAC address which is stored in BLK3 of EFUSE or external storage before initializing WiFi/BT/Ethernet.

Note Base MAC must be a unicast MAC (least significant bit of first byte must be zero).

Note If not using a valid OUI, set the "locally administered" bit (bit value 0x02 in the first byte) to avoid collisions.

Return `ESP_OK` on success `ESP_ERR_INVALID_ARG` If *mac* is NULL or is not a unicast MAC

Parameters

- *mac*: base MAC address, length: 6 bytes.

`esp_err_t esp_base_mac_addr_get` (uint8_t **mac*)

Return base MAC address which is set using `esp_base_mac_addr_set`.

Return `ESP_OK` on success `ESP_ERR_INVALID_MAC` base MAC address has not been set

Parameters

- *mac*: base MAC address, length: 6 bytes.

`esp_err_t esp_efuse_mac_get_custom` (uint8_t **mac*)

Return base MAC address which was previously written to BLK3 of EFUSE.

Base MAC address is used to generate the MAC addresses used by the networking interfaces. This API returns the custom base MAC address which was previously written to BLK3 of EFUSE. Writing this EFUSE allows setting of a different (non-Espressif) base MAC address. It is also possible to store a custom base MAC address elsewhere, see `esp_base_mac_addr_set()` for details.

Return `ESP_OK` on success `ESP_ERR_INVALID_VERSION` An invalid MAC version field was read from BLK3 of EFUSE `ESP_ERR_INVALID_CRC` An invalid MAC CRC was read from BLK3 of EFUSE

Parameters

- *mac*: base MAC address, length: 6 bytes.

`esp_err_t esp_efuse_mac_get_default` (uint8_t **mac*)

Return base MAC address which is factory-programmed by Espressif in BLK0 of EFUSE.

Return ESP_OK on success

Parameters

- `mac`: base MAC address, length: 6 bytes.

`esp_err_t esp_read_mac` (`uint8_t *mac`, `esp_mac_type_t type`)

Read base MAC address and set MAC address of the interface.

This function first get base MAC address using `esp_base_mac_addr_get` or reads base MAC address from BLK0 of EFUSE. Then set the MAC address of the interface including wifi station, wifi softap, bluetooth and ethernet.

Return ESP_OK on success

Parameters

- `mac`: MAC address of the interface, length: 6 bytes.
- `type`: type of MAC address, 0:wifi station, 1:wifi softap, 2:bluetooth, 3:ethernet.

`esp_err_t esp_derive_local_mac` (`uint8_t *local_mac`, `const uint8_t *universal_mac`)

Derive local MAC address from universal MAC address.

This function derives a local MAC address from an universal MAC address. A definition of local vs universal MAC address can be found on Wikipedia <>. In ESP32, universal MAC address is generated from base MAC address in EFUSE or other external storage. Local MAC address is derived from the universal MAC address.

Return ESP_OK on success

Parameters

- `local_mac`: Derived local MAC address, length: 6 bytes.
- `universal_mac`: Source universal MAC address, length: 6 bytes.

void `esp_system_abort` (`const char *details`)

Trigger a software abort.

Parameters

- `details`: Details that will be displayed during panic handling.

void `esp_chip_info` (`esp_chip_info_t *out_info`)

Fill an `esp_chip_info_t` structure with information about the chip.

Parameters

- [out] `out_info`: structure to be filled

Structures

`struct esp_chip_info_t`

The structure represents information about the chip.

Public Members

`esp_chip_model_t model`

chip model, one of `esp_chip_model_t`

`uint32_t features`

bit mask of `CHIP_FEATURE_x` feature flags

`uint8_t cores`

number of CPU cores

`uint8_t revision`

chip revision number

Macros

`CHIP_FEATURE_EMB_FLASH`

Chip has embedded flash memory.

CHIP_FEATURE_WIFI_BGN

Chip has 2.4GHz WiFi.

CHIP_FEATURE_BLE

Chip has Bluetooth LE.

CHIP_FEATURE_BT

Chip has Bluetooth Classic.

Type Definitions**typedef** void (***shutdown_handler_t**) (void)

Shutdown handler type

Enumerations**enum esp_mac_type_t***Values:***ESP_MAC_WIFI_STA****ESP_MAC_WIFI_SOFTAP****ESP_MAC_BT****ESP_MAC_ETH****enum esp_reset_reason_t**

Reset reasons.

*Values:***ESP_RST_UNKNOWN**

Reset reason can not be determined.

ESP_RST_POWERON

Reset due to power-on event.

ESP_RST_EXT

Reset by external pin (not applicable for ESP32)

ESP_RST_SW

Software reset via esp_restart.

ESP_RST_PANIC

Software reset due to exception/panic.

ESP_RST_INT_WDT

Reset (software or hardware) due to interrupt watchdog.

ESP_RST_TASK_WDT

Reset due to task watchdog.

ESP_RST_WDT

Reset due to other watchdogs.

ESP_RST_DEEPSLEEP

Reset after exiting deep sleep mode.

ESP_RST_BROWNOUT

Brownout reset (software or hardware)

ESP_RST_SDIO

Reset over SDIO.

enum esp_chip_model_t

Chip models.

Values:

```
CHIP_ESP32 = 1
    ESP32.

CHIP_ESP32S2 = 2
    ESP32-S2.

CHIP_ESP32S3 = 4
    ESP32-S3.

CHIP_ESP32C3 = 5
    ESP32-C3.
```

Header File

- [esp_common/include/esp_idf_version.h](#)

Functions

const char *esp_get_idf_version (void)
Return full IDF version string, same as ‘git describe’ output.

Note If you are printing the ESP-IDF version in a log file or other information, this function provides more information than using the numerical version macros. For example, numerical version macros don’t differentiate between development, pre-release and release versions, but the output of this function does.

Return constant string from IDF_VER

Macros

ESP_IDF_VERSION_MAJOR
Major version number (X.x.x)

ESP_IDF_VERSION_MINOR
Minor version number (x.X.x)

ESP_IDF_VERSION_PATCH
Patch version number (x.x.X)

ESP_IDF_VERSION_VAL (major, minor, patch)
Macro to convert IDF version number into an integer

To be used in comparisons, such as `ESP_IDF_VERSION >= ESP_IDF_VERSION_VAL(4, 0, 0)`

ESP_IDF_VERSION
Current IDF version, as an integer

To be used in comparisons, such as `ESP_IDF_VERSION >= ESP_IDF_VERSION_VAL(4, 0, 0)`

2.7.19 Over The Air Updates (OTA)

OTA Process Overview

The OTA update mechanism allows a device to update itself based on data received while the normal firmware is running (for example, over Wi-Fi or Bluetooth.)

OTA requires configuring the *Partition Table* of the device with at least two “OTA app slot” partitions (i.e. *ota_0* and *ota_1*) and an “OTA Data Partition” .

The OTA operation functions write a new app firmware image to whichever OTA app slot that is currently not selected for booting. Once the image is verified, the OTA Data partition is updated to specify that this image should be used for the next boot.

OTA Data Partition

An OTA data partition (type `data`, subtype `ota`) must be included in the *Partition Table* of any project which uses the OTA functions.

For factory boot settings, the OTA data partition should contain no data (all bytes erased to 0xFF). In this case the esp-idf software bootloader will boot the factory app if it is present in the the partition table. If no factory app is included in the partition table, the first available OTA slot (usually `ota_0`) is booted.

After the first OTA update, the OTA data partition is updated to specify which OTA app slot partition should be booted next.

The OTA data partition is two flash sectors (0x2000 bytes) in size, to prevent problems if there is a power failure while it is being written. Sectors are independently erased and written with matching data, and if they disagree a counter field is used to determine which sector was written more recently.

App rollback

The main purpose of the application rollback is to keep the device working after the update. This feature allows you to roll back to the previous working application in case a new application has critical errors. When the rollback process is enabled and an OTA update provides a new version of the app, one of three things can happen:

- The application works fine, `esp_ota_mark_app_valid_cancel_rollback()` marks the running application with the state `ESP_OTA_IMG_VALID`. There are no restrictions on booting this application.
- The application has critical errors and further work is not possible, a rollback to the previous application is required, `esp_ota_mark_app_invalid_rollback_and_reboot()` marks the running application with the state `ESP_OTA_IMG_INVALID` and reset. This application will not be selected by the bootloader for boot and will boot the previously working application.
- If the `CONFIG_BOOTLOADER_APP_ROLLBACK_ENABLE` option is set, and a reset occurs without calling either function then the application is rolled back.

Note: The state is not written to the binary image of the application it is written to the `otadata` partition. The partition contains a `ota_seq` counter which is a pointer to the slot (`ota_0`, `ota_1`, ...) from which the application will be selected for boot.

App OTA State States control the process of selecting a boot app:

States	Restriction of selecting a boot app in bootloader
<code>ESP_OTA_IMG_VALID</code>	No restriction. Will be selected.
<code>ESP_OTA_IMG_UNDEFINED</code>	No restriction. Will be selected.
<code>ESP_OTA_IMG_INVALID</code>	Will not be selected.
<code>ESP_OTA_IMG_ABORTED</code>	Will not be selected.
<code>ESP_OTA_IMG_NEW</code>	If <code>CONFIG_BOOTLOADER_APP_ROLLBACK_ENABLE</code> option is set it will be selected only once. In bootloader the state immediately changes to <code>ESP_OTA_IMG_PENDING_VERIFY</code> .
<code>ESP_OTA_IMG_PENDING_VERIFY</code>	If <code>CONFIG_BOOTLOADER_APP_ROLLBACK_ENABLE</code> option is set it will not be selected and the state will change to <code>ESP_OTA_IMG_ABORTED</code> .

If `CONFIG_BOOTLOADER_APP_ROLLBACK_ENABLE` option is not enabled (by default), then the use of the following functions `esp_ota_mark_app_valid_cancel_rollback()` and `esp_ota_mark_app_invalid_rollback_and_reboot()` are optional, and `ESP_OTA_IMG_NEW` and `ESP_OTA_IMG_PENDING_VERIFY` states are not used.

An option in Kconfig `CONFIG_BOOTLOADER_APP_ROLLBACK_ENABLE` allows you to track the first boot of a new application. In this case, the application must confirm its operability by calling `esp_ota_mark_app_valid_cancel_rollback()` function, otherwise the application will be rolled back upon reboot. It allows you to control the operability of the application during the boot phase. Thus, a new application has only one attempt to boot successfully.

Rollback Process The description of the rollback process when `CONFIG_BOOTLOADER_APP_ROLLBACK_ENABLE` option is enabled:

- The new application successfully downloaded and `esp_ota_set_boot_partition()` function makes this partition bootable and sets the state `ESP_OTA_IMG_NEW`. This state means that the application is new and should be monitored for its first boot.
- Reboot `esp_restart()`.
- The bootloader checks for the `ESP_OTA_IMG_PENDING_VERIFY` state if it is set, then it will be written to `ESP_OTA_IMG_ABORTED`.
- The bootloader selects a new application to boot so that the state is not set as `ESP_OTA_IMG_INVALID` or `ESP_OTA_IMG_ABORTED`.
- The bootloader checks the selected application for `ESP_OTA_IMG_NEW` state if it is set, then it will be written to `ESP_OTA_IMG_PENDING_VERIFY`. This state means that the application requires confirmation of its operability, if this does not happen and a reboot occurs, this state will be overwritten to `ESP_OTA_IMG_ABORTED` (see above) and this application will no longer be able to start, i.e. there will be a rollback to the previous work application.
- A new application has started and should make a self-test.
- If the self-test has completed successfully, then you must call the function `esp_ota_mark_app_valid_cancel_rollback()` because the application is awaiting confirmation of operability (`ESP_OTA_IMG_PENDING_VERIFY` state).
- If the self-test fails then call `esp_ota_mark_app_invalid_rollback_and_reboot()` function to roll back to the previous working application, while the invalid application is set `ESP_OTA_IMG_INVALID` state.
- If the application has not been confirmed, the state remains `ESP_OTA_IMG_PENDING_VERIFY`, and the next boot it will be changed to `ESP_OTA_IMG_ABORTED`. That will prevent re-boot of this application. There will be a rollback to the previous working application.

Unexpected Reset If a power loss or an unexpected crash occurs at the time of the first boot of a new application, it will roll back the application.

Recommendation: Perform the self-test procedure as quickly as possible, to prevent rollback due to power loss.

Only OTA partitions can be rolled back. Factory partition is not rolled back.

Booting invalid/aborted apps Booting an application which was previously set to `ESP_OTA_IMG_INVALID` or `ESP_OTA_IMG_ABORTED` is possible:

- Get the last invalid application partition `esp_ota_get_last_invalid_partition()`.
- Pass the received partition to `esp_ota_set_boot_partition()`, this will update the `otadata`.
- Restart `esp_restart()`. The bootloader will boot the specified application.

To determine if self-tests should be run during startup of an application, call the `esp_ota_get_state_partition()` function. If result is `ESP_OTA_IMG_PENDING_VERIFY` then self-testing and subsequent confirmation of operability is required.

Where the states are set A brief description of where the states are set:

- `ESP_OTA_IMG_VALID` state is set by `esp_ota_mark_app_valid_cancel_rollback()` function.
- `ESP_OTA_IMG_UNDEFINED` state is set by `esp_ota_set_boot_partition()` function if `CONFIG_BOOTLOADER_APP_ROLLBACK_ENABLE` option is not enabled.
- `ESP_OTA_IMG_NEW` state is set by `esp_ota_set_boot_partition()` function if `CONFIG_BOOTLOADER_APP_ROLLBACK_ENABLE` option is enabled.
- `ESP_OTA_IMG_INVALID` state is set by `esp_ota_mark_app_invalid_rollback_and_reboot()` function.
- `ESP_OTA_IMG_ABORTED` state is set if there was no confirmation of the application operability and occurs reboots (if `CONFIG_BOOTLOADER_APP_ROLLBACK_ENABLE` option is enabled).

- `ESP_OTA_IMG_PENDING_VERIFY` state is set in a bootloader if `CONFIG_BOOTLOADER_APP_ROLLBACK_ENABLE` option is enabled and selected app has `ESP_OTA_IMG_NEW` state.

Anti-rollback

Anti-rollback prevents rollback to application with security version lower than one programmed in eFuse of chip.

This function works if set `CONFIG_BOOTLOADER_APP_ANTI_ROLLBACK` option. In the bootloader, when selecting a bootable application, an additional security version check is added which is on the chip and in the application image. The version in the bootable firmware must be greater than or equal to the version in the chip.

`CONFIG_BOOTLOADER_APP_ANTI_ROLLBACK` and `CONFIG_BOOTLOADER_APP_ROLLBACK_ENABLE` options are used together. In this case, rollback is possible only on the security version which is equal or higher than the version in the chip.

A typical anti-rollback scheme is

- New firmware released with the elimination of vulnerabilities with the previous version of security.
- After the developer makes sure that this firmware is working. He can increase the security version and release a new firmware.
- Download new application.
- To make it bootable, run the function `esp_ota_set_boot_partition()`. If the security version of the new application is smaller than the version in the chip, the new application will be erased. Update to new firmware is not possible.
- Reboot.
- In the bootloader, an application with a security version greater than or equal to the version in the chip will be selected. If otadata is in the initial state, and one firmware was loaded via a serial channel, whose secure version is higher than the chip, then the secure version of efuse will be immediately updated in the bootloader.
- New application booted. Then the application should perform diagnostics of the operation and if it is completed successfully, you should call `esp_ota_mark_app_valid_cancel_rollback()` function to mark the running application with the `ESP_OTA_IMG_VALID` state and update the secure version on chip. Note that if was called `esp_ota_mark_app_invalid_rollback_and_reboot()` function a rollback may not happen due to the device may not have any bootable apps then it will return `ESP_ERR_OTA_ROLLBACK_FAILED` error and stay in the `ESP_OTA_IMG_PENDING_VERIFY` state.
- The next update of app is possible if a running app is in the `ESP_OTA_IMG_VALID` state.

Recommendation:

If you want to avoid the download/erase overhead in case of the app from the server has security version lower than running app, you have to get `new_app_info.secure_version` from the first package of an image and compare it with the secure version of efuse. Use `esp_efuse_check_secure_version(new_app_info.secure_version)` function if it is true then continue downloading otherwise abort.

```

....
bool image_header_was_checked = false;
while (1) {
    int data_read = esp_http_client_read(client, ota_write_data, BUFFSIZE);
    ...
    if (data_read > 0) {
        if (image_header_was_checked == false) {
            esp_app_desc_t new_app_info;
            if (data_read > sizeof(esp_image_header_t) + sizeof(esp_image_segment_
↪header_t) + sizeof(esp_app_desc_t)) {
                // check current version with downloading
                if (esp_efuse_check_secure_version(new_app_info.secure_version) ==
↪false) {
                    ESP_LOGE(TAG, "This a new app can not be downloaded due to a
↪secure version is lower than stored in efuse.");
                    http_cleanup(client);

```

(continues on next page)

(continued from previous page)

```

        task_fatal_error();
    }

    image_header_was_checked = true;

    esp_ota_begin(update_partition, OTA_SIZE_UNKNOWN, &update_handle);
}
}
esp_ota_write( update_handle, (const void *)ota_write_data, data_read);
}
...

```

Restrictions:

- The number of bits in the `secure_version` field is limited to 32 bits. This means that only 32 times you can do an anti-rollback. You can reduce the length of this efuse field use [CONFIG_BOOTLOADER_APP_SEC_VER_SIZE_EFUSE_FIELD](#) option.
- Anti-rollback only works if the encoding scheme for efuse is set to NONE.
- The partition table should not have a factory partition, only two of the app.

`security_version`:

- In application image it is stored in `esp_app_desc` structure. The number is set [CONFIG_BOOTLOADER_APP_SECURE_VERSION](#).

Secure OTA Updates Without Secure boot

The verification of signed OTA updates can be performed even without enabling hardware secure boot. This can be achieved by setting [CONFIG_SECURE_SIGNED_APPS_NO_SECURE_BOOT](#) and [CONFIG_SECURE_SIGNED_ON_UPDATE_NO_SECURE_BOOT](#)

OTA Tool (otatool.py)

The component `app_update` provides a tool [otatool.py](#) for performing OTA partition-related operations on a target device. The following operations can be performed using the tool:

- read contents of otadata partition (`read_otadata`)
- erase otadata partition, effectively resetting device to factory app (`erase_otadata`)
- switch OTA partitions (`switch_ota_partition`)
- erasing OTA partition (`erase_ota_partition`)
- write to OTA partition (`write_ota_partition`)
- read contents of OTA partition (`read_ota_partition`)

The tool can either be imported and used from another Python script or invoked from shell script for users wanting to perform operation programmatically. This is facilitated by the tool's Python API and command-line interface, respectively.

Python API Before anything else, make sure that the `otatool` module is imported.

```

import sys
import os

idf_path = os.environ["IDF_PATH"] # get value of IDF_PATH from environment
otatool_dir = os.path.join(idf_path, "components", "app_update") # otatool.py_
↳ lives in $IDF_PATH/components/app_update

sys.path.append(otatool_dir) # this enables Python to find otatool module
from otatool import * # import all names inside otatool module

```

The starting point for using the tool's Python API to do is create a *OtatoolTarget* object:

```
# Create a partool.py target device connected on serial port /dev/ttyUSB1
target = OtatoolTarget("/dev/ttyUSB1")
```

The created object can now be used to perform operations on the target device:

```
# Erase otadata, resetting the device to factory app
target.erase_otadata()

# Erase contents of OTA app slot 0
target.erase_ota_partition(0)

# Switch boot partition to that of app slot 1
target.switch_ota_partition(1)

# Read OTA partition 'ota_3' and save contents to a file named 'ota_3.bin'
target.read_ota_partition("ota_3", "ota_3.bin")
```

The OTA partition to operate on is specified using either the app slot number or the partition name.

More information on the Python API is available in the docstrings for the tool.

Command-line Interface The command-line interface of *otatool.py* has the following structure:

```
otatool.py [command-args] [subcommand] [subcommand-args]

- command-args - these are arguments that are needed for executing the main_
↳command (partool.py), mostly pertaining to the target device
- subcommand - this is the operation to be performed
- subcommand-args - these are arguments that are specific to the chosen operation
```

```
# Erase otadata, resetting the device to factory app
otatool.py --port "/dev/ttyUSB1" erase_otadata

# Erase contents of OTA app slot 0
otatool.py --port "/dev/ttyUSB1" erase_ota_partition --slot 0

# Switch boot partition to that of app slot 1
otatool.py --port "/dev/ttyUSB1" switch_ota_partition --slot 1

# Read OTA partition 'ota_3' and save contents to a file named 'ota_3.bin'
otatool.py --port "/dev/ttyUSB1" read_ota_partition --name=ota_3 --output=ota_3.bin
```

More information can be obtained by specifying *-help* as argument:

```
# Display possible subcommands and show main command argument descriptions
otatool.py --help

# Show descriptions for specific subcommand arguments
otatool.py [subcommand] --help
```

See also

- [Partition Table documentation](#)
- [Lower-Level SPI Flash/Partition API](#)
- [ESP HTTPS OTA](#)

Application Example

End-to-end example of OTA firmware update workflow: [system/ota](#).

API Reference

Header File

- [app_update/include/esp_ota_ops.h](#)

Functions

const *esp_app_desc_t* ***esp_ota_get_app_description** (void)

Return *esp_app_desc* structure. This structure includes app version.

Return description for running app.

Return Pointer to *esp_app_desc* structure.

int **esp_ota_get_app_elf_sha256** (char **dst*, size_t *size*)

Fill the provided buffer with SHA256 of the ELF file, formatted as hexadecimal, null-terminated. If the buffer size is not sufficient to fit the entire SHA256 in hex plus a null terminator, the largest possible number of bytes will be written followed by a null.

Return Number of bytes written to *dst* (including null terminator)

Parameters

- *dst*: Destination buffer
- *size*: Size of the buffer

esp_err_t **esp_ota_begin** (const *esp_partition_t* **partition*, size_t *image_size*, *esp_ota_handle_t* **out_handle*)

Commence an OTA update writing to the specified partition.

The specified partition is erased to the specified image size.

If image size is not yet known, pass `OTA_SIZE_UNKNOWN` which will cause the entire partition to be erased.

On success, this function allocates memory that remains in use until `esp_ota_end()` is called with the returned handle.

Note: If the rollback option is enabled and the running application has the `ESP_OTA_IMG_PENDING_VERIFY` state then it will lead to the `ESP_ERR_OTA_ROLLBACK_INVALID_STATE` error. Confirm the running app before to run download a new app, use `esp_ota_mark_app_valid_cancel_rollback()` function for it (this should be done as early as possible when you first download a new application).

Return

- `ESP_OK`: OTA operation commenced successfully.
- `ESP_ERR_INVALID_ARG`: partition or *out_handle* arguments were NULL, or partition doesn't point to an OTA app partition.
- `ESP_ERR_NO_MEM`: Cannot allocate memory for OTA operation.
- `ESP_ERR_OTA_PARTITION_CONFLICT`: Partition holds the currently running firmware, cannot update in place.
- `ESP_ERR_NOT_FOUND`: Partition argument not found in partition table.
- `ESP_ERR_OTA_SELECT_INFO_INVALID`: The OTA data partition contains invalid data.
- `ESP_ERR_INVALID_SIZE`: Partition doesn't fit in configured flash size.
- `ESP_ERR_FLASH_OP_TIMEOUT` or `ESP_ERR_FLASH_OP_FAIL`: Flash write failed.
- `ESP_ERR_OTA_ROLLBACK_INVALID_STATE`: If the running app has not confirmed state. Before performing an update, the application must be valid.

Parameters

- *partition*: Pointer to info for partition which will receive the OTA update. Required.
- *image_size*: Size of new OTA app image. Partition will be erased in order to receive this size of image. If 0 or `OTA_SIZE_UNKNOWN`, the entire partition is erased.

- `out_handle`: On success, returns a handle which should be used for subsequent `esp_ota_write()` and `esp_ota_end()` calls.

esp_err_t **esp_ota_write** (*esp_ota_handle_t* handle, **const** void *data, size_t size)

Write OTA update data to partition.

This function can be called multiple times as data is received during the OTA operation. Data is written sequentially to the partition.

Return

- `ESP_OK`: Data was written to flash successfully.
- `ESP_ERR_INVALID_ARG`: handle is invalid.
- `ESP_ERR_OTA_VALIDATE_FAILED`: First byte of image contains invalid app image magic byte.
- `ESP_ERR_FLASH_OP_TIMEOUT` or `ESP_ERR_FLASH_OP_FAIL`: Flash write failed.
- `ESP_ERR_OTA_SELECT_INFO_INVALID`: OTA data partition has invalid contents

Parameters

- `handle`: Handle obtained from `esp_ota_begin`
- `data`: Data buffer to write
- `size`: Size of data buffer in bytes.

esp_err_t **esp_ota_write_with_offset** (*esp_ota_handle_t* handle, **const** void *data, size_t size, uint32_t offset)

Write OTA update data to partition.

This function can write data in non contiguous manner. If flash encryption is enabled, data should be 16 byte aligned.

Note While performing OTA, if the packets arrive out of order, `esp_ota_write_with_offset()` can be used to write data in non contiguous manner. Use of `esp_ota_write_with_offset()` in combination with `esp_ota_write()` is not recommended.

Return

- `ESP_OK`: Data was written to flash successfully.
- `ESP_ERR_INVALID_ARG`: handle is invalid.
- `ESP_ERR_OTA_VALIDATE_FAILED`: First byte of image contains invalid app image magic byte.
- `ESP_ERR_FLASH_OP_TIMEOUT` or `ESP_ERR_FLASH_OP_FAIL`: Flash write failed.
- `ESP_ERR_OTA_SELECT_INFO_INVALID`: OTA data partition has invalid contents

Parameters

- `handle`: Handle obtained from `esp_ota_begin`
- `data`: Data buffer to write
- `size`: Size of data buffer in bytes
- `offset`: Offset in flash partition

esp_err_t **esp_ota_end** (*esp_ota_handle_t* handle)

Finish OTA update and validate newly written app image.

Note After calling `esp_ota_end()`, the handle is no longer valid and any memory associated with it is freed (regardless of result).

Return

- `ESP_OK`: Newly written OTA app image is valid.
- `ESP_ERR_NOT_FOUND`: OTA handle was not found.
- `ESP_ERR_INVALID_ARG`: Handle was never written to.
- `ESP_ERR_OTA_VALIDATE_FAILED`: OTA image is invalid (either not a valid app image, or - if secure boot is enabled - signature failed to verify.)
- `ESP_ERR_INVALID_STATE`: If flash encryption is enabled, this result indicates an internal error writing the final encrypted bytes to flash.

Parameters

- `handle`: Handle obtained from `esp_ota_begin()`.

esp_err_t **esp_ota_abort** (*esp_ota_handle_t* handle)

Abort OTA update, free the handle and memory associated with it.

Return

- `ESP_OK`: Handle and its associated memory is freed successfully.

- `ESP_ERR_NOT_FOUND`: OTA handle was not found.

Parameters

- `handle`: obtained from `esp_ota_begin()`.

`esp_err_t esp_ota_set_boot_partition (const esp_partition_t *partition)`

Configure OTA data for a new boot partition.

Note If this function returns `ESP_OK`, calling `esp_restart()` will boot the newly configured app partition.

Return

- `ESP_OK`: OTA data updated, next reboot will use specified partition.
- `ESP_ERR_INVALID_ARG`: partition argument was `NULL` or didn't point to a valid OTA partition of type "app".
- `ESP_ERR_OTA_VALIDATE_FAILED`: Partition contained invalid app image. Also returned if secure boot is enabled and signature validation failed.
- `ESP_ERR_NOT_FOUND`: OTA data partition not found.
- `ESP_ERR_FLASH_OP_TIMEOUT` or `ESP_ERR_FLASH_OP_FAIL`: Flash erase or write failed.

Parameters

- `partition`: Pointer to info for partition containing app image to boot.

`const esp_partition_t *esp_ota_get_boot_partition (void)`

Get partition info of currently configured boot app.

If `esp_ota_set_boot_partition()` has been called, the partition which was set by that function will be returned.

If `esp_ota_set_boot_partition()` has not been called, the result is usually the same as `esp_ota_get_running_partition()`. The two results are not equal if the configured boot partition does not contain a valid app (meaning that the running partition will be an app that the bootloader chose via fallback).

If the OTA data partition is not present or not valid then the result is the first app partition found in the partition table. In priority order, this means: the factory app, the first OTA app slot, or the test app partition.

Note that there is no guarantee the returned partition is a valid app. Use `esp_image_verify(ESP_IMAGE_VERIFY, ...)` to verify if the returned partition contains a bootable image.

Return Pointer to info for partition structure, or `NULL` if partition table is invalid or a flash read operation failed. Any returned pointer is valid for the lifetime of the application.

`const esp_partition_t *esp_ota_get_running_partition (void)`

Get partition info of currently running app.

This function is different to `esp_ota_get_boot_partition()` in that it ignores any change of selected boot partition caused by `esp_ota_set_boot_partition()`. Only the app whose code is currently running will have its partition information returned.

The partition returned by this function may also differ from `esp_ota_get_boot_partition()` if the configured boot partition is somehow invalid, and the bootloader fell back to a different app partition at boot.

Return Pointer to info for partition structure, or `NULL` if no partition is found or flash read operation failed. Returned pointer is valid for the lifetime of the application.

`const esp_partition_t *esp_ota_get_next_update_partition (const esp_partition_t *start_from)`

Return the next OTA app partition which should be written with a new firmware.

Call this function to find an OTA app partition which can be passed to `esp_ota_begin()`.

Finds next partition round-robin, starting from the current running partition.

Return Pointer to info for partition which should be updated next. `NULL` result indicates invalid OTA data partition, or that no eligible OTA app slot partition was found.

Parameters

- `start_from`: If set, treat this partition info as describing the current running partition. Can be `NULL`, in which case `esp_ota_get_running_partition()` is used to find the currently running partition. The result of this function is never the same as this argument.

esp_err_t **esp_ota_get_partition_description**(const *esp_partition_t* *partition, *esp_app_desc_t* *app_desc)

Returns esp_app_desc structure for app partition. This structure includes app version.

Returns a description for the requested app partition.

Return

- ESP_OK Successful.
- ESP_ERR_NOT_FOUND app_desc structure is not found. Magic word is incorrect.
- ESP_ERR_NOT_SUPPORTED Partition is not application.
- ESP_ERR_INVALID_ARG Arguments is NULL or if partition' s offset exceeds partition size.
- ESP_ERR_INVALID_SIZE Read would go out of bounds of the partition.
- or one of error codes from lower-level flash driver.

Parameters

- [in] partition: Pointer to app partition. (only app partition)
- [out] app_desc: Structure of info about app.

esp_err_t **esp_ota_mark_app_valid_cancel_rollback**(void)

This function is called to indicate that the running app is working well.

Return

- ESP_OK: if successful.

esp_err_t **esp_ota_mark_app_invalid_rollback_and_reboot**(void)

This function is called to roll back to the previously workable app with reboot.

If rollback is successful then device will reset else API will return with error code. Checks applications on a flash drive that can be booted in case of rollback. If the flash does not have at least one app (except the running app) then rollback is not possible.

Return

- ESP_FAIL: if not successful.
- ESP_ERR_OTA_ROLLBACK_FAILED: The rollback is not possible due to flash does not have any apps.

const *esp_partition_t* ***esp_ota_get_last_invalid_partition**(void)

Returns last partition with invalid state (ESP_OTA_IMG_INVALID or ESP_OTA_IMG_ABORTED).

Return partition.

esp_err_t **esp_ota_get_state_partition**(const *esp_partition_t* *partition, *esp_ota_img_states_t* *ota_state)

Returns state for given partition.

Return

- ESP_OK: Successful.
- ESP_ERR_INVALID_ARG: partition or ota_state arguments were NULL.
- ESP_ERR_NOT_SUPPORTED: partition is not ota.
- ESP_ERR_NOT_FOUND: Partition table does not have otadata or state was not found for given partition.

Parameters

- [in] partition: Pointer to partition.
- [out] ota_state: state of partition (if this partition has a record in otadata).

esp_err_t **esp_ota_erase_last_boot_app_partition**(void)

Erase previous boot app partition and corresponding otadata select for this partition.

When current app is marked to as valid then you can erase previous app partition.

Return

- ESP_OK: Successful, otherwise ESP_ERR.

bool **esp_ota_check_rollback_is_possible**(void)

Checks applications on the slots which can be booted in case of rollback.

These applications should be valid (marked in otadata as not UNDEFINED, INVALID or ABORTED and crc is good) and be able booted, and secure_version of app >= secure_version of efuse (if anti-rollback is enabled).

Return

- True: Returns true if the slots have at least one app (except the running app).
- False: The rollback is not possible.

`esp_err_t esp_ota_revoke_secure_boot_public_key(esp_ota_secure_boot_public_key_index_t index)`

Revokes the old signature digest. To be called in the application after the rollback logic.

Relevant for Secure boot v2 on targets where upto 3 key digests can be stored (Key N-1, Key N, Key N+1). When key N-1 used to sign an app is invalidated, an OTA update is to be sent with an app signed with key N-1 & Key N. After successfully booting the OTA app should call this function to revoke Key N-1.

Return

- ESP_OK: If revocation is successful.
- ESP_ERR_INVALID_ARG: If the index of the public key to be revoked is incorrect.
- ESP_FAIL: If secure boot v2 has not been enabled.

Parameters

- `index`: - The index of the signature block to be revoked

Macros**OTA_SIZE_UNKNOWN**

Used for `esp_ota_begin()` if new image size is unknown

OTA_WITH_SEQUENTIAL_WRITES

Used for `esp_ota_begin()` if new image size is unknown and erase can be done in incremental manner (assuming write operation is in continuous sequence)

ESP_ERR_OTA_BASE

Base error code for `ota_ops` api

ESP_ERR_OTA_PARTITION_CONFLICT

Error if request was to write or erase the current running partition

ESP_ERR_OTA_SELECT_INFO_INVALID

Error if OTA data partition contains invalid content

ESP_ERR_OTA_VALIDATE_FAILED

Error if OTA app image is invalid

ESP_ERR_OTA_SMALL_SEC_VER

Error if the firmware has a secure version less than the running firmware.

ESP_ERR_OTA_ROLLBACK_FAILED

Error if flash does not have valid firmware in passive partition and hence rollback is not possible

ESP_ERR_OTA_ROLLBACK_INVALID_STATE

Error if current active firmware is still marked in pending validation state (`ESP_OTA_IMG_PENDING_VERIFY`), essentially first boot of firmware image post upgrade and hence firmware upgrade is not possible

Type Definitions

```
typedef uint32_t esp_ota_handle_t
```

Opaque handle for an application OTA update.

`esp_ota_begin()` returns a handle which is then used for subsequent calls to `esp_ota_write()` and `esp_ota_end()`.

Enumerations

```
enum esp_ota_secure_boot_public_key_index_t
```

Secure Boot V2 public key indexes.

Values:

SECURE_BOOT_PUBLIC_KEY_INDEX_0

Points to the 0th index of the Secure Boot v2 public key

SECURE_BOOT_PUBLIC_KEY_INDEX_1

Points to the 1st index of the Secure Boot v2 public key

SECURE_BOOT_PUBLIC_KEY_INDEX_2

Points to the 2nd index of the Secure Boot v2 public key

2.7.20 Power Management

Overview

Power management algorithm included in ESP-IDF can adjust the advanced peripheral bus (APB) frequency, CPU frequency, and put the chip into light sleep mode to run an application at smallest possible power consumption, given the requirements of application components.

Application components can express their requirements by creating and acquiring power management locks.

For example:

- Driver for a peripheral clocked from APB can request the APB frequency to be set to 80 MHz while the peripheral is used.
- RTOS can request the CPU to run at the highest configured frequency while there are tasks ready to run.
- A peripheral driver may need interrupts to be enabled, which means it will have to request disabling light sleep.

Since requesting higher APB or CPU frequencies or disabling light sleep causes higher current consumption, please keep the usage of power management locks by components to a minimum.

Configuration

Power management can be enabled at compile time, using the option [*CONFIG_PM_ENABLE*](#).

Enabling power management features comes at the cost of increased interrupt latency. Extra latency depends on a number of factors, such as the CPU frequency, single/dual core mode, whether or not frequency switch needs to be done. Minimum extra latency is 0.2 us (when the CPU frequency is 240 MHz and frequency scaling is not enabled). Maximum extra latency is 40 us (when frequency scaling is enabled, and a switch from 40 MHz to 80 MHz is performed on interrupt entry).

Dynamic frequency scaling (DFS) and automatic light sleep can be enabled in an application by calling the function [*esp_pm_configure\(\)*](#). Its argument is a structure defining the frequency scaling settings, [*esp_pm_config_esp32c3_t*](#). In this structure, three fields need to be initialized:

- `max_freq_mhz`: Maximum CPU frequency in MHz, i.e., the frequency used when the `ESP_PM_CPU_FREQ_MAX` lock is acquired. This field will usually be set to the default CPU frequency.
- `min_freq_mhz`: Minimum CPU frequency in MHz, i.e., the frequency used when only the `ESP_PM_APB_FREQ_MAX` lock is acquired. This field can be set to the XTAL frequency value, or the XTAL frequency divided by an integer. Note that 10 MHz is the lowest frequency at which the default REF_TICK clock of 1 MHz can be generated.
- `light_sleep_enable`: Whether the system should automatically enter light sleep when no locks are acquired (`true/false`).

Alternatively, if you enable the option [*CONFIG_PM_DFS_INIT_AUTO*](#) in menuconfig, the maximum CPU frequency will be determined by the [*CONFIG_ESP32C3_DEFAULT_CPU_FREQ_MHZ*](#) setting, and the minimum CPU frequency will be locked to the XTAL frequency.

Note: Automatic light sleep is based on FreeRTOS Tickless Idle functionality. If automatic light sleep is requested while the option [*CONFIG_FREERTOS_USE_TICKLESS_IDLE*](#) is not enabled in menuconfig, [*esp_pm_configure\(\)*](#) will return the error `ESP_ERR_NOT_SUPPORTED`.

Note: In light sleep, peripherals are clock gated, and interrupts (from GPIOs and internal peripherals) will not be generated. A wakeup source described in the *Sleep Modes* documentation can be used to trigger wakeup from the light sleep state.

Power Management Locks

Applications have the ability to acquire/release locks in order to control the power management algorithm. When an application acquires a lock, the power management algorithm operation is restricted in a way described below. When the lock is released, such restrictions are removed.

Power management locks have acquire/release counters. If the lock has been acquired a number of times, it needs to be released the same number of times to remove associated restrictions.

ESP32-C3 supports three types of locks described in the table below.

Lock	Description
ESP_PM_CPU_FREQ_REQ	Requests CPU frequency to be at the maximum value set with <code>esp_pm_configure()</code> . For ESP32-C3, this value can be set to 80 MHz, 160 MHz, or 240 MHz.
ESP_PM_APB_FREQ_REQ	Requests the APB frequency to be at the maximum supported value. For ESP32-C3, this is 80 MHz.
ESP_PM_NO_LIGHT_SLEEP	Disables automatic switching to light sleep.

ESP32-C3 Power Management Algorithm

The table below shows how CPU and APB frequencies will be switched if dynamic frequency scaling is enabled. You can specify the maximum CPU frequency with either `esp_pm_configure()` or `CONFIG_ESP32C3_DEFAULT_CPU_FREQ_MHZ`.

Max CPU Frequency Set	Lock Acquisition	CPU and APB Frequencies
240	ESP_PM_CPU_FREQ_MAX acquired	CPU: 240 MHz APB: 80 MHz
	ESP_PM_APB_FREQ_MAX acquired, ESP_PM_CPU_FREQ_MAX not acquired	CPU: 80 MHz APB: 80 MHz
	None	Min values for both frequencies set with <code>esp_pm_configure()</code>
160	ESP_PM_CPU_FREQ_MAX acquired	CPU: 160 MHz APB: 80 MHz
	ESP_PM_APB_FREQ_MAX acquired, ESP_PM_CPU_FREQ_MAX not acquired	CPU: 80 MHz APB: 80 MHz
	None	Min values for both frequencies set with <code>esp_pm_configure()</code>
80	Any of ESP_PM_CPU_FREQ_MAX or ESP_PM_APB_FREQ_MAX acquired	CPU: 80 MHz APB: 80 MHz
	None	Min values for both frequencies set with <code>esp_pm_configure()</code>

If none of the locks are acquired, and light sleep is enabled in a call to `esp_pm_configure()`, the system will go into light sleep mode. The duration of light sleep will be determined by:

- FreeRTOS tasks blocked with finite timeouts
- Timers registered with *High resolution timer* APIs

Light sleep duration will be chosen to wake up the chip before the nearest event (task being unblocked, or timer elapses).

Dynamic Frequency Scaling and Peripheral Drivers

When DFS is enabled, the APB frequency can be changed multiple times within a single RTOS tick. The APB frequency change does not affect the work of some peripherals, while other peripherals may have issues. For example, Timer Group peripheral timers will keep counting, however, the speed at which they count will change proportionally to the APB frequency.

The following peripherals work normally even when the APB frequency is changing:

- **UART:** if REF_TICK is used as a clock source. See `use_ref_tick` member of `uart_config_t`.
- **LEDC:** if REF_TICK is used as a clock source. See `ledc_timer_config()` function.
- **RMT:** if REF_TICK or XTAL is used as a clock source. See `flags` member of `rmt_config_t` and macro `RMT_CHANNEL_FLAGS_AWARE_DFS`.

Currently, the following peripheral drivers are aware of DFS and will use the ESP_PM_APB_FREQ_MAX lock for the duration of the transaction:

- SPI master
- I2C
- I2S (If the APPLL clock is used, then it will use the ESP_PM_NO_LIGHT_SLEEP lock)
- SDMMC

The following drivers will hold the ESP_PM_APB_FREQ_MAX lock while the driver is enabled:

- **SPI slave:** between calls to `spi_slave_initialize()` and `spi_slave_free()`.
- **Ethernet:** between calls to `esp_eth_driver_install()` and `esp_eth_driver_uninstall()`.
- **WiFi:** between calls to `esp_wifi_start()` and `esp_wifi_stop()`. If modem sleep is enabled, the lock will be released for the periods of time when radio is disabled.
- **TWAI:** between calls to `twai_driver_install()` and `twai_driver_uninstall()`.
- **Bluetooth:** between calls to `esp_bt_controller_enable()` and `esp_bt_controller_disable()`. If Bluetooth modem sleep is enabled, the ESP_PM_APB_FREQ_MAX lock will be released for the periods of time when radio is disabled. However the ESP_PM_NO_LIGHT_SLEEP lock will still be held.

The following peripheral drivers are not aware of DFS yet. Applications need to acquire/release locks themselves, when necessary:

- PCNT
- Sigma-delta
- Timer group

API Reference

Header File

- `esp_pm/include/esp_pm.h`

Functions

`esp_err_t esp_pm_configure(const void *config)`

Set implementation-specific power management configuration.

Return

- ESP_OK on success
- ESP_ERR_INVALID_ARG if the configuration values are not correct
- ESP_ERR_NOT_SUPPORTED if certain combination of values is not supported, or if CONFIG_PM_ENABLE is not enabled in sdkconfig

Parameters

- `config`: pointer to implementation-specific configuration structure (e.g. `esp_pm_config_esp32`)

`esp_err_t esp_pm_get_configuration(void *config)`

Get implementation-specific power management configuration.

Return

- ESP_OK on success
- ESP_ERR_INVALID_ARG if the pointer is null

Parameters

- `config`: pointer to implementation-specific configuration structure (e.g. `esp_pm_config_esp32`)

`esp_err_t esp_pm_lock_create(esp_pm_lock_type_t lock_type, int arg, const char *name, esp_pm_lock_handle_t *out_handle)`

Initialize a lock handle for certain power management parameter.

When lock is created, initially it is not taken. Call `esp_pm_lock_acquire` to take the lock.

This function must not be called from an ISR.

Return

- ESP_OK on success
- ESP_ERR_NO_MEM if the lock structure can not be allocated
- ESP_ERR_INVALID_ARG if `out_handle` is NULL or type argument is not valid

- ESP_ERR_NOT_SUPPORTED if CONFIG_PM_ENABLE is not enabled in sdkconfig

Parameters

- `lock_type`: Power management constraint which the lock should control
- `arg`: argument, value depends on `lock_type`, see `esp_pm_lock_type_t`
- `name`: arbitrary string identifying the lock (e.g. “wifi” or “spi”). Used by the `esp_pm_dump_locks` function to list existing locks. May be set to NULL. If not set to NULL, must point to a string which is valid for the lifetime of the lock.
- `[out] out_handle`: handle returned from this function. Use this handle when calling `esp_pm_lock_delete`, `esp_pm_lock_acquire`, `esp_pm_lock_release`. Must not be NULL.

esp_err_t **esp_pm_lock_acquire** (*esp_pm_lock_handle_t* handle)

Take a power management lock.

Once the lock is taken, power management algorithm will not switch to the mode specified in a call to `esp_pm_lock_create`, or any of the lower power modes (higher numeric values of ‘mode’).

The lock is recursive, in the sense that if `esp_pm_lock_acquire` is called a number of times, `esp_pm_lock_release` has to be called the same number of times in order to release the lock.

This function may be called from an ISR.

This function is not thread-safe w.r.t. calls to other `esp_pm_lock_*` functions for the same handle.

Return

- ESP_OK on success
- ESP_ERR_INVALID_ARG if the handle is invalid
- ESP_ERR_NOT_SUPPORTED if CONFIG_PM_ENABLE is not enabled in sdkconfig

Parameters

- `handle`: handle obtained from `esp_pm_lock_create` function

esp_err_t **esp_pm_lock_release** (*esp_pm_lock_handle_t* handle)

Release the lock taken using `esp_pm_lock_acquire`.

Call to this functions removes power management restrictions placed when taking the lock.

Locks are recursive, so if `esp_pm_lock_acquire` is called a number of times, `esp_pm_lock_release` has to be called the same number of times in order to actually release the lock.

This function may be called from an ISR.

This function is not thread-safe w.r.t. calls to other `esp_pm_lock_*` functions for the same handle.

Return

- ESP_OK on success
- ESP_ERR_INVALID_ARG if the handle is invalid
- ESP_ERR_INVALID_STATE if lock is not acquired
- ESP_ERR_NOT_SUPPORTED if CONFIG_PM_ENABLE is not enabled in sdkconfig

Parameters

- `handle`: handle obtained from `esp_pm_lock_create` function

esp_err_t **esp_pm_lock_delete** (*esp_pm_lock_handle_t* handle)

Delete a lock created using `esp_pm_lock`.

The lock must be released before calling this function.

This function must not be called from an ISR.

Return

- ESP_OK on success
- ESP_ERR_INVALID_ARG if the handle argument is NULL
- ESP_ERR_INVALID_STATE if the lock is still acquired
- ESP_ERR_NOT_SUPPORTED if CONFIG_PM_ENABLE is not enabled in sdkconfig

Parameters

- `handle`: handle obtained from `esp_pm_lock_create` function

esp_err_t **esp_pm_dump_locks** (FILE *stream)

Dump the list of all locks to stderr

This function dumps debugging information about locks created using `esp_pm_lock_create` to an output stream.

This function must not be called from an ISR. If `esp_pm_lock_acquire/release` are called while this function is running, inconsistent results may be reported.

Return

- `ESP_OK` on success
- `ESP_ERR_NOT_SUPPORTED` if `CONFIG_PM_ENABLE` is not enabled in `sdkconfig`

Parameters

- `stream`: stream to print information to; use `stdout` or `stderr` to print to the console; use `fmemopen/open_memstream` to print to a string buffer.

Type Definitions

```
typedef struct esp_pm_lock *esp_pm_lock_handle_t
```

Opaque handle to the power management lock.

Enumerations

```
enum esp_pm_lock_type_t
```

Power management constraints.

Values:

ESP_PM_CPU_FREQ_MAX

Require CPU frequency to be at the maximum value set via `esp_pm_configure`. Argument is unused and should be set to 0.

ESP_PM_APB_FREQ_MAX

Require APB frequency to be at the maximum value supported by the chip. Argument is unused and should be set to 0.

ESP_PM_NO_LIGHT_SLEEP

Prevent the system from going into light sleep. Argument is unused and should be set to 0.

Header File

- [esp_pm/include/esp32c3/pm.h](#)

Structures

```
struct esp_pm_config_esp32c3_t
```

Power management config for ESP32C3.

Pass a pointer to this structure as an argument to `esp_pm_configure` function.

Public Members

int **max_freq_mhz**
Maximum CPU frequency, in MHz

int **min_freq_mhz**
Minimum CPU frequency to use when no locks are taken, in MHz

bool **light_sleep_enable**
Enter light sleep when no locks are taken

2.7.21 Sleep Modes

Overview

ESP32-C3 is capable of light sleep and deep sleep power saving modes.

In light sleep mode, digital peripherals, most of the RAM, and CPUs are clock-gated, and supply voltage is reduced. Upon exit from light sleep, peripherals and CPUs resume operation, their internal state is preserved.

In deep sleep mode, CPUs, most of the RAM, and all the digital peripherals which are clocked from APB_CLK are powered off. The only parts of the chip which can still be powered on are:

- RTC controller
- RTC peripherals
- RTC fast memory

Wakeup from deep and light sleep modes can be done using several sources. These sources can be combined, in this case the chip will wake up when any one of the sources is triggered. Wakeup sources can be enabled using `esp_sleep_enable_X_wakeup` APIs and can be disabled using `esp_sleep_disable_wakeup_source()` API. Next section describes these APIs in detail. Wakeup sources can be configured at any moment before entering light or deep sleep mode.

Additionally, the application can force specific powerdown modes for the RTC peripherals and RTC memories using `esp_sleep_pd_config()` API.

Once wakeup sources are configured, application can enter sleep mode using `esp_light_sleep_start()` or `esp_deep_sleep_start()` APIs. At this point the hardware will be configured according to the requested wakeup sources, and RTC controller will either power down or power off the CPUs and digital peripherals.

If WiFi connection needs to be maintained, enable WiFi modem sleep, and enable automatic light sleep feature (see [Power Management APIs](#)). This will allow the system to wake up from sleep automatically when required by WiFi driver, thereby maintaining connection to the AP.

WiFi/BT and sleep modes

In deep sleep and light sleep modes, wireless peripherals are powered down. Before entering deep sleep or light sleep modes, applications must disable WiFi and BT using appropriate calls (`esp_bluedroid_disable()`, `esp_bt_controller_disable()`, `esp_wifi_stop()`). WiFi and BT connections will not be maintained in deep sleep or light sleep, even if these functions are not called.

Wakeup sources

Timer RTC controller has a built in timer which can be used to wake up the chip after a predefined amount of time. Time is specified at microsecond precision, but the actual resolution depends on the clock source selected for RTC SLOW_CLK.

This wakeup mode doesn't require RTC peripherals or RTC memories to be powered on during sleep.

`esp_sleep_enable_timer_wakeup()` function can be used to enable deep sleep wakeup using a timer.

UART wakeup (light sleep only) When ESP32-C3 receives UART input from external devices, it is often required to wake up the chip when input data is available. UART peripheral contains a feature which allows waking up the chip from light sleep when a certain number of positive edges on RX pin are seen. This number of positive edges can be set using `uart_set_wakeup_threshold()` function. Note that the character which triggers wakeup (and any characters before it) will not be received by the UART after wakeup. This means that the external device typically needs to send an extra character to the ESP32-C3 to trigger wakeup, before sending the data.

`esp_sleep_enable_uart_wakeup()` function can be used to enable this wakeup source.

Power-down of RTC peripherals and memories

By default, `esp_deep_sleep_start()` and `esp_light_sleep_start()` functions will power down all RTC power domains which are not needed by the enabled wakeup sources. To override this behaviour, `esp_sleep_pd_config()` function is provided.

In ESP32-C3 there is only RTC fast memory, so if some variables in the program are marked by `RTC_DATA_ATTR`, `RTC_SLOW_ATTR` or `RTC_FAST_ATTR` attributes, all of them go to RTC fast memory. It will be kept powered on by default. This can be overridden using `esp_sleep_pd_config()` function, if desired.

Entering light sleep

`esp_light_sleep_start()` function can be used to enter light sleep once wakeup sources are configured. It is also possible to go into light sleep with no wakeup sources configured, in this case the chip will be in light sleep mode indefinitely, until external reset is applied.

Entering deep sleep

`esp_deep_sleep_start()` function can be used to enter deep sleep once wakeup sources are configured. It is also possible to go into deep sleep with no wakeup sources configured, in this case the chip will be in deep sleep mode indefinitely, until external reset is applied.

Configuring IOs

Some ESP32-C3 IOs have internal pullups or pulldowns, which are enabled by default. If an external circuit drives this pin in deep sleep mode, current consumption may increase due to current flowing through these pullups and pulldowns.

To isolate a pin, preventing extra current draw, call `rtc_gpio_isolate()` function.

For example, on ESP32-WROVER module, GPIO12 is pulled up externally. GPIO12 also has an internal pull-down in the ESP32 chip. This means that in deep sleep, some current will flow through these external and internal resistors, increasing deep sleep current above the minimal possible value. Add the following code before `esp_deep_sleep_start()` to remove this extra current:

```
rtc_gpio_isolate(GPIO_NUM_12);
```

UART output handling

Before entering sleep mode, `esp_deep_sleep_start()` will flush the contents of UART FIFOs.

When entering light sleep mode using `esp_light_sleep_start()`, UART FIFOs will not be flushed. Instead, UART output will be suspended, and remaining characters in the FIFO will be sent out after wakeup from light sleep.

Checking sleep wakeup cause

`esp_sleep_get_wakeup_cause()` function can be used to check which wakeup source has triggered wakeup from sleep mode.

Disable sleep wakeup source

Previously configured wakeup source can be disabled later using `esp_sleep_disable_wakeup_source()` API. This function deactivates trigger for the given wakeup source. Additionally it can disable all triggers if the argument is `ESP_SLEEP_WAKEUP_ALL`.

Application Example

Implementation of basic functionality of deep sleep is shown in [protocols/sntp](#) example, where ESP module is periodically waken up to retrieve time from NTP server.

An example in [system/deep_sleep](#) illustrates usage of deep sleep wakeup triggered by timer.

API Reference

Header File

- [esp_system/include/esp_sleep.h](#)

Functions

esp_err_t **esp_sleep_disable_wakeup_source** (*esp_sleep_source_t* source)

Disable wakeup source.

This function is used to deactivate wake up trigger for source defined as parameter of the function.

See docs/sleep-modes.rst for details.

Note This function does not modify wake up configuration in RTC. It will be performed in `esp_sleep_start` function.

Return

- ESP_OK on success
- ESP_ERR_INVALID_STATE if trigger was not active

Parameters

- source: - number of source to disable of type `esp_sleep_source_t`

esp_err_t **esp_sleep_enable_timer_wakeup** (*uint64_t* time_in_us)

Enable wakeup by timer.

Return

- ESP_OK on success
- ESP_ERR_INVALID_ARG if value is out of range (TBD)

Parameters

- time_in_us: time before wakeup, in microseconds

bool **esp_sleep_is_valid_wakeup_gpio** (*gpio_num_t* gpio_num)

Returns true if a GPIO number is valid for use as wakeup source.

Note For SoCs with RTC IO capability, this can be any valid RTC IO input pin.

Return True if this GPIO number will be accepted as a sleep wakeup source.

Parameters

- gpio_num: Number of the GPIO to test for wakeup source capability

esp_err_t **esp_deep_sleep_enable_gpio_wakeup** (*uint64_t* gpio_num, *gpio_pin_mask_t* gpio_pin_mask, *esp_deepsleep_gpio_wake_up_mode_t* mode)

Enable wakeup using specific gpio pins.

This function enables an IO pin to wake the chip from deep sleep

Note This function does not modify pin configuration. The pins are configured in `esp_sleep_start`, immediately before entering sleep mode.

Note You don't need to care to pull-up or pull-down before using this function, because this will be done in `esp_sleep_start` based on param mask you give. BTW, when you use low level to wake up the chip, we strongly recommend you to add external registers(pull-up).

Return

- ESP_OK on success
- ESP_ERR_INVALID_ARG if gpio num is more than 5 or mode is invalid,

Parameters

- gpio_pin_mask: Bit mask of GPIO numbers which will cause wakeup. Only GPIOs which are have RTC functionality can be used in this bit map.
- mode: Select logic function used to determine wakeup condition:
 - ESP_GPIO_WAKEUP_GPIO_LOW: wake up when the gpio turn to low.
 - ESP_GPIO_WAKEUP_GPIO_HIGH: wake up when the gpio turn to high.

esp_err_t **esp_sleep_enable_gpio_wakeup** (void)

Enable wakeup from light sleep using GPIOs.

Each GPIO supports wakeup function, which can be triggered on either low level or high level. Unlike EXT0 and EXT1 wakeup sources, this method can be used both for all IOs: RTC IOs and digital IOs. It can only be used to wakeup from light sleep though.

To enable wakeup, first call `gpio_wakeup_enable`, specifying gpio number and wakeup level, for each GPIO which is used for wakeup. Then call this function to enable wakeup feature.

Note In revisions 0 and 1 of the ESP32, GPIO wakeup source can not be used together with touch or ULP wakeup sources.

Return

- ESP_OK on success
- ESP_ERR_INVALID_STATE if wakeup triggers conflict

esp_err_t **esp_sleep_enable_uart_wakeup** (int *uart_num*)

Enable wakeup from light sleep using UART.

Use `uart_set_wakeup_threshold` function to configure UART wakeup threshold.

Wakeup from light sleep takes some time, so not every character sent to the UART can be received by the application.

Note ESP32 does not support wakeup from UART2.

Return

- ESP_OK on success
- ESP_ERR_INVALID_ARG if wakeup from given UART is not supported

Parameters

- *uart_num*: UART port to wake up from

esp_err_t **esp_sleep_enable_wifi_wakeup** (void)

Enable wakeup by WiFi MAC.

Return

- ESP_OK on success

esp_err_t **esp_sleep_disable_wifi_wakeup** (void)

Disable wakeup by WiFi MAC.

Return

- ESP_OK on success

uint64_t **esp_sleep_get_ext1_wakeup_status** (void)

Get the bit mask of GPIOs which caused wakeup (ext1)

If wakeup was caused by another source, this function will return 0.

Return bit mask, if GPIO_n caused wakeup, BIT(n) will be set

uint64_t **esp_sleep_get_gpio_wakeup_status** (void)

Get the bit mask of GPIOs which caused wakeup (gpio)

If wakeup was caused by another source, this function will return 0.

Return bit mask, if GPIO_n caused wakeup, BIT(n) will be set

esp_err_t **esp_sleep_pd_config** (*esp_sleep_pd_domain_t* *domain*, *esp_sleep_pd_option_t* *option*)

Set power down mode for an RTC power domain in sleep mode.

If not set using this API, all power domains default to ESP_PD_OPTION_AUTO.

Return

- ESP_OK on success
- ESP_ERR_INVALID_ARG if either of the arguments is out of range

Parameters

- *domain*: power domain to configure
- *option*: power down option (ESP_PD_OPTION_OFF, ESP_PD_OPTION_ON, or ESP_PD_OPTION_AUTO)

void **esp_deep_sleep_start** (void)
Enter deep sleep with the configured wakeup options.

This function does not return.

esp_err_t **esp_light_sleep_start** (void)
Enter light sleep with the configured wakeup options.

Return

- ESP_OK on success (returned after wakeup)
- ESP_ERR_INVALID_STATE if WiFi or BT is not stopped

void **esp_deep_sleep** (uint64_t *time_in_us*)
Enter deep-sleep mode.

The device will automatically wake up after the deep-sleep time. Upon waking up, the device calls deep sleep wake stub, and then proceeds to load application.

Call to this function is equivalent to a call to `esp_deep_sleep_enable_timer_wakeup` followed by a call to `esp_deep_sleep_start`.

`esp_deep_sleep` does not shut down WiFi, BT, and higher level protocol connections gracefully. Make sure relevant WiFi and BT stack functions are called to close any connections and deinitialize the peripherals. These include:

- `esp_bluedroid_disable`
- `esp_bt_controller_disable`
- `esp_wifi_stop`

This function does not return.

Note The device will wake up immediately if the deep-sleep time is set to 0

Parameters

- *time_in_us*: deep-sleep time, unit: microsecond

esp_sleep_wakeup_cause_t **esp_sleep_get_wakeup_cause** (void)
Get the wakeup source which caused wakeup from sleep.

Return cause of wake up from last sleep (deep sleep or light sleep)

void **esp_wake_deep_sleep** (void)
Default stub to run on wake from deep sleep.

Allows for executing code immediately on wake from sleep, before the software bootloader or ESP-IDF app has started up.

This function is weak-linked, so you can implement your own version to run code immediately when the chip wakes from sleep.

See docs/deep-sleep-stub.rst for details.

void **esp_set_deep_sleep_wake_stub** (*esp_deep_sleep_wake_stub_fn_t* *new_stub*)
Install a new stub at runtime to run on wake from deep sleep.

If implementing `esp_wake_deep_sleep()` then it is not necessary to call this function.

However, it is possible to call this function to substitute a different deep sleep stub. Any function used as a deep sleep stub must be marked `RTC_IRAM_ATTR`, and must obey the same rules given for `esp_wake_deep_sleep()`.

esp_deep_sleep_wake_stub_fn_t **esp_get_deep_sleep_wake_stub** (void)
Get current wake from deep sleep stub.

Return Return current wake from deep sleep stub, or NULL if no stub is installed.

void **esp_default_wake_deep_sleep** (void)
The default esp-idf-provided `esp_wake_deep_sleep()` stub.

See docs/deep-sleep-stub.rst for details.

void **esp_deep_sleep_disable_rom_logging** (void)
Disable logging from the ROM code after deep sleep.

Using LSB of RTC_STORE4.

void **esp_sleep_config_gpio_isolate** (void)
Configure to isolate all GPIO pins in sleep state.

void **esp_sleep_enable_gpio_switch** (bool *enable*)
Enable or disable GPIO pins status switching between slept status and waked status.

Parameters

- *enable*: decide whether to switch status or not

Type Definitions

typedef *esp_sleep_source_t* **esp_sleep_wakeup_cause_t**

typedef void (***esp_deep_sleep_wake_stub_fn_t**) (void)
Function type for stub to run on wake from sleep.

Enumerations

enum **esp_sleep_ext1_wakeup_mode_t**
Logic function used for EXT1 wakeup mode.

Values:

ESP_EXT1_WAKEUP_ALL_LOW = 0
Wake the chip when all selected GPIOs go low.

ESP_EXT1_WAKEUP_ANY_HIGH = 1
Wake the chip when any of the selected GPIOs go high.

enum **esp_deepsleep_gpio_wake_up_mode_t**

Values:

ESP_GPIO_WAKEUP_GPIO_LOW = 0

ESP_GPIO_WAKEUP_GPIO_HIGH = 1

enum **esp_sleep_pd_domain_t**
Power domains which can be powered down in sleep mode.

Values:

ESP_PD_DOMAIN_RTC_PERIPH
RTC IO, sensors and ULP co-processor.

ESP_PD_DOMAIN_RTC_SLOW_MEM
RTC slow memory.

ESP_PD_DOMAIN_RTC_FAST_MEM
RTC fast memory.

ESP_PD_DOMAIN_XTAL
XTAL oscillator.

ESP_PD_DOMAIN_CPU
CPU core.

ESP_PD_DOMAIN_RTC8M
Internal 8M oscillator.

ESP_PD_DOMAIN_VDDSDIO
VDD_SDIO.

ESP_PD_DOMAIN_MAX
Number of domains.

enum esp_sleep_pd_option_t

Power down options.

Values:

ESP_PD_OPTION_OFF

Power down the power domain in sleep mode.

ESP_PD_OPTION_ON

Keep power domain enabled during sleep mode.

ESP_PD_OPTION_AUTO

Keep power domain enabled in sleep mode, if it is needed by one of the wakeup options. Otherwise power it down.

enum esp_sleep_source_t

Sleep wakeup cause.

Values:

ESP_SLEEP_WAKEUP_UNDEFINED

In case of deep sleep, reset was not caused by exit from deep sleep.

ESP_SLEEP_WAKEUP_ALL

Not a wakeup cause, used to disable all wakeup sources with `esp_sleep_disable_wakeup_source`.

ESP_SLEEP_WAKEUP_EXT0

Wakeup caused by external signal using RTC_IO.

ESP_SLEEP_WAKEUP_EXT1

Wakeup caused by external signal using RTC_CNTL.

ESP_SLEEP_WAKEUP_TIMER

Wakeup caused by timer.

ESP_SLEEP_WAKEUP_TOUCHPAD

Wakeup caused by touchpad.

ESP_SLEEP_WAKEUP_ULP

Wakeup caused by ULP program.

ESP_SLEEP_WAKEUP_GPIO

Wakeup caused by GPIO (light sleep only)

ESP_SLEEP_WAKEUP_UART

Wakeup caused by UART (light sleep only)

ESP_SLEEP_WAKEUP_WIFI

Wakeup caused by WIFI (light sleep only)

ESP_SLEEP_WAKEUP_COCPU

Wakeup caused by COCPU int.

ESP_SLEEP_WAKEUP_COCPU_TRAP_TRIG

Wakeup caused by COCPU crash.

ESP_SLEEP_WAKEUP_BT

Wakeup caused by BT (light sleep only)

2.7.22 Watchdogs

Overview

The ESP-IDF has support for two types of watchdogs: The Interrupt Watchdog Timer and the Task Watchdog Timer (TWDT). The Interrupt Watchdog Timer and the TWDT can both be enabled using [Project Configuration Menu](#), however the TWDT can also be enabled during runtime. The Interrupt Watchdog is responsible for detecting instances

where FreeRTOS task switching is blocked for a prolonged period of time. The TWDT is responsible for detecting instances of tasks running without yielding for a prolonged period.

Interrupt watchdog The interrupt watchdog makes sure the FreeRTOS task switching interrupt isn't blocked for a long time. This is bad because no other tasks, including potentially important ones like the WiFi task and the idle task, can't get any CPU runtime. A blocked task switching interrupt can happen because a program runs into an infinite loop with interrupts disabled or hangs in an interrupt.

The default action of the interrupt watchdog is to invoke the panic handler, causing a register dump and an opportunity for the programmer to find out, using either OpenOCD or gdbstub, what bit of code is stuck with interrupts disabled. Depending on the configuration of the panic handler, it can also blindly reset the CPU, which may be preferred in a production environment.

The interrupt watchdog is built around the hardware watchdog in timer group 1. If this watchdog for some reason cannot execute the NMI handler that invokes the panic handler (e.g. because IRAM is overwritten by garbage), it will hard-reset the SOC. If the panic handler executes, it will display the panic reason as "Interrupt wdt timeout on CPU0" or "Interrupt wdt timeout on CPU1" (as applicable).

Configuration The interrupt watchdog is enabled by default via the `CONFIG_ESP_INT_WDT` configuration flag. The timeout is configured by setting `CONFIG_ESP_INT_WDT_TIMEOUT_MS`. The default timeout is higher if PSRAM support is enabled, as a critical section or interrupt routine that accesses a large amount of PSRAM will take longer to complete in some circumstances. The INT WDT timeout should always be longer than the period between FreeRTOS ticks (see `CONFIG_FREERTOS_HZ`).

Tuning If you find the Interrupt watchdog timeout is triggering because an interrupt or critical section is running longer than the timeout period, consider rewriting the code: critical sections should be made as short as possible, with non-critical computation happening outside the critical section. Interrupt handlers should also perform the minimum possible amount of computation, consider pushing data into a queue from the ISR and processing it in a task instead. Neither critical sections or interrupt handlers should ever block waiting for another event to occur.

If changing the code to reduce the processing time is not possible or desirable, it's possible to increase the `CONFIG_ESP_INT_WDT_TIMEOUT_MS` setting instead.

Task Watchdog Timer The Task Watchdog Timer (TWDT) is responsible for detecting instances of tasks running for a prolonged period of time without yielding. This is a symptom of CPU starvation and is usually caused by a higher priority task looping without yielding to a lower-priority task thus starving the lower priority task from CPU time. This can be an indicator of poorly written code that spinloops on a peripheral, or a task that is stuck in an infinite loop.

By default the TWDT will watch the Idle task, however any task can subscribe to be watched by the TWDT. Each watched task must 'reset' the TWDT periodically to indicate that they have been allocated CPU time. If a task does not reset within the TWDT timeout period, a warning will be printed with information about which tasks failed to reset the TWDT in time and which tasks are currently running.

It is also possible to redefine the function `esp_task_wdt_isr_user_handler` in the user code, in order to receive the timeout event and handle it differently.

The TWDT is built around the Hardware Watchdog Timer in Timer Group 0. The TWDT can be initialized by calling `esp_task_wdt_init()` which will configure the hardware timer. A task can then subscribe to the TWDT using `esp_task_wdt_add()` in order to be watched. Each subscribed task must periodically call `esp_task_wdt_reset()` to reset the TWDT. Failure by any subscribed tasks to periodically call `esp_task_wdt_reset()` indicates that one or more tasks have been starved of CPU time or are stuck in a loop somewhere.

A watched task can be unsubscribed from the TWDT using `esp_task_wdt_delete()`. A task that has been unsubscribed should no longer call `esp_task_wdt_reset()`. Once all tasks have unsubscribed from the TWDT, the TWDT can be deinitialized by calling `esp_task_wdt_deinit()`.

The default timeout period for the TWDT is set using config item `CONFIG_ESP_TASK_WDT_TIMEOUT_S`. This should be set to at least as long as you expect any single task will need to monopolise the CPU (for example, if you expect the app will do a long intensive calculation and should not yield to other tasks). It is also possible to change this timeout at runtime by calling `esp_task_wdt_init()`.

The following config options control TWDT configuration at startup. They are all enabled by default:

- `CONFIG_ESP_TASK_WDT` - the TWDT is initialized automatically during startup. If this option is disabled, it is still possible to initialize the Task WDT at runtime by calling `esp_task_wdt_init()`.
- `CONFIG_ESP_TASK_WDT_CHECK_IDLE_TASK_CPU0` - Idle task is subscribed to the TWDT during startup. If this option is disabled, it is still possible to subscribe the idle task by calling `esp_task_wdt_add()` at any time.

JTAG and watchdogs While debugging using OpenOCD, the CPUs will be halted every time a breakpoint is reached. However if the watchdog timers continue to run when a breakpoint is encountered, they will eventually trigger a reset making it very difficult to debug code. Therefore OpenOCD will disable the hardware timers of both the interrupt and task watchdogs at every breakpoint. Moreover, OpenOCD will not reenale them upon leaving the breakpoint. This means that interrupt watchdog and task watchdog functionality will essentially be disabled. No warnings or panics from either watchdogs will be generated when the ESP32-C3 is connected to OpenOCD via JTAG.

Interrupt Watchdog API Reference

Header File

- [esp_common/include/esp_int_wdt.h](#)

Functions

void `esp_int_wdt_init` (void)

Initialize the non-CPU-specific parts of interrupt watchdog. This is called in the init code if the interrupt watchdog is enabled in menuconfig.

Task Watchdog API Reference

A full example using the Task Watchdog is available in esp-idf: [system/task_watchdog](#)

Header File

- [esp_common/include/esp_task_wdt.h](#)

Functions

`esp_err_t esp_task_wdt_init` (uint32_t *timeout*, bool *panic*)

Initialize the Task Watchdog Timer (TWDT)

This function configures and initializes the TWDT. If the TWDT is already initialized when this function is called, this function will update the TWDT's timeout period and panic configurations instead. After initializing the TWDT, any task can elect to be watched by the TWDT by subscribing to it using `esp_task_wdt_add()`.

Return

- `ESP_OK`: Initialization was successful
- `ESP_ERR_NO_MEM`: Initialization failed due to lack of memory

Note `esp_task_wdt_init()` must only be called after the scheduler started

Parameters

- [in] `timeout`: Timeout period of TWDT in seconds
- [in] `panic`: Flag that controls whether the panic handler will be executed when the TWDT times out

***esp_err_t* esp_task_wdt_deinit** (void)

Deinitialize the Task Watchdog Timer (TWDT)

This function will deinitialize the TWDT. Calling this function whilst tasks are still subscribed to the TWDT, or when the TWDT is already deinitialized, will result in an error code being returned.

Return

- ESP_OK: TWDT successfully deinitialized
- ESP_ERR_INVALID_STATE: Error, tasks are still subscribed to the TWDT
- ESP_ERR_NOT_FOUND: Error, TWDT has already been deinitialized

***esp_err_t* esp_task_wdt_add** (*TaskHandle_t* handle)

Subscribe a task to the Task Watchdog Timer (TWDT)

This function subscribes a task to the TWDT. Each subscribed task must periodically call `esp_task_wdt_reset()` to prevent the TWDT from elapsing its timeout period. Failure to do so will result in a TWDT timeout. If the task being subscribed is one of the Idle Tasks, this function will automatically enable `esp_task_wdt_reset()` to be called from the Idle Hook of the Idle Task. Calling this function whilst the TWDT is uninitialized or attempting to subscribe an already subscribed task will result in an error code being returned.

Return

- ESP_OK: Successfully subscribed the task to the TWDT
- ESP_ERR_INVALID_ARG: Error, the task is already subscribed
- ESP_ERR_NO_MEM: Error, could not subscribe the task due to lack of memory
- ESP_ERR_INVALID_STATE: Error, the TWDT has not been initialized yet

Parameters

- [in] handle: Handle of the task. Input NULL to subscribe the current running task to the TWDT

***esp_err_t* esp_task_wdt_reset** (void)

Reset the Task Watchdog Timer (TWDT) on behalf of the currently running task.

This function will reset the TWDT on behalf of the currently running task. Each subscribed task must periodically call this function to prevent the TWDT from timing out. If one or more subscribed tasks fail to reset the TWDT on their own behalf, a TWDT timeout will occur. If the IDLE tasks have been subscribed to the TWDT, they will automatically call this function from their idle hooks. Calling this function from a task that has not subscribed to the TWDT, or when the TWDT is uninitialized will result in an error code being returned.

Return

- ESP_OK: Successfully reset the TWDT on behalf of the currently running task
- ESP_ERR_NOT_FOUND: Error, the current running task has not subscribed to the TWDT
- ESP_ERR_INVALID_STATE: Error, the TWDT has not been initialized yet

***esp_err_t* esp_task_wdt_delete** (*TaskHandle_t* handle)

Unsubscribes a task from the Task Watchdog Timer (TWDT)

This function will unsubscribe a task from the TWDT. After being unsubscribed, the task should no longer call `esp_task_wdt_reset()`. If the task is an IDLE task, this function will automatically disable the calling of `esp_task_wdt_reset()` from the Idle Hook. Calling this function whilst the TWDT is uninitialized or attempting to unsubscribe an already unsubscribed task from the TWDT will result in an error code being returned.

Return

- ESP_OK: Successfully unsubscribed the task from the TWDT
- ESP_ERR_INVALID_ARG: Error, the task is already unsubscribed
- ESP_ERR_INVALID_STATE: Error, the TWDT has not been initialized yet

Parameters

- [in] handle: Handle of the task. Input NULL to unsubscribe the current running task.

***esp_err_t* esp_task_wdt_status** (*TaskHandle_t* handle)

Query whether a task is subscribed to the Task Watchdog Timer (TWDT)

This function will query whether a task is currently subscribed to the TWDT, or whether the TWDT is initialized.

Return :

- **ESP_OK:** The task is currently subscribed to the TWDT
- **ESP_ERR_NOT_FOUND:** The task is currently not subscribed to the TWDT
- **ESP_ERR_INVALID_STATE:** The TWDT is not initialized, therefore no tasks can be subscribed

Parameters

- `[in] handle`: Handle of the task. Input NULL to query the current running task.

2.7.23 System Time

Overview

System time can be kept using either one time source or two time sources simultaneously. The choice depends on the application purpose and accuracy requirements for system time.

There are the following two time sources:

- **RTC timer:** Allows keeping the system time during any resets and sleep modes, only the power-up reset leads to resetting the RTC timer. The frequency deviation depends on an *RTC Clock Source* and affects accuracy only in sleep modes, in which case the time will be measured at 6.6667 us resolution.
- **High-resolution timer:** Not available during any reset and sleep modes. The reason for using this timer is to achieve greater accuracy. It uses the APB_CLK clock source (typically 80 MHz), which has a frequency deviation of less than ± 10 ppm. Time will be measured at 1 us resolution.

The settings for the system time source are as follows:

- RTC and high-resolution timer (default)
- RTC
- High-resolution timer
- None

It is recommended to stick to the default setting which provides maximum accuracy. If you want to choose a different timer, configure `CONFIG_ESP32C3_TIME_SYSCALL` in project configuration.

RTC Clock Source

The RTC timer has the following clock sources:

- **Internal 150kHz RC oscillator (default):** Features lowest deep sleep current consumption and no dependence on any external components. However, as frequency stability is affected by temperature fluctuations, time may drift in both Deep and Light sleep modes.
- **External 32kHz crystal:** Requires a 32kHz crystal to be connected to the 32K_XP and 32K_XN pins. Provides better frequency stability at the expense of slightly higher (by 1 uA) Deep sleep current consumption.
- **External 32kHz oscillator at 32K_XN pin:** Allows using 32kHz clock generated by an external circuit. The external clock signal must be connected to the 32K_XN pin. The amplitude should be less than 1.2 V for sine wave signal and less than 1 V for square wave signal. Common mode voltage should be in the range of $0.1 < V_{cm} < 0.5 \times V_{amp}$, where V_{amp} is signal amplitude. Additionally, a 1 nF capacitor must be placed between the 32K_XP pin and ground. In this case, the 32K_XP pin cannot be used as a GPIO pin.
- **Internal 8.5MHz oscillator, divided by 256 (~33kHz):** Provides better frequency stability than the internal 150kHz RC oscillator at the expense of higher (by 5 uA) deep sleep current consumption. It also does not require external components.

The choice depends on your requirements for system time accuracy and power consumption in sleep modes. To modify the RTC clock source, set `CONFIG_ESP32C3_RTC_CLK_SRC` in project configuration.

More details on wiring requirements for the External 32kHz crystal and External 32kHz oscillator at 32K_XN pin sources can be found in Section *Crystal Oscillator* of [ESP32 Hardware Design Guidelines](#).

Get Current Time

To get the current time, use the POSIX function `gettimeofday()`. Additionally, you can use the following standard C library functions to obtain time and manipulate it:

```
gettimeofday
time
asctime
clock
ctime
difftime
gmtime
localtime
mktime
strftime
adjtime*
```

* -To stop smooth time adjustment and update the current time immediately, use the POSIX function `settimeofday()`.

If you need to obtain time with one second resolution, use the following method:

```
time_t now;
char strftime_buf[64];
struct tm timeinfo;

time(&now);
// Set timezone to China Standard Time
setenv("TZ", "CST-8", 1);
tzset();

localtime_r(&now, &timeinfo);
strftime(strftime_buf, sizeof(strftime_buf), "%c", &timeinfo);
ESP_LOGI(TAG, "The current date/time in Shanghai is: %s", strftime_buf);
```

If you need to obtain time with one microsecond resolution, use the code snippet below:

```
struct timeval tv_now;
gettimeofday(&tv_now, NULL);
int64_t time_us = (int64_t)tv_now.tv_sec * 1000000L + (int64_t)tv_now.tv_usec;
```

SNTP Time Synchronization

To set the current time, you can use the POSIX functions `settimeofday()` and `adjtime()`. They are used internally in the lwIP SNTP library to set current time when a response from the NTP server is received. These functions can also be used separately from the lwIP SNTP library.

A function to use inside the lwIP SNTP library depends on a sync mode for system time. Use the function `sntp_set_sync_mode()` to set one of the following sync modes:

- `SNTP_SYNC_MODE_IMMED` (default) updates system time immediately upon receiving a response from the SNTP server after using `settimeofday()`.
- `SNTP_SYNC_MODE_SMOOTH` updates time smoothly by gradually reducing time error using the function `adjtime()`. If the difference between the SNTP response time and system time is more than 35 minutes, update system time immediately by using `settimeofday()`.

The lwIP SNTP library has API functions for setting a callback function for a certain event. You might need the following functions:

- `sntp_set_time_sync_notification_cb()` - use it for setting a callback function that will notify of the time synchronization process

- `sntp_get_sync_status()` and `sntp_set_sync_status()` - use it to get/set time synchronization status

To start synchronization via SNTP, just call the following three functions.

```
sntp_setoperatingmode (SNTP_OPMODE_POLL);
sntp_setservername(0, "pool.ntp.org");
sntp_init();
```

An application with this initialization code will periodically synchronize the time. The time synchronization period is determined by `CONFIG_LWIP_SNTP_UPDATE_DELAY` (default value is one hour). To modify the variable, set `CONFIG_LWIP_SNTP_UPDATE_DELAY` in project configuration.

A code example that demonstrates the implementation of time synchronization based on the lwIP SNTP library is provided in `protocols/sntp` directory.

Timezones

To set local timezone, use the following POSIX functions:

1. Call `setenv()` to set the TZ environment variable to the correct value depending on the device location. The format of the time string is the same as described in the [GNU libc documentation](#) (although the implementation is different).
2. Call `tzset()` to update C library runtime data for the new time zone.

Once these steps are completed, call the standard C library function `localtime()`, and it will return correct local time taking into account the time zone offset and daylight saving time.

API Reference

Header File

- `lwip/include/apps/esp_sntp.h`

Functions

void `sntp_sync_time` (`struct timeval *tv`)

This function updates the system time.

This is a weak-linked function. It is possible to replace all SNTP update functionality by placing a `sntp_sync_time()` function in the app firmware source. If the default implementation is used, calling `sntp_set_sync_mode()` allows the time synchronization mode to be changed to instant or smooth. If a callback function is registered via `sntp_set_time_sync_notification_cb()`, it will be called following time synchronization.

Parameters

- `tv`: Time received from SNTP server.

void `sntp_set_sync_mode` (`sntp_sync_mode_t sync_mode`)

Set the sync mode.

Allowable two mode: `SNTP_SYNC_MODE_IMMED` and `SNTP_SYNC_MODE_SMOOTH`.

Parameters

- `sync_mode`: Sync mode.

`sntp_sync_mode_t` `sntp_get_sync_mode` (void)

Get set sync mode.

Return `SNTP_SYNC_MODE_IMMED`: Update time immediately. `SNTP_SYNC_MODE_SMOOTH`: Smooth time updating.

sntp_sync_status_t **sntp_get_sync_status** (void)

Get status of time sync.

After the update is completed, the status will be returned as `SNTP_SYNC_STATUS_COMPLETED`. After that, the status will be reset to `SNTP_SYNC_STATUS_RESET`. If the update operation is not completed yet, the status will be `SNTP_SYNC_STATUS_RESET`. If a smooth mode was chosen and the synchronization is still continuing (adjtime works), then it will be `SNTP_SYNC_STATUS_IN_PROGRESS`.

Return `SNTP_SYNC_STATUS_RESET`: Reset status. `SNTP_SYNC_STATUS_COMPLETED`: Time is synchronized. `SNTP_SYNC_STATUS_IN_PROGRESS`: Smooth time sync in progress.

void **sntp_set_sync_status** (*sntp_sync_status_t* sync_status)

Set status of time sync.

Parameters

- sync_status: status of time sync (see `sntp_sync_status_t`)

void **sntp_set_time_sync_notification_cb** (*sntp_sync_time_cb_t* callback)

Set a callback function for time synchronization notification.

Parameters

- callback: a callback function

void **sntp_set_sync_interval** (uint32_t interval_ms)

Set the sync interval of SNTP operation.

Note: SNTPv4 RFC 4330 enforces a minimum sync interval of 15 seconds. This sync interval will be used in the next attempt update time through SNTP. To apply the new sync interval call the `sntp_restart()` function, otherwise, it will be applied after the last interval expired.

Parameters

- interval_ms: The sync interval in ms. It cannot be lower than 15 seconds, otherwise 15 seconds will be set.

uint32_t **sntp_get_sync_interval** (void)

Get the sync interval of SNTP operation.

Return the sync interval

bool **sntp_restart** (void)

Restart SNTP.

Return True - Restart False - SNTP was not initialized yet

Type Definitions

typedef void (**sntp_sync_time_cb_t*) (**struct** timeval *tv)

SNTP callback function for notifying about time sync event.

Parameters

- tv: Time received from SNTP server.

Enumerations

enum *sntp_sync_mode_t*

SNTP time update mode.

Values:

SNTP_SYNC_MODE_IMMED

Update system time immediately when receiving a response from the SNTP server.

SNTP_SYNC_MODE_SMOOTH

Smooth time updating. Time error is gradually reduced using adjtime function. If the difference between SNTP response time and system time is large (more than 35 minutes) then update immediately.

enum sntp_sync_status_t

SNTP sync status.

*Values:***SNTP_SYNC_STATUS_RESET****SNTP_SYNC_STATUS_COMPLETED****SNTP_SYNC_STATUS_IN_PROGRESS**

2.7.24 Internal and Unstable APIs

This section is listing some APIs that are internal or likely to be changed or removed in the next releases of ESP-IDF.

API Reference

Header File

- [esp_rom/include/esp_rom_sys.h](#)

Functions

int esp_rom_printf (**const** char **fmt*, ...)

Print formatted string to console device.

Note float and long long data are not supported!**Return** int: Total number of characters written on success; A negative number on failure.**Parameters**

- *fmt*: Format string
- . . . : Additional arguments, depending on the format string

void esp_rom_delay_us (uint32_t *us*)Pauses execution for *us* microseconds.**Parameters**

- *us*: Number of microseconds to pause

void esp_rom_install_channel_putc (int *channel*, void (**putc*)) char *c**esp_rom_printf* can print message to different channels simultaneously. This function can help install the low level *putc* function for *esp_rom_printf*.**Parameters**

- *channel*: Channel number (starting from 1)
- *putc*: Function pointer to the *putc* implementation. Set NULL can disconnect *esp_rom_printf* with *putc*.

void esp_rom_disable_logging (void)

Disable logging from the ROM code.

void esp_rom_install_uart_printf (void)Install UART1 as the default console channel, equivalent to `esp_rom_install_channel_putc(1, esp_rom_uart_putc)`

Code examples for this API section are provided in the [system](#) directory of ESP-IDF examples.

2.8 Project Configuration

2.8.1 Introduction

ESP-IDF uses [kconfiglib](#) which is a Python-based extension to the [Kconfig](#) system which provides a compile-time project configuration mechanism. Kconfig is based around options of several types: integer, string, boolean. Kconfig

files specify dependencies between options, default values of the options, the way the options are grouped together, etc.

For the complete list of available features please see [Kconfig](#) and [kconfiglib extensions](#).

2.8.2 Project Configuration Menu

Application developers can open a terminal-based project configuration menu with the `idf.py menuconfig` build target.

After being updated, this configuration is saved inside `sdkconfig` file in the project root directory. Based on `sd-kconfig`, application build targets will generate `sdkconfig.h` file in the build directory, and will make `sdkconfig` options available to the project build system and source files.

(For the legacy GNU Make build system, the project configuration menu is opened with `make menuconfig`.)

2.8.3 Using `sdkconfig.defaults`

In some cases, such as when `sdkconfig` file is under revision control, the fact that `sdkconfig` file gets changed by the build system may be inconvenient. The build system offers a way to avoid this, in the form of `sdkconfig.defaults` file. This file is never touched by the build system, and must be created manually. It can contain all the options which matter for the given application. The format is the same as that of the `sdkconfig` file. Once `sdkconfig.defaults` is created, `sdkconfig` can be deleted and added to the ignore list of the revision control system (e.g. `.gitignore` file for git). Project build targets will automatically create `sdkconfig` file, populated with the settings from `sdkconfig.defaults` file, and the rest of the settings will be set to their default values. Note that the build process will not override settings that are already in `sdkconfig` by ones from `sdkconfig.defaults`. For more information, see [Custom `sdkconfig.defaults`](#).

2.8.4 Kconfig Formatting Rules

The following attributes of `Kconfig` files are standardized:

- Within any menu, option names should have a consistent prefix. The prefix length is currently set to at least 3 characters.
- The indentation style is 4 characters created by spaces. All sub-items belonging to a parent item are indented by one level deeper. For example, `menu` is indented by 0 characters, the `config` inside of the menu by 4 characters, the `help` of the `config` by 8 characters and the text of the `help` by 12 characters.
- No trailing spaces are allowed at the end of the lines.
- The maximum length of options is set to 40 characters.
- The maximum length of lines is set to 120 characters.
- Lines cannot be wrapped by backslash (because there is a bug in earlier versions of `conf-idf` which causes that Windows line endings are not recognized after a backslash).

Format checker

`tools/check_kconfigs.py` is provided for checking the `Kconfig` formatting rules. The checker checks all `Kconfig` and `Kconfig.projbuild` files in the ESP-IDF directory and generates a new file with suffix `.new` with some recommendations how to fix issues (if there are any). Please note that the checker cannot correct all rules and the responsibility of the developer is to check and make final corrections in order to pass the tests. For example, indentations will be corrected if there isn't some misleading previous formatting but it cannot come up with a common prefix for options inside a menu.

2.8.5 Backward Compatibility of Kconfig Options

The standard **Kconfig** tools ignore unknown options in `sdkconfig`. So if a developer has custom settings for options which are renamed in newer ESP-IDF releases then the given setting for the option would be silently ignored. Therefore, several features have been adopted to avoid this:

1. `confgen.py` is used by the tool chain to pre-process `sdkconfig` files before anything else, for example `menuconfig`, would read them. As the consequence, the settings for old options will be kept and not ignored.
2. `confgen.py` recursively finds all `sdkconfig.rename` files in ESP-IDF directory which contain old and new **Kconfig** option names. Old options are replaced by new ones in the `sdkconfig` file.
3. `confgen.py` post-processes `sdkconfig` files and generates all build outputs (`sdkconfig.h`, `sdkconfig.cmake`, `auto.conf`) by adding a list of compatibility statements, i.e. value of the old option is set the value of the new option (after modification). This is done in order to not break customer codes where old option might still be used.
4. *Deprecated options and their replacements* are automatically generated by `confgen.py`.

2.8.6 Configuration Options Reference

Subsequent sections contain the list of available ESP-IDF options, automatically generated from **Kconfig** files. Note that depending on the options selected, some options listed here may not be visible by default in the interface of `menuconfig`.

By convention, all option names are upper case with underscores. When **Kconfig** generates `sdkconfig` and `sdkconfig.h` files, option names are prefixed with `CONFIG_`. So if an option `ENABLE_FOO` is defined in a **Kconfig** file and selected in `menuconfig`, then `sdkconfig` and `sdkconfig.h` files will have `CONFIG_ENABLE_FOO` defined. In this reference, option names are also prefixed with `CONFIG_`, same as in the source code.

SDK tool configuration

Contains:

- `CONFIG_SDK_MAKE_WARN_UNDEFINED_VARIABLES`
- `CONFIG_SDK_TOOLPREFIX`
- `CONFIG_SDK_PYTHON`
- `CONFIG_SDK_TOOLCHAIN_SUPPORTS_TIME_WIDE_64_BITS`

CONFIG_SDK_TOOLPREFIX

Compiler toolchain path/prefix

Found in: [SDK tool configuration](#)

The prefix/path that is used to call the toolchain. The default setting assumes a `cross-tool-ng` gcc setup that is in your `PATH`.

Default value:

- “riscv32-esp-elf- “

CONFIG_SDK_PYTHON

Python interpreter

Found in: [SDK tool configuration](#)

The executable name/path that is used to run python.

(Note: This option is used with the legacy GNU Make build system only.)

Default value:

- “python”

CONFIG_SDK_MAKE_WARN_UNDEFINED_VARIABLES

‘make’ warns on undefined variables

Found in: SDK tool configuration

Adds `--warn-undefined-variables` to `MAKEFLAGS`. This causes make to print a warning any time an undefined variable is referenced.

This option helps find places where a variable reference is misspelled or otherwise missing, but it can be unwanted if you have Makefiles which depend on undefined variables expanding to an empty string.

(Note: this option is used with the legacy GNU Make build system only.)

Default value:

- Yes (enabled)

CONFIG_SDK_TOOLCHAIN_SUPPORTS_TIME_WIDE_64_BITS

Toolchain supports `time_t` wide 64-bits

Found in: SDK tool configuration

Enable this option in case you have a custom toolchain which supports `time_t` wide 64-bits. This option checks `time_t` is 64-bits and disables ROM time functions to use the time functions from the toolchain instead. This option allows resolving the Y2K38 problem. See “Setup Linux Toolchain from Scratch” to build a custom toolchain which supports 64-bits `time_t`.

Note: ESP-IDF does not currently come with any pre-compiled toolchain that supports 64-bit wide `time_t`. This will change in a future major release, but currently 64-bit `time_t` requires a custom built toolchain.

Default value:

- No (disabled)

Build type

Contains:

- [CONFIG_APP_BUILD_TYPE](#)

CONFIG_APP_BUILD_TYPE

Application build type

Found in: Build type

Select the way the application is built.

By default, the application is built as a binary file in a format compatible with the ESP-IDF bootloader. In addition to this application, 2nd stage bootloader is also built. Application and bootloader binaries can be written into flash and loaded/executed from there.

Another option, useful for only very small and limited applications, is to only link the `.elf` file of the application, such that it can be loaded directly into RAM over JTAG. Note that since IRAM and DRAM sizes are very limited, it is not possible to build any complex application this way. However for kinds of testing and debugging, this option may provide faster iterations, since the application does not need to be written into flash. Note that at the moment, ESP-IDF does not contain all the startup code required to initialize the CPUs and ROM memory (`data/bss`). Therefore it is necessary to execute a bit of ROM code prior to executing the application. A `gdbinit` file may look as follows (for ESP32):

```
# Connect to a running instance of OpenOCD target remote :3333 # Reset and halt the target
mon reset halt # Run to a specific point in ROM code, # where most of initialization is
complete. thb *0x40007d54 c # Load the application into RAM load # Run till app_main tb
app_main c
```

Execute this gdbinit file as follows:

```
xtensa-esp32-elf-gdb build/app-name.elf -x gdbinit
```

Example gdbinit files for other targets can be found in `tools/test_apps/system/gdb_loadable_elf/`

Recommended `sdkconfig.defaults` for building loadable ELF files is as follows. `CONFIG_APP_BUILD_TYPE_ELF_RAM` is required, other options help reduce application memory footprint.

```
CONFIG_APP_BUILD_TYPE_ELF_RAM=y CONFIG_VFS_SUPPORT_TERMIOS=  
CONFIG_NEWLIB_NANO_FORMAT=y CONFIG_ESP_SYSTEM_PANIC_PRINT_HALT=y  
CONFIG_ESP_DEBUG_STUBS_ENABLE= CONFIG_ESP_ERR_TO_NAME_LOOKUP=
```

Available options:

- Default (binary application + 2nd stage bootloader) (`APP_BUILD_TYPE_APP_2NDBOOT`)
- ELF file, loadable into RAM (EXPERIMENTAL)) (`APP_BUILD_TYPE_ELF_RAM`)

Application manager

Contains:

- [*CONFIG_APP_EXCLUDE_PROJECT_NAME_VAR*](#)
- [*CONFIG_APP_EXCLUDE_PROJECT_VER_VAR*](#)
- [*CONFIG_APP_PROJECT_VER_FROM_CONFIG*](#)
- [*CONFIG_APP_RETRIEVE_LEN_ELF_SHA*](#)
- [*CONFIG_APP_COMPILE_TIME_DATE*](#)

CONFIG_APP_COMPILE_TIME_DATE

Use time/date stamp for app

Found in: [Application manager](#)

If set, then the app will be built with the current time/date stamp. It is stored in the app description structure. If not set, time/date stamp will be excluded from app image. This can be useful for getting the same binary image files made from the same source, but at different times.

Default value:

- Yes (enabled)

CONFIG_APP_EXCLUDE_PROJECT_VER_VAR

Exclude `PROJECT_VER` from firmware image

Found in: [Application manager](#)

The `PROJECT_VER` variable from the build system will not affect the firmware image. This value will not be contained in the `esp_app_desc` structure.

Default value:

- No (disabled)

CONFIG_APP_EXCLUDE_PROJECT_NAME_VAR

Exclude `PROJECT_NAME` from firmware image

Found in: [Application manager](#)

The `PROJECT_NAME` variable from the build system will not affect the firmware image. This value will not be contained in the `esp_app_desc` structure.

Default value:

- No (disabled)

CONFIG_APP_PROJECT_VER_FROM_CONFIG

Get the project version from Kconfig

Found in: Application manager

If this is enabled, then config item APP_PROJECT_VER will be used for the variable PROJECT_VER. Other ways to set PROJECT_VER will be ignored.

Default value:

- No (disabled)

CONFIG_APP_PROJECT_VER

Project version

Found in: Application manager > CONFIG_APP_PROJECT_VER_FROM_CONFIG

Project version

Default value:

- 1 if *CONFIG_APP_PROJECT_VER_FROM_CONFIG*

CONFIG_APP_RETRIEVE_LEN_ELF_SHA

The length of APP ELF SHA is stored in RAM(chars)

Found in: Application manager

At startup, the app will read this many hex characters from the embedded APP ELF SHA-256 hash value and store it in static RAM. This ensures the app ELF SHA-256 value is always available if it needs to be printed by the panic handler code. Changing this value will change the size of a static buffer, in bytes.

Range:

- from 8 to 64

Default value:

- 16

Bootloader config

Contains:

- *CONFIG_BOOTLOADER_LOG_LEVEL*
- *CONFIG_BOOTLOADER_COMPILER_OPTIMIZATION*
- *CONFIG_BOOTLOADER_APP_ROLLBACK_ENABLE*
- *CONFIG_BOOTLOADER_FLASH_XMC_SUPPORT*
- *CONFIG_BOOTLOADER_APP_TEST*
- *CONFIG_BOOTLOADER_FACTORY_RESET*
- *CONFIG_BOOTLOADER_HOLD_TIME_GPIO*
- *CONFIG_BOOTLOADER_CUSTOM_RESERVE_RTC*
- *CONFIG_BOOTLOADER_SKIP_VALIDATE_ALWAYS*
- *CONFIG_BOOTLOADER_SKIP_VALIDATE_ON_POWER_ON*
- *CONFIG_BOOTLOADER_SKIP_VALIDATE_IN_DEEP_SLEEP*
- *CONFIG_BOOTLOADER_WDT_ENABLE*
- *CONFIG_BOOTLOADER_VDDSDIO_BOOST*

CONFIG_BOOTLOADER_COMPILER_OPTIMIZATION

Bootloader optimization Level

Found in: [Bootloader config](#)

This option sets compiler optimization level (gcc -O argument) for the bootloader.

- The default “Size” setting will add the -Os flag to CFLAGS.
- The “Debug” setting will add the -Og flag to CFLAGS.
- The “Performance” setting will add the -O2 flag to CFLAGS.
- The “None” setting will add the -O0 flag to CFLAGS.

Note that custom optimization levels may be unsupported.

Available options:

- Size (-Os) (BOOTLOADER_COMPILER_OPTIMIZATION_SIZE)
- Debug (-Og) (BOOTLOADER_COMPILER_OPTIMIZATION_DEBUG)
- Optimize for performance (-O2) (BOOTLOADER_COMPILER_OPTIMIZATION_PERF)
- Debug without optimization (-O0) (BOOTLOADER_COMPILER_OPTIMIZATION_NONE)

CONFIG_BOOTLOADER_LOG_LEVEL

Bootloader log verbosity

Found in: [Bootloader config](#)

Specify how much output to see in bootloader logs.

Available options:

- No output (BOOTLOADER_LOG_LEVEL_NONE)
- Error (BOOTLOADER_LOG_LEVEL_ERROR)
- Warning (BOOTLOADER_LOG_LEVEL_WARN)
- Info (BOOTLOADER_LOG_LEVEL_INFO)
- Debug (BOOTLOADER_LOG_LEVEL_DEBUG)
- Verbose (BOOTLOADER_LOG_LEVEL_VERBOSE)

CONFIG_BOOTLOADER_VDDSDIO_BOOST

VDDSDIO LDO voltage

Found in: [Bootloader config](#)

If this option is enabled, and VDDSDIO LDO is set to 1.8V (using eFuse or MTDI bootstrapping pin), bootloader will change LDO settings to output 1.9V instead. This helps prevent flash chip from browning out during flash programming operations.

This option has no effect if VDDSDIO is set to 3.3V, or if the internal VDDSDIO regulator is disabled via eFuse.

Available options:

- 1.8V (BOOTLOADER_VDDSDIO_BOOST_1_8V)
- 1.9V (BOOTLOADER_VDDSDIO_BOOST_1_9V)

CONFIG_BOOTLOADER_FACTORY_RESET

GPIO triggers factory reset

Found in: [Bootloader config](#)

Allows to reset the device to factory settings: - clear one or more data partitions; - boot from “factory” partition. The factory reset will occur if there is a GPIO input pulled low while device starts up. See settings below.

Default value:

- No (disabled)

CONFIG_BOOTLOADER_NUM_PIN_FACTORY_RESET

Number of the GPIO input for factory reset

Found in: [Bootloader config](#) > [CONFIG_BOOTLOADER_FACTORY_RESET](#)

The selected GPIO will be configured as an input with internal pull-up enabled. To trigger a factory reset, this GPIO must be pulled low on reset. Note that GPIO34-39 do not have an internal pullup and an external one must be provided.

Default value:

- 4 if [CONFIG_BOOTLOADER_FACTORY_RESET](#)

CONFIG_BOOTLOADER_OTA_DATA_ERASE

Clear OTA data on factory reset (select factory partition)

Found in: [Bootloader config](#) > [CONFIG_BOOTLOADER_FACTORY_RESET](#)

The device will boot from “factory” partition (or OTA slot 0 if no factory partition is present) after a factory reset.

CONFIG_BOOTLOADER_DATA_FACTORY_RESET

Comma-separated names of partitions to clear on factory reset

Found in: [Bootloader config](#) > [CONFIG_BOOTLOADER_FACTORY_RESET](#)

Allows customers to select which data partitions will be erased while factory reset.

Specify the names of partitions as a comma-delimited with optional spaces for readability. (Like this: “nvs, phy_init, …”) Make sure that the name specified in the partition table and here are the same. Partitions of type “app” cannot be specified here.

Default value:

- “nvs” if [CONFIG_BOOTLOADER_FACTORY_RESET](#)

CONFIG_BOOTLOADER_APP_TEST

GPIO triggers boot from test app partition

Found in: [Bootloader config](#)

Allows to run the test app from “TEST” partition. A boot from “test” partition will occur if there is a GPIO input pulled low while device starts up. See settings below.

Default value:

- No (disabled) if [CONFIG_BOOTLOADER_APP_ANTI_ROLLBACK](#)

CONFIG_BOOTLOADER_NUM_PIN_APP_TEST

Number of the GPIO input to boot TEST partition

Found in: [Bootloader config](#) > [CONFIG_BOOTLOADER_APP_TEST](#)

The selected GPIO will be configured as an input with internal pull-up enabled. To trigger a test app, this GPIO must be pulled low on reset. After the GPIO input is deactivated and the device reboots, the old application will boot. (factory or OTA[x]). Note that GPIO34-39 do not have an internal pullup and an external one must be provided.

Range:

- from 0 to 39 if [CONFIG_BOOTLOADER_APP_TEST](#)

Default value:

- 18 if `CONFIG_BOOTLOADER_APP_TEST`

CONFIG_BOOTLOADER_HOLD_TIME_GPIO

Hold time of GPIO for reset/test mode (seconds)

Found in: [Bootloader config](#)

The GPIO must be held low continuously for this period of time after reset before a factory reset or test partition boot (as applicable) is performed.

Default value:

- 5 if `CONFIG_BOOTLOADER_FACTORY_RESET` || `CONFIG_BOOTLOADER_APP_TEST`

CONFIG_BOOTLOADER_WDT_ENABLE

Use RTC watchdog in start code

Found in: [Bootloader config](#)

Tracks the execution time of startup code. If the execution time is exceeded, the RTC_WDT will restart system. It is also useful to prevent a lock up in start code caused by an unstable power source. NOTE: Tracks the execution time starts from the bootloader code - re-set timeout, while selecting the source for slow_clk - and ends calling app_main. Re-set timeout is needed due to WDT uses a SLOW_CLK clock source. After changing a frequency slow_clk a time of WDT needs to re-set for new frequency. slow_clk depends on ESP32_RTC_CLK_SRC (INTERNAL_RC or EXTERNAL_CRYSTAL).

Default value:

- Yes (enabled)

CONFIG_BOOTLOADER_WDT_DISABLE_IN_USER_CODE

Allows RTC watchdog disable in user code

Found in: [Bootloader config](#) > `CONFIG_BOOTLOADER_WDT_ENABLE`

If it is set, the client must itself reset or disable rtc_wdt in their code (app_main()). Otherwise rtc_wdt will be disabled before calling app_main function. Use function rtc_wdt_feed() for resetting counter of rtc_wdt. Use function rtc_wdt_disable() for disabling rtc_wdt.

Default value:

- No (disabled)

CONFIG_BOOTLOADER_WDT_TIME_MS

Timeout for RTC watchdog (ms)

Found in: [Bootloader config](#) > `CONFIG_BOOTLOADER_WDT_ENABLE`

Verify that this parameter is correct and more then the execution time. Pay attention to options such as reset to factory, trigger test partition and encryption on boot - these options can increase the execution time. Note: RTC_WDT will reset while encryption operations will be performed.

Range:

- from 0 to 120000

Default value:

- 9000

CONFIG_BOOTLOADER_APP_ROLLBACK_ENABLE

Enable app rollback support

Found in: [Bootloader config](#)

After updating the app, the bootloader runs a new app with the “ESP_OTA_IMG_PENDING_VERIFY” state set. This state prevents the re-run of this app. After the first boot of the new app in the user code, the function should be called to confirm the operability of the app or vice versa about its non-operability. If the app is working, then it is marked as valid. Otherwise, it is marked as not valid and rolls back to the previous working app. A reboot is performed, and the app is booted before the software update. Note: If during the first boot a new app the power goes out or the WDT works, then roll back will happen. Rollback is possible only between the apps with the same security versions.

Default value:

- No (disabled)

CONFIG_BOOTLOADER_APP_ANTI_ROLLBACK

Enable app anti-rollback support

Found in: [Bootloader config](#) > [CONFIG_BOOTLOADER_APP_ROLLBACK_ENABLE](#)

This option prevents rollback to previous firmware/application image with lower security version.

Default value:

- No (disabled) if [CONFIG_BOOTLOADER_APP_ROLLBACK_ENABLE](#)

CONFIG_BOOTLOADER_APP_SECURE_VERSION

eFuse secure version of app

Found in: [Bootloader config](#) > [CONFIG_BOOTLOADER_APP_ROLLBACK_ENABLE](#) > [CONFIG_BOOTLOADER_APP_ANTI_ROLLBACK](#)

The secure version is the sequence number stored in the header of each firmware. The security version is set in the bootloader, version is recorded in the eFuse field as the number of set ones. The allocated number of bits in the efuse field for storing the security version is limited (see [BOOTLOADER_APP_SEC_VER_SIZE_EFUSE_FIELD](#) option).

Bootloader: When bootloader selects an app to boot, an app is selected that has a security version greater or equal that recorded in eFuse field. The app is booted with a higher (or equal) secure version.

The security version is worth increasing if in previous versions there is a significant vulnerability and their use is not acceptable.

Your partition table should has a scheme with ota_0 + ota_1 (without factory).

Default value:

- 0 if [CONFIG_BOOTLOADER_APP_ANTI_ROLLBACK](#)

CONFIG_BOOTLOADER_APP_SEC_VER_SIZE_EFUSE_FIELD

Size of the efuse secure version field

Found in: [Bootloader config](#) > [CONFIG_BOOTLOADER_APP_ROLLBACK_ENABLE](#) > [CONFIG_BOOTLOADER_APP_ANTI_ROLLBACK](#)

The size of the efuse secure version field. Its length is limited to 32 bits for ESP32 and 16 bits for ESP32-S2. This determines how many times the security version can be increased.

Range:

- from 1 to 16 if [CONFIG_BOOTLOADER_APP_ANTI_ROLLBACK](#)

Default value:

- 16 if [CONFIG_BOOTLOADER_APP_ANTI_ROLLBACK](#)

CONFIG_BOOTLOADER_EFUSE_SECURE_VERSION_EMULATE

Emulate operations with efuse secure version(only test)

Found in: `Bootloader config > CONFIG_BOOTLOADER_APP_ROLLBACK_ENABLE > CONFIG_BOOTLOADER_APP_ANTI_ROLLBACK`

This option allow emulate read/write operations with efuse secure version. It allow to test anti-rollback implementation without permanent write eFuse bits. In partition table should be exist this partition `emul_efuse, data, 5, , 0x2000`.

Default value:

- No (disabled) if `CONFIG_BOOTLOADER_APP_ANTI_ROLLBACK`

CONFIG_BOOTLOADER_SKIP_VALIDATE_IN_DEEP_SLEEP

Skip image validation when exiting deep sleep

Found in: `Bootloader config`

This option disables the normal validation of an image coming out of deep sleep (checksums, SHA256, and signature). This is a trade-off between wakeup performance from deep sleep, and image integrity checks.

Only enable this if you know what you are doing. It should not be used in conjunction with using `deep_sleep()` entry and changing the active OTA partition as this would skip the validation upon first load of the new OTA partition.

It is possible to enable this option with Secure Boot if “allow insecure options” is enabled, however it’s strongly recommended to NOT enable it as it may allow a Secure Boot bypass.

Default value:

- No (disabled) if `(CONFIG_SECURE_BOOT && CONFIG_SECURE_BOOT_INSECURE) || CONFIG_SECURE_BOOT`

CONFIG_BOOTLOADER_SKIP_VALIDATE_ON_POWER_ON

Skip image validation from power on reset (READ HELP FIRST)

Found in: `Bootloader config`

Some applications need to boot very quickly from power on. By default, the entire app binary is read from flash and verified which takes up a significant portion of the boot time.

Enabling this option will skip validation of the app when the SoC boots from power on. Note that in this case it’s not possible for the bootloader to detect if an app image is corrupted in the flash, therefore it’s not possible to safely fall back to a different app partition. Flash corruption of this kind is unlikely but can happen if there is a serious firmware bug or physical damage.

Following other reset types, the bootloader will still validate the app image. This increases the chances that flash corruption resulting in a crash can be detected following soft reset, and the bootloader will fall back to a valid app image. To increase the chances of successfully recovering from a flash corruption event, keep the option `BOOTLOADER_WDT_ENABLE` enabled and consider also enabling `BOOTLOADER_WDT_DISABLE_IN_USER_CODE` - then manually disable the RTC Watchdog once the app is running. In addition, enable both the Task and Interrupt watchdog timers with reset options set.

Default value:

- No (disabled)

CONFIG_BOOTLOADER_SKIP_VALIDATE_ALWAYS

Skip image validation always (READ HELP FIRST)

Found in: `Bootloader config`

Selecting this option prevents the bootloader from ever validating the app image before booting it. Any flash corruption of the selected app partition will make the entire SoC unbootable.

Although flash corruption is a very rare case, it is not recommended to select this option. Consider selecting “Skip image validation from power on reset” instead. However, if boot time is the only important factor then it can be enabled.

Default value:

- No (disabled)

CONFIG_BOOTLOADER_CUSTOM_RESERVE_RTC

Reserve RTC FAST memory for custom purposes

Found in: [Bootloader config](#)

This option allows the customer to place data in the RTC FAST memory, this area remains valid when rebooted, except for power loss. This memory is located at a fixed address and is available for both the bootloader and the application. (The application and bootloader must be compiled with the same option). The RTC FAST memory has access only through PRO_CPU.

Default value:

- No (disabled)

CONFIG_BOOTLOADER_CUSTOM_RESERVE_RTC_SIZE

Size in bytes for custom purposes

Found in: [Bootloader config](#) > [CONFIG_BOOTLOADER_CUSTOM_RESERVE_RTC](#)

This option reserves in RTC FAST memory the area for custom purposes. If you want to create your own bootloader and save more information in this area of memory, you can increase it. It must be a multiple of 4 bytes. This area (`rtc_retain_mem_t`) is reserved and has access from the bootloader and an application.

Range:

- from 0 to 0x10 if [CONFIG_BOOTLOADER_CUSTOM_RESERVE_RTC](#)

Default value:

- 0 if [CONFIG_BOOTLOADER_CUSTOM_RESERVE_RTC](#)

CONFIG_BOOTLOADER_FLASH_XMC_SUPPORT

Enable the support for flash chips of XMC (READ HELP FIRST)

Found in: [Bootloader config](#)

Perform the startup flow recommended by XMC. Please consult XMC for the details of this flow. XMC chips will be forbidden to be used, when this option is disabled.

DON’ T DISABLE THIS UNLESS YOU KNOW WHAT YOU ARE DOING.

Default value:

- Yes (enabled)

Security features

Contains:

- [CONFIG_SECURE_BOOT_INSECURE](#)
- [CONFIG_SECURE_SIGNED_APPS_SCHEME](#)
- [CONFIG_SECURE_BOOT_ENABLE_AGGRESSIVE_KEY_REVOKE](#)
- [CONFIG_SECURE_FLASH_ENC_ENABLED](#)
- [CONFIG_SECURE_BOOT](#)

- *Potentially insecure options*
- `CONFIG_SECURE_SIGNED_APPS_NO_SECURE_BOOT`
- `CONFIG_SECURE_BOOT_VERIFICATION_KEY`
- `CONFIG_SECURE_BOOT_BUILD_SIGNED_BINARIES`
- `CONFIG_SECURE_UART_ROM_DL_MODE`
- `CONFIG_SECURE_SIGNED_ON_UPDATE_NO_SECURE_BOOT`

CONFIG_SECURE_SIGNED_APPS_NO_SECURE_BOOT

Require signed app images

Found in: Security features

Require apps to be signed to verify their integrity.

This option uses the same app signature scheme as hardware secure boot, but unlike hardware secure boot it does not prevent the bootloader from being physically updated. This means that the device can be secured against remote network access, but not physical access. Compared to using hardware Secure Boot this option is much simpler to implement.

CONFIG_SECURE_SIGNED_APPS_SCHEME

App Signing Scheme

Found in: Security features

Select the Secure App signing scheme. Depends on the Chip Revision. There are two options: 1. ECDSA based secure boot scheme. (Only choice for Secure Boot V1) Supported in ESP32 and ESP32-ECO3. 2. The RSA based secure boot scheme. (Only choice for Secure Boot V2) Supported in ESP32-ECO3 (ESP32 Chip Revision 3 onwards), ESP32-S2, ESP32-C3, ESP32-S3.

Available options:

- ECDSA (`SECURE_SIGNED_APPS_ECDSA_SCHEME`)
Embeds the ECDSA public key in the bootloader and signs the application with an ECDSA key.
Refer to the documentation before enabling.
- RSA (`SECURE_SIGNED_APPS_RSA_SCHEME`)
Appends the RSA-3072 based Signature block to the application. Refer to <Secure Boot Version 2 documentation link> before enabling.

CONFIG_SECURE_SIGNED_ON_UPDATE_NO_SECURE_BOOT

Verify app signature on update

Found in: Security features

If this option is set, any OTA updated apps will have the signature verified before being considered valid.

When enabled, the signature is automatically checked whenever the `esp_ota_ops.h` APIs are used for OTA updates, or `esp_image_format.h` APIs are used to verify apps.

If hardware secure boot is enabled, this option is always enabled and cannot be disabled. If hardware secure boot is not enabled, this option still adds significant security against network-based attackers by preventing spoofing of OTA updates.

Default value:

- Yes (enabled) if `CONFIG_SECURE_SIGNED_APPS_NO_SECURE_BOOT`

CONFIG_SECURE_BOOT

Enable hardware Secure Boot in bootloader (READ DOCS FIRST)

Found in: Security features

Build a bootloader which enables Secure Boot on first boot.

Once enabled, Secure Boot will not boot a modified bootloader. The bootloader will only load a partition table or boot an app if the data has a verified digital signature. There are implications for reflashing updated apps once secure boot is enabled.

When enabling secure boot, JTAG and ROM BASIC Interpreter are permanently disabled by default.

Default value:

- No (disabled)

CONFIG_SECURE_BOOT_VERSION

Select secure boot version

Found in: [Security features](#) > [CONFIG_SECURE_BOOT](#)

Select the Secure Boot Version. Depends on the Chip Revision. Secure Boot V2 is the new RSA based secure boot scheme. Supported in ESP32-ECO3 (ESP32 Chip Revision 3 onwards), ESP32-S2, ESP32-C3 ECO3. Secure Boot V1 is the AES based secure boot scheme. Supported in ESP32 and ESP32-ECO3.

Available options:

- Enable Secure Boot version 1 (SECURE_BOOT_V1_ENABLED)
Build a bootloader which enables secure boot version 1 on first boot. Refer to the Secure Boot section of the ESP-IDF Programmer's Guide for this version before enabling.
- Enable Secure Boot version 2 (SECURE_BOOT_V2_ENABLED)
Build a bootloader which enables Secure Boot version 2 on first boot. Refer to Secure Boot V2 section of the ESP-IDF Programmer's Guide for this version before enabling.

CONFIG_SECURE_BOOT_BUILD_SIGNED_BINARIES

Sign binaries during build

Found in: [Security features](#)

Once secure boot or signed app requirement is enabled, app images are required to be signed.

If enabled (default), these binary files are signed as part of the build process. The file named in "Secure boot private signing key" will be used to sign the image.

If disabled, unsigned app/partition data will be built. They must be signed manually using `espsecure.py`. Version 1 to enable ECDSA Based Secure Boot and Version 2 to enable RSA based Secure Boot. (for example, on a remote signing server.)

CONFIG_SECURE_BOOT_SIGNING_KEY

Secure boot private signing key

Found in: [Security features](#) > [CONFIG_SECURE_BOOT_BUILD_SIGNED_BINARIES](#)

Path to the key file used to sign app images.

Key file is an ECDSA private key (NIST256p curve) in PEM format for Secure Boot V1. Key file is an RSA private key in PEM format for Secure Boot V2.

Path is evaluated relative to the project directory.

You can generate a new signing key by running the following command: `espsecure.py generate_signing_key secure_boot_signing_key.pem`

See the Secure Boot section of the ESP-IDF Programmer's Guide for this version for details.

Default value:

- "secure_boot_signing_key.pem" if [CONFIG_SECURE_BOOT_BUILD_SIGNED_BINARIES](#)

CONFIG_SECURE_BOOT_VERIFICATION_KEY

Secure boot public signature verification key

Found in: Security features

Path to a public key file used to verify signed images. Secure Boot V1: This ECDSA public key is compiled into the bootloader and/or app, to verify app images. Secure Boot V2: This RSA public key is compiled into the signature block at the end of the bootloader/app.

Key file is in raw binary format, and can be extracted from a PEM formatted private key using the `espsecure.py extract_public_key` command.

Refer to the Secure Boot section of the ESP-IDF Programmer's Guide for this version before enabling.

CONFIG_SECURE_BOOT_ENABLE_AGGRESSIVE_KEY_REVOKE

Enable Aggressive key revoke strategy

Found in: Security features

If this option is set, ROM bootloader will revoke the public key digest burned in efuse block if it fails to verify the signature of software bootloader with it. Revocation of keys does not happen when enabling secure boot. Once secure boot is enabled, key revocation checks will be done on subsequent boot-up, while verifying the software bootloader

This feature provides a strong resistance against physical attacks on the device.

NOTE: Once a digest slot is revoked, it can never be used again to verify an image This can lead to permanent bricking of the device, in case all keys are revoked because of signature verification failure.

Default value:

- No (disabled) if `CONFIG_SECURE_BOOT`

CONFIG_SECURE_BOOT_INSECURE

Allow potentially insecure options

Found in: Security features

You can disable some of the default protections offered by secure boot, in order to enable testing or a custom combination of security features.

Only enable these options if you are very sure.

Refer to the Secure Boot section of the ESP-IDF Programmer's Guide for this version before enabling.

Default value:

- No (disabled) if `CONFIG_SECURE_BOOT`

CONFIG_SECURE_FLASH_ENC_ENABLED

Enable flash encryption on boot (READ DOCS FIRST)

Found in: Security features

If this option is set, flash contents will be encrypted by the bootloader on first boot.

Note: After first boot, the system will be permanently encrypted. Re-flashing an encrypted system is complicated and not always possible.

Read *Flash Encryption* before enabling.

Default value:

- No (disabled)

CONFIG_SECURE_FLASH_ENCRYPTION_MODE

Enable usage mode

Found in: *Security features* > *CONFIG_SECURE_FLASH_ENC_ENABLED*

By default Development mode is enabled which allows UART bootloader to perform flash encryption operations

Select Release mode only for production or manufacturing. Once enabled you can not reflash using UART bootloader

Refer to the Secure Boot section of the ESP-IDF Programmer's Guide for this version and *Flash Encryption* for details.

Available options:

- Development(NOT SECURE) (SECURE_FLASH_ENCRYPTION_MODE_DEVELOPMENT)
- Release (SECURE_FLASH_ENCRYPTION_MODE_RELEASE)

Potentially insecure options Contains:

- *CONFIG_SECURE_BOOT_V2_ALLOW_EFUSE_RD_DIS*
- *CONFIG_SECURE_BOOT_ALLOW_SHORT_APP_PARTITION*
- *CONFIG_SECURE_BOOT_ALLOW_JTAG*
- *CONFIG_SECURE_FLASH_UART_BOOTLOADER_ALLOW_ENC*
- *CONFIG_SECURE_FLASH_UART_BOOTLOADER_ALLOW_CACHE*
- *CONFIG_SECURE_FLASH_REQUIRE_ALREADY_ENABLED*

CONFIG_SECURE_BOOT_ALLOW_JTAG

Allow JTAG Debugging

Found in: *Security features* > *Potentially insecure options*

If not set (default), the bootloader will permanently disable JTAG (across entire chip) on first boot when either secure boot or flash encryption is enabled.

Setting this option leaves JTAG on for debugging, which negates all protections of flash encryption and some of the protections of secure boot.

Only set this option in testing environments.

Default value:

- No (disabled) if *CONFIG_SECURE_BOOT_INSECURE* || *SECURE_FLASH_ENCRYPTION_MODE_DEVELOPMENT*

CONFIG_SECURE_BOOT_ALLOW_SHORT_APP_PARTITION

Allow app partition length not 64KB aligned

Found in: *Security features* > *Potentially insecure options*

If not set (default), app partition size must be a multiple of 64KB. App images are padded to 64KB length, and the bootloader checks any trailing bytes after the signature (before the next 64KB boundary) have not been written. This is because flash cache maps entire 64KB pages into the address space. This prevents an attacker from appending unverified data after the app image in the flash, causing it to be mapped into the address space.

Setting this option allows the app partition length to be unaligned, and disables padding of the app image to this length. It is generally not recommended to set this option, unless you have a legacy partitioning scheme which doesn't support 64KB aligned partition lengths.

CONFIG_SECURE_BOOT_V2_ALLOW_EFUSE_RD_DIS

Allow additional read protecting of efuses

Found in: Security features > Potentially insecure options

If not set (default, recommended), on first boot the bootloader will burn the WR_DIS_RD_DIS efuse when Secure Boot is enabled. This prevents any more efuses from being read protected.

If this option is set, it will remain possible to write the EFUSE_RD_DIS efuse field after Secure Boot is enabled. This may allow an attacker to read-protect the BLK2 efuse (for ESP32) and BLOCK4-BLOCK10 (i.e. BLOCK_KEY0-BLOCK_KEY5)(for other chips) holding the public key digest, causing an immediate denial of service and possibly allowing an additional fault injection attack to bypass the signature protection.

NOTE: Once a BLOCK is read-protected, the application will read all zeros from that block

NOTE: If “UART ROM download mode (Permanently disabled (recommended))” or “UART ROM download mode (Permanently switch to Secure mode (recommended))” is set, then it is NOT possible to read/write efuses using esepfuse.py utility. However, efuse can be read/written from the application

CONFIG_SECURE_FLASH_UART_BOOTLOADER_ALLOW_ENC

Leave UART bootloader encryption enabled

Found in: Security features > Potentially insecure options

If not set (default), the bootloader will permanently disable UART bootloader encryption access on first boot. If set, the UART bootloader will still be able to access hardware encryption.

It is recommended to only set this option in testing environments.

Default value:

- No (disabled) if SECURE_FLASH_ENCRYPTION_MODE_DEVELOPMENT

CONFIG_SECURE_FLASH_UART_BOOTLOADER_ALLOW_CACHE

Leave UART bootloader flash cache enabled

Found in: Security features > Potentially insecure options

If not set (default), the bootloader will permanently disable UART bootloader flash cache access on first boot. If set, the UART bootloader will still be able to access the flash cache.

Only set this option in testing environments.

Default value:

- No (disabled) if SECURE_FLASH_ENCRYPTION_MODE_DEVELOPMENT

CONFIG_SECURE_FLASH_REQUIRE_ALREADY_ENABLED

Require flash encryption to be already enabled

Found in: Security features > Potentially insecure options

If not set (default), and flash encryption is not yet enabled in eFuses, the 2nd stage bootloader will enable flash encryption: generate the flash encryption key and program eFuses. If this option is set, and flash encryption is not yet enabled, the bootloader will error out and reboot. If flash encryption is enabled in eFuses, this option does not change the bootloader behavior.

Only use this option in testing environments, to avoid accidentally enabling flash encryption on the wrong device. The device needs to have flash encryption already enabled using esepfuse.py.

Default value:

- No (disabled) if SECURE_FLASH_ENCRYPTION_MODE_DEVELOPMENT

CONFIG_SECURE_UART_ROM_DL_MODE

UART ROM download mode

Found in: *Security features*

Available options:

- UART ROM download mode (Permanently disabled (recommended)) (SECURE_DISABLE_ROM_DL_MODE)
If set, during startup the app will burn an eFuse bit to permanently disable the UART ROM Download Mode. This prevents any future use of esptool.py, espfuse.py and similar tools. Once disabled, if the SoC is booted with strapping pins set for ROM Download Mode then an error is printed instead.
It is recommended to enable this option in any production application where Flash Encryption and/or Secure Boot is enabled and access to Download Mode is not required.
It is also possible to permanently disable Download Mode by calling `esp_efuse_disable_rom_download_mode()` at runtime.
- UART ROM download mode (Permanently switch to Secure mode (recommended)) (SECURE_ENABLE_SECURE_ROM_DL_MODE)
If set, during startup the app will burn an eFuse bit to permanently switch the UART ROM Download Mode into a separate Secure Download mode. This option can only work if Download Mode is not already disabled by eFuse.
Secure Download mode limits the use of Download Mode functions to simple flash read, write and erase operations, plus a command to return a summary of currently enabled security features.
Secure Download mode is not compatible with the esptool.py flasher stub feature, espfuse.py, read/writing memory or registers, encrypted download, or any other features that interact with unsupported Download Mode commands.
Secure Download mode should be enabled in any application where Flash Encryption and/or Secure Boot is enabled. Disabling this option does not immediately cancel the benefits of the security features, but it increases the potential “attack surface” for an attacker to try and bypass them with a successful physical attack.
It is also possible to enable secure download mode at runtime by calling `esp_efuse_enable_rom_secure_download_mode()`
- UART ROM download mode (Enabled (not recommended)) (SECURE_INSECURE_ALLOW_DL_MODE)
This is a potentially insecure option. Enabling this option will allow the full UART download mode to stay enabled. This option SHOULD NOT BE ENABLED for production use cases.

Serial flasher config

Contains:

- *CONFIG_ESPTOOLPY_MONITOR_BAUD*
- *CONFIG_ESPTOOLPY_AFTER*
- *CONFIG_ESPTOOLPY_BEFORE*
- *CONFIG_ESPTOOLPY_MONITOR_BAUD_OTHER_VAL*
- *CONFIG_ESPTOOLPY_BAUD*
- *CONFIG_ESPTOOLPY_PORT*
- *CONFIG_ESPTOOLPY_FLASHSIZE_DETECT*
- *CONFIG_ESPTOOLPY_NO_STUB*
- *CONFIG_ESPTOOLPY_FLASHSIZE*
- *CONFIG_ESPTOOLPY_FLASHMODE*
- *CONFIG_ESPTOOLPY_FLASHFREQ*
- *CONFIG_ESPTOOLPY_BAUD_OTHER_VAL*
- *CONFIG_ESPTOOLPY_COMPRESSED*

CONFIG_ESPTOOLPY_PORT

Default serial port

Found in: Serial flasher config

The serial port that's connected to the ESP chip. This can be overridden by setting the ESPPORT environment variable.

This value is ignored when using the CMake-based build system or idf.py.

Default value:

- “/dev/ttyUSB0”

CONFIG_ESPTOOLPY_BAUD

Default baud rate

Found in: Serial flasher config

Default baud rate to use while communicating with the ESP chip. Can be overridden by setting the ESPBAUD variable.

This value is ignored when using the CMake-based build system or idf.py.

Available options:

- 115200 baud (ESPTOOLPY_BAUD_115200B)
- 230400 baud (ESPTOOLPY_BAUD_230400B)
- 921600 baud (ESPTOOLPY_BAUD_921600B)
- 2Mbaud (ESPTOOLPY_BAUD_2MB)
- Other baud rate (ESPTOOLPY_BAUD_OTHER)

CONFIG_ESPTOOLPY_BAUD_OTHER_VAL

Other baud rate value

Found in: Serial flasher config

Default value:

- 115200

CONFIG_ESPTOOLPY_COMPRESSED

Use compressed upload

Found in: Serial flasher config

The flasher tool can send data compressed using zlib, letting the ROM on the ESP chip decompress it on the fly before flashing it. For most payloads, this should result in a speed increase.

Default value:

- Yes (enabled)

CONFIG_ESPTOOLPY_NO_STUB

Disable download stub

Found in: Serial flasher config

The flasher tool sends a precompiled download stub first by default. That stub allows things like compressed downloads and more. Usually you should not need to disable that feature

Default value:

- No (disabled)

CONFIG_ESPTOOLPY_FLASHMODE

Flash SPI mode

Found in: Serial flasher config

Mode the flash chip is flashed in, as well as the default mode for the binary to run in.

Available options:

- QIO (ESPTOOLPY_FLASHMODE_QIO)
- QOUT (ESPTOOLPY_FLASHMODE_QOUT)
- DIO (ESPTOOLPY_FLASHMODE_DIO)
- DOUT (ESPTOOLPY_FLASHMODE_DOUT)

CONFIG_ESPTOOLPY_FLASHFREQ

Flash SPI speed

Found in: Serial flasher config

The SPI flash frequency to be used.

Available options:

- 80 MHz (ESPTOOLPY_FLASHFREQ_80M)
- 40 MHz (ESPTOOLPY_FLASHFREQ_40M)
- 26 MHz (ESPTOOLPY_FLASHFREQ_26M)
- 20 MHz (ESPTOOLPY_FLASHFREQ_20M)

CONFIG_ESPTOOLPY_FLASHSIZE

Flash size

Found in: Serial flasher config

SPI flash size, in megabytes

Available options:

- 1 MB (ESPTOOLPY_FLASHSIZE_1MB)
- 2 MB (ESPTOOLPY_FLASHSIZE_2MB)
- 4 MB (ESPTOOLPY_FLASHSIZE_4MB)
- 8 MB (ESPTOOLPY_FLASHSIZE_8MB)
- 16 MB (ESPTOOLPY_FLASHSIZE_16MB)

CONFIG_ESPTOOLPY_FLASHSIZE_DETECT

Detect flash size when flashing bootloader

Found in: Serial flasher config

If this option is set, flashing the project will automatically detect the flash size of the target chip and update the bootloader image before it is flashed.

Default value:

- Yes (enabled)

CONFIG_ESPTOOLPY_BEFORE

Before flashing

Found in: Serial flasher config

Configure whether esptool.py should reset the ESP32 before flashing.

Automatic resetting depends on the RTS & DTR signals being wired from the serial port to the ESP32. Most USB development boards do this internally.

Available options:

- Reset to bootloader (ESPTOOLPY_BEFORE_RESET)
- No reset (ESPTOOLPY_BEFORE_NORESET)

CONFIG_ESPTOOLPY_AFTER

After flashing

Found in: Serial flasher config

Configure whether esptool.py should reset the ESP32 after flashing.

Automatic resetting depends on the RTS & DTR signals being wired from the serial port to the ESP32. Most USB development boards do this internally.

Available options:

- Reset after flashing (ESPTOOLPY_AFTER_RESET)
- Stay in bootloader (ESPTOOLPY_AFTER_NORESET)

CONFIG_ESPTOOLPY_MONITOR_BAUD

‘idf.py monitor’ baud rate

Found in: Serial flasher config

Baud rate to use when running ‘idf.py monitor’ or ‘make monitor’ to view serial output from a running chip.

If “Same as UART Console baud rate” is chosen then the value will follow the “UART Console baud rate” config item.

Can override by setting the MONITORBAUD environment variable.

Available options:

- Same as UART console baud rate (ESPTOOLPY_MONITOR_BAUD_CONSOLE)
- 9600 bps (ESPTOOLPY_MONITOR_BAUD_9600B)
- 57600 bps (ESPTOOLPY_MONITOR_BAUD_57600B)
- 115200 bps (ESPTOOLPY_MONITOR_BAUD_115200B)
- 230400 bps (ESPTOOLPY_MONITOR_BAUD_230400B)
- 921600 bps (ESPTOOLPY_MONITOR_BAUD_921600B)
- 2 Mbps (ESPTOOLPY_MONITOR_BAUD_2MB)
- Custom baud rate (ESPTOOLPY_MONITOR_BAUD_OTHER)

CONFIG_ESPTOOLPY_MONITOR_BAUD_OTHER_VAL

Custom baud rate value

Found in: Serial flasher config

Default value:

- 115200

Partition Table

Contains:

- *CONFIG_PARTITION_TABLE_CUSTOM_FILENAME*
- *CONFIG_PARTITION_TABLE_MD5*
- *CONFIG_PARTITION_TABLE_OFFSET*
- *CONFIG_PARTITION_TABLE_TYPE*

CONFIG_PARTITION_TABLE_TYPE

Partition Table

Found in: [Partition Table](#)

The partition table to flash to the ESP32. The partition table determines where apps, data and other resources are expected to be found.

The predefined partition table CSV descriptions can be found in the components/partition_table directory. Otherwise it's possible to create a new custom partition CSV for your application.

Available options:

- Single factory app, no OTA (PARTITION_TABLE_SINGLE_APP)
- Factory app, two OTA definitions (PARTITION_TABLE_TWO_OTA)
- Custom partition table CSV (PARTITION_TABLE_CUSTOM)
- Single factory app, no OTA, encrypted NVS (PARTITION_TABLE_SINGLE_APP_ENCRYPTED_NVS)
- Factory app, two OTA definitions, encrypted NVS (PARTITION_TABLE_TWO_OTA_ENCRYPTED_NVS)

CONFIG_PARTITION_TABLE_CUSTOM_FILENAME

Custom partition CSV file

Found in: [Partition Table](#)

Name of the custom partition CSV filename. This path is evaluated relative to the project root directory.

Default value:

- "partitions.csv"

CONFIG_PARTITION_TABLE_OFFSET

Offset of partition table

Found in: [Partition Table](#)

The address of partition table (by default 0x8000). Allows you to move the partition table, it gives more space for the bootloader. Note that the bootloader and app will both need to be compiled with the same PARTITION_TABLE_OFFSET value.

This number should be a multiple of 0x1000.

Note that partition offsets in the partition table CSV file may need to be changed if this value is set to a higher value. To have each partition offset adapt to the configured partition table offset, leave all partition offsets blank in the CSV file.

Default value:

- "0x8000"

CONFIG_PARTITION_TABLE_MD5

Generate an MD5 checksum for the partition table

Found in: [Partition Table](#)

Generate an MD5 checksum for the partition table for protecting the integrity of the table. The generation should be turned off for legacy bootloaders which cannot recognize the MD5 checksum in the partition table.

Default value:

- Yes (enabled) if ESP32_COMPATIBLE_PRE_V3_1_BOOTLOADERS

Compiler options

Contains:

- [CONFIG_COMPILER_OPTIMIZATION_ASSERTION_LEVEL](#)
- [CONFIG_COMPILER_DISABLE_GCC8_WARNINGS](#)
- [CONFIG_COMPILER_DUMP_RTL_FILES](#)
- [CONFIG_COMPILER_WARN_WRITE_STRINGS](#)
- [CONFIG_COMPILER_CXX_EXCEPTIONS](#)
- [CONFIG_COMPILER_CXX_RTTI](#)
- [CONFIG_COMPILER_OPTIMIZATION](#)
- [CONFIG_COMPILER_STACK_CHECK_MODE](#)

CONFIG_COMPILER_OPTIMIZATION

Optimization Level

Found in: [Compiler options](#)

This option sets compiler optimization level (gcc -O argument) for the app.

- The “Default” setting will add the -Og flag to CFLAGS.
- The “Size” setting will add the -Os flag to CFLAGS.
- The “Performance” setting will add the -O2 flag to CFLAGS.
- The “None” setting will add the -O0 flag to CFLAGS.

The “Size” setting cause the compiled code to be smaller and faster, but may lead to difficulties of correlating code addresses to source file lines when debugging.

The “Performance” setting causes the compiled code to be larger and faster, but will be easier to correlated code addresses to source file lines.

“None” with -O0 produces compiled code without optimization.

Note that custom optimization levels may be unsupported.

Compiler optimization for the IDF bootloader is set separately, see the `BOOT-LOADER_COMPILER_OPTIMIZATION` setting.

Available options:

- Debug (-Og) (`COMPILER_OPTIMIZATION_DEFAULT`)
- Optimize for size (-Os) (`COMPILER_OPTIMIZATION_SIZE`)
- Optimize for performance (-O2) (`COMPILER_OPTIMIZATION_PERF`)
- Debug without optimization (-O0) (`COMPILER_OPTIMIZATION_NONE`)

CONFIG_COMPILER_OPTIMIZATION_ASSERTION_LEVEL

Assertion level

Found in: [Compiler options](#)

Assertions can be:

- Enabled. Failure will print verbose assertion details. This is the default.
- Set to “silent” to save code size (failed assertions will abort() but user needs to use the aborting address to find the line number with the failed assertion.)
- Disabled entirely (not recommended for most configurations.) `-DNDEBUG` is added to `CPPFLAGS` in this case.

Available options:

- Enabled (`COMPILER_OPTIMIZATION_ASSERTIONS_ENABLE`)
Enable assertions. Assertion content and line number will be printed on failure.
- Silent (saves code size) (`COMPILER_OPTIMIZATION_ASSERTIONS_SILENT`)
Enable silent assertions. Failed assertions will abort(), user needs to use the aborting address to find the line number with the failed assertion.

- Disabled (sets `-DNDEBUG`) (`COMPILER_OPTIMIZATION_ASSERTIONS_DISABLE`)
If assertions are disabled, `-DNDEBUG` is added to `CPPFLAGS`.

CONFIG_COMPILER_CXX_EXCEPTIONS

Enable C++ exceptions

Found in: [Compiler options](#)

Enabling this option compiles all IDF C++ files with exception support enabled.

Disabling this option disables C++ exception support in all compiled files, and any `libstdc++` code which throws an exception will abort instead.

Enabling this option currently adds an additional ~500 bytes of heap overhead when an exception is thrown in user code for the first time.

Default value:

- No (disabled)

Contains:

- [CONFIG_COMPILER_CXX_EXCEPTIONS_EMG_POOL_SIZE](#)

CONFIG_COMPILER_CXX_EXCEPTIONS_EMG_POOL_SIZE

Emergency Pool Size

Found in: [Compiler options](#) > [CONFIG_COMPILER_CXX_EXCEPTIONS](#)

Size (in bytes) of the emergency memory pool for C++ exceptions. This pool will be used to allocate memory for thrown exceptions when there is not enough memory on the heap.

Default value:

- 0 if [CONFIG_COMPILER_CXX_EXCEPTIONS](#)

CONFIG_COMPILER_CXX_RTTI

Enable C++ run-time type info (RTTI)

Found in: [Compiler options](#)

Enabling this option compiles all C++ files with RTTI support enabled. This increases binary size (typically by tens of kB) but allows using `dynamic_cast` conversion and `typeid` operator.

Default value:

- No (disabled)

CONFIG_COMPILER_STACK_CHECK_MODE

Stack smashing protection mode

Found in: [Compiler options](#)

Stack smashing protection mode. Emit extra code to check for buffer overflows, such as stack smashing attacks. This is done by adding a guard variable to functions with vulnerable objects. The guards are initialized when a function is entered and then checked when the function exits. If a guard check fails, program is halted. Protection has the following modes:

- In **NORMAL** mode (GCC flag: `-fstack-protector`) only functions that call `alloca`, and functions with buffers larger than 8 bytes are protected.
- **STRONG** mode (GCC flag: `-fstack-protector-strong`) is like **NORMAL**, but includes additional functions to be protected –those that have local array definitions, or have references to local frame addresses.
- In **OVERALL** mode (GCC flag: `-fstack-protector-all`) all functions are protected.

Modes have the following impact on code performance and coverage:

- performance: NORMAL > STRONG > OVERALL
- coverage: NORMAL < STRONG < OVERALL

Available options:

- None (COMPILER_STACK_CHECK_MODE_NONE)
- Normal (COMPILER_STACK_CHECK_MODE_NORM)
- Strong (COMPILER_STACK_CHECK_MODE_STRONG)
- Overall (COMPILER_STACK_CHECK_MODE_ALL)

CONFIG_COMPILER_WARN_WRITE_STRINGS

Enable -Wwrite-strings warning flag

Found in: [Compiler options](#)

Adds -Wwrite-strings flag for the C/C++ compilers.

For C, this gives string constants the type `const char[]` so that copying the address of one into a non-const `char *` pointer produces a warning. This warning helps to find at compile time code that tries to write into a string constant.

For C++, this warns about the deprecated conversion from string literals to `char *`.

Default value:

- No (disabled)

CONFIG_COMPILER_DISABLE_GCC8_WARNINGS

Disable new warnings introduced in GCC 6 - 8

Found in: [Compiler options](#)

Enable this option if using GCC 6 or newer, and wanting to disable warnings which don't appear with GCC 5.

Default value:

- No (disabled)

CONFIG_COMPILER_DUMP_RTL_FILES

Dump RTL files during compilation

Found in: [Compiler options](#)

If enabled, RTL files will be produced during compilation. These files can be used by other tools, for example to calculate call graphs.

Component config

Contains:

- [ADC-Calibration](#)
- [Application Level Tracing](#)
- [Bluetooth](#)
- [CoAP Configuration](#)
- [Common ESP-related](#)
- [Core dump](#)
- [Driver configurations](#)
- [eFuse Bit Manager](#)
- [CONFIG_BLE_MESH](#)
- [ESP HTTP client](#)

- *ESP HTTPS OTA*
- *ESP HTTPS server*
- *ESP NETIF Adapter*
- *ESP System Settings*
- *ESP-ASIO*
- *ESP-MQTT Configurations*
- *ESP-TLS*
- *ESP32C3-Specific*
- *Ethernet*
- *Event Loop Library*
- *FAT Filesystem support*
- *FreeRTOS*
- *GDB Stub*
- *Heap memory debugging*
- *High resolution timer (esp_timer)*
- *HTTP Server*
- *jsmn*
- *libsodium*
- *Log output*
- *LWIP*
- *mbedTLS*
- *mDNS*
- *Modbus configuration*
- *Newlib*
- *NVS*
- *OpenSSL*
- *PHY*
- *Power Management*
- *PThreads*
- *SPI Flash driver*
- *SPIFFS Configuration*
- *Supplicant*
- *TCP Transport*
- *TinyUSB*
- *Unity unit testing library*
- *Virtual file system*
- *Wear Levelling*
- *Wi-Fi*
- *Wi-Fi Provisioning Manager*

Application Level Tracing Contains:

- *CONFIG_APPTRACE_DESTINATION*
- *FreeRTOS System View Tracing*
- *CONFIG_APPTRACE_GCOV_ENABLE*
- *CONFIG_APPTRACE_BUF_SIZE*
- *CONFIG_APPTRACE_PENDING_DATA_SIZE_MAX*
- *CONFIG_APPTRACE_POSTMORTEM_FLUSH_THRESH*
- *CONFIG_APPTRACE_ONPANIC_HOST_FLUSH_TMO*

CONFIG_APPTRACE_DESTINATION

Data Destination

Found in: Component config > Application Level Tracing

Select destination for application trace: JTAG or none (to disable).

Available options:

- JTAG (APPTRACE_DEST_JTAG)
- None (APPTRACE_DEST_NONE)

CONFIG_APPTRACE_ONPANIC_HOST_FLUSH_TMO

Timeout for flushing last trace data to host on panic

Found in: [Component config](#) > [Application Level Tracing](#)

Timeout for flushing last trace data to host in case of panic. In ms. Use -1 to disable timeout and wait forever.

CONFIG_APPTRACE_POSTMORTEM_FLUSH_THRESH

Threshold for flushing last trace data to host on panic

Found in: [Component config](#) > [Application Level Tracing](#)

Threshold for flushing last trace data to host on panic in post-mortem mode. This is minimal amount of data needed to perform flush. In bytes.

CONFIG_APPTRACE_BUF_SIZE

Size of the apptrace buffer

Found in: [Component config](#) > [Application Level Tracing](#)

Size of the memory buffer for trace data in bytes.

CONFIG_APPTRACE_PENDING_DATA_SIZE_MAX

Size of the pending data buffer

Found in: [Component config](#) > [Application Level Tracing](#)

Size of the buffer for events in bytes. It is useful for buffering events from the time critical code (scheduler, ISRs etc). If this parameter is 0 then events will be discarded when main HW buffer is full.

FreeRTOS SystemView Tracing Contains:

- [CONFIG_APPTRACE_SV_ENABLE](#)

CONFIG_APPTRACE_SV_ENABLE

SystemView Tracing Enable

Found in: [Component config](#) > [Application Level Tracing](#) > [FreeRTOS SystemView Tracing](#)

Enables support for SEGGER SystemView tracing functionality.

CONFIG_APPTRACE_SV_TS_SOURCE

Timer to use as timestamp source

Found in: [Component config](#) > [Application Level Tracing](#) > [FreeRTOS SystemView Tracing](#) > [CONFIG_APPTRACE_SV_ENABLE](#)

SystemView needs to use a hardware timer as the source of timestamps when tracing. This option selects the timer for it.

Available options:

- CPU cycle counter (CCOUNT) (APPTRACE_SV_TS_SOURCE_CCOUNT)
- Timer 0, Group 0 (APPTRACE_SV_TS_SOURCE_TIMER_00)

- Timer 1, Group 0 (APPTRACE_SV_TS_SOURCE_TIMER_01)
- Timer 0, Group 1 (APPTRACE_SV_TS_SOURCE_TIMER_10)
- Timer 1, Group 1 (APPTRACE_SV_TS_SOURCE_TIMER_11)
- esp_timer high resolution timer (APPTRACE_SV_TS_SOURCE_ESP_TIMER)

CONFIG_APPTRACE_SV_MAX_TASKS

Maximum supported tasks

Found in: Component config > Application Level Tracing > FreeRTOS SystemView Tracing > CONFIG_APPTRACE_SV_ENABLE

Configures maximum supported tasks in sysview debug

CONFIG_APPTRACE_SV_BUF_WAIT_TMO

Trace buffer wait timeout

Found in: Component config > Application Level Tracing > FreeRTOS SystemView Tracing > CONFIG_APPTRACE_SV_ENABLE

Configures timeout (in us) to wait for free space in trace buffer. Set to -1 to wait forever and avoid lost events.

CONFIG_APPTRACE_SV_EVT_OVERFLOW_ENABLE

Trace Buffer Overflow Event

Found in: Component config > Application Level Tracing > FreeRTOS SystemView Tracing > CONFIG_APPTRACE_SV_ENABLE

Enables “Trace Buffer Overflow” event.

CONFIG_APPTRACE_SV_EVT_ISR_ENTER_ENABLE

ISR Enter Event

Found in: Component config > Application Level Tracing > FreeRTOS SystemView Tracing > CONFIG_APPTRACE_SV_ENABLE

Enables “ISR Enter” event.

CONFIG_APPTRACE_SV_EVT_ISR_EXIT_ENABLE

ISR Exit Event

Found in: Component config > Application Level Tracing > FreeRTOS SystemView Tracing > CONFIG_APPTRACE_SV_ENABLE

Enables “ISR Exit” event.

CONFIG_APPTRACE_SV_EVT_ISR_TO_SCHED_ENABLE

ISR Exit to Scheduler Event

Found in: Component config > Application Level Tracing > FreeRTOS SystemView Tracing > CONFIG_APPTRACE_SV_ENABLE

Enables “ISR to Scheduler” event.

CONFIG_APPTRACE_SV_EVT_TASK_START_EXEC_ENABLE

Task Start Execution Event

Found in: [Component config](#) > [Application Level Tracing](#) > [FreeRTOS SystemView Tracing](#) > [CONFIG_APPTRACE_SV_ENABLE](#)

Enables “Task Start Execution” event.

CONFIG_APPTRACE_SV_EVT_TASK_STOP_EXEC_ENABLE

Task Stop Execution Event

Found in: [Component config](#) > [Application Level Tracing](#) > [FreeRTOS SystemView Tracing](#) > [CONFIG_APPTRACE_SV_ENABLE](#)

Enables “Task Stop Execution” event.

CONFIG_APPTRACE_SV_EVT_TASK_START_READY_ENABLE

Task Start Ready State Event

Found in: [Component config](#) > [Application Level Tracing](#) > [FreeRTOS SystemView Tracing](#) > [CONFIG_APPTRACE_SV_ENABLE](#)

Enables “Task Start Ready State” event.

CONFIG_APPTRACE_SV_EVT_TASK_STOP_READY_ENABLE

Task Stop Ready State Event

Found in: [Component config](#) > [Application Level Tracing](#) > [FreeRTOS SystemView Tracing](#) > [CONFIG_APPTRACE_SV_ENABLE](#)

Enables “Task Stop Ready State” event.

CONFIG_APPTRACE_SV_EVT_TASK_CREATE_ENABLE

Task Create Event

Found in: [Component config](#) > [Application Level Tracing](#) > [FreeRTOS SystemView Tracing](#) > [CONFIG_APPTRACE_SV_ENABLE](#)

Enables “Task Create” event.

CONFIG_APPTRACE_SV_EVT_TASK_TERMINATE_ENABLE

Task Terminate Event

Found in: [Component config](#) > [Application Level Tracing](#) > [FreeRTOS SystemView Tracing](#) > [CONFIG_APPTRACE_SV_ENABLE](#)

Enables “Task Terminate” event.

CONFIG_APPTRACE_SV_EVT_IDLE_ENABLE

System Idle Event

Found in: [Component config](#) > [Application Level Tracing](#) > [FreeRTOS SystemView Tracing](#) > [CONFIG_APPTRACE_SV_ENABLE](#)

Enables “System Idle” event.

CONFIG_APPTRACE_SV_EVT_TIMER_ENTER_ENABLE

Timer Enter Event

Found in: [Component config](#) > [Application Level Tracing](#) > [FreeRTOS SystemView Tracing](#) > [CONFIG_APPTRACE_SV_ENABLE](#)

Enables “Timer Enter” event.

CONFIG_APPTRACE_SV_EVT_TIMER_EXIT_ENABLE

Timer Exit Event

Found in: [Component config](#) > [Application Level Tracing](#) > [FreeRTOS SystemView Tracing](#) > [CONFIG_APPTRACE_SV_ENABLE](#)

Enables “Timer Exit” event.

CONFIG_APPTRACE_GCOV_ENABLE

GCOV to Host Enable

Found in: [Component config](#) > [Application Level Tracing](#)

Enables support for GCOV data transfer to host.

ESP-ASIO Contains:

- [CONFIG_ASIO_SSL_SUPPORT](#)

CONFIG_ASIO_SSL_SUPPORT

Enable SSL/TLS support of ASIO

Found in: [Component config](#) > [ESP-ASIO](#)

Enable support for basic SSL/TLS features, available for mbedTLS/OpenSSL as well as wolfSSL TLS library.

Default value:

- No (disabled)

CONFIG_ASIO_SSL_LIBRARY_CHOICE

Choose SSL/TLS library for ESP-TLS (See help for more Info)

Found in: [Component config](#) > [ESP-ASIO](#) > [CONFIG_ASIO_SSL_SUPPORT](#)

The ASIO support multiple backend TLS libraries. Currently the mbedTLS with a thin ESP-OpenSSL port layer (default choice) and WolfSSL are supported. Different TLS libraries may support different features and have different resource usage. Consult the ESP-TLS documentation in ESP-IDF Programming guide for more details.

Available options:

- esp-openssl (ASIO_USE_ESP_OPENSSL)
- wolfSSL (License info in wolfSSL directory README) (ASIO_USE_ESP_WOLFSSL)

Bluetooth Contains:

- [Bluedroid Options](#)
- [CONFIG_BT_ENABLED](#)
- [NimBLE Options](#)

CONFIG_BT_ENABLED

Bluetooth

Found in: *Component config > Bluetooth*

Select this option to enable Bluetooth and show the submenu with Bluetooth configuration choices.

Bluetooth controller Contains:

- *CONFIG_BT_CTRL_BLE_ADV_REPORT_FLOW_CTRL_SUPP*
- *CONFIG_BT_CTRL_DFT_TX_POWER_LEVEL*
- *CONFIG_BT_CTRL_BLE_MAX_ACT*
- *CONFIG_BT_CTRL_BLE_SCAN_DUPL*
- *CONFIG_BT_CTRL_BLE_STATIC_ACL_TX_BUF_NB*
- *CONFIG_BT_CTRL_HW_CCA_VAL*
- *CONFIG_BT_CTRL_COEX_PHY_CODED_TX_RX_TLIM*
- *CONFIG_BT_CTRL_CE_LENGTH_TYPE*
- *CONFIG_BT_CTRL_RX_ANTENNA_INDEX*
- *CONFIG_BT_CTRL_TX_ANTENNA_INDEX*
- *CONFIG_BT_CTRL_AGC_RECORRECT_EN*
- *CONFIG_BT_CTRL_HCI_MODE_CHOICE*
- *CONFIG_BT_CTRL_HW_CCA*
- *MODEM_SLEEP Options*
- *CONFIG_BT_CTRL_ADV_DUP_FILT_MAX*

CONFIG_BT_CTRL_BLE_MAX_ACT

BLE Max Instances

Found in: *Component config > Bluetooth > CONFIG_BT_ENABLED > Bluetooth controller*

BLE maximum activities of bluetooth controller, both of connections, scan, sync and adv(periodic adv, multi-adv).

Range:

- from 1 to 10 if *CONFIG_BT_ENABLED*

Default value:

- 10 if *CONFIG_BT_ENABLED*

CONFIG_BT_CTRL_BLE_STATIC_ACL_TX_BUF_NB

BLE static ACL TX buffer numbers

Found in: *Component config > Bluetooth > CONFIG_BT_ENABLED > Bluetooth controller*

BLE ACL buffer have two methods to be allocated. One is persistent allocating (allocate when controller initialise, never free until controller de-initialise) another is dynamically allocating (allocate before TX and free after TX).

Range:

- from 0 to 12 if *CONFIG_BT_ENABLED*

Default value:

- 0 if *CONFIG_BT_ENABLED*

CONFIG_BT_CTRL_HCI_MODE_CHOICE

HCI mode

Found in: *Component config > Bluetooth > CONFIG_BT_ENABLED > Bluetooth controller*

Specify HCI mode as VHCI or UART(H4)

Available options:

- VHCI (BT_CTRL_HCI_MODE_VHCI)
Normal option. Mostly, choose this VHCI when bluetooth host run on ESP32C3, too.
- UART(H4) (BT_CTRL_HCI_MODE_UART_H4)
If use external bluetooth host which run on other hardware and use UART as the HCI interface, choose this option.

CONFIG_BT_CTRL_ADV_DUP_FILT_MAX

The maximum number of 5.0 extend duplicate scan filter

Found in: Component config > Bluetooth > CONFIG_BT_ENABLED > Bluetooth controller

The maximum number of duplicate scan filter

Range:

- from 1 to 500 if *CONFIG_BT_ENABLED*

Default value:

- 30 if *CONFIG_BT_ENABLED*

CONFIG_BT_CTRL_HW_CCA

HW CCA check enable

Found in: Component config > Bluetooth > CONFIG_BT_ENABLED > Bluetooth controller

It enables HW CCA feature in controller

Default value:

- No (disabled) if *CONFIG_BT_ENABLED*

CONFIG_BT_CTRL_HW_CCA_VAL

CCA threshold value

Found in: Component config > Bluetooth > CONFIG_BT_ENABLED > Bluetooth controller

It is the threshold value of HW CCA, if the value is 30, it means CCA threshold is -30 dBm.

Range:

- from 20 to 60 if *CONFIG_BT_ENABLED*

Default value:

- 20 if *CONFIG_BT_ENABLED*

CONFIG_BT_CTRL_CE_LENGTH_TYPE

Connection event length determination method

Found in: Component config > Bluetooth > CONFIG_BT_ENABLED > Bluetooth controller

Specify connection event length determination

Available options:

- ORIGINAL (BT_CTRL_CE_LENGTH_TYPE_ORIG)
- Use CE parameter for HCI command (BT_CTRL_CE_LENGTH_TYPE_CE)
- Use Espressif self-defined method (BT_CTRL_CE_LENGTH_TYPE_SD)

CONFIG_BT_CTRL_TX_ANTENNA_INDEX

default Tx antenna used

Found in: Component config > Bluetooth > CONFIG_BT_ENABLED > Bluetooth controller

Specify default Tx antenna used for bluetooth

Available options:

- Antenna 0 (BT_CTRL_TX_ANTENNA_INDEX_0)
- Antenna 1 (BT_CTRL_TX_ANTENNA_INDEX_1)

CONFIG_BT_CTRL_RX_ANTENNA_INDEX

default Rx antenna used

Found in: [Component config](#) > [Bluetooth](#) > [CONFIG_BT_ENABLED](#) > [Bluetooth controller](#)

Specify default Rx antenna used for bluetooth

Available options:

- Antenna 0 (BT_CTRL_RX_ANTENNA_INDEX_0)
- Antenna 1 (BT_CTRL_RX_ANTENNA_INDEX_1)

CONFIG_BT_CTRL_DFT_TX_POWER_LEVEL

BLE default Tx power level

Found in: [Component config](#) > [Bluetooth](#) > [CONFIG_BT_ENABLED](#) > [Bluetooth controller](#)

Specify default Tx power level

Available options:

- -27dBm (BT_CTRL_DFT_TX_POWER_LEVEL_N27)
- -24dBm (BT_CTRL_DFT_TX_POWER_LEVEL_N24)
- -21dBm (BT_CTRL_DFT_TX_POWER_LEVEL_N21)
- -18dBm (BT_CTRL_DFT_TX_POWER_LEVEL_N18)
- -15dBm (BT_CTRL_DFT_TX_POWER_LEVEL_N15)
- -12dBm (BT_CTRL_DFT_TX_POWER_LEVEL_N12)
- **-9dBm** (BT_CTRL_DFT_TX_POWER_LEVEL_N9)
- **-6dBm** (BT_CTRL_DFT_TX_POWER_LEVEL_N6)
- **-3dBm** (BT_CTRL_DFT_TX_POWER_LEVEL_N3)
- 0dBm (BT_CTRL_DFT_TX_POWER_LEVEL_N0)
- **+3dBm** (BT_CTRL_DFT_TX_POWER_LEVEL_P3)
- **+6dBm** (BT_CTRL_DFT_TX_POWER_LEVEL_P6)
- **+9dBm** (BT_CTRL_DFT_TX_POWER_LEVEL_P9)
- +12dBm (BT_CTRL_DFT_TX_POWER_LEVEL_P12)
- +15dBm (BT_CTRL_DFT_TX_POWER_LEVEL_P15)
- +18dBm (BT_CTRL_DFT_TX_POWER_LEVEL_P18)

CONFIG_BT_CTRL_BLE_ADV_REPORT_FLOW_CTRL_SUPP

BLE adv report flow control supported

Found in: [Component config](#) > [Bluetooth](#) > [CONFIG_BT_ENABLED](#) > [Bluetooth controller](#)

The function is mainly used to enable flow control for advertising reports. When it is enabled, advertising reports will be discarded by the controller if the number of unprocessed advertising reports exceeds the size of BLE adv report flow control.

Default value:

- Yes (enabled) if [CONFIG_BT_ENABLED](#)

CONFIG_BT_CTRL_BLE_ADV_REPORT_FLOW_CTRL_NUM

BLE adv report flow control number

Found in: [Component config](#) > [Bluetooth](#) > [CONFIG_BT_ENABLED](#) > [Bluetooth controller](#) > [CONFIG_BT_CTRL_BLE_ADV_REPORT_FLOW_CTRL_SUPP](#)

The number of unprocessed advertising report that bluetooth host can save. If you set `BT_CTRL_BLE_ADV_REPORT_FLOW_CTRL_NUM` to a small value, this may cause adv packets lost. If you set `BT_CTRL_BLE_ADV_REPORT_FLOW_CTRL_NUM` to a large value, bluetooth host may cache a lot of adv packets and this may cause system memory run out. For example, if you set it to 50, the maximum memory consumed by host is $35 * 50$ bytes. Please set `BT_CTRL_BLE_ADV_REPORT_FLOW_CTRL_NUM` according to your system free memory and handle adv packets as fast as possible, otherwise it will cause adv packets lost.

Range:

- from 50 to 1000 if `CONFIG_BT_CTRL_BLE_ADV_REPORT_FLOW_CTRL_SUPP` && `CONFIG_BT_ENABLED`

Default value:

- 100 if `CONFIG_BT_CTRL_BLE_ADV_REPORT_FLOW_CTRL_SUPP` && `CONFIG_BT_ENABLED`

CONFIG_BT_CTRL_BLE_ADV_REPORT_DISCARD_THRSHOLD

BLE adv lost event threshold value

Found in: Component config > Bluetooth > CONFIG_BT_ENABLED > Bluetooth controller > CONFIG_BT_CTRL_BLE_ADV_REPORT_FLOW_CTRL_SUPP

When adv report flow control is enabled, The ADV lost event will be generated when the number of ADV packets lost in the controller reaches this threshold. It is better to set a larger value. If you set `BT_CTRL_BLE_ADV_REPORT_DISCARD_THRSHOLD` to a small value or printf every adv lost event, it may cause adv packets lost more.

Range:

- from 1 to 1000 if `CONFIG_BT_CTRL_BLE_ADV_REPORT_FLOW_CTRL_SUPP` && `CONFIG_BT_ENABLED`

Default value:

- 20 if `CONFIG_BT_CTRL_BLE_ADV_REPORT_FLOW_CTRL_SUPP` && `CONFIG_BT_ENABLED`

CONFIG_BT_CTRL_BLE_SCAN_DUPL

BLE Scan Duplicate Options

Found in: Component config > Bluetooth > CONFIG_BT_ENABLED > Bluetooth controller

This select enables parameters setting of BLE scan duplicate.

Default value:

- Yes (enabled) if `CONFIG_BT_ENABLED`

CONFIG_BT_CTRL_SCAN_DUPL_TYPE

Scan Duplicate Type

Found in: Component config > Bluetooth > CONFIG_BT_ENABLED > Bluetooth controller > CONFIG_BT_CTRL_BLE_SCAN_DUPL

Scan duplicate have three ways. one is “Scan Duplicate By Device Address”, This way is to use advertiser address filtering. The adv packet of the same address is only allowed to be reported once. Another way is “Scan Duplicate By Device Address And Advertising Data”. This way is to use advertising data and device address filtering. All different adv packets with the same address are allowed to be reported. The last way is “Scan Duplicate By Advertising Data”. This way is to use advertising data filtering. All same advertising data only allow to be reported once even though they are from different devices.

Available options:

- Scan Duplicate By Device Address (`BT_CTRL_SCAN_DUPL_TYPE_DEVICE`)
This way is to use advertiser address filtering. The adv packet of the same address is only allowed to be reported once

- Scan Duplicate By Advertising Data (BT_CTRL_SCAN_DUPL_TYPE_DATA)
This way is to use advertising data filtering. All same advertising data only allow to be reported once even though they are from different devices.
- Scan Duplicate By Device Address And Advertising Data (BT_CTRL_SCAN_DUPL_TYPE_DATA_DEVICE)
This way is to use advertising data and device address filtering. All different adv packets with the same address are allowed to be reported.

CONFIG_BT_CTRL_SCAN_DUPL_CACHE_SIZE

Maximum number of devices in scan duplicate filter

Found in: Component config > Bluetooth > CONFIG_BT_ENABLED > Bluetooth controller > CONFIG_BT_CTRL_BLE_SCAN_DUPL

Maximum number of devices which can be recorded in scan duplicate filter. When the maximum amount of device in the filter is reached, the cache will be refreshed.

Range:

- from 10 to 1000 if *CONFIG_BT_CTRL_BLE_SCAN_DUPL* && *CONFIG_BT_ENABLED*

Default value:

- 100 if *CONFIG_BT_CTRL_BLE_SCAN_DUPL* && *CONFIG_BT_ENABLED*

CONFIG_BT_CTRL_BLE_MESH_SCAN_DUPL_EN

Special duplicate scan mechanism for BLE Mesh scan

Found in: Component config > Bluetooth > CONFIG_BT_ENABLED > Bluetooth controller > CONFIG_BT_CTRL_BLE_SCAN_DUPL

This enables the BLE scan duplicate for special BLE Mesh scan.

Default value:

- No (disabled) if *CONFIG_BT_CTRL_BLE_SCAN_DUPL* && *CONFIG_BT_ENABLED*

CONFIG_BT_CTRL_MESH_DUPL_SCAN_CACHE_SIZE

Maximum number of Mesh adv packets in scan duplicate filter

Found in: Component config > Bluetooth > CONFIG_BT_ENABLED > Bluetooth controller > CONFIG_BT_CTRL_BLE_SCAN_DUPL > CONFIG_BT_CTRL_BLE_MESH_SCAN_DUPL_EN

Maximum number of adv packets which can be recorded in duplicate scan cache for BLE Mesh. When the maximum amount of device in the filter is reached, the cache will be refreshed.

Range:

- from 10 to 1000 if *CONFIG_BT_CTRL_BLE_MESH_SCAN_DUPL_EN* && *CONFIG_BT_ENABLED*

Default value:

- 100 if *CONFIG_BT_CTRL_BLE_MESH_SCAN_DUPL_EN* && *CONFIG_BT_ENABLED*

CONFIG_BT_CTRL_COEX_PHY_CODED_TX_RX_TLIM

Coexistence: limit on MAX Tx/Rx time for coded-PHY connection

Found in: Component config > Bluetooth > CONFIG_BT_ENABLED > Bluetooth controller

When using PHY-Coded in BLE connection, limitation on max tx/rx time can be applied to better avoid dramatic performance deterioration of Wi-Fi.

Available options:

- Force Enable (BT_CTRL_COEX_PHY_CODED_TX_RX_TLIM_EN)
Always enable the limitation on max tx/rx time for Coded-PHY connection

- Force Disable (BT_CTRL_COEX_PHY_CODED_TX_RX_TLIM_DIS)
Disable the limitation on max tx/rx time for Coded-PHY connection

MODEM SLEEP Options Contains:

- [CONFIG_BT_CTRL_MODEM_SLEEP](#)
- [CONFIG_BT_CTRL_MAIN_XTAL_PU_DURING_LIGHT_SLEEP](#)

CONFIG_BT_CTRL_MODEM_SLEEP

Bluetooth modem sleep

Found in: [Component config](#) > [Bluetooth](#) > [CONFIG_BT_ENABLED](#) > [Bluetooth controller](#) > [MODEM SLEEP Options](#)

Enable/disable bluetooth controller low power mode. Modem sleep is not supported to be used with UART HCI.

Default value:

- No (disabled) if [BT_CTRL_HCI_MODE_UART_H4](#) && [CONFIG_BT_ENABLED](#)

CONFIG_BT_CTRL_MODEM_SLEEP_MODE_1

Bluetooth Modem sleep Mode 1

Found in: [Component config](#) > [Bluetooth](#) > [CONFIG_BT_ENABLED](#) > [Bluetooth controller](#) > [MODEM SLEEP Options](#) > [CONFIG_BT_CTRL_MODEM_SLEEP](#)

Mode 1 is the currently supported sleep mode. In this mode, bluetooth controller sleeps between and BLE events. A low power clock is used to maintain bluetooth reference clock.

Default value:

- Yes (enabled) if [CONFIG_BT_CTRL_MODEM_SLEEP](#) && [CONFIG_BT_ENABLED](#)

CONFIG_BT_CTRL_LOW_POWER_CLOCK

Bluetooth low power clock

Found in: [Component config](#) > [Bluetooth](#) > [CONFIG_BT_ENABLED](#) > [Bluetooth controller](#) > [MODEM SLEEP Options](#) > [CONFIG_BT_CTRL_MODEM_SLEEP](#) > [CONFIG_BT_CTRL_MODEM_SLEEP_MODE_1](#)

Select the low power clock source for bluetooth controller

Available options:

- Main crystal (BT_CTRL_LPCLK_SEL_MAIN_XTAL)
Main crystal can be used as low power clock for bluetooth modem sleep. If this option is selected, bluetooth modem sleep can work under Dynamic Frequency Scaling(DFS) enabled, and bluetooth can work under light sleep enabled. Main crystal has a relatively better performance than other bluetooth low power clock sources.
- External 32kHz crystal (BT_CTRL_LPCLK_SEL_EXT_32K_XTAL)
External 32kHz crystal has a nominal frequency of 32.768kHz and provides good frequency stability. If used as Bluetooth low power clock, External 32kHz can support Bluetooth modem sleep to be used with both DFS and light sleep.
- Internal 150kHz RC oscillator (BT_CTRL_LPCLK_SEL_RTC_SLOW)
Internal 150kHz RC oscillator. The accuracy of this clock is a lot larger than 500ppm which is required in Bluetooth communication, so don't select this option in scenarios such as BLE connection state.

CONFIG_BT_CTRL_MAIN_XTAL_PU_DURING_LIGHT_SLEEP

power up main XTAL during light sleep

Found in: Component config > Bluetooth > CONFIG_BT_ENABLED > Bluetooth controller > MODEM SLEEP Options

If this option is selected, the main crystal will power up during light sleep when the low power clock selects an external 32kHz crystal but the external 32kHz crystal does not exist or the low power clock selects the main crystal.

Default value:

- No (disabled) if (BT_CTRL_LPCLK_SEL_MAIN_XTAL || BT_CTRL_LPCLK_SEL_EXT_32K_XTAL) && CONFIG_BT_ENABLED && CONFIG_FREERTOS_USE_TICKLESS_IDLE && CONFIG_BT_ENABLED

CONFIG_BT_CTRL_AGC_RECORRECT_EN

Enable HW AGC recorrect

Found in: Component config > Bluetooth > CONFIG_BT_ENABLED > Bluetooth controller

Enable uncoded phy AGC recorrect

Default value:

- No (disabled) if CONFIG_BT_ENABLED

CONFIG_BT_CTRL_CODED_AGC_RECORRECT_EN

Enable coded phy AGC recorrect

Found in: Component config > Bluetooth > CONFIG_BT_ENABLED > Bluetooth controller > CONFIG_BT_CTRL_AGC_RECORRECT_EN

Enable coded phy AGC recorrect

Default value:

- No (disabled) if CONFIG_BT_CTRL_AGC_RECORRECT_EN && CONFIG_BT_ENABLED

CONFIG_BT_HOST

Bluetooth Host

Found in: Component config > Bluetooth > CONFIG_BT_ENABLED

This helps to choose Bluetooth host stack

Available options:

- Bluedroid - Dual-mode (BT_BLUEDROID_ENABLED)
This option is recommended for classic Bluetooth or for dual-mode usecases
- NimBLE - BLE only (BT_NIMBLE_ENABLED)
This option is recommended for BLE only usecases to save on memory
- Controller Only (BT_CONTROLLER_ONLY)
This option is recommended when you want to communicate directly with the controller (without any host) or when you are using any other host stack not supported by Espressif (not mentioned here).

Bluedroid Options Contains:

- CONFIG_BT_BLE_HOST_QUEUE_CONG_CHECK
- CONFIG_BT_BLUEDROID_MEM_DEBUG
- CONFIG_BT_BTU_TASK_STACK_SIZE
- CONFIG_BT_BTC_TASK_STACK_SIZE
- CONFIG_BT_BLE_ENABLED

- *BT_DEBUG_LOG_LEVEL*
- *CONFIG_BT_ACL_CONNECTIONS*
- *CONFIG_BT_ALLOCATION_FROM_SPIRAM_FIRST*
- *CONFIG_BT_STACK_NO_LOG*
- *CONFIG_BT_BLE_42_FEATURES_SUPPORTED*
- *CONFIG_BT_BLE_50_FEATURES_SUPPORTED*
- *CONFIG_BT_MULTI_CONNECTION_ENBALE*
- *CONFIG_BT_MAX_DEVICE_NAME_LEN*
- *CONFIG_BT_BLE_ACT_SCAN_REP_ADV_SCAN*
- *CONFIG_BT_BLUEDROID_PINNED_TO_CORE_CHOICE*
- *CONFIG_BT_BLE_ESTAB_LINK_CONN_TOUT*
- *CONFIG_BT_BLE_RPA_SUPPORTED*
- *CONFIG_BT_BLE_DYNAMIC_ENV_MEMORY*

CONFIG_BT_BTC_TASK_STACK_SIZE

Bluetooth event (callback to application) task stack size

Found in: Component config > Bluetooth > Bluedroid Options

This select btc task stack size

Default value:

- 3072 if BT_BLUEDROID_ENABLED && BT_BLUEDROID_ENABLED

CONFIG_BT_BLUEDROID_PINNED_TO_CORE_CHOICE

The cpu core which Bluedroid run

Found in: Component config > Bluetooth > Bluedroid Options

Which the cpu core to run Bluedroid. Can choose core0 and core1. Can not specify no-affinity.

Available options:

- Core 0 (PRO CPU) (BT_BLUEDROID_PINNED_TO_CORE_0)
- Core 1 (APP CPU) (BT_BLUEDROID_PINNED_TO_CORE_1)

CONFIG_BT_BTU_TASK_STACK_SIZE

Bluetooth Bluedroid Host Stack task stack size

Found in: Component config > Bluetooth > Bluedroid Options

This select btu task stack size

Default value:

- 4096 if BT_BLUEDROID_ENABLED && BT_BLUEDROID_ENABLED

CONFIG_BT_BLUEDROID_MEM_DEBUG

Bluedroid memory debug

Found in: Component config > Bluetooth > Bluedroid Options

Bluedroid memory debug

Default value:

- No (disabled) if BT_BLUEDROID_ENABLED && BT_BLUEDROID_ENABLED

CONFIG_BT_BLE_ENABLED

Bluetooth Low Energy

Found in: Component config > Bluetooth > Bluedroid Options

This enables Bluetooth Low Energy

Default value:

- Yes (enabled) if `BT_BLUEDROID_ENABLED` && `BT_BLUEDROID_ENABLED`

CONFIG_BT_GATTS_ENABLE

Include GATT server module(GATTS)

Found in: Component config > Bluetooth > Bluedroid Options > CONFIG_BT_BLE_ENABLED

This option can be disabled when the app work only on gatt client mode

Default value:

- Yes (enabled) if `CONFIG_BT_BLE_ENABLED` && `BT_BLUEDROID_ENABLED`

CONFIG_BT_GATTS_PPCP_CHAR_GAP

Enable Peripheral Preferred Connection Parameters characteristic in GAP service

Found in: Component config > Bluetooth > Bluedroid Options > CONFIG_BT_BLE_ENABLED > CONFIG_BT_GATTS_ENABLE

This enables “Peripheral Preferred Connection Parameters” characteristic (UUID: 0x2A04) in GAP service that has connection parameters like min/max connection interval, slave latency and supervision timeout multiplier

Default value:

- No (disabled) if `CONFIG_BT_GATTS_ENABLE` && `BT_BLUEDROID_ENABLED`

CONFIG_BT_BLE_BLUFI_ENABLE

Include blufi function

Found in: Component config > Bluetooth > Bluedroid Options > CONFIG_BT_BLE_ENABLED > CONFIG_BT_GATTS_ENABLE

This option can be close when the app does not require blufi function.

Default value:

- No (disabled) if `CONFIG_BT_GATTS_ENABLE` && `BT_BLUEDROID_ENABLED`

CONFIG_BT_GATT_MAX_SR_PROFILES

Max GATT Server Profiles

Found in: Component config > Bluetooth > Bluedroid Options > CONFIG_BT_BLE_ENABLED > CONFIG_BT_GATTS_ENABLE

Maximum GATT Server Profiles Count

Range:

- from 1 to 32 if `CONFIG_BT_GATTS_ENABLE` && `BT_BLUEDROID_ENABLED` && `BT_BLUEDROID_ENABLED`

Default value:

- 8 if `CONFIG_BT_GATTS_ENABLE` && `BT_BLUEDROID_ENABLED` && `BT_BLUEDROID_ENABLED`

CONFIG_BT_GATTS_SEND_SERVICE_CHANGE_MODE

GATTS Service Change Mode

Found in: Component config > Bluetooth > Bluedroid Options > CONFIG_BT_BLE_ENABLED > CONFIG_BT_GATTS_ENABLE

Service change indication mode for GATT Server.

Available options:

- GATTS manually send service change indication (BT_GATTS_SEND_SERVICE_CHANGE_MANUAL)
Manually send service change indication through API
esp_ble_gatts_send_service_change_indication()
- GATTS automatically send service change indication (BT_GATTS_SEND_SERVICE_CHANGE_AUTO)
Let Bluedroid handle the service change indication internally

CONFIG_BT_GATTC_ENABLE

Include GATT client module(GATTC)

Found in: Component config > Bluetooth > Bluedroid Options > CONFIG_BT_BLE_ENABLED

This option can be close when the app work only on gatt server mode

Default value:

- Yes (enabled) if *CONFIG_BT_BLE_ENABLED* && BT_BLUEDROID_ENABLED

CONFIG_BT_GATTC_CACHE_NVS_FLASH

Save gattc cache data to nvs flash

Found in: Component config > Bluetooth > Bluedroid Options > CONFIG_BT_BLE_ENABLED > CONFIG_BT_GATTC_ENABLE

This select can save gattc cache data to nvs flash

Default value:

- No (disabled) if *CONFIG_BT_GATTC_ENABLE* && BT_BLUEDROID_ENABLED

CONFIG_BT_GATTC_CONNECT_RETRY_COUNT

The number of attempts to reconnect if the connection establishment failed

Found in: Component config > Bluetooth > Bluedroid Options > CONFIG_BT_BLE_ENABLED > CONFIG_BT_GATTC_ENABLE

The number of attempts to reconnect if the connection establishment failed

Range:

- from 0 to 7 if *CONFIG_BT_GATTC_ENABLE* && BT_BLUEDROID_ENABLED

Default value:

- 3 if *CONFIG_BT_GATTC_ENABLE* && BT_BLUEDROID_ENABLED

CONFIG_BT_BLE_SMP_ENABLE

Include BLE security module(SMP)

Found in: Component config > Bluetooth > Bluedroid Options > CONFIG_BT_BLE_ENABLED

This option can be close when the app not used the ble security connect.

Default value:

- Yes (enabled) if *CONFIG_BT_BLE_ENABLED* && BT_BLUEDROID_ENABLED

CONFIG_BT_SMP_SLAVE_CON_PARAMS_UPD_ENABLE

Slave enable connection parameters update during pairing

Found in: Component config > Bluetooth > Bluedroid Options > CONFIG_BT_BLE_ENABLED > CONFIG_BT_BLE_SMP_ENABLE

In order to reduce the pairing time, slave actively initiates connection parameters update during pairing.

Default value:

- No (disabled) if *CONFIG_BT_BLE_SMP_ENABLE* && BT_BLUEDROID_ENABLED

CONFIG_BT_STACK_NO_LOG

Disable BT debug logs (minimize bin size)

Found in: Component config > Bluetooth > Bluedroid Options

This select can save the rodata code size

Default value:

- No (disabled) if BT_BLUEDROID_ENABLED && BT_BLUEDROID_ENABLED

BT DEBUG LOG LEVEL

 Contains:

- *CONFIG_BT_LOG_A2D_TRACE_LEVEL*
- *CONFIG_BT_LOG_APPL_TRACE_LEVEL*
- *CONFIG_BT_LOG_AVCT_TRACE_LEVEL*
- *CONFIG_BT_LOG_AVDT_TRACE_LEVEL*
- *CONFIG_BT_LOG_AVRC_TRACE_LEVEL*
- *CONFIG_BT_LOG_BLUFI_TRACE_LEVEL*
- *CONFIG_BT_LOG_BNEP_TRACE_LEVEL*
- *CONFIG_BT_LOG_BTC_TRACE_LEVEL*
- *CONFIG_BT_LOG_BTIF_TRACE_LEVEL*
- *CONFIG_BT_LOG_BTM_TRACE_LEVEL*
- *CONFIG_BT_LOG_GAP_TRACE_LEVEL*
- *CONFIG_BT_LOG_GATT_TRACE_LEVEL*
- *CONFIG_BT_LOG_HCI_TRACE_LEVEL*
- *CONFIG_BT_LOG_HID_TRACE_LEVEL*
- *CONFIG_BT_LOG_L2CAP_TRACE_LEVEL*
- *CONFIG_BT_LOG_MCA_TRACE_LEVEL*
- *CONFIG_BT_LOG_OSI_TRACE_LEVEL*
- *CONFIG_BT_LOG_PAN_TRACE_LEVEL*
- *CONFIG_BT_LOG_RFCOMM_TRACE_LEVEL*
- *CONFIG_BT_LOG_SDP_TRACE_LEVEL*
- *CONFIG_BT_LOG_SMP_TRACE_LEVEL*

CONFIG_BT_LOG_HCI_TRACE_LEVEL

HCI layer

Found in: Component config > Bluetooth > Bluedroid Options > BT_DEBUG_LOG_LEVEL

Define BT trace level for HCI layer

Available options:

- NONE (BT_LOG_HCI_TRACE_LEVEL_NONE)
- ERROR (BT_LOG_HCI_TRACE_LEVEL_ERROR)
- WARNING (BT_LOG_HCI_TRACE_LEVEL_WARNING)
- API (BT_LOG_HCI_TRACE_LEVEL_API)
- EVENT (BT_LOG_HCI_TRACE_LEVEL_EVENT)
- DEBUG (BT_LOG_HCI_TRACE_LEVEL_DEBUG)

- VERBOSE (BT_LOG_HCI_TRACE_LEVEL_VERBOSE)

CONFIG_BT_LOG_BTM_TRACE_LEVEL

BTM layer

Found in: [Component config](#) > [Bluetooth](#) > [Bluedroid Options](#) > [BT DEBUG LOG LEVEL](#)

Define BT trace level for BTM layer

Available options:

- NONE (BT_LOG_BTM_TRACE_LEVEL_NONE)
- ERROR (BT_LOG_BTM_TRACE_LEVEL_ERROR)
- WARNING (BT_LOG_BTM_TRACE_LEVEL_WARNING)
- API (BT_LOG_BTM_TRACE_LEVEL_API)
- EVENT (BT_LOG_BTM_TRACE_LEVEL_EVENT)
- DEBUG (BT_LOG_BTM_TRACE_LEVEL_DEBUG)
- VERBOSE (BT_LOG_BTM_TRACE_LEVEL_VERBOSE)

CONFIG_BT_LOG_L2CAP_TRACE_LEVEL

L2CAP layer

Found in: [Component config](#) > [Bluetooth](#) > [Bluedroid Options](#) > [BT DEBUG LOG LEVEL](#)

Define BT trace level for L2CAP layer

Available options:

- NONE (BT_LOG_L2CAP_TRACE_LEVEL_NONE)
- ERROR (BT_LOG_L2CAP_TRACE_LEVEL_ERROR)
- WARNING (BT_LOG_L2CAP_TRACE_LEVEL_WARNING)
- API (BT_LOG_L2CAP_TRACE_LEVEL_API)
- EVENT (BT_LOG_L2CAP_TRACE_LEVEL_EVENT)
- DEBUG (BT_LOG_L2CAP_TRACE_LEVEL_DEBUG)
- VERBOSE (BT_LOG_L2CAP_TRACE_LEVEL_VERBOSE)

CONFIG_BT_LOG_RFCOMM_TRACE_LEVEL

RFCOMM layer

Found in: [Component config](#) > [Bluetooth](#) > [Bluedroid Options](#) > [BT DEBUG LOG LEVEL](#)

Define BT trace level for RFCOMM layer

Available options:

- NONE (BT_LOG_RFCOMM_TRACE_LEVEL_NONE)
- ERROR (BT_LOG_RFCOMM_TRACE_LEVEL_ERROR)
- WARNING (BT_LOG_RFCOMM_TRACE_LEVEL_WARNING)
- API (BT_LOG_RFCOMM_TRACE_LEVEL_API)
- EVENT (BT_LOG_RFCOMM_TRACE_LEVEL_EVENT)
- DEBUG (BT_LOG_RFCOMM_TRACE_LEVEL_DEBUG)
- VERBOSE (BT_LOG_RFCOMM_TRACE_LEVEL_VERBOSE)

CONFIG_BT_LOG_SDP_TRACE_LEVEL

SDP layer

Found in: [Component config](#) > [Bluetooth](#) > [Bluedroid Options](#) > [BT DEBUG LOG LEVEL](#)

Define BT trace level for SDP layer

Available options:

- NONE (BT_LOG_SDP_TRACE_LEVEL_NONE)

- ERROR (BT_LOG_SDP_TRACE_LEVEL_ERROR)
- WARNING (BT_LOG_SDP_TRACE_LEVEL_WARNING)
- API (BT_LOG_SDP_TRACE_LEVEL_API)
- EVENT (BT_LOG_SDP_TRACE_LEVEL_EVENT)
- DEBUG (BT_LOG_SDP_TRACE_LEVEL_DEBUG)
- VERBOSE (BT_LOG_SDP_TRACE_LEVEL_VERBOSE)

CONFIG_BT_LOG_GAP_TRACE_LEVEL

GAP layer

Found in: [Component config](#) > [Bluetooth](#) > [Bluedroid Options](#) > [BT DEBUG LOG LEVEL](#)

Define BT trace level for GAP layer

Available options:

- NONE (BT_LOG_GAP_TRACE_LEVEL_NONE)
- ERROR (BT_LOG_GAP_TRACE_LEVEL_ERROR)
- WARNING (BT_LOG_GAP_TRACE_LEVEL_WARNING)
- API (BT_LOG_GAP_TRACE_LEVEL_API)
- EVENT (BT_LOG_GAP_TRACE_LEVEL_EVENT)
- DEBUG (BT_LOG_GAP_TRACE_LEVEL_DEBUG)
- VERBOSE (BT_LOG_GAP_TRACE_LEVEL_VERBOSE)

CONFIG_BT_LOG_BNEP_TRACE_LEVEL

BNEP layer

Found in: [Component config](#) > [Bluetooth](#) > [Bluedroid Options](#) > [BT DEBUG LOG LEVEL](#)

Define BT trace level for BNEP layer

Available options:

- NONE (BT_LOG_BNEP_TRACE_LEVEL_NONE)
- ERROR (BT_LOG_BNEP_TRACE_LEVEL_ERROR)
- WARNING (BT_LOG_BNEP_TRACE_LEVEL_WARNING)
- API (BT_LOG_BNEP_TRACE_LEVEL_API)
- EVENT (BT_LOG_BNEP_TRACE_LEVEL_EVENT)
- DEBUG (BT_LOG_BNEP_TRACE_LEVEL_DEBUG)
- VERBOSE (BT_LOG_BNEP_TRACE_LEVEL_VERBOSE)

CONFIG_BT_LOG_PAN_TRACE_LEVEL

PAN layer

Found in: [Component config](#) > [Bluetooth](#) > [Bluedroid Options](#) > [BT DEBUG LOG LEVEL](#)

Define BT trace level for PAN layer

Available options:

- NONE (BT_LOG_PAN_TRACE_LEVEL_NONE)
- ERROR (BT_LOG_PAN_TRACE_LEVEL_ERROR)
- WARNING (BT_LOG_PAN_TRACE_LEVEL_WARNING)
- API (BT_LOG_PAN_TRACE_LEVEL_API)
- EVENT (BT_LOG_PAN_TRACE_LEVEL_EVENT)
- DEBUG (BT_LOG_PAN_TRACE_LEVEL_DEBUG)
- VERBOSE (BT_LOG_PAN_TRACE_LEVEL_VERBOSE)

CONFIG_BT_LOG_A2D_TRACE_LEVEL

A2D layer

Found in: [Component config](#) > [Bluetooth](#) > [Bluebird Options](#) > [BT DEBUG LOG LEVEL](#)

Define BT trace level for A2D layer

Available options:

- NONE (BT_LOG_A2D_TRACE_LEVEL_NONE)
- ERROR (BT_LOG_A2D_TRACE_LEVEL_ERROR)
- WARNING (BT_LOG_A2D_TRACE_LEVEL_WARNING)
- API (BT_LOG_A2D_TRACE_LEVEL_API)
- EVENT (BT_LOG_A2D_TRACE_LEVEL_EVENT)
- DEBUG (BT_LOG_A2D_TRACE_LEVEL_DEBUG)
- VERBOSE (BT_LOG_A2D_TRACE_LEVEL_VERBOSE)

CONFIG_BT_LOG_AVDT_TRACE_LEVEL

AVDT layer

Found in: [Component config](#) > [Bluetooth](#) > [Bluebird Options](#) > [BT DEBUG LOG LEVEL](#)

Define BT trace level for AVDT layer

Available options:

- NONE (BT_LOG_AVDT_TRACE_LEVEL_NONE)
- ERROR (BT_LOG_AVDT_TRACE_LEVEL_ERROR)
- WARNING (BT_LOG_AVDT_TRACE_LEVEL_WARNING)
- API (BT_LOG_AVDT_TRACE_LEVEL_API)
- EVENT (BT_LOG_AVDT_TRACE_LEVEL_EVENT)
- DEBUG (BT_LOG_AVDT_TRACE_LEVEL_DEBUG)
- VERBOSE (BT_LOG_AVDT_TRACE_LEVEL_VERBOSE)

CONFIG_BT_LOG_AVCT_TRACE_LEVEL

AVCT layer

Found in: [Component config](#) > [Bluetooth](#) > [Bluebird Options](#) > [BT DEBUG LOG LEVEL](#)

Define BT trace level for AVCT layer

Available options:

- NONE (BT_LOG_AVCT_TRACE_LEVEL_NONE)
- ERROR (BT_LOG_AVCT_TRACE_LEVEL_ERROR)
- WARNING (BT_LOG_AVCT_TRACE_LEVEL_WARNING)
- API (BT_LOG_AVCT_TRACE_LEVEL_API)
- EVENT (BT_LOG_AVCT_TRACE_LEVEL_EVENT)
- DEBUG (BT_LOG_AVCT_TRACE_LEVEL_DEBUG)
- VERBOSE (BT_LOG_AVCT_TRACE_LEVEL_VERBOSE)

CONFIG_BT_LOG_AVRC_TRACE_LEVEL

AVRC layer

Found in: [Component config](#) > [Bluetooth](#) > [Bluebird Options](#) > [BT DEBUG LOG LEVEL](#)

Define BT trace level for AVRC layer

Available options:

- NONE (BT_LOG_AVRC_TRACE_LEVEL_NONE)
- ERROR (BT_LOG_AVRC_TRACE_LEVEL_ERROR)
- WARNING (BT_LOG_AVRC_TRACE_LEVEL_WARNING)
- API (BT_LOG_AVRC_TRACE_LEVEL_API)
- EVENT (BT_LOG_AVRC_TRACE_LEVEL_EVENT)

- DEBUG (BT_LOG_AVRC_TRACE_LEVEL_DEBUG)
- VERBOSE (BT_LOG_AVRC_TRACE_LEVEL_VERBOSE)

CONFIG_BT_LOG_MCA_TRACE_LEVEL

MCA layer

Found in: [Component config](#) > [Bluetooth](#) > [Bluedroid Options](#) > [BT DEBUG LOG LEVEL](#)

Define BT trace level for MCA layer

Available options:

- NONE (BT_LOG_MCA_TRACE_LEVEL_NONE)
- ERROR (BT_LOG_MCA_TRACE_LEVEL_ERROR)
- WARNING (BT_LOG_MCA_TRACE_LEVEL_WARNING)
- API (BT_LOG_MCA_TRACE_LEVEL_API)
- EVENT (BT_LOG_MCA_TRACE_LEVEL_EVENT)
- DEBUG (BT_LOG_MCA_TRACE_LEVEL_DEBUG)
- VERBOSE (BT_LOG_MCA_TRACE_LEVEL_VERBOSE)

CONFIG_BT_LOG_HID_TRACE_LEVEL

HID layer

Found in: [Component config](#) > [Bluetooth](#) > [Bluedroid Options](#) > [BT DEBUG LOG LEVEL](#)

Define BT trace level for HID layer

Available options:

- NONE (BT_LOG_HID_TRACE_LEVEL_NONE)
- ERROR (BT_LOG_HID_TRACE_LEVEL_ERROR)
- WARNING (BT_LOG_HID_TRACE_LEVEL_WARNING)
- API (BT_LOG_HID_TRACE_LEVEL_API)
- EVENT (BT_LOG_HID_TRACE_LEVEL_EVENT)
- DEBUG (BT_LOG_HID_TRACE_LEVEL_DEBUG)
- VERBOSE (BT_LOG_HID_TRACE_LEVEL_VERBOSE)

CONFIG_BT_LOG_APPL_TRACE_LEVEL

APPL layer

Found in: [Component config](#) > [Bluetooth](#) > [Bluedroid Options](#) > [BT DEBUG LOG LEVEL](#)

Define BT trace level for APPL layer

Available options:

- NONE (BT_LOG_APPL_TRACE_LEVEL_NONE)
- ERROR (BT_LOG_APPL_TRACE_LEVEL_ERROR)
- WARNING (BT_LOG_APPL_TRACE_LEVEL_WARNING)
- API (BT_LOG_APPL_TRACE_LEVEL_API)
- EVENT (BT_LOG_APPL_TRACE_LEVEL_EVENT)
- DEBUG (BT_LOG_APPL_TRACE_LEVEL_DEBUG)
- VERBOSE (BT_LOG_APPL_TRACE_LEVEL_VERBOSE)

CONFIG_BT_LOG_GATT_TRACE_LEVEL

GATT layer

Found in: [Component config](#) > [Bluetooth](#) > [Bluedroid Options](#) > [BT DEBUG LOG LEVEL](#)

Define BT trace level for GATT layer

Available options:

- NONE (BT_LOG_GATT_TRACE_LEVEL_NONE)
- ERROR (BT_LOG_GATT_TRACE_LEVEL_ERROR)
- WARNING (BT_LOG_GATT_TRACE_LEVEL_WARNING)
- API (BT_LOG_GATT_TRACE_LEVEL_API)
- EVENT (BT_LOG_GATT_TRACE_LEVEL_EVENT)
- DEBUG (BT_LOG_GATT_TRACE_LEVEL_DEBUG)
- VERBOSE (BT_LOG_GATT_TRACE_LEVEL_VERBOSE)

CONFIG_BT_LOG_SMP_TRACE_LEVEL

SMP layer

Found in: [Component config](#) > [Bluetooth](#) > [Bluedroid Options](#) > [BT DEBUG LOG LEVEL](#)

Define BT trace level for SMP layer

Available options:

- NONE (BT_LOG_SMP_TRACE_LEVEL_NONE)
- ERROR (BT_LOG_SMP_TRACE_LEVEL_ERROR)
- WARNING (BT_LOG_SMP_TRACE_LEVEL_WARNING)
- API (BT_LOG_SMP_TRACE_LEVEL_API)
- EVENT (BT_LOG_SMP_TRACE_LEVEL_EVENT)
- DEBUG (BT_LOG_SMP_TRACE_LEVEL_DEBUG)
- VERBOSE (BT_LOG_SMP_TRACE_LEVEL_VERBOSE)

CONFIG_BT_LOG_BTIF_TRACE_LEVEL

BTIF layer

Found in: [Component config](#) > [Bluetooth](#) > [Bluedroid Options](#) > [BT DEBUG LOG LEVEL](#)

Define BT trace level for BTIF layer

Available options:

- NONE (BT_LOG_BTIF_TRACE_LEVEL_NONE)
- ERROR (BT_LOG_BTIF_TRACE_LEVEL_ERROR)
- WARNING (BT_LOG_BTIF_TRACE_LEVEL_WARNING)
- API (BT_LOG_BTIF_TRACE_LEVEL_API)
- EVENT (BT_LOG_BTIF_TRACE_LEVEL_EVENT)
- DEBUG (BT_LOG_BTIF_TRACE_LEVEL_DEBUG)
- VERBOSE (BT_LOG_BTIF_TRACE_LEVEL_VERBOSE)

CONFIG_BT_LOG_BTC_TRACE_LEVEL

BTC layer

Found in: [Component config](#) > [Bluetooth](#) > [Bluedroid Options](#) > [BT DEBUG LOG LEVEL](#)

Define BT trace level for BTC layer

Available options:

- NONE (BT_LOG_BTC_TRACE_LEVEL_NONE)
- ERROR (BT_LOG_BTC_TRACE_LEVEL_ERROR)
- WARNING (BT_LOG_BTC_TRACE_LEVEL_WARNING)
- API (BT_LOG_BTC_TRACE_LEVEL_API)
- EVENT (BT_LOG_BTC_TRACE_LEVEL_EVENT)
- DEBUG (BT_LOG_BTC_TRACE_LEVEL_DEBUG)
- VERBOSE (BT_LOG_BTC_TRACE_LEVEL_VERBOSE)

CONFIG_BT_LOG_OSI_TRACE_LEVEL

OSI layer

Found in: [Component config](#) > [Bluetooth](#) > [Bluedroid Options](#) > [BT DEBUG LOG LEVEL](#)

Define BT trace level for OSI layer

Available options:

- NONE (BT_LOG_OSI_TRACE_LEVEL_NONE)
- ERROR (BT_LOG_OSI_TRACE_LEVEL_ERROR)
- WARNING (BT_LOG_OSI_TRACE_LEVEL_WARNING)
- API (BT_LOG_OSI_TRACE_LEVEL_API)
- EVENT (BT_LOG_OSI_TRACE_LEVEL_EVENT)
- DEBUG (BT_LOG_OSI_TRACE_LEVEL_DEBUG)
- VERBOSE (BT_LOG_OSI_TRACE_LEVEL_VERBOSE)

CONFIG_BT_LOG_BLUFI_TRACE_LEVEL

BLUFI layer

Found in: [Component config](#) > [Bluetooth](#) > [Bluedroid Options](#) > [BT DEBUG LOG LEVEL](#)

Define BT trace level for BLUFI layer

Available options:

- NONE (BT_LOG_BLUFI_TRACE_LEVEL_NONE)
- ERROR (BT_LOG_BLUFI_TRACE_LEVEL_ERROR)
- WARNING (BT_LOG_BLUFI_TRACE_LEVEL_WARNING)
- API (BT_LOG_BLUFI_TRACE_LEVEL_API)
- EVENT (BT_LOG_BLUFI_TRACE_LEVEL_EVENT)
- DEBUG (BT_LOG_BLUFI_TRACE_LEVEL_DEBUG)
- VERBOSE (BT_LOG_BLUFI_TRACE_LEVEL_VERBOSE)

CONFIG_BT_ACL_CONNECTIONS

BT/BLE MAX ACL CONNECTIONS(1~7)

Found in: [Component config](#) > [Bluetooth](#) > [Bluedroid Options](#)

Maximum BT/BLE connection count

Range:

- from 1 to 7 if BT_BLUEDROID_ENABLED && BT_BLUEDROID_ENABLED

Default value:

- 4 if BT_BLUEDROID_ENABLED && BT_BLUEDROID_ENABLED

CONFIG_BT_MULTI_CONNECTION_ENBALE

Enable BLE multi-connections

Found in: [Component config](#) > [Bluetooth](#) > [Bluedroid Options](#)

Enable this option if there are multiple connections

Default value:

- Yes (enabled) if BT_BLUEDROID_ENABLED && BT_BLUEDROID_ENABLED

CONFIG_BT_ALLOCATION_FROM_SPIRAM_FIRST

BT/BLE will first malloc the memory from the PSRAM

Found in: [Component config](#) > [Bluetooth](#) > [Bluedroid Options](#)

This select can save the internal RAM if there have the PSRAM

Default value:

- No (disabled) if BT_BLUEDROID_ENABLED && BT_BLUEDROID_ENABLED

CONFIG_BT_BLE_DYNAMIC_ENV_MEMORY

Use dynamic memory allocation in BT/BLE stack

Found in: [Component config](#) > [Bluetooth](#) > [Bluedroid Options](#)

This select can make the allocation of memory will become more flexible

Default value:

- No (disabled) if BT_BLUEDROID_ENABLED && BT_BLUEDROID_ENABLED

CONFIG_BT_BLE_HOST_QUEUE_CONG_CHECK

BLE queue congestion check

Found in: [Component config](#) > [Bluetooth](#) > [Bluedroid Options](#)

When scanning and scan duplicate is not enabled, if there are a lot of adv packets around or application layer handling adv packets is slow, it will cause the controller memory to run out. if enabled, adv packets will be lost when host queue is congested.

Default value:

- No (disabled) if BT_BLUEDROID_ENABLED && BT_BLUEDROID_ENABLED

CONFIG_BT_BLE_ACT_SCAN_REP_ADV_SCAN

Report adv data and scan response individually when BLE active scan

Found in: [Component config](#) > [Bluetooth](#) > [Bluedroid Options](#)

Originally, when doing BLE active scan, Bluedroid will not report adv to application layer until receive scan response. This option is used to disable the behavior. When enable this option, Bluedroid will report adv data or scan response to application layer immediately.

Memory reserved at start of DRAM for Bluetooth stack

Default value:

- No (disabled) if BT_BLUEDROID_ENABLED && (BTDM_CTRL_MODE_BTDM || BTDM_CTRL_MODE_BLE_ONLY) && BT_BLUEDROID_ENABLED

CONFIG_BT_BLE_ESTAB_LINK_CONN_TOUT

Timeout of BLE connection establishment

Found in: [Component config](#) > [Bluetooth](#) > [Bluedroid Options](#)

Bluetooth Connection establishment maximum time, if connection time exceeds this value, the connection establishment fails, ESP_GATTC_OPEN_EVT or ESP_GATTS_OPEN_EVT is triggered.

Range:

- from 1 to 60 if BT_BLUEDROID_ENABLED && BT_BLUEDROID_ENABLED

Default value:

- 30 if BT_BLUEDROID_ENABLED && BT_BLUEDROID_ENABLED

CONFIG_BT_MAX_DEVICE_NAME_LEN

length of bluetooth device name

Found in: [Component config](#) > [Bluetooth](#) > [Bluedroid Options](#)

Bluetooth Device name length shall be no larger than 248 octets, If the broadcast data cannot contain the complete device name, then only the shortname will be displayed, the rest parts that can't fit in will be truncated.

Range:

- from 32 to 248 if BT_BLUEDROID_ENABLED && BT_BLUEDROID_ENABLED

Default value:

- 32 if BT_BLUEDROID_ENABLED && BT_BLUEDROID_ENABLED

CONFIG_BT_BLE_RPA_SUPPORTED

Update RPA to Controller

Found in: Component config > Bluetooth > Bluedroid Options

This enables controller RPA list function. For ESP32, ESP32 only support network privacy mode. If this option is enabled, ESP32 will only accept advertising packets from peer devices that contain private address, HW will not receive the advertising packets contain identity address after IRK changed. If this option is disabled, address resolution will be performed in the host, so the functions that require controller to resolve address in the white list cannot be used. This option is disabled by default on ESP32, please enable or disable this option according to your own needs.

For ESP32C3 and esp32s3, devices support network privacy mode and device privacy mode, users can switch the two modes according to their own needs. So this option is enabled by default.

Default value:

- Yes (enabled) if BT_BLUEDROID_ENABLED && BT_BLUEDROID_ENABLED

CONFIG_BT_BLE_50_FEATURES_SUPPORTED

Enable BLE 5.0 features

Found in: Component config > Bluetooth > Bluedroid Options

This enables BLE 5.0 features, this option only support esp32c3/esp32s3 chip

Default value:

- Yes (enabled) if BT_BLUEDROID_ENABLED && BT_BLUEDROID_ENABLED

CONFIG_BT_BLE_42_FEATURES_SUPPORTED

Enable BLE 4.2 features

Found in: Component config > Bluetooth > Bluedroid Options

This enables BLE 4.2 features.

Default value:

- No (disabled) if BT_BLUEDROID_ENABLED && BT_BLUEDROID_ENABLED

NimBLE Options Contains:

- [CONFIG_BT_NIMBLE_ACL_BUF_COUNT](#)
- [CONFIG_BT_NIMBLE_ACL_BUF_SIZE](#)
- [CONFIG_BT_NIMBLE_SVC_GAP_DEVICE_NAME](#)
- [CONFIG_BT_NIMBLE_HS_STOP_TIMEOUT_MS](#)
- [CONFIG_BT_NIMBLE_ROLE_BROADCASTER](#)
- [CONFIG_BT_NIMBLE_ROLE_CENTRAL](#)
- [CONFIG_BT_NIMBLE_MESH](#)
- [CONFIG_BT_NIMBLE_ROLE_OBSERVER](#)
- [CONFIG_BT_NIMBLE_ROLE_PERIPHERAL](#)
- [CONFIG_BT_NIMBLE_BLUFI_ENABLE](#)
- [CONFIG_BT_NIMBLE_ENABLE_CONN_REATTEMPT](#)

- `CONFIG_BT_NIMBLE_USE_ESP_TIMER`
- `CONFIG_BT_NIMBLE_EXT_ADV`
- `CONFIG_BT_NIMBLE_DEBUG`
- `CONFIG_BT_NIMBLE_HOST_BASED_PRIVACY`
- `CONFIG_BT_NIMBLE_HS_FLOW_CTRL`
- `CONFIG_BT_NIMBLE_SVC_GAP_APPEARANCE`
- `CONFIG_BT_NIMBLE_HCI_EVT_BUF_SIZE`
- `CONFIG_BT_NIMBLE_HCI_EVT_HI_BUF_COUNT`
- `CONFIG_BT_NIMBLE_HCI_EVT_LO_BUF_COUNT`
- `CONFIG_BT_NIMBLE_GAP_DEVICE_NAME_MAX_LEN`
- `CONFIG_BT_NIMBLE_MAX BONDS`
- `CONFIG_BT_NIMBLE_MAX CCCDS`
- `CONFIG_BT_NIMBLE_MAX CONNECTIONS`
- `CONFIG_BT_NIMBLE_L2CAP_COC_MAX_NUM`
- `CONFIG_BT_NIMBLE_MEM_ALLOC_MODE`
- `CONFIG_BT_NIMBLE_MSYS1_BLOCK_COUNT`
- `CONFIG_BT_NIMBLE_LOG_LEVEL`
- `CONFIG_BT_NIMBLE_TASK_STACK_SIZE`
- `CONFIG_BT_NIMBLE_CRYPT_STACK_MBEDTLS`
- `CONFIG_BT_NIMBLE_NVS_PERSIST`
- `CONFIG_BT_NIMBLE_ATT_PREFERRED_MTU`
- `CONFIG_BT_NIMBLE_RPA_TIMEOUT`
- `CONFIG_BT_NIMBLE_SM_LEGACY`
- `CONFIG_BT_NIMBLE_SM_SC`
- `CONFIG_BT_NIMBLE_PINNED_TO_CORE_CHOICE`
- `CONFIG_BT_NIMBLE_SM_SC_DEBUG_KEYS`

CONFIG_BT_NIMBLE_MEM_ALLOC_MODE

Memory allocation strategy

Found in: Component config > Bluetooth > NimBLE Options

Allocation strategy for NimBLE host stack, essentially provides ability to allocate all required dynamic allocations from,

- Internal DRAM memory only
- External SPIRAM memory only
- Either internal or external memory based on default malloc() behavior in ESP-IDF
- Internal IRAM memory wherever applicable else internal DRAM

Available options:

- Internal memory (`BT_NIMBLE_MEM_ALLOC_MODE_INTERNAL`)
- External SPIRAM (`BT_NIMBLE_MEM_ALLOC_MODE_EXTERNAL`)
- Default alloc mode (`BT_NIMBLE_MEM_ALLOC_MODE_DEFAULT`)
- Internal IRAM (`BT_NIMBLE_MEM_ALLOC_MODE_IRAM_8BIT`)

Allows to use IRAM memory region as 8bit accessible region.

Every unaligned (8bit or 16bit) access will result in an exception and incur penalty of certain clock cycles per unaligned read/write.

CONFIG_BT_NIMBLE_LOG_LEVEL

NimBLE Host log verbosity

Found in: Component config > Bluetooth > NimBLE Options

Select NimBLE log level. Please make a note that the selected NimBLE log verbosity can not exceed the level set in “Component config -> Log output -> Default log verbosity” .

Available options:

- No logs (`BT_NIMBLE_LOG_LEVEL_NONE`)

- Error logs (BT_NIMBLE_LOG_LEVEL_ERROR)
- Warning logs (BT_NIMBLE_LOG_LEVEL_WARNING)
- Info logs (BT_NIMBLE_LOG_LEVEL_INFO)
- Debug logs (BT_NIMBLE_LOG_LEVEL_DEBUG)

CONFIG_BT_NIMBLE_MAX_CONNECTIONS

Maximum number of concurrent connections

Found in: Component config > Bluetooth > NimBLE Options

Defines maximum number of concurrent BLE connections. For ESP32, user is expected to configure BTDM_CTRL_BLE_MAX_CONN from controller menu along with this option. Similarly for ESP32-C3 or ESP32-S3, user is expected to configure BT_CTRL_BLE_MAX_ACT from controller menu.

Range:

- from 1 to 8 if BT_NIMBLE_ENABLED && BT_NIMBLE_ENABLED

Default value:

- 3 if BT_NIMBLE_ENABLED && BT_NIMBLE_ENABLED

CONFIG_BT_NIMBLE_MAX BONDS

Maximum number of bonds to save across reboots

Found in: Component config > Bluetooth > NimBLE Options

Defines maximum number of bonds to save for peer security and our security

Default value:

- 3 if BT_NIMBLE_ENABLED && BT_NIMBLE_ENABLED

CONFIG_BT_NIMBLE_MAX_CCCDS

Maximum number of CCC descriptors to save across reboots

Found in: Component config > Bluetooth > NimBLE Options

Defines maximum number of CCC descriptors to save

Default value:

- 8 if BT_NIMBLE_ENABLED && BT_NIMBLE_ENABLED

CONFIG_BT_NIMBLE_L2CAP_COC_MAX_NUM

Maximum number of connection oriented channels

Found in: Component config > Bluetooth > NimBLE Options

Defines maximum number of BLE Connection Oriented Channels. When set to (0), BLE COC is not compiled in

Range:

- from 0 to 9 if BT_NIMBLE_ENABLED && BT_NIMBLE_ENABLED

Default value:

- 0 if BT_NIMBLE_ENABLED && BT_NIMBLE_ENABLED

CONFIG_BT_NIMBLE_PINNED_TO_CORE_CHOICE

The CPU core on which NimBLE host will run

Found in: Component config > Bluetooth > NimBLE Options

The CPU core on which NimBLE host will run. You can choose Core 0 or Core 1. Cannot specify no-affinity

Available options:

- Core 0 (PRO CPU) (BT_NIMBLE_PINNED_TO_CORE_0)
- Core 1 (APP CPU) (BT_NIMBLE_PINNED_TO_CORE_1)

CONFIG_BT_NIMBLE_TASK_STACK_SIZE

NimBLE Host task stack size

Found in: [Component config](#) > [Bluetooth](#) > [NimBLE Options](#)

This configures stack size of NimBLE host task

Default value:

- 5120 if `CONFIG_BLE_MESH` && `BT_NIMBLE_ENABLED` && `BT_NIMBLE_ENABLED`
- 4096 if `BT_NIMBLE_ENABLED` && `BT_NIMBLE_ENABLED`

CONFIG_BT_NIMBLE_ROLE_CENTRAL

Enable BLE Central role

Found in: [Component config](#) > [Bluetooth](#) > [NimBLE Options](#)

Default value:

- Yes (enabled) if `BT_NIMBLE_ENABLED` && `BT_NIMBLE_ENABLED`

CONFIG_BT_NIMBLE_ROLE_PERIPHERAL

Enable BLE Peripheral role

Found in: [Component config](#) > [Bluetooth](#) > [NimBLE Options](#)

Default value:

- Yes (enabled) if `BT_NIMBLE_ENABLED` && `BT_NIMBLE_ENABLED`

CONFIG_BT_NIMBLE_ROLE_BROADCASTER

Enable BLE Broadcaster role

Found in: [Component config](#) > [Bluetooth](#) > [NimBLE Options](#)

Default value:

- Yes (enabled) if `BT_NIMBLE_ENABLED` && `BT_NIMBLE_ENABLED`

CONFIG_BT_NIMBLE_ROLE_OBSERVER

Enable BLE Observer role

Found in: [Component config](#) > [Bluetooth](#) > [NimBLE Options](#)

Default value:

- Yes (enabled) if `BT_NIMBLE_ENABLED` && `BT_NIMBLE_ENABLED`

CONFIG_BT_NIMBLE_NVS_PERSIST

Persist the BLE Bonding keys in NVS

Found in: [Component config](#) > [Bluetooth](#) > [NimBLE Options](#)

Enable this flag to make bonding persistent across device reboots

Default value:

- Yes (enabled) if `BT_NIMBLE_ENABLED` && `BT_NIMBLE_ENABLED`

CONFIG_BT_NIMBLE_SM_LEGACY

Security manager legacy pairing

Found in: [Component config](#) > [Bluetooth](#) > [NimBLE Options](#)

Enable security manager legacy pairing

Default value:

- Yes (enabled) if BT_NIMBLE_ENABLED && BT_NIMBLE_ENABLED

CONFIG_BT_NIMBLE_SM_SC

Security manager secure connections (4.2)

Found in: [Component config](#) > [Bluetooth](#) > [NimBLE Options](#)

Enable security manager secure connections

Default value:

- Yes (enabled) if BT_NIMBLE_ENABLED && BT_NIMBLE_ENABLED

CONFIG_BT_NIMBLE_DEBUG

Enable extra runtime asserts and host debugging

Found in: [Component config](#) > [Bluetooth](#) > [NimBLE Options](#)

This enables extra runtime asserts and host debugging

Default value:

- No (disabled) if BT_NIMBLE_ENABLED && BT_NIMBLE_ENABLED

CONFIG_BT_NIMBLE_SM_SC_DEBUG_KEYS

Use predefined public-private key pair

Found in: [Component config](#) > [Bluetooth](#) > [NimBLE Options](#)

If this option is enabled, SM uses predefined DH key pair as described in Core Specification, Vol. 3, Part H, 2.3.5.6.1. This allows to decrypt air traffic easily and thus should only be used for debugging.

Default value:

- No (disabled) if [CONFIG_BT_NIMBLE_SM_SC](#) && BT_NIMBLE_ENABLED

CONFIG_BT_NIMBLE_SVC_GAP_DEVICE_NAME

BLE GAP default device name

Found in: [Component config](#) > [Bluetooth](#) > [NimBLE Options](#)

The Device Name characteristic shall contain the name of the device as an UTF-8 string. This name can be changed by using API `ble_svc_gap_device_name_set()`

Default value:

- “nimble” if BT_NIMBLE_ENABLED && BT_NIMBLE_ENABLED

CONFIG_BT_NIMBLE_GAP_DEVICE_NAME_MAX_LEN

Maximum length of BLE device name in octets

Found in: [Component config](#) > [Bluetooth](#) > [NimBLE Options](#)

Device Name characteristic value shall be 0 to 248 octets in length

Default value:

- 31 if BT_NIMBLE_ENABLED && BT_NIMBLE_ENABLED

CONFIG_BT_NIMBLE_ATT_PREFERRED_MTU

Preferred MTU size in octets

Found in: [Component config](#) > [Bluetooth](#) > [NimBLE Options](#)

This is the default value of ATT MTU indicated by the device during an ATT MTU exchange. This value can be changed using API `ble_att_set_preferred_mtu()`

Default value:

- 256 if `BT_NIMBLE_ENABLED` && `BT_NIMBLE_ENABLED`

CONFIG_BT_NIMBLE_SVC_GAP_APPEARANCE

External appearance of the device

Found in: [Component config](#) > [Bluetooth](#) > [NimBLE Options](#)

Standard BLE GAP Appearance value in HEX format e.g. 0x02C0

Default value:

- 0 if `BT_NIMBLE_ENABLED` && `BT_NIMBLE_ENABLED`

CONFIG_BT_NIMBLE_ACL_BUF_COUNT

ACL Buffer count

Found in: [Component config](#) > [Bluetooth](#) > [NimBLE Options](#)

The number of ACL data buffers.

Default value:

- 20 if `BT_NIMBLE_ENABLED` && `BT_NIMBLE_ENABLED`

CONFIG_BT_NIMBLE_ACL_BUF_SIZE

ACL Buffer size

Found in: [Component config](#) > [Bluetooth](#) > [NimBLE Options](#)

This is the maximum size of the data portion of HCI ACL data packets. It does not include the HCI data header (of 4 bytes)

Default value:

- 255 if `BT_NIMBLE_ENABLED` && `BT_NIMBLE_ENABLED`

CONFIG_BT_NIMBLE_HCI_EVT_BUF_SIZE

HCI Event Buffer size

Found in: [Component config](#) > [Bluetooth](#) > [NimBLE Options](#)

This is the size of each HCI event buffer in bytes. In case of extended advertising, packets can be fragmented. 257 bytes is the maximum size of a packet.

Default value:

- 257 if `CONFIG_BT_NIMBLE_EXT_ADV` && `BT_NIMBLE_ENABLED` && `BT_NIMBLE_ENABLED`
- 70 if `BT_NIMBLE_ENABLED` && `BT_NIMBLE_ENABLED`

CONFIG_BT_NIMBLE_HCI_EVT_HI_BUF_COUNT

High Priority HCI Event Buffer count

Found in: [Component config](#) > [Bluetooth](#) > [NimBLE Options](#)

This is the high priority HCI events' buffer size. High-priority event buffers are for everything except advertising reports. If there are no free high-priority event buffers then host will try to allocate a low-priority buffer instead

Default value:

- 30 if BT_NIMBLE_ENABLED && BT_NIMBLE_ENABLED

CONFIG_BT_NIMBLE_HCI_EVT_LO_BUF_COUNT

Low Priority HCI Event Buffer count

Found in: [Component config](#) > [Bluetooth](#) > [NimBLE Options](#)

This is the low priority HCI events' buffer size. Low-priority event buffers are only used for advertising reports. If there are no free low-priority event buffers, then an incoming advertising report will get dropped

Default value:

- 8 if BT_NIMBLE_ENABLED && BT_NIMBLE_ENABLED

CONFIG_BT_NIMBLE_MSYS1_BLOCK_COUNT

MSYS_1 Block Count

Found in: [Component config](#) > [Bluetooth](#) > [NimBLE Options](#)

MSYS is a system level mbuf registry. For prepare write & prepare responses Mbufs are allocated out of msys_1 pool. For NIMBLE_MESH enabled cases, this block count is increased by 8 than user defined count.

Default value:

- 12 if BT_NIMBLE_ENABLED && BT_NIMBLE_ENABLED

CONFIG_BT_NIMBLE_HS_FLOW_CTRL

Enable Host Flow control

Found in: [Component config](#) > [Bluetooth](#) > [NimBLE Options](#)

Enable Host Flow control

Default value:

- Yes (enabled) if BT_NIMBLE_ENABLED && BT_NIMBLE_ENABLED

CONFIG_BT_NIMBLE_HS_FLOW_CTRL_ITVL

Host Flow control interval

Found in: [Component config](#) > [Bluetooth](#) > [NimBLE Options](#) > [CONFIG_BT_NIMBLE_HS_FLOW_CTRL](#)

Host flow control interval in msec

Default value:

- 1000 if [CONFIG_BT_NIMBLE_HS_FLOW_CTRL](#) && BT_NIMBLE_ENABLED

CONFIG_BT_NIMBLE_HS_FLOW_CTRL_THRESH

Host Flow control threshold

Found in: Component config > Bluetooth > NimBLE Options > CONFIG_BT_NIMBLE_HS_FLOW_CTRL

Host flow control threshold, if the number of free buffers are at or below this threshold, send an immediate number-of-completed-packets event

Default value:

- 2 if *CONFIG_BT_NIMBLE_HS_FLOW_CTRL* && BT_NIMBLE_ENABLED

CONFIG_BT_NIMBLE_HS_FLOW_CTRL_TX_ON_DISCONNECT

Host Flow control on disconnect

Found in: Component config > Bluetooth > NimBLE Options > CONFIG_BT_NIMBLE_HS_FLOW_CTRL

Enable this option to send number-of-completed-packets event to controller after disconnection

Default value:

- Yes (enabled) if *CONFIG_BT_NIMBLE_HS_FLOW_CTRL* && BT_NIMBLE_ENABLED

CONFIG_BT_NIMBLE_RPA_TIMEOUT

RPA timeout in seconds

Found in: Component config > Bluetooth > NimBLE Options

Time interval between RPA address change. This is applicable in case of Host based RPA

Range:

- from 1 to 41400 if BT_NIMBLE_ENABLED && BT_NIMBLE_ENABLED

Default value:

- 900 if BT_NIMBLE_ENABLED && BT_NIMBLE_ENABLED

CONFIG_BT_NIMBLE_MESH

Enable BLE mesh functionality

Found in: Component config > Bluetooth > NimBLE Options

Enable BLE Mesh functionality

Default value:

- No (disabled) if BT_NIMBLE_ENABLED && BT_NIMBLE_ENABLED

Contains:

- *CONFIG_BT_NIMBLE_MESH_PROVISIONER*
- *CONFIG_BT_NIMBLE_MESH_PROV*
- *CONFIG_BT_NIMBLE_MESH_GATT_PROXY*
- *CONFIG_BT_NIMBLE_MESH_FRIEND*
- *CONFIG_BT_NIMBLE_MESH_LOW_POWER*
- *CONFIG_BT_NIMBLE_MESH_PROXY*
- *CONFIG_BT_NIMBLE_MESH_RELAY*
- *CONFIG_BT_NIMBLE_MESH_DEVICE_NAME*
- *CONFIG_BT_NIMBLE_MESH_NODE_COUNT*

CONFIG_BT_NIMBLE_MESH_PROXY

Enable mesh proxy functionality

Found in: Component config > Bluetooth > NimBLE Options > CONFIG_BT_NIMBLE_MESH

Enable proxy. This is automatically set whenever `NIMBLE_MESH_PB_GATT` or `NIMBLE_MESH_GATT_PROXY` is set

Default value:

- No (disabled) if `CONFIG_BT_NIMBLE_MESH` && `BT_NIMBLE_ENABLED`

CONFIG_BT_NIMBLE_MESH_PROV

Enable BLE mesh provisioning

Found in: Component config > Bluetooth > NimBLE Options > CONFIG_BT_NIMBLE_MESH

Enable mesh provisioning

Default value:

- Yes (enabled) if `CONFIG_BT_NIMBLE_MESH` && `BT_NIMBLE_ENABLED`

CONFIG_BT_NIMBLE_MESH_PB_ADV

Enable mesh provisioning over advertising bearer

Found in: Component config > Bluetooth > NimBLE Options > CONFIG_BT_NIMBLE_MESH > CONFIG_BT_NIMBLE_MESH_PROV

Enable this option to allow the device to be provisioned over the advertising bearer

Default value:

- Yes (enabled) if `CONFIG_BT_NIMBLE_MESH_PROV` && `BT_NIMBLE_ENABLED`

CONFIG_BT_NIMBLE_MESH_PB_GATT

Enable mesh provisioning over GATT bearer

Found in: Component config > Bluetooth > NimBLE Options > CONFIG_BT_NIMBLE_MESH > CONFIG_BT_NIMBLE_MESH_PROV

Enable this option to allow the device to be provisioned over the GATT bearer

Default value:

- Yes (enabled) if `CONFIG_BT_NIMBLE_MESH_PROV` && `BT_NIMBLE_ENABLED`

CONFIG_BT_NIMBLE_MESH_GATT_PROXY

Enable GATT Proxy functionality

Found in: Component config > Bluetooth > NimBLE Options > CONFIG_BT_NIMBLE_MESH

This option enables support for the Mesh GATT Proxy Service, i.e. the ability to act as a proxy between a Mesh GATT Client and a Mesh network

Default value:

- Yes (enabled) if `CONFIG_BT_NIMBLE_MESH` && `BT_NIMBLE_ENABLED`

CONFIG_BT_NIMBLE_MESH_RELAY

Enable mesh relay functionality

Found in: Component config > Bluetooth > NimBLE Options > CONFIG_BT_NIMBLE_MESH

Support for acting as a Mesh Relay Node

Default value:

- No (disabled) if `CONFIG_BT_NIMBLE_MESH` && `BT_NIMBLE_ENABLED`

CONFIG_BT_NIMBLE_MESH_LOW_POWER

Enable mesh low power mode

Found in: [Component config](#) > [Bluetooth](#) > [NimBLE Options](#) > [CONFIG_BT_NIMBLE_MESH](#)

Enable this option to be able to act as a Low Power Node

Default value:

- No (disabled) if [CONFIG_BT_NIMBLE_MESH](#) && BT_NIMBLE_ENABLED

CONFIG_BT_NIMBLE_MESH_FRIEND

Enable mesh friend functionality

Found in: [Component config](#) > [Bluetooth](#) > [NimBLE Options](#) > [CONFIG_BT_NIMBLE_MESH](#)

Enable this option to be able to act as a Friend Node

Default value:

- No (disabled) if [CONFIG_BT_NIMBLE_MESH](#) && BT_NIMBLE_ENABLED

CONFIG_BT_NIMBLE_MESH_DEVICE_NAME

Set mesh device name

Found in: [Component config](#) > [Bluetooth](#) > [NimBLE Options](#) > [CONFIG_BT_NIMBLE_MESH](#)

This value defines Bluetooth Mesh device/node name

Default value:

- “nimble-mesh-node” if [CONFIG_BT_NIMBLE_MESH](#) && BT_NIMBLE_ENABLED

CONFIG_BT_NIMBLE_MESH_NODE_COUNT

Set mesh node count

Found in: [Component config](#) > [Bluetooth](#) > [NimBLE Options](#) > [CONFIG_BT_NIMBLE_MESH](#)

Defines mesh node count.

Default value:

- 1 if [CONFIG_BT_NIMBLE_MESH](#) && BT_NIMBLE_ENABLED

CONFIG_BT_NIMBLE_MESH_PROVISIONER

Enable BLE mesh provisioner

Found in: [Component config](#) > [Bluetooth](#) > [NimBLE Options](#) > [CONFIG_BT_NIMBLE_MESH](#)

Enable mesh provisioner.

Default value:

- 0 if [CONFIG_BT_NIMBLE_MESH](#) && BT_NIMBLE_ENABLED

CONFIG_BT_NIMBLE_CRYPTO_STACK_MBEDTLS

Override TinyCrypt with mbedTLS for crypto computations

Found in: [Component config](#) > [Bluetooth](#) > [NimBLE Options](#)

Enable this option to choose mbedTLS instead of TinyCrypt for crypto computations.

Default value:

- Yes (enabled) if BT_NIMBLE_ENABLED && BT_NIMBLE_ENABLED

CONFIG_BT_NIMBLE_HS_STOP_TIMEOUT_MS

BLE host stop timeout in msec

Found in: [Component config](#) > [Bluetooth](#) > [NimBLE Options](#)

BLE Host stop procedure timeout in milliseconds.

Default value:

- 2000 if BT_NIMBLE_ENABLED && BT_NIMBLE_ENABLED

CONFIG_BT_NIMBLE_HOST_BASED_PRIVACY

Enable host based privacy for random address.

Found in: [Component config](#) > [Bluetooth](#) > [NimBLE Options](#)

Use this option to do host based Random Private Address resolution. If this option is disabled then controller based privacy is used.

Default value:

- No (disabled) if BT_NIMBLE_ENABLED && BT_NIMBLE_ENABLED

CONFIG_BT_NIMBLE_ENABLE_CONN_REATTEMPT

Enable connection reattempts on connection establishment error

Found in: [Component config](#) > [Bluetooth](#) > [NimBLE Options](#)

Enable to make the NimBLE host to reattempt GAP connection on connection establishment failure.

Default value:

- Yes (enabled) if BT_NIMBLE_ENABLED

CONFIG_BT_NIMBLE_MAX_CONN_REATTEMPT

Maximum number connection reattempts

Found in: [Component config](#) > [Bluetooth](#) > [NimBLE Options](#) > [CONFIG_BT_NIMBLE_ENABLE_CONN_REATTEMPT](#)

Defines maximum number of connection reattempts.

Range:

- from 1 to 7 if BT_NIMBLE_ENABLED && [CONFIG_BT_NIMBLE_ENABLE_CONN_REATTEMPT](#) && BT_NIMBLE_ENABLED

Default value:

- 3 if BT_NIMBLE_ENABLED && [CONFIG_BT_NIMBLE_ENABLE_CONN_REATTEMPT](#) && BT_NIMBLE_ENABLED

CONFIG_BT_NIMBLE_EXT_ADV

Enable extended advertising.

Found in: [Component config](#) > [Bluetooth](#) > [NimBLE Options](#)

Enable this option to do extended advertising. Extended advertising will be supported from BLE 5.0 onwards.

CONFIG_BT_NIMBLE_MAX_EXT_ADV_INSTANCES

Maximum number of extended advertising instances.

Found in: [Component config](#) > [Bluetooth](#) > [NimBLE Options](#) > [CONFIG_BT_NIMBLE_EXT_ADV](#)

Change this option to set maximum number of extended advertising instances. Minimum there is always one instance of advertising. Enter how many more advertising instances you want.

Range:

- from 0 to 4 if [CONFIG_BT_NIMBLE_EXT_ADV](#) && [BT_NIMBLE_ENABLED](#)

Default value:

- 1 if [CONFIG_BT_NIMBLE_EXT_ADV](#) && [CONFIG_BT_NIMBLE_EXT_ADV](#) && [BT_NIMBLE_ENABLED](#)
- 0 if [CONFIG_BT_NIMBLE_EXT_ADV](#) && [BT_NIMBLE_ENABLED](#)

CONFIG_BT_NIMBLE_MAX_EXT_ADV_DATA_LEN

Maximum length of the advertising data.

Found in: [Component config](#) > [Bluetooth](#) > [NimBLE Options](#) > [CONFIG_BT_NIMBLE_EXT_ADV](#)

Defines size of extended advertising data. Size should not increase 1650.

Range:

- from 0 to 1650 if [CONFIG_BT_NIMBLE_EXT_ADV](#) && [BT_NIMBLE_ENABLED](#)

Default value:

- 1650 if [CONFIG_BT_NIMBLE_EXT_ADV](#) && [CONFIG_BT_NIMBLE_EXT_ADV](#) && [BT_NIMBLE_ENABLED](#)
- 0 if [CONFIG_BT_NIMBLE_EXT_ADV](#) && [BT_NIMBLE_ENABLED](#)

CONFIG_BT_NIMBLE_ENABLE_PERIODIC_ADV

Enable periodic advertisement.

Found in: [Component config](#) > [Bluetooth](#) > [NimBLE Options](#) > [CONFIG_BT_NIMBLE_EXT_ADV](#)

Enable this option to start periodic advertisement.

Default value:

- Yes (enabled) if [CONFIG_BT_NIMBLE_EXT_ADV](#) && [BT_NIMBLE_ENABLED](#)

CONFIG_BT_NIMBLE_MAX_PERIODIC_SYNCS

Maximum number of periodic advertising syncs.

Found in: [Component config](#) > [Bluetooth](#) > [NimBLE Options](#) > [CONFIG_BT_NIMBLE_EXT_ADV](#) > [CONFIG_BT_NIMBLE_ENABLE_PERIODIC_ADV](#)

Set this option to set the upper limit for number of periodic sync connections. This should be less than maximum connections allowed by controller.

Range:

- from 1 to 8 if [CONFIG_BT_NIMBLE_ENABLE_PERIODIC_ADV](#) && [BT_NIMBLE_ENABLED](#)

Default value:

- 1 if [CONFIG_BT_NIMBLE_ENABLE_PERIODIC_ADV](#) && [CONFIG_BT_NIMBLE_ENABLE_PERIODIC_ADV](#) && [BT_NIMBLE_ENABLED](#)
- 0 if [CONFIG_BT_NIMBLE_ENABLE_PERIODIC_ADV](#) && [BT_NIMBLE_ENABLED](#)

CONFIG_BT_NIMBLE_USE_ESP_TIMER

Enable Esp Timer for Nimble

Found in: Component config > Bluetooth > NimBLE Options

Set this option to use Esp Timer which has higher priority timer instead of FreeRTOS timer

Default value:

- Yes (enabled) if BT_NIMBLE_ENABLED

CONFIG_BT_NIMBLE_BLUFI_ENABLE

Enable blufi functionality

Found in: Component config > Bluetooth > NimBLE Options

Set this option to enable blufi functionality.

Default value:

- No (disabled) if BT_NIMBLE_ENABLED && BT_NIMBLE_ENABLED

CONFIG_BLE_MESH

ESP BLE Mesh Support

Found in: Component config

This option enables ESP BLE Mesh support. The specific features that are available may depend on other features that have been enabled in the stack, such as Bluetooth Support, Bluedroid Support & GATT support.

Contains:

- *BLE Mesh and BLE coexistence support*
- *CONFIG_BLE_MESH_GATT_PROXY_CLIENT*
- *CONFIG_BLE_MESH_GATT_PROXY_SERVER*
- *BLE Mesh NET BUF DEBUG LOG LEVEL*
- *CONFIG_BLE_MESH_PROV*
- *CONFIG_BLE_MESH_PROXY*
- *BLE Mesh specific test option*
- *BLE Mesh STACK DEBUG LOG LEVEL*
- *CONFIG_BLE_MESH_NO_LOG*
- *CONFIG_BLE_MESH_IVU_DIVIDER*
- *CONFIG_BLE_MESH_FAST_PROV*
- *CONFIG_BLE_MESH_FREERTOS_STATIC_ALLOC*
- *CONFIG_BLE_MESH_CRPL*
- *CONFIG_BLE_MESH_RX_SDU_MAX*
- *CONFIG_BLE_MESH_MODEL_KEY_COUNT*
- *CONFIG_BLE_MESH_APP_KEY_COUNT*
- *CONFIG_BLE_MESH_MODEL_GROUP_COUNT*
- *CONFIG_BLE_MESH_LABEL_COUNT*
- *CONFIG_BLE_MESH_SUBNET_COUNT*
- *CONFIG_BLE_MESH_TX_SEG_MAX*
- *CONFIG_BLE_MESH_RX_SEG_MSG_COUNT*
- *CONFIG_BLE_MESH_TX_SEG_MSG_COUNT*
- *CONFIG_BLE_MESH_MEM_ALLOC_MODE*
- *CONFIG_BLE_MESH_MSG_CACHE_SIZE*
- *CONFIG_BLE_MESH_ADV_BUF_COUNT*
- *CONFIG_BLE_MESH_PB_GATT*
- *CONFIG_BLE_MESH_PB_ADV*
- *CONFIG_BLE_MESH_RELAY*
- *CONFIG_BLE_MESH_SETTINGS*

- `CONFIG_BLE_MESH_DEINIT`
- `CONFIG_BLE_MESH_USE_DUPLICATE_SCAN`
- Support for BLE Mesh Client/Server models
- Support for BLE Mesh Foundation models
- `CONFIG_BLE_MESH_NODE`
- `CONFIG_BLE_MESH_PROVISIONER`
- `CONFIG_BLE_MESH_FRIEND`
- `CONFIG_BLE_MESH_LOW_POWER`
- `CONFIG_BLE_MESH_HCI_5_0`
- `CONFIG_BLE_MESH_IV_UPDATE_TEST`
- `CONFIG_BLE_MESH_CLIENT_MSG_TIMEOUT`

CONFIG_BLE_MESH_HCI_5_0

Support sending 20ms non-connectable adv packets

Found in: *Component config* > `CONFIG_BLE_MESH`

It is a temporary solution and needs further modifications.

Default value:

- Yes (enabled) if `CONFIG_BLE_MESH`

CONFIG_BLE_MESH_USE_DUPLICATE_SCAN

Support Duplicate Scan in BLE Mesh

Found in: *Component config* > `CONFIG_BLE_MESH`

Enable this option to allow using specific duplicate scan filter in BLE Mesh, and Scan Duplicate Type must be set by choosing the option in the Bluetooth Controller section in menuconfig, which is “Scan Duplicate By Device Address and Advertising Data” .

Default value:

- Yes (enabled) if `BT_BLUEDROID_ENABLED` && `CONFIG_BLE_MESH`

CONFIG_BLE_MESH_MEM_ALLOC_MODE

Memory allocation strategy

Found in: *Component config* > `CONFIG_BLE_MESH`

Allocation strategy for BLE Mesh stack, essentially provides ability to allocate all required dynamic allocations from,

- Internal DRAM memory only
- External SPIRAM memory only
- Either internal or external memory based on default malloc() behavior in ESP-IDF
- Internal IRAM memory wherever applicable else internal DRAM

Recommended mode here is always internal (*), since that is most preferred from security perspective. But if application requirement does not allow sufficient free internal memory then alternate mode can be selected.

(*) In case of ESP32-S2/ESP32-S3, hardware allows encryption of external SPIRAM contents provided hardware flash encryption feature is enabled. In that case, using external SPIRAM allocation strategy is also safe choice from security perspective.

Available options:

- Internal DRAM (`BLE_MESH_MEM_ALLOC_MODE_INTERNAL`)
- External SPIRAM (`BLE_MESH_MEM_ALLOC_MODE_EXTERNAL`)
- Default alloc mode (`BLE_MESH_MEM_ALLOC_MODE_DEFAULT`)

Enable this option to use the default memory allocation strategy when external SPIRAM is enabled. See the SPIRAM options for more details.

- Internal IRAM (BLE_MESH_MEM_ALLOC_MODE_IRAM_8BIT)
Allows to use IRAM memory region as 8bit accessible region. Every unaligned (8bit or 16bit) access will result in an exception and incur penalty of certain clock cycles per unaligned read/write.

CONFIG_BLE_MESH_FREERTOS_STATIC_ALLOC

Enable FreeRTOS static allocation

Found in: *Component config* > *CONFIG_BLE_MESH*

Enable this option to use FreeRTOS static allocation APIs for BLE Mesh, which provides the ability to use different dynamic memory (i.e. SPIRAM or IRAM) for FreeRTOS objects. If this option is disabled, the FreeRTOS static allocation APIs will not be used, and internal DRAM will be allocated for FreeRTOS objects.

Default value:

- No (disabled) if (ESP32_SPIRAM_SUPPORT || ESP32_IRAM_AS_8BIT_ACCESSIBLE_MEMORY) && *CONFIG_BLE_MESH*

CONFIG_BLE_MESH_FREERTOS_STATIC_ALLOC_MODE

Memory allocation for FreeRTOS objects

Found in: *Component config* > *CONFIG_BLE_MESH* > *CONFIG_BLE_MESH_FREERTOS_STATIC_ALLOC*

Choose the memory to be used for FreeRTOS objects.

Available options:

- External SPIRAM (BLE_MESH_FREERTOS_STATIC_ALLOC_EXTERNAL)
If enabled, BLE Mesh allocates dynamic memory from external SPIRAM for FreeRTOS objects, i.e. mutex, queue, and task stack. External SPIRAM can only be used for task stack when SPIRAM_ALLOW_STACK_EXTERNAL_MEMORY is enabled. See the SPIRAM options for more details.
- Internal IRAM (BLE_MESH_FREERTOS_STATIC_ALLOC_IRAM_8BIT)
If enabled, BLE Mesh allocates dynamic memory from internal IRAM for FreeRTOS objects, i.e. mutex, queue. Note: IRAM region cannot be used as task stack.

CONFIG_BLE_MESH_DEINIT

Support de-initialize BLE Mesh stack

Found in: *Component config* > *CONFIG_BLE_MESH*

If enabled, users can use the function `esp_ble_mesh_deinit()` to de-initialize the whole BLE Mesh stack.

Default value:

- Yes (enabled) if *CONFIG_BLE_MESH*

BLE Mesh and BLE coexistence support

 Contains:

- *CONFIG_BLE_MESH_SUPPORT_BLE_SCAN*
- *CONFIG_BLE_MESH_SUPPORT_BLE_ADV*

CONFIG_BLE_MESH_SUPPORT_BLE_ADV

Support sending normal BLE advertising packets

Found in: *Component config* > *CONFIG_BLE_MESH* > *BLE Mesh and BLE coexistence support*

When selected, users can send normal BLE advertising packets with specific API.

Default value:

- No (disabled) if `CONFIG_BLE_MESH`

CONFIG_BLE_MESH_BLE_ADV_BUF_COUNT

Number of advertising buffers for BLE advertising packets

Found in: Component config > CONFIG_BLE_MESH > BLE Mesh and BLE coexistence support > CONFIG_BLE_MESH_SUPPORT_BLE_ADV

Number of advertising buffers for BLE packets available.

Range:

- from 1 to 255 if `CONFIG_BLE_MESH_SUPPORT_BLE_ADV` && `CONFIG_BLE_MESH`

Default value:

- 3 if `CONFIG_BLE_MESH_SUPPORT_BLE_ADV` && `CONFIG_BLE_MESH`

CONFIG_BLE_MESH_SUPPORT_BLE_SCAN

Support scanning normal BLE advertising packets

Found in: Component config > CONFIG_BLE_MESH > BLE Mesh and BLE coexistence support

When selected, users can register a callback and receive normal BLE advertising packets in the application layer.

Default value:

- No (disabled) if `CONFIG_BLE_MESH`

CONFIG_BLE_MESH_FAST_PROV

Enable BLE Mesh Fast Provisioning

Found in: Component config > CONFIG_BLE_MESH

Enable this option to allow BLE Mesh fast provisioning solution to be used. When there are multiple unprovisioned devices around, fast provisioning can greatly reduce the time consumption of the whole provisioning process. When this option is enabled, and after an unprovisioned device is provisioned into a node successfully, it can be changed to a temporary Provisioner.

Default value:

- No (disabled) if `CONFIG_BLE_MESH`

CONFIG_BLE_MESH_NODE

Support for BLE Mesh Node

Found in: Component config > CONFIG_BLE_MESH

Enable the device to be provisioned into a node. This option should be enabled when an unprovisioned device is going to be provisioned into a node and communicate with other nodes in the BLE Mesh network.

CONFIG_BLE_MESH_PROVISIONER

Support for BLE Mesh Provisioner

Found in: Component config > CONFIG_BLE_MESH

Enable the device to be a Provisioner. The option should be enabled when a device is going to act as a Provisioner and provision unprovisioned devices into the BLE Mesh network.

CONFIG_BLE_MESH_WAIT_FOR_PROV_MAX_DEV_NUM

Maximum number of unprovisioned devices that can be added to device queue

Found in: Component config > CONFIG_BLE_MESH > CONFIG_BLE_MESH_PROVISIONER

This option specifies how many unprovisioned devices can be added to device queue for provisioning. Users can use this option to define the size of the queue in the bottom layer which is used to store unprovisioned device information (e.g. Device UUID, address).

Range:

- from 1 to 100 if *CONFIG_BLE_MESH_PROVISIONER* && *CONFIG_BLE_MESH*

Default value:

- 10 if *CONFIG_BLE_MESH_PROVISIONER* && *CONFIG_BLE_MESH*

CONFIG_BLE_MESH_MAX_PROV_NODES

Maximum number of devices that can be provisioned by Provisioner

Found in: Component config > CONFIG_BLE_MESH > CONFIG_BLE_MESH_PROVISIONER

This option specifies how many devices can be provisioned by a Provisioner. This value indicates the maximum number of unprovisioned devices which can be provisioned by a Provisioner. For instance, if the value is 6, it means the Provisioner can provision up to 6 unprovisioned devices. Theoretically a Provisioner without the limitation of its memory can provision up to 32766 unprovisioned devices, here we limit the maximum number to 100 just to limit the memory used by a Provisioner. The bigger the value is, the more memory it will cost by a Provisioner to store the information of nodes.

Range:

- from 1 to 1000 if *CONFIG_BLE_MESH_PROVISIONER* && *CONFIG_BLE_MESH*

Default value:

- 10 if *CONFIG_BLE_MESH_PROVISIONER* && *CONFIG_BLE_MESH*

CONFIG_BLE_MESH_PBA_SAME_TIME

Maximum number of PB-ADV running at the same time by Provisioner

Found in: Component config > CONFIG_BLE_MESH > CONFIG_BLE_MESH_PROVISIONER

This option specifies how many devices can be provisioned at the same time using PB-ADV. For example, if the value is 2, it means a Provisioner can provision two unprovisioned devices with PB-ADV at the same time.

Range:

- from 1 to 10 if *CONFIG_BLE_MESH_PB_ADV* && *CONFIG_BLE_MESH_PROVISIONER* && *CONFIG_BLE_MESH*

Default value:

- 2 if *CONFIG_BLE_MESH_PB_ADV* && *CONFIG_BLE_MESH_PROVISIONER* && *CONFIG_BLE_MESH*

CONFIG_BLE_MESH_PBG_SAME_TIME

Maximum number of PB-GATT running at the same time by Provisioner

Found in: Component config > CONFIG_BLE_MESH > CONFIG_BLE_MESH_PROVISIONER

This option specifies how many devices can be provisioned at the same time using PB-GATT. For example, if the value is 2, it means a Provisioner can provision two unprovisioned devices with PB-GATT at the same time.

Range:

- from 1 to 5 if *CONFIG_BLE_MESH_PB_GATT* && *CONFIG_BLE_MESH_PROVISIONER* && *CONFIG_BLE_MESH*

Default value:

- 1 if `CONFIG_BLE_MESH_PB_GATT` && `CONFIG_BLE_MESH_PROVISIONER` && `CONFIG_BLE_MESH`

CONFIG_BLE_MESH_PROVISIONER_SUBNET_COUNT

Maximum number of mesh subnets that can be created by Provisioner

Found in: Component config > CONFIG_BLE_MESH > CONFIG_BLE_MESH_PROVISIONER

This option specifies how many subnets per network a Provisioner can create. Indeed, this value decides the number of network keys which can be added by a Provisioner.

Range:

- from 1 to 4096 if `CONFIG_BLE_MESH_PROVISIONER` && `CONFIG_BLE_MESH`

Default value:

- 3 if `CONFIG_BLE_MESH_PROVISIONER` && `CONFIG_BLE_MESH`

CONFIG_BLE_MESH_PROVISIONER_APP_KEY_COUNT

Maximum number of application keys that can be owned by Provisioner

Found in: Component config > CONFIG_BLE_MESH > CONFIG_BLE_MESH_PROVISIONER

This option specifies how many application keys the Provisioner can have. Indeed, this value decides the number of the application keys which can be added by a Provisioner.

Range:

- from 1 to 4096 if `CONFIG_BLE_MESH_PROVISIONER` && `CONFIG_BLE_MESH`

Default value:

- 3 if `CONFIG_BLE_MESH_PROVISIONER` && `CONFIG_BLE_MESH`

CONFIG_BLE_MESH_PROVISIONER_RECV_HB

Support receiving Heartbeat messages

Found in: Component config > CONFIG_BLE_MESH > CONFIG_BLE_MESH_PROVISIONER

When this option is enabled, Provisioner can call specific functions to enable or disable receiving Heartbeat messages and notify them to the application layer.

Default value:

- No (disabled) if `CONFIG_BLE_MESH_PROVISIONER` && `CONFIG_BLE_MESH`

CONFIG_BLE_MESH_PROVISIONER_RECV_HB_FILTER_SIZE

Maximum number of filter entries for receiving Heartbeat messages

Found in: Component config > CONFIG_BLE_MESH > CONFIG_BLE_MESH_PROVISIONER > CONFIG_BLE_MESH_PROVISIONER_RECV_HB

This option specifies how many heartbeat filter entries Provisioner supports. The heartbeat filter (acceptlist or rejectlist) entries are used to store a list of SRC and DST which can be used to decide if a heartbeat message will be processed and notified to the application layer by Provisioner. Note: The filter is an empty rejectlist by default.

Range:

- from 1 to 1000 if `CONFIG_BLE_MESH_PROVISIONER_RECV_HB` && `CONFIG_BLE_MESH_PROVISIONER` && `CONFIG_BLE_MESH`

Default value:

- 3 if `CONFIG_BLE_MESH_PROVISIONER_RECV_HB` && `CONFIG_BLE_MESH_PROVISIONER` && `CONFIG_BLE_MESH`

CONFIG_BLE_MESH_PROV

BLE Mesh Provisioning support

Found in: [Component config](#) > [CONFIG_BLE_MESH](#)

Enable this option to support BLE Mesh Provisioning functionality. For BLE Mesh, this option should be always enabled.

Default value:

- Yes (enabled) if [CONFIG_BLE_MESH](#)

CONFIG_BLE_MESH_PB_ADV

Provisioning support using the advertising bearer (PB-ADV)

Found in: [Component config](#) > [CONFIG_BLE_MESH](#)

Enable this option to allow the device to be provisioned over the advertising bearer. This option should be enabled if PB-ADV is going to be used during provisioning procedure.

Default value:

- Yes (enabled) if [CONFIG_BLE_MESH](#)

CONFIG_BLE_MESH_UNPROVISIONED_BEACON_INTERVAL

Interval between two consecutive Unprovisioned Device Beacon

Found in: [Component config](#) > [CONFIG_BLE_MESH](#) > [CONFIG_BLE_MESH_PB_ADV](#)

This option specifies the interval of sending two consecutive unprovisioned device beacon, users can use this option to change the frequency of sending unprovisioned device beacon. For example, if the value is 5, it means the unprovisioned device beacon will send every 5 seconds. When the option of BLE_MESH_FAST_PROV is selected, the value is better to be 3 seconds, or less.

Range:

- from 1 to 100 if [CONFIG_BLE_MESH_NODE](#) && [CONFIG_BLE_MESH_PB_ADV](#) && [CONFIG_BLE_MESH](#)

Default value:

- 5 if [CONFIG_BLE_MESH_NODE](#) && [CONFIG_BLE_MESH_PB_ADV](#) && [CONFIG_BLE_MESH](#)
- 3 if [CONFIG_BLE_MESH_FAST_PROV](#) && [CONFIG_BLE_MESH_NODE](#) && [CONFIG_BLE_MESH_PB_ADV](#) && [CONFIG_BLE_MESH](#)

CONFIG_BLE_MESH_PB_GATT

Provisioning support using GATT (PB-GATT)

Found in: [Component config](#) > [CONFIG_BLE_MESH](#)

Enable this option to allow the device to be provisioned over GATT. This option should be enabled if PB-GATT is going to be used during provisioning procedure.

Virtual option enabled whenever any Proxy protocol is needed

CONFIG_BLE_MESH_PROXY

BLE Mesh Proxy protocol support

Found in: [Component config](#) > [CONFIG_BLE_MESH](#)

Enable this option to support BLE Mesh Proxy protocol used by PB-GATT and other proxy pdu transmission.

Default value:

- Yes (enabled) if `CONFIG_BLE_MESH`

CONFIG_BLE_MESH_GATT_PROXY_SERVER

BLE Mesh GATT Proxy Server

Found in: `Component config > CONFIG_BLE_MESH`

This option enables support for Mesh GATT Proxy Service, i.e. the ability to act as a proxy between a Mesh GATT Client and a Mesh network. This option should be enabled if a node is going to be a Proxy Server.

Default value:

- Yes (enabled) if `CONFIG_BLE_MESH_NODE` && `CONFIG_BLE_MESH`

CONFIG_BLE_MESH_NODE_ID_TIMEOUT

Node Identity advertising timeout

Found in: `Component config > CONFIG_BLE_MESH > CONFIG_BLE_MESH_GATT_PROXY_SERVER`

This option determines for how long the local node advertises using Node Identity. The given value is in seconds. The specification limits this to 60 seconds and lists it as the recommended value as well. So leaving the default value is the safest option. When an unprovisioned device is provisioned successfully and becomes a node, it will start to advertise using Node Identity during the time set by this option. And after that, Network ID will be advertised.

Range:

- from 1 to 60 if `CONFIG_BLE_MESH_GATT_PROXY_SERVER` && `CONFIG_BLE_MESH`

Default value:

- 60 if `CONFIG_BLE_MESH_GATT_PROXY_SERVER` && `CONFIG_BLE_MESH`

CONFIG_BLE_MESH_PROXY_FILTER_SIZE

Maximum number of filter entries per Proxy Client

Found in: `Component config > CONFIG_BLE_MESH > CONFIG_BLE_MESH_GATT_PROXY_SERVER`

This option specifies how many Proxy Filter entries the local node supports. The entries of Proxy filter (whitelist or blacklist) are used to store a list of addresses which can be used to decide which messages will be forwarded to the Proxy Client by the Proxy Server.

Range:

- from 1 to 32767 if `CONFIG_BLE_MESH_GATT_PROXY_SERVER` && `CONFIG_BLE_MESH`

Default value:

- 4 if `CONFIG_BLE_MESH_GATT_PROXY_SERVER` && `CONFIG_BLE_MESH`

CONFIG_BLE_MESH_GATT_PROXY_CLIENT

BLE Mesh GATT Proxy Client

Found in: `Component config > CONFIG_BLE_MESH`

This option enables support for Mesh GATT Proxy Client. The Proxy Client can use the GATT bearer to send mesh messages to a node that supports the advertising bearer.

Default value:

- No (disabled) if `CONFIG_BLE_MESH`

CONFIG_BLE_MESH_SETTINGS

Store BLE Mesh configuration persistently

Found in: [Component config](#) > [CONFIG_BLE_MESH](#)

When selected, the BLE Mesh stack will take care of storing/restoring the BLE Mesh configuration persistently in flash. If the device is a BLE Mesh node, when this option is enabled, the configuration of the device will be stored persistently, including unicast address, NetKey, AppKey, etc. And if the device is a BLE Mesh Provisioner, the information of the device will be stored persistently, including the information of provisioned nodes, NetKey, AppKey, etc.

Default value:

- No (disabled) if [CONFIG_BLE_MESH](#)

CONFIG_BLE_MESH_STORE_TIMEOUT

Delay (in seconds) before storing anything persistently

Found in: [Component config](#) > [CONFIG_BLE_MESH](#) > [CONFIG_BLE_MESH_SETTINGS](#)

This value defines in seconds how soon any pending changes are actually written into persistent storage (flash) after a change occurs. The option allows nodes to delay a certain period of time to save proper information to flash. The default value is 0, which means information will be stored immediately once there are updates.

Range:

- from 0 to 1000000 if [CONFIG_BLE_MESH_SETTINGS](#) && [CONFIG_BLE_MESH](#)

Default value:

- 0 if [CONFIG_BLE_MESH_SETTINGS](#) && [CONFIG_BLE_MESH](#)

CONFIG_BLE_MESH_SEQ_STORE_RATE

How often the sequence number gets updated in storage

Found in: [Component config](#) > [CONFIG_BLE_MESH](#) > [CONFIG_BLE_MESH_SETTINGS](#)

This value defines how often the local sequence number gets updated in persistent storage (i.e. flash). e.g. a value of 100 means that the sequence number will be stored to flash on every 100th increment. If the node sends messages very frequently a higher value makes more sense, whereas if the node sends infrequently a value as low as 0 (update storage for every increment) can make sense. When the stack gets initialized it will add sequence number to the last stored one, so that it starts off with a value that's guaranteed to be larger than the last one used before power off.

Range:

- from 0 to 1000000 if [CONFIG_BLE_MESH_SETTINGS](#) && [CONFIG_BLE_MESH](#)

Default value:

- 0 if [CONFIG_BLE_MESH_SETTINGS](#) && [CONFIG_BLE_MESH](#)

CONFIG_BLE_MESH_RPL_STORE_TIMEOUT

Minimum frequency that the RPL gets updated in storage

Found in: [Component config](#) > [CONFIG_BLE_MESH](#) > [CONFIG_BLE_MESH_SETTINGS](#)

This value defines in seconds how soon the RPL (Replay Protection List) gets written to persistent storage after a change occurs. If the node receives messages frequently, then a large value is recommended. If the node receives messages rarely, then the value can be as low as 0 (which means the RPL is written into the storage immediately). Note that if the node operates in a security-sensitive case, and there is a risk of sudden power-off, then a value of 0 is strongly recommended. Otherwise, a power loss before RPL being written into the storage may introduce message replay attacks and system security will be in a vulnerable state.

Range:

- from 0 to 1000000 if `CONFIG_BLE_MESH_SETTINGS` && `CONFIG_BLE_MESH`

Default value:

- 0 if `CONFIG_BLE_MESH_SETTINGS` && `CONFIG_BLE_MESH`

CONFIG_BLE_MESH_SETTINGS_BACKWARD_COMPATIBILITY

A specific option for settings backward compatibility

Found in: `Component config > CONFIG_BLE_MESH > CONFIG_BLE_MESH_SETTINGS`

This option is created to solve the issue of failure in recovering node information after mesh stack updates. In the old version mesh stack, there is no key of “mesh/role” in nvs. In the new version mesh stack, key of “mesh/role” is added in nvs, recovering node information needs to check “mesh/role” key in nvs and implements selective recovery of mesh node information. Therefore, there may be failure in recovering node information during node restarting after OTA.

The new version mesh stack adds the option of “mesh/role” because we have added the support of storing Provisioner information, while the old version only supports storing node information.

If users are updating their nodes from old version to new version, we recommend enabling this option, so that system could set the flag in advance before recovering node information and make sure the node information recovering could work as expected.

Default value:

- No (disabled) if `CONFIG_BLE_MESH_NODE` && `CONFIG_BLE_MESH_SETTINGS` && `CONFIG_BLE_MESH`

CONFIG_BLE_MESH_SPECIFIC_PARTITION

Use a specific NVS partition for BLE Mesh

Found in: `Component config > CONFIG_BLE_MESH > CONFIG_BLE_MESH_SETTINGS`

When selected, the mesh stack will use a specified NVS partition instead of default NVS partition. Note that the specified partition must be registered with NVS using `nvs_flash_init_partition()` API, and the partition must exist in the csv file. When Provisioner needs to store a large amount of nodes' information in the flash (e.g. more than 20), this option is recommended to be enabled.

Default value:

- No (disabled) if `CONFIG_BLE_MESH_SETTINGS` && `CONFIG_BLE_MESH`

CONFIG_BLE_MESH_PARTITION_NAME

Name of the NVS partition for BLE Mesh

Found in: `Component config > CONFIG_BLE_MESH > CONFIG_BLE_MESH_SETTINGS > CONFIG_BLE_MESH_SPECIFIC_PARTITION`

This value defines the name of the specified NVS partition used by the mesh stack.

Default value:

- “ble_mesh” if `CONFIG_BLE_MESH_SPECIFIC_PARTITION` && `CONFIG_BLE_MESH_SETTINGS` && `CONFIG_BLE_MESH`

CONFIG_BLE_MESH_USE_MULTIPLE_NAMESPACE

Support using multiple NVS namespaces by Provisioner

Found in: `Component config > CONFIG_BLE_MESH > CONFIG_BLE_MESH_SETTINGS`

When selected, Provisioner can use different NVS namespaces to store different instances of mesh information. For example, if in the first room, Provisioner uses NetKey A, AppKey A and provisions three devices, these information will be treated as mesh information instance A. When the Provisioner

moves to the second room, it uses NetKey B, AppKey B and provisions two devices, then the information will be treated as mesh information instance B. Here instance A and instance B will be stored in different namespaces. With this option enabled, Provisioner needs to use specific functions to open the corresponding NVS namespace, restore the mesh information, release the mesh information or erase the mesh information.

Default value:

- No (disabled) if `CONFIG_BLE_MESH_PROVISIONER` && `CONFIG_BLE_MESH_SETTINGS` && `CONFIG_BLE_MESH`

CONFIG_BLE_MESH_MAX_NVS_NAMESPACE

Maximum number of NVS namespaces

Found in: `Component config > CONFIG_BLE_MESH > CONFIG_BLE_MESH_SETTINGS > CONFIG_BLE_MESH_USE_MULTIPLE_NAMESPACE`

This option specifies the maximum NVS namespaces supported by Provisioner.

Range:

- from 1 to 255 if `CONFIG_BLE_MESH_USE_MULTIPLE_NAMESPACE` && `CONFIG_BLE_MESH_SETTINGS` && `CONFIG_BLE_MESH`

Default value:

- 2 if `CONFIG_BLE_MESH_USE_MULTIPLE_NAMESPACE` && `CONFIG_BLE_MESH_SETTINGS` && `CONFIG_BLE_MESH`

CONFIG_BLE_MESH_SUBNET_COUNT

Maximum number of mesh subnets per network

Found in: `Component config > CONFIG_BLE_MESH`

This option specifies how many subnets a Mesh network can have at the same time. Indeed, this value decides the number of the network keys which can be owned by a node.

Range:

- from 1 to 4096 if `CONFIG_BLE_MESH`

Default value:

- 3 if `CONFIG_BLE_MESH`

CONFIG_BLE_MESH_APP_KEY_COUNT

Maximum number of application keys per network

Found in: `Component config > CONFIG_BLE_MESH`

This option specifies how many application keys the device can store per network. Indeed, this value decides the number of the application keys which can be owned by a node.

Range:

- from 1 to 4096 if `CONFIG_BLE_MESH`

Default value:

- 3 if `CONFIG_BLE_MESH`

CONFIG_BLE_MESH_MODEL_KEY_COUNT

Maximum number of application keys per model

Found in: `Component config > CONFIG_BLE_MESH`

This option specifies the maximum number of application keys to which each model can be bound.

Range:

- from 1 to 4096 if `CONFIG_BLE_MESH`

Default value:

- 3 if `CONFIG_BLE_MESH`

CONFIG_BLE_MESH_MODEL_GROUP_COUNT

Maximum number of group address subscriptions per model

Found in: `Component config` > `CONFIG_BLE_MESH`

This option specifies the maximum number of addresses to which each model can be subscribed.

Range:

- from 1 to 4096 if `CONFIG_BLE_MESH`

Default value:

- 3 if `CONFIG_BLE_MESH`

CONFIG_BLE_MESH_LABEL_COUNT

Maximum number of Label UUIDs used for Virtual Addresses

Found in: `Component config` > `CONFIG_BLE_MESH`

This option specifies how many Label UUIDs can be stored. Indeed, this value decides the number of the Virtual Addresses can be supported by a node.

Range:

- from 0 to 4096 if `CONFIG_BLE_MESH`

Default value:

- 3 if `CONFIG_BLE_MESH`

CONFIG_BLE_MESH_CRPL

Maximum capacity of the replay protection list

Found in: `Component config` > `CONFIG_BLE_MESH`

This option specifies the maximum capacity of the replay protection list. It is similar to Network message cache size, but has a different purpose. The replay protection list is used to prevent a node from replay attack, which will store the source address and sequence number of the received mesh messages. For Provisioner, the replay protection list size should not be smaller than the maximum number of nodes whose information can be stored. And the element number of each node should also be taken into consideration. For example, if Provisioner can provision up to 20 nodes and each node contains two elements, then the replay protection list size of Provisioner should be at least 40.

Range:

- from 2 to 65535 if `CONFIG_BLE_MESH`

Default value:

- 10 if `CONFIG_BLE_MESH`

CONFIG_BLE_MESH_MSG_CACHE_SIZE

Network message cache size

Found in: `Component config` > `CONFIG_BLE_MESH`

Number of messages that are cached for the network. This helps prevent unnecessary decryption operations and unnecessary relays. This option is similar to Replay protection list, but has a different purpose. A node is not required to cache the entire Network PDU and may cache only part of it for tracking, such as values for SRC/SEQ or others.

Range:

- from 2 to 65535 if `CONFIG_BLE_MESH`

Default value:

- 10 if *CONFIG_BLE_MESH*

CONFIG_BLE_MESH_ADV_BUF_COUNT

Number of advertising buffers

Found in: Component config > CONFIG_BLE_MESH

Number of advertising buffers available. The transport layer reserves ADV_BUF_COUNT - 3 buffers for outgoing segments. The maximum outgoing SDU size is 12 times this value (out of which 4 or 8 bytes are used for the Transport Layer MIC). For example, 5 segments means the maximum SDU size is 60 bytes, which leaves 56 bytes for application layer data using a 4-byte MIC, or 52 bytes using an 8-byte MIC.

Range:

- from 6 to 256 if *CONFIG_BLE_MESH*

Default value:

- 60 if *CONFIG_BLE_MESH*

CONFIG_BLE_MESH_IVU_DIVIDER

Divider for IV Update state refresh timer

Found in: Component config > CONFIG_BLE_MESH

When the IV Update state enters Normal operation or IV Update in Progress, we need to keep track of how many hours has passed in the state, since the specification requires us to remain in the state at least for 96 hours (Update in Progress has an additional upper limit of 144 hours).

In order to fulfill the above requirement, even if the node might be powered off once in a while, we need to store persistently how many hours the node has been in the state. This doesn't necessarily need to happen every hour (thanks to the flexible duration range). The exact cadence will depend a lot on the ways that the node will be used and what kind of power source it has.

Since there is no single optimal answer, this configuration option allows specifying a divider, i.e. how many intervals the 96 hour minimum gets split into. After each interval the duration that the node has been in the current state gets stored to flash. E.g. the default value of 4 means that the state is saved every 24 hours (96 / 4).

Range:

- from 2 to 96 if *CONFIG_BLE_MESH*

Default value:

- 4 if *CONFIG_BLE_MESH*

CONFIG_BLE_MESH_TX_SEG_MSG_COUNT

Maximum number of simultaneous outgoing segmented messages

Found in: Component config > CONFIG_BLE_MESH

Maximum number of simultaneous outgoing multi-segment and/or reliable messages. The default value is 1, which means the device can only send one segmented message at a time. And if another segmented message is going to be sent, it should wait for the completion of the previous one. If users are going to send multiple segmented messages at the same time, this value should be configured properly.

Range:

- from 1 to if *CONFIG_BLE_MESH*

Default value:

- 1 if *CONFIG_BLE_MESH*

CONFIG_BLE_MESH_RX_SEG_MSG_COUNT

Maximum number of simultaneous incoming segmented messages

Found in: [Component config](#) > [CONFIG_BLE_MESH](#)

Maximum number of simultaneous incoming multi-segment and/or reliable messages. The default value is 1, which means the device can only receive one segmented message at a time. And if another segmented message is going to be received, it should wait for the completion of the previous one. If users are going to receive multiple segmented messages at the same time, this value should be configured properly.

Range:

- from 1 to 255 if [CONFIG_BLE_MESH](#)

Default value:

- 1 if [CONFIG_BLE_MESH](#)

CONFIG_BLE_MESH_RX_SDU_MAX

Maximum incoming Upper Transport Access PDU length

Found in: [Component config](#) > [CONFIG_BLE_MESH](#)

Maximum incoming Upper Transport Access PDU length. Leave this to the default value, unless you really need to optimize memory usage.

Range:

- from 36 to 384 if [CONFIG_BLE_MESH](#)

Default value:

- 384 if [CONFIG_BLE_MESH](#)

CONFIG_BLE_MESH_TX_SEG_MAX

Maximum number of segments in outgoing messages

Found in: [Component config](#) > [CONFIG_BLE_MESH](#)

Maximum number of segments supported for outgoing messages. This value should typically be fine-tuned based on what models the local node supports, i.e. what's the largest message payload that the node needs to be able to send. This value affects memory and call stack consumption, which is why the default is lower than the maximum that the specification would allow (32 segments).

The maximum outgoing SDU size is 12 times this number (out of which 4 or 8 bytes is used for the Transport Layer MIC). For example, 5 segments means the maximum SDU size is 60 bytes, which leaves 56 bytes for application layer data using a 4-byte MIC and 52 bytes using an 8-byte MIC.

Be sure to specify a sufficient number of advertising buffers when setting this option to a higher value. There must be at least three more advertising buffers ([BLE_MESH_ADV_BUF_COUNT](#)) as there are outgoing segments.

Range:

- from 2 to 32 if [CONFIG_BLE_MESH](#)

Default value:

- 32 if [CONFIG_BLE_MESH](#)

CONFIG_BLE_MESH_RELAY

Relay support

Found in: [Component config](#) > [CONFIG_BLE_MESH](#)

Support for acting as a Mesh Relay Node. Enabling this option will allow a node to support the Relay feature, and the Relay feature can still be enabled or disabled by proper configuration messages. Disabling this option will let a node not support the Relay feature.

Default value:

- Yes (enabled) if `CONFIG_BLE_MESH_NODE` && `CONFIG_BLE_MESH`

CONFIG_BLE_MESH_RELAY_ADV_BUF

Use separate advertising buffers for relay packets

Found in: `Component config > CONFIG_BLE_MESH > CONFIG_BLE_MESH_RELAY`

When selected, self-send packets will be put in a high-priority queue and relay packets will be put in a low-priority queue.

Default value:

- No (disabled) if `CONFIG_BLE_MESH_RELAY` && `CONFIG_BLE_MESH`

CONFIG_BLE_MESH_RELAY_ADV_BUF_COUNT

Number of advertising buffers for relay packets

Found in: `Component config > CONFIG_BLE_MESH > CONFIG_BLE_MESH_RELAY > CONFIG_BLE_MESH_RELAY_ADV_BUF`

Number of advertising buffers for relay packets available.

Range:

- from 6 to 256 if `CONFIG_BLE_MESH_RELAY_ADV_BUF` && `CONFIG_BLE_MESH_RELAY` && `CONFIG_BLE_MESH`

Default value:

- 60 if `CONFIG_BLE_MESH_RELAY_ADV_BUF` && `CONFIG_BLE_MESH_RELAY` && `CONFIG_BLE_MESH`

CONFIG_BLE_MESH_LOW_POWER

Support for Low Power features

Found in: `Component config > CONFIG_BLE_MESH`

Enable this option to operate as a Low Power Node. If low power consumption is required by a node, this option should be enabled. And once the node enters the mesh network, it will try to find a Friend node and establish a friendship.

CONFIG_BLE_MESH_LPN_ESTABLISHMENT

Perform Friendship establishment using low power

Found in: `Component config > CONFIG_BLE_MESH > CONFIG_BLE_MESH_LOW_POWER`

Perform the Friendship establishment using low power with the help of a reduced scan duty cycle. The downside of this is that the node may miss out on messages intended for it until it has successfully set up Friendship with a Friend node. When this option is enabled, the node will stop scanning for a period of time after a Friend Request or Friend Poll is sent, so as to reduce more power consumption.

Default value:

- No (disabled) if `CONFIG_BLE_MESH_LOW_POWER` && `CONFIG_BLE_MESH`

CONFIG_BLE_MESH_LPN_AUTO

Automatically start looking for Friend nodes once provisioned

Found in: `Component config > CONFIG_BLE_MESH > CONFIG_BLE_MESH_LOW_POWER`

Once provisioned, automatically enable LPN functionality and start looking for Friend nodes. If this option is disabled LPN mode needs to be manually enabled by calling `bt_mesh_lpn_set(true)`. When an

unprovisioned device is provisioned successfully and becomes a node, enabling this option will trigger the node starts to send Friend Request at a certain period until it finds a proper Friend node.

Default value:

- No (disabled) if `CONFIG_BLE_MESH_LOW_POWER` && `CONFIG_BLE_MESH`

CONFIG_BLE_MESH_LPN_AUTO_TIMEOUT

Time from last received message before going to LPN mode

Found in: Component config > CONFIG_BLE_MESH > CONFIG_BLE_MESH_LOW_POWER > CONFIG_BLE_MESH_LPN_AUTO

Time in seconds from the last received message, that the node waits out before starting to look for Friend nodes.

Range:

- from 0 to 3600 if `CONFIG_BLE_MESH_LPN_AUTO` && `CONFIG_BLE_MESH_LOW_POWER` && `CONFIG_BLE_MESH`

Default value:

- 15 if `CONFIG_BLE_MESH_LPN_AUTO` && `CONFIG_BLE_MESH_LOW_POWER` && `CONFIG_BLE_MESH`

CONFIG_BLE_MESH_LPN_RETRY_TIMEOUT

Retry timeout for Friend requests

Found in: Component config > CONFIG_BLE_MESH > CONFIG_BLE_MESH_LOW_POWER

Time in seconds between Friend Requests, if a previous Friend Request did not yield any acceptable Friend Offers.

Range:

- from 1 to 3600 if `CONFIG_BLE_MESH_LOW_POWER` && `CONFIG_BLE_MESH`

Default value:

- 6 if `CONFIG_BLE_MESH_LOW_POWER` && `CONFIG_BLE_MESH`

CONFIG_BLE_MESH_LPN_RSSI_FACTOR

RSSIFactor, used in Friend Offer Delay calculation

Found in: Component config > CONFIG_BLE_MESH > CONFIG_BLE_MESH_LOW_POWER

The contribution of the RSSI, measured by the Friend node, used in Friend Offer Delay calculations. 0 = 1, 1 = 1.5, 2 = 2, 3 = 2.5. RSSIFactor, one of the parameters carried by Friend Request sent by Low Power node, which is used to calculate the Friend Offer Delay.

Range:

- from 0 to 3 if `CONFIG_BLE_MESH_LOW_POWER` && `CONFIG_BLE_MESH`

Default value:

- 0 if `CONFIG_BLE_MESH_LOW_POWER` && `CONFIG_BLE_MESH`

CONFIG_BLE_MESH_LPN_RECV_WIN_FACTOR

ReceiveWindowFactor, used in Friend Offer Delay calculation

Found in: Component config > CONFIG_BLE_MESH > CONFIG_BLE_MESH_LOW_POWER

The contribution of the supported Receive Window used in Friend Offer Delay calculations. 0 = 1, 1 = 1.5, 2 = 2, 3 = 2.5. ReceiveWindowFactor, one of the parameters carried by Friend Request sent by Low Power node, which is used to calculate the Friend Offer Delay.

Range:

- from 0 to 3 if `CONFIG_BLE_MESH_LOW_POWER` && `CONFIG_BLE_MESH`

Default value:

- 0 if `CONFIG_BLE_MESH_LOW_POWER` && `CONFIG_BLE_MESH`

CONFIG_BLE_MESH_LPN_MIN_QUEUE_SIZE

Minimum size of the acceptable friend queue (MinQueueSizeLog)

Found in: Component config > CONFIG_BLE_MESH > CONFIG_BLE_MESH_LOW_POWER

The MinQueueSizeLog field is defined as $\log_2(N)$, where N is the minimum number of maximum size Lower Transport PDUs that the Friend node can store in its Friend Queue. As an example, MinQueueSizeLog value 1 gives $N = 2$, and value 7 gives $N = 128$.

Range:

- from 1 to 7 if `CONFIG_BLE_MESH_LOW_POWER` && `CONFIG_BLE_MESH`

Default value:

- 1 if `CONFIG_BLE_MESH_LOW_POWER` && `CONFIG_BLE_MESH`

CONFIG_BLE_MESH_LPN_RECV_DELAY

Receive delay requested by the local node

Found in: Component config > CONFIG_BLE_MESH > CONFIG_BLE_MESH_LOW_POWER

The ReceiveDelay is the time between the Low Power node sending a request and listening for a response. This delay allows the Friend node time to prepare the response. The value is in units of milliseconds.

Range:

- from 10 to 255 if `CONFIG_BLE_MESH_LOW_POWER` && `CONFIG_BLE_MESH`

Default value:

- 100 if `CONFIG_BLE_MESH_LOW_POWER` && `CONFIG_BLE_MESH`

CONFIG_BLE_MESH_LPN_POLL_TIMEOUT

The value of the PollTimeout timer

Found in: Component config > CONFIG_BLE_MESH > CONFIG_BLE_MESH_LOW_POWER

PollTimeout timer is used to measure time between two consecutive requests sent by a Low Power node. If no requests are received the Friend node before the PollTimeout timer expires, then the friendship is considered terminated. The value is in units of 100 milliseconds, so e.g. a value of 300 means 30 seconds. The smaller the value, the faster the Low Power node tries to get messages from corresponding Friend node and vice versa.

Range:

- from 10 to 244735 if `CONFIG_BLE_MESH_LOW_POWER` && `CONFIG_BLE_MESH`

Default value:

- 300 if `CONFIG_BLE_MESH_LOW_POWER` && `CONFIG_BLE_MESH`

CONFIG_BLE_MESH_LPN_INIT_POLL_TIMEOUT

The starting value of the PollTimeout timer

Found in: Component config > CONFIG_BLE_MESH > CONFIG_BLE_MESH_LOW_POWER

The initial value of the PollTimeout timer when Friendship is to be established for the first time. After this, the timeout gradually grows toward the actual PollTimeout, doubling in value for each iteration. The value is in units of 100 milliseconds, so e.g. a value of 300 means 30 seconds.

Range:

- from 10 to if `CONFIG_BLE_MESH_LOW_POWER` && `CONFIG_BLE_MESH`

Default value:

- if `CONFIG_BLE_MESH_LOW_POWER` && `CONFIG_BLE_MESH`

CONFIG_BLE_MESH_LPN_SCAN_LATENCY

Latency for enabling scanning

Found in: Component config > CONFIG_BLE_MESH > CONFIG_BLE_MESH_LOW_POWER

Latency (in milliseconds) is the time it takes to enable scanning. In practice, it means how much time in advance of the Receive Window, the request to enable scanning is made.

Range:

- from 0 to 50 if *CONFIG_BLE_MESH_LOW_POWER* && *CONFIG_BLE_MESH*

Default value:

- 10 if *CONFIG_BLE_MESH_LOW_POWER* && *CONFIG_BLE_MESH*

CONFIG_BLE_MESH_LPN_GROUPS

Number of groups the LPN can subscribe to

Found in: Component config > CONFIG_BLE_MESH > CONFIG_BLE_MESH_LOW_POWER

Maximum number of groups to which the LPN can subscribe.

Range:

- from 0 to 16384 if *CONFIG_BLE_MESH_LOW_POWER* && *CONFIG_BLE_MESH*

Default value:

- 8 if *CONFIG_BLE_MESH_LOW_POWER* && *CONFIG_BLE_MESH*

CONFIG_BLE_MESH_FRIEND

Support for Friend feature

Found in: Component config > CONFIG_BLE_MESH

Enable this option to be able to act as a Friend Node.

CONFIG_BLE_MESH_FRIEND_RECV_WIN

Friend Receive Window

Found in: Component config > CONFIG_BLE_MESH > CONFIG_BLE_MESH_FRIEND

Receive Window in milliseconds supported by the Friend node.

Range:

- from 1 to 255 if *CONFIG_BLE_MESH_FRIEND* && *CONFIG_BLE_MESH*

Default value:

- 255 if *CONFIG_BLE_MESH_FRIEND* && *CONFIG_BLE_MESH*

CONFIG_BLE_MESH_FRIEND_QUEUE_SIZE

Minimum number of buffers supported per Friend Queue

Found in: Component config > CONFIG_BLE_MESH > CONFIG_BLE_MESH_FRIEND

Minimum number of buffers available to be stored for each local Friend Queue. This option decides the size of each buffer which can be used by a Friend node to store messages for each Low Power node.

Range:

- from 2 to 65536 if *CONFIG_BLE_MESH_FRIEND* && *CONFIG_BLE_MESH*

Default value:

- 16 if *CONFIG_BLE_MESH_FRIEND* && *CONFIG_BLE_MESH*

CONFIG_BLE_MESH_FRIEND_SUB_LIST_SIZE

Friend Subscription List Size

Found in: Component config > CONFIG_BLE_MESH > CONFIG_BLE_MESH_FRIEND

Size of the Subscription List that can be supported by a Friend node for a Low Power node. And Low Power node can send Friend Subscription List Add or Friend Subscription List Remove messages to the Friend node to add or remove subscription addresses.

Range:

- from 0 to 1023 if *CONFIG_BLE_MESH_FRIEND* && *CONFIG_BLE_MESH*

Default value:

- 3 if *CONFIG_BLE_MESH_FRIEND* && *CONFIG_BLE_MESH*

CONFIG_BLE_MESH_FRIEND_LPN_COUNT

Number of supported LPN nodes

Found in: Component config > CONFIG_BLE_MESH > CONFIG_BLE_MESH_FRIEND

Number of Low Power Nodes with which a Friend can have Friendship simultaneously. A Friend node can have friendship with multiple Low Power nodes at the same time, while a Low Power node can only establish friendship with only one Friend node at the same time.

Range:

- from 1 to 1000 if *CONFIG_BLE_MESH_FRIEND* && *CONFIG_BLE_MESH*

Default value:

- 2 if *CONFIG_BLE_MESH_FRIEND* && *CONFIG_BLE_MESH*

CONFIG_BLE_MESH_FRIEND_SEG_RX

Number of incomplete segment lists per LPN

Found in: Component config > CONFIG_BLE_MESH > CONFIG_BLE_MESH_FRIEND

Number of incomplete segment lists tracked for each Friends' LPN. In other words, this determines from how many elements can segmented messages destined for the Friend queue be received simultaneously.

Range:

- from 1 to 1000 if *CONFIG_BLE_MESH_FRIEND* && *CONFIG_BLE_MESH*

Default value:

- 1 if *CONFIG_BLE_MESH_FRIEND* && *CONFIG_BLE_MESH*

CONFIG_BLE_MESH_NO_LOG

Disable BLE Mesh debug logs (minimize bin size)

Found in: Component config > CONFIG_BLE_MESH

Select this to save the BLE Mesh related rodata code size. Enabling this option will disable the output of BLE Mesh debug log.

Default value:

- No (disabled) if *CONFIG_BLE_MESH* && *CONFIG_BLE_MESH*

BLE Mesh STACK DEBUG LOG LEVEL

 Contains:

- *CONFIG_BLE_MESH_STACK_TRACE_LEVEL*

CONFIG_BLE_MESH_STACK_TRACE_LEVEL

BLE_MESH_STACK

Found in: *Component config* > *CONFIG_BLE_MESH* > *BLE Mesh STACK DEBUG LOG LEVEL*

Define BLE Mesh trace level for BLE Mesh stack.

Available options:

- NONE (BLE_MESH_TRACE_LEVEL_NONE)
- ERROR (BLE_MESH_TRACE_LEVEL_ERROR)
- WARNING (BLE_MESH_TRACE_LEVEL_WARNING)
- INFO (BLE_MESH_TRACE_LEVEL_INFO)
- DEBUG (BLE_MESH_TRACE_LEVEL_DEBUG)
- VERBOSE (BLE_MESH_TRACE_LEVEL_VERBOSE)

BLE Mesh NET BUF DEBUG LOG LEVEL Contains:

- *CONFIG_BLE_MESH_NET_BUF_TRACE_LEVEL*

CONFIG_BLE_MESH_NET_BUF_TRACE_LEVEL

BLE_MESH_NET_BUF

Found in: *Component config* > *CONFIG_BLE_MESH* > *BLE Mesh NET BUF DEBUG LOG LEVEL*

Define BLE Mesh trace level for BLE Mesh net buffer.

Available options:

- NONE (BLE_MESH_NET_BUF_TRACE_LEVEL_NONE)
- ERROR (BLE_MESH_NET_BUF_TRACE_LEVEL_ERROR)
- WARNING (BLE_MESH_NET_BUF_TRACE_LEVEL_WARNING)
- INFO (BLE_MESH_NET_BUF_TRACE_LEVEL_INFO)
- DEBUG (BLE_MESH_NET_BUF_TRACE_LEVEL_DEBUG)
- VERBOSE (BLE_MESH_NET_BUF_TRACE_LEVEL_VERBOSE)

CONFIG_BLE_MESH_CLIENT_MSG_TIMEOUT

Timeout(ms) for client message response

Found in: *Component config* > *CONFIG_BLE_MESH*

Timeout value used by the node to get response of the acknowledged message which is sent by the client model. This value indicates the maximum time that a client model waits for the response of the sent acknowledged messages. If a client model uses 0 as the timeout value when sending acknowledged messages, then the default value will be used which is four seconds.

Range:

- from 100 to 1200000 if *CONFIG_BLE_MESH*

Default value:

- 4000 if *CONFIG_BLE_MESH*

Support for BLE Mesh Foundation models Contains:

- *CONFIG_BLE_MESH_CFG_CLI*
- *CONFIG_BLE_MESH_HEALTH_CLI*
- *CONFIG_BLE_MESH_HEALTH_SRV*

CONFIG_BLE_MESH_CFG_CLI

Configuration Client model

Found in: Component config > CONFIG_BLE_MESH > Support for BLE Mesh Foundation models

Enable support for Configuration Client model.

CONFIG_BLE_MESH_HEALTH_CLI

Health Client model

Found in: Component config > CONFIG_BLE_MESH > Support for BLE Mesh Foundation models

Enable support for Health Client model.

CONFIG_BLE_MESH_HEALTH_SRV

Health Server model

Found in: Component config > CONFIG_BLE_MESH > Support for BLE Mesh Foundation models

Enable support for Health Server model.

Default value:

- Yes (enabled) if *CONFIG_BLE_MESH*

Support for BLE Mesh Client/Server models Contains:

- *CONFIG_BLE_MESH_GENERIC_BATTERY_CLI*
- *CONFIG_BLE_MESH_GENERIC_DEF_TRANS_TIME_CLI*
- *CONFIG_BLE_MESH_GENERIC_LEVEL_CLI*
- *CONFIG_BLE_MESH_GENERIC_LOCATION_CLI*
- *CONFIG_BLE_MESH_GENERIC_ONOFF_CLI*
- *CONFIG_BLE_MESH_GENERIC_POWER_LEVEL_CLI*
- *CONFIG_BLE_MESH_GENERIC_POWER_ONOFF_CLI*
- *CONFIG_BLE_MESH_GENERIC_PROPERTY_CLI*
- *CONFIG_BLE_MESH_GENERIC_SERVER*
- *CONFIG_BLE_MESH_LIGHT_CTL_CLI*
- *CONFIG_BLE_MESH_LIGHT_HSL_CLI*
- *CONFIG_BLE_MESH_LIGHT_LC_CLI*
- *CONFIG_BLE_MESH_LIGHT_LIGHTNESS_CLI*
- *CONFIG_BLE_MESH_LIGHT_XYL_CLI*
- *CONFIG_BLE_MESH_LIGHTING_SERVER*
- *CONFIG_BLE_MESH_SCENE_CLI*
- *CONFIG_BLE_MESH_SCHEDULER_CLI*
- *CONFIG_BLE_MESH_SENSOR_CLI*
- *CONFIG_BLE_MESH_SENSOR_SERVER*
- *CONFIG_BLE_MESH_TIME_SCENE_SERVER*
- *CONFIG_BLE_MESH_TIME_CLI*

CONFIG_BLE_MESH_GENERIC_ONOFF_CLI

Generic OnOff Client model

Found in: Component config > CONFIG_BLE_MESH > Support for BLE Mesh Client/Server models

Enable support for Generic OnOff Client model.

CONFIG_BLE_MESH_GENERIC_LEVEL_CLI

Generic Level Client model

Found in: [Component config](#) > [CONFIG_BLE_MESH](#) > [Support for BLE Mesh Client/Server models](#)

Enable support for Generic Level Client model.

CONFIG_BLE_MESH_GENERIC_DEF_TRANS_TIME_CLI

Generic Default Transition Time Client model

Found in: [Component config](#) > [CONFIG_BLE_MESH](#) > [Support for BLE Mesh Client/Server models](#)

Enable support for Generic Default Transition Time Client model.

CONFIG_BLE_MESH_GENERIC_POWER_ONOFF_CLI

Generic Power OnOff Client model

Found in: [Component config](#) > [CONFIG_BLE_MESH](#) > [Support for BLE Mesh Client/Server models](#)

Enable support for Generic Power OnOff Client model.

CONFIG_BLE_MESH_GENERIC_POWER_LEVEL_CLI

Generic Power Level Client model

Found in: [Component config](#) > [CONFIG_BLE_MESH](#) > [Support for BLE Mesh Client/Server models](#)

Enable support for Generic Power Level Client model.

CONFIG_BLE_MESH_GENERIC_BATTERY_CLI

Generic Battery Client model

Found in: [Component config](#) > [CONFIG_BLE_MESH](#) > [Support for BLE Mesh Client/Server models](#)

Enable support for Generic Battery Client model.

CONFIG_BLE_MESH_GENERIC_LOCATION_CLI

Generic Location Client model

Found in: [Component config](#) > [CONFIG_BLE_MESH](#) > [Support for BLE Mesh Client/Server models](#)

Enable support for Generic Location Client model.

CONFIG_BLE_MESH_GENERIC_PROPERTY_CLI

Generic Property Client model

Found in: [Component config](#) > [CONFIG_BLE_MESH](#) > [Support for BLE Mesh Client/Server models](#)

Enable support for Generic Property Client model.

CONFIG_BLE_MESH_SENSOR_CLI

Sensor Client model

Found in: [Component config](#) > [CONFIG_BLE_MESH](#) > [Support for BLE Mesh Client/Server models](#)

Enable support for Sensor Client model.

CONFIG_BLE_MESH_TIME_CLI

Time Client model

Found in: [Component config](#) > [CONFIG_BLE_MESH](#) > [Support for BLE Mesh Client/Server models](#)

Enable support for Time Client model.

CONFIG_BLE_MESH_SCENE_CLI

Scene Client model

Found in: [Component config](#) > [CONFIG_BLE_MESH](#) > [Support for BLE Mesh Client/Server models](#)

Enable support for Scene Client model.

CONFIG_BLE_MESH_SCHEDULER_CLI

Scheduler Client model

Found in: [Component config](#) > [CONFIG_BLE_MESH](#) > [Support for BLE Mesh Client/Server models](#)

Enable support for Scheduler Client model.

CONFIG_BLE_MESH_LIGHT_LIGHTNESS_CLI

Light Lightness Client model

Found in: [Component config](#) > [CONFIG_BLE_MESH](#) > [Support for BLE Mesh Client/Server models](#)

Enable support for Light Lightness Client model.

CONFIG_BLE_MESH_LIGHT_CTL_CLI

Light CTL Client model

Found in: [Component config](#) > [CONFIG_BLE_MESH](#) > [Support for BLE Mesh Client/Server models](#)

Enable support for Light CTL Client model.

CONFIG_BLE_MESH_LIGHT_HSL_CLI

Light HSL Client model

Found in: [Component config](#) > [CONFIG_BLE_MESH](#) > [Support for BLE Mesh Client/Server models](#)

Enable support for Light HSL Client model.

CONFIG_BLE_MESH_LIGHT_XYL_CLI

Light XYL Client model

Found in: [Component config](#) > [CONFIG_BLE_MESH](#) > [Support for BLE Mesh Client/Server models](#)

Enable support for Light XYL Client model.

CONFIG_BLE_MESH_LIGHT_LC_CLI

Light LC Client model

Found in: [Component config](#) > [CONFIG_BLE_MESH](#) > [Support for BLE Mesh Client/Server models](#)

Enable support for Light LC Client model.

CONFIG_BLE_MESH_GENERIC_SERVER

Generic server models

Found in: Component config > CONFIG_BLE_MESH > Support for BLE Mesh Client/Server models

Enable support for Generic server models.

Default value:

- Yes (enabled) if *CONFIG_BLE_MESH*

CONFIG_BLE_MESH_SENSOR_SERVER

Sensor server models

Found in: Component config > CONFIG_BLE_MESH > Support for BLE Mesh Client/Server models

Enable support for Sensor server models.

Default value:

- Yes (enabled) if *CONFIG_BLE_MESH*

CONFIG_BLE_MESH_TIME_SCENE_SERVER

Time and Scenes server models

Found in: Component config > CONFIG_BLE_MESH > Support for BLE Mesh Client/Server models

Enable support for Time and Scenes server models.

Default value:

- Yes (enabled) if *CONFIG_BLE_MESH*

CONFIG_BLE_MESH_LIGHTING_SERVER

Lighting server models

Found in: Component config > CONFIG_BLE_MESH > Support for BLE Mesh Client/Server models

Enable support for Lighting server models.

Default value:

- Yes (enabled) if *CONFIG_BLE_MESH*

CONFIG_BLE_MESH_IV_UPDATE_TEST

Test the IV Update Procedure

Found in: Component config > CONFIG_BLE_MESH

This option removes the 96 hour limit of the IV Update Procedure and lets the state to be changed at any time. If IV Update test mode is going to be used, this option should be enabled.

Default value:

- No (disabled) if *CONFIG_BLE_MESH*

BLE Mesh specific test option Contains:

- *CONFIG_BLE_MESH_DEBUG*
- *CONFIG_BLE_MESH_SHELL*
- *CONFIG_BLE_MESH_SELF_TEST*

CONFIG_BLE_MESH_SELF_TEST

Perform BLE Mesh self-tests

Found in: Component config > CONFIG_BLE_MESH > BLE Mesh specific test option

This option adds extra self-tests which are run every time BLE Mesh networking is initialized.

Default value:

- No (disabled) if *CONFIG_BLE_MESH*

CONFIG_BLE_MESH_TEST_AUTO_ENTER_NETWORK

Unprovisioned device enters mesh network automatically

Found in: Component config > CONFIG_BLE_MESH > BLE Mesh specific test option > CONFIG_BLE_MESH_SELF_TEST

With this option enabled, an unprovisioned device can automatically enter mesh network using a specific test function without the provisioning procedure. And on the Provisioner side, a test function needs to be invoked to add the node information into the mesh stack.

Default value:

- Yes (enabled) if *CONFIG_BLE_MESH_SELF_TEST* && *CONFIG_BLE_MESH*

CONFIG_BLE_MESH_TEST_USE_WHITE_LIST

Use white list to filter mesh advertising packets

Found in: Component config > CONFIG_BLE_MESH > BLE Mesh specific test option > CONFIG_BLE_MESH_SELF_TEST

With this option enabled, users can use white list to filter mesh advertising packets while scanning.

Default value:

- No (disabled) if *CONFIG_BLE_MESH_SELF_TEST* && *CONFIG_BLE_MESH*

CONFIG_BLE_MESH_SHELL

Enable BLE Mesh shell

Found in: Component config > CONFIG_BLE_MESH > BLE Mesh specific test option

Activate shell module that provides BLE Mesh commands to the console.

Default value:

- No (disabled) if *CONFIG_BLE_MESH*

CONFIG_BLE_MESH_DEBUG

Enable BLE Mesh debug logs

Found in: Component config > CONFIG_BLE_MESH > BLE Mesh specific test option

Enable debug logs for the BLE Mesh functionality.

Default value:

- No (disabled) if *CONFIG_BLE_MESH*

CONFIG_BLE_MESH_DEBUG_NET

Network layer debug

Found in: [Component config](#) > [CONFIG_BLE_MESH](#) > [BLE Mesh specific test option](#) > [CONFIG_BLE_MESH_DEBUG](#)

Enable Network layer debug logs for the BLE Mesh functionality.

CONFIG_BLE_MESH_DEBUG_TRANS

Transport layer debug

Found in: [Component config](#) > [CONFIG_BLE_MESH](#) > [BLE Mesh specific test option](#) > [CONFIG_BLE_MESH_DEBUG](#)

Enable Transport layer debug logs for the BLE Mesh functionality.

CONFIG_BLE_MESH_DEBUG_BEACON

Beacon debug

Found in: [Component config](#) > [CONFIG_BLE_MESH](#) > [BLE Mesh specific test option](#) > [CONFIG_BLE_MESH_DEBUG](#)

Enable Beacon-related debug logs for the BLE Mesh functionality.

CONFIG_BLE_MESH_DEBUG_CRYPTO

Crypto debug

Found in: [Component config](#) > [CONFIG_BLE_MESH](#) > [BLE Mesh specific test option](#) > [CONFIG_BLE_MESH_DEBUG](#)

Enable cryptographic debug logs for the BLE Mesh functionality.

CONFIG_BLE_MESH_DEBUG_PROV

Provisioning debug

Found in: [Component config](#) > [CONFIG_BLE_MESH](#) > [BLE Mesh specific test option](#) > [CONFIG_BLE_MESH_DEBUG](#)

Enable Provisioning debug logs for the BLE Mesh functionality.

CONFIG_BLE_MESH_DEBUG_ACCESS

Access layer debug

Found in: [Component config](#) > [CONFIG_BLE_MESH](#) > [BLE Mesh specific test option](#) > [CONFIG_BLE_MESH_DEBUG](#)

Enable Access layer debug logs for the BLE Mesh functionality.

CONFIG_BLE_MESH_DEBUG_MODEL

Foundation model debug

Found in: [Component config](#) > [CONFIG_BLE_MESH](#) > [BLE Mesh specific test option](#) > [CONFIG_BLE_MESH_DEBUG](#)

Enable Foundation Models debug logs for the BLE Mesh functionality.

CONFIG_BLE_MESH_DEBUG_ADV

Advertising debug

Found in: Component config > CONFIG_BLE_MESH > BLE Mesh specific test option > CONFIG_BLE_MESH_DEBUG

Enable advertising debug logs for the BLE Mesh functionality.

CONFIG_BLE_MESH_DEBUG_LOW_POWER

Low Power debug

Found in: Component config > CONFIG_BLE_MESH > BLE Mesh specific test option > CONFIG_BLE_MESH_DEBUG

Enable Low Power debug logs for the BLE Mesh functionality.

CONFIG_BLE_MESH_DEBUG_FRIEND

Friend debug

Found in: Component config > CONFIG_BLE_MESH > BLE Mesh specific test option > CONFIG_BLE_MESH_DEBUG

Enable Friend debug logs for the BLE Mesh functionality.

CONFIG_BLE_MESH_DEBUG_PROXY

Proxy debug

Found in: Component config > CONFIG_BLE_MESH > BLE Mesh specific test option > CONFIG_BLE_MESH_DEBUG

Enable Proxy protocol debug logs for the BLE Mesh functionality.

CoAP Configuration Contains:

- *CONFIG_COAP_MBEDTLS_ENCRYPTION_MODE*
- *CONFIG_COAP_MBEDTLS_DEBUG*

CONFIG_COAP_MBEDTLS_ENCRYPTION_MODE

CoAP Encryption method

Found in: Component config > CoAP Configuration

If the CoAP information is to be encrypted, the encryption environment can be set up in one of two ways (default being Pre-Shared key mode)

- Encrypt using defined Pre-Shared Keys (PSK if uri includes coaps://)
- Encrypt using defined Public Key Infrastructure (PKI if uri includes coaps://)

Available options:

- Pre-Shared Keys (COAP_MBEDTLS_PSK)
- PKI Certificates (COAP_MBEDTLS_PKI)

CONFIG_COAP_MBEDTLS_DEBUG

Enable CoAP debugging

Found in: [Component config](#) > [CoAP Configuration](#)

Enable CoAP debugging functions at compile time for the example code.

If this option is enabled, call `coap_set_log_level()` at runtime in order to enable CoAP debug output via the ESP log mechanism.

Default value:

- No (disabled)

CONFIG_COAP_MBEDTLS_DEBUG_LEVEL

Set CoAP debugging level

Found in: [Component config](#) > [CoAP Configuration](#) > [CONFIG_COAP_MBEDTLS_DEBUG](#)

Set CoAP debugging level

Available options:

- Emergency (COAP_LOG_EMERG)
- Alert (COAP_LOG_ALERT)
- Critical (COAP_LOG_CRIT)
- Error (COAP_LOG_ERROR)
- Warning (COAP_LOG_WARNING)
- Notice (COAP_LOG_NOTICE)
- Info (COAP_LOG_INFO)
- Debug (COAP_LOG_DEBUG)

Driver configurations Contains:

- [ADC configuration](#)
- [SPI configuration](#)
- [TWAI configuration](#)
- [UART configuration](#)

ADC configuration Contains:

- [CONFIG_ADC_DISABLE_DAC](#)
- [CONFIG_ADC_FORCE_XPD_FSM](#)

CONFIG_ADC_FORCE_XPD_FSM

Use the FSM to control ADC power

Found in: [Component config](#) > [Driver configurations](#) > [ADC configuration](#)

ADC power can be controlled by the FSM instead of software. This allows the ADC to be shut off when it is not working leading to lower power consumption. However using the FSM control ADC power will increase the noise of ADC.

Default value:

- No (disabled)

CONFIG_ADC_DISABLE_DAC

Disable DAC when ADC2 is used on GPIO 25 and 26

Found in: [Component config](#) > [Driver configurations](#) > [ADC configuration](#)

If this is set, the ADC2 driver will disable the output of the DAC corresponding to the specified channel. This is the default value.

For testing, disable this option so that we can measure the output of DAC by internal ADC.

Default value:

- Yes (enabled)

SPI configuration Contains:

- [CONFIG_SPI_MASTER_ISR_IN_IRAM](#)
- [CONFIG_SPI_SLAVE_ISR_IN_IRAM](#)
- [CONFIG_SPI_MASTER_IN_IRAM](#)
- [CONFIG_SPI_SLAVE_IN_IRAM](#)

CONFIG_SPI_MASTER_IN_IRAM

Place transmitting functions of SPI master into IRAM

Found in: [Component config](#) > [Driver configurations](#) > [SPI configuration](#)

Normally only the ISR of SPI master is placed in the IRAM, so that it can work without the flash when interrupt is triggered. For other functions, there's some possibility that the flash cache miss when running inside and out of SPI functions, which may increase the interval of SPI transactions. Enable this to put `queue_trans`, `get_trans_result` and `transmit` functions into the IRAM to avoid possible cache miss.

During unit test, this is enabled to measure the ideal case of api.

Default value:

- No (disabled)

CONFIG_SPI_MASTER_ISR_IN_IRAM

Place SPI master ISR function into IRAM

Found in: [Component config](#) > [Driver configurations](#) > [SPI configuration](#)

Place the SPI master ISR in to IRAM to avoid possible cache miss.

Also you can forbid the ISR being disabled during flash writing access, by add `ESP_INTR_FLAG_IRAM` when initializing the driver.

Default value:

- Yes (enabled)

CONFIG_SPI_SLAVE_IN_IRAM

Place transmitting functions of SPI slave into IRAM

Found in: [Component config](#) > [Driver configurations](#) > [SPI configuration](#)

Normally only the ISR of SPI slave is placed in the IRAM, so that it can work without the flash when interrupt is triggered. For other functions, there's some possibility that the flash cache miss when running inside and out of SPI functions, which may increase the interval of SPI transactions. Enable this to put `queue_trans`, `get_trans_result` and `transmit` functions into the IRAM to avoid possible cache miss.

Default value:

- No (disabled)

CONFIG_SPI_SLAVE_ISR_IN_IRAM

Place SPI slave ISR function into IRAM

Found in: [Component config](#) > [Driver configurations](#) > [SPI configuration](#)

Place the SPI slave ISR in to IRAM to avoid possible cache miss.

Also you can forbid the ISR being disabled during flash writing access, by add ESP_INTR_FLAG_IRAM when initializing the driver.

Default value:

- Yes (enabled)

TWAI configuration Contains:

- [CONFIG_TWAI_ISR_IN_IRAM](#)

CONFIG_TWAI_ISR_IN_IRAM

Place TWAI ISR function into IRAM

Found in: [Component config](#) > [Driver configurations](#) > [TWAI configuration](#)

Place the TWAI ISR in to IRAM. This will allow the ISR to avoid cache misses, and also be able to run whilst the cache is disabled (such as when writing to SPI Flash). Note that if this option is enabled: - Users should also set the ESP_INTR_FLAG_IRAM in the driver configuration structure when installing the driver (see docs for specifics). - Alert logging (i.e., setting of the TWAI_ALERT_AND_LOG flag) will have no effect.

Default value:

- No (disabled)

UART configuration Contains:

- [CONFIG_UART_ISR_IN_IRAM](#)

CONFIG_UART_ISR_IN_IRAM

Place UART ISR function into IRAM

Found in: [Component config](#) > [Driver configurations](#) > [UART configuration](#)

If this option is not selected, UART interrupt will be disabled for a long time and may cause data lost when doing spi flash operation.

Default value:

- No (disabled)

eFuse Bit Manager Contains:

- [CONFIG_EFUSE_VIRTUAL](#)
- [CONFIG_EFUSE_CUSTOM_TABLE](#)

CONFIG_EFUSE_CUSTOM_TABLE

Use custom eFuse table

Found in: [Component config](#) > [eFuse Bit Manager](#)

Allows to generate a structure for eFuse from the CSV file.

Default value:

- No (disabled)

CONFIG_EFUSE_CUSTOM_TABLE_FILENAME

Custom eFuse CSV file

Found in: [Component config](#) > [eFuse Bit Manager](#) > [CONFIG_EFUSE_CUSTOM_TABLE](#)

Name of the custom eFuse CSV filename. This path is evaluated relative to the project root directory.

Default value:

- “main/esp_efuse_custom_table.csv” if [CONFIG_EFUSE_CUSTOM_TABLE](#)

CONFIG_EFUSE_VIRTUAL

Simulate eFuse operations in RAM

Found in: [Component config](#) > [eFuse Bit Manager](#)

All read and writes operations are redirected to RAM instead of eFuse registers. If this option is set, all permanent changes (via eFuse) are disabled. Log output will state changes which would be applied, but they will not be.

Default value:

- No (disabled)

ESP-TLS

 Contains:

- [CONFIG_ESP_TLS_INSECURE](#)
- [CONFIG_ESP_TLS_LIBRARY_CHOOSE](#)
- [CONFIG_ESP_DEBUG_WOLFSSL](#)
- [CONFIG_ESP_TLS_SERVER](#)
- [CONFIG_ESP_TLS_PSK_VERIFICATION](#)
- [CONFIG_ESP_WOLFSSL_SMALL_CERT_VERIFY](#)
- [CONFIG_ESP_TLS_USE_DS_PERIPHERAL](#)

CONFIG_ESP_TLS_LIBRARY_CHOOSE

Choose SSL/TLS library for ESP-TLS (See help for more Info)

Found in: [Component config](#) > [ESP-TLS](#)

The ESP-TLS APIs support multiple backend TLS libraries. Currently mbedTLS and WolfSSL are supported. Different TLS libraries may support different features and have different resource usage. Consult the ESP-TLS documentation in ESP-IDF Programming guide for more details.

Available options:

- mbedTLS ([ESP_TLS_USING_MBEDTLS](#))
- wolfSSL (License info in wolfSSL directory README) ([ESP_TLS_USING_WOLFSSL](#))

CONFIG_ESP_TLS_USE_DS_PERIPHERAL

Use Digital Signature (DS) Peripheral with ESP-TLS

Found in: [Component config](#) > [ESP-TLS](#)

Enable use of the Digital Signature Peripheral for ESP-TLS. The DS peripheral can only be used when it is appropriately configured for TLS. Consult the ESP-TLS documentation in ESP-IDF Programming Guide for more details.

Default value:

- Yes (enabled)

CONFIG_ESP_TLS_SERVER

Enable ESP-TLS Server

Found in: [Component config](#) > [ESP-TLS](#)

Enable support for creating server side SSL/TLS session, available for mbedTLS as well as wolfSSL TLS library.

Default value:

- No (disabled)

CONFIG_ESP_TLS_PSK_VERIFICATION

Enable PSK verification

Found in: [Component config](#) > [ESP-TLS](#)

Enable support for pre shared key ciphers, supported for both mbedTLS as well as wolfSSL TLS library.

Default value:

- No (disabled)

CONFIG_ESP_TLS_INSECURE

Allow potentially insecure options

Found in: [Component config](#) > [ESP-TLS](#)

You can enable some potentially insecure options. These options should only be used for testing purposes. Only enable these options if you are very sure.

CONFIG_ESP_TLS_SKIP_SERVER_CERT_VERIFY

Skip server certificate verification by default (WARNING: ONLY FOR TESTING PURPOSE, READ HELP)

Found in: [Component config](#) > [ESP-TLS](#) > [CONFIG_ESP_TLS_INSECURE](#)

After enabling this option the esp-tls client will skip the server certificate verification by default. Note that this option will only modify the default behaviour of esp-tls client regarding server cert verification. The default behaviour should only be applicable when no other option regarding the server cert verification is opted in the esp-tls config (e.g. `crt_bundle_attach`, `use_global_ca_store` etc.). WARNING : Enabling this option comes with a potential risk of establishing a TLS connection with a server which has a fake identity, provided that the server certificate is not provided either through API or other mechanism like `ca_store` etc.

CONFIG_ESP_WOLFSSL_SMALL_CERT_VERIFY

Enable SMALL_CERT_VERIFY

Found in: [Component config](#) > [ESP-TLS](#)

Enables server verification with Intermediate CA cert, does not authenticate full chain of trust upto the root CA cert (After Enabling this option client only needs to have Intermediate CA certificate of the server to authenticate server, root CA cert is not necessary).

Default value:

- Yes (enabled) if `ESP_TLS_USING_WOLFSSL`

CONFIG_ESP_DEBUG_WOLFSSL

Enable debug logs for wolfSSL

Found in: [Component config](#) > [ESP-TLS](#)

Enable detailed debug prints for wolfSSL SSL library.

Default value:

- No (disabled) if ESP_TLS_USING_WOLFSSL

ESP32C3-Specific Contains:

- [CONFIG_ESP32C3_DEFAULT_CPU_FREQ_MHZ](#)
- [CONFIG_ESP32C3_BROWNOUT_DET](#)
- [CONFIG_ESP32C3_LIGHTSLEEP_GPIO_RESET_WORKAROUND](#)
- [CONFIG_ESP32C3_DEBUG_OCDAWARE](#)
- [CONFIG_ESP32C3_REV_MIN](#)
- [CONFIG_ESP32C3_NO_BLOBS](#)
- [CONFIG_ESP32C3_RTC_CLK_CAL_CYCLES](#)
- [CONFIG_ESP32C3_UNIVERSAL_MAC_ADDRESSES](#)
- [CONFIG_ESP32C3_DEBUG_STUBS_ENABLE](#)
- [CONFIG_ESP32C3_RTC_CLK_SRC](#)
- [CONFIG_ESP32C3_TIME_SYSCALL](#)

CONFIG_ESP32C3_DEFAULT_CPU_FREQ_MHZ

CPU frequency

Found in: [Component config](#) > [ESP32C3-Specific](#)

CPU frequency to be set on application startup.

Available options:

- 40 MHz (ESP32C3_DEFAULT_CPU_FREQ_40)
- 80 MHz (ESP32C3_DEFAULT_CPU_FREQ_80)
- 160 MHz (ESP32C3_DEFAULT_CPU_FREQ_160)

CONFIG_ESP32C3_REV_MIN

Minimum Supported ESP32-C3 Revision

Found in: [Component config](#) > [ESP32C3-Specific](#)

Minimum revision that ESP-IDF would support.

Only supporting higher chip revisions can reduce binary size.

Available options:

- Rev 0 (ESP32C3_REV_MIN_0)
- Rev 1 (ESP32C3_REV_MIN_1)
- Rev 2 (ESP32C3_REV_MIN_2)
- Rev 3 (ESP32C3_REV_MIN_3)
- Rev 4 (ESP32C3_REV_MIN_4)

CONFIG_ESP32C3_UNIVERSAL_MAC_ADDRESSES

Number of universally administered (by IEEE) MAC address

Found in: [Component config](#) > [ESP32C3-Specific](#)

Configure the number of universally administered (by IEEE) MAC addresses.

During initialization, MAC addresses for each network interface are generated or derived from a single base MAC address.

If the number of universal MAC addresses is four, all four interfaces (WiFi station, WiFi softap, Bluetooth and Ethernet) receive a universally administered MAC address. These are generated sequentially by adding 0, 1, 2 and 3 (respectively) to the final octet of the base MAC address.

If the number of universal MAC addresses is two, only two interfaces (WiFi station and Bluetooth) receive a universally administered MAC address. These are generated sequentially by adding 0 and 1 (respectively) to the base MAC address. The remaining two interfaces (WiFi softap and Ethernet) receive local MAC addresses. These are derived from the universal WiFi station and Bluetooth MAC addresses, respectively.

When using the default (Espressif-assigned) base MAC address, either setting can be used. When using a custom universal MAC address range, the correct setting will depend on the allocation of MAC addresses in this range (either 2 or 4 per device.)

Note that ESP32-C3 has no integrated Ethernet MAC. Although it's possible to use the `esp_read_mac()` API to return a MAC for Ethernet, this can only be used with an external MAC peripheral.

Available options:

- Two (ESP32C3_UNIVERSAL_MAC_ADDRESSES_TWO)
- Four (ESP32C3_UNIVERSAL_MAC_ADDRESSES_FOUR)

CONFIG_ESP32C3_DEBUG_OCDAWARE

Make exception and panic handlers JTAG/OCD aware

Found in: [Component config](#) > [ESP32C3-Specific](#)

The FreeRTOS panic and unhandled exception handlers can detect a JTAG OCD debugger and instead of panicking, have the debugger stop on the offending instruction.

Default value:

- Yes (enabled)

CONFIG_ESP32C3_DEBUG_STUBS_ENABLE

OpenOCD debug stubs

Found in: [Component config](#) > [ESP32C3-Specific](#)

Debug stubs are used by OpenOCD to execute pre-compiled onboard code which does some useful debugging, e.g. GCOV data dump.

Default value:

- “COMPILER_OPTIMIZATION_LEVEL_DEBUG” if ESP32C3_TRAX

CONFIG_ESP32C3_BROWNOUT_DET

Hardware brownout detect & reset

Found in: [Component config](#) > [ESP32C3-Specific](#)

The ESP32-C3 has a built-in brownout detector which can detect if the voltage is lower than a specific value. If this happens, it will reset the chip in order to prevent unintended behaviour.

Default value:

- Yes (enabled)

CONFIG_ESP32C3_BROWNOUT_DET_LVL_SEL

Brownout voltage level

Found in: Component config > ESP32C3-Specific > CONFIG_ESP32C3_BROWNOUT_DET

The brownout detector will reset the chip when the supply voltage is approximately below this level. Note that there may be some variation of brownout voltage level between each chip.

#The voltage levels here are estimates, more work needs to be done to figure out the exact voltages #of the brownout threshold levels.

Available options:

- 2.51V (ESP32C3_BROWNOUT_DET_LVL_SEL_7)
- 2.64V (ESP32C3_BROWNOUT_DET_LVL_SEL_6)
- 2.76V (ESP32C3_BROWNOUT_DET_LVL_SEL_5)
- 2.92V (ESP32C3_BROWNOUT_DET_LVL_SEL_4)
- 3.10V (ESP32C3_BROWNOUT_DET_LVL_SEL_3)
- 3.27V (ESP32C3_BROWNOUT_DET_LVL_SEL_2)

CONFIG_ESP32C3_TIME_SYSCALL

Timers used for gettimeofday function

Found in: Component config > ESP32C3-Specific

This setting defines which hardware timers are used to implement ‘gettimeofday’ and ‘time’ functions in C library.

- If both high-resolution (systimer) and RTC timers are used, timekeeping will continue in deep sleep. Time will be reported at 1 microsecond resolution. This is the default, and the recommended option.
- If only high-resolution timer (systimer) is used, gettimeofday will provide time at microsecond resolution. Time will not be preserved when going into deep sleep mode.
- If only RTC timer is used, timekeeping will continue in deep sleep, but time will be measured at 6.(6) microsecond resolution. Also the gettimeofday function itself may take longer to run.
- If no timers are used, gettimeofday and time functions return -1 and set errno to ENOSYS.
- When RTC is used for timekeeping, two RTC_STORE registers are used to keep time in deep sleep mode.

Available options:

- RTC and high-resolution timer (ESP32C3_TIME_SYSCALL_USE_RTC_SYSTIMER)
- RTC (ESP32C3_TIME_SYSCALL_USE_RTC)
- High-resolution timer (ESP32C3_TIME_SYSCALL_USE_SYSTIMER)
- None (ESP32C3_TIME_SYSCALL_USE_NONE)

CONFIG_ESP32C3_RTC_CLK_SRC

RTC clock source

Found in: Component config > ESP32C3-Specific

Choose which clock is used as RTC clock source.

Available options:

- Internal 150kHz RC oscillator (ESP32C3_RTC_CLK_SRC_INT_RC)
- External 32kHz crystal (ESP32C3_RTC_CLK_SRC_EXT_CRYST)
- External 32kHz oscillator at 32K_XP pin (ESP32C3_RTC_CLK_SRC_EXT_OSC)
- Internal 8MHz oscillator, divided by 256 (~32kHz) (ESP32C3_RTC_CLK_SRC_INT_8MD256)

CONFIG_ESP32C3_RTC_CLK_CAL_CYCLES

Number of cycles for RTC_SLOW_CLK calibration

Found in: [Component config](#) > [ESP32C3-Specific](#)

When the startup code initializes RTC_SLOW_CLK, it can perform calibration by comparing the RTC_SLOW_CLK frequency with main XTAL frequency. This option sets the number of RTC_SLOW_CLK cycles measured by the calibration routine. Higher numbers increase calibration precision, which may be important for applications which spend a lot of time in deep sleep. Lower numbers reduce startup time.

When this option is set to 0, clock calibration will not be performed at startup, and approximate clock frequencies will be assumed:

- 150000 Hz if internal RC oscillator is used as clock source. For this use value 1024.
- 32768 Hz if the 32k crystal oscillator is used. For this use value 3000 or more. In case more value will help improve the definition of the launch of the crystal. If the crystal could not start, it will be switched to internal RC.

Range:

- from 0 to 125000

Default value:

- 3000 if ESP32C3_RTC_CLK_SRC_EXT_CRYSTAL || ESP32C3_RTC_CLK_SRC_EXT_OSC || ESP32C3_RTC_CLK_SRC_INT_8MD256
- 1024

CONFIG_ESP32C3_NO_BLOBS

No Binary Blobs

Found in: [Component config](#) > [ESP32C3-Specific](#)

If enabled, this disables the linking of binary libraries in the application build. Note that after enabling this Wi-Fi/Bluetooth will not work.

Default value:

- No (disabled) if [CONFIG_BT_ENABLED](#)

CONFIG_ESP32C3_LIGHTSLEEP_GPIO_RESET_WORKAROUND

light sleep GPIO reset workaround

Found in: [Component config](#) > [ESP32C3-Specific](#)

ESP32C3 will reset at wake-up if GPIO is received a small electrostatic pulse during light sleep, with specific condition

- GPIO needs to be configured as input-mode only
- The pin receives a small electrostatic pulse, and reset occurs when the pulse voltage is higher than 6 V

For GPIO set to input mode only, it is not a good practice to leave it open/floating, The hardware design needs to controlled it with determined supply or ground voltage is necessary.

This option provides a software workaround for this issue. Configure to isolate all GPIO pins in sleep state.

Default value:

- Yes (enabled)

ADC-Calibration

Common ESP-related Contains:

- `CONFIG_ESP_CONSOLE_UART`
- `CONFIG_ESP_CONSOLE_SECONDARY`
- `CONFIG_ESP_ERR_TO_NAME_LOOKUP`
- `CONFIG_ESP_SYSTEM_EVENT_TASK_STACK_SIZE`
- `CONFIG_ESP_TASK_WDT`
- `CONFIG_ESP_IPC_TASK_STACK_SIZE`
- `CONFIG_ESP_INT_WDT`
- `CONFIG_ESP_IPC_USES_CALLERS_PRIORITY`
- `CONFIG_ESP_MAIN_TASK_STACK_SIZE`
- `CONFIG_ESP_MINIMAL_SHARED_STACK_SIZE`
- `CONFIG_ESP_PANIC_HANDLER_IRAM`
- `CONFIG_ESP_SYSTEM_EVENT_QUEUE_SIZE`
- `CONFIG_ESP_CONSOLE_UART_BAUDRATE`
- `CONFIG_ESP_CONSOLE_UART_NUM`
- `CONFIG_ESP_CONSOLE_UART_RX_GPIO`
- `CONFIG_ESP_CONSOLE_UART_TX_GPIO`

CONFIG_ESP_ERR_TO_NAME_LOOKUP

Enable lookup of error code strings

Found in: [Component config](#) > [Common ESP-related](#)

Functions `esp_err_to_name()` and `esp_err_to_name_r()` return string representations of error codes from a pre-generated lookup table. This option can be used to turn off the use of the look-up table in order to save memory but this comes at the price of sacrificing distinguishable (meaningful) output string representations.

Default value:

- Yes (enabled)

CONFIG_ESP_SYSTEM_EVENT_QUEUE_SIZE

System event queue size

Found in: [Component config](#) > [Common ESP-related](#)

Config system event queue size in different application.

Default value:

- 32

CONFIG_ESP_SYSTEM_EVENT_TASK_STACK_SIZE

Event loop task stack size

Found in: [Component config](#) > [Common ESP-related](#)

Config system event task stack size in different application.

Default value:

- 2304

CONFIG_ESP_MAIN_TASK_STACK_SIZE

Main task stack size

Found in: [Component config](#) > [Common ESP-related](#)

Configure the “main task” stack size. This is the stack of the task which calls `app_main()`. If `app_main()` returns then this task is deleted and its stack memory is freed.

Default value:

- 3584

CONFIG_ESP_IPC_TASK_STACK_SIZE

Inter-Processor Call (IPC) task stack size

Found in: [Component config](#) > [Common ESP-related](#)

Configure the IPC tasks stack size. One IPC task runs on each core (in dual core mode), and allows for cross-core function calls.

See IPC documentation for more details.

The default stack size should be enough for most common use cases. It can be shrunk if you are sure that you do not use any custom IPC functionality.

Range:

- from 512 to 65536

Default value:

- 1024

CONFIG_ESP_IPC_USES_CALLERS_PRIORITY

IPC runs at caller's priority

Found in: [Component config](#) > [Common ESP-related](#)

If this option is not enabled then the IPC task will keep behavior same as prior to that of ESP-IDF v4.0, and hence IPC task will run at (configMAX_PRIORITIES - 1) priority.

Default value:

- Yes (enabled)

CONFIG_ESP_MINIMAL_SHARED_STACK_SIZE

Minimal allowed size for shared stack

Found in: [Component config](#) > [Common ESP-related](#)

Minimal value of size, in bytes, accepted to execute a expression with shared stack.

Default value:

- 2048

CONFIG_ESP_CONSOLE_UART

Channel for console output

Found in: [Component config](#) > [Common ESP-related](#)

Select where to send console output (through stdout and stderr).

- Default is to use UART0 on pre-defined GPIOs.
- If “Custom” is selected, UART0 or UART1 can be chosen, and any pins can be selected.
- If “None” is selected, there will be no console output on any UART, except for initial output from ROM bootloader. This ROM output can be suppressed by GPIO strapping or EFUSE, refer to chip datasheet for details.
- On chips with USB OTG peripheral, “USB CDC” option redirects output to the CDC port. This option uses the CDC driver in the chip ROM. This option is incompatible with TinyUSB stack.
- On chips with an USB serial/JTAG debug controller, selecting the option for that redirects output to the CDC/ACM (serial port emulation) component of that device.

Available options:

- Default: UART0 (ESP_CONSOLE_UART_DEFAULT)

- USB CDC (ESP_CONSOLE_USB_CDC)
- USB Serial/JTAG Controller (ESP_CONSOLE_USB_SERIAL_JTAG)
- Custom UART (ESP_CONSOLE_UART_CUSTOM)
- None (ESP_CONSOLE_NONE)

CONFIG_ESP_CONSOLE_SECONDARY

Channel for console secondary output

Found in: [Component config](#) > [Common ESP-related](#)

This secondary option supports output through other specific port like USB_SERIAL_JTAG when UART0 port as a primary is selected but not connected. This secondary output currently only supports non-blocking mode without using REPL. If you want to output in blocking mode with REPL or input through this secondary port, please change the primary config to this port in *Channel for console output* menu.

Available options:

- No secondary console (ESP_CONSOLE_SECONDARY_NONE)
- USB_SERIAL_JTAG PORT (ESP_CONSOLE_SECONDARY_USB_SERIAL_JTAG)
This option supports output through USB_SERIAL_JTAG port when the UART0 port is not connected. The output currently only supports non-blocking mode without using the console. If you want to output in blocking mode with REPL or input through USB_SERIAL_JTAG port, please change the primary config to ESP_CONSOLE_USB_SERIAL_JTAG above.

CONFIG_ESP_CONSOLE_UART_NUM

UART peripheral to use for console output (0-1)

Found in: [Component config](#) > [Common ESP-related](#)

This UART peripheral is used for console output from the ESP-IDF Bootloader and the app.

If the configuration is different in the Bootloader binary compared to the app binary, UART is reconfigured after the bootloader exits and the app starts.

Due to an ESP32 ROM bug, UART2 is not supported for console output via esp_rom_printf.

Available options:

- UART0 (ESP_CONSOLE_UART_CUSTOM_NUM_0)
- UART1 (ESP_CONSOLE_UART_CUSTOM_NUM_1)

CONFIG_ESP_CONSOLE_UART_TX_GPIO

UART TX on GPIO#

Found in: [Component config](#) > [Common ESP-related](#)

This GPIO is used for console UART TX output in the ESP-IDF Bootloader and the app (including boot log output and default standard output and standard error of the app).

If the configuration is different in the Bootloader binary compared to the app binary, UART is reconfigured after the bootloader exits and the app starts.

Range:

- from 0 to 46 if ESP_CONSOLE_UART_CUSTOM

Default value:

- 21 if ESP_CONSOLE_UART_CUSTOM
- 43 if ESP_CONSOLE_UART_CUSTOM

CONFIG_ESP_CONSOLE_UART_RX_GPIO

UART RX on GPIO#

Found in: [Component config](#) > [Common ESP-related](#)

This GPIO is used for UART RX input in the ESP-IDF Bootloader and the app (including default default standard input of the app).

Note: The default ESP-IDF Bootloader configures this pin but doesn't read anything from the UART.

If the configuration is different in the Bootloader binary compared to the app binary, UART is reconfigured after the bootloader exits and the app starts.

Range:

- from 0 to 46 if ESP_CONSOLE_UART_CUSTOM

Default value:

- 20 if ESP_CONSOLE_UART_CUSTOM
- 44 if ESP_CONSOLE_UART_CUSTOM

CONFIG_ESP_CONSOLE_UART_BAUDRATE

UART console baud rate

Found in: [Component config](#) > [Common ESP-related](#)

This baud rate is used by both the ESP-IDF Bootloader and the app (including boot log output and default standard input/output/error of the app).

The app's maximum baud rate depends on the UART clock source. If Power Management is disabled, the UART clock source is the APB clock and all baud rates in the available range will be sufficiently accurate. If Power Management is enabled, REF_TICK clock source is used so the baud rate is divided from 1MHz. Baud rates above 1Mbps are not possible and values between 500Kbps and 1Mbps may not be accurate.

If the configuration is different in the Bootloader binary compared to the app binary, UART is reconfigured after the bootloader exits and the app starts.

Range:

- from 1200 to 4000000 if [CONFIG_PM_ENABLE](#)
- from 1200 to 1000000 if [CONFIG_PM_ENABLE](#)

Default value:

- 115200

CONFIG_ESP_INT_WDT

Interrupt watchdog

Found in: [Component config](#) > [Common ESP-related](#)

This watchdog timer can detect if the FreeRTOS tick interrupt has not been called for a certain time, either because a task turned off interrupts and did not turn them on for a long time, or because an interrupt handler did not return. It will try to invoke the panic handler first and failing that reset the SoC.

Default value:

- Yes (enabled)

CONFIG_ESP_INT_WDT_TIMEOUT_MS

Interrupt watchdog timeout (ms)

Found in: [Component config](#) > [Common ESP-related](#) > [CONFIG_ESP_INT_WDT](#)

The timeout of the watchdog, in milliseconds. Make this higher than the FreeRTOS tick rate.

Range:

- from 10 to 10000

Default value:

- 300 if ESP32_SPIRAM_SUPPORT && [CONFIG_ESP_INT_WDT](#)
- 800 if ESP32_SPIRAM_SUPPORT && [CONFIG_ESP_INT_WDT](#)

CONFIG_ESP_INT_WDT_CHECK_CPU1

Also watch CPU1 tick interrupt

Found in: [Component config](#) > [Common ESP-related](#) > [CONFIG_ESP_INT_WDT](#)

Also detect if interrupts on CPU 1 are disabled for too long.

Default value:

- Yes (enabled)

CONFIG_ESP_TASK_WDT

Initialize Task Watchdog Timer on startup

Found in: [Component config](#) > [Common ESP-related](#)

The Task Watchdog Timer can be used to make sure individual tasks are still running. Enabling this option will cause the Task Watchdog Timer to be initialized automatically at startup. The Task Watchdog timer can be initialized after startup as well (see Task Watchdog Timer API Reference)

Default value:

- Yes (enabled)

CONFIG_ESP_TASK_WDT_PANIC

Invoke panic handler on Task Watchdog timeout

Found in: [Component config](#) > [Common ESP-related](#) > [CONFIG_ESP_TASK_WDT](#)

If this option is enabled, the Task Watchdog Timer will be configured to trigger the panic handler when it times out. This can also be configured at run time (see Task Watchdog Timer API Reference)

Default value:

- No (disabled)

CONFIG_ESP_TASK_WDT_TIMEOUT_S

Task Watchdog timeout period (seconds)

Found in: [Component config](#) > [Common ESP-related](#) > [CONFIG_ESP_TASK_WDT](#)

Timeout period configuration for the Task Watchdog Timer in seconds. This is also configurable at run time (see Task Watchdog Timer API Reference)

Range:

- from 1 to 60

Default value:

- 5

CONFIG_ESP_TASK_WDT_CHECK_IDLE_TASK_CPU0

Watch CPU0 Idle Task

Found in: [Component config](#) > [Common ESP-related](#) > [CONFIG_ESP_TASK_WDT](#)

If this option is enabled, the Task Watchdog Timer will watch the CPU0 Idle Task. Having the Task Watchdog watch the Idle Task allows for detection of CPU starvation as the Idle Task not being called is

usually a symptom of CPU starvation. Starvation of the Idle Task is detrimental as FreeRTOS household tasks depend on the Idle Task getting some runtime every now and then.

Default value:

- Yes (enabled)

CONFIG_ESP_TASK_WDT_CHECK_IDLE_TASK_CPU1

Watch CPU1 Idle Task

Found in: [Component config](#) > [Common ESP-related](#) > [CONFIG_ESP_TASK_WDT](#)

If this option is enabled, the Task Watchdog Timer will watch the CPU1 Idle Task.

Default value:

- Yes (enabled)

CONFIG_ESP_PANIC_HANDLER_IRAM

Place panic handler code in IRAM

Found in: [Component config](#) > [Common ESP-related](#)

If this option is disabled (default), the panic handler code is placed in flash not IRAM. This means that if ESP-IDF crashes while flash cache is disabled, the panic handler will automatically re-enable flash cache before running GDB Stub or Core Dump. This adds some minor risk, if the flash cache status is also corrupted during the crash.

If this option is enabled, the panic handler code is placed in IRAM. This allows the panic handler to run without needing to re-enable cache first. This may be necessary to debug some complex issues with crashes while flash cache is disabled (for example, when writing to SPI flash.)

Default value:

- No (disabled)

Ethernet Contains:

- [CONFIG_ETH_USE_OPENETH](#)
- [CONFIG_ETH_USE_SPI_ETHERNET](#)

CONFIG_ETH_USE_SPI_ETHERNET

Support SPI to Ethernet Module

Found in: [Component config](#) > [Ethernet](#)

ESP-IDF can also support some SPI-Ethernet modules.

Default value:

- Yes (enabled)

Contains:

- [CONFIG_ETH_SPI_ETHERNET_DM9051](#)
- [CONFIG_ETH_SPI_ETHERNET_W5500](#)

CONFIG_ETH_SPI_ETHERNET_DM9051

Use DM9051

Found in: [Component config](#) > [Ethernet](#) > [CONFIG_ETH_USE_SPI_ETHERNET](#)

DM9051 is a fast Ethernet controller with an SPI interface. It's also integrated with a 10/100M PHY and MAC. Select this to enable DM9051 driver.

CONFIG_ETH_SPI_ETHERNET_W5500

Use W5500 (MAC RAW)

Found in: Component config > Ethernet > CONFIG_ETH_USE_SPI_ETHERNET

W5500 is a HW TCP/IP embedded Ethernet controller. TCP/IP stack, 10/100 Ethernet MAC and PHY are embedded in a single chip. However the driver in ESP-IDF only enables the RAW MAC mode, making it compatible with the software TCP/IP stack. Say yes to enable W5500 driver.

CONFIG_ETH_USE_OPENETH

Support OpenCores Ethernet MAC (for use with QEMU)

Found in: Component config > Ethernet

OpenCores Ethernet MAC driver can be used when an ESP-IDF application is executed in QEMU. This driver is not supported when running on a real chip.

Default value:

- No (disabled)

Contains:

- [CONFIG_ETH_OPENETH_DMA_RX_BUFFER_NUM](#)
- [CONFIG_ETH_OPENETH_DMA_TX_BUFFER_NUM](#)

CONFIG_ETH_OPENETH_DMA_RX_BUFFER_NUM

Number of Ethernet DMA Rx buffers

Found in: Component config > Ethernet > CONFIG_ETH_USE_OPENETH

Number of DMA receive buffers, each buffer is 1600 bytes.

Range:

- from 1 to 64 if [CONFIG_ETH_USE_OPENETH](#)

Default value:

- 4 if [CONFIG_ETH_USE_OPENETH](#)

CONFIG_ETH_OPENETH_DMA_TX_BUFFER_NUM

Number of Ethernet DMA Tx buffers

Found in: Component config > Ethernet > CONFIG_ETH_USE_OPENETH

Number of DMA transmit buffers, each buffer is 1600 bytes.

Range:

- from 1 to 64 if [CONFIG_ETH_USE_OPENETH](#)

Default value:

- 1 if [CONFIG_ETH_USE_OPENETH](#)

Event Loop Library Contains:

- [CONFIG_ESP_EVENT_LOOP_PROFILING](#)
- [CONFIG_ESP_EVENT_POST_FROM_ISR](#)

CONFIG_ESP_EVENT_LOOP_PROFILING

Enable event loop profiling

Found in: Component config > Event Loop Library

Enables collections of statistics in the event loop library such as the number of events posted to/received by an event loop, number of callbacks involved, number of events dropped to a full event loop queue, run time of event handlers, and number of times/run time of each event handler.

Default value:

- No (disabled)

CONFIG_ESP_EVENT_POST_FROM_ISR

Support posting events from ISRs

Found in: [Component config](#) > [Event Loop Library](#)

Enable posting events from interrupt handlers.

Default value:

- Yes (enabled)

CONFIG_ESP_EVENT_POST_FROM_IRAM_ISR

Support posting events from ISRs placed in IRAM

Found in: [Component config](#) > [Event Loop Library](#) > [CONFIG_ESP_EVENT_POST_FROM_ISR](#)

Enable posting events from interrupt handlers placed in IRAM. Enabling this option places API functions `esp_event_post` and `esp_event_post_to` in IRAM.

Default value:

- Yes (enabled)

GDB Stub Contains:

- [CONFIG_ESP_GDBSTUB_SUPPORT_TASKS](#)

CONFIG_ESP_GDBSTUB_SUPPORT_TASKS

Enable listing FreeRTOS tasks through GDB Stub

Found in: [Component config](#) > [GDB Stub](#)

If enabled, GDBStub can supply the list of FreeRTOS tasks to GDB. Thread list can be queried from GDB using 'info threads' command. Note that if GDB task lists were corrupted, this feature may not work. If GDBStub fails, try disabling this feature.

CONFIG_ESP_GDBSTUB_MAX_TASKS

Maximum number of tasks supported by GDB Stub

Found in: [Component config](#) > [GDB Stub](#) > [CONFIG_ESP_GDBSTUB_SUPPORT_TASKS](#)

Set the number of tasks which GDB Stub will support.

Default value:

- 32 if [CONFIG_ESP_GDBSTUB_SUPPORT_TASKS](#)

ESP HTTP client Contains:

- [CONFIG_ESP_HTTP_CLIENT_ENABLE_BASIC_AUTH](#)
- [CONFIG_ESP_HTTP_CLIENT_ENABLE_HTTPS](#)

CONFIG_ESP_HTTP_CLIENT_ENABLE_HTTPS

Enable https

Found in: [Component config](#) > [ESP HTTP client](#)

This option will enable https protocol by linking esp-tls library and initializing SSL transport

Default value:

- Yes (enabled)

CONFIG_ESP_HTTP_CLIENT_ENABLE_BASIC_AUTH

Enable HTTP Basic Authentication

Found in: [Component config](#) > [ESP HTTP client](#)

This option will enable HTTP Basic Authentication. It is disabled by default as Basic auth uses unencrypted encoding, so it introduces a vulnerability when not using TLS

Default value:

- No (disabled)

HTTP Server Contains:

- [CONFIG_HTTPD_PURGE_BUF_LEN](#)
- [CONFIG_HTTPD_LOG_PURGE_DATA](#)
- [CONFIG_HTTPD_MAX_REQ_HDR_LEN](#)
- [CONFIG_HTTPD_MAX_URI_LEN](#)
- [CONFIG_HTTPD_ERR_RESP_NO_DELAY](#)
- [CONFIG_HTTPD_WS_SUPPORT](#)

CONFIG_HTTPD_MAX_REQ_HDR_LEN

Max HTTP Request Header Length

Found in: [Component config](#) > [HTTP Server](#)

This sets the maximum supported size of headers section in HTTP request packet to be processed by the server

Default value:

- 512

CONFIG_HTTPD_MAX_URI_LEN

Max HTTP URI Length

Found in: [Component config](#) > [HTTP Server](#)

This sets the maximum supported size of HTTP request URI to be processed by the server

Default value:

- 512

CONFIG_HTTPD_ERR_RESP_NO_DELAY

Use TCP_NODELAY socket option when sending HTTP error responses

Found in: [Component config](#) > [HTTP Server](#)

Using TCP_NODELAY socket option ensures that HTTP error response reaches the client before the underlying socket is closed. Please note that turning this off may cause multiple test failures

Default value:

- Yes (enabled)

CONFIG_HTTPD_PURGE_BUF_LEN

Length of temporary buffer for purging data

Found in: [Component config](#) > [HTTP Server](#)

This sets the size of the temporary buffer used to receive and discard any remaining data that is received from the HTTP client in the request, but not processed as part of the server HTTP request handler.

If the remaining data is larger than the available buffer size, the buffer will be filled in multiple iterations. The buffer should be small enough to fit on the stack, but large enough to avoid excessive iterations.

Default value:

- 32

CONFIG_HTTPD_LOG_PURGE_DATA

Log purged content data at Debug level

Found in: [Component config](#) > [HTTP Server](#)

Enabling this will log discarded binary HTTP request data at Debug level. For large content data this may not be desirable as it will clutter the log.

Default value:

- No (disabled)

CONFIG_HTTPD_WS_SUPPORT

WebSocket server support

Found in: [Component config](#) > [HTTP Server](#)

This sets the WebSocket server support.

Default value:

- No (disabled)

ESP HTTPS OTA Contains:

- [CONFIG_OTA_ALLOW_HTTP](#)

CONFIG_OTA_ALLOW_HTTP

Allow HTTP for OTA (WARNING: ONLY FOR TESTING PURPOSE, READ HELP)

Found in: [Component config](#) > [ESP HTTPS OTA](#)

It is highly recommended to keep HTTPS (along with server certificate validation) enabled. Enabling this option comes with potential risk of: - Non-encrypted communication channel with server - Accepting firmware upgrade image from server with fake identity

Default value:

- No (disabled)

ESP HTTPS server Contains:

- [CONFIG_ESP_HTTPS_SERVER_ENABLE](#)

CONFIG_ESP_HTTPS_SERVER_ENABLE

Enable ESP_HTTPS_SERVER component

Found in: [Component config](#) > [ESP HTTPS server](#)

Enable ESP HTTPS server component

ESP NETIF Adapter Contains:

- [CONFIG_ESP_NETIF_TCPIP_ADAPTER_COMPATIBLE_LAYER](#)
- [CONFIG_ESP_NETIF_IP_LOST_TIMER_INTERVAL](#)
- [CONFIG_ESP_NETIF_USE_TCPIP_STACK_LIB](#)

CONFIG_ESP_NETIF_IP_LOST_TIMER_INTERVAL

IP Address lost timer interval (seconds)

Found in: [Component config](#) > [ESP NETIF Adapter](#)

The value of 0 indicates the IP lost timer is disabled, otherwise the timer is enabled.

The IP address may be lost because of some reasons, e.g. when the station disconnects from soft-AP, or when DHCP IP renew fails etc. If the IP lost timer is enabled, it will be started everytime the IP is lost. Event SYSTEM_EVENT_STA_LOST_IP will be raised if the timer expires. The IP lost timer is stopped if the station get the IP again before the timer expires.

Range:

- from 0 to 65535

Default value:

- 120

CONFIG_ESP_NETIF_USE_TCPIP_STACK_LIB

TCP/IP Stack Library

Found in: [Component config](#) > [ESP NETIF Adapter](#)

Choose the TCP/IP Stack to work, for example, LwIP, uIP, etc.

Available options:

- LwIP (ESP_NETIF_TCPIP_LWIP)
lwIP is a small independent implementation of the TCP/IP protocol suite.
- Loopback (ESP_NETIF_LOOPBACK)
Dummy implementation of esp-netif functionality which connects driver transmit to receive function. This option is for testing purpose only

CONFIG_ESP_NETIF_TCPIP_ADAPTER_COMPATIBLE_LAYER

Enable backward compatible tcpip_adapter interface

Found in: [Component config](#) > [ESP NETIF Adapter](#)

Backward compatible interface to tcpip_adapter is enabled by default to support legacy TCP/IP stack initialisation code. Disable this option to use only esp-netif interface.

Default value:

- Yes (enabled)

Power Management Contains:

- [CONFIG_PM_SLP_DISABLE_GPIO](#)
- [CONFIG_PM_SLP_IRAM_OPT](#)
- [CONFIG_PM_RTOS_IDLE_OPT](#)
- [CONFIG_PM_ENABLE](#)

CONFIG_PM_ENABLE

Support for power management

Found in: [Component config](#) > [Power Management](#)

If enabled, application is compiled with support for power management. This option has run-time overhead (increased interrupt latency, longer time to enter idle state), and it also reduces accuracy of RTOS ticks and timers used for timekeeping. Enable this option if application uses power management APIs.

Default value:

- No (disabled)

CONFIG_PM_DFS_INIT_AUTO

Enable dynamic frequency scaling (DFS) at startup

Found in: [Component config](#) > [Power Management](#) > [CONFIG_PM_ENABLE](#)

If enabled, startup code configures dynamic frequency scaling. Max CPU frequency is set to DEFAULT_CPU_FREQ_MHZ setting, min frequency is set to XTAL frequency. If disabled, DFS will not be active until the application configures it using esp_pm_configure function.

Default value:

- No (disabled) if [CONFIG_PM_ENABLE](#)

CONFIG_PM_PROFILING

Enable profiling counters for PM locks

Found in: [Component config](#) > [Power Management](#) > [CONFIG_PM_ENABLE](#)

If enabled, esp_pm_* functions will keep track of the amount of time each of the power management locks has been held, and esp_pm_dump_locks function will print this information. This feature can be used to analyze which locks are preventing the chip from going into a lower power state, and see what time the chip spends in each power saving mode. This feature does incur some run-time overhead, so should typically be disabled in production builds.

Default value:

- No (disabled) if [CONFIG_PM_ENABLE](#)

CONFIG_PM_TRACE

Enable debug tracing of PM using GPIOs

Found in: [Component config](#) > [Power Management](#) > [CONFIG_PM_ENABLE](#)

If enabled, some GPIOs will be used to signal events such as RTOS ticks, frequency switching, entry/exit from idle state. Refer to pm_trace.c file for the list of GPIOs. This feature is intended to be used when analyzing/debugging behavior of power management implementation, and should be kept disabled in applications.

Default value:

- No (disabled) if [CONFIG_PM_ENABLE](#)

CONFIG_PM_SLP_IRAM_OPT

Put lightsleep related codes in internal RAM

Found in: [Component config](#) > [Power Management](#)

If enabled, about 1.8KB of lightsleep related source code would be in IRAM and chip would sleep longer for 760us at most each time. This feature is intended to be used when lower power consumption is needed while there is enough place in IRAM to place source code.

CONFIG_PM_RTOS_IDLE_OPT

Put RTOS IDLE related codes in internal RAM

Found in: [Component config](#) > [Power Management](#)

If enabled, about 260B of RTOS_IDLE related source code would be in IRAM and chip would sleep longer for 40us at most each time. This feature is intended to be used when lower power consumption is needed while there is enough place in IRAM to place source code.

CONFIG_PM_SLP_DISABLE_GPIO

Disable all GPIO when chip at sleep

Found in: [Component config](#) > [Power Management](#)

This feature is intended to disable all GPIO pins at automatic sleep to get a lower power mode. If enabled, chips will disable all GPIO pins at automatic sleep to reduce about 200~300 uA current. If you want to specifically use some pins normally as chip wakes when chip sleeps, you can call 'gpio_sleep_sel_dis' to disable this feature on those pins. You can also keep this feature on and call 'gpio_sleep_set_direction' and 'gpio_sleep_set_pull_mode' to have a different GPIO configuration at sleep. **Warning:** If you want to enable this option on ESP32, you should enable `GPIO_ESP32_SUPPORT_SWITCH_SLP_PULL` at first, otherwise you will not be able to switch pullup/pulldown mode.

ESP System Settings Contains:

- [CONFIG_ESP_SYSTEM_RTC_EXT_XTAL_BOOTSTRAP_CYCLES](#)
- [CONFIG_ESP_SYSTEM_ALLOW_RTC_FAST_MEM_AS_HEAP](#)
- [CONFIG_ESP_SYSTEM_FLASH_LEAKAGE_WORKAROUND](#)
- [Memory protection](#)
- [CONFIG_ESP_SYSTEM_PANIC](#)
- [CONFIG_ESP_SYSTEM_PD_FLASH](#)
- [CONFIG_ESP_SYSTEM_PM_POWER_DOWN_CPU](#)
- [CONFIG_ESP_SYSTEM_PSRAM_LEAKAGE_WORKAROUND](#)
- [RTC Clock Config](#)

CONFIG_ESP_SYSTEM_PANIC

Panic handler behaviour

Found in: [Component config](#) > [ESP System Settings](#)

If FreeRTOS detects unexpected behaviour or an unhandled exception, the panic handler is invoked. Configure the panic handler's action here.

Available options:

- Print registers and halt (`ESP_SYSTEM_PANIC_PRINT_HALT`)
Outputs the relevant registers over the serial port and halt the processor. Needs a manual reset to restart.
- Print registers and reboot (`ESP_SYSTEM_PANIC_PRINT_REBOOT`)
Outputs the relevant registers over the serial port and immediately reset the processor.

- Silent reboot (ESP_SYSTEM_PANIC_SILENT_REBOOT)
Just resets the processor without outputting anything
- Invoke GDBStub (ESP_SYSTEM_PANIC_GDBSTUB)
Invoke gdbstub on the serial port, allowing for gdb to attach to it to do a postmortem of the crash.

CONFIG_ESP_SYSTEM_RTC_EXT_XTAL_BOOTSTRAP_CYCLES

Bootstrap cycles for external 32kHz crystal

Found in: [Component config](#) > [ESP System Settings](#)

To reduce the startup time of an external RTC crystal, we bootstrap it with a 32kHz square wave for a fixed number of cycles. Setting 0 will disable bootstrapping (if disabled, the crystal may take longer to start up or fail to oscillate under some conditions).

If this value is too high, a faulty crystal may initially start and then fail. If this value is too low, an otherwise good crystal may not start.

To accurately determine if the crystal has started, set a larger “Number of cycles for RTC_SLOW_CLK calibration” (about 3000).

CONFIG_ESP_SYSTEM_ALLOW_RTC_FAST_MEM_AS_HEAP

Enable RTC fast memory for dynamic allocations

Found in: [Component config](#) > [ESP System Settings](#)

This config option allows to add RTC fast memory region to system heap with capability similar to that of DRAM region but without DMA. This memory will be consumed first per heap initialization order by early startup services and scheduler related code. Speed wise RTC fast memory operates on APB clock and hence does not have much performance impact.

Default value:

- Yes (enabled)

CONFIG_ESP_SYSTEM_PD_FLASH

PD flash at light sleep when there is no SPIRAM

Found in: [Component config](#) > [ESP System Settings](#)

If enabled, chip will try to power down flash at light sleep, which costs more time when chip wakes up. Can only be enabled if there is no SPIRAM configured. This option will in fact consider VDD_SDIO auto power value (ESP_PD_OPTION_AUTO) as OFF. Also, it is possible to force a power domain to stay ON during light sleep by using esp_sleep_pd_config() function.

Default value:

- Yes (enabled) if SPIRAM

CONFIG_ESP_SYSTEM_PM_POWER_DOWN_CPU

Power down CPU in light sleep

Found in: [Component config](#) > [ESP System Settings](#)

If enabled, the CPU will be powered down in light sleep. Enabling this option will consume 1.68 KB of internal RAM and will reduce sleep current consumption by about 100 uA.

Default value:

- Yes (enabled)

CONFIG_ESP_SYSTEM_PSRAM_LEAKAGE_WORKAROUND

PSRAM leakage current workaround in light sleep

Found in: [Component config](#) > [ESP System Settings](#)

When the CS pin of SPIRAM is not pulled up, the sleep current will increase during light sleep. If the CS pin of SPIRAM has an external pull-up, you do not need to select this option, otherwise, you should enable this option.

CONFIG_ESP_SYSTEM_FLASH_LEAKAGE_WORKAROUND

Flash leakage current workaround in light sleep

Found in: [Component config](#) > [ESP System Settings](#)

When the CS pin of Flash is not pulled up, the sleep current will increase during light sleep. If the CS pin of Flash has an external pull-up, you do not need to select this option, otherwise, you should enable this option.

RTC Clock Config Contains:

- [CONFIG_RTC_CLOCK_BBPLL_POWER_ON_WITH_USB](#)

CONFIG_RTC_CLOCK_BBPLL_POWER_ON_WITH_USB

Keep BBPLL clock always work

Found in: [Component config](#) > [ESP System Settings](#) > [RTC Clock Config](#)

When the chip goes sleep or software reset, the clock source would change to XTAL and switch off the BBPLL clock for saving power. However, this might make the USB_SERIAL_JTAG down which depends on BBPLL as its unique clock source. Therefore, this is used for keeping bbpll clock always on when USB_SERIAL_JTAG PORT is using. If you want to use USB_SERIAL_JTAG under sw_reset case or sleep-wakeup case, you should select this option. But be aware that this might increase the power consumption.

Default value:

- Yes (enabled)

Memory protection Contains:

- [CONFIG_ESP_SYSTEM_MEMPROT_FEATURE](#)

CONFIG_ESP_SYSTEM_MEMPROT_FEATURE

Enable memory protection

Found in: [Component config](#) > [ESP System Settings](#) > [Memory protection](#)

If enabled, the permission control module watches all the memory access and fires the panic handler if a permission violation is detected. This feature automatically splits the SRAM memory into data and instruction segments and sets Read/Execute permissions for the instruction part (below given splitting address) and Read/Write permissions for the data part (above the splitting address). The memory protection is effective on all access through the IRAM0 and DRAM0 buses.

Default value:

- Yes (enabled)

CONFIG_ESP_SYSTEM_MEMPROT_FEATURE_LOCK

Lock memory protection settings

Found in: [Component config](#) > [ESP System Settings](#) > [Memory protection](#) > [CONFIG_ESP_SYSTEM_MEMPROT_FEATURE](#)

Once locked, memory protection settings cannot be changed anymore. The lock is reset only on the chip startup.

Default value:

- Yes (enabled)

High resolution timer (esp_timer) Contains:

- [CONFIG_ESP_TIMER_PROFILING](#)
- [CONFIG_ESP_TIMER_IMPL](#)
- [CONFIG_ESP_TIMER_TASK_STACK_SIZE](#)

CONFIG_ESP_TIMER_PROFILING

Enable esp_timer profiling features

Found in: [Component config](#) > [High resolution timer \(esp_timer\)](#)

If enabled, esp_timer_dump will dump information such as number of times the timer was started, number of times the timer has triggered, and the total time it took for the callback to run. This option has some effect on timer performance and the amount of memory used for timer storage, and should only be used for debugging/testing purposes.

Default value:

- No (disabled)

CONFIG_ESP_TIMER_TASK_STACK_SIZE

High-resolution timer task stack size

Found in: [Component config](#) > [High resolution timer \(esp_timer\)](#)

Configure the stack size of “timer_task” task. This task is used to dispatch callbacks of timers created using ets_timer and esp_timer APIs. If you are seeing stack overflow errors in timer task, increase this value.

Note that this is not the same as FreeRTOS timer task. To configure FreeRTOS timer task size, see “FreeRTOS timer task stack size” option in “FreeRTOS” menu.

Range:

- from 2048 to 65536

Default value:

- 3584

CONFIG_ESP_TIMER_IMPL

Hardware timer to use for esp_timer

Found in: [Component config](#) > [High resolution timer \(esp_timer\)](#)

esp_timer APIs can be implemented using different hardware timers.

- “FRC2 (legacy)” implementation has been used in ESP-IDF v2.x - v4.1.
- “LAC timer of Timer Group 0” implementation is simpler, and has smaller run time overhead because software handling of timer overflow is not needed.
- “SYSTIMER” implementation is similar to “LAC timer of Timer Group 0” but for non ESP32 chips.

Available options:

- FRC2 (legacy) timer (ESP_TIMER_IMPL_FRC2)
- LAC timer of Timer Group 0 (ESP_TIMER_IMPL_TG0_LAC)
- SYSTIMER (ESP_TIMER_IMPL_SYSTIMER)

Wi-Fi Contains:

- `CONFIG_ESP32_WIFI_ENABLE_WPA3_SAE`
- `CONFIG_ESP32_WIFI_SOFTAP_BEACON_MAX_LEN`
- `CONFIG_ESP32_WIFI_CACHE_TX_BUFFER_NUM`
- `CONFIG_ESP32_WIFI_DYNAMIC_RX_BUFFER_NUM`
- `CONFIG_ESP32_WIFI_DYNAMIC_TX_BUFFER_NUM`
- `CONFIG_ESP32_WIFI_STATIC_RX_BUFFER_NUM`
- `CONFIG_ESP32_WIFI_STATIC_TX_BUFFER_NUM`
- `CONFIG_ESP_WIFI_STA_DISCONNECTED_PM_ENABLE`
- `CONFIG_ESP32_WIFI_SW_COEXIST_ENABLE`
- `CONFIG_ESP32_WIFI_TX_BUFFER`
- `CONFIG_ESP32_WIFI_AMPDU_RX_ENABLED`
- `CONFIG_ESP32_WIFI_AMPDU_TX_ENABLED`
- `CONFIG_ESP32_WIFI_AMSDU_TX_ENABLED`
- `CONFIG_ESP32_WIFI_CSI_ENABLED`
- `CONFIG_ESP32_WIFI_LOG_DEFAULT_LEVEL`
- `CONFIG_ESP_WIFI_FTM_ENABLE`
- `CONFIG_ESP32_WIFI_IRAM_OPT`
- `CONFIG_ESP32_WIFI_MGMT_SBUF_NUM`
- `CONFIG_ESP32_WIFI_NVS_ENABLED`
- `CONFIG_ESP32_WIFI_RX_IRAM_OPT`
- `CONFIG_ESP_WIFI_SLP_IRAM_OPT`
- `CONFIG_ESP32_WIFI_TASK_CORE_ID`

CONFIG_ESP32_WIFI_SW_COEXIST_ENABLE

Software controls WiFi/Bluetooth coexistence

Found in: [Component config](#) > [Wi-Fi](#)

If enabled, WiFi & Bluetooth coexistence is controlled by software rather than hardware. Recommended for heavy traffic scenarios. Both coexistence configuration options are automatically managed, no user intervention is required. If only Bluetooth is used, it is recommended to disable this option to reduce binary file size.

Default value:

- Yes (enabled) if `CONFIG_BT_ENABLED`

CONFIG_ESP32_WIFI_STATIC_RX_BUFFER_NUM

Max number of WiFi static RX buffers

Found in: [Component config](#) > [Wi-Fi](#)

Set the number of WiFi static RX buffers. Each buffer takes approximately 1.6KB of RAM. The static rx buffers are allocated when `esp_wifi_init` is called, they are not freed until `esp_wifi_deinit` is called.

WiFi hardware use these buffers to receive all 802.11 frames. A higher number may allow higher throughput but increases memory use. If `ESP32_WIFI_AMPDU_RX_ENABLED` is enabled, this value is recommended to set equal or bigger than `ESP32_WIFI_RX_BA_WIN` in order to achieve better throughput and compatibility with both stations and APs.

Range:

- from 2 to 25

Default value:

- 10 if SPIRAM_TRY_ALLOCATE_WIFI_LWIP
- 16 if SPIRAM_TRY_ALLOCATE_WIFI_LWIP

CONFIG_ESP32_WIFI_DYNAMIC_RX_BUFFER_NUM

Max number of WiFi dynamic RX buffers

Found in: [Component config](#) > [Wi-Fi](#)

Set the number of WiFi dynamic RX buffers, 0 means unlimited RX buffers will be allocated (provided sufficient free RAM). The size of each dynamic RX buffer depends on the size of the received data frame.

For each received data frame, the WiFi driver makes a copy to an RX buffer and then delivers it to the high layer TCP/IP stack. The dynamic RX buffer is freed after the higher layer has successfully received the data frame.

For some applications, WiFi data frames may be received faster than the application can process them. In these cases we may run out of memory if RX buffer number is unlimited (0).

If a dynamic RX buffer limit is set, it should be at least the number of static RX buffers.

Range:

- from 0 to 128 if [CONFIG_LWIP_WND_SCALE](#)
- from 0 to 1024 if [CONFIG_LWIP_WND_SCALE](#)

Default value:

- 32

CONFIG_ESP32_WIFI_TX_BUFFER

Type of WiFi TX buffers

Found in: [Component config](#) > [Wi-Fi](#)

Select type of WiFi TX buffers:

If “Static” is selected, WiFi TX buffers are allocated when WiFi is initialized and released when WiFi is de-initialized. The size of each static TX buffer is fixed to about 1.6KB.

If “Dynamic” is selected, each WiFi TX buffer is allocated as needed when a data frame is delivered to the WiFi driver from the TCP/IP stack. The buffer is freed after the data frame has been sent by the WiFi driver. The size of each dynamic TX buffer depends on the length of each data frame sent by the TCP/IP layer.

If PSRAM is enabled, “Static” should be selected to guarantee enough WiFi TX buffers. If PSRAM is disabled, “Dynamic” should be selected to improve the utilization of RAM.

Available options:

- Static (ESP32_WIFI_STATIC_TX_BUFFER)
- Dynamic (ESP32_WIFI_DYNAMIC_TX_BUFFER)

CONFIG_ESP32_WIFI_STATIC_TX_BUFFER_NUM

Max number of WiFi static TX buffers

Found in: [Component config](#) > [Wi-Fi](#)

Set the number of WiFi static TX buffers. Each buffer takes approximately 1.6KB of RAM. The static RX buffers are allocated when `esp_wifi_init()` is called, they are not released until `esp_wifi_deinit()` is called.

For each transmitted data frame from the higher layer TCP/IP stack, the WiFi driver makes a copy of it in a TX buffer. For some applications especially UDP applications, the upper layer can deliver frames faster than WiFi layer can transmit. In these cases, we may run out of TX buffers.

Range:

- from 1 to 64 if ESP32_WIFI_STATIC_TX_BUFFER

Default value:

- 16 if ESP32_WIFI_STATIC_TX_BUFFER

CONFIG_ESP32_WIFI_CACHE_TX_BUFFER_NUM

Max number of WiFi cache TX buffers

Found in: [Component config](#) > [Wi-Fi](#)

Set the number of WiFi cache TX buffer number.

For each TX packet from uplayer, such as LWIP etc, WiFi driver needs to allocate a static TX buffer and makes a copy of uplayer packet. If WiFi driver fails to allocate the static TX buffer, it caches the uplayer packets to a dedicated buffer queue, this option is used to configure the size of the cached TX queue.

Range:

- from 16 to 128 if ESP32_SPIRAM_SUPPORT || ESP32S2_SPIRAM_SUPPORT || ESP32S3_SPIRAM_SUPPORT

Default value:

- 32 if ESP32_SPIRAM_SUPPORT || ESP32S2_SPIRAM_SUPPORT || ESP32S3_SPIRAM_SUPPORT

CONFIG_ESP32_WIFI_DYNAMIC_TX_BUFFER_NUM

Max number of WiFi dynamic TX buffers

Found in: [Component config](#) > [Wi-Fi](#)

Set the number of WiFi dynamic TX buffers. The size of each dynamic TX buffer is not fixed, it depends on the size of each transmitted data frame.

For each transmitted frame from the higher layer TCP/IP stack, the WiFi driver makes a copy of it in a TX buffer. For some applications, especially UDP applications, the upper layer can deliver frames faster than WiFi layer can transmit. In these cases, we may run out of TX buffers.

Range:

- from 1 to 128

Default value:

- 32

CONFIG_ESP32_WIFI_CSI_ENABLED

WiFi CSI(Channel State Information)

Found in: [Component config](#) > [Wi-Fi](#)

Select this option to enable CSI(Channel State Information) feature. CSI takes about CONFIG_ESP32_WIFI_STATIC_RX_BUFFER_NUM KB of RAM. If CSI is not used, it is better to disable this feature in order to save memory.

Default value:

- No (disabled)

CONFIG_ESP32_WIFI_AMPDU_TX_ENABLED

WiFi AMPDU TX

Found in: [Component config](#) > [Wi-Fi](#)

Select this option to enable AMPDU TX feature

Default value:

- Yes (enabled)

CONFIG_ESP32_WIFI_TX_BA_WIN

WiFi AMPDU TX BA window size

Found in: [Component config](#) > [Wi-Fi](#) > [CONFIG_ESP32_WIFI_AMPDU_TX_ENABLED](#)

Set the size of WiFi Block Ack TX window. Generally a bigger value means higher throughput but more memory. Most of time we should NOT change the default value unless special reason, e.g. test the maximum UDP TX throughput with iperf etc. For iperf test in shieldbox, the recommended value is 9~12.

Range:

- from 2 to 32

Default value:

- 6

CONFIG_ESP32_WIFI_AMPDU_RX_ENABLED

WiFi AMPDU RX

Found in: [Component config](#) > [Wi-Fi](#)

Select this option to enable AMPDU RX feature

Default value:

- Yes (enabled)

CONFIG_ESP32_WIFI_RX_BA_WIN

WiFi AMPDU RX BA window size

Found in: [Component config](#) > [Wi-Fi](#) > [CONFIG_ESP32_WIFI_AMPDU_RX_ENABLED](#)

Set the size of WiFi Block Ack RX window. Generally a bigger value means higher throughput and better compatibility but more memory. Most of time we should NOT change the default value unless special reason, e.g. test the maximum UDP RX throughput with iperf etc. For iperf test in shieldbox, the recommended value is 9~12. If PSRAM is used and WiFi memory is preferred to allocate in PSRAM first, the default and minimum value should be 16 to achieve better throughput and compatibility with both stations and APs.

Range:

- from 2 to 32

Default value:

- 6 if SPIRAM_TRY_ALLOCATE_WIFI_LWIP && [CONFIG_ESP32_WIFI_AMPDU_RX_ENABLED](#)
- 16 if SPIRAM_TRY_ALLOCATE_WIFI_LWIP && [CONFIG_ESP32_WIFI_AMPDU_RX_ENABLED](#)

CONFIG_ESP32_WIFI_AMSDU_TX_ENABLED

WiFi AMSDU TX

Found in: [Component config](#) > [Wi-Fi](#)

Select this option to enable AMSDU TX feature

Default value:

- No (disabled) if ESP32_SPIRAM_SUPPORT || ESP32S2_SPIRAM_SUPPORT || ESP32S3_SPIRAM_SUPPORT

CONFIG_ESP32_WIFI_NVS_ENABLED

WiFi NVS flash

Found in: [Component config](#) > [Wi-Fi](#)

Select this option to enable WiFi NVS flash

Default value:

- Yes (enabled)

CONFIG_ESP32_WIFI_TASK_CORE_ID

WiFi Task Core ID

Found in: [Component config](#) > [Wi-Fi](#)

Pinned WiFi task to core 0 or core 1.

Available options:

- Core 0 (ESP32_WIFI_TASK_PINNED_TO_CORE_0)
- Core 1 (ESP32_WIFI_TASK_PINNED_TO_CORE_1)

CONFIG_ESP32_WIFI_SOFTAP_BEACON_MAX_LEN

Max length of WiFi SoftAP Beacon

Found in: [Component config](#) > [Wi-Fi](#)

ESP-MESH utilizes beacon frames to detect and resolve root node conflicts (see documentation). However the default length of a beacon frame can simultaneously hold only five root node identifier structures, meaning that a root node conflict of up to five nodes can be detected at one time. In the occurrence of more root nodes conflict involving more than five root nodes, the conflict resolution process will detect five of the root nodes, resolve the conflict, and re-detect more root nodes. This process will repeat until all root node conflicts are resolved. However this process can generally take a very long time.

To counter this situation, the beacon frame length can be increased such that more root nodes can be detected simultaneously. Each additional root node will require 36 bytes and should be added on top of the default beacon frame length of 752 bytes. For example, if you want to detect 10 root nodes simultaneously, you need to set the beacon frame length as 932 (752+36*5).

Setting a longer beacon length also assists with debugging as the conflicting root nodes can be identified more quickly.

Range:

- from 752 to 1256

Default value:

- 752

CONFIG_ESP32_WIFI_MGMT_SBUF_NUM

WiFi mgmt short buffer number

Found in: [Component config](#) > [Wi-Fi](#)

Set the number of WiFi management short buffer.

Range:

- from 6 to 32

Default value:

- 32

CONFIG_ESP32_WIFI_LOG_DEFAULT_LEVEL

WiFi default log level

Found in: [Component config](#) > [Wi-Fi](#)

Specify how much output to see in logs by default. You can set lower verbosity level at runtime using `esp_log_level_set` function.

Note that this setting limits which log statements are compiled into the program. So setting this to, say, “Warning” would mean that changing log level to “Debug” at runtime will not be possible.

Available options:

- No output (`WIFI_LOG_DEFAULT_LEVEL_NONE`)
- Error (`WIFI_LOG_DEFAULT_LEVEL_ERROR`)
- Warning (`WIFI_LOG_DEFAULT_LEVEL_WARN`)
- Info (`WIFI_LOG_DEFAULT_LEVEL_INFO`)
- Debug (`WIFI_LOG_DEFAULT_LEVEL_DEBUG`)
- Verbose (`WIFI_LOG_DEFAULT_LEVEL_VERBOSE`)

CONFIG_ESP32_WIFI_IRAM_OPT

WiFi IRAM speed optimization

Found in: [Component config](#) > [Wi-Fi](#)

Select this option to place frequently called Wi-Fi library functions in IRAM. When this option is disabled, more than 10Kbytes of IRAM memory will be saved but Wi-Fi throughput will be reduced.

Default value:

- No (disabled) if `CONFIG_BT_ENABLED` && `ESP32_SPIRAM_SUPPORT`
- Yes (enabled)

CONFIG_ESP32_WIFI_RX_IRAM_OPT

WiFi RX IRAM speed optimization

Found in: [Component config](#) > [Wi-Fi](#)

Select this option to place frequently called Wi-Fi library RX functions in IRAM. When this option is disabled, more than 17Kbytes of IRAM memory will be saved but Wi-Fi performance will be reduced.

Default value:

- No (disabled) if `CONFIG_BT_ENABLED` && `ESP32_SPIRAM_SUPPORT`
- Yes (enabled)

CONFIG_ESP32_WIFI_ENABLE_WPA3_SAE

Enable WPA3-Personal

Found in: [Component config](#) > [Wi-Fi](#)

Select this option to allow the device to establish a WPA3-Personal connection with eligible AP's. PMF (Protected Management Frames) is a prerequisite feature for a WPA3 connection, it needs to be explicitly configured before attempting connection. Please refer to the Wi-Fi Driver API Guide for details.

Default value:

- Yes (enabled)

CONFIG_ESP_WIFI_SLP_IRAM_OPT

WiFi SLP IRAM speed optimization

Found in: [Component config](#) > [Wi-Fi](#)

Select this option to place called Wi-Fi library TBTT process and receive beacon functions in IRAM. Some functions can be put in IRAM either by ESP32_WIFI_IRAM_OPT and ESP32_WIFI_RX_IRAM_OPT, or this one. If already enabled ESP32_WIFI_IRAM_OPT, the other 7.3KB IRAM memory would be taken by this option. If already enabled ESP32_WIFI_RX_IRAM_OPT, the other 1.3KB IRAM memory would be taken by this option. If neither of them are enabled, the other 7.4KB IRAM memory would be taken by this option. Wi-Fi power-save mode average current would be reduced if this option is enabled.

CONFIG_ESP_WIFI_SLP_DEFAULT_MIN_ACTIVE_TIME

Minimum active time

Found in: [Component config](#) > [Wi-Fi](#) > [CONFIG_ESP_WIFI_SLP_IRAM_OPT](#)

The minimum timeout for waiting to receive data, unit: milliseconds.

Range:

- from 8 to 60 if [CONFIG_ESP_WIFI_SLP_IRAM_OPT](#)

Default value:

- 50 if [CONFIG_ESP_WIFI_SLP_IRAM_OPT](#)

CONFIG_ESP_WIFI_SLP_DEFAULT_MAX_ACTIVE_TIME

Maximum keep alive time

Found in: [Component config](#) > [Wi-Fi](#) > [CONFIG_ESP_WIFI_SLP_IRAM_OPT](#)

The maximum time that wifi keep alive, unit: seconds.

Range:

- from 10 to 60 if [CONFIG_ESP_WIFI_SLP_IRAM_OPT](#)

Default value:

- 10 if [CONFIG_ESP_WIFI_SLP_IRAM_OPT](#)

CONFIG_ESP_WIFI_FTM_ENABLE

WiFi FTM

Found in: [Component config](#) > [Wi-Fi](#)

Enable feature Fine Timing Measurement for calculating WiFi Round-Trip-Time (RTT).

Default value:

- No (disabled)

CONFIG_ESP_WIFI_FTM_INITIATOR_SUPPORT

FTM Initiator support

Found in: [Component config](#) > [Wi-Fi](#) > [CONFIG_ESP_WIFI_FTM_ENABLE](#)

Default value:

- Yes (enabled) if [CONFIG_ESP_WIFI_FTM_ENABLE](#)

CONFIG_ESP_WIFI_FTM_RESPONDER_SUPPORT

FTM Responder support

Found in: *Component config* > *Wi-Fi* > *CONFIG_ESP_WIFI_FTM_ENABLE*

Default value:

- Yes (enabled) if *CONFIG_ESP_WIFI_FTM_ENABLE*

CONFIG_ESP_WIFI_STA_DISCONNECTED_PM_ENABLE

Power Management for station at disconnected

Found in: *Component config* > *Wi-Fi*

Select this option to enable power_management for station when disconnected. Chip will do modem-sleep when rf module is not in use any more.

PHY Contains:

- *CONFIG_ESP_PHY_ENABLE_USB*
- *CONFIG_ESP32_PHY_MAX_WIFI_TX_POWER*
- *CONFIG_ESP32_PHY_MAC_BB_PD*
- *CONFIG_ESP32_PHY_CALIBRATION_AND_DATA_STORAGE*
- *CONFIG_ESP32_PHY_INIT_DATA_IN_PARTITION*

CONFIG_ESP32_PHY_CALIBRATION_AND_DATA_STORAGE

Store phy calibration data in NVS

Found in: *Component config* > *PHY*

If this option is enabled, NVS will be initialized and calibration data will be loaded from there. PHY calibration will be skipped on deep sleep wakeup. If calibration data is not found, full calibration will be performed and stored in NVS. Normally, only partial calibration will be performed. If this option is disabled, full calibration will be performed.

If it's easy that your board calibrate bad data, choose 'n'. Two cases for example, you should choose 'n': 1.If your board is easy to be booted up with antenna disconnected. 2.Because of your board design, each time when you do calibration, the result are too unstable. If unsure, choose 'y'.

Default value:

- Yes (enabled)

CONFIG_ESP32_PHY_INIT_DATA_IN_PARTITION

Use a partition to store PHY init data

Found in: *Component config* > *PHY*

If enabled, PHY init data will be loaded from a partition. When using a custom partition table, make sure that PHY data partition is included (type: 'data', subtype: 'phy'). With default partition tables, this is done automatically. If PHY init data is stored in a partition, it has to be flashed there, otherwise runtime error will occur.

If this option is not enabled, PHY init data will be embedded into the application binary.

If unsure, choose 'n'.

Default value:

- No (disabled)

Contains:

- *CONFIG_ESP32_PHY_DEFAULT_INIT_IF_INVALID*

- [CONFIG_ESP32_SUPPORT_MULTIPLE_PHY_INIT_DATA_BIN](#)

CONFIG_ESP32_PHY_DEFAULT_INIT_IF_INVALID

Reset default PHY init data if invalid

Found in: Component config > PHY > CONFIG_ESP32_PHY_INIT_DATA_IN_PARTITION

If enabled, PHY init data will be restored to default if it cannot be verified successfully to avoid endless bootloops.

If unsure, choose 'n' .

Default value:

- No (disabled) if [CONFIG_ESP32_PHY_INIT_DATA_IN_PARTITION](#)

CONFIG_ESP32_SUPPORT_MULTIPLE_PHY_INIT_DATA_BIN

Support multiple PHY init data bin

Found in: Component config > PHY > CONFIG_ESP32_PHY_INIT_DATA_IN_PARTITION

If enabled, the corresponding PHY init data type can be automatically switched according to the country code. China's PHY init data bin is used by default. Can be modified by country information in API `esp_wifi_set_country()`. The priority of switching the PHY init data type is: 1. Country configured by API `esp_wifi_set_country()` and the parameter policy is `WIFI_COUNTRY_POLICY_MANUAL`. 2. Country notified by the connected AP. 3. Country configured by API `esp_wifi_set_country()` and the parameter policy is `WIFI_COUNTRY_POLICY_AUTO`.

Default value:

- No (disabled) if [CONFIG_ESP32_PHY_INIT_DATA_IN_PARTITION](#) && [CONFIG_ESP32_PHY_INIT_DATA_IN_PARTITION](#)

CONFIG_ESP32_MULTIPLE_PHY_DATA_BIN_EMBEDDED

Support embedded multiple phy init data bin to app bin

Found in: Component config > PHY > CONFIG_ESP32_PHY_INIT_DATA_IN_PARTITION > CONFIG_ESP32_SUPPORT_MULTIPLE_PHY_INIT_DATA_BIN

If enabled, multiple phy init data bin will embedded into app bin. If not enabled, multiple phy init data bin will still leave alone, and need to be flashed by users.

Default value:

- No (disabled) if [CONFIG_ESP32_SUPPORT_MULTIPLE_PHY_INIT_DATA_BIN](#) && [CONFIG_ESP32_PHY_INIT_DATA_IN_PARTITION](#)

CONFIG_ESP32_PHY_INIT_DATA_ERROR

Terminate operation when PHY init data error

Found in: Component config > PHY > CONFIG_ESP32_PHY_INIT_DATA_IN_PARTITION > CONFIG_ESP32_SUPPORT_MULTIPLE_PHY_INIT_DATA_BIN

If enabled, when an error occurs while the PHY init data is updated, the program will terminate and restart. If not enabled, the PHY init data will not be updated when an error occurs.

Default value:

- No (disabled) if [CONFIG_ESP32_SUPPORT_MULTIPLE_PHY_INIT_DATA_BIN](#) && [CONFIG_ESP32_PHY_INIT_DATA_IN_PARTITION](#)

CONFIG_ESP32_PHY_MAX_WIFI_TX_POWER

Max WiFi TX power (dBm)

Found in: *Component config* > *PHY*

Set maximum transmit power for WiFi radio. Actual transmit power for high data rates may be lower than this setting.

Range:

- from 10 to 20

Default value:

- 20

CONFIG_ESP32_PHY_MAC_BB_PD

Power down MAC and baseband of Wi-Fi and Bluetooth when PHY is disabled

Found in: *Component config* > *PHY*

If enabled, the MAC and baseband of Wi-Fi and Bluetooth will be powered down when PHY is disabled. Enabling this setting reduces power consumption by a small amount but increases RAM use by approximately 4 KB(Wi-Fi only), 2 KB(Bluetooth only) or 5.3 KB(Wi-Fi + Bluetooth).

Default value:

- No (disabled) if *CONFIG_FREERTOS_USE_TICKLESS_IDLE*

CONFIG_ESP_PHY_ENABLE_USB

Enable USB when phy init

Found in: *Component config* > *PHY*

When using USB Serial/JTAG/OTG/CDC, PHY should enable USB, otherwise USB module can not work properly. Notice: Enabling this configuration option will slightly impact wifi performance.

Default value:

- Yes (enabled)
- No (disabled)

Core dump

 Contains:

- *CONFIG_ESP_COREDUMP_CHECK_BOOT*
- *CONFIG_ESP_COREDUMP_DATA_FORMAT*
- *CONFIG_ESP_COREDUMP_CHECKSUM*
- *CONFIG_ESP_COREDUMP_TO_FLASH_OR_UART*
- *CONFIG_ESP_COREDUMP_UART_DELAY*
- *CONFIG_ESP_COREDUMP_DECODE*
- *CONFIG_ESP_COREDUMP_MAX_TASKS_NUM*
- *CONFIG_ESP_COREDUMP_STACK_SIZE*
- *CONFIG_ESP_COREDUMP_SUMMARY_STACKDUMP_SIZE*

CONFIG_ESP_COREDUMP_TO_FLASH_OR_UART

Data destination

Found in: *Component config* > *Core dump*

Select place to store core dump: flash, uart or none (to disable core dumps generation).

Core dumps to Flash are not available if PSRAM is used for task stacks.

If core dump is configured to be stored in flash and custom partition table is used add corresponding entry to your CSV. For examples, please see predefined partition table CSV descriptions in the components/partition_table directory.

Available options:

- Flash (ESP_COREDUMP_ENABLE_TO_FLASH)
- UART (ESP_COREDUMP_ENABLE_TO_UART)
- None (ESP_COREDUMP_ENABLE_TO_NONE)

CONFIG_ESP_COREDUMP_DATA_FORMAT

Core dump data format

Found in: [Component config](#) > [Core dump](#)

Select the data format for core dump.

Available options:

- Binary format (ESP_COREDUMP_DATA_FORMAT_BIN)
- ELF format (ESP_COREDUMP_DATA_FORMAT_ELF)

CONFIG_ESP_COREDUMP_CHECKSUM

Core dump data integrity check

Found in: [Component config](#) > [Core dump](#)

Select the integrity check for the core dump.

Available options:

- Use CRC32 for integrity verification (ESP_COREDUMP_CHECKSUM_CRC32)
- Use SHA256 for integrity verification (ESP_COREDUMP_CHECKSUM_SHA256)

CONFIG_ESP_COREDUMP_CHECK_BOOT

Check core dump data integrity on boot

Found in: [Component config](#) > [Core dump](#)

When enabled, if any data are found on the flash core dump partition, they will be checked by calculating their checksum.

Default value:

- Yes (enabled) if ESP_COREDUMP_ENABLE_TO_FLASH

CONFIG_ESP_COREDUMP_MAX_TASKS_NUM

Maximum number of tasks

Found in: [Component config](#) > [Core dump](#)

Maximum number of tasks snapshots in core dump.

CONFIG_ESP_COREDUMP_UART_DELAY

Delay before print to UART

Found in: [Component config](#) > [Core dump](#)

Config delay (in ms) before printing core dump to UART. Delay can be interrupted by pressing Enter key.

Default value:

- 0 if ESP_COREDUMP_ENABLE_TO_UART

CONFIG_ESP_COREDUMP_STACK_SIZE

Reserved stack size

Found in: *Component config > Core dump*

Size of the memory to be reserved for core dump stack. If 0 core dump process will run on the stack of crashed task/ISR, otherwise special stack will be allocated. To ensure that core dump itself will not overflow task/ISR stack set this to the value above 800. NOTE: It eats DRAM.

CONFIG_ESP_COREDUMP_SUMMARY_STACKDUMP_SIZE

Size of the stack dump buffer

Found in: *Component config > Core dump*

Size of the buffer that would be reserved for extracting backtrace info summary. This buffer will contain the stack dump of the crashed task. This dump is useful in generating backtrace

Range:

- from 512 to 4096 if ESP_COREDUMP_DATA_FORMAT_ELF && ESP_COREDUMP_ENABLE_TO_FLASH

Default value:

- 1024 if ESP_COREDUMP_DATA_FORMAT_ELF && ESP_COREDUMP_ENABLE_TO_FLASH

CONFIG_ESP_COREDUMP_DECODE

Handling of UART core dumps in IDF Monitor

Found in: *Component config > Core dump*

Available options:

- Decode and show summary (info_corefile) (ESP_COREDUMP_DECODE_INFO)
- Don't decode (ESP_COREDUMP_DECODE_DISABLE)

FAT Filesystem support

 Contains:

- *CONFIG_FATFS_API_ENCODING*
- *CONFIG_FATFS_USE_FASTSEEK*
- *CONFIG_FATFS_LONG_FILENAMES*
- *CONFIG_FATFS_MAX_LFN*
- *CONFIG_FATFS_FS_LOCK*
- *CONFIG_FATFS_CHOOSE_CODEPAGE*
- *CONFIG_FATFS_ALLOC_PREFER_EXTRAM*
- *CONFIG_FATFS_TIMEOUT_MS*
- *CONFIG_FATFS_PER_FILE_CACHE*

CONFIG_FATFS_CHOOSE_CODEPAGE

OEM Code Page

Found in: *Component config > FAT Filesystem support*

OEM code page used for file name encodings.

If “Dynamic” is selected, code page can be chosen at runtime using `f_setcp` function. Note that choosing this option will increase application size by ~480kB.

Available options:

- Dynamic (all code pages supported) (FATFS_CODEPAGE_DYNAMIC)
- US (CP437) (FATFS_CODEPAGE_437)
- Arabic (CP720) (FATFS_CODEPAGE_720)

- Greek (CP737) (FATFS_CODEPAGE_737)
- KBL (CP771) (FATFS_CODEPAGE_771)
- Baltic (CP775) (FATFS_CODEPAGE_775)
- Latin 1 (CP850) (FATFS_CODEPAGE_850)
- Latin 2 (CP852) (FATFS_CODEPAGE_852)
- Cyrillic (CP855) (FATFS_CODEPAGE_855)
- Turkish (CP857) (FATFS_CODEPAGE_857)
- Portugese (CP860) (FATFS_CODEPAGE_860)
- Icelandic (CP861) (FATFS_CODEPAGE_861)
- Hebrew (CP862) (FATFS_CODEPAGE_862)
- Canadian French (CP863) (FATFS_CODEPAGE_863)
- Arabic (CP864) (FATFS_CODEPAGE_864)
- Nordic (CP865) (FATFS_CODEPAGE_865)
- Russian (CP866) (FATFS_CODEPAGE_866)
- Greek 2 (CP869) (FATFS_CODEPAGE_869)
- Japanese (DBCS) (CP932) (FATFS_CODEPAGE_932)
- Simplified Chinese (DBCS) (CP936) (FATFS_CODEPAGE_936)
- Korean (DBCS) (CP949) (FATFS_CODEPAGE_949)
- Traditional Chinese (DBCS) (CP950) (FATFS_CODEPAGE_950)

CONFIG_FATFS_LONG_FILENAMES

Long filename support

Found in: [Component config](#) > [FAT Filesystem support](#)

Support long filenames in FAT. Long filename data increases memory usage. FATFS can be configured to store the buffer for long filename data in stack or heap.

Available options:

- No long filenames (FATFS_LFN_NONE)
- Long filename buffer in heap (FATFS_LFN_HEAP)
- Long filename buffer on stack (FATFS_LFN_STACK)

CONFIG_FATFS_MAX_LFN

Max long filename length

Found in: [Component config](#) > [FAT Filesystem support](#)

Maximum long filename length. Can be reduced to save RAM.

Range:

- from 12 to 255

Default value:

- 255

CONFIG_FATFS_API_ENCODING

API character encoding

Found in: [Component config](#) > [FAT Filesystem support](#)

Choose encoding for character and string arguments/returns when using FATFS APIs. The encoding of arguments will usually depend on text editor settings.

Available options:

- API uses ANSI/OEM encoding (FATFS_API_ENCODING_ANSI_OEM)
- API uses UTF-16 encoding (FATFS_API_ENCODING_UTF_16)
- API uses UTF-8 encoding (FATFS_API_ENCODING_UTF_8)

CONFIG_FATFS_FS_LOCK

Number of simultaneously open files protected by lock function

Found in: [Component config](#) > [FAT Filesystem support](#)

This option sets the FATFS configuration value `_FS_LOCK`. The option `_FS_LOCK` switches file lock function to control duplicated file open and illegal operation to open objects.

* 0: Disable file lock function. To avoid volume corruption, application should avoid illegal open, remove and rename to the open objects.

* >0: Enable file lock function. The value defines how many files/sub-directories can be opened simultaneously under file lock control.

Note that the file lock control is independent of re-entrancy.

Range:

- from 0 to 65535

Default value:

- 0

CONFIG_FATFS_TIMEOUT_MS

Timeout for acquiring a file lock, ms

Found in: [Component config](#) > [FAT Filesystem support](#)

This option sets FATFS configuration value `_FS_TIMEOUT`, scaled to milliseconds. Sets the number of milliseconds FATFS will wait to acquire a mutex when operating on an open file. For example, if one task is performing a lengthy operation, another task will wait for the first task to release the lock, and time out after amount of time set by this option.

Default value:

- 10000

CONFIG_FATFS_PER_FILE_CACHE

Use separate cache for each file

Found in: [Component config](#) > [FAT Filesystem support](#)

This option affects FATFS configuration value `_FS_TINY`.

If this option is set, `_FS_TINY` is 0, and each open file has its own cache, size of the cache is equal to the `_MAX_SS` variable (512 or 4096 bytes). This option uses more RAM if more than 1 file is open, but needs less reads and writes to the storage for some operations.

If this option is not set, `_FS_TINY` is 1, and single cache is used for all open files, size is also equal to `_MAX_SS` variable. This reduces the amount of heap used when multiple files are open, but increases the number of read and write operations which FATFS needs to make.

Default value:

- Yes (enabled)

CONFIG_FATFS_ALLOC_PREFER_EXTRAM

Prefer external RAM when allocating FATFS buffers

Found in: [Component config](#) > [FAT Filesystem support](#)

When the option is enabled, internal buffers used by FATFS will be allocated from external RAM. If the allocation from external RAM fails, the buffer will be allocated from the internal RAM. Disable this option if optimizing for performance. Enable this option if optimizing for internal memory size.

Default value:

- Yes (enabled) if SPIRAM_USE_CAPS_ALLOC || SPIRAM_USE_MALLOC

CONFIG_FATFS_USE_FASTSEEK

Enable fast seek algorithm when using lseek function through VFS FAT

Found in: Component config > FAT Filesystem support

The fast seek feature enables fast backward/long seek operations without FAT access by using an in-memory CLMT (cluster link map table). Please note, fast-seek is only allowed for read-mode files, if a file is opened in write-mode, the seek mechanism will automatically fallback to the default implementation.

Default value:

- No (disabled)

CONFIG_FATFS_FAST_SEEK_BUFFER_SIZE

Fast seek CLMT buffer size

Found in: Component config > FAT Filesystem support > CONFIG_FATFS_USE_FASTSEEK

If fast seek algorithm is enabled, this defines the size of CLMT buffer used by this algorithm in 32-bit word units. This value should be chosen based on prior knowledge of maximum elements of each file entry would store.

Default value:

- 64 if *CONFIG_FATFS_USE_FASTSEEK*

Modbus configuration Contains:

- *CONFIG_FMB_COMM_MODE_ASCII_EN*
- *CONFIG_FMB_COMM_MODE_RTU_EN*
- *CONFIG_FMB_COMM_MODE_TCP_EN*
- *CONFIG_FMB_MASTER_TIMER_GROUP*
- *CONFIG_FMB_MASTER_TIMER_INDEX*
- *CONFIG_FMB_CONTROLLER_NOTIFY_QUEUE_SIZE*
- *CONFIG_FMB_CONTROLLER_NOTIFY_TIMEOUT*
- *CONFIG_FMB_CONTROLLER_SLAVE_ID_SUPPORT*
- *CONFIG_FMB_CONTROLLER_STACK_SIZE*
- *CONFIG_FMB_PORT_TASK_PRIO*
- *CONFIG_FMB_PORT_TASK_STACK_SIZE*
- *CONFIG_FMB_QUEUE_LENGTH*
- *CONFIG_FMB_SERIAL_BUF_SIZE*
- *CONFIG_FMB_EVENT_QUEUE_TIMEOUT*
- *CONFIG_FMB_TIMER_PORT_ENABLED*
- *CONFIG_FMB_PORT_TASK_AFFINITY*
- *CONFIG_FMB_SERIAL_ASCII_BITS_PER_SYMB*
- *CONFIG_FMB_TIMER_ISR_IN_IRAM*
- *CONFIG_FMB_SERIAL_ASCII_TIMEOUT_RESPOND_MS*
- *CONFIG_FMB_MASTER_DELAY_MS_CONVERT*
- *CONFIG_FMB_MASTER_TIMEOUT_MS_RESPOND*
- *CONFIG_FMB_TIMER_GROUP*
- *CONFIG_FMB_TIMER_INDEX*

CONFIG_FMB_COMM_MODE_TCP_EN

Enable Modbus stack support for TCP communication mode

Found in: Component config > Modbus configuration

Enable Modbus TCP option for stack.

Default value:

- Yes (enabled)

CONFIG_FMB_TCP_PORT_DEFAULT

Modbus TCP port number

Found in: [Component config](#) > [Modbus configuration](#) > [CONFIG_FMB_COMM_MODE_TCP_EN](#)

Modbus default port number used by Modbus TCP stack

Range:

- from 0 to 65535

Default value:

- 502

CONFIG_FMB_TCP_PORT_MAX_CONN

Maximum allowed connections for TCP stack

Found in: [Component config](#) > [Modbus configuration](#) > [CONFIG_FMB_COMM_MODE_TCP_EN](#)

Maximum allowed connections number for Modbus TCP stack. This is used by Modbus master and slave port layer to establish connections. This parameter may decrease performance of Modbus stack and can cause increasing of processing time (increase only if absolutely necessary).

Range:

- from 1 to 6

Default value:

- 5

CONFIG_FMB_TCP_CONNECTION_TOUT_SEC

Modbus TCP connection timeout

Found in: [Component config](#) > [Modbus configuration](#) > [CONFIG_FMB_COMM_MODE_TCP_EN](#)

Modbus TCP connection timeout in seconds. Once expired the current connection with the client will be closed and Modbus slave will be waiting for new connection to accept.

Range:

- from 1 to 3600

Default value:

- 20

CONFIG_FMB_COMM_MODE_RTU_EN

Enable Modbus stack support for RTU mode

Found in: [Component config](#) > [Modbus configuration](#)

Enable RTU Modbus communication mode option for Modbus serial stack.

Default value:

- Yes (enabled)

CONFIG_FMB_COMM_MODE_ASCII_EN

Enable Modbus stack support for ASCII mode

Found in: [Component config](#) > [Modbus configuration](#)

Enable ASCII Modbus communication mode option for Modbus serial stack.

Default value:

- Yes (enabled)

CONFIG_FMB_MASTER_TIMEOUT_MS_RESPOND

Slave respond timeout (Milliseconds)

Found in: [Component config](#) > [Modbus configuration](#)

If master sends a frame which is not broadcast, it has to wait sometime for slave response. if slave is not respond in this time, the master will process timeout error.

Range:

- from 50 to 3000

Default value:

- 150

CONFIG_FMB_MASTER_DELAY_MS_CONVERT

Slave conversion delay (Milliseconds)

Found in: [Component config](#) > [Modbus configuration](#)

If master sends a broadcast frame, it has to wait conversion time to delay, then master can send next frame.

Range:

- from 50 to 400

Default value:

- 200

CONFIG_FMB_QUEUE_LENGTH

Modbus serial task queue length

Found in: [Component config](#) > [Modbus configuration](#)

Modbus serial driver queue length. It is used by event queue task. See the serial driver API for more information.

Range:

- from 0 to 200

Default value:

- 20

CONFIG_FMB_PORT_TASK_STACK_SIZE

Modbus port task stack size

Found in: [Component config](#) > [Modbus configuration](#)

Modbus port task stack size for rx/tx event processing. It may be adjusted when debugging is enabled (for example).

Range:

- from 2048 to 8192

Default value:

- 4096

CONFIG_FMB_SERIAL_BUF_SIZE

Modbus serial task RX/TX buffer size

Found in: [Component config](#) > [Modbus configuration](#)

Modbus serial task RX and TX buffer size for UART driver initialization. This buffer is used for modbus frame transfer. The Modbus protocol maximum frame size is 256 bytes. Bigger size can be used for non standard implementations.

Range:

- from 0 to 2048

Default value:

- 256

CONFIG_FMB_SERIAL_ASCII_BITS_PER_SYMB

Number of data bits per ASCII character

Found in: [Component config](#) > [Modbus configuration](#)

This option defines the number of data bits per ASCII character.

Range:

- from 7 to 8

Default value:

- 8

CONFIG_FMB_SERIAL_ASCII_TIMEOUT_RESPOND_MS

Response timeout for ASCII communication mode (ms)

Found in: [Component config](#) > [Modbus configuration](#)

This option defines response timeout of slave in milliseconds for ASCII communication mode. Thus the timeout will expire and allow the master program to handle the error.

Range:

- from 300 to 2000

Default value:

- 1000

CONFIG_FMB_PORT_TASK_PRIO

Modbus port task priority

Found in: [Component config](#) > [Modbus configuration](#)

Modbus port data processing task priority. The priority of Modbus controller task is equal to (CONFIG_FMB_PORT_TASK_PRIO - 1).

Range:

- from 3 to 23

Default value:

- 10

CONFIG_FMB_PORT_TASK_AFFINITY

Modbus task affinity

Found in: [Component config](#) > [Modbus configuration](#)

Allows setting the core affinity of the Modbus controller task, i.e. whether the task is pinned to particular CPU, or allowed to run on any CPU.

Available options:

- No affinity (FMB_PORT_TASK_AFFINITY_NO_AFFINITY)
- CPU0 (FMB_PORT_TASK_AFFINITY_CPU0)
- CPU1 (FMB_PORT_TASK_AFFINITY_CPU1)

CONFIG_FMB_CONTROLLER_SLAVE_ID_SUPPORT

Modbus controller slave ID support

Found in: [Component config](#) > [Modbus configuration](#)

Modbus slave ID support enable. When enabled the Modbus <Report Slave ID> command is supported by stack.

Default value:

- Yes (enabled)

CONFIG_FMB_CONTROLLER_SLAVE_ID

Modbus controller slave ID

Found in: [Component config](#) > [Modbus configuration](#) > [CONFIG_FMB_CONTROLLER_SLAVE_ID_SUPPORT](#)

Modbus slave ID value to identify modbus device in the network using <Report Slave ID> command. Most significant byte of ID is used as short device ID and other three bytes used as long ID.

Range:

- from 0 to 4294967295

Default value:

- “0x00112233”

CONFIG_FMB_CONTROLLER_NOTIFY_TIMEOUT

Modbus controller notification timeout (ms)

Found in: [Component config](#) > [Modbus configuration](#)

Modbus controller notification timeout in milliseconds. This timeout is used to send notification about accessed parameters.

Range:

- from 0 to 200

Default value:

- 20

CONFIG_FMB_CONTROLLER_NOTIFY_QUEUE_SIZE

Modbus controller notification queue size

Found in: [Component config](#) > [Modbus configuration](#)

Modbus controller notification queue size. The notification queue is used to get information about accessed parameters.

Range:

- from 0 to 200

Default value:

- 20

CONFIG_FMB_CONTROLLER_STACK_SIZE

Modbus controller stack size

Found in: [Component config](#) > [Modbus configuration](#)

Modbus controller task stack size. The Stack size may be adjusted when debug mode is used which requires more stack size (for example).

Range:

- from 0 to 8192

Default value:

- 4096

CONFIG_FMB_EVENT_QUEUE_TIMEOUT

Modbus stack event queue timeout (ms)

Found in: [Component config](#) > [Modbus configuration](#)

Modbus stack event queue timeout in milliseconds. This may help to optimize Modbus stack event processing time.

Range:

- from 0 to 500

Default value:

- 20

CONFIG_FMB_TIMER_PORT_ENABLED

Modbus stack use timer for 3.5T symbol time measurement

Found in: [Component config](#) > [Modbus configuration](#)

If this option is set the Modbus stack uses timer for T3.5 time measurement. Else the internal UART TOUT timeout is used for 3.5T symbol time measurement.

Default value:

- No (disabled)

CONFIG_FMB_TIMER_GROUP

Slave Timer group number

Found in: [Component config](#) > [Modbus configuration](#)

Modbus slave Timer group number that is used for timeout measurement.

Range:

- from 0 to 1

Default value:

- 0

CONFIG_FMB_TIMER_INDEX

Slave Timer index in the group

Found in: [Component config](#) > [Modbus configuration](#)

Modbus slave Timer Index in the group that is used for timeout measurement.

Range:

- from 0 to 1

Default value:

- 0

CONFIG_FMB_MASTER_TIMER_GROUP

Master Timer group number

Found in: Component config > Modbus configuration

Modbus master Timer group number that is used for timeout measurement.

Range:

- from 0 to 1

Default value:

- 0

CONFIG_FMB_MASTER_TIMER_INDEX

Master Timer index

Found in: Component config > Modbus configuration

Modbus master Timer Index in the group that is used for timeout measurement. Note: Modbus master and slave should have different timer index to be able to work simultaneously.

Range:

- from 0 to 1

Default value:

- 0

CONFIG_FMB_TIMER_ISR_IN_IRAM

Place timer interrupt handler into IRAM

Found in: Component config > Modbus configuration

This option places Modbus timer IRQ handler into IRAM. This allows to avoid delays related to processing of non-IRAM-safe interrupts during a flash write operation (NVS updating a value, or some other flash API which has to perform a read/write operation and disable CPU cache). This option has dependency with the UART_ISR_IN_IRAM option which places UART interrupt handler into IRAM to prevent delays related to processing of UART events.

Default value:

- No (disabled)

FreeRTOS Contains:

- `CONFIG_FREERTOS_CHECK_STACKOVERFLOW`
- `CONFIG_FREERTOS_CHECK_MUTEX_GIVEN_BY_OWNER`
- `CONFIG_FREERTOS_INTERRUPT_BACKTRACE`
- `CONFIG_FREERTOS_OPTIMIZED_SCHEDULER`
- `CONFIG_FREERTOS_GENERATE_RUN_TIME_STATS`
- `CONFIG_FREERTOS_USE_TRACE_FACILITY`
- `CONFIG_FREERTOS_ENABLE_STATIC_TASK_CLEAN_UP`
- `CONFIG_FREERTOS_TASK_FUNCTION_WRAPPER`
- `CONFIG_FREERTOS_ASSERT`
- `CONFIG_FREERTOS_QUEUE_REGISTRY_SIZE`
- `CONFIG_FREERTOS_TIMER_QUEUE_LENGTH`
- `CONFIG_FREERTOS_TIMER_TASK_PRIORITY`
- `CONFIG_FREERTOS_TIMER_TASK_STACK_DEPTH`
- `CONFIG_FREERTOS_ASSERT_ON_UNTESTED_FUNCTION`
- `CONFIG_FREERTOS_IDLE_TASK_STACKSIZE`
- `CONFIG_FREERTOS_ISR_STACKSIZE`
- `CONFIG_FREERTOS_MAX_TASK_NAME_LEN`
- `CONFIG_FREERTOS_THREAD_LOCAL_STORAGE_POINTERS`

- [CONFIG_FREERTOS_PLACE_FUNCTIONS_INTO_FLASH](#)
- [CONFIG_FREERTOS_UNICORE](#)
- [CONFIG_FREERTOS_WATCHPOINT_END_OF_STACK](#)
- [CONFIG_FREERTOS_CHECK_PORT_CRITICAL_COMPLIANCE](#)
- [CONFIG_FREERTOS_HZ](#)
- [CONFIG_FREERTOS_USE_TICKLESS_IDLE](#)
- [CONFIG_FREERTOS_LEGACY_HOOKS](#)
- [CONFIG_FREERTOS_CORETIMER](#)

CONFIG_FREERTOS_UNICORE

Run FreeRTOS only on first core

Found in: [Component config](#) > [FreeRTOS](#)

This version of FreeRTOS normally takes control of all cores of the CPU. Select this if you only want to start it on the first core. This is needed when e.g. another process needs complete control over the second core.

This invisible config value sets the value of `tskNO_AFFINITY` in `task.h`. # Intended to be used as a constant from other Kconfig files. # Value is (32-bit) `INT_MAX`.

CONFIG_FREERTOS_CORETIMER

Xtensa timer to use as the FreeRTOS tick source

Found in: [Component config](#) > [FreeRTOS](#)

FreeRTOS needs a timer with an associated interrupt to use as the main tick source to increase counters, run timers and do pre-emptive multitasking with. There are multiple timers available to do this, with different interrupt priorities. Check

Available options:

- Timer 0 (int 6, level 1) (`FREERTOS_CORETIMER_0`)
Select this to use timer 0
- Timer 1 (int 15, level 3) (`FREERTOS_CORETIMER_1`)
Select this to use timer 1

CONFIG_FREERTOS_OPTIMIZED_SCHEDULER

Enable FreeRTOS platform optimized scheduler

Found in: [Component config](#) > [FreeRTOS](#)

On most platforms there are instructions can speedup the ready task searching. Enabling this option the FreeRTOS with this instructions support will be built.

Default value:

- Yes (enabled)

CONFIG_FREERTOS_HZ

Tick rate (Hz)

Found in: [Component config](#) > [FreeRTOS](#)

Select the tick rate at which FreeRTOS does pre-emptive context switching.

Range:

- from 1 to 1000

Default value:

- 100

CONFIG_FREERTOS_ASSERT_ON_UNTESTED_FUNCTION

Halt when an SMP-untested function is called

Found in: [Component config > FreeRTOS](#)

Some functions in FreeRTOS have not been thoroughly tested yet when moving to the SMP implementation of FreeRTOS. When this option is enabled, these functions will throw an assert().

Default value:

- Yes (enabled)

CONFIG_FREERTOS_CHECK_STACKOVERFLOW

Check for stack overflow

Found in: [Component config > FreeRTOS](#)

FreeRTOS can check for stack overflows in threads and trigger an user function called `vApplication-StackOverflowHook` when this happens.

Available options:

- No checking (`FREERTOS_CHECK_STACKOVERFLOW_NONE`)
Do not check for stack overflows (`configCHECK_FOR_STACK_OVERFLOW=0`)
- Check by stack pointer value (`FREERTOS_CHECK_STACKOVERFLOW_PTRVAL`)
Check for stack overflows on each context switch by checking if the stack pointer is in a valid range. Quick but does not detect stack overflows that happened between context switches (`configCHECK_FOR_STACK_OVERFLOW=1`)
- Check using canary bytes (`FREERTOS_CHECK_STACKOVERFLOW_CANARY`)
Places some magic bytes at the end of the stack area and on each context switch, check if these bytes are still intact. More thorough than just checking the pointer, but also slightly slower. (`configCHECK_FOR_STACK_OVERFLOW=2`)

CONFIG_FREERTOS_WATCHPOINT_END_OF_STACK

Set a debug watchpoint as a stack overflow check

Found in: [Component config > FreeRTOS](#)

FreeRTOS can check if a stack has overflowed its bounds by checking either the value of the stack pointer or by checking the integrity of canary bytes. (See `FREERTOS_CHECK_STACKOVERFLOW` for more information.) These checks only happen on a context switch, and the situation that caused the stack overflow may already be long gone by then. This option will use the last debug memory watchpoint to allow breaking into the debugger (or panic'ing) as soon as any of the last 32 bytes on the stack of a task are overwritten. The side effect is that using gdb, you effectively have one hardware watchpoint less because the last one is overwritten as soon as a task switch happens.

Another consequence is that due to alignment requirements of the watchpoint, the usable stack size decreases by up to 60 bytes. This is because the watchpoint region has to be aligned to its size and the size for the stack watchpoint in IDF is 32 bytes.

This check only triggers if the stack overflow writes within 32 bytes near the end of the stack, rather than overshooting further, so it is worth combining this approach with one of the other stack overflow check methods.

When this watchpoint is hit, gdb will stop with a SIGTRAP message. When no JTAG OCD is attached, `esp-idf` will panic on an unhandled debug exception.

Default value:

- No (disabled)

CONFIG_FREERTOS_INTERRUPT_BACKTRACE

Enable backtrace from interrupt to task context

Found in: [Component config](#) > [FreeRTOS](#)

If this option is enabled, interrupt stack frame will be modified to point to the code of the interrupted task as its return address. This helps the debugger (or the panic handler) show a backtrace from the interrupt to the task which was interrupted. This also works for nested interrupts: higher level interrupt stack can be traced back to the lower level interrupt. This option adds 4 instructions to the interrupt dispatching code.

Default value:

- Yes (enabled)

CONFIG_FREERTOS_THREAD_LOCAL_STORAGE_POINTERS

Number of thread local storage pointers

Found in: [Component config](#) > [FreeRTOS](#)

FreeRTOS has the ability to store per-thread pointers in the task control block. This controls the number of pointers available.

This value must be at least 1. Index 0 is reserved for use by the pthreads API thread-local-storage. Other indexes can be used for any desired purpose.

Range:

- from 1 to 256

Default value:

- 1

CONFIG_FREERTOS_ASSERT

FreeRTOS assertions

Found in: [Component config](#) > [FreeRTOS](#)

Failed FreeRTOS configASSERT() assertions can be configured to behave in different ways.

By default these behave the same as the global project assert settings.

Available options:

- abort() on failed assertions (FREERTOS_ASSERT_FAIL_ABORT)
If a FreeRTOS configASSERT() fails, FreeRTOS will abort() and halt execution. The panic handler can be configured to handle the outcome of an abort() in different ways.
If assertions are disabled for the entire project, they are also disabled in FreeRTOS and this option is unavailable.
- Print and continue failed assertions (FREERTOS_ASSERT_FAIL_PRINT_CONTINUE)
If a FreeRTOS assertion fails, print it out and continue.
- Disable FreeRTOS assertions (FREERTOS_ASSERT_DISABLE)
FreeRTOS configASSERT() will not be compiled into the binary.

CONFIG_FREERTOS_IDLE_TASK_STACKSIZE

Idle Task stack size

Found in: [Component config](#) > [FreeRTOS](#)

The idle task has its own stack, sized in bytes. The default size is enough for most uses. Size can be reduced to 768 bytes if no (or simple) FreeRTOS idle hooks are used and pthread local storage or FreeRTOS local storage cleanup callbacks are not used.

The stack size may need to be increased above the default if the app installs idle or thread local storage cleanup hooks that use a lot of stack memory.

Range:

- from 768 to 32768

Default value:

- 2304

CONFIG_FREERTOS_ISR_STACKSIZE

ISR stack size

Found in: [Component config](#) > [FreeRTOS](#)

The interrupt handlers have their own stack. The size of the stack can be defined here. Each processor has its own stack, so the total size occupied will be twice this.

Range:

- from 2096 to 32768 if ESP_COREDUMP_DATA_FORMAT_ELF
- from 1536 to 32768

Default value:

- 2096 if ESP_COREDUMP_DATA_FORMAT_ELF
- 1536

CONFIG_FREERTOS_LEGACY_HOOKS

Use FreeRTOS legacy hooks

Found in: [Component config](#) > [FreeRTOS](#)

FreeRTOS offers a number of hooks/callback functions that are called when a timer tick happens, the idle thread runs etc. esp-idf replaces these by runtime registerable hooks using the esp_register_freertos_xxx_hook system, but for legacy reasons the old hooks can also still be enabled. Please enable this only if you have code that for some reason can't be migrated to the esp_register_freertos_xxx_hook system.

Default value:

- No (disabled)

CONFIG_FREERTOS_MAX_TASK_NAME_LEN

Maximum task name length

Found in: [Component config](#) > [FreeRTOS](#)

Changes the maximum task name length. Each task allocated will include this many bytes for a task name. Using a shorter value saves a small amount of RAM, a longer value allows more complex names.

For most uses, the default of 16 is OK.

Range:

- from 1 to 256

Default value:

- 16

CONFIG_FREERTOS_ENABLE_STATIC_TASK_CLEAN_UP

Enable static task clean up hook

Found in: [Component config](#) > [FreeRTOS](#)

Enable this option to make FreeRTOS call the static task clean up hook when a task is deleted.

Bear in mind that if this option is enabled you will need to implement the following function:

```
void vPortCleanUpTCB ( void \*pxTCB ) {  
    // place clean up code here  
}
```

Default value:

- No (disabled)

CONFIG_FREERTOS_TIMER_TASK_PRIORITY

FreeRTOS timer task priority

Found in: [Component config](#) > [FreeRTOS](#)

The timer service task (primarily) makes use of existing FreeRTOS features, allowing timer functionality to be added to an application with minimal impact on the size of the application's executable binary.

Use this constant to define the priority that the timer task will run at.

Range:

- from 1 to 25

Default value:

- 1

CONFIG_FREERTOS_TIMER_TASK_STACK_DEPTH

FreeRTOS timer task stack size

Found in: [Component config](#) > [FreeRTOS](#)

The timer service task (primarily) makes use of existing FreeRTOS features, allowing timer functionality to be added to an application with minimal impact on the size of the application's executable binary.

Use this constant to define the size (in bytes) of the stack allocated for the timer task.

Range:

- from 1536 to 32768

Default value:

- 2048

CONFIG_FREERTOS_TIMER_QUEUE_LENGTH

FreeRTOS timer queue length

Found in: [Component config](#) > [FreeRTOS](#)

FreeRTOS provides a set of timer related API functions. Many of these functions use a standard FreeRTOS queue to send commands to the timer service task. The queue used for this purpose is called the 'timer command queue'. The 'timer command queue' is private to the FreeRTOS timer implementation, and cannot be accessed directly.

For most uses the default value of 10 is OK.

Range:

- from 5 to 20

Default value:

- 10

CONFIG_FREERTOS_QUEUE_REGISTRY_SIZE

FreeRTOS queue registry size

Found in: [Component config](#) > [FreeRTOS](#)

FreeRTOS uses the queue registry as a means for kernel aware debuggers to locate queues, semaphores, and mutexes. The registry allows for a textual name to be associated with a queue for easy identification within a debugging GUI. A value of 0 will disable queue registry functionality, and a value larger than 0 will specify the number of queues/semaphores/mutexes that the registry can hold.

Range:

- from 0 to 20

Default value:

- 0

CONFIG_FREERTOS_USE_TRACE_FACILITY

Enable FreeRTOS trace facility

Found in: [Component config](#) > [FreeRTOS](#)

If enabled, configUSE_TRACE_FACILITY will be defined as 1 in FreeRTOS. This will allow the usage of trace facility functions such as uxTaskGetSystemState().

Default value:

- No (disabled)

CONFIG_FREERTOS_USE_STATS_FORMATTING_FUNCTIONS

Enable FreeRTOS stats formatting functions

Found in: [Component config](#) > [FreeRTOS](#) > [CONFIG_FREERTOS_USE_TRACE_FACILITY](#)

If enabled, configUSE_STATS_FORMATTING_FUNCTIONS will be defined as 1 in FreeRTOS. This will allow the usage of stats formatting functions such as vTaskList().

Default value:

- No (disabled) if [CONFIG_FREERTOS_USE_TRACE_FACILITY](#)

CONFIG_FREERTOS_VTASKLIST_INCLUDE_COREID

Enable display of xCoreID in vTaskList

Found in: [Component config](#) > [FreeRTOS](#) > [CONFIG_FREERTOS_USE_TRACE_FACILITY](#) > [CONFIG_FREERTOS_USE_STATS_FORMATTING_FUNCTIONS](#)

If enabled, this will include an extra column when vTaskList is called to display the CoreID the task is pinned to (0,1) or -1 if not pinned.

Default value:

- No (disabled) if [CONFIG_FREERTOS_USE_STATS_FORMATTING_FUNCTIONS](#)

CONFIG_FREERTOS_GENERATE_RUN_TIME_STATS

Enable FreeRTOS to collect run time stats

Found in: [Component config](#) > [FreeRTOS](#)

If enabled, configGENERATE_RUN_TIME_STATS will be defined as 1 in FreeRTOS. This will allow FreeRTOS to collect information regarding the usage of processor time amongst FreeRTOS tasks. Run time stats are generated using either the ESP Timer or the CPU Clock as the clock source (Note that run time stats are only valid until the clock source overflows). The function vTaskGetRunTimeStats() will also be available if FREERTOS_USE_STATS_FORMATTING_FUNCTIONS and FREERTOS_USE_TRACE_FACILITY are enabled. vTaskGetRunTimeStats() will display the run time of each task as a % of the total run time of all CPUs (task run time / no of CPUs) / (total run time / 100)

Default value:

- No (disabled)

CONFIG_FREERTOS_RUN_TIME_STATS_CLK

Choose the clock source for run time stats

Found in: [Component config](#) > [FreeRTOS](#) > [CONFIG_FREERTOS_GENERATE_RUN_TIME_STATS](#)

Choose the clock source for FreeRTOS run time stats. Options are CPU0's CPU Clock or the ESP Timer. Both clock sources are 32 bits. The CPU Clock can run at a higher frequency hence provide a finer resolution but will overflow much quicker. Note that run time stats are only valid until the clock source overflows.

Available options:

- Use ESP TIMER for run time stats (FREERTOS_RUN_TIME_STATS_USING_ESP_TIMER) ESP Timer will be used as the clock source for FreeRTOS run time stats. The ESP Timer runs at a frequency of 1MHz regardless of Dynamic Frequency Scaling. Therefore the ESP Timer will overflow in approximately 4290 seconds.
- Use CPU Clock for run time stats (FREERTOS_RUN_TIME_STATS_USING_CPU_CLK) CPU Clock will be used as the clock source for the generation of run time stats. The CPU Clock has a frequency dependent on ESP32_DEFAULT_CPU_FREQ_MHZ and Dynamic Frequency Scaling (DFS). Therefore the CPU Clock frequency can fluctuate between 80 to 240MHz. Run time stats generated using the CPU Clock represents the number of CPU cycles each task is allocated and DOES NOT reflect the amount of time each task runs for (as CPU clock frequency can change). If the CPU clock consistently runs at the maximum frequency of 240MHz, it will overflow in approximately 17 seconds.

CONFIG_FREERTOS_USE_TICKLESS_IDLE

Tickless idle support

Found in: [Component config](#) > [FreeRTOS](#)

If power management support is enabled, FreeRTOS will be able to put the system into light sleep mode when no tasks need to run for a number of ticks. This number can be set using FREERTOS_IDLE_TIME_BEFORE_SLEEP option. This feature is also known as "automatic light sleep".

Note that timers created using esp_timer APIs may prevent the system from entering sleep mode, even when no tasks need to run.

If disabled, automatic light sleep support will be disabled.

Default value:

- No (disabled) if [CONFIG_PM_ENABLE](#)

CONFIG_FREERTOS_IDLE_TIME_BEFORE_SLEEP

Minimum number of ticks to enter sleep mode for

Found in: [Component config](#) > [FreeRTOS](#) > [CONFIG_FREERTOS_USE_TICKLESS_IDLE](#)

FreeRTOS will enter light sleep mode if no tasks need to run for this number of ticks.

Range:

- from 2 to 4294967295 if [CONFIG_FREERTOS_USE_TICKLESS_IDLE](#)

Default value:

- 3 if [CONFIG_FREERTOS_USE_TICKLESS_IDLE](#)

CONFIG_FREERTOS_TASK_FUNCTION_WRAPPER

Enclose all task functions in a wrapper function

Found in: [Component config](#) > [FreeRTOS](#)

If enabled, all FreeRTOS task functions will be enclosed in a wrapper function. If a task function mistakenly returns (i.e. does not delete), the call flow will return to the wrapper function. The wrapper

function will then log an error and abort the application. This option is also required for GDB backtraces and C++ exceptions to work correctly inside top-level task functions.

Default value:

- Yes (enabled)

CONFIG_FREERTOS_CHECK_MUTEX_GIVEN_BY_OWNER

Check that mutex semaphore is given by owner task

Found in: [Component config](#) > [FreeRTOS](#)

If enabled, assert that when a mutex semaphore is given, the task giving the semaphore is the task which is currently holding the mutex.

Default value:

- Yes (enabled)

CONFIG_FREERTOS_CHECK_PORT_CRITICAL_COMPLIANCE

Tests compliance with Vanilla FreeRTOS port*_CRITICAL calls

Found in: [Component config](#) > [FreeRTOS](#)

If enabled, context of port*_CRITICAL calls (ISR or Non-ISR) would be checked to be in compliance with Vanilla FreeRTOS. e.g Calling port*_CRITICAL from ISR context would cause assert failure

Default value:

- No (disabled)

CONFIG_FREERTOS_PLACE_FUNCTIONS_INTO_FLASH

Place FreeRTOS functions into Flash

Found in: [Component config](#) > [FreeRTOS](#)

When enabled the selected Non-ISR FreeRTOS functions will be placed into Flash memory instead of IRAM. This saves up to 8KB of IRAM depending on which functions are used.

Default value:

- No (disabled)

Heap memory debugging Contains:

- [CONFIG_HEAP_ABORT_WHEN_ALLOCATION_FAILS](#)
- [CONFIG_HEAP_TASK_TRACKING](#)
- [CONFIG_HEAP_CORRUPTION_DETECTION](#)
- [CONFIG_HEAP_TRACING_DEST](#)
- [CONFIG_HEAP_TRACING_STACK_DEPTH](#)

CONFIG_HEAP_CORRUPTION_DETECTION

Heap corruption detection

Found in: [Component config](#) > [Heap memory debugging](#)

Enable heap poisoning features to detect heap corruption caused by out-of-bounds access to heap memory.

See the “Heap Memory Debugging” page of the IDF documentation for a description of each level of heap corruption detection.

Available options:

- Basic (no poisoning) (HEAP_POISONING_DISABLED)

- Light impact (HEAP_POISONING_LIGHT)
- Comprehensive (HEAP_POISONING_COMPREHENSIVE)

CONFIG_HEAP_TRACING_DEST

Heap tracing

Found in: [Component config](#) > [Heap memory debugging](#)

Enables the heap tracing API defined in esp_heap_trace.h.

This function causes a moderate increase in IRAM code size and a minor increase in heap function (malloc/free/realloc) CPU overhead, even when the tracing feature is not used. So it's best to keep it disabled unless tracing is being used.

Available options:

- Disabled (HEAP_TRACING_OFF)
- Standalone (HEAP_TRACING_STANDALONE)
- Host-based (HEAP_TRACING_TOHOST)

CONFIG_HEAP_TRACING_STACK_DEPTH

Heap tracing stack depth

Found in: [Component config](#) > [Heap memory debugging](#)

Number of stack frames to save when tracing heap operation callers.

More stack frames uses more memory in the heap trace buffer (and slows down allocation), but can provide useful information.

CONFIG_HEAP_TASK_TRACKING

Enable heap task tracking

Found in: [Component config](#) > [Heap memory debugging](#)

Enables tracking the task responsible for each heap allocation.

This function depends on heap poisoning being enabled and adds four more bytes of overhead for each block allocated.

CONFIG_HEAP_ABORT_WHEN_ALLOCATION_FAILS

Abort if memory allocation fails

Found in: [Component config](#) > [Heap memory debugging](#)

When enabled, if a memory allocation operation fails it will cause a system abort.

Default value:

- No (disabled)

jsmn Contains:

- [CONFIG_JSMN_PARENT_LINKS](#)
- [CONFIG_JSMN_STRICT](#)

CONFIG_JSMN_PARENT_LINKS

Enable parent links

Found in: *Component config > jsmn*

You can access to parent node of parsed json

Default value:

- No (disabled)

CONFIG_JSMN_STRICT

Enable strict mode

Found in: *Component config > jsmn*

In strict mode primitives are: numbers and booleans

Default value:

- No (disabled)

libsodium Contains:

- [CONFIG_LIBSODIUM_USE_MBEDTLS_SHA](#)

CONFIG_LIBSODIUM_USE_MBEDTLS_SHA

Use mbedTLS SHA256 & SHA512 implementations

Found in: *Component config > libsodium*

If this option is enabled, libsodium will use thin wrappers around mbedTLS for SHA256 & SHA512 operations.

This saves some code size if mbedTLS is also used. However it is incompatible with hardware SHA acceleration (due to the way libsodium's API manages SHA state).

Default value:

- Yes (enabled)

Log output Contains:

- [CONFIG_LOG_DEFAULT_LEVEL](#)
- [CONFIG_LOG_TIMESTAMP_SOURCE](#)
- [CONFIG_LOG_COLORS](#)

CONFIG_LOG_DEFAULT_LEVEL

Default log verbosity

Found in: *Component config > Log output*

Specify how much output to see in logs by default. You can set lower verbosity level at runtime using `esp_log_level_set` function.

Note that this setting limits which log statements are compiled into the program. So setting this to, say, "Warning" would mean that changing log level to "Debug" at runtime will not be possible.

Available options:

- No output (LOG_DEFAULT_LEVEL_NONE)
- Error (LOG_DEFAULT_LEVEL_ERROR)
- Warning (LOG_DEFAULT_LEVEL_WARN)
- Info (LOG_DEFAULT_LEVEL_INFO)
- Debug (LOG_DEFAULT_LEVEL_DEBUG)

- Verbose (LOG_DEFAULT_LEVEL_VERBOSE)

CONFIG_LOG_COLORS

Use ANSI terminal colors in log output

Found in: [Component config](#) > [Log output](#)

Enable ANSI terminal color codes in bootloader output.

In order to view these, your terminal program must support ANSI color codes.

Default value:

- Yes (enabled)

CONFIG_LOG_TIMESTAMP_SOURCE

Log Timestamps

Found in: [Component config](#) > [Log output](#)

Choose what sort of timestamp is displayed in the log output:

- Milliseconds since boot is calculated from the RTOS tick count multiplied by the tick period. This time will reset after a software reboot. e.g. (90000)
- System time is taken from POSIX time functions which use the ESP32's RTC and FRC1 timers to maintain an accurate time. The system time is initialized to 0 on startup, it can be set with an SNTP sync, or with POSIX time functions. This time will not reset after a software reboot. e.g. (00:01:30.000)
- NOTE: Currently this will not get used in logging from binary blobs (i.e WiFi & Bluetooth libraries), these will always print milliseconds since boot.

Available options:

- Milliseconds Since Boot (LOG_TIMESTAMP_SOURCE_RTOS)
- System Time (LOG_TIMESTAMP_SOURCE_SYSTEM)

LWIP Contains:

- *Checksums*
- *DHCP server*
- *CONFIG_LWIP_DHCP_DISABLE_CLIENT_ID*
- *CONFIG_LWIP_DHCP_DOES_ARP_CHECK*
- *CONFIG_LWIP_DHCP_RESTORE_LAST_IP*
- *CONFIG_LWIP_PPP_CHAP_SUPPORT*
- *CONFIG_LWIP_L2_TO_L3_COPY*
- *CONFIG_LWIP_IP4_FRAG*
- *CONFIG_LWIP_IP6_FRAG*
- *CONFIG_LWIP_IP_FORWARD*
- *CONFIG_LWIP_NETBUF_RECVINFO*
- *CONFIG_LWIP_AUTOIP*
- *CONFIG_LWIP_IPV6*
- *CONFIG_LWIP_ETHARP_TRUST_IP_MAC*
- *CONFIG_LWIP_ESP_LWIP_ASSERT*
- *CONFIG_LWIP_DEBUG*
- *CONFIG_LWIP_IRAM_OPTIMIZATION*
- *CONFIG_LWIP_STATS*
- *CONFIG_LWIP_TIMERS_ONDEMAND*
- *CONFIG_LWIP_DNS_SUPPORT_MDNS_QUERIES*
- *CONFIG_LWIP_PPP_MPPE_SUPPORT*
- *CONFIG_LWIP_PPP_MSCHAP_SUPPORT*
- *CONFIG_LWIP_PPP_NOTIFY_PHASE_SUPPORT*

- `CONFIG_LWIP_PPP_PAP_SUPPORT`
- `CONFIG_LWIP_PPP_DEBUG_ON`
- `CONFIG_LWIP_PPP_SUPPORT`
- `CONFIG_LWIP_IP4_REASSEMBLY`
- `CONFIG_LWIP_IP6_REASSEMBLY`
- `CONFIG_LWIP_SLIP_SUPPORT`
- `CONFIG_LWIP_SO_LINGER`
- `CONFIG_LWIP_SO_RCVBUF`
- `CONFIG_LWIP_SO_REUSE`
- *Hooks*
- `ICMP`
- `CONFIG_LWIP_LOCAL_HOSTNAME`
- `LWIP_RAW_API`
- `CONFIG_LWIP_IPV6_ND6_NUM_NEIGHBORS`
- `CONFIG_LWIP_IPV6_MEMP_NUM_ND6_QUEUE`
- `CONFIG_LWIP_MAX_SOCKETS`
- `CONFIG_LWIP_ESP_GRATUITOUS_ARP`
- `SNTP`
- `CONFIG_LWIP_USE_ONLY_LWIP_SELECT`
- `CONFIG_LWIP_NETIF_LOOPBACK`
- `TCP`
- `CONFIG_LWIP_TCPIP_TASK_AFFINITY`
- `CONFIG_LWIP_TCPIP_TASK_STACK_SIZE`
- `CONFIG_LWIP_TCPIP_RECVMBOX_SIZE`
- `UDP`

CONFIG_LWIP_LOCAL_HOSTNAME

Local netif hostname

Found in: [Component config](#) > [LWIP](#)

The default name this device will report to other devices on the network. Could be updated at runtime with `esp_netif_set_hostname()`

Default value:

- “espressif”

CONFIG_LWIP_DNS_SUPPORT_MDNS_QUERIES

Enable mDNS queries in resolving host name

Found in: [Component config](#) > [LWIP](#)

If this feature is enabled, standard API such as `gethostbyname` support .local addresses by sending one shot multicast mDNS query

Default value:

- Yes (enabled)

CONFIG_LWIP_L2_TO_L3_COPY

Enable copy between Layer2 and Layer3 packets

Found in: [Component config](#) > [LWIP](#)

If this feature is enabled, all traffic from layer2(WIFI Driver) will be copied to a new buffer before sending it to layer3(LWIP stack), freeing the layer2 buffer. Please be notified that the total layer2 receiving buffer is fixed and ESP32 currently supports 25 layer2 receiving buffer, when layer2 buffer runs out of memory, then the incoming packets will be dropped in hardware. The layer3 buffer is allocated from the heap, so the total layer3 receiving buffer depends on the available heap size, when heap runs out of

memory, no copy will be sent to layer3 and packet will be dropped in layer2. Please make sure you fully understand the impact of this feature before enabling it.

Default value:

- No (disabled)

CONFIG_LWIP_IRAM_OPTIMIZATION

Enable LWIP IRAM optimization

Found in: [Component config](#) > [LWIP](#)

If this feature is enabled, some functions relating to RX/TX in LWIP will be put into IRAM, it can improve UDP/TCP throughput by >10% for single core mode, it doesn't help too much for dual core mode. On the other hand, it needs about 10KB IRAM for these optimizations.

If this feature is disabled, all lwip functions will be put into FLASH.

Default value:

- No (disabled)

CONFIG_LWIP_TIMERS_ONDEMAND

Enable LWIP Timers on demand

Found in: [Component config](#) > [LWIP](#)

If this feature is enabled, IGMP and MLD6 timers will be activated only when joining groups or receiving QUERY packets.

This feature will reduce the power consumption for applications which do not use IGMP and MLD6.

Default value:

- Yes (enabled)

CONFIG_LWIP_MAX_SOCKETS

Max number of open sockets

Found in: [Component config](#) > [LWIP](#)

Sockets take up a certain amount of memory, and allowing fewer sockets to be open at the same time conserves memory. Specify the maximum amount of sockets here. The valid value is from 1 to 16.

Range:

- from 1 to 16

Default value:

- 10

CONFIG_LWIP_USE_ONLY_LWIP_SELECT

Support LWIP socket select() only (DEPRECATED)

Found in: [Component config](#) > [LWIP](#)

This option is deprecated. Use VFS_SUPPORT_SELECT instead, which is the inverse of this option.

The virtual filesystem layer of select() redirects sockets to lwip_select() and non-socket file descriptors to their respective driver implementations. If this option is enabled then all calls of select() will be redirected to lwip_select(), therefore, select can be used for sockets only.

Default value:

- No (disabled)

CONFIG_LWIP_SO_LINGER

Enable SO_LINGER processing

Found in: [Component config](#) > [LWIP](#)

Enabling this option allows SO_LINGER processing. `l_onoff = 1`, `l_linger` can set the timeout.

If `l_linger=0`, When a connection is closed, TCP will terminate the connection. This means that TCP will discard any data packets stored in the socket send buffer and send an RST to the peer.

If `l_linger!=0`, Then `closesocket()` calls to block the process until the remaining data packets has been sent or timed out.

Default value:

- No (disabled)

CONFIG_LWIP_SO_REUSE

Enable SO_REUSEADDR option

Found in: [Component config](#) > [LWIP](#)

Enabling this option allows binding to a port which remains in TIME_WAIT.

Default value:

- Yes (enabled)

CONFIG_LWIP_SO_REUSE_RXTOALL

SO_REUSEADDR copies broadcast/multicast to all matches

Found in: [Component config](#) > [LWIP](#) > [CONFIG_LWIP_SO_REUSE](#)

Enabling this option means that any incoming broadcast or multicast packet will be copied to all of the local sockets that it matches (may be more than one if SO_REUSEADDR is set on the socket.)

This increases memory overhead as the packets need to be copied, however they are only copied per matching socket. You can safely disable it if you don't plan to receive broadcast or multicast traffic on more than one socket at a time.

Default value:

- Yes (enabled)

CONFIG_LWIP_SO_RCVBUF

Enable SO_RCVBUF option

Found in: [Component config](#) > [LWIP](#)

Enabling this option allows checking for available data on a netconn.

Default value:

- No (disabled)

CONFIG_LWIP_NETBUF_RECVINFO

Enable IP_PKTINFO option

Found in: [Component config](#) > [LWIP](#)

Enabling this option allows checking for the destination address of a received IPv4 Packet.

Default value:

- No (disabled)

CONFIG_LWIP_IP4_FRAG

Enable fragment outgoing IP4 packets

Found in: [Component config](#) > [LWIP](#)

Enabling this option allows fragmenting outgoing IP4 packets if their size exceeds MTU.

Default value:

- Yes (enabled)

CONFIG_LWIP_IP6_FRAG

Enable fragment outgoing IP6 packets

Found in: [Component config](#) > [LWIP](#)

Enabling this option allows fragmenting outgoing IP6 packets if their size exceeds MTU.

Default value:

- Yes (enabled)

CONFIG_LWIP_IP4_REASSEMBLY

Enable reassembly incoming fragmented IP4 packets

Found in: [Component config](#) > [LWIP](#)

Enabling this option allows reassembling incoming fragmented IP4 packets.

Default value:

- No (disabled)

CONFIG_LWIP_IP6_REASSEMBLY

Enable reassembly incoming fragmented IP6 packets

Found in: [Component config](#) > [LWIP](#)

Enabling this option allows reassembling incoming fragmented IP6 packets.

Default value:

- No (disabled)

CONFIG_LWIP_IP_FORWARD

Enable IP forwarding

Found in: [Component config](#) > [LWIP](#)

Enabling this option allows packets forwarding across multiple interfaces.

Default value:

- No (disabled)

CONFIG_LWIP_IPV4_NAPT

Enable NAT (new/experimental)

Found in: [Component config](#) > [LWIP](#) > [CONFIG_LWIP_IP_FORWARD](#)

Enabling this option allows Network Address and Port Translation.

Default value:

- No (disabled) if [CONFIG_LWIP_IP_FORWARD](#)

CONFIG_LWIP_STATS

Enable LWIP statistics

Found in: [Component config](#) > [LWIP](#)

Enabling this option allows LWIP statistics

Default value:

- No (disabled)

CONFIG_LWIP_ETHARP_TRUST_IP_MAC

Enable LWIP ARP trust

Found in: [Component config](#) > [LWIP](#)

Enabling this option allows ARP table to be updated.

If this option is enabled, the incoming IP packets cause the ARP table to be updated with the source MAC and IP addresses supplied in the packet. You may want to disable this if you do not trust LAN peers to have the correct addresses, or as a limited approach to attempt to handle spoofing. If disabled, lwIP will need to make a new ARP request if the peer is not already in the ARP table, adding a little latency. The peer *is* in the ARP table if it requested our address before. Also notice that this slows down input processing of every IP packet!

There are two known issues in real application if this feature is enabled: - The LAN peer may have bug to update the ARP table after the ARP entry is aged out. If the ARP entry on the LAN peer is aged out but failed to be updated, all IP packets sent from LWIP to the LAN peer will be dropped by LAN peer. - The LAN peer may not be trustful, the LAN peer may send IP packets to LWIP with two different MACs, but the same IP address. If this happens, the LWIP has problem to receive IP packets from LAN peer.

So the recommendation is to disable this option. Here the LAN peer means the other side to which the ESP station or soft-AP is connected.

Default value:

- No (disabled)

CONFIG_LWIP_ESP_GRATUITOUS_ARP

Send gratuitous ARP periodically

Found in: [Component config](#) > [LWIP](#)

Enable this option allows to send gratuitous ARP periodically.

This option solve the compatibility issues.If the ARP table of the AP is old, and the AP doesn't send ARP request to update it's ARP table, this will lead to the STA sending IP packet fail. Thus we send gratuitous ARP periodically to let AP update it's ARP table.

Default value:

- Yes (enabled)

CONFIG_LWIP_GARP_TMR_INTERVAL

GARP timer interval(seconds)

Found in: [Component config](#) > [LWIP](#) > [CONFIG_LWIP_ESP_GRATUITOUS_ARP](#)

Set the timer interval for gratuitous ARP. The default value is 60s

Default value:

- 60

CONFIG_LWIP_TCPIP_RECVMBOX_SIZE

TCPIP task receive mail box size

Found in: [Component config > LWIP](#)

Set TCPIP task receive mail box size. Generally bigger value means higher throughput but more memory. The value should be bigger than UDP/TCP mail box size.

Range:

- from 6 to 64 if [CONFIG_LWIP_WND_SCALE](#)
- from 6 to 1024 if [CONFIG_LWIP_WND_SCALE](#)

Default value:

- 32

CONFIG_LWIP_DHCP_DOES_ARP_CHECK

DHCP: Perform ARP check on any offered address

Found in: [Component config > LWIP](#)

Enabling this option performs a check (via ARP request) if the offered IP address is not already in use by another host on the network.

Default value:

- Yes (enabled)

CONFIG_LWIP_DHCP_DISABLE_CLIENT_ID

DHCP: Disable Use of HW address as client identification

Found in: [Component config > LWIP](#)

This option could be used to disable DHCP client identification with its MAC address. (Client id is used by DHCP servers to uniquely identify clients and are included in the DHCP packets as an option 61) Set this option to “y” in order to exclude option 61 from DHCP packets.

Default value:

- No (disabled)

CONFIG_LWIP_DHCP_RESTORE_LAST_IP

DHCP: Restore last IP obtained from DHCP server

Found in: [Component config > LWIP](#)

When this option is enabled, DHCP client tries to re-obtain last valid IP address obtained from DHCP server. Last valid DHCP configuration is stored in nvs and restored after reset/power-up. If IP is still available, there is no need for sending discovery message to DHCP server and save some time.

Default value:

- No (disabled)

DHCP server Contains:

- [CONFIG_LWIP_DHCPS](#)

CONFIG_LWIP_DHCPS

DHCPS: Enable IPv4 Dynamic Host Configuration Protocol Server (DHCPS)

Found in: [Component config > LWIP > DHCP server](#)

Enabling this option allows the device to run the DHCP server (to dynamically assign IPv4 addresses to clients).

Default value:

- Yes (enabled)

CONFIG_LWIP_DHCPS_LEASE_UNIT

Multiplier for lease time, in seconds

Found in: [Component config](#) > [LWIP](#) > [DHCP server](#) > [CONFIG_LWIP_DHCPS](#)

The DHCP server is calculating lease time multiplying the sent and received times by this number of seconds per unit. The default is 60, that equals one minute.

Range:

- from 1 to 3600

Default value:

- 60

CONFIG_LWIP_DHCPS_MAX_STATION_NUM

Maximum number of stations

Found in: [Component config](#) > [LWIP](#) > [DHCP server](#) > [CONFIG_LWIP_DHCPS](#)

The maximum number of DHCP clients that are connected to the server. After this number is exceeded, DHCP server removes of the oldest device from it's address pool, without notification.

Range:

- from 1 to 64

Default value:

- 8

CONFIG_LWIP_AUTOIP

Enable IPV4 Link-Local Addressing (AUTOIP)

Found in: [Component config](#) > [LWIP](#)

Enabling this option allows the device to self-assign an address in the 169.256/16 range if none is assigned statically or via DHCP.

See RFC 3927.

Default value:

- No (disabled)

Contains:

- [CONFIG_LWIP_AUTOIP_TRIES](#)
- [CONFIG_LWIP_AUTOIP_MAX_CONFLICTS](#)
- [CONFIG_LWIP_AUTOIP_RATE_LIMIT_INTERVAL](#)

CONFIG_LWIP_AUTOIP_TRIES

DHCP Probes before self-assigning IPv4 LL address

Found in: [Component config](#) > [LWIP](#) > [CONFIG_LWIP_AUTOIP](#)

DHCP client will send this many probes before self-assigning a link local address.

From LWIP help: "This can be set as low as 1 to get an AutoIP address very quickly, but you should be prepared to handle a changing IP address when DHCP overrides AutoIP." (In the case of ESP-IDF, this means multiple SYSTEM_EVENT_STA_GOT_IP events.)

Range:

- from 1 to 100 if [CONFIG_LWIP_AUTOIP](#)

Default value:

- 2 if `CONFIG_LWIP_AUTOIP`

CONFIG_LWIP_AUTOIP_MAX_CONFLICTS

Max IP conflicts before rate limiting

Found in: Component config > LWIP > CONFIG_LWIP_AUTOIP

If the AUTOIP functionality detects this many IP conflicts while self-assigning an address, it will go into a rate limited mode.

Range:

- from 1 to 100 if `CONFIG_LWIP_AUTOIP`

Default value:

- 9 if `CONFIG_LWIP_AUTOIP`

CONFIG_LWIP_AUTOIP_RATE_LIMIT_INTERVAL

Rate limited interval (seconds)

Found in: Component config > LWIP > CONFIG_LWIP_AUTOIP

If rate limiting self-assignment requests, wait this long between each request.

Range:

- from 5 to 120 if `CONFIG_LWIP_AUTOIP`

Default value:

- 20 if `CONFIG_LWIP_AUTOIP`

CONFIG_LWIP_IPV6

Enable IPv6

Found in: Component config > LWIP

Enable IPv6 function. If not use IPv6 function, set this option to n. If disabling LWIP_IPV6 then some other components (coap and asio) will no longer be available.

Default value:

- Yes (enabled)

CONFIG_LWIP_IPV6_AUTOCONFIG

Enable IPV6 stateless address autoconfiguration (SLAAC)

Found in: Component config > LWIP > CONFIG_LWIP_IPV6

Enabling this option allows the devices to IPV6 stateless address autoconfiguration (SLAAC).

See RFC 4862.

Default value:

- No (disabled)

CONFIG_LWIP_NETIF_LOOPBACK

Support per-interface loopback

Found in: Component config > LWIP

Enabling this option means that if a packet is sent with a destination address equal to the interface's own IP address, it will "loop back" and be received by this interface.

Default value:

- Yes (enabled)

Contains:

- [CONFIG_LWIP_LOOPBACK_MAX_PBUFS](#)

CONFIG_LWIP_LOOPBACK_MAX_PBUFS

Max queued loopback packets per interface

Found in: [Component config](#) > [LWIP](#) > [CONFIG_LWIP_NETIF_LOOPBACK](#)

Configure the maximum number of packets which can be queued for loopback on a given interface. Reducing this number may cause packets to be dropped, but will avoid filling memory with queued packet data.

Range:

- from 0 to 16

Default value:

- 8

TCP Contains:

- [CONFIG_LWIP_TCP_WND_DEFAULT](#)
- [CONFIG_LWIP_TCP_SND_BUF_DEFAULT](#)
- [CONFIG_LWIP_TCP_RECVMBOX_SIZE](#)
- [CONFIG_LWIP_TCP_RTO_TIME](#)
- [CONFIG_LWIP_TCP_KEEP_CONNECTION_WHEN_IP_CHANGES](#)
- [CONFIG_LWIP_MAX_ACTIVE_TCP](#)
- [CONFIG_LWIP_MAX_LISTENING_TCP](#)
- [CONFIG_LWIP_TCP_MAXRTX](#)
- [CONFIG_LWIP_TCP_SYNMAXRTX](#)
- [CONFIG_LWIP_TCP_MSL](#)
- [CONFIG_LWIP_TCP_MSS](#)
- [CONFIG_LWIP_TCP_OVERSIZE](#)
- [CONFIG_LWIP_TCP_QUEUE_OOSEQ](#)
- [CONFIG_LWIP_TCP_SACK_OUT](#)
- [CONFIG_LWIP_WND_SCALE](#)
- [CONFIG_LWIP_TCP_HIGH_SPEED_RETRANSMISSION](#)
- [CONFIG_LWIP_TCP_TMR_INTERVAL](#)

CONFIG_LWIP_MAX_ACTIVE_TCP

Maximum active TCP Connections

Found in: [Component config](#) > [LWIP](#) > [TCP](#)

The maximum number of simultaneously active TCP connections. The practical maximum limit is determined by available heap memory at runtime.

Changing this value by itself does not substantially change the memory usage of LWIP, except for preventing new TCP connections after the limit is reached.

Range:

- from 1 to 1024

Default value:

- 16

CONFIG_LWIP_MAX_LISTENING_TCP

Maximum listening TCP Connections

Found in: [Component config](#) > [LWIP](#) > [TCP](#)

The maximum number of simultaneously listening TCP connections. The practical maximum limit is determined by available heap memory at runtime.

Changing this value by itself does not substantially change the memory usage of LWIP, except for preventing new listening TCP connections after the limit is reached.

Range:

- from 1 to 1024

Default value:

- 16

CONFIG_LWIP_TCP_HIGH_SPEED_RETRANSMISSION

TCP high speed retransmissions

Found in: [Component config](#) > [LWIP](#) > [TCP](#)

Speed up the TCP retransmission interval. If disabled, it is recommended to change the number of SYN retransmissions to 6, and TCP initial rto time to 3000.

Default value:

- Yes (enabled)

CONFIG_LWIP_TCP_MAXRTX

Maximum number of retransmissions of data segments

Found in: [Component config](#) > [LWIP](#) > [TCP](#)

Set maximum number of retransmissions of data segments.

Range:

- from 3 to 12

Default value:

- 12

CONFIG_LWIP_TCP_SYNMAXRTX

Maximum number of retransmissions of SYN segments

Found in: [Component config](#) > [LWIP](#) > [TCP](#)

Set maximum number of retransmissions of SYN segments.

Range:

- from 3 to 12

Default value:

- 6
- 12

CONFIG_LWIP_TCP_MSS

Maximum Segment Size (MSS)

Found in: [Component config](#) > [LWIP](#) > [TCP](#)

Set maximum segment size for TCP transmission.

Can be set lower to save RAM, the default value 1460(ipv4)/1440(ipv6) will give best throughput. IPv4 TCP_MSS Range: 576 <= TCP_MSS <= 1460 IPv6 TCP_MSS Range: 1220 <= TCP_mSS <= 1440

Range:

- from 536 to 1460

Default value:

- 1440

CONFIG_LWIP_TCP_TMR_INTERVAL

TCP timer interval(ms)

Found in: [Component config](#) > [LWIP](#) > [TCP](#)

Set TCP timer interval in milliseconds.

Can be used to speed connections on bad networks. A lower value will redeliver unacked packets faster.

Default value:

- 250

CONFIG_LWIP_TCP_MSL

Maximum segment lifetime (MSL)

Found in: [Component config](#) > [LWIP](#) > [TCP](#)

Set maximum segment lifetime in in milliseconds.

Default value:

- 60000

CONFIG_LWIP_TCP_SND_BUF_DEFAULT

Default send buffer size

Found in: [Component config](#) > [LWIP](#) > [TCP](#)

Set default send buffer size for new TCP sockets.

Per-socket send buffer size can be changed at runtime with `lwip_setsockopt(s, TCP_SNDBUF, ...)`.

This value must be at least 2x the MSS size, and the default is 4x the default MSS size.

Setting a smaller default SNDBUF size can save some RAM, but will decrease performance.

Range:

- from 2440 to 65535 if [CONFIG_LWIP_WND_SCALE](#)
- from 2440 to 1024000 if [CONFIG_LWIP_WND_SCALE](#)

Default value:

- 5744

CONFIG_LWIP_TCP_WND_DEFAULT

Default receive window size

Found in: [Component config](#) > [LWIP](#) > [TCP](#)

Set default TCP receive window size for new TCP sockets.

Per-socket receive window size can be changed at runtime with `lwip_setsockopt(s, TCP_WINDOW, ...)`.

Setting a smaller default receive window size can save some RAM, but will significantly decrease performance.

Range:

- from 2440 to 65535 if [CONFIG_LWIP_WND_SCALE](#)
- from 2440 to 1024000 if [CONFIG_LWIP_WND_SCALE](#)

Default value:

- 5744

CONFIG_LWIP_TCP_RECVMBOX_SIZE

Default TCP receive mail box size

Found in: [Component config](#) > [LWIP](#) > [TCP](#)

Set TCP receive mail box size. Generally bigger value means higher throughput but more memory. The recommended value is: $LWIP_TCP_WND_DEFAULT/TCP_MSS + 2$, e.g. if $LWIP_TCP_WND_DEFAULT=14360$, $TCP_MSS=1436$, then the recommended receive mail box size is $(14360/1436 + 2) = 12$.

TCP receive mail box is a per socket mail box, when the application receives packets from TCP socket, LWIP core firstly posts the packets to TCP receive mail box and the application then fetches the packets from mail box. It means LWIP can cache maximum $LWIP_TCP_RECVMBOX_SIZE$ packets for each TCP socket, so the maximum possible cached TCP packets for all TCP sockets is $LWIP_TCP_RECVMBOX_SIZE$ multiples the maximum TCP socket number. In other words, the bigger $LWIP_TCP_RECVMBOX_SIZE$ means more memory. On the other hand, if the receive mail box is too small, the mail box may be full. If the mail box is full, the LWIP drops the packets. So generally we need to make sure the TCP receive mail box is big enough to avoid packet drop between LWIP core and application.

Range:

- from 6 to 64 if [CONFIG_LWIP_WND_SCALE](#)
- from 6 to 1024 if [CONFIG_LWIP_WND_SCALE](#)

Default value:

- 6

CONFIG_LWIP_TCP_QUEUE_OOSEQ

Queue incoming out-of-order segments

Found in: [Component config](#) > [LWIP](#) > [TCP](#)

Queue incoming out-of-order segments for later use.

Disable this option to save some RAM during TCP sessions, at the expense of increased retransmissions if segments arrive out of order.

Default value:

- Yes (enabled)

CONFIG_LWIP_TCP_SACK_OUT

Support sending selective acknowledgements

Found in: [Component config](#) > [LWIP](#) > [TCP](#)

TCP will support sending selective acknowledgements (SACKs).

Default value:

- No (disabled)

CONFIG_LWIP_TCP_KEEP_CONNECTION_WHEN_IP_CHANGES

Keep TCP connections when IP changed

Found in: [Component config](#) > [LWIP](#) > [TCP](#)

This option is enabled when the following scenario happen: network dropped and reconnected, IP changes is like: 192.168.0.2->0.0.0.0->192.168.0.2

Disable this option to keep consistent with the original LWIP code behavior.

Default value:

- No (disabled)

CONFIG_LWIP_TCP_OVERSIZE

Pre-allocate transmit PBUF size

Found in: [Component config](#) > [LWIP](#) > [TCP](#)

Allows enabling “oversize” allocation of TCP transmission pbufs ahead of time, which can reduce the length of pbuf chains used for transmission.

This will not make a difference to sockets where Nagle’s algorithm is disabled.

Default value of MSS is fine for most applications, 25% MSS may save some RAM when only transmitting small amounts of data. Disabled will have worst performance and fragmentation characteristics, but uses least RAM overall.

Available options:

- MSS (LWIP_TCP_OVERSIZE_MSS)
- 25% MSS (LWIP_TCP_OVERSIZE_QUARTER_MSS)
- Disabled (LWIP_TCP_OVERSIZE_DISABLE)

CONFIG_LWIP_WND_SCALE

Support TCP window scale

Found in: [Component config](#) > [LWIP](#) > [TCP](#)

Enable this feature to support TCP window scaling.

Default value:

- No (disabled) if SPIRAM_TRY_ALLOCATE_WIFI_LWIP

CONFIG_LWIP_TCP_RCV_SCALE

Set TCP receiving window scaling factor

Found in: [Component config](#) > [LWIP](#) > [TCP](#) > [CONFIG_LWIP_WND_SCALE](#)

Enable this feature to support TCP window scaling.

Range:

- from 0 to 14 if [CONFIG_LWIP_WND_SCALE](#)

Default value:

- 0 if [CONFIG_LWIP_WND_SCALE](#)

CONFIG_LWIP_TCP_RTO_TIME

Default TCP rto time

Found in: [Component config](#) > [LWIP](#) > [TCP](#)

Set default TCP rto time for a reasonable initial rto. In bad network environment, recommend set value of rto time to 1500.

Default value:

- 3000
- 1500

UDP Contains:

- [CONFIG_LWIP_UDP_RECVMBOX_SIZE](#)
- [CONFIG_LWIP_MAX_UDP_PCBS](#)

CONFIG_LWIP_MAX_UDP_PCBS

Maximum active UDP control blocks

Found in: [Component config](#) > [LWIP](#) > [UDP](#)

The maximum number of active UDP “connections” (ie UDP sockets sending/receiving data). The practical maximum limit is determined by available heap memory at runtime.

Range:

- from 1 to 1024

Default value:

- 16

CONFIG_LWIP_UDP_RECVMBOX_SIZE

Default UDP receive mail box size

Found in: [Component config](#) > [LWIP](#) > [UDP](#)

Set UDP receive mail box size. The recommended value is 6.

UDP receive mail box is a per socket mail box, when the application receives packets from UDP socket, LWIP core firstly posts the packets to UDP receive mail box and the application then fetches the packets from mail box. It means LWIP can caches maximum UDP_RECCVMBOX_SIZE packets for each UDP socket, so the maximum possible cached UDP packets for all UDP sockets is UDP_RECCVMBOX_SIZE multiplies the maximum UDP socket number. In other words, the bigger UDP_RECVMBOX_SIZE means more memory. On the other hand, if the receive mail box is too small, the mail box may be full. If the mail box is full, the LWIP drops the packets. So generally we need to make sure the UDP receive mail box is big enough to avoid packet drop between LWIP core and application.

Range:

- from 6 to 64

Default value:

- 6

Checksums Contains:

- [CONFIG_LWIP_CHECKSUM_CHECK_ICMP](#)
- [CONFIG_LWIP_CHECKSUM_CHECK_IP](#)
- [CONFIG_LWIP_CHECKSUM_CHECK_UDP](#)

CONFIG_LWIP_CHECKSUM_CHECK_IP

Enable LWIP IP checksums

Found in: [Component config](#) > [LWIP](#) > [Checksums](#)

Enable checksum checking for received IP messages

Default value:

- No (disabled)

CONFIG_LWIP_CHECKSUM_CHECK_UDP

Enable LWIP UDP checksums

Found in: [Component config](#) > [LWIP](#) > [Checksums](#)

Enable checksum checking for received UDP messages

Default value:

- No (disabled)

CONFIG_LWIP_CHECKSUM_CHECK_ICMP

Enable LWIP ICMP checksums

Found in: [Component config](#) > [LWIP](#) > [Checksums](#)

Enable checksum checking for received ICMP messages

Default value:

- Yes (enabled)

CONFIG_LWIP_TCPIP_TASK_STACK_SIZE

TCP/IP Task Stack Size

Found in: [Component config](#) > [LWIP](#)

Configure TCP/IP task stack size, used by LWIP to process multi-threaded TCP/IP operations. Setting this stack too small will result in stack overflow crashes.

Range:

- from 2048 to 65536

Default value:

- 3072

CONFIG_LWIP_TCPIP_TASK_AFFINITY

TCP/IP task affinity

Found in: [Component config](#) > [LWIP](#)

Allows setting LwIP tasks affinity, i.e. whether the task is pinned to CPU0, pinned to CPU1, or allowed to run on any CPU. Currently this applies to “TCP/IP” task and “Ping” task.

Available options:

- No affinity (LWIP_TCPIP_TASK_AFFINITY_NO_AFFINITY)
- CPU0 (LWIP_TCPIP_TASK_AFFINITY_CPU0)
- CPU1 (LWIP_TCPIP_TASK_AFFINITY_CPU1)

CONFIG_LWIP_PPP_SUPPORT

Enable PPP support (new/experimental)

Found in: [Component config](#) > [LWIP](#)

Enable PPP stack. Now only PPP over serial is possible.

PPP over serial support is experimental and unsupported.

Default value:

- No (disabled)

Contains:

- [CONFIG_LWIP_PPP_ENABLE_IPV6](#)

CONFIG_LWIP_PPP_ENABLE_IPV6

Enable IPV6 support for PPP connections (IPV6CP)

Found in: [Component config](#) > [LWIP](#) > [CONFIG_LWIP_PPP_SUPPORT](#)

Enable IPV6 support in PPP for the local link between the DTE (processor) and DCE (modem). There are some modems which do not support the IPV6 addressing in the local link. If they are requested for IPV6CP negotiation, they may time out. This would in turn fail the configuration for the whole link. If your modem is not responding correctly to PPP Phase Network, try to disable IPV6 support.

Default value:

- Yes (enabled) if `CONFIG_LWIP_PPP_SUPPORT` && `CONFIG_LWIP_IPV6`

CONFIG_LWIP_IPV6_MEMP_NUM_ND6_QUEUE

Max number of IPv6 packets to queue during MAC resolution

Found in: [Component config](#) > [LWIP](#)

Config max number of IPv6 packets to queue during MAC resolution.

Range:

- from 3 to 20

Default value:

- 3

CONFIG_LWIP_IPV6_ND6_NUM_NEIGHBORS

Max number of entries in IPv6 neighbor cache

Found in: [Component config](#) > [LWIP](#)

Config max number of entries in IPv6 neighbor cache

Range:

- from 3 to 10

Default value:

- 5

CONFIG_LWIP_PPP_NOTIFY_PHASE_SUPPORT

Enable Notify Phase Callback

Found in: [Component config](#) > [LWIP](#)

Enable to set a callback which is called on change of the internal PPP state machine.

Default value:

- No (disabled) if `CONFIG_LWIP_PPP_SUPPORT`

CONFIG_LWIP_PPP_PAP_SUPPORT

Enable PAP support

Found in: [Component config](#) > [LWIP](#)

Enable Password Authentication Protocol (PAP) support

Default value:

- No (disabled) if `CONFIG_LWIP_PPP_SUPPORT`

CONFIG_LWIP_PPP_CHAP_SUPPORT

Enable CHAP support

Found in: [Component config](#) > [LWIP](#)

Enable Challenge Handshake Authentication Protocol (CHAP) support

Default value:

- No (disabled) if `CONFIG_LWIP_PPP_SUPPORT`

CONFIG_LWIP_PPP_MSCHAP_SUPPORT

Enable MSCHAP support

Found in: [Component config](#) > [LWIP](#)

Enable Microsoft version of the Challenge-Handshake Authentication Protocol (MSCHAP) support

Default value:

- No (disabled) if [CONFIG_LWIP_PPP_SUPPORT](#)

CONFIG_LWIP_PPP_MPPE_SUPPORT

Enable MPPE support

Found in: [Component config](#) > [LWIP](#)

Enable Microsoft Point-to-Point Encryption (MPPE) support

Default value:

- No (disabled) if [CONFIG_LWIP_PPP_SUPPORT](#)

CONFIG_LWIP_PPP_DEBUG_ON

Enable PPP debug log output

Found in: [Component config](#) > [LWIP](#)

Enable PPP debug log output

Default value:

- No (disabled) if [CONFIG_LWIP_PPP_SUPPORT](#)

CONFIG_LWIP_SLIP_SUPPORT

Enable SLIP support (new/experimental)

Found in: [Component config](#) > [LWIP](#)

Enable SLIP stack. Now only SLIP over serial is possible.

SLIP over serial support is experimental and unsupported.

Default value:

- No (disabled)

Contains:

- [CONFIG_LWIP_SLIP_DEBUG_ON](#)

CONFIG_LWIP_SLIP_DEBUG_ON

Enable SLIP debug log output

Found in: [Component config](#) > [LWIP](#) > [CONFIG_LWIP_SLIP_SUPPORT](#)

Enable SLIP debug log output

Default value:

- No (disabled) if [CONFIG_LWIP_SLIP_SUPPORT](#)

ICMP Contains:

- [CONFIG_LWIP_ICMP](#)
- [CONFIG_LWIP_BROADCAST_PING](#)
- [CONFIG_LWIP_MULTICAST_PING](#)

CONFIG_LWIP_ICMP

ICMP: Enable ICMP

Found in: [Component config](#) > [LWIP](#) > [ICMP](#)

Enable ICMP module for check network stability

Default value:

- Yes (enabled)

CONFIG_LWIP_MULTICAST_PING

Respond to multicast pings

Found in: [Component config](#) > [LWIP](#) > [ICMP](#)

Default value:

- No (disabled)

CONFIG_LWIP_BROADCAST_PING

Respond to broadcast pings

Found in: [Component config](#) > [LWIP](#) > [ICMP](#)

Default value:

- No (disabled)

LWIP RAW API

 Contains:

- [CONFIG_LWIP_MAX_RAW_PCBS](#)

CONFIG_LWIP_MAX_RAW_PCBS

Maximum LWIP RAW PCBs

Found in: [Component config](#) > [LWIP](#) > [LWIP RAW API](#)

The maximum number of simultaneously active LWIP RAW protocol control blocks. The practical maximum limit is determined by available heap memory at runtime.

Range:

- from 1 to 1024

Default value:

- 16

SNTP

 Contains:

- [CONFIG_LWIP_DHCP_MAX_NTP_SERVERS](#)
- [CONFIG_LWIP_SNTP_UPDATE_DELAY](#)

CONFIG_LWIP_DHCP_MAX_NTP_SERVERS

Maximum number of NTP servers

Found in: [Component config](#) > [LWIP](#) > [SNTP](#)

Set maximum number of NTP servers used by LwIP SNTP module. First argument of `sntp_setserver/sntp_setservername` functions is limited to this value.

Range:

- from 1 to 16

Default value:

- 1

CONFIG_LWIP_SNTP_UPDATE_DELAY

Request interval to update time (ms)

Found in: [Component config](#) > [LWIP](#) > [SNTP](#)

This option allows you to set the time update period via SNTP. Default is 1 hour. Must not be below 15 seconds by specification. (SNTPv4 RFC 4330 enforces a minimum update time of 15 seconds).

Range:

- from 15000 to 4294967295

Default value:

- 3600000

CONFIG_LWIP_ESP_LWIP_ASSERT

Enable LWIP ASSERT checks

Found in: [Component config](#) > [LWIP](#)

Enable this option keeps LWIP assertion checks enabled. It is recommended to keep this option enabled.

If asserts are disabled for the entire project, they are also disabled for LWIP and this option is ignored.

Default value:

- Yes (enabled) if COMPILER_OPTIMIZATION_ASSERTIONS_DISABLE

Hooks Contains:

- [CONFIG_LWIP_HOOK_IP6_ROUTE](#)
- [CONFIG_LWIP_HOOK_NETCONN_EXTERNAL_RESOLVE](#)
- [CONFIG_LWIP_HOOK_TCP_ISN](#)

CONFIG_LWIP_HOOK_TCP_ISN

TCP ISN Hook

Found in: [Component config](#) > [LWIP](#) > [Hooks](#)

Enables to define a TCP ISN hook to randomize initial sequence number in TCP connection. The default TCP ISN algorithm used in IDF (standardized in RFC 6528) produces ISN by combining an MD5 of the new TCP id and a stable secret with the current time. This is because the lwIP implementation (*tcp_next_isn*) is not very strong, as it does not take into consideration any platform specific entropy source.

Set to `LWIP_HOOK_TCP_ISN_CUSTOM` to provide custom implementation. Set to `LWIP_HOOK_TCP_ISN_NONE` to use lwIP implementation.

Available options:

- No hook declared (`LWIP_HOOK_TCP_ISN_NONE`)
- Default implementation (`LWIP_HOOK_TCP_ISN_DEFAULT`)
- Custom implementation (`LWIP_HOOK_TCP_ISN_CUSTOM`)

CONFIG_LWIP_HOOK_IP6_ROUTE

IPv6 route Hook

Found in: [Component config](#) > [LWIP](#) > [Hooks](#)

Enables custom IPv6 route hook. Setting this to “default” provides weak implementation stub that could be overwritten in application code. Setting this to “custom” provides hook’s declaration only and expects the application to implement it.

Available options:

- No hook declared (LWIP_HOOK_IP6_ROUTE_NONE)
- Default (weak) implementation (LWIP_HOOK_IP6_ROUTE_DEFAULT)
- Custom implementation (LWIP_HOOK_IP6_ROUTE_CUSTOM)

CONFIG_LWIP_HOOK_NETCONN_EXTERNAL_RESOLVE

Netconn external resolve Hook

Found in: [Component config](#) > [LWIP](#) > [Hooks](#)

Enables custom DNS resolve hook. Setting this to “default” provides weak implementation stub that could be overwritten in application code. Setting this to “custom” provides hook’s declaration only and expects the application to implement it.

Available options:

- No hook declared (LWIP_HOOK_NETCONN_EXT_RESOLVE_NONE)
- Default (weak) implementation (LWIP_HOOK_NETCONN_EXT_RESOLVE_DEFAULT)
- Custom implementation (LWIP_HOOK_NETCONN_EXT_RESOLVE_CUSTOM)

CONFIG_LWIP_DEBUG

Enable LWIP Debug

Found in: [Component config](#) > [LWIP](#)

Default value:

- No (disabled)

Contains:

- [CONFIG_LWIP_API_LIB_DEBUG](#)
- [CONFIG_LWIP_DHCP_DEBUG](#)
- [CONFIG_LWIP_DHCP_STATE_DEBUG](#)
- [CONFIG_LWIP_ETHARP_DEBUG](#)
- [CONFIG_LWIP_ICMP_DEBUG](#)
- [CONFIG_LWIP_ICMP6_DEBUG](#)
- [CONFIG_LWIP_IP_DEBUG](#)
- [CONFIG_LWIP_IP6_DEBUG](#)
- [CONFIG_LWIP_NETIF_DEBUG](#)
- [CONFIG_LWIP_PBUF_DEBUG](#)
- [CONFIG_LWIP_SOCKETS_DEBUG](#)
- [CONFIG_LWIP_TCP_DEBUG](#)
- [CONFIG_LWIP_DEBUG_ESP_LOG](#)

CONFIG_LWIP_DEBUG_ESP_LOG

Route LWIP debugs through ESP_LOG interface

Found in: [Component config](#) > [LWIP](#) > [CONFIG_LWIP_DEBUG](#)

Enabling this option routes all enabled LWIP debugs through ESP_LOGD.

Default value:

- No (disabled) if [CONFIG_LWIP_DEBUG](#)

CONFIG_LWIP_NETIF_DEBUG

Enable netif debug messages

Found in: [Component config](#) > [LWIP](#) > [CONFIG_LWIP_DEBUG](#)

Default value:

- No (disabled) if `CONFIG_LWIP_DEBUG`

CONFIG_LWIP_PBUF_DEBUG

Enable pbuf debug messages

Found in: [Component config](#) > [LWIP](#) > [CONFIG_LWIP_DEBUG](#)

Default value:

- No (disabled) if `CONFIG_LWIP_DEBUG`

CONFIG_LWIP_ETHARP_DEBUG

Enable etharp debug messages

Found in: [Component config](#) > [LWIP](#) > [CONFIG_LWIP_DEBUG](#)

Default value:

- No (disabled) if `CONFIG_LWIP_DEBUG`

CONFIG_LWIP_API_LIB_DEBUG

Enable api lib debug messages

Found in: [Component config](#) > [LWIP](#) > [CONFIG_LWIP_DEBUG](#)

Default value:

- No (disabled) if `CONFIG_LWIP_DEBUG`

CONFIG_LWIP_SOCKETS_DEBUG

Enable socket debug messages

Found in: [Component config](#) > [LWIP](#) > [CONFIG_LWIP_DEBUG](#)

Default value:

- No (disabled) if `CONFIG_LWIP_DEBUG`

CONFIG_LWIP_IP_DEBUG

Enable IP debug messages

Found in: [Component config](#) > [LWIP](#) > [CONFIG_LWIP_DEBUG](#)

Default value:

- No (disabled) if `CONFIG_LWIP_DEBUG`

CONFIG_LWIP_ICMP_DEBUG

Enable ICMP debug messages

Found in: [Component config](#) > [LWIP](#) > [CONFIG_LWIP_DEBUG](#)

Default value:

- No (disabled) if `CONFIG_LWIP_DEBUG` && `CONFIG_LWIP_ICMP`

CONFIG_LWIP_DHCP_STATE_DEBUG

Enable DHCP state tracking

Found in: [Component config](#) > [LWIP](#) > [CONFIG_LWIP_DEBUG](#)

Default value:

- No (disabled) if `CONFIG_LWIP_DEBUG`

CONFIG_LWIP_DHCP_DEBUG

Enable DHCP debug messages

Found in: Component config > LWIP > CONFIG_LWIP_DEBUG

Default value:

- No (disabled) if *CONFIG_LWIP_DEBUG*

CONFIG_LWIP_IP6_DEBUG

Enable IP6 debug messages

Found in: Component config > LWIP > CONFIG_LWIP_DEBUG

Default value:

- No (disabled) if *CONFIG_LWIP_DEBUG*

CONFIG_LWIP_ICMP6_DEBUG

Enable ICMP6 debug messages

Found in: Component config > LWIP > CONFIG_LWIP_DEBUG

Default value:

- No (disabled) if *CONFIG_LWIP_DEBUG*

CONFIG_LWIP_TCP_DEBUG

Enable TCP debug messages

Found in: Component config > LWIP > CONFIG_LWIP_DEBUG

Default value:

- No (disabled) if *CONFIG_LWIP_DEBUG*

mbedtls Contains:

- *CONFIG_MBEDTLS_ASYMMETRIC_CONTENT_LEN*
- *Certificate Bundle*
- *Certificates*
- *CONFIG_MBEDTLS_CHACHA20_C*
- *CONFIG_MBEDTLS_ECP_C*
- *CONFIG_MBEDTLS_CMAC_C*
- *CONFIG_MBEDTLS_ECDSA_DETERMINISTIC*
- *CONFIG_MBEDTLS_HARDWARE_AES*
- *CONFIG_MBEDTLS_ATCA_HW_ECDSA_SIGN*
- *CONFIG_MBEDTLS_ATCA_HW_ECDSA_VERIFY*
- *CONFIG_MBEDTLS_HARDWARE_MPI*
- *CONFIG_MBEDTLS_HARDWARE_SHA*
- *CONFIG_MBEDTLS_DEBUG*
- *CONFIG_MBEDTLS_ECP_RESTARTABLE*
- *CONFIG_MBEDTLS_HAVE_TIME*
- *CONFIG_MBEDTLS_RIPEMD160_C*
- *CONFIG_MBEDTLS_SHA512_C*
- *CONFIG_MBEDTLS_THREADING_C*
- *CONFIG_MBEDTLS_X509_CHECK_EXTENDED_KEY_USAGE*
- *CONFIG_MBEDTLS_X509_CHECK_KEY_USAGE*
- *CONFIG_MBEDTLS_LARGE_KEY_SOFTWARE_MPI*
- *CONFIG_MBEDTLS_HKDF_C*
- *CONFIG_MBEDTLS_SSL_PROTO_SSL3*
- *mbedtls v2.28.x related*

- `CONFIG_MBEDTLS_MEM_ALLOC_MODE`
- `CONFIG_MBEDTLS_POLY1305_C`
- `CONFIG_MBEDTLS_SECURITY_RISKS`
- `CONFIG_MBEDTLS_SSL_ALPN`
- `CONFIG_MBEDTLS_SSL_PROTO_DTLS`
- `CONFIG_MBEDTLS_SSL_PROTO_TLS1`
- `CONFIG_MBEDTLS_SSL_PROTO_TLS1_1`
- `CONFIG_MBEDTLS_SSL_PROTO_TLS1_2`
- `CONFIG_MBEDTLS_SSL_RENEGOTIATION`
- *Symmetric Ciphers*
- *TLS Key Exchange Methods*
- `CONFIG_MBEDTLS_SSL_MAX_CONTENT_LEN`
- `CONFIG_MBEDTLS_TLS_MODE`
- `CONFIG_MBEDTLS_CLIENT_SSL_SESSION_TICKETS`
- `CONFIG_MBEDTLS_SERVER_SSL_SESSION_TICKETS`
- `CONFIG_MBEDTLS_ROM_MD5`
- `CONFIG_MBEDTLS_DYNAMIC_BUFFER`

CONFIG_MBEDTLS_MEM_ALLOC_MODE

Memory allocation strategy

Found in: `Component config > mbedTLS`

Allocation strategy for mbedTLS, essentially provides ability to allocate all required dynamic allocations from,

- Internal DRAM memory only
- External SPIRAM memory only
- Either internal or external memory based on default `malloc()` behavior in ESP-IDF
- Custom allocation mode, by overwriting `calloc()/free()` using `mbedtls_platform_set_calloc_free()` function
- Internal IRAM memory wherever applicable else internal DRAM

Recommended mode here is always internal (*), since that is most preferred from security perspective. But if application requirement does not allow sufficient free internal memory then alternate mode can be selected.

(*) In case of ESP32-S2/ESP32-S3, hardware allows encryption of external SPIRAM contents provided hardware flash encryption feature is enabled. In that case, using external SPIRAM allocation strategy is also safe choice from security perspective.

Available options:

- Internal memory (`MBEDTLS_INTERNAL_MEM_ALLOC`)
- External SPIRAM (`MBEDTLS_EXTERNAL_MEM_ALLOC`)
- Default alloc mode (`MBEDTLS_DEFAULT_MEM_ALLOC`)
- Custom alloc mode (`MBEDTLS_CUSTOM_MEM_ALLOC`)
- Internal IRAM (`MBEDTLS_IRAM_8BIT_MEM_ALLOC`)
Allows to use IRAM memory region as 8bit accessible region.
TLS input and output buffers will be allocated in IRAM section which is 32bit aligned memory. Every unaligned (8bit or 16bit) access will result in an exception and incur penalty of certain clock cycles per unaligned read/write.

CONFIG_MBEDTLS_SSL_MAX_CONTENT_LEN

TLS maximum message content length

Found in: `Component config > mbedTLS`

Maximum TLS message length (in bytes) supported by mbedTLS.

16384 is the default and this value is required to comply fully with TLS standards.

However you can set a lower value in order to save RAM. This is safe if the other end of the connection supports Maximum Fragment Length Negotiation Extension (`max_fragment_length`, see RFC6066) or you know for certain that it will never send a message longer than a certain number of bytes.

If the value is set too low, symptoms are a failed TLS handshake or a return value of `MBEDTLS_ERR_SSL_INVALID_RECORD` (-0x7200).

Range:

- from 512 to 16384

Default value:

- 16384

CONFIG_MBEDTLS_ASYMMETRIC_CONTENT_LEN

Asymmetric in/out fragment length

Found in: [Component config](#) > [mbedtls](#)

If enabled, this option allows customizing TLS in/out fragment length in asymmetric way. Please note that enabling this with default values saves 12KB of dynamic memory per TLS connection.

Default value:

- Yes (enabled)

CONFIG_MBEDTLS_SSL_IN_CONTENT_LEN

TLS maximum incoming fragment length

Found in: [Component config](#) > [mbedtls](#) > [CONFIG_MBEDTLS_ASYMMETRIC_CONTENT_LEN](#)

This defines maximum incoming fragment length, overriding default maximum content length (`MBEDTLS_SSL_MAX_CONTENT_LEN`).

Range:

- from 512 to 16384

Default value:

- 16384

CONFIG_MBEDTLS_SSL_OUT_CONTENT_LEN

TLS maximum outgoing fragment length

Found in: [Component config](#) > [mbedtls](#) > [CONFIG_MBEDTLS_ASYMMETRIC_CONTENT_LEN](#)

This defines maximum outgoing fragment length, overriding default maximum content length (`MBEDTLS_SSL_MAX_CONTENT_LEN`).

Range:

- from 512 to 16384

Default value:

- 4096

CONFIG_MBEDTLS_DYNAMIC_BUFFER

Using dynamic TX/RX buffer

Found in: [Component config](#) > [mbedtls](#)

Using dynamic TX/RX buffer. After enabling this option, mbedtls will allocate TX buffer when need to send data and then free it if all data is sent, allocate RX buffer when need to receive data and then free it when all data is used or read by upper layer.

By default, when SSL is initialized, mbedTLS also allocate TX and RX buffer with the default value of “MBEDTLS_SSL_OUT_CONTENT_LEN” or “MBEDTLS_SSL_IN_CONTENT_LEN” , so to save more heap, users can set the options to be an appropriate value.

Default value:

- No (disabled) if `CONFIG_MBEDTLS_SSL_PROTO_DTLS` && `CONFIG_MBEDTLS_SSL_VARIABLE_BUFFER_LENGTH`

CONFIG_MBEDTLS_DYNAMIC_FREE_PEER_CERT

Free SSL peer certificate after its usage

Found in: `Component config > mbedTLS > CONFIG_MBEDTLS_DYNAMIC_BUFFER`

Free peer certificate after its usage in handshake process.

Default value:

- No (disabled) if `CONFIG_MBEDTLS_DYNAMIC_BUFFER`

CONFIG_MBEDTLS_DYNAMIC_FREE_CONFIG_DATA

Free private key and DHM data after its usage

Found in: `Component config > mbedTLS > CONFIG_MBEDTLS_DYNAMIC_BUFFER`

Free private key and DHM data after its usage in handshake process.

The option will decrease heap cost when handshake, but also lead to problem:

Because all certificate, private key and DHM data are freed so users should register certificate and private key to ssl config object again.

Default value:

- No (disabled) if `CONFIG_MBEDTLS_DYNAMIC_BUFFER`

CONFIG_MBEDTLS_DYNAMIC_FREE_CA_CERT

Free SSL CA certificate after its usage

Found in: `Component config > mbedTLS > CONFIG_MBEDTLS_DYNAMIC_BUFFER > CONFIG_MBEDTLS_DYNAMIC_FREE_CONFIG_DATA`

Free CA certificate after its usage in the handshake process. This option will decrease the heap footprint for the TLS handshake, but may lead to a problem: If the respective ssl object needs to perform the TLS handshake again, the CA certificate should once again be registered to the ssl object.

Default value:

- Yes (enabled) if `CONFIG_MBEDTLS_DYNAMIC_FREE_CONFIG_DATA`

CONFIG_MBEDTLS_DEBUG

Enable mbedTLS debugging

Found in: `Component config > mbedTLS`

Enable mbedTLS debugging functions at compile time.

If this option is enabled, you can include “mbedtls/esp_debug.h” and call `mbedtls_esp_enable_debug_log()` at runtime in order to enable mbedTLS debug output via the ESP log mechanism.

Default value:

- No (disabled)

CONFIG_MBEDTLS_DEBUG_LEVEL

Set mbedTLS debugging level

Found in: [Component config](#) > [mbedtls](#) > [CONFIG_MBEDTLS_DEBUG](#)

Set mbedTLS debugging level

Available options:

- Warning (MBEDTLS_DEBUG_LEVEL_WARN)
- Info (MBEDTLS_DEBUG_LEVEL_INFO)
- Debug (MBEDTLS_DEBUG_LEVEL_DEBUG)
- Verbose (MBEDTLS_DEBUG_LEVEL_VERBOSE)

mbedtls v2.28.x related Contains:

- [DTLS-based configurations](#)
- [CONFIG_MBEDTLS_SSL_CONTEXT_SERIALIZATION](#)
- [CONFIG_MBEDTLS_X509_TRUSTED_CERT_CALLBACK](#)
- [CONFIG_MBEDTLS_SSL_KEEP_PEER_CERTIFICATE](#)
- [CONFIG_MBEDTLS_ECDH_LEGACY_CONTEXT](#)
- [CONFIG_MBEDTLS_SSL_VARIABLE_BUFFER_LENGTH](#)

CONFIG_MBEDTLS_SSL_VARIABLE_BUFFER_LENGTH

Variable SSL buffer length

Found in: [Component config](#) > [mbedtls](#) > [mbedtls v2.28.x related](#)

This enables the SSL buffer to be resized automatically based on the negotiated maximum fragment length in each direction.

Default value:

- No (disabled)

CONFIG_MBEDTLS_ECDH_LEGACY_CONTEXT

Use a backward compatible ECDH context (Experimental)

Found in: [Component config](#) > [mbedtls](#) > [mbedtls v2.28.x related](#)

Use the legacy ECDH context format. Define this option only if you enable MBEDTLS_ECP_RESTARTABLE or if you want to access ECDH context fields directly.

Default value:

- Yes (enabled) if `CONFIG_MBEDTLS_ECDH_C` && `CONFIG_MBEDTLS_ECP_RESTARTABLE`

CONFIG_MBEDTLS_X509_TRUSTED_CERT_CALLBACK

Enable trusted certificate callbacks

Found in: [Component config](#) > [mbedtls](#) > [mbedtls v2.28.x related](#)

Enables users to configure the set of trusted certificates through a callback instead of a linked list.

See mbedtls documentation for required API and more details.

Default value:

- No (disabled)

CONFIG_MBEDTLS_SSL_CONTEXT_SERIALIZATION

Enable serialization of the TLS context structures

Found in: [Component config](#) > [mbedtls](#) > [mbedtls v2.28.x related](#)

Enable serialization of the TLS context structures This is a local optimization in handling a single, potentially long-lived connection.

See mbedtls documentation for required API and more details. Disabling this option will save some code size.

Default value:

- No (disabled)

CONFIG_MBEDTLS_SSL_KEEP_PEER_CERTIFICATE

Keep peer certificate after handshake completion

Found in: [Component config](#) > [mbedtls](#) > [mbedtls v2.28.x related](#)

Keep the peer's certificate after completion of the handshake. Disabling this option will save about 4kB of heap and some code size.

See mbedtls documentation for required API and more details.

Default value:

- Yes (enabled) if [CONFIG_MBEDTLS_DYNAMIC_FREE_PEER_CERT](#)

DTLS-based configurations Contains:

- [CONFIG_MBEDTLS_SSL_DTLS_SRTP](#)
- [CONFIG_MBEDTLS_SSL_DTLS_CONNECTION_ID](#)

CONFIG_MBEDTLS_SSL_DTLS_CONNECTION_ID

Support for the DTLS Connection ID extension

Found in: [Component config](#) > [mbedtls](#) > [mbedtls v2.28.x related](#) > [DTLS-based configurations](#)

Enable support for the DTLS Connection ID extension which allows to identify DTLS connections across changes in the underlying transport. The Connection ID extension is still in draft state. Refer: version draft-ietf-tls-dtls-connection-id-05

Default value:

- No (disabled) if [CONFIG_MBEDTLS_SSL_PROTO_DTLS](#)

CONFIG_MBEDTLS_SSL_CID_IN_LEN_MAX

Maximum length of CIDs used for incoming DTLS messages

Found in: [Component config](#) > [mbedtls](#) > [mbedtls v2.28.x related](#) > [DTLS-based configurations](#) > [CONFIG_MBEDTLS_SSL_DTLS_CONNECTION_ID](#)

Maximum length of CIDs used for incoming DTLS messages

Range:

- from 0 to 32 if [CONFIG_MBEDTLS_SSL_DTLS_CONNECTION_ID](#)

Default value:

- 32 if [CONFIG_MBEDTLS_SSL_DTLS_CONNECTION_ID](#)

CONFIG_MBEDTLS_SSL_CID_OUT_LEN_MAX

Maximum length of CIDs used for outgoing DTLS messages

Found in: [Component config](#) > [mbedtls](#) > [mbedtls v2.28.x related](#) > [DTLS-based configurations](#) > [CONFIG_MBEDTLS_SSL_DTLS_CONNECTION_ID](#)

Maximum length of CIDs used for outgoing DTLS messages

Range:

- from 0 to 32 if [CONFIG_MBEDTLS_SSL_DTLS_CONNECTION_ID](#)

Default value:

- 32 if [CONFIG_MBEDTLS_SSL_DTLS_CONNECTION_ID](#)

CONFIG_MBEDTLS_SSL_CID_PADDING_GRANULARITY

Record plaintext padding (for DTLS 1.2)

Found in: [Component config](#) > [mbedtls](#) > [mbedtls v2.28.x related](#) > [DTLS-based configurations](#) > [CONFIG_MBEDTLS_SSL_DTLS_CONNECTION_ID](#)

Controls the use of record plaintext padding when using the Connection ID extension in DTLS 1.2.

The padding will always be chosen so that the length of the padded plaintext is a multiple of the value of this option.

Notes: A value of 1 means that no padding will be used for outgoing records. On systems lacking division instructions, a power of two should be preferred.

Range:

- from 0 to 32 if [CONFIG_MBEDTLS_SSL_DTLS_CONNECTION_ID](#)

Default value:

- 16 if [CONFIG_MBEDTLS_SSL_DTLS_CONNECTION_ID](#)

CONFIG_MBEDTLS_SSL_DTLS_SRTP

Enable support for negotiation of DTLS-SRTP (RFC 5764)

Found in: [Component config](#) > [mbedtls](#) > [mbedtls v2.28.x related](#) > [DTLS-based configurations](#)

Enable support for negotiation of DTLS-SRTP (RFC 5764) through the use_srtp extension.

See mbedtls documentation for required API and more details. Disabling this option will save some code size.

Default value:

- No (disabled) if [CONFIG_MBEDTLS_SSL_PROTO_DTLS](#)

Certificate Bundle Contains:

- [CONFIG_MBEDTLS_CERTIFICATE_BUNDLE](#)

CONFIG_MBEDTLS_CERTIFICATE_BUNDLE

Enable trusted root certificate bundle

Found in: [Component config](#) > [mbedtls](#) > [Certificate Bundle](#)

Enable support for large number of default root certificates

When enabled this option allows user to store default as well as customer specific root certificates in compressed format rather than storing full certificate. For the root certificates the public key and the subject name will be stored.

Default value:

- Yes (enabled)

CONFIG_MBEDTLS_DEFAULT_CERTIFICATE_BUNDLE

Default certificate bundle options

Found in: [Component config](#) > [mbedtls](#) > [Certificate Bundle](#) > [CONFIG_MBEDTLS_CERTIFICATE_BUNDLE](#)

Available options:

- Use the full default certificate bundle (MBEDTLS_CERTIFICATE_BUNDLE_DEFAULT_FULL)
- Use only the most common certificates from the default bundles (MBEDTLS_CERTIFICATE_BUNDLE_DEFAULT_CMN)
Use only the most common certificates from the default bundles, reducing the size with 50%, while still having around 99% coverage.
- Do not use the default certificate bundle (MBEDTLS_CERTIFICATE_BUNDLE_DEFAULT_NONE)

CONFIG_MBEDTLS_CUSTOM_CERTIFICATE_BUNDLE

Add custom certificates to the default bundle

Found in: [Component config](#) > [mbedtls](#) > [Certificate Bundle](#) > [CONFIG_MBEDTLS_CERTIFICATE_BUNDLE](#)

Default value:

- No (disabled)

CONFIG_MBEDTLS_CUSTOM_CERTIFICATE_BUNDLE_PATH

Custom certificate bundle path

Found in: [Component config](#) > [mbedtls](#) > [Certificate Bundle](#) > [CONFIG_MBEDTLS_CERTIFICATE_BUNDLE](#) > [CONFIG_MBEDTLS_CUSTOM_CERTIFICATE_BUNDLE](#)

Name of the custom certificate directory or file. This path is evaluated relative to the project root directory.

CONFIG_MBEDTLS_CERTIFICATE_BUNDLE_MAX_CERTS

Maximum no of certificates allowed in certificate bundle

Found in: [Component config](#) > [mbedtls](#) > [Certificate Bundle](#) > [CONFIG_MBEDTLS_CERTIFICATE_BUNDLE](#)

Default value:

- 200

CONFIG_MBEDTLS_ECP_RESTARTABLE

Enable mbedtls ecp restartable

Found in: [Component config](#) > [mbedtls](#)

Enable “non-blocking” ECC operations that can return early and be resumed.

Default value:

- No (disabled)

CONFIG_MBEDTLS_CMAC_C

Enable CMAC mode for block ciphers

Found in: [Component config](#) > [mbedtls](#)

Enable the CMAC (Cipher-based Message Authentication Code) mode for block ciphers.

Default value:

- No (disabled)

CONFIG_MBEDTLS_HARDWARE_AES

Enable hardware AES acceleration

Found in: [Component config](#) > [mbedtls](#)

Enable hardware accelerated AES encryption & decryption.

Note that if the ESP32 CPU is running at 240MHz, hardware AES does not offer any speed boost over software AES.

Default value:

- Yes (enabled) if SPIRAM_CACHE_WORKAROUND_STRATEGY_DUPLDST

CONFIG_MBEDTLS_HARDWARE_MPI

Enable hardware MPI (bignum) acceleration

Found in: [Component config](#) > [mbedtls](#)

Enable hardware accelerated multiple precision integer operations.

Hardware accelerated multiplication, modulo multiplication, and modular exponentiation for up to SOC_RSA_MAX_BIT_LEN bit results.

These operations are used by RSA.

Default value:

- Yes (enabled) if SPIRAM_CACHE_WORKAROUND_STRATEGY_DUPLDST

CONFIG_MBEDTLS_HARDWARE_SHA

Enable hardware SHA acceleration

Found in: [Component config](#) > [mbedtls](#)

Enable hardware accelerated SHA1, SHA256, SHA384 & SHA512 in mbedtls.

Due to a hardware limitation, on the ESP32 hardware acceleration is only guaranteed if SHA digests are calculated one at a time. If more than one SHA digest is calculated at the same time, one will be calculated fully in hardware and the rest will be calculated (at least partially calculated) in software. This happens automatically.

SHA hardware acceleration is faster than software in some situations but slower in others. You should benchmark to find the best setting for you.

Default value:

- Yes (enabled) if SPIRAM_CACHE_WORKAROUND_STRATEGY_DUPLDST

CONFIG_MBEDTLS_ROM_MD5

Use MD5 implementation in ROM

Found in: [Component config](#) > [mbedtls](#)

Use ROM MD5 in mbedtls.

Default value:

- Yes (enabled)

CONFIG_MBEDTLS_ATCA_HW_ECDSA_SIGN

Enable hardware ECDSA sign acceleration when using ATECC608A

Found in: [Component config](#) > [mbedtls](#)

This option enables hardware acceleration for ECDSA sign function, only when using ATECC608A cryptoauth chip (integrated with ESP32-WROOM-32SE)

Default value:

- No (disabled)

CONFIG_MBEDTLS_ATCA_HW_ECDSA_VERIFY

Enable hardware ECDSA verify acceleration when using ATECC608A

Found in: [Component config](#) > [mbedtls](#)

This option enables hardware acceleration for ECDSA sign function, only when using ATECC608A cryptoauth chip (integrated with ESP32-WROOM-32SE)

Default value:

- No (disabled)

CONFIG_MBEDTLS_HAVE_TIME

Enable mbedtls time support

Found in: [Component config](#) > [mbedtls](#)

Enable use of time.h functions (time() and gmtime()) by mbedtls.

This option doesn't require the system time to be correct, but enables functionality that requires relative timekeeping - for example periodic expiry of TLS session tickets or session cache entries.

Disabling this option will save some firmware size, particularly if the rest of the firmware doesn't call any standard timekeeping functions.

Default value:

- Yes (enabled)

CONFIG_MBEDTLS_HAVE_TIME_DATE

Enable mbedtls certificate expiry check

Found in: [Component config](#) > [mbedtls](#) > [CONFIG_MBEDTLS_HAVE_TIME](#)

Enables X.509 certificate expiry checks in mbedtls.

If this option is disabled (default) then X.509 certificate "valid from" and "valid to" timestamp fields are ignored.

If this option is enabled, these fields are compared with the current system date and time. The time is retrieved using the standard time() and gmtime() functions. If the certificate is not valid for the current system time then verification will fail with code MBEDTLS_X509_BADCERT_FUTURE or MBEDTLS_X509_BADCERT_EXPIRED.

Enabling this option requires adding functionality in the firmware to set the system clock to a valid timestamp before using TLS. The recommended way to do this is via ESP-IDF's SNTP functionality, but any method can be used.

In the case where only a small number of certificates are trusted by the device, please carefully consider the tradeoffs of enabling this option. There may be undesired consequences, for example if all trusted certificates expire while the device is offline and a TLS connection is required to update. Or if an issue with the SNTP server means that the system time is invalid for an extended period after a reset.

Default value:

- No (disabled)

CONFIG_MBEDTLS_ECDSA_DETERMINISTIC

Enable deterministic ECDSA

Found in: [Component config](#) > [mbedtls](#)

Standard ECDSA is “fragile” in the sense that lack of entropy when signing may result in a compromise of the long-term signing key.

Default value:

- Yes (enabled)

CONFIG_MBEDTLS_SHA512_C

Enable the SHA-384 and SHA-512 cryptographic hash algorithms

Found in: [Component config](#) > [mbedtls](#)

Enable MBEDTLS_SHA512_C adds support for SHA-384 and SHA-512.

Default value:

- Yes (enabled)

CONFIG_MBEDTLS_TLS_MODE

TLS Protocol Role

Found in: [Component config](#) > [mbedtls](#)

mbedtls can be compiled with protocol support for the TLS server, TLS client, or both server and client.

Reducing the number of TLS roles supported saves code size.

Available options:

- Server & Client (MBEDTLS_TLS_SERVER_AND_CLIENT)
- Server (MBEDTLS_TLS_SERVER_ONLY)
- Client (MBEDTLS_TLS_CLIENT_ONLY)
- None (MBEDTLS_TLS_DISABLED)

TLS Key Exchange Methods

 Contains:

- [CONFIG_MBEDTLS_KEY_EXCHANGE_DHE_RSA](#)
- [CONFIG_MBEDTLS_KEY_EXCHANGE_ECJPAKE](#)
- [CONFIG_MBEDTLS_PSK_MODES](#)
- [CONFIG_MBEDTLS_KEY_EXCHANGE_RSA](#)
- [CONFIG_MBEDTLS_KEY_EXCHANGE_ELLIPTIC_CURVE](#)

CONFIG_MBEDTLS_PSK_MODES

Enable pre-shared-key ciphersuites

Found in: [Component config](#) > [mbedtls](#) > [TLS Key Exchange Methods](#)

Enable to show configuration for different types of pre-shared-key TLS authentication methods.

Leaving this options disabled will save code size if they are not used.

Default value:

- No (disabled)

CONFIG_MBEDTLS_KEY_EXCHANGE_PSK

Enable PSK based ciphersuite modes

Found in: [Component config](#) > [mbedtls](#) > [TLS Key Exchange Methods](#) > [CONFIG_MBEDTLS_PSK_MODES](#)

Enable to support symmetric key PSK (pre-shared-key) TLS key exchange modes.

Default value:

- No (disabled) if [CONFIG_MBEDTLS_PSK_MODES](#)

CONFIG_MBEDTLS_KEY_EXCHANGE_DHE_PSK

Enable DHE-PSK based ciphersuite modes

Found in: [Component config](#) > [mbedtls](#) > [TLS Key Exchange Methods](#) > [CONFIG_MBEDTLS_PSK_MODES](#)

Enable to support Diffie-Hellman PSK (pre-shared-key) TLS authentication modes.

Default value:

- Yes (enabled) if [CONFIG_MBEDTLS_PSK_MODES](#)

CONFIG_MBEDTLS_KEY_EXCHANGE_ECDHE_PSK

Enable ECDHE-PSK based ciphersuite modes

Found in: [Component config](#) > [mbedtls](#) > [TLS Key Exchange Methods](#) > [CONFIG_MBEDTLS_PSK_MODES](#)

Enable to support Elliptic-Curve-Diffie-Hellman PSK (pre-shared-key) TLS authentication modes.

Default value:

- Yes (enabled) if [CONFIG_MBEDTLS_PSK_MODES](#) && [CONFIG_MBEDTLS_ECDH_C](#)

CONFIG_MBEDTLS_KEY_EXCHANGE_RSA_PSK

Enable RSA-PSK based ciphersuite modes

Found in: [Component config](#) > [mbedtls](#) > [TLS Key Exchange Methods](#) > [CONFIG_MBEDTLS_PSK_MODES](#)

Enable to support RSA PSK (pre-shared-key) TLS authentication modes.

Default value:

- Yes (enabled) if [CONFIG_MBEDTLS_PSK_MODES](#)

CONFIG_MBEDTLS_KEY_EXCHANGE_RSA

Enable RSA-only based ciphersuite modes

Found in: [Component config](#) > [mbedtls](#) > [TLS Key Exchange Methods](#)

Enable to support ciphersuites with prefix TLS-RSA-WITH-

Default value:

- Yes (enabled)

CONFIG_MBEDTLS_KEY_EXCHANGE_DHE_RSA

Enable DHE-RSA based ciphersuite modes

Found in: [Component config](#) > [mbedtls](#) > [TLS Key Exchange Methods](#)

Enable to support ciphersuites with prefix TLS-DHE-RSA-WITH-

Default value:

- Yes (enabled)

CONFIG_MBEDTLS_KEY_EXCHANGE_ELLIPTIC_CURVE

Support Elliptic Curve based ciphersuites

Found in: [Component config](#) > [mbedtls](#) > [TLS Key Exchange Methods](#)

Enable to show Elliptic Curve based ciphersuite mode options.

Disabling all Elliptic Curve ciphersuites saves code size and can give slightly faster TLS handshakes, provided the server supports RSA-only ciphersuite modes.

Default value:

- Yes (enabled)

CONFIG_MBEDTLS_KEY_EXCHANGE_ECDHE_RSA

Enable ECDHE-RSA based ciphersuite modes

Found in: [Component config](#) > [mbedtls](#) > [TLS Key Exchange Methods](#) > [CONFIG_MBEDTLS_KEY_EXCHANGE_ELLIPTIC_CURVE](#)

Enable to support ciphersuites with prefix TLS-ECDHE-RSA-WITH-

Default value:

- Yes (enabled)

CONFIG_MBEDTLS_KEY_EXCHANGE_ECDHE_ECDSA

Enable ECDHE-ECDSA based ciphersuite modes

Found in: [Component config](#) > [mbedtls](#) > [TLS Key Exchange Methods](#) > [CONFIG_MBEDTLS_KEY_EXCHANGE_ELLIPTIC_CURVE](#)

Enable to support ciphersuites with prefix TLS-ECDHE-RSA-WITH-

Default value:

- Yes (enabled)

CONFIG_MBEDTLS_KEY_EXCHANGE_ECDH_ECDSA

Enable ECDH-ECDSA based ciphersuite modes

Found in: [Component config](#) > [mbedtls](#) > [TLS Key Exchange Methods](#) > [CONFIG_MBEDTLS_KEY_EXCHANGE_ELLIPTIC_CURVE](#)

Enable to support ciphersuites with prefix TLS-ECDHE-RSA-WITH-

Default value:

- Yes (enabled)

CONFIG_MBEDTLS_KEY_EXCHANGE_ECDH_RSA

Enable ECDH-RSA based ciphersuite modes

Found in: [Component config](#) > [mbedtls](#) > [TLS Key Exchange Methods](#) > [CONFIG_MBEDTLS_KEY_EXCHANGE_ELLIPTIC_CURVE](#)

Enable to support ciphersuites with prefix TLS-ECDHE-RSA-WITH-

Default value:

- Yes (enabled)

CONFIG_MBEDTLS_KEY_EXCHANGE_ECJPAKE

Enable ECJPAKE based ciphersuite modes

Found in: [Component config](#) > [mbedtls](#) > [TLS Key Exchange Methods](#)

Enable to support ciphersuites with prefix TLS-ECJPAKE-WITH-

Default value:

- No (disabled) if `CONFIG_MBEDTLS_ECJPAKE_C` && `CONFIG_MBEDTLS_ECP_DP_SECP256R1_ENABLED`

CONFIG_MBEDTLS_SSL_RENEGOTIATION

Support TLS renegotiation

Found in: [Component config](#) > [mbedtls](#)

The two main uses of renegotiation are (1) refresh keys on long-lived connections and (2) client authentication after the initial handshake. If you don't need renegotiation, disabling it will save code size and reduce the possibility of abuse/vulnerability.

Default value:

- Yes (enabled)

CONFIG_MBEDTLS_SSL_PROTO_SSL3

Legacy SSL 3.0 support

Found in: [Component config](#) > [mbedtls](#)

Support the legacy SSL 3.0 protocol. Most servers will speak a newer TLS protocol these days.

Default value:

- No (disabled)

CONFIG_MBEDTLS_SSL_PROTO_TLS1

Support TLS 1.0 protocol

Found in: [Component config](#) > [mbedtls](#)

Default value:

- Yes (enabled)

CONFIG_MBEDTLS_SSL_PROTO_TLS1_1

Support TLS 1.1 protocol

Found in: [Component config](#) > [mbedtls](#)

Default value:

- Yes (enabled)

CONFIG_MBEDTLS_SSL_PROTO_TLS1_2

Support TLS 1.2 protocol

Found in: [Component config](#) > [mbedtls](#)

Default value:

- Yes (enabled)

CONFIG_MBEDTLS_SSL_PROTO_DTLS

Support DTLS protocol (all versions)

Found in: [Component config > mbedTLS](#)

Requires TLS 1.1 to be enabled for DTLS 1.0 Requires TLS 1.2 to be enabled for DTLS 1.2

Default value:

- No (disabled)

CONFIG_MBEDTLS_SSL_ALPN

Support ALPN (Application Layer Protocol Negotiation)

Found in: [Component config > mbedTLS](#)

Disabling this option will save some code size if it is not needed.

Default value:

- Yes (enabled)

CONFIG_MBEDTLS_CLIENT_SSL_SESSION_TICKETS

TLS: Client Support for RFC 5077 SSL session tickets

Found in: [Component config > mbedTLS](#)

Client support for RFC 5077 session tickets. See mbedTLS documentation for more details. Disabling this option will save some code size.

Default value:

- Yes (enabled)

CONFIG_MBEDTLS_X509_CHECK_KEY_USAGE

Enable verification of the keyUsage extension

Found in: [Component config > mbedTLS](#)

Disabling this avoids problems with mis-issued and/or misused (intermediate) CA and leaf certificates. Depending on your PKI use, disabling this can be a security risk.

Default value:

- Yes (enabled)

CONFIG_MBEDTLS_X509_CHECK_EXTENDED_KEY_USAGE

Enable verification of the extendedKeyUsage extension

Found in: [Component config > mbedTLS](#)

Disabling this avoids problems with mis-issued and/or misused certificates. Depending on your PKI use, disabling this can be a security risk.

Default value:

- Yes (enabled)

CONFIG_MBEDTLS_SERVER_SSL_SESSION_TICKETS

TLS: Server Support for RFC 5077 SSL session tickets

Found in: [Component config > mbedTLS](#)

Server support for RFC 5077 session tickets. See mbedTLS documentation for more details. Disabling this option will save some code size.

Default value:

- Yes (enabled)

Symmetric Ciphers Contains:

- [CONFIG_MBEDTLS_AES_C](#)
- [CONFIG_MBEDTLS_BLOWFISH_C](#)
- [CONFIG_MBEDTLS_CAMELLIA_C](#)
- [CONFIG_MBEDTLS_CCM_C](#)
- [CONFIG_MBEDTLS_DES_C](#)
- [CONFIG_MBEDTLS_GCM_C](#)
- [CONFIG_MBEDTLS_NIST_KW_C](#)
- [CONFIG_MBEDTLS_RC4_MODE](#)
- [CONFIG_MBEDTLS_XTEA_C](#)

CONFIG_MBEDTLS_AES_C

AES block cipher

Found in: [Component config](#) > [mbedtls](#) > [Symmetric Ciphers](#)

Default value:

- Yes (enabled)

CONFIG_MBEDTLS_CAMELLIA_C

Camellia block cipher

Found in: [Component config](#) > [mbedtls](#) > [Symmetric Ciphers](#)

Default value:

- No (disabled)

CONFIG_MBEDTLS_DES_C

DES block cipher (legacy, insecure)

Found in: [Component config](#) > [mbedtls](#) > [Symmetric Ciphers](#)

Enables the DES block cipher to support 3DES-based TLS ciphersuites.

3DES is vulnerable to the Sweet32 attack and should only be enabled if absolutely necessary.

Default value:

- No (disabled)

CONFIG_MBEDTLS_RC4_MODE

RC4 Stream Cipher (legacy, insecure)

Found in: [Component config](#) > [mbedtls](#) > [Symmetric Ciphers](#)

ARCFOUR (RC4) stream cipher can be disabled entirely, enabled but not added to default ciphersuites, or enabled completely.

Please consider the security implications before enabling RC4.

Available options:

- Disabled (MBEDTLS_RC4_DISABLED)
- Enabled, not in default ciphersuites (MBEDTLS_RC4_ENABLED_NO_DEFAULT)
- Enabled (MBEDTLS_RC4_ENABLED)

CONFIG_MBEDTLS_BLOWFISH_C

Blowfish block cipher (read help)

Found in: [Component config](#) > [mbedtls](#) > [Symmetric Ciphers](#)

Enables the Blowfish block cipher (not used for TLS sessions.)

The Blowfish cipher is not used for mbedtls TLS sessions but can be used for other purposes. Read up on the limitations of Blowfish (including Sweet32) before enabling.

Default value:

- No (disabled)

CONFIG_MBEDTLS_XTEA_C

XTEA block cipher

Found in: [Component config](#) > [mbedtls](#) > [Symmetric Ciphers](#)

Enables the XTEA block cipher.

Default value:

- No (disabled)

CONFIG_MBEDTLS_CCM_C

CCM (Counter with CBC-MAC) block cipher modes

Found in: [Component config](#) > [mbedtls](#) > [Symmetric Ciphers](#)

Enable Counter with CBC-MAC (CCM) modes for AES and/or Camellia ciphers.

Disabling this option saves some code size.

Default value:

- Yes (enabled)

CONFIG_MBEDTLS_GCM_C

GCM (Galois/Counter) block cipher modes

Found in: [Component config](#) > [mbedtls](#) > [Symmetric Ciphers](#)

Enable Galois/Counter Mode for AES and/or Camellia ciphers.

This option is generally faster than CCM.

Default value:

- Yes (enabled)

CONFIG_MBEDTLS_NIST_KW_C

NIST key wrapping (KW) and KW padding (KWP)

Found in: [Component config](#) > [mbedtls](#) > [Symmetric Ciphers](#)

Enable NIST key wrapping and key wrapping padding.

Default value:

- No (disabled)

CONFIG_MBEDTLS_RIPEMD160_C

Enable RIPEMD-160 hash algorithm

Found in: [Component config > mbedTLS](#)

Enable the RIPEMD-160 hash algorithm.

Default value:

- No (disabled)

Certificates Contains:

- [CONFIG_MBEDTLS_PEM_PARSE_C](#)
- [CONFIG_MBEDTLS_PEM_WRITE_C](#)
- [CONFIG_MBEDTLS_X509_CRL_PARSE_C](#)
- [CONFIG_MBEDTLS_X509_CSR_PARSE_C](#)

CONFIG_MBEDTLS_PEM_PARSE_C

Read & Parse PEM formatted certificates

Found in: [Component config > mbedTLS > Certificates](#)

Enable decoding/parsing of PEM formatted certificates.

If your certificates are all in the simpler DER format, disabling this option will save some code size.

Default value:

- Yes (enabled)

CONFIG_MBEDTLS_PEM_WRITE_C

Write PEM formatted certificates

Found in: [Component config > mbedTLS > Certificates](#)

Enable writing of PEM formatted certificates.

If writing certificate data only in DER format, disabling this option will save some code size.

Default value:

- Yes (enabled)

CONFIG_MBEDTLS_X509_CRL_PARSE_C

X.509 CRL parsing

Found in: [Component config > mbedTLS > Certificates](#)

Support for parsing X.509 Certificate Revocation Lists.

Default value:

- Yes (enabled)

CONFIG_MBEDTLS_X509_CSR_PARSE_C

X.509 CSR parsing

Found in: [Component config > mbedTLS > Certificates](#)

Support for parsing X.509 Certificate Signing Requests

Default value:

- Yes (enabled)

CONFIG_MBEDTLS_ECP_C

Elliptic Curve Ciphers

Found in: *Component config* > *mbedTLS*

Default value:

- Yes (enabled)

Contains:

- *CONFIG_MBEDTLS_ECDH_C*
- *CONFIG_MBEDTLS_ECJPAKE_C*
- *CONFIG_MBEDTLS_ECP_DP_BP256R1_ENABLED*
- *CONFIG_MBEDTLS_ECP_DP_BP384R1_ENABLED*
- *CONFIG_MBEDTLS_ECP_DP_BP512R1_ENABLED*
- *CONFIG_MBEDTLS_ECP_DP_CURVE25519_ENABLED*
- *CONFIG_MBEDTLS_ECP_DP_SECP192K1_ENABLED*
- *CONFIG_MBEDTLS_ECP_DP_SECP192R1_ENABLED*
- *CONFIG_MBEDTLS_ECP_DP_SECP224K1_ENABLED*
- *CONFIG_MBEDTLS_ECP_DP_SECP224R1_ENABLED*
- *CONFIG_MBEDTLS_ECP_DP_SECP256K1_ENABLED*
- *CONFIG_MBEDTLS_ECP_DP_SECP256R1_ENABLED*
- *CONFIG_MBEDTLS_ECP_DP_SECP384R1_ENABLED*
- *CONFIG_MBEDTLS_ECP_DP_SECP521R1_ENABLED*
- *CONFIG_MBEDTLS_ECP_NIST_OPTIM*

CONFIG_MBEDTLS_ECDH_C

Elliptic Curve Diffie-Hellman (ECDH)

Found in: *Component config* > *mbedTLS* > *CONFIG_MBEDTLS_ECP_C*

Enable ECDH. Needed to use ECDHE-xxx TLS ciphersuites.

Default value:

- Yes (enabled)

CONFIG_MBEDTLS_ECDSA_C

Elliptic Curve DSA

Found in: *Component config* > *mbedTLS* > *CONFIG_MBEDTLS_ECP_C* > *CONFIG_MBEDTLS_ECDH_C*

Enable ECDSA. Needed to use ECDSA-xxx TLS ciphersuites.

Default value:

- Yes (enabled)

CONFIG_MBEDTLS_ECJPAKE_C

Elliptic curve J-PAKE

Found in: *Component config* > *mbedTLS* > *CONFIG_MBEDTLS_ECP_C*

Enable ECJPAKE. Needed to use ECJPAKE-xxx TLS ciphersuites.

Default value:

- No (disabled)

CONFIG_MBEDTLS_ECP_DP_SECP192R1_ENABLED

Enable SECP192R1 curve

Found in: Component config > mbedTLS > CONFIG_MBEDTLS_ECP_C

Enable support for SECP192R1 Elliptic Curve.

Default value:

- Yes (enabled) if (`CONFIG_MBEDTLS_ATCA_HW_ECDSA_SIGN` || `CONFIG_MBEDTLS_ATCA_HW_ECDSA_VERIFY`) && `CONFIG_MBEDTLS_ECP_C`

CONFIG_MBEDTLS_ECP_DP_SECP224R1_ENABLED

Enable SECP224R1 curve

Found in: Component config > mbedTLS > CONFIG_MBEDTLS_ECP_C

Enable support for SECP224R1 Elliptic Curve.

Default value:

- Yes (enabled) if (`CONFIG_MBEDTLS_ATCA_HW_ECDSA_SIGN` || `CONFIG_MBEDTLS_ATCA_HW_ECDSA_VERIFY`) && `CONFIG_MBEDTLS_ECP_C`

CONFIG_MBEDTLS_ECP_DP_SECP256R1_ENABLED

Enable SECP256R1 curve

Found in: Component config > mbedTLS > CONFIG_MBEDTLS_ECP_C

Enable support for SECP256R1 Elliptic Curve.

Default value:

- Yes (enabled)

CONFIG_MBEDTLS_ECP_DP_SECP384R1_ENABLED

Enable SECP384R1 curve

Found in: Component config > mbedTLS > CONFIG_MBEDTLS_ECP_C

Enable support for SECP384R1 Elliptic Curve.

Default value:

- Yes (enabled) if (`CONFIG_MBEDTLS_ATCA_HW_ECDSA_SIGN` || `CONFIG_MBEDTLS_ATCA_HW_ECDSA_VERIFY`) && `CONFIG_MBEDTLS_ECP_C`

CONFIG_MBEDTLS_ECP_DP_SECP521R1_ENABLED

Enable SECP521R1 curve

Found in: Component config > mbedTLS > CONFIG_MBEDTLS_ECP_C

Enable support for SECP521R1 Elliptic Curve.

Default value:

- Yes (enabled) if (`CONFIG_MBEDTLS_ATCA_HW_ECDSA_SIGN` || `CONFIG_MBEDTLS_ATCA_HW_ECDSA_VERIFY`) && `CONFIG_MBEDTLS_ECP_C`

CONFIG_MBEDTLS_ECP_DP_SECP192K1_ENABLED

Enable SECP192K1 curve

Found in: Component config > mbedTLS > CONFIG_MBEDTLS_ECP_C

Enable support for SECP192K1 Elliptic Curve.

Default value:

- Yes (enabled) if (`CONFIG_MBEDTLS_ATCA_HW_ECDSA_SIGN` || `CONFIG_MBEDTLS_ATCA_HW_ECDSA_VERIFY`) && `CONFIG_MBEDTLS_ECP_C`

CONFIG_MBEDTLS_ECP_DP_SECP224K1_ENABLED

Enable SECP224K1 curve

Found in: Component config > mbedTLS > CONFIG_MBEDTLS_ECP_C

Enable support for SECP224K1 Elliptic Curve.

Default value:

- Yes (enabled) if (`CONFIG_MBEDTLS_ATCA_HW_ECDSA_SIGN` || `CONFIG_MBEDTLS_ATCA_HW_ECDSA_VERIFY`) && `CONFIG_MBEDTLS_ECP_C`

CONFIG_MBEDTLS_ECP_DP_SECP256K1_ENABLED

Enable SECP256K1 curve

Found in: Component config > mbedTLS > CONFIG_MBEDTLS_ECP_C

Enable support for SECP256K1 Elliptic Curve.

Default value:

- Yes (enabled) if (`CONFIG_MBEDTLS_ATCA_HW_ECDSA_SIGN` || `CONFIG_MBEDTLS_ATCA_HW_ECDSA_VERIFY`) && `CONFIG_MBEDTLS_ECP_C`

CONFIG_MBEDTLS_ECP_DP_BP256R1_ENABLED

Enable BP256R1 curve

Found in: Component config > mbedTLS > CONFIG_MBEDTLS_ECP_C

support for DP Elliptic Curve.

Default value:

- Yes (enabled) if (`CONFIG_MBEDTLS_ATCA_HW_ECDSA_SIGN` || `CONFIG_MBEDTLS_ATCA_HW_ECDSA_VERIFY`) && `CONFIG_MBEDTLS_ECP_C`

CONFIG_MBEDTLS_ECP_DP_BP384R1_ENABLED

Enable BP384R1 curve

Found in: Component config > mbedTLS > CONFIG_MBEDTLS_ECP_C

support for DP Elliptic Curve.

Default value:

- Yes (enabled) if (`CONFIG_MBEDTLS_ATCA_HW_ECDSA_SIGN` || `CONFIG_MBEDTLS_ATCA_HW_ECDSA_VERIFY`) && `CONFIG_MBEDTLS_ECP_C`

CONFIG_MBEDTLS_ECP_DP_BP512R1_ENABLED

Enable BP512R1 curve

Found in: Component config > mbedTLS > CONFIG_MBEDTLS_ECP_C

support for DP Elliptic Curve.

Default value:

- Yes (enabled) if (`CONFIG_MBEDTLS_ATCA_HW_ECDSA_SIGN` || `CONFIG_MBEDTLS_ATCA_HW_ECDSA_VERIFY`) && `CONFIG_MBEDTLS_ECP_C`

CONFIG_MBEDTLS_ECP_DP_CURVE25519_ENABLED

Enable CURVE25519 curve

Found in: [Component config](#) > [mbedtls](#) > [CONFIG_MBEDTLS_ECP_C](#)

Enable support for CURVE25519 Elliptic Curve.

Default value:

- Yes (enabled) if `(CONFIG_MBEDTLS_ATCA_HW_ECDSA_SIGN || CONFIG_MBEDTLS_ATCA_HW_ECDSA_VERIFY) && CONFIG_MBEDTLS_ECP_C`

CONFIG_MBEDTLS_ECP_NIST_OPTIM

NIST ‘modulo p’ optimisations

Found in: [Component config](#) > [mbedtls](#) > [CONFIG_MBEDTLS_ECP_C](#)

NIST ‘modulo p’ optimisations increase Elliptic Curve operation performance.

Disabling this option saves some code size.

end of Elliptic Curve options

Default value:

- Yes (enabled)

CONFIG_MBEDTLS_POLY1305_C

Poly1305 MAC algorithm

Found in: [Component config](#) > [mbedtls](#)

Enable support for Poly1305 MAC algorithm.

Default value:

- No (disabled)

CONFIG_MBEDTLS_CHACHA20_C

Chacha20 stream cipher

Found in: [Component config](#) > [mbedtls](#)

Enable support for Chacha20 stream cipher.

Default value:

- No (disabled)

CONFIG_MBEDTLS_CHACHAPOLY_C

ChaCha20-Poly1305 AEAD algorithm

Found in: [Component config](#) > [mbedtls](#) > [CONFIG_MBEDTLS_CHACHA20_C](#)

Enable support for ChaCha20-Poly1305 AEAD algorithm.

Default value:

- No (disabled) if `CONFIG_MBEDTLS_CHACHA20_C && CONFIG_MBEDTLS_POLY1305_C`

CONFIG_MBEDTLS_HKDF_C

HKDF algorithm (RFC 5869)

Found in: [Component config > mbedTLS](#)

Enable support for the Hashed Message Authentication Code (HMAC)-based key derivation function (HKDF).

Default value:

- No (disabled)

CONFIG_MBEDTLS_THREADING_C

Enable the threading abstraction layer

Found in: [Component config > mbedTLS](#)

If you do intend to use contexts between threads, you will need to enable this layer to prevent race conditions.

Default value:

- No (disabled)

CONFIG_MBEDTLS_THREADING_ALT

Enable threading alternate implementation

Found in: [Component config > mbedTLS > CONFIG_MBEDTLS_THREADING_C](#)

Enable threading alt to allow your own alternate threading implementation.

Default value:

- Yes (enabled) if [CONFIG_MBEDTLS_THREADING_C](#)

CONFIG_MBEDTLS_THREADING_PTHREAD

Enable threading pthread implementation

Found in: [Component config > mbedTLS > CONFIG_MBEDTLS_THREADING_C](#)

Enable the pthread wrapper layer for the threading layer.

Default value:

- No (disabled) if [CONFIG_MBEDTLS_THREADING_C](#)

CONFIG_MBEDTLS_LARGE_KEY_SOFTWARE_MPI

Fallback to software implementation for larger MPI values

Found in: [Component config > mbedTLS](#)

Fallback to software implementation for RSA key lengths larger than `SOC_RSA_MAX_BIT_LEN`. If this is not active then the ESP will be unable to process keys greater than `SOC_RSA_MAX_BIT_LEN`.

Default value:

- Yes (enabled)
- No (disabled)

CONFIG_MBEDTLS_SECURITY_RISKS

Show configurations with potential security risks

Found in: [Component config > mbedTLS](#)

Default value:

- No (disabled)

Contains:

- [CONFIG_MBEDTLS_ALLOW_UNSUPPORTED_CRITICAL_EXT](#)

CONFIG_MBEDTLS_ALLOW_UNSUPPORTED_CRITICAL_EXT

X.509 CRT parsing with unsupported critical extensions

Found in: [Component config](#) > [mbedtls](#) > [CONFIG_MBEDTLS_SECURITY_RISKS](#)

Allow the X.509 certificate parser to load certificates with unsupported critical extensions

Default value:

- No (disabled) if [CONFIG_MBEDTLS_SECURITY_RISKS](#)

mDNS Contains:

- [CONFIG_MDNS_MAX_SERVICES](#)
- [CONFIG_MDNS_SERVICE_ADD_TIMEOUT_MS](#)
- [CONFIG_MDNS_STRICT_MODE](#)
- [CONFIG_MDNS_TASK_AFFINITY](#)
- [CONFIG_MDNS_TASK_PRIORITY](#)
- [CONFIG_MDNS_TASK_STACK_SIZE](#)
- [CONFIG_MDNS_TIMER_PERIOD_MS](#)

CONFIG_MDNS_MAX_SERVICES

Max number of services

Found in: [Component config](#) > [mDNS](#)

Services take up a certain amount of memory, and allowing fewer services to be open at the same time conserves memory. Specify the maximum amount of services here. The valid value is from 1 to 64.

Range:

- from 1 to 64

Default value:

- 10

CONFIG_MDNS_TASK_PRIORITY

mDNS task priority

Found in: [Component config](#) > [mDNS](#)

Allows setting mDNS task priority. Please do not set the task priority higher than priorities of system tasks. Compile time warning/error would be emitted if the chosen task priority were too high.

Range:

- from 1 to 255

Default value:

- 1

CONFIG_MDNS_TASK_STACK_SIZE

mDNS task stack size

Found in: [Component config](#) > [mDNS](#)

Allows setting mDNS task stacksize.

Default value:

- 4096

CONFIG_MDNS_TASK_AFFINITY

mDNS task affinity

Found in: [Component config](#) > [mDNS](#)

Allows setting mDNS tasks affinity, i.e. whether the task is pinned to CPU0, pinned to CPU1, or allowed to run on any CPU.

Available options:

- No affinity (MDNS_TASK_AFFINITY_NO_AFFINITY)
- CPU0 (MDNS_TASK_AFFINITY_CPU0)
- CPU1 (MDNS_TASK_AFFINITY_CPU1)

CONFIG_MDNS_SERVICE_ADD_TIMEOUT_MS

mDNS adding service timeout (ms)

Found in: [Component config](#) > [mDNS](#)

Configures timeout for adding a new mDNS service. Adding a service fails if could not be completed within this time.

Range:

- from 10 to 30000

Default value:

- 2000

CONFIG_MDNS_STRICT_MODE

mDNS strict mode

Found in: [Component config](#) > [mDNS](#)

Configures strict mode. Set this to 1 for the mDNS library to strictly follow the RFC6762: Currently the only strict feature: Do not repeat original questions in response packets (defined in RFC6762 sec. 6). Default configuration is 0, i.e. non-strict mode, since some implementations, such as lwIP mdns resolver (used by standard POSIX API like getaddrinfo, gethostbyname) could not correctly resolve advertised names.

Default value:

- No (disabled)

CONFIG_MDNS_TIMER_PERIOD_MS

mDNS timer period (ms)

Found in: [Component config](#) > [mDNS](#)

Configures period of mDNS timer, which periodically transmits packets and schedules mDNS searches.

Range:

- from 10 to 10000

Default value:

- 100

ESP-MQTT Configurations

 Contains:

- [CONFIG_MQTT_CUSTOM_OUTBOX](#)
- [CONFIG_MQTT_TRANSPORT_SSL](#)
- [CONFIG_MQTT_TRANSPORT_WEBSOCKET](#)

- [CONFIG_MQTT_PROTOCOL_311](#)
- [CONFIG_MQTT_TASK_CORE_SELECTION_ENABLED](#)
- [CONFIG_MQTT_USE_CUSTOM_CONFIG](#)
- [CONFIG_MQTT_OUTBOX_EXPIRED_TIMEOUT_MS](#)
- [CONFIG_MQTT_REPORT_DELETED_MESSAGES](#)
- [CONFIG_MQTT_SKIP_PUBLISH_IF_DISCONNECTED](#)
- [CONFIG_MQTT_MSG_ID_INCREMENTAL](#)

CONFIG_MQTT_PROTOCOL_311

Enable MQTT protocol 3.1.1

Found in: [Component config](#) > [ESP-MQTT Configurations](#)

If not, this library will use MQTT protocol 3.1

Default value:

- Yes (enabled)

CONFIG_MQTT_TRANSPORT_SSL

Enable MQTT over SSL

Found in: [Component config](#) > [ESP-MQTT Configurations](#)

Enable MQTT transport over SSL with mbedtls

Default value:

- Yes (enabled)

CONFIG_MQTT_TRANSPORT_WEBSOCKET

Enable MQTT over Websocket

Found in: [Component config](#) > [ESP-MQTT Configurations](#)

Enable MQTT transport over Websocket.

Default value:

- Yes (enabled)

CONFIG_MQTT_TRANSPORT_WEBSOCKET_SECURE

Enable MQTT over Websocket Secure

Found in: [Component config](#) > [ESP-MQTT Configurations](#) > [CONFIG_MQTT_TRANSPORT_WEBSOCKET](#)

Enable MQTT transport over Websocket Secure.

Default value:

- Yes (enabled)

CONFIG_MQTT_MSG_ID_INCREMENTAL

Use Incremental Message Id

Found in: [Component config](#) > [ESP-MQTT Configurations](#)

Set this to true for the message id (2.3.1 Packet Identifier) to be generated as an incremental number rather than a random value (used by default)

Default value:

- No (disabled)

CONFIG_MQTT_SKIP_PUBLISH_IF_DISCONNECTED

Skip publish if disconnected

Found in: [Component config](#) > [ESP-MQTT Configurations](#)

Set this to true to avoid publishing (enqueueing messages) if the client is disconnected. The MQTT client tries to publish all messages by default, even in the disconnected state (where the qos1 and qos2 packets are stored in the internal outbox to be published later) The MQTT_SKIP_PUBLISH_IF_DISCONNECTED option allows applications to override this behaviour and not enqueue publish packets in the disconnected state.

Default value:

- No (disabled)

CONFIG_MQTT_REPORT_DELETED_MESSAGES

Report deleted messages

Found in: [Component config](#) > [ESP-MQTT Configurations](#)

Set this to true to post events for all messages which were deleted from the outbox before being correctly sent and confirmed.

Default value:

- No (disabled)

CONFIG_MQTT_USE_CUSTOM_CONFIG

MQTT Using custom configurations

Found in: [Component config](#) > [ESP-MQTT Configurations](#)

Custom MQTT configurations.

Default value:

- No (disabled)

CONFIG_MQTT_TCP_DEFAULT_PORT

Default MQTT over TCP port

Found in: [Component config](#) > [ESP-MQTT Configurations](#) > [CONFIG_MQTT_USE_CUSTOM_CONFIG](#)

Default MQTT over TCP port

Default value:

- 1883 if [CONFIG_MQTT_USE_CUSTOM_CONFIG](#)

CONFIG_MQTT_SSL_DEFAULT_PORT

Default MQTT over SSL port

Found in: [Component config](#) > [ESP-MQTT Configurations](#) > [CONFIG_MQTT_USE_CUSTOM_CONFIG](#)

Default MQTT over SSL port

Default value:

- 8883 if [CONFIG_MQTT_USE_CUSTOM_CONFIG](#) && [CONFIG_MQTT_TRANSPORT_SSL](#)

CONFIG_MQTT_WS_DEFAULT_PORT

Default MQTT over Websocket port

Found in: Component config > ESP-MQTT Configurations > CONFIG_MQTT_USE_CUSTOM_CONFIG

Default MQTT over Websocket port

Default value:

- 80 if `CONFIG_MQTT_USE_CUSTOM_CONFIG` && `CONFIG_MQTT_TRANSPORT_WEBSOCKET`

CONFIG_MQTT_WSS_DEFAULT_PORT

Default MQTT over Websocket Secure port

Found in: Component config > ESP-MQTT Configurations > CONFIG_MQTT_USE_CUSTOM_CONFIG

Default MQTT over Websocket Secure port

Default value:

- 443 if `CONFIG_MQTT_USE_CUSTOM_CONFIG` && `CONFIG_MQTT_TRANSPORT_WEBSOCKET` && `CONFIG_MQTT_TRANSPORT_WEBSOCKET_SECURE`

CONFIG_MQTT_BUFFER_SIZE

Default MQTT Buffer Size

Found in: Component config > ESP-MQTT Configurations > CONFIG_MQTT_USE_CUSTOM_CONFIG

This buffer size using for both transmit and receive

Default value:

- 1024 if `CONFIG_MQTT_USE_CUSTOM_CONFIG`

CONFIG_MQTT_TASK_STACK_SIZE

MQTT task stack size

Found in: Component config > ESP-MQTT Configurations > CONFIG_MQTT_USE_CUSTOM_CONFIG

MQTT task stack size

Default value:

- 6144 if `CONFIG_MQTT_USE_CUSTOM_CONFIG`

CONFIG_MQTT_DISABLE_API_LOCKS

Disable API locks

Found in: Component config > ESP-MQTT Configurations > CONFIG_MQTT_USE_CUSTOM_CONFIG

Default config employs API locks to protect internal structures. It is possible to disable these locks if the user code doesn't access MQTT API from multiple concurrent tasks

Default value:

- No (disabled) if `CONFIG_MQTT_USE_CUSTOM_CONFIG`

CONFIG_MQTT_TASK_PRIORITY

MQTT task priority

Found in: Component config > ESP-MQTT Configurations > CONFIG_MQTT_USE_CUSTOM_CONFIG

MQTT task priority. Higher number denotes higher priority.

Default value:

- 5 if *CONFIG_MQTT_USE_CUSTOM_CONFIG*

CONFIG_MQTT_TASK_CORE_SELECTION_ENABLED

Enable MQTT task core selection

Found in: Component config > ESP-MQTT Configurations

This will enable core selection

Default value:

- “false”

CONFIG_MQTT_TASK_CORE_SELECTION

Core to use ?

Found in: Component config > ESP-MQTT Configurations > CONFIG_MQTT_TASK_CORE_SELECTION_ENABLED

Available options:

- Core 0 (MQTT_USE_CORE_0)
- Core 1 (MQTT_USE_CORE_1)

CONFIG_MQTT_CUSTOM_OUTBOX

Enable custom outbox implementation

Found in: Component config > ESP-MQTT Configurations

Set to true if a specific implementation of message outbox is needed (e.g. persistent outbox in NVM or similar).

Default value:

- No (disabled)

CONFIG_MQTT_OUTBOX_EXPIRED_TIMEOUT_MS

Outbox message expired timeout[ms]

Found in: Component config > ESP-MQTT Configurations

Messages which stays in the outbox longer than this value before being published will be discarded.

Default value:

- 30000 if *CONFIG_MQTT_USE_CUSTOM_CONFIG*

Newlib Contains:

- *CONFIG_NEWLIB_NANO_FORMAT*
- *CONFIG_NEWLIB_STDIN_LINE_ENDING*
- *CONFIG_NEWLIB_STDOUT_LINE_ENDING*

CONFIG_NEWLIB_STDOUT_LINE_ENDING

Line ending for UART output

Found in: Component config > Newlib

This option allows configuring the desired line endings sent to UART when a newline (‘n’ , LF) appears on stdout. Three options are possible:

CRLF: whenever LF is encountered, prepend it with CR

LF: no modification is applied, stdout is sent as is

CR: each occurrence of LF is replaced with CR

This option doesn't affect behavior of the UART driver (drivers/uart.h).

Available options:

- CRLF (NEWLIB_STDOUT_LINE_ENDING_CRLF)
- LF (NEWLIB_STDOUT_LINE_ENDING_LF)
- CR (NEWLIB_STDOUT_LINE_ENDING_CR)

CONFIG_NEWLIB_STDIN_LINE_ENDING

Line ending for UART input

Found in: [Component config](#) > [Newlib](#)

This option allows configuring which input sequence on UART produces a newline ('n' , LF) on stdin. Three options are possible:

CRLF: CRLF is converted to LF

LF: no modification is applied, input is sent to stdin as is

CR: each occurrence of CR is replaced with LF

This option doesn't affect behavior of the UART driver (drivers/uart.h).

Available options:

- CRLF (NEWLIB_STDIN_LINE_ENDING_CRLF)
- LF (NEWLIB_STDIN_LINE_ENDING_LF)
- CR (NEWLIB_STDIN_LINE_ENDING_CR)

CONFIG_NEWLIB_NANO_FORMAT

Enable 'nano' formatting options for printf/scanf family

Found in: [Component config](#) > [Newlib](#)

ESP32 ROM contains parts of newlib C library, including printf/scanf family of functions. These functions have been compiled with so-called "nano" formatting option. This option doesn't support 64-bit integer formats and C99 features, such as positional arguments.

For more details about "nano" formatting option, please see newlib readme file, search for 'enable-newlib-nano-formatted-io' : <https://sourceware.org/newlib/README>

If this option is enabled, build system will use functions available in ROM, reducing the application binary size. Functions available in ROM run faster than functions which run from flash. Functions available in ROM can also run when flash instruction cache is disabled.

If you need 64-bit integer formatting support or C99 features, keep this option disabled.

Default value:

- No (disabled)

NVS Contains:

- [CONFIG_NVS_ENCRYPTION](#)
- [CONFIG_NVS_COMPATIBLE_PRE_V4_3_ENCRYPTION_FLAG](#)

CONFIG_NVS_ENCRYPTION

Enable NVS encryption

Found in: [Component config > NVS](#)

This option enables encryption for NVS. When enabled, AES-XTS is used to encrypt the complete NVS data, except the page headers. It requires XTS encryption keys to be stored in an encrypted partition. This means enabling flash encryption is a pre-requisite for this feature.

Default value:

- Yes (enabled) if [CONFIG_SECURE_FLASH_ENC_ENABLED](#)

CONFIG_NVS_COMPATIBLE_PRE_V4_3_ENCRYPTION_FLAG

NVS partition encrypted flag compatible with ESP-IDF before v4.3

Found in: [Component config > NVS](#)

Enabling this will ignore “encrypted” flag for NVS partitions. NVS encryption scheme is different than hardware flash encryption and hence it is not recommended to have “encrypted” flag for NVS partitions. This was not being checked in pre v4.3 IDF. Hence, if you have any devices where this flag is kept enabled in partition table then enabling this config will allow to have same behavior as pre v4.3 IDF.

OpenSSL Contains:

- [CONFIG_OPENSSL_DEBUG](#)
- [CONFIG_OPENSSL_ERROR_STACK](#)
- [CONFIG_OPENSSL_LOWLEVEL_DEBUG](#)
- [CONFIG_OPENSSL_DEBUG_LEVEL](#)
- [CONFIG_OPENSSL_ASSERT](#)

CONFIG_OPENSSL_DEBUG

Enable OpenSSL debugging

Found in: [Component config > OpenSSL](#)

Enable OpenSSL debugging function.

If the option is enabled, “SSL_DEBUG” works.

Default value:

- No (disabled)

CONFIG_OPENSSL_ERROR_STACK

Enable OpenSSL error structure

Found in: [Component config > OpenSSL](#)

Enable OpenSSL Error reporting

Default value:

- Yes (enabled)

CONFIG_OPENSSL_DEBUG_LEVEL

OpenSSL debugging level

Found in: [Component config > OpenSSL](#)

OpenSSL debugging level.

Only function whose debugging level is higher than “OPENSSL_DEBUG_LEVEL” works.

For example: If OPENSSL_DEBUG_LEVEL = 2, you use function “SSL_DEBUG(1, “malloc failed”)” . Because 1 < 2, it will not print.

Range:

- from 0 to 255 if *CONFIG_OPENSSL_DEBUG*

Default value:

- 0 if *CONFIG_OPENSSL_DEBUG*

CONFIG_OPENSSL_LOWLEVEL_DEBUG

Enable OpenSSL low-level module debugging

Found in: *Component config > OpenSSL*

If the option is enabled, low-level module debugging function of OpenSSL is enabled, e.g. mbedtls internal debugging function.

Default value:

- No (disabled) if *CONFIG_OPENSSL_DEBUG*

CONFIG_OPENSSL_ASSERT

Select OpenSSL assert function

Found in: *Component config > OpenSSL*

OpenSSL function needs “assert” function to check if input parameters are valid.

If you want to use assert debugging function, “OPENSSL_DEBUG” should be enabled.

Available options:

- Do nothing (OPENSSL_ASSERT_DO_NOTHING)
Do nothing and “SSL_ASSERT” does not work.
- Check and exit (OPENSSL_ASSERT_EXIT)
Enable assert exiting, it will check and return error code.
- Show debugging message (OPENSSL_ASSERT_DEBUG)
Enable assert debugging, it will check and show debugging message.
- Show debugging message and exit (OPENSSL_ASSERT_DEBUG_EXIT)
Enable assert debugging and exiting, it will check, show debugging message and return error code.
- Show debugging message and block (OPENSSL_ASSERT_DEBUG_BLOCK)
Enable assert debugging and blocking, it will check, show debugging message and block by “while (1);” .

PThreads Contains:

- *CONFIG_PTHREAD_TASK_NAME_DEFAULT*
- *CONFIG_PTHREAD_TASK_CORE_DEFAULT*
- *CONFIG_PTHREAD_TASK_PRIO_DEFAULT*
- *CONFIG_PTHREAD_TASK_STACK_SIZE_DEFAULT*
- *CONFIG_PTHREAD_STACK_MIN*

CONFIG_PTHREAD_TASK_PRIO_DEFAULT

Default task priority

Found in: *Component config > PThreads*

Priority used to create new tasks with default pthread parameters.

Range:

- from 0 to 255

Default value:

- 5

CONFIG_PTHREAD_TASK_STACK_SIZE_DEFAULT

Default task stack size

Found in: [Component config](#) > [PThreads](#)

Stack size used to create new tasks with default pthread parameters.

Default value:

- 3072

CONFIG_PTHREAD_STACK_MIN

Minimum allowed pthread stack size

Found in: [Component config](#) > [PThreads](#)

Minimum allowed pthread stack size set in attributes passed to pthread_create

Default value:

- 768

CONFIG_PTHREAD_TASK_CORE_DEFAULT

Default pthread core affinity

Found in: [Component config](#) > [PThreads](#)

The default core to which pthreads are pinned.

Available options:

- No affinity (PTHREAD_DEFAULT_CORE_NO_AFFINITY)
- Core 0 (PTHREAD_DEFAULT_CORE_0)
- Core 1 (PTHREAD_DEFAULT_CORE_1)

CONFIG_PTHREAD_TASK_NAME_DEFAULT

Default name of pthreads

Found in: [Component config](#) > [PThreads](#)

The default name of pthreads.

Default value:

- “pthread”

SPI Flash driver Contains:

- [CONFIG_SPI_FLASH_AUTO_SUSPEND](#)
- [Auto-detect flash chips](#)
- [CONFIG_SPI_FLASH_BYPASS_BLOCK_ERASE](#)
- [CONFIG_SPI_FLASH_ENABLE_ENCRYPTED_READ_WRITE](#)
- [CONFIG_SPI_FLASH_ENABLE_COUNTERS](#)
- [CONFIG_SPI_FLASH_ROM_DRIVER_PATCH](#)
- [CONFIG_SPI_FLASH_YIELD_DURING_ERASE](#)
- [CONFIG_SPI_FLASH_CHECK_ERASE_TIMEOUT_DISABLED](#)
- [CONFIG_SPI_FLASH_WRITE_CHUNK_SIZE](#)
- [CONFIG_SPI_FLASH_SIZE_OVERRIDE](#)
- [CONFIG_SPI_FLASH_SHARE_SPI_BUS](#)

- [CONFIG_SPI_FLASH_ROM_IMPL](#)
- [CONFIG_SPI_FLASH_USE_LEGACY_IMPL](#)
- [CONFIG_SPI_FLASH_VERIFY_WRITE](#)
- [CONFIG_SPI_FLASH_DANGEROUS_WRITE](#)

CONFIG_SPI_FLASH_VERIFY_WRITE

Verify SPI flash writes

Found in: [Component config](#) > [SPI Flash driver](#)

If this option is enabled, any time SPI flash is written then the data will be read back and verified. This can catch hardware problems with SPI flash, or flash which was not erased before verification.

Default value:

- No (disabled)

CONFIG_SPI_FLASH_LOG_FAILED_WRITE

Log errors if verification fails

Found in: [Component config](#) > [SPI Flash driver](#) > [CONFIG_SPI_FLASH_VERIFY_WRITE](#)

If this option is enabled, if SPI flash write verification fails then a log error line will be written with the address, expected & actual values. This can be useful when debugging hardware SPI flash problems.

Default value:

- No (disabled) if [CONFIG_SPI_FLASH_VERIFY_WRITE](#)

CONFIG_SPI_FLASH_WARN_SETTING_ZERO_TO_ONE

Log warning if writing zero bits to ones

Found in: [Component config](#) > [SPI Flash driver](#) > [CONFIG_SPI_FLASH_VERIFY_WRITE](#)

If this option is enabled, any SPI flash write which tries to set zero bits in the flash to ones will log a warning. Such writes will not result in the requested data appearing identically in flash once written, as SPI NOR flash can only set bits to one when an entire sector is erased. After erasing, individual bits can only be written from one to zero.

Note that some software (such as SPIFFS) which is aware of SPI NOR flash may write one bits as an optimisation, relying on the data in flash becoming a bitwise AND of the new data and any existing data. Such software will log spurious warnings if this option is enabled.

Default value:

- No (disabled) if [CONFIG_SPI_FLASH_VERIFY_WRITE](#)

CONFIG_SPI_FLASH_ENABLE_COUNTERS

Enable operation counters

Found in: [Component config](#) > [SPI Flash driver](#)

This option enables the following APIs:

- `spi_flash_reset_counters`
- `spi_flash_dump_counters`
- `spi_flash_get_counters`

These APIs may be used to collect performance data for `spi_flash` APIs and to help understand behaviour of libraries which use SPI flash.

Default value:

- 0

CONFIG_SPI_FLASH_ROM_DRIVER_PATCH

Enable SPI flash ROM driver patched functions

Found in: [Component config](#) > [SPI Flash driver](#)

Enable this flag to use patched versions of SPI flash ROM driver functions. This option should be enabled, if any one of the following is true: (1) need to write to flash on ESP32-D2WD; (2) main SPI flash is connected to non-default pins; (3) main SPI flash chip is manufactured by ISSI.

Default value:

- Yes (enabled)

CONFIG_SPI_FLASH_ROM_IMPL

Use esp_flash implementation in ROM

Found in: [Component config](#) > [SPI Flash driver](#)

Enable this flag to use new SPI flash driver functions from ROM instead of ESP-IDF.

If keeping this as “n” in your project, you will have less free IRAM. But you can use all of our flash features.

If making this as “y” in your project, you will increase free IRAM. But you may miss out on some flash features and support for new flash chips.

Currently the ROM cannot support the following features:

- SPI_FLASH_AUTO_SUSPEND (C3, S3)

Default value:

- No (disabled)

CONFIG_SPI_FLASH_DANGEROUS_WRITE

Writing to dangerous flash regions

Found in: [Component config](#) > [SPI Flash driver](#)

SPI flash APIs can optionally abort or return a failure code if erasing or writing addresses that fall at the beginning of flash (covering the bootloader and partition table) or that overlap the app partition that contains the running app.

It is not recommended to ever write to these regions from an IDF app, and this check prevents logic errors or corrupted firmware memory from damaging these regions.

Note that this feature **does not** check calls to the esp_rom_XXX SPI flash ROM functions. These functions should not be called directly from IDF applications.

Available options:

- Aborts (SPI_FLASH_DANGEROUS_WRITE_ABORTS)
- Fails (SPI_FLASH_DANGEROUS_WRITE_FAILS)
- Allowed (SPI_FLASH_DANGEROUS_WRITE_ALLOWED)

CONFIG_SPI_FLASH_USE_LEGACY_IMPL

Use the legacy implementation before IDF v4.0

Found in: [Component config](#) > [SPI Flash driver](#)

The implementation of SPI flash has been greatly changed in IDF v4.0. Enable this option to use the legacy implementation.

Default value:

- No (disabled)

CONFIG_SPI_FLASH_SHARE_SPI1_BUS

Support other devices attached to SPI1 bus

Found in: [Component config](#) > [SPI Flash driver](#)

Each SPI bus needs a lock for arbitration among devices. This allows multiple devices on a same bus, but may reduce the speed of esp_flash driver access to the main flash chip.

If you only need to use esp_flash driver to access the main flash chip, disable this option, and the lock will be bypassed on SPI1 bus. Otherwise if extra devices are needed to attach to SPI1 bus, enable this option.

Default value:

- No (disabled) if [CONFIG_SPI_FLASH_USE_LEGACY_IMPL](#)

CONFIG_SPI_FLASH_BYPASS_BLOCK_ERASE

Bypass a block erase and always do sector erase

Found in: [Component config](#) > [SPI Flash driver](#)

Some flash chips can have very high “max” erase times, especially for block erase (32KB or 64KB). This option allows to bypass “block erase” and always do sector erase commands. This will be much slower overall in most cases, but improves latency for other code to run.

Default value:

- No (disabled)

CONFIG_SPI_FLASH_YIELD_DURING_ERASE

Enables yield operation during flash erase

Found in: [Component config](#) > [SPI Flash driver](#)

This allows to yield the CPUs between erase commands. Prevents starvation of other tasks.

Default value:

- Yes (enabled)

CONFIG_SPI_FLASH_ERASE_YIELD_DURATION_MS

Duration of erasing to yield CPUs (ms)

Found in: [Component config](#) > [SPI Flash driver](#) > [CONFIG_SPI_FLASH_YIELD_DURING_ERASE](#)

If a duration of one erase command is large then it will yield CPUs after finishing a current command.

Default value:

- 20

CONFIG_SPI_FLASH_ERASE_YIELD_TICKS

CPU release time (tick) for an erase operation

Found in: [Component config](#) > [SPI Flash driver](#) > [CONFIG_SPI_FLASH_YIELD_DURING_ERASE](#)

Defines how many ticks will be before returning to continue a erasing.

Default value:

- 1

CONFIG_SPI_FLASH_AUTO_SUSPEND

Auto suspend long erase/write operations (READ DOCS FIRST)

Found in: [Component config](#) > [SPI Flash driver](#)

This option is default n before ESP32-C3, because it needs bootloader support.

CAUTION: If you want to OTA to an app with this feature turned on, please make sure the bootloader has the support for it. (later than IDF v4.3)

Auto-suspend feature is only supported by XMC chip. If you are using an official module, please contact Espressif Business support. Also reading auto suspend part in *SPI Flash API* document before you enable this function.

Default value:

- No (disabled) if `CONFIG_SPI_FLASH_USE_LEGACY_IMPL` && `CONFIG_SPI_FLASH_ROM_IMPL`

CONFIG_SPI_FLASH_WRITE_CHUNK_SIZE

Flash write chunk size

Found in: [Component config](#) > [SPI Flash driver](#)

Flash write is broken down in terms of multiple (smaller) write operations. This configuration options helps to set individual write chunk size, smaller value here ensures that cache (and non-IRAM resident interrupts) remains disabled for shorter duration.

Range:

- from 256 to 8192

Default value:

- 8192

CONFIG_SPI_FLASH_SIZE_OVERRIDE

Override flash size in bootloader header by ESPTOOLPY_FLASHSIZE

Found in: [Component config](#) > [SPI Flash driver](#)

SPI Flash driver uses the flash size configured in bootloader header by default. Enable this option to override flash size with latest ESPTOOLPY_FLASHSIZE value from the app header if the size in the bootloader header is incorrect.

Default value:

- No (disabled)

CONFIG_SPI_FLASH_CHECK_ERASE_TIMEOUT_DISABLED

Flash timeout checkout disabled

Found in: [Component config](#) > [SPI Flash driver](#)

This option is helpful if you are using a flash chip whose timeout is quite large or unpredictable.

Default value:

- No (disabled) if `CONFIG_SPI_FLASH_USE_LEGACY_IMPL`

Auto-detect flash chips Contains:

- `CONFIG_SPI_FLASH_SUPPORT_BOYA_CHIP`
- `CONFIG_SPI_FLASH_SUPPORT_GD_CHIP`
- `CONFIG_SPI_FLASH_SUPPORT_ISSI_CHIP`
- `CONFIG_SPI_FLASH_SUPPORT_MXIC_CHIP`
- `CONFIG_SPI_FLASH_SUPPORT_TH_CHIP`

- [CONFIG_SPI_FLASH_SUPPORT_WINBOND_CHIP](#)

CONFIG_SPI_FLASH_SUPPORT_ISSI_CHIP

ISSI

Found in: Component config > SPI Flash driver > Auto-detect flash chips

Enable this to support auto detection of ISSI chips if chip vendor not directly given by `chip_drv` member of the chip struct. This adds support for variant chips, however will extend detecting time.

Default value:

- Yes (enabled)

CONFIG_SPI_FLASH_SUPPORT_MXIC_CHIP

MXIC

Found in: Component config > SPI Flash driver > Auto-detect flash chips

Enable this to support auto detection of MXIC chips if chip vendor not directly given by `chip_drv` member of the chip struct. This adds support for variant chips, however will extend detecting time.

Default value:

- Yes (enabled)

CONFIG_SPI_FLASH_SUPPORT_GD_CHIP

GigaDevice

Found in: Component config > SPI Flash driver > Auto-detect flash chips

Enable this to support auto detection of GD (GigaDevice) chips if chip vendor not directly given by `chip_drv` member of the chip struct. If you are using Wrover modules, please don't disable this, otherwise your flash may not work in 4-bit mode.

This adds support for variant chips, however will extend detecting time and image size. Note that the default chip driver supports the GD chips with product ID 60H.

Default value:

- Yes (enabled)

CONFIG_SPI_FLASH_SUPPORT_WINBOND_CHIP

Winbond

Found in: Component config > SPI Flash driver > Auto-detect flash chips

Enable this to support auto detection of Winbond chips if chip vendor not directly given by `chip_drv` member of the chip struct. This adds support for variant chips, however will extend detecting time.

Default value:

- Yes (enabled)

CONFIG_SPI_FLASH_SUPPORT_BOYA_CHIP

BOYA

Found in: Component config > SPI Flash driver > Auto-detect flash chips

Enable this to support auto detection of BOYA chips if chip vendor not directly given by `chip_drv` member of the chip struct. This adds support for variant chips, however will extend detecting time.

Default value:

- Yes (enabled)

CONFIG_SPI_FLASH_SUPPORT_TH_CHIP

TH

Found in: Component config > SPI Flash driver > Auto-detect flash chips

Enable this to support auto detection of TH chips if chip vendor not directly given by `chip_drv` member of the chip struct. This adds support for variant chips, however will extend detecting time.

Default value:

- Yes (enabled)

CONFIG_SPI_FLASH_ENABLE_ENCRYPTED_READ_WRITE

Enable encrypted partition read/write operations

Found in: Component config > SPI Flash driver

This option enables flash read/write operations to encrypted partition/s. This option is kept enabled irrespective of state of flash encryption feature. However, in case application is not using flash encryption feature and is in need of some additional memory from IRAM region (~1KB) then this config can be disabled.

Default value:

- Yes (enabled)

SPIFFS Configuration Contains:

- *Debug Configuration*
- *CONFIG_SPIFFS_USE_MAGIC*
- *CONFIG_SPIFFS_GC_STATS*
- *CONFIG_SPIFFS_PAGE_CHECK*
- *CONFIG_SPIFFS_FOLLOW_SYMLINKS*
- *CONFIG_SPIFFS_MAX_PARTITIONS*
- *CONFIG_SPIFFS_USE_MTIME*
- *CONFIG_SPIFFS_GC_MAX_RUNS*
- *CONFIG_SPIFFS_OBJ_NAME_LEN*
- *CONFIG_SPIFFS_META_LENGTH*
- *SPIFFS Cache Configuration*
- *CONFIG_SPIFFS_PAGE_SIZE*
- *CONFIG_SPIFFS_MTIME_WIDE_64_BITS*

CONFIG_SPIFFS_MAX_PARTITIONS

Maximum Number of Partitions

Found in: Component config > SPIFFS Configuration

Define maximum number of partitions that can be mounted.

Range:

- from 1 to 10

Default value:

- 3

SPIFFS Cache Configuration Contains:

- *CONFIG_SPIFFS_CACHE*

CONFIG_SPIFFS_CACHE

Enable SPIFFS Cache

Found in: [Component config](#) > [SPIFFS Configuration](#) > [SPIFFS Cache Configuration](#)

Enables/disable memory read caching of nucleus file system operations.

Default value:

- Yes (enabled)

CONFIG_SPIFFS_CACHE_WR

Enable SPIFFS Write Caching

Found in: [Component config](#) > [SPIFFS Configuration](#) > [SPIFFS Cache Configuration](#) > [CONFIG_SPIFFS_CACHE](#)

Enables memory write caching for file descriptors in hydrogen.

Default value:

- Yes (enabled)

CONFIG_SPIFFS_CACHE_STATS

Enable SPIFFS Cache Statistics

Found in: [Component config](#) > [SPIFFS Configuration](#) > [SPIFFS Cache Configuration](#) > [CONFIG_SPIFFS_CACHE](#)

Enable/disable statistics on caching. Debug/test purpose only.

Default value:

- No (disabled)

CONFIG_SPIFFS_PAGE_CHECK

Enable SPIFFS Page Check

Found in: [Component config](#) > [SPIFFS Configuration](#)

Always check header of each accessed page to ensure consistent state. If enabled it will increase number of reads from flash, especially if cache is disabled.

Default value:

- Yes (enabled)

CONFIG_SPIFFS_GC_MAX_RUNS

Set Maximum GC Runs

Found in: [Component config](#) > [SPIFFS Configuration](#)

Define maximum number of GC runs to perform to reach desired free pages.

Range:

- from 1 to 255

Default value:

- 10

CONFIG_SPIFFS_GC_STATS

Enable SPIFFS GC Statistics

Found in: [Component config](#) > [SPIFFS Configuration](#)

Enable/disable statistics on gc. Debug/test purpose only.

Default value:

- No (disabled)

CONFIG_SPIFFS_PAGE_SIZE

SPIFFS logical page size

Found in: [Component config](#) > [SPIFFS Configuration](#)

Logical page size of SPIFFS partition, in bytes. Must be multiple of flash page size (which is usually 256 bytes). Larger page sizes reduce overhead when storing large files, and improve filesystem performance when reading large files. Smaller page sizes reduce overhead when storing small (< page size) files.

Range:

- from 256 to 1024

Default value:

- 256

CONFIG_SPIFFS_OBJ_NAME_LEN

Set SPIFFS Maximum Name Length

Found in: [Component config](#) > [SPIFFS Configuration](#)

Object name maximum length. Note that this length include the zero-termination character, meaning maximum string of characters can at most be SPIFFS_OBJ_NAME_LEN - 1.

SPIFFS_OBJ_NAME_LEN + SPIFFS_META_LENGTH should not exceed SPIFFS_PAGE_SIZE - 64.

Range:

- from 1 to 256

Default value:

- 32

CONFIG_SPIFFS_FOLLOW_SYMLINKS

Enable symbolic links for image creation

Found in: [Component config](#) > [SPIFFS Configuration](#)

If this option is enabled, symbolic links are taken into account during partition image creation.

Default value:

- No (disabled)

CONFIG_SPIFFS_USE_MAGIC

Enable SPIFFS Filesystem Magic

Found in: [Component config](#) > [SPIFFS Configuration](#)

Enable this to have an identifiable spiffs filesystem. This will look for a magic in all sectors to determine if this is a valid spiffs system or not at mount time.

Default value:

- Yes (enabled)

CONFIG_SPIFFS_USE_MAGIC_LENGTH

Enable SPIFFS Filesystem Length Magic

Found in: [Component config](#) > [SPIFFS Configuration](#) > [CONFIG_SPIFFS_USE_MAGIC](#)

If this option is enabled, the magic will also be dependent on the length of the filesystem. For example, a filesystem configured and formatted for 4 megabytes will not be accepted for mounting with a configuration defining the filesystem as 2 megabytes.

Default value:

- Yes (enabled)

CONFIG_SPIFFS_META_LENGTH

Size of per-file metadata field

Found in: [Component config](#) > [SPIFFS Configuration](#)

This option sets the number of extra bytes stored in the file header. These bytes can be used in an application-specific manner. Set this to at least 4 bytes to enable support for saving file modification time.

SPIFFS_OBJ_NAME_LEN + SPIFFS_META_LENGTH should not exceed SPIFFS_PAGE_SIZE - 64.

Default value:

- 4

CONFIG_SPIFFS_USE_MTIME

Save file modification time

Found in: [Component config](#) > [SPIFFS Configuration](#)

If enabled, then the first 4 bytes of per-file metadata will be used to store file modification time (mtime), accessible through stat/fstat functions. Modification time is updated when the file is opened.

Default value:

- Yes (enabled)

CONFIG_SPIFFS_MTIME_WIDE_64_BITS

The time field occupies 64 bits in the image instead of 32 bits

Found in: [Component config](#) > [SPIFFS Configuration](#)

If this option is not set, the time field is 32 bits (up to 2106 year), otherwise it is 64 bits and make sure it matches SPIFFS_META_LENGTH. If the chip already has the spiffs image with the time field = 32 bits then this option cannot be applied in this case. Erase it first before using this option. To resolve the Y2K38 problem for the spiffs, use a toolchain with support time_t 64 bits (see SDK_TOOLCHAIN_SUPPORTS_TIME_WIDE_64_BITS).

Default value:

- No (disabled) if [CONFIG_SPIFFS_META_LENGTH](#) >= 8

Debug Configuration Contains:

- [CONFIG_SPIFFS_DBG](#)
- [CONFIG_SPIFFS_API_DBG](#)
- [CONFIG_SPIFFS_CACHE_DBG](#)
- [CONFIG_SPIFFS_CHECK_DBG](#)
- [CONFIG_SPIFFS_TEST_VISUALISATION](#)
- [CONFIG_SPIFFS_GC_DBG](#)

CONFIG_SPIFFS_DBG

Enable general SPIFFS debug

Found in: [Component config](#) > [SPIFFS Configuration](#) > [Debug Configuration](#)

Enabling this option will print general debug messages to the console.

Default value:

- No (disabled)

CONFIG_SPIFFS_API_DBG

Enable SPIFFS API debug

Found in: [Component config](#) > [SPIFFS Configuration](#) > [Debug Configuration](#)

Enabling this option will print API debug messages to the console.

Default value:

- No (disabled)

CONFIG_SPIFFS_GC_DBG

Enable SPIFFS Garbage Cleaner debug

Found in: [Component config](#) > [SPIFFS Configuration](#) > [Debug Configuration](#)

Enabling this option will print GC debug messages to the console.

Default value:

- No (disabled)

CONFIG_SPIFFS_CACHE_DBG

Enable SPIFFS Cache debug

Found in: [Component config](#) > [SPIFFS Configuration](#) > [Debug Configuration](#)

Enabling this option will print cache debug messages to the console.

Default value:

- No (disabled)

CONFIG_SPIFFS_CHECK_DBG

Enable SPIFFS Filesystem Check debug

Found in: [Component config](#) > [SPIFFS Configuration](#) > [Debug Configuration](#)

Enabling this option will print Filesystem Check debug messages to the console.

Default value:

- No (disabled)

CONFIG_SPIFFS_TEST_VISUALISATION

Enable SPIFFS Filesystem Visualization

Found in: [Component config](#) > [SPIFFS Configuration](#) > [Debug Configuration](#)

Enable this option to enable SPIFFS_vis function in the API.

Default value:

- No (disabled)

TCP Transport Contains:

- [Websocket](#)

Websocket Contains:

- [CONFIG_WS_TRANSPORT](#)

CONFIG_WS_TRANSPORT

Enable Websocket Transport

Found in: [Component config](#) > [TCP Transport](#) > [Websocket](#)

Enable support for creating websocket transport.

Default value:

- Yes (enabled)

CONFIG_WS_BUFFER_SIZE

Websocket transport buffer size

Found in: [Component config](#) > [TCP Transport](#) > [Websocket](#) > [CONFIG_WS_TRANSPORT](#)

Size of the buffer used for constructing the HTTP Upgrade request during connect

Default value:

- 1024

TinyUSB

Unity unit testing library Contains:

- [CONFIG_UNITY_ENABLE_COLOR](#)
- [CONFIG_UNITY_ENABLE_IDF_TEST_RUNNER](#)
- [CONFIG_UNITY_ENABLE_FIXTURE](#)
- [CONFIG_UNITY_ENABLE_BACKTRACE_ON_FAIL](#)
- [CONFIG_UNITY_ENABLE_DOUBLE](#)
- [CONFIG_UNITY_ENABLE_FLOAT](#)

CONFIG_UNITY_ENABLE_FLOAT

Support for float type

Found in: [Component config](#) > [Unity unit testing library](#)

If not set, assertions on float arguments will not be available.

Default value:

- Yes (enabled)

CONFIG_UNITY_ENABLE_DOUBLE

Support for double type

Found in: [Component config](#) > [Unity unit testing library](#)

If not set, assertions on double arguments will not be available.

Default value:

- Yes (enabled)

CONFIG_UNITY_ENABLE_COLOR

Colorize test output

Found in: [Component config](#) > [Unity unit testing library](#)

If set, Unity will colorize test results using console escape sequences.

Default value:

- No (disabled)

CONFIG_UNITY_ENABLE_IDF_TEST_RUNNER

Include ESP-IDF test registration/running helpers

Found in: [Component config](#) > [Unity unit testing library](#)

If set, then the following features will be available:

- TEST_CASE macro which performs automatic registration of test functions
- Functions to run registered test functions: `unity_run_all_tests`, `unity_run_tests_with_filter`, `unity_run_single_test_by_name`.
- Interactive menu which lists test cases and allows choosing the tests to be run, available via `unity_run_menu` function.

Disable if a different test registration mechanism is used.

Default value:

- Yes (enabled)

CONFIG_UNITY_ENABLE_FIXTURE

Include Unity test fixture

Found in: [Component config](#) > [Unity unit testing library](#)

If set, `unity_fixture.h` header file and associated source files are part of the build. These provide an optional set of macros and functions to implement test groups.

Default value:

- No (disabled)

CONFIG_UNITY_ENABLE_BACKTRACE_ON_FAIL

Print a backtrace when a unit test fails

Found in: [Component config](#) > [Unity unit testing library](#)

If set, the unity framework will print the backtrace information before jumping back to the test menu. The jumping is usually occurs in assert functions such as `TEST_ASSERT`, `TEST_FAIL` etc.

Default value:

- No (disabled)

Virtual file system Contains:

- [CONFIG_VFS_SUPPORT_IO](#)

CONFIG_VFS_SUPPORT_IO

Provide basic I/O functions

Found in: [Component config](#) > [Virtual file system](#)

If enabled, the following functions are provided by the VFS component.

open, close, read, write, pread, pwrite, lseek, fstat, fsync, ioctl, fcntl

Filesystem drivers can then be registered to handle these functions for specific paths.

Disabling this option can save memory when the support for these functions is not required.

Default value:

- Yes (enabled)

CONFIG_VFS_SUPPORT_DIR

Provide directory related functions

Found in: [Component config](#) > [Virtual file system](#) > [CONFIG_VFS_SUPPORT_IO](#)

If enabled, the following functions are provided by the VFS component.

stat, link, unlink, rename, utime, access, truncate, rmdir, mkdir, opendir, closedir, readdir, readdir_r, seekdir, telldir, rewinddir

Filesystem drivers can then be registered to handle these functions for specific paths.

Disabling this option can save memory when the support for these functions is not required.

Default value:

- Yes (enabled)

CONFIG_VFS_SUPPORT_SELECT

Provide select function

Found in: [Component config](#) > [Virtual file system](#) > [CONFIG_VFS_SUPPORT_IO](#)

If enabled, select function is provided by the VFS component, and can be used on peripheral file descriptors (such as UART) and sockets at the same time.

If disabled, the default select implementation will be provided by LWIP for sockets only.

Disabling this option can reduce code size if support for “select” on UART file descriptors is not required.

Default value:

- Yes (enabled) if `CONFIG_VFS_SUPPORT_IO` && `CONFIG_LWIP_USE_ONLY_LWIP_SELECT`

CONFIG_VFS_SUPPRESS_SELECT_DEBUG_OUTPUT

Suppress select() related debug outputs

Found in: [Component config](#) > [Virtual file system](#) > [CONFIG_VFS_SUPPORT_IO](#) > [CONFIG_VFS_SUPPORT_SELECT](#)

Select() related functions might produce an inconveniently lot of debug outputs when one sets the default log level to DEBUG or higher. It is possible to suppress these debug outputs by enabling this option.

Default value:

- Yes (enabled)

CONFIG_VFS_SUPPORT_TERMIOS

Provide termios.h functions

Found in: [Component config](#) > [Virtual file system](#) > [CONFIG_VFS_SUPPORT_IO](#)

Disabling this option can save memory when the support for termios.h is not required.

Default value:

- Yes (enabled)

Host File System I/O (Semihosting) Contains:

- [CONFIG_VFS_SEMIHOSTFS_MAX_MOUNT_POINTS](#)
- [CONFIG_VFS_SEMIHOSTFS_HOST_PATH_MAX_LEN](#)

CONFIG_VFS_SEMIHOSTFS_MAX_MOUNT_POINTS

Host FS: Maximum number of the host filesystem mount points

Found in: [Component config](#) > [Virtual file system](#) > [CONFIG_VFS_SUPPORT_IO](#) > [Host File System I/O \(Semihosting\)](#)

Define maximum number of host filesystem mount points.

Default value:

- 1

CONFIG_VFS_SEMIHOSTFS_HOST_PATH_MAX_LEN

Host FS: Maximum path length for the host base directory

Found in: [Component config](#) > [Virtual file system](#) > [CONFIG_VFS_SUPPORT_IO](#) > [Host File System I/O \(Semihosting\)](#)

Define maximum path length for the host base directory which is to be mounted. If host path passed to `esp_vfs_semihost_register()` is longer than this value it will be truncated.

Default value:

- 128

Wear Levelling Contains:

- [CONFIG_WL_SECTOR_MODE](#)
- [CONFIG_WL_SECTOR_SIZE](#)

CONFIG_WL_SECTOR_SIZE

Wear Levelling library sector size

Found in: [Component config](#) > [Wear Levelling](#)

Sector size used by wear levelling library. You can set default sector size or size that will fit to the flash device sector size.

With sector size set to 4096 bytes, wear levelling library is more efficient. However if FAT filesystem is used on top of wear levelling library, it will need more temporary storage: 4096 bytes for each mounted filesystem and 4096 bytes for each opened file.

With sector size set to 512 bytes, wear levelling library will perform more operations with flash memory, but less RAM will be used by FAT filesystem library (512 bytes for the filesystem and 512 bytes for each file opened).

Available options:

- 512 ([WL_SECTOR_SIZE_512](#))
- 4096 ([WL_SECTOR_SIZE_4096](#))

CONFIG_WL_SECTOR_MODE

Sector store mode

Found in: [Component config](#) > [Wear Levelling](#)

Specify the mode to store data into flash:

- In Performance mode a data will be stored to the RAM and then stored back to the flash. Compared to the Safety mode, this operation is faster, but if power will be lost when erase sector operation is in progress, then the data from complete flash device sector will be lost.
- In Safety mode data from complete flash device sector will be read from flash, modified, and then stored back to flash. Compared to the Performance mode, this operation is slower, but if power is lost during erase sector operation, then the data from full flash device sector will not be lost.

Available options:

- Performance (WL_SECTOR_MODE_PERF)
- Safety (WL_SECTOR_MODE_SAFE)

Wi-Fi Provisioning Manager Contains:

- [CONFIG_WIFI_PROV_BLE_BONDING](#)
- [CONFIG_WIFI_PROV_BLE_SEC_CONN](#)
- [CONFIG_WIFI_PROV_BLE_FORCE_ENCRYPTION](#)
- [CONFIG_WIFI_PROV_SCAN_MAX_ENTRIES](#)
- [CONFIG_WIFI_PROV_AUTOSTOP_TIMEOUT](#)

CONFIG_WIFI_PROV_SCAN_MAX_ENTRIES

Max Wi-Fi Scan Result Entries

Found in: [Component config](#) > [Wi-Fi Provisioning Manager](#)

This sets the maximum number of entries of Wi-Fi scan results that will be kept by the provisioning manager

Range:

- from 1 to 255

Default value:

- 16

CONFIG_WIFI_PROV_AUTOSTOP_TIMEOUT

Provisioning auto-stop timeout

Found in: [Component config](#) > [Wi-Fi Provisioning Manager](#)

Time (in seconds) after which the Wi-Fi provisioning manager will auto-stop after connecting to a Wi-Fi network successfully.

Range:

- from 5 to 600

Default value:

- 30

CONFIG_WIFI_PROV_BLE_BONDING

Enable BLE bonding

Found in: [Component config](#) > [Wi-Fi Provisioning Manager](#)

This option is applicable only when provisioning transport is BLE.

Default value:

- Yes (enabled) if *CONFIG_BT_ENABLED*

CONFIG_WIFI_PROV_BLE_SEC_CONN

Enable BLE Secure connection flag

Found in: Component config > Wi-Fi Provisioning Manager

Used to enable Secure connection support when provisioning transport is BLE.

Default value:

- Yes (enabled) if *BT_NIMBLE_ENABLED*

CONFIG_WIFI_PROV_BLE_FORCE_ENCRYPTION

Force Link Encryption during characteristic Read / Write

Found in: Component config > Wi-Fi Provisioning Manager

Used to enforce link encryption when attempting to read / write characteristic

Default value:

- Yes (enabled) if *BT_NIMBLE_ENABLED*

Supplicant Contains:

- *CONFIG_WPA_TESTING_OPTIONS*
- *CONFIG_WPA_11KV_SUPPORT*
- *CONFIG_WPA_DPP_SUPPORT*
- *CONFIG_WPA_WAPI_PSK*
- *CONFIG_WPA_DEBUG_PRINT*
- *CONFIG_WPA_WPS_STRICT*
- *CONFIG_WPA_MBEDTLS_CRYPTO*

CONFIG_WPA_MBEDTLS_CRYPTO

Use MbedTLS crypto APIs

Found in: Component config > Supplicant

Select this option to use MbedTLS crypto APIs which utilize hardware acceleration.

Default value:

- Yes (enabled)

CONFIG_WPA_WAPI_PSK

Enable WAPI PSK support

Found in: Component config > Supplicant

Select this option to enable WAPI-PSK which is a Chinese National Standard Encryption for Wireless LANs (GB 15629.11-2003).

Default value:

- No (disabled)

CONFIG_WPA_DEBUG_PRINT

Print debug messages from WPA Supplicant

Found in: [Component config](#) > [Supplicant](#)

Select this option to print logging information from WPA supplicant, this includes handshake information and key hex dumps depending on the project logging level.

Enabling this could increase the build size ~60kb depending on the project logging level.

Default value:

- No (disabled)

CONFIG_WPA_TESTING_OPTIONS

Add DPP testing code

Found in: [Component config](#) > [Supplicant](#)

Select this to enable unity test for DPP.

Default value:

- No (disabled)

CONFIG_WPA_WPS_STRICT

Strictly validate all WPS attributes

Found in: [Component config](#) > [Supplicant](#)

Select this option to enable validate each WPS attribute rigorously. Disabling this add the workarounds with various APs. Enabling this may cause inter operability issues with some APs.

Default value:

- No (disabled)

CONFIG_WPA_11KV_SUPPORT

Enable 802.11k, 802.11v APIs handling

Found in: [Component config](#) > [Supplicant](#)

Select this option to enable 802.11k 802.11v APIs(RRM and BTM support). Only APIs which are helpful for network assisted roaming are supported for now. Enable this option with BTM and RRM enabled in sta config to make device ready for network assisted roaming. BTM: BSS transition management enables an AP to request a station to transition to a specific AP, or to indicate to a station a set of preferred APs. RRM: Radio measurements enable STAs to understand the radio environment, it enables STAs to observe and gather data on radio link performance and on the radio environment. Current implementation adds beacon report, link measurement, neighbor report.

Default value:

- No (disabled)

CONFIG_WPA_SCAN_CACHE

Keep scan results in cache

Found in: [Component config](#) > [Supplicant](#) > [CONFIG_WPA_11KV_SUPPORT](#)

Keep scan results in cache, if not enabled, those will be flushed immediately.

Default value:

- No (disabled) if [CONFIG_WPA_11KV_SUPPORT](#)

CONFIG_WPA_DPP_SUPPORT

Enable DPP support

Found in: *Component config > Supplicant*

Select this option to enable WiFi Easy Connect Support.

Default value:

- No (disabled)

Compatibility options

Contains:

- [CONFIG_LEGACY_INCLUDE_COMMON_HEADERS](#)

CONFIG_LEGACY_INCLUDE_COMMON_HEADERS

Include headers across components as before IDF v4.0

Found in: *Compatibility options*

Soc, esp32, and driver components, the most common components. Some header of these components are included implicitly by headers of other components before IDF v4.0. It's not required for high-level components, but still included through long header chain everywhere.

This is harmful to the modularity. So it's changed in IDF v4.0.

You can still include these headers in a legacy way until it is totally deprecated by enable this option.

Default value:

- No (disabled)

Deprecated options and their replacements

- **CONFIG_A2D_INITIAL_TRACE_LEVEL** ([CONFIG_BT_LOG_A2D_TRACE_LEVEL](#))
 - CONFIG_A2D_TRACE_LEVEL_NONE
 - CONFIG_A2D_TRACE_LEVEL_ERROR
 - CONFIG_A2D_TRACE_LEVEL_WARNING
 - CONFIG_A2D_TRACE_LEVEL_API
 - CONFIG_A2D_TRACE_LEVEL_EVENT
 - CONFIG_A2D_TRACE_LEVEL_DEBUG
 - CONFIG_A2D_TRACE_LEVEL_VERBOSE
- CONFIG_ADC2_DISABLE_DAC ([CONFIG_ADC_DISABLE_DAC](#))
- **CONFIG_APPL_INITIAL_TRACE_LEVEL** ([CONFIG_BT_LOG_APPL_TRACE_LEVEL](#))
 - CONFIG_APPL_TRACE_LEVEL_NONE
 - CONFIG_APPL_TRACE_LEVEL_ERROR
 - CONFIG_APPL_TRACE_LEVEL_WARNING
 - CONFIG_APPL_TRACE_LEVEL_API
 - CONFIG_APPL_TRACE_LEVEL_EVENT
 - CONFIG_APPL_TRACE_LEVEL_DEBUG
 - CONFIG_APPL_TRACE_LEVEL_VERBOSE
- CONFIG_APP_ANTI_ROLLBACK ([CONFIG_BOOTLOADER_APP_ANTI_ROLLBACK](#))
- CONFIG_APP_ROLLBACK_ENABLE ([CONFIG_BOOTLOADER_APP_ROLLBACK_ENABLE](#))
- CONFIG_APP_SECURE_VERSION ([CONFIG_BOOTLOADER_APP_SECURE_VERSION](#))
- CONFIG_APP_SECURE_VERSION_SIZE_EFUSE_FIELD ([CONFIG_BOOTLOADER_APP_SEC_VER_SIZE_EFUSE_FIELD](#))
- **CONFIG_AVCT_INITIAL_TRACE_LEVEL** ([CONFIG_BT_LOG_AVCT_TRACE_LEVEL](#))
 - CONFIG_AVCT_TRACE_LEVEL_NONE
 - CONFIG_AVCT_TRACE_LEVEL_ERROR
 - CONFIG_AVCT_TRACE_LEVEL_WARNING

- CONFIG_AVCT_TRACE_LEVEL_API
- CONFIG_AVCT_TRACE_LEVEL_EVENT
- CONFIG_AVCT_TRACE_LEVEL_DEBUG
- CONFIG_AVCT_TRACE_LEVEL_VERBOSE
- **CONFIG_AVDT_INITIAL_TRACE_LEVEL** (*CONFIG_BT_LOG_AVDT_TRACE_LEVEL*)
 - CONFIG_AVDT_TRACE_LEVEL_NONE
 - CONFIG_AVDT_TRACE_LEVEL_ERROR
 - CONFIG_AVDT_TRACE_LEVEL_WARNING
 - CONFIG_AVDT_TRACE_LEVEL_API
 - CONFIG_AVDT_TRACE_LEVEL_EVENT
 - CONFIG_AVDT_TRACE_LEVEL_DEBUG
 - CONFIG_AVDT_TRACE_LEVEL_VERBOSE
- **CONFIG_AVRC_INITIAL_TRACE_LEVEL** (*CONFIG_BT_LOG_AVRC_TRACE_LEVEL*)
 - CONFIG_AVRC_TRACE_LEVEL_NONE
 - CONFIG_AVRC_TRACE_LEVEL_ERROR
 - CONFIG_AVRC_TRACE_LEVEL_WARNING
 - CONFIG_AVRC_TRACE_LEVEL_API
 - CONFIG_AVRC_TRACE_LEVEL_EVENT
 - CONFIG_AVRC_TRACE_LEVEL_DEBUG
 - CONFIG_AVRC_TRACE_LEVEL_VERBOSE
- CONFIG_BLE_ACTIVE_SCAN_REPORT_ADV_SCAN_RSP_INDIVIDUALLY (*CON-
FIG_BT_BLE_ACT_SCAN_REP_ADV_SCAN*)
- CONFIG_BLE_ESTABLISH_LINK_CONNECTION_TIMEOUT (*CON-
FIG_BT_BLE_ESTAB_LINK_CONN_TOUT*)
- CONFIG_BLE_HOST_QUEUE_CONGESTION_CHECK (*CONFIG_BT_BLE_HOST_QUEUE_CONG_CHECK*)
- CONFIG_BLE_MESH_GATT_PROXY (*CONFIG_BLE_MESH_GATT_PROXY_SERVER*)
- CONFIG_BLE_SMP_ENABLE (*CONFIG_BT_BLE_SMP_ENABLE*)
- CONFIG_BLUEDROID_MEM_DEBUG (*CONFIG_BT_BLUEDROID_MEM_DEBUG*)
- **CONFIG_BLUEDROID_PINNED_TO_CORE_CHOICE** (*CONFIG_BT_BLUEDROID_PINNED_TO_CORE_CHOICE*)
 - CONFIG_BLUEDROID_PINNED_TO_CORE_0
 - CONFIG_BLUEDROID_PINNED_TO_CORE_1
- **CONFIG_BLUFI_INITIAL_TRACE_LEVEL** (*CONFIG_BT_LOG_BLUFI_TRACE_LEVEL*)
 - CONFIG_BLUFI_TRACE_LEVEL_NONE
 - CONFIG_BLUFI_TRACE_LEVEL_ERROR
 - CONFIG_BLUFI_TRACE_LEVEL_WARNING
 - CONFIG_BLUFI_TRACE_LEVEL_API
 - CONFIG_BLUFI_TRACE_LEVEL_EVENT
 - CONFIG_BLUFI_TRACE_LEVEL_DEBUG
 - CONFIG_BLUFI_TRACE_LEVEL_VERBOSE
- CONFIG_BNEP_INITIAL_TRACE_LEVEL (*CONFIG_BT_LOG_BNEP_TRACE_LEVEL*)
- **CONFIG_BTC_INITIAL_TRACE_LEVEL** (*CONFIG_BT_LOG_BTC_TRACE_LEVEL*)
 - CONFIG_BTC_TRACE_LEVEL_NONE
 - CONFIG_BTC_TRACE_LEVEL_ERROR
 - CONFIG_BTC_TRACE_LEVEL_WARNING
 - CONFIG_BTC_TRACE_LEVEL_API
 - CONFIG_BTC_TRACE_LEVEL_EVENT
 - CONFIG_BTC_TRACE_LEVEL_DEBUG
 - CONFIG_BTC_TRACE_LEVEL_VERBOSE
- CONFIG_BTC_TASK_STACK_SIZE (*CONFIG_BT_BTC_TASK_STACK_SIZE*)
- **CONFIG_BTH_LOG_SDP_INITIAL_TRACE_LEVEL** (*CONFIG_BT_LOG_SDP_TRACE_LEVEL*)
 - CONFIG_SDP_TRACE_LEVEL_NONE
 - CONFIG_SDP_TRACE_LEVEL_ERROR
 - CONFIG_SDP_TRACE_LEVEL_WARNING
 - CONFIG_SDP_TRACE_LEVEL_API
 - CONFIG_SDP_TRACE_LEVEL_EVENT
 - CONFIG_SDP_TRACE_LEVEL_DEBUG
 - CONFIG_SDP_TRACE_LEVEL_VERBOSE

- **CONFIG_BTIF_INITIAL_TRACE_LEVEL** (*CONFIG_BT_LOG_BTIF_TRACE_LEVEL*)
 - CONFIG_BTIF_TRACE_LEVEL_NONE
 - CONFIG_BTIF_TRACE_LEVEL_ERROR
 - CONFIG_BTIF_TRACE_LEVEL_WARNING
 - CONFIG_BTIF_TRACE_LEVEL_API
 - CONFIG_BTIF_TRACE_LEVEL_EVENT
 - CONFIG_BTIF_TRACE_LEVEL_DEBUG
 - CONFIG_BTIF_TRACE_LEVEL_VERBOSE
- **CONFIG_BTM_INITIAL_TRACE_LEVEL** (*CONFIG_BT_LOG_BTM_TRACE_LEVEL*)
 - CONFIG_BTM_TRACE_LEVEL_NONE
 - CONFIG_BTM_TRACE_LEVEL_ERROR
 - CONFIG_BTM_TRACE_LEVEL_WARNING
 - CONFIG_BTM_TRACE_LEVEL_API
 - CONFIG_BTM_TRACE_LEVEL_EVENT
 - CONFIG_BTM_TRACE_LEVEL_DEBUG
 - CONFIG_BTM_TRACE_LEVEL_VERBOSE
- **CONFIG_BTU_TASK_STACK_SIZE** (*CONFIG_BT_BTU_TASK_STACK_SIZE*)
- **CONFIG_CONSOLE_UART** (*CONFIG_ESP_CONSOLE_UART*)
 - CONFIG_CONSOLE_UART_DEFAULT
 - CONFIG_CONSOLE_UART_CUSTOM
 - CONFIG_ESP_CONSOLE_UART_NONE
- **CONFIG_CONSOLE_UART_BAUDRATE** (*CONFIG_ESP_CONSOLE_UART_BAUDRATE*)
- **CONFIG_CONSOLE_UART_NUM** (*CONFIG_ESP_CONSOLE_UART_NUM*)
 - CONFIG_CONSOLE_UART_CUSTOM_NUM_0
 - CONFIG_CONSOLE_UART_CUSTOM_NUM_1
- **CONFIG_CONSOLE_UART_RX_GPIO** (*CONFIG_ESP_CONSOLE_UART_RX_GPIO*)
- **CONFIG_CONSOLE_UART_TX_GPIO** (*CONFIG_ESP_CONSOLE_UART_TX_GPIO*)
- **CONFIG_CXX_EXCEPTIONS** (*CONFIG_COMPILER_CXX_EXCEPTIONS*)
- **CONFIG_CXX_EXCEPTIONS_EMG_POOL_SIZE** (*CONFIG_COMPILER_CXX_EXCEPTIONS_EMG_POOL_SIZE*)
- **CONFIG_DISABLE_GCC8_WARNINGS** (*CONFIG_COMPILER_DISABLE_GCC8_WARNINGS*)
- **CONFIG_EFUSE_SECURE_VERSION_EMULATE** (*CONFIG_BOOTLOADER_EFUSE_SECURE_VERSION_EMULATE*)
- **CONFIG_ENABLE_STATIC_TASK_CLEAN_UP_HOOK** (*CONFIG_FREERTOS_ENABLE_STATIC_TASK_CLEAN_UP*)
- **CONFIG_ESP32C3_MEMPROT_FEATURE** (*CONFIG_ESP_SYSTEM_MEMPROT_FEATURE*)
- **CONFIG_ESP32C3_MEMPROT_FEATURE_LOCK** (*CONFIG_ESP_SYSTEM_MEMPROT_FEATURE_LOCK*)
- **CONFIG_ESP32S2_ALLOW_RTC_FAST_MEM_AS_HEAP** (*CONFIG_ESP_SYSTEM_ALLOW_RTC_FAST_MEM_AS_HEAP*)
- **CONFIG_ESP32S2_MEMPROT_FEATURE** (*CONFIG_ESP_SYSTEM_MEMPROT_FEATURE*)
- **CONFIG_ESP32S2_MEMPROT_FEATURE_LOCK** (*CONFIG_ESP_SYSTEM_MEMPROT_FEATURE_LOCK*)
- **CONFIG_ESP32S2_PANIC** (*CONFIG_ESP_SYSTEM_PANIC*)
 - CONFIG_ESP32S2_PANIC_PRINT_HALT
 - CONFIG_ESP32S2_PANIC_PRINT_REBOOT
 - CONFIG_ESP32S2_PANIC_SILENT_REBOOT
 - CONFIG_ESP32S2_PANIC_GDBSTUB
- **CONFIG_ESP32_ALLOW_RTC_FAST_MEM_AS_HEAP** (*CONFIG_ESP_SYSTEM_ALLOW_RTC_FAST_MEM_AS_HEAP*)
- **CONFIG_ESP32_APPTRACE_DESTINATION** (*CONFIG_APPTRACE_DESTINATION*)
 - CONFIG_ESP32_APPTRACE_DEST_TRAX
 - CONFIG_ESP32_APPTRACE_DEST_NONE
- **CONFIG_ESP32_APPTRACE_ONPANIC_HOST_FLUSH_TMO** (*CONFIG_APPTRACE_ONPANIC_HOST_FLUSH_TMO*)
- **CONFIG_ESP32_APPTRACE_PENDING_DATA_SIZE_MAX** (*CONFIG_APPTRACE_PENDING_DATA_SIZE_MAX*)
- **CONFIG_ESP32_APPTRACE_POSTMORTEM_FLUSH_TRAX_THRESH** (*CONFIG_APPTRACE_POSTMORTEM_FLUSH_THRESH*)
- **CONFIG_ESP32_CORE_DUMP_DECODE** (*CONFIG_ESP_COREDUMP_DECODE*)
 - CONFIG_ESP32_CORE_DUMP_DECODE_INFO
 - CONFIG_ESP32_CORE_DUMP_DECODE_DISABLE
- **CONFIG_ESP32_CORE_DUMP_MAX_TASKS_NUM** (*CONFIG_ESP_COREDUMP_MAX_TASKS_NUM*)
- **CONFIG_ESP32_CORE_DUMP_STACK_SIZE** (*CONFIG_ESP_COREDUMP_STACK_SIZE*)
- **CONFIG_ESP32_CORE_DUMP_UART_DELAY** (*CONFIG_ESP_COREDUMP_UART_DELAY*)
- **CONFIG_ESP32_GCOV_ENABLE** (*CONFIG_APPTRACE_GCOV_ENABLE*)

- **CONFIG_ESP32_PANIC** (*CONFIG_ESP_SYSTEM_PANIC*)
 - CONFIG_ESP32S2_PANIC_PRINT_HALT
 - CONFIG_ESP32S2_PANIC_PRINT_REBOOT
 - CONFIG_ESP32S2_PANIC_SILENT_REBOOT
 - CONFIG_ESP32S2_PANIC_GDBSTUB
- CONFIG_ESP32_PTHREAD_STACK_MIN (*CONFIG_PTHREAD_STACK_MIN*)
- **CONFIG_ESP32_PTHREAD_TASK_CORE_DEFAULT** (*CONFIG_PTHREAD_TASK_CORE_DEFAULT*)
 - CONFIG_ESP32_DEFAULT_PTHREAD_CORE_NO_AFFINITY
 - CONFIG_ESP32_DEFAULT_PTHREAD_CORE_0
 - CONFIG_ESP32_DEFAULT_PTHREAD_CORE_1
- CONFIG_ESP32_PTHREAD_TASK_NAME_DEFAULT (*CONFIG_PTHREAD_TASK_NAME_DEFAULT*)
- CONFIG_ESP32_PTHREAD_TASK_PRIO_DEFAULT (*CONFIG_PTHREAD_TASK_PRIO_DEFAULT*)
- CONFIG_ESP32_PTHREAD_TASK_STACK_SIZE_DEFAULT (*CONFIG_PTHREAD_TASK_STACK_SIZE_DEFAULT*)
- CONFIG_ESP32_RTC_XTAL_BOOTSTRAP_CYCLES (*CONFIG_ESP_SYSTEM_RTC_EXT_XTAL_BOOTSTRAP_CYCLES*)
- CONFIG_ESP_GRATUITOUS_ARP (*CONFIG_LWIP_ESP_GRATUITOUS_ARP*)
- CONFIG_ESP_TCP_KEEP_CONNECTION_WHEN_IP_CHANGES (*CONFIG_LWIP_TCP_KEEP_CONNECTION_WHEN_IP_CHANGES*)
- CONFIG_EVENT_LOOP_PROFILING (*CONFIG_ESP_EVENT_LOOP_PROFILING*)
- CONFIG_FLASH_ENCRYPTION_ENABLED (*CONFIG_SECURE_FLASH_ENC_ENABLED*)
- CONFIG_FLASH_ENCRYPTION_UART_BOOTLOADER_ALLOW_CACHE (*CONFIG_SECURE_FLASH_UART_BOOTLOADER_ALLOW_CACHE*)
- CONFIG_FLASH_ENCRYPTION_UART_BOOTLOADER_ALLOW_ENCRYPT (*CONFIG_SECURE_FLASH_UART_BOOTLOADER_ALLOW_ENC*)
- **CONFIG_GAP_INITIAL_TRACE_LEVEL** (*CONFIG_BT_LOG_GAP_TRACE_LEVEL*)
 - CONFIG_GAP_TRACE_LEVEL_NONE
 - CONFIG_GAP_TRACE_LEVEL_ERROR
 - CONFIG_GAP_TRACE_LEVEL_WARNING
 - CONFIG_GAP_TRACE_LEVEL_API
 - CONFIG_GAP_TRACE_LEVEL_EVENT
 - CONFIG_GAP_TRACE_LEVEL_DEBUG
 - CONFIG_GAP_TRACE_LEVEL_VERBOSE
- CONFIG_GARP_TMR_INTERVAL (*CONFIG_LWIP_GARP_TMR_INTERVAL*)
- CONFIG_GATTC_CACHE_NVS_FLASH (*CONFIG_BT_GATTC_CACHE_NVS_FLASH*)
- CONFIG_GATTC_ENABLE (*CONFIG_BT_GATTC_ENABLE*)
- CONFIG_GATTS_ENABLE (*CONFIG_BT_GATTS_ENABLE*)
- **CONFIG_GATTS_SEND_SERVICE_CHANGE_MODE** (*CONFIG_BT_GATTS_SEND_SERVICE_CHANGE_MODE*)
 - CONFIG_GATTS_SEND_SERVICE_CHANGE_MANUAL
 - CONFIG_GATTS_SEND_SERVICE_CHANGE_AUTO
- **CONFIG_GATT_INITIAL_TRACE_LEVEL** (*CONFIG_BT_LOG_GATT_TRACE_LEVEL*)
 - CONFIG_GATT_TRACE_LEVEL_NONE
 - CONFIG_GATT_TRACE_LEVEL_ERROR
 - CONFIG_GATT_TRACE_LEVEL_WARNING
 - CONFIG_GATT_TRACE_LEVEL_API
 - CONFIG_GATT_TRACE_LEVEL_EVENT
 - CONFIG_GATT_TRACE_LEVEL_DEBUG
 - CONFIG_GATT_TRACE_LEVEL_VERBOSE
- CONFIG_GDBSTUB_MAX_TASKS (*CONFIG_ESP_GDBSTUB_MAX_TASKS*)
- CONFIG_GDBSTUB_SUPPORT_TASKS (*CONFIG_ESP_GDBSTUB_SUPPORT_TASKS*)
- **CONFIG_HCI_INITIAL_TRACE_LEVEL** (*CONFIG_BT_LOG_HCI_TRACE_LEVEL*)
 - CONFIG_HCI_TRACE_LEVEL_NONE
 - CONFIG_HCI_TRACE_LEVEL_ERROR
 - CONFIG_HCI_TRACE_LEVEL_WARNING
 - CONFIG_HCI_TRACE_LEVEL_API
 - CONFIG_HCI_TRACE_LEVEL_EVENT
 - CONFIG_HCI_TRACE_LEVEL_DEBUG
 - CONFIG_HCI_TRACE_LEVEL_VERBOSE

- **CONFIG_HID_INITIAL_TRACE_LEVEL** (*CONFIG_BT_LOG_HID_TRACE_LEVEL*)
 - CONFIG_HID_TRACE_LEVEL_NONE
 - CONFIG_HID_TRACE_LEVEL_ERROR
 - CONFIG_HID_TRACE_LEVEL_WARNING
 - CONFIG_HID_TRACE_LEVEL_API
 - CONFIG_HID_TRACE_LEVEL_EVENT
 - CONFIG_HID_TRACE_LEVEL_DEBUG
 - CONFIG_HID_TRACE_LEVEL_VERBOSE
- CONFIG_INT_WDT (*CONFIG_ESP_INT_WDT*)
- CONFIG_INT_WDT_CHECK_CPU1 (*CONFIG_ESP_INT_WDT_CHECK_CPU1*)
- CONFIG_INT_WDT_TIMEOUT_MS (*CONFIG_ESP_INT_WDT_TIMEOUT_MS*)
- CONFIG_IPC_TASK_STACK_SIZE (*CONFIG_ESP_IPC_TASK_STACK_SIZE*)
- **CONFIG_L2CAP_INITIAL_TRACE_LEVEL** (*CONFIG_BT_LOG_L2CAP_TRACE_LEVEL*)
 - CONFIG_L2CAP_TRACE_LEVEL_NONE
 - CONFIG_L2CAP_TRACE_LEVEL_ERROR
 - CONFIG_L2CAP_TRACE_LEVEL_WARNING
 - CONFIG_L2CAP_TRACE_LEVEL_API
 - CONFIG_L2CAP_TRACE_LEVEL_EVENT
 - CONFIG_L2CAP_TRACE_LEVEL_DEBUG
 - CONFIG_L2CAP_TRACE_LEVEL_VERBOSE
- CONFIG_L2_TO_L3_COPY (*CONFIG_LWIP_L2_TO_L3_COPY*)
- **CONFIG_LOG_BOOTLOADER_LEVEL** (*CONFIG_BOOTLOADER_LOG_LEVEL*)
 - CONFIG_LOG_BOOTLOADER_LEVEL_NONE
 - CONFIG_LOG_BOOTLOADER_LEVEL_ERROR
 - CONFIG_LOG_BOOTLOADER_LEVEL_WARN
 - CONFIG_LOG_BOOTLOADER_LEVEL_INFO
 - CONFIG_LOG_BOOTLOADER_LEVEL_DEBUG
 - CONFIG_LOG_BOOTLOADER_LEVEL_VERBOSE
- CONFIG_MAC_BB_PD (*CONFIG_ESP32_PHY_MAC_BB_PD*)
- CONFIG_MAIN_TASK_STACK_SIZE (*CONFIG_ESP_MAIN_TASK_STACK_SIZE*)
- CONFIG_MAKE_WARN_UNDEFINED_VARIABLES (*CONFIG_SDK_MAKE_WARN_UNDEFINED_VARIABLES*)
- CONFIG_MB_CONTROLLER_NOTIFY_QUEUE_SIZE (*CONFIG_FMB_CONTROLLER_NOTIFY_QUEUE_SIZE*)
- CONFIG_MB_CONTROLLER_NOTIFY_TIMEOUT (*CONFIG_FMB_CONTROLLER_NOTIFY_TIMEOUT*)
- CONFIG_MB_CONTROLLER_SLAVE_ID (*CONFIG_FMB_CONTROLLER_SLAVE_ID*)
- CONFIG_MB_CONTROLLER_SLAVE_ID_SUPPORT (*CONFIG_FMB_CONTROLLER_SLAVE_ID_SUPPORT*)
- CONFIG_MB_CONTROLLER_STACK_SIZE (*CONFIG_FMB_CONTROLLER_STACK_SIZE*)
- CONFIG_MB_EVENT_QUEUE_TIMEOUT (*CONFIG_FMB_EVENT_QUEUE_TIMEOUT*)
- CONFIG_MB_MASTER_DELAY_MS_CONVERT (*CONFIG_FMB_MASTER_DELAY_MS_CONVERT*)
- CONFIG_MB_MASTER_TIMEOUT_MS_RESPOND (*CONFIG_FMB_MASTER_TIMEOUT_MS_RESPOND*)
- CONFIG_MB_QUEUE_LENGTH (*CONFIG_FMB_QUEUE_LENGTH*)
- CONFIG_MB_SERIAL_BUF_SIZE (*CONFIG_FMB_SERIAL_BUF_SIZE*)
- CONFIG_MB_SERIAL_TASK_PRIO (*CONFIG_FMB_PORT_TASK_PRIO*)
- CONFIG_MB_SERIAL_TASK_STACK_SIZE (*CONFIG_FMB_PORT_TASK_STACK_SIZE*)
- CONFIG_MB_TIMER_GROUP (*CONFIG_FMB_TIMER_GROUP*)
- CONFIG_MB_TIMER_INDEX (*CONFIG_FMB_TIMER_INDEX*)
- CONFIG_MB_TIMER_PORT_ENABLED (*CONFIG_FMB_TIMER_PORT_ENABLED*)
- **CONFIG_MCA_INITIAL_TRACE_LEVEL** (*CONFIG_BT_LOG_MCA_TRACE_LEVEL*)
 - CONFIG_MCA_TRACE_LEVEL_NONE
 - CONFIG_MCA_TRACE_LEVEL_ERROR
 - CONFIG_MCA_TRACE_LEVEL_WARNING
 - CONFIG_MCA_TRACE_LEVEL_API
 - CONFIG_MCA_TRACE_LEVEL_EVENT
 - CONFIG_MCA_TRACE_LEVEL_DEBUG
 - CONFIG_MCA_TRACE_LEVEL_VERBOSE
- **CONFIG_MONITOR_BAUD** (*CONFIG_ESPTOOLPY_MONITOR_BAUD*)
 - CONFIG_MONITOR_BAUD_9600B
 - CONFIG_MONITOR_BAUD_57600B
 - CONFIG_MONITOR_BAUD_115200B

- CONFIG_MONITOR_BAUD_230400B
- CONFIG_MONITOR_BAUD_921600B
- CONFIG_MONITOR_BAUD_2MB
- CONFIG_MONITOR_BAUD_OTHER
- CONFIG_MONITOR_BAUD_OTHER_VAL (*CONFIG_ESPTOOLPY_MONITOR_BAUD_OTHER_VAL*)
- CONFIG_NIMBLE_ACL_BUF_COUNT (*CONFIG_BT_NIMBLE_ACL_BUF_COUNT*)
- CONFIG_NIMBLE_ACL_BUF_SIZE (*CONFIG_BT_NIMBLE_ACL_BUF_SIZE*)
- CONFIG_NIMBLE_ATT_PREFERRED_MTU (*CONFIG_BT_NIMBLE_ATT_PREFERRED_MTU*)
- CONFIG_NIMBLE_CRYPTOSTACK_MBEDTLS (*CONFIG_BT_NIMBLE_CRYPTOSTACK_MBEDTLS*)
- CONFIG_NIMBLE_DEBUG (*CONFIG_BT_NIMBLE_DEBUG*)
- CONFIG_NIMBLE_GAP_DEVICE_NAME_MAX_LEN (*CONFIG_BT_NIMBLE_GAP_DEVICE_NAME_MAX_LEN*)
- CONFIG_NIMBLE_HCI_EVT_BUF_SIZE (*CONFIG_BT_NIMBLE_HCI_EVT_BUF_SIZE*)
- CONFIG_NIMBLE_HCI_EVT_HI_BUF_COUNT (*CONFIG_BT_NIMBLE_HCI_EVT_HI_BUF_COUNT*)
- CONFIG_NIMBLE_HCI_EVT_LO_BUF_COUNT (*CONFIG_BT_NIMBLE_HCI_EVT_LO_BUF_COUNT*)
- CONFIG_NIMBLE_HS_FLOW_CTRL (*CONFIG_BT_NIMBLE_HS_FLOW_CTRL*)
- CONFIG_NIMBLE_HS_FLOW_CTRL_ITVL (*CONFIG_BT_NIMBLE_HS_FLOW_CTRL_ITVL*)
- CONFIG_NIMBLE_HS_FLOW_CTRL_THRESH (*CONFIG_BT_NIMBLE_HS_FLOW_CTRL_THRESH*)
- CONFIG_NIMBLE_HS_FLOW_CTRL_TX_ON_DISCONNECT (*CONFIG_BT_NIMBLE_HS_FLOW_CTRL_TX_ON_DISCONNECT*)
- CONFIG_NIMBLE_L2CAP_COC_MAX_NUM (*CONFIG_BT_NIMBLE_L2CAP_COC_MAX_NUM*)
- CONFIG_NIMBLE_MAX_BONDS (*CONFIG_BT_NIMBLE_MAX_BONDS*)
- CONFIG_NIMBLE_MAX_CCCDS (*CONFIG_BT_NIMBLE_MAX_CCCDS*)
- CONFIG_NIMBLE_MAX_CONNECTIONS (*CONFIG_BT_NIMBLE_MAX_CONNECTIONS*)
- **CONFIG_NIMBLE_MEM_ALLOC_MODE (*CONFIG_BT_NIMBLE_MEM_ALLOC_MODE*)**
 - CONFIG_NIMBLE_MEM_ALLOC_MODE_INTERNAL
 - CONFIG_NIMBLE_MEM_ALLOC_MODE_EXTERNAL
 - CONFIG_NIMBLE_MEM_ALLOC_MODE_DEFAULT
- CONFIG_NIMBLE_MESH (*CONFIG_BT_NIMBLE_MESH*)
- CONFIG_NIMBLE_MESH_DEVICE_NAME (*CONFIG_BT_NIMBLE_MESH_DEVICE_NAME*)
- CONFIG_NIMBLE_MESH_FRIEND (*CONFIG_BT_NIMBLE_MESH_FRIEND*)
- CONFIG_NIMBLE_MESH_GATT_PROXY (*CONFIG_BT_NIMBLE_MESH_GATT_PROXY*)
- CONFIG_NIMBLE_MESH_LOW_POWER (*CONFIG_BT_NIMBLE_MESH_LOW_POWER*)
- CONFIG_NIMBLE_MESH_PB_ADV (*CONFIG_BT_NIMBLE_MESH_PB_ADV*)
- CONFIG_NIMBLE_MESH_PB_GATT (*CONFIG_BT_NIMBLE_MESH_PB_GATT*)
- CONFIG_NIMBLE_MESH_PROV (*CONFIG_BT_NIMBLE_MESH_PROV*)
- CONFIG_NIMBLE_MESH_PROXY (*CONFIG_BT_NIMBLE_MESH_PROXY*)
- CONFIG_NIMBLE_MESH_RELAY (*CONFIG_BT_NIMBLE_MESH_RELAY*)
- CONFIG_NIMBLE_MSYS1_BLOCK_COUNT (*CONFIG_BT_NIMBLE_MSYS1_BLOCK_COUNT*)
- CONFIG_NIMBLE_NVS_PERSIST (*CONFIG_BT_NIMBLE_NVS_PERSIST*)
- **CONFIG_NIMBLE_PINNED_TO_CORE_CHOICE (*CONFIG_BT_NIMBLE_PINNED_TO_CORE_CHOICE*)**
 - CONFIG_NIMBLE_PINNED_TO_CORE_0
 - CONFIG_NIMBLE_PINNED_TO_CORE_1
- CONFIG_NIMBLE_ROLE_BROADCASTER (*CONFIG_BT_NIMBLE_ROLE_BROADCASTER*)
- CONFIG_NIMBLE_ROLE_CENTRAL (*CONFIG_BT_NIMBLE_ROLE_CENTRAL*)
- CONFIG_NIMBLE_ROLE_OBSERVER (*CONFIG_BT_NIMBLE_ROLE_OBSERVER*)
- CONFIG_NIMBLE_ROLE_PERIPHERAL (*CONFIG_BT_NIMBLE_ROLE_PERIPHERAL*)
- CONFIG_NIMBLE_RPA_TIMEOUT (*CONFIG_BT_NIMBLE_RPA_TIMEOUT*)
- CONFIG_NIMBLE_SM_LEGACY (*CONFIG_BT_NIMBLE_SM_LEGACY*)
- CONFIG_NIMBLE_SM_SC (*CONFIG_BT_NIMBLE_SM_SC*)
- CONFIG_NIMBLE_SM_SC_DEBUG_KEYS (*CONFIG_BT_NIMBLE_SM_SC_DEBUG_KEYS*)
- CONFIG_NIMBLE_SVC_GAP_APPEARANCE (*CONFIG_BT_NIMBLE_SVC_GAP_APPEARANCE*)
- CONFIG_NIMBLE_SVC_GAP_DEVICE_NAME (*CONFIG_BT_NIMBLE_SVC_GAP_DEVICE_NAME*)
- CONFIG_NIMBLE_TASK_STACK_SIZE (*CONFIG_BT_NIMBLE_TASK_STACK_SIZE*)
- **CONFIG_OPTIMIZATION_ASSERTION_LEVEL (*CONFIG_COMPILER_OPTIMIZATION_ASSERTION_LEVEL*)**
 - CONFIG_OPTIMIZATION_ASSERTIONS_ENABLED
 - CONFIG_OPTIMIZATION_ASSERTIONS_SILENT

- CONFIG_OPTIMIZATION_ASSERTIONS_DISABLED
- **CONFIG_OPTIMIZATION_COMPILER** (*CONFIG_COMPILER_OPTIMIZATION*)
 - CONFIG_COMPILER_OPTIMIZATION_LEVEL_DEBUG
 - CONFIG_COMPILER_OPTIMIZATION_LEVEL_RELEASE
- **CONFIG_OSI_INITIAL_TRACE_LEVEL** (*CONFIG_BT_LOG_OSI_TRACE_LEVEL*)
 - CONFIG_OSI_TRACE_LEVEL_NONE
 - CONFIG_OSI_TRACE_LEVEL_ERROR
 - CONFIG_OSI_TRACE_LEVEL_WARNING
 - CONFIG_OSI_TRACE_LEVEL_API
 - CONFIG_OSI_TRACE_LEVEL_EVENT
 - CONFIG_OSI_TRACE_LEVEL_DEBUG
 - CONFIG_OSI_TRACE_LEVEL_VERBOSE
- **CONFIG_PAN_INITIAL_TRACE_LEVEL** (*CONFIG_BT_LOG_PAN_TRACE_LEVEL*)
 - CONFIG_PAN_TRACE_LEVEL_NONE
 - CONFIG_PAN_TRACE_LEVEL_ERROR
 - CONFIG_PAN_TRACE_LEVEL_WARNING
 - CONFIG_PAN_TRACE_LEVEL_API
 - CONFIG_PAN_TRACE_LEVEL_EVENT
 - CONFIG_PAN_TRACE_LEVEL_DEBUG
 - CONFIG_PAN_TRACE_LEVEL_VERBOSE
- CONFIG_POST_EVENTS_FROM_IRAM_ISR (*CONFIG_ESP_EVENT_POST_FROM_IRAM_ISR*)
- CONFIG_POST_EVENTS_FROM_ISR (*CONFIG_ESP_EVENT_POST_FROM_ISR*)
- CONFIG_PPP_CHAP_SUPPORT (*CONFIG_LWIP_PPP_CHAP_SUPPORT*)
- CONFIG_PPP_DEBUG_ON (*CONFIG_LWIP_PPP_DEBUG_ON*)
- CONFIG_PPP_MPPE_SUPPORT (*CONFIG_LWIP_PPP_MPPE_SUPPORT*)
- CONFIG_PPP_MSCHAP_SUPPORT (*CONFIG_LWIP_PPP_MSCHAP_SUPPORT*)
- CONFIG_PPP_NOTIFY_PHASE_SUPPORT (*CONFIG_LWIP_PPP_NOTIFY_PHASE_SUPPORT*)
- CONFIG_PPP_PAP_SUPPORT (*CONFIG_LWIP_PPP_PAP_SUPPORT*)
- CONFIG_PPP_SUPPORT (*CONFIG_LWIP_PPP_SUPPORT*)
- CONFIG_PYTHON (*CONFIG_SDK_PYTHON*)
- **CONFIG_RFCOMM_INITIAL_TRACE_LEVEL** (*CONFIG_BT_LOG_RFCOMM_TRACE_LEVEL*)
 - CONFIG_RFCOMM_TRACE_LEVEL_NONE
 - CONFIG_RFCOMM_TRACE_LEVEL_ERROR
 - CONFIG_RFCOMM_TRACE_LEVEL_WARNING
 - CONFIG_RFCOMM_TRACE_LEVEL_API
 - CONFIG_RFCOMM_TRACE_LEVEL_EVENT
 - CONFIG_RFCOMM_TRACE_LEVEL_DEBUG
 - CONFIG_RFCOMM_TRACE_LEVEL_VERBOSE
- CONFIG_SEMIHOSTFS_HOST_PATH_MAX_LEN (*CONFIG_VFS_SEMIHOSTFS_HOST_PATH_MAX_LEN*)
- CONFIG_SEMIHOSTFS_MAX_MOUNT_POINTS (*CONFIG_VFS_SEMIHOSTFS_MAX_MOUNT_POINTS*)
- **CONFIG_SMP_INITIAL_TRACE_LEVEL** (*CONFIG_BT_LOG_SMP_TRACE_LEVEL*)
 - CONFIG_SMP_TRACE_LEVEL_NONE
 - CONFIG_SMP_TRACE_LEVEL_ERROR
 - CONFIG_SMP_TRACE_LEVEL_WARNING
 - CONFIG_SMP_TRACE_LEVEL_API
 - CONFIG_SMP_TRACE_LEVEL_EVENT
 - CONFIG_SMP_TRACE_LEVEL_DEBUG
 - CONFIG_SMP_TRACE_LEVEL_VERBOSE
- CONFIG_SMP_SLAVE_CON_PARAMS_UPD_ENABLE (*CONFIG_BT_SMP_SLAVE_CON_PARAMS_UPD_ENABLE*)
- **CONFIG_SPI_FLASH_WRITING_DANGEROUS_REGIONS** (*CONFIG_SPI_FLASH_DANGEROUS_WRITE*)
 - CONFIG_SPI_FLASH_WRITING_DANGEROUS_REGIONS_ABORTS
 - CONFIG_SPI_FLASH_WRITING_DANGEROUS_REGIONS_FAILS
 - CONFIG_SPI_FLASH_WRITING_DANGEROUS_REGIONS_ALLOWED
- **CONFIG_STACK_CHECK_MODE** (*CONFIG_COMPILER_STACK_CHECK_MODE*)
 - CONFIG_STACK_CHECK_NONE
 - CONFIG_STACK_CHECK_NORM
 - CONFIG_STACK_CHECK_STRONG

- CONFIG_STACK_CHECK_ALL
- CONFIG_SUPPORT_TERMIOS (*CONFIG_VFS_SUPPORT_TERMIOS*)
- CONFIG_SUPPRESS_SELECT_DEBUG_OUTPUT (*CONFIG_VFS_SUPPRESS_SELECT_DEBUG_OUTPUT*)
- CONFIG_SW_COEXIST_ENABLE (*CONFIG_ESP32_WIFI_SW_COEXIST_ENABLE*)
- CONFIG_SYSTEM_EVENT_QUEUE_SIZE (*CONFIG_ESP_SYSTEM_EVENT_QUEUE_SIZE*)
- CONFIG_SYSTEM_EVENT_TASK_STACK_SIZE (*CONFIG_ESP_SYSTEM_EVENT_TASK_STACK_SIZE*)
- CONFIG_SYSVIEW_BUF_WAIT_TMO (*CONFIG_APPTRACE_SV_BUF_WAIT_TMO*)
- CONFIG_SYSVIEW_ENABLE (*CONFIG_APPTRACE_SV_ENABLE*)
- CONFIG_SYSVIEW_EVT_IDLE_ENABLE (*CONFIG_APPTRACE_SV_EVT_IDLE_ENABLE*)
- CONFIG_SYSVIEW_EVT_ISR_ENTER_ENABLE (*CONFIG_APPTRACE_SV_EVT_ISR_ENTER_ENABLE*)
- CONFIG_SYSVIEW_EVT_ISR_EXIT_ENABLE (*CONFIG_APPTRACE_SV_EVT_ISR_EXIT_ENABLE*)
- CONFIG_SYSVIEW_EVT_ISR_TO_SCHEDULER_ENABLE (*CONFIG_APPTRACE_SV_EVT_ISR_TO_SCHED_ENABLE*)
- CONFIG_SYSVIEW_EVT_OVERFLOW_ENABLE (*CONFIG_APPTRACE_SV_EVT_OVERFLOW_ENABLE*)
- CONFIG_SYSVIEW_EVT_TASK_CREATE_ENABLE (*CONFIG_APPTRACE_SV_EVT_TASK_CREATE_ENABLE*)
- CONFIG_SYSVIEW_EVT_TASK_START_EXEC_ENABLE (*CONFIG_APPTRACE_SV_EVT_TASK_START_EXEC_ENABLE*)
- CONFIG_SYSVIEW_EVT_TASK_START_READY_ENABLE (*CONFIG_APPTRACE_SV_EVT_TASK_START_READY_ENABLE*)
- CONFIG_SYSVIEW_EVT_TASK_STOP_EXEC_ENABLE (*CONFIG_APPTRACE_SV_EVT_TASK_STOP_EXEC_ENABLE*)
- CONFIG_SYSVIEW_EVT_TASK_STOP_READY_ENABLE (*CONFIG_APPTRACE_SV_EVT_TASK_STOP_READY_ENABLE*)
- CONFIG_SYSVIEW_EVT_TASK_TERMINATE_ENABLE (*CONFIG_APPTRACE_SV_EVT_TASK_TERMINATE_ENABLE*)
- CONFIG_SYSVIEW_EVT_TIMER_ENTER_ENABLE (*CONFIG_APPTRACE_SV_EVT_TIMER_ENTER_ENABLE*)
- CONFIG_SYSVIEW_EVT_TIMER_EXIT_ENABLE (*CONFIG_APPTRACE_SV_EVT_TIMER_EXIT_ENABLE*)
- CONFIG_SYSVIEW_MAX_TASKS (*CONFIG_APPTRACE_SV_MAX_TASKS*)
- **CONFIG_SYSVIEW_TS_SOURCE** (*CONFIG_APPTRACE_SV_TS_SOURCE*)
 - CONFIG_SYSVIEW_TS_SOURCE_CCOUNT
 - CONFIG_SYSVIEW_TS_SOURCE_TIMER_00
 - CONFIG_SYSVIEW_TS_SOURCE_TIMER_01
 - CONFIG_SYSVIEW_TS_SOURCE_TIMER_10
 - CONFIG_SYSVIEW_TS_SOURCE_TIMER_11
 - CONFIG_SYSVIEW_TS_SOURCE_ESP_TIMER
- CONFIG_TASK_WDT (*CONFIG_ESP_TASK_WDT*)
- CONFIG_TASK_WDT_CHECK_IDLE_TASK_CPU0 (*CONFIG_ESP_TASK_WDT_CHECK_IDLE_TASK_CPU0*)
- CONFIG_TASK_WDT_CHECK_IDLE_TASK_CPU1 (*CONFIG_ESP_TASK_WDT_CHECK_IDLE_TASK_CPU1*)
- CONFIG_TASK_WDT_PANIC (*CONFIG_ESP_TASK_WDT_PANIC*)
- CONFIG_TASK_WDT_TIMEOUT_S (*CONFIG_ESP_TASK_WDT_TIMEOUT_S*)
- CONFIG_TCPIP_RECVMBOX_SIZE (*CONFIG_LWIP_TCPIP_RECVMBOX_SIZE*)
- **CONFIG_TCPIP_TASK_AFFINITY** (*CONFIG_LWIP_TCPIP_TASK_AFFINITY*)
 - CONFIG_TCPIP_TASK_AFFINITY_NO_AFFINITY
 - CONFIG_TCPIP_TASK_AFFINITY_CPU0
 - CONFIG_TCPIP_TASK_AFFINITY_CPU1
- CONFIG_TCPIP_TASK_STACK_SIZE (*CONFIG_LWIP_TCPIP_TASK_STACK_SIZE*)
- CONFIG_TCP_MAXRTX (*CONFIG_LWIP_TCP_MAXRTX*)
- CONFIG_TCP_MSL (*CONFIG_LWIP_TCP_MSL*)
- CONFIG_TCP_MSS (*CONFIG_LWIP_TCP_MSS*)
- **CONFIG_TCP_OVERSIZE** (*CONFIG_LWIP_TCP_OVERSIZE*)
 - CONFIG_TCP_OVERSIZE_MSS
 - CONFIG_TCP_OVERSIZE_QUARTER_MSS
 - CONFIG_TCP_OVERSIZE_DISABLE
- CONFIG_TCP_QUEUE_OOSEQ (*CONFIG_LWIP_TCP_QUEUE_OOSEQ*)
- CONFIG_TCP_RECVMBOX_SIZE (*CONFIG_LWIP_TCP_RECVMBOX_SIZE*)
- CONFIG_TCP_SND_BUF_DEFAULT (*CONFIG_LWIP_TCP_SND_BUF_DEFAULT*)
- CONFIG_TCP_SYNMAXRTX (*CONFIG_LWIP_TCP_SYNMAXRTX*)
- CONFIG_TCP_WND_DEFAULT (*CONFIG_LWIP_TCP_WND_DEFAULT*)
- CONFIG_TIMER_QUEUE_LENGTH (*CONFIG_FREERTOS_TIMER_QUEUE_LENGTH*)
- CONFIG_TIMER_TASK_PRIORITY (*CONFIG_FREERTOS_TIMER_TASK_PRIORITY*)
- CONFIG_TIMER_TASK_STACK_DEPTH (*CONFIG_FREERTOS_TIMER_TASK_STACK_DEPTH*)
- CONFIG_TIMER_TASK_STACK_SIZE (*CONFIG_ESP_TIMER_TASK_STACK_SIZE*)
- CONFIG_TOOLPREFIX (*CONFIG_SDK_TOOLPREFIX*)
- CONFIG_UDP_RECVMBOX_SIZE (*CONFIG_LWIP_UDP_RECVMBOX_SIZE*)

- `CONFIG_USE_ONLY_LWIP_SELECT` (`CONFIG_LWIP_USE_ONLY_LWIP_SELECT`)
- `CONFIG_WARN_WRITE_STRINGS` (`CONFIG_COMPILER_WARN_WRITE_STRINGS`)

2.8.7 Customisations

Because IDF builds by default with *Warning On Undefined Variables*, when the Kconfig tool generates Makefiles (the `auto.conf` file) its behaviour has been customised. In normal Kconfig, a variable which is set to “no” is undefined. In IDF’s version of Kconfig, this variable is defined in the Makefile but has an empty value.

(Note that `ifdef` and `ifndef` can still be used in Makefiles, because they test if a variable is defined *and has a non-empty value*.)

When generating header files for C & C++, the behaviour is not customised - so `#ifdef` can be used to test if a boolean config item is set or not.

2.9 Error Codes Reference

This section lists various error code constants defined in ESP-IDF.

For general information about error codes in ESP-IDF, see *Error Handling*.

`ESP_FAIL` (-1): Generic `esp_err_t` code indicating failure

`ESP_OK` (0): `esp_err_t` value indicating success (no error)

`ESP_ERR_NO_MEM` (0x101): Out of memory

`ESP_ERR_INVALID_ARG` (0x102): Invalid argument

`ESP_ERR_INVALID_STATE` (0x103): Invalid state

`ESP_ERR_INVALID_SIZE` (0x104): Invalid size

`ESP_ERR_NOT_FOUND` (0x105): Requested resource not found

`ESP_ERR_NOT_SUPPORTED` (0x106): Operation or feature not supported

`ESP_ERR_TIMEOUT` (0x107): Operation timed out

`ESP_ERR_INVALID_RESPONSE` (0x108): Received response was invalid

`ESP_ERR_INVALID_CRC` (0x109): CRC or checksum was invalid

`ESP_ERR_INVALID_VERSION` (0x10a): Version was invalid

`ESP_ERR_INVALID_MAC` (0x10b): MAC address was invalid

`ESP_ERR_NOT_FINISHED` (0x201)

`ESP_ERR_NVS_BASE` (0x1100): Starting number of error codes

`ESP_ERR_NVS_NOT_INITIALIZED` (0x1101): The storage driver is not initialized

`ESP_ERR_NVS_NOT_FOUND` (0x1102): Id namespace doesn’t exist yet and mode is `NVS_READONLY`

`ESP_ERR_NVS_TYPE_MISMATCH` (0x1103): The type of set or get operation doesn’t match the type of value stored in NVS

`ESP_ERR_NVS_READ_ONLY` (0x1104): Storage handle was opened as read only

`ESP_ERR_NVS_NOT_ENOUGH_SPACE` (0x1105): There is not enough space in the underlying storage to save the value

`ESP_ERR_NVS_INVALID_NAME` (0x1106): Namespace name doesn’t satisfy constraints

`ESP_ERR_NVS_INVALID_HANDLE` (0x1107): Handle has been closed or is NULL

ESP_ERR_NVS_REMOVE_FAILED (0x1108): The value wasn't updated because flash write operation has failed. The value was written however, and update will be finished after re-initialization of nvs, provided that flash operation doesn't fail again.

ESP_ERR_NVS_KEY_TOO_LONG (0x1109): Key name is too long

ESP_ERR_NVS_PAGE_FULL (0x110a): Internal error; never returned by nvs API functions

ESP_ERR_NVS_INVALID_STATE (0x110b): NVS is in an inconsistent state due to a previous error. Call `nvs_flash_init` and `nvs_open` again, then retry.

ESP_ERR_NVS_INVALID_LENGTH (0x110c): String or blob length is not sufficient to store data

ESP_ERR_NVS_NO_FREE_PAGES (0x110d): NVS partition doesn't contain any empty pages. This may happen if NVS partition was truncated. Erase the whole partition and call `nvs_flash_init` again.

ESP_ERR_NVS_VALUE_TOO_LONG (0x110e): String or blob length is longer than supported by the implementation

ESP_ERR_NVS_PART_NOT_FOUND (0x110f): Partition with specified name is not found in the partition table

ESP_ERR_NVS_NEW_VERSION_FOUND (0x1110): NVS partition contains data in new format and cannot be recognized by this version of code

ESP_ERR_NVS_XTS_ENCR_FAILED (0x1111): XTS encryption failed while writing NVS entry

ESP_ERR_NVS_XTS_DECR_FAILED (0x1112): XTS decryption failed while reading NVS entry

ESP_ERR_NVS_XTS_CFG_FAILED (0x1113): XTS configuration setting failed

ESP_ERR_NVS_XTS_CFG_NOT_FOUND (0x1114): XTS configuration not found

ESP_ERR_NVS_ENCR_NOT_SUPPORTED (0x1115): NVS encryption is not supported in this version

ESP_ERR_NVS_KEYS_NOT_INITIALIZED (0x1116): NVS key partition is uninitialized

ESP_ERR_NVS_CORRUPT_KEY_PART (0x1117): NVS key partition is corrupt

ESP_ERR_NVS_CONTENT_DIFFERS (0x1118): Internal error; never returned by nvs API functions. NVS key is different in comparison

ESP_ERR_NVS_WRONG_ENCRYPTION (0x1119): NVS partition is marked as encrypted with generic flash encryption. This is forbidden since the NVS encryption works differently.

ESP_ERR_ULP_BASE (0x1200): Offset for ULP-related error codes

ESP_ERR_ULP_SIZE_TOO_BIG (0x1201): Program doesn't fit into RTC memory reserved for the ULP

ESP_ERR_ULP_INVALID_LOAD_ADDR (0x1202): Load address is outside of RTC memory reserved for the ULP

ESP_ERR_ULP_DUPLICATE_LABEL (0x1203): More than one label with the same number was defined

ESP_ERR_ULP_UNDEFINED_LABEL (0x1204): Branch instructions references an undefined label

ESP_ERR_ULP_BRANCH_OUT_OF_RANGE (0x1205): Branch target is out of range of B instruction (try replacing with BX)

ESP_ERR_OTA_BASE (0x1500): Base error code for ota_ops api

ESP_ERR_OTA_PARTITION_CONFLICT (0x1501): Error if request was to write or erase the current running partition

ESP_ERR_OTA_SELECT_INFO_INVALID (0x1502): Error if OTA data partition contains invalid content

ESP_ERR_OTA_VALIDATE_FAILED (0x1503): Error if OTA app image is invalid

ESP_ERR_OTA_SMALL_SEC_VER (0x1504): Error if the firmware has a secure version less than the running firmware.

ESP_ERR_OTA_ROLLBACK_FAILED (0x1505): Error if flash does not have valid firmware in passive partition and hence rollback is not possible

ESP_ERR_OTA_ROLLBACK_INVALID_STATE (0x1506): Error if current active firmware is still marked in pending validation state (*ESP_OTA_IMG_PENDING_VERIFY*), essentially first boot of firmware image post upgrade and hence firmware upgrade is not possible

ESP_ERR_EFUSE (0x1600): Base error code for efuse api.

ESP_OK_EFUSE_CNT (0x1601): OK the required number of bits is set.

ESP_ERR_EFUSE_CNT_IS_FULL (0x1602): Error field is full.

ESP_ERR_EFUSE_REPEATED_PROG (0x1603): Error repeated programming of programmed bits is strictly forbidden.

ESP_ERR_CODING (0x1604): Error while a encoding operation.

ESP_ERR_NOT_ENOUGH_UNUSED_KEY_BLOCKS (0x1605): Error not enough unused key blocks available

ESP_ERR_IMAGE_BASE (0x2000)

ESP_ERR_IMAGE_FLASH_FAIL (0x2001)

ESP_ERR_IMAGE_INVALID (0x2002)

ESP_ERR_WIFI_BASE (0x3000): Starting number of WiFi error codes

ESP_ERR_WIFI_NOT_INIT (0x3001): WiFi driver was not installed by *esp_wifi_init*

ESP_ERR_WIFI_NOT_STARTED (0x3002): WiFi driver was not started by *esp_wifi_start*

ESP_ERR_WIFI_NOT_STOPPED (0x3003): WiFi driver was not stopped by *esp_wifi_stop*

ESP_ERR_WIFI_IF (0x3004): WiFi interface error

ESP_ERR_WIFI_MODE (0x3005): WiFi mode error

ESP_ERR_WIFI_STATE (0x3006): WiFi internal state error

ESP_ERR_WIFI_CONN (0x3007): WiFi internal control block of station or soft-AP error

ESP_ERR_WIFI_NVS (0x3008): WiFi internal NVS module error

ESP_ERR_WIFI_MAC (0x3009): MAC address is invalid

ESP_ERR_WIFI_SSID (0x300a): SSID is invalid

ESP_ERR_WIFI_PASSWORD (0x300b): Password is invalid

ESP_ERR_WIFI_TIMEOUT (0x300c): Timeout error

ESP_ERR_WIFI_WAKE_FAIL (0x300d): WiFi is in sleep state(RF closed) and wakeup fail

ESP_ERR_WIFI_WOULD_BLOCK (0x300e): The caller would block

ESP_ERR_WIFI_NOT_CONNECT (0x300f): Station still in disconnect status

ESP_ERR_WIFI_POST (0x3012): Failed to post the event to WiFi task

ESP_ERR_WIFI_INIT_STATE (0x3013): Invalid WiFi state when init/deinit is called

ESP_ERR_WIFI_STOP_STATE (0x3014): Returned when WiFi is stopping

ESP_ERR_WIFI_NOT_ASSOC (0x3015): The WiFi connection is not associated

ESP_ERR_WIFI_TX_DISALLOW (0x3016): The WiFi TX is disallowed

ESP_ERR_WIFI_REGISTRAR (0x3033): WPS registrar is not supported

ESP_ERR_WIFI_WPS_TYPE (0x3034): WPS type error

ESP_ERR_WIFI_WPS_SM (0x3035): WPS state machine is not initialized

ESP_ERR_ESPNOW_BASE (0x3064): ESPNOW error number base.

ESP_ERR_ESPNOW_NOT_INIT (0x3065): ESPNOW is not initialized.

ESP_ERR_ESPNOW_ARG (0x3066): Invalid argument

ESP_ERR_ESPNOW_NO_MEM (**0x3067**): Out of memory

ESP_ERR_ESPNOW_FULL (**0x3068**): ESPNOW peer list is full

ESP_ERR_ESPNOW_NOT_FOUND (**0x3069**): ESPNOW peer is not found

ESP_ERR_ESPNOW_INTERNAL (**0x306a**): Internal error

ESP_ERR_ESPNOW_EXIST (**0x306b**): ESPNOW peer has existed

ESP_ERR_ESPNOW_IF (**0x306c**): Interface error

ESP_ERR_DPP_FAILURE (**0x3097**): Generic failure during DPP Operation

ESP_ERR_DPP_TX_FAILURE (**0x3098**): DPP Frame Tx failed OR not Acked

ESP_ERR_DPP_INVALID_ATTR (**0x3099**): Encountered invalid DPP Attribute

ESP_ERR_MESH_BASE (**0x4000**): Starting number of MESH error codes

ESP_ERR_MESH_WIFI_NOT_START (**0x4001**)

ESP_ERR_MESH_NOT_INIT (**0x4002**)

ESP_ERR_MESH_NOT_CONFIG (**0x4003**)

ESP_ERR_MESH_NOT_START (**0x4004**)

ESP_ERR_MESH_NOT_SUPPORT (**0x4005**)

ESP_ERR_MESH_NOT_ALLOWED (**0x4006**)

ESP_ERR_MESH_NO_MEMORY (**0x4007**)

ESP_ERR_MESH_ARGUMENT (**0x4008**)

ESP_ERR_MESH_EXCEED_MTU (**0x4009**)

ESP_ERR_MESH_TIMEOUT (**0x400a**)

ESP_ERR_MESH_DISCONNECTED (**0x400b**)

ESP_ERR_MESH_QUEUE_FAIL (**0x400c**)

ESP_ERR_MESH_QUEUE_FULL (**0x400d**)

ESP_ERR_MESH_NO_PARENT_FOUND (**0x400e**)

ESP_ERR_MESH_NO_ROUTE_FOUND (**0x400f**)

ESP_ERR_MESH_OPTION_NULL (**0x4010**)

ESP_ERR_MESH_OPTION_UNKNOWN (**0x4011**)

ESP_ERR_MESH_XON_NO_WINDOW (**0x4012**)

ESP_ERR_MESH_INTERFACE (**0x4013**)

ESP_ERR_MESH_DISCARD_DUPLICATE (**0x4014**)

ESP_ERR_MESH_DISCARD (**0x4015**)

ESP_ERR_MESH_VOTING (**0x4016**)

ESP_ERR_MESH_XMIT (**0x4017**)

ESP_ERR_MESH_QUEUE_READ (**0x4018**)

ESP_ERR_MESH_PS (**0x4019**)

ESP_ERR_MESH_RECV_RELEASE (**0x401a**)

ESP_ERR_ESP_NETIF_BASE (**0x5000**)

ESP_ERR_ESP_NETIF_INVALID_PARAMS (**0x5001**)

ESP_ERR_ESP_NETIF_IF_NOT_READY (**0x5002**)

ESP_ERR_ESP_NETIF_DHCP_START_FAILED (**0x5003**)

ESP_ERR_ESP_NETIF_DHCP_ALREADY_STARTED (**0x5004**)

ESP_ERR_ESP_NETIF_DHCP_ALREADY_STOPPED (**0x5005**)

ESP_ERR_ESP_NETIF_NO_MEM (**0x5006**)

ESP_ERR_ESP_NETIF_DHCP_NOT_STOPPED (**0x5007**)

ESP_ERR_ESP_NETIF_DRIVER_ATTACH_FAILED (**0x5008**)

ESP_ERR_ESP_NETIF_INIT_FAILED (**0x5009**)

ESP_ERR_ESP_NETIF_DNS_NOT_CONFIGURED (**0x500a**)

ESP_ERR_FLASH_BASE (**0x6000**): Starting number of flash error codes

ESP_ERR_FLASH_OP_FAIL (**0x6001**)

ESP_ERR_FLASH_OP_TIMEOUT (**0x6002**)

ESP_ERR_FLASH_NOT_INITIALISED (**0x6003**)

ESP_ERR_FLASH_UNSUPPORTED_HOST (**0x6004**)

ESP_ERR_FLASH_UNSUPPORTED_CHIP (**0x6005**)

ESP_ERR_FLASH_PROTECTED (**0x6006**)

ESP_ERR_HTTP_BASE (**0x7000**): Starting number of HTTP error codes

ESP_ERR_HTTP_MAX_REDIRECT (**0x7001**): The error exceeds the number of HTTP redirects

ESP_ERR_HTTP_CONNECT (**0x7002**): Error open the HTTP connection

ESP_ERR_HTTP_WRITE_DATA (**0x7003**): Error write HTTP data

ESP_ERR_HTTP_FETCH_HEADER (**0x7004**): Error read HTTP header from server

ESP_ERR_HTTP_INVALID_TRANSPORT (**0x7005**): There are no transport support for the input scheme

ESP_ERR_HTTP_CONNECTING (**0x7006**): HTTP connection hasn't been established yet

ESP_ERR_HTTP_EAGAIN (**0x7007**): Mapping of errno EAGAIN to esp_err_t

ESP_ERR_ESP_TLS_BASE (**0x8000**): Starting number of ESP-TLS error codes

ESP_ERR_ESP_TLS_CANNOT_RESOLVE_HOSTNAME (**0x8001**): Error if hostname couldn't be resolved upon tls connection

ESP_ERR_ESP_TLS_CANNOT_CREATE_SOCKET (**0x8002**): Failed to create socket

ESP_ERR_ESP_TLS_UNSUPPORTED_PROTOCOL_FAMILY (**0x8003**): Unsupported protocol family

ESP_ERR_ESP_TLS_FAILED_CONNECT_TO_HOST (**0x8004**): Failed to connect to host

ESP_ERR_ESP_TLS_SOCKET_SETOPT_FAILED (**0x8005**): failed to set socket option

ESP_ERR_MBEDTLS_CERT_PARTLY_OK (**0x8006**): mbedtls parse certificates was partly successful

ESP_ERR_MBEDTLS_CTR_DRBG_SEED_FAILED (**0x8007**): mbedtls api returned error

ESP_ERR_MBEDTLS_SSL_SET_HOSTNAME_FAILED (**0x8008**): mbedtls api returned error

ESP_ERR_MBEDTLS_SSL_CONFIG_DEFAULTS_FAILED (**0x8009**): mbedtls api returned error

ESP_ERR_MBEDTLS_SSL_CONF_ALPN_PROTOCOLS_FAILED (**0x800a**): mbedtls api returned error

ESP_ERR_MBEDTLS_X509_CERT_PARSE_FAILED (**0x800b**): mbedtls api returned error

ESP_ERR_MBEDTLS_SSL_CONF_OWN_CERT_FAILED (**0x800c**): mbedtls api returned error

ESP_ERR_MBEDTLS_SSL_SETUP_FAILED (**0x800d**): mbedtls api returned error

ESP_ERR_MBEDTLS_SSL_WRITE_FAILED (**0x800e**): mbedtls api returned error

ESP_ERR_MBEDTLS_PK_PARSE_KEY_FAILED (0x800f): mbedtls api returned failed

ESP_ERR_MBEDTLS_SSL_HANDSHAKE_FAILED (0x8010): mbedtls api returned failed

ESP_ERR_MBEDTLS_SSL_CONF_PSK_FAILED (0x8011): mbedtls api returned failed

ESP_ERR_ESP_TLS_CONNECTION_TIMEOUT (0x8012): new connection in esp_tls_low_level_conn connection timed out

ESP_ERR_WOLFSSL_SSL_SET_HOSTNAME_FAILED (0x8013): wolfSSL api returned error

ESP_ERR_WOLFSSL_SSL_CONF_ALPN_PROTOCOLS_FAILED (0x8014): wolfSSL api returned error

ESP_ERR_WOLFSSL_CERT_VERIFY_SETUP_FAILED (0x8015): wolfSSL api returned error

ESP_ERR_WOLFSSL_KEY_VERIFY_SETUP_FAILED (0x8016): wolfSSL api returned error

ESP_ERR_WOLFSSL_SSL_HANDSHAKE_FAILED (0x8017): wolfSSL api returned failed

ESP_ERR_WOLFSSL_CTX_SETUP_FAILED (0x8018): wolfSSL api returned failed

ESP_ERR_WOLFSSL_SSL_SETUP_FAILED (0x8019): wolfSSL api returned failed

ESP_ERR_WOLFSSL_SSL_WRITE_FAILED (0x801a): wolfSSL api returned failed

ESP_ERR_ESP_TLS_SE_FAILED (0x801b)

ESP_ERR_HTTPS_OTA_BASE (0x9000)

ESP_ERR_HTTPS_OTA_IN_PROGRESS (0x9001)

ESP_ERR_PING_BASE (0xa000)

ESP_ERR_PING_INVALID_PARAMS (0xa001)

ESP_ERR_PING_NO_MEM (0xa002)

ESP_ERR_HTTPD_BASE (0xb000): Starting number of HTTPD error codes

ESP_ERR_HTTPD_HANDLERS_FULL (0xb001): All slots for registering URI handlers have been consumed

ESP_ERR_HTTPD_HANDLER_EXISTS (0xb002): URI handler with same method and target URI already registered

ESP_ERR_HTTPD_INVALID_REQ (0xb003): Invalid request pointer

ESP_ERR_HTTPD_RESULT_TRUNC (0xb004): Result string truncated

ESP_ERR_HTTPD_RESP_HDR (0xb005): Response header field larger than supported

ESP_ERR_HTTPD_RESP_SEND (0xb006): Error occurred while sending response packet

ESP_ERR_HTTPD_ALLOC_MEM (0xb007): Failed to dynamically allocate memory for resource

ESP_ERR_HTTPD_TASK (0xb008): Failed to launch server task/thread

ESP_ERR_HW_CRYPTO_BASE (0xc000): Starting number of HW cryptography module error codes

ESP_ERR_HW_CRYPTO_DS_HMAC_FAIL (0xc001): HMAC peripheral problem

ESP_ERR_HW_CRYPTO_DS_INVALID_KEY (0xc002)

ESP_ERR_HW_CRYPTO_DS_INVALID_DIGEST (0xc004)

ESP_ERR_HW_CRYPTO_DS_INVALID_PADDING (0xc005)

Chapter 3

ESP32-C3 Hardware Reference

3.1 ESP32-C3 Modules and Boards

Espressif designs and manufactures different modules and development boards to help users evaluate the potential of the ESP32-C3 family of chips.

This document provides description of modules and development boards currently available from Espressif.

Note: For description of previous versions of modules and development boards as well as for description of discontinued ones, please go to Section [Previous Versions of ESP32-C3 Modules and Boards](#).

3.1.1 Related Documents

- [Previous Versions of ESP32-C3 Modules and Boards](#)

3.2 Previous Versions of ESP32-C3 Modules and Boards

This sections contains overview and links to documentation of previous version ESP32-C3 Modules and Boards that have been replaced with newer versions or discontinued. It is maintained for convenience of users as previous versions of some modules and boards are still in use and some may still be available for purchase.

3.2.1 Related Documents

- [ESP32-C3 Modules and Boards](#)

3.3 Chip Series Comparison

The comparison below covers key features of chips supported by ESP-IDF. For the full list of features please refer to respective datasheets in Section [Related Documents](#).

Table 1: Chip Series Comparison

Feature	ESP32 Series	ESP32-S2 Series	ESP32-C3 Series
Launch year	2016	2020	2020

Continued on next page

Table 1 – continued from previous page

Feature	ESP32 Series	ESP32-S2 Series	ESP32-C3 Series
Variants	See ESP32 Datasheet (PDF)	See ESP32-S2 Datasheet (PDF)	See ESP32-C3 Datasheet (PDF)
Core	Xtensa® dual-core 32-bit LX6 with 600 MIPS (in total); 200 MIPS for ESP32-U4WDH/ESP32-S0WD (single-core variants); 400 MIPS for ESP32-D2WD	Xtensa® single-core 32-bit LX7 with 300 MIPS	32-bit single-core RISC-V
Wi-Fi protocols	802.11 b/g/n, 2.4 GHz	802.11 b/g/n, 2.4 GHz	802.11 b/g/n, 2.4 GHz
Bluetooth®	Bluetooth v4.2 BR/EDR and Bluetooth Low Energy	✘	Bluetooth 5.0
Typical frequency	240 MHz (160 MHz for ESP32-S0WD, ESP32-D2WD, and ESP32-U4WDH)	240 MHz	160 MHz
SRAM	520 KB	320 KB	400 KB
ROM	448 KB for booting and core functions	128 KB for booting and core functions	384 KB for booting and core functions
Embedded flash	2 MB, 4 MB, or none, depending on variants	2 MB, 4 MB, or none, depending on variants	4 MB or none, depending on variants
External flash	Up to 16 MB device, address 11 MB + 248 KB each time	Up to 1 GB device, address 11.5 MB each time	Up to 16 MB device, address 8 MB each time
External RAM	Up to 8 MB device, address 4 MB each time	Up to 1 GB device, address 11.5 MB each time	✘
Cache	✓ Two-way set associative	✓ Four-way set associative, independent instruction cache and data cache	✓ Eight-way set associative, 32-bit data/instruction bus width
Peripherals			
ADC	Two 12-bit, 18 channels	Two 13-bit, 20 channels	Two 12-bit SAR ADCs, at most 6 channels
DAC	Two 8-bit channels	Two 8-bit channels	✘
Temperature sensor	✘	1	1
Touch sensor	10	14	✘
Hall sensor	1	✘	✘
GPIO	34	43	22
SPI	4	4 with more modes, compared with ESP32	3
LCD interface	1	1	✘
UART	3	2 ¹	2 ¹
I2C	2	2	1
I2S	2, can be configured to operate with 8/16/32/40/48-bit resolution as an input or output channel.	1, can be configured to operate with 8/16/24/32/48/64-bit resolution as an input or output channel.	1, can be configured to operate with 8/16/24/32-bit resolution as an input or output channel.
Camera interface	1	1	✘
DMA	Dedicated DMA to UART, SPI, I2S, SDIO slave, SD/MMC host, EMAC, BT, and Wi-Fi	Dedicated DMA to UART, SPI, AES, SHA, I2S, and ADC Controller	General-purpose, 3 TX channels, 3 RX channels

Continued on next page

Table 1 – continued from previous page

Feature	ESP32 Series	ESP32-S2 Series	ESP32-C3 Series
RMT	8 channels	4 channels ¹ , can be configured to TX/RX channels	4 channels ² , 2 TX channels, 2 RX channels
Pulse counter	8 channels	4 channels ¹	✘
LED PWM	16 channels	8 channels ¹	6 channels ²
USB OTG	✘	1	✘
TWAI® controller (compatible with ISO 11898-1)	1	1	1
SD/SDIO/MMCI host controller		✘	✘
SDIO slave controller	1	✘	✘
Ethernet MAC	1	✘	✘
ULP	ULP FSM	PicoRV32 core with 8 KB SRAM, ULP FSM with more instructions	✘
Debug Assist	✘	✘	1
Security			
Secure boot	✓	✓ Faster and safer, compared with ESP32	✓ Faster and safer, compared with ESP32
Flash encryption	✓	✓ Support for PSRAM encryption. Safer, compared with ESP32	✓ Safer, compared with ESP32
OTP	1024-bit	4096-bit	4096-bit
AES	✓ AES-128, AES-192, AES-256 (FIPS PUB 197)	✓ AES-128, AES-192, AES-256 (FIPS PUB 197)	✓ AES-128, AES-256 (FIPS PUB 197)
HASH	SHA-1, SHA-256, SHA-384, SHA-512 (FIPS PUB 180-4)	SHA-1, SHA-224, SHA-256, SHA-384, SHA-512, SHA-512/224, SHA-512/256, SHA-512/t (FIPS PUB 180-4); DMA support	SHA-1, SHA-224, SHA-256 (FIPS PUB 180-4)
RSA	Up to 4096 bits	Up to 4096 bits, improved acceleration options compared with ESP32	Up to 3072 bits
RNG	✓	✓	✓
HMAC	✘	✓	✓
Digital signature	✘	✓	✓
XTS	✘	✓ XTS-AES-128, XTS-AES-256	✓ XTS-AES-128
Other			
Deep-sleep (ULP sensor-monitored pattern)	100 µA (when ADC work with a duty cycle of 1%)	22 µA (when touch sensors work with a duty cycle of 1%)	No such pattern
Size	QFN48 5*5, 6*6, depending on variants	QFN56 7*7	QFN32 5*5

Note 1: Reduced chip area compared with ESP32

Note 2: Reduced chip area compared with ESP32 and ESP32-S2

Note 3: Die size: ESP32-C3 < ESP32-S2 < ESP32

3.3.1 Related Documents

- [ESP32 Datasheet \(PDF\)](#)
- [ESP32-PICO Datasheets \(PDF\)](#)
 - [ESP32-PICO-D4](#)
 - [ESP32-PICO-V3](#)
 - [ESP32-PICO-V3-02](#)
- [ESP32-S2 Datasheet \(PDF\)](#)
- [ESP32-C3 Datasheet \(PDF\)](#)
- [ESP Product Selector](#)

Chapter 4

API Guides

4.1 Application Level Tracing library

4.1.1 Overview

IDF provides useful feature for program behavior analysis: application level tracing. It is implemented in the corresponding library and can be enabled in menuconfig. This feature allows to transfer arbitrary data between host and ESP32-C3 via JTAG interface with small overhead on program execution.

Developers can use this library to send application specific state of execution to the host and receive commands or other type of info in the opposite direction at runtime. The main use cases of this library are:

1. Collecting application specific data, see [Application Specific Tracing](#)
2. Lightweight logging to the host, see [Logging to Host](#)
3. System behavior analysis, see [System Behavior Analysis with SEGGER SystemView](#)
4. Source code coverage, see [Gcov \(Source Code Coverage\)](#)

Tracing components when working over JTAG interface are shown in the figure below.

4.1.2 Modes of Operation

The library supports two modes of operation:

Post-mortem mode. This is the default mode. The mode does not need interaction with the host side. In this mode tracing module does not check whether host has read all the data from *HW UP BUFFER* buffer and overwrites old data with the new ones. This mode is useful when only the latest trace data are interesting to the user, e.g. for analyzing program's behavior just before the crash. Host can read the data later on upon user request, e.g. via special OpenOCD command in case of working via JTAG interface.

Streaming mode. Tracing module enters this mode when host connects to ESP32-C3. In this mode before writing new data to *HW UP BUFFER* tracing module checks that there is enough space in it and if necessary waits for the host to read data and free enough memory. Maximum waiting time is controlled via timeout values passed by users to corresponding API routines. So when application tries to write data to trace buffer using finite value of the maximum waiting time it is possible situation that this data will be dropped. Especially this is true for tracing from time critical code (ISRs, OS scheduler code etc.) when infinite timeouts can lead to system malfunction. In order to avoid loss of such critical data developers can enable additional data buffering via menuconfig option [CONFIG_APPTRACE_PENDING_DATA_SIZE_MAX](#). This macro specifies the size of data which can be buffered in above conditions. The option can also help to overcome situation when data transfer to the host is temporarily slowed down, e.g. due to USB bus congestions etc. But it will not help when average bitrate of trace data stream exceeds HW interface capabilities.

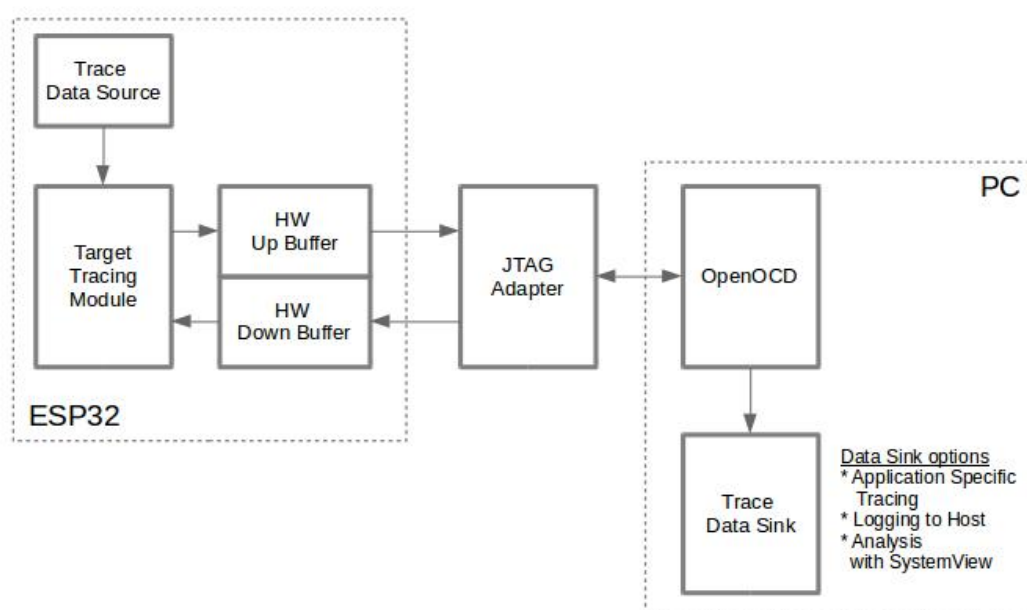

Fig. 1: Tracing Components when Working Over JTAG

4.1.3 Configuration Options and Dependencies

Using of this feature depends on two components:

1. **Host side:** Application tracing is done over JTAG, so it needs OpenOCD to be set up and running on host machine. For instructions on how to set it up, please see [JTAG Debugging](#) for details.
2. **Target side:** Application tracing functionality can be enabled in menuconfig. *Component config > Application Level Tracing* menu allows selecting destination for the trace data (HW interface for transport). Choosing any of the destinations automatically enables `CONFIG_APPTRACE_ENABLE` option.

Note: In order to achieve higher data rates and minimize number of dropped packets it is recommended to optimize setting of JTAG clock frequency, so it is at maximum and still provides stable operation of JTAG, see [Optimize JTAG speed](#).

There are two additional menuconfig options not mentioned above:

1. *Threshold for flushing last trace data to host on panic* (`CONFIG_APPTRACE_POSTMORTEM_FLUSH_THRESH`). This option is necessary due to the nature of working over JTAG. In that mode trace data are exposed to the host in 16 KB blocks. In post-mortem mode when one block is filled it is exposed to the host and the previous one becomes unavailable. In other words trace data are overwritten in 16 KB granularity. On panic the latest data from the current input block are exposed to host and host can read them for post-analysis. System panic may occur when very small amount of data are not exposed to the host yet. In this case the previous 16 KB of collected data will be lost and host will see the latest, but very small piece of the trace. It can be insufficient to diagnose the problem. This menuconfig option allows avoiding such situations. It controls the threshold for flushing data in case of panic. For example user can decide that it needs not less then 512 bytes of the recent trace data, so if there is less then 512 bytes of pending data at the moment of panic they will not be flushed and will not overwrite previous 16 KB. The option is only meaningful in post-mortem mode and when working over JTAG.
2. *Timeout for flushing last trace data to host on panic* (`CONFIG_APPTRACE_ONPANIC_HOST_FLUSH_TMO`). The option is only meaningful in streaming mode and controls the maximum time tracing module will wait for the host to read the last data in case of panic.

4.1.4 How to use this library

This library provides API for transferring arbitrary data between host and ESP32-C3. When enabled in menuconfig target application tracing module is initialized automatically at the system startup, so all what the user needs to do is to call corresponding API to send, receive or flush the data.

Application Specific Tracing

In general user should decide what type of data should be transferred in every direction and how these data must be interpreted (processed). The following steps must be performed to transfer data between target and host:

1. On target side user should implement algorithms for writing trace data to the host. Piece of code below shows an example how to do this.

```
#include "esp_app_trace.h"
...
char buf[] = "Hello World!";
esp_err_t res = esp_apptrace_write(ESP_APPTRACE_DEST_TRAX, buf, strlen(buf),
↳ESP_APPTRACE_TMO_INFINITE);
if (res != ESP_OK) {
    ESP_LOGE(TAG, "Failed to write data to host!");
    return res;
}
```

`esp_apptrace_write()` function uses `memcpy` to copy user data to the internal buffer. In some cases it can be more optimal to use `esp_apptrace_buffer_get()` and `esp_apptrace_buffer_put()` functions. They allow developers to allocate buffer and fill it themselves. The following piece of code shows how to do this.

```
#include "esp_app_trace.h"
...
int number = 10;
char *ptr = (char *)esp_apptrace_buffer_get(ESP_APPTRACE_DEST_TRAX, 32, 100/
↳*tmo in us*);
if (ptr == NULL) {
    ESP_LOGE(TAG, "Failed to get buffer!");
    return ESP_FAIL;
}
sprintf(ptr, "Here is the number %d", number);
esp_err_t res = esp_apptrace_buffer_put(ESP_APPTRACE_DEST_TRAX, ptr, 100/*tmo_
↳in us*);
if (res != ESP_OK) {
    /* in case of error host tracing tool (e.g. OpenOCD) will report_
↳incomplete user buffer */
    ESP_LOGE(TAG, "Failed to put buffer!");
    return res;
}
```

Also according to his needs user may want to receive data from the host. Piece of code below shows an example how to do this.

```
#include "esp_app_trace.h"
...
char buf[32];
char down_buf[32];
size_t sz = sizeof(buf);

/* config down buffer */
esp_apptrace_down_buffer_config(down_buf, sizeof(down_buf));
/* check for incoming data and read them if any */
esp_err_t res = esp_apptrace_read(ESP_APPTRACE_DEST_TRAX, buf, &sz, 0/*do not_
↳wait*);
```

(continues on next page)

(continued from previous page)

```

if (res != ESP_OK) {
    ESP_LOGE(TAG, "Failed to read data from host!");
    return res;
}
if (sz > 0) {
    /* we have data, process them */
    ...
}

```

esp_appttrace_read() function uses memcpy to copy host data to user buffer. In some cases it can be more optimal to use esp_appttrace_down_buffer_get() and esp_appttrace_down_buffer_put() functions. They allow developers to occupy chunk of read buffer and process it in-place. The following piece of code shows how to do this.

```

#include "esp_app_trace.h"
...
char down_buf[32];
uint32_t *number;
size_t sz = 32;

/* config down buffer */
esp_appttrace_down_buffer_config(down_buf, sizeof(down_buf));
char *ptr = (char *)esp_appttrace_down_buffer_get(ESP_APPTRACE_DEST_TRAX, &sz,
↳100/*tmo in us*/);
if (ptr == NULL) {
    ESP_LOGE(TAG, "Failed to get buffer!");
    return ESP_FAIL;
}
if (sz > 4) {
    number = (uint32_t *)ptr;
    printf("Here is the number %d", *number);
} else {
    printf("No data");
}
esp_err_t res = esp_appttrace_down_buffer_put(ESP_APPTRACE_DEST_TRAX, ptr, 100/
↳*tmo in us*/);
if (res != ESP_OK) {
    /* in case of error host tracing tool (e.g. OpenOCD) will report
↳incomplete user buffer */
    ESP_LOGE(TAG, "Failed to put buffer!");
    return res;
}

```

2. The next step is to build the program image and download it to the target as described in the [Getting Started Guide](#).
3. Run OpenOCD (see [JTAG Debugging](#)).
4. Connect to OpenOCD telnet server. It can be done using the following command in terminal telnet <oocd_host> 4444. If telnet session is opened on the same machine which runs OpenOCD you can use localhost as <oocd_host> in the command above.
5. Start trace data collection using special OpenOCD command. This command will transfer tracing data and redirect them to specified file or socket (currently only files are supported as trace data destination). For description of the corresponding commands see [OpenOCD Application Level Tracing Commands](#).
6. The final step is to process received data. Since format of data is defined by user the processing stage is out of the scope of this document. Good starting points for data processor are python scripts in \$IDF_PATH/tools/esp_app_trace: appttrace_proc.py (used for feature tests) and logtrace_proc.py (see more details in section [Logging to Host](#)).

OpenOCD Application Level Tracing Commands HW UP BUFFER is shared between user data blocks and filling of the allocated memory is performed on behalf of the API caller (in task or ISR context). In multithreading environment it can happen that task/ISR which fills the buffer is preempted by another high priority task/ISR. So

it is possible situation that user data preparation process is not completed at the moment when that chunk is read by the host. To handle such conditions tracing module prepends all user data chunks with header which contains allocated user buffer size (2 bytes) and length of actually written data (2 bytes). So total length of the header is 4 bytes. OpenOCD command which reads trace data reports error when it reads incomplete user data chunk, but in any case it puts contents of the whole user chunk (including unfilled area) to output file.

Below is the description of available OpenOCD application tracing commands.

Note: Currently OpenOCD does not provide commands to send arbitrary user data to the target.

Command usage:

```
esp apptrace [start <options>] | [stop] | [status] | [dump <cores_num>
<outfile>]
```

Sub-commands:

start Start tracing (continuous streaming).
stop Stop tracing.
status Get tracing status.
dump Dump all data from (post-mortem dump).

Start command syntax:

```
start <outfile> [poll_period [trace_size [stop_tmo [wait4halt
[skip_size]]]]]
```

outfile Path to file to save data from both CPUs. This argument should have the following format: `file://path/to/file`.

poll_period Data polling period (in ms) for available trace data. If greater than 0 then command runs in non-blocking mode. By default 1 ms.

trace_size Maximum size of data to collect (in bytes). Tracing is stopped after specified amount of data is received. By default -1 (trace size stop trigger is disabled).

stop_tmo Idle timeout (in sec). Tracing is stopped if there is no data for specified period of time. By default -1 (disable this stop trigger). Optionally set it to value longer than longest pause between tracing commands from target.

wait4halt If 0 start tracing immediately, otherwise command waits for the target to be halted (after reset, by breakpoint etc.) and then automatically resumes it and starts tracing. By default 0.

skip_size Number of bytes to skip at the start. By default 0.

Note: If `poll_period` is 0, OpenOCD telnet command line will not be available until tracing is stopped. You must stop it manually by resetting the board or pressing Ctrl+C in OpenOCD window (not one with the telnet session). Another option is to set `trace_size` and wait until this size of data is collected. At this point tracing stops automatically.

Command usage examples:

1. Collect 2048 bytes of tracing data to a file “trace.log”. The file will be saved in “openocd-esp32” directory.

```
esp apptrace start file://trace.log 1 2048 5 0 0
```

The tracing data will be retrieved and saved in non-blocking mode. This process will stop automatically after 2048 bytes are collected, or if no data are available for more than 5 seconds.

Note: Tracing data is buffered before it is made available to OpenOCD. If you see “Data timeout!” message, then the target is likely sending not enough data to empty the buffer to OpenOCD before expiration of timeout. Either increase the timeout or use a function `esp_apptrace_flush()` to flush the data on specific intervals.

2. Retrieve tracing data indefinitely in non-blocking mode.

```
esp apptrace start file://trace.log 1 -1 -1 0 0
```

There is no limitation on the size of collected data and there is no any data timeout set. This process may be stopped by issuing `esp apptrace stop` command on OpenOCD telnet prompt, or by pressing Ctrl+C in OpenOCD window.

3. Retrieve tracing data and save them indefinitely.

```
esp apptrace start file://trace.log 0 -1 -1 0 0
```

OpenOCD telnet command line prompt will not be available until tracing is stopped. To stop tracing press Ctrl+C in OpenOCD window.

4. Wait for target to be halted. Then resume target's operation and start data retrieval. Stop after collecting 2048 bytes of data:

```
esp apptrace start file://trace.log 0 2048 -1 1 0
```

To configure tracing immediately after reset use the `openocd reset halt` command.

Logging to Host

IDF implements useful feature: logging to host via application level tracing library. This is a kind of semihosting when all `ESP_LOGx` calls send strings to be printed to the host instead of UART. This can be useful because “printing to host” eliminates some steps performed when logging to UART. The most part of work is done on the host.

By default IDF's logging library uses `vprintf`-like function to write formatted output to dedicated UART. In general it involves the following steps:

1. Format string is parsed to obtain type of each argument.
2. According to its type every argument is converted to string representation.
3. Format string combined with converted arguments is sent to UART.

Though implementation of `vprintf`-like function can be optimized to a certain level, all steps above have to be performed in any case and every step takes some time (especially item 3). So it frequently occurs that with additional log added to the program to identify the problem, the program behavior is changed and the problem cannot be reproduced or in the worst cases the program cannot work normally at all and ends up with an error or even hangs.

Possible ways to overcome this problem are to use higher UART bitrates (or another faster interface) and/or move string formatting procedure to the host.

Application level tracing feature can be used to transfer log information to host using `esp_appttrace_vprintf` function. This function does not perform full parsing of the format string and arguments, instead it just calculates number of arguments passed and sends them along with the format string address to the host. On the host log data are processed and printed out by a special Python script.

Limitations Current implementation of logging over JTAG has some limitations:

1. Tracing from `ESP_EARLY_LOGx` macros is not supported.
2. No support for `printf` arguments which size exceeds 4 bytes (e.g. `double` and `uint64_t`).
3. Only strings from `.rodata` section are supported as format strings and arguments.
4. Maximum number of `printf` arguments is 256.

How To Use It In order to use logging via trace module user needs to perform the following steps:

1. On target side special `vprintf`-like function needs to be installed. As it was mentioned earlier this function is `esp_appttrace_vprintf`. It sends log data to the host. Example code is provided in [system/app_trace_to_host](#).
2. Follow instructions in items 2-5 in [Application Specific Tracing](#).
3. To print out collected log records, run the following command in terminal: `$IDF_PATH/tools/esp_app_trace/logtrace_proc.py /path/to/trace/file /path/to/program/elf/file`.

Log Trace Processor Command Options Command usage:

```
logtrace_proc.py [-h] [--no-errors] <trace_file> <elf_file>
```

Positional arguments:

trace_file Path to log trace file**elf_file** Path to program ELF file

Optional arguments:

-h, --help show this help message and exit**--no-errors, -n** Do not print errors**System Behavior Analysis with SEGGER SystemView**

Another useful IDF feature built on top of application tracing library is the system level tracing which produces traces compatible with SEGGER SystemView tool (see [SystemView](#)). SEGGER SystemView is a real-time recording and visualization tool that allows to analyze runtime behavior of an application.

Note: Currently IDF-based application is able to generate SystemView compatible traces in form of files to be opened in SystemView application. The tracing process cannot yet be controlled using that tool.

How To Use It Support for this feature is enabled by *Component config > Application Level Tracing > FreeRTOS SystemView Tracing (CONFIG_APPTRACE_SV_ENABLE)* menuconfig option. There are several other options enabled under the same menu:

1. ESP32-C3 timer to use as SystemView timestamp source: (*CONFIG_APPTRACE_SV_TS_SOURCE*) selects the source of timestamps for SystemView events. In single core mode timestamps are generated using ESP32-C3 internal cycle counter running at maximum 240 Mhz (~4 ns granularity). In dual-core mode external timer working at 40 Mhz is used, so timestamp granularity is 25 ns.
2. Individually enabled or disabled collection of SystemView events (*CONFIG_APPTRACE_SV_EVT_XXX*):
 - Trace Buffer Overflow Event
 - ISR Enter Event
 - ISR Exit Event
 - ISR Exit to Scheduler Event
 - Task Start Execution Event
 - Task Stop Execution Event
 - Task Start Ready State Event
 - Task Stop Ready State Event
 - Task Create Event
 - Task Terminate Event
 - System Idle Event
 - Timer Enter Event
 - Timer Exit Event

IDF has all the code required to produce SystemView compatible traces, so user can just configure necessary project options (see above), build, download the image to target and use OpenOCD to collect data as described in the previous sections.

OpenOCD SystemView Tracing Command Options Command usage:

```
esp sysview [start <options>] | [stop] | [status]
```

Sub-commands:

start Start tracing (continuous streaming).**stop** Stop tracing.**status** Get tracing status.

Start command syntax:

```
start <outfile1> [outfile2] [poll_period [trace_size [stop_tmo]]]
```

outfile1 Path to file to save data from PRO CPU. This argument should have the following format: `file://path/to/file`.

outfile2 Path to file to save data from APP CPU. This argument should have the following format: `file://path/to/file`.

poll_period Data polling period (in ms) for available trace data. If greater than 0 then command runs in non-blocking mode. By default 1 ms.

trace_size Maximum size of data to collect (in bytes). Tracing is stopped after specified amount of data is received. By default -1 (trace size stop trigger is disabled).

stop_tmo Idle timeout (in sec). Tracing is stopped if there is no data for specified period of time. By default -1 (disable this stop trigger).

Note: If `poll_period` is 0 OpenOCD telnet command line will not be available until tracing is stopped. You must stop it manually by resetting the board or pressing Ctrl+C in OpenOCD window (not one with the telnet session). Another option is to set `trace_size` and wait until this size of data is collected. At this point tracing stops automatically.

Command usage examples:

1. Collect SystemView tracing data to files “pro-cpu.SVdat” and “app-cpu.SVdat” . The files will be saved in “openocd-esp32” directory.

```
esp sysview start file://pro-cpu.SVdat file://app-cpu.SVdat
```

The tracing data will be retrieved and saved in non-blocking mode. To stop data this process enter `esp apptrace stop` command on OpenOCD telnet prompt, optionally pressing Ctrl+C in OpenOCD window.

2. Retrieve tracing data and save them indefinitely.

```
esp sysview start file://pro-cpu.SVdat file://app-cpu.SVdat 0 -1 -1
```

OpenOCD telnet command line prompt will not be available until tracing is stopped. To stop tracing, press Ctrl+C in OpenOCD window.

Data Visualization After trace data are collected user can use special tool to visualize the results and inspect behavior of the program.

It is uneasy and awkward to analyze data for every core in separate instance of the tool. Fortunately there is Eclipse plugin called *Impulse* which can load several trace files and makes it possible to inspect events from both cores in one view. Also this plugin has no limitation of 1,000,000 events as compared to free version of SystemView.

Good instruction on how to install, configure and visualize data in Impulse from one core can be found [here](#).

Note: IDF uses its own mapping for SystemView FreeRTOS events IDs, so user needs to replace original file with mapping `$(SYSVIEW_INSTALL_DIR)/Description/SYSVIEW_FreeRTOS.txt` with `$(IDF_PATH)/docs/api-guides/SYSVIEW_FreeRTOS.txt`. Also contents of that IDF specific file should be used when configuring SystemView serializer using above link.

Gcov (Source Code Coverage)

Basics of Gcov and Gcovr Source code coverage is data indicating the count and frequency of every program execution path that has been taken within a program’ s runtime. **Gcov** is a GCC tool that, when used in concert with the compiler, can generate log files indicating the execution count of each line of a source file. The **Gcovr** tool is utility for managing Gcov and generating summarized code coverage results.

Generally, using Gcov to compile and run programs on the Host will undergo these steps:

1. Compile the source code using GCC with the `--coverage` option enabled. This will cause the compiler to generate a `.gcno` notes files during compilation. The notes files contain information to reconstruct execution path block graphs and map each block to source code line numbers. Each source file compiled with the `--coverage` option should have their own `.gcno` file of the same name (e.g., a `main.c` will generate a `main.gcno` when compiled).
2. Execute the program. During execution, the program should generate `.gda` data files. These data files contain the counts of the number of times an execution path was taken. The program will generate a `.gda` file for each source file compiled with the `--coverage` option (e.g., `main.c` will generate a `main.gda`).
3. Gcov or Gcovr can be used generate a code coverage based on the `.gcno`, `.gda`, and source files. Gcov will generate a text based coverage report for each source file in the form of a `.gcov` file, whilst Gcovr will generate a coverage report in HTML format.

Gcov and Gcovr in ESP-IDF Using Gcov in ESP-IDF is complicated by the fact that the program is running remotely from the Host (i.e., on the target). The code coverage data (i.e., the `.gda` files) is initially stored on the target itself. OpenOCD is then used to dump the code coverage data from the target to the host via JTAG during runtime. Using Gcov in ESP-IDF can be split into the following steps.

1. [Setting Up a Project for Gcov](#)
2. [Dumping Code Coverage Data](#)
3. [Generating Coverage Report](#)

Setting Up a Project for Gcov

Compiler Option In order to obtain code coverage data in a project, one or more source files within the project must be compiled with the `--coverage` option. In ESP-IDF, this can be achieved at the component level or the individual source file level:

To cause all source files in a component to be compiled with the `--coverage` option.

- Add `target_compile_options(${COMPONENT_LIB} PRIVATE --coverage)` to the `CMakeLists.txt` file of the component if using CMake.
- Add `CFLAGS += --coverage` to the component `.mk` file of the component if using Make.

To cause a select number of source files (e.g. `source1.c` and `source2.c`) in the same component to be compiled with the

- Add `set_source_files_properties(source1.c source2.c PROPERTIES COMPILE_FLAGS --coverage)` to the `CMakeLists.txt` file of the component if using CMake.
- Add `source1.o: CFLAGS += --coverage` and `source2.o: CFLAGS += --coverage` to the component `.mk` file of the component if using Make.

When a source file is compiled with the `--coverage` option (e.g. `gcov_example.c`), the compiler will generate the `gcov_example.gcno` file in the project's build directory.

Project Configuration Before building a project with source code coverage, ensure that the following project configuration options are enabled by running `idf.py menuconfig` (or `make menuconfig` if using the legacy Make build system).

- Enable the application tracing module by choosing *Trace Memory* for the [CONFIG_APPTRACE_DESTINATION](#) option.
- Enable Gcov to host via the [CONFIG_APPTRACE_GCOV_ENABLE](#)

Dumping Code Coverage Data Once a project has been compiled with the `--coverage` option and flashed onto the target, code coverage data will be stored internally on the target (i.e., in trace memory) whilst the application runs. The process of transferring code coverage data from the target to the Host is known as dumping.

The dumping of coverage data is done via OpenOCD (see [JTAG Debugging](#) on how to setup and run OpenOCD). A dump is triggered by issuing commands to OpenOCD, therefore a telnet session to OpenOCD must be opened to issue such commands (run `telnet localhost 4444`). Note that GDB could be used instead of telnet to issue commands to OpenOCD, however all commands issued from GDB will need to be prefixed as `mon <ocd_command>`.

When the target dumps code coverage data, the `.gcda` files are stored in the project's build directory. For example, if `gcov_example_main.c` of the main component was compiled with the `--coverage` option, then dumping the code coverage data would generate a `gcov_example_main.gcda` in `build/esp-idf/main/CMakeFiles/___idf_main.dir/gcov_example_main.c.gcda` (or `build/main/gcov_example_main.gcda` if using the legacy Make build system). Note that the `.gcno` files produced during compilation are also placed in the same directory.

The dumping of code coverage data can be done multiple times throughout an application's life time. Each dump will simply update the `.gcda` file with the newest code coverage information. Code coverage data is accumulative, thus the newest data will contain the total execution count of each code path over the application's entire lifetime.

ESP-IDF supports two methods of dumping code coverage data from the target to the host:

- Instant Run-Time Dump
- Hard-coded Dump

Instant Run-Time Dump An Instant Run-Time Dump is triggered by calling the `ESP32-C3 gcov OpenOCD` command (via a telnet session). Once called, OpenOCD will immediately preempt the ESP32-C3's current state and execute a builtin IDF Gcov debug stub function. The debug stub function will handle the dumping of data to the Host. Upon completion, the ESP32-C3 will resume its current state.

Hard-coded Dump A Hard-coded Dump is triggered by the application itself by calling `esp_gcov_dump()` from somewhere within the application. When called, the application will halt and wait for OpenOCD to connect and retrieve the code coverage data. Once `esp_gcov_dump()` is called, the Host must execute the `esp gcov dump` OpenOCD command (via a telnet session). The `esp gcov dump` command will cause OpenOCD to connect to the ESP32-C3, retrieve the code coverage data, then disconnect from the ESP32-C3 thus allowing the application to resume. Hard-coded Dumps can also be triggered multiple times throughout an application's lifetime.

Hard-coded dumps are useful if code coverage data is required at certain points of an application's lifetime by placing `esp_gcov_dump()` where necessary (e.g., after application initialization, during each iteration of an application's main loop).

GDB can be used to set a breakpoint on `esp_gcov_dump()`, then call `mon esp gcov dump` automatically via the use a `gdbinit` script (see Using GDB from [Command Line](#)).

The following GDB script is will add a breakpoint at `esp_gcov_dump()`, then call the `mon esp gcov dump` OpenOCD command.

```
b esp_gcov_dump
commands
mon esp gcov dump
end
```

Note: Note that all OpenOCD commands should be invoked in GDB as: `mon <oocd_command>`.

Generating Coverage Report Once the code coverage data has been dumped, the `.gcno`, `.gcda` and the source files can be used to generate a code coverage report. A code coverage report is simply a report indicating the number of times each line in a source file has been executed.

Both Gcov and Gcovr can be used to generate code coverage reports. Gcov is provided along with the Xtensa toolchain, whilst Gcovr may need to be installed separately. For details on how to use Gcov or Gcovr, refer to [Gcov documentation](#) and [Gcovr documentation](#).

Adding Gcovr Build Target to Project To make report generation more convenient, users can define additional build targets in their projects such report generation can be done with a single build command.

CMake Build System For the CMake build systems, add the following lines to the `CMakeLists.txt` file of your project.

```
include($ENV{IDF_PATH}/tools/cmake/gcov.cmake)
idf_create_coverage_report(${CMAKE_CURRENT_BINARY_DIR}/coverage_report)
idf_clean_coverage_report(${CMAKE_CURRENT_BINARY_DIR}/coverage_report)
```

The following commands can now be used:

- `cmake --build build/ --target gcovr-report` will generate an HTML coverage report in `$(BUILD_DIR_BASE)/coverage_report/html` directory.
- `cmake --build build/ --target cov-data-clean` will remove all coverage data files.

Make Build System For the Make build systems, add the following lines to the Makefile of your project.

```
GCOV := $(call dequote,$(CONFIG_SDK_TOOLPREFIX))gcov
REPORT_DIR := $(BUILD_DIR_BASE)/coverage_report

gcovr-report:
    echo "Generating coverage report in: $(REPORT_DIR) "
    echo "Using gcov: $(GCOV) "
    mkdir -p $(REPORT_DIR)/html
    cd $(BUILD_DIR_BASE)
    gcovr -r $(PROJECT_PATH) --gcov-executable $(GCOV) -s --html-details $(REPORT_
↪DIR)/html/index.html

cov-data-clean:
    echo "Remove coverage data files..."
    find $(BUILD_DIR_BASE) -name "*.gcda" -exec rm {} +
    rm -rf $(REPORT_DIR)

.PHONY: gcovr-report cov-data-clean
```

The following commands can now be used:

- `make gcovr-report` will generate an HTML coverage report in `$(BUILD_DIR_BASE)/coverage_report/html` directory.
- `make cov-data-clean` will remove all coverage data files.

4.2 Application Startup Flow

This note explains various steps which happen before `app_main` function of an ESP-IDF application is called.

The high level view of startup process is as follows:

1. *First stage bootloader* in ROM loads second-stage bootloader image to RAM (IRAM & DRAM) from flash offset 0x0.
2. *Second stage bootloader* loads partition table and main app image from flash. Main app incorporates both RAM segments and read-only segments mapped via flash cache.
3. *Application startup* executes. At this point the second CPU and RTOS scheduler are started.

This process is explained in detail in the following sections.

4.2.1 First stage bootloader

After SoC reset, the CPU will start running immediately to perform initialization. The reset vector code is located in the mask ROM of the ESP32-C3 chip and cannot be modified.

Startup code called from the reset vector determines the boot mode by checking `GPIO_STRAP_REG` register for bootstrap pin states. Depending on the reset reason, the following takes place:

1. Reset from deep sleep: if the value in `RTC_CNTL_STORE6_REG` is non-zero, and CRC value of RTC memory in `RTC_CNTL_STORE7_REG` is valid, use `RTC_CNTL_STORE6_REG` as an entry point address and jump immediately to it. If `RTC_CNTL_STORE6_REG` is zero, or `RTC_CNTL_STORE7_REG` contains invalid CRC, or once the code called via `RTC_CNTL_STORE6_REG` returns, proceed with boot as if it was a power-on reset. **Note:** to run customized code at this point, a deep sleep stub mechanism is provided. Please see [deep sleep](#) documentation for this.
2. For power-on reset, software SOC reset, and watchdog SOC reset: check the `GPIO_STRAP_REG` register if a custom boot mode (such as UART Download Mode) is requested. If this is the case, this custom loader mode is executed from ROM. Otherwise, proceed with boot as if it was due to software CPU reset. Consult ESP32-C3 datasheet for a description of SoC boot modes and how to execute them.
3. For software CPU reset and watchdog CPU reset: configure SPI flash based on EFUSE values, and attempt to load the code from flash. This step is described in more detail in the next paragraphs.

Note: During normal boot modes the RTC watchdog is enabled when this happens, so if the process is interrupted or stalled then the watchdog will reset the SOC automatically and repeat the boot process. This may cause the SoC to strap into a new boot mode, if the strapping GPIOs have changed.

Second stage bootloader binary image is loaded from the start of flash at offset 0x0.

4.2.2 Second stage bootloader

In ESP-IDF, the binary image which resides at offset 0x0 in flash is the second stage bootloader. Second stage bootloader source code is available in [components/bootloader](#) directory of ESP-IDF. Second stage bootloader is used in ESP-IDF to add flexibility to flash layout (using partition tables), and allow for various flows associated with flash encryption, secure boot, and over-the-air updates (OTA) to take place.

When the first stage bootloader is finished checking and loading the second stage bootloader, it jumps to the second stage bootloader entry point found in the binary image header.

Second stage bootloader reads the partition table found by default at offset 0x8000 (*configurable value*). See [partition tables](#) documentation for more information. The bootloader finds factory and OTA app partitions. If OTA app partitions are found in the partition table, the bootloader consults the `otadata` partition to determine which one should be booted. See [Over The Air Updates \(OTA\)](#) for more information.

For a full description of the configuration options available for the ESP-IDF bootloader, see [Bootloader](#).

For the selected partition, second stage bootloader reads the binary image from flash one segment at a time:

- For segments with load addresses in internal *IRAM (Instruction RAM)* or *DRAM (Data RAM)*, the contents are copied from flash to the load address.
- For segments which have load addresses in *DROM (data stored in Flash)* or *IROM (code executed from Flash)* regions, the flash MMU is configured to provide the correct mapping from the flash to the load address.

Once all segments are processed - meaning code is loaded and flash MMU is set up, second stage bootloader verifies the integrity of the application and then jumps to the application entry point found in the binary image header.

4.2.3 Application startup

Application startup covers everything that happens after the app starts executing and before the `app_main` function starts running inside the main task. This is split into three stages:

- Port initialization of hardware and basic C runtime environment.
- System initialization of software services and FreeRTOS.
- Running the main task and calling `app_main`.

Note: Understanding all stages of ESP-IDF app initialization is often not necessary. To understand initialization from the application developer's perspective only, skip forward to [Running the main task](#).

Port Initialization

ESP-IDF application entry point is `call_start_cpu0` function found in `components/esp_system/port/cpu_start.c`. This function is executed by the second stage bootloader, and never returns.

This port-layer initialization function initializes the basic C Runtime Environment (“CRT”) and performs initial configuration of the SoC’ s internal hardware:

- Reconfigure CPU exceptions for the app (allowing app interrupt handlers to run, and causing *Fatal Errors* to be handled using the options configured for the app rather than the simpler error handler provided by ROM).
- If the option `CONFIG_BOOTLOADER_WDT_ENABLE` is not set then the RTC watchdog timer is disabled.
- Initialize internal memory (data & bss).
- Finish configuring the MMU cache.
- Set the CPU clocks to the frequencies configured for the project.
- Initialize memory protection if configured.

Once `call_start_cpu0` completes running, it calls the “system layer” initialization function `start_cpu0` found in `components/esp_system/startup.c`.

System Initialization

The main system initialization function is `start_cpu0`. By default, this function is weak-linked to the function `start_cpu0_default`. This means that it’ s possible to override this function to add some additional initialization steps.

The primary system initialization stage includes:

- Log information about this application (project name, *App version*, etc.) if default log level enables this.
- Initialize the heap allocator (before this point all allocations must be static or on the stack).
- Initialize newlib component syscalls and time functions.
- Configure the brownout detector.
- Setup libc stdin, stdout, and stderr according to the *serial console configuration*.
- Perform any security-related checks, including burning efuses that should be burned for this configuration (including *permanently limiting ROM download modes*).
- Initialize SPI flash API support.
- Call global C++ constructors and any C functions marked with `__attribute__((constructor))`.

Secondary system initialization allows individual components to be initialized. If a component has an initialization function annotated with the `ESP_SYSTEM_INIT_FN` macro, it will be called as part of secondary initialization.

Running the main task

After all other components are initialized, the main task is created and the FreeRTOS scheduler starts running.

After doing some more initialization tasks (that require the scheduler to have started), the main task runs the application-provided function `app_main` in the firmware.

The main task that runs `app_main` has a fixed RTOS priority (one higher than the minimum) and a *configurable stack size*.

Unlike normal FreeRTOS tasks (or embedded C `main` functions), the `app_main` task is allowed to return. If this happens, The task is cleaned up and the system will continue running with other RTOS tasks scheduled normally. Therefore, it is possible to implement `app_main` as either a function that creates other application tasks and then returns, or as a main application task itself.

4.3 BluFi

4.3.1 Overview

The BluFi for ESP32-C3 is a Wi-Fi network configuration function via Bluetooth channel. It provides a secure protocol to pass Wi-Fi configuration and credentials to the ESP32-C3. Using this information ESP32-C3 can then e.g. connect to an AP or establish a SoftAP.

Fragmenting, data encryption, checksum verification in the BluFi layer are the key elements of this process.

You can customize symmetric encryption, asymmetric encryption and checksum support customization. Here we use the DH algorithm for key negotiation, 128-AES algorithm for data encryption, and CRC16 algorithm for checksum verification.

4.3.2 The BluFi Flow

The BluFi networking flow includes the configuration of the SoftAP and Station.

The following uses Station as an example to illustrate the core parts of the procedure, including broadcast, connection, service discovery, negotiation of the shared key, data transmission, connection status backhaul.

1. Set the ESP32-C3 into GATT Server mode and then it will send broadcasts with specific *advertising data*. You can customize this broadcast as needed, which is not a part of the BluFi Profile.
2. Use the App installed on the mobile phone to search for this particular broadcast. The mobile phone will connect to ESP32-C3 as the GATT Client once the broadcast is confirmed. The App used during this part is up to you.
3. After the GATT connection is successfully established, the mobile phone will send a data frame for key negotiation to ESP32-C3 (see the section *The Frame Formats Defined in BluFi* for details).
4. After ESP32-C3 receives the data frame of key negotiation, it will parse the content according to the user-defined negotiation method.
5. The mobile phone works with ESP32-C3 for key negotiation using the encryption algorithms such as DH, RSA or ECC.
6. After the negotiation process is completed, the mobile phone will send a control frame for security-mode setup to ESP32-C3.
7. When receiving this control frame, ESP32-C3 will be able to encrypt and decrypt the communication data using the shared key and the security configuration.
8. The mobile phone sends the data frame defined in the section of *The Frame Formats Defined in BluFi*, with the Wi-Fi configuration information to ESP32-C3, including SSID, password, etc.
9. The mobile phone sends a control frame of Wi-Fi connection request to ESP32-C3. When receiving this control frame, ESP32-C3 will regard the communication of essential information as done and get ready to connect to the Wi-Fi.
10. After connecting to the Wi-Fi, ESP32-C3 will send a control frame of Wi-Fi connection status report to the mobile phone, to report the connection status. At this point the networking procedure is completed.

Note:

1. After ESP32-C3 receives the control frame of security-mode configuration, it will execute the operations in accordance with the defined security mode.
 2. The data lengths before and after symmetric encryption/decryption must stay the same. It also supports in-place encryption and decryption.
-

4.3.3 The flow chart of BluFi

4.3.4 The Frame Formats Defined in BluFi

The frame formats for the communication between the mobile phone App and ESP32-C3 are defined as follows:

The frame format with no fragment (8 bit):

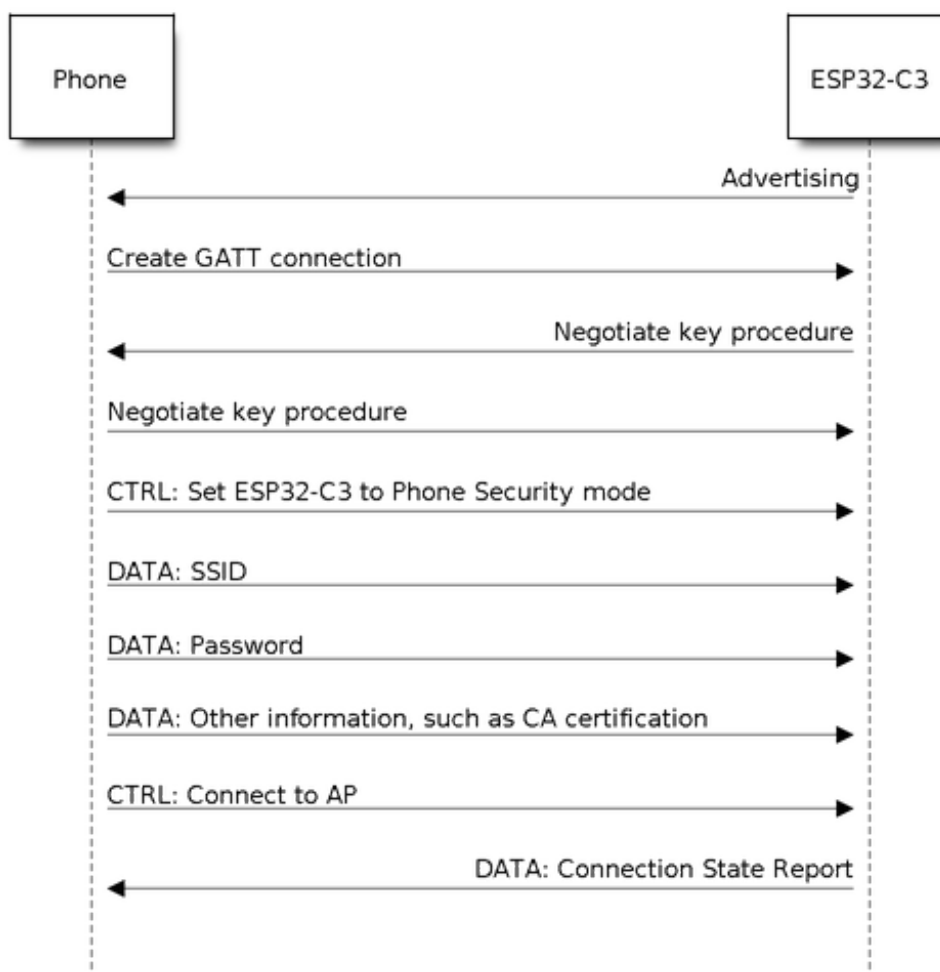

Fig. 2: BluFi Flow Chart

Description	Value
LSB - Type	1
Frame Control	1
Sequence Number	1
Data Length	1
Data	\${Data Length}
MSB - CheckSum	2

If the **Frame Ctrl** bit is enabled, the **Total length** bit indicates the length of remaining part of the frame. It can tell the remote how much memory needs to be allocated.

The frame format with fragments (8 bit) :

Description	Value
LSB - Type	1
FrameControl(Frag)	1
SequenceNumber	1
DataLength	1
Data	Total Content Length 2
	Content \${Data Length} - 2
MSB - CheckSum	2

Normally, the control frame does not contain data bits, except for Ack Frame.

The format of Ack Frame (8 bit) :

Description	Value
LSB - Type (Ack)	1
Frame Control	1
SequenceNumber	1
DataLength	1
Data	Acked Sequence Number 2
MSB - CheckSum	2

1. Type

The **Type** field, taking 1 byte, is divided into **Type** and **Subtype**, that Type uses the lower 2 bits and **Subtype** uses the upper 6 bits.

- The control frame is not encrypted for the time being and supports to be verified;
- The data frame supports to be encrypted and verified.

1.1 Control Frame (0x0 b' 00)

Control Frame (Binary)	Implication	Explanation	Note
0x0 (b' 000000)	Ack	The data field of the Ack frame uses the same sequence value of the frame to reply to.	The data field consumes a byte and its value is the same as the sequence field of the frame to reply to.
0x1 (b' 000001)	Set ESP device to the security mode.	To inform ESP device of the security mode to use when sending data, which is allowed to be reset multiple times during the process. Each setting affects the subsequent security mode used. If it is not set, ESP device will send the control frame and data frame with no checksum and encryption by default. The data transmission from the mobile phone to ESP device is controlled by this control frame.	<p>The data field consumes a byte. The higher 4 bits are for the security mode setting of the control frame, and the lower 4 bits are for the security mode setting of the data frame.</p> <p>b' 0000: no checksum and no encryption;</p> <p>b' 0001: with checksum but no encryption;</p> <p>b' 0010: no checksum but with encryption;</p> <p>b' 0011: with both checksum and encryption.</p>
0x2 (b' 000010)	Set the opmode of Wi-Fi.	The frame contains opmode settings for configuring for the Wi-Fi mode of ESP device.	<p>data[0] is for opmode settings, including:</p> <p>0x00: NULL;</p> <p>0x01: STA;</p> <p>0x02: SoftAP;</p> <p>0x03: SoftAP&STA.</p> <p>Please set the SSID/Password/Max Connection Number of the AP mode in the first place if an AP gets involved.</p>
0x3 (b' 000011)	Connect ESP device to the AP.	To notify ESP device that the essential information has been sent and it is allowed to connect to the AP.	No data field is contained.
0x4 (b' 000100)	Disconnect ESP device from the AP.		No data field is contained.
0x5 (b' 000101)	To get the information of ESP device's		No data field is contained. When receiving this control frame, ESP device will send back a follow-up frame of Wi-Fi connection state report to the mobile phone with the information of the current opmode, connection status, SSID and so on. The types of information sent to the
Espressif Systems	Wi-Fi mode and its status	1375	the mobile phone is defined by the application installed on the phone.

1.2 Data Frame (0x1 b' 01)

Data Frame(Binary)	Implication	Explanation
0x0 (b' 000000)	Send the negotiation data.	The negotiation data will be sent to the callback
0x1 (b' 000001)	Send the BSSID for STA mode.	To send the BSSID of the AP for the STA device
0x2 (b' 000010)	Send the SSID for STA mode.	To send the SSID of the AP for the STA device
0x3 (b' 000011)	Send the password for STA mode.	To send the password of the AP for the STA device
0x4 (b' 000100)	Send the SSID for SoftAP mode.	
0x5 (b' 000101)	Send the password for SoftAP mode.	
0x6 (b' 000110)	Set the maximum connection number for SoftAP mode.	
0x7 (b' 000111)	Set the authentication mode for the SoftAP.	
0x8 (b' 001000)	Set the channel amount for SoftAP mode.	
0x9 (b' 001001)	Username	It provides the username of the GATT client when using encryption
0xa (b' 001010)	CA Certification	It provides the CA Certification when using encryption
0xb (b' 001011)	Client Certification	It provides the client certification when using encryption
0xc (b' 001100)	Server Certification	It provides the server certification when using encryption
0xd (b' 001101)	ClientPrivate Key	It provides the private key of the client when using encryption
0xe (b' 001110)	ServerPrivate Key	It provides the private key of the server when using encryption
0xf (b' 001111)	Wi-Fi Connection State Report	To notify the phone of the ESP device's Wi-Fi status, including STA status and SoftAP status. It is for the STA device to connect to the mobile phone or the SoftAP. However, when the mobile phone receives the Wi-Fi status, it can reply to other frames in addition to this frame.
0x10 (b' 010000)	Version	
0x11 (b' 010001)	Wi-Fi List	To send the Wi-Fi list to ESP device.
0x12 (b' 010010)	Report Error	To notify the mobile phone that there is an error with BluFi.
0x13 (b' 010011)	Custom Data	To send or receive custom data.

2. Frame Control

Control field, takes 1 byte and each bit has a different meaning.

Bit	Meaning
0x01	Indicates whether the frame is encrypted.
	1 means encryption, and 0 means unencrypted.
	The encrypted part of the frame includes the full clear data before the DATA field is encrypted (no checksum).
	Control frame is not encrypted, so this bit is 0.
0x02	The data field that indicates whether a frame contains a checksum (such as SHA1,MD5,CRC, etc.) for the end of the frame data field includes SEQUCNE + data length + clear text. Both the control frame and the data frame can contain a check bit or not.
0x04	Represents the data direction.
	0 means the mobile phone to ESP device; 1 means ESP device to the mobile phone.
0x08	Indicates whether the other person is required to reply to an ACK.
	0 indicates no requirement; 1 indicates to reply Ack.
0x10	Indicates whether there are subsequent data fragments.
	0 indicates that there are no subsequent data fragments for this frame;
	1 indicates that there are subsequent data fragments and used to transmit longer data.
	In the case of a frag frame, the total length of the current content section + subsequent content section is given, in the first 2 bytes of the data field (that is, the content data of the maximum support 64K).
0x10~0x80 re- served	

3. Sequence Control

Sequence control field. When a frame is sent, the value of sequence field is automatically incremented by 1 regardless of the type of frame, which prevents Replay Attack. The sequence is cleared after each reconnection.

4. Length

The length of the data field that does not include CheckSum.

5. Data

The instruction of the data field is different according to various values of Type or Subtype. Please refer to the table above.

6. CheckSum

This field takes 2 bytes that is used to check “sequence + data length + clear text data” .

4.3.5 The Security Implementation of ESP32-C3

1. Securing data

To ensure that the transmission of the Wi-Fi SSID and password is secure, the message needs to be encrypted using symmetric encryption algorithms, such as AES, DES and so on. Before using symmetric encryption algorithms, the devices are required to negotiate (or generate) a shared key using an asymmetric encryption algorithm (DH, RSA, ECC, etc).

2. Ensuring data integrity

To ensure data integrity, you need to add a checksum algorithm, such as SHA1, MD5, CRC, etc.

3. Securing identity (signature)

Algorithm like RSA can be used to secure identity. But for DH, it needs other algorithms as a companion for signature.

4. Replay attack prevention

It is added to the Sequence field and used during the checksum verification.

For the coding of ESP32-C3, you can determine and develop the security processing, such as key negotiation. The mobile application sends the negotiation data to ESP32-C3 and then the data will be sent to the application layer for processing. If the application layer does not process it, you can use the DH encryption algorithm provided by BluFi to negotiate the key.

The application layer needs to register several security-related functions to BluFi:

```
typedef void (*esp_blufi_negotiate_data_handler_t)(uint8_t *data, int len, uint8_t_  
↳**output_data, int *output_len, bool *need_free)
```

This function is for ESP32-C3 to receive normal data during negotiation, and after processing is completed, the data will be transmitted using `Output_data` and `Output_len`.

BluFi will send `output_data` from `Negotiate_data_handler` after `Negotiate_data_handler` is called.

Here are two “*” , because the length of the data to be emitted is unknown that requires the function to allocate itself (malloc) or point to the global variable, and to inform whether the memory needs to be freed by `NEED_FREE`.

```
typedef int (* esp_blufi_encrypt_func_t)(uint8_t iv8, uint8_t *crypt_data, int_  
↳crypt_len)
```

The data to be encrypted and decrypted must use the same length. The IV8 is a 8 bit sequence value of frames, which can be used as a 8 bit of IV.

```
typedef int (* esp_blufi_decrypt_func_t)(uint8_t iv8, uint8_t *crypt_data, int_  
↳crypt_len)
```

The data to be encrypted and decrypted must use the same length. The IV8 is a 8 bit sequence value of frames, which can be used as a 8 bit of IV.

```
typedef uint16_t (*esp_blufi_checksum_func_t)(uint8_t iv8, uint8_t *data, int len)
```

This function is used to compute CheckSum and return a value of CheckSum. BluFi uses the returned value to compare the CheckSum of the frame.

4.3.6 GATT Related Instructions

UUID

BluFi Service UUID: 0xFFFF, 16 bit

BluFi (the mobile -> ESP32-C3): 0xFF01, writable

Blufi (ESP32-C3 -> the mobile phone): 0xFF02, readable and callable

4.4 Bootloader

The ESP-IDF Software Bootloader performs the following functions:

1. Minimal initial configuration of internal modules;
2. Initialize *Flash Encryption* and/or *Secure* features, if configured;
3. Select the application partition to boot, based on the partition table and `ota_data` (if any);
4. Load this image to RAM (IRAM & DRAM) and transfer management to it.

Bootloader is located at the address 0x0 in the flash.

For a full description of the startup process including the the ESP-IDF bootloader, see [Application Startup Flow](#).

4.4.1 Bootloader compatibility

It is recommended to update to newer *versions of ESP-IDF*: when they are released. The OTA (over the air) update process can flash new apps in the field but cannot flash a new bootloader. For this reason, the bootloader supports booting apps built from newer versions of ESP-IDF.

The bootloader does not support booting apps from older versions of ESP-IDF. When updating ESP-IDF manually on an existing product that might need to downgrade the app to an older version, keep using the older ESP-IDF bootloader binary as well.

Note: If testing an OTA update for an existing product in production, always test it using the same ESP-IDF bootloader binary that is deployed in production.

SPI Flash Configuration

Each ESP-IDF application or bootloader .bin file contains a header with `CONFIG_ESPTOOLPY_FLASHMODE`, `CONFIG_ESPTOOLPY_FLASHFREQ`, `CONFIG_ESPTOOLPY_FLASHSIZE` embedded in it. These are used to configure the SPI flash during boot.

The *First stage bootloader* in ROM reads the *Second stage bootloader* header from flash and uses these settings to load it. However, at this time the system clock speed is lower than configured and not all flash modes are supported. When the *Second stage bootloader* then runs and re-configures the flash, it reads values from the currently selected app binary header not the bootloader header. This allows an OTA update to change the SPI flash settings in use.

4.4.2 Factory reset

The user can write a basic working firmware and load it into the factory app partition.

Next, update the firmware via OTA (over the air). The updated firmware will be loaded into an OTA app partition slot and the OTA data partition is updated to boot from this partition.

If you want to be able to roll back to the factory firmware and clear the settings, then you need to set `CONFIG_BOOTLOADER_FACTORY_RESET`. The factory reset mechanism allows to reset the device to factory settings:

- Clear one or more data partitions.
- Boot from “factory” partition.

`CONFIG_BOOTLOADER_DATA_FACTORY_RESET` allows customers to select which data partitions will be erased when the factory reset is executed. Can specify the names of partitions through comma-delimited with optional spaces for readability. (Like this: “nvs, phy_init, nvs_custom, ...”). Make sure that the name specified in the partition table and here are the same. Partitions of type “app” cannot be specified here.

`CONFIG_BOOTLOADER_OTA_DATA_ERASE` - the device will boot from “factory” partition after a factory reset. The OTA data partition will be cleared.

`CONFIG_BOOTLOADER_NUM_PIN_FACTORY_RESET` - number of the GPIO input for factory reset uses to trigger a factory reset, this GPIO must be pulled low on reset to trigger this.

`CONFIG_BOOTLOADER_HOLD_TIME_GPIO` - this is hold time of GPIO for reset/test mode (by default 5 seconds). The GPIO must be held low continuously for this period of time after reset before a factory reset or test partition boot (as applicable) is performed.

Partition table.:

```
# Name, Type, SubType, Offset, Size, Flags
# Note: if you have increased the bootloader size, make sure to update the offsets.
↳to avoid overlap
nvs, data, nvs, 0x9000, 0x4000
otadata, data, ota, 0xd000, 0x2000
phy_init, data, phy, 0xf000, 0x1000
factory, 0, 0, 0x10000, 1M
test, 0, test, , 512K
ota_0, 0, ota_0, , 512K
ota_1, 0, ota_1, , 512K
```

4.4.3 Boot from test app partition

The user can write a special firmware for testing in production, and run it as needed. The partition table also needs a dedicated partition for this testing firmware (See *partition table*). To trigger a test app you need to set `CONFIG_BOOTLOADER_APP_TEST`.

`CONFIG_BOOTLOADER_NUM_PIN_APP_TEST` - GPIO number to boot TEST partition. The selected GPIO will be configured as an input with internal pull-up enabled. To trigger a test app, this GPIO must be pulled low on reset. After the GPIO input is deactivated and the device reboots, the normally configured application will boot (factory or any OTA slot).

`CONFIG_BOOTLOADER_HOLD_TIME_GPIO` - this is hold time of GPIO for reset/test mode (by default 5 seconds). The GPIO must be held low continuously for this period of time after reset before a factory reset or test partition boot (as applicable) is performed.

4.4.4 Fast boot from Deep Sleep

The bootloader has the `CONFIG_BOOTLOADER_SKIP_VALIDATE_IN_DEEP_SLEEP` option which allows to reduce the wake-up time (useful to reduce consumption). This option is available when the `CONFIG_SECURE_BOOT` option is disabled. Reduction of time is achieved due to the lack of image verification. During the first boot, the bootloader stores the address of the application being launched in the RTC FAST memory. And during the awakening, this address is used for booting without any checks, thus fast loading is achieved.

4.4.5 Custom bootloader

The current bootloader implementation allows a project to override it. To do this, you must copy the directory `/esp-idf/components/bootloader` to your project components directory and then edit `/your_project/components/bootloader/subproject/main/bootloader_start.c`.

In the bootloader space, you cannot use the drivers and functions from other components. If necessary, then the required functionality should be placed in the project's `bootloader` directory (note that this will increase its size).

If the bootloader grows too large then it can collide with the partition table, which is flashed at offset 0x8000 by default. Increase the *partition table offset* value to place the partition table later in the flash. This increases the space available for the bootloader.

Note: The first time you copy the bootloader into an existing project, the project may fail to build as paths have changed unexpectedly. If this happens, run `idf.py fullclean` (or delete the project build directory) and then build again.

4.5 Build System

This document explains the implementation of the ESP-IDF build system and the concept of “components”. Read this document if you want to know how to organize and build a new ESP-IDF project or component.

4.5.1 Overview

An ESP-IDF project can be seen as an amalgamation of a number of components. For example, for a webserver that shows the current humidity, there could be:

- The ESP-IDF base libraries (libc, ROM bindings, etc)
- The Wi-Fi drivers
- A TCP/IP stack
- The FreeRTOS operating system

- A webservice
- A driver for the humidity sensor
- Main code tying it all together

ESP-IDF makes these components explicit and configurable. To do that, when a project is compiled, the build system will look up all the components in the ESP-IDF directories, the project directories and (optionally) in additional custom component directories. It then allows the user to configure the ESP-IDF project using a text-based menu system to customize each component. After the components in the project are configured, the build system will compile the project.

Concepts

- A “project” is a directory that contains all the files and configuration to build a single “app” (executable), as well as additional supporting elements such as a partition table, data/filesystem partitions, and a bootloader.
- “Project configuration” is held in a single file called `sdkconfig` in the root directory of the project. This configuration file is modified via `idf.py menuconfig` to customise the configuration of the project. A single project contains exactly one project configuration.
- An “app” is an executable which is built by ESP-IDF. A single project will usually build two apps - a “project app” (the main executable, ie your custom firmware) and a “bootloader app” (the initial bootloader program which launches the project app).
- “components” are modular pieces of standalone code which are compiled into static libraries (.a files) and linked into an app. Some are provided by ESP-IDF itself, others may be sourced from other places.
- “Target” is the hardware for which an application is built. At the moment, ESP-IDF supports `esp32`, `esp32s2` and `esp32c3` targets.

Some things are not part of the project:

- “ESP-IDF” is not part of the project. Instead it is standalone, and linked to the project via the `IDF_PATH` environment variable which holds the path of the `esp-idf` directory. This allows the IDF framework to be decoupled from your project.
- The toolchain for compilation is not part of the project. The toolchain should be installed in the system command line `PATH`.

4.5.2 Using the Build System

`idf.py`

The `idf.py` command line tool provides a front-end for easily managing your project builds. It manages the following tools:

- `CMake`, which configures the project to be built
- A command line build tool (either [Ninja](#) build or *GNU Make*)
- `esptool.py` for flashing the target.

The [getting started guide](#) contains a brief introduction to how to set up `idf.py` to configure, build, and flash projects.

`idf.py` should be run in an ESP-IDF “project” directory, ie one containing a `CMakeLists.txt` file. Older style projects with a Makefile will not work with `idf.py`.

Type `idf.py --help` for a list of commands. Here are a summary of the most useful ones:

- `idf.py set-target <target>` sets the target (chip) for which the project is built. See [Selecting the Target](#).
- `idf.py menuconfig` runs the “menuconfig” tool to configure the project.
- `idf.py build` will build the project found in the current directory. This can involve multiple steps:
 - Create the build directory if needed. The sub-directory `build` is used to hold build output, although this can be changed with the `-B` option.
 - Run `CMake` as necessary to configure the project and generate build files for the main build tool.
 - Run the main build tool ([Ninja](#) or *GNU Make*). By default, the build tool is automatically detected but it can be explicitly set by passing the `-G` option to `idf.py`.

Building is incremental so if no source files or configuration has changed since the last build, nothing will be done.

- `idf.py clean` will “clean” the project by deleting build output files from the build directory, forcing a “full rebuild” the next time the project is built. Cleaning doesn’t delete CMake configuration output and some other files.
- `idf.py fullclean` will delete the entire “build” directory contents. This includes all CMake configuration output. The next time the project is built, CMake will configure it from scratch. Note that this option recursively deletes *all* files in the build directory, so use with care. Project configuration is not deleted.
- `idf.py flash` will automatically build the project if necessary, and then flash it to the target. The `-p` and `-b` options can be used to set serial port name and flasher baud rate, respectively.
- `idf.py monitor` will display serial output from the target. The `-p` option can be used to set the serial port name. Type `Ctrl-J` to exit the monitor. See *IDF Monitor* for more details about using the monitor.

Multiple `idf.py` commands can be combined into one. For example, `idf.py -p COM4 clean flash monitor` will clean the source tree, then build the project and flash it to the target before running the serial monitor.

For commands that are not known to `idf.py` an attempt to execute them as a build system target will be made.

The command `idf.py` supports [shell autocompletion](#) for bash, zsh and fish shells.

In order to make [shell autocompletion](#) supported, please make sure you have at least Python 3.5 and [click 7.1](#) or newer (*see also*).

To enable autocompletion for `idf.py` use the `export` command (*see this*). Autocompletion is initiated by pressing the TAB key. Type “`idf.py -`” and press the TAB key to autocomplete options.

The autocomplete support for PowerShell is planned in the future.

Note: The environment variables `ESPPORT` and `ESPBAUD` can be used to set default values for the `-p` and `-b` options, respectively. Providing these options on the command line overrides the default.

Advanced Commands

- `idf.py app`, `idf.py bootloader`, `idf.py partition_table` can be used to build only the app, bootloader, or partition table from the project as applicable.
- There are matching commands `idf.py app-flash`, etc. to flash only that single part of the project to the target.
- `idf.py -p PORT erase_flash` will use `esptool.py` to erase the target’s entire flash chip.
- `idf.py size` prints some size information about the app. `size-components` and `size-files` are similar commands which print more detailed per-component or per-source-file information, respectively. If you define variable `-DOUTPUT_JSON=1` when running CMake (or `idf.py`), the output will be formatted as JSON not as human readable text.
- `idf.py reconfigure` re-runs [CMake](#) even if it doesn’t seem to need re-running. This isn’t necessary during normal usage, but can be useful after adding/removing files from the source tree, or when modifying CMake cache variables. For example, `idf.py -DNAME='VALUE' reconfigure` can be used to set variable `NAME` in CMake cache to value `VALUE`.
- `idf.py python-clean` deletes generated Python byte code from the IDF directory which may cause issues when switching between IDF and Python versions. It is advised to run this target after switching versions of Python.

The order of multiple `idf.py` commands on the same invocation is not important, they will automatically be executed in the correct order for everything to take effect (ie building before flashing, erasing before flashing, etc.).

idf.py options To list all available root level options, run `idf.py --help`. To list options that are specific for a subcommand, run `idf.py <command> --help`, for example `idf.py monitor --help`. Here is a list of some useful options:

- `-C <dir>` allows overriding the project directory from the default current working directory.
- `-B <dir>` allows overriding the build directory from the default `build` subdirectory of the project directory.

- `--ccache` flag can be used to enable [CCache](#) when compiling source files, if the [CCache](#) tool is installed. This can dramatically reduce some build times.

Note that some older versions of [CCache](#) may exhibit bugs on some platforms, so if files are not rebuilt as expected then try disabling [CCache](#) and build again. [CCache](#) can be enabled by default by setting the `IDF_CCACHE_ENABLE` environment variable to a non-zero value.

- `-v` flag causes both `idf.py` and the build system to produce verbose build output. This can be useful for debugging build problems.
- `--cmake-warn-uninitialized` (or `-w`) will cause [CMake](#) to print uninitialized variable warnings inside the project directory (not for directories not found inside the project directory). This only controls [CMake](#) variable warnings inside [CMake](#) itself, not other types of build warnings. This option can also be set permanently by setting the `IDF_CMAKE_WARN_UNINITIALIZED` environment variable to a non-zero value.

Start a new project

Use the command `idf.py create-project` for starting a new project. Execute `idf.py create-project --help` for more information.

Example:

```
idf.py create-project --path my_projects my_new_project
```

This example will create a new project called `my_new_project` directly into the directory `my_projects`.

Using CMake Directly

`idf.py` is a wrapper around [CMake](#) for convenience. However, you can also invoke [CMake](#) directly if you prefer.

When `idf.py` does something, it prints each command that it runs for easy reference. For example, the `idf.py build` command is the same as running these commands in a bash shell (or similar commands for Windows Command Prompt):

```
mkdir -p build
cd build
cmake .. -G Ninja # or 'Unix Makefiles'
ninja
```

In the above list, the `cmake` command configures the project and generates build files for use with the final build tool. In this case the final build tool is [Ninja](#): running `ninja` actually builds the project.

It's not necessary to run `cmake` more than once. After the first build, you only need to run `ninja` each time. `ninja` will automatically re-invoke `cmake` if the project needs reconfiguration.

If using [CMake](#) with `ninja` or `make`, there are also targets for more of the `idf.py` sub-commands - for example running `make menuconfig` or `ninja menuconfig` in the build directory will work the same as `idf.py menuconfig`.

Note: If you're already familiar with [CMake](#), you may find the ESP-IDF [CMake](#)-based build system unusual because it wraps a lot of [CMake](#)'s functionality to reduce boilerplate. See [writing pure CMake components](#) for some information about writing more “[CMake style](#)” components.

Flashing with `ninja` or `make` It's possible to build and flash directly from `ninja` or `make` by running a target like:

```
ninja flash
```

Or:

```
make app-flash
```

Available targets are: `flash`, `app-flash` (app only), `bootloader-flash` (bootloader only).

When flashing this way, optionally set the `ESPPORT` and `ESPBAUD` environment variables to specify the serial port and baud rate. You can set environment variables in your operating system or IDE project. Alternatively, set them directly on the command line:

```
ESPPORT=/dev/ttyUSB0 ninja flash
```

Note: Providing environment variables at the start of the command like this is Bash shell Syntax. It will work on Linux and macOS. It won't work when using Windows Command Prompt, but it will work when using Bash-like shells on Windows.

Or:

```
make -j3 app-flash ESPPORT=COM4 ESPBAUD=2000000
```

Note: Providing variables at the end of the command line is make syntax, and works for make on all platforms.

Using CMake in an IDE

You can also use an IDE with CMake integration. The IDE will want to know the path to the project's `CMakeLists.txt` file. IDEs with CMake integration often provide their own build tools (CMake calls these "generators") to build the source files as part of the IDE.

When adding custom non-build steps like "flash" to the IDE, it is recommended to execute `idf.py` for these "special" commands.

For more detailed information about integrating ESP-IDF with CMake into an IDE, see [Build System Metadata](#).

Setting up the Python Interpreter

ESP-IDF works well with all supported Python versions. It should work out-of-box even if you have a legacy system where the default `python` interpreter is still Python 2.7, however, it is advised to switch to Python 3 if possible.

`idf.py` and other Python scripts will run with the default Python interpreter, i.e. `python`. You can switch to a different one like `python3 $IDF_PATH/tools/idf.py . . .`, or you can set up a shell alias or another script to simplify the command.

If using CMake directly, running `cmake -D PYTHON=python3 . . .` will cause CMake to override the default Python interpreter.

If using an IDE with CMake, setting the `PYTHON` value as a CMake cache override in the IDE UI will override the default Python interpreter.

To manage the Python version more generally via the command line, check out the tools [pyenv](#) or [virtualenv](#). These let you change the default Python version.

Possible issues The user of `idf.py` may sometimes experience `ImportError` described below.

```
Traceback (most recent call last):
  File "/Users/user_name/e/esp-idf/tools/kconfig_new/configgen.py", line 27, in
↳<module>
    import kconfiglib
ImportError: bad magic number in 'kconfiglib': b'\x03\xf3\r\n'
```

The exception is often caused by `.pyc` files generated by different Python versions. To solve the issue run the following command:

```
idf.py python-clean
```

4.5.3 Example Project

An example project directory tree might look like this:

```
- myProject/
  - CMakeLists.txt
  - sdkconfig
  - components/
    - component1/
      - CMakeLists.txt
      - Kconfig
      - src1.c
    - component2/
      - CMakeLists.txt
      - Kconfig
      - src1.c
      - include/
        - component2.h
  - main/
    - CMakeLists.txt
    - src1.c
    - src2.c
  - build/
```

This example “myProject” contains the following elements:

- A top-level project `CMakeLists.txt` file. This is the primary file which CMake uses to learn how to build the project; and may set project-wide CMake variables. It includes the file `/tools/cmake/project.cmake` which implements the rest of the build system. Finally, it sets the project name and defines the project.
- “`sdkconfig`” project configuration file. This file is created/updated when `idf.py menuconfig` runs, and holds configuration for all of the components in the project (including ESP-IDF itself). The “`sdkconfig`” file may or may not be added to the source control system of the project.
- Optional “`components`” directory contains components that are part of the project. A project does not have to contain custom components of this kind, but it can be useful for structuring reusable code or including third party components that aren’t part of ESP-IDF. Alternatively, `EXTRA_COMPONENT_DIRS` can be set in the top-level `CMakeLists.txt` to look for components in other places. See the [renaming main](#) section for more info. If you have a lot of source files in your project, we recommend grouping most into components instead of putting them all in “`main`”.
- “`main`” directory is a special component that contains source code for the project itself. “`main`” is a default name, the CMake variable `COMPONENT_DIRS` includes this component but you can modify this variable.
- “`build`” directory is where build output is created. This directory is created by `idf.py` if it doesn’t already exist. CMake configures the project and generates interim build files in this directory. Then, after the main build process is run, this directory will also contain interim object files and libraries as well as final binary output files. This directory is usually not added to source control or distributed with the project source code.

Component directories each contain a component `CMakeLists.txt` file. This file contains variable definitions to control the build process of the component, and its integration into the overall project. See [Component CMakeLists Files](#) for more details.

Each component may also include a `Kconfig` file defining the [component configuration](#) options that can be set via `menuconfig`. Some components may also include `Kconfig.projbuild` and `project_include.cmake` files, which are special files for [overriding parts of the project](#).

4.5.4 Project CMakeLists File

Each project has a single top-level `CMakeLists.txt` file that contains build settings for the entire project. By default, the project `CMakeLists` can be quite minimal.

Minimal Example CMakeLists

Minimal project:

```
cmake_minimum_required(VERSION 3.5)
include($ENV{IDF_PATH}/tools/cmake/project.cmake)
project(myProject)
```

Mandatory Parts

The inclusion of these three lines, in the order shown above, is necessary for every project:

- `cmake_minimum_required(VERSION 3.5)` tells CMake the minimum version that is required to build the project. ESP-IDF is designed to work with CMake 3.5 or newer. This line must be the first line in the `CMakeLists.txt` file.
- `include($ENV{IDF_PATH}/tools/cmake/project.cmake)` pulls in the rest of the CMake functionality to configure the project, discover all the components, etc.
- `project(myProject)` creates the project itself, and specifies the project name. The project name is used for the final binary output files of the app - ie `myProject.elf`, `myProject.bin`. Only one project can be defined per `CMakeLists` file.

Optional Project Variables

These variables all have default values that can be overridden for custom behaviour. Look in </tools/cmake/project.cmake> for all of the implementation details.

- `COMPONENT_DIRS`: Directories to search for components. Defaults to `IDF_PATH/components`, `PROJECT_DIR/components`, and `EXTRA_COMPONENT_DIRS`. Override this variable if you don't want to search for components in these places.
- `EXTRA_COMPONENT_DIRS`: Optional list of additional directories to search for components. Paths can be relative to the project directory, or absolute.
- `COMPONENTS`: A list of component names to build into the project. Defaults to all components found in the `COMPONENT_DIRS` directories. Use this variable to “trim down” the project for faster build times. Note that any component which “requires” another component via the `REQUIRES` or `PRIV_REQUIRES` arguments on component registration will automatically have it added to this list, so the `COMPONENTS` list can be very short.

Any paths in these variables can be absolute paths, or set relative to the project directory.

To set these variables, use the `cmake set command` ie `set(VARIABLE "VALUE")`. The `set()` commands should be placed after the `cmake_minimum(...)` line but before the `include(...)` line.

Renaming main component

The build system provides special treatment to the `main` component. It is a component that gets automatically added to the build provided that it is in the expected location, `PROJECT_DIR/main`. All other components in the build are also added as its dependencies, saving the user from hunting down dependencies and providing a build that works right out of the box. Renaming the `main` component causes the loss of these behind-the-scenes heavy lifting, requiring the user to specify the location of the newly renamed component and manually specifying its dependencies. Specifically, the steps to renaming `main` are as follows:

1. Rename `main` directory.
2. Set `EXTRA_COMPONENT_DIRS` in the project `CMakeLists.txt` to include the renamed `main` directory.
3. Specify the dependencies in the renamed component's `CMakeLists.txt` file via `REQUIRES` or `PRIV_REQUIRES` arguments *on component registration*.

4.5.5 Component CMakeLists Files

Each project contains one or more components. Components can be part of ESP-IDF, part of the project's own components directory, or added from custom component directories (*see above*).

A component is any directory in the `COMPONENT_DIRS` list which contains a `CMakeLists.txt` file.

Searching for Components

The list of directories in `COMPONENT_DIRS` is searched for the project's components. Directories in this list can either be components themselves (ie they contain a `CMakeLists.txt` file), or they can be top-level directories whose sub-directories are components.

When CMake runs to configure the project, it logs the components included in the build. This list can be useful for debugging the inclusion/exclusion of certain components.

Multiple components with the same name

When ESP-IDF is collecting all the components to compile, it will do this in the order specified by `COMPONENT_DIRS`; by default, this means ESP-IDF's internal components first, then the project's components, and finally any components set in `EXTRA_COMPONENT_DIRS`. If two or more of these directories contain component sub-directories with the same name, the component in the last place searched is used. This allows, for example, overriding ESP-IDF components with a modified version by copying that component from the ESP-IDF components directory to the project components directory and then modifying it there. If used in this way, the ESP-IDF directory itself can remain untouched.

Note: If a component is overridden in an existing project by moving it to a new location, the project will not automatically see the new component path. Run `idf.py reconfigure` (or delete the project build folder) and then build again.

Minimal Component CMakeLists

The minimal component `CMakeLists.txt` file simply registers the component to the build system using `idf_component_register`:

```
idf_component_register(SRCS "foo.c" "bar.c"
                      INCLUDE_DIRS "include"
                      REQUIRES mbedtls)
```

- `SRCS` is a list of source files (`*.c`, `*.cpp`, `*.cc`, `*.S`). These source files will be compiled into the component library.
- `INCLUDE_DIRS` is a list of directories to add to the global include search path for any component which requires this component, and also the main source files.
- `REQUIRES` is not actually required, but it is very often required to declare what other components this component will use. See *Component Requirements*.

A library with the name of the component will be built and linked into the final app.

Directories are usually specified relative to the `CMakeLists.txt` file itself, although they can be absolute.

There are other arguments that can be passed to `idf_component_register`. These arguments are discussed *here*.

See *example component requirements* and *example component CMakeLists* for more complete component `CMakeLists.txt` examples.

Create a new component

Use the command `idf.py create-component` for creating a new component. The new component will contain set of files necessary for building a component. You may include the component's header file into your project and use its functionality. For more information execute `idf.py create-component --help`.

Example:

```
idf.py -C components create-component my_component
```

The example will create a new component in the subdirectory `components` under the current working directory. For more information about components follow the documentation page [see above](#).

Preset Component Variables

The following component-specific variables are available for use inside component CMakeLists, but should not be modified:

- `COMPONENT_DIR`: The component directory. Evaluates to the absolute path of the directory containing `CMakeLists.txt`. The component path cannot contain spaces. This is the same as the `CMAKE_CURRENT_SOURCE_DIR` variable.
- `COMPONENT_NAME`: Name of the component. Same as the name of the component directory.
- `COMPONENT_ALIAS`: Alias of the library created internally by the build system for the component.
- `COMPONENT_LIB`: Name of the library created internally by the build system for the component.

The following variables are set at the project level, but available for use in component CMakeLists:

- `CONFIG_*`: Each value in the project configuration has a corresponding variable available in cmake. All names begin with `CONFIG_`. [More information here](#).
- `ESP_PLATFORM`: Set to 1 when the CMake file is processed within ESP-IDF build system.

Build/Project Variables

The following are some project/build variables that are available as build properties and whose values can be queried using `idf_build_get_property` from the component CMakeLists.txt:

- `PROJECT_NAME`: Name of the project, as set in project CMakeLists.txt file.
- `PROJECT_DIR`: Absolute path of the project directory containing the project CMakeLists. Same as the `CMAKE_SOURCE_DIR` variable.
- `COMPONENTS`: Names of all components that are included in this build, formatted as a semicolon-delimited CMake list.
- `IDF_VER`: Git version of ESP-IDF (produced by `git describe`)
- `IDF_VERSION_MAJOR`, `IDF_VERSION_MINOR`, `IDF_VERSION_PATCH`: Components of ESP-IDF version, to be used in conditional expressions. Note that this information is less precise than that provided by `IDF_VER` variable. `v4.0-dev-*`, `v4.0-beta1`, `v4.0-rc1` and `v4.0` will all have the same values of `IDF_VERSION_*` variables, but different `IDF_VER` values.
- `IDF_TARGET`: Name of the target for which the project is being built.
- `PROJECT_VER`: Project version.
 - If `CONFIG_APP_PROJECT_VER_FROM_CONFIG` option is set, the value of `CONFIG_APP_PROJECT_VER` will be used.
 - Else, if `PROJECT_VER` variable is set in project CMakeLists.txt file, its value will be used.
 - Else, if the `PROJECT_DIR/version.txt` exists, its contents will be used as `PROJECT_VER`.
 - Else, if the project is located inside a Git repository, the output of `git describe` will be used.
 - Otherwise, `PROJECT_VER` will be "1" .

Other build properties are listed [here](#).

Controlling Component Compilation

To pass compiler options when compiling source files belonging to a particular component, use the `target_compile_options` function:

```
target_compile_options(${COMPONENT_LIB} PRIVATE -Wno-unused-variable)
```

To apply the compilation flags to a single source file, use the CMake `set_source_files_properties` command:

```
set_source_files_properties(mysrc.c
    PROPERTIES COMPILE_FLAGS
        -Wno-unused-variable
)
```

This can be useful if there is upstream code that emits warnings.

When using these commands, place them after the call to `idf_component_register` in the component CMakeLists file.

4.5.6 Component Configuration

Each component can also have a `Kconfig` file, alongside `CMakeLists.txt`. This contains configuration settings to add to the configuration menu for this component.

These settings are found under the “Component Settings” menu when `menuconfig` is run.

To create a component `Kconfig` file, it is easiest to start with one of the `Kconfig` files distributed with ESP-IDF.

For an example, see [Adding conditional configuration](#).

4.5.7 Preprocessor Definitions

The ESP-IDF build system adds the following C preprocessor definitions on the command line:

- `ESP_PLATFORM`: Can be used to detect that build happens within ESP-IDF.
- `IDF_VER`: Defined to a git version string. E.g. `v2.0` for a tagged release or `v1.0-275-g0efaa4f` for an arbitrary commit.

4.5.8 Component Requirements

When compiling each component, the ESP-IDF build system recursively evaluates its dependencies. This means each component needs to declare the components that it depends on (“requires”).

When writing a component

```
idf_component_register(...
    REQUIRES mbedtls
    PRIV_REQUIRES console spiffs)
```

- `REQUIRES` should be set to all components whose header files are `#included` from the *public* header files of this component.
- `PRIV_REQUIRES` should be set to all components whose header files are `#included` from *any source files* in this component, unless already listed in `REQUIRES`. Also any component which is required to be linked in order for this component to function correctly.
- The values of `REQUIRES` and `PRIV_REQUIRES` should not depend on any configuration choices (`CONFIG_XXX` macros). This is because requirements are expanded before configuration is loaded. Other component variables (like include paths or source files) can depend on configuration choices.

- Not setting either or both `REQUIRES` variables is fine. If the component has no requirements except for the *Common component requirements* needed for RTOS, libc, etc.

If a component only supports some target chips (values of `IDF_TARGET`) then it can specify `REQUIRED_IDF_TARGETS` in the `idf_component_register` call to express these requirements. In this case the build system will generate an error if the component is included into the build, but does not support the selected target.

Note: In CMake terms, `REQUIRES` & `PRIV_REQUIRES` are approximate wrappers around the CMake functions `target_link_libraries(... PUBLIC ...)` and `target_link_libraries(... PRIVATE ...)`.

Example of component requirements

Imagine there is a `car` component, which uses the `engine` component, which uses the `spark_plug` component:

```
- autoProject/
  - CMakeLists.txt
  - components/ - car/ - CMakeLists.txt
                    - car.c
                    - car.h
                - engine/ - CMakeLists.txt
                    - engine.c
                    - include/ - engine.h
            - spark_plug/ - CMakeLists.txt
                    - plug.c
                    - plug.h
```

Car component The `car.h` header file is the public interface for the `car` component. This header includes `engine.h` directly because it uses some declarations from this header:

```
/* car.h */
#include "engine.h"

#ifdef ENGINE_IS_HYBRID
#define CAR_MODEL "Hybrid"
#endif
```

And `car.c` includes `car.h` as well:

```
/* car.c */
#include "car.h"
```

This means the `car/CMakeLists.txt` file needs to declare that `car` requires `engine`:

```
idf_component_register(SRCS "car.c"
                      INCLUDE_DIRS "."
                      REQUIRES engine)
```

- `SRCS` gives the list of source files in the `car` component.
- `INCLUDE_DIRS` gives the list of public include directories for this component. Because the public interface is `car.h`, the directory containing `car.h` is listed here.
- `REQUIRES` gives the list of components required by the public interface of this component. Because `car.h` is a public header and includes a header from `engine`, we include `engine` here. This makes sure that any other component which includes `car.h` will be able to recursively include the required `engine.h` also.

Engine component The engine component also has a public header file `include/engine.h`, but this header is simpler:

```
/* engine.h */
#define ENGINE_IS_HYBRID

void engine_start(void);
```

The implementation is in `engine.c`:

```
/* engine.c */
#include "engine.h"
#include "spark_plug.h"

...
```

In this component, `engine` depends on `spark_plug` but this is a private dependency. `spark_plug.h` is needed to compile `engine.c`, but not needed to include `engine.h`.

This means that the `engine/CMakeLists.txt` file can use `PRIV_REQUIRES`:

```
idf_component_register(SRCS "engine.c"
                      INCLUDE_DIRS "include"
                      PRIV_REQUIRES spark_plug)
```

As a result, source files in the `car` component don't need the `spark_plug` include directories added to their compiler search path. This can speed up compilation, and stops compiler command lines from becoming longer than necessary.

Spark Plug Component The `spark_plug` component doesn't depend on anything else. It has a public header file `spark_plug.h`, but this doesn't include headers from any other components.

This means that the `spark_plug/CMakeLists.txt` file doesn't need any `REQUIRES` or `PRIV_REQUIRES` clauses:

```
idf_component_register(SRCS "spark_plug.c"
                      INCLUDE_DIRS ".")
```

Source File Include Directories

Each component's source file is compiled with these include path directories, as specified in the passed arguments to `idf_component_register`:

```
idf_component_register(..
                      INCLUDE_DIRS "include"
                      PRIV_INCLUDE_DIRS "other")
```

- The current component's `INCLUDE_DIRS` and `PRIV_INCLUDE_DIRS`.
- The `INCLUDE_DIRS` belonging to all other components listed in the `REQUIRES` and `PRIV_REQUIRES` parameters (ie all the current component's public and private dependencies).
- Recursively, all of the `INCLUDE_DIRS` of those components `REQUIRES` lists (ie all public dependencies of this component's dependencies, recursively expanded).

Main component requirements

The component named `main` is special because it automatically requires all other components in the build. So it's not necessary to pass `REQUIRES` or `PRIV_REQUIRES` to this component. See [renaming main](#) for a description of what needs to be changed if no longer using the `main` component.

Common component requirements

To avoid duplication, every component automatically requires some “common” IDF components even if they are not mentioned explicitly. Headers from these components can always be included.

The list of common components is: `freertos`, `newlib`, `heap`, `log`, `soc`, `esp_rom`, `esp_common`, `xtensa/riscv`, `cxx`.

Including components in the build

- By default, every component is included in the build.
- If you set the `COMPONENTS` variable to a minimal list of components used directly by your project, then the build will expand to also include required components. The full list of components will be:
 - Components mentioned explicitly in `COMPONENTS`.
 - Those components’ requirements (evaluated recursively).
 - The “common” components that every component depends on.
- Setting `COMPONENTS` to the minimal list of required components can significantly reduce compile times.

Requirements in the build system implementation

- Very early in the CMake configuration process, the script `expand_requirements.cmake` is run. This script does a partial evaluation of all component `CMakeLists.txt` files and builds a graph of component requirements (this graph may have cycles). The graph is used to generate a file `component_depends.cmake` in the build directory.
- The main CMake process then includes this file and uses it to determine the list of components to include in the build (internal `BUILD_COMPONENTS` variable). The `BUILD_COMPONENTS` variable is sorted so dependencies are listed first, however as the component dependency graph has cycles this cannot be guaranteed for all components. The order should be deterministic given the same set of components and component dependencies.
- The value of `BUILD_COMPONENTS` is logged by CMake as “Component names: “
- Configuration is then evaluated for the components included in the build.
- Each component is included in the build normally and the `CMakeLists.txt` file is evaluated again to add the component libraries to the build.

Component Dependency Order The order of components in the `BUILD_COMPONENTS` variable determines other orderings during the build:

- Order that `project_include.cmake` files are included into the project.
- Order that the list of header paths is generated for compilation (via `-I` argument). (Note that for a given component’ s source files, only that component’ s dependency’ s header paths are passed to the compiler.)

4.5.9 Overriding Parts of the Project

`project_include.cmake`

For components that have build requirements which must be evaluated before any component `CMakeLists` files are evaluated, you can create a file called `project_include.cmake` in the component directory. This CMake file is included when `project.cmake` is evaluating the entire project.

`project_include.cmake` files are used inside ESP-IDF, for defining project-wide build features such as `esptool.py` command line arguments and the bootloader “special app” .

Unlike component `CMakeLists.txt` files, when including a `project_include.cmake` file the current source directory (`CMAKE_CURRENT_SOURCE_DIR` and working directory) is the project directory. Use the variable `COMPONENT_DIR` for the absolute directory of the component.

Note that `project_include.cmake` isn't necessary for the most common component uses - such as adding include directories to the project, or `LDFLAGS` to the final linking step. These values can be customised via the `CMakeLists.txt` file itself. See [Optional Project Variables](#) for details.

`project_include.cmake` files are included in the order given in `BUILD_COMPONENTS` variable (as logged by CMake). This means that a component's `project_include.cmake` file will be included after it's all dependencies' `project_include.cmake` files, unless both components are part of a dependency cycle. This is important if a `project_include.cmake` file relies on variables set by another component. See also [above](#).

Take great care when setting variables or targets in a `project_include.cmake` file. As the values are included into the top-level project CMake pass, they can influence or break functionality across all components!

KConfig.projbuild

This is an equivalent to `project_include.cmake` for [Component Configuration](#) KConfig files. If you want to include configuration options at the top-level of `menuconfig`, rather than inside the "Component Configuration" sub-menu, then these can be defined in the `KConfig.projbuild` file alongside the `CMakeLists.txt` file.

Take care when adding configuration values in this file, as they will be included across the entire project configuration. Where possible, it's generally better to create a KConfig file for [Component Configuration](#).

`project_include.cmake` files are used inside ESP-IDF, for defining project-wide build features such as `esptool.py` command line arguments and the bootloader "special app" .

4.5.10 Configuration-Only Components

Special components which contain no source files, only `Kconfig.projbuild` and `KConfig`, can have a one-line `CMakeLists.txt` file which calls the function `idf_component_register()` with no arguments specified. This function will include the component in the project build, but no library will be built *and* no header files will be added to any include paths.

4.5.11 Debugging CMake

For full details about CMake and CMake commands, see the [CMake v3.5 documentation](#).

Some tips for debugging the ESP-IDF CMake-based build system:

- When CMake runs, it prints quite a lot of diagnostic information including lists of components and component paths.
- Running `cmake -DDEBUG=1` will produce more verbose diagnostic output from the IDF build system.
- Running `cmake` with the `--trace` or `--trace-expand` options will give a lot of information about control flow. See the [cmake command line documentation](#).

When included from a project `CMakeLists` file, the `project.cmake` file defines some utility modules and global variables and then sets `IDF_PATH` if it was not set in the system environment.

It also defines an overridden custom version of the built-in CMake `project` function. This function is overridden to add all of the ESP-IDF specific project functionality.

Warning On Undefined Variables

By default, `idf.py` passes the `--warn-uninitialized` flag to CMake so it will print a warning if an undefined variable is referenced in the build. This can be very useful to find buggy CMake files.

If you don't want this behaviour, it can be disabled by passing `--no-warnings` to `idf.py`.

Browse the [/tools/cmake/project.cmake](#) file and supporting functions in [/tools/cmake/](#) for more details.

4.5.12 Example Component CMakeLists

Because the build environment tries to set reasonable defaults that will work most of the time, component `CMakeLists.txt` can be very small or even empty (see *Minimal Component CMakeLists*). However, overriding *component variables* is usually required for some functionality.

Here are some more advanced examples of component CMakeLists files.

Adding conditional configuration

The configuration system can be used to conditionally compile some files depending on the options selected in the project configuration.

Kconfig:

```
config FOO_ENABLE_BAR
    bool "Enable the BAR feature."
    help
        This enables the BAR feature of the FOO component.
```

CMakeLists.txt:

```
set(srcs "foo.c" "more_foo.c")

if(CONFIG_FOO_ENABLE_BAR)
    list(APPEND srcs "bar.c")
endif()

idf_component_register(SRCS "${srcs}"
    ...)
```

This example makes use of the CMake `if` function and `list APPEND` function.

This can also be used to select or stub out an implementation, as such:

Kconfig:

```
config ENABLE_LCD_OUTPUT
    bool "Enable LCD output."
    help
        Select this if your board has a LCD.

config ENABLE_LCD_CONSOLE
    bool "Output console text to LCD"
    depends on ENABLE_LCD_OUTPUT
    help
        Select this to output debugging output to the lcd

config ENABLE_LCD_PLOT
    bool "Output temperature plots to LCD"
    depends on ENABLE_LCD_OUTPUT
    help
        Select this to output temperature plots
```

CMakeLists.txt:

```
if(CONFIG_ENABLE_LCD_OUTPUT)
    set(srcs lcd-real.c lcd-spi.c)
else()
    set(srcs lcd-dummy.c)
endif()
```

(continues on next page)

(continued from previous page)

```
# We need font if either console or plot is enabled
if(CONFIG_ENABLE_LCD_CONSOLE OR CONFIG_ENABLE_LCD_PLOT)
    list(APPEND srcs "font.c")
endif()

idf_component_register(SRCS "${srcs}"
    ...)
```

Conditions which depend on the target

The current target is available to CMake files via `IDF_TARGET` variable.

In addition to that, if target `xyz` is used (`IDF_TARGET=xyz`), then Kconfig variable `CONFIG_IDF_TARGET_XYZ` will be set.

Note that component dependencies may depend on `IDF_TARGET` variable, but not on Kconfig variables. Also one can not use Kconfig variables in `include` statements in CMake files, but `IDF_TARGET` can be used in such context.

Source Code Generation

Some components will have a situation where a source file isn't supplied with the component itself but has to be generated from another file. Say our component has a header file that consists of the converted binary data of a BMP file, converted using a hypothetical tool called `bmp2h`. The header file is then included in as C source file called `graphics_lib.c`:

```
add_custom_command(OUTPUT logo.h
    COMMAND bmp2h -i ${COMPONENT_DIR}/logo.bmp -o log.h
    DEPENDS ${COMPONENT_DIR}/logo.bmp
    VERBATIM)

add_custom_target(logo DEPENDS logo.h)
add_dependencies(${COMPONENT_LIB} logo)

set_property(DIRECTORY "${COMPONENT_DIR}" APPEND PROPERTY
    ADDITIONAL_MAKE_CLEAN_FILES logo.h)
```

This answer is adapted from the [CMake FAQ entry](#), which contains some other examples that will also work with ESP-IDF builds.

In this example, `logo.h` will be generated in the current directory (the build directory) while `logo.bmp` comes with the component and resides under the component path. Because `logo.h` is a generated file, it should be cleaned when the project is cleaned. For this reason it is added to the [ADDITIONAL_MAKE_CLEAN_FILES](#) property.

Note: If generating files as part of the project `CMakeLists.txt` file, not a component `CMakeLists.txt`, then use build property `PROJECT_DIR` instead of `${COMPONENT_DIR}` and `${PROJECT_NAME}.elf` instead of `${COMPONENT_LIB}`.)

If a source file from another component included `logo.h`, then `add_dependencies` would need to be called to add a dependency between the two components, to ensure that the component source files were always compiled in the correct order.

Embedding Binary Data

Sometimes you have a file with some binary or text data that you'd like to make available to your component - but you don't want to reformat the file as C source.

You can specify argument `EMBED_FILES` in the component registration, giving space-delimited names of the files to embed:

```
idf_component_register(...
    EMBED_FILES server_root_cert.der)
```

Or if the file is a string, you can use the variable `EMBED_TXTFILES`. This will embed the contents of the text file as a null-terminated string:

```
idf_component_register(...
    EMBED_TXTFILES server_root_cert.pem)
```

The file's contents will be added to the `.rodata` section in flash, and are available via symbol names as follows:

```
extern const uint8_t server_root_cert_pem_start[] asm("_binary_server_root_cert_
↪pem_start");
extern const uint8_t server_root_cert_pem_end[]   asm("_binary_server_root_cert_
↪pem_end");
```

The names are generated from the full name of the file, as given in `EMBED_FILES`. Characters `/`, `.`, etc. are replaced with underscores. The `_binary` prefix in the symbol name is added by objcopy and is the same for both text and binary files.

To embed a file into a project, rather than a component, you can call the function `target_add_binary_data` like this:

```
target_add_binary_data(myproject.elf "main/data.bin" TEXT)
```

Place this line after the `project()` line in your project `CMakeLists.txt` file. Replace `myproject.elf` with your project name. The final argument can be `TEXT` to embed a null-terminated string, or `BINARY` to embed the content as-is.

For an example of using this technique, see the “main” component of the [file_serving example protocols/http_server/file_serving/main/CMakeLists.txt](#) - two files are loaded at build time and linked into the firmware.

It is also possible embed a generated file:

```
add_custom_command(OUTPUT my_processed_file.bin
    COMMAND my_process_file_cmd my_unprocessed_file.bin)
target_add_binary_data(my_target "my_processed_file.bin" BINARY)
```

In the example above, `my_processed_file.bin` is generated from `my_unprocessed_file.bin` through some command `my_process_file_cmd`, then embedded into the target.

To specify a dependence on a target, use the `DEPENDS` argument:

```
add_custom_target(my_process COMMAND ...)
target_add_binary_data(my_target "my_embed_file.bin" BINARY DEPENDS my_process)
```

The `DEPENDS` argument to `target_add_binary_data` ensures that the target executes first.

Code and Data Placements

ESP-IDF has a feature called linker script generation that enables components to define where its code and data will be placed in memory through linker fragment files. These files are processed by the build system, and is used to augment the linker script used for linking app binary. See [Linker Script Generation](#) for a quick start guide as well as a detailed discussion of the mechanism.

Fully Overriding The Component Build Process

Obviously, there are cases where all these recipes are insufficient for a certain component, for example when the component is basically a wrapper around another third-party component not originally intended to be compiled under this build system. In that case, it's possible to forego the ESP-IDF build system entirely by using a CMake feature called [ExternalProject](#). Example component CMakeLists:

```
# External build process for quirc, runs in source dir and
# produces libquirc.a
externalproject_add(quirc_build
    PREFIX ${COMPONENT_DIR}
    SOURCE_DIR ${COMPONENT_DIR}/quirc
    CONFIGURE_COMMAND ""
    BUILD_IN_SOURCE 1
    BUILD_COMMAND make CC=${CMAKE_C_COMPILER} libquirc.a
    INSTALL_COMMAND ""
)

# Add libquirc.a to the build process
add_library(quirc STATIC IMPORTED GLOBAL)
add_dependencies(quirc quirc_build)

set_target_properties(quirc PROPERTIES IMPORTED_LOCATION
    ${COMPONENT_DIR}/quirc/libquirc.a)
set_target_properties(quirc PROPERTIES INTERFACE_INCLUDE_DIRECTORIES
    ${COMPONENT_DIR}/quirc/lib)

set_directory_properties( PROPERTIES ADDITIONAL_MAKE_CLEAN_FILES
    "${COMPONENT_DIR}/quirc/libquirc.a")
```

(The above CMakeLists.txt can be used to create a component named `quirc` that builds the `quirc` project using its own Makefile.)

- `externalproject_add` defines an external build system.
 - `SOURCE_DIR`, `CONFIGURE_COMMAND`, `BUILD_COMMAND` and `INSTALL_COMMAND` should always be set. `CONFIGURE_COMMAND` can be set to an empty string if the build system has no “configure” step. `INSTALL_COMMAND` will generally be empty for ESP-IDF builds.
 - Setting `BUILD_IN_SOURCE` means the build directory is the same as the source directory. Otherwise you can set `BUILD_DIR`.
 - Consult the [ExternalProject](#) documentation for more details about `externalproject_add()`
- The second set of commands adds a library target, which points to the “imported” library file built by the external system. Some properties need to be set in order to add include directories and tell CMake where this file is.
- Finally, the generated library is added to `ADDITIONAL_MAKE_CLEAN_FILES`. This means `make clean` will delete this library. (Note that the other object files from the build won't be deleted.)

ExternalProject dependencies, clean builds CMake has some unusual behaviour around external project builds:

- `ADDITIONAL_MAKE_CLEAN_FILES` only works when “make” is used as the build system. If [Ninja](#) or an IDE build system is used, it won't delete these files when cleaning.
- However, the [ExternalProject](#) `configure` & `build` commands will *always* be re-run after a clean is run.
- Therefore, there are two alternative recommended ways to configure the external build command:
 1. Have the external `BUILD_COMMAND` run a full clean compile of all sources. The build command will be run if any of the dependencies passed to `externalproject_add` with `DEPENDS` have changed, or if this is a clean build (ie any of `idf.py clean`, `ninja clean`, or `make clean` was run.)
 2. Have the external `BUILD_COMMAND` be an incremental build command. Pass the parameter `BUILD_ALWAYS 1` to `externalproject_add`. This means the external project will be built each time a build is run, regardless of dependencies. This is only recommended if the external project has correct incremental build behaviour, and doesn't take too long to run.

The best of these approaches for building an external project will depend on the project itself, its build system, and whether you anticipate needing to frequently recompile the project.

4.5.13 Custom sdkconfig defaults

For example projects or other projects where you don't want to specify a full `sdkconfig` configuration, but you do want to override some key values from the ESP-IDF defaults, it is possible to create a file `sdkconfig.defaults` in the project directory. This file will be used when creating a new config from scratch, or when any new config value hasn't yet been set in the `sdkconfig` file.

To override the name of this file or to specify multiple files, set the `SDKCONFIG_DEFAULTS` environment variable or set `SDKCONFIG_DEFAULTS` in top-level `CMakeLists.txt`. If specifying multiple files, use semicolon as the list separator. File names not specified as full paths are resolved relative to current project.

Target-dependent sdkconfig defaults

In addition to `sdkconfig.defaults` file, build system will also load defaults from `sdkconfig.defaults.TARGET_NAME` file, where `TARGET_NAME` is the value of `IDF_TARGET`. For example, for `esp32` target, default settings will be taken from `sdkconfig.defaults` first, and then from `sdkconfig.defaults.esp32`.

If `SDKCONFIG_DEFAULTS` is used to override the name of defaults file/files, the name of target-specific defaults file will be derived from `SDKCONFIG_DEFAULTS` value/values using the rule above.

4.5.14 Flash arguments

There are some scenarios that we want to flash the target board without IDF. For this case we want to save the built binaries, `esptool.py` and `esptool write_flash` arguments. It's simple to write a script to save binaries and `esptool.py`.

After running a project build, the build directory contains binary output files (`.bin` files) for the project and also the following flashing data files:

- `flash_project_args` contains arguments to flash the entire project (app, bootloader, partition table, PHY data if this is configured).
- `flash_app_args` contains arguments to flash only the app.
- `flash_bootloader_args` contains arguments to flash only the bootloader.

You can pass any of these flasher argument files to `esptool.py` as follows:

```
python esptool.py --chip esp32 write_flash @build/flash_project_args
```

Alternatively, it is possible to manually copy the parameters from the argument file and pass them on the command line.

The build directory also contains a generated file `flasher_args.json` which contains project flash information, in JSON format. This file is used by `idf.py` and can also be used by other tools which need information about the project build.

4.5.15 Building the Bootloader

The bootloader is built by default as part of `idf.py build`, or can be built standalone via `idf.py bootloader`.

The bootloader is a special “subproject” inside `/components/bootloader/subproject`. It has its own project `CMakeLists.txt` file and builds separate `.ELF` and `.BIN` files to the main project. However it shares its configuration and build directory with the main project.

The subproject is inserted as an external project from the top-level project, by the file `/components/bootloader/project_include.cmake`. The main build process runs CMake for the subproject, which includes

discovering components (a subset of the main components) and generating a bootloader-specific config (derived from the main `sdkconfig`).

4.5.16 Selecting the Target

ESP-IDF supports multiple targets (chips). The identifiers used for each chip are as follows:

- `esp32` —for ESP32-D0WD, ESP32-D2WD, ESP32-S0WD (ESP-SOLO), ESP32-U4WDH, ESP32-PICO-D4
- `esp32s2`—for ESP32-S2
- `esp32c3`—for ESP32-C3

To select the target before building the project, use `idf.py set-target <target>` command, for example:

```
idf.py set-target esp32s2
```

Important: `idf.py set-target` will clear the build directory and re-generate the `sdkconfig` file from scratch. The old `sdkconfig` file will be saved as `sdkconfig.old`.

Note: The behavior of `idf.py set-target` command is equivalent to:

1. clearing the build directory (`idf.py fullclean`)
 2. removing the `sdkconfig` file (`mv sdkconfig sdkconfig.old`)
 3. configuring the project with the new target (`idf.py -DIDF_TARGET=esp32 reconfigure`)
-

It is also possible to pass the desired `IDF_TARGET` as an environment variable (e.g. `export IDF_TARGET=esp32s2`) or as a CMake variable (e.g. `-DIDF_TARGET=esp32s2` argument to CMake or `idf.py`). Setting the environment variable is a convenient method if you mostly work with one type of the chip.

To specify the `_default_` value of `IDF_TARGET` for a given project, add `CONFIG_IDF_TARGET` value to `sdkconfig.defaults`. For example, `CONFIG_IDF_TARGET="esp32s2"`. This value will be used if `IDF_TARGET` is not specified by other method: using an environment variable, CMake variable, or `idf.py set-target` command.

If the target has not been set by any of these methods, the build system will default to `esp32` target.

4.5.17 Writing Pure CMake Components

The ESP-IDF build system “wraps” CMake with the concept of “components”, and helper functions to automatically integrate these components into a project build.

However, underneath the concept of “components” is a full CMake build system. It is also possible to make a component which is pure CMake.

Here is an example minimal “pure CMake” component CMakeLists file for a component named `json`:

```
add_library(json STATIC
cJSON/cJSON.c
cJSON/cJSON_Utils.c)

target_include_directories(json PUBLIC cJSON)
```

- This is actually an equivalent declaration to the IDF `json` component `/components/json/CMakeLists.txt`.
- This file is quite simple as there are not a lot of source files. For components with a large number of files, the globbing behaviour of ESP-IDF’s component logic can make the component CMakeLists style simpler.)
- Any time a component adds a library target with the component name, the ESP-IDF build system will automatically add this to the build, expose public include directories, etc. If a component wants to add a library target with a different name, dependencies will need to be added manually via CMake commands.

4.5.18 Using Third-Party CMake Projects with Components

CMake is used for a lot of open-source C and C++ projects —code that users can tap into for their applications. One of the benefits of having a CMake build system is the ability to import these third-party projects, sometimes even without modification! This allows for users to be able to get functionality that may not yet be provided by a component, or use another library for the same functionality.

Importing a library might look like this for a hypothetical library `foo` to be used in the `main` component:

```
# Register the component
idf_component_register(...)

# Set values of hypothetical variables that control the build of `foo`
set(FOO_BUILD_STATIC OFF)
set(FOO_BUILD_TESTS OFF)

# Create and import the library targets
add_subdirectory(foo)

# Publicly link `foo` to `main` component
target_link_libraries(main PUBLIC foo)
```

For an actual example, take a look at [build_system/cmake/import_lib](#). Take note that what needs to be done in order to import the library may vary. It is recommended to read up on the library's documentation for instructions on how to import it from other projects. Studying the library's `CMakeLists.txt` and build structure can also be helpful.

It is also possible to wrap a third-party library to be used as a component in this manner. For example, the `mbedtls` component is a wrapper for Espressif's fork of `mbedtls`. See its [component CMakeLists.txt](#).

The CMake variable `ESP_PLATFORM` is set to 1 whenever the ESP-IDF build system is being used. Tests such as `if (ESP_PLATFORM)` can be used in generic CMake code if special IDF-specific logic is required.

Using ESP-IDF components from external libraries

The above example assumes that the external library `foo` (or `tinyclib` in the case of the `import_lib` example) doesn't need to use any ESP-IDF APIs apart from common APIs such as `libc`, `libstdc++`, etc. If the external library needs to use APIs provided by other ESP-IDF components, this needs to be specified in the external `CMakeLists.txt` file by adding a dependency on the library target `idf::<componentname>`.

For example, in the `foo/CMakeLists.txt` file:

```
add_library(foo bar.c fizz.cpp buzz.cpp)

if(ESP_PLATFORM)
  # On ESP-IDF, bar.c needs to include esp_spi_flash.h from the spi_flash component
  target_link_libraries(foo PRIVATE idf::spi_flash)
endif()
```

4.5.19 Using Prebuilt Libraries with Components

Another possibility is that you have a prebuilt static library (`.a` file), built by some other build process.

The ESP-IDF build system provides a utility function `add_prebuilt_library` for users to be able to easily import and use prebuilt libraries:

```
add_prebuilt_library(target_name lib_path [REQUIRES req1 req2 ...] [PRIV_REQUIRES_
→req1 req2 ...])
```

where:

- `target_name`- name that can be used to reference the imported library, such as when linking to other targets

- `lib_path`- path to prebuilt library; may be an absolute or relative path to the component directory

Optional arguments `REQUIRES` and `PRIV_REQUIRES` specify dependency on other components. These have the same meaning as the arguments for `idf_component_register`.

Take note that the prebuilt library must have been compiled for the same target as the consuming project. Configuration relevant to the prebuilt library must also match. If not paid attention to, these two factors may contribute to subtle bugs in the app.

For an example, take a look at [build_system/cmake/import_prebuilt](#).

4.5.20 Using ESP-IDF in Custom CMake Projects

ESP-IDF provides a template CMake project for easily creating an application. However, in some instances the user might already have an existing CMake project or may want to create a custom one. In these cases it is desirable to be able to consume IDF components as libraries to be linked to the user's targets (libraries/ executables).

It is possible to do so by using the *build system APIs provided* by `tools/cmake/idf.cmake`. For example:

```
cmake_minimum_required(VERSION 3.5)
project(my_custom_app C)

# Include CMake file that provides ESP-IDF CMake build system APIs.
include($ENV{IDF_PATH}/tools/cmake/idf.cmake)

# Include ESP-IDF components in the build, may be thought as an equivalent of
# add_subdirectory() but with some additional processing and magic for ESP-IDF_
↔build
# specific build processes.
idf_build_process(esp32)

# Create the project executable and plainly link the newlib component to it using
# its alias, idf::newlib.
add_executable(${CMAKE_PROJECT_NAME}.elf main.c)
target_link_libraries(${CMAKE_PROJECT_NAME}.elf idf::newlib)

# Let the build system know what the project executable is to attach more targets, ↪
↔dependencies, etc.
idf_build_executable(${CMAKE_PROJECT_NAME}.elf)
```

The example in [build_system/cmake/idf_as_lib](#) demonstrates the creation of an application equivalent to [hello world application](#) using a custom CMake project.

4.5.21 ESP-IDF CMake Build System API

idf-build-commands

```
idf_build_get_property(var property [GENERATOR_EXPRESSION])
```

Retrieve a *build property* `property` and store it in `var` accessible from the current scope. Specifying `GENERATOR_EXPRESSION` will retrieve the generator expression string for that property, instead of the actual value, which can be used with CMake commands that support generator expressions.

```
idf_build_set_property(property val [APPEND])
```

Set a *build property* `property` with value `val`. Specifying `APPEND` will append the specified value to the current value of the property. If the property does not previously exist or it is currently empty, the specified value becomes the first element/member instead.

```
idf_build_component (component_dir)
```

Present a directory *component_dir* that contains a component to the build system. Relative paths are converted to absolute paths with respect to current directory. All calls to this command must be performed before *idf_build_process*.

This command does not guarantee that the component will be processed during build (see the *COMPONENTS* argument description for *idf_build_process*)

```
idf_build_process (target
    [PROJECT_DIR project_dir]
    [PROJECT_VER project_ver]
    [PROJECT_NAME project_name]
    [SDKCONFIG sdkconfig]
    [SDKCONFIG_DEFAULTS sdkconfig_defaults]
    [BUILD_DIR build_dir]
    [COMPONENTS component1 component2 ...])
```

Performs the bulk of the behind-the-scenes magic for including ESP-IDF components such as component configuration, libraries creation, dependency expansion and resolution. Among these functions, perhaps the most important from a user's perspective is the libraries creation by calling each component's *idf_component_register*. This command creates the libraries for each component, which are accessible using aliases in the form *idf::component_name*. These aliases can be used to link the components to the user's own targets, either libraries or executables.

The call requires the target chip to be specified with *target* argument. Optional arguments for the call include:

- **PROJECT_DIR** - directory of the project; defaults to **CMAKE_SOURCE_DIR**
- **PROJECT_NAME** - name of the project; defaults to **CMAKE_PROJECT_NAME**
- **PROJECT_VER** - version/revision of the project; defaults to "1"
- **SDKCONFIG** - output path of generated *sdkconfig* file; defaults to **PROJECT_DIR/sdkconfig** or **CMAKE_SOURCE_DIR/sdkconfig** depending if **PROJECT_DIR** is set
- **SDKCONFIG_DEFAULTS** - list of files containing default config to use in the build (list must contain full paths); defaults to empty. For each value *filename* in the list, the config from file *filename.target*, if it exists, is also loaded.
- **BUILD_DIR** - directory to place ESP-IDF build-related artifacts, such as generated binaries, text files, components; defaults to **CMAKE_BINARY_DIR**
- **COMPONENTS** - select components to process among the components known by the build system (added via *idf_build_component*). This argument is used to trim the build. Other components are automatically added if they are required in the dependency chain, i.e. the public and private requirements of the components in this list are automatically added, and in turn the public and private requirements of those requirements, so on and so forth. If not specified, all components known to the build system are processed.

```
idf_build_executable (executable)
```

Specify the executable *executable* for ESP-IDF build. This attaches additional targets such as dependencies related to flashing, generating additional binary files, etc. Should be called after *idf_build_process*.

```
idf_build_get_config (var config [GENERATOR_EXPRESSION])
```

Get the value of the specified config. Much like build properties, specifying *GENERATOR_EXPRESSION* will retrieve the generator expression string for that config, instead of the actual value, which can be used with CMake commands that support generator expressions. Actual config values are only known after call to *idf_build_process*, however.

idf-build-properties

These are properties that describe the build. Values of build properties can be retrieved by using the build command *idf_build_get_property*. For example, to get the Python interpreter used for the build:

```
idf_build_get_property(python PYTHON)
message(STATUS "The Python interpreter is: ${python}")
```

- BUILD_DIR - build directory; set from `idf_build_process BUILD_DIR` argument
- BUILD_COMPONENTS - list of components included in the build; set by `idf_build_process`
- BUILD_COMPONENT_ALIASES - list of library alias of components included in the build; set by `idf_build_process`
- C_COMPILE_OPTIONS - compile options applied to all components' C source files
- COMPILE_OPTIONS - compile options applied to all components' source files, regardless of it being C or C++
- COMPILE_DEFINITIONS - compile definitions applied to all component source files
- CXX_COMPILE_OPTIONS - compile options applied to all components' C++ source files
- EXECUTABLE - project executable; set by call to `idf_build_executable`
- EXECUTABLE_NAME - name of project executable without extension; set by call to `idf_build_executable`
- EXECUTABLE_DIR - path containing the output executable
- IDF_COMPONENT_MANAGER - the component manager is enabled by default, but if this property is set to 0 it was disabled by the `IDF_COMPONENT_MANAGER` environment variable
- IDF_PATH - ESP-IDF path; set from `IDF_PATH` environment variable, if not, inferred from the location of `idf.cmake`
- IDF_TARGET - target chip for the build; set from the required target argument for `idf_build_process`
- IDF_VER - ESP-IDF version; set from either a version file or the Git revision of the `IDF_PATH` repository
- INCLUDE_DIRECTORIES - include directories for all component source files
- KCONFIGS - list of Kconfig files found in components in build; set by `idf_build_process`
- KCONFIG_PROJBUILDS - list of Kconfig.projbuild files found in components in build; set by `idf_build_process`
- PROJECT_NAME - name of the project; set from `idf_build_process PROJECT_NAME` argument
- PROJECT_DIR - directory of the project; set from `idf_build_process PROJECT_DIR` argument
- PROJECT_VER - version of the project; set from `idf_build_process PROJECT_VER` argument
- PYTHON - Python interpreter used for the build; set from `PYTHON` environment variable if available, if not "python" is used
- SDKCONFIG - full path to output config file; set from `idf_build_process SDKCONFIG` argument
- SDKCONFIG_DEFAULTS - list of files containing default config to use in the build; set from `idf_build_process SDKCONFIG_DEFAULTS` argument
- SDKCONFIG_HEADER - full path to C/C++ header file containing component configuration; set by `idf_build_process`
- SDKCONFIG_CMAKE - full path to CMake file containing component configuration; set by `idf_build_process`
- SDKCONFIG_JSON - full path to JSON file containing component configuration; set by `idf_build_process`
- SDKCONFIG_JSON_MENUS - full path to JSON file containing config menus; set by `idf_build_process`

idf-component-commands

```
idf_component_get_property(var component property [GENERATOR_EXPRESSION])
```

Retrieve a specified *component's component property, property* and store it in *var* accessible from the current scope. Specifying `GENERATOR_EXPRESSION` will retrieve the generator expression string for that property, instead of the actual value, which can be used with CMake commands that support generator expressions.

```
idf_component_set_property(component property val [APPEND])
```

Set a specified *component's component property, property* with value *val*. Specifying `APPEND` will append the specified value to the current value of the property. If the property does not previously exist or it is currently empty, the specified value becomes the first element/member instead.

```
idf_component_register([[SRCS src1 src2 ...] | [[SRC_DIRS dir1 dir2 ...] [EXCLUDE_
↪SRCS src1 src2 ...]])
    [INCLUDE_DIRS dir1 dir2 ...]
    [PRIV_INCLUDE_DIRS dir1 dir2 ...]
    [REQUIRES component1 component2 ...]
    [PRIV_REQUIRES component1 component2 ...]
    [LDFRAGMENTS ldfragment1 ldfragment2 ...]
    [REQUIRED_IDF_TARGETS target1 target2 ...]
    [EMBED_FILES file1 file2 ...]
    [EMBED_TXTFILES file1 file2 ...]
    [KCONFIG kconfig]
    [KCONFIG_PROJBUILD kconfig_projbuild])
```

Register a component to the build system. Much like the `project()` CMake command, this should be called from the component's `CMakeLists.txt` directly (not through a function or macro) and is recommended to be called before any other command. Here are some guidelines on what commands can **not** be called before `idf_component_register`:

- commands that are not valid in CMake script mode
- custom commands defined in `project_include.cmake`
- build system API commands except `idf_build_get_property`; although consider whether the property may not have been set yet

Commands that set and operate on variables are generally okay to call before `idf_component_register`.

The arguments for `idf_component_register` include:

- `SRCS` - component source files used for creating a static library for the component; if not specified, component is treated as a config-only component and an interface library is created instead.
- `SRC_DIRS`, `EXCLUDE_SRCS` - used to glob source files (.c, .cpp, .S) by specifying directories, instead of specifying source files manually via `SRCS`. Note that this is subject to the *limitations of globbing in CMake*. Source files specified in `EXCLUDE_SRCS` are removed from the globbed files.
- `INCLUDE_DIRS` - paths, relative to the component directory, which will be added to the include search path for all other components which require the current component
- `PRIV_INCLUDE_DIRS` - directory paths, must be relative to the component directory, which will be added to the include search path for this component's source files only
- `REQUIRES` - public component requirements for the component
- `PRIV_REQUIRES` - private component requirements for the component; ignored on config-only components
- `LDFRAGMENTS` - component linker fragment files
- `REQUIRED_IDF_TARGETS` - specify the only target the component supports
- `KCONFIG` - override the default Kconfig file
- `KCONFIG_PROJBUILD` - override the default Kconfig.projbuild file

The following are used for *embedding data into the component*, and is considered as source files when determining if a component is config-only. This means that even if the component does not specify source files, a static library is still created internally for the component if it specifies either:

- `EMBED_FILES` - binary files to be embedded in the component
- `EMBED_TXTFILES` - text files to be embedded in the component

idf-component-properties

These are properties that describe a component. Values of component properties can be retrieved by using the build command `idf_component_get_property`. For example, to get the directory of the `freertos` component:

```
idf_component_get_property(dir freertos COMPONENT_DIR)
message(STATUS "The 'freertos' component directory is: ${dir}")
```

- `COMPONENT_ALIAS` - alias for `COMPONENT_LIB` used for linking the component to external targets; set by `idf_build_component` and alias library itself is created by `idf_component_register`
- `COMPONENT_DIR` - component directory; set by `idf_build_component`

- `COMPONENT_OVERRIDEN_DIR` - contains the directory of the original component if *this component overrides another component*
- `COMPONENT_LIB` - name for created component static/interface library; set by `idf_build_component` and library itself is created by `idf_component_register`
- `COMPONENT_NAME` - name of the component; set by `idf_build_component` based on the component directory name
- `COMPONENT_TYPE` - type of the component, whether `LIBRARY` or `CONFIG_ONLY`. A component is of type `LIBRARY` if it specifies source files or embeds a file
- `EMBED_FILES` - list of files to embed in component; set from `idf_component_register` `EMBED_FILES` argument
- `EMBED_TXTFILES` - list of text files to embed in component; set from `idf_component_register` `EMBED_TXTFILES` argument
- `INCLUDE_DIRS` - list of component include directories; set from `idf_component_register` `INCLUDE_DIRS` argument
- `KCONFIG` - component Kconfig file; set by `idf_build_component`
- `KCONFIG_PROJBUILD` - component Kconfig.projbuild; set by `idf_build_component`
- `LDFRAGMENTS` - list of component linker fragment files; set from `idf_component_register` `LDFRAGMENTS` argument
- `PRIV_INCLUDE_DIRS` - list of component private include directories; set from `idf_component_register` `PRIV_INCLUDE_DIRS` on components of type `LIBRARY`
- `PRIV_REQUIRES` - list of private component dependencies; set from `idf_component_register` `PRIV_REQUIRES` argument
- `REQUIRED_IDF_TARGETS` - list of targets the component supports; set from `idf_component_register` `EMBED_TXTFILES` argument
- `REQUIRES` - list of public component dependencies; set from `idf_component_register` `REQUIRES` argument
- `SRCS` - list of component source files; set from `SRCS` or `SRC_DIRS/EXCLUDE_SRCS` argument of `idf_component_register`

4.5.22 File Globbing & Incremental Builds

The preferred way to include source files in an ESP-IDF component is to list them manually via `SRCS` argument to `idf_component_register`:

```
idf_component_register(SRCS library/a.c library/b.c platform/platform.c
    ...)
```

This preference reflects the [CMake best practice](#) of manually listing source files. This could, however, be inconvenient when there are lots of source files to add to the build. The ESP-IDF build system provides an alternative way for specifying source files using `SRC_DIRS`:

```
idf_component_register(SRC_DIRS library platform
    ...)
```

This uses globbing behind the scenes to find source files in the specified directories. Be aware, however, that if a new source file is added and this method is used, then CMake won't know to automatically re-run and this file won't be added to the build.

The trade-off is acceptable when you're adding the file yourself, because you can trigger a clean build or run `idf.py reconfigure` to manually re-run CMake. However, the problem gets harder when you share your project with others who may check out a new version using a source control tool like Git...

For components which are part of ESP-IDF, we use a third party Git CMake integration module ([/tools/cmake/third_party/GetGitRevisionDescription.cmake](#)) which automatically re-runs CMake any time the repository commit changes. This means if you check out a new ESP-IDF version, CMake will automatically re-run.

For project components (not part of ESP-IDF), there are a few different options:

- If keeping your project file in Git, ESP-IDF will automatically track the Git revision and re-run CMake if the revision changes.
- If some components are kept in a third git repository (not the project repository or ESP-IDF repository), you can add a call to the `git_describe` function in a component CMakeLists file in order to automatically trigger re-runs of CMake when the Git revision changes.
- If not using Git, remember to manually run `idf.py reconfigure` whenever a source file may change.
- To avoid this problem entirely, use `SRCS` argument to `idf_component_register` to list all source files in project components.

The best option will depend on your particular project and its users.

4.5.23 Build System Metadata

For integration into IDEs and other build systems, when CMake runs the build process generates a number of metadata files in the `build/` directory. To regenerate these files, run `cmake` or `idf.py reconfigure` (or any other `idf.py build` command).

- `compile_commands.json` is a standard format JSON file which describes every source file which is compiled in the project. A CMake feature generates this file, and many IDEs know how to parse it.
- `project_description.json` contains some general information about the ESP-IDF project, configured paths, etc.
- `flasher_args.json` contains `esptool.py` arguments to flash the project's binary files. There are also `flash_*_args` files which can be used directly with `esptool.py`. See *Flash arguments*.
- `CMakeCache.txt` is the CMake cache file which contains other information about the CMake process, toolchain, etc.
- `config/sdkconfig.json` is a JSON-formatted version of the project configuration values.
- `config/kconfig_menus.json` is a JSON-formatted version of the menus shown in `menuconfig`, for use in external IDE UIs.

JSON Configuration Server

A tool called `confserver.py` is provided to allow IDEs to easily integrate with the configuration system logic. `confserver.py` is designed to run in the background and interact with a calling process by reading and writing JSON over process `stdin` & `stdout`.

You can run `confserver.py` from a project via `idf.py confserver` or `ninja confserver`, or a similar target triggered from a different build generator.

For more information about `confserver.py`, see tools/kconfig_new/README.md.

4.5.24 Build System Internals

Build Scripts

The listfiles for the ESP-IDF build system reside in `/tools/cmake`. The modules which implement core build system functionality are as follows:

- `build.cmake` - Build related commands i.e. build initialization, retrieving/setting build properties, build processing.
- `component.cmake` - Component related commands i.e. adding components, retrieving/setting component properties, registering components.
- `kconfig.cmake` - Generation of configuration files (`sdkconfig`, `sdkconfig.h`, `sdkconfig.cmake`, etc.) from `Kconfig` files.
- `ldgen.cmake` - Generation of final linker script from linker fragment files.
- `target.cmake` - Setting build target and toolchain file.
- `utilities.cmake` - Miscellaneous helper commands.

Aside from these files, there are two other important CMake scripts in `/tools/cmake`:

- `idf.cmake` - Sets up the build and includes the core modules listed above. Included in CMake projects in order to access ESP-IDF build system functionality.
- `project.cmake` - Includes `idf.cmake` and provides a custom `project()` command that takes care of all the heavy lifting of building an executable. Included in the top-level `CMakeLists.txt` of standard ESP-IDF projects.

The rest of the files in `/tools/cmake` are support or third-party scripts used in the build process.

Build Process

This section describes the standard ESP-IDF application build process. The build process can be broken down roughly into four phases:



Fig. 3: ESP-IDF Build System Process

Initialization This phase sets up necessary parameters for the build.

- **Upon inclusion of `idf.cmake` in `project.cmake`, the following steps are performed:**
 - Set `IDF_PATH` from environment variable or inferred from path to `project.cmake` included in the top-level `CMakeLists.txt`.
 - Add `/tools/cmake` to `CMAKE_MODULE_PATH` and include core modules plus the various helper/third-party scripts.
 - Set build tools/executables such as default Python interpreter.
 - Get ESP-IDF git revision and store as `IDF_VER`.
 - Set global build specifications i.e. compile options, compile definitions, include directories for all components in the build.
 - Add components in `components` to the build.
- **The initial part of the custom `project()` command performs the following steps:**
 - Set `IDF_TARGET` from environment variable or CMake cache and the corresponding `CMAKE_TOOLCHAIN_FILE` to be used.
 - Add components in `EXTRA_COMPONENTS_DIRS` to the build.
 - Prepare arguments for calling command `idf_build_process()` from variables such as `COMPONENTS/EXCLUDE_COMPONENTS`, `SDKCONFIG`, `SDKCONFIG_DEFAULTS`.

The call to `idf_build_process()` command marks the end of this phase.

Enumeration

This phase builds a final list of components to be processed in the build, and is performed in the first half of `idf_build_process()`.

- Retrieve each component's public and private requirements. A child process is created which executes each component's `CMakeLists.txt` in script mode. The values of `idf_component_register` `REQUIRES` and `PRIV_REQUIRES` argument is returned to the parent build process. This is called early expansion. The variable `CMAKE_BUILD_EARLY_EXPANSION` is defined during this step.
- Recursively include components based on public and private requirements.

Processing

This phase processes the components in the build, and is the second half of `idf_build_process()`.

- Load project configuration from `sdkconfig` file and generate an `sdkconfig.cmake` and `sdkconfig.h` header. These define configuration variables/macros that are accessible from the build scripts and C/C++ source/header files, respectively.
- Include each component's `project_include.cmake`.
- Add each component as a subdirectory, processing its `CMakeLists.txt`. The component `CMakeLists.txt` calls the registration command, `idf_component_register` which adds source files, include directories, creates component library, links dependencies, etc.

Finalization

This phase is everything after `idf_build_process()`.

- Create executable and link the component libraries to it.
- Generate project metadata files such as `project_description.json` and display relevant information about the project built.

Browse </tools/cmake/project.cmake> for more details.

4.5.25 Migrating from ESP-IDF GNU Make System

Some aspects of the CMake-based ESP-IDF build system are very similar to the older GNU Make-based system. The developer needs to provide values the include directories, source files etc. There is a syntactical difference, however, as the developer needs to pass these as arguments to the registration command, `idf_component_register`.

Automatic Conversion Tool

An automatic project conversion tool is available in /tools/cmake/convert_to_cmake.py. Run this command line tool with the path to a project like this:

```
$IDF_PATH/tools/cmake/convert_to_cmake.py /path/to/project_dir
```

The project directory must contain a Makefile, and GNU Make (`make`) must be installed and available on the `PATH`.

The tool will convert the project Makefile and any component `component.mk` files to their equivalent CMake-`Lists.txt` files.

It does so by running `make` to expand the ESP-IDF build system variables which are set by the build, and then producing equivalent CMakefiles to set the same variables.

Important: When the conversion tool converts a `component.mk` file, it doesn't determine what other components that component depends on. This information needs to be added manually by editing the new component `CMakeLists.txt` file and adding `REQUIRES` and/or `PRIV_REQUIRES` clauses. Otherwise, source files in the component will fail to compile as headers from other components are not found. See [Component Requirements](#).

The conversion tool is not capable of dealing with complex Makefile logic or unusual targets. These will need to be converted by hand.

No Longer Available in CMake

Some features are significantly different or removed in the CMake-based system. The following variables no longer exist in the CMake-based build system:

- `COMPONENT_BUILD_DIR`: Use `CMAKE_CURRENT_BINARY_DIR` instead.

- `COMPONENT_LIBRARY`: Defaulted to `$(COMPONENT_NAME).a`, but the library name could be overridden by the component. The name of the component library can no longer be overridden by the component.
- `CC`, `LD`, `AR`, `OBJCOPY`: Full paths to each tool from the gcc xtensa cross-toolchain. Use `CMAKE_C_COMPILER`, `CMAKE_C_LINK_EXECUTABLE`, `CMAKE_OBJCOPY`, etc instead. [Full list here](#).
- `HOSTCC`, `HOSTLD`, `HOSTAR`: Full names of each tool from the host native toolchain. These are no longer provided, external projects should detect any required host toolchain manually.
- `COMPONENT_ADD_LDFLAGS`: Used to override linker flags. Use the CMake [target_link_libraries](#) command instead.
- `COMPONENT_ADD_LINKER_DEPS`: List of files that linking should depend on. [target_link_libraries](#) will usually infer these dependencies automatically. For linker scripts, use the provided custom CMake function `target_linker_scripts`.
- `COMPONENT_SUBMODULES`: No longer used, the build system will automatically enumerate all submodules in the ESP-IDF repository.
- `COMPONENT_EXTRA_INCLUDES`: Used to be an alternative to `COMPONENT_PRIV_INCLUDEDIRS` for absolute paths. Use `COMPONENT_PRIV_INCLUDE_DIRS` argument to `idf_component_register` for all cases now (can be relative or absolute).
- `COMPONENT_OBJS`: Previously, component sources could be specified as a list of object files. Now they can be specified as a list of source files via `SRC` argument to `idf_component_register`.
- `COMPONENT_OBJEXCLUDE`: Has been replaced with `EXCLUDE_SRCS` argument to `idf_component_register`. Specify source files (as absolute paths or relative to component directory), instead.
- `COMPONENT_EXTRA_CLEAN`: Set property `ADDITIONAL_MAKE_CLEAN_FILES` instead but note [CMake has some restrictions around this functionality](#).
- `COMPONENT_OWNBUILDTARGET` & `COMPONENT_OWNCLEANTARGET`: Use CMake [ExternalProject](#) instead. See [Fully Overriding The Component Build Process](#) for full details.
- `COMPONENT_CONFIG_ONLY`: Call `idf_component_register` without any arguments instead. See [Configuration-Only Components](#).
- `CFLAGS`, `CPPFLAGS`, `CXXFLAGS`: Use equivalent CMake commands instead. See [Controlling Component Compilation](#).

No Default Values

Unlike in the legacy Make-based build system, the following have no default values:

- Source directories (`COMPONENT_SRCDIRS` variable in Make, `SRC_DIRS` argument to `idf_component_register` in CMake)
- Include directories (`COMPONENT_ADD_INCLUDEDIRS` variable in Make, `INCLUDE_DIRS` argument to `idf_component_register` in CMake)

No Longer Necessary

- In the legacy Make-based build system, it is required to also set `COMPONENT_SRCDIRS` if `COMPONENT_SRCS` is set. In CMake, the equivalent is not necessary i.e. specifying `SRC_DIRS` to `idf_component_register` if `SRC` is also specified (in fact, `SRC` is ignored if `SRC_DIRS` is specified).

Flashing from make

`make flash` and similar targets still work to build and flash. However, project `sdkconfig` no longer specifies serial port and baud rate. Environment variables can be used to override these. See [Flashing with ninja or make](#) for more details.

4.6 Deep Sleep Wake Stubs

ESP32-C3 supports running a “deep sleep wake stub” when coming out of deep sleep. This function runs immediately as soon as the chip wakes up - before any normal initialisation, bootloader, or ESP-IDF code has run. After the wake stub runs, the SoC can go back to sleep or continue to start ESP-IDF normally.

Deep sleep wake stub code is loaded into “RTC Fast Memory” and any data which it uses must also be loaded into RTC memory. RTC memory regions hold their contents during deep sleep.

4.6.1 Rules for Wake Stubs

Wake stub code must be carefully written:

- As the SoC has freshly woken from sleep, most of the peripherals are in reset states. The SPI flash is unmapped.
- The wake stub code can only call functions implemented in ROM or loaded into RTC Fast Memory (see below.)
- The wake stub code can only access data loaded in RTC memory. All other RAM will be uninitialised and have random contents. The wake stub can use other RAM for temporary storage, but the contents will be overwritten when the SoC goes back to sleep or starts ESP-IDF.
- RTC memory must include any read-only data (.rodata) used by the stub.
- Data in RTC memory is initialised whenever the SoC restarts, except when waking from deep sleep. When waking from deep sleep, the values which were present before going to sleep are kept.
- Wake stub code is a part of the main esp-idf app. During normal running of esp-idf, functions can call the wake stub functions or access RTC memory. It is as if these were regular parts of the app.

4.6.2 Implementing A Stub

The wake stub in esp-idf is called `esp_wake_deep_sleep()`. This function runs whenever the SoC wakes from deep sleep. There is a default version of this function provided in esp-idf, but the default function is weak-linked so if your app contains a function named `esp_wake_deep_sleep()` then this will override the default.

If supplying a custom wake stub, the first thing it does should be to call `esp_default_wake_deep_sleep()`.

It is not necessary to implement `esp_wake_deep_sleep()` in your app in order to use deep sleep. It is only necessary if you want to have special behaviour immediately on wake.

If you want to swap between different deep sleep stubs at runtime, it is also possible to do this by calling the `esp_set_deep_sleep_wake_stub()` function. This is not necessary if you only use the default `esp_wake_deep_sleep()` function.

All of these functions are declared in the `esp_sleep.h` header under `components/esp32c3`.

4.6.3 Loading Code Into RTC Memory

Wake stub code must be resident in RTC Fast Memory. This can be done in one of two ways.

The first way is to use the `RTC_IRAM_ATTR` attribute to place a function into RTC memory:

```
void RTC_IRAM_ATTR esp_wake_deep_sleep(void) {
    esp_default_wake_deep_sleep();
    // Add additional functionality here
}
```

The second way is to place the function into any source file whose name starts with `rtc_wake_stub`. Files names `rtc_wake_stub*` have their contents automatically put into RTC memory by the linker.

The first way is simpler for very short and simple code, or for source files where you want to mix “normal” and “RTC” code. The second way is simpler when you want to write longer pieces of code for RTC memory.

4.6.4 Loading Data Into RTC Memory

Data used by stub code must be resident in RTC memory.

Specifying this data can be done in one of two ways:

The first way is to use the `RTC_DATA_ATTR` and `RTC_RODATA_ATTR` to specify any data (writeable or read-only, respectively) which should be loaded into RTC memory:

```
RTC_DATA_ATTR int wake_count;

void RTC_IRAM_ATTR esp_wake_deep_sleep(void) {
    esp_default_wake_deep_sleep();
    static RTC_RODATA_ATTR const char fmt_str[] = "Wake count %d\n";
    esp_rom_printf(fmt_str, wake_count++);
}
```

The attributes `RTC_FAST_ATTR` and `RTC_SLOW_ATTR` can be used to specify data that will be force placed into `RTC_FAST` and `RTC_SLOW` memory respectively, but for ESP32-C3 there is only RTC fast memory, so both attributes will map to this region.

Unfortunately, any string constants used in this way must be declared as arrays and marked with `RTC_RODATA_ATTR`, as shown in the example above.

The second way is to place the data into any source file whose name starts with `rtc_wake_stub`.

For example, the equivalent example in `rtc_wake_stub_counter.c`:

```
int wake_count;

void RTC_IRAM_ATTR esp_wake_deep_sleep(void) {
    esp_default_wake_deep_sleep();
    esp_rom_printf("Wake count %d\n", wake_count++);
}
```

The second way is a better option if you need to use strings, or write other more complex code.

To reduce wake-up time use the `CONFIG_BOOTLOADER_SKIP_VALIDATE_IN_DEEP_SLEEP` Kconfig option, see more information in [Fast boot from Deep Sleep](#).

4.6.5 CRC Check For Wake Stubs

During deep sleep, all RTC Fast memory areas will be validated with CRC. When ESP32-C3 wakes up from deep sleep, the RTC fast memory will be validated with CRC again. If the validation passes, the wake stubs code will be executed. Otherwise, the normal initialization, bootloader and esp-idf codes will be executed.

Note: When the `CONFIG_ESP_SYSTEM_ALLOW_RTC_FAST_MEM_AS_HEAP` option is enabled, all the RTC fast memory except the wake stubs area is added to the heap.

4.7 Error Handling

4.7.1 Overview

Identifying and handling run-time errors is important for developing robust applications. There can be multiple kinds of run-time errors:

- Recoverable errors:
 - Errors indicated by functions through return values (error codes)
 - C++ exceptions, thrown using `throw` keyword

- Unrecoverable (fatal) errors:
 - Failed assertions (using `assert` macro and equivalent methods) and `abort()` calls.
 - CPU exceptions: access to protected regions of memory, illegal instruction, etc.
 - System level checks: watchdog timeout, cache access error, stack overflow, stack smashing, heap corruption, etc.

This guide explains ESP-IDF error handling mechanisms related to recoverable errors, and provides some common error handling patterns.

For instructions on diagnosing unrecoverable errors, see [Fatal Errors](#).

4.7.2 Error codes

The majority of ESP-IDF-specific functions use `esp_err_t` type to return error codes. `esp_err_t` is a signed integer type. Success (no error) is indicated with `ESP_OK` code, which is defined as zero.

Various ESP-IDF header files define possible error codes using preprocessor defines. Usually these defines start with `ESP_ERR_` prefix. Common error codes for generic failures (out of memory, timeout, invalid argument, etc.) are defined in `esp_err.h` file. Various components in ESP-IDF may define additional error codes for specific situations.

For the complete list of error codes, see [Error Code Reference](#).

4.7.3 Converting error codes to error messages

For each error code defined in ESP-IDF components, `esp_err_t` value can be converted to an error code name using `esp_err_to_name()` or `esp_err_to_name_r()` functions. For example, passing `0x101` to `esp_err_to_name()` will return “ESP_ERR_NO_MEM” string. Such strings can be used in log output to make it easier to understand which error has happened.

Additionally, `esp_err_to_name_r()` function will attempt to interpret the error code as a [standard POSIX error code](#), if no matching `ESP_ERR_` value is found. This is done using `strerror_r` function. POSIX error codes (such as `ENOENT`, `ENOMEM`) are defined in `errno.h` and are typically obtained from `errno` variable. In ESP-IDF this variable is thread-local: multiple FreeRTOS tasks have their own copies of `errno`. Functions which set `errno` only modify its value for the task they run in.

This feature is enabled by default, but can be disabled to reduce application binary size. See [CONFIG_ESP_ERR_TO_NAME_LOOKUP](#). When this feature is disabled, `esp_err_to_name()` and `esp_err_to_name_r()` are still defined and can be called. In this case, `esp_err_to_name()` will return `UNKNOWN_ERROR`, and `esp_err_to_name_r()` will return `Unknown error 0xXXXX(YYYY)`, where `0xXXXX` and `YYYY` are the hexadecimal and decimal representations of the error code, respectively.

4.7.4 ESP_ERROR_CHECK macro

`ESP_ERROR_CHECK()` macro serves similar purpose as `assert`, except that it checks `esp_err_t` value rather than a `bool` condition. If the argument of `ESP_ERROR_CHECK()` is not equal `ESP_OK`, then an error message is printed on the console, and `abort()` is called.

Error message will typically look like this:

```
ESP_ERROR_CHECK failed: esp_err_t 0x107 (ESP_ERR_TIMEOUT) at 0x400d1fdf
file: "/Users/user/esp/example/main/main.c" line 20
func: app_main
expression: sdmmc_card_init(host, &card)

Backtrace: 0x40086e7c:0x3ffb4ff0 0x40087328:0x3ffb5010 0x400d1fdf:0x3ffb5030_
↳0x400d0816:0x3ffb5050
```

Note: If *IDF monitor* is used, addresses in the backtrace will be converted to file names and line numbers.

- The first line mentions the error code as a hexadecimal value, and the identifier used for this error in source code. The latter depends on *CONFIG_ESP_ERR_TO_NAME_LOOKUP* option being set. Address in the program where error has occurred is printed as well.
- Subsequent lines show the location in the program where `ESP_ERROR_CHECK()` macro was called, and the expression which was passed to the macro as an argument.
- Finally, backtrace is printed. This is part of panic handler output common to all fatal errors. See *Fatal Errors* for more information about the backtrace.

4.7.5 Error handling patterns

1. Attempt to recover. Depending on the situation, this might mean to retry the call after some time, or attempt to de-initialize the driver and re-initialize it again, or fix the error condition using an out-of-band mechanism (e.g reset an external peripheral which is not responding).

Example:

```
esp_err_t err;
do {
    err = sdio_slave_send_queue(addr, len, arg, timeout);
    // keep retrying while the sending queue is full
} while (err == ESP_ERR_TIMEOUT);
if (err != ESP_OK) {
    // handle other errors
}
```

2. Propagate the error to the caller. In some middleware components this means that a function must exit with the same error code, making sure any resource allocations are rolled back.

Example:

```
sdmmc_card_t* card = calloc(1, sizeof(sdmmc_card_t));
if (card == NULL) {
    return ESP_ERR_NO_MEM;
}
esp_err_t err = sdmmc_card_init(host, &card);
if (err != ESP_OK) {
    // Clean up
    free(card);
    // Propagate the error to the upper layer (e.g. to notify the user).
    // Alternatively, application can define and return custom error code.
    return err;
}
```

3. Convert into unrecoverable error, for example using `ESP_ERROR_CHECK`. See *ESP_ERROR_CHECK macro* section for details.

Terminating the application in case of an error is usually undesirable behaviour for middleware components, but is sometimes acceptable at application level.

Many ESP-IDF examples use `ESP_ERROR_CHECK` to handle errors from various APIs. This is not the best practice for applications, and is done to make example code more concise.

Example:

```
ESP_ERROR_CHECK(spi_bus_initialize(host, bus_config, dma_chan));
```

4.7.6 C++ Exceptions

Support for C++ Exceptions in ESP-IDF is disabled by default, but can be enabled using *CONFIG_COMPILER_CXX_EXCEPTIONS* option.

Enabling exception handling normally increases application binary size by a few kB. Additionally it may be necessary to reserve some amount of RAM for exception emergency pool. Memory from this pool will be used if it is not possible to allocate exception object from the heap. Amount of memory in the emergency pool can be set using `CONFIG_COMPILER_CXX_EXCEPTIONS_EMG_POOL_SIZE` variable.

If an exception is thrown, but there is no `catch` block, the program will be terminated by `abort` function, and backtrace will be printed. See *Fatal Errors* for more information about backtraces.

See [cxx/exceptions](#) for an example of C++ exception handling.

4.8 ESP-BLE-MESH

Bluetooth® mesh networking enables many-to-many (m:m) device communications and is optimized for creating large-scale device networks.

Devices may relay data to other devices not in direct radio range of the originating device. In this way, mesh networks can span very large physical areas and contain large numbers of devices. It is ideally suited for building automation, sensor networks, and other IoT solutions where tens, hundreds, or thousands of devices need to reliably and securely communicate with one another.

Bluetooth mesh is not a wireless communications technology, but a networking technology. This technology is dependent upon Bluetooth Low Energy (BLE) - a wireless communications protocol stack.

Built on top of Zephyr Bluetooth Mesh stack, the ESP-BLE-MESH implementation supports device provisioning and node control. It also supports such node features as Proxy, Relay, Low power and Friend.

Please see the *ESP-BLE-MESH Architecture* for information about the implementation of ESP-BLE-MESH architecture and *ESP-BLE-MESH API Reference* for information about respective API.

ESP-BLE-MESH is implemented and certified based on the latest Mesh Profile v1.0.1, users can refer [here](#) for the certification details of ESP-BLE-MESH.

Note: If you are looking for Wi-Fi based implementation of mesh for ESP32-C3, please check another product by Espressif called ESP-MESH. For more information and documentation see *ESP-MESH*.

4.8.1 Getting Started with ESP-BLE-MESH

This section is intended to help you get started with ESP-BLE-MESH for the hardware based on the ESP32-C3 chip by Espressif.

We are going to demonstrate process of setting and operation of a small ESP-BLE-MESH network of three nodes. This process will cover device provisioning and node configuration, and then sending on/off commands to Generic OnOff Server Models on specific nodes.

If you are new to ESP-IDF, please first set up development environment, compile, flash and run example application following top level ESP-IDF *Get Started* documentation.

What You Need

Hardware:

- Three ESP32-C3 boards, see *options*.
- USB cables to connect the boards.
- Computer configured with ESP-IDF.
- Mobile phone or tablet running Android or iOS.

Software:

- Example application [bluetooth/esp_ble_mesh/ble_mesh_node/onoff_server](#) code to load to the ESP32-C3 boards.
- Mobile App: **nRF Mesh** for Android or iOS. Optionally you can use some other Apps:
 - [EspBLEMesh](#) Android App
 - Silicon Labs Android or iOS App

Installation Step by Step

This is a detailed roadmap to walk you through the installation process.

Step 1. Check Hardware Both [ESP32-DevKitC](#) and [ESP-WROVER-KIT](#) development boards are supported for ESP-BLE-MESH implementation. You can choose particular board through menuconfig: `idf.py menuconfig` > Example Configuration > Board selection for ESP-BLE-MESH

Note: If you plan to use [ESP32-DevKitC](#), connect a RGB LED to GPIO pins 25, 26 and 27.

Step 2. Configure Software Enter the [bluetooth/esp_ble_mesh/ble_mesh_node/onoff_server](#) example directory, run `idf.py menuconfig` to select your board and then run `idf.py build` to compile the example.

Step 3. Upload Application to Nodes After the [bluetooth/esp_ble_mesh/ble_mesh_node/onoff_server](#) example is compiled successfully, users can run `idf.py flash` to upload the same generated binary files into each of the three development boards.

Once boards are powered on, the RGB LED on each board should turn **GREEN**.

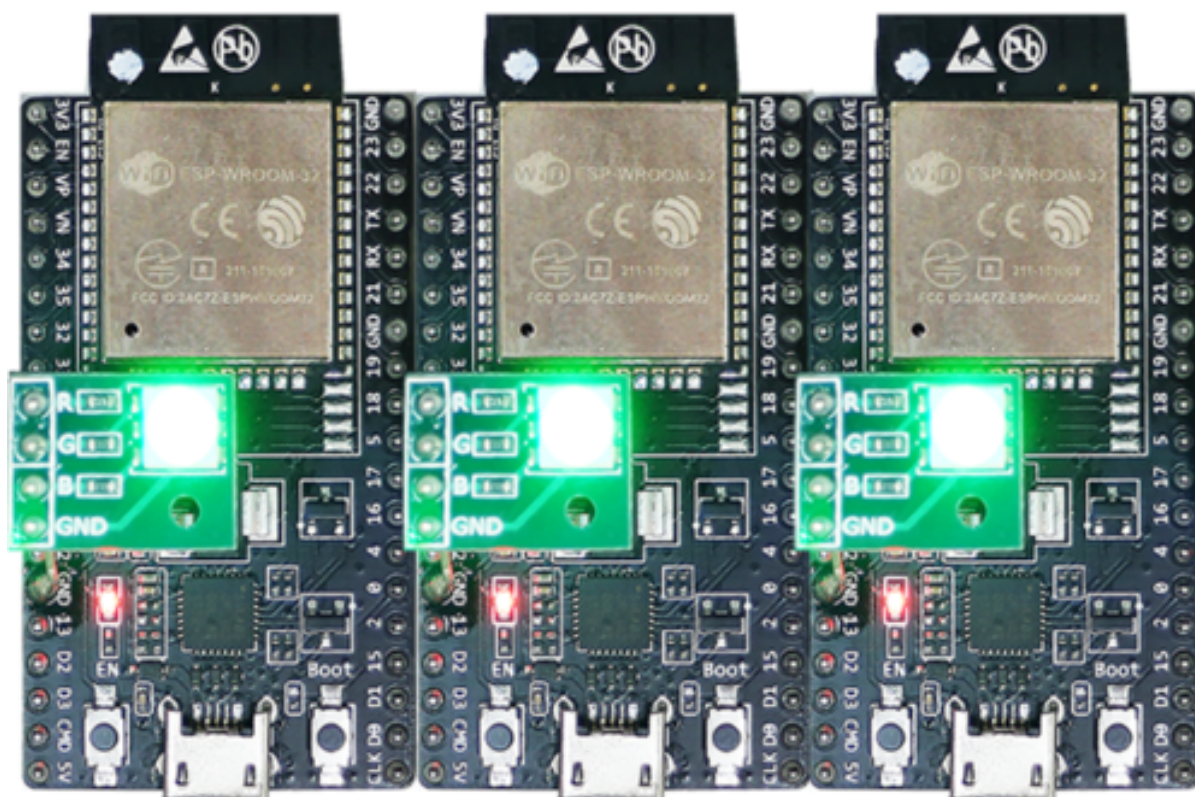

Fig. 4: ESP-BLE-MESH Devices Power On

Step 4. Provision Nodes In this section, we will use the **nRF Mesh Android** App to demonstrate how to provision an unprovisioned device. Users can also get its iOS version from the App Store.

4.1 Scanner The Scanner is App's functionality to search for unprovisioned devices in range. Open the App, press **Scanner** at the bottom and the search will start. After a short while we should see three unprovisioned devices displayed.

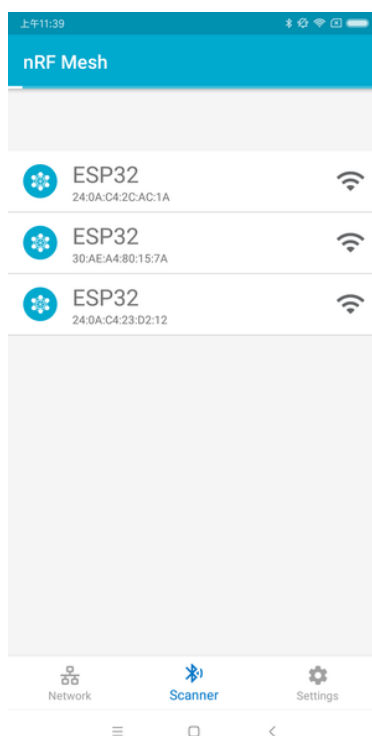

Fig. 5: nRF Mesh - Scanner

4.2 Identify Users can select any unprovisioned device, then the App will try to set up a connection with the selected device. After the BLE connection is established successfully (sometimes users need to try multiple times to get connected), and proper ESP-BLE-MESH GATT Service is discovered, users can see the **IDENTIFY** interface button on the screen. The IDENTIFY operation can be used to tell users which device is going to be provisioned.

Note: The IDENTIFY operation also needs some cooperation on the device side, then users can see which device is in the provisioning process. Currently when pressing the **IDENTIFY** interface button, no signs can be seen from the device except from the log on the serial monitor.

After the **IDENTIFY** interface button is pressed, users can see the **PROVISION** interface button.

4.3 Provision Then, the App will try to provision the unprovisioned device. When the device is provisioned successfully, the RGB LED on the board will turn off, and the App will implement the following procedures:

1. Disconnect with the node
2. Try to reconnect with the node
3. Connect successfully and discover ESP-BLE-MESH GATT Service
4. Get Composition Data of the node and add AppKey to it

When all the procedures are finished, the node is configured properly. And after pressing **OK**, users can see that unicast address is assigned, and Composition Data of the node is decoded successfully.

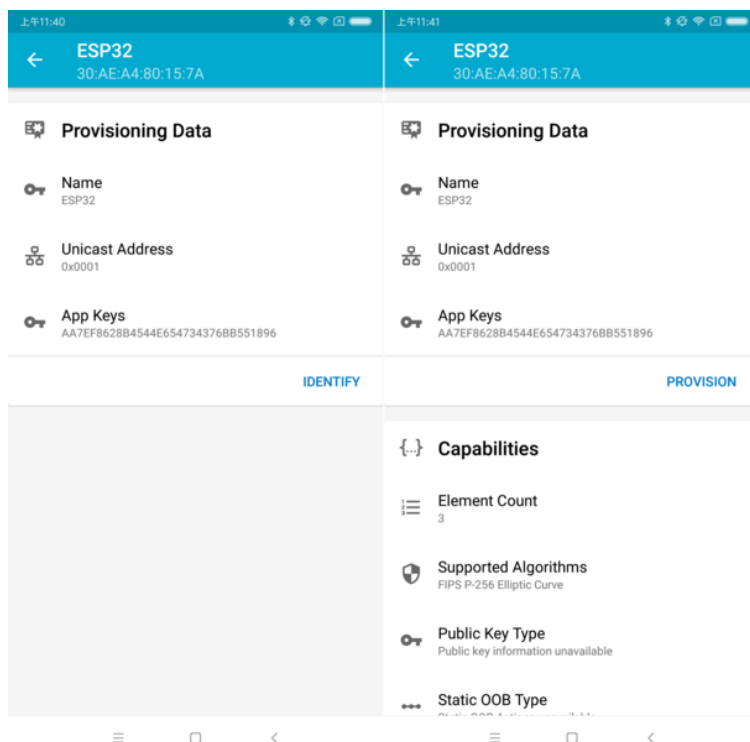

Fig. 6: nRF Mesh - IDENTIFY - PROVISION

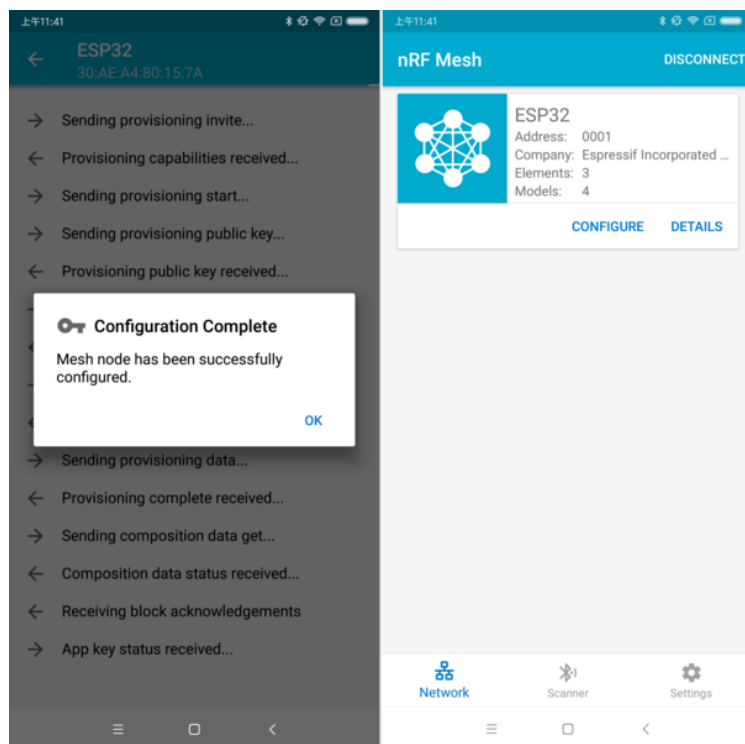

Fig. 7: nRF Mesh - Configuration Complete

Sometimes in procedure 2, the App may fail to reconnect with the node. In this case, after pressing **OK**, users can see that only unicast address of the node has been assigned, but no Composition Data has been got. Then users need to press **CONNECT** on the top right, and the previously provisioned node will be displayed on the screen, and users need to choose it and try to connect with the node.

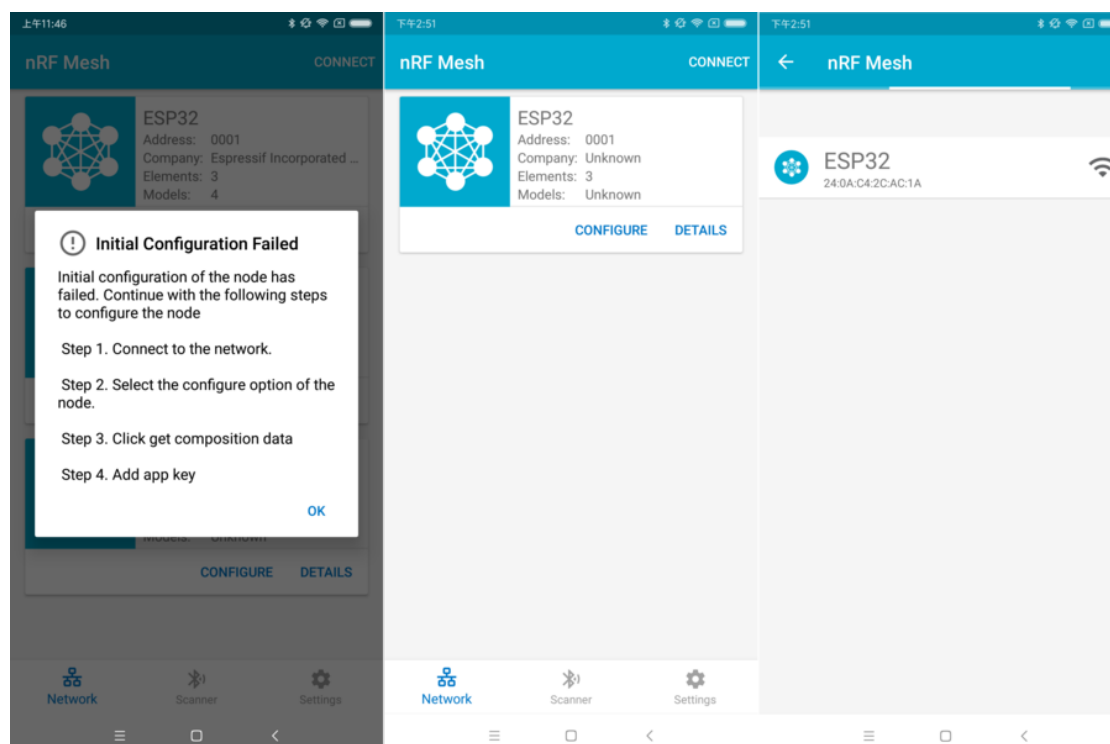

Fig. 8: nRF Mesh - Initial Configuration Failed

After connecting successfully, the App will show the interface buttons which can be used to get Composition Data and add AppKey.

If the device is the second or the third one which has been provisioned by the App, and after pressing **CONNECT**, users can see two or three nodes on the screen. In this situation, users can choose any device to connect with, once succeed then go back to the main screen to choose the node which needs to be configured.

Here an example of three devices listed.

- The left picture shows that the third device is provisioned successfully, but the App failed to connect with it. When it tries to reconnect with the third node, three nodes are displayed on the App.
- The right picture shows that after connecting with any node successfully, the App displays the information of the three nodes. Users can see that the App has got the Composition Data of the first and the second nodes, but for the third one, only the unicast address has been assigned to it while the Composition Data is unknown.

4.4 Configuration When provisioning and initial configuration are finished, users can start to configure the node, such as binding AppKey with each model with the elements, setting publication information to it, etc.

Example below shows how to bind AppKey with Generic OnOff Server Model within the Primary Element.

Note: No need to bind AppKey with the Configuration Server Model, since it only uses the DevKey to encrypt messages in the Upper Transport Layer.

Step 5. Operate Network After all the Generic OnOff Server Models within the three elements are bound with proper AppKey, users can use the App to turn on/off the RGB LED.

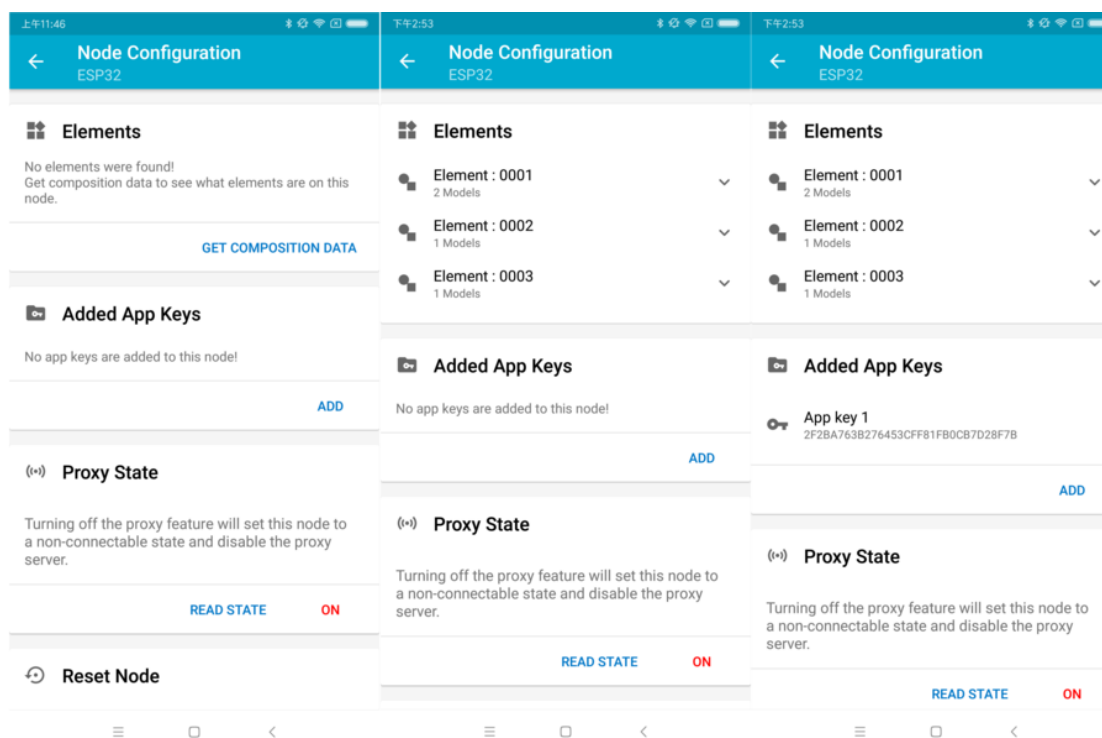

Fig. 9: nRF Mesh - Reconnect - Initial Configuration

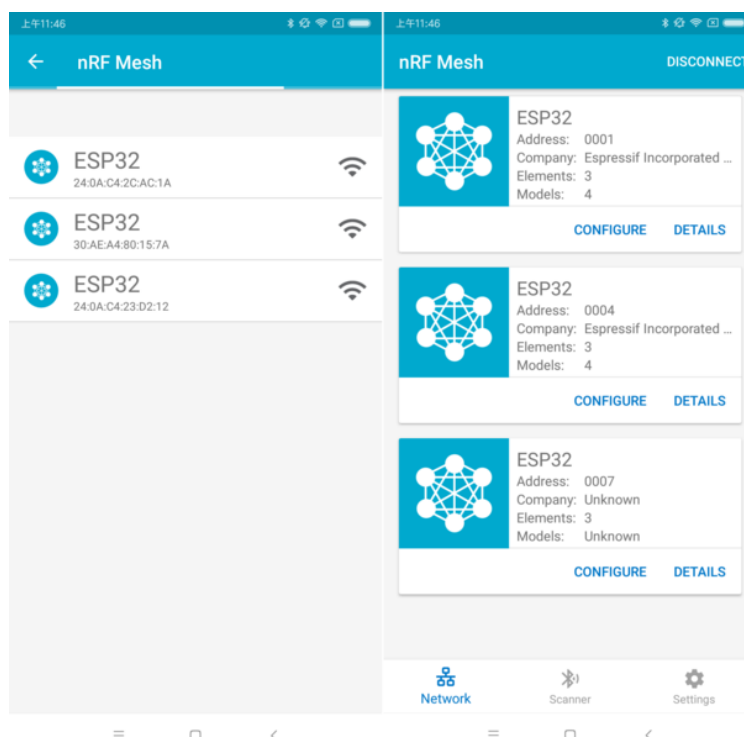

Fig. 10: nRF Mesh - Reconnect - Three Nodes

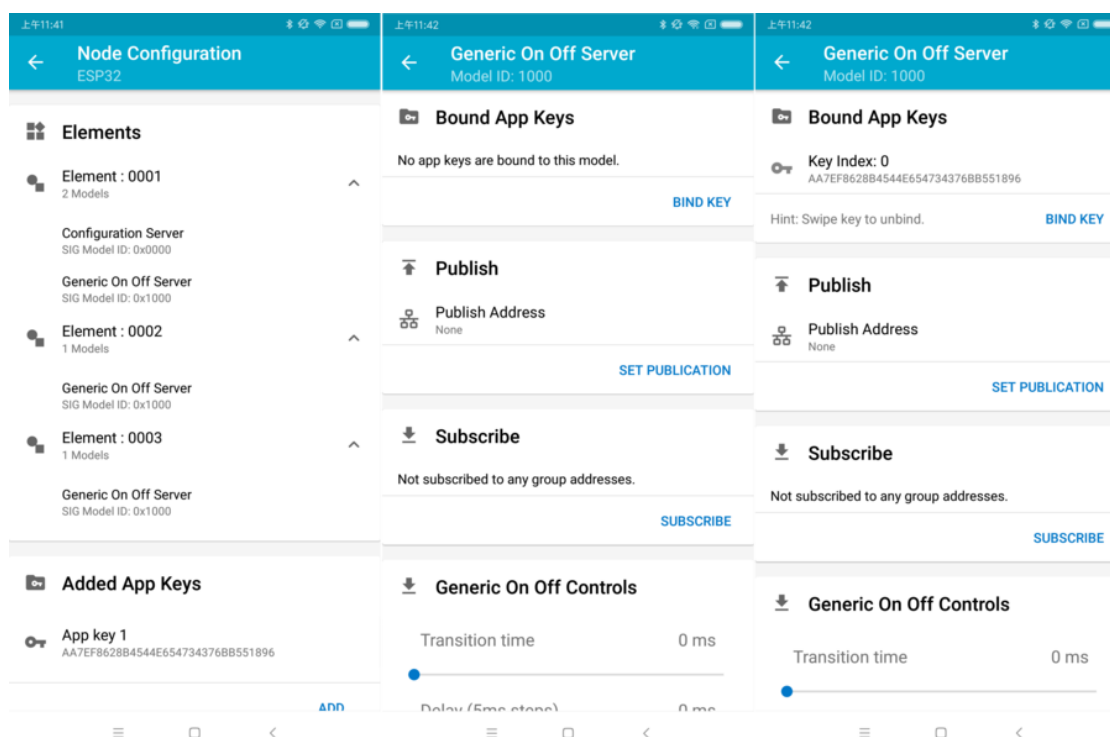

Fig. 11: nRF Mesh - Model Bind AppKey

In the [bluetooth/esp_ble_mesh/ble_mesh_node/onoff_server](#) example, the first Generic OnOff Server Model is used to control the **RED** color, the second one is used to control the **GREEN** color and the third one is used to control the **BLUE** color.

The following screenshot shows different board with different color on.

Note: For nRF Mesh iOS App [version 1.0.4], when the node contains more than one element, the App is not behaving correctly. If users try to turn on/off the second or the third Generic OnOff Server Model, the message sent by the App is destined to the first Generic OnOff Server Model within the Primary Element.

4.8.2 ESP-BLE-MESH Examples

- [ESP-BLE-MESH Node OnOff Server](#) - shows the use of ESP-BLE-MESH as a node having a Configuration Server model and a Generic OnOff Server model. A ESP-BLE-MESH Provisioner can then provision the unprovisioned device and control a RGB LED representing on/off state, see [example code](#) .
- [ESP-BLE-MESH Node OnOff Client](#) - shows how a Generic OnOff Client model works within a node. The node has a Configuration Server model and a Generic OnOff Client model, see [example code](#) .
- [ESP-BLE-MESH Provisioner](#) - shows how a device can act as an ESP-BLE-MESH Provisioner to provision devices. The Provisioner has a Configuration Server model, a Configuration Client model and a Generic OnOff Client model, see [example code](#) .
- [ESP-BLE-MESH Fast Provisioning - Client](#) and [Server](#) - this example is used for showing how fast provisioning can be used in order to create a mesh network. It takes no more than 60 seconds to provision 100 devices, see [example client code](#) and [example server code](#) .
- [ESP-BLE-MESH and Wi-Fi Coexistence](#) - an example that demonstrates the Wi-Fi and Bluetooth (BLE/BR/EDR) coexistence feature of ESP32-C3. Simply put, users can use the Wi-Fi while operating Bluetooth, see [example code](#) .
- [ESP-BLE-MESH Console](#) - an example that implements BLE Mesh basic features. Within this example a node can be scanned and provisioned by Provisioner and reply to get/set message from Provisioner, see [example node code](#) .

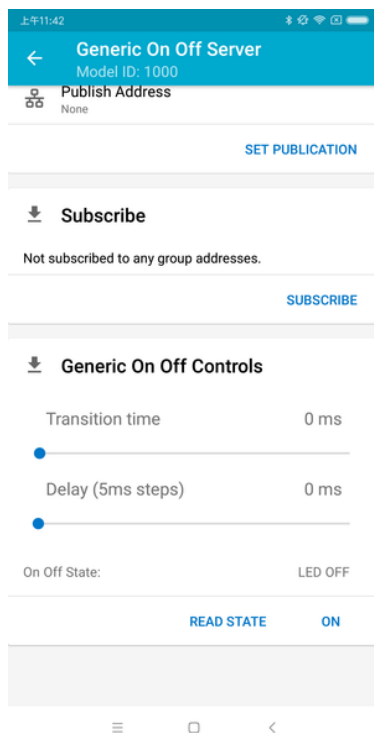

Fig. 12: nRF Mesh - Generic OnOff Control

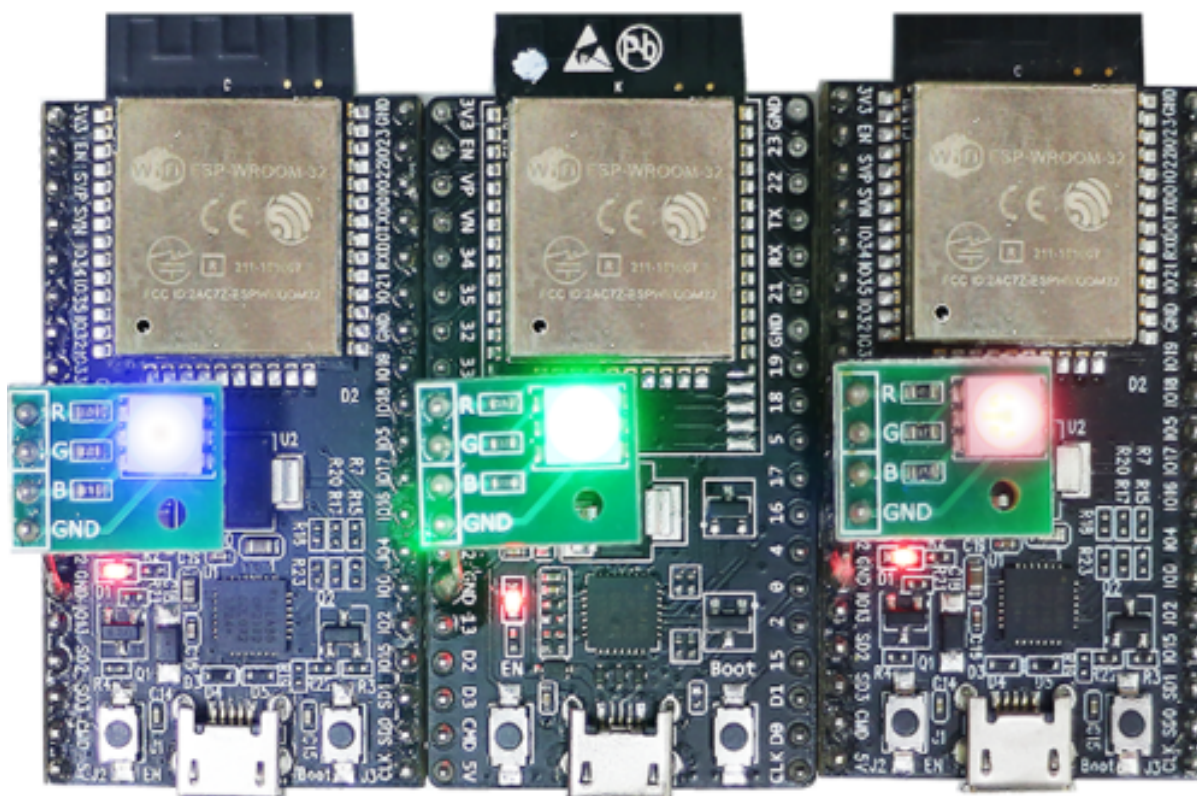

Fig. 13: Three ESP-BLE-MESH Nodes On

4.8.3 ESP-BLE-MESH Demo Videos

- [Espressif Fast Provisioning using ESP-BLE-MESH App](#)
- [Espressif ESP-BLE-MESH and Wi-Fi Coexistence](#)

4.8.4 ESP-BLE-MESH FAQ

- [1. Provisioner Development](#)
- [2. Node Development](#)
- [3. ESP-BLE-MESH and Wi-Fi Coexistence](#)
- [4. Fast Provisioning](#)
- [5. Log Help](#)
- [6. Example Help](#)
- [7. Others](#)

4.8.5 Related Documents

ESP-BLE-MESH Feature List

Supported Features

Mesh Core

- **Provisioning: Node Role**
 - PB-ADV and PB-GATT
 - OOB Authentication
- **Provisioning: Provisioner Role**
 - PB-ADV and PB-GATT
 - OOB Authentication
- **Networking**
 - Relay
 - Segmentation and Reassembly
 - Key Refresh Procedure
 - IV Update Procedure
 - Friend
 - Low Power
 - Proxy Server
 - Proxy Client
- **Multiple Client Models Run Simultaneously**
 - Support multiple client models send packets to different nodes simultaneously
 - No blocking between client model and server model
- **NVS Storing**
 - Store provisioning and configuration information of ESP-BLE-MESH Node

Mesh Models

- **Foundation models**
 - Configuration Server model
 - Configuration Client model
 - Health Server model
 - Health Client model
- **Generic client models**
 - Generic OnOff Client
 - Generic Level Client
 - Generic Default Transition Time Client
 - Generic Power OnOff Client

- Generic Power Level Client
- Generic Battery Client
- Generic Location Client
- Generic Property Client
- **Sensor client models**
 - Sensor Client
- **Time and Scenes client models**
 - Time Client
 - Scene Client
 - Scheduler Client
- **Lighting client models**
 - Light Lightness Client
 - Light CTL Client
 - Light HSL Client
 - Light xyL Client
 - Light LC Client
- **Generic server models**
 - Generic OnOff Server
 - Generic Level Server
 - Generic Default Transition Time Server
 - Generic Power OnOff Server
 - Generic Power OnOff Setup Server
 - Generic Power Level Server
 - Generic Power Level Setup Server
 - Generic Battery Server
 - Generic Location Server
 - Generic Location Setup Server
 - Generic User Property Server
 - Generic Admin Property Server
 - Generic Manufacturer Property Server
 - Generic Client Property Server
- **Sensor server models**
 - Sensor Server
 - Sensor Setup Server
- **Time and Scenes server models**
 - Time Server
 - Time Setup Server
 - Scene Server
 - Scene Setup Server
 - Scheduler Server
 - Scheduler Setup Server
- **Lighting server models**
 - Light Lightness Server
 - Light Lightness Setup Server
 - Light CTL Server
 - Light CTL Temperature Server
 - Light CTL Setup Server
 - Light HSL Server
 - Light HSL Hue Server
 - Light HSL Saturation Server
 - Light HSL Setup Server
 - Light xyL Server
 - Light xyL Setup Server
 - Light LC Server
 - Light LC Setup Server

Mesh Applications

- **ESP-BLE-MESH Node**
 - [Tutorial](#)
 - [Tutorial](#)
 - [Example](#)
- **ESP-BLE-MESH Provisioner**
 - [Tutorial](#)
 - [Example](#)
- **ESP-BLE-MESH Fast Provisioning**
 - [Fast Provisioning Client Model Tutorial](#)
 - [Fast Provisioning Server Model Tutorial](#)
 - [Example](#)
 - [Demo Video](#)
- **ESP-BLE-MESH and Wi-Fi Coexistence**
 - [Tutorial](#)
 - [Example](#)
 - [Demo Video](#)
- **ESP-BLE-MESH Console Commands**
 - [Example](#)

Future Release Features

Mesh Core

- Provisioner NVS Storage

Mesh Applications

- Fast OTA
- Friendship

ESP-BLE-MESH Architecture

This document introduces ESP-BLE-MESH architecture overview, ESP-BLE-MESH architecture implementation as well as ESP-BLE-MESH auxiliary routines.

- ESP-BLE-MESH Architecture Overview
 - Describes the five major parts of ESP-BLE-MESH architecture and the functionality of each part.
- ESP-BLE-MESH Architecture Implementation
 - Describes the basic functions of ESP-BLE-MESH files, the correspondence between files and ESP-BLE-MESH architecture, and the interface for calling among files.
- ESP-BLE-MESH Auxiliary Routines
 - Describe the auxiliary routines of ESP-BLE-MESH, such as Mesh network management, Mesh features, etc.

1. ESP-BLE-MESH Architecture Overview Currently ESP-BLE-MESH has implemented most functions of Mesh Profile and all the Client Models defined in Mesh Model specification. Those missing functions/models are under development and will be provided soon. ESP-BLE-MESH architecture has been granted the official Bluetooth [certification](#).

ESP-BLE-MESH architecture includes five key parts:

- Mesh Protocol Stack
 - Mesh Networking is responsible for processing of messages of ESP-BLE-MESH nodes.
 - Mesh Provisioning is responsible for provisioning flow of ESP-BLE-MESH devices.
 - Mesh Models is responsible for the implementation of SIG-defined models.
- Network Management

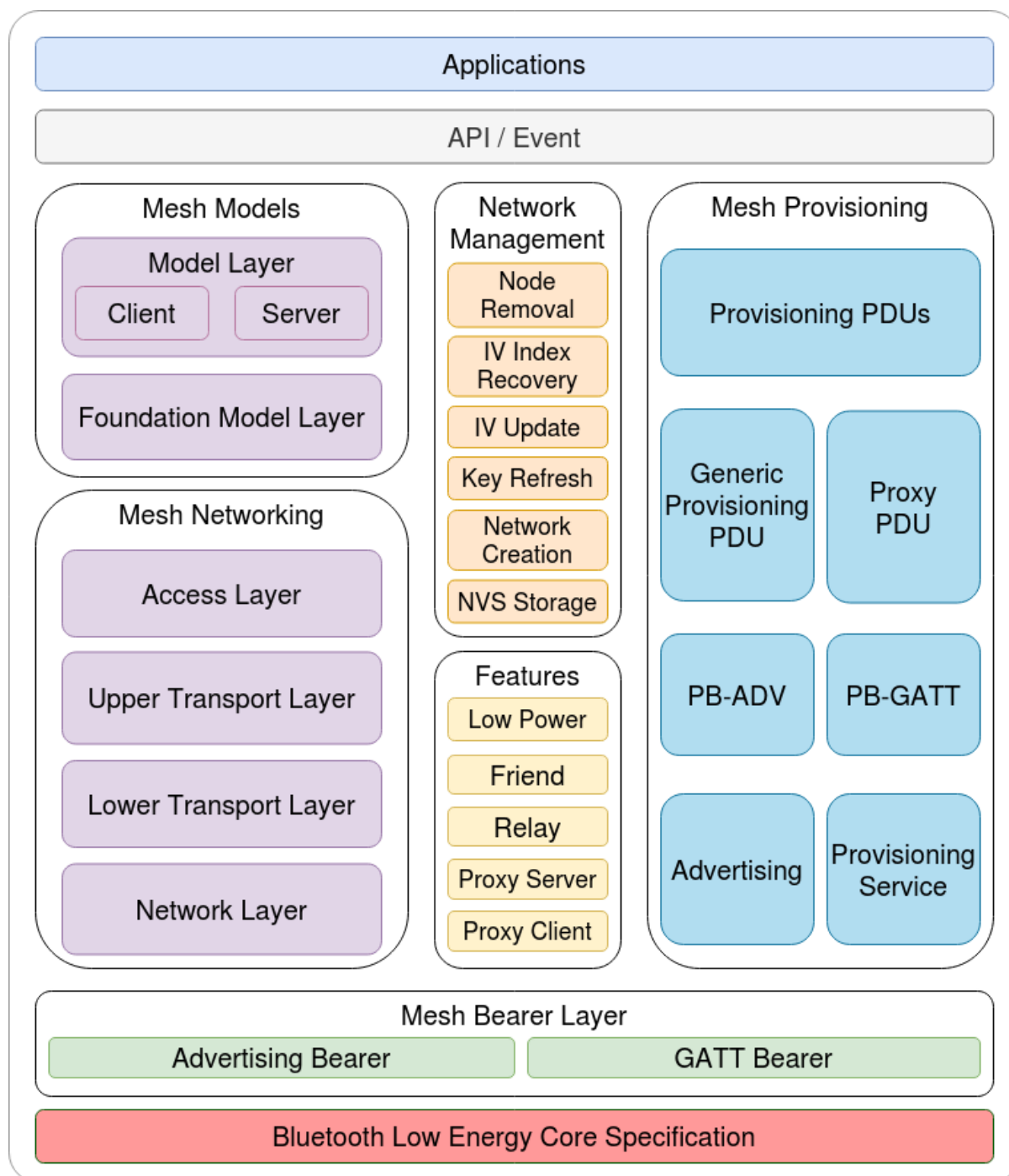

Fig. 14: Figure 1.1 ESP-BLE-MESH Architecture Diagram

- Implements several network management procedures, including node removal procedure, IV Index recovery procedure, etc.
- Features
 - Include several ESP-BLE-MESH features, e.g. Low Power feature, Friend feature, Relay feature, etc.
- Mesh Bearer Layer
 - Includes Advertising Bearer and GATT Bearer. The bearer layer is crucial to ESP-BLE-MESH protocol stack which is built on Bluetooth Low-Energy technology, because the protocol stack must make use of the bearer layer to transmit data via the BLE advertising channel and connection channel.
- Applications
 - Based on ESP-BLE-MESH protocol stack and Mesh Models.
 - By calling API and handling Event, Applications interact with Mesh Networking and Mesh Provisioning in ESP-BLE-MESH protocol stack, as well as a series of Models provided by Mesh Models.

1.1 Mesh Protocol Stack

1.1.1 Mesh Networking Mesh Networking in the protocol stack architecture implements the following functions:

- The communication between nodes in the Mesh network.
- Encryption and decryption of messages in the Mesh network.
- Management of Mesh network resources (Network Key, IV Index, etc.).
- Segmentation and reassembly of Mesh network messages.
- Model mapping of messages between different models.
- For more features, please see [ESP-BLE-MESH Feature List](#).

The implementation of Mesh Networking functions is based on hierarchy structure. Functions of each layer are shown in Table 1.1:

Table 2: Table 1.1 Mesh Networking Architecture Description

Layer	Function
Access Layer	Access Layer not only defines the format of application data, but also defines and controls the encryption and decryption of the data packets conducted by Upper Transport Layer.
Upper Transport Layer	Upper Transport Layer encrypts, decrypts, and authenticates application data to and from the access layer; it also handles special messages called “transport control messages” , including messages related to “friendship” and heartbeat messages.
Lower Transport Layer	Lower Transport Layer handles segmentation and reassembly of PDU.
Network Layer	Network Layer defines the address type and format of the network messages, and implements the relay function of the device.

1.1.2 Mesh Provisioning Mesh Provisioning in the protocol stack architecture implements the following functions:

- Provisioning of unprovisioned devices.
- Allocation of Mesh network resources (unicast address, IV Index, NetKey, etc.).
- Four authentication methods support during provisioning.
- For more features, please see [ESP-BLE-MESH Feature List](#).

The implementation of Mesh Provisioning functions is based on hierarchy structure. Functions of each layer are shown in Table 1.2:

Table 3: Table 1.2 Mesh Provisioning Architecture Description

Layer	Function
Provisioning PDUs	Provisioning PDUs from different layers are handled using provisioning protocol.
Generic Provisioning PDU/Proxy PDU	The Provisioning PDUs are transmitted to an unprovisioned device using a Generic Provisioning layer or Proxy protocol layer.
PB-ADV/PB-GATT	These layers define how the Provisioning PDUs are transmitted as transactions that can be segmented and reassembled.
Advertising/Provisioning Service	The provisioning bearers define how sessions are established such that the transactions from the generic provisioning layer can be delivered to a single device.

1.1.3 Mesh Models Mesh Models in the protocol stack architecture implements the following functions:

- Configuration Client/Server Models
- Health Client/Server Models
- Generic Client/Server Models
- Sensor Client/Server Models
- Time and Scenes Client/Server Models
- Lighting Client/Server Models

Functions of each layer are shown in Table 1.3:

Table 4: Table 1.3 Mesh Models Architecture Description

Layer	Function
Model Layer	Model Layer implements models used to standardize the operation of typical user scenarios, including Generic Client/Server Models, Sensor Client/Server Models, Time and Scenes Client/Server Models, Lighting Client/Server Models and several vendor models.
Foundation Model Layer	Foundation Model Layer implements models related to ESP-BLE-MESH configuration, management, self diagnosis, etc.

1.2 Mesh Network Management Network Management implements the following functions:

- Node removal procedure is used to remove a node from the network.
- IV Index recovery procedure is used to recover a node's IV Index.
- IV update procedure is used to update the nodes' IV Index.
- Key refresh procedure is used to update the nodes' NetKey, AppKey, etc.
- Network creation procedure is used to create a mesh network.
- NVS storage is used to store node's networking information.

1.3 Mesh Features Features includes the following options:

- Low Power feature is used to reduce node's power consumption.
- Friend feature is used to store messages for Low Power nodes.
- Relay feature is used to relay/forward Network PDUs received by a node over the advertising bearer.
- Proxy Server/Client are two node roles in proxy protocol, which enable nodes to send and receive Network PDUs, mesh beacons, proxy configuration messages and Provisioning PDUs over a connection-oriented bearer.

1.4 Mesh Bearer Layer Bearers in the protocol stack architecture are responsible for passing of data between ESP-BLE-MESH protocol stack and Bluetooth Low Energy Core.

Bearers can be taken as a carrier layer based on Bluetooth Low Energy Core, which implements the function of receiving and transmitting data for the ESP-BLE-MESH protocol stack.

Table 5: Table 1.3 Mesh Bearers Description

Layer	Function
GATT Bearer	The GATT Bearer uses the Proxy protocol to transmit and receive Proxy PDUs between two devices over a GATT connection.
Advertising Bearer	When using the Advertising Bearer, a mesh packet shall be sent in the Advertising Data of a Bluetooth Low Energy advertising PDU using the Mesh Message AD Type.

1.5 Mesh Applications The Applications in the protocol stack architecture implement the corresponding functions by calling the API provided by the ESP-BLE-MESH protocol stack and processing the Event reported by the protocol stack. There are some common applications, such as gateway, lighting and etc.

Interaction between application layer (Applications) and API / Event

- Application layer calls API
 - Call the provisioning-related API for provisioning.
 - Call the model-related API to send messages.
 - Call the device-attributes-related API to get local information about the device.
- Application layer processes Event

The application layer is designed based on events, which take parameters to the application layer. Events are mainly divided into two categories.

 - **The events completed by calling API.**
 - * Such as nodes sending messages.
 - **The events that the protocol stack actively reports to the application layer.**
 - * The Event that the protocol stack actively reports.
 - * The Event that Model actively reports.
- The event is reported by the callback function registered by the application layer, and the callback function also contains the corresponding processing of the event.

Interaction between API / Event and ESP-BLE-MESH protocol stack

- API used by user mainly calls functions provided by Mesh Networking, Mesh Provisioning and Mesh Models.
- The interaction between API / Event and the protocol stack does not operate across the hierarchy of the protocol stack. For example, API does not call functions related to Network Layer.

2. ESP-BLE-MESH Architecture Implementation The design and implementation of ESP-BLE-MESH architecture is based on layers and modules. In details, Section 2.1 (Mesh Networking Implementation), Section 2.2 (Mesh Provisioning Implementation) and Section 2.3 (Mesh Bearers Implementation) are based on layers, and Section 2.4 (Mesh Models Implementation) is on modules.

- **Layer-based Approach:** With Layer-based approach, the architecture is designed according to the layers specified in the Mesh Profile Specification. Each layer has its unique files which include APIs of this layer and etc. The specific design is shown in Figure 2.1.
- **Module-based Approach:** Every file implements an independent function that can be called by other programs.

The design of ESP-BLE-MESH architecture uses layer-based approach. The sequence of layers which data packets are processed through is fixed, i.e., the processing of packets will form a message flow. Thus, we could see flows of messages from the Protocol Stack Interface Diagram in Figure 2.1.

2.1 Mesh Protocol Stack Implementation

2.1.1 Mesh Networking Implementation The list of files and the functions implemented in each file in Mesh Networking are shown in Table 2.1:

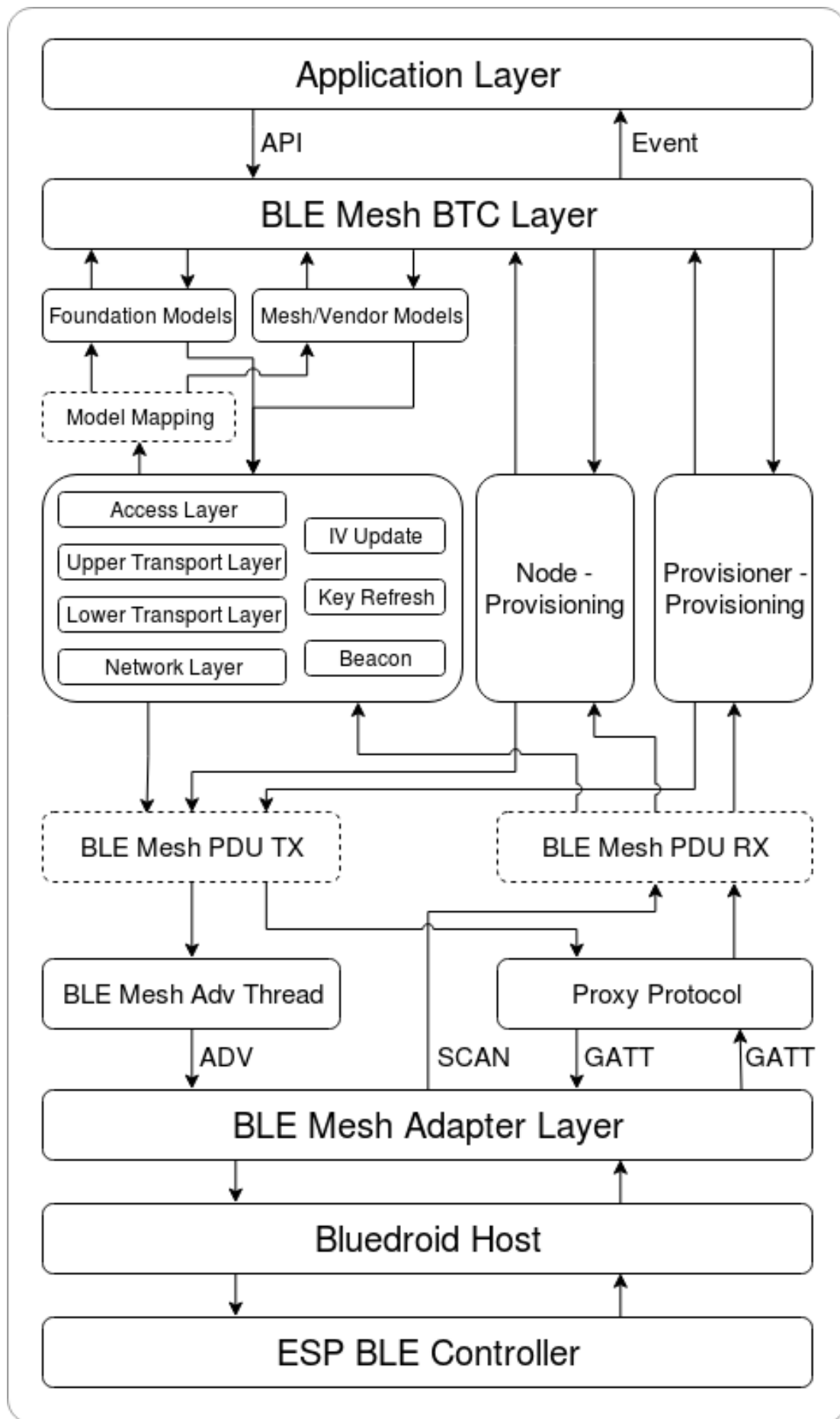

Fig. 15: Figure 2.1 ESP-BLE-MESH Architecture Implementation Diagram

Table 6: Table 2.1 Mesh Networking File Description :widths: 40 150
:header-rows: 1

File	Functionality
ac- cess.c	ESP-BLE-MESH Access Layer
trans- port.c	ESP-BLE-MESH Lower/Upper Transport Layer
net.c	ESP-BLE-MESH Network Layer
adv.c	A task used to send ESP-BLE-MESH advertising packets, a callback used to handle received advertising packets and APIs used to allocate adv buffers

2.1.2 Mesh Provisioning Implementation The implementation of Mesh Provisioning is divided into two chunks due to the Node/Provisioner coexistence.

Specific files that provide implementation of provisioning of Node are shown in Table 2.2:

Table 7: Table 2.2 Mesh Provisioning (Node) File Description

File	Functionality
prov.c	ESP-BLE-MESH Node provisioning (PB-ADV & PB-GATT)
proxy_server.c	ESP-BLE-MESH Proxy Server related functionalities
beacon.c	APIs used to handle ESP-BLE-MESH Beacons

Specific files that implement functions of Provisioner are shown in Table 2.3:

Table 8: Table 2.3 Mesh Provisioning (Provisioner) File Description

File	Functionality
provisioner_prov.c	ESP-BLE-MESH Provisioner provisioning (PB-ADV & PB-GATT)
proxy_client.c	ESP-BLE-MESH Proxy Client related functionalities
provisioner_main.c	ESP-BLE-MESH Provisioner networking related functionalities

2.1.3 Mesh Models Implementation Mesh Models are used to implement the specific functions of model in nodes. Server model is used to maintain node status. Client model is used to obtain and modify node state.

Table 9: Table 2.4 Mesh Models File Description

File	Functionality
cfg_cli.c	Send Configuration Client messages and receive corresponding response messages
cfg_srv.c	Receive Configuration Client messages and send proper response messages
health_cli.c	Send Health Client messages and receive corresponding response messages
health_srv.c	Receive Health Client messages and send proper response messages
client_common.c	ESP-BLE-MESH model related operations
generic_client.c	Send ESP-BLE-MESH Generic Client messages and receive corresponding response messages
lighting_client.c	Send ESP-BLE-MESH Lighting Client messages and receive corresponding response messages
sensor_client.c	Send ESP-BLE-MESH Sensor Client messages and receive corresponding response messages
time_scene_client.c	Send ESP-BLE-MESH Time Scene Client messages and receive corresponding response messages
generic_server.c	Receive ESP-BLE-MESH Generic Client messages and send corresponding response messages
lighting_server.c	Receive ESP-BLE-MESH Lighting Client messages and send corresponding response messages
sensor_server.c	Receive ESP-BLE-MESH Sensor Client messages and send corresponding response messages
time_scene_server.c	Receive ESP-BLE-MESH Time Scene Client messages and send corresponding response messages

2.2 Mesh Bearers Implementation Portability is fully considered in the implementation of Mesh Bearers. When the ESP-BLE-MESH protocol stack is being ported to other platforms, users only need to modify [mesh_bearer_adapt.c](#) (example of [NimBLE version](#)).

Table 10: Table 2.5 Mesh Bearers File Description

File	Functionality
mesh_bearer_adapt.c	ESP-BLE-MESH Bearer Layer adapter , This file provides the interfaces used to receive and send ESP-BLE-MESH ADV & GATT related packets.

Note: [mesh_bearer_adapt.c](#) is the implementation of Advertising Bearer and GATT Bearer in Mesh Networking framework.

2.3 Mesh Applications Implementation We have provided a series of application examples for customer development, and users can develop products based on [ESP-BLE-MESH Examples](#).

3. Auxiliary Routine Auxiliary routine refers to optional functions in the ESP-BLE-MESH protocol stack. The design of the auxiliary routine generally implement the truncation of code through [CONFIG_BLE_MESH](#).

3.1 Features

- Low Power
- Friend
- Relay
- Proxy Client/Server

3.2 Network Management

- Node Removal procedure
- IV Index Recovery procedure
- IV Update procedure
- Key Refresh procedure
- Network Creation procedure
- NVS Storage

3.3 Auxiliary Routine Implementation When adopting the design of independent module, the two main factors should be considered:

- The module can not be implemented hierarchically, and it can be completely independent, which means it does not rely on the implementation of other modules.
- The functions in the module will be used repeatedly, so it is reasonable to design it into a module. Independent module is shown in Table 3.1:

Table 11: Table 3.1 Module File Description

File	Functionality
lpn.c	ESP-BLE-MESH Low Power functionality
friend.c	ESP-BLE-MESH Friend functionality
net.c	ESP-BLE-MESH Relay feature, network creation, IV Update procedure, IV Index recovery procedure, Key Refresh procedure related functionalities
proxy_server.c	ESP-BLE-MESH Proxy Server related functionalities
proxy_client.c	ESP-BLE-MESH Proxy Client related functionalities
settings.c	ESP-BLE-MESH NVS storage functionality
main.c	ESP-BLE-MESH stack initialize, stack enable, node removal related functionalities

ESP-BLE-MESH FAQ

This document provides a summary of frequently asked questions about developing with ESP-BLE-MESH, and is divided into seven sections:

- [1. Provisioner Development](#)
- [2. Node Development](#)
- [3. ESP-BLE-MESH and Wi-Fi Coexistence](#)
- [4. Fast Provisioning](#)
- [5. Log Help](#)
- [6. Example Help](#)
- [7. Others](#)

Users could refer to the sections for quick answer to their questions. This document will be updated based on the feedback collected via various channels.

1. Provisioner Development Generally, a Provisioner is used to provision unprovisioned devices and form a mesh network. And after provisioning, roles of the unprovisioned devices will be changed to those of a node.

1.1 What is the flow for an unprovisioned device to join ESP-BLE-MESH network?

There are two phases for a device to join ESP-BLE-MESH network via a Provisioner, namely, provisioning and configuration.

- The phase of provisioning is to assign unicast address, add NetKey and etc. to a device. By provisioning, the device joins the ESP-BLE-MESH network and its role is changed from an unprovisioned device to a node.

- The phase of configuration is to add AppKeys to the node and bind AppKeys to corresponding models. And some items are optional during configuration, including adding subscription addresses to the node, set publication information, etc. By configuration, the node can actually transmit messages to a Provisioner and receive messages from it.

1.2 If a Provisioner wants to change states of a node, what requirements should be met for a Provisioner?

- Client model that corresponds to server model of the node is required.
- NetKey and AppKey used to encrypt messages shall be owned by both the node and the Provisioner.
- The address owned by the node shall be known, which could be its unicast address or subscription address.

1.3 How can NetKey and AppKey be used?

- NetKey is used for encryption of messages in Network Layer. Nodes with the same NetKey are assumed to be in the same subnet while those with different NetKeys cannot communicate with each other.
- AppKey is used for encryption of messages in Upper Transport Layer. If client model and server model are bound to different AppKeys, the communication cannot be achieved.

1.4 How to generate a NetKey or AppKey for Provisioner? Can we use a fixed NetKey or AppKey?

- The API `esp_ble_mesh_provisioner_add_local_net_key()` can be used to add a NetKey with a fixed or random value.
- The API `esp_ble_mesh_provisioner_add_local_app_key()` can be used to add an AppKey with a fixed or random value.

1.5 Is the unicast address of Provisioner fixed?

The value of `prov_unicast_addr` in `esp_ble_mesh_prov_t` is used to set the unicast address of Provisioner, it can be set only once during initialization and can't be changed afterwards.

1.6 Can the address of Provisioner serve as destination address of the node-reporting-status message ?

The unicast address of Provisioner can be set only once during initialization and can't be changed afterwards. In theory, it can serve as the destination address of the node-reporting-status message, provided that the unicast address of the Provisioner is known by nodes. Nodes can know the unicast address of Provisioner during configuration since Provisioner sends messages to them with its unicast address used as the source address. Subscription address can also be used. Provisioner subscribes to a group address or virtual address, and nodes send messages to the subscription address.

1.7 Is the unicast address of the node that is firstly provisioned by Provisioner to ESP-BLE-MESH network fixed ?

The value of `prov_start_address` in `esp_ble_mesh_prov_t` is used to set the starting address when the Provisioner provisions unprovisioned devices, i.e. the unicast address of the node it firstly provisioned. It can be set only once during initialization and can't be changed afterwards.

1.8 Is the unicast address of the node that mobile App firstly provisioned fixed?

The App will decide the unicast address, and currently most of them are fixed.

1.9 How to know which unprovisioned device is the Provisioner that is provisioning currently?

The value of `prov_attention` in `esp_ble_mesh_prov_t` is used by Provisioner set to unprovisioned device during provisioning. It can be set only once during initialization and can't be changed afterwards. When the unprovisioned device is joining the mesh network, it can display in a specific way like flashing light to notify Provisioner that it is being provisioned.

1.10 How many ways to authenticate the devices during provisioning? Which way was used in the provided examples ?

There are four authentication methods, i.e. No OOB, Static OOB, Output OOB and Input OOB. In the provided examples, No OOB is used.

1.11 What information can be carried by the advertising packets of the unprovisioned device before provisioning into the network?

- Device UUID
- OOB Info
- URL Hash (optional)

1.12 Can such information be used for device identification?

For example, each unprovisioned device contains a unique Device UUID, which can be used for device identification.

1.13 How is the unicast address assigned when the node provisioned by Provisioner contains multiple elements?

- Provisioner will assign an unicast address for the primary element of the node, and unicast address of the remaining elements are incremented one by one.
- For example: If an unprovisioned device has three elements, i.e. the primary element, the second element and the third element. After provisioning, the primary element address of the node is 0x0002 while the second element address is 0x0003, and the third element address is 0x0004.

1.14 How can Provisioner get and parse the Composition Data of nodes through Configuration Client Model?

- Provisioner can get the Composition Data of nodes using the *Configuration Client Model* API `esp_ble_mesh_config_client_set_state()` with `comp_data_get` in the parameter `esp_ble_mesh_cfg_client_get_state_t` set properly.
- Users can refer to the following code to parse the Composition Data:

```
#include <stdio.h>
#include <string.h>
#include <stdint.h>

//test date: 0C001A0001000800030000010501000000800100001003103F002A00
//0C00 1A00 0100 0800 0300 0001 05 01 0000 0080 0100 0010 0310 3F002A00

// CID is 0x000C
// PID is 0x001A
// VID is 0x0001
// CRPL is 0x0008
// Features is 0x0003 - Relay and Friend features.
// Loc is "front" - 0x0100
// NumS is 5
// NumV is 1
// The Bluetooth SIG Models supported are: 0x0000, 0x8000, 0x0001, 0x1000,
→ 0x1003
// The Vendor Models supported are: Company Identifier 0x003F and Model_
→Identifier 0x002A

typedef struct {
    int16_t cid;
    int16_t pid;
    int16_t vid;
    int16_t crpl;
```

(continues on next page)

(continued from previous page)

```

    uint16_t features;
    uint16_t all_models;
    uint8_t sig_models;
    uint8_t vnd_models;
} esp_ble_mesh_composition_head;

typedef struct {
    uint16_t model_id;
    uint16_t vendor_id;
} tsModel;

typedef struct {
    // reserve space for up to 20 SIG models
    uint16_t SIG_models[20];
    uint8_t numSIGModels;

    // reserve space for up to 4 vendor models
    tsModel Vendor_models[4];
    uint8_t numVendorModels;
} esp_ble_mesh_composition_decode;

int decode_comp_data(esp_ble_mesh_composition_head *head, esp_ble_mesh_
↳composition_decode *data, uint8_t *mystr, int size)
{
    int pos_sig_base;
    int pos_vnd_base;
    int i;

    memcpy(head, mystr, sizeof(*head));

    if(size < sizeof(*head) + head->sig_models * 2 + head->vnd_models * 2
↳4) {
        return -1;
    }

    pos_sig_base = sizeof(*head) - 1;

    for(i = 1; i < head->sig_models * 2; i = i + 2) {
        data->SIG_models[i/2] = mystr[i + pos_sig_base] | (mystr[i + pos_
↳sig_base + 1] << 8);
        printf("%d: %4.4x\n", i/2, data->SIG_models[i/2]);
    }

    pos_vnd_base = head->sig_models * 2 + pos_sig_base;

    for(i = 1; i < head->vnd_models * 2; i = i + 2) {
        data->Vendor_models[i/2].model_id = mystr[i + pos_vnd_base] |
↳(mystr[i + pos_vnd_base + 1] << 8);
        printf("%d: %4.4x\n", i/2, data->Vendor_models[i/2].model_id);

        data->Vendor_models[i/2].vendor_id = mystr[i + pos_vnd_base + 2]
↳| (mystr[i + pos_vnd_base + 3] << 8);
        printf("%d: %4.4x\n", i/2, data->Vendor_models[i/2].vendor_id);
    }

    return 0;
}

void app_main(void)
{
    esp_ble_mesh_composition_head head = {0};

```

(continues on next page)

(continued from previous page)

```

esp_ble_mesh_composition_decode data = {0};
uint8_t mystr[] = { 0x0C, 0x00, 0x1A, 0x00,
                   0x01, 0x00, 0x08, 0x00,
                   0x03, 0x00, 0x00, 0x01,
                   0x05, 0x01, 0x00, 0x00,
                   0x00, 0x80, 0x01, 0x00,
                   0x00, 0x10, 0x03, 0x10,
                   0x3F, 0x00, 0x2A, 0x00};

int ret;

ret = decode_comp_data(&head, &data, mystr, sizeof(mystr));
if (ret == -1) {
    printf("decode_comp_data error");
}
}

```

1.15 How can Provisioner further configure nodes through obtained Composition Data?

Provisioner do the following configuration by calling the *Configuration Client Model* API `esp_ble_mesh_config_client_set_state()`.

- Add AppKey to nodes with `app_key_add` in the parameter `esp_ble_mesh_cfg_client_set_state_t` set properly.
- Add subscription address to the models of nodes with `model_sub_add` in the parameter `esp_ble_mesh_cfg_client_set_state_t` set properly.
- Set publication information to the models of nodes with `model_pub_set` in the parameter `esp_ble_mesh_cfg_client_set_state_t` set properly.

1.16 Can nodes add corresponding configurations for themselves?

This method can be used in special cases like testing period.

- Here is an example to show nodes add new group addresses for their models.

```

esp_err_t example_add_fast_prov_group_address(uint16_t model_id, uint16_t_
→group_addr)
{
    const esp_ble_mesh_comp_t *comp = NULL;
    esp_ble_mesh_elem_t *element = NULL;
    esp_ble_mesh_model_t *model = NULL;
    int i, j;

    if (!ESP_BLE_MESH_ADDR_IS_GROUP(group_addr)) {
        return ESP_ERR_INVALID_ARG;
    }

    comp = esp_ble_mesh_get_composition_data();
    if (!comp) {
        return ESP_FAIL;
    }

    for (i = 0; i < comp->element_count; i++) {
        element = &comp->elements[i];
        model = esp_ble_mesh_find_sig_model(element, model_id);
        if (!model) {
            continue;
        }
        for (j = 0; j < ARRAY_SIZE(model->groups); j++) {
            if (model->groups[j] == group_addr) {
                break;
            }
        }
    }
}

```

(continues on next page)

(continued from previous page)

```
    }
  }
  if (j != ARRAY_SIZE(model->groups)) {
    ESP_LOGW(TAG, "%s: Group address already exists, element_
->index: %d", __func__, i);
    continue;
  }
  for (j = 0; j < ARRAY_SIZE(model->groups); j++) {
    if (model->groups[j] == ESP_BLE_MESH_ADDR_UNASSIGNED) {
      model->groups[j] = group_addr;
      break;
    }
  }
  if (j == ARRAY_SIZE(model->groups)) {
    ESP_LOGE(TAG, "%s: Model is full of group addresses, element_
->index: %d", __func__, i);
  }
}

return ESP_OK;
}
```

Note: When the NVS storage of the node is enabled, group address added and AppKey bound by this method will not be saved in the NVS when the device is powered off currently. These configuration information can only be saved if they are configured by Configuration Client Model.

1.17 How does Provisioner control nodes by grouping?

Generally there are two approaches to implement group control in ESP-BLE-MESH network, group address approach and virtual address approach. And supposing there are 10 devices, i.e., five devices with blue lights and five devices with red lights.

- Method 1: 5 blue lights can subscribe to a group address, 5 red lights subscribe to another one. By sending messages to different group addresses, Provisioner can realize group control.
- Method 2: 5 blue lights can subscribe to a virtual address, 5 red lights subscribe to another one. By sending messages to different virtual addresses, Provisioner can realize group control.

1.18 How does Provisioner add nodes to multiple subnets?

Provisioner can add multiple NetKeys to nodes during configuration, and nodes sharing the same NetKey belong to the same subnet. Provisioner can communicate with nodes on different subnets by using different NetKeys.

1.19 How does Provisioner know if a node in the mesh network is offline?

Node offline is usually defined as: the condition that the node cannot be properly communicated with other nodes in the mesh network due to power failure or some other reasons.

There is no connection between nodes and nodes in the ESP-BLE-MESH network. They communicate with each other through advertising channels.

An example is given here to show how to detect a node is offline by Provisioner.

- The node can periodically send heartbeat messages to Provisioner. And if Provisioner failed to receive heartbeat messages in a certain period, the node is considered to be offline.

Note: The heartbeat message should be designed into a single package (less than 11 bytes), so the transmission and reception of it can be more efficient.

1.20 What operations should be performed when Provisioner removes nodes from the network?

Usually when Provisioner tries to remove node from the mesh network, the procedure includes three main steps:

- Firstly, Provisioner adds the node that need to be removed to the “blacklist” .
- Secondly, Provisioner performs the *Key Refresh procedure*.
- Lastly, the node performs node reset procedure, and switches itself to an unprovisioned device.

1.21 In the Key Refresh procedure, how does Provisioner update the Netkey owned by nodes?

- Provisioner updates the NetKey of nodes using the *Configuration Client Model* API `esp_ble_mesh_config_client_set_state()` with `net_key_update` in the parameter `esp_ble_mesh_cfg_client_set_state_t` set properly.
- Provisioner updates the AppKey of nodes using the *Configuration Client Model* API `esp_ble_mesh_config_client_set_state()` with `app_key_update` in the parameter `esp_ble_mesh_cfg_client_set_state_t` set properly.

1.22 How does Provisioner manage nodes in the mesh network?

ESP-BLE-MESH implements several functions related to basic node management in the example, such as `esp_ble_mesh_store_node_info()`. And ESP-BLE-MESH also provides the API `esp_ble_mesh_provisioner_set_node_name()` which can be used to set the node’s local name and the API `esp_ble_mesh_provisioner_get_node_name()` which can be used to get the node’s local name.

1.23 What does Provisioner need when trying to control the server model of nodes?

Provisioner must include corresponding client model before controlling the server model of nodes.

Provisioner shall add its local NetKey and AppKey.

- Provisioner add NetKey by calling the API `esp_ble_mesh_provisioner_add_local_net_key()`.
- Provisioner add AppKey by calling the API `esp_ble_mesh_provisioner_add_local_app_key()`.

Provisioner shall configure its own client model.

- Provisioner bind AppKey to its own client model by calling the API `esp_ble_mesh_provisioner_bind_app_key_to_local_model()`.

1.24 How does Provisioner control the server model of nodes?

ESP-BLE-MESH supports all SIG-defined client models. Provisioner can use these client models to control the server models of nodes. And the client models are divided into 6 categories with each category has the corresponding functions.

- Configuration Client Model
 - The API `esp_ble_mesh_config_client_get_state()` can be used to get the `esp_ble_mesh_cfg_client_get_state_t` values of Configuration Server Model.
 - The API `esp_ble_mesh_config_client_set_state()` can be used to set the `esp_ble_mesh_cfg_client_set_state_t` values of Configuration Server Model.
- Health Client Model
 - The API `esp_ble_mesh_health_client_get_state()` can be used to get the `esp_ble_mesh_health_client_get_state_t` values of Health Server Model.

- The API `esp_ble_mesh_health_client_set_state()` can be used to set the `esp_ble_mesh_health_client_set_state_t` values of Health Server Model.
- **Generic Client Models**
 - The API `esp_ble_mesh_generic_client_get_state()` can be used to get the `esp_ble_mesh_generic_client_get_state_t` values of Generic Server Models.
 - The API `esp_ble_mesh_generic_client_set_state()` can be used to set the `esp_ble_mesh_generic_client_set_state_t` values of Generic Server Models.
- **Lighting Client Models**
 - The API `esp_ble_mesh_light_client_get_state()` can be used to get the `esp_ble_mesh_light_client_get_state_t` values of Lighting Server Models.
 - The API `esp_ble_mesh_light_client_set_state()` can be used to set the `esp_ble_mesh_light_client_set_state_t` values of Lighting Server Models.
- **Sensor Client Models**
 - The API `esp_ble_mesh_sensor_client_get_state()` can be used to get the `esp_ble_mesh_sensor_client_get_state_t` values of Sensor Server Model.
 - The API `esp_ble_mesh_sensor_client_set_state()` can be used to set the `esp_ble_mesh_sensor_client_set_state_t` values of Sensor Server Model.
- **Time and Scenes Client Models**
 - The API `esp_ble_mesh_time_scene_client_get_state()` can be used to get the `esp_ble_mesh_time_scene_client_get_state_t` values of Time and Scenes Server Models.
 - The API `esp_ble_mesh_time_scene_client_set_state()` can be used to set the `esp_ble_mesh_time_scene_client_set_state_t` values of Time and Scenes Server Models.

2. Node Development

2.1 What kind of models are included by nodes?

- In ESP-BLE-MESH, nodes are all composed of a series of models with each model implements some functions of the node.
- Model has two types, client model and server model. Client model can get and set the states of server model.
- Model can also be divided into SIG model and vendor model. All behaviors of SIG models are officially defined while behaviors of vendor models are defined by users.

2.2 Is the format of messages corresponding to each model fixed?

- Messages, which consist of opcode and payload, are divided by opcode.
- The type and the format of the messages corresponding to models are both fixed, which means the messages transmitted between models are fixed.

2.3 Which functions can be used to send messages with the models of nodes?

- For client models, users can use the API `esp_ble_mesh_client_model_send_msg()` to send messages.
- For server models, users can use the API `esp_ble_mesh_server_model_send_msg()` to send messages.
- For publication, users call the API `esp_ble_mesh_model_publish()` to publish messages.

2.4 How to achieve the transmission of messages without packet loss?

Acknowledged message is needed if users want to transmit messages without packet loss. The default time to wait for corresponding response is set in `CONFIG_BLE_MESH_CLIENT_MSG_TIMEOUT`. If the sender waits for the response until the timer expires, the corresponding timeout event would be triggered.

Note: Response timeout can be set in the API `esp_ble_mesh_client_model_send_msg()`. The default value (4 seconds) would be applied if the parameter `msg_timeout` is set to **0**.

2.5 How to send unacknowledged messages?

For client models, users can use the API `esp_ble_mesh_client_model_send_msg()` with the parameter `need_rsp` set to `false` to send unacknowledged messages.

For server models, the messages sent by using the API `esp_ble_mesh_server_model_send_msg()` are always unacknowledged messages.

2.6 How to add subscription address to models?

Subscription address can be added through Configuration Client Model.

2.7 What is the difference between messages sent and published by models?

Messages sent by calling the API `esp_ble_mesh_client_model_send_msg()` or `esp_ble_mesh_server_model_send_msg()` will be sent in the duration determined by the Network Transmit state.

Messages published by calling the API `esp_ble_mesh_model_publish()` will be published determined by the Model Publication state. And the publication of messages is generally periodic or with a fixed number of counts. The publication period and publication count are controlled by the Model Publication state, and can be configured through Configuration Client Model.

2.8 How many bytes can be carried when sending unsegmented messages?

The total payload length (which can be set by users) of unsegmented message is 11 octets, so if the opcode of the message is 2 octets, then the message can carry 9-octets of valid information. For vendor messages, due to the 3-octets opcode, the remaining payload length is 8 octets.

2.9 When should the Relay feature of nodes be enabled?

Users can enable the Relay feature of all nodes when nodes detected in the mesh network are sparse.

For dense mesh network, users can choose to just enable the Relay feature of several nodes.

And users can enable the Relay feature by default if the mesh network size is unknown.

2.10 When should the Proxy feature of node be enabled?

If the unprovisioned device is expected to be provisioned by a phone, then it should enable the Proxy feature since almost all the phones do not support sending ESP-BLE-MESH packets through advertising bearer currently. And after the unprovisioned device is provisioned successfully and becoming a Proxy node, it will communicate with the phone using GATT bearer and using advertising bearer to communicate with other nodes in the mesh network.

2.11 How to use the Proxy filter?

The Proxy filter is used to reduce the number of Network PDUs exchanged between a Proxy Client (e.g. the phone) and a Proxy Server (e.g. the node). And with the Proxy filter, Proxy Client can explicitly request to receive only mesh messages with certain destination addresses from Proxy Server.

2.12 When a message can be relayed by a Relay node?

If a message need to be relayed, the following conditions should be met.

- The message is in the mesh network.
- The message is not sent to the unicast address of the node.
- The value of TTL in the message is greater than 1.

2.13 If a message is segmented into several segments, should the other Relay nodes just relay when one of these segments is received or wait until the message is received completely?

Relay nodes will forward segments when one of them are received rather than keeping waiting until all the segments are received.

2.14 What is the principle of reducing power consumption using Low Power feature?

- When the radio is turned on for listening, the device is consuming energy. When low power feature of the node is enabled, it will turn off its radio in the most of the time.
- And cooperation is needed between low power node and friend node, thus low power node can receive messages at an appropriate or lower frequency without the need to keep listening.
- When there are some new messages for low power node, its friend node will store the messages for it. And low power node can poll friend nodes to see if there are new messages at a fixed interval.

2.15 How to continue the communication on the network after powering-down and powering-up again?

Enable the configuration `Store ESP-BLE-MESH Node configuration persistently` in `menuconfig`.

2.16 How to send out the self-test results of nodes?

It is recommended that nodes can publish its self-test results periodically through Health Server Model.

2.17 How to transmit information between nodes?

One possible application scenario for transmitting information between nodes is that spray nodes would be triggered once smoke alarm detected high smoke concentration. There are two approaches in implementation.

- Approach 1 is that spray node subscribes to a group address. When smoke alarm detects high smoke concentration, it will publish a message whose destination address is the group address which has been subscribed by spray node.
- Approach 2 is that Provisioner can configure the unicast address of spray node to the smoke alarm. When high smoke concentration is detected, smoke alarm can use send messages to the spray node with the spray node's unicast address as the destination address.

2.18 Is gateway a must for nodes communication?

- Situation 1: nodes only communicate within the mesh network. In this situation, no gateway is need. ESP-BLE-MESH network is a flooded network, messages in the network have no fixed paths, and nodes can communicate with each other freely.
- Situation 2: if users want to control the nodes remotely, for example turn on some nodes before getting home, then a gateway is needed.

2.19 When will the IV Update procedure be performed?

IV Update procedure would be performed once sequence number of messages sent detected by the bottom layer of node reached a critical value.

2.20 How to perform IV Update procedure?

Nodes can perform IV Update procedure with Secure Network Beacon.

3. ESP-BLE-MESH and Wi-Fi Coexistence

3.1 Which modes does Wi-Fi support when it coexists with ESP-BLE-MESH?

Currently only Wi-Fi station mode supports the coexistence.

3.2 Why is the Wi-Fi throughput so low when Wi-Fi and ESP-BLE-MESH coexist?

The `ESP32-DevKitC` board without PSRAM can run properly but the throughput of it is low since it has no PSRAM. When Bluetooth and Wi-Fi coexist, the throughput of ESP32-DevKitC with PSRAM can be stabilized to more than 1Mbps.

And some configurations in `menuconfig` shall be enabled to support PSRAM.

- `ESP32-specific` --> Support for external, SPI-connected RAM --> Try to allocate memories of Wi-Fi and LWIP...
- `Bluetooth` --> `Bluedroid Enable` --> BT/BLE will first malloc the memory from the PSRAM
- `Bluetooth` --> `Bluedroid Enable` --> Use dynamic memory allocation in BT/BLE stack.
- `Bluetooth` --> `Bluetooth controller` --> BLE full scan feature supported.
- `Wi-Fi` --> Software controls Wi-Fi/Bluetooth coexistence --> Wi-Fi

4. Fast Provisioning

4.1 Why is fast provisioning needed?

Normally when they are several unprovisioned devices, users can provision them one by one. But when it comes to a large number of unprovisioned devices (e.g. 100), provisioning them one by one will take huge amount of time. With fast provisioning, users can provision 100 unprovisioned devices in about 50 seconds.

4.2 Why EspBleMesh App would wait for a long time during fast provisioning?

After the App provisioned one Proxy node, it will disconnect from the App during fast provisioning, and reconnect with the App when all the nodes are provisioned.

4.3 Why is the number of node addresses displayed in the App is more than that of existing node addresses?

Each time after a fast provisioning process, and before starting a new one, the node addresses in the App should be cleared, otherwise the number of the node address will be incorrect.

4.4 What is the usage of the count value which was input in EspBleMesh App?

The **count** value is provided to the Proxy node which is provisioned by the App so as to determine when to start Proxy advertising in advance.

4.5 When will Configuration Client Model of the node running fast_prov_server example start to work?

Configuration Client Model will start to work after the Temporary Provisioner functionality is enabled.

4.6 Will the Temporary Provisioner functionality be enabled all the time?

After the nodes receive messages used to turn on/off lights, all the nodes will disable its Temporary Provisioner functionality and become nodes.

5. Log Help

You can find meaning of errors or warnings when they appear at the bottom of ESP-BLE-MESH stack.

5.1 What is the meaning of warning **ran out of retransmit attempts?**

When the node transmits a segmented message, and due to some reasons, the receiver doesn't receive the complete message. Then the node will retransmit the message. When the retransmission count reaches the maximum number, which is 4 currently, then this warning will appear.

5.2 What is the meaning of warning **Duplicate found in Network Message Cache?**

When the node receives a message, it will compare the message with the ones stored in the network cache. If the same has been found in the cache, which means it has been received before, then the message will be dropped.

5.3 What is the meaning of warning **Incomplete timer expired?**

When the node doesn't receive all the segments of a segmented message during a certain period (e.g. 10 seconds), then the Incomplete timer will expire and this warning will appear.

5.4 What is the meaning of warning **No matching TX context for ack?**

When the node receives a segment ack and it doesn't find any self-send segmented message related with this ack, then this warning will appear.

5.5 What is the meaning of warning **No free slots for new incoming segmented messages?**

When the node has no space for receiving new segmented message, this warning will appear. Users can make the space larger through the configuration `CONFIG_BLE_MESH_RX_SEG_MSG_COUNT`.

5.6 What is the meaning of error **Model not bound to Appkey 0x0000 ?**

When the node sends messages with a model and the model has not been bound to the AppKey with AppKey Index 0x000, then this error will appear.

5.7 What is the meaning of error **Busy sending message to DST xxxx?**

This error means client model of the node has transmitted a message to the target node and now is waiting for a response, users can not send messages to the same node with the same unicast address. After the corresponding response is received or timer is expired, then another message can be sent.

6. Example Help

6.1 How are the ESP-BLE-MESH callback functions classified?

- The API `esp_ble_mesh_register_prov_callback()` is used to register callback function used to handle provisioning and networking related events.
- The API `esp_ble_mesh_register_config_client_callback()` is used to register callback function used to handle Configuration Client Model related events.
- The API `esp_ble_mesh_register_config_server_callback()` is used to register callback function used to handle Configuration Server Model related events.

- The API `esp_ble_mesh_register_health_client_callback()` is used to register callback function used to handle Health Client Model related events.
- The API `esp_ble_mesh_register_health_server_callback()` is used to register callback function used to handle Health Server Model related events.
- The API `esp_ble_mesh_register_generic_client_callback()` is used to register callback function used to handle Generic Client Models related events.
- The API `esp_ble_mesh_register_light_client_callback()` is used to register callback function used to handle Lighting Client Models related events.
- The API `esp_ble_mesh_register_sensor_client_callback()` is used to register callback function used to handle Sensor Client Model related events.
- The API `esp_ble_mesh_register_time_scene_client_callback()` is used to register callback function used to handle Time and Scenes Client Models related events.
- The API `esp_ble_mesh_register_custom_model_callback()` is used to register callback function used to handle vendor model and unrealized server models related events.

7. Others

7.1 How to print the message context?

The examples use `ESP_LOG_BUFFER_HEX()` to print the message context while the ESP-BLE-MESH protocol stack uses `bt_hex()`.

7.2 Which API can be used to restart ESP32-C3?

The API `esp_restart()`.

7.3 How to monitor the remaining space of the stack of a task?

The API `vTaskList()` can be used to print the remaining space of the task stack periodically.

7.4 How to change the level of log without changing the menuconfig output level?

The API `esp_log_level_set()` can be used to change the log output level rather than using menuconfig to change it.

ESP-BLE-MESH Terminology

Table 12: Table 1 ESP-BLE-MESH Terminology - Role

Term	Official Definition	Detailed Explanation
Unprovisioned Device	A device that is not a member of a mesh network is known as an unprovisioned device.	Examples: lighting devices, temperature control devices, manufacturing equipments and electric doors, etc.
Node	A node is a provisioned device.	The role of unprovisioned device will change to node after being provisioned to ESP-BLE-MESH network. Nodes (such as lighting devices, temperature control devices, manufacturing equipments, and electric doors) are devices that can send, receive, or relay messages in ESP-BLE-MESH network, and they can optionally support one or more subnets.
Relay Node	A node that supports the Relay feature and has the Relay feature enabled is known as a Relay node.	Relay nodes can receive and resend ESP-BLE-MESH messages, so the messages can be transferred further. Users can decide whether or not to enable forwarding function of nodes according to nodes' status. Messages can be relayed for multiple times, and each relay is considered as a "hop". Messages can hop up to 126 times, which is enough for message transmission in a wide area.
Proxy Node	A node that supports the Proxy feature and has the Proxy feature enabled is known as a Proxy node.	Proxy nodes receive messages from one bearer (it generally includes advertising bearer and GATT bearer) and resend it from another one. The purpose is to connect communication equipments that only support GATT bearer to ESP-BLE-MESH network. Generally, mobile apps need a Proxy node to access Mesh network. Without Proxy nodes, mobile apps cannot communicate with members in Mesh network.
Friend Node	A node that supports the Friend feature, has the Friend feature enabled, and has a friendship with a node that supports the Low Power feature is known as a Friend node.	Friend node, like the backup of Low Power node (LPN), can store messages that are sent to Low Power node and security updates; the stored information will be transferred to Low Power node when Low Power node needs it. Low Power node must establish "friendship" with another node that supports the Friend Feature to reduce duty cycle of its receiver, thus power consumption of Low Power node can be reduced. Low Power node needs to find a Friend node to establish a friendship with it. The process involved is called "friendship establishment". Cooperation between Low Power node and Friend nodes enables Low Power node to schedule the use of the radio, thus Low Power node can receive messages at an appropriate or lower frequency without the need of keeping listening. Low Power node will poll Friend node to see if there is new message.
Low Power Node	A node that supports the Low Power feature and has a friendship with a node that supports the Friend feature is known as a Low Power node.	By polling, Low Power node gets information from Friend node, such as messages, security updates, and etc.
Provisioner	A node that is capable of adding a device to a mesh network.	The device that can provision unprovisioned devices is called a Provisioner. This process usually needs to be implemented through an app that is typically provided by the product manufacturer and can be used on a gateway, a smartphone, tablet or other carriers.

Table 13: Table 2 ESP-BLE-MESH Terminology - Composition

Term	Official Definition	Detailed Explanation
State	A value representing a condition of an element that is exposed by an element of a node.	Each node in a ESP-BLE-MESH network has an independent set of state values that indicate certain states of the device, like brightness, and color of lighting device. Change of state value will lead to change of the physical state of devices. For example, changing the on/off state of a device is actually turning on/off the device.
Model	A model defines the basic functionality of a node.	A node may contain multiple models, and each model defines basic functionalities of nodes, like the states needed by the nodes, the messages controlling the states, and actions resulted from messages handling. The function implementation of the nodes is based on models, which can be divided into SIG Model and Vendor Model, with the former defined by SIG and latter defined by users.
Element	An addressable entity within a device.	A node can contain one or more elements, with each having a unicast address and one or more models, and the models contained by the same element must not be the same.
Composition Data State	The Composition Data state contains information about a node, the elements it includes, and the supported models.	By reading the value of the Composition Data state, users can know basic information of the node, such as the number of elements, and the models in each element. Provisioner gets this message to further provision the device, such as configuring subscription address and publishing address of nodes.

Table 14: Table 3 ESP-BLE-MESH Terminology - Features

Term	Official Definition	Detailed Explanation
Low Power Feature	The ability to operate within a mesh network at significantly reduced receiver duty cycles only in conjunction with a node supporting the Friend feature.	Low Power feature reduces power consumption of nodes. When a Low Power node is searching for a Friend node, and there are multiple Friend nodes nearby, it selects the most suitable Friend node through algorithm.
Friend Feature	The ability to help a node supporting the Low Power feature to operate by storing messages destined for those nodes.	By enabling friend feature, the node can help to store information for Low Power node. The nodes enabled with friend feature may cause more power and memory consumption.
Relay Feature	The ability to receive and retransmit mesh messages over the advertising bearer to enable larger networks.	The relay feature enables ESP-BLE-MESH messages to hop among nodes for multiple times, and the transmission distance can exceed the range of direct radio transmission between two nodes, thereby covering the entire network. When a node is enabled with the relay feature to relay messages, it only relays the messages of its own subnet, and does not relay the messages of other subnets. The data integrity will not be considered when the node enabled with relay feature relays segmented messages. The node would relay every segmented message once it receives one rather than waiting for the complete message.
Proxy Feature	The ability to receive and retransmit mesh messages between GATT and advertising bearers.	The purpose of the proxy feature is to allow nodes without an advertising bearer to access the ESP-BLE-MESH network. The proxy feature is typically used in nodes that need to connect to mobile apps.

Table 15: Table 4 ESP-BLE-MESH Terminology - Provisioning

Term	Official Definition	Detailed Explanation
PB-ADV	PB-ADV is a provisioning bearer used to provision a device using Generic Provisioning PDUs over the advertising channels.	PB-ADV transfers packets generated during the provisioning process over the advertising channels. This way can only be used for provisioning when provisioner and unprovisioned device both support PB-ADV.
PB-GATT	PB-GATT is a provisioning bearer used to provision a device using Proxy PDUs to encapsulate Provisioning PDUs within the Mesh Provisioning Service.	PB-GATT uses connection channels to transfer packets generated during the provisioning process. If an unprovisioned device wants to be provisioned through this method, it needs to implement the related Mesh Provisioning Service. Unprovisioned devices which don't implement such service cannot be provisioned into mesh network through PB-GATT bearer.
Provisioning	Provisioning is a process of adding an unprovisioned device to a mesh network, managed by a Provisioner.	The process of provisioning turns the “unprovisioned device” into a “node”, making it a member of the ESP-BLE-MESH network.
Authentication Method	Authentication is a step during the provisioning of nodes.	There are four authentication methods for unprovisioned devices: Output OOB, Input OOB, Static OOB, and No OOB.
Input OOB	Input Out-of-Band	For example, a Provisioner generates and displays a random number, and then prompts users to take appropriate actions to input the random number into the unprovisioned device. Taking lighting switch as an example, users can press the button for several times in a certain period of time to input the random number displayed on the Provisioner. Authentication method of the Input OOB is similar to that of Output OOB, but the role of the device is reversed.
Output OOB	Output Out-of-Band	For example, an unprovisioned device will choose a random number and output the number in a way that is compatible with its functionality. If the unprovisioned device is a bulb, it can flash a specified number of times. If the unprovisioned device has an LCD screen, the random number can display as a multi-digit value. Users who start provisioning should input the observed number to authenticate the unprovisioned device.
Static OOB	Static Out-of-Band	Authentication method of Static OOB: use Static OOB information. Use 0 as Static OOB information if No OOB information is needed. Use Static OOB information to authenticate devices which are going through provisioning if OOB information is needed.
No OOB	No Out-of-Band	Authentication method of No OOB: Set the value of the Static OOB field to 0. Using this way is like not authenticating the unprovisioned devices.

Table 16: Table 5 ESP-BLE-MESH Terminology - Address

Term	Official Definition	Detailed Explanation
Unassigned Address	This is a special address type, with a value of 0x0000. Its use indicates that an Element has not yet been configured or had a Unicast Address assigned to it.	The addresses owned by elements which has not been configured yet or no address has been allocated are unassigned addresses. These elements will not be used for messages transfer because they have no fixed address. Unassigned address is recommended to set as the value of the address before setting the address of user code.
Unicast Address	A unicast address is a unique address allocated to each element.	During provisioning, the Provisioner will assign a unicast address to each element of node within the life cycle of the nodes in the network. A unicast address may appear in the source/destination address field of a message. Messages sent to a unicast address can only be processed by the element that owns the unicast address.
Virtual Address	A virtual address represents a set of destination addresses. Each virtual address logically represents a Label UUID, which is a 128-bit value that does not have to be managed centrally.	Associated with specific UUID labels, a virtual address may serve as the publishing or subscription address of the model. A UUID label is a 128-bit value associated with elements of one or more nodes. For virtual addresses, the 15th and 14th bits are set to 1 and 0 respectively; bits from 13th to 0 are set to hash values (providing 16384 hash values). The hash is a derivation of the Label UUID. To use subscribing elements to check the full 128-bit UUID is very inefficient while hash values provide a more efficient way to determine which elements that which messages are finally sent to.
Group Address	A group address is an address that is programmed into zero or more elements	Group address is another kind of multicast address in the ESP-BLE-MESH network, which is usually used to group nodes. A message sent to the all-proxies address shall be processed by the primary element of all nodes that have the proxy functionality enabled. A message sent to the all-friends address shall be processed by the primary element of all nodes that have the friend functionality enabled. A message sent to the all-relays address shall be processed by the primary element of all nodes that have the relay functionality enabled. A message sent to the all-nodes address shall be processed by the primary element of all nodes.

Table 17: Table 6 ESP-BLE-MESH Terminology - Security

Term	Official Definition	Detailed Explanation
Device Key (DevKey)	There is also a device key, which is a special application key that is unique to each node, is known only to the node and a Configuration Client, and is used to secure communications between the node and a Configuration Client.	The device key enables you to provision the devices, configure the nodes. The device key is used to encrypt Configuration Messages, i.e. the message transferred between the Provisioner and the node when the device is configured.
Application Key (App-Key)	Application keys are used to secure communications at the upper transport layer.	Application key is used for decryption of application data before delivering application data to application layer and encryption of them during the delivery of application layer. Some nodes in the network have a specific purpose and can restrict access to potentially sensitive data based on the needs of the application. With specific application keys, these nodes are associated with specific applications. Generally speaking, the fields using different application keys include security (access control of buildings, machine rooms and CEO offices), lighting (plant, exterior building and sidewalks) and HVAC systems. Application keys are bound to Network keys. This means application keys are only used in a context of a Network key they are bound to. An application key shall only be bound to a single Network key.
Master Security Material	The master security material is derived from the network key (NetKey) and can be used by other nodes in the same network. Messages encrypted with master security material can be decoded by any node in the same network.	The corresponding friendship messages encrypted with the friendship security material: 1. Friend Poll, 2. Friend Update, 3. Friend Subscription List, add/delete/confirm, 4. The Stored Messages” sent by friend nodes to Low Power node. The corresponding friendship messages encrypted with the master security material: 1. Friend Clear, 2. Friend Clear Confirm. Based on the setup of the applications, the messages sent from the Low Power node to the friend nodes will be encrypted with the friendship security material or master security material, with the former being used by the messages transmitted between Low Power node and friend nodes and the latter being used by other network messages.

Table 18: Table 7 ESP-BLE-MESH Terminology - Message

Term	Official Definition	Detailed Explanation
Reassembly / Segmentation	Segmentation and reassembly (SAR) is a method of communication network, which is divided into small units before transmitting packets and reassembled in a proper order at the communication receiving end.	The lower transport layer will automatically segment the message whose size is too big. The receiving end will return a response message, and the transmitting end will send the data packet again that the receiving end does not receive according to the response message. This is automatically completed by the lower transport layer. Unsegmented messages have at most 15 bytes, of which 4 bytes are transMIC, so the remaining is 11 bytes; in the case of segmentation, there are 12 valid bytes in the first several packets, and 8 in the last one. Special case: A shorter packet requires mandatory segmentation from lower transport layer, in which case the valid byte is 8 bytes.
Unacknowledged / Acknowledged	There are two types of messages: Unacknowledged or Acknowledged	Based on the whether or not the receiving end needs to send the response message, the messages sent are divided into two kinds. The sending end should set the maximum number of retransmission.

Table 19: Table 8 ESP-BLE-MESH Terminology - Foundation Models

Term	Official Definition	Detailed Explanation
Configuration Server Model	This model is used to represent a mesh network configuration of a device.	The node must contain the Configuration Server Model, which is responsible for maintaining configuration-related states. The states that Configuration Server Model maintains include: NetKey List, AppKey List, Model to AppKey List, Node Identity, Key Refresh Phase, Heartbeat Publish, Heartbeat Subscription, Network Transmit, Relay Retransmit etc.
Configuration Client Model	The model is used to represent an element that can control and monitor the configuration of a node.	The Configuration Client Model uses messages to control the state maintained by the Configuration Server Model. The Provisioner must contain the Configuration Client Model, with which the configuration messages, like Configuration Composition Data Get can be sent.
Health Server Model	This model is used to represent a mesh network diagnostics of a device.	The Health Server Model is primarily used by devices to check their states and see if there is an error. The states maintained by Health Server model include: Current Fault, Registered Fault, Health Period, and Attention Timer.
Health Client Model	The model is used to represent an element that can control and monitor the health of a node.	The Health Client Model uses messages to control the state maintained by the Health Server Model. The model can get the self-test information of other nodes through the message “Health Fault Get” .

Table 20: Table 9 ESP-BLE-MESH Terminology - Network Management

Term	Official Definition	Detailed Explanation
Key Refresh procedure	This procedure is used when the security of one or more network keys and/or one or more of the application keys has been compromised or could be compromised.	Key Refresh Procedure is used to update network key and application key of ESP-BLE-MESH network. Key Refresh Procedure is used when the security of one or more network keys and/or one or more application keys is threatened or potentially threatened. Keys are usually updated after some nodes in the network are removed.
IV (Initialisation Vector) Update Procedure	A node can also use an IV Update procedure to signal to peer nodes that it is updating the IV Index.	The IV Update procedure is used to update the value of ESP-BLE-MESH network’s IV Index. This value is related to the random number required for message encryption. To ensure that the value of the random number is not repeated, this value is periodically incremented. IV Index is a 32-bit value and a shared network resource. For example, all nodes in a mesh network share the same IV Index value. Starting from 0x00000000, the IV Index increments during the IV Update procedure and maintained by a specific process, ensuring the IV Index shared in the mesh network is the same. This can be done when the node believes that it has the risk of exhausting its sequence number, or when it determines that another node is nearly exhausting its sequence number. Note: The update time must not be less than 96 hours. It can be triggered when a secure network beacon is received, or when the node determines that its sequence number is greater than a certain value.

For more terms, please see: [ESP-BLE-MESH Glossary of Terms](#).

Bluetooth SIG Documentation

- [BLE Mesh Core Specification](#)
- [BLE Mesh Model Specification](#)
- [An Intro to Bluetooth Mesh Part 1 / Part 2](#)

- [The Fundamental Concepts of Bluetooth Mesh Networking, Part 1 / Part 2](#)
- [Bluetooth Mesh Networking: Friendship](#)
- [Management of Devices in a Bluetooth Mesh Network](#)
- [Bluetooth Mesh Security Overview](#)
- [Provisioning a Bluetooth Mesh Network Part 1 / Part 2](#)

4.9 ESP-MESH

This guide provides information regarding the ESP-MESH protocol. Please see the [MESH API Reference](#) for more information about API usage.

4.9.1 Overview

ESP-MESH is a networking protocol built atop the Wi-Fi protocol. ESP-MESH allows numerous devices (henceforth referred to as nodes) spread over a large physical area (both indoors and outdoors) to be interconnected under a single WLAN (Wireless Local-Area Network). ESP-MESH is self-organizing and self-healing meaning the network can be built and maintained autonomously.

The ESP-MESH guide is split into the following sections:

1. [Introduction](#)
2. [ESP-MESH Concepts](#)
3. [Building a Network](#)
4. [Managing a Network](#)
5. [Data Transmission](#)
6. [Channel Switching](#)
7. [Performance](#)
8. [Further Notes](#)

4.9.2 Introduction

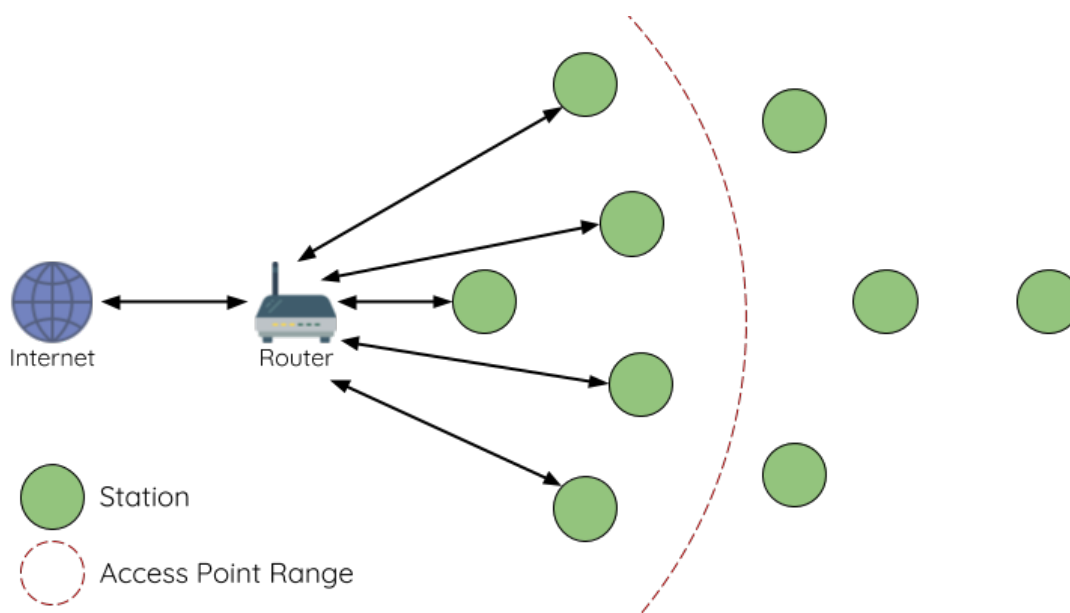

Fig. 16: Traditional Wi-Fi Network Architecture

A traditional infrastructure Wi-Fi network is a point-to-multipoint network where a single central node known as the access point (AP) is directly connected to all other nodes known as stations. The AP is responsible for arbitrating and

forwarding transmissions between the stations. Some APs also relay transmissions to/from an external IP network via a router. Traditional infrastructure Wi-Fi networks suffer the disadvantage of limited coverage area due to the requirement that every station must be in range to directly connect with the AP. Furthermore, traditional Wi-Fi networks are susceptible to overloading as the maximum number of stations permitted in the network is limited by the capacity of the AP.

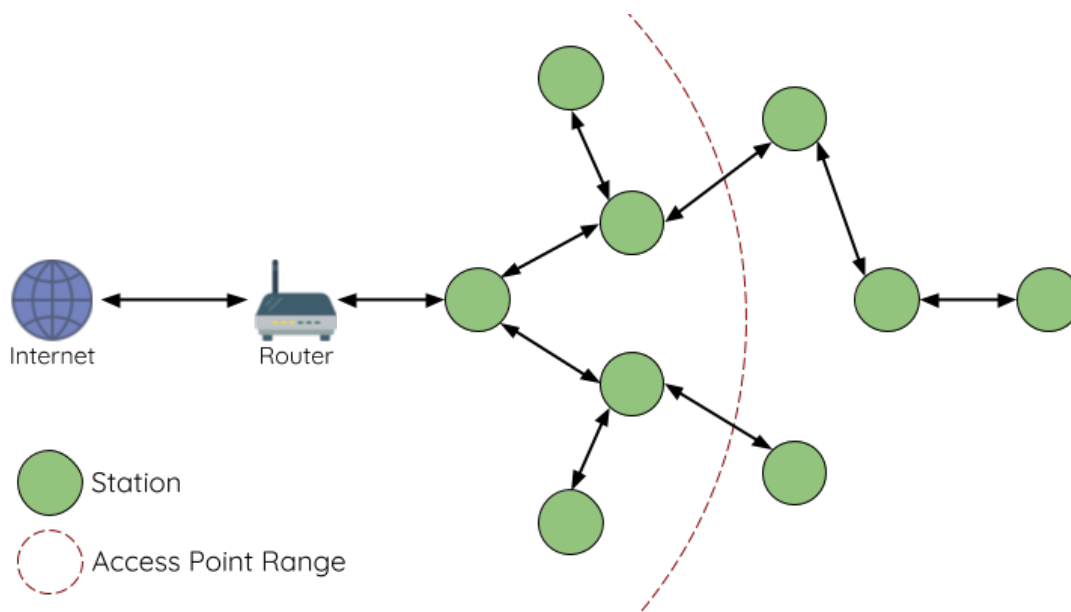

Fig. 17: ESP-MESH Network Architecture

ESP-MESH differs from traditional infrastructure Wi-Fi networks in that nodes are not required to connect to a central node. Instead, nodes are permitted to connect with neighboring nodes. Nodes are mutually responsible for relaying each others transmissions. This allows an ESP-MESH network to have much greater coverage area as nodes can still achieve interconnectivity without needing to be in range of the central node. Likewise, ESP-MESH is also less susceptible to overloading as the number of nodes permitted on the network is no longer limited by a single central node.

4.9.3 ESP-MESH Concepts

Terminology

Term	Description
Node	Any device that is or can be part of an ESP-MESH network
Root Node	The top node in the network
Child Node	A node X is a child node when it is connected to another node Y where the connection makes node X more distant from the root node than node Y (in terms of number of connections).
Parent Node	The converse notion of a child node
Descendant Node	Any node reachable by repeated proceeding from parent to child
Sibling Nodes	Nodes that share the same parent node
Connection	A traditional Wi-Fi association between an AP and a station. A node in ESP-MESH will use its station interface to associate with the softAP interface of another node, thus forming a connection. The connection process includes the authentication and association processes in Wi-Fi.
Upstream Connection	The connection from a node to its parent node
Downstream Connection	The connection from a node to one of its child nodes
Wireless Hop	The portion of the path between source and destination nodes that corresponds to a single wireless connection. A data packet that traverses a single connection is known as single-hop whereas traversing multiple connections is known as multi-hop .
Subnetwork	A subnetwork is subdivision of an ESP-MESH network which consists of a node and all of its descendant nodes. Therefore the subnetwork of the root node consists of all nodes in an ESP-MESH network.
MAC Address	Media Access Control Address used to uniquely identify each node or router within an ESP-MESH network.
DS	Distribution System (External IP Network)

Tree Topology

ESP-MESH is built atop the infrastructure Wi-Fi protocol and can be thought of as a networking protocol that combines many individual Wi-Fi networks into a single WLAN. In Wi-Fi, stations are limited to a single connection with an AP (upstream connection) at any time, whilst an AP can be simultaneously connected to multiple stations (downstream connections). However ESP-MESH allows nodes to simultaneously act as a station and an AP. Therefore a node in ESP-MESH can have **multiple downstream connections using its softAP interface**, whilst simultaneously having a **single upstream connection using its station interface**. This naturally results in a tree network topology with a parent-child hierarchy consisting of multiple layers.

ESP-MESH is a multiple hop (multi-hop) network meaning nodes can transmit packets to other nodes in the network through one or more wireless hops. Therefore, nodes in ESP-MESH not only transmit their own packets, but simultaneously serve as relays for other nodes. Provided that a path exists between any two nodes on the physical layer (via one or more wireless hops), any pair of nodes within an ESP-MESH network can communicate.

Note: The size (total number of nodes) in an ESP-MESH network is dependent on the maximum number of layers permitted in the network, and the maximum number of downstream connections each node can have. Both of these variables can be configured to limit the size of the network.

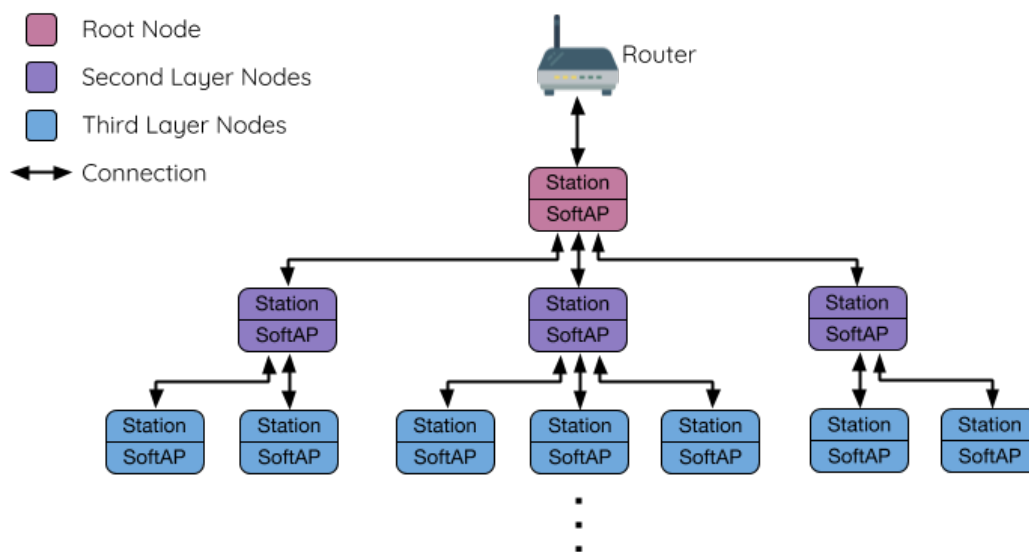

Fig. 18: ESP-MESH Tree Topology

Node Types

Root Node: The root node is the top node in the network and serves as the only interface between the ESP-MESH network and an external IP network. The root node is connected to a conventional Wi-Fi router and relays packets to/from the external IP network to nodes within the ESP-MESH network. **There can only be one root node within an ESP-MESH network** and the root node's upstream connection may only be with the router. Referring to the diagram above, node A is the root node of the network.

Leaf Nodes: A leaf node is a node that is not permitted to have any child nodes (no downstream connections). Therefore a leaf node can only transmit or receive its own packets, but cannot forward the packets of other nodes. If a node is situated on the network's maximum permitted layer, it will be assigned as a leaf node. This prevents the node from forming any downstream connections thus ensuring the network does not add an extra layer. Some nodes without a softAP interface (station only) will also be assigned as leaf nodes due to the requirement of a softAP interface for any downstream connections. Referring to the diagram above, nodes L/M/N are situated on the networks maximum permitted layer hence have been assigned as leaf nodes .

Intermediate Parent Nodes: Connected nodes that are neither the root node or a leaf node are intermediate parent nodes. An intermediate parent node must have a single upstream connection (a single parent node), but can have zero to multiple downstream connections (zero to multiple child nodes). Therefore an intermediate parent node can transmit and receive packets, but also forward packets sent from its upstream and downstream connections. Referring to the diagram above, nodes B to J are intermediate parent nodes. **Intermediate parent nodes without downstream connections such as nodes E/F/G/I/J are not equivalent to leaf nodes** as they are still permitted to form downstream connections in the future.

Idle Nodes: Nodes that have yet to join the network are assigned as idle nodes. Idle nodes will attempt to form an upstream connection with an intermediate parent node or attempt to become the root node under the correct circumstances (see [Automatic Root Node Selection](#)). Referring to the diagram above, nodes K and O are idle nodes.

Beacon Frames & RSSI Thresholding

Every node in ESP-MESH that is able to form downstream connections (i.e. has a softAP interface) will periodically transmit Wi-Fi beacon frames. A node uses beacon frames to allow other nodes to detect its presence and know of its status. Idle nodes will listen for beacon frames to generate a list of potential parent nodes, one of which the idle node will form an upstream connection with. ESP-MESH uses the Vendor Information Element to store metadata such as:

- Node Type (Root, Intermediate Parent, Leaf, Idle)

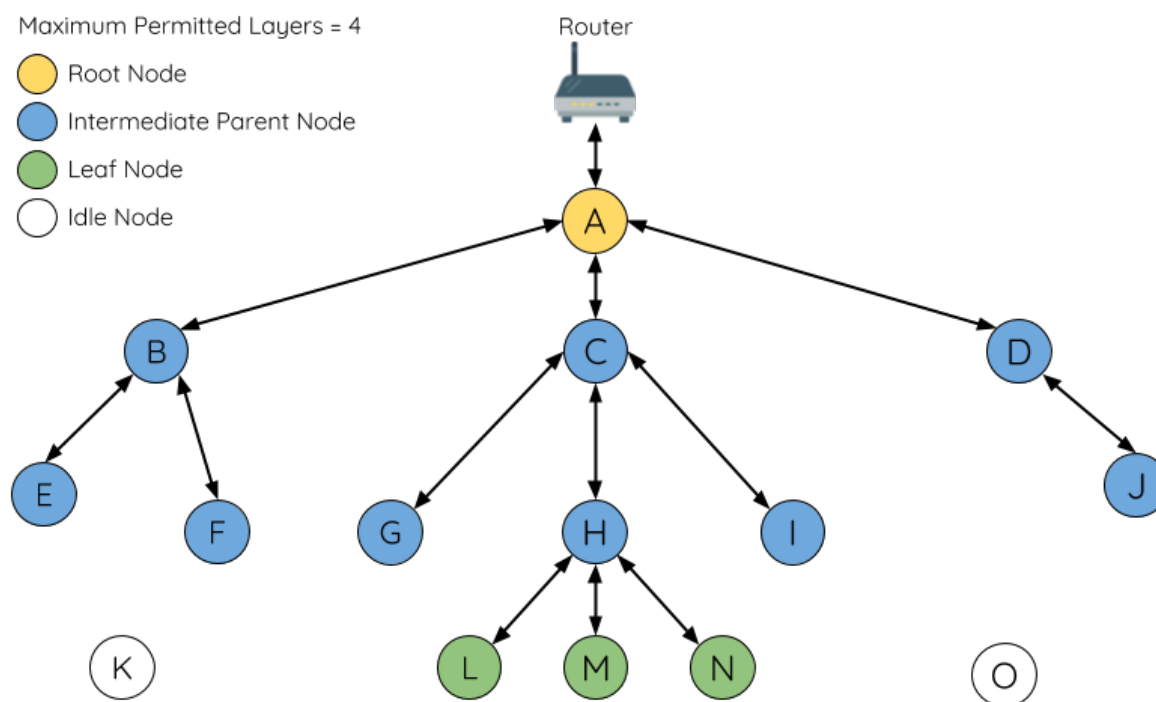

Fig. 19: ESP-MESH Node Types

- Current layer of Node
- Maximum number of layers permitted in the network
- Current number of child nodes
- Maximum number of downstream connections to accept

The signal strength of a potential upstream connection is represented by RSSI (Received Signal Strength Indication) of the beacon frames of the potential parent node. To prevent nodes from forming a weak upstream connection, ESP-MESH implements an RSSI threshold mechanism for beacon frames. If a node detects a beacon frame with an RSSI below a preconfigured threshold, the transmitting node will be disregarded when forming an upstream connection.

Panel A of the illustration above demonstrates how the RSSI threshold affects the number of parent node candidates an idle node has.

Panel B of the illustration above demonstrates how an RF shielding object can lower the RSSI of a potential parent node. Due to the RF shielding object, the area in which the RSSI of node X is above the threshold is significantly reduced. This causes the idle node to disregard node X even though node X is physically adjacent. The idle node will instead form an upstream connection with the physically distant node Y due to a stronger RSSI.

Note: Nodes technically still receive all beacon frames on the MAC layer. The RSSI threshold is an ESP-MESH feature that simply filters out all received beacon frames that are below the preconfigured threshold.

Preferred Parent Node

When an idle node has multiple parent nodes candidates (potential parent nodes), the idle node will form an upstream connection with the **preferred parent node**. The preferred parent node is determined based on the following criteria:

- Which layer the parent node candidate is situated on
- The number of downstream connections (child nodes) the parent node candidate currently has

The selection of the preferred parent node will always prioritize the parent node candidate on the shallowest layer of the network (including the root node). This helps minimize the total number of layers in an ESP-MESH network

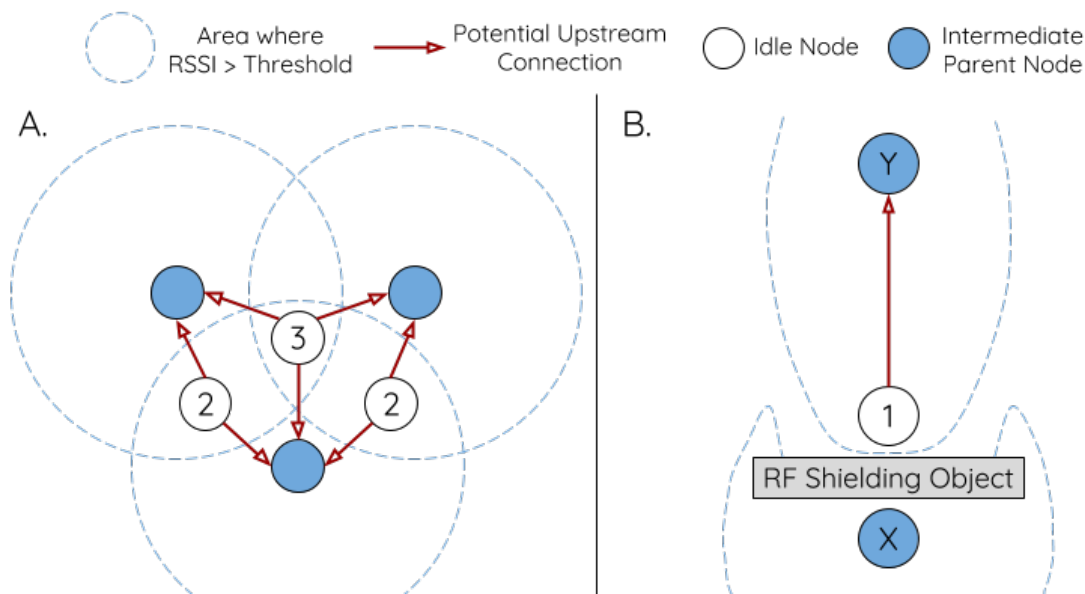

Fig. 20: Effects of RSSI Thresholding

when upstream connections are formed. For example, given a second layer node and a third layer node, the second layer node will always be preferred.

If there are multiple parent node candidates within the same layer, the parent node candidate with the least child nodes will be preferred. This criteria has the effect of balancing the number of downstream connections amongst nodes of the same layer.

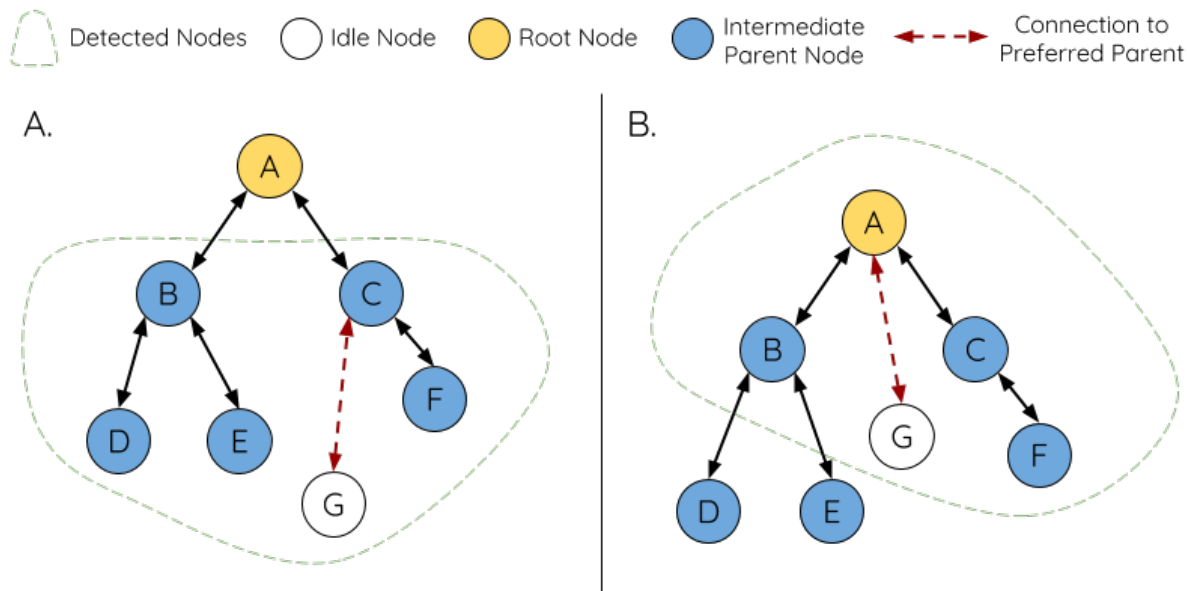

Fig. 21: Preferred Parent Node Selection

Panel A of the illustration above demonstrates an example of how the idle node G selects a preferred parent node given the five parent node candidates B/C/D/E/F. Nodes on the shallowest layer are preferred, hence nodes B/C are prioritized since they are second layer nodes whereas nodes D/E/F are on the third layer. Node C is selected as the preferred parent node due it having fewer downstream connections (fewer child nodes) compared to node B.

Panel B of the illustration above demonstrates the case where the root node is within range of the idle node G. In other words, the root node’s beacon frames are above the RSSI threshold when received by node G. The root node is always the shallowest node in an ESP-MESH network hence is always the preferred parent given multiple

parent node candidates.

Note: Users may also define their own algorithm for selecting a preferred parent node, or force a node to only connect with a specific parent node (see the [Mesh Manual Networking Example](#)).

Routing Tables

Each node within an ESP-MESH network will maintain its individual routing table used to correctly route ESP-MESH packets (see [ESP-MESH Packet](#)) to the correct destination node. The routing table of a particular node will **consist of the MAC addresses of all nodes within the particular node's subnetwork** (including the MAC address of the particular node itself). Each routing table is internally partitioned into multiple subtables with each subtable corresponding to the subnetwork of each child node.

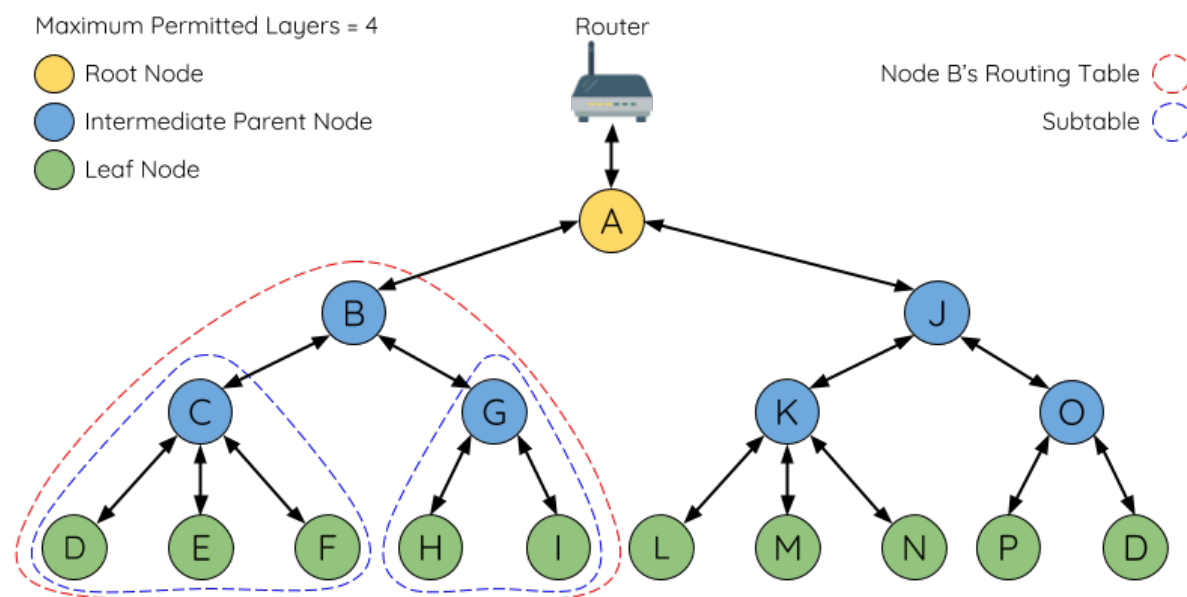

Fig. 22: ESP-MESH Routing Tables Example

Using the diagram above as an example, the routing table of node B would consist of the MAC addresses of nodes B to I (i.e. equivalent to the subnetwork of node B). Node B's routing table is internally partitioned into two subtables containing of nodes C to F and nodes G to I (i.e. equivalent to the subnetworks of nodes C and G respectively).

ESP-MESH utilizes routing tables to determine whether an ESP-MESH packet should be forwarded upstream or downstream based on the following rules.

1. If the packet's destination MAC address is within the current node's routing table and is not the current node, select the subtable that contains the destination MAC address and forward the data packet downstream to the child node corresponding to the subtable.
2. If the destination MAC address is not within the current node's routing table, forward the data packet upstream to the current node's parent node. Doing so repeatedly will result in the packet arriving at the root node where the routing table should contain all nodes within the network.

Note: Users can call `esp_mesh_get_routing_table()` to obtain a node's routing table, or `esp_mesh_get_routing_table_size()` to obtain the size of a node's routing table.

`esp_mesh_get_subnet_nodes_list()` can be used to obtain the corresponding subtable of a specific child node. Likewise `esp_mesh_get_subnet_nodes_num()` can be used to obtain the size of the subtable.

4.9.4 Building a Network

General Process

Warning: Before the ESP-MESH network building process can begin, certain parts of the configuration must be uniform across each node in the network (see `mesh_cfg_t`). Each node must be configured with **the same Mesh Network ID, router configuration, and softAP configuration.**

An ESP-MESH network building process involves selecting a root node, then forming downstream connections layer by layer until all nodes have joined the network. The exact layout of the network can be dependent on factors such as root node selection, parent node selection, and asynchronous power-on reset. However, the ESP-MESH network building process can be generalized into the following steps:

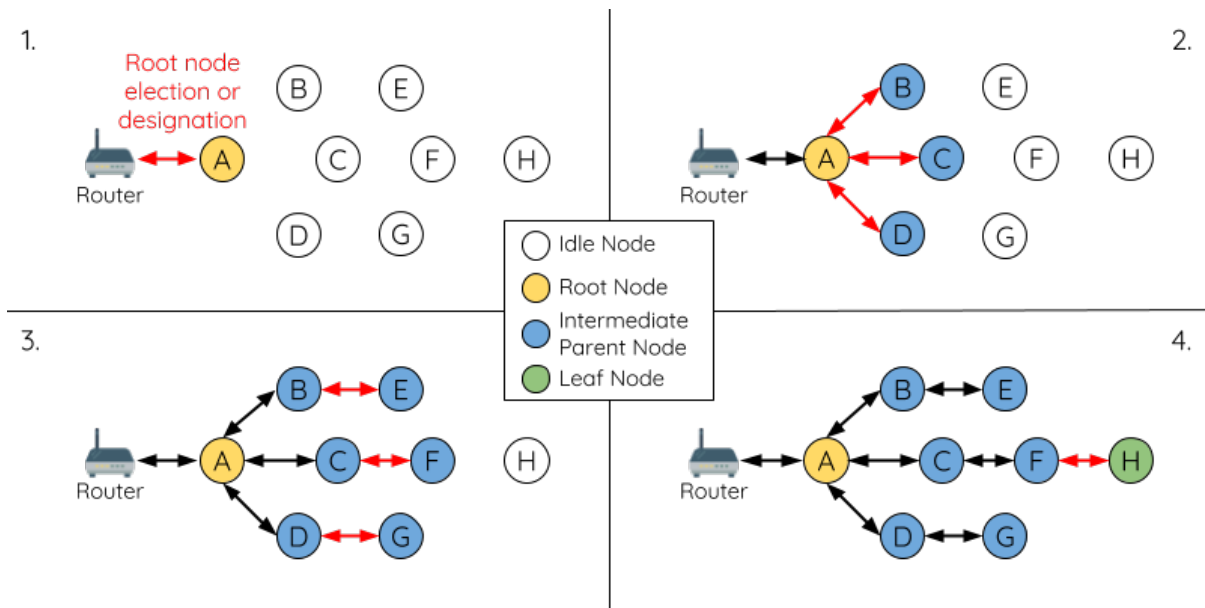

Fig. 23: ESP-MESH Network Building Process

1. Root Node Selection The root node can be designated during configuration (see section on *User Designated Root Node*), or dynamically elected based on the signal strength between each node and the router (see *Automatic Root Node Selection*). Once selected, the root node will connect with the router and begin allowing downstream connections to form. Referring to the figure above, node A is selected to be the root node hence node A forms an upstream connection with the router.

2. Second Layer Formation Once the root node has connected to the router, idle nodes in range of the root node will begin connecting with the root node thereby forming the second layer of the network. Once connected, the second layer nodes become intermediate parent nodes (assuming maximum permitted layers > 2) hence the next layer to form. Referring to the figure above, nodes B to D are in range of the root node. Therefore nodes B to D form upstream connections with the root node and become intermediate parent nodes.

3. Formation of remaining layers The remaining idle nodes will connect with intermediate parent nodes within range thereby forming a new layer in the network. Once connected, the idle nodes become intermediate parent node or leaf nodes depending on the network's maximum permitted layers. This step is repeated until there are no more idle nodes within the network or until the maximum permitted layer of the network has been reached. Referring to the figure above, nodes E/F/G connect with nodes B/C/D respectively and become intermediate parent nodes themselves.

4. Limiting Tree Depth To prevent the network from exceeding the maximum permitted number of layers, nodes on the maximum layer will automatically become leaf nodes once connected. This prevents any other idle node from connecting with the leaf node thereby prevent a new layer form forming. However if an idle node has no other potential parent node, it will remain idle indefinitely. Referring to the figure above, the network' s number of maximum permitted layers is set to four. Therefore when node H connects, it becomes a leaf node to prevent any downstream connections from forming.

Automatic Root Node Selection

The automatic selection of a root node involves an election process amongst all idle nodes based on their signal strengths with the router. Each idle node will transmit their MAC addresses and router RSSI values via Wi-Fi beacon frames. **The MAC address is used to uniquely identify each node in the network** whilst the **router RSSI** is used to indicate a node' s signal strength with reference to the router.

Each node will then simultaneously scan for the beacon frames from other idle nodes. If a node detects a beacon frame with a stronger router RSSI, the node will begin transmitting the contents of that beacon frame (i.e. voting for the node with the stronger router RSSI). The process of transmission and scanning will repeat for a preconfigured minimum number of iterations (10 iterations by default) and result in the beacon frame with the strongest router RSSI being propagated throughout the network.

After all iterations, each node will individually check for its **vote percentage** (number of votes/number of nodes participating in election) to determine if it should become the root node. **If a node has a vote percentage larger than a preconfigured threshold (90% by default), the node will become a root node.**

The following diagram demonstrates how an ESP-MESH network is built when the root node is automatically selected.

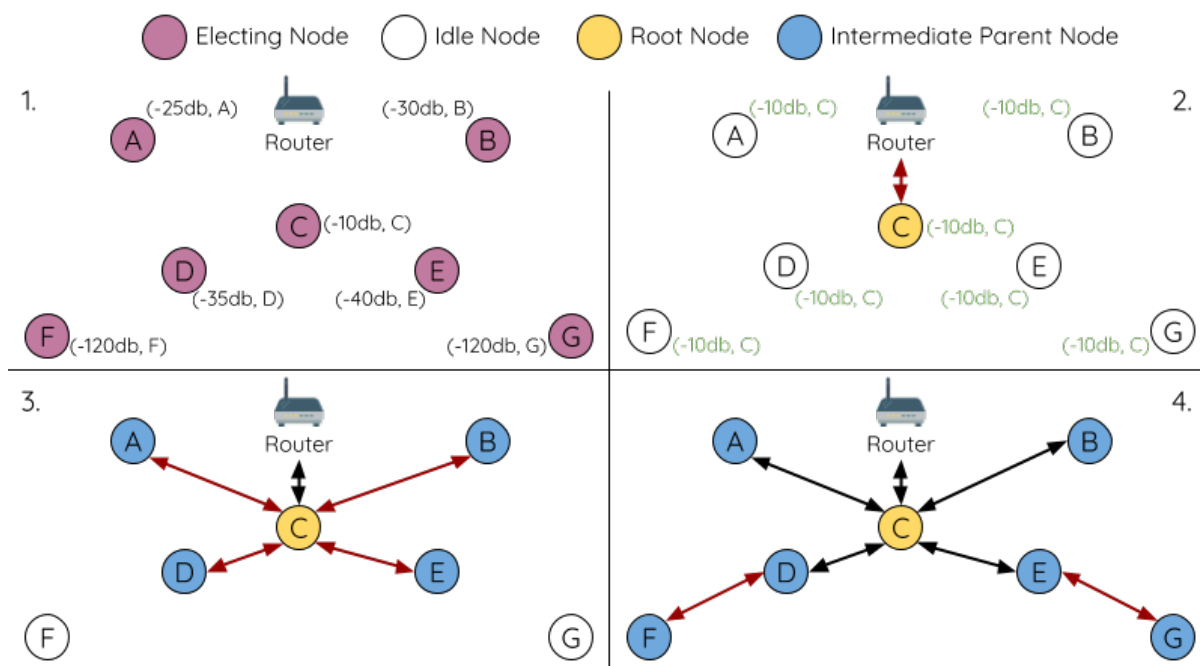

Fig. 24: Root Node Election Example

1. On power-on reset, each node begins transmitting beacon frames consisting of their own MAC addresses and their router RSSIs.
2. Over multiple iterations of transmission and scanning, the beacon frame with the strongest router RSSI is propagated throughout the network. Node C has the strongest router RSSI (-10 dB) hence its beacon frame is propagated throughout the network. All nodes participating in the election vote for node C thus giving node C a vote percentage of 100%. Therefore node C becomes a root node and connects with the router.
3. Once Node C has connected with the router, nodes A/B/D/E connect with node C as it is the preferred parent node (i.e. the shallowest node). Nodes A/B/D/E form the second layer of the network.

4. Node F and G connect with nodes D and E respectively and the network building process is complete.

Note: The minimum number of iterations for the election process can be configured using `esp_mesh_set_attempts()`. Users should adjust the number of iterations based on the number of nodes within the network (i.e. the larger the network the larger number of scan iterations required).

Warning: `Vote percentage threshold` can also be configured using `esp_mesh_set_vote_percentage()`. Setting a low vote percentage threshold **can result in two or more nodes becoming root nodes** within the same ESP-MESH network leading to the building of multiple networks. If such is the case, ESP-MESH has internal mechanisms to autonomously resolve the **root node conflict**. The networks of the multiple root nodes will be combined into a single network with a single root node. However, root node conflicts where two or more root nodes have the same router SSID but different router BSSID are not handled.

User Designated Root Node

The root node can also be designated by user which will entail the designated root node to directly connect with the router and forgo the election process. When a root node is designated, all other nodes within the network must also forgo the election process to prevent the occurrence of a root node conflict. The following diagram demonstrates how an ESP-MESH network is built when the root node is designated by the user.

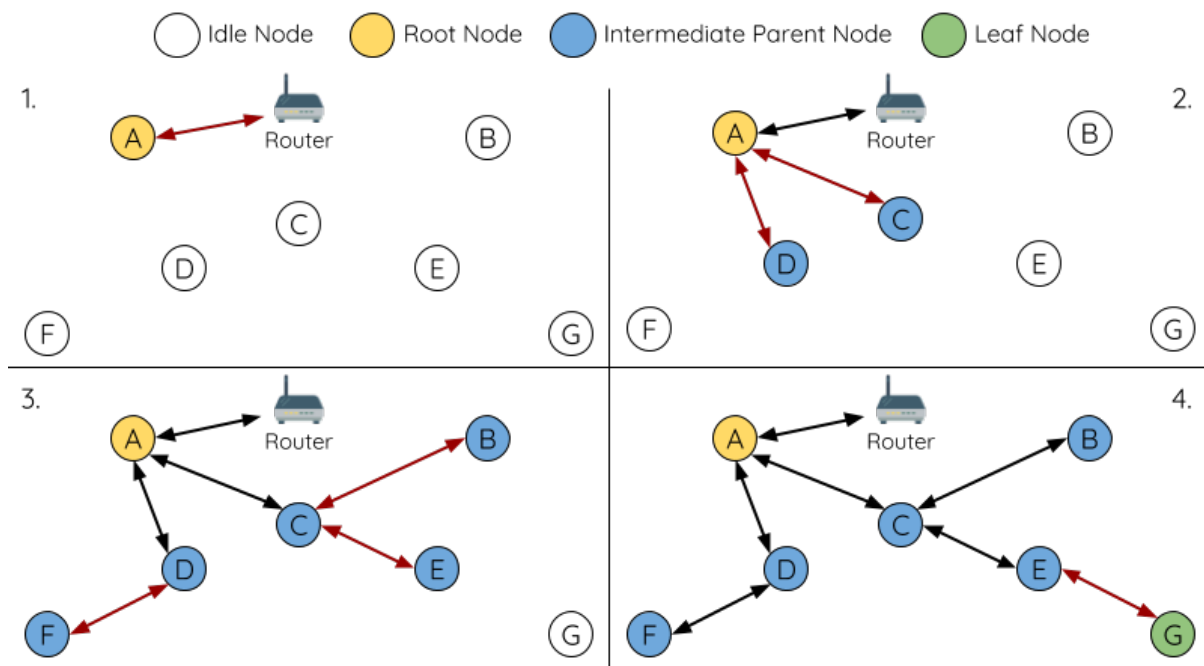

Fig. 25: Root Node Designation Example (Root Node = A, Max Layers = 4)

1. Node A is designated the root node by the user therefore directly connects with the router. All other nodes forgo the election process.
2. Nodes C/D connect with node A as their preferred parent node. Both nodes form the second layer of the network.
3. Likewise, nodes B/E connect with node C, and node F connects with node D. Nodes B/E/F form the third layer of the network.
4. Node G connects with node E, forming the fourth layer of the network. However the maximum permitted number of layers in this network is configured as four, therefore node G becomes a leaf node to prevent any new layers from forming.

Note: When designating a root node, the root node should call `esp_mesh_set_parent()` in order to directly connect with the router. Likewise, all other nodes should call `esp_mesh_fix_root()` to forgo the election process.

Parent Node Selection

By default, ESP-MESH is self organizing meaning that each node will autonomously select which potential parent node to form an upstream connection with. The autonomously selected parent node is known as the preferred parent node. The criteria used for selecting the preferred parent node is designed to reduce the number of layers in the ESP-MESH network and to balance the number of downstream connections between potential parent nodes (see section on *Preferred Parent Node*).

However ESP-MESH also allows users to disable self-organizing behavior which will allow users to define their own criteria for parent node selection, or to configure nodes to have designated parent nodes (see the [Mesh Manual Networking Example](#)).

Asynchronous Power-on Reset

ESP-MESH network building can be affected by the order in which nodes power-on. If certain nodes within the network power-on asynchronously (i.e. separated by several minutes), **the final structure of the network could differ from the ideal case where all nodes are powered on synchronously**. Nodes that are delayed in powering on will adhere to the following rules:

Rule 1: If a root node already exists in the network, the delayed node will not attempt to elect a new root node, even if it has a stronger RSSI with the router. The delayed node will instead join the network like any other idle node by connecting with a preferred parent node. If the delayed node is the designated root node, all other nodes in the network will remain idle until the delayed node powers-on.

Rule 2: If a delayed node forms an upstream connection and becomes an intermediate parent node, it may also become the new preferred parent of other nodes (i.e. being a shallower node). This will cause the other nodes to switch their upstream connections to connect with the delayed node (see *Parent Node Switching*).

Rule 3: If an idle node has a designated parent node which is delayed in powering-on, the idle node will not attempt to form any upstream connections in the absence of its designated parent node. The idle node will remain idle indefinitely until its designated parent node powers-on.

The following example demonstrates the effects of asynchronous power-on with regards to network building.

1. Nodes A/C/D/F/G/H are powered-on synchronously and begin the root node election process by broadcasting their MAC addresses and router RSSIs. Node A is elected as the root node as it has the strongest RSSI.
2. Once node A becomes the root node, the remaining nodes begin forming upstream connections layer by layer with their preferred parent nodes. The result is a network with five layers.
3. Node B/E are delayed in powering-on but neither attempt to become the root node even though they have stronger router RSSIs (-20 dB and -10 dB) compared to node A. Instead both delayed nodes form upstream connections with their preferred parent nodes A and C respectively. Both nodes B/E become intermediate parent nodes after connecting.
4. Nodes D/G switch their upstream connections as node B is the new preferred parent node due to it being on a shallower layer (second layer node). Due to the switch, the resultant network has three layers instead of the original five layers.

Synchronous Power-On: Had all nodes powered-on synchronously, node E would have become the root node as it has the strongest router RSSI (-10 dB). This would result in a significantly different network layout compared to the network formed under the conditions of asynchronous power-on. **However the synchronous power-on network layout can still be reached if the user manually switches the root node** (see `esp_mesh_waive_root()`).

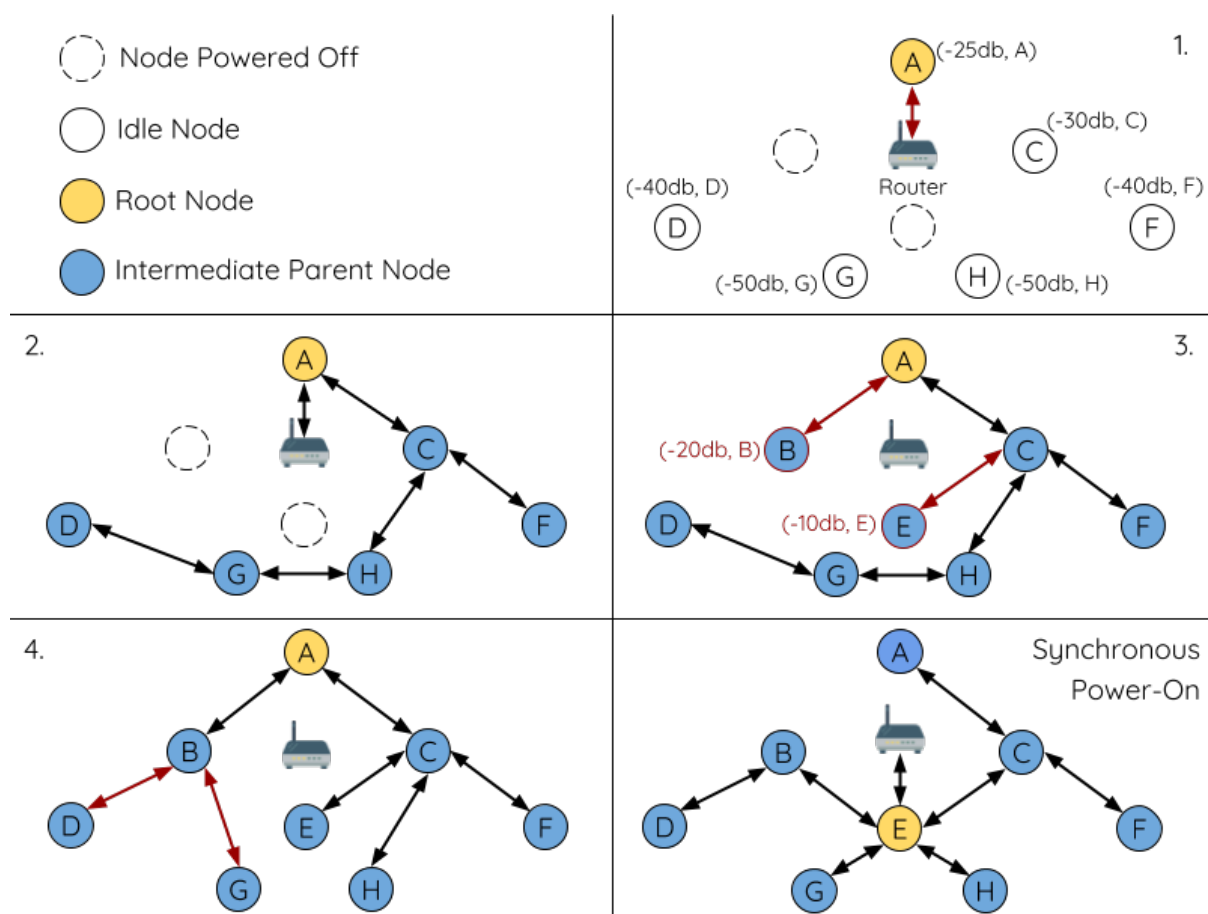

Fig. 26: Network Building with Asynchronous Power On Example

Note: Differences in parent node selection caused by asynchronous power-on are autonomously corrected for to some extent in ESP-MESH (see *Parent Node Switching*)

Loop-back Avoidance, Detection, and Handling

A loop-back is the situation where a particular node forms an upstream connection with one of its descendant nodes (a node within the particular node's subnetwork). This results in a circular connection path thereby breaking the tree topology. ESP-MESH prevents loop-back during parent selection by excluding nodes already present in the selecting node's routing table (see *Routing Tables*) thus prevents a particular node from attempting to connect to any node within its subnetwork.

In the event that a loop-back occurs, ESP-MESH utilizes a path verification mechanism and energy transfer mechanism to detect the loop-back occurrence. The parent node of the upstream connection that caused the loop-back will then inform the child node of the loop-back and initiate a disconnection.

4.9.5 Managing a Network

ESP-MESH is a self healing network meaning it can detect and correct for failures in network routing. Failures occur when a parent node with one or more child nodes breaks down, or when the connection between a parent node and its child nodes becomes unstable. Child nodes in ESP-MESH will autonomously select a new parent node and form an upstream connection with it to maintain network interconnectivity. ESP-MESH can handle both Root Node Failures and Intermediate Parent Node Failures.

Root Node Failure

If the root node breaks down, the nodes connected with it (second layer nodes) will promptly detect the failure of the root node. The second layer nodes will initially attempt to reconnect with the root node. However after multiple failed attempts, the second layer nodes will initialize a new round of root node election. **The second layer node with the strongest router RSSI will be elected as the new root node** whilst the remaining second layer nodes will form an upstream connection with the new root node (or a neighboring parent node if not in range).

If the root node and multiple downstream layers simultaneously break down (e.g. root node, second layer, and third layer), the shallowest layer that is still functioning will initialize the root node election. The following example illustrates an example of self healing from a root node break down.

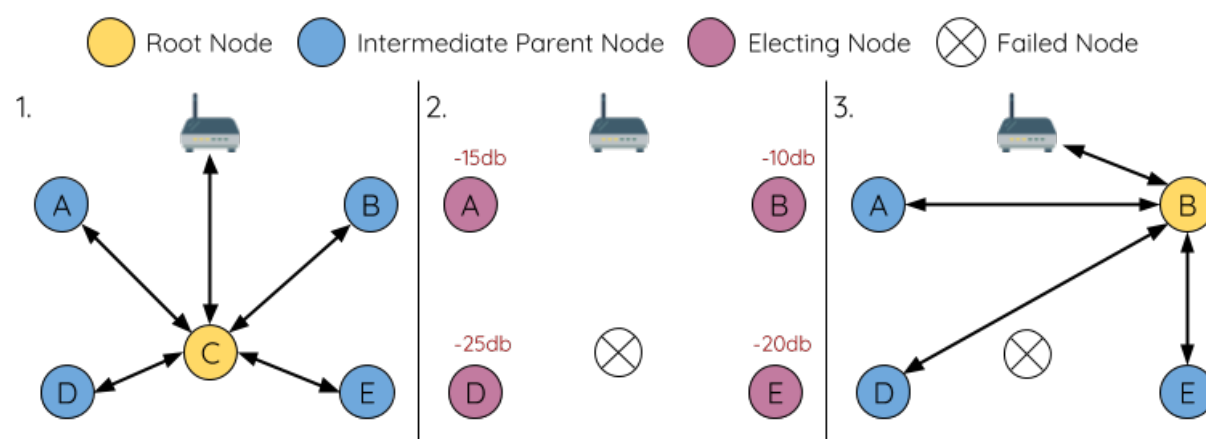

Fig. 27: Self Healing From Root Node Failure

1. Node C is the root node of the network. Nodes A/B/D/E are second layer nodes connected to node C.
2. Node C breaks down. After multiple failed attempts to reconnect, the second layer nodes begin the election process by broadcasting their router RSSIs. Node B has the strongest router RSSI.

3. Node B is elected as the root node and begins accepting downstream connections. The remaining second layer nodes A/D/E form upstream connections with node B thus the network is healed and can continue operating normally.

Note: If a designated root node breaks down, the remaining nodes **will not autonomously attempt to elect a new root node** as an election process will never be attempted whilst a designated root node is used.

Intermediate Parent Node Failure

If an intermediate parent node breaks down, the disconnected child nodes will initially attempt to reconnect with the parent node. After multiple failed attempts to reconnect, each child node will begin to scan for potential parent nodes (see *Beacon Frames & RSSI Thresholding*).

If other potential parent nodes are available, each child node will individually select a new preferred parent node (see *Preferred Parent Node*) and form an upstream connection with it. If there are no other potential parent nodes for a particular child node, it will remain idle indefinitely.

The following diagram illustrates an example of self healing from an Intermediate Parent Node break down.

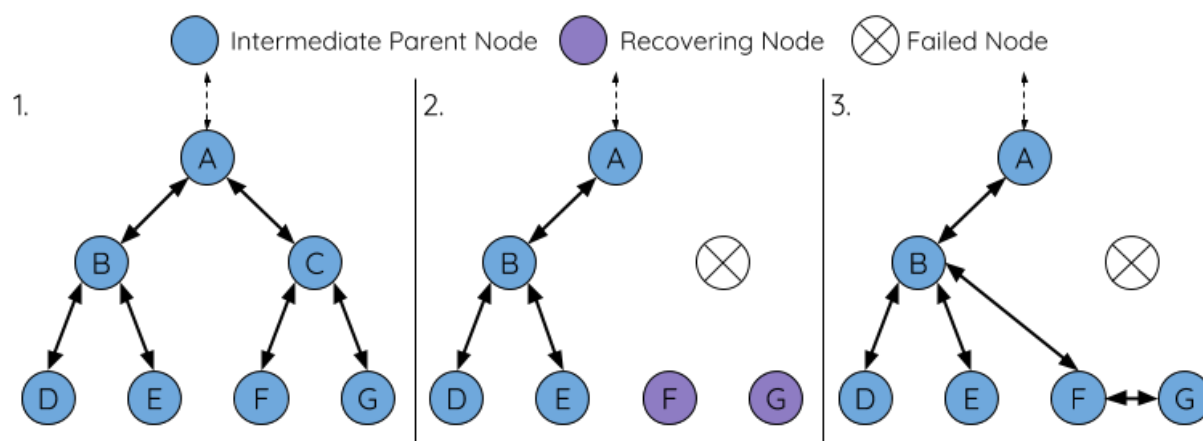

Fig. 28: Self Healing From Intermediate Parent Node Failure

1. The following branch of the network consists of nodes A to G.
2. Node C breaks down. Nodes F/G detect the break down and attempt to reconnect with node C. After multiple failed attempts to reconnect, nodes F/G begin to select a new preferred parent node.
3. Node G is out of range from any other parent node hence remains idle for the time being. Node F is in range of nodes B/E, however node B is selected as it is the shallower node. Node F becomes an intermediate parent node after connecting with Node B thus node G can connect with node F. The network is healed, however the network routing as been affected and an extra layer has been added.

Note: If a child node has a designated parent node that breaks down, the child node will make no attempt to connect with a new parent node. The child node will remain idle indefinitely.

Root Node Switching

ESP-MESH does not automatically switch the root node unless the root node breaks down. Even if the root node's router RSSI degrades to the point of disconnection, the root node will remain unchanged. Root node switching is the act of explicitly starting a new election such that a node with a stronger router RSSI will be elected as the new root node. This can be a useful method of adapting to degrading root node performance.

To trigger a root node switch, the current root node must explicitly call `esp_mesh_waive_root()` to trigger a new election. The current root node will signal all nodes within the network to begin transmitting and scanning for beacon frames (see [Automatic Root Node Selection](#)) **whilst remaining connected to the network (i.e. not idle)**. If another node receives more votes than the current root node, a root node switch will be initiated. **The root node will remain unchanged otherwise.**

A newly elected root node sends a **switch request** to the current root node which in turn will respond with an acknowledgment signifying both nodes are ready to switch. Once the acknowledgment is received, the newly elected root node will disconnect from its parent and promptly form an upstream connection with the router thereby becoming the new root node of the network. The previous root node will disconnect from the router **whilst maintaining all of its downstream connections** and enter the idle state. The previous root node will then begin scanning for potential parent nodes and selecting a preferred parent.

The following diagram illustrates an example of a root node switch.

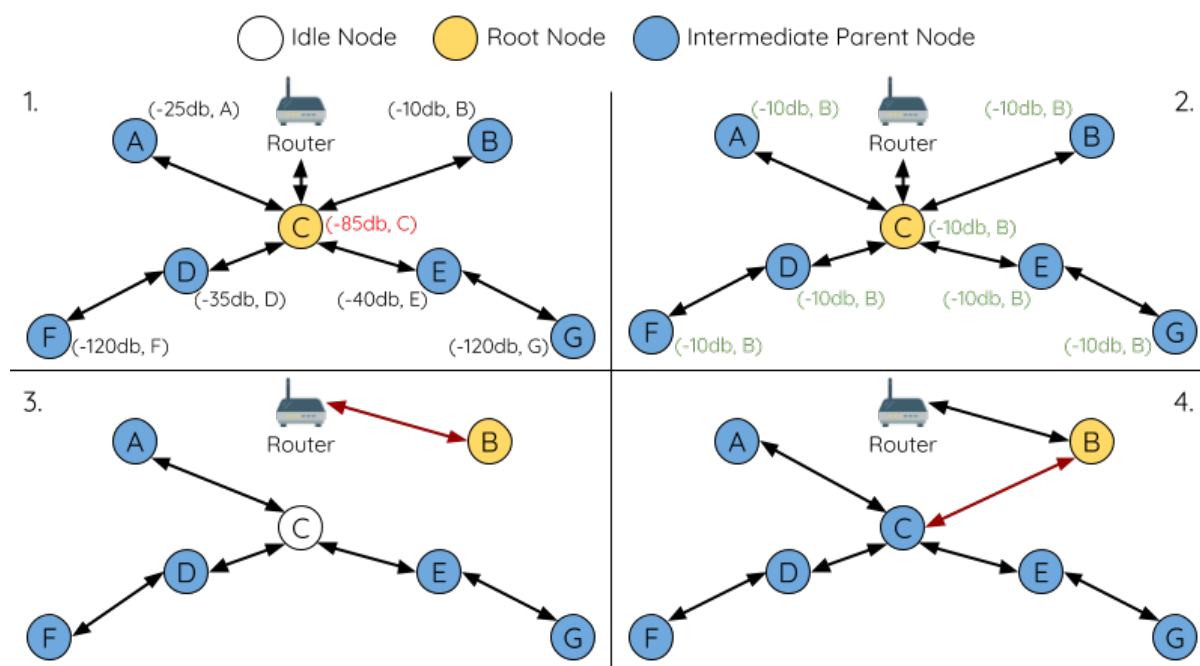

Fig. 29: Root Node Switch Example

1. Node C is the current root node but has degraded signal strength with the router (-85db). The node C triggers a new election and all nodes begin transmitting and scanning for beacon frames **whilst still being connected**.

2. After multiple rounds of transmission and scanning, node B is elected as the new root node. Node B sends node C a **switch request** and node C responds with an acknowledgment.

3. Node B disconnects from its parent and connects with the router becoming the network's new root node. Node C disconnects from the router, enters the idle state, and begins scanning for and selecting a new preferred parent node. **Node C maintains all its downstream connections throughout this process.**

4. Node C selects node B as its preferred parent node, forms an upstream connection, and becomes a second layer node. The network layout is similar after the switch as node C still maintains the same subnetwork. However each node in node C's subnetwork has been placed one layer deeper as a result of the switch. [Parent Node Switching](#) may adjust the network layout afterwards if any nodes have a new preferred parent node as a result of the root node switch.

Note: Root node switching must require an election hence is only supported when using a self-organized ESP-MESH network. In other words, root node switching cannot occur if a designated root node is used.

Parent Node Switching

Parent Node Switching entails a child node switching its upstream connection to another parent node of a shallower layer. **Parent Node Switching occurs autonomously** meaning that a child node will change its upstream connection automatically if a potential parent node of a shallower layer becomes available (i.e. due to a *Asynchronous Power-on Reset*).

All potential parent nodes periodically transmit beacon frames (see *Beacon Frames & RSSI Thresholding*) allowing for a child node to scan for the availability of a shallower parent node. Due to parent node switching, a self-organized ESP-MESH network can dynamically adjust its network layout to ensure each connection has a good RSSI and that the number of layers in the network is minimized.

4.9.6 Data Transmission

ESP-MESH Packet

ESP-MESH network data transmissions use ESP-MESH packets. ESP-MESH packets are **entirely contained within the frame body of a Wi-Fi data frame**. A multi-hop data transmission in an ESP-MESH network will involve a single ESP-MESH packet being carried over each wireless hop by a different Wi-Fi data frame.

The following diagram shows the structure of an ESP-MESH packet and its relation with a Wi-Fi data frame.

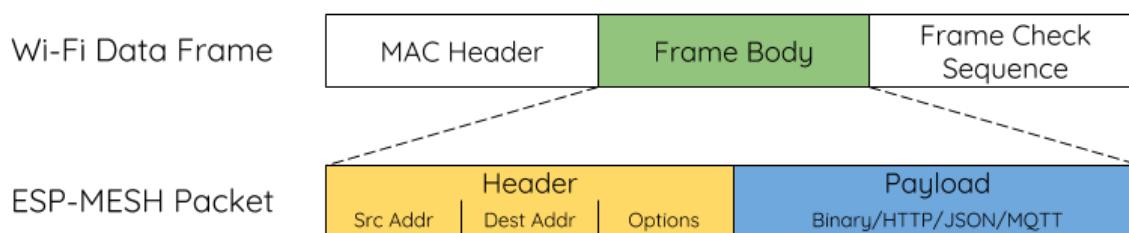

Fig. 30: ESP-MESH Packet

The header of an ESP-MESH packet contains the MAC addresses of the source and destination nodes. The options field contains information pertaining to the special types of ESP-MESH packets such as a group transmission or a packet originating from the external IP network (see *MESH_OPT_SEND_GROUP* and *MESH_OPT_RECV_DS_ADDR*).

The payload of an ESP-MESH packet contains the actual application data. This data can be raw binary data, or encoded under an application layer protocol such as HTTP, MQTT, and JSON (see *mesh_proto_t*).

Note: When sending an ESP-MESH packet to the external IP network, the destination address field of the header will contain the IP address and port of the target server rather than the MAC address of a node (see *mesh_addr_t*). Furthermore the root node will handle the formation of the outgoing TCP/IP packet.

Group Control & Multicasting

Multicasting is a feature that allows a single ESP-MESH packet to be transmitted simultaneously to multiple nodes within the network. Multicasting in ESP-MESH can be achieved by either specifying a list of target nodes, or specifying a preconfigured group of nodes. Both methods of multicasting are called via *esp_mesh_send()*.

To multicast by specifying a list of target nodes, users must first set the ESP-MESH packet's destination address to the **Multicast-Group Address** (01:00:5E:xx:xx:xx). This signifies that the ESP-MESH packet is a multicast packet with a group of addresses, and that the address should be obtained from the header options. Users must then list the MAC addresses of the target nodes as options (see *mesh_opt_t* and *MESH_OPT_SEND_GROUP*). This

method of multicasting requires no prior setup but can incur a large amount of overhead data as each target node's MAC address must be listed in the options field of the header.

Multicasting by group allows a ESP-MESH packet to be transmitted to a preconfigured group of nodes. Each grouping is identified by a unique ID, and a node can be placed into a group via `esp_mesh_set_group_id()`. Multicasting to a group involves setting the destination address of the ESP-MESH packet to the target group ID. Furthermore, the `MESH_DATA_GROUP` flag must set. Using groups to multicast incurs less overhead, but requires nodes to previously added into groups.

Note: During a multicast, all nodes within the network still receive the ESP-MESH packet on the MAC layer. However, nodes not included in the MAC address list or the target group will simply filter out the packet.

Broadcasting

Broadcasting is a feature that allows a single ESP-MESH packet to be transmitted simultaneously to all nodes within the network. Each node essentially forwards a broadcast packet to all of its upstream and downstream connections such that the packet propagates throughout the network as quickly as possible. However, ESP-MESH utilizes the following methods to avoid wasting bandwidth during a broadcast.

1. When an intermediate parent node receives a broadcast packet from its parent, it will forward the packet to each of its child nodes whilst storing a copy of the packet for itself.
2. When an intermediate parent node is the source node of the broadcast, it will transmit the broadcast packet upstream to its parent node and downstream to each of its child nodes.
3. When an intermediate parent node receives a broadcast packet from one of its child nodes, it will forward the packet to its parent node and each of its remaining child nodes whilst storing a copy of the packet for itself.
4. When a leaf node is the source node of a broadcast, it will directly transmit the packet to its parent node.
5. When the root node is the source node of a broadcast, the root node will transmit the packet to all of its child nodes.
6. When the root node receives a broadcast packet from one of its child nodes, it will forward the packet to each of its remaining child nodes whilst storing a copy of the packet for itself.
7. When a node receives a broadcast packet with a source address matching its own MAC address, the node will discard the broadcast packet.
8. When an intermediate parent node receives a broadcast packet from its parent node which was originally transmitted from one of its child nodes, it will discard the broadcast packet

Upstream Flow Control

ESP-MESH relies on parent nodes to control the upstream data flow of their immediate child nodes. To prevent a parent node's message buffer from overflowing due to an overload of upstream transmissions, a parent node will allocate a quota for upstream transmissions known as a **receiving window** for each of its child nodes. **Each child node must apply for a receiving window before it is permitted to transmit upstream.** The size of a receiving window can be dynamically adjusted. An upstream transmission from a child node to the parent node consists of the following steps:

1. Before each transmission, the child node sends a window request to its parent node. The window request consists of a sequence number which corresponds to the child node's data packet that is pending transmission.
2. The parent node receives the window request and compares the sequence number with the sequence number of the previous packet sent by the child node. The comparison is used to calculate the size of the receiving window which is transmitted back to the child node.
3. The child node transmits the data packet in accordance with the window size specified by the parent node. If the child node depletes its receiving window, it must obtain another receiving windows by sending a request before it is permitted to continue transmitting.

Note: ESP-MESH does not support any downstream flow control.

Warning: Due to *Parent Node Switching*, packet loss may occur during upstream transmissions.

Due to the fact that the root node acts as the sole interface to an external IP network, it is critical that downstream nodes are aware of the root node's connection status with the external IP network. Failing to do so can lead to nodes attempting to pass data upstream to the root node whilst it is disconnected from the IP network. This results in unnecessary transmissions and packet loss. ESP-MESH address this issue by providing a mechanism to stabilize the throughput of outgoing data based on the connection status between the root node and the external IP network. The root node can broadcast its external IP network connection status to all other nodes by calling `esp_mesh_post_toDS_state()`.

Bi-Directional Data Stream

The following diagram illustrates the various network layers involved in an ESP-MESH Bidirectional Data Stream.

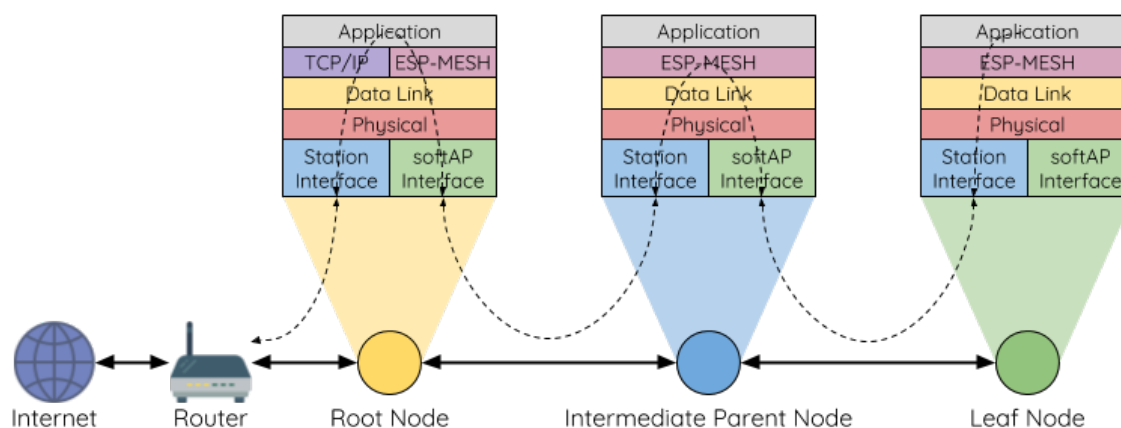

Fig. 31: ESP-MESH Bidirectional Data Stream

Due to the use of *Routing Tables*, **ESP-MESH is able to handle pack forwarding entirely on the mesh layer**. A TCP/IP layer is only required on the root node when it transmits/receives a packet to/from an external IP network.

4.9.7 Channel Switching

Background

In traditional Wi-Fi networks, **channels** are predetermined frequency ranges. In an infrastructure basic service set (BSS), the serving AP and its connected stations must be on the same operating channels (1 to 14) in which beacons are transmitted. Physically adjacent BSS (Basic Service Sets) operating on the same channel can lead to interference and degraded performance.

In order to allow a BSS adapt to changing physical layer conditions and maintain performance, Wi-Fi contains mechanisms for **network channel switching**. A network channel switch is an attempt to move a BSS to a new operating channel whilst minimizing disruption to the BSS during this process. However it should be recognized that a channel switch may be unsuccessful in moving all stations to the new operating channel.

In an infrastructure Wi-Fi network, network channel switches are triggered by the AP with the aim of having the AP and all connected stations synchronously switch to a new channel. Network channel switching is implemented by embedding a **Channel Switch Announcement (CSA)** element within the AP's periodically transmitted beacon

frames. The CSA element is used to advertise to all connected stations regarding an upcoming network channel switch and will be included in multiple beacon frames up until the switch occurs.

A CSA element contains information regarding the **New Channel Number** and a **Channel Switch Count** which indicates the number of beacon frame intervals (TBTTs) remaining until the network channel switch occurs. Therefore, the Channel Switch Count is decremented every beacon frame and allows connected stations to synchronize their channel switch with the AP.

ESP-MESH Network Channel Switching

ESP-MESH Network Channel Switching also utilize beacon frames that contain a CSA element. However, being a multi-hop network makes the switching process in ESP-MESH is more complex due to the fact that a beacon frame might not be able to reach all nodes within the network (i.e. in a single hop). Therefore, an ESP-MESH network relies on nodes to forward the CSA element so that it is propagated throughout the network.

When an intermediate parent node with one or more child nodes receives a beacon frame containing a CSA, the node will forward the CSA element by including the element in its next transmitted beacon frame (i.e. with the same **New Channel Number** and **Channel Switch Count**). Given that all nodes within an ESP-MESH network receive the same CSA, the nodes can synchronize their channel switches using the Channel Switch Count, albeit with a short delay due to CSA element forwarding.

An ESP-MESH network channel switch can be triggered by either the router or the root node.

Root Node Triggered A root node triggered channel switch can only occur when the ESP-MESH network is not connected to a router. By calling `esp_mesh_switch_channel()`, the root node will set an initial Channel Switch Count value and begin including a CSA element in its beacon frames. Each CSA element is then received by second layer nodes, and forwarded downstream in the their own beacon frames.

Router Triggered When an ESP-MESH network is connected to a router, the entire network must use the same channel as the router. Therefore, **the root node will not be permitted to trigger a channel switch when it is connected to a router.**

When the root node receives beacon frame containing a CSA element from the router, **the root node will set Channel Switch Count value in the CSA element to a custom value before forwarding it downstream via beacon frames.** It will also decrement the Channel Switch Count of subsequent CSA elements relative to the custom value. This custom value can be based on factors such as the number of network layers, the current number of nodes etc.

The setting the Channel Switch Count value to a custom value is due to the fact that the ESP-MESH network and its router may have a different and varying beacon intervals. Therefore, the Channel Switch Count value provided by the router is irrelevant to an ESP-MESH network. By using a custom value, nodes within the ESP-MESH network are able to switch channels synchronously relative to the ESP-MESH network's beacon interval. However, this will also result in the ESP-MESH network's channel switch being unsynchronized with the channel switch of the router and its connected stations.

Impact of Network Channel Switching

- **Due to the ESP-MESH network channel switch being unsynchronized with the router's channel switch, there will be**
 - The ESP-MESH network's channel switch time is dependent on the ESP-MESH network's beacon interval and the root node's custom Channel Switch Count value.
 - The channel discrepancy prevents any data exchange between the root node and the router during that ESP-MESH network's switch.
 - In the ESP-MESH network, the root node and intermediate parent nodes will request their connected child nodes to stop transmissions until the channel switch takes place by setting the **Channel Switch Mode** field in the CSA element to 1.
 - Frequent router triggered network channel switches can degrade the ESP-MESH network's performance. Note that this can be caused by the ESP-MESH network itself (e.g. due to wireless medium

contention with ESP-MESH network). If this is the case, users should disable the automatic channel switching on the router and use a specified channel instead.

- **When there is a temporary channel discrepancy, the root node remains technically connected to the router.**
 - Disconnection occurs after the root node fails to receive any beacon frames or probe responses from the router over a fixed number of router beacon intervals.
 - Upon disconnection, the root node will automatically re-scan all channels for the presence of a router.
- **If the root node is unable to receive any of the router's CSA beacon frames (e.g. due to short switch time given by the router).**
 - After the router switches channels, the root node will no longer be able to receive the router's beacon frames and probe responses and result in a disconnection after a fixed number of beacon intervals.
 - The root node will re-scan all channels for the router after disconnection.
 - The root node will maintain downstream connections throughout this process.

Note: Although ESP-MESH network channel switching aims to move all nodes within the network to a new operating channel, it should be recognized that a channel switch might not successfully move all nodes (e.g. due to reasons such as node failures).

Channel and Router Switching Configuration

ESP-MESH allows for autonomous channel switching to be enabled/disabled via configuration. Likewise, autonomous router switching (i.e. when a root node autonomously connects to another router) can also be enabled/disabled by configuration. Autonomous channel switching and router switching is dependent on the following configuration parameters and run-time conditions.

Allow Channel Switch: This parameter is set via the `allow_channel_switch` field of the `mesh_cfg_t` structure and permits an ESP-MESH network to dynamically switch channels when set.

Preset Channel: An ESP-MESH network can have a preset channel by setting the `channel` field of the `mesh_cfg_t` structure to the desired channel number. If this field is unset, the `allow_channel_switch` parameter is overridden such that channel switches are always permitted.

Allow Router Switch: This parameter is set via the `allow_router_switch` field of the `mesh_router_t` and permits an ESP-MESH to dynamically switch to a different router when set.

Preset Router BSSID: An ESP-MESH network can have a preset router by setting the `bssid` field of the `mesh_router_t` structure to the BSSID of the desired router. If this field is unset, the `allow_router_switch` parameter is overridden such that router switches are always permitted.

Root Node Present: The presence of a root node will also affect whether or a channel or router switch is permitted.

The following table illustrates how the different combinations of parameters/conditions affect whether channel switching and/or router switching is permitted. Note that X represents a “don't care” for the parameter.

Preset Channel	Allow Channel Switch	Preset Router BSSID	Allow Router Switch	Root Node Present	Permitted Switches ?
N	X	N	X	X	Channel and Router
N	X	Y	N	X	Channel Only
N	X	Y	Y	X	Channel and Router
Y	Y	N	X	X	Channel and Router
Y	N	N	X	N	Router Only
Y	N	N	X	Y	Channel and Router
Y	Y	Y	N	X	Channel Only
Y	N	Y	N	N	N
Y	N	Y	N	Y	Channel Only
Y	Y	Y	Y	X	Channel and Router
Y	N	Y	Y	N	Router Only
Y	N	Y	Y	Y	Channel and Router

4.9.8 Performance

The performance of an ESP-MESH network can be evaluated based on multiple metrics such as the following:

Network Building Time: The amount of time taken to build an ESP-MESH network from scratch.

Healing Time: The amount of time taken for the network to detect a node break down and carry out appropriate actions to heal the network (such as generating a new root node or forming new connections).

Per-hop latency: The latency of data transmission over one wireless hop. In other words, the time taken to transmit a data packet from a parent node to a child node or vice versa.

Network Node Capacity: The total number of nodes the ESP-MESH network can simultaneously support. This number is determined by the maximum number of downstream connections a node can accept and the maximum number of layers permissible in the network.

The following table lists the common performance figures of an ESP-MESH network:

- Network Building Time: < 60 seconds
- **Healing time:**
 - Root node break down: < 10 seconds
 - Child node break down: < 5 seconds
- Per-hop latency: 10 to 30 milliseconds

Note: The following test conditions were used to generate the performance figures above.

- Number of test devices: **100**
- Maximum Downstream Connections to Accept: **6**
- Maximum Permissible Layers: **6**

Note: Throughput depends on packet error rate and hop count.

Note: The throughput of root node's access to the external IP network is directly affected by the number of nodes in the ESP-MESH network and the bandwidth of the router.

Note: The performance figures can vary greatly between installations based on network configuration and operating environment.

4.9.9 Further Notes

- Data transmission uses Wi-Fi WPA2-PSK encryption
- Mesh networking IE uses AES encryption

Router and internet icon made by Smashicons from www.flaticon.com

4.10 Core Dump

4.10.1 Overview

ESP-IDF provides support to generate core dumps on unrecoverable software errors. This useful technique allows post-mortem analysis of software state at the moment of failure. Upon the crash system enters panic state, prints some information and halts or reboots depending configuration. User can choose to generate core dump in order to analyse the reason of failure on PC later on. Core dump contains snapshots of all tasks in the system at the moment of failure. Snapshots include tasks control blocks (TCB) and stacks. So it is possible to find out what task, at what instruction (line of code) and what callstack of that task lead to the crash. It is also possible dumping variables content on demand if previously attributed accordingly. ESP-IDF provides special script *espcoredump.py* to help users to retrieve and analyse core dumps. This tool provides two commands for core dumps analysis:

- `info_corefile` - prints crashed task's registers, callstack, list of available tasks in the system, memory regions and contents of memory stored in core dump (TCBs and stacks)
- `dbg_corefile` - creates core dump ELF file and runs GDB debug session with this file. User can examine memory, variables and tasks states manually. Note that since not all memory is saved in core dump only values of variables allocated on stack will be meaningful

For more information about core dump internals see the - Core dump internals

4.10.2 Configurations

There are a number of core dump related configuration options which user can choose in project configuration menu (`idf.py menuconfig`).

Core dump data destination (Components -> Core dump -> Data destination)

- Save core dump to Flash (Flash)
- Print core dump to UART (UART)
- Disable core dump generation (None)

Core dump data format (Components -> Core dump -> Core dump data format)

- ELF format (Executable and Linkable Format file for core dump)
- Binary format (Basic binary format for core dump)

The ELF format contains extended features and allow to save more information about broken tasks and crashed software but it requires more space in the flash memory. This format of core dump is recommended for new software designs and is flexible enough to extend saved information for future revisions.

The Binary format is kept for compatibility standpoint, it uses less space in the memory to keep data and provides better performance.

Core dump data integrity check (Components -> Core dump -> Core dump data integrity check)

- Use CRC32 for core dump integrity verification

Maximum number of tasks snapshots in core dump (Components -> Core dump -> Maximum number of tasks)

Delay before core dump is printed to UART (Components -> Core dump -> Delay before print to UART)

The value is in ms.

Handling of UART core dumps in IDF Monitor (Components -> Core dump -> Delay before print to UART)

The value is base64 encoded.

- Decode and show summary (info_corefile)
- Don't decode

Reserved stack size (Components -> Core dump -> Reserved stack size)

Size of the memory to be reserved for core dump stack. If 0 core dump process will run on the stack of crashed task/ISR, otherwise special stack will be allocated. To ensure that core dump itself will not overflow task/ISR stack set this to the value above 800.

4.10.3 Save core dump to flash

When this option is selected core dumps are saved to special partition on flash. When using default partition table files which are provided with ESP-IDF it automatically allocates necessary space on flash, But if user wants to use its own layout file together with core dump feature it should define separate partition for core dump as it is shown below:

```
# Name, Type, SubType, Offset, Size
# Note: if you have increased the bootloader size, make sure to update the offsets.
↳to avoid overlap
nvs, data, nvs, 0x9000, 0x6000
phy_init, data, phy, 0xf000, 0x1000
factory, app, factory, 0x10000, 1M
coredump, data, coredump,, 64K
```

There are no special requirements for partition name. It can be chosen according to the user application needs, but partition type should be 'data' and sub-type should be 'coredump'. Also when choosing partition size note that core dump data structure introduces constant overhead of 20 bytes and per-task overhead of 12 bytes. This overhead does not include size of TCB and stack for every task. So partition size should be at least 20 + max tasks number x (12 + TCB size + max task stack size) bytes.

The example of generic command to analyze core dump from flash is: `espcoredump.py -p </path/to/serial/port> info_corefile </path/to/program/elf/file>` or `espcoredump.py -p </path/to/serial/port> dbg_corefile </path/to/program/elf/file>`

4.10.4 Print core dump to UART

When this option is selected base64-encoded core dumps are printed on UART upon system panic. In this case user should save core dump text body to some file manually and then run the following command: `espcoredump.py --chip <target_chip_type> info_corefile -t b64 -c </path/to/saved/base64/text> </path/to/program/elf/file>` or `espcoredump.py --chip <target_chip_type> dbg_corefile -t b64 -c </path/to/saved/base64/text> </path/to/program/elf/file>`

Base64-encoded body of core dump will be between the following header and footer:

```
===== CORE DUMP START =====
<body of base64-encoded core dump, save it to file on disk>
===== CORE DUMP END =====
```

The CORE DUMP START and CORE DUMP END lines must not be included in core dump text file.

4.10.5 ROM Functions in Backtraces

It is possible situation that at the moment of crash some tasks or/and crashed task itself have one or more ROM functions in their callstacks. Since ROM is not part of the program ELF it will be impossible for GDB to parse such callstacks, because it tries to analyse functions' prologues to accomplish that. In that case callstack printing will be broken with error message at the first ROM function. To overcome this issue you can use ROM ELF provided by Espressif (https://dl.espressif.com/dl/esp32c3_rev3_rom.elf) and pass it to 'espcoredump.py'.

4.10.6 Dumping variables on demand

Sometimes you want to read the last value of a variable to understand the root cause of a crash. Core dump supports retrieving variable data over GDB by attributing special notations declared variables.

Supported notations and RAM regions

- COREDUMP_DRAM_ATTR places variable into DRAM area which will be included into dump.
- COREDUMP_RTC_ATTR places variable into RTC area which will be included into dump.
- COREDUMP_RTC_FAST_ATTR places variable into RTC_FAST area which will be included into dump.

Example

1. In *Project Configuration Menu*, enable *COREDUMP TO FLASH*, then save and exit.
2. In your project, create a global variable in DRAM area as such as:

```
// uint8_t global_var;
COREDUMP_DRAM_ATTR uint8_t global_var;
```

3. In main application, set the variable to any value and `assert(0)` to cause a crash.

```
global_var = 25;
assert(0);
```

4. Build, flash and run the application on a target device and wait for the dumping information.
5. Run the command below to start core dumping in GDB, where `PORT` is the device USB port:

```
espcoredump.py -p PORT dbg_corefile <path/to/elf>
```

6. In GDB shell, type `p global_var` to get the variable content:

```
(gdb) p global_var
$1 = 25 '\031'
```

4.10.7 Running espcoredump.py

Generic command syntax: `espcoredump.py [options] command [args]`

Script Options

- chip {auto,esp32,esp32s2,esp32c3} Target chip type. Default value is “auto”
- port PORT, -p PORT Serial port device. Either “chip” or “port” need to be specified to determine the port when you have multi-target connected at the same time.
- baud BAUD, -b BAUD Serial port baud rate used when flashing/reading
- gdb-timeout-sec GDB_TIMEOUT_SEC Overwrite the default internal delay for gdb responses

Commands `dbg_corefile` Starts GDB debugging session with specified corefile

`info_corefile` Print core dump info from file

Command Arguments

- debug DEBUG, -d DEBUG** Log level (0..3)
- gdb GDB, -g GDB** Path to gdb
- core CORE, -c CORE** Path to core dump file (if skipped core dump will be read from flash)
- core-format {b64,elf,raw}, -t {b64,elf,raw}** File specified with “-c” is an ELF (“elf”), raw (raw) or base64-encoded (b64) binary
- off OFF, -o OFF** Offset of coredump partition in flash (type “make partition_table” to see).
- save-core SAVE_CORE, -s SAVE_CORE** Save core to file. Otherwise temporary core file will be deleted. Does not work with “-c”
- rom-elf ROM_ELF, -r ROM_ELF** Path to ROM ELF file. Will use “<target>_rom.elf” if not specified
- print-mem, -m** Print memory dump. Only valid when info_corefile.
- <prog>** Path to program ELF file.

4.11 Event Handling

Several ESP-IDF components use *events* to inform application about state changes, such as connection or disconnection. This document gives an overview of these event mechanisms.

4.11.1 Wi-Fi, Ethernet, and IP Events

Before the introduction of *esp_event library*, events from Wi-Fi driver, Ethernet driver, and TCP/IP stack were dispatched using the so-called *legacy event loop*. The following sections explain each of the methods.

esp_event Library Event Loop

esp_event library is designed to supersede the legacy event loop for the purposes of event handling in ESP-IDF. In the legacy event loop, all possible event types and event data structures had to be defined in *system_event_id_t* enumeration and *system_event_info_t* union, which made it impossible to send custom events to the event loop, and use the event loop for other kinds of events (e.g. Mesh). Legacy event loop also supported only one event handler function, therefore application components could not handle some of Wi-Fi or IP events themselves, and required application to forward these events from its event handler function.

See *esp_event library API reference* for general information on using this library. Wi-Fi, Ethernet, and IP events are sent to the *default event loop* provided by this library.

Legacy Event Loop

This event loop implementation is started using *esp_event_loop_init()* function. Application typically supplies an *event handler*, a function with the following signature:

```
esp_err_t event_handler(void *ctx, system_event_t *event)
{
}
```

Both the pointer to event handler function, and an arbitrary context pointer are passed to *esp_event_loop_init()*.

When Wi-Fi, Ethernet, or IP stack generate an event, this event is sent to a high-priority *event* task via a queue. Application-provided event handler function is called in the context of this task. Event task stack size and event queue size can be adjusted using *CONFIG_ESP_SYSTEM_EVENT_TASK_STACK_SIZE* and *CONFIG_ESP_SYSTEM_EVENT_QUEUE_SIZE* options, respectively.

Event handler receives a pointer to the event structure (*system_event_t*) which describes current event. This structure follows a *tagged union* pattern: *event_id* member indicates the type of event, and *event_info* member is a union of description structures. Application event handler will typically use `switch(event->event_id)` to handle different kinds of events.

If application event handler needs to relay the event to some other task, it is important to note that event pointer passed to the event handler is a pointer to temporary structure. To pass the event to another task, application has to make a copy of the entire structure.

Event IDs and Corresponding Data Structures

Event ID (legacy event ID)	Event data structure
Wi-Fi	
WIFI_EVENT_WIFI_READY (SYSTEM_EVENT_WIFI_READY)	n/a
WIFI_EVENT_SCAN_DONE (SYSTEM_EVENT_SCAN_DONE)	<i>wifi_event_sta_scan_done_t</i>
WIFI_EVENT_STA_START (SYSTEM_EVENT_STA_START)	n/a
WIFI_EVENT_STA_STOP (SYSTEM_EVENT_STA_STOP)	n/a
WIFI_EVENT_STA_CONNECTED (SYSTEM_EVENT_STA_CONNECTED)	<i>wifi_event_sta_connected_t</i>
WIFI_EVENT_STA_DISCONNECTED (SYSTEM_EVENT_STA_DISCONNECTED)	<i>wifi_event_sta_disconnected_t</i>
WIFI_EVENT_STA_AUTHMODE_CHANGE (SYSTEM_EVENT_STA_AUTHMODE_CHANGE)	<i>wifi_event_sta_authmode_change_t</i>
WIFI_EVENT_STA_WPS_ER_SUCCESS (SYSTEM_EVENT_STA_WPS_ER_SUCCESS)	n/a
WIFI_EVENT_STA_WPS_ER_FAILED (SYSTEM_EVENT_STA_WPS_ER_FAILED)	<i>wifi_event_sta_wps_fail_reason_t</i>
WIFI_EVENT_STA_WPS_ER_TIMEOUT (SYSTEM_EVENT_STA_WPS_ER_TIMEOUT)	n/a
WIFI_EVENT_STA_WPS_ER_PIN (SYSTEM_EVENT_STA_WPS_ER_PIN)	<i>wifi_event_sta_wps_er_pin_t</i>
WIFI_EVENT_AP_START (SYSTEM_EVENT_AP_START)	n/a
WIFI_EVENT_AP_STOP (SYSTEM_EVENT_AP_STOP)	n/a
WIFI_EVENT_AP_STACONNECTED (SYSTEM_EVENT_AP_STACONNECTED)	<i>wifi_event_ap_staconnected_t</i>
WIFI_EVENT_AP_STADISCONNECTED (SYSTEM_EVENT_AP_STADISCONNECTED)	<i>wifi_event_ap_stadisconnected_t</i>
WIFI_EVENT_AP_PROBEREQRCVD (SYSTEM_EVENT_AP_PROBEREQRCVD)	<i>wifi_event_ap_probe_req_rx_t</i>
Ethernet	
ETHERNET_EVENT_START (SYSTEM_EVENT_ETH_START)	n/a
ETHERNET_EVENT_STOP (SYSTEM_EVENT_ETH_STOP)	n/a
ETHERNET_EVENT_CONNECTED (SYSTEM_EVENT_ETH_CONNECTED)	n/a
ETHERNET_EVENT_DISCONNECTED (SYSTEM_EVENT_ETH_DISCONNECTED)	n/a
IP	
IP_EVENT_STA_GOT_IP (SYSTEM_EVENT_STA_GOT_IP)	<i>ip_event_got_ip_t</i>
IP_EVENT_STA_LOST_IP (SYSTEM_EVENT_STA_LOST_IP)	n/a
IP_EVENT_AP_STAIPASSIGNED (SYSTEM_EVENT_AP_STAIPASSIGNED)	n/a
IP_EVENT_GOT_IP6 (SYSTEM_EVENT_GOT_IP6)	<i>ip_event_got_ip6_t</i>
IP_EVENT_ETH_GOT_IP (SYSTEM_EVENT_ETH_GOT_IP)	<i>ip_event_got_ip_t</i>

4.11.2 Mesh Events

ESP-MESH uses a system similar to the *Legacy Event Loop* to deliver events to the application. See *System Events* for details.

4.11.3 Bluetooth Events

Various modules of the Bluetooth stack deliver events to applications via dedicated callback functions. Callback functions receive the event type (enumerated value) and event data (union of structures for each event type). The following list gives the registration API name, event enumeration type, and event parameters type.

- BLE GAP: `esp_ble_gap_register_callback()`, `esp_gap_ble_cb_event_t`, `esp_ble_gap_cb_param_t`.
- BT GAP: `esp_bt_gap_register_callback()`, `esp_bt_gap_cb_event_t`, `esp_bt_gap_cb_param_t`.
- GATT: `esp_ble_gattc_register_callback()`, `esp_bt_gattc_cb_event_t`, `esp_bt_gattc_cb_param_t`.
- GATTS: `esp_ble_gatts_register_callback()`, `esp_bt_gatts_cb_event_t`, `esp_bt_gatts_cb_param_t`.
- SPP: `esp_spp_register_callback()`, `esp_spp_cb_event_t`, `esp_spp_cb_param_t`.
- Blufi: `esp_blufi_register_callbacks()`, `esp_blufi_cb_event_t`, `esp_blufi_cb_param_t`.
- A2DP: `esp_a2d_register_callback()`, `esp_a2d_cb_event_t`, `esp_a2d_cb_param_t`.
- AVRC: `esp_avrc_ct_register_callback()`, `esp_avrc_ct_cb_event_t`, `esp_avrc_ct_cb_param_t`.
- HFP Client: `esp_hf_client_register_callback()`, `esp_hf_client_cb_event_t`, `esp_hf_client_cb_param_t`.
- HFP AG: `esp_hf_ag_register_callback()`, `esp_hf_ag_cb_event_t`, `esp_hf_ag_cb_param_t`.

4.12 Fatal Errors

4.12.1 Overview

In certain situations, execution of the program can not be continued in a well defined way. In ESP-IDF, these situations include:

- CPU Exceptions: Illegal Instruction, Load/Store Alignment Error, Load/Store Prohibited error.
- System level checks and safeguards:
 - *Interrupt watchdog* timeout
 - *Task watchdog* timeout (only fatal if `CONFIG_ESP_TASK_WDT_PANIC` is set)
 - Cache access error
 - Brownout detection event
 - Stack overflow
 - Stack smashing protection check
 - Heap integrity check
- Failed assertions, via `assert`, `configASSERT` and similar macros.

This guide explains the procedure used in ESP-IDF for handling these errors, and provides suggestions on troubleshooting the errors.

4.12.2 Panic Handler

Every error cause listed in the *Overview* will be handled by *panic handler*.

Panic handler will start by printing the cause of the error to the console. For CPU exceptions, the message will be similar to

```
Guru Meditation Error: Core 0 panic'ed (Illegal instruction). Exception_
↳was unhandled.
```

For some of the system level checks (interrupt watchdog, cache access error), the message will be similar to

```
Guru Meditation Error: Core 0 panic'ed (Cache error). Exception was_
↳unhandled.
```

In all cases, error cause will be printed in parentheses. See [Guru Meditation Errors](#) for a list of possible error causes.

Subsequent behavior of the panic handler can be set using `CONFIG_ESP_SYSTEM_PANIC` configuration choice. The available options are:

- Print registers and reboot (`CONFIG_ESP_SYSTEM_PANIC_PRINT_REBOOT`) —default option. This will print register values at the point of the exception, print the backtrace, and restart the chip.
- Print registers and halt (`CONFIG_ESP_SYSTEM_PANIC_PRINT_HALT`) Similar to the above option, but halt instead of rebooting. External reset is required to restart the program.
- Silent reboot (`CONFIG_ESP_SYSTEM_PANIC_SILENT_REBOOT`) Don't print registers or backtrace, restart the chip immediately.
- Invoke GDB Stub (`CONFIG_ESP_SYSTEM_PANIC_GDBSTUB`) Start GDB server which can communicate with GDB over console UART port. See [GDB Stub](#) for more details.

Behavior of panic handler is affected by two other configuration options.

- If `CONFIG_ESP32C3_DEBUG_OCDAWARE` is enabled (which is the default), panic handler will detect whether a JTAG debugger is connected. If it is, execution will be halted and control will be passed to the debugger. In this case registers and backtrace are not dumped to the console, and GDBStub / Core Dump functions are not used.
- If `Core Dump` feature is enabled, then system state (task stacks and registers) will be dumped either to Flash or UART, for later analysis.
- If `CONFIG_ESP_PANIC_HANDLER_IRAM` is disabled (disabled by default), the panic handler code is placed in flash memory not IRAM. This means that if ESP-IDF crashes while flash cache is disabled, the panic handler will automatically re-enable flash cache before running GDB Stub or Core Dump. This adds some minor risk, if the flash cache status is also corrupted during the crash. If this option is enabled, the panic handler code is placed in IRAM. This allows the panic handler to run without needing to re-enable cache first. This may be necessary to debug some complex issues with crashes while flash cache is disabled (for example, when writing to SPI flash).

The following diagram illustrates panic handler behavior:

4.12.3 Register Dump and Backtrace

Unless `CONFIG_ESP_SYSTEM_PANIC_SILENT_REBOOT` option is enabled, panic handler prints some of the CPU registers, and the backtrace, to the console

```
Core 0 register dump:
MEPC   : 0x420048b4  RA      : 0x420048b4  SP      : 0x3fc8f2f0  GP      : _
↳0x3fc8a600
TP     : 0x3fc8a2ac  T0     : 0x40057fa6  T1     : 0x0000000f  T2     : _
↳0x00000000
S0/FP  : 0x00000000  S1     : 0x00000000  A0     : 0x00000001  A1     : _
↳0x00000001
A2     : 0x00000064  A3     : 0x00000004  A4     : 0x00000001  A5     : _
↳0x00000000
A6     : 0x42001fd6  A7     : 0x00000000  S2     : 0x00000000  S3     : _
↳0x00000000
S4     : 0x00000000  S5     : 0x00000000  S6     : 0x00000000  S7     : _
↳0x00000000
S8     : 0x00000000  S9     : 0x00000000  S10    : 0x00000000  S11    : _
↳0x00000000
```

(continues on next page)

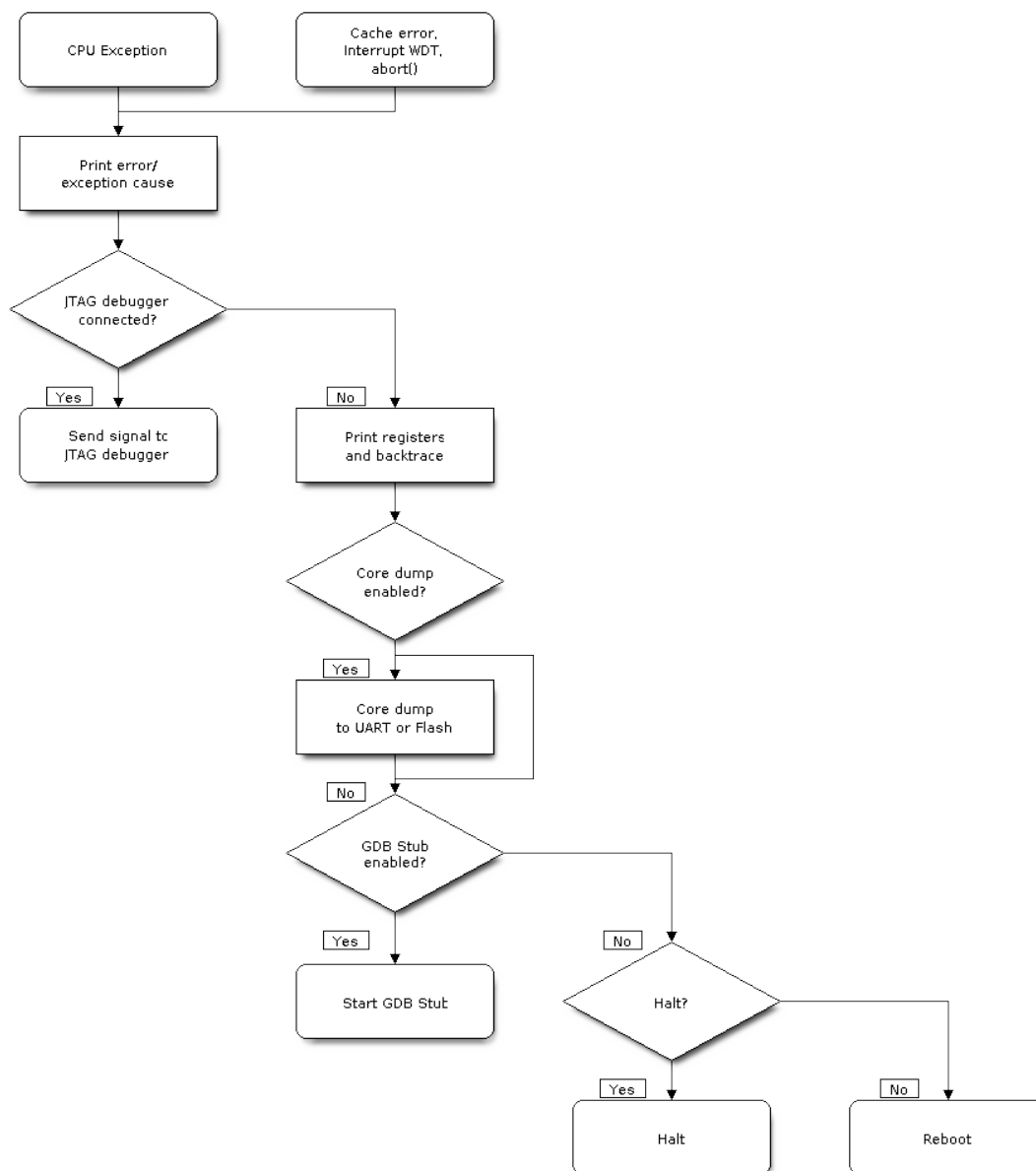

Fig. 32: Panic Handler Flowchart (click to enlarge)

(continued from previous page)

```

T3      : 0x00000000  T4      : 0x00000000  T5      : 0x00000000  T6      : _
↪0x00000000
MSTATUS : 0x00001881  MTVEC   : 0x40380001  MCAUSE  : 0x00000007  MTVAL   : _
↪0x00000000
MHARTID : 0x00000000

```

Register values printed are the register values in the exception frame, i.e. values at the moment when CPU exception or other fatal error has occurred.

Register dump is not printed if the panic handler was executed as a result of an `abort()` call.

If *IDF Monitor* is used, Program Counter values will be converted to code locations (function name, file name, and line number), and the output will be annotated with additional lines

```

Core 0 register dump:
MEPC    : 0x420048b4  RA      : 0x420048b4  SP      : 0x3fc8f2f0  GP      : _
↪0x3fc8a600
0x420048b4: app_main at /Users/user/esp/example/main/hello_world_main.c:20
0x420048b4: app_main at /Users/user/esp/example/main/hello_world_main.c:20

TP      : 0x3fc8a2ac  T0      : 0x40057fa6  T1      : 0x0000000f  T2      : _
↪0x00000000
S0/FP   : 0x00000000  S1      : 0x00000000  A0      : 0x00000001  A1      : _
↪0x00000001
A2      : 0x00000064  A3      : 0x00000004  A4      : 0x00000001  A5      : _
↪0x00000000
A6      : 0x42001fd6  A7      : 0x00000000  S2      : 0x00000000  S3      : _
↪0x00000000
0x42001fd6: uart_write at /Users/user/esp/esp-idf/components/vfs/vfs_uart.c:201

S4      : 0x00000000  S5      : 0x00000000  S6      : 0x00000000  S7      : _
↪0x00000000
S8      : 0x00000000  S9      : 0x00000000  S10     : 0x00000000  S11     : _
↪0x00000000
T3      : 0x00000000  T4      : 0x00000000  T5      : 0x00000000  T6      : _
↪0x00000000
MSTATUS : 0x00001881  MTVEC   : 0x40380001  MCAUSE  : 0x00000007  MTVAL   : _
↪0x00000000
MHARTID : 0x00000000

```

To find the location where a fatal error has happened, look at the lines which follow the “Backtrace” line. Fatal error location is the top line, and subsequent lines show the call stack.

4.12.4 GDB Stub

If `CONFIG_ESP_SYSTEM_PANIC_GDBSTUB` option is enabled, panic handler will not reset the chip when fatal error happens. Instead, it will start GDB remote protocol server, commonly referred to as GDB Stub. When this happens, GDB instance running on the host computer can be instructed to connect to the ESP32-C3 UART port.

If *IDF Monitor* is used, GDB is started automatically when GDB Stub prompt is detected on the UART. The output would look like this:

```

Entering gdb stub now.
$T0b#e6GNU gdb (crosstool-NG crosstool-ng-1.22.0-80-gff1f415) 7.10
Copyright (C) 2015 Free Software Foundation, Inc.
License GPLv3+: GNU GPL version 3 or later <http://gnu.org/licenses/gpl.html>
This is free software: you are free to change and redistribute it.
There is NO WARRANTY, to the extent permitted by law. Type "show copying"
and "show warranty" for details.

```

(continues on next page)

(continued from previous page)

```

This GDB was configured as "--host=x86_64-build_apple-darwin16.3.0 --
↳target=riscv32-esp-elf".
Type "show configuration" for configuration details.
For bug reporting instructions, please see:
<http://www.gnu.org/software/gdb/bugs/>.
Find the GDB manual and other documentation resources online at:
<http://www.gnu.org/software/gdb/documentation/>.
For help, type "help".
Type "apropos word" to search for commands related to "word"...
Reading symbols from /Users/user/esp/example/build/example.elf...done.
Remote debugging using /dev/cu.usbserial-31301
0x400e1b41 in app_main ()
    at /Users/user/esp/example/main/main.cpp:36
36      *((int*) 0) = 0;
(gdb)

```

GDB prompt can be used to inspect CPU registers, local and static variables, and arbitrary locations in memory. It is not possible to set breakpoints, change PC, or continue execution. To reset the program, exit GDB and perform external reset: Ctrl-T Ctrl-R in IDF Monitor, or using external reset button on the development board.

4.12.5 Guru Meditation Errors

This section explains the meaning of different error causes, printed in parens after Guru Meditation Error: Core panic'ed message.

Note: See [Wikipedia article](#) for historical origins of “Guru Meditation” .

Illegal instruction

This CPU exception indicates that the instruction which was executed was not a valid instruction. Most common reasons for this error include:

- FreeRTOS task function has returned. In FreeRTOS, if task function needs to terminate, it should call `vTaskDelete()` function and delete itself, instead of returning.
- Failure to load next instruction from SPI flash. This usually happens if:
 - Application has reconfigured SPI flash pins as some other function (GPIO, UART, etc.). Consult Hardware Design Guidelines and the Datasheet for the chip or module for details about SPI flash pins.
 - Some external device was accidentally connected to SPI flash pins, and has interfered with communication between ESP32-C3 and SPI flash.

Instruction address misaligned

This CPU exception indicates that the address of the instruction to execute is not 2-byte aligned.

Instruction access fault, Load access fault, Store access fault

This CPU exception happens when application attempts to execute, read from or write to an invalid memory location. The address which was written/read is found in `MTVAL` register in the register dump. If this address is zero, it usually means that application attempted to dereference a NULL pointer. If this address is close to zero, it usually means that application attempted to access member of a structure, but the pointer to the structure was NULL. If this address is something else (garbage value, not in `0x3fxxxxxx - 0x6xxxxxxx` range), it likely means that the pointer used to access the data was either not initialized or was corrupted.

Breakpoint

This CPU exception happens when the instruction EBREAK is executed.

Load address misaligned, Store address misaligned

Application has attempted to read or write memory location, and address alignment did not match load/store size. For example, 32-bit load can only be done from 4-byte aligned address, and 16-bit load can only be done from a 2-byte aligned address.

Interrupt wdt timeout on CPU0 / CPU1

Indicates that interrupt watchdog timeout has occurred. See [Watchdogs](#) for more information.

Cache error

In some situations ESP-IDF will temporarily disable access to external SPI Flash and SPI RAM via caches. For example, this happens with spi_flash APIs are used to read/write/erase/mmap regions of SPI Flash. In these situations, tasks are suspended, and interrupt handlers not registered with ESP_INTR_FLAG_IRAM are disabled. Make sure that any interrupt handlers registered with this flag have all the code and data in IRAM/DRAM. Refer to the [SPI flash API documentation](#) for more details.

4.12.6 Other Fatal Errors

Brownout

ESP32-C3 has a built-in brownout detector, which is enabled by default. Brownout detector can trigger system reset if supply voltage goes below safe level. Brownout detector can be configured using [CONFIG_ESP32C3_BROWNOUT_DET](#) and [CONFIG_ESP32C3_BROWNOUT_DET_LVL_SEL](#) options.

When brownout detector triggers, the following message is printed:

```
Brownout detector was triggered
```

Chip is reset after the message is printed.

Note that if supply voltage is dropping at a fast rate, only part of the message may be seen on the console.

Corrupt Heap

ESP-IDF heap implementation contains a number of run-time checks of heap structure. Additional checks (“Heap Poisoning”) can be enabled in menuconfig. If one of the checks fails, message similar to the following will be printed:

```
CORRUPT HEAP: Bad tail at 0x3ffe270a. Expected 0xbaad5678 got 0xbaac5678
assertion "head != NULL" failed: file "/Users/user/esp/esp-idf/components/heap/
↪multi_heap_poisoning.c", line 201, function: multi_heap_free
abort() was called at PC 0x400dca43 on core 0
```

Consult [Heap Memory Debugging](#) documentation for further information.

Stack Smashing

Stack smashing protection (based on GCC `-fstack-protector*` flags) can be enabled in ESP-IDF using [CONFIG_COMPILER_STACK_CHECK_MODE](#) option. If stack smashing is detected, message similar to the following will be printed:

```
Stack smashing protect failure!  
  
abort() was called at PC 0x400d2138 on core 0  
  
Backtrace: 0x4008e6c0:0x3ffc1780 0x4008e8b7:0x3ffc17a0 0x400d2138:0x3ffc17c0_  
↳0x400e79d5:0x3ffc17e0 0x400e79a7:0x3ffc1840 0x400e79df:0x3ffc18a0_  
↳0x400e2235:0x3ffc18c0 0x400e1916:0x3ffc18f0 0x400e19cd:0x3ffc1910_  
↳0x400e1a11:0x3ffc1930 0x400e1bb2:0x3ffc1950 0x400d2c44:0x3ffc1a80  
0
```

The backtrace should point to the function where stack smashing has occurred. Check the function code for unbounded access to local arrays.

4.13 Flash Encryption

This is a quick start guide to ESP32-C3's flash encryption feature. Using an application code example, it demonstrates how to test and verify flash encryption operations during development and production.

4.13.1 Introduction

Flash encryption is intended for encrypting the contents of the ESP32-C3's off-chip flash memory. Once this feature is enabled, firmware is flashed as plaintext, and then the data is encrypted in place on the first boot. As a result, physical readout of flash will not be sufficient to recover most flash contents.

With flash encryption enabled, the following types of data are encrypted by default:

- Firmware bootloader
- Partition Table
- All “app” type partitions

Other types of data can be encrypted conditionally:

- Any partition marked with the `encrypted` flag in the partition table. For details, see [Encrypted Partition Flag](#).
- Secure Boot bootloader digest if Secure Boot is enabled (see below).

Important: For production use, flash encryption should be enabled in the “Release” mode only.

Important: Enabling flash encryption limits the options for further updates of ESP32-C3. Before using this feature, read the document and make sure to understand the implications.

4.13.2 Relevant eFuses

The flash encryption operation is controlled by various eFuses available on ESP32-C3. The list of eFuses and their descriptions is given in the table below. The names in eFuse column are also used by `esp-fuse.py` tool. For usage in the eFuse API, modify the name by adding `ESP_EFUSE_`, for example: `esp_efuse_read_field_bit(ESP_EFUSE_**DISABLE_DL_ENCRYPT**)`.

Table 21: eFuses Used in Flash Encryption

eFuse	Description	Bit Depth	R/W Access Control Available	Default Value
BLOCK_KEYN	AES key storage. N is between 0 and 5.	256	Yes	x
KEY_PURPOSE_N	Controls the purpose of eFuse block BLOCK_KEYN, where N is between 0 and 5. For flash encryption the only valid value is 4 for XTS_AES_128_KEY.	4	Yes	0
DIS_DOWNLOAD_MANUAL_ENCRYPT	If set, disables flash encryption when in download bootmodes.	1	Yes	0
SPI_BOOT_CRYPT_CNT	Enables encryption and decryption, when an SPI boot mode is set. Feature is enabled if 1 or 3 bits are set in the eFuse, disabled otherwise.	3	Yes	0

Read and write access to eFuse bits is controlled by appropriate fields in the registers `WR_DIS` and `RD_DIS`. For more information on ESP32-C3 eFuses, see *eFuse manager*. To change protection bits of eFuse field using `espefuse.py`, use these two commands: `read_protect_efuse` and `write_protect_efuse`. Example `espefuse.py write_protect_efuse DISABLE_DL_ENCRYPT`.

4.13.3 Flash Encryption Process

Assuming that the eFuse values are in their default states and the firmware bootloader is compiled to support flash encryption, the flash encryption process executes as shown below:

1. On the first power-on reset, all data in flash is un-encrypted (plaintext). The ROM bootloader loads the firmware bootloader.
2. Firmware bootloader reads the `SPI_BOOT_CRYPT_CNT` eFuse value (0b000). Since the value is 0 (even number of bits set), it configures and enables the flash encryption block. For more information on the flash encryption block, see [ESP32-C3 Technical Reference Manual](#).
3. Firmware bootloader uses RNG (random) module to generate an 256 bit key and then writes it into `BLOCK_KEYN` eFuse. The software also updates the `KEY_PURPOSE_N` for the block where the key were stored. The key cannot be accessed via software as the write and read protection bits for `BLOCK_KEYN` eFuse are set. `KEY_PURPOSE_N` field is write-protected as well. The flash encryption operations happen entirely by hardware, and the key cannot be accessed via software.
4. Flash encryption block encrypts the flash contents - the firmware bootloader, applications and partitions marked as `encrypted`. Encrypting in-place can take time, up to a minute for large partitions.
5. Firmware bootloader sets the first available bit in `SPI_BOOT_CRYPT_CNT` (0b001) to mark the flash contents as encrypted. Odd number of bits is set.
6. For *Development Mode*, the firmware bootloader allows the UART bootloader to re-flash encrypted binaries. Also, the `SPI_BOOT_CRYPT_CNT` eFuse bits are NOT write-protected. In addition, the firmware bootloader by default sets the eFuse bits `DIS_DOWNLOAD_ICACHE`, `DIS_PAD_JTAG`, `DIS_USB_JTAG` and `DIS_LEGACY_SPI_BOOT`.
7. For *Release Mode*, the firmware bootloader sets all the eFuse bits set under development mode as well as `DIS_DOWNLOAD_MANUAL_ENCRYPT`. It also write-protects the `SPI_BOOT_CRYPT_CNT` eFuse bits. To modify this behavior, see [Enabling UART Bootloader Encryption/Decryption](#).
8. The device is then rebooted to start executing the encrypted image. The firmware bootloader calls the flash decryption block to decrypt the flash contents and then loads the decrypted contents into IRAM.

During the development stage, there is a frequent need to program different plaintext flash images and test the flash encryption process. This requires that Firmware Download mode is able to load new plaintext images as many times as it might be needed. However, during manufacturing or production stages, Firmware Download mode should not be allowed to access flash contents for security reasons.

Hence, two different flash encryption configurations were created: for development and for production. For details on these configurations, see Section [Flash Encryption Configuration](#).

4.13.4 Flash Encryption Configuration

The following flash encryption modes are available:

- *Development Mode* - recommended for use ONLY DURING DEVELOPMENT, as it does not prevent modification and possible readout of encrypted flash contents.
- *Release Mode* - recommended for manufacturing and production to prevent physical readout of encrypted flash contents.

This section provides information on the mentioned flash encryption modes and step by step instructions on how to use them.

Development Mode

During development, you can encrypt flash using either an ESP32-C3 generated key or external host-generated key.

Using ESP32-C3 Generated Key Development mode allows you to download multiple plaintext images using Firmware Download mode.

To test flash encryption process, take the following steps:

1. Ensure that you have an ESP32-C3 device with default flash encryption eFuse settings as shown in *Relevant eFuses*.

See how to check *ESP32-C3 Flash Encryption Status*.

2. In *Project Configuration Menu*, do the following:

- *Enable flash encryption on boot*
- *Select encryption mode (Development mode by default)*
- **ref** *Select UART ROM download mode <CONFIG_SECURE_UART_ROM_DL_MODE> (enabled by default.)*
- *Select the appropriate bootloader log verbosity*
- Save the configuration and exit.

Enabling flash encryption will increase the size of bootloader, which might require updating partition table offset. See *secure-boot-bootloader-size*.

3. Run the command given below to build and flash the complete images.

```
idf.py flash monitor
```

Note: This command does not include any user files which should be written to the partitions on the flash memory. Please write them manually before running this command otherwise the files should be encrypted separately before writing.

This command will write to flash memory unencrypted images: the firmware bootloader, the partition table and applications. Once the flashing is complete, ESP32-C3 will reset. On the next boot, the firmware bootloader encrypts: the firmware bootloader, application partitions and partitions marked as encrypted then resets. Encrypting in-place can take time, up to a minute for large partitions. After that, the application is decrypted at runtime and executed.

A sample output of the first ESP32-C3 boot after enabling flash encryption is given below:

```
rst:0x1 (POWERON),boot:0xf (SPI_FAST_FLASH_BOOT)
SPIWP:0xee
mode:DIO, clock div:2
load:0x3fcd6260,len:0x1b8
load:0x3fcd6418,len:0x2538
load:0x403ce000,len:0x704
```

(continues on next page)

(continued from previous page)

```

load:0x403d0000,len:0x34f0
entry 0x403ce03e
I (12) boot: ESP-IDF qa-test-v4.3-20201113-766-g870d 2nd stage bootloader
I (13) boot: compile time 12:10:57
I (13) boot: chip revision: 0
I (16) boot.esp32c3: SPI Speed      : 40MHz
I (17) boot.esp32c3: SPI Mode      : DIO
I (19) boot.esp32c3: SPI Flash Size : 2MB
I (22) boot: Enabling RNG early entropy source...
I (28) boot: Partition Table:
I (30) boot: ## Label                Usage            Type ST Offset   Length
I (33) boot:  0 nvs                   WiFi data        01 02 0000a000 00006000
I (37) boot:  1 storage                Unknown data     01 ff 00010000 00001000
I (41) boot:  2 factory                factory app      00 00 00020000 00100000
I (44) boot: End of partition table
I (46) esp_image: segment 0: paddr=0x00020020 vaddr=0x3c020020 size=0x05508 ( ↵
↪21768) map
I (61) esp_image: segment 1: paddr=0x00025530 vaddr=0x3fc88780 size=0x014cc ( ↵
↪5324) load
I (64) esp_image: segment 2: paddr=0x00026a04 vaddr=0x40380000 size=0x08780 ( ↵
↪34688) load
0x40380000: _vector_table at ???

I (81) esp_image: segment 3: paddr=0x0002f18c vaddr=0x00000000 size=0x00e8c ( ↵
↪3724)
I (84) esp_image: segment 4: paddr=0x00030020 vaddr=0x42000020 size=0x171a8 ( ↵
↪94632) map
0x42000020: esp_ota_get_app_description at /home/marius/clean/esp-idf_2/components/
↪app_update/esp_app_desc.c:63

I (132) boot: Loaded app from partition at offset 0x20000
I (133) boot: Checking flash encryption...
I (137) efuse: Batch mode of writing fields is enabled
I (140) flash_encrypt: Generating new flash encryption key...
I (144) efuse: Writing EFUSE_BLK_KEY0 with purpose 4
W (148) flash_encrypt: Not disabling UART bootloader encryption
I (152) flash_encrypt: Disable UART bootloader cache...
I (155) flash_encrypt: Disable JTAG...
I (161) efuse: Batch mode. Prepared fields are committed
I (162) esp_image: segment 0: paddr=0x00000020 vaddr=0x3fcd6260 size=0x001b8 ( ↵
↪440)
I (164) esp_image: segment 1: paddr=0x000001e0 vaddr=0x3fcd6418 size=0x02538 ( ↵
↪9528)
I (173) esp_image: segment 2: paddr=0x00002720 vaddr=0x403ce000 size=0x00704 ( ↵
↪1796)
I (174) esp_image: segment 3: paddr=0x00002e2c vaddr=0x403d0000 size=0x034f0 ( ↵
↪13552)
I (571) flash_encrypt: bootloader encrypted successfully
I (627) flash_encrypt: partition table encrypted and loaded successfully
I (628) flash_encrypt: Encrypting partition 1 at offset 0x10000 (length 0x1000)...
I (685) flash_encrypt: Done encrypting
I (686) esp_image: segment 0: paddr=0x00020020 vaddr=0x3c020020 size=0x05508 ( ↵
↪21768) map
I (696) esp_image: segment 1: paddr=0x00025530 vaddr=0x3fc88780 size=0x014cc ( ↵
↪5324)
I (699) esp_image: segment 2: paddr=0x00026a04 vaddr=0x40380000 size=0x08780 ( ↵
↪34688)
0x40380000: _vector_table at ???

I (715) esp_image: segment 3: paddr=0x0002f18c vaddr=0x00000000 size=0x00e8c ( ↵
↪3724)

```

(continues on next page)

(continued from previous page)

```

I (717) esp_image: segment 4: paddr=0x00030020 vaddr=0x42000020 size=0x171a8 ( ↵
↪94632) map
0x42000020: esp_ota_get_app_description at /home/marius/clean/esp-idf_2/components/
↪app_update/esp_app_desc.c:63

I (760) flash_encrypt: Encrypting partition 2 at offset 0x20000 (length 0x100000)..
↪.
I (14797) flash_encrypt: Done encrypting
I (14801) flash_encrypt: Flash encryption completed
I (14802) boot: Resetting with flash encryption enabled...

```

A sample output of subsequent ESP32-C3 boots just mentions that flash encryption is already enabled:

```

rst:0x3 (RTC_SW_SYS_RST),boot:0xf (SPI_FAST_FLASH_BOOT)
Saved PC:0x403d0dde
SPIWP:0xee
mode:DIO, clock div:2
load:0x3fcd6260,len:0x1b8
load:0x3fcd6418,len:0x2538
load:0x403ce000,len:0x704
load:0x403d0000,len:0x34f0
entry 0x403ce03e
I (15) boot: ESP-IDF qa-test-v4.3-20201113-766-g870d 2nd stage bootloader
I (15) boot: compile time 12:10:57
I (16) boot: chip revision: 0
I (19) boot.esp32c3: SPI Speed      : 40MHz
I (19) boot.esp32c3: SPI Mode      : DIO
I (22) boot.esp32c3: SPI Flash Size : 2MB
I (24) boot: Enabling RNG early entropy source...
I (30) boot: Partition Table:
I (32) boot: ## Label                Usage            Type ST Offset   Length
I (36) boot:  0 nvs                   WiFi data        01 02 0000a000 00006000
I (39) boot:  1 storage                Unknown data     01 ff 00010000 00001000
I (43) boot:  2 factory                factory app      00 00 00020000 00100000
I (47) boot: End of partition table
I (49) esp_image: segment 0: paddr=0x00020020 vaddr=0x3c020020 size=0x05508 ( ↵
↪21768) map
I (64) esp_image: segment 1: paddr=0x00025530 vaddr=0x3fc88780 size=0x014cc ( ↵
↪5324) load
I (67) esp_image: segment 2: paddr=0x00026a04 vaddr=0x40380000 size=0x08780 ( ↵
↪34688) load
0x40380000: _vector_table at ???

I (86) esp_image: segment 3: paddr=0x0002f18c vaddr=0x00000000 size=0x00e8c ( ↵
↪3724)
I (88) esp_image: segment 4: paddr=0x00030020 vaddr=0x42000020 size=0x171a8 ( ↵
↪94632) map
0x42000020: esp_ota_get_app_description at /home/marius/clean/esp-idf_2/components/
↪app_update/esp_app_desc.c:63

I (139) boot: Loaded app from partition at offset 0x20000
I (139) boot: Checking flash encryption...
I (144) flash_encrypt: flash encryption is enabled (1 plaintext flashes left)
I (148) boot: Disabling RNG early entropy source...
I (160) cpu_start: Pro cpu start user code
I (160) cpu_start: cpu freq: 40000000
I (161) cpu_start: Application information:
I (161) cpu_start: Project name:      flash_encryption
I (164) cpu_start: App version:      qa-test-v4.3-20201113-766-g870d
I (168) cpu_start: Compile time:     Dec 21 2020 12:10:55
I (171) cpu_start: ELF file SHA256:  209e8947c2e6a6a6...

```

(continues on next page)

(continued from previous page)

```

I (174) cpu_start: ESP-IDF:          qa-test-v4.3-20201113-766-g870d
I (178) heap_init: Initializing. RAM available for dynamic allocation:
I (181) heap_init: At 3FC8A9F0 len 00035610 (213 KiB): D/IRAM
I (184) heap_init: At 3FCC0000 len 0001F260 (124 KiB): STACK/DRAM
I (188) heap_init: At 50000000 len 00002000 (8 KiB): FAKEDRAM
W (192) flash_encrypt: Flash encryption mode is DEVELOPMENT (not secure)
I (195) spi_flash: detected chip: gd
I (197) spi_flash: flash io: dio
W (199) spi_flash: Detected size(4096k) larger than the size in the binary image_
↳header(2048k). Using the size in the binary image header.
I (207) cpu_start: Starting scheduler.

```

Example to check Flash Encryption status

```

This is esp32c3 chip with 1 CPU core(s), WiFi/BLE, silicon revision 0, 2MB_
↳external flash
FLASH_CRYPT_CNT eFuse value is 1
Flash encryption feature is enabled in DEVELOPMENT mode

```

At this stage, if you need to update and re-flash binaries, see [Re-flashing Updated Partitions](#).

Using Host Generated Key It is possible to pre-generate a flash encryption key on the host computer and burn it into the eFuse. This allows you to pre-encrypt data on the host and flash already encrypted data without needing a plaintext flash update. This feature can be used in both [Development Mode](#) and [Release Mode](#). Without a pre-generated key, data is flashed in plaintext and then ESP32-C3 encrypts the data in-place.

Note: This option is not recommended for production, unless a separate key is generated for each individual device.

To use a host generated key, take the following steps:

1. Ensure that you have an ESP32-C3 device with default flash encryption eFuse settings as shown in [Relevant eFuses](#).

See how to check [ESP32-C3 Flash Encryption Status](#).

2. Generate a random key by running:

```
espsecure.py generate_flash_encryption_key my_flash_encryption_key.bin
```

3. **Before the first encrypted boot**, burn the key into your device' s eFuse using the command below. This action can be done **only once**.

```
espefuse.py --port PORT burn_key BLOCK my_flash_encryption_key.bin XTS_AES_128_KEY
```

where *BLOCK* is a free keyblock between *BLOCK_KEY0* and *BLOCK_KEY5*.

If the key is not burned and the device is started after enabling flash encryption, the ESP32-C3 will generate a random key that software cannot access or modify.

4. In [Project Configuration Menu](#), do the following:
 - [Enable flash encryption on boot](#)
 - [Select encryption mode \(Development mode by default\)](#)
 - [Select the appropriate bootloader log verbosity](#)
 - Save the configuration and exit.

Enabling flash encryption will increase the size of bootloader, which might require updating partition table offset. See [secure-boot-bootloader-size](#).

5. Run the command given below to build and flash the complete images.

```
idf.py flash monitor
```

Note: This command does not include any user files which should be written to the partitions on the flash memory. Please write them manually before running this command otherwise the files should be encrypted separately before writing.

This command will write to flash memory unencrypted images: the firmware bootloader, the partition table and applications. Once the flashing is complete, ESP32-C3 will reset. On the next boot, the firmware bootloader encrypts: the firmware bootloader, application partitions and partitions marked as `encrypted` then resets. Encrypting in-place can take time, up to a minute for large partitions. After that, the application is decrypted at runtime and executed.

At this stage, if you need to update and re-flash binaries, see [Re-flashing Updated Partitions](#).

Re-flashing Updated Partitions If you update your application code (done in plaintext) and want to re-flash it, you will need to encrypt it before flashing. To encrypt the application and flash it in one step, run:

```
idf.py encrypted-app-flash monitor
```

If all partitions needs to be updated in encrypted format, run:

```
idf.py encrypted-flash monitor
```

Release Mode

In Release mode, UART bootloader cannot perform flash encryption operations. New plaintext images can ONLY be downloaded using the over-the-air (OTA) scheme which will encrypt the plaintext image before writing to flash.

To use this mode, take the following steps:

1. Ensure that you have an ESP32-C3 device with default flash encryption eFuse settings as shown in [Relevant eFuses](#).

See how to check [ESP32-C3 Flash Encryption Status](#).

2. In [Project Configuration Menu](#), do the following:
 - [Enable flash encryption on boot](#)
 - [Select Release mode](#) (Note that once Release mode is selected, the `EFUSE_DIS_DOWNLOAD_MANUAL_ENCRYPT` eFuse bit will be burned to disable UART bootloader access to flash contents)
 - [Select UART ROM download mode](#) (By default the option to permanently switch to UART ROM Secure download mode is selected)
 - [Select the appropriate bootloader log verbosity](#)
 - Save the configuration and exit.

Enabling flash encryption will increase the size of bootloader, which might require updating partition table offset. See `secure-boot-bootloader-size`.

3. Run the command given below to build and flash the complete images.

```
idf.py flash monitor
```

Note: This command does not include any user files which should be written to the partitions on the flash memory. Please write them manually before running this command otherwise the files should be encrypted separately before writing.

This command will write to flash memory unencrypted images: the firmware bootloader, the partition table and applications. Once the flashing is complete, ESP32-C3 will reset. On the next boot, the firmware bootloader encrypts: the firmware bootloader, application partitions and partitions marked as

encrypted then resets. Encrypting in-place can take time, up to a minute for large partitions. After that, the application is decrypted at runtime and executed.

Once the flash encryption is enabled in Release mode, the bootloader will write-protect the SPI_BOOT_CRYPT_CNT eFuse.

For subsequent plaintext field updates, use [OTA scheme](#).

._flash-encrypt-best-practices:

Best Practices

When using Flash Encryption in production:

- Do not reuse the same flash encryption key between multiple devices. This means that an attacker who copies encrypted data from one device cannot transfer it to a second device.
- The UART ROM Download Mode should be disabled entirely if it is not needed, or permanently set to “Secure Download Mode” otherwise. Secure Download Mode permanently limits the available commands to basic flash read and write only. The default behaviour is to set Secure Download Mode on first boot in Release mode. To disable Download Mode entirely select the [CONFIG_SECURE_UART_ROM_DL_MODE](#) to “Permanently disable ROM Download Mode (recommended)” or call `esp_efuse_disable_rom_download_mode()` at runtime.
- Enable [Secure Boot](#) as an extra layer of protection, and to prevent an attacker from selectively corrupting any part of the flash before boot.

4.13.5 Possible Failures

Once flash encryption is enabled, the SPI_BOOT_CRYPT_CNT eFuse value will have an odd number of bits set. It means that all the partitions marked with the encryption flag are expected to contain encrypted ciphertext. Below are the three typical failure cases if the ESP32-C3 is erroneously loaded with plaintext data:

1. If the bootloader partition is re-flashed with a **plaintext firmware bootloader image**, the ROM bootloader will fail to load the firmware bootloader resulting in the following failure:

```
rst:0x3 (SW_RESET),boot:0x13 (SPI_FAST_FLASH_BOOT)
invalid header: 0xb414f76b
invalid header: 0xb414f76b
invalid header: 0xb414f76b
invalid header: 0xb414f76b
invalid header: 0xb414f76b
invalid header: 0xb414f76b
invalid header: 0xb414f76b
```

Note: The value of invalid header will be different for every application.

Note: This error also appears if the flash contents are erased or corrupted.

2. If the firmware bootloader is encrypted, but the partition table is re-flashed with a **plaintext partition table image**, the bootloader will fail to read the partition table resulting in the following failure:

```
rst:0x3 (SW_RESET),boot:0x13 (SPI_FAST_FLASH_BOOT)
configsip: 0, SPIWP:0xee
clk_drv:0x00,q_drv:0x00,d_drv:0x00,cs0_drv:0x00,hd_drv:0x00,wp_drv:0x00
mode:DIO, clock div:2
load:0x3fff0018,len:4
load:0x3fff001c,len:10464
ho 0 tail 12 room 4
```

(continues on next page)

(continued from previous page)

```

load:0x40078000,len:19168
load:0x40080400,len:6664
entry 0x40080764
I (60) boot: ESP-IDF v4.0-dev-763-g2c55fae6c-dirty 2nd stage bootloader
I (60) boot: compile time 19:15:54
I (62) boot: Enabling RNG early entropy source...
I (67) boot: SPI Speed      : 40MHz
I (72) boot: SPI Mode      : DIO
I (76) boot: SPI Flash Size : 4MB
E (80) flash_parts: partition 0 invalid magic number 0x94f6
E (86) boot: Failed to verify partition table
E (91) boot: load partition table error!

```

3. If the bootloader and partition table are encrypted, but the application is re-flashed with a **plaintext application image**, the bootloader will fail to load the application resulting in the following failure:

```

rst:0x3 (SW_RESET),boot:0x13 (SPI_FAST_FLASH_BOOT)
configsip: 0, SPIWP:0xee
clk_drv:0x00,q_drv:0x00,d_drv:0x00,cs0_drv:0x00,hd_drv:0x00,wp_drv:0x00
mode:DIO, clock div:2
load:0x3fff0018,len:4
load:0x3fff001c,len:8452
load:0x40078000,len:13616
load:0x40080400,len:6664
entry 0x40080764
I (56) boot: ESP-IDF v4.0-dev-850-gc4447462d-dirty 2nd stage bootloader
I (56) boot: compile time 15:37:14
I (58) boot: Enabling RNG early entropy source...
I (64) boot: SPI Speed      : 40MHz
I (68) boot: SPI Mode      : DIO
I (72) boot: SPI Flash Size : 4MB
I (76) boot: Partition Table:
I (79) boot:  ## Label                Usage                Type ST Offset   Length
I (87) boot:  0 nvs                    WiFi data            01 02 0000a000 00006000
I (94) boot:  1 phy_init                RF data              01 01 00010000 00001000
I (102) boot:  2 factory                    factory app          00 00 00020000 00100000
I (109) boot: End of partition table
E (113) esp_image: image at 0x20000 has invalid magic byte
W (120) esp_image: image at 0x20000 has invalid SPI mode 108
W (126) esp_image: image at 0x20000 has invalid SPI size 11
E (132) boot: Factory app partition is not bootable
E (138) boot: No bootable app partitions in the partition table

```

4.13.6 ESP32-C3 Flash Encryption Status

1. Ensure that you have an ESP32-C3 device with default flash encryption eFuse settings as shown in [Relevant eFuses](#).

To check if flash encryption on your ESP32-C3 device is enabled, do one of the following:

- flash the application example [security/flash_encryption](#) onto your device. This application prints the SPI_BOOT_CRYPT_CNT eFuse value and if flash encryption is enabled or disabled.
- [Find the serial port name](#) under which your ESP32-C3 device is connected, replace PORT with your port name in the following command, and run it:

```
espefuse.py -p PORT summary
```

4.13.7 Reading and Writing Data in Encrypted Flash

ESP32-C3 application code can check if flash encryption is currently enabled by calling `esp_flash_encryption_enabled()`. Also, a device can identify the flash encryption mode by calling `esp_get_flash_encryption_mode()`.

Once flash encryption is enabled, be more careful with accessing flash contents from code.

Scope of Flash Encryption

Whenever the `SPI_BOOT_CRYPT_CNT` eFuse is set to a value with an odd number of bits, all flash content accessed via the MMU's flash cache is transparently decrypted. It includes:

- Executable application code in flash (IROM).
- All read-only data stored in flash (DROM).
- Any data accessed via `spi_flash_mmap()`.
- The firmware bootloader image when it is read by the ROM bootloader.

Important: The MMU flash cache unconditionally decrypts all existing data. Data which is stored unencrypted in flash memory will also be “transparently decrypted” via the flash cache and will appear to software as random garbage.

Reading from Encrypted Flash

To read data without using a flash cache MMU mapping, you can use the partition read function `esp_partition_read()`. This function will only decrypt data when it is read from an encrypted partition. Data read from unencrypted partitions will not be decrypted. In this way, software can access encrypted and non-encrypted flash in the same way.

You can also use the following SPI flash API functions:

- `esp_flash_read()` to read raw (encrypted) data which will not be decrypted
- `esp_flash_read_decrypted()` to read and decrypt data

The ROM function `SPIRead()` can read data without decryption, however, this function is not supported in esp-idf applications.

Data stored using the Non-Volatile Storage (NVS) API is always stored and read decrypted from the perspective of flash encryption. It is up to the library to provide encryption feature if required. Refer to *NVS Encryption* for more details.

Writing to Encrypted Flash

It is recommended to use the partition write function `esp_partition_write()`. This function will only encrypt data when it is written to an encrypted partition. Data written to unencrypted partitions will not be encrypted. In this way, software can access encrypted and non-encrypted flash in the same way.

You can also pre-encrypt and write data using the function `esp_flash_write_decrypted()`

Also, the following ROM function exist but not supported in esp-idf applications:

- `esp_rom_spiflash_write_decrypted` pre-encrypts and writes data to flash
- `SPIWrite` writes unencrypted data to flash

Since data is encrypted in blocks, the minimum write size for encrypted data is 16 bytes and the alignment is also 16 bytes.

4.13.8 Updating Encrypted Flash

OTA Updates

OTA updates to encrypted partitions will automatically write encrypted data if the function `esp_partition_write()` is used.

Before building the application image for OTA updating of an already encrypted device, enable the option *Enable flash encryption on boot* in project configuration menu.

For general information about ESP-IDF OTA updates, please refer to *OTA*

4.13.9 Disabling Flash Encryption

If flash encryption was enabled accidentally, flashing of plaintext data will soft-brick the ESP32-C3. The device will reboot continuously, printing the error `flash read err, 1000` or `invalid header: 0xFFFFFFFF`.

For flash encryption in Development mode, encryption can be disabled by burning the `SPI_BOOT_CRYPT_CNT` eFuse. It can only be done one time per chip by taking the following steps:

1. In *Project Configuration Menu*, disable *Enable flash encryption on boot*, then save and exit.
2. Open project configuration menu again and **double-check** that you have disabled this option! If this option is left enabled, the bootloader will immediately re-enable encryption when it boots.
3. With flash encryption disabled, build and flash the new bootloader and application by running `idf.py flash`.
4. Use `espefuse.py` (in `components/esptool_py/esptool`) to disable the `SPI_BOOT_CRYPT_CNT` by running:

```
espefuse.py burn_efuse SPI_BOOT_CRYPT_CNT
```

Reset the ESP32-C3. Flash encryption will be disabled, and the bootloader will boot as usual.

4.13.10 Key Points About Flash Encryption

- Flash memory contents is encrypted using XTS-AES-128. The flash encryption key is 256 bits and stored one `BLOCK_KEYN` eFuse internal to the chip and, by default, is protected from software access.
- Flash access is transparent via the flash cache mapping feature of ESP32-C3 - any flash regions which are mapped to the address space will be transparently decrypted when read. Some data partitions might need to remain unencrypted for ease of access or might require the use of flash-friendly update algorithms which are ineffective if the data is encrypted. NVS partitions for non-volatile storage cannot be encrypted since the NVS library is not directly compatible with flash encryption. For details, refer to *NVS Encryption*.
- If flash encryption might be used in future, the programmer must keep it in mind and take certain precautions when writing code that *uses encrypted flash*.
- If secure boot is enabled, re-flashing the bootloader of an encrypted device requires a “Re-flashable” secure boot digest (see *Flash Encryption and Secure Boot*).

Enabling flash encryption will increase the size of bootloader, which might require updating partition table offset. See `secure-boot-bootloader-size`.

Important: Do not interrupt power to the ESP32-C3 while the first boot encryption pass is running. If power is interrupted, the flash contents will be corrupted and will require flashing with unencrypted data again. In this case, re-flashing will not count towards the flashing limit.

4.13.11 Limitations of Flash Encryption

Flash encryption protects firmware against unauthorised readout and modification. It is important to understand the limitations of the flash encryption feature:

- Flash encryption is only as strong as the key. For this reason, we recommend keys are generated on the device during first boot (default behaviour). If generating keys off-device, ensure proper procedure is followed and don't share the same key between all production devices.
- Not all data is stored encrypted. If storing data on flash, check if the method you are using (library, API, etc.) supports flash encryption.
- Flash encryption does not prevent an attacker from understanding the high-level layout of the flash. This is because the same AES key is used for every pair of adjacent 16 byte AES blocks. When these adjacent 16 byte blocks contain identical content (such as empty or padding areas), these blocks will encrypt to produce matching pairs of encrypted blocks. This may allow an attacker to make high-level comparisons between encrypted devices (i.e. to tell if two devices are probably running the same firmware version).
- Flash encryption alone may not prevent an attacker from modifying the firmware of the device. To prevent unauthorised firmware from running on the device, use flash encryption in combination with [Secure Boot](#).

4.13.12 Flash Encryption and Secure Boot

It is recommended to use flash encryption in combination with Secure Boot. However, if Secure Boot is enabled, additional restrictions apply to device re-flashing:

- [OTA Updates](#) are not restricted, provided that the new app is signed correctly with the Secure Boot signing key.

4.13.13 Advanced Features

The following section covers advanced features of flash encryption.

Encrypted Partition Flag

Some partitions are encrypted by default. Other partitions can be marked in the partition table description as requiring encryption by adding the flag `encrypted` to the partitions' flag field. As a result, data in these marked partitions will be treated as encrypted in the same manner as an app partition.

```
# Name, Type, SubType, Offset, Size, Flags
nvs, data, nvs, 0x9000, 0x6000
phy_init, data, phy, 0xf000, 0x1000
factory, app, factory, 0x10000, 1M
secret_data, 0x40, 0x01, 0x20000, 256K, encrypted
```

For details on partition table description, see [partition table](#).

Further information about encryption of partitions:

- Default partition tables do not include any encrypted data partitions.
- With flash encryption enabled, the `app` partition is always treated as encrypted and does not require marking.
- If flash encryption is not enabled, the flag “encrypted” has no effect.
- You can also consider protecting `phy_init` data from physical access, readout, or modification, by marking the optional `phy` partition with the flag `encrypted`.
- The `nvs` partition cannot be encrypted, because the NVS library is not directly compatible with flash encryption.

Enabling UART Bootloader Encryption/Decryption

On the first boot, the flash encryption process burns by default the following eFuses:

- `DIS_DOWNLOAD_MANUAL_ENCRYPT` which disables flash encryption operation when running in UART bootloader boot mode.
- `DIS_DOWNLOAD_ICACHE` which disables the entire MMU flash cache when running in UART bootloader mode.
- `DIS_PAD_JTAG` and `DIS_USB_JTAG` which disables JTAG.
- `DIS_LEGACY_SPI_BOOT` which disables Legacy SPI boot mode

However, before the first boot you can choose to keep any of these features enabled by burning only selected eFuses and write-protect the rest of eFuses with unset value 0. For example:

```
espefuse.py --port PORT burn_efuse DIS_DOWNLOAD_MANUAL_ENCRYPT
espefuse.py --port PORT write_protect_efuse DIS_DOWNLOAD_MANUAL_ENCRYPT
```

Note: Set all appropriate bits before write-protecting!

Write protection of all the three eFuses is controlled by one bit. It means that write-protecting one eFuse bit will inevitably write-protect all unset eFuse bits.

Write protecting these eFuses to keep them unset is not currently very useful, as `esptool.py` does not support reading encrypted flash.

JTAG Debugging

By default, when Flash Encryption is enabled (in either Development or Release mode) then JTAG debugging is disabled via eFuse. The bootloader does this on first boot, at the same time it enables flash encryption.

See *JTAG with Flash Encryption or Secure Boot* for more information about using JTAG Debugging with Flash Encryption.

4.13.14 Technical Details

The following sections provide some reference information about the operation of flash encryption.

Flash Encryption Algorithm

- ESP32-C3 use the XTS-AES block cipher mode with 256 bit size for flash encryption.
- XTS-AES is a block cipher mode specifically designed for disc encryption and addresses the weaknesses other potential modes (e.g. AES-CTR) have for this use case. A detailed description of the XTS-AES algorithm can be found in [IEEE Std 1619-2007](https://doi.org/10.1109/6004235.2007).
- The flash encryption key is stored in one `BLOCK_KEYN` eFuse and, by default, is protected from further writes or software readout.
- To see the full flash encryption algorithm implemented in Python, refer to the `_flash_encryption_operation()` function in the `espsecure.py` source code.

4.14 ESP-IDF FreeRTOS SMP Changes

4.14.1 Overview

The ESP-IDF FreeRTOS is a modified version of vanilla FreeRTOS which supports symmetric multiprocessing (SMP). ESP-IDF FreeRTOS is based on the Xtensa port of FreeRTOS v10.2.0. This guide outlines the major differences between vanilla FreeRTOS and ESP-IDF FreeRTOS. The API reference for vanilla FreeRTOS can be found via <https://www.freertos.org/a00106.html>

For information regarding features that are exclusive to ESP-IDF FreeRTOS, see *ESP-IDF FreeRTOS Additions*.

Thread Local Storage Pointers & Deletion Callbacks: Deletion callbacks are called automatically during task deletion and are used to free memory pointed to by TLSP. Call `vTaskSetThreadLocalStoragePointerAndDeletionCallback()` to set TLSP and Deletion Callbacks.

Configuring ESP-IDF FreeRTOS: Several aspects of ESP-IDF FreeRTOS can be set in the project configuration (`idf.py menuconfig`) such as running ESP-IDF in Unicore (single core) Mode, or configuring the number of Thread Local Storage Pointers each task will have.

It is not necessary to manually start the FreeRTOS scheduler by calling `vTaskStartScheduler()`. In ESP-IDF the scheduler is started by the *Application Startup Flow* and is already running when the `app_main` function is called (see *Running the main task* for details).

4.14.2 Tasks and Task Creation

Tasks in ESP-IDF FreeRTOS are designed to run on a particular core, therefore two new task creation functions have been added to ESP-IDF FreeRTOS by appending `PinnedToCore` to the names of the task creation functions in vanilla FreeRTOS. The vanilla FreeRTOS functions of `xTaskCreate()` and `xTaskCreateStatic()` have led to the addition of `xTaskCreatePinnedToCore()` and `xTaskCreateStaticPinnedToCore()` in ESP-IDF FreeRTOS

For more details see [freertos/tasks.c](#)

The ESP-IDF FreeRTOS task creation functions are nearly identical to their vanilla counterparts with the exception of the extra parameter known as `xCoreID`. This parameter specifies the core on which the task should run on and can be one of the following values.

- 0 pins the task to **PRO_CPU**
- 1 pins the task to **APP_CPU**
- `tskNO_AFFINITY` allows the task to be run on both CPUs

For example `xTaskCreatePinnedToCore(tsk_callback, "APP_CPU Task", 1000, NULL, 10, NULL, 1)` creates a task of priority 10 that is pinned to **APP_CPU** with a stack size of 1000 bytes. It should be noted that the `uxStackDepth` parameter in vanilla FreeRTOS specifies a task's stack depth in terms of the number of words, whereas ESP-IDF FreeRTOS specifies the stack depth in terms of bytes.

Note that the vanilla FreeRTOS functions `xTaskCreate()` and `xTaskCreateStatic()` have been defined in ESP-IDF FreeRTOS as inline functions which call `xTaskCreatePinnedToCore()` and `xTaskCreateStaticPinnedToCore()` respectively with `tskNO_AFFINITY` as the `xCoreID` value.

Each Task Control Block (TCB) in ESP-IDF stores the `xCoreID` as a member. Hence when each core calls the scheduler to select a task to run, the `xCoreID` member will allow the scheduler to determine if a given task is permitted to run on the core that called it.

4.14.3 Scheduling

The vanilla FreeRTOS implements scheduling in the `vTaskSwitchContext()` function. This function is responsible for selecting the highest priority task to run from a list of tasks in the Ready state known as the Ready Tasks List (described in the next section). In ESP-IDF FreeRTOS, each core will call `vTaskSwitchContext()` independently to select a task to run from the Ready Tasks List which is shared between both cores. There are several differences in scheduling behavior between vanilla and ESP-IDF FreeRTOS such as differences in Round Robin scheduling, scheduler suspension, and tick interrupt synchronicity.

Round Robin Scheduling

Given multiple tasks in the Ready state and of the same priority, vanilla FreeRTOS implements Round Robin scheduling between multiple ready state tasks of the same priority. This will result in running those tasks in turn each time the scheduler is called (e.g. when the tick interrupt occurs or when a task blocks/yields).

On the other hand, it is not possible for the ESP-IDF FreeRTOS scheduler to implement perfect Round Robin due to the fact that a particular task may not be able to run on a particular core due to the following reasons:

- The task is pinned to the another core.
- For unpinned tasks, the task is already being run by another core.

Therefore, when a core searches the ready state task list for a task to run, the core may need to skip over a few tasks in the same priority list or drop to a lower priority in order to find a ready state task that the core can run.

The ESP-IDF FreeRTOS scheduler implements a Best Effort Round Robin scheduling for ready state tasks of the same priority by ensuring that tasks that have been selected to run will be placed at the back of the list, thus giving unselected tasks a higher priority on the next scheduling iteration (i.e., the next tick interrupt or yield)

The following example demonstrates the Best Effort Round Robin Scheduling in action. Assume that:

- There are four ready state tasks of the same priority AX, B0, C1, D1 where: - The priority is the current highest priority with ready state tasks - The first character represents the task's names (i.e., A, B, C, D) - And the second character represents the tasks core pinning (and X means unpinned)
- The task list is always searched from the head

1. Starting state. None of the ready state tasks have been selected to run

```
Head [ AX , B0 , C1 , D0 ] Tail
```

2. Core 0 has tick interrupt and searches for a task to run.
Task A is selected and is moved to the back of the list

```
Core0--|
Head [ AX , B0 , C1 , D0 ] Tail
```

```

          0
Head [ B0 , C1 , D0 , AX ] Tail
```

3. Core 1 has a tick interrupt and searches for a task to run.
Task B cannot be run due to incompatible affinity, so core 1 skips to Task C.
Task C is selected and is moved to the back of the list

```
Core1-----|          0
Head [ B0 , C1 , D0 , AX ] Tail
```

```

          0    1
Head [ B0 , D0 , AX , C1 ] Tail
```

4. Core 0 has another tick interrupt and searches for a task to run.
Task B is selected and moved to the back of the list

```
Core0--|          1
Head [ B0 , D0 , AX , C1 ] Tail
```

```

          1    0
Head [ D0 , AX , C1 , B0 ] Tail
```

5. Core 1 has another tick and searches for a task to run.
Task D cannot be run due to incompatible affinity, so core 1 skips to Task A
Task A is selected and moved to the back of the list

(continues on next page)

```

Core1-----|          0
Head [ D0 , AX , C1 , B0 ] Tail

          0    1
Head [ D0 , C1 , B0 , AX ] Tail

```

The implications to users regarding the Best Effort Round Robin Scheduling:

- Users cannot expect multiple ready state tasks of the same priority to run sequentially (as is the case in Vanilla FreeRTOS). As demonstrated in the example above, a core may need to skip over tasks.
- However, given enough ticks, a task will eventually be given some processing time.
- If a core cannot find a task runnable task at the highest ready state priority, it will drop to a lower priority to search for tasks.
- To achieve ideal round robin scheduling, users should ensure that all tasks of a particular priority are pinned to the same core.

Scheduler Suspension

In vanilla FreeRTOS, suspending the scheduler via `vTaskSuspendAll()` will prevent calls of `vTaskSwitchContext` from context switching until the scheduler has been resumed with `xTaskResumeAll()`. However servicing ISRs are still permitted. Therefore any changes in task states as a result from the current running task or ISRs will not be executed until the scheduler is resumed. Scheduler suspension in vanilla FreeRTOS is a common protection method against simultaneous access of data shared between tasks, whilst still allowing ISRs to be serviced.

In ESP-IDF FreeRTOS, `xTaskSuspendAll()` will only prevent calls of `vTaskSwitchContext()` from switching contexts on the core that called for the suspension. Hence if **PRO_CPU** calls `vTaskSuspendAll()`, **APP_CPU** will still be able to switch contexts. If data is shared between tasks that are pinned to different cores, scheduler suspension is **NOT** a valid method of protection against simultaneous access. Consider using critical sections (disables interrupts) or semaphores (does not disable interrupts) instead when protecting shared resources in ESP-IDF FreeRTOS.

In general, it's better to use other RTOS primitives like mutex semaphores to protect against data shared between tasks, rather than `vTaskSuspendAll()`.

Tick Interrupt Synchronicity

In ESP-IDF FreeRTOS, tasks on different cores that unblock on the same tick count might not run at exactly the same time due to the scheduler calls from each core being independent, and the tick interrupts to each core being unsynchronized.

In vanilla FreeRTOS the tick interrupt triggers a call to `xTaskIncrementTick()` which is responsible for incrementing the tick counter, checking if tasks which have called `vTaskDelay()` have fulfilled their delay period, and moving those tasks from the Delayed Task List to the Ready Task List. The tick interrupt will then call the scheduler if a context switch is necessary.

In ESP-IDF FreeRTOS, delayed tasks are unblocked with reference to the tick interrupt on **PRO_CPU** as **PRO_CPU** is responsible for incrementing the shared tick count. However tick interrupts to each core might not be synchronized (same frequency but out of phase) hence when **PRO_CPU** receives a tick interrupt, **APP_CPU** might not have received it yet. Therefore if multiple tasks of the same priority are unblocked on the same tick count, the task pinned to **PRO_CPU** will run immediately whereas the task pinned to **APP_CPU** must wait until **APP_CPU** receives its out of sync tick interrupt. Upon receiving the tick interrupt, **APP_CPU** will then call for a context switch and finally switches contexts to the newly unblocked task.

Therefore, task delays should **NOT** be used as a method of synchronization between tasks in ESP-IDF FreeRTOS. Instead, consider using a counting semaphore to unblock multiple tasks at the same time.

4.14.4 Critical Sections & Disabling Interrupts

Vanilla FreeRTOS implements critical sections with `taskENTER_CRITICAL()` which calls `portDISABLE_INTERRUPTS()`. This prevents preemptive context switches and servicing of ISRs during a critical section. Therefore, critical sections are used as a valid protection method against simultaneous access in vanilla FreeRTOS.

ESP-IDF contains some modifications to work with dual core concurrency, and the dual core API is used even on a single core only chip.

For this reason, ESP-IDF FreeRTOS implements critical sections using special mutexes, referred by `portMUX_Type` objects. These are implemented on top of a specific spinlock component. Calls to `taskENTER_CRITICAL` or `taskEXIT_CRITICAL` each provide a spinlock object as an argument. The spinlock is associated with a shared resource requiring access protection. When entering a critical section in ESP-IDF FreeRTOS, the calling core will disable interrupts similar to the vanilla FreeRTOS implementation, and will then take the spinlock and enter the critical section. The other core is unaffected at this point, unless it enters its own critical section and attempts to take the same spinlock. In that case it will spin until the lock is released. Therefore, the ESP-IDF FreeRTOS implementation of critical sections allows a core to have protected access to a shared resource without disabling the other core. The other core will only be affected if it tries to concurrently access the same resource.

The ESP-IDF FreeRTOS critical section functions have been modified as follows...

- `taskENTER_CRITICAL(mux)`, `taskENTER_CRITICAL_ISR(mux)`, `portENTER_CRITICAL(mux)`, `portENTER_CRITICAL_ISR(mux)` are all macro defined to call internal function `vPortEnterCritical()`
- `taskEXIT_CRITICAL(mux)`, `taskEXIT_CRITICAL_ISR(mux)`, `portEXIT_CRITICAL(mux)`, `portEXIT_CRITICAL_ISR(mux)` are all macro defined to call internal function `vPortExitCritical()`
- `portENTER_CRITICAL_SAFE(mux)`, `portEXIT_CRITICAL_SAFE(mux)` macro identifies the context of execution, i.e ISR or Non-ISR, and calls appropriate critical section functions (`port*_CRITICAL` in Non-ISR and `port*_CRITICAL_ISR` in ISR) in order to be in compliance with Vanilla FreeRTOS.

For more details see [esp_hw_support/include/soc/spinlock.h](#), [freertos/include/freertos/task.h](#), and [freertos/tasks.c](#)

It should be noted that when modifying vanilla FreeRTOS code to be ESP-IDF FreeRTOS compatible, it is trivial to modify the type of critical section called as they are all defined to call the same function. As long as the same spinlock is provided upon entering and exiting, the exact macro or function used for the call should not matter.

4.14.5 Task Deletion

In FreeRTOS task deletion the freeing of task memory will occur immediately (within `vTaskDelete()`) if the task being deleted is not currently running or is not pinned to the other core (with respect to the core `vTaskDelete()` is called on). TLSP deletion callbacks will also run immediately if the same conditions are met.

However, calling `vTaskDelete()` to delete a task that is either currently running or pinned to the other core will still result in the freeing of memory being delegated to the Idle Task.

4.14.6 Thread Local Storage Pointers & Deletion Callbacks

Thread Local Storage Pointers (TLSP) are pointers stored directly in the TCB. TLSP allow each task to have its own unique set of pointers to data structures. However task deletion behavior in vanilla FreeRTOS does not automatically free the memory pointed to by TLSP. Therefore if the memory pointed to by TLSP is not explicitly freed by the user before task deletion, memory leak will occur.

ESP-IDF FreeRTOS provides the added feature of Deletion Callbacks. Deletion Callbacks are called automatically during task deletion to free memory pointed to by TLSP. Each TLSP can have its own Deletion Callback. Note that due to the to [Task Deletion](#) behavior, there can be instances where Deletion Callbacks are called in the context of the Idle Tasks. Therefore Deletion Callbacks **should never attempt to block** and critical sections should be kept as short as possible to minimize priority inversion.

Deletion callbacks are of type `void (*TlsDeleteCallbackFunction_t)(int, void *)` where the first parameter is the index number of the associated TLSP, and the second parameter is the TLSP itself.

Deletion callbacks are set alongside TLSP by calling `vTaskSetThreadLocalStoragePointerAndDeleteCallback()`. Calling the vanilla FreeRTOS function `vTaskSetThreadLocalStoragePointer()` will simply set the TLSP's associated Deletion Callback to `NULL` meaning that no callback will be called for that TLSP during task deletion. If a deletion callback is `NULL`, users should manually free the memory pointed to by the associated TLSP before task deletion in order to avoid memory leak.

For more details see [FreeRTOS API reference](#).

4.14.7 Configuring ESP-IDF FreeRTOS

The ESP-IDF FreeRTOS can be configured in the project configuration menu (`idf.py menuconfig`) under `Component Config/FreeRTOS`. The following section highlights some of the ESP-IDF FreeRTOS configuration options. For a full list of ESP-IDF FreeRTOS configurations, see [FreeRTOS](#)

As ESP32-C3 is a single core SoC, the config item `CONFIG_FREERTOS_UNICORE` is always set. This means ESP-IDF only runs on the single CPU. Note that this is **not equivalent to running vanilla FreeRTOS**. Behaviors of multiple components in ESP-IDF will be modified. For more details regarding the effects of running ESP-IDF FreeRTOS on a single core, search for occurrences of `CONFIG_FREERTOS_UNICORE` in the ESP-IDF components.

`CONFIG_FREERTOS_ASSERT_ON_UNTESTED_FUNCTION` will trigger a halt in particular functions in ESP-IDF FreeRTOS which have not been fully tested in an SMP context.

`CONFIG_FREERTOS_TASK_FUNCTION_WRAPPER` will enclose all task functions within a wrapper function. In the case that a task function mistakenly returns (i.e. does not call `vTaskDelete()`), the call flow will return to the wrapper function. The wrapper function will then log an error and abort the application, as illustrated below:

```
E (25) FreeRTOS: FreeRTOS task should not return. Aborting now!  
abort() was called at PC 0x40085c53 on core 0
```

4.15 Hardware Abstraction

Hardware abstraction in ESP-IDF are a group of API that allow users to control peripherals at differing levels of abstraction, as opposed to interfacing with hardware using only the ESP-IDF drivers. ESP-IDF Hardware abstraction will likely be useful for users writing high performance bare-metal drivers, or for those attempting to port an ESP chip to another platform.

This guide is split into the following sections:

1. [Architecture](#)
2. [LL \(Low Level\) Layer](#)
3. [HAL \(Hardware Abstraction Layer\)](#)

Warning: Hardware abstraction API (excluding the driver and `xxx_types.h`) should be considered an experimental feature, thus cannot be considered public API. Hardware abstraction API do not adhere to the API name changing restrictions of ESP-IDF's versioning scheme. In other words, it is possible that Hardware Abstraction API may change in between non-major release versions.

Note: Although this document mainly focuses on hardware abstraction of peripherals (e.g., UART, SPI, I2C), certain layers of hardware abstraction extend to other aspects of hardware as well (e.g., some of the CPU's features are partially abstracted).

4.15.1 Architecture

Hardware abstraction in ESP-IDF is comprised of the following layers, ordered from low level (closer to hardware) to high level (further away from hardware) of abstraction.

- Low Level (LL) Layer
- Hardware Abstraction Layer (HAL)
- Driver Layers

The LL Layer, and HAL are entirely contained within the `hal` component. Each layer is dependent on the layer below it (i.e., driver depends on HAL, HAL depends on LL, LL depends on the register header files).

For a particular peripheral `xxx`, its hardware abstraction will generally consist of the header files described in the table below. Files that are **Target Specific** will have a separate implementation for each target (i.e., a separate copy for each chip). However, the `#include` directive will still be target-independent (i.e., will be the same for different targets) as the build system will automatically include the correct version of the header and source files.

Table 22: Hardware Abstraction Header Files

Include Directive	Target Specific	Description
<code>#include 'soc/xxx_caps.h'</code>	Y	This header contains a list of C macros specifying the various capabilities of the ESP32-C3's peripheral <code>xxx</code> . Hardware capabilities of a peripheral include things such as the number of channels, DMA support, hardware FIFO/buffer lengths, etc.
<code>#include "soc/xxx_struct.h"</code> <code>#include "soc/xxx_reg.h"</code>	Y	The two headers contain a representation of a peripheral's registers in C structure and C macro format respectively. Users can operate a peripheral at the register level via either of these two header files.
<code>#include "soc/xxx_pins.h"</code>	Y	If certain signals of a peripheral are mapped to a particular pin of the ESP32-C3, their mappings are defined in this header as C macros.
<code>#include "soc/xxx_periph.h"</code>	N	This header is mainly used as a convenience header file to automatically include <code>xxx_caps.h</code> , <code>xxx_struct.h</code> , and <code>xxx_reg.h</code> .
<code>#include "hal/xxx_types.h"</code>	N	This header contains type definitions and macros that are shared among the LL, HAL, and driver layers. Moreover, it is considered public API thus can be included by the application level. The shared types and definitions usually related to non-implementation specific concepts such as the following: <ul style="list-style-type: none"> • Protocol related types/macros such a frames, modes, common bus speeds, etc. • Features/characteristics of an <code>xxx</code> peripheral that are likely to be present on any implementation (implementation-independent) such as channels, operating modes, signal amplification or attenuation intensities, etc.
<code>#include "hal/xxx_ll.h"</code>	Y	This header contains the Low Level (LL) Layer of hardware abstraction. LL Layer API are primarily used to abstract away register operations into readable functions.
<code>#include "hal/xxx_hal.h"</code>	Y	The Hardware Abstraction Layer (HAL) is used to abstract away peripheral operation steps into functions (e.g., reading a buffer, starting a transmission, handling an event, etc). The HAL is built on top of the LL Layer.
<code>#include "driver/xxx.h"</code>	N	The driver layer is the highest level of ESP-IDF's hardware abstraction. Driver layer API are meant to be called from ESP-IDF applications, and internally utilize OS primitives. Thus, driver layer API are event-driven, and can used in a multi-threaded environment.

4.15.2 LL (Low Level) Layer

The primary purpose of the LL Layer is to abstract away register field access into more easily understandable functions. LL functions essentially translate various in/out arguments into the register fields of a peripheral in the form of `get/set`

functions. All the necessary bit shifting, masking, offsetting, and endianness of the register fields should be handled by the LL functions.

```
//Inside xxx_ll.h

static inline void xxx_ll_set_baud_rate(xxx_dev_t *hw,
                                       xxx_ll_clk_src_t clock_source,
                                       uint32_t baud_rate) {
    uint32_t src_clk_freq = (source_clk == XXX_SCLK_APB) ? APB_CLK_FREQ : REF_CLK_
↪FREQ;
    uint32_t clock_divider = src_clk_freq / baud;
    // Set clock select field
    hw->clk_div_reg.divider = clock_divider >> 4;
    // Set clock divider field
    hw->config.clk_sel = (source_clk == XXX_SCLK_APB) ? 0 : 1;
}

static inline uint32_t xxx_ll_get_rx_byte_count(xxx_dev_t *hw) {
    return hw->status_reg.rx_cnt;
}
```

The code snippet above illustrates typical LL functions for a peripheral `xxx`. LL functions typically have the following characteristics:

- All LL functions are defined as `static inline` so that there is minimal overhead when calling these functions due to compiler optimization.
- The first argument should be a pointer to a `xxx_dev_t` type. The `xxx_dev_t` type is a structure representing the peripheral's registers, thus the first argument is always a pointer to the starting address of the peripheral's registers. Note that in some cases where the peripheral has multiple channels with identical register layouts, `xxx_dev_t *hw` may point to the registers of a particular channel instead.
- LL functions should be short and in most cases are deterministic. In other words, the worst case runtime of the LL function can be determined at compile time. Thus, any loops in LL functions should be finite bounded; however, there are currently a few exceptions to this rule.
- LL functions are not thread safe, it is the responsibility of the upper layers (driver layer) to ensure that registers or register fields are not accessed concurrently.

4.15.3 HAL (Hardware Abstraction Layer)

The HAL layer models the operational process of a peripheral as a set of general steps, where each step has an associated function. For each step, the details of a peripheral's register implementation (i.e., which registers need to be set/read) are hidden (abstracted away) by the HAL. By modelling peripheral operation as a set of functional steps, any minor hardware implementation differences of the peripheral between different targets or chip versions can be abstracted away by the HAL (i.e., handled transparently). In other words, the HAL API for a particular peripheral will remain mostly the same across multiple targets/chip versions.

The following HAL function examples are selected from the Watchdog Timer HAL as each function maps to one of the steps in a WDT's operation life cycle, thus illustrating how a HAL abstracts a peripheral's operation into functional steps.

```
// Initialize one of the WDTs
void wdt_hal_init(wdt_hal_context_t *hal, wdt_inst_t wdt_inst, uint32_t prescaler,
↪bool enable_intr);

// Configure a particular timeout stage of the WDT
void wdt_hal_config_stage(wdt_hal_context_t *hal, wdt_stage_t stage, uint32_t
↪timeout, wdt_stage_action_t behavior);

// Start the WDT
void wdt_hal_enable(wdt_hal_context_t *hal);
```

(continues on next page)

```
// Feed (i.e., reset) the WDT
void wdt_hal_feed(wdt_hal_context_t *hal);

// Handle a WDT timeout
void wdt_hal_handle_intr(wdt_hal_context_t *hal);

// Stop the WDT
void wdt_hal_disable(wdt_hal_context_t *hal);

// De-initialize the WDT
void wdt_hal_deinit(wdt_hal_context_t *hal);
```

HAL functions will generally have the following characteristics:

- The first argument to a HAL function has the `xxx_hal_context_t *` type. The HAL context type is used to store information about a particular instance of the peripheral (i.e. the context instance). A HAL context is initialized by the `xxx_hal_init()` function and can store information such as the following:
 - The channel number of this instance
 - Pointer to the peripheral's (or channel's) registers (i.e., a `xxx_dev_t *` type)
 - Information about an ongoing transaction (e.g., pointer to DMA descriptor list in use)
 - Some configuration values for the instance (e.g., channel configurations)
 - Variables to maintain state information regarding the instance (e.g., a flag to indicate if the instance is waiting for transaction to complete)
- HAL functions should not contain any OS primitives such as queues, semaphores, mutexes, etc. All synchronization/concurrency should be handled at higher layers (e.g., the driver).
- Some peripherals may have steps that cannot be further abstracted by the HAL, thus will end up being a direct wrapper (or macro) for an LL function.
- Some HAL functions may be placed in IRAM thus may carry an `IRAM_ATTR` or be placed in a separate `xxx_hal_iram.c` source file.

4.16 JTAG Debugging

This document provides a guide to installing OpenOCD for ESP32-C3 and debugging using GDB. The document is structured as follows:

Introduction Introduction to the purpose of this guide.

How it Works? Description how ESP32-C3, JTAG interface, OpenOCD and GDB are interconnected and working together to enable debugging of ESP32-C3.

Selecting JTAG Adapter What are the criteria and options to select JTAG adapter hardware.

Setup of OpenOCD Procedure to install OpenOCD and verify that it is installed.

Configuring ESP32-C3 Target Configuration of OpenOCD software and setting up of JTAG adapter hardware, which together make up the debugging target.

Launching Debugger Steps to start up a debug session with GDB from *Eclipse* and from *Command Line*.

Debugging Examples If you are not familiar with GDB, check this section for debugging examples provided from *Eclipse* as well as from *Command Line*.

Building OpenOCD from Sources Procedure to build OpenOCD from sources for *Windows*, *Linux* and *macOS* operating systems.

Tips and Quirks This section provides collection of tips and quirks related to JTAG debugging of ESP32-C3 with OpenOCD and GDB.

4.16.1 Introduction

Espressif has ported OpenOCD to support the ESP32-C3 processor and the multi-core FreeRTOS (which is the foundation of most ESP32-C3 apps). Additionally, some extra tools have been written to provide extra features that OpenOCD does not support natively.

determine the chip revision is to look for the `Chip is ESP32-C3 (revision 3)` message near the end of a successful chip flashing done by `idf.py flash`.

Depending on user preferences, both *debugger* and *idf.py build* can be operated directly from terminal/command line, instead from Eclipse.

4.16.3 Selecting JTAG Adapter

The quickest and most convenient way to start with JTAG debugging is through a USB cable connected to the D+/D-USB pins of ESP32-C3. No need for an external JTAG adapter and extra wiring / cable to connect JTAG to ESP32-C3.

If you decide to use separate JTAG adapter, look for one that is compatible with both the voltage levels on the ESP32-C3 as well as with the OpenOCD software. The JTAG port on the ESP32-C3 is an industry-standard JTAG port which lacks (and does not need) the TRST pin. The JTAG I/O pins all are powered from the VDD_3P3_RTC pin (which normally would be powered by a 3.3 V rail) so the JTAG adapter needs to be able to work with JTAG pins in that voltage range.

On the software side, OpenOCD supports a fair amount of JTAG adapters. See <http://openocd.org/doc/html/Debug-Adapter-Hardware.html> for an (unfortunately slightly incomplete) list of the adapters OpenOCD works with. This page lists SWD-compatible adapters as well; take note that the ESP32-C3 does not support SWD. JTAG adapters that are hardcoded to a specific product line, e.g. ST-LINK debugging adapters for STM32 families, will not work.

The minimal signalling to get a working JTAG connection are TDI, TDO, TCK, TMS and GND. Some JTAG debuggers also need a connection from the ESP32-C3 power line to a line called e.g. Vtar to set the working voltage. SRST can optionally be connected to the CH_PD of the ESP32-C3, although for now, support in OpenOCD for that line is pretty minimal.

[ESP-Prog](#) is an example for using an external board for debugging by connecting it to the JTAG pins of ESP32-C3.

4.16.4 Setup of OpenOCD

If you have already set up ESP-IDF with CMake build system according to the *Getting Started Guide*, then OpenOCD is already installed. After *setting up the environment* in your terminal, you should be able to run OpenOCD. Check this by executing the following command:

```
openocd --version
```

The output should be as follows (although the version may be more recent than listed here):

```
Open On-Chip Debugger v0.10.0-esp32-20190708 (2019-07-08-11:04)
Licensed under GNU GPL v2
For bug reports, read
  http://openocd.org/doc/doxygen/bugs.html
```

You may also verify that OpenOCD knows where its configuration scripts are located by printing the value of OPENOCD_SCRIPTS environment variable, by typing `echo $OPENOCD_SCRIPTS` (for Linux and macOS) or `echo %OPENOCD_SCRIPTS%` (for Windows). If a valid path is printed, then OpenOCD is set up correctly.

If any of these steps do not work, please go back to the *setting up the tools* section of the Getting Started Guide.

Note: It is also possible to build OpenOCD from source. Please refer to *Building OpenOCD from Sources* section for details.

4.16.5 Configuring ESP32-C3 Target

Once OpenOCD is installed, you can proceed to configuring the ESP32-C3 target (i.e ESP32-C3 board with JTAG interface). Configuring the target is split into the following three steps:

- Configure and connect JTAG interface
- Run OpenOCD
- Upload application for debugging

Configure and connect JTAG interface

This step depends on the JTAG and ESP32-C3 board you are using (see the two cases described below).

Configure ESP32-C3 built-in JTAG Interface ESP32-C3 has a built-in JTAG circuitry and can be debugged without any additional chip. Only an USB cable connected to the D+/D- pins is necessary. The necessary connections are shown in the following section.

Configure Hardware

Table 23: ESP32-C3 pins and USB signals

ESP32-C3 Pin	USB Signal
GPIO18	D-
GPIO19	D+
5V	V_BUS
GND	Ground

Please verify that the ESP32-C3 pins used for USB communication are not connected to some other HW that may disturb the JTAG operation.

Configure USB Drivers JTAG communication should work on all supported platforms. Windows users might get *LIBUSB_ERROR_NOT_FOUND* errors. Please use version 2.8 (or newer) of the *ESP-IDF Tools Installer* and select the driver “Espressif - WinUSB support for JTAG (ESP32-C3)” in order to resolve this issue. If you don’t want to re-run the installer then the same can be achieved with *idf-env* by running the following command from PowerShell:

```
Invoke-WebRequest 'https://dl.espressif.com/dl/idf-env/idf-env.exe' -OutFile .\idf-
↪env.exe; .\idf-env.exe driver install --espressif
```

Configure Other JTAG Interface Refer to section *Selecting JTAG Adapter* for guidance what JTAG interface to select, so it is able to operate with OpenOCD and ESP32-C3. Then follow three configuration steps below to get it working.

Configure Hardware

1. Identify all pins / signals on JTAG interface and ESP32-C3 board, that should be connected to establish communication.

Table 24: ESP32-C3 pins and JTAG signals

ESP32-C3 Pin	JTAG Signal
MTDO / GPIO7	TDO
MTDI / GPIO5	TDI
MTCK / GPIO6	TCK
MTMS / GPIO4	TMS

2. Verify if ESP32-C3 pins used for JTAG communication are not connected to some other h/w that may disturb JTAG operation.

3. Connect identified pin / signals of ESP32-C3 and JTAG interface.

Configure Drivers You may need to install driver s/w to make JTAG work with computer. Refer to documentation of JTAG adapter, that should provide related details.

Connect Connect JTAG interface to the computer. Power on ESP32-C3 and JTAG interface boards. Check if JTAG interface is visible by computer.

To carry on with debugging environment setup, proceed to section [Run OpenOCD](#).

Run OpenOCD

Once target is configured and connected to computer, you are ready to launch OpenOCD.

Open a terminal and set it up for using the ESP-IDF as described in the [setting up the environment](#) section of the Getting Started Guide. Then run OpenOCD (this command works on Windows, Linux, and macOS):

```
openocd -f board/esp32c3-builtin.cfg
```

Note: The files provided after `-f` above are specific for ESP32-C3 through built-in USB connection. You may need to provide different files depending on the hardware that is used. For guidance see [Configuration of OpenOCD for specific target](#).

For example, `board/esp32c3-ftdi.cfg` can be used for a custom board with an FT2232H or FT232H chip used for JTAG connection, or with ESP-Prog.

You should now see similar output (this log is for ESP32-C3 through built-in USB connection):

```
user-name@computer-name:~/esp/esp-idf$ openocd -f board/esp32c3-builtin.cfg
Open On-Chip Debugger v0.10.0-esp32-20201202-26-g05a036c2 (2021-03-15-17:18)
Licensed under GNU GPL v2
For bug reports, read
  http://openocd.org/doc/doxygen/bugs.html
Info : only one transport option; autoselect 'jtag'
Warn : Transport "jtag" was already selected
force hard breakpoints
Info : Listening on port 6666 for tcl connections
Info : Listening on port 4444 for telnet connections
Info : esp_usb_jtag: Device found. Base speed 40000KHz, div range 1 to 255
Info : clock speed 40000 kHz
Info : JTAG tap: esp32c3.cpu tap/device found: 0x00005c25 (mfg: 0x612 (Espressif_
↔Systems), part: 0x0005, ver: 0x0)
Info : datacount=2 progbufsize=16
Info : Examined RISC-V core; found 1 harts
Info : hart 0: XLEN=32, misa=0x40101104
Info : Listening on port 3333 for gdb connections
```

- If there is an error indicating permission problems, please see section on “Permissions delegation” in the OpenOCD README file located in the `~/esp/openocd-esp32` directory.
- In case there is an error in finding the configuration files, e.g. Can't find `board/esp32c3-builtin.cfg`, check if the `OPENOCD_SCRIPTS` environment variable is set correctly. This variable is used by OpenOCD to look for the files specified after the `-f` option. See [Setup of OpenOCD](#) section for details. Also check if the file is indeed under the provided path.
- If you see JTAG errors (e.g., `...all ones` or `...all zeroes`), please check your JTAG connections, whether other signals are connected to JTAG besides ESP32-C3's pins, and see if everything is powered on correctly.

Upload application for debugging

Build and upload your application to ESP32-C3 as usual, see [Step 8. Build the Project](#).

Another option is to write application image to flash using OpenOCD via JTAG with commands like this:

```
openocd -f board/esp32c3-builtin.cfg -c "program_esp filename.bin 0x10000 verify_
↵exit"
```

OpenOCD flashing command `program_esp` has the following format:

```
program_esp <image_file> <offset> [verify] [reset] [exit]
```

- `image_file` - Path to program image file.
- `offset` - Offset in flash bank to write image.
- `verify` - Optional. Verify flash contents after writing.
- `reset` - Optional. Reset target after programing.
- `exit` - Optional. Finally exit OpenOCD.

You are now ready to start application debugging. Follow the steps described in the section below.

4.16.6 Launching Debugger

The toolchain for ESP32-C3 features GNU Debugger, in short GDB. It is available with other toolchain programs under filename: `riscv32-esp-elf-gdb`. GDB can be called and operated directly from command line in a terminal. Another option is to call it from within IDE (like Eclipse, Visual Studio Code, etc.) and operate indirectly with help of GUI instead of typing commands in a terminal.

Both options of using debugger are discussed under links below.

- [Eclipse](#)
- [Command Line](#)

It is recommended to first check if debugger works from [Command Line](#) and then move to using [Eclipse](#).

4.16.7 Debugging Examples

This section is intended for users not familiar with GDB. It presents example debugging session from [Eclipse](#) using simple application available under [get-started/blink](#) and covers the following debugging actions:

1. [Navigating through the code, call stack and threads](#)
2. [Setting and clearing breakpoints](#)
3. [Halting the target manually](#)
4. [Stepping through the code](#)
5. [Checking and setting memory](#)
6. [Watching and setting program variables](#)
7. [Setting conditional breakpoints](#)

Similar debugging actions are provided using GDB from [Command Line](#).

Before proceeding to examples, set up your ESP32-C3 target and load it with [get-started/blink](#).

4.16.8 Building OpenOCD from Sources

Please refer to separate documents listed below, that describe build process.

Building OpenOCD from Sources for Windows

The following instructions are alternative to downloading binary OpenOCD from [Espressif GitHub](#). To quickly setup the binary OpenOCD, instead of compiling it yourself, backup and proceed to section *Setup of OpenOCD*.

Note: Following instructions are assumed to be runned in MSYS2 environment with MINGW32 subsystem!

Install Dependencies Install packages that are required to compile OpenOCD:

```
pacman -S --noconfirm --needed autoconf automake git make \  
mingw-w64-i686-gcc \  
mingw-w64-i686-toolchain \  
mingw-w64-i686-libtool \  
mingw-w64-i686-pkg-config \  
mingw-w64-cross-winpthreads-git \  
p7zip
```

Download Sources of OpenOCD The sources for the ESP32-C3-enabled variant of OpenOCD are available from Espressif GitHub under <https://github.com/espressif/openocd-esp32>. To download the sources, use the following commands:

```
cd ~/esp  
git clone --recursive https://github.com/espressif/openocd-esp32.git
```

The clone of sources should be now saved in ~/esp/openocd-esp32 directory.

Downloading libusb Build and export variables for a following OpenOCD compilation:

```
wget https://github.com/libusb/libusb/releases/download/v1.0.22/libusb-1.0.22.7z  
7z x -olibusb ./libusb-1.0.22.7z  
export CPPFLAGS="$CPPFLAGS -I${PWD}/libusb/include/libusb-1.0"  
export LDFLAGS="$LDFLAGS -L${PWD}/libusb/MinGW32/.libs/dll"
```

Build OpenOCD Proceed with configuring and building OpenOCD:

```
cd ~/esp/openocd-esp32  
export CPPFLAGS="$CPPFLAGS -D__USE_MINGW_ANSI_STDIO=1 -Wno-error"; export CFLAGS="  
↪$CFLAGS -Wno-error"  
./bootstrap  
./configure --disable-doxxygen-pdf --enable-ftdi --enable-jlink --enable-ulink --  
↪build=i686-w64-mingw32 --host=i686-w64-mingw32  
make  
cp ../libusb/MinGW32/dll/libusb-1.0.dll ./src  
cp /opt/i686-w64-mingw32/bin/libwinpthread-1.dll ./src
```

Optionally you can add `make install` step at the end. Skip it, if you have an existing OpenOCD (from e.g. another development platform), as it may get overwritten. Also you could use `export DESTDIR="/custom/install/dir"; make install`.

Note:

- Should an error occur, resolve it and try again until the command `make` works.
- If there is a submodule problem from OpenOCD, please `cd` to the `openocd-esp32` directory and input `git submodule update --init`.

- If the `./configure` is successfully run, information of enabled JTAG will be printed under OpenOCD configuration summary.
- If the information of your device is not shown in the log, use `./configure` to enable it as described in `../openocd-esp32/doc/INSTALL.txt`.
- For details concerning compiling OpenOCD, please refer to `openocd-esp32/README.Windows`.
- Don't forget to copy `libusb-1.0.dll` and `libwinpthread-1.dll` into `OOCD_INSTALLDIR/bin` from `~/esp/openocd-esp32/src`.

Once make process is successfully completed, the executable of OpenOCD will be saved in `~/esp/openocd-esp32/src` directory.

Full Listing A complete described previously process is provided below for the faster execution, e.g. as a shell script:

```
pacman -S --noconfirm --needed autoconf automake git make mingw-w64-i686-gcc mingw-
↳w64-i686-toolchain mingw-w64-i686-libtool mingw-w64-i686-pkg-config mingw-w64-
↳cross-winpthreads-git p7zip
cd ~/esp
git clone --recursive https://github.com/espressif/openocd-esp32.git

wget https://github.com/libusb/libusb/releases/download/v1.0.22/libusb-1.0.22.7z
7z x -olibusb ./libusb-1.0.22.7z
export CPPFLAGS="$CPPFLAGS -I${PWD}/libusb/include/libusb-1.0"; export LDFLAGS="
↳$LDFLAGS -L${PWD}/libusb/MinGW32/.libs/dll"

export CPPFLAGS="$CPPFLAGS -D__USE_MINGW_ANSI_STDIO=1 -Wno-error"; export CFLAGS="
↳$CFLAGS -Wno-error"
cd ~/esp/openocd-esp32
./bootstrap
./configure --disable-doxxygen-pdf --enable-ftdi --enable-jlink --enable-ulink --
↳build=i686-w64-mingw32 --host=i686-w64-mingw32
make
cp ../libusb/MinGW32/dll/libusb-1.0.dll ./src
cp /opt/i686-w64-mingw32/bin/libwinpthread-1.dll ./src

# # optional
# export DESTDIR="$PWD"
# make install
# cp ./src/libusb-1.0.dll $DESTDIR/mingw32/bin
# cp ./src/libwinpthread-1.dll $DESTDIR/mingw32/bin
```

Next Steps To carry on with debugging environment setup, proceed to section [Configuring ESP32-C3 Target](#).

Building OpenOCD from Sources for Linux

The following instructions are alternative to downloading binary OpenOCD from [Espressif GitHub](#). To quickly setup the binary OpenOCD, instead of compiling it yourself, backup and proceed to section [Setup of OpenOCD](#).

Download Sources of OpenOCD The sources for the ESP32-C3-enabled variant of OpenOCD are available from Espressif GitHub under <https://github.com/espressif/openocd-esp32>. To download the sources, use the following commands:

```
cd ~/esp
git clone --recursive https://github.com/espressif/openocd-esp32.git
```

The clone of sources should be now saved in `~/esp/openocd-esp32` directory.

Install Dependencies Install packages that are required to compile OpenOCD.

Note: Install the following packages one by one, check if installation was successful and then proceed to the next package. Resolve reported problems before moving to the next step.

```
sudo apt-get install make
sudo apt-get install libtool
sudo apt-get install pkg-config
sudo apt-get install autoconf
sudo apt-get install automake
sudo apt-get install texinfo
sudo apt-get install libusb-1.0
```

Note:

- Version of pkg-config should be 0.2.3 or above.
 - Version of autoconf should be 2.6.4 or above.
 - Version of automake should be 1.9 or above.
 - When using USB-Blaster, ASIX Presto, OpenJTAG and FT2232 as adapters, drivers libFTDI and FTD2XX need to be downloaded and installed.
 - When using CMSIS-DAP, HIDAPI is needed.
-

Build OpenOCD Proceed with configuring and building OpenOCD:

```
cd ~/esp/openocd-esp32
./bootstrap
./configure
make
```

Optionally you can add `sudo make install` step at the end. Skip it, if you have an existing OpenOCD (from e.g. another development platform), as it may get overwritten.

Note:

- Should an error occur, resolve it and try again until the command `make` works.
 - If there is a submodule problem from OpenOCD, please `cd` to the `openocd-esp32` directory and input `git submodule update --init`.
 - If the `./configure` is successfully run, information of enabled JTAG will be printed under OpenOCD configuration summary.
 - If the information of your device is not shown in the log, use `./configure` to enable it as described in `../openocd-esp32/doc/INSTALL.txt`.
 - For details concerning compiling OpenOCD, please refer to `openocd-esp32/README`.
-

Once `make` process is successfully completed, the executable of OpenOCD will be saved in `~/openocd-esp32/bin` directory.

Next Steps To carry on with debugging environment setup, proceed to section [Configuring ESP32-C3 Target](#).

Building OpenOCD from Sources for MacOS

The following instructions are alternative to downloading binary OpenOCD from [Espressif GitHub](#). To quickly setup the binary OpenOCD, instead of compiling it yourself, backup and proceed to section [Setup of OpenOCD](#).

Download Sources of OpenOCD The sources for the ESP32-C3-enabled variant of OpenOCD are available from Espressif GitHub under <https://github.com/espressif/openocd-esp32>. To download the sources, use the following commands:

```
cd ~/esp
git clone --recursive https://github.com/espressif/openocd-esp32.git
```

The clone of sources should be now saved in `~/esp/openocd-esp32` directory.

Install Dependencies Install packages that are required to compile OpenOCD using Homebrew:

```
brew install automake libtool libusb wget gcc@4.9 pkg-config
```

Build OpenOCD Proceed with configuring and building OpenOCD:

```
cd ~/esp/openocd-esp32
./bootstrap
./configure
make
```

Optionally you can add `sudo make install` step at the end. Skip it, if you have an existing OpenOCD (from e.g. another development platform), as it may get overwritten.

Note:

- Should an error occur, resolve it and try again until the command `make` works.
- If there is a submodule problem from OpenOCD, please `cd` to the `openocd-esp32` directory and input `git submodule update --init`.
- If the `./configure` is successfully run, information of enabled JTAG will be printed under OpenOCD configuration summary.
- If the information of your device is not shown in the log, use `./configure` to enable it as described in `../openocd-esp32/doc/INSTALL.txt`.
- For details concerning compiling OpenOCD, please refer to `openocd-esp32/README.OSX`.

Once `make` process is successfully completed, the executable of OpenOCD will be saved in `~/esp/openocd-esp32/src/openocd` directory.

Next Steps To carry on with debugging environment setup, proceed to section [Configuring ESP32-C3 Target](#).

The examples of invoking OpenOCD in this document assume using pre-built binary distribution described in section [Setup of OpenOCD](#).

To use binaries build locally from sources, change the path to OpenOCD executable to `src/openocd` and set the `OPENOCD_SCRIPTS` environment variable so that OpenOCD can find the configuration files. For Linux and macOS:

```
cd ~/esp/openocd-esp32
export OPENOCD_SCRIPTS=$PWD/tcl
```

For Windows:

```
cd %USERPROFILE%\esp\openocd-esp32
set "OPENOCD_SCRIPTS=%CD%\tcl"
```

Example of invoking OpenOCD build locally from sources, for Linux and macOS:

```
src/openocd -f board/esp32c3-builtin.cfg
```

and Windows:

```
src\openocd -f board/esp32c3-builtin.cfg
```

4.16.9 Tips and Quirks

This section provides collection of links to all tips and quirks referred to from various parts of this guide.

Tips and Quirks

This section provides collection of all tips and quirks referred to from various parts of this guide.

Breakpoints and watchpoints available ESP32-C3 debugger supports 2 hardware implemented breakpoints and 64 software ones. Hardware breakpoints are implemented by ESP32-C3 chip's logic and can be set anywhere in the code: either in flash or IRAM program's regions. Additionally there are 2 types of software breakpoints implemented by OpenOCD: flash (up to 32) and IRAM (up to 32) breakpoints. Currently GDB can not set software breakpoints in flash. So until this limitation is removed those breakpoints have to be emulated by OpenOCD as hardware ones (see *below* for details). ESP32-C3 also supports two watchpoints, so two variables can be watched for change or read by the GDB command `watch myVariable`. Note that menuconfig option `CONFIG_FREERTOS_WATCHPOINT_END_OF_STACK` uses the 2nd watchpoint and will not provide expected results, if you also try to use it within OpenOCD / GDB. See menuconfig's help for detailed description.

What else should I know about breakpoints? Emulating part of hardware breakpoints using software flash ones means that the GDB command `hb myFunction` which is invoked for function in flash will use pure hardware breakpoint if it is available otherwise one of the 32 software flash breakpoints is used. The same rule applies to `b myFunction`-like commands. In this case GDB will decide what type of breakpoint to set itself. If `myFunction` is resided in writable region (IRAM) software IRAM breakpoint will be used otherwise hardware or software flash breakpoint is used as it is done for `hb` command.

Flash Mappings vs SW Flash Breakpoints In order to set/clear software breakpoints in flash, OpenOCD needs to know their flash addresses. To accomplish conversion from the ESP32-C3 address space to the flash one, OpenOCD uses mappings of program's code regions resided in flash. Those mappings are kept in the image header which is prepended to program binary data (code and data segments) and is specific to every application image written to the flash. So to support software flash breakpoints OpenOCD should know where application image under debugging is resided in the flash. By default OpenOCD reads partition table at 0x8000 and uses mappings from the first found application image, but there can be the cases when it will not work, e.g. partition table is not at standard flash location or even there can be multiple images: one factory and two OTA and you may want to debug any of them. To cover all possible debugging scenarios OpenOCD supports special command which can be used to set arbitrary location of application image to debug. The command has the following format:

```
esp appimage_offset <offset>
```

Offset should be in hex format. To reset to the default behaviour you can specify `-1` as offset.

Note: Since GDB requests memory map from OpenOCD only once when connecting to it, this command should be specified in one of the TCL configuration files, or passed to OpenOCD via its command line. In the latter case command line should look like below:

```
openocd -f board/esp32c3-builtin.cfg -c "init; halt; esp appimage_offset 0x210000"
```

Another option is to execute that command via OpenOCD telnet session and then connect GDB, but it seems to be less handy.

Why stepping with “next” does not bypass subroutine calls? When stepping through the code with `next` command, GDB is internally setting a breakpoint (one out of two available) ahead in the code to bypass the subroutine calls. This functionality will not work, if the two available breakpoints are already set elsewhere in the code. If this is the case, delete breakpoints to have one “spare”. With both breakpoints already used, stepping through the code with `next` command will work as like with `step` command and debugger will step inside subroutine calls.

Support options for OpenOCD at compile time ESP-IDF has some support options for OpenOCD debugging which can be set at compile time:

- `CONFIG_ESP32C3_DEBUG_OCDAWARE` is enabled by default. If a panic or unhandled exception is thrown and a JTAG debugger is connected (ie OpenOCD is running), ESP-IDF will break into the debugger.
- `CONFIG_FREERTOS_WATCHPOINT_END_OF_STACK` (disabled by default) sets watchpoint index 1 (the second of two) at the end of any task stack. This is the most accurate way to debug task stack overflows. Click the link for more details.

Please see the [project configuration menu](#) menu for more details on setting compile-time options.

FreeRTOS support OpenOCD has explicit support for the ESP-IDF FreeRTOS. GDB can see FreeRTOS tasks as threads. Viewing them all can be done using the GDB `i threads` command, changing to a certain task is done with `thread n`, with `n` being the number of the thread. FreeRTOS detection can be disabled in target’s configuration. For more details see [Configuration of OpenOCD for specific target](#).

Optimize JTAG speed In order to achieve higher data rates and minimize number of dropped packets it is recommended to optimize setting of JTAG clock frequency, so it is at maximum and still provides stable operation of JTAG. To do so use the following tips.

1. The upper limit of JTAG clock frequency is 20 MHz if CPU runs at 80 MHz, or 26 MHz if CPU runs at 160 MHz or 240 MHz.
2. Depending on particular JTAG adapter and the length of connecting cables, you may need to reduce JTAG frequency below 20 / 26 MHz.
3. In particular reduce frequency, if you get DSR/DIR errors (and they do not relate to OpenOCD trying to read from a memory range without physical memory being present there).
4. ESP-WROVER-KIT operates stable at 20 / 26 MHz.

What is the meaning of debugger’s startup commands? On startup, debugger is issuing sequence of commands to reset the chip and halt it at specific line of code. This sequence (shown below) is user defined to pick up at most convenient / appropriate line and start debugging.

- `set remote hardware-watchpoint-limit 2`—Restrict GDB to using two hardware watchpoints supported by the chip, 2 for ESP32-C3. For more information see <https://sourceware.org/gdb/onlinedocs/gdb/Remote-Configuration.html>.
- `mon reset halt`—reset the chip and keep the CPUs halted
- `flushregs`—monitor (`mon`) command can not inform GDB that the target state has changed. GDB will assume that whatever stack the target had before `mon reset halt` will still be valid. In fact, after reset the target state will change, and executing `flushregs` is a way to force GDB to get new state from the target.
- `thb app_main`—insert a temporary hardware breakpoint at `app_main`, put here another function name if required
- `c`—resume the program. It will then stop at breakpoint inserted at `app_main`.

Configuration of OpenOCD for specific target There are several kinds of OpenOCD configuration files (*.cfg). All configuration files are located in subdirectories of `share/openocd/scripts` directory of OpenOCD distribution (or `tcl/scripts` directory of the source repository). For the purposes of this guide, the most important ones are `board`, `interface` and `target`.

- `interface` configuration files describe the JTAG adapter. Examples of JTAG adapters are ESP-Prog and J-Link.
- `target` configuration files describe specific chips, or in some cases, modules.

- board configuration files are provided for development boards with a built-in JTAG adapter. Such files include an `interface` configuration file to choose the adapter, and `target` configuration file to choose the chip/module.

The following configuration files are available for ESP32-C3:

Table 25: OpenOCD configuration files for ESP32-C3

Name	Description
<code>board/esp32c3-builtin.cfg</code>	Board configuration file for ESP32-C3 through built-in USB, includes target and adapter configuration.
<code>board/esp32c3-ftdi.cfg</code>	Board configuration file for ESP32-C3 debug through an ESP-Prog compatible FTDI, includes target and adapter configuration.
<code>target/esp32c3.cfg</code>	ESP32-C3 target configuration file. Can be used together with one of the <code>interface/</code> configuration files.
<code>interface/esp_usb_jtag.cfg</code>	JTAG adapter configuration file for ESP32-C3.
<code>interface/ftdi/esp32_devkitj_v1.cfg</code>	JTAG adapter configuration file for ESP-Prog boards.

If you are using one of the boards which have a pre-defined configuration file, you only need to pass one `-f` argument to OpenOCD, specifying that file.

If you are using a board not listed here, you need to specify both the interface configuration file and target configuration file.

Custom configuration files OpenOCD configuration files are written in TCL, and include a variety of choices for customization and scripting. This can be useful for non-standard debugging situations. Please refer to [OpenOCD Manual](#) for the TCL scripting reference.

OpenOCD configuration variables The following variables can be optionally set before including the ESP-specific target configuration file. This can be done either in a custom configuration file, or from the command line.

The syntax for setting a variable in TCL is:

```
set VARIABLE_NAME value
```

To set a variable from the command line (replace the name of `.cfg` file with the correct file for your board):

```
openocd -c 'set VARIABLE_NAME value' -f board/esp-xxxxx-kit.cfg
```

It is important to set the variable before including the ESP-specific configuration file, otherwise the variable will not have effect. You can set multiple variables by repeating the `-c` option.

Table 26: Common ESP-related OpenOCD variables

Variable	Description
<code>ESP_RTOS</code>	Set to <code>none</code> to disable RTOS support. In this case, thread list will not be available in GDB. Can be useful when debugging FreeRTOS itself, and stepping through the scheduler code.
<code>ESP_FLASH_SIZE</code>	Set to <code>0</code> to disable Flash breakpoints support.
<code>ESP_SEMIHOST_BASED</code>	Set to the path (on the host) which will be the default directory for semihosting functions.

How debugger resets ESP32-C3? The board can be reset by entering `mon reset` or `mon reset halt` into GDB.

Do not use JTAG pins for something else Operation of JTAG may be disturbed, if some other h/w is connected to JTAG pins besides ESP32-C3 module and JTAG adapter. ESP32-C3 JTAG is using the following pins:

Table 27: ESP32-C3 pins and JTAG signals

ESP32-C3 Pin	JTAG Signal
MTDO / GPIO7	TDO
MTDI / GPIO5	TDI
MTCK / GPIO6	TCK
MTMS / GPIO4	TMS

JTAG communication will likely fail, if configuration of JTAG pins is changed by user application. If OpenOCD initializes correctly (detects the two Tensilica cores), but loses sync and spews out a lot of DTR/DIR errors when the program is ran, it is likely that the application reconfigures the JTAG pins to something else, or the user forgot to connect Vtar to a JTAG adapter that needed it.

Below is an excerpt from series of errors reported by GDB after the application stepped into the code that reconfigured MTDO pin to be an input:

```
cpu0: xtensa_resume (line 431): DSR (FFFFFFFF) indicates target still busy!
cpu0: xtensa_resume (line 431): DSR (FFFFFFFF) indicates DIR instruction generated.
↳an exception!
cpu0: xtensa_resume (line 431): DSR (FFFFFFFF) indicates DIR instruction generated.
↳an overrun!
cpu1: xtensa_resume (line 431): DSR (FFFFFFFF) indicates target still busy!
cpu1: xtensa_resume (line 431): DSR (FFFFFFFF) indicates DIR instruction generated.
↳an exception!
cpu1: xtensa_resume (line 431): DSR (FFFFFFFF) indicates DIR instruction generated.
↳an overrun!
```

JTAG with Flash Encryption or Secure Boot By default, enabling Flash Encryption and/or Secure Boot will disable JTAG debugging. On first boot, the bootloader will burn an eFuse bit to permanently disable JTAG at the same time it enables the other features.

The project configuration option `CONFIG_SECURE_BOOT_ALLOW_JTAG` will keep JTAG enabled at this time, removing all physical security but allowing debugging. (Although the name suggests Secure Boot, this option can be applied even when only Flash Encryption is enabled).

However, OpenOCD may attempt to automatically read and write the flash in order to set *software breakpoints*. This has two problems:

- Software breakpoints are incompatible with Flash Encryption, OpenOCD currently has no support for encrypting or decrypting flash contents.
- If Secure Boot is enabled, setting a software breakpoint will change the digest of a signed app and make the signature invalid. This means if a software breakpoint is set and then a reset occurs, the signature verification will fail on boot.

To disable software breakpoints while using JTAG, add an extra argument `-c 'set ESP_FLASH_SIZE 0'` to the start of the OpenOCD command line, see *OpenOCD configuration variables*.

Note: For the same reason, the ESP-IDF app may fail bootloader verification of app signatures, when this option is enabled and a software breakpoint is set.

Reporting issues with OpenOCD / GDB In case you encounter a problem with OpenOCD or GDB programs itself and do not find a solution searching available resources on the web, open an issue in the OpenOCD issue tracker under <https://github.com/espressif/openocd-esp32/issues>.

1. In issue report provide details of your configuration:
 - a. JTAG adapter type, and the chip/module being debugged.

- b. Release of ESP-IDF used to compile and load application that is being debugged.
 - c. Details of OS used for debugging.
 - d. Is OS running natively on a PC or on a virtual machine?
2. Create a simple example that is representative to observed issue. Describe steps how to reproduce it. In such an example debugging should not be affected by non-deterministic behaviour introduced by the Wi-Fi stack, so problems will likely be easier to reproduce, if encountered once.
3. Prepare logs from debugging session by adding additional parameters to start up commands.
OpenOCD:

```
openocd -l openocd_log.txt -d3 -f board/esp32c3-builtin.cfg
```

Logging to a file this way will prevent information displayed on the terminal. This may be a good thing taken amount of information provided, when increased debug level `-d3` is set. If you still like to see the log on the screen, then use another command instead:

```
openocd -d3 -f board/esp32c3-builtin.cfg 2>&1 | tee openocd.log
```

Debugger:

```
riscv32-esp-elf-gdb -ex "set remotelogfile gdb_log.txt" <all other options>
```

Optionally add command `remotelogfile gdb_log.txt` to the `gdbinit` file.

4. Attach both `openocd_log.txt` and `gdb_log.txt` files to your issue report.

4.16.10 Related Documents

Using Debugger

This section covers configuration and running debugger using several methods:

- from [Eclipse](#)
- from [Command Line](#)
- using [idf.py debug targets](#).

Eclipse

Note: It is recommended to first check if debugger works using [idf.py debug targets](#) or from [Command Line](#) and then move to using Eclipse.

Debugging functionality is provided out of box in standard Eclipse installation. Another option is to use pluggins like “GDB Hardware Debugging” plugin. We have found this plugin quite convenient and decided to use throughout this guide.

To begin with, install “GDB Hardware Debugging” plugin by opening Eclipse and going to *Help > Install New Software*.

Once installation is complete, configure debugging session following steps below. Please note that some of configuration parameters are generic and some are project specific. This will be shown below by configuring debugging for “blink” example project. If not done already, add this project to Eclipse workspace following guidance in section [Build and Flash with Eclipse IDE](#). The source of [get-started/blink](#) application is available in [examples](#) directory of ESP-IDF repository.

1. In Eclipse go to *Run > Debug Configuration*. A new window will open. In the window’s left pane double click “GDB Hardware Debugging” (or select “GDB Hardware Debugging” and press the “New” button) to create a new configuration.
2. In a form that will show up on the right, enter the “Name:” of this configuration, e.g. “Blink checking” .
3. On the “Main” tab below, under “Project:” , press “Browse” button and select the “blink” project.
4. In next line “C/C++ Application:” press “Browse” button and select “blink.elf” file. If “blink.elf” is not there, then likely this project has not been build yet. See [Build and Flash with Eclipse IDE](#) how to do it.
5. Finally, under “Build (if required) before launching” click “Disable auto build” .
A sample window with settings entered in points 1 - 5 is shown below.

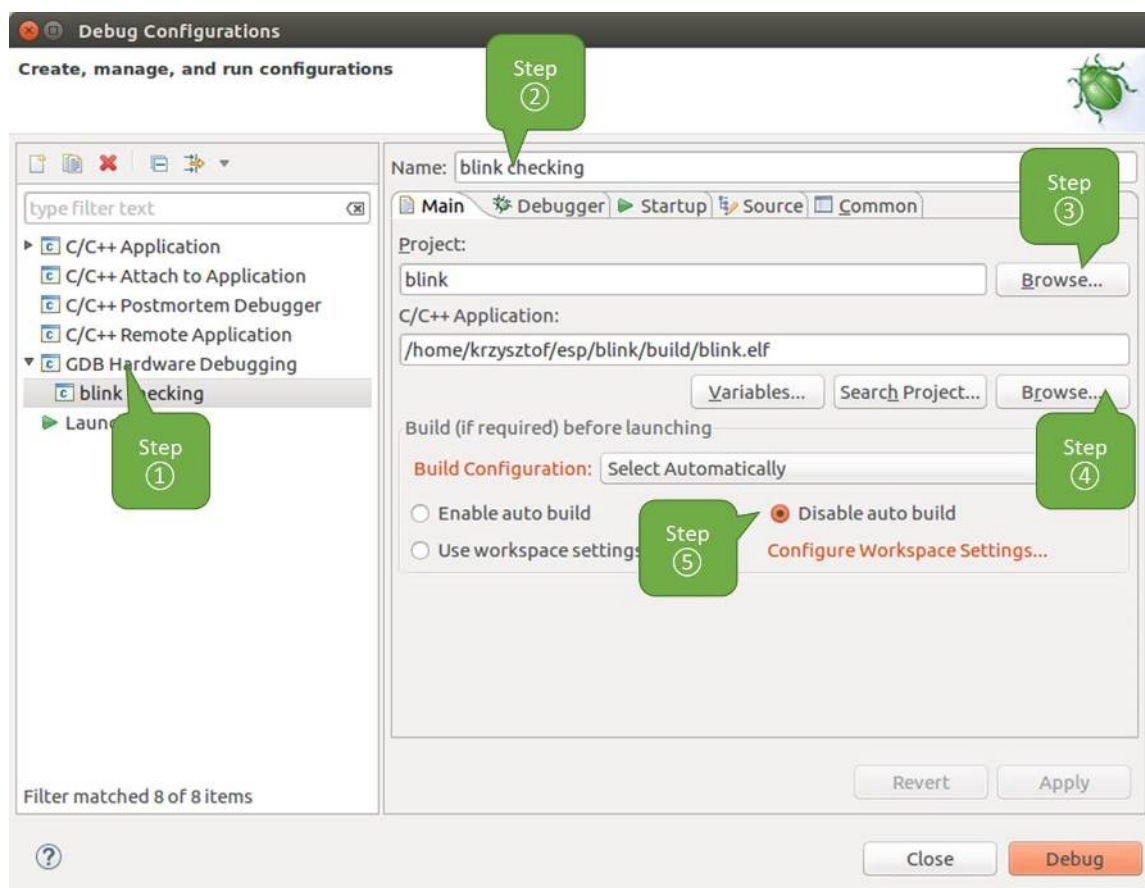

Fig. 34: Configuration of GDB Hardware Debugging - Main tab

6. Click “Debugger” tab. In field “GDB Command” enter `riscv32-esp-elf-gdb` to invoke debugger.
7. Change default configuration of “Remote host” by entering 3333 under the “Port number” .
Configuration entered in points 6 and 7 is shown on the following picture.

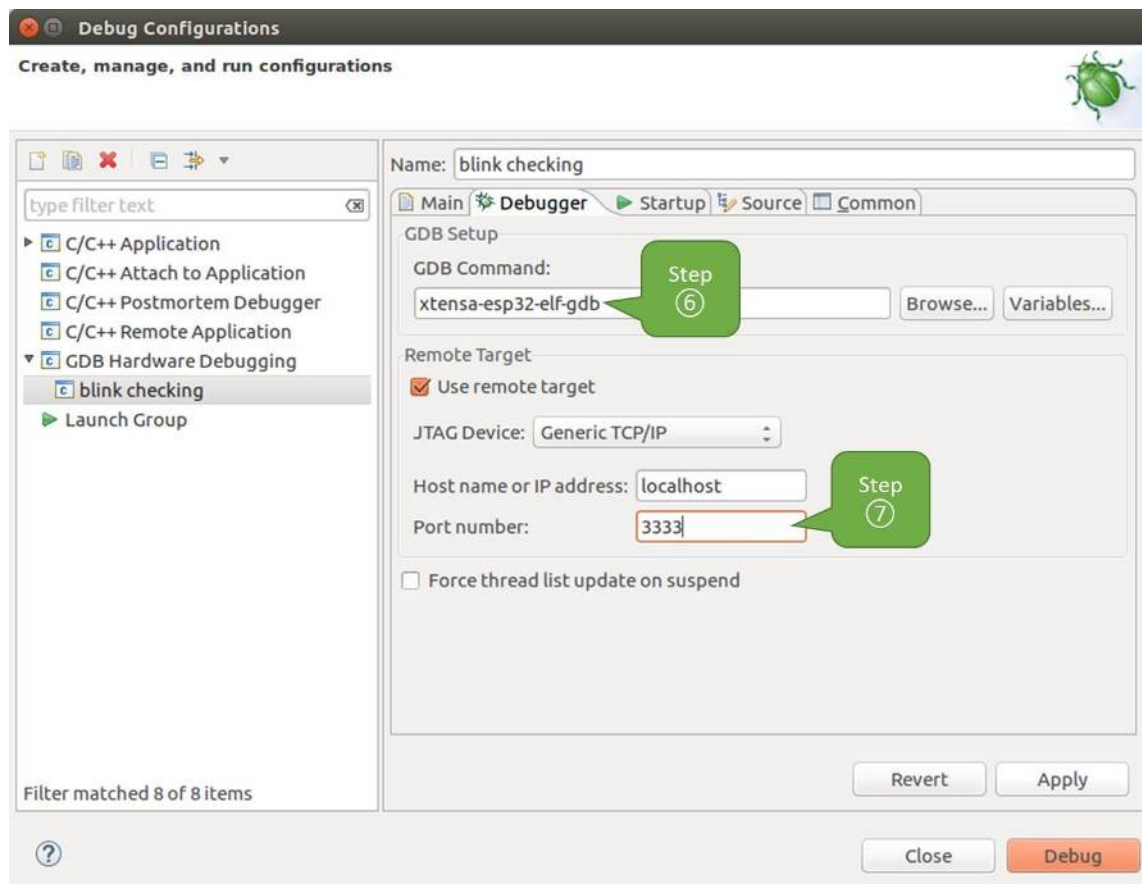

Fig. 35: Configuration of GDB Hardware Debugging - Debugger tab

8. The last tab to that requires changing of default configuration is “Startup” . Under “Initialization Commands” uncheck “Reset and Delay (seconds)” and “Halt” . Then, in entry field below, enter the following lines:

```
mon reset halt
flushregs
set remote hardware-watchpoint-limit 2
```

Note: If you want to update image in the flash automatically before starting new debug session add the following lines of commands at the beginning of “Initialization Commands” textbox:

```
mon reset halt
mon program_esp ${workspace_loc:blink/build/blink.bin} 0x10000 verify
```

For description of `program_esp` command see [Upload application for debugging](#).

9. Under “Load Image and Symbols” uncheck “Load image” option.
10. Further down on the same tab, establish an initial breakpoint to halt CPUs after they are reset by debugger. The plugin will set this breakpoint at the beginning of the function entered under “Set break point at:” . Check out this option and enter `app_main` in provided field.
11. Checkout “Resume” option. This will make the program to resume after `mon reset halt` is invoked per point 8. The program will then stop at breakpoint inserted at `app_main`.
Configuration described in points 8 - 11 is shown below.
If the “Startup” sequence looks convoluted and respective “Initialization Commands” are not clear to you, check [What is the meaning of debugger’s startup commands?](#) for additional explanation.

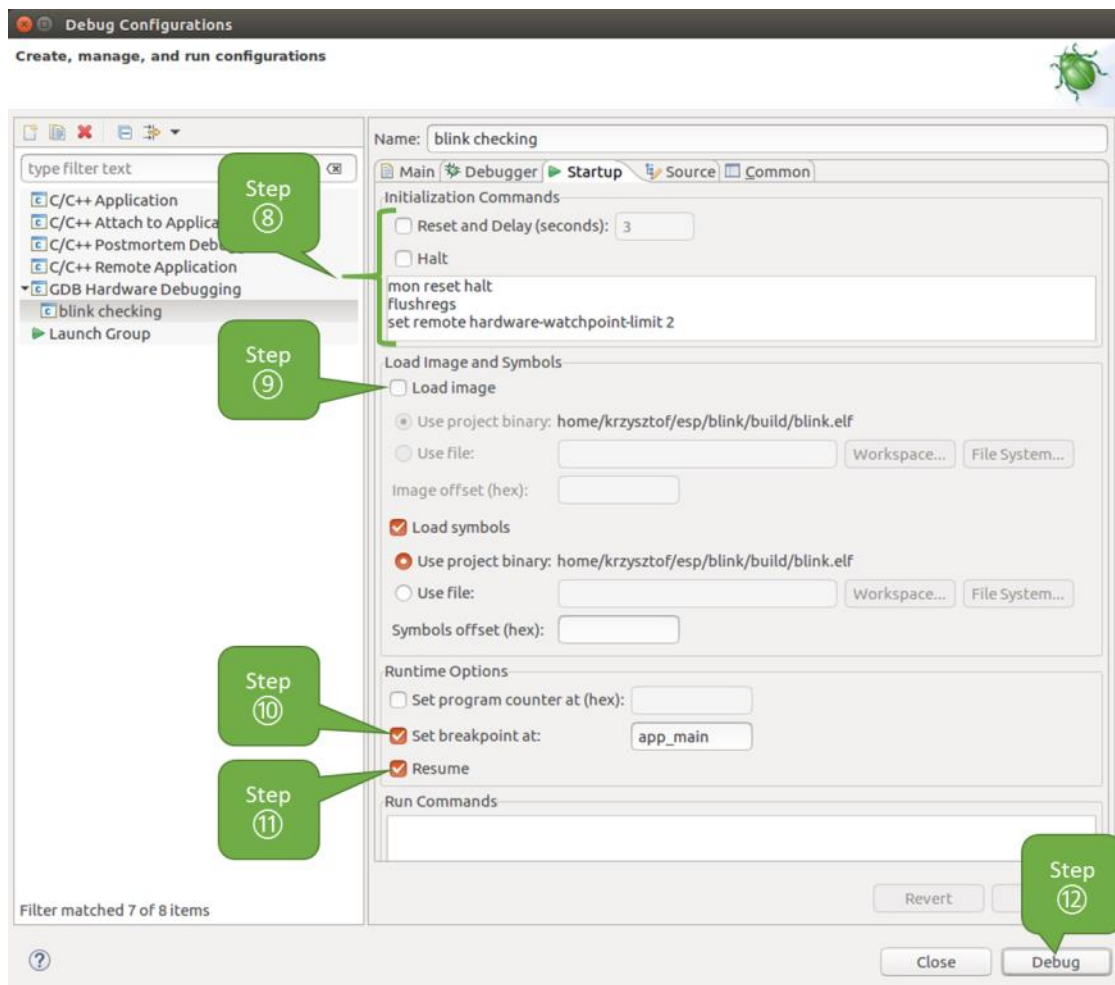

Fig. 36: Configuration of GDB Hardware Debugging - Startup tab

- If you previously completed *Configuring ESP32-C3 Target* steps described above, so the target is running and ready to talk to debugger, go right to debugging by pressing “Debug” button. Otherwise press “Apply” to save changes, go back to *Configuring ESP32-C3 Target* and return here to start debugging.

Once all 1 - 12 configuration steps are satisfied, the new Eclipse perspective called “Debug” will open as shown on example picture below.

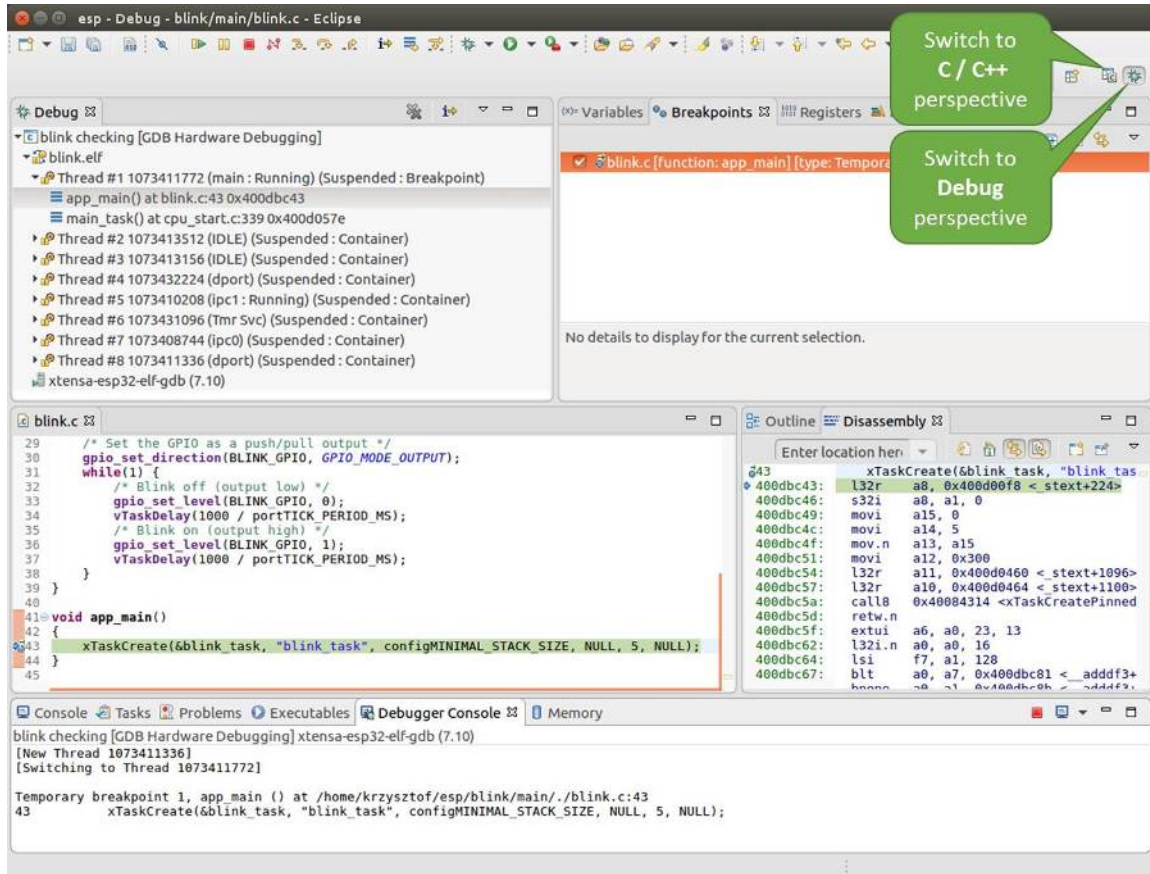

Fig. 37: Debug Perspective in Eclipse

If you are not quite sure how to use GDB, check *Eclipse* example debugging session in section *Debugging Examples*.

Command Line

- Begin with completing steps described under *Configuring ESP32-C3 Target*. This is prerequisite to start a debugging session.
- Open a new terminal session and go to directory that contains project for debugging, e.g.

```
cd ~/esp/blink
```

- When launching a debugger, you will need to provide couple of configuration parameters and commands. Instead of entering them one by one in command line, create a configuration file and name it `gdbinit`:

```
target remote :3333
set remote hardware-watchpoint-limit 2
mon reset halt
flushregs
thb app_main
c
```

Save this file in current directory.

For more details what's inside `gdbinit` file, see *What is the meaning of debugger's startup commands?*

4. Now you are ready to launch GDB. Type the following in terminal:

```
riscv32-esp-elf-gdb -x gdbinit build/blink.elf
```

5. If previous steps have been done correctly, you will see a similar log concluded with (gdb) prompt:

```
user-name@computer-name:~/esp/blink$ riscv32-esp-elf-gdb -x gdbinit build/
↳blink.elf
GNU gdb (crosstool-NG crosstool-ng-1.22.0-61-gab8375a) 7.10
Copyright (C) 2015 Free Software Foundation, Inc.
License GPLv3+: GNU GPL version 3 or later <http://gnu.org/licenses/gpl.html>
This is free software: you are free to change and redistribute it.
There is NO WARRANTY, to the extent permitted by law. Type "show copying"
and "show warranty" for details.
This GDB was configured as "--host=x86_64-build_pc-linux-gnu --target=riscv32-
↳esp-elf".
Type "show configuration" for configuration details.
For bug reporting instructions, please see:
<http://www.gnu.org/software/gdb/bugs/>.
Find the GDB manual and other documentation resources online at:
<http://www.gnu.org/software/gdb/documentation/>.
For help, type "help".
Type "apropos word" to search for commands related to "word"...
Reading symbols from build/blink.elf...done.
0x400d10d8 in esp_vApplicationIdleHook () at /home/user-name/esp/esp-idf/
↳components/esp32c3/./freertos_hooks.c:52
52      asm("waiti 0");
JTAG tap: esp32c3.cpu0 tap/device found: 0x120034e5 (mfg: 0x272 (Tensilica),
↳part: 0x2003, ver: 0x1)
JTAG tap: esp32c3.slave tap/device found: 0x120034e5 (mfg: 0x272 (Tensilica),
↳part: 0x2003, ver: 0x1)
esp32c3: Debug controller was reset (pwrstat=0x5F, after clear 0x0F).
esp32c3: Core was reset (pwrstat=0x5F, after clear 0x0F).
Target halted. PRO_CPU: PC=0x5000004B (active) APP_CPU: PC=0x00000000
esp32c3: target state: halted
esp32c3: Core was reset (pwrstat=0x1F, after clear 0x0F).
Target halted. PRO_CPU: PC=0x40000400 (active) APP_CPU: PC=0x40000400
esp32c3: target state: halted
Hardware assisted breakpoint 1 at 0x400db717: file /home/user-name/esp/blink/
↳main/./blink.c, line 43.
0x0: 0x00000000
Target halted. PRO_CPU: PC=0x400DB717 (active) APP_CPU: PC=0x400D10D8
[New Thread 1073428656]
[New Thread 1073413708]
[New Thread 1073431316]
[New Thread 1073410672]
[New Thread 1073408876]
[New Thread 1073432196]
[New Thread 1073411552]
[Switching to Thread 1073411996]

Temporary breakpoint 1, app_main () at /home/user-name/esp/blink/main/./blink.
↳c:43
43      xTaskCreate(&blink_task, "blink_task", 512, NULL, 5, NULL);
(gdb)
```

Note the third line from bottom that shows debugger halting at breakpoint established in `gdbinit` file at function `app_main()`. Since the processor is halted, the LED should not be blinking. If this is what you see as well, you are ready to start debugging.

If you are not quite sure how to use GDB, check *Command Line* example debugging session in section *Debugging Examples*.

idf.py debug targets It is also possible to execute the described debugging tools conveniently from `idf.py`. These commands are supported:

1. `idf.py openocd`
Runs OpenOCD in a console with configuration defined in the environment or via command line. It uses default script directory defined as `OPENOCD_SCRIPTS` environmental variable, which is automatically added from an Export script (`export.sh` or `export.bat`). It is possible to override the script location using command line argument `--openocd-scripts`.
As for the JTAG configuration of the current board, please use the environmental variable `OPENOCD_COMMANDS` or `--openocd-commands` command line argument. If none of the above is defined, OpenOCD is started with `-f board/esp32c3-builtin.cfg` board definition.
2. `idf.py gdb`
Starts the gdb the same way as the *Command Line*, but generates the initial gdb scripts referring to the current project elf file.
3. `idf.py gdbtui`
The same as 2, but starts the gdb with `tui` argument allowing very simple source code view.
4. `idf.py gdbgui`
Starts `gdbgui` debugger frontend enabling out-of-the-box debugging in a browser window.
It is possible to combine these debugging actions on a single command line allowing convenient setup of blocking and non-blocking actions in one step. `idf.py` implements a simple logic to move the background actions (such as `openocd`) to the beginning and the interactive ones (such as `gdb`, `monitor`) to the end of the action list. An example of a very useful combination is:

```
idf.py openocd gdbgui monitor
```

The above command runs OpenOCD in the background, starts `gdbgui` to open a browser window with active debugger frontend and opens a serial monitor in the active console.

Debugging Examples

This section describes debugging with GDB from *Eclipse* as well as from *Command Line*.

Eclipse Verify if your target is ready and loaded with [get-started/blink](#) example. Configure and start debugger following steps in section *Eclipse*. Pick up where target was left by debugger, i.e. having the application halted at breakpoint established at `app_main()`.

Examples in this section

1. [Navigating through the code, call stack and threads](#)
2. [Setting and clearing breakpoints](#)
3. [Halting the target manually](#)
4. [Stepping through the code](#)
5. [Checking and setting memory](#)
6. [Watching and setting program variables](#)
7. [Setting conditional breakpoints](#)

Navigating through the code, call stack and threads When the target is halted, debugger shows the list of threads in “Debug” window. The line of code where program halted is highlighted in another window below, as shown on the following picture. The LED stops blinking.

Specific thread where the program halted is expanded showing the call stack. It represents function calls that lead up to the highlighted line of code, where the target halted. The first line of call stack under Thread #1 contains the last called function `app_main()`, that in turn was called from function `main_task()` shown in a line below. Each line of the stack also contains the file name and line number where the function was called. By clicking / highlighting the stack entries, in window below, you will see contents of this file.

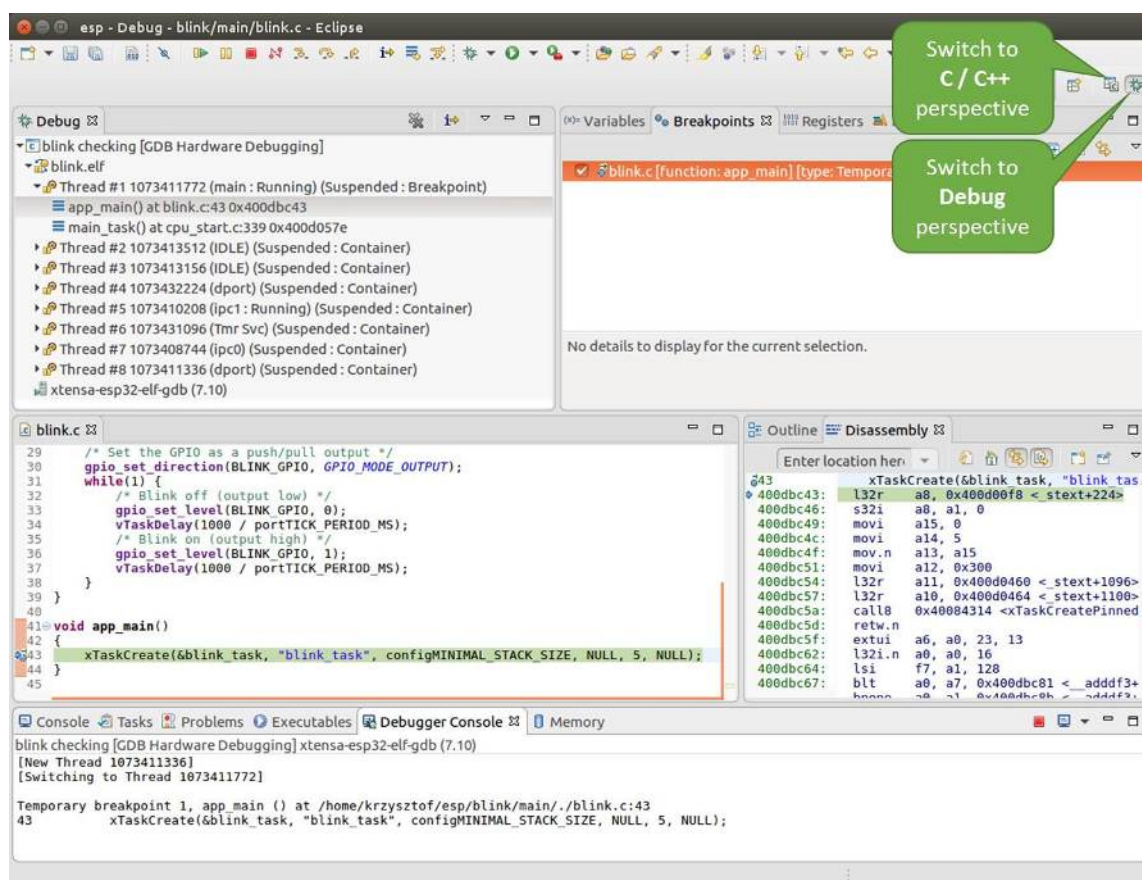

Fig. 38: Debug Perspective in Eclipse

By expanding threads you can navigate throughout the application. Expand Thread #5 that contains much longer call stack. You will see there, besides function calls, numbers like `0x4000000c`. They represent addresses of binary code not provided in source form.

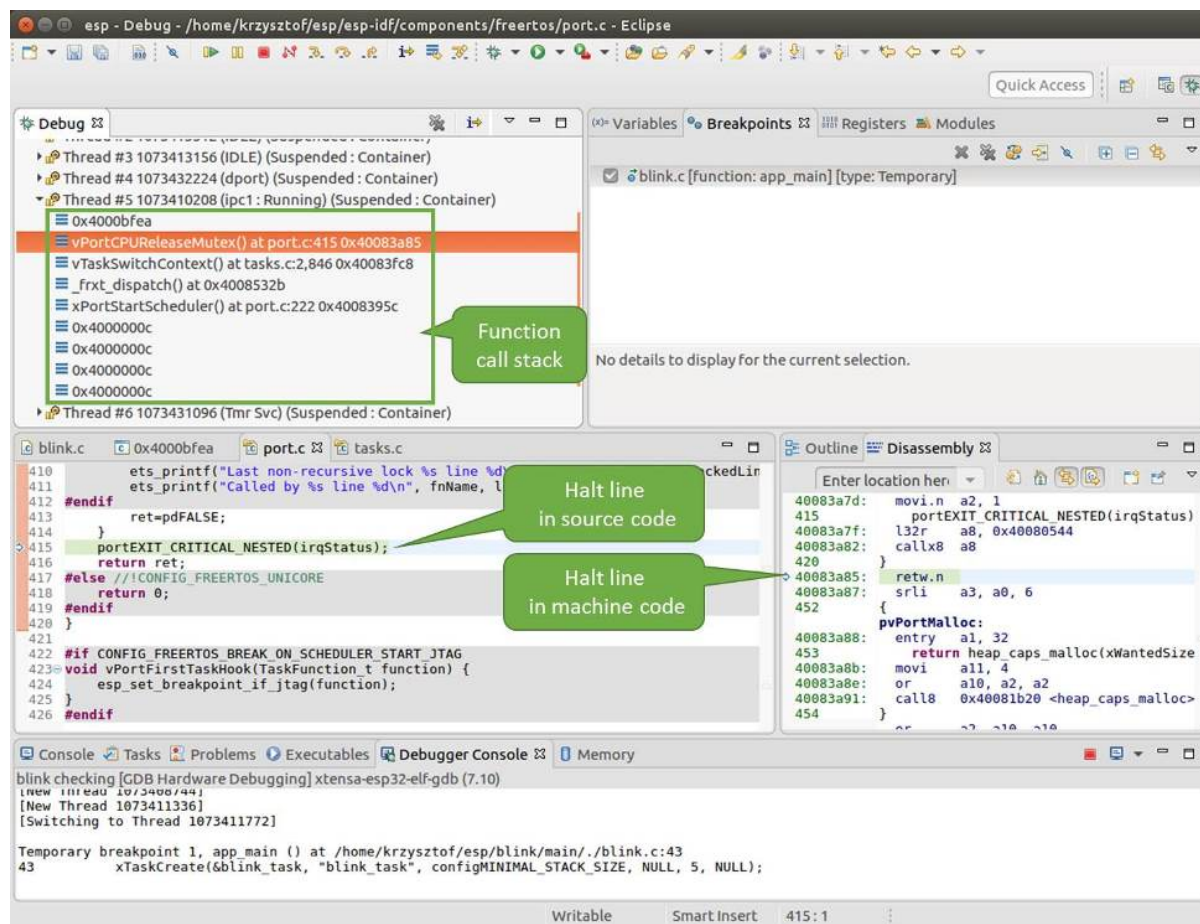

Fig. 40: Navigate through the call stack

In another window on right, you can see the disassembled machine code no matter if your project provides it in source or only the binary form.

Go back to the `app_main()` in Thread #1 to familiar code of `blink.c` file that will be examined in more details in the following examples. Debugger makes it easy to navigate through the code of entire application. This comes handy when stepping through the code and working with breakpoints and will be discussed below.

Setting and clearing breakpoints When debugging, we would like to be able to stop the application at critical lines of code and then examine the state of specific variables, memory and registers / peripherals. To do so we are using breakpoints. They provide a convenient way to quickly get to and halt the application at specific line.

Let's establish two breakpoints when the state of LED changes. Basing on code listing above, this happens at lines 33 and 36. To do so, hold the "Control" on the keyboard and double click on number 33 in file `blink.c` file. A dialog will open where you can confirm your selection by pressing "OK" button. If you do not like to see the dialog just double click the line number. Set another breakpoint in line 36.

Information how many breakpoints are set and where is shown in window "Breakpoints" on top right. Click "Show Breakpoints Supported by Selected Target" to refresh this list. Besides the two just set breakpoints the list may contain temporary breakpoint at function `app_main()` established at debugger start. As maximum two breakpoints are allowed (see [Breakpoints and watchpoints available](#)), you need to delete it, or debugging will fail.

If you now click "Resume" (click `blink_task()` under "Tread #8", if "Resume" button is grayed out), the processor will run and halt at a breakpoint. Clicking "Resume" another time will make it run again, halt on second breakpoint, and so on.

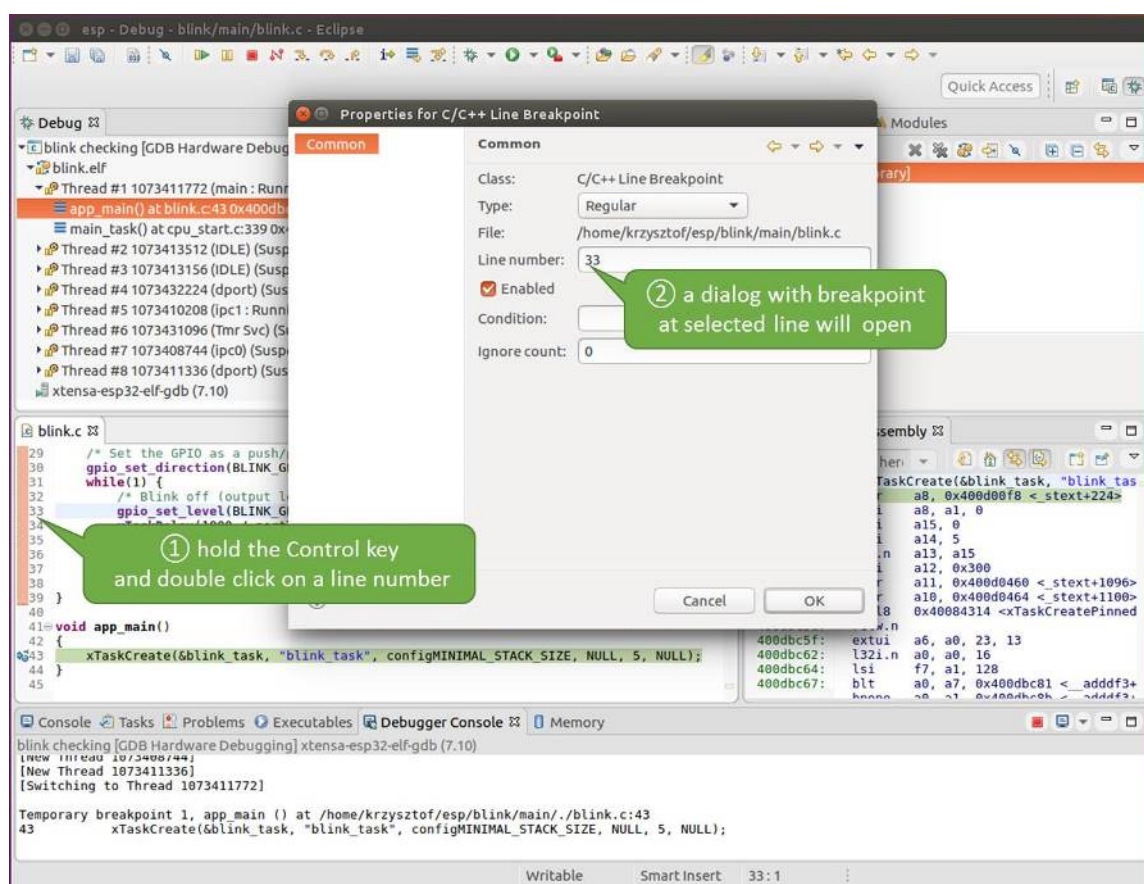

Fig. 41: Setting a breakpoint



Fig. 42: Three breakpoints are set / maximum two are allowed

You will be also able to see that LED is changing the state after each click to “Resume” program execution.

Read more about breakpoints under [Breakpoints and watchpoints available](#) and [What else should I know about breakpoints?](#)

Halting the target manually When debugging, you may resume application and enter code waiting for some event or staying in infinite loop without any break points defined. In such case, to go back to debugging mode, you can break program execution manually by pressing “Suspend” button.

To check it, delete all breakpoints and click “Resume” . Then click “Suspend” . Application will be halted at some random point and LED will stop blinking. Debugger will expand tread and highlight the line of code where application halted.

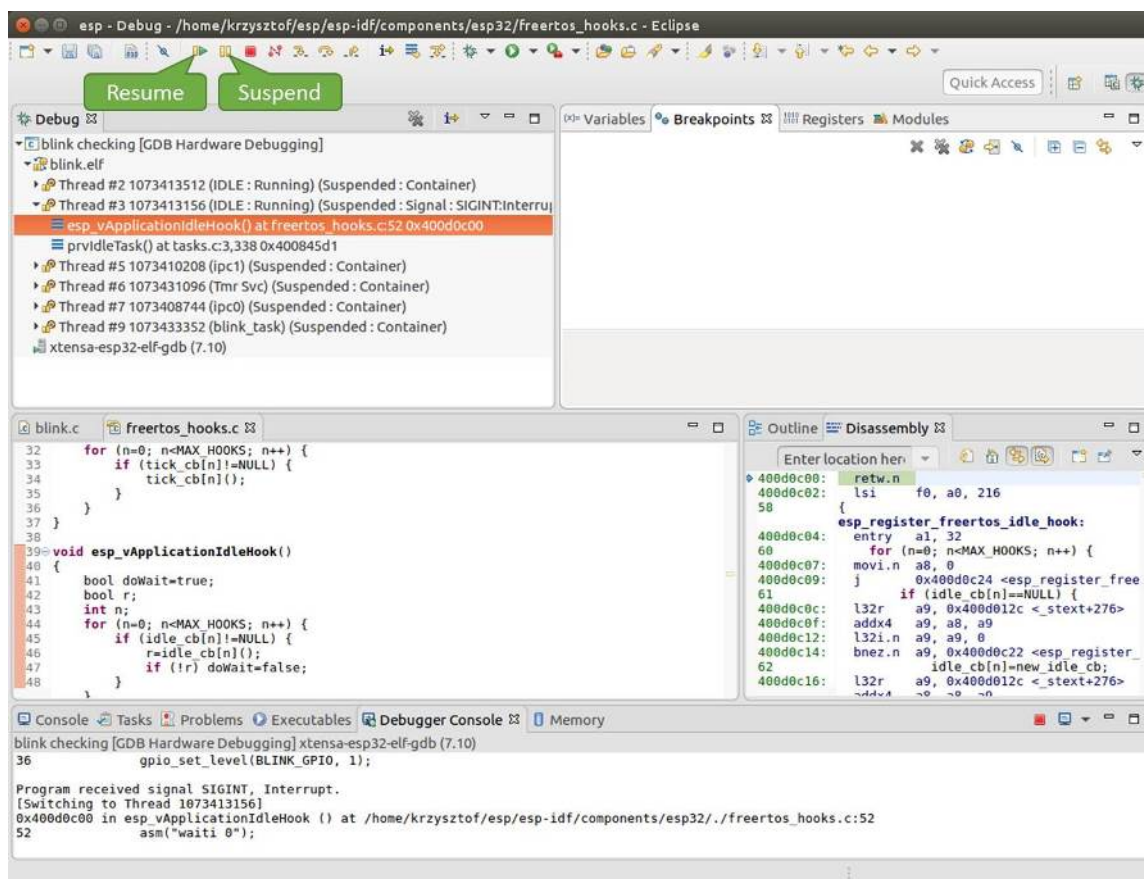

Fig. 43: Target halted manually

In particular case above, the application has been halted in line 52 of code in file `freertos_hooks.c` Now you can resume it again by pressing “Resume” button or do some debugging as discussed below.

Stepping through the code It is also possible to step through the code using “Step Into (F5)” and “Step Over (F6)” commands. The difference is that “Step Into (F5)” is entering inside subroutines calls, while “Step Over (F6)” steps over the call, treating it as a single source line.

Before being able to demonstrate this functionality, using information discussed in previous paragraph, make sure that you have only one breakpoint defined at line 36 of `blink.c`.

Resume program by entering pressing F8 and let it halt. Now press “Step Over (F6)” , one by one couple of times, to see how debugger is stepping one program line at a time.

If you press “Step Into (F5)” instead, then debugger will step inside subroutine calls.

In this particular case debugger stepped inside `gpio_set_level(BLINK_GPIO, 0)` and effectively moved to `gpio.c` driver code.



Fig. 44: Stepping through the code with “Step Over (F6)”

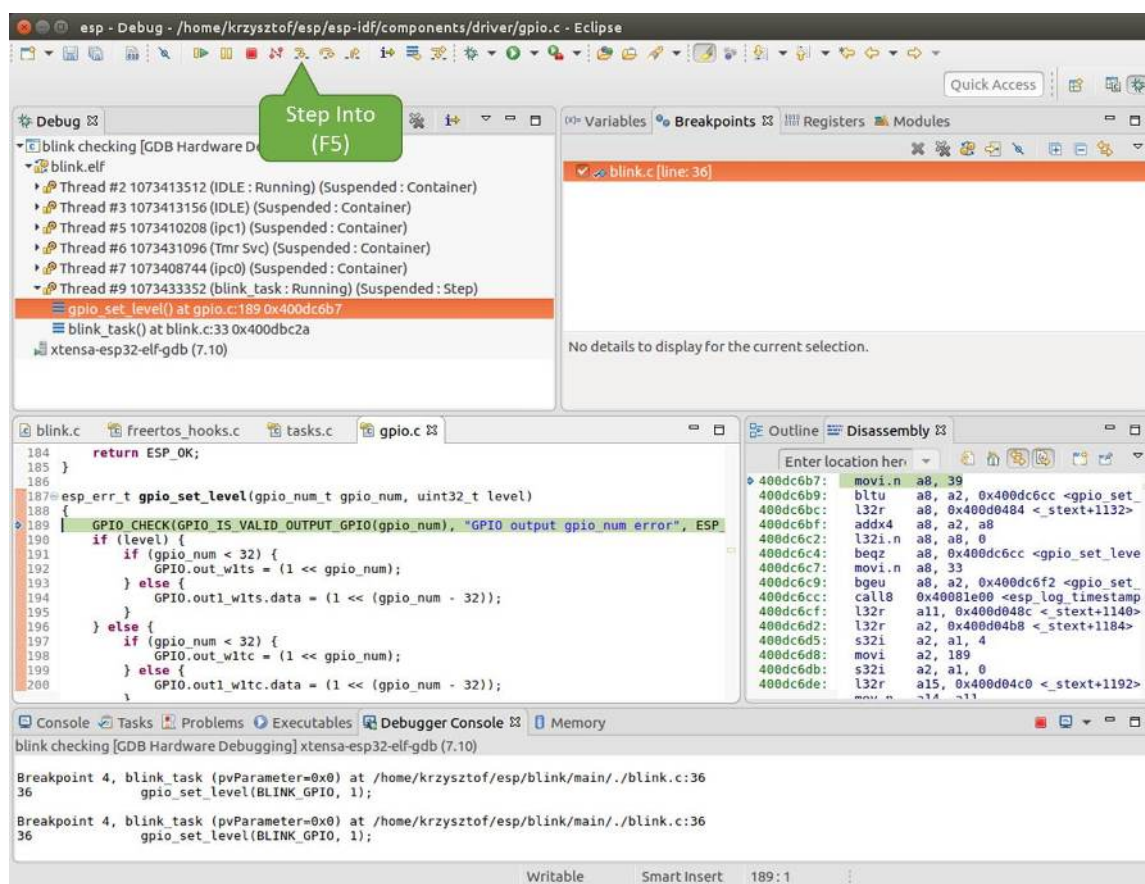

Fig. 45: Stepping through the code with “Step Into (F5)”

See *Why stepping with “next” does not bypass subroutine calls?* for potential limitation of using next command.

Checking and setting memory To display or set contents of memory use “Memory” tab at the bottom of “Debug” perspective.

With the “Memory” tab, we will read from and write to the memory location 0x3FF44004 labeled as GPIO_OUT_REG used to set and clear individual GPIO’s.

For more information, see *ESP32-C3 Technical Reference Manual > IO MUX and GPIO Matrix (GPIO, IO_MUX)* [PDF].

Being in the same blink.c project as before, set two breakpoints right after gpio_set_level instruction. Click “Memory” tab and then “Add Memory Monitor” button. Enter 0x3FF44004 in provided dialog.

Now resume program by pressing F8 and observe “Monitor” tab.

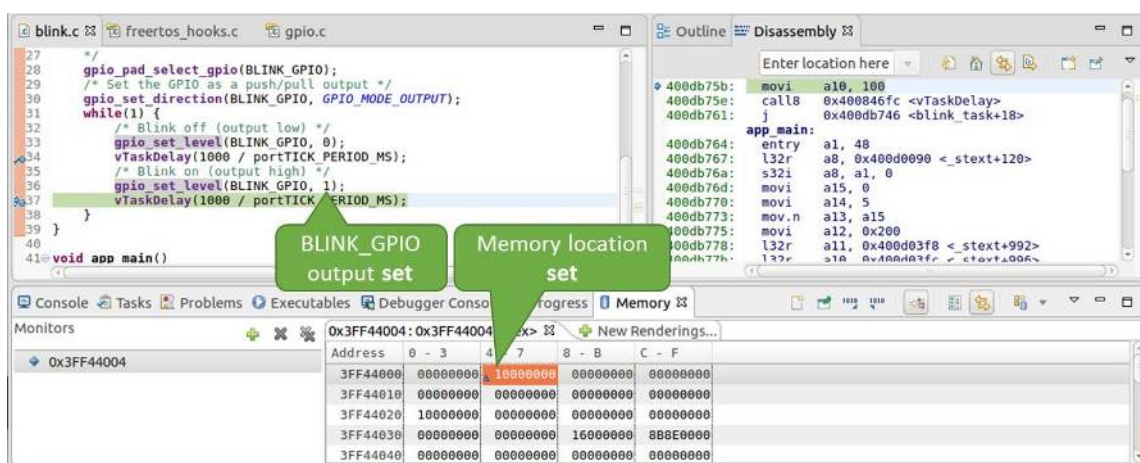

Fig. 46: Observing memory location 0x3FF44004 changing one bit to “ON”

You should see one bit being flipped over at memory location 0x3FF44004 (and LED changing the state) each time F8 is pressed.

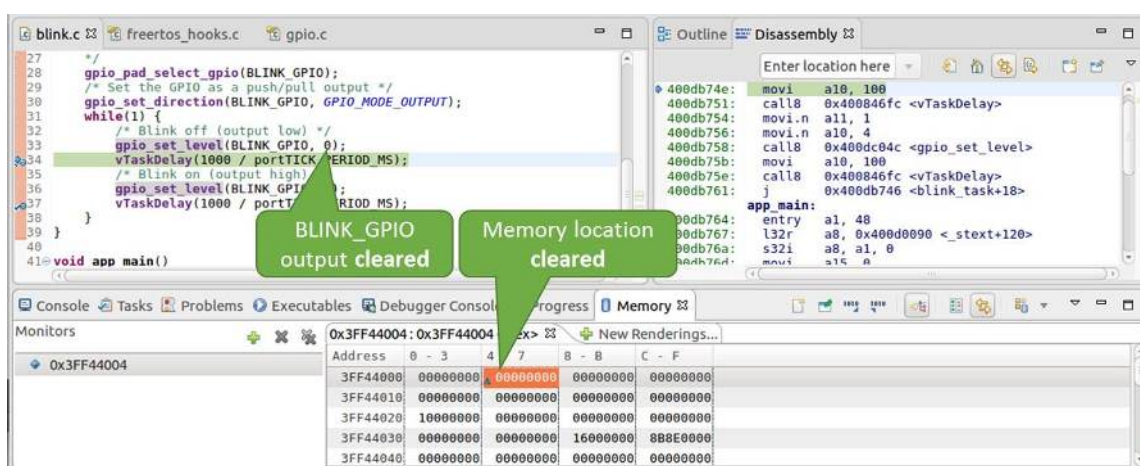

Fig. 47: Observing memory location 0x3FF44004 changing one bit to “OFF”

To set memory use the same “Monitor” tab and the same memory location. Type in alternate bit pattern as previously observed. Immediately after pressing enter you will see LED changing the state.

Watching and setting program variables A common debugging task is checking the value of a program variable as the program runs. To be able to demonstrate this functionality, update file blink.c by adding a declaration of

a global variable `int i` above definition of function `blink_task`. Then add `i++` inside `while(1)` of this function to get `i` incremented on each blink.

Exit debugger, so it is not confused with new code, build and flash the code to the ESP and restart debugger. There is no need to restart OpenOCD.

Once application is halted, enter a breakpoint in the line where you put `i++`.

In next step, in the window with “Breakpoints”, click the “Expressions” tab. If this tab is not visible, then add it by going to the top menu `Window > Show View > Expressions`. Then click “Add new expression” and enter `i`.

Resume program execution by pressing `F8`. Each time the program is halted you will see `i` value being incremented.

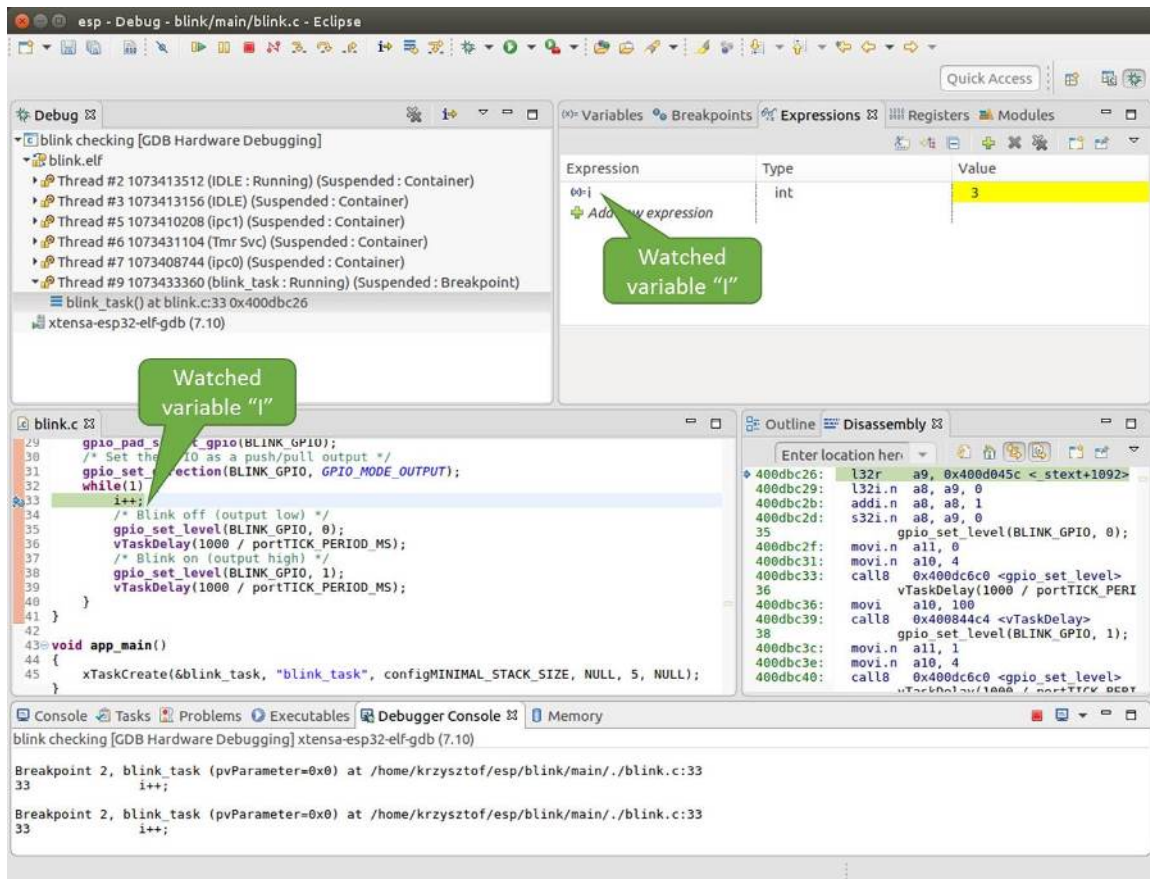

Fig. 48: Watching program variable “i”

To modify `i` enter a new number in “Value” column. After pressing “Resume (F8)” the program will keep incrementing `i` starting from the new entered number.

Setting conditional breakpoints Here comes more interesting part. You may set a breakpoint to halt the program execution, if certain condition is satisfied. Right click on the breakpoint to open a context menu and select “Breakpoint Properties”. Change the selection under “Type:” to “Hardware” and enter a “Condition:” like `i == 2`.

If current value of `i` is less than 2 (change it if required) and program is resumed, it will blink LED in a loop until condition `i == 2` gets true and then finally halt.

Command Line Verify if your target is ready and loaded with [get-started/blink](#) example. Configure and start debugger following steps in section [Command Line](#). Pick up where target was left by debugger, i.e. having the application halted at breakpoint established at `app_main()`:

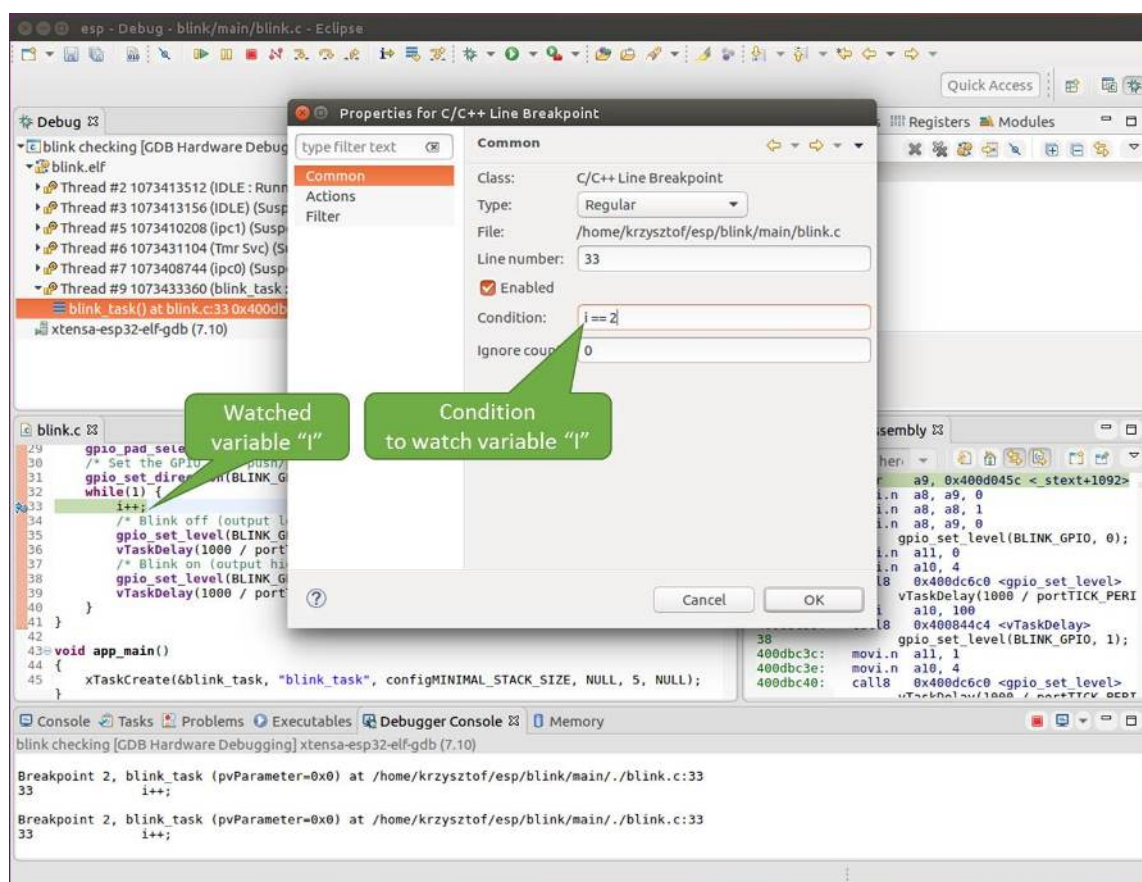

Fig. 49: Setting a conditional breakpoint

```
Temporary breakpoint 1, app_main () at /home/user-name/esp/blink/main/./blink.c:43
43     xTaskCreate(&blink_task, "blink_task", configMINIMAL_STACK_SIZE, NULL, 5, &
↳NULL);
(gdb)
```

Examples in this section

1. *Navigating through the code, call stack and threads*
2. *Setting and clearing breakpoints*
3. *Halting and resuming the application*
4. *Stepping through the code*
5. *Checking and setting memory*
6. *Watching and setting program variables*
7. *Setting conditional breakpoints*

Navigating through the code, call stack and threads When you see the (gdb) prompt, the application is halted. LED should not be blinking.

To find out where exactly the code is halted, enter `l` or `list`, and debugger will show couple of lines of code around the halt point (line 43 of code in file `blink.c`)

```
(gdb) l
38     }
39 }
40
41 void app_main()
42 {
43     xTaskCreate(&blink_task, "blink_task", configMINIMAL_STACK_SIZE, NULL, 5, &
↳NULL);
44 }
(gdb)
```

Check how code listing works by entering, e.g. `l 30, 40` to see particular range of lines of code.

You can use `bt` or `backtrace` to see what function calls lead up to this code:

```
(gdb) bt
#0 app_main () at /home/user-name/esp/blink/main/./blink.c:43
#1 0x400d057e in main_task (args=0x0) at /home/user-name/esp/esp-idf/components/
↳esp32c3/./cpu_start.c:339
(gdb)
```

Line #0 of output provides the last function call before the application halted, i.e. `app_main ()` we have listed previously. The `app_main ()` was in turn called by function `main_task` from line 339 of code located in file `cpu_start.c`.

To get to the context of `main_task` in file `cpu_start.c`, enter `frame N`, where `N = 1`, because the `main_task` is listed under #1):

```
(gdb) frame 1
#1 0x400d057e in main_task (args=0x0) at /home/user-name/esp/esp-idf/components/
↳esp32c3/./cpu_start.c:339
339     app_main();
(gdb)
```

Enter `l` and this will reveal the piece of code that called `app_main ()` (in line 339):

```
(gdb) l
334     ;
335 }
```

(continues on next page)

(continued from previous page)

```

336 #endif
337     //Enable allocation in region where the startup stacks were located.
338     heap_caps_enable_nonos_stack_heaps();
339     app_main();
340     vTaskDelete(NULL);
341 }
342
(gdb)

```

By listing some lines before, you will see the function name `main_task` we have been looking for:

```

(gdb) l 326, 341
326 static void main_task(void* args)
327 {
328     // Now that the application is about to start, disable boot watchdogs
329     REG_CLR_BIT(TIMG_WDTCONFIG0_REG(0), TIMG_WDT_FLASHBOOT_MOD_EN_S);
330     REG_CLR_BIT(RTC_CNTL_WDTCONFIG0_REG, RTC_CNTL_WDT_FLASHBOOT_MOD_EN);
331 #if !CONFIG_FREERTOS_UNICORE
332     // Wait for FreeRTOS initialization to finish on APP CPU, before replacing
↳ its startup stack
333     while (port_xSchedulerRunning[1] == 0) {
334         ;
335     }
336 #endif
337     //Enable allocation in region where the startup stacks were located.
338     heap_caps_enable_nonos_stack_heaps();
339     app_main();
340     vTaskDelete(NULL);
341 }
(gdb)

```

To see the other code, enter `i threads`. This will show the list of threads running on target:

```

(gdb) i threads
Id   Target Id           Frame
  8   Thread 1073411336 (dport) 0x400d0848 in dport_access_init_core (arg=
↳ <optimized out>)
    at /home/user-name/esp/esp-idf/components/esp32c3/./dport_access.c:170
  7   Thread 1073408744 (ipc0) xQueueGenericReceive (xQueue=0x3ffae694,
↳ pvBuffer=0x0, xTicksToWait=1644638200,
    xJustPeeking=0) at /home/user-name/esp/esp-idf/components/freertos/./queue.
↳ c:1452
  6   Thread 1073431096 (Tmr Svc) prvTimerTask (pvParameters=0x0)
    at /home/user-name/esp/esp-idf/components/freertos/./timers.c:445
  5   Thread 1073410208 (ipc1 : Running) 0x4000bfea in ?? ()
  4   Thread 1073432224 (dport) dport_access_init_core (arg=0x0)
    at /home/user-name/esp/esp-idf/components/esp32c3/./dport_access.c:150
  3   Thread 1073413156 (IDLE) prvIdleTask (pvParameters=0x0)
    at /home/user-name/esp/esp-idf/components/freertos/./tasks.c:3282
  2   Thread 1073413512 (IDLE) prvIdleTask (pvParameters=0x0)
    at /home/user-name/esp/esp-idf/components/freertos/./tasks.c:3282
* 1   Thread 1073411772 (main : Running) app_main () at /home/user-name/esp/blink/
↳ main/./blink.c:43
(gdb)

```

The thread list shows the last function calls per each thread together with the name of C source file if available.

You can navigate to specific thread by entering `thread N`, where `N` is the thread Id. To see how it works go to thread thread 5:

```
(gdb) thread 5
```

(continues on next page)

(continued from previous page)

```
[Switching to thread 5 (Thread 1073410208)]
#0 0x4000bfea in ?? ()
(gdb)
```

Then check the backtrace:

```
(gdb) bt
#0 0x4000bfea in ?? ()
#1 0x40083a85 in vPortCPUReleaseMutex (mux=<optimized out>) at /home/user-name/
↳esp/esp-idf/components/freertos/./port.c:415
#2 0x40083fc8 in vTaskSwitchContext () at /home/user-name/esp/esp-idf/components/
↳freertos/./tasks.c:2846
#3 0x4008532b in _frxt_dispatch ()
#4 0x4008395c in xPortStartScheduler () at /home/user-name/esp/esp-idf/components/
↳freertos/./port.c:222
#5 0x4000000c in ?? ()
#6 0x4000000c in ?? ()
#7 0x4000000c in ?? ()
#8 0x4000000c in ?? ()
(gdb)
```

As you see, the backtrace may contain several entries. This will let you check what exact sequence of function calls lead to the code where the target halted. Question marks ?? instead of a function name indicate that application is available only in binary format, without any source file in C language. The value like 0x4000bfea is the memory address of the function call.

Using `bt`, `i threads`, `thread N` and `list` commands we are now able to navigate through the code of entire application. This comes handy when stepping through the code and working with breakpoints and will be discussed below.

Setting and clearing breakpoints When debugging, we would like to be able to stop the application at critical lines of code and then examine the state of specific variables, memory and registers / peripherals. To do so we are using breakpoints. They provide a convenient way to quickly get to and halt the application at specific line.

Let's establish two breakpoints when the state of LED changes. Basing on code listing above this happens at lines 33 and 36. Breakpoints may be established using command `break M` where `M` is the code line number:

```
(gdb) break 33
Breakpoint 2 at 0x400db6f6: file /home/user-name/esp/blink/main/./blink.c, line 33.
(gdb) break 36
Breakpoint 3 at 0x400db704: file /home/user-name/esp/blink/main/./blink.c, line 36.
```

If you now enter `c`, the processor will run and halt at a breakpoint. Entering `c` another time will make it run again, halt on second breakpoint, and so on:

```
(gdb) c
Continuing.
Target halted. PRO_CPU: PC=0x400DB6F6 (active)    APP_CPU: PC=0x400D10D8

Breakpoint 2, blink_task (pvParameter=0x0) at /home/user-name/esp/blink/main/./
↳blink.c:33
33         gpio_set_level(BLINK_GPIO, 0);
(gdb) c
Continuing.
Target halted. PRO_CPU: PC=0x400DB6F8 (active)    APP_CPU: PC=0x400D10D8
Target halted. PRO_CPU: PC=0x400DB704 (active)    APP_CPU: PC=0x400D10D8

Breakpoint 3, blink_task (pvParameter=0x0) at /home/user-name/esp/blink/main/./
↳blink.c:36
36         gpio_set_level(BLINK_GPIO, 1);
```

(continues on next page)

(continued from previous page)

```
(gdb)
```

You will be also able to see that LED is changing the state only if you resume program execution by entering `c`.

To examine how many breakpoints are set and where, use command `info break`:

```
(gdb) info break
Num      Type          Disp Enb Address      What
2        breakpoint    keep y  0x400db6f6 in blink_task at /home/user-name/esp/
↳blink/main/./blink.c:33
    breakpoint already hit 1 time
3        breakpoint    keep y  0x400db704 in blink_task at /home/user-name/esp/
↳blink/main/./blink.c:36
    breakpoint already hit 1 time
(gdb)
```

Please note that breakpoint numbers (listed under `Num`) start with 2. This is because first breakpoint has been already established at function `app_main()` by running command `thb app_main` on debugger launch. As it was a temporary breakpoint, it has been automatically deleted and now is not listed anymore.

To remove breakpoints enter `delete N` command (in short `d N`), where `N` is the breakpoint number:

```
(gdb) delete 1
No breakpoint number 1.
(gdb) delete 2
(gdb)
```

Read more about breakpoints under *Breakpoints and watchpoints available* and *What else should I know about breakpoints?*

Halting and resuming the application When debugging, you may resume application and enter code waiting for some event or staying in infinite loop without any break points defined. In such case, to go back to debugging mode, you can break program execution manually by entering `Ctrl+C`.

To check it delete all breakpoints and enter `c` to resume application. Then enter `Ctrl+C`. Application will be halted at some random point and LED will stop blinking. Debugger will print the following:

```
(gdb) c
Continuing.
^CTarget halted. PRO_CPU: PC=0x400D0C00          APP_CPU: PC=0x400D0C00 (active)
[New Thread 1073433352]

Program received signal SIGINT, Interrupt.
[Switching to Thread 1073413512]
0x400d0c00 in esp_vApplicationIdleHook () at /home/user-name/esp/esp-idf/
↳components/esp32c3/./freertos_hooks.c:52
52          asm("waiti 0");
(gdb)
```

In particular case above, the application has been halted in line 52 of code in file `freertos_hooks.c`. Now you can resume it again by enter `c` or do some debugging as discussed below.

Note: In MSYS2 shell `Ctrl+C` does not halt the target but exists debugger. To resolve this issue consider debugging with *Eclipse* or check a workaround under http://www.mingw.org/wiki/Workaround_for_GDB_Ctrl_C_Interrupt.

Stepping through the code It is also possible to step through the code using `step` and `next` commands (in short `s` and `n`). The difference is that `step` is entering inside subroutines calls, while `next` steps over the call, treating it as a single source line.

To demonstrate this functionality, using command `break` and `delete` discussed in previous paragraph, make sure that you have only one breakpoint defined at line 36 of `blink.c`:

```
(gdb) info break
Num      Type           Disp Enb Address      What
3        breakpoint      keep y  0x400db704 in blink_task at /home/user-name/esp/
↳blink/main/./blink.c:36
        breakpoint already hit 1 time
(gdb)
```

Resume program by entering `c` and let it halt:

```
(gdb) c
Continuing.
Target halted. PRO_CPU: PC=0x400DB754 (active)   APP_CPU: PC=0x400D1128

Breakpoint 3, blink_task (pvParameter=0x0) at /home/user-name/esp/blink/main/./
↳blink.c:36
36          gpio_set_level(BLINK_GPIO, 1);
(gdb)
```

Then enter `n` couple of times to see how debugger is stepping one program line at a time:

```
(gdb) n
Target halted. PRO_CPU: PC=0x400DB756 (active)   APP_CPU: PC=0x400D1128
Target halted. PRO_CPU: PC=0x400DB758 (active)   APP_CPU: PC=0x400D1128
Target halted. PRO_CPU: PC=0x400DC04C (active)   APP_CPU: PC=0x400D1128
Target halted. PRO_CPU: PC=0x400DB75B (active)   APP_CPU: PC=0x400D1128
37          vTaskDelay(1000 / portTICK_PERIOD_MS);
(gdb) n
Target halted. PRO_CPU: PC=0x400DB75E (active)   APP_CPU: PC=0x400D1128
Target halted. PRO_CPU: PC=0x400846FC (active)   APP_CPU: PC=0x400D1128
Target halted. PRO_CPU: PC=0x400DB761 (active)   APP_CPU: PC=0x400D1128
Target halted. PRO_CPU: PC=0x400DB746 (active)   APP_CPU: PC=0x400D1128
33          gpio_set_level(BLINK_GPIO, 0);
(gdb)
```

If you enter `s` instead, then debugger will step inside subroutine calls:

```
(gdb) s
Target halted. PRO_CPU: PC=0x400DB748 (active)   APP_CPU: PC=0x400D1128
Target halted. PRO_CPU: PC=0x400DB74B (active)   APP_CPU: PC=0x400D1128
Target halted. PRO_CPU: PC=0x400DC04C (active)   APP_CPU: PC=0x400D1128
Target halted. PRO_CPU: PC=0x400DC04F (active)   APP_CPU: PC=0x400D1128
gpio_set_level (gpio_num=GPIO_NUM_4, level=0) at /home/user-name/esp/esp-idf/
↳components/driver/./gpio.c:183
183      GPIO_CHECK(GPIO_IS_VALID_OUTPUT_GPIO(gpio_num), "GPIO output gpio_num error
↳", ESP_ERR_INVALID_ARG);
(gdb)
```

In this particular case debugger stepped inside `gpio_set_level(BLINK_GPIO, 0)` and effectively moved to `gpio.c` driver code.

See [Why stepping with “next” does not bypass subroutine calls?](#) for potential limitation of using `next` command.

Checking and setting memory Displaying the contents of memory is done with command `x`. With additional parameters you may vary the format and count of memory locations displayed. Run `help x` to see more details. Companion command to `x` is `set` that let you write values to the memory.

We will demonstrate how `x` and `set` work by reading from and writing to the memory location `0x3FF44004` labeled as `GPIO_OUT_REG` used to set and clear individual GPIO's.

For more information, see *ESP32-C3 Technical Reference Manual > IO MUX and GPIO Matrix (GPIO, IO_MUX)* [PDF].

Being in the same `blink.c` project as before, set two breakpoints right after `gpio_set_level` instruction. Enter two times `c` to get to the break point followed by `x /1wx 0x3FF44004` to display contents of `GPIO_OUT_REG` memory location:

```
(gdb) c
Continuing.
Target halted. PRO_CPU: PC=0x400DB75E (active)   APP_CPU: PC=0x400D1128
Target halted. PRO_CPU: PC=0x400DB74E (active)   APP_CPU: PC=0x400D1128

Breakpoint 2, blink_task (pvParameter=0x0) at /home/user-name/esp/blink/main/.//
↳blink.c:34
34         vTaskDelay(1000 / portTICK_PERIOD_MS);
(gdb) x /1wx 0x3FF44004
0x3ff44004: 0x00000000
(gdb) c
Continuing.
Target halted. PRO_CPU: PC=0x400DB751 (active)   APP_CPU: PC=0x400D1128
Target halted. PRO_CPU: PC=0x400DB75B (active)   APP_CPU: PC=0x400D1128

Breakpoint 3, blink_task (pvParameter=0x0) at /home/user-name/esp/blink/main/.//
↳blink.c:37
37         vTaskDelay(1000 / portTICK_PERIOD_MS);
(gdb) x /1wx 0x3FF44004
0x3ff44004: 0x00000010
(gdb)
```

If you are blinking LED connected to GPIO4, then you should see fourth bit being flipped each time the LED changes the state:

```
0x3ff44004: 0x00000000
...
0x3ff44004: 0x00000010
```

Now, when the LED is off, that corresponds to `0x3ff44004: 0x00000000` being displayed, try using `set` command to set this bit by writing `0x00000010` to the same memory location:

```
(gdb) x /1wx 0x3FF44004
0x3ff44004: 0x00000000
(gdb) set {unsigned int}0x3FF44004=0x000010
```

You should see the LED to turn on immediately after entering `set {unsigned int}0x3FF44004=0x000010` command.

Watching and setting program variables A common debugging task is checking the value of a program variable as the program runs. To be able to demonstrate this functionality, update file `blink.c` by adding a declaration of a global variable `int i` above definition of function `blink_task`. Then add `i++` inside `while(1)` of this function to get `i` incremented on each blink.

Exit debugger, so it is not confused with new code, build and flash the code to the ESP and restart debugger. There is no need to restart OpenOCD.

Once application is halted, enter the command `watch i`:

```
(gdb) watch i
Hardware watchpoint 2: i
(gdb)
```

This will insert so called “watchpoint” in each place of code where variable `i` is being modified. Now enter `continue` to resume the application and observe it being halted:

```
(gdb) c
Continuing.
Target halted. PRO_CPU: PC=0x400DB751 (active)   APP_CPU: PC=0x400D0811
[New Thread 1073432196]

Program received signal SIGTRAP, Trace/breakpoint trap.
[Switching to Thread 1073432196]
0x400db751 in blink_task (pvParameter=0x0) at /home/user-name/esp/blink/main/.
↳blink.c:33
33         i++;
(gdb)
```

Resume application couple more times so `i` gets incremented. Now you can enter `print i` (in short `p i`) to check the current value of `i`:

```
(gdb) p i
$1 = 3
(gdb)
```

To modify the value of `i` use `set` command as below (you can then print it out to check if it has been indeed changed):

```
(gdb) set var i = 0
(gdb) p i
$3 = 0
(gdb)
```

You may have up to two watchpoints, see [Breakpoints and watchpoints available](#).

Setting conditional breakpoints Here comes more interesting part. You may set a breakpoint to halt the program execution, if certain condition is satisfied. Delete existing breakpoints and try this:

```
(gdb) break blink.c:34 if (i == 2)
Breakpoint 3 at 0x400db753: file /home/user-name/esp/blink/main/.blink.c, line 34.
(gdb)
```

Above command sets conditional breakpoint to halt program execution in line 34 of `blink.c` if `i == 2`.

If current value of `i` is less than 2 and program is resumed, it will blink LED in a loop until condition `i == 2` gets true and then finally halt:

```
(gdb) set var i = 0
(gdb) c
Continuing.
Target halted. PRO_CPU: PC=0x400DB755 (active)   APP_CPU: PC=0x400D112C
Target halted. PRO_CPU: PC=0x400DB753 (active)   APP_CPU: PC=0x400D112C
Target halted. PRO_CPU: PC=0x400DB755 (active)   APP_CPU: PC=0x400D112C
Target halted. PRO_CPU: PC=0x400DB753 (active)   APP_CPU: PC=0x400D112C

Breakpoint 3, blink_task (pvParameter=0x0) at /home/user-name/esp/blink/main/.
↳blink.c:34
34         gpio_set_level(BLINK_GPIO, 0);
(gdb)
```

Obtaining help on commands Commands presented so far should provide a very basic and intended to let you quickly get started with JTAG debugging. Check help what are the other commands at your disposal. To obtain help on syntax and functionality of a particular command, being at `(gdb)` prompt type `help` and command name:

```
(gdb) help next
Step program, proceeding through subroutine calls.
Usage: next [N]
Unlike "step", if the current source line calls a subroutine,
this command does not enter the subroutine, but instead steps over
the call, in effect treating it as a single source line.
(gdb)
```

By typing just `help`, you will get top level list of command classes, to aid you drilling down to more details. Optionally refer to available GDB cheat sheets, for instance <https://darkdust.net/files/GDB%20Cheat%20Sheet.pdf>. Good to have as a reference (even if not all commands are applicable in an embedded environment).

Ending debugger session To quit debugger enter `q`:

```
(gdb) q
A debugging session is active.

    Inferior 1 [Remote target] will be detached.

Quit anyway? (y or n) y
Detaching from program: /home/user-name/esp/blink/build/blink.elf, Remote target
Ending remote debugging.
user-name@computer-name:~/esp/blink$
```

- [Using Debugger](#)
- [Debugging Examples](#)
- [Tips and Quirks](#)
- [Application Level Tracing library](#)
- [Introduction to ESP-Prog Board](#)

4.17 Linker Script Generation

4.17.1 Overview

There are several *memory regions* where code and data can be placed. Code and read-only data are placed by default in flash, writable data in RAM, etc. However, it is sometimes necessary to change these default placements.

For example, it may be necessary to place critical code in RAM for performance reasons or to place code in RTC memory for use in a wake stub.

With the linker script generation mechanism, it is possible to specify these placements at the component level within ESP-IDF. The component presents information on how it would like to place its symbols, objects or the entire archive. During build the information presented by the components are collected, parsed and processed; and the placement rules generated is used to link the app.

4.17.2 Quick Start

This section presents a guide for quickly placing code/data to RAM and RTC memory - placements ESP-IDF provides out-of-the-box.

For this guide, suppose we have the following:

```
- components/
    - my_component/
        - CMakeLists.txt
        - component.mk
        - Kconfig
```

(continues on next page)

(continued from previous page)

```

- src/
  - my_src1.c
  - my_src2.c
  - my_src3.c
- my_linker_fragment_file.lf

```

- a component named `my_component` that is archived as library `libmy_component.a` during build
- three source files archived under the library, `my_src1.c`, `my_src2.c` and `my_src3.c` which are compiled as `my_src1.o`, `my_src2.o` and `my_src3.o`, respectively
- under `my_src1.o`, the function `my_function1` is defined; under `my_src2.o`, the function `my_function2` is defined
- there exist bool-type config `PERFORMANCE_MODE` (y/n) and int type config `PERFORMANCE_LEVEL` (with range 0-3) in `my_component`'s Kconfig

Creating and Specifying a Linker Fragment File

Before anything else, a linker fragment file needs to be created. A linker fragment file is simply a text file with a `.lf` extension upon which the desired placements will be written. After creating the file, it is then necessary to present it to the build system. The instructions for the build systems supported by ESP-IDF are as follows:

Make In the component's `component.mk` file, set the variable `COMPONENT_ADD_LDFRAGMENTS` to the path of the created linker fragment file. The path can either be an absolute path or a relative path from the component directory.

```
COMPONENT_ADD_LDFRAGMENTS += my_linker_fragment_file.lf
```

CMake In the component's `CMakeLists.txt` file, specify argument `LDFRAGMENTS` in the `idf_component_register` call. The value of `LDFRAGMENTS` can either be an absolute path or a relative path from the component directory to the created linker fragment file.

```

# file paths relative to CMakeLists.txt
idf_component_register(...
    LDFRAGMENTS "path/to/linker_fragment_file.lf" "path/to/
↳another_linker_fragment_file.lf"
    ...
)

```

Specifying placements

It is possible to specify placements at the following levels of granularity:

- object file (`.obj` or `.o` files)
- symbol (function/variable)
- archive (`.a` files)

Placing object files Suppose the entirety of `my_src1.o` is performance-critical, so it is desirable to place it in RAM. On the other hand, the entirety of `my_src2.o` contains symbols needed coming out of deep sleep, so it needs to be put under RTC memory. In the linker fragment file, we can write:

```

[mapping:my_component]
archive: libmy_component.a
entries:
    my_src1 (noflash)      # places all my_src1 code/read-only data under IRAM/DRAM
    my_src2 (rtc)         # places all my_src2 code/ data and read-only data under_
↳RTC fast memory/RTC slow memory

```

What happens to `my_src3.o`? Since it is not specified, default placements are used for `my_src3.o`. More on default placements [here](#).

Placing symbols Continuing our example, suppose that among functions defined under `object1.o`, only `my_function1` is performance-critical; and under `object2.o`, only `my_function2` needs to execute after the chip comes out of deep sleep. This could be accomplished by writing:

```
[mapping:my_component]
archive: libmy_component.a
entries:
    my_src1:my_function1 (noflash)
    my_src2:my_function2 (rtc)
```

The default placements are used for the rest of the functions in `my_src1.o` and `my_src2.o` and the entire `object3.o`. Something similar can be achieved for placing data by writing the variable name instead of the function name, like so:

```
my_src1:my_variable (noflash)
```

Warning: There are *limitations* in placing code/data at symbol granularity. In order to ensure proper placements, an alternative would be to group relevant code and data into source files, and *use object-granularity placements*.

Placing entire archive In this example, suppose that the entire component archive needs to be placed in RAM. This can be written as:

```
[mapping:my_component]
archive: libmy_component.a
entries:
    * (noflash)
```

Similarly, this places the entire component in RTC memory:

```
[mapping:my_component]
archive: libmy_component.a
entries:
    * (rtc)
```

Configuration-dependent placements Suppose that the entire component library should only have special placement when a certain condition is true; for example, when `CONFIG_PERFORMANCE_MODE == y`. This could be written as:

```
[mapping:my_component]
archive: libmy_component.a
entries:
    if PERFORMANCE_MODE = y:
        * (noflash)
    else:
        * (default)
```

For a more complex config-dependent placement, suppose the following requirements: when `CONFIG_PERFORMANCE_LEVEL == 1`, only `object1.o` is put in RAM; when `CONFIG_PERFORMANCE_LEVEL == 2`, `object1.o` and `object2.o`; and when `CONFIG_PERFORMANCE_LEVEL == 3` all object files under the archive are to be put into RAM. When these three are false however, put entire library in RTC memory. This scenario is a bit contrived, but, it can be written as:

```
[mapping:my_component]
archive: libmy_component.a
entries:
    if PERFORMANCE_LEVEL = 1:
        my_src1 (noflash)
    elif PERFORMANCE_LEVEL = 2:
        my_src1 (noflash)
        my_src2 (noflash)
    elif PERFORMANCE_LEVEL = 3:
        my_src1 (noflash)
        my_src2 (noflash)
        my_src3 (noflash)
    else:
        * (rtc)
```

Nesting condition-checking is also possible. The following is equivalent to the snippet above:

```
[mapping:my_component]
archive: libmy_component.a
entries:
    if PERFORMANCE_LEVEL <= 3 && PERFORMANCE_LEVEL > 0:
        if PERFORMANCE_LEVEL >= 1:
            object1 (noflash)
            if PERFORMANCE_LEVEL >= 2:
                object2 (noflash)
                if PERFORMANCE_LEVEL >= 3:
                    object2 (noflash)
    else:
        * (rtc)
```

The ‘default’ placements

Up until this point, the term ‘default placements’ has been mentioned as fallback placements when the placement rules `rtc` and `noflash` are not specified. It is important to note that the tokens `noflash` or `rtc` are not merely keywords, but are actually entities called fragments, specifically *schemes*.

In the same manner as `rtc` and `noflash` are schemes, there exists a `default` scheme which defines what the default placement rules should be. As the name suggests, it is where code and data are usually placed, i.e. code/constants is placed in flash, variables placed in RAM, etc. More on the default scheme [here](#).

Note: For an example of an ESP-IDF component using the linker script generation mechanism, see [freertos/CMakeLists.txt](#). `freertos` uses this to place its object files to the instruction RAM for performance reasons.

This marks the end of the quick start guide. The following text discusses the internals of the mechanism in a little bit more detail. The following sections should be helpful in creating custom placements or modifying default behavior.

4.17.3 Linker Script Generation Internals

Linking is the last step in the process of turning C/C++ source files into an executable. It is performed by the toolchain’s linker, and accepts linker scripts which specify code/data placements, among other things. With the linker script generation mechanism, this process is no different, except that the linker script passed to the linker is dynamically generated from: (1) the collected *linker fragment files* and (2) *linker script template*.

Note: The tool that implements the linker script generation mechanism lives under `tools/ldgen`.

Linker Fragment Files

As mentioned in the quick start guide, fragment files are simple text files with the `.lf` extension containing the desired placements. This is a simplified description of what fragment files contain, however. What fragment files actually contain are ‘fragments’. Fragments are entities which contain pieces of information which, when put together, form placement rules that tell where to place sections of object files in the output binary. There are three types of fragments: *sections*, *scheme* and *mapping*.

Grammar The three fragment types share a common grammar:

```
[type:name]
key: value
key:
  value
  value
  value
  ...
```

- **type:** Corresponds to the fragment type, can either be `sections`, `scheme` or `mapping`.
- **name:** The name of the fragment, should be unique for the specified fragment type.
- **key, value:** Contents of the fragment; each fragment type may support different keys and different grammars for the key values.

Note: In cases where multiple fragments of the same type and name are encountered, an exception is thrown.

Note: The only valid characters for fragment names and keys are alphanumeric characters and underscore.

Condition Checking

Condition checking enable the linker script generation to be configuration-aware. Depending on whether expressions involving configuration values are true or not, a particular set of values for a key can be used. The evaluation uses `eval_string` from `kconfiglib` package and adheres to its required syntax and limitations. Supported operators are as follows:

- **comparison**
 - `LessThan <`
 - `LessThanOrEqualTo <=`
 - `MoreThan >`
 - `MoreThanOrEqualTo >=`
 - `Equal =`
 - `NotEqual !=`
- **logical**
 - `Or ||`
 - `And &&`
 - `Negation !`
- **grouping**
 - `Parenthesis ()`

Condition checking behaves as you would expect an `if...elseif/elif...else` block in other languages. Condition-checking is possible for both key values and entire fragments. The two sample fragments below are equivalent:

```
# Value for keys is dependent on config
[type:name]
key_1:
  if CONDITION = y:
    value_1
```

(continues on next page)

(continued from previous page)

```
else:
    value_2
key_2:
    if CONDITION = y:
        value_a
    else:
        value_b
```

```
# Entire fragment definition is dependent on config
if CONDITION = y:
    [type:name]
    key_1:
        value_1
    key_2:
        value_b
else:
    [type:name]
    key_1:
        value_2
    key_2:
        value_b
```

Comments

Comment in linker fragment files begin with #. Like in other languages, comment are used to provide helpful descriptions and documentation and are ignored during processing.

Compatibility with ESP-IDF v3.x Linker Script Fragment Files ESP-IDF v4.0 brings some changes to the linker script fragment file grammar:

- indentation is enforced and improperly indented fragment files generate a parse exception; this was not enforced in the old version but previous documentation and examples demonstrates properly indented grammar
- move to `if...elif...else` structure for conditionals, with the ability to nest checks and place entire fragments themselves inside conditionals
- mapping fragments now requires a name like other fragment types

Linker script generator should be able to parse ESP-IDF v3.x linker fragment files that are indented properly (as demonstrated by the ESP-IDF v3.x version of this document). Backward compatibility with the previous mapping fragment grammar (optional name and the old grammar for conditionals) has also been retained but with a deprecation warning. Users should switch to the newer grammar discussed in this document as support for the old grammar is planned to be removed in the future.

Note that linker fragment files using the new ESP-IDF v4.0 grammar is not supported on ESP-IDF v3.x, however.

Types Sections

Sections fragments defines a list of object file sections that the GCC compiler emits. It may be a default section (e.g. `.text`, `.data`) or it may be user defined section through the `__attribute__` keyword.

The use of an optional '+' indicates the inclusion of the section in the list, as well as sections that start with it. This is the preferred method over listing both explicitly.

```
[sections:name]
entries:
    .section+
    .section
    ...
```

Example:

```
# Non-preferred
[sections:text]
entries:
    .text
    .text.*
    .literal
    .literal.*

# Preferred, equivalent to the one above
[sections:text]
entries:
    .text+           # means .text and .text.*
    .literal+       # means .literal and .literal.*
```

Scheme

Scheme fragments define what `target` a sections fragment is assigned to.

```
[scheme:name]
entries:
    sections -> target
    sections -> target
    ...
```

Example:

```
[scheme:noflash]
entries:
    text -> iram0_text           # the entries under the sections fragment named...
    ↪text will go to iram0_text
    rodata -> dram0_data       # the entries under the sections fragment named...
    ↪rodata will go to dram0_data
```

The default scheme

There exists a special scheme with the name `default`. This scheme is special because catch-all placement rules are generated from its entries. This means that, if one of its entries is `text -> flash_text`, the placement rule

```
*(.literal .literal.* .text .text.*)
```

will be generated for the target `flash_text`.

These catch-all rules then effectively serve as fallback rules for those whose mappings were not specified.

The default scheme is defined in [esp32c3/ld/esp32c3_fragments.ld](#). The `noflash` and `rtc` scheme fragments which are built-in schemes referenced in the quick start guide are also defined in this file.

Mapping

Mapping fragments define what scheme fragment to use for mappable entities, i.e. object files, function names, variable names, archives.

```
[mapping:name]
archive: archive           # output archive file name, as built (i.e. libxxx.
    ↪a)
entries:
    object:symbol (scheme) # symbol granularity
    object (scheme)       # object granularity
    * (scheme)            # archive granularity
```

There are three levels of placement granularity:

- **symbol:** The object file name and symbol name are specified. The symbol name can be a function name or a variable name.
- **object:** Only the object file name is specified.

- archive: * is specified, which is a short-hand for all the object files under the archive.

To know what an entry means, let us expand a sample object-granularity placement:

```
object (scheme)
```

Then expanding the scheme fragment from its entries definitions, we have:

```
object (sections -> target,  
        sections -> target,  
        ...)
```

Expanding the sections fragment with its entries definition:

```
object (.section,      # given this object file  
        .section,      # put its sections listed here at this  
        ... -> target, # target  
  
        .section,  
        .section,      # same should be done for these sections  
        ... -> target,  
  
        ...)          # and so on
```

Example:

```
[mapping:map]  
archive: libfreertos.a  
entries:  
    * (noflash)
```

On Symbol-Granularity Placements Symbol granularity placements is possible due to compiler flags `-ffunction-sections` and `-ffdata-sections`. ESP-IDF compiles with these flags by default. If the user opts to remove these flags, then the symbol-granularity placements will not work. Furthermore, even with the presence of these flags, there are still other limitations to keep in mind due to the dependence on the compiler's emitted output sections.

For example, with `-ffunction-sections`, separate sections are emitted for each function; with section names predictably constructed i.e. `.text.{func_name}` and `.literal.{func_name}`. This is not the case for string literals within the function, as they go to pooled or generated section names.

With `-fdata-sections`, for global scope data the compiler predictably emits either `.data.{var_name}`, `.rodata.{var_name}` or `.bss.{var_name}`; and so Type I mapping entry works for these. However, this is not the case for static data declared in function scope, as the generated section name is a result of mangling the variable name with some other information.

Linker Script Template

The linker script template is the skeleton in which the generated placement rules are put into. It is an otherwise ordinary linker script, with a specific marker syntax that indicates where the generated placement rules are placed.

To reference the placement rules collected under a `target` token, the following syntax is used:

```
mapping[target]
```

Example:

The example below is an excerpt from a possible linker script template. It defines an output section `.iram0.text`, and inside is a marker referencing the target `iram0_text`.

```
.iram0.text :
{
    /* Code marked as running out of IRAM */
    _iram_text_start = ABSOLUTE(.);

    /* Marker referencing iram0_text */
    mapping[iram0_text]

    _iram_text_end = ABSOLUTE(.);
} > iram0_0_seg
```

Suppose the generator collected the fragment definitions below:

```
[sections:text]
.text+
.literal+

[sections:iram]
.iram1+

[scheme:default]
entries:
text -> flash_text
iram -> iram0_text

[scheme:noflash]
entries:
text -> iram0_text

[mapping:freertos]
archive: libfreertos.a
entries:
* (noflash)
```

Then the corresponding excerpt from the generated linker script will be as follows:

```
.iram0.text :
{
    /* Code marked as running out of IRAM */
    _iram_text_start = ABSOLUTE(.);

    /* Placement rules generated from the processed fragments, placed where the_
↔marker was in the template */
    *(.iram1 .iram1.*)
    *libfreertos.a:(.literal .text .literal.* .text.*)

    _iram_text_end = ABSOLUTE(.);
} > iram0_0_seg
```

```
*libfreertos.a:(.literal .text .literal.* .text.*)
```

Rule generated from the entry `* (noflash)` of the `freertos` mapping fragment. All `text` sections of all object files under the archive `libfreertos.a` will be collected under the target `iram0_text` (as per the `noflash` scheme) and placed wherever in the template `iram0_text` is referenced by a marker.

```
*(.iram1 .iram1.*)
```

Rule generated from the default scheme entry `iram -> iram0_text`. Since the default scheme specifies an `iram -> iram0_text` entry, it too is placed wherever `iram0_text` is referenced by a marker. Since it is a rule generated from the default scheme, it comes first among all other rules collected under the same target name.

The linker script template currently used is [esp32c3/ld/esp32c3.project.ld.in](#), specified by the `esp32c3` component; the generated output script is put under its build directory.

4.18 Memory Types

ESP32-C3 chip has multiple memory types and flexible memory mapping features. This section describes how ESP-IDF uses these features by default.

ESP-IDF distinguishes between instruction memory bus (IRAM, IROM, RTC FAST memory) and data memory bus (DRAM, DROM). Instruction memory is executable, and can only be read or written via 4-byte aligned words. Data memory is not executable and can be accessed via individual byte operations. For more information about the different memory buses consult the ESP32-C3 Technical Reference Manual* > *System and Memory* [PDF].

4.18.1 DRAM (Data RAM)

Non-constant static data (`.data`) and zero-initialized data (`.bss`) is placed by the linker into Internal SRAM as data memory. Remaining space in this region is used for the runtime heap.

Note: The maximum statically allocated DRAM size is reduced by the *IRAM (Instruction RAM)* size of the compiled application. The available heap memory at runtime is reduced by the total static IRAM and DRAM usage of the application.

Constant data may also be placed into DRAM, for example if it is used in an non-flash-safe ISR (see explanation under *How to place code in IRAM*).

“noinit” DRAM

The macro `__NOINIT_ATTR` can be used as attribute to place data into `.noinit` section. The values placed into this section will not be initialized at startup and should keep its value after software restart.

Example:

```
__NOINIT_ATTR uint32_t noinit_data;
```

4.18.2 IRAM (Instruction RAM)

Note: Any internal SRAM which is not used for Instruction RAM will be made available as *DRAM (Data RAM)* for static data and dynamic allocation (heap).

Why place code in IRAM

Cases when parts of application should be placed into IRAM:

- Interrupt handlers must be placed into IRAM if `ESP_INTR_FLAG_IRAM` is used when registering the interrupt handler. For more information, see *IRAM-Safe Interrupt Handlers*.
- Some timing critical code may be placed into IRAM to reduce the penalty associated with loading the code from flash. ESP32-C3 reads code and data from flash via the MMU cache. In some cases, placing a function into IRAM may reduce delays caused by a cache miss and significantly improve that function's performance.

How to place code in IRAM

Some code is automatically placed into the IRAM region using the linker script.

If some specific application code needs to be placed into IRAM, it can be done by using the [Linker Script Generation](#) feature and adding a linker script fragment file to your component that targets entire source files or functions with the `noflash` placement. See the [Linker Script Generation](#) docs for more information.

Alternatively, it's possible to specify IRAM placement in the source code using the `IRAM_ATTR` macro:

```
#include "esp_attr.h"

void IRAM_ATTR gpio_isr_handler(void* arg)
{
    // ...
}
```

There are some possible issues with placement in IRAM, that may cause problems with IRAM-safe interrupt handlers:

- Strings or constants inside an `IRAM_ATTR` function may not be placed in RAM automatically. It's possible to use `DRAM_ATTR` attributes to mark these, or using the linker script method will cause these to be automatically placed correctly.

```
void IRAM_ATTR gpio_isr_handler(void* arg)
{
    const static DRAM_ATTR uint8_t INDEX_DATA[] = { 45, 33, 12, 0 };
    const static char *MSG = DRAM_STR("I am a string stored in RAM");
}
```

Note that knowing which data should be marked with `DRAM_ATTR` can be hard, the compiler will sometimes recognize that a variable or expression is constant (even if it is not marked `const`) and optimize it into flash, unless it is marked with `DRAM_ATTR`.

- GCC optimizations that automatically generate jump tables or switch/case lookup tables place these tables in flash. There are two possible ways to resolve this issue:
 - Use a [linker script fragment](#) to mark the entire source file as `noflash`
 - Pass specific flags to the compiler to disable these optimizations in the relevant source files. For CMake, place the following in the component CMakeLists.txt file:

```
set_source_files_properties("${CMAKE_CURRENT_LIST_DIR}/relative/path/to/
↪file" PROPERTIES
                                COMPILER_FLAGS "-fno-jump-tables -fno-tree-
↪switch-conversion")
```

4.18.3 IROM (code executed from Flash)

If a function is not explicitly placed into *IRAM (Instruction RAM)* or RTC memory, it is placed into flash. The mechanism by which Flash MMU is used to allow code execution from flash is described in *ESP32-C3 Technical Reference Manual > Memory Management and Protection Units (MMU, MPU)* [PDF]. As IRAM is limited, most of an application's binary code must be placed into IROM instead.

During [Application Startup Flow](#), the bootloader (which runs from IRAM) configures the MMU flash cache to map the app's instruction code region to the instruction space. Flash accessed via the MMU is cached using some internal SRAM and accessing cached flash data is as fast as accessing other types of internal memory.

4.18.4 RTC fast memory

The same region of RTC fast memory can be accessed as both instruction and data memory. Code which has to run after wake-up from deep sleep mode has to be placed into RTC memory. Please check detailed description in [deep sleep](#) documentation.

Remaining RTC fast memory is added to the heap unless the option `CONFIG_ESP_SYSTEM_ALLOW_RTC_FAST_MEM_AS_HEAP` is disabled. This memory can be used interchangeably with *DRAM (Data RAM)*, but is slightly slower to access.

4.18.5 DROM (data stored in Flash)

By default, constant data is placed by the linker into a region mapped to the MMU flash cache. This is the same as the *IROM (code executed from Flash)* section, but is for read-only data not executable code.

The only constant data not placed into this memory type by default are literal constants which are embedded by the compiler into application code. These are placed as the surrounding function's executable instructions.

The `DRAM_ATTR` attribute can be used to force constants from DROM into the *DRAM (Data RAM)* section (see above).

4.18.6 DMA Capable Requirement

Most peripheral DMA controllers (e.g. SPI, sdmmc, etc.) have requirements that sending/receiving buffers should be placed in DRAM and word-aligned. We suggest to place DMA buffers in static variables rather than in the stack. Use macro `DMA_ATTR` to declare global/local static variables like:

```
DMA_ATTR uint8_t buffer[]="I want to send something";

void app_main()
{
    // initialization code...
    spi_transaction_t temp = {
        .tx_buffer = buffer,
        .length = 8 * sizeof(buffer),
    };
    spi_device_transmit(spi, &temp);
    // other stuff
}
```

Or:

```
void app_main()
{
    DMA_ATTR static uint8_t buffer[] = "I want to send something";
    // initialization code...
    spi_transaction_t temp = {
        .tx_buffer = buffer,
        .length = 8 * sizeof(buffer),
    };
    spi_device_transmit(spi, &temp);
    // other stuff
}
```

It is also possible to allocate DMA-capable memory buffers dynamically by using the `MALLOC_CAP_DMA` capabilities flag.

4.18.7 DMA Buffer in the stack

Placing DMA buffers in the stack is possible but discouraged. If doing so, pay attention to the following:

- Use macro `WORD_ALIGNED_ATTR` in functions before variables to place them in proper positions like:

```
void app_main()
{
    uint8_t stuff;
    WORD_ALIGNED_ATTR uint8_t buffer[] = "I want to send something"; //or_
    ↪the buffer will be placed right after stuff.
    // initialization code...
    spi_transaction_t temp = {
        .tx_buffer = buffer,
        .length = 8 * sizeof(buffer),
    };
    spi_device_transmit(spi, &temp);
    // other stuff
}
```

4.19 lwIP

ESP-IDF uses the open source [lwIP lightweight TCP/IP stack](#). The ESP-IDF version of lwIP ([esp-lwip](#)) has some modifications and additions compared to the upstream project.

4.19.1 Supported APIs

ESP-IDF supports the following lwIP TCP/IP stack functions:

- [BSD Sockets API](#)
- [Netconn API](#) is enabled but not officially supported for ESP-IDF applications

Adapted APIs

Some common lwIP “app” APIs are supported indirectly by ESP-IDF:

- DHCP Server & Client are supported indirectly via the [ESP-NETIF](#) functionality
- Simple Network Time Protocol (SNTP) is supported via the [lwip/include/apps/sntp/sntp.h](#) [lwip/lwip/src/include/lwip/apps/sntp.h](#) functions (see also [SNTP Time Synchronization](#))
- ICMP Ping is supported using a variation on the lwIP ping API. See [ICMP Echo](#).
- NetBIOS lookup is available using the standard lwIP API. [protocols/http_server/restful_server](#) has an option to demonstrate using NetBIOS to look up a host on the LAN.
- mDNS uses a different implementation to the lwIP default mDNS (see [mDNS Service](#)), but lwIP can look up mDNS hosts using standard APIs such as `gethostbyname()` and the convention `hostname.local`, provided the [CONFIG_LWIP_DNS_SUPPORT_MDNS_QUERIES](#) setting is enabled.

4.19.2 BSD Sockets API

The BSD Sockets API is a common cross-platform TCP/IP sockets API that originated in the Berkeley Standard Distribution of UNIX but is now standardized in a section of the POSIX specification. BSD Sockets are sometimes called POSIX Sockets or Berkeley Sockets.

As implemented in ESP-IDF, lwIP supports all of the common usages of the BSD Sockets API.

References

A wide range of BSD Sockets reference material is available, including:

- [Single UNIX Specification BSD Sockets page](#)
- [Berkeley Sockets Wikipedia page](#)

Examples

A number of ESP-IDF examples show how to use the BSD Sockets APIs:

- [protocols/sockets/tcp_server](#)
- [protocols/sockets/tcp_client](#)
- [protocols/sockets/udp_server](#)
- [protocols/sockets/udp_client](#)
- [protocols/sockets/udp_multicast](#)
- [protocols/http_request](#) (Note: this is a simplified example of using a TCP socket to send an HTTP request. The *ESP HTTP Client* is a much better option for sending HTTP requests.)

Supported functions

The following BSD socket API functions are supported. For full details see [lwip/lwip/src/include/lwip/sockets.h](#).

- `socket()`
- `bind()`
- `accept()`
- `shutdown()`
- `getpeername()`
- `getsockopt()` & `setsockopt()` (see [Socket Options](#))
- `close()` (via [Virtual filesystem component](#))
- `read()`, `readv()`, `write()`, `writew()` (via [Virtual filesystem component](#))
- `recv()`, `recvmsg()`, `recvfrom()`
- `send()`, `sendmsg()`, `sendto()`
- `select()` (via [Virtual filesystem component](#))
- `poll()` (Note: on ESP-IDF, `poll()` is implemented by calling `select` internally, so using `select()` directly is recommended if a choice of methods is available.)
- `fcntl()` (see [fcntl](#))

Non-standard functions:

- `ioctl()` (see [ioctls](#))

Note: Some lwIP application sample code uses prefixed versions of BSD APIs, for example `lwip_socket()` instead of the standard `socket()`. Both forms can be used with ESP-IDF, but using standard names is recommended.

Socket Error Handling

BSD Socket error handling code is very important for robust socket applications. Normally the socket error handling involves the following aspects:

- Detecting the error.
- Getting the error reason code.
- Handle the error according to the reason code.

In lwIP, we have two different scenarios of handling socket errors:

- Socket API returns an error. For more information, see [Socket API Errors](#).
- `select(int maxfdp1, fd_set *readset, fd_set *writeset, fd_set *exceptset, struct timeval *timeout)` has exception descriptor indicating that the socket has an error. For more information, see [select\(\) Errors](#).

Socket API Errors

The error detection

- We can know that the socket API fails according to its return value.

Get the error reason code

- When socket API fails, the return value doesn't contain the failure reason and the application can get the error reason code by accessing `errno`. Different values indicate different meanings. For more information, see <[Socket Error Reason Code](#)>.

Example:

```
int err;
int sockfd;

if (sockfd = socket(AF_INET, SOCK_STREAM, 0) < 0) {
    // the error code is obtained from errno
    err = errno;
    return err;
}
```

select() Errors

The error detection

- Socket error when `select()` has exception descriptor

Get the error reason code

- If the `select` indicates that the socket fails, we can't get the error reason code by accessing `errno`, instead we should call `getsockopt()` to get the failure reason code. Because `select()` has exception descriptor, the error code will not be given to `errno`.

Note: `getsockopt` function prototype `int getsockopt(int s, int level, int optname, void *optval, socklen_t *optlen)`. Its function is to get the current value of the option of any type, any state socket, and store the result in `optval`. For example, when you get the error code on a socket, you can get it by `getsockopt(sockfd, SOL_SOCKET, SO_ERROR, &err, &optlen)`.

Example:

```
int err;

if (select(sockfd + 1, NULL, NULL, &exfds, &tval) <= 0) {
    err = errno;
    return err;
} else {
    if (FD_ISSET(sockfd, &exfds)) {
        // select() exception set using getsockopt()
        int optlen = sizeof(int);
        getsockopt(sockfd, SOL_SOCKET, SO_ERROR, &err, &optlen);
        return err;
    }
}
```

Socket Error Reason Code Below is a list of common error codes. For more detailed list of standard POSIX/C error codes, please see `newlib errno.h` <<https://github.com/espressif/newlib-esp32/blob/master/newlib/libc/include/sys/errno.h>> and the platform-specific extensions `newlib/platform_include/errno.h`

Error code	Description
ECONNREFUSED	Connection refused
EADDRINUSE	Address already in use
ECONNABORTED	Software caused connection abort
ENETUNREACH	Network is unreachable
ENETDOWN	Network interface is not configured
ETIMEDOUT	Connection timed out
EHOSTDOWN	Host is down
EHOSTUNREACH	Host is unreachable
EINPROGRESS	Connection already in progress
EALREADY	Socket already connected
EDESTADDRREQ	Destination address required
EPROTONOSUPPORT	Unknown protocol

Socket Options

The `getsockopt()` and `setsockopt()` functions allow getting/setting per-socket options.

Not all standard socket options are supported by lwIP in ESP-IDF. The following socket options are supported:

Common options Used with level argument `SOL_SOCKET`.

- `SO_REUSEADDR` (available if `CONFIG_LWIP_SO_REUSE` is set, behavior can be customized by setting `CONFIG_LWIP_SO_REUSE_RXTOALL`)
- `SO_KEEPALIVE`
- `SO_BROADCAST`
- `SO_ACCEPTCONN`
- `SO_RCVBUF` (available if `CONFIG_LWIP_SO_RCVBUF` is set)
- `SO_SNDTIMEO` / `SO_RCVTIMEO`
- `SO_ERROR` (this option is only used with `select()`, see [Socket Error Handling](#))
- `SO_TYPE`
- `SO_NO_CHECK` (for UDP sockets only)

IP options Used with level argument `IPPROTO_IP`.

- `IP_TOS`
- `IP_TTL`
- `IP_PKTINFO` (available if `CONFIG_LWIP_NETBUF_RECVINFO` is set)

For multicast UDP sockets:

- `IP_MULTICAST_IF`
- `IP_MULTICAST_LOOP`
- `IP_MULTICAST_TTL`
- `IP_ADD_MEMBERSHIP`
- `IP_DROP_MEMBERSHIP`

TCP options TCP sockets only. Used with level argument `IPPROTO_TCP`.

- `TCP_NODELAY`

Options relating to TCP keepalive probes:

- `TCP_KEEPALIVE` (int value, TCP keepalive period in milliseconds)
- `TCP_KEEPIDLE` (same as `TCP_KEEPALIVE`, but the value is in seconds)
- `TCP_KEEPINTVL` (int value, interval between keepalive probes in seconds)
- `TCP_KEEPCNT` (int value, number of keepalive probes before timing out)

IPv6 options IPv6 sockets only. Used with level argument `IPPROTO_IPV6`

- `IPV6_CHECKSUM`
- `IPV6_V6ONLY`

For multicast IPv6 UDP sockets:

- `IPV6_JOIN_GROUP / IPV6_ADD_MEMBERSHIP`
- `IPV6_LEAVE_GROUP / IPV6_DROP_MEMBERSHIP`
- `IPV6_MULTICAST_IF`
- `IPV6_MULTICAST_HOPS`
- `IPV6_MULTICAST_LOOP`

fcntl

The `fcntl()` function is a standard API for manipulating options related to a file descriptor. In ESP-IDF, the *Virtual filesystem component* layer is used to implement this function.

When the file descriptor is a socket, only the following `fcntl()` values are supported:

- `O_NONBLOCK` to set/clear non-blocking I/O mode. Also supports `O_NDELAY`, which is identical to `O_NONBLOCK`.
- `O_RDONLY`, `O_WRONLY`, `O_RDWR` flags for different read/write modes. These can read via `F_GETFL` only, they cannot be set using `F_SETFL`. A TCP socket will return a different mode depending on whether the connection has been closed at either end or is still open at both ends. UDP sockets always return `O_RDWR`.

ioctl

The `ioctl()` function provides a semi-standard way to access some internal features of the TCP/IP stack. In ESP-IDF, the *Virtual filesystem component* layer is used to implement this function.

When the file descriptor is a socket, only the following `ioctl()` values are supported:

- `FIONREAD` returns the number of bytes of pending data already received in the socket's network buffer.
- `FIONBIO` is an alternative way to set/clear non-blocking I/O status for a socket, equivalent to `fcntl(fd, F_SETFL, O_NONBLOCK, ...)`.

4.19.3 Netconn API

lwIP supports two lower level APIs as well as the BSD Sockets API: the Netconn API and the Raw API.

The lwIP Raw API is designed for single threaded devices and is not supported in ESP-IDF.

The Netconn API is used to implement the BSD Sockets API inside lwIP, and it can also be called directly from ESP-IDF apps. This API has lower resource usage than the BSD Sockets API, in particular it can send and receive data without needing to first copy it into internal lwIP buffers.

Important: Espressif does not test the Netconn API in ESP-IDF. As such, this functionality is *enabled but not supported*. Some functionality may only work correctly when used from the BSD Sockets API.

For more information about the Netconn API, consult [lwip/lwip/src/include/lwip/api.h](#) and [this wiki page which is part of the unofficial lwIP Application Developers Manual](#).

4.19.4 lwIP FreeRTOS Task

lwIP creates a dedicated TCP/IP FreeRTOS task to handle socket API requests from other tasks.

A number of configuration items are available to modify the task and the queues (“mailboxes”) used to send data to/from the TCP/IP task:

- [CONFIG_LWIP_TCPIP_RECVMBOX_SIZE](#)
- [CONFIG_LWIP_TCPIP_TASK_STACK_SIZE](#)
- [CONFIG_LWIP_TCPIP_TASK_AFFINITY](#)

4.19.5 esp-lwip custom modifications

Additions

The following code is added which is not present in the upstream lwIP release:

Thread-safe sockets It is possible to `close()` a socket from a different thread to the one that created it. The `close()` call will block until any function calls currently using that socket from other tasks have returned.

It is, however, not possible to delete a task while it is actively waiting on `select()` or `poll()` APIs. It is always necessary that these APIs exit before destroying the task, as this might corrupt internal structures and cause subsequent crashes of the lwIP. (These APIs allocate globally referenced callback pointers on stack, so that when the task gets destroyed before unrolling the stack, the lwIP would still hold pointers to the deleted stack)

On demand timers lwIP IGMP and MLD6 features both initialize a timer in order to trigger timeout events at certain times.

The default lwIP implementation is to have these timers enabled all the time, even if no timeout events are active. This increases CPU usage and power consumption when using automatic light sleep mode. `esp-lwip` default behaviour is to set each timer “on demand” so it is only enabled when an event is pending.

To return to the default lwIP behaviour (always-on timers), disable [CONFIG_LWIP_TIMERS_ONDEMAND](#).

Lwip timers API When users are not using WiFi, these APIs provide users with the ability to turn off LwIP timer to reduce power consumption.

The following API functions are supported. For full details see [lwip/lwip/src/include/lwip/timeouts.h](#).

- `sys_timeouts_init()`
- `sys_timeouts_deinit()`

Abort TCP connections when IP changes [CONFIG_LWIP_TCP_KEEP_CONNECTION_WHEN_IP_CHANGES](#) is disabled by default. This disables the default lwIP behaviour of keeping TCP connections open if an interface IP changes, in case the interface IP changes back (for example, if an interface connection goes down and comes back up). Enable this option to keep TCP connections open in this case, until they time out normally. This may increase the number of sockets in use if a network interface goes down temporarily.

Additional Socket Options

- Some standard IPV4 and IPV6 multicast socket options are implemented (see *Socket Options*).
- Possible to set IPV6-only UDP and TCP sockets with `IPV6_V6ONLY` socket option (normal lwIP is TCP only).

IP layer features

- IPV4 source based routing implementation is different.
- IPV4 mapped IPV6 addresses are supported.

Limitations

Calling `send()` or `sendto()` repeatedly on a UDP socket may eventually fail with `errno` equal to `ENOMEM`. This is a limitation of buffer sizes in the lower layer network interface drivers. If all driver transmit buffers are full then UDP transmission will fail. Applications sending a high volume of UDP datagrams who don't wish for any to be dropped by the sender should check for this error code and re-send the datagram after a short delay.

Increasing the number of TX buffers in the [Wi-Fi](#) project configuration may also help.

4.19.6 Performance Optimization

TCP/IP performance is a complex subject, and performance can be optimized towards multiple goals. The default settings of ESP-IDF are tuned for a compromise between throughput, latency, and moderate memory usage.

Maximum throughput

Espressif tests ESP-IDF TCP/IP throughput using the [wifi/iperf](#) example in an RF sealed enclosure.

The [wifi/iperf/sdkconfig.defaults](#) file for the iperf example contains settings known to maximize TCP/IP throughput, usually at the expense of higher RAM usage. To get maximum TCP/IP throughput in an application at the expense of other factors then suggest applying settings from this file into the project `sdkconfig`.

Important: Suggest applying changes a few at a time and checking the performance each time with a particular application workload.

- If a lot of tasks are competing for CPU time on the system, consider that the lwIP task has configurable CPU affinity (`CONFIG_LWIP_TCPIP_TASK_AFFINITY`) and runs at fixed priority `ESP_TASK_TCPIP_PRI0` (18). Configure competing tasks to be pinned to a different core, or to run at a lower priority.
- If using `select()` function with socket arguments only, setting `CONFIG_LWIP_USE_ONLY_LWIP_SELECT` will make `select()` calls faster.

If using a Wi-Fi network interface, please also refer to [Wi-Fi Buffer Usage](#).

Minimum latency

Except for increasing buffer sizes, most changes which increase throughput will also decrease latency by reducing the amount of CPU time spent in lwIP functions.

- For TCP sockets, lwIP supports setting the standard `TCP_NODELAY` flag to disable Nagle's algorithm.

Minimum RAM usage

Most lwIP RAM usage is on-demand, as RAM is allocated from the heap as needed. Therefore, changing lwIP settings to reduce RAM usage may not change RAM usage at idle but can change it at peak.

- Reducing `CONFIG_LWIP_MAX_SOCKETS` reduces the maximum number of sockets in the system. This will also cause TCP sockets in the `WAIT_CLOSE` state to be closed and recycled more rapidly (if needed to open a new socket), further reducing peak RAM usage.
- Reducing `CONFIG_LWIP_TCPIP_RECVMBOX_SIZE`, `CONFIG_LWIP_TCP_RECVMBOX_SIZE` and `CONFIG_LWIP_UDP_RECVMBOX_SIZE` reduce memory usage at the expense of throughput, depending on usage.
- Disable `CONFIG_LWIP_IPV6` can save about 39 KB for firmware size and 2KB RAM when system power up and 7KB RAM when TCPIP stack running. If there is no requirement for supporting IPV6 then it can be disabled to save flash and RAM footprint.

If using Wi-Fi, please also refer to [Wi-Fi Buffer Usage](#).

Peak Buffer Usage The peak heap memory that lwIP consumes is the **theoretically-maximum memory** that the lwIP driver consumes. Generally, the peak heap memory that lwIP consumes depends on:

- the memory required to create a UDP connection: `lwip_udp_conn`
- the memory required to create a TCP connection: `lwip_tcp_conn`
- the number of UDP connections that the application has: `lwip_udp_con_num`
- the number of TCP connections that the application has: `lwip_tcp_con_num`
- the TCP TX window size: `lwip_tcp_tx_win_size`
- the TCP RX window size: `lwip_tcp_rx_win_size`

So, the peak heap memory that the LwIP consumes can be calculated with the following formula:

$$\text{lwip_dynamic_peek_memory} = (\text{lwip_udp_con_num} * \text{lwip_udp_conn}) + (\text{lwip_tcp_con_num} * (\text{lwip_tcp_tx_win_size} + \text{lwip_tcp_rx_win_size} + \text{lwip_tcp_conn}))$$

Some TCP-based applications need only one TCP connection. However, they may choose to close this TCP connection and create a new one when an error (such as a sending failure) occurs. This may result in multiple TCP connections existing in the system simultaneously, because it may take a long time for a TCP connection to close, according to the TCP state machine (refer to RFC793).

4.20 Partition Tables

4.20.1 Overview

A single ESP32-C3's flash can contain multiple apps, as well as many different kinds of data (calibration data, filesystems, parameter storage, etc). For this reason a partition table is flashed to (*default offset*) 0x8000 in the flash.

Partition table length is 0xC00 bytes (maximum 95 partition table entries). An MD5 checksum, which is used for checking the integrity of the partition table, is appended after the table data.

Each entry in the partition table has a name (label), type (app, data, or something else), subtype and the offset in flash where the partition is loaded.

The simplest way to use the partition table is to open the project configuration menu (`idf.py menuconfig`) and choose one of the simple predefined partition tables under `CONFIG_PARTITION_TABLE_TYPE`:

- “Single factory app, no OTA”
- “Factory app, two OTA definitions”

In both cases the factory app is flashed at offset 0x10000. If you execute `idf.py partition_table` then it will print a summary of the partition table.

4.20.2 Built-in Partition Tables

Here is the summary printed for the “Single factory app, no OTA” configuration:

```
# ESP-IDF Partition Table
# Name, Type, SubType, Offset, Size, Flags
nvs, data, nvs, 0x9000, 0x6000,
phy_init, data, phy, 0xf000, 0x1000,
factory, app, factory, 0x10000, 1M,
```

- At a 0x10000 (64KB) offset in the flash is the app labelled “factory” . The bootloader will run this app by default.
- There are also two data regions defined in the partition table for storing NVS library partition and PHY init data.

Here is the summary printed for the “Factory app, two OTA definitions” configuration:

```
# ESP-IDF Partition Table
# Name, Type, SubType, Offset, Size, Flags
nvs, data, nvs, 0x9000, 0x4000,
otadata, data, ota, 0xd000, 0x2000,
phy_init, data, phy, 0xf000, 0x1000,
factory, app, factory, 0x10000, 1M,
ota_0, app, ota_0, 0x110000, 1M,
ota_1, app, ota_1, 0x210000, 1M,
```

- There are now three app partition definitions. The type of the factory app (at 0x10000) and the next two “OTA” apps are all set to “app”, but their subtypes are different.
- There is also a new “otadata” slot, which holds the data for OTA updates. The bootloader consults this data in order to know which app to execute. If “ota data” is empty, it will execute the factory app.

4.20.3 Creating Custom Tables

If you choose “Custom partition table CSV” in menuconfig then you can also enter the name of a CSV file (in the project directory) to use for your partition table. The CSV file can describe any number of definitions for the table you need.

The CSV format is the same format as printed in the summaries shown above. However, not all fields are required in the CSV. For example, here is the “input” CSV for the OTA partition table:

```
# Name, Type, SubType, Offset, Size, Flags
nvs, data, nvs, 0x9000, 0x4000
otadata, data, ota, 0xd000, 0x2000
phy_init, data, phy, 0xf000, 0x1000
factory, app, factory, 0x10000, 1M
ota_0, app, ota_0, , 1M
ota_1, app, ota_1, , 1M
nvs_key, data, nvs_keys, , 0x1000
```

- Whitespace between fields is ignored, and so is any line starting with # (comments).
- Each non-comment line in the CSV file is a partition definition.
- The “Offset” field for each partition is empty. The `gen_esp32part.py` tool fills in each blank offset, starting after the partition table and making sure each partition is aligned correctly.

Name field

Name field can be any meaningful name. It is not significant to the ESP32-C3. Names longer than 16 characters will be truncated.

Type field

Partition type field can be specified as `app` (0x00) or `data` (0x01). Or it can be a number 0-254 (or as hex 0x00-0xFE). Types 0x00-0x3F are reserved for ESP-IDF core functions.

If your app needs to store data in a format not already supported by ESP-IDF, then please add a custom partition type value in the range 0x40-0xFE.

See [esp_partition_type_t](#) for the enum definitions for `app` and `data` partitions.

If writing in C++ then specifying a application-defined partition type requires casting an integer to [esp_partition_type_t](#) in order to use it with the [partition API](#). For example:

```
static const esp_partition_type_t APP_PARTITION_TYPE_A = (esp_partition_type_t)0x40;
```

The ESP-IDF bootloader ignores any partition types other than `app` (0x00) and `data` (0x01).

SubType

The 8-bit subtype field is specific to a given partition type. ESP-IDF currently only specifies the meaning of the subtype field for `app` and `data` partition types.

See enum `esp_partition_subtype_t` for the full list of subtypes defined by ESP-IDF, including the following:

- When type is `app`, the subtype field can be specified as `factory` (0x00), `ota_0` (0x10) ... `ota_15` (0x1F) or `test` (0x20).
 - `factory` (0x00) is the default `app` partition. The bootloader will execute the factory app unless there it sees a partition of type `data/ota`, in which case it reads this partition to determine which OTA image to boot.
 - * OTA never updates the factory partition.
 - * If you want to conserve flash usage in an OTA project, you can remove the factory partition and use `ota_0` instead.
 - `ota_0` (0x10) ... `ota_15` (0x1F) are the OTA app slots. When *OTA* is in use, the OTA data partition configures which app slot the bootloader should boot. When using OTA, an application should have at least two OTA application slots (`ota_0` & `ota_1`). Refer to the *OTA documentation* for more details.
 - `test` (0x20) is a reserved subtype for factory test procedures. It will be used as the fallback boot partition if no other valid app partition is found. It is also possible to configure the bootloader to read a GPIO input during each boot, and boot this partition if the GPIO is held low, see *Boot from test app partition*.
- When type is `data`, the subtype field can be specified as `ota` (0x00), `phy` (0x01), `nvs` (0x02), `nvs_keys` (0x04), or a range of other component-specific subtypes (see *subtype enum*).
 - `ota` (0) is the *OTA data partition* which stores information about the currently selected OTA app slot. This partition should be 0x2000 bytes in size. Refer to the *OTA documentation* for more details.
 - `phy` (1) is for storing PHY initialisation data. This allows PHY to be configured per-device, instead of in firmware.
 - * In the default configuration, the phy partition is not used and PHY initialisation data is compiled into the app itself. As such, this partition can be removed from the partition table to save space.
 - * To load PHY data from this partition, open the project configuration menu (`idf.py menuconfig`) and enable `CONFIG_ESP32_PHY_INIT_DATA_IN_PARTITION` option. You will also need to flash your devices with phy init data as the esp-idf build system does not do this automatically.
 - `nvs` (2) is for the *Non-Volatile Storage (NVS) API*.
 - * NVS is used to store per-device PHY calibration data (different to initialisation data).
 - * NVS is used to store WiFi data if the `esp_wifi_set_storage(WIFI_STORAGE_FLASH)` initialisation function is used.
 - * The NVS API can also be used for other application data.
 - * It is strongly recommended that you include an NVS partition of at least 0x3000 bytes in your project.
 - * If using NVS API to store a lot of data, increase the NVS partition size from the default 0x6000 bytes.
 - `nvs_keys` (4) is for the NVS key partition. See *Non-Volatile Storage (NVS) API* for more details.
 - * It is used to store NVS encryption keys when *NVS Encryption* feature is enabled.
 - * The size of this partition should be 4096 bytes (minimum partition size).
 - There are other predefined data subtypes for data storage supported by ESP-IDF. These include *FAT filesystem* (`ESP_PARTITION_SUBTYPE_DATA_FAT`), *SPIFFS* (`ESP_PARTITION_SUBTYPE_DATA_SPIFFS`), etc.

Other subtypes of `data` type are reserved for future ESP-IDF uses.

- If the partition type is any application-defined value (range 0x40-0xFE), then `subtype` field can be any value chosen by the application (range 0x00-0xFE).

Note that when writing in C++, an application-defined subtype value requires casting to type `esp_partition_subtype_t` in order to use it with the *partition API*.

Offset & Size

Partitions with blank offsets in the CSV file will start after the previous partition, or after the partition table in the case of the first partition.

Partitions of type `app` have to be placed at offsets aligned to 0x10000 (64K). If you leave the offset field blank, `gen_esp32part.py` will automatically align the partition. If you specify an unaligned offset for an app partition,

the tool will return an error.

Sizes and offsets can be specified as decimal numbers, hex numbers with the prefix 0x, or size multipliers K or M (1024 and 1024*1024 bytes).

If you want the partitions in the partition table to work relative to any placement (*CONFIG_PARTITION_TABLE_OFFSET*) of the table itself, leave the offset field (in CSV file) for all partitions blank. Similarly, if changing the partition table offset then be aware that all blank partition offsets may change to match, and that any fixed offsets may now collide with the partition table (causing an error).

Flags

Only one flag is currently supported, `encrypted`. If this field is set to `encrypted`, this partition will be encrypted if *Flash Encryption* is enabled.

Note: `app` type partitions will always be encrypted, regardless of whether this flag is set or not.

4.20.4 Generating Binary Partition Table

The partition table which is flashed to the ESP32-C3 is in a binary format, not CSV. The tool `partition_table/gen_esp32part.py` is used to convert between CSV and binary formats.

If you configure the partition table CSV name in the project configuration (`idf.py menuconfig`) and then build the project or run `idf.py partition_table`, this conversion is done as part of the build process.

To convert CSV to Binary manually:

```
python gen_esp32part.py input_partitions.csv binary_partitions.bin
```

To convert binary format back to CSV manually:

```
python gen_esp32part.py binary_partitions.bin input_partitions.csv
```

To display the contents of a binary partition table on stdout (this is how the summaries displayed when running `idf.py partition_table` are generated:

```
python gen_esp32part.py binary_partitions.bin
```

MD5 checksum

The binary format of the partition table contains an MD5 checksum computed based on the partition table. This checksum is used for checking the integrity of the partition table during the boot.

The MD5 checksum generation can be disabled by the `--disable-md5sum` option of `gen_esp32part.py` or by the *CONFIG_PARTITION_TABLE_MD5* option.

4.20.5 Flashing the partition table

- `idf.py partition_table-flash`: will flash the partition table with `esptool.py`.
- `idf.py flash`: Will flash everything including the partition table.

A manual flashing command is also printed as part of `idf.py partition_table` output.

Note: Note that updating the partition table doesn't erase data that may have been stored according to the old partition table. You can use `idf.py erase_flash` (or `esptool.py erase_flash`) to erase the entire flash contents.

4.20.6 Partition Tool (`parttool.py`)

The component `partition_table` provides a tool `parttool.py` for performing partition-related operations on a target device. The following operations can be performed using the tool:

- reading a partition and saving the contents to a file (`read_partition`)
- writing the contents of a file to a partition (`write_partition`)
- erasing a partition (`erase_partition`)
- retrieving info such as name, offset, size and flag (“encrypted”) of a given partition (`get_partition_info`)

The tool can either be imported and used from another Python script or invoked from shell script for users wanting to perform operation programmatically. This is facilitated by the tool's Python API and command-line interface, respectively.

Python API

Before anything else, make sure that the `parttool` module is imported.

```
import sys
import os

idf_path = os.environ["IDF_PATH"] # get value of IDF_PATH from environment
parttool_dir = os.path.join(idf_path, "components", "partition_table") # parttool.
↳py lives in $IDF_PATH/components/partition_table

sys.path.append(parttool_dir) # this enables Python to find parttool module
from parttool import * # import all names inside parttool module
```

The starting point for using the tool's Python API to do is create a `ParttoolTarget` object:

```
# Create a parttool.py target device connected on serial port /dev/ttyUSB1
target = ParttoolTarget("/dev/ttyUSB1")
```

The created object can now be used to perform operations on the target device:

```
# Erase partition with name 'storage'
target.erase_partition(PartitionName("storage"))

# Read partition with type 'data' and subtype 'spiffs' and save to file 'spiffs.bin'
↳'
target.read_partition(PartitionType("data", "spiffs"), "spiffs.bin")

# Write to partition 'factory' the contents of a file named 'factory.bin'
target.write_partition(PartitionName("factory"), "factory.bin")

# Print the size of default boot partition
storage = target.get_partition_info(PARTITION_BOOT_DEFAULT)
print(storage.size)
```

The partition to operate on is specified using `PartitionName` or `PartitionType` or `PARTITION_BOOT_DEFAULT`. As the name implies, these can be used to refer to partitions of a particular name, type-subtype combination, or the default boot partition.

More information on the Python API is available in the docstrings for the tool.

Command-line Interface

The command-line interface of *parttool.py* has the following structure:

```
parttool.py [command-args] [subcommand] [subcommand-args]

- command-args - These are arguments that are needed for executing the main_
↳command (parttool.py), mostly pertaining to the target device
- subcommand - This is the operation to be performed
- subcommand-args - These are arguments that are specific to the chosen operation
```

```
# Erase partition with name 'storage'
parttool.py --port "/dev/ttyUSB1" erase_partition --partition-name=storage

# Read partition with type 'data' and subtype 'spiffs' and save to file 'spiffs.bin'
↳'
parttool.py --port "/dev/ttyUSB1" read_partition --partition-type=data --partition-
↳subtype=spiffs --output "spiffs.bin"

# Write to partition 'factory' the contents of a file named 'factory.bin'
parttool.py --port "/dev/ttyUSB1" write_partition --partition-name=factory --input
↳"factory.bin"

# Print the size of default boot partition
parttool.py --port "/dev/ttyUSB1" get_partition_info --partition-boot-default --
↳info size
```

More information can be obtained by specifying *-help* as argument:

```
# Display possible subcommands and show main command argument descriptions
parttool.py --help

# Show descriptions for specific subcommand arguments
parttool.py [subcommand] --help
```

4.21 RF calibration

ESP32-C3 supports three RF calibration methods during RF initialization:

1. Partial calibration
2. Full calibration
3. No calibration

4.21.1 Partial calibration

During RF initialization, the partial calibration method is used by default for RF calibration. It is done based on the full calibration data which is stored in the NVS. To use this method, please go to `menuconfig` and enable `CONFIG_ESP32_PHY_CALIBRATION_AND_DATA_STORAGE`.

4.21.2 Full calibration

Full calibration is triggered in the following conditions:

1. NVS does not exist.
2. The NVS partition to store calibration data is erased.
3. Hardware MAC address is changed.
4. PHY library version is changed.

5. The RF calibration data loaded from the NVS partition is broken.

It takes about 100ms more than partial calibration. If boot duration is not critical, it is suggested to use the full calibration method. To switch to the full calibration method, go to `menuconfig` and disable `CONFIG_ESP32_PHY_CALIBRATION_AND_DATA_STORAGE`. If you use the default method of RF calibration, there are two ways to add the function of triggering full calibration as a last-resort remedy.

1. Erase the NVS partition if you don't mind all of the data stored in the NVS partition is erased. That is indeed the easiest way.
2. Call API `esp_phy_erase_cal_data_in_nvs()` before initializing WiFi and BT/BLE based on some conditions (e.g. an option provided in some diagnostic mode). In this case, only phy namespace of the NVS partition is erased.

4.21.3 No calibration

No calibration method is only used when the device wakes up from deep sleep.

4.21.4 PHY initialization data

The PHY initialization data is used for RF calibration. There are two ways to get the PHY initialization data.

One is the default initialization data which is located in the header file `components/esp_wifi/esp32c3/include/phy_init_data.h`.

It is embedded into the application binary after compiling and then stored into read-only memory (DROM). To use the default initialization data, please go to `menuconfig` and disable `CONFIG_ESP32_PHY_INIT_DATA_IN_PARTITION`.

Another is the initialization data which is stored in a partition. When using a custom partition table, make sure that PHY data partition is included (type: `data`, subtype: `phy`). With default partition table, this is done automatically. If initialization data is stored in a partition, it has to be flashed there, otherwise runtime error will occur. To switch to the initialization data stored in a partition, go to `menuconfig` and enable `CONFIG_ESP32_PHY_INIT_DATA_IN_PARTITION`.

4.22 Secure Boot V2

Important: The references in this document are related to Secure Boot V2, the preferred scheme from ESP32 ECO3 onwards, in ESP32-S2, and from ESP32-C3 ECO3 onwards.

Secure Boot V2 uses RSA based app and bootloader verification. This document can also be referred for signing apps with the RSA scheme without signing the bootloader.

Secure Boot V2 is available for ESP32-C3 from ECO3 onwards. To get these options visible in the `menuconfig` set `CONFIG_ESP32C3_REV_MIN` greater than or equal to `Rev 3`.

4.22.1 Background

Secure Boot protects a device from running unsigned code (verification at time of load). A new RSA based secure boot verification scheme (Secure Boot V2) has been introduced for ESP32-S2, ESP32-C3 ECO3 onwards, and ESP32 ECO3 onwards.

- The software bootloader's RSA-PSS signature is verified by the Mask ROM and it is executed post successful verification.
- The verified software bootloader verifies the RSA-PSS signature of the application image before it is executed.

4.22.2 Advantages

- The RSA public key is stored on the device. The corresponding RSA private key is kept secret on a server and is never accessed by the device.
- Up to three public keys can be generated and stored in the chip during manufacturing.
- ESP32-C3 provides the facility to permanently revoke individual public keys. This can be configured conservatively or aggressively.
- Conservatively - The old key is revoked after the bootloader and application have successfully migrated to a new key. Aggressively - The key is revoked as soon as verification with this key fails.
- Same image format & signature verification is applied for applications & software bootloader.
- No secrets are stored on the device. Therefore immune to passive side-channel attacks (timing or power analysis, etc.)

4.22.3 Secure Boot V2 Process

This is an overview of the Secure Boot V2 Process, Step by step instructions are supplied under [How To Enable Secure Boot V2](#).

1. Secure Boot V2 verifies the signature blocks appended to the bootloader and application binaries. The signature block contains the image binary signed by a RSA-3072 private key and its corresponding public key. More details on the [Signature Block Format](#).
2. On startup, ROM code checks the Secure Boot V2 bit in eFuse.
3. If secure boot is enabled, ROM checks the SHA-256 of the public key in the signature block in the eFuse.
4. The ROM code validates the public key embedded in the software bootloader's signature block by matching the SHA-256 of its public key to the SHA-256 in eFuse as per the earlier step. Boot process will be aborted if a valid hash of the public key isn't found in the eFuse.
5. The ROM code verifies the signature of the bootloader with the pre-validated public key with the RSA-PSS Scheme. In depth information on [Verifying the signature Block](#).
6. Software bootloader, reads the app partition and performs similar verification on the application. The application is verified on every boot up and OTA update. If selected OTA app partition fails verification, bootloader will fall back and look for another correctly signed partition.

4.22.4 Signature Block Format

The bootloader and application images are padded to the next 4096 byte boundary, thus the signature has a flash sector of its own. The signature is calculated over all bytes in the image including the padding bytes.

Each signature block contains the following:

- **Offset 0 (1 byte):** Magic byte (0xe7)
- **Offset 1 (1 byte):** Version number byte (currently 0x02), 0x01 is for Secure Boot V1.
- **Offset 2 (2 bytes):** Padding bytes, Reserved. Should be zero.
- **Offset 4 (32 bytes):** SHA-256 hash of only the image content, not including the signature block.
- **Offset 36 (384 bytes):** RSA Public Modulus used for signature verification. (value 'n' in RFC8017).
- **Offset 420 (4 bytes):** RSA Public Exponent used for signature verification (value 'e' in RFC8017).
- **Offset 424 (384 bytes):** Precalculated R, derived from 'n'.
- **Offset 808 (4 bytes):** Precalculated M', derived from 'n'
- **Offset 812 (384 bytes):** RSA-PSS Signature result (section 8.1.1 of RFC8017) of image content, computed using following PSS parameters: SHA256 hash, MFG1 function, 0 length salt, default trailer field (0xBC).
- **Offset 1196:** CRC32 of the preceding 1095 bytes.
- **Offset 1200 (16 bytes):** Zero padding to length 1216 bytes.

Note: R and M' are used for hardware-assisted Montgomery Multiplication.

The remainder of the signature sector is erased flash (0xFF) which allows writing other signature blocks after previous signature block.

4.22.5 Verifying the signature Block

A signature block is “valid” if the first byte is 0xe7 and a valid CRC32 is stored at offset 1196.

Upto 3 signature blocks can be appended to the bootloader or application image in ESP32-C3.

An image is “verified” if the public key stored in any signature block is valid for this device, and if the stored signature is valid for the image data read from flash.

1. The magic byte, signature block CRC is validated.
 2. Public key digests are generated per signature block and compared with the digests from eFuse. If none of the digests match, the verification process is aborted.
 3. The application image digest is generated and matched with the image digest in the signature blocks. The verification process is aborted if the digests don't match.
 4. The public key is used to verify the signature of the bootloader image, using RSA-PSS (section 8.1.2 of RFC8017) with the image digest calculated in step (3) for comparison.
- The application signing scheme is set to RSA for Secure Boot V2 and to ECDSA for Secure Boot V1.

Important: It is recommended to use Secure Boot V2 on the chip versions supporting them.

4.22.6 Bootloader Size

Enabling Secure boot and/or flash encryption will increase the size of bootloader, which might require updating partition table offset. See [secure-boot-bootloader-size](#).

4.22.7 eFuse usage

- `SECURE_BOOT_EN` - Enables secure boot protection on boot.
- `KEY_PURPOSE_X` - Set the purpose of the key block on ESP32-C3 by programming `SECURE_BOOT_DIGESTX` ($X = 0, 1, 2$) into `KEY_PURPOSE_X` ($X = 0, 1, 2, 3, 4, 5$). Example: If `KEY_PURPOSE_2` is set to `SECURE_BOOT_DIGEST1`, then `BLOCK_KEY2` will have the Secure Boot V2 public key digest. The write-protection bit must be set (this field does not have a read-protection bit).
- `BLOCK_KEYX` - The block contains the data corresponding to its purpose programmed in `KEY_PURPOSE_X`. Stores the SHA-256 digest of the public key. SHA-256 hash of public key modulus, exponent, precalculated R & M' values (represented as 776 bytes –offsets 36 to 812 - as per the [Signature Block Format](#)) is written to an eFuse key block. The write-protection bit must be set, but the read-protection bit must not.
- `KEY_REVOKEX` - The revocation bits corresponding to each of the 3 key block. Ex. Setting `KEY_REVOKE2` revokes the key block whose key purpose is `SECURE_BOOT_DIGEST2`.
- `SECURE_BOOT_AGGRESSIVE_REVOKE` - Enables aggressive revocation of keys. The key is revoked as soon as verification with this key fails.

The key(s) must be readable in order to give software access to it. If the key(s) is read-protected then the software reads the key(s) as all zeros and the signature verification process occurs with error, bootloader and app can not be run.

4.22.8 How To Enable Secure Boot V2

1. Open the [Project Configuration Menu](#), in “Security features” set “Enable hardware Secure Boot in bootloader” to enable Secure Boot.
2. The “Secure Boot V2” option will be selected and the “App Signing Scheme” would be set to RSA by default.
3. Specify the path to secure boot signing key, relative to the project directory.

4. Select the desired UART ROM download mode in “UART ROM download mode” . By default, it is set to “Permanently switch to Secure mode” which is generally recommended. For production devices, the most secure option is to set it to “Permanently disabled” .
5. Set other menuconfig options (as desired). Pay particular attention to the “Bootloader Config” options, as you can only flash the bootloader once. Then exit menuconfig and save your configuration.
6. The first time you run `make` or `idf.py build`, if the signing key is not found then an error message will be printed with a command to generate a signing key via `espsecure.py generate_signing_key`.

Important: A signing key generated this way will use the best random number source available to the OS and its Python installation (`/dev/urandom` on OSX/Linux and `CryptGenRandom()` on Windows). If this random number source is weak, then the private key will be weak.

Important: For production environments, we recommend generating the keypair using openssl or another industry standard encryption program. See [Generating Secure Boot Signing Key](#) for more details.

7. Run `idf.py bootloader` to build a secure boot enabled bootloader. The build output will include a prompt for a flashing command, using `esptool.py write_flash`.
8. When you’re ready to flash the bootloader, run the specified command (you have to enter it yourself, this step is not performed by the build system) and then wait for flashing to complete.
9. Run `idf.py flash` to build and flash the partition table and the just-built app image. The app image will be signed using the signing key you generated in step 4.

Note: `idf.py flash` doesn’t flash the bootloader if secure boot is enabled.

10. Reset the ESP32-C3 and it will boot the software bootloader you flashed. The software bootloader will enable secure boot on the chip, and then it verifies the app image signature and boots the app. You should watch the serial console output from the ESP32-C3 to verify that secure boot is enabled and no errors have occurred due to the build configuration.

Note: Secure boot won’t be enabled until after a valid partition table and app image have been flashed. This is to prevent accidents before the system is fully configured.

Note: If the ESP32-C3 is reset or powered down during the first boot, it will start the process again on the next boot.

11. On subsequent boots, the secure boot hardware will verify the software bootloader has not changed and the software bootloader will verify the signed app image (using the validated public key portion of its appended signature block).

4.22.9 Restrictions after Secure Boot is enabled

- Any updated bootloader or app will need to be signed with a key matching the digest already stored in efuse.
- After Secure Boot is enabled, no further efuses can be read protected. (If [Flash Encryption](#) is enabled then the bootloader will ensure that any flash encryption key generated on first boot will already be read protected.) If [CONFIG_SECURE_BOOT_INSECURE](#) is enabled then this behaviour can be disabled, but this is not recommended.

4.22.10 Generating Secure Boot Signing Key

The build system will prompt you with a command to generate a new signing key via `espsecure.py generate_signing_key`. The `--version 2` parameter will generate the RSA 3072 private key for Secure Boot V2.

The strength of the signing key is proportional to (a) the random number source of the system, and (b) the correctness of the algorithm used. For production devices, we recommend generating signing keys from a system with a quality entropy source, and using the best available RSA key generation utilities.

For example, to generate a signing key using the `openssl` command line:

```
openssl genrsa -out my_secure_boot_signing_key.pem 3072`
```

Remember that the strength of the secure boot system depends on keeping the signing key private.

4.22.11 Remote Signing of Images

For production builds, it can be good practice to use a remote signing server rather than have the signing key on the build machine (which is the default `esp-idf` secure boot configuration). The `espsecure.py` command line program can be used to sign app images & partition table data for secure boot, on a remote system.

To use remote signing, disable the option “Sign binaries during build”. The private signing key does not need to be present on the build system.

After the app image and partition table are built, the build system will print signing steps using `espsecure.py`:

```
espsecure.py sign_data --version 2 --keyfile PRIVATE_SIGNING_KEY BINARY_FILE
```

The above command appends the image signature to the existing binary. You can use the `--output` argument to write the signed binary to a separate file:

```
espsecure.py sign_data --version 2 --keyfile PRIVATE_SIGNING_KEY --output SIGNED_
↪BINARY_FILE BINARY_FILE
```

4.22.12 Secure Boot Best Practices

- Generate the signing key on a system with a quality source of entropy.
- Keep the signing key private at all times. A leak of this key will compromise the secure boot system.
- Do not allow any third party to observe any aspects of the key generation or signing process using `espsecure.py`. Both processes are vulnerable to timing or other side-channel attacks.
- Enable all secure boot options in the Secure Boot Configuration. These include flash encryption, disabling of JTAG, disabling BASIC ROM interpreter, and disabling the UART bootloader encrypted flash access.
- Use secure boot in combination with *flash encryption* to prevent local readout of the flash contents.

4.22.13 Key Management

- Between 1 and 3 RSA-3072 public keypairs (Keys #0, #1, #2) should be computed independently and stored separately.
- The `KEY_DIGEST` efuses should be write protected after being programmed.
- The unused `KEY_DIGEST` slots must have their corresponding `KEY_REVOKE` efuse burned to permanently disable them. This must happen before the device leaves the factory.
- The eFuses can either be written by the software bootloader during first boot after enabling “Secure Boot V2” from `menuconfig` or can be done using `espefuse.py` which communicates with the serial bootloader program in ROM.
- The `KEY_DIGEST`s should be numbered sequentially beginning at key digest #0. (ie if key digest #1 is used, key digest #0 should be used. If key digest #2 is used, key digest #0 & #1 must be used.)
- The software bootloader (non OTA upgradeable) is signed using at least one, possibly all three, private keys and flashed in the factory.

- Apps should only be signed with a single private key (the others being stored securely elsewhere), however they may be signed with multiple private keys if some are being revoked (see Key Revocation, below).

4.22.14 Multiple Keys

- The bootloader should be signed with all the private key(s) that are needed for the life of the device, before it is flashed.
- The build system can sign with at most one private key, user has to run manual commands to append more signatures if necessary.
- **You can use the append functionality of `espsecure.py`, this command would also printed at the end of the Secure B**
`espsecure.py sign_data -k secure_boot_signing_key2.pem -v 2 --append_signatures -o signed_bootloader.bin build/bootloader/bootloader.bin`
- While signing with multiple private keys, it is recommended that the private keys be signed independently, if possible on different servers and stored separately.
- **You can check the signatures attached to a binary using** - `espsecure.py signature_info_v2 datafile.bin`

4.22.15 Key Revocation

- Keys are processed in a linear order. (key #0, key #1, key #2).
- Applications should be signed with only one key at a time, to minimise the exposure of unused private keys.
- The bootloader can be signed with multiple keys from the factory.

Conservative approach:

Assuming a trusted private key (N-1) has been compromised, to update to new key pair (N).

1. Server sends an OTA update with an application signed with the new private key (#N).
 2. The new OTA update is written to an unused OTA app partition.
 3. The new application's signature block is validated. The public keys are checked against the digests programmed in the eFuse & the application is verified using the verified public key.
 4. The active partition is set to the new OTA application's partition.
 5. Device resets, loads the bootloader (verified with key #N-1) which then boots new app (verified with key #N).
 6. The new app verifies bootloader with key #N (as a final check) and then runs code to revoke key #N-1 (sets KEY_REVOKE efuse bit).
 7. The API `esp_ota_revoke_secure_boot_public_key()` can be used to revoke the key #N-1.
- A similar approach can also be used to physically reflash with a new key. For physical reflashing, the bootloader content can also be changed at the same time.

Aggressive approach:

ROM code has an additional feature of revoking a public key digest if the signature verification fails.

To enable this feature, you need to burn `SECURE_BOOT_AGGRESSIVE_REVOKE` efuse or enable `CONFIG_SECURE_BOOT_ENABLE_AGGRESSIVE_KEY_REVOKE`

Key revocation is not applicable unless secure boot is successfully enabled. Also, a key is not revoked in case of invalid signature block or invalid image digest, it is only revoked in case the signature verification fails, i.e. revoke key only if failure in step 4 of [Verifying the signature Block](#)

Once a key is revoked, it can never be used for verifying a signature of an image. This feature provides strong resistance against physical attacks on the device. However, this could also brick the device permanently if all the keys are revoked because of signature verification failure.

4.22.16 Technical Details

The following sections contain low-level reference descriptions of various secure boot elements:

Manual Commands

Secure boot is integrated into the esp-idf build system, so `make` or `idf.py build` will sign an app image and `idf.py bootloader` will produce a signed bootloader if secure signed binaries on build is enabled.

However, it is possible to use the `espsecure.py` tool to make standalone signatures and digests.

To sign a binary image:

```
espsecure.py sign_data --version 2 --keyfile ./my_signing_key.pem --output ./image_
↳signed.bin image-unsigned.bin
```

Keyfile is the PEM file containing an RSA-3072 private signing key.

4.22.17 Secure Boot & Flash Encryption

If secure boot is used without *Flash Encryption*, it is possible to launch “time-of-check to time-of-use” attack, where flash contents are swapped after the image is verified and running. Therefore, it is recommended to use both the features together.

4.22.18 Signed App Verification Without Hardware Secure Boot

The Secure Boot V2 signature of apps can be checked on OTA update, without enabling the hardware secure boot option. This option uses the same app signature scheme as Secure Boot V2, but unlike hardware secure boot it does not prevent an attacker who can write to flash from bypassing the signature protection.

This may be desirable in cases where the delay of Secure Boot verification on startup is unacceptable, and/or where the threat model does not include physical access or attackers writing to bootloader or app partitions in flash.

In this mode, the public key which is present in the signature block of the currently running app will be used to verify the signature of a newly updated app. (The signature on the running app isn't verified during the update process, it's assumed to be valid.) In this way the system creates a chain of trust from the running app to the newly updated app.

For this reason, it's essential that the initial app flashed to the device is also signed. A check is run on app startup and the app will abort if no signatures are found. This is to try and prevent a situation where no update is possible. The app should have only one valid signature block in the first position. Note again that, unlike hardware Secure Boot V2, the signature of the running app isn't verified on boot. The system only verifies a signature block in the first position and ignores any other appended signatures.

only:: not esp32

Although multiple trusted keys are supported when using hardware Secure Boot, only the first public key in the signature block is used to verify updates if signature checking without Secure Boot is configured. If multiple trusted public keys are required, it's necessary to enable the full Secure Boot feature instead.

Note: In general, it's recommended to use full hardware Secure Boot unless certain that this option is sufficient for application security needs.

How To Enable Signed App Verification

1. Open *Project Configuration Menu* -> Security features
2. Ensure *App Signing Scheme* is *RSA*
3. Enable *CONFIG_SECURE_SIGNED_APPS_NO_SECURE_BOOT*
4. By default, “Sign binaries during build” will be enabled on selecting “Require signed app images” option, which will sign binary files as a part of build process. The file named in “Secure boot private signing key” will be used to sign the image.

5. If you disable “Sign binaries during build” option then all app binaries must be manually signed by following instructions in *Remote Signing of Images*.

Warning: It is very important that all apps flashed have been signed, either during the build or after the build.

4.22.19 Advanced Features

JTAG Debugging

By default, when Secure Boot is enabled then JTAG debugging is disabled via eFuse. The bootloader does this on first boot, at the same time it enables Secure Boot.

See *JTAG with Flash Encryption or Secure Boot* for more information about using JTAG Debugging with either Secure Boot or signed app verification enabled.

4.23 Thread Local Storage

4.23.1 Overview

Thread-local storage (TLS) is a mechanism by which variables are allocated such that there is one instance of the variable per extant thread. ESP-IDF provides three ways to make use of such variables:

- *FreeRTOS Native API*: ESP-IDF FreeRTOS native API.
- *Pthread API*: ESP-IDF's pthread API.
- *C11 Standard*: C11 standard introduces special keyword to declare variables as thread local.

4.23.2 FreeRTOS Native API

The ESP-IDF FreeRTOS provides the following API to manage thread local variables:

- `vTaskSetThreadLocalStoragePointer()`
- `pvTaskGetThreadLocalStoragePointer()`
- `vTaskSetThreadLocalStoragePointerAndDelCallback()`

In this case maximum number of variables that can be allocated is limited by `configNUM_THREAD_LOCAL_STORAGE_POINTERS` macro. Variables are kept in the task control block (TCB) and accessed by their index. Note that index 0 is reserved for ESP-IDF internal uses. Using that API user can allocate thread local variables of an arbitrary size and assign them to any number of tasks. Different tasks can have different sets of TLS variables. If size of the variable is more than 4 bytes then user is responsible for allocating/deallocating memory for it. Variable's deallocation is initiated by FreeRTOS when task is deleted, but user must provide function (callback) to do proper cleanup.

4.23.3 Pthread API

The ESP-IDF provides the following pthread API to manage thread local variables:

- `pthread_key_create()`
- `pthread_key_delete()`
- `pthread_getspecific()`
- `pthread_setspecific()`

This API has all benefits of the one above, but eliminates some its limits. The number of variables is limited only by size of available memory on the heap. Due to the dynamic nature this API introduces additional performance overhead compared to the native one.

4.23.4 C11 Standard

The ESP-IDF FreeRTOS supports thread local variables according to C11 standard (ones specified with `__thread` keyword). For details on this GCC feature please see <https://gcc.gnu.org/onlinedocs/gcc-5.5.0/gcc/Thread-Local.html#Thread-Local>. Storage for that kind of variables is allocated on the task's stack. Note that area for all such variables in the program will be allocated on the stack of every task in the system even if that task does not use such variables at all. For example ESP-IDF system tasks (like `ipc`, `timer` tasks etc.) will also have that extra stack space allocated. So this feature should be used with care. There is a tradeoff: C11 thread local variables are quite handy to use in programming and can be accessed using just a few Xtensa instructions, but this benefit goes with the cost of additional stack usage for all tasks in the system. Due to static nature of variables allocation all tasks in the system have the same sets of C11 thread local variables.

4.24 Tools

4.24.1 Downloadable Tools

ESP-IDF build process relies on a number of tools: cross-compiler toolchains, CMake build system, and others.

Installing the tools using an OS-specific package manager (like `apt`, `yum`, `brew`, etc.) is the preferred method when the required version of the tool is available. This recommendation is reflected in the *Getting Started* guide. For example, on Linux and macOS it is recommended to install CMake using an OS package manager.

However, some of the tools are IDF-specific and are not available in OS package repositories. Furthermore, different versions of ESP-IDF require different versions of the tools to operate correctly. To solve these two problems, ESP-IDF provides a set of scripts for downloading and installing the correct versions of tools, and exposing them in the environment.

The rest of the document refers to these downloadable tools simply as “tools”. Other kinds of tools used in ESP-IDF are:

- Python scripts bundled with ESP-IDF (such as `idf.py`)
- Python packages installed from PyPI.

The following sections explain the installation method, and provide the list of tools installed on each platform.

Note: This document is provided for advanced users who need to customize their installation, users who wish to understand the installation process, and ESP-IDF developers.

If you are looking for instructions on how to install the tools, see the *Getting Started Guide*.

Tools metadata file

The list of tools and tool versions required for each platform is located in [tools/tools.json](#). The schema of this file is defined by [tools/tools_schema.json](#).

This file is used by [tools/idf_tools.py](#) script when installing the tools or setting up the environment variables.

Tools installation directory

`IDF_TOOLS_PATH` environment variable specifies the location where the tools are to be downloaded and installed. If not set, `IDF_TOOLS_PATH` defaults to `HOME/.espressif` on Linux and macOS, and `%USER_PROFILE%\espressif` on Windows.

Inside `IDF_TOOLS_PATH`, the scripts performing tools installation create the following directories:

- `dist` —where the archives of the tools are downloaded.
- `tools` —where the tools are extracted. The tools are extracted into subdirectories: `tools/TOOL_NAME/VERSION/`. This arrangement allows different versions of tools to be installed side by side.

GitHub Assets Mirror

Most of the tools downloaded by the tools installer are GitHub Release Assets, which are files attached to a software release on GitHub.

If GitHub downloads are inaccessible or slow to access, it's possible to configure a GitHub assets mirror.

To use Espressif's download server, set the environment variable `IDF_GITHUB_ASSETS` to `dl.espressif.com/github_assets`. When the install process is downloading a tool from `github.com`, the URL will be rewritten to use this server instead.

Any mirror server can be used provided the URL matches the `github.com` download URL format: the install process will replace `https://github.com` with `https://${IDF_GITHUB_ASSETS}` for any GitHub asset URL that it downloads.

Note: The Espressif download server doesn't currently mirror everything from GitHub, it only mirrors files attached as Assets to some releases as well as source archives for some releases.

idf_tools.py script

`tools/idf_tools.py` script bundled with ESP-IDF performs several functions:

- `install`: Download the tool into `${IDF_TOOLS_PATH}/dist` directory, extract it into `${IDF_TOOLS_PATH}/tools/TOOL_NAME/VERSION`. `install` command accepts the list of tools to install, in `TOOL_NAME` or `TOOL_NAME@VERSION` format. If `all` is given, all the tools (required and optional ones) are installed. If no argument or `required` is given, only the required tools are installed.
- `download`: Similar to `install` but doesn't extract the tools. An optional `--platform` argument may be used to download the tools for the specific platform.
- `export`: Lists the environment variables which need to be set to use the installed tools. For most of the tools, setting `PATH` environment variable is sufficient, but some tools require extra environment variables. The environment variables can be listed in either of `shell` or `key-value` formats, set by `--format` parameter:
 - `shell` produces output suitable for evaluation in the shell. For example,

```
export PATH="/home/user/.espressif/tools/tool/v1.0.0/bin:$PATH"
```

on Linux and macOS, and

```
set "PATH=C:\Users\user\.espressif\tools\v1.0.0\bin;%PATH%"
```

on Windows.

Note: Exporting environment variables in Powershell format is not supported at the moment. `key-value` format may be used instead.

The output of this command may be used to update the environment variables, if the shell supports this. For example:

```
eval `${IDF_PATH}/tools/idf_tools.py export`
```

- `key-value` produces output in `VARIABLE=VALUE` format, suitable for parsing by other scripts:

```
PATH=/home/user/.espressif/tools/tool/v1.0.0:$PATH
```

Note that the script consuming this output has to perform expansion of `$VAR` or `%VAR%` patterns found in the output.

- `list`: Lists the known versions of the tools, and indicates which ones are installed.
- `check`: For each tool, checks whether the tool is available in the system path and in `IDF_TOOLS_PATH`.

Install scripts

Shell-specific user-facing scripts are provided in the root of ESP-IDF repository to facilitate tools installation. These are:

- `install.bat` for Windows Command Prompt
- `install.ps1` for Powershell
- `install.sh` for Bash

Aside from downloading and installing the tools into `IDF_TOOLS_PATH`, these scripts prepare a Python virtual environment, and install the required packages into that environment.

Export scripts

Since the installed tools are not permanently added into the user or system `PATH` environment variable, an extra step is required to use them in the command line. The following scripts modify the environment variables in the current shell to make the correct versions of the tools available:

- `export.bat` for Windows Command Prompt
- `export.ps1` for Powershell
- `export.sh` for Bash

Note: To modify the shell environment in Bash, `export.sh` must be “sourced” : `./export.sh` (note the leading dot and space).

`export.sh` may be used with shells other than Bash (such as zsh). However in this case the `IDF_PATH` environment variable must be set before running the script. When used in Bash, the script will guess the `IDF_PATH` value from its own location.

In addition to calling `idf_tools.py`, these scripts list the directories which have been added to the `PATH`.

Other installation methods

Depending on the environment, more user-friendly wrappers for `idf_tools.py` are provided:

- *IDF Tools installer for Windows* can download and install the tools. Internally the installer uses `idf_tools.py`.
- *Eclipse plugin for ESP-IDF* includes a menu item to set up the tools. Internally the plugin calls `idf_tools.py`.
- Visual Studio Code extension for ESP-IDF includes an onboarding flow. This flow helps setting up the tools. Although the extension does not rely on `idf_tools.py`, the same installation method is used.

Custom installation

Although the methods above are recommended for ESP-IDF users, they are not a must for building ESP-IDF applications. ESP-IDF build system expects that all the necessary tools are installed somewhere, and made available in the `PATH`.

List of IDF Tools

xtensa-esp32-elf Toolchain for Xtensa (ESP32) based on GCC

License: [GPL-3.0-with-GCC-exception](#)

More info: <https://github.com/espressif/crosstool-NG>

Platform	Required	Download
linux-amd64	required	https://github.com/espressif/crostoool-NG/releases/download/esp-2021r2-patch3/xtensa-esp32-elf-gcc8_4_0-esp-2021r2-patch3-linux-amd64.tar.gz SHA256: 9edd1e77627688f435561922d14299f6a0021ba1f6ff67e472e1108695a69e53
linux-arm64	required	https://github.com/espressif/crostoool-NG/releases/download/esp-2021r2-patch3/xtensa-esp32-elf-gcc8_4_0-esp-2021r2-patch3-linux-arm64.tar.gz SHA256: 3a21a3e310e6b1e7d7bed1f3e59698a5bd29ed3a5ca79fba9265d7dd2f1e0cd2
linux-armel	required	https://github.com/espressif/crostoool-NG/releases/download/esp-2021r2-patch3/xtensa-esp32-elf-gcc8_4_0-esp-2021r2-patch3-linux-armel.tar.gz SHA256: 89313c4c1d8db1b01624f31b58bf3f5e527160569828ac4301e9daa75c52716d
linux-armhf	required	https://github.com/espressif/crostoool-NG/releases/download/esp-2021r2-patch3/xtensa-esp32-elf-gcc8_4_0-esp-2021r2-patch3-linux-armhf.tar.gz SHA256: ec07a9c75a0aa4b86496cacf2034154cd4a693b6f317c66a4a122c71fd04a518
linux-i686	required	https://github.com/espressif/crostoool-NG/releases/download/esp-2021r2-patch3/xtensa-esp32-elf-gcc8_4_0-esp-2021r2-patch3-linux-i686.tar.gz SHA256: a1f165a836f175daa6fbfde4ca99cb93b377f021fbfc41f79a700bd4df965a9a
macos	required	https://github.com/espressif/crostoool-NG/releases/download/esp-2021r2-patch3/xtensa-esp32-elf-gcc8_4_0-esp-2021r2-patch3-macos.tar.gz SHA256: dda3d7a43efd995d9a51d5a5741626dbf915df46078aef0b5aea7163ac82398b
win32	required	https://github.com/espressif/crostoool-NG/releases/download/esp-2021r2-patch3/xtensa-esp32-elf-gcc8_4_0-esp-2021r2-patch3-win32.zip SHA256: fd147592928ef2d7092ba34b01ecd776fe26ba3d7e3f9b6b215a3b46e981ee2c
win64	required	https://github.com/espressif/crostoool-NG/releases/download/esp-2021r2-patch3/xtensa-esp32-elf-gcc8_4_0-esp-2021r2-patch3-win64.zip SHA256: 9395315c07de0b9f05c9a6616ba1f05e76ab651053f2f40479163a8e03cfa830

xtensa-esp32s2-elf Toolchain for Xtensa (ESP32-S2) based on GCC

License: [GPL-3.0-with-GCC-exception](https://www.gnu.org/licenses/gpl-3.0.html)

More info: <https://github.com/espressif/crostoool-NG>

Platform	Required	Download
linux-amd64	required	https://github.com/espressif/crostoool-NG/releases/download/esp-2021r2-patch3/xtensa-esp32s2-elf-gcc8_4_0-esp-2021r2-patch3-linux-amd64.tar.gz SHA256: a32451a8edc1104b83cd9971178e61826e957d7db9ad9f81798a8969fd5a954e
linux-arm64	required	https://github.com/espressif/crostoool-NG/releases/download/esp-2021r2-patch3/xtensa-esp32s2-elf-gcc8_4_0-esp-2021r2-patch3-linux-arm64.tar.gz SHA256: 2ac2c94a533a99a091d2159c678c611c712c494b5f68d97913254712047260f9
linux-armel	required	https://github.com/espressif/crostoool-NG/releases/download/esp-2021r2-patch3/xtensa-esp32s2-elf-gcc8_4_0-esp-2021r2-patch3-linux-armel.tar.gz SHA256: da49afee1e2e03eaab3f492718789442d33b562800e2a892679f95b50be24d14
linux-armhf	required	https://github.com/espressif/crostoool-NG/releases/download/esp-2021r2-patch3/xtensa-esp32s2-elf-gcc8_4_0-esp-2021r2-patch3-linux-armhf.tar.gz SHA256: f2b9b89522f28547c8725a54c4e57e8a35dac56edc26aa8cd607c87a050249ac
linux-i686	required	https://github.com/espressif/crostoool-NG/releases/download/esp-2021r2-patch3/xtensa-esp32s2-elf-gcc8_4_0-esp-2021r2-patch3-linux-i686.tar.gz SHA256: 36d3c4990a5feb68aa8534463bc9e8ee367fe23886f78e1d726f4411c7571462
macos	required	https://github.com/espressif/crostoool-NG/releases/download/esp-2021r2-patch3/xtensa-esp32s2-elf-gcc8_4_0-esp-2021r2-patch3-macos.tar.gz SHA256: de9af641678c93775e932ee5ec4f478f8925cfc1ebc22e41adc4fb85430a0c35
win32	required	https://github.com/espressif/crostoool-NG/releases/download/esp-2021r2-patch3/xtensa-esp32s2-elf-gcc8_4_0-esp-2021r2-patch3-win32.zip SHA256: ccf08afe60046f87b0e81ca17dc5073eda68ab5e7522c163dd5b583d713b7b39
win64	required	https://github.com/espressif/crostoool-NG/releases/download/esp-2021r2-patch3/xtensa-esp32s2-elf-gcc8_4_0-esp-2021r2-patch3-win64.zip SHA256: 37c91490b8fc75e638c23785e261eaf553be2dcd106cf6cff5b76981fa02955b

xtensa-esp32s3-elf Toolchain for Xtensa (ESP32-S3) based on GCC

License: [GPL-3.0-with-GCC-exception](#)

More info: <https://github.com/espressif/crosstool-NG>

Platform	Required	Download
linux-amd64	required	https://github.com/espressif/crosstool-NG/releases/download/esp-2021r2-patch3/xtensa-esp32s3-elf-gcc8_4_0-esp-2021r2-patch3-linux-amd64.tar.gz SHA256: 59b271d014ff3915b6db1b43b610a45eea15fe5d6877d12cae8a191cc996ed37
linux-arm64	required	https://github.com/espressif/crosstool-NG/releases/download/esp-2021r2-patch3/xtensa-esp32s3-elf-gcc8_4_0-esp-2021r2-patch3-linux-arm64.tar.gz SHA256: 7051b32483e61f98606d71c98e372929428a5165df791dcd5830ed9517763152
linux-armel	required	https://github.com/espressif/crosstool-NG/releases/download/esp-2021r2-patch3/xtensa-esp32s3-elf-gcc8_4_0-esp-2021r2-patch3-linux-armel.tar.gz SHA256: 48c8dbbf96ecc691a812327dc580042d9718fe989e60c2111ebfd692ac710081
linux-armhf	required	https://github.com/espressif/crosstool-NG/releases/download/esp-2021r2-patch3/xtensa-esp32s3-elf-gcc8_4_0-esp-2021r2-patch3-linux-armhf.tar.gz SHA256: efc037db5b3565d907c611ef9d17f156080949c0382feeaec86ed7b54d9fa2ae
linux-i686	required	https://github.com/espressif/crosstool-NG/releases/download/esp-2021r2-patch3/xtensa-esp32s3-elf-gcc8_4_0-esp-2021r2-patch3-linux-i686.tar.gz SHA256: 552dca3f4302ab7ca88a934b0391200198c9d10a4d8ac413fe604cbf8601f950
macos	required	https://github.com/espressif/crosstool-NG/releases/download/esp-2021r2-patch3/xtensa-esp32s3-elf-gcc8_4_0-esp-2021r2-patch3-macos.tar.gz SHA256: e5af78f05d3af07617805d06ebb45ff2fe9b6aed6970a84c35eea28a5d8d5e53
win32	required	https://github.com/espressif/crosstool-NG/releases/download/esp-2021r2-patch3/xtensa-esp32s3-elf-gcc8_4_0-esp-2021r2-patch3-win32.zip SHA256: 1b70163acccc5655449de1d149427a54f384156bd35816ec60c422d76d033f05
win64	required	https://github.com/espressif/crosstool-NG/releases/download/esp-2021r2-patch3/xtensa-esp32s3-elf-gcc8_4_0-esp-2021r2-patch3-win64.zip SHA256: 58e58575d1938879fd51e822181e54bcb343aa846eb3fca8f616c2cde7bd0041

riscv32-esp-elf Toolchain for 32-bit RISC-V based on GCC

License: [GPL-3.0-with-GCC-exception](#)

More info: <https://github.com/espressif/crosstool-NG>

Platform	Required	Download
linux-amd64	required	https://github.com/espressif/crosstool-NG/releases/download/esp-2021r2-patch3/riscv32-esp-elf-gcc8_4_0-esp-2021r2-patch3-linux-amd64.tar.gz SHA256: 179cbad579790ad35e0f414a18d90017c0f158c397022411a8e9867db2174f15
linux-arm64	required	https://github.com/espressif/crosstool-NG/releases/download/esp-2021r2-patch3/riscv32-esp-elf-gcc8_4_0-esp-2021r2-patch3-linux-arm64.tar.gz SHA256: fb339d476c79c76db8f903b265cab6bb6950d5ed954dec644445252d3378023c
linux-armel	required	https://github.com/espressif/crosstool-NG/releases/download/esp-2021r2-patch3/riscv32-esp-elf-gcc8_4_0-esp-2021r2-patch3-linux-armel.tar.gz SHA256: 51a6296d8334b7452dba44b2b62e87afd7fd1c74bafa1aa29b1f4ab72cb9e5e0
linux-armhf	required	https://github.com/espressif/crosstool-NG/releases/download/esp-2021r2-patch3/riscv32-esp-elf-gcc8_4_0-esp-2021r2-patch3-linux-armhf.tar.gz SHA256: faa723e2fe84154ea8081ef204d9db51c5b7e5702497dff4f3b33e250e42f776
linux-i686	required	https://github.com/espressif/crosstool-NG/releases/download/esp-2021r2-patch3/riscv32-esp-elf-gcc8_4_0-esp-2021r2-patch3-linux-i686.tar.gz SHA256: fef60f7ef37ffaa50416d8f244cdbc710d6729dae41ef06c4ec0e50a1f3b7dd7
macos	required	https://github.com/espressif/crosstool-NG/releases/download/esp-2021r2-patch3/riscv32-esp-elf-gcc8_4_0-esp-2021r2-patch3-macos.tar.gz SHA256: 4aacc1742a76349d790b1ac8e9e9d963daefda5346dbd6741cfe8e7a35a44e4e
win32	required	https://github.com/espressif/crosstool-NG/releases/download/esp-2021r2-patch3/riscv32-esp-elf-gcc8_4_0-esp-2021r2-patch3-win32.zip SHA256: eb2a442d7f551eb842995ec372ec4b364314ca2d7aae779399a74972f7d6bc
win64	required	https://github.com/espressif/crosstool-NG/releases/download/esp-2021r2-patch3/riscv32-esp-elf-gcc8_4_0-esp-2021r2-patch3-win64.zip SHA256: f5607e5187317d521f0474cade83f8eb590f2d165d95c3779b6ce11fbac21d1f

esp32ulp-elf Toolchain for ESP32 ULP coprocessor

License: [GPL-2.0-or-later](#)

More info: <https://github.com/espressif/binutils-esp32ulp>

Platform	Required	Download
linux-amd64	required	https://github.com/espressif/binutils-esp32ulp/releases/download/v2.28.51-esp-20191205/binutils-esp32ulp-linux-amd64-2.28.51-esp-20191205.tar.gz SHA256: 3016c4fc551181175bd9979869bc1d1f28fa8efa25a0e29ad7f833fca4bc03d7
linux-armel	required	https://github.com/espressif/binutils-esp32ulp/releases/download/v2.28.51-esp-20191205/binutils-esp32ulp-linux-armel-2.28.51-esp-20191205.tar.gz SHA256: 88967c086a6e71834282d9ae05841ee74dae1815f27807b25cdd3f7775a47101
macos	required	https://github.com/espressif/binutils-esp32ulp/releases/download/v2.28.51-esp-20191205/binutils-esp32ulp-macos-2.28.51-esp-20191205.tar.gz SHA256: a35d9e7a0445247c7fc9dccc3fbc35682f0fafc28beeb10c94b59466317190c4
win32	required	https://github.com/espressif/binutils-esp32ulp/releases/download/v2.28.51-esp-20191205/binutils-esp32ulp-win32-2.28.51-esp-20191205.zip SHA256: bade309353a9f0a4e5cc03bfe84845e33205f05502c4b199195e871ded271ab5
win64	required	https://github.com/espressif/binutils-esp32ulp/releases/download/v2.28.51-esp-20191205/binutils-esp32ulp-win32-2.28.51-esp-20191205.zip SHA256: bade309353a9f0a4e5cc03bfe84845e33205f05502c4b199195e871ded271ab5

esp32s2ulp-elf Toolchain for ESP32-S2 ULP coprocessor

License: [GPL-2.0-or-later](#)

More info: <https://github.com/espressif/binutils-esp32ulp>

Platform	Required	Download
linux-amd64	required	https://github.com/espressif/binutils-esp32ulp/releases/download/v2.28.51-esp-20191205/binutils-esp32s2ulp-linux-amd64-2.28.51-esp-20191205.tar.gz SHA256: df7b2ff6c7c718a7cbe3b4b6dbcd68180d835d164d1913bc4698fd3781b9a466
linux-armel	required	https://github.com/espressif/binutils-esp32ulp/releases/download/v2.28.51-esp-20191205/binutils-esp32s2ulp-linux-armel-2.28.51-esp-20191205.tar.gz SHA256: 893b213c8f716d455a6efb2b08b6cf1bc34d08b78ee19c31e82ac44b1b45417e
macos	required	https://github.com/espressif/binutils-esp32ulp/releases/download/v2.28.51-esp-20191205/binutils-esp32s2ulp-macos-2.28.51-esp-20191205.tar.gz SHA256: 5a9bb678a5246638cbda303f523d9bb8121a9a24dc01ecb22c21c46c41184155
win32	required	https://github.com/espressif/binutils-esp32ulp/releases/download/v2.28.51-esp-20191205/binutils-esp32s2ulp-win32-2.28.51-esp-20191205.zip SHA256: 587de59fbb469a39f96168ae3eaa9f06b2601e6e0543c87eaf1bd97f23e5c4ca
win64	required	https://github.com/espressif/binutils-esp32ulp/releases/download/v2.28.51-esp-20191205/binutils-esp32s2ulp-win32-2.28.51-esp-20191205.zip SHA256: 587de59fbb469a39f96168ae3eaa9f06b2601e6e0543c87eaf1bd97f23e5c4ca

cmake CMake build system

On Linux and macOS, it is recommended to install CMake using the OS-specific package manager (like apt, yum, brew, etc.). However, for convenience it is possible to install CMake using idf_tools.py along with the other tools.

License: [BSD-3-Clause](#)

More info: <https://github.com/Kitware/CMake>

Platform	Required	Download
linux-amd64	optional	https://github.com/Kitware/CMake/releases/download/v3.16.4/cmake-3.16.4-Linux-x86_64.tar.gz SHA256: 12a577aa04b6639766ae908f33cf70baefc11ac4499b8b1c8812d99f05fb6a02
linux-armel	optional	https://dl.espressif.com/dl/cmake/cmake-3.20.3-Linux-armv7l.tar.gz SHA256: f8bd050c2745f0dcc4b7cef9738bbfef775950a10f5bd377abb0062835e669dc
macos	optional	https://github.com/Kitware/CMake/releases/download/v3.16.4/cmake-3.16.4-Darwin-x86_64.tar.gz SHA256: f60e0ef96da48725cd8da7d6abe83cd9501167aa51625c90dd4d31081a631279
win32	required	https://github.com/Kitware/CMake/releases/download/v3.16.4/cmake-3.16.4-win64-x64.zip SHA256: f37963bcfcebdf5864926a3623f6c21220c35790c39cd65e64bd521cbb39c55
win64	required	https://github.com/Kitware/CMake/releases/download/v3.16.4/cmake-3.16.4-win64-x64.zip SHA256: f37963bcfcebdf5864926a3623f6c21220c35790c39cd65e64bd521cbb39c55

openocd-esp32 OpenOCD for ESP32

License: [GPL-2.0-only](#)

More info: <https://github.com/espressif/openocd-esp32>

Platform	Required	Download
linux-amd64	required	https://github.com/espressif/openocd-esp32/releases/download/v0.11.0-esp32-20220706/openocd-esp32-linux-amd64-0.11.0-esp32-20220706.tar.gz SHA256: 26f1f18dd93eb70a13203848d3fb1cc2e0de1fd6749c7dd771b2de8709735aed
linux-arm64	required	https://github.com/espressif/openocd-esp32/releases/download/v0.11.0-esp32-20220706/openocd-esp32-linux-arm64-0.11.0-esp32-20220706.tar.gz SHA256: f97792bc2852937ec0acbb9f0eb2e49926c0f747a71f101a4e34aed75d2c6fcc
linux-armel	required	https://github.com/espressif/openocd-esp32/releases/download/v0.11.0-esp32-20220706/openocd-esp32-linux-armel-0.11.0-esp32-20220706.tar.gz SHA256: 27e4c628994cf342e7fc5b07f49ca5533ba892fd8a150683a382a08758c3dfbe
linux-armhf	required	https://github.com/espressif/openocd-esp32/releases/download/v0.11.0-esp32-20220706/openocd-esp32-linux-armhf-0.11.0-esp32-20220706.tar.gz SHA256: 7f3b57332104e8b8e6194553365a70a9d3754878cfc063d5dc5d839513a63de9
macos	required	https://github.com/espressif/openocd-esp32/releases/download/v0.11.0-esp32-20220706/openocd-esp32-macos-0.11.0-esp32-20220706.tar.gz SHA256: 333ee2ec3c9b5dc6ad4509faae55335cdea7f8bf83a56bfcf5327e4497c8538a
win32	required	https://github.com/espressif/openocd-esp32/releases/download/v0.11.0-esp32-20220706/openocd-esp32-win32-0.11.0-esp32-20220706.zip SHA256: c3d39eb4365a9947e71f1d3780ce031185bc6437f21186568a5c05f23f57a8d0
win64	required	https://github.com/espressif/openocd-esp32/releases/download/v0.11.0-esp32-20220706/openocd-esp32-win32-0.11.0-esp32-20220706.zip SHA256: c3d39eb4365a9947e71f1d3780ce031185bc6437f21186568a5c05f23f57a8d0

ninja Ninja build system

On Linux and macOS, it is recommended to install ninja using the OS-specific package manager (like apt, yum, brew, etc.). However, for convenience it is possible to install ninja using idf_tools.py along with the other tools.

License: [Apache-2.0](#)

More info: <https://github.com/ninja-build/ninja>

Platform	Required	Download
linux-amd64	optional	https://dl.espressif.com/dl/ninja-1.10.2-linux64.tar.gz SHA256: 32bb769de4d57aa7ee0e292cfcb7553e7cc8ea0961f7aa2b3aee60aa407c4033
macos	optional	https://dl.espressif.com/dl/ninja-1.10.2-osx.tar.gz SHA256: 847bb1ca4bc16d8dba6aed3ecb5055498b86bc68c364c37583eb5738bb440f1
win64	required	https://dl.espressif.com/dl/ninja-1.10.2-win64.zip SHA256: bbde850d247d2737c5764c927d1071cbb1f1957dcabda4a130fa8547c12c695f

idf-exe IDF wrapper tool for Windows

License: [Apache-2.0](#)

More info: tools/windows/idf_exe

Platform	Required	Download
win32	required	https://dl.espressif.com/dl/idf-exe-v1.0.1.zip SHA256: 53eb6aaaf034cc7ed1a97d5c577afa0f99815b7793905e9408e74012d357d04a
win64	required	https://dl.espressif.com/dl/idf-exe-v1.0.1.zip SHA256: 53eb6aaaf034cc7ed1a97d5c577afa0f99815b7793905e9408e74012d357d04a

ccache Ccache (compiler cache)

License: [GPL-3.0-or-later](#)

More info: <https://github.com/ccache/ccache>

Platform	Required	Download
win64	required	https://dl.espressif.com/dl/ccache-3.7-w64.zip SHA256: 37e833f3f354f1145503533e776c1bd44ec2e77ff8a2476a1d2039b0b10c78d6

dfu-util dfu-util (Device Firmware Upgrade Utilities)

License: [GPL-2.0-only](#)

More info: <http://dfu-util.sourceforge.net/>

Platform	Required	Download
win64	required	https://dl.espressif.com/dl/dfu-util-0.9-win64.zip SHA256: 5816d7ec68ef3ac07b5ac9fb9837c57d2efe45b6a80a2f2bbe6b40b1c15c470e

4.24.2 IDF Docker Image

IDF Docker image (`espressif/idf`) is intended for building applications and libraries with specific versions of ESP-IDF, when doing automated builds.

The image contains:

- Common utilities such as `git`, `wget`, `curl`, `zip`.
- Python 3.6 or newer.
- A copy of a specific version of ESP-IDF (see below for information about versions). `IDF_PATH` environment variable is set, and points to ESP-IDF location in the container.
- All the build tools required for the specific version of ESP-IDF: `CMake`, `make`, `ninja`, cross-compiler toolchains, etc.
- All Python packages required by ESP-IDF are installed in a virtual environment.

The image entrypoint sets up `PATH` environment variable to point to the correct version of tools, and activates the Python virtual environment. As a result, the environment is ready to use the ESP-IDF build system.

The image can also be used as a base for custom images, if additional utilities are required.

Tags

Multiple tags of this image are maintained:

- `latest`: tracks `master` branch of ESP-IDF
- `vX.Y`: corresponds to ESP-IDF release `vX.Y`
- `release-vX.Y`: tracks `release/vX.Y` branch of ESP-IDF

Note: Versions of ESP-IDF released before this feature was introduced do not have corresponding Docker image versions. You can check the up-to-date list of available tags at <https://hub.docker.com/r/espressif/idf/tags>.

Usage

Setting up Docker Before using the `espressif/idf` Docker image locally, make sure you have Docker installed. Follow the instructions at <https://docs.docker.com/install/>, if it is not installed yet.

If using the image in CI environment, consult the documentation of your CI service on how to specify the image used for the build process.

Building a project with CMake In the project directory, run:

```
docker run --rm -v $PWD:/project -w /project espressif/idf idf.py build
```

The above command explained:

- `docker run`: runs a Docker image. It is a shorter form of the command `docker container run`.
- `--rm`: removes the container when the build is finished
- `-v $PWD:/project`: mounts the current directory on the host (`$PWD`) as `/project` directory in the container
- `espressif/idf`: uses Docker image `espressif/idf` with tag `latest` (implicitly added by Docker when no tag is specified)
- `idf.py build`: runs this command inside the container

To build with a specific docker image tag, specify it as `espressif/idf:TAG`, for example:

```
docker run --rm -v $PWD:/project -w /project espressif/idf:release-v4.4 idf.py ↵  
↵build
```

You can check the up-to-date list of available tags at <https://hub.docker.com/r/espressif/idf/tags>.

Building a project with GNU Make Same as for CMake, except that the build command is different:

```
docker run --rm -v $PWD:/project -w /project espressif/idf make defconfig all -j4
```

Note: If the `sdkconfig` file does not exist, the default behavior of GNU Make build system is to open the `menuconfig` UI. This may be not desired in automated build environments. To ensure that the `sdkconfig` file exists, `defconfig` target is added before `all`.

If you intend to build the same project repeatedly, you may bind the `tools/kconfig` directory of ESP-IDF to a named volume. This will prevent Kconfig tools, located in ESP-IDF directory, from being rebuilt, causing a rebuild of the rest of the project:

```
docker run --rm -v $PWD:/project -v kconfig:/opt/esp/idf/tools/kconfig -w /project ↵  
↵espressif/idf make defconfig all -j4
```

If you need clean up the `kconfig` volume, run `docker volume rm kconfig`.

Binding the `tools/kconfig` directory to a volume is not necessary when using the CMake build system.

Using the image interactively It is also possible to do builds interactively, to debug build issues or test the automated build scripts. Start the container with `-i -t` flags:

```
docker run --rm -v $PWD:/project -w /project -it espressif/idf
```

Then inside the container, use `idf.py` as usual:

```
idf.py menuconfig  
idf.py build
```

Note: Commands which communicate with the development board, such as `idf.py flash` and `idf.py monitor` will not work in the container unless the serial port is passed through into the container. However currently this is not possible with Docker for Windows (<https://github.com/docker/for-win/issues/1018>) and Docker for Mac (<https://github.com/docker/for-mac/issues/900>).

Building custom images

The Dockerfile in ESP-IDF repository provides several build arguments which can be used to customize the Docker image:

- `IDF_CLONE_URL`: URL of the repository to clone ESP-IDF from. Can be set to a custom URL when working with a fork of ESP-IDF. Default is `https://github.com/espressif/esp-idf.git`.
- `IDF_CLONE_BRANCH_OR_TAG`: Name of a git branch or tag use when cloning ESP-IDF. This value is passed to `git clone` command using the `--branch` argument. Default is `master`.
- `IDF_CHECKOUT_REF`: If this argument is set to a non-empty value, `git checkout $IDF_CHECKOUT_REF` command will be performed after cloning. This argument can be set to the SHA of the specific commit to check out, for example if some specific commit on a release branch is desired.
- `IDF_CLONE_SHALLOW`: If this argument is set to a non-empty value, `--depth=1 --shallow-submodules` arguments will be used when performing `git clone`. This significantly reduces the amount of data downloaded and the size of the resulting Docker image. However, if switching to a different branch in such a “shallow” repository is necessary, an additional `git fetch origin <branch>` command must be executed first.
- `IDF_INSTALL_TARGETS`: Comma-separated list of IDF targets to install toolchains for, or `all` to install toolchains for all targets. Selecting specific targets reduces the amount of data downloaded and the size of the resulting Docker image. Default is `all`.

To use these arguments, pass them via the `--build-arg` command line option. For example, the following command will build a Docker image with a shallow clone of ESP-IDF v4.4.1 and tools for ESP32-C3, only:

```
docker build -t idf-custom:v4.4.1-esp32c3 \
  --build-arg IDF_CLONE_BRANCH_OR_TAG=v4.4.1 \
  --build-arg IDF_CLONE_SHALLOW=1 \
  --build-arg IDF_INSTALL_TARGETS=esp32c3 \
  tools/docker
```

4.24.3 IDF Windows Installer

Command-line parameters

Windows Installer `esp-idf-tools-setup` provides the following command-line parameters:

- `/GITRECURSIVE=[yes|no]` - Clone recursively all git repository submodules. Default: `yes`
- `/GITREPO=[URL|PATH]` - URL of repository to clone ESP-IDF. Default: <https://github.com/espressif/esp-idf.git>
- `/GITRESET=[yes|no]` - Enable/Disable git reset of repository during installation. Default: `yes`.
- `/HELP` - Display command line options provided by Inno Setup installer.
- `/IDFDIR=[PATH]` - Path to directory where it will be installed. Default: `{userdesktop}\esp-idf`
- `/IDFVERSION=[v4.3|v4.1|master]` - Use specific IDF version. E.g. `v4.1`, `v4.2`, `master`. Default: empty, pick the first version in the list.
- `/IDFVERSIONSURL=[URL]` - Use URL to download list of IDF versions. Default: https://dl.espressif.com/dl/esp-idf/idf_versions.txt
- `/LOG=[PATH]` - Store installation log file in specific directory. Default: empty.
- `/OFFLINE=[yes|no]` - Execute installation of Python packages by PIP in offline mode. The same result can be achieved by setting the environment variable `PIP_NO_INDEX`. Default: `no`.
- `/USEEMBEDDEDPYTHON=[yes|no]` - Use Embedded Python version for the installation. Set to `no` to allow Python selection screen in the installer. Default: `yes`.
- `/PYTHONWHEELSURL=[URL]` - Specify URLs to PyPi repositories for resolving binary Python Wheel dependencies. The same result can be achieved by setting the environment variable `PIP_EXTRA_INDEX_URL`. Default: <https://dl.espressif.com/pypi>
- `/SKIPSYSTEMCHECK=[yes|no]` - Skip System Check page. Default: `no`.
- `/VERYSILENT /SUPPRESSMSGBOXES /SP- /NOCANCEL` - Perform silent installation.

Unattended installation

The unattended installation of IDF can be achieved by following command-line parameters:

```
esp-idf-tools-setup-x.x.exe /VERYSILENT /SUPPRESSMSGBOXES /SP- /NOCANCEL
```

The installer detaches its process from the command-line. Waiting for installation to finish could be achieved by following PowerShell script:

```
esp-idf-tools-setup-x.x.exe /VERYSILENT /SUPPRESSMSGBOXES /SP- /NOCANCEL
$InstallerProcess = Get-Process esp-idf-tools-setup
Wait-Process -Id $InstallerProcess.id
```

Custom Python and custom location of Python wheels

The IDF installer is using by default embedded Python with reference to Python Wheel mirror.

Following parameters allows to select custom Python and custom location of Python wheels:

```
esp-idf-tools-setup-x.x.exe /USEEMBEDDEDPYTHON=no /PYTHONWHEELSURL=https://pypi.
↳org/simple/
```

4.24.4 IDF Component Manager

The IDF Component manager is a tool that downloads dependencies for any ESP-IDF CMake project. The download happens automatically during a run of CMake. It can source components either from [the component registry](#) or from a git repository.

A list of components can be found on <https://components.espressif.com/>

Using with a project

Dependencies for each component in the project are defined in a separate manifest file named `idf_component.yml` placed in the root of the component. The manifest file template can be created for a component by running `idf.py create-manifest --component=my_component`. When a new manifest is added to one of the components in the project it's necessary to reconfigure it manually by running `idf.py reconfigure`. Then build will track changes in `idf_component.yml` manifests and automatically triggers CMake when necessary.

There is an example application: `example:build_system/cmake/component_manager` that uses components installed by the component manager.

It's not necessary to have a manifest for components that don't need any managed dependencies.

When CMake configures the project (e.g. `idf.py reconfigure`) component manager does a few things:

- Processes `idf_component.yml` manifests for every component in the project and recursively solves dependencies
- Creates a `dependencies.lock` file in the root of the project with a full list of dependencies
- Downloads all dependencies to the `managed_components` directory

The lock-file `dependencies.lock` and content of `managed_components` directory is not supposed to be modified by a user. When the component manager runs it always make sure they are up to date. If these files were accidentally modified it's possible to re-run the component manager by triggering CMake with `idf.py reconfigure`

Defining dependencies in the manifest

```
dependencies:
# Required IDF version
idf: ">=4.1"
# Defining a dependency from the registry:
# https://components.espressif.com/component/example/cmp
example/cmp: ">=1.0.0"

# # Other ways to define dependencies
#
# # For components maintained by Espressif only name can be used.
# # Same as `espressif/cmp`
# component: "~1.0.0"
#
# # Or in a longer form with extra parameters
# component2:
#   version: ">=2.0.0"
#
# # For transient dependencies `public` flag can be set.
# # `public` flag doesn't affect the `main` component.
# # All dependencies of `main` are public by default.
# public: true
#
# # For components hosted on non-default registry:
# service_url: "https://componentregistry.company.com"
#
# # For components in git repository:
# test_component:
#   path: test_component
#   git: ssh://git@gitlab.com/user/components.git
#
# # For test projects during component development
# # components can be used from a local directory
# # with relative or absolute path
# some_local_component:
#   path: ../../projects/component
```

Disabling the Component Manager

The component manager can be explicitly disabled by setting `IDF_COMPONENT_MANAGER` environment variable to 0.

4.25 Unit Testing in ESP32-C3

ESP-IDF comes with a unit test application that is based on the Unity - unit test framework. Unit tests are integrated in the ESP-IDF repository and are placed in the `test` subdirectories of each component respectively.

4.25.1 Normal Test Cases

Unit tests are located in the `test` subdirectory of a component. Tests are written in C, and a single C source file can contain multiple test cases. Test files start with the word “test” .

Each test file should include the `unity.h` header and the header for the C module to be tested.

Tests are added in a function in the C file as follows:

```
TEST_CASE("test name", "[module name]"
{
    // Add test here
})
```

The first argument is a descriptive name for the test, the second argument is an identifier in square brackets. Identifiers are used to group related test, or tests with specific properties.

Note: There is no need to add a main function with `UNITY_BEGIN()` and `UNITY_END()` in each test case. `unity_platform.c` will run `UNITY_BEGIN()` autonomously, and run the test cases, then call `UNITY_END()`.

The test subdirectory should contain a *component CMakeLists.txt*, since they are themselves, components. ESP-IDF uses the `unity` test framework and should be specified as a requirement for the component. Normally, components *should list their sources manually*; for component tests however, this requirement is relaxed and the use of the `SRC_DIRS` argument in `idf_component_register` is advised.

Overall, the minimal test subdirectory `CMakeLists.txt` file should contain the following:

```
idf_component_register(SRC_DIRS "."
                      INCLUDE_DIRS "."
                      REQUIRES unity)
```

See <http://www.throwtheswitch.org/unity> for more information about writing tests in Unity.

4.25.2 Multi-device Test Cases

The normal test cases will be executed on one DUT (Device Under Test). However, components that require some form of communication (e.g., GPIO, SPI) require another device to communicate with, thus cannot be tested normal test cases. Multi-device test cases involve writing multiple test functions, and running them on multiple DUTs.

The following is an example of a multi-device test case:

```
void gpio_master_test()
{
    gpio_config_t slave_config = {
        .pin_bit_mask = 1 << MASTER_GPIO_PIN,
        .mode = GPIO_MODE_INPUT,
    };
    gpio_config(&slave_config);
    unity_wait_for_signal("output high level");
    TEST_ASSERT(gpio_get_level(MASTER_GPIO_PIN) == 1);
}

void gpio_slave_test()
{
    gpio_config_t master_config = {
        .pin_bit_mask = 1 << SLAVE_GPIO_PIN,
        .mode = GPIO_MODE_OUTPUT,
    };
    gpio_config(&master_config);
    gpio_set_level(SLAVE_GPIO_PIN, 1);
    unity_send_signal("output high level");
}

TEST_CASE_MULTIPLE_DEVICES("gpio multiple devices test example", "[driver]", gpio_
↪master_test, gpio_slave_test);
```

The macro `TEST_CASE_MULTIPLE_DEVICES` is used to declare a multi-device test case. The first argument is test case name, the second argument is test case description. From the third argument, up to 5 test functions can be

defined, each function will be the entry point of tests running on each DUT.

Running test cases from different DUTs could require synchronizing between DUTs. We provide `unity_wait_for_signal` and `unity_send_signal` to support synchronizing with UART. As the scenario in the above example, the slave should get GPIO level after master set level. DUT UART console will prompt and user interaction is required:

DUT1 (master) console:

```
Waiting for signal: [output high level]!
Please press "Enter" key to once any board send this signal.
```

DUT2 (slave) console:

```
Send signal: [output high level]!
```

Once the signal is sent from DUT2, you need to press “Enter” on DUT1, then DUT1 unblocks from `unity_wait_for_signal` and starts to change GPIO level.

4.25.3 Multi-stage Test Cases

The normal test cases are expected to finish without reset (or only need to check if reset happens). Sometimes we expect to run some specific tests after certain kinds of reset. For example, we expect to test if the reset reason is correct after a wakeup from deep sleep. We need to create a deep-sleep reset first and then check the reset reason. To support this, we can define multi-stage test cases, to group a set of test functions:

```
static void trigger_deepsleep(void)
{
    esp_sleep_enable_timer_wakeup(2000);
    esp_deep_sleep_start();
}

void check_deepsleep_reset_reason()
{
    RESET_REASON reason = rtc_get_reset_reason(0);
    TEST_ASSERT(reason == DEEPSLEEP_RESET);
}

TEST_CASE_MULTIPLE_STAGES("reset reason check for deepsleep", "[esp32c3]", trigger_
↪deepsleep, check_deepsleep_reset_reason);
```

Multi-stage test cases present a group of test functions to users. It needs user interactions (select cases and select different stages) to run the case.

4.25.4 Tests For Different Targets

Some tests (especially those related to hardware) cannot run on all targets. Below is a guide how to make your unit tests run on only specified targets.

1. Wrap your test code by `!(TEMPORARY_)DISABLED_FOR_TARGETS()` macros and place them either in the original test file, or separate the code into files grouped by functions, but make sure all these files will be processed by the compiler. E.g.:

```
#if !TEMPORARY_DISABLED_FOR_TARGETS(ESP32, ESP8266)
TEST_CASE("a test that is not ready for esp32 and esp8266 yet", "[ ]")
{
}
#endif //!TEMPORARY_DISABLED_FOR_TARGETS(ESP32, ESP8266)
```

Once you need one of the tests to be compiled on a specified target, just modify the targets in the disabled list. It's more encouraged to use some general conception that can be described in `soc_caps.h` to control the disabling of tests. If this is done but some of the tests are not ready yet, use both of them (and remove `!(TEMPORARY_)DISABLED_FOR_TARGETS()` later). E.g.:

```
#if SOC_SDIO_SLAVE_SUPPORTED
#if !TEMPORARY_DISABLED_FOR_TARGETS(ESP64)
TEST_CASE("a sdio slave tests that is not ready for esp64 yet", "[sdio_slave]")
{
    //available for esp32 now, and will be available for esp64 in the future
}
#endif //!TEMPORARY_DISABLED_FOR_TARGETS(ESP64)
#endif //SOC_SDIO_SLAVE_SUPPORTED
```

- For test code that you are 100% for sure that will not be supported (e.g. no peripheral at all), use `DISABLED_FOR_TARGETS`; for test code that should be disabled temporarily, or due to lack of runners, etc., use `TEMPORARY_DISABLED_FOR_TARGETS`.

Some old ways of disabling unit tests for targets, that have obvious disadvantages, are deprecated:

- DON'T put the test code under `test/target` folder and use `CMakeLists.txt` to choose one of the target folder. This is prevented because test code is more likely to be reused than the implementations. If you put something into `test/esp32` just to avoid building it on `esp32s2`, it's hard to make the code tidy if you want to enable the test again on `esp32s3`.
- DON'T use `CONFIG_IDF_TARGET_XXX` macros to disable the test items any more. This makes it harder to track disabled tests and enable them again. Also, a black-list style `#if !disabled` is preferred to white-list style `#if CONFIG_IDF_TARGET_XXX`, since you will not silently disable cases when new targets are added in the future. But for test implementations, it's allowed to use `#if CONFIG_IDF_TARGET_XXX` to pick one of the implementation code.
 - Test item: some items that will be performed on some targets, but skipped on other targets. E.g. There are three test items SD 1-bit, SD 4-bit and SDSPI. For ESP32-S2, which doesn't have SD host, among the tests only SDSPI is enabled on ESP32-S2.
 - Test implementation: some code will always happen, but in different ways. E.g. There is no SDIO PKT_LEN register on ESP8266. If you want to get the length from the slave as a step in the test process, you can have different implementation code protected by `#if CONFIG_IDF_TARGET_XXX` reading in different ways. But please avoid using `#else` macro. When new target is added, the test case will fail at building stage, so that the maintainer will be aware of this, and choose one of the implementations explicitly.

4.25.5 Building Unit Test App

Follow the setup instructions in the top-level `esp-idf` README. Make sure that `IDF_PATH` environment variable is set to point to the path of `esp-idf` top-level directory.

Change into `tools/unit-test-app` directory to configure and build it:

- `idf.py menuconfig` - configure unit test app.
- `idf.py -T all build` - build unit test app with tests for each component having tests in the `test` subdirectory.
- `idf.py -T "xxx yyy" build` - build unit test app with tests for some space-separated specific components (For instance: `idf.py -T heap build` - build unit tests only for heap component directory).
- `idf.py -T all -E "xxx yyy" build` - build unit test app with all unit tests, except for unit tests of some components (For instance: `idf.py -T all -E "ulp mbedt1s" build` - build all unit tests excludes `ulp` and `mbedt1s` components).

When the build finishes, it will print instructions for flashing the chip. You can simply run `idf.py flash` to flash all build output.

You can also run `idf.py -T all flash` or `idf.py -T xxx flash` to build and flash. Everything needed will be rebuilt automatically before flashing.

Use `menuconfig` to set the serial port for flashing.

4.25.6 Running Unit Tests

After flashing reset the ESP32-C3 and it will boot the unit test app.

When unit test app is idle, press “Enter” will make it print test menu with all available tests:

```
Here's the test menu, pick your combo:
(1)    "esp_ota_begin() verifies arguments" [ota]
(2)    "esp_ota_get_next_update_partition logic" [ota]
(3)    "Verify bootloader image in flash" [bootloader_support]
(4)    "Verify unit test app image" [bootloader_support]
(5)    "can use new and delete" [cxx]
(6)    "can call virtual functions" [cxx]
(7)    "can use static initializers for non-POD types" [cxx]
(8)    "can use std::vector" [cxx]
(9)    "static initialization guards work as expected" [cxx]
(10)   "global initializers run in the correct order" [cxx]
(11)   "before scheduler has started, static initializers work correctly" [cxx]
(12)   "adc2 work with wifi" [adc]
(13)   "gpio master/slave test example" [ignore][misc][test_env=UT_T2_1][multi_
↪device]
      (1)    "gpio_master_test"
      (2)    "gpio_slave_test"
(14)   "SPI Master clockdiv calculation routines" [spi]
(15)   "SPI Master test" [spi][ignore]
(16)   "SPI Master test, interaction of multiple devs" [spi][ignore]
(17)   "SPI Master no response when switch from host1 (SPI2) to host2 (SPI3)" ↪
↪[spi]
(18)   "SPI Master DMA test, TX and RX in different regions" [spi]
(19)   "SPI Master DMA test: length, start, not aligned" [spi]
(20)   "reset reason check for deepsleep" [esp32c3][test_env=UT_T2_1][multi_stage]
      (1)    "trigger_deepsleep"
      (2)    "check_deepsleep_reset_reason"
```

The normal case will print the case name and description. Master-slave cases will also print the sub-menu (the registered test function names).

Test cases can be run by inputting one of the following:

- Test case name in quotation marks to run a single test case
- Test case index to run a single test case
- Module name in square brackets to run all test cases for a specific module
- An asterisk to run all test cases

[multi_device] and [multi_stage] tags tell the test runner whether a test case is a multiple devices or multiple stages of test case. These tags are automatically added by `TEST_CASE_MULTIPLE_STAGES` and `TEST_CASE_MULTIPLE_DEVICES` macros.

After you select a multi-device test case, it will print sub-menu:

```
Running gpio master/slave test example...
gpio master/slave test example
      (1)    "gpio_master_test"
      (2)    "gpio_slave_test"
```

You need to input a number to select the test running on the DUT.

Similar to multi-device test cases, multi-stage test cases will also print sub-menu:

```
Running reset reason check for deepsleep...
reset reason check for deepsleep
      (1)    "trigger_deepsleep"
      (2)    "check_deepsleep_reset_reason"
```

First time you execute this case, input 1 to run first stage (trigger deepsleep). After DUT is rebooted and able to run test cases, select this case again and input 2 to run the second stage. The case only passes if the last stage passes and all previous stages trigger reset.

4.25.7 Timing Code with Cache Compensated Timer

Instructions and data stored in external memory (e.g. SPI Flash and SPI RAM) are accessed through the CPU's unified instruction and data cache. When code or data is in cache, access is very fast (i.e., a cache hit).

However, if the instruction or data is not in cache, it needs to be fetched from external memory (i.e., a cache miss). Access to external memory is significantly slower, as the CPU must execute stall cycles whilst waiting for the instruction or data to be retrieved from external memory. This can cause the overall code execution speed to vary depending on the number of cache hits or misses.

Code and data placements can vary between builds, and some arrangements may be more favorable with regards to cache access (i.e., minimizing cache misses). This can technically affect execution speed, however these factors are usually irrelevant as their effect 'average out' over the device's operation.

The effect of the cache on execution speed, however, can be relevant in benchmarking scenarios (especially microbenchmarks). There might be some variability in measured time between runs and between different builds. A technique for eliminating for some of the variability is to place code and data in instruction or data RAM (IRAM/DRAM), respectively. The CPU can access IIRAM and DRAM directly, eliminating the cache out of the equation. However, this might not always be viable as the size of IIRAM and DRAM is limited.

The cache compensated timer is an alternative to placing the code/data to be benchmarked in IIRAM/DRAM. This timer uses the processor's internal event counters in order to determine the amount of time spent on waiting for code/data in case of a cache miss, then subtract that from the recorded wall time.

```
// Start the timer
ccomp_timer_start();

// Function to time
func_code_to_time();

// Stop the timer, and return the elapsed time in microseconds relative to
// ccomp_timer_start
int64_t t = ccomp_timer_stop();
```

One limitation of the cache compensated timer is that the task that benchmarked functions should be pinned to a core. This is due to each core having its own event counters that are independent of each other. For example, if `ccomp_timer_start` gets called on one core, put to sleep by the scheduler, wakes up, and gets rescheduled on the other core, then the corresponding `ccomp_timer_stop` will be invalid.

4.25.8 Mocks

ESP-IDF has a component which integrates the CMock mocking framework. CMock usually uses Unity as a submodule, but due to some Espressif-internal limitations with CI, we still have Unity as an ordinary module in ESP-IDF. To use the IDF-supplied Unity component which isn't a submodule, the build system needs to pass an environment variable `UNITY_IDR` to CMock. This variable simply contains the path to the Unity directory in IDF, e.g. `export "UNITY_IDR=${IDF_PATH}/components/unity/unity"`. Refer to `cmock/CMock/lib/cmock_generator.rb` to see how the Unity directory is determined in CMock.

An example `cmake` build command to create mocks of a component inside that component's `CMakeLists.txt` may look like this:

```
add_custom_command(
  OUTPUT ${MOCK_OUTPUT}
  COMMAND ruby ${CMOCK_DIR}/lib/cmock.rb -o${CMAKE_CURRENT_SOURCE_DIR}/mock/mock_
  ↪config.yaml ${MOCK_HEADERS}
```

(continues on next page)

(continued from previous page)

```

COMMAND ${CMAKE_COMMAND} -E env "UNITY_DIR=${IDF_PATH}/components/unity/unity" \
↳ruby ${CMOCK_DIR}/lib/cmock.rb -o${CMAKE_CURRENT_SOURCE_DIR}/mock/mock_config.
↳yaml ${MOCK_HEADERS}
)

```

`${MOCK_OUTPUT}` contains all CMock generated output files, `${MOCK_HEADERS}` contains all headers to be mocked and `${CMOCK_DIR}` needs to be set to CMock directory inside IDF. `${CMAKE_COMMAND}` is automatically set.

Refer to [cmock/CMock/docs/CMock_Summary.md](#) for more details on how CMock works and how to create and use mocks.

4.26 USB Serial/JTAG Controller Console

On chips with an integrated USB Serial/JTAG Controller, it is possible to use the part of this controller that implements a serial port (CDC) to implement the serial console, instead of using UART with an external USB-UART bridge chip. ESP32-C3 contains this controller, providing the following functions:

- Bidirectional serial console, which can be used with *IDF Monitor* or another serial monitor
- Flashing using `esptool.py` and `idf.py flash`.
- JTAG debugging using e.g. OpenOCD, simultaneous with serial operations

Note that, in contrast with the USB OTG peripheral found in some Espressif chips, the USB Serial/JTAG Controller is a fixed function device, implemented entirely in hardware. This means it cannot be reconfigured to perform any function other than to provide a serial channel and JTAG debugging functionality.

4.26.1 Hardware Requirements

Connect ESP32-C3 to the USB port as follows:

GPIO	USB
19	D+ (green)
18	D- (white)
GND	GND (black)
	+5V (red)

Some development boards may offer a USB connector for the USB Serial/JTAG Controller —in that case, no extra connections are required.

4.26.2 Software Configuration

USB console feature can be enabled using `CONFIG_ESP_CONSOLE_USB_SERIAL_JTAG` option in menuconfig tool (see [CONFIG_ESP_CONSOLE_UART](#)).

Once the option is enabled, build the project as usual.

4.26.3 Uploading the Application

The USB Serial/JTAG Controller is able to put the ESP32-C3 into download mode automatically. Simply flash as usual, but specify the USB Serial/JTAG Controller port on your system: `idf.py flash -p PORT` where `PORT` is the name of the proper port.

4.26.4 Limitations

There are several limitations to the USB console feature. These may or may not be significant, depending on the type of application being developed, and the development workflow.

1. If the application accidentally reconfigures the USB peripheral pins, or disables the USB Serial/JTAG Controller, the device will disappear from the system. After fixing the issue in the application, you will need to manually put the ESP32-C3 into download mode by pulling low GPIO9 and resetting the chip.
2. If the application enters deep sleep mode, USB CDC device will disappear from the system.
3. The behaviour between an actual USB-to-serial bridge chip and the USB Serial/JTAG Controller is slightly different if the ESP-IDF application does not listen for incoming bytes. An USB-to-serial bridge chip will just send the bytes to a (not listening) chip, while the USB Serial/JTAG Controller will block until the application reads the bytes. This can lead to a non-responsive looking terminal program.
4. If the application enters light-sleep (including automatic light-sleep) or software reset, etc. The USB CDC device will still work on the system. But be aware that this might increase the power consumption, if you don't need USB CDC in sleep and want to keep low power consumption, please disable the menuconfig `CONFIG_RTC_CLOCK_BBPLL_POWER_ON_WITH_USB`. Moreover, the power consumption will only increase when your USB CDC port is really in use (like data transaction), therefore, if your USB CDC just connects with power bank or battery, rather than something like computer, you don't need to care about the increasing power consumption mentioned above.

4.27 Wi-Fi Driver

4.27.1 ESP32-C3 Wi-Fi Feature List

- Support 4 virtual WiFi interfaces, which are STA, AP, Sniffer and reserved.
- Support station-only mode, AP-only mode, station/AP-coexistence mode
- Support IEEE 802.11b, IEEE 802.11g, IEEE 802.11n, and APIs to configure the protocol mode
- Support WPA/WPA2/WPA3/WPA2-Enterprise and WPS
- Support AMPDU, HT40, QoS and other key features
- Support Modem-sleep
- Support an Espressif-specific protocol which, in turn, supports up to **1 km** of data traffic
- Up to 20 MBit/s TCP throughput and 30 MBit/s UDP throughput over the air
- Support Sniffer
- Support both fast scan and all-channel scan
- Support multiple antennas
- Support channel state information

4.27.2 How To Write a Wi-Fi Application

Preparation

Generally, the most effective way to begin your own Wi-Fi application is to select an example which is similar to your own application, and port the useful part into your project. It is not a MUST but it is strongly recommended that you take some time to read this article first, especially if you want to program a robust Wi-Fi application.

This article is supplementary to the Wi-Fi APIs/Examples. It describes the principles of using the Wi-Fi APIs, the limitations of the current Wi-Fi API implementation, and the most common pitfalls in using Wi-Fi. This article also reveals some design details of the Wi-Fi driver. We recommend you to select an [example](#) .

Setting Wi-Fi Compile-time Options

Refer to [Wi-Fi Menuconfig](#).

Init Wi-Fi

Refer to *ESP32-C3 Wi-Fi Station General Scenario*, *ESP32-C3 Wi-Fi AP General Scenario*.

Start/Connect Wi-Fi

Refer to *ESP32-C3 Wi-Fi Station General Scenario*, *ESP32-C3 Wi-Fi AP General Scenario*.

Event-Handling

Generally, it is easy to write code in “sunny-day” scenarios, such as *WIFI_EVENT_STA_START*, *WIFI_EVENT_STA_CONNECTED* etc. The hard part is to write routines in “rainy-day” scenarios, such as *WIFI_EVENT_STA_DISCONNECTED* etc. Good handling of “rainy-day” scenarios is fundamental to robust Wi-Fi applications. Refer to *ESP32-C3 Wi-Fi Event Description*, *ESP32-C3 Wi-Fi Station General Scenario*, *ESP32-C3 Wi-Fi AP General Scenario*. See also *an overview of event handling in ESP-IDF*.

Write Error-Recovery Routines Correctly at All Times

Just like the handling of “rainy-day” scenarios, a good error-recovery routine is also fundamental to robust Wi-Fi applications. Refer to *ESP32-C3 Wi-Fi API Error Code*.

4.27.3 ESP32-C3 Wi-Fi API Error Code

All of the ESP32-C3 Wi-Fi APIs have well-defined return values, namely, the error code. The error code can be categorized into:

- No errors, e.g. ESP_OK means that the API returns successfully.
- Recoverable errors, such as ESP_ERR_NO_MEM, etc.
- Non-recoverable, non-critical errors.
- Non-recoverable, critical errors.

Whether the error is critical or not depends on the API and the application scenario, and it is defined by the API user.

The primary principle to write a robust application with Wi-Fi API is to always check the error code and write the error-handling code. Generally, the error-handling code can be used:

- For recoverable errors, in which case you can write a recoverable-error code. For example, when *esp_wifi_start()* returns ESP_ERR_NO_MEM, the recoverable-error code *vTaskDelay* can be called in order to get a microseconds’ delay for another try.
- For non-recoverable, yet non-critical errors, in which case printing the error code is a good method for error handling.
- For non-recoverable and also critical errors, in which case “assert” may be a good method for error handling. For example, if *esp_wifi_set_mode()* returns ESP_ERR_WIFI_NOT_INIT, it means that the Wi-Fi driver is not initialized by *esp_wifi_init()* successfully. You can detect this kind of error very quickly in the application development phase.

In *esp_err.h*, ESP_ERROR_CHECK checks the return values. It is a rather commonplace error-handling code and can be used as the default error-handling code in the application development phase. However, we strongly recommend that API users write their own error-handling code.

4.27.4 ESP32-C3 Wi-Fi API Parameter Initialization

When initializing struct parameters for the API, one of two approaches should be followed:

- explicitly set all fields of the parameter
- use get API to get current configuration first, then set application specific fields

Initializing or getting the entire structure is very important because most of the time the value 0 indicates the default value is used. More fields may be added to the struct in the future and initializing these to zero ensures the application will still work correctly after IDF is updated to a new release.

4.27.5 ESP32-C3 Wi-Fi Programming Model

The ESP32-C3 Wi-Fi programming model is depicted as follows:

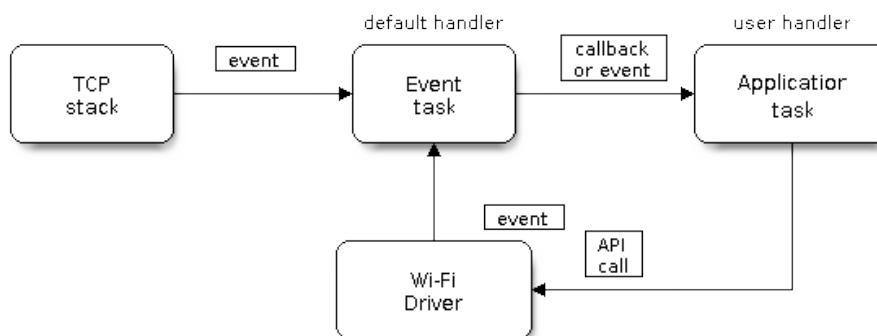

Fig. 50: Wi-Fi Programming Model

The Wi-Fi driver can be considered a black box that knows nothing about high-layer code, such as the TCP/IP stack, application task, and event task. The application task (code) generally calls *Wi-Fi driver APIs* to initialize Wi-Fi and handles Wi-Fi events when necessary. Wi-Fi driver receives API calls, handles them, and posts events to the application.

Wi-Fi event handling is based on the *esp_event library*. Events are sent by the Wi-Fi driver to the *default event loop*. Application may handle these events in callbacks registered using *esp_event_handler_register()*. Wi-Fi events are also handled by *esp_netif component* to provide a set of default behaviors. For example, when Wi-Fi station connects to an AP, *esp_netif* will automatically start the DHCP client by default.

4.27.6 ESP32-C3 Wi-Fi Event Description

WIFI_EVENT_WIFI_READY

The Wi-Fi driver will never generate this event, which, as a result, can be ignored by the application event callback. This event may be removed in future releases.

WIFI_EVENT_SCAN_DONE

The scan-done event is triggered by *esp_wifi_scan_start()* and will arise in the following scenarios:

- The scan is completed, e.g., the target AP is found successfully, or all channels have been scanned.
- The scan is stopped by *esp_wifi_scan_stop()*.
- The *esp_wifi_scan_start()* is called before the scan is completed. A new scan will override the current scan and a scan-done event will be generated.

The scan-done event will not arise in the following scenarios:

- It is a blocked scan.
- The scan is caused by *esp_wifi_connect()*.

Upon receiving this event, the event task does nothing. The application event callback needs to call `esp_wifi_scan_get_ap_num()` and `esp_wifi_scan_get_ap_records()` to fetch the scanned AP list and trigger the Wi-Fi driver to free the internal memory which is allocated during the scan (**do not forget to do this!**). Refer to *ESP32-C3 Wi-Fi Scan* for a more detailed description.

WIFI_EVENT_STA_START

If `esp_wifi_start()` returns `ESP_OK` and the current Wi-Fi mode is Station or AP+Station, then this event will arise. Upon receiving this event, the event task will initialize the LwIP network interface (netif). Generally, the application event callback needs to call `esp_wifi_connect()` to connect to the configured AP.

WIFI_EVENT_STA_STOP

If `esp_wifi_stop()` returns `ESP_OK` and the current Wi-Fi mode is Station or AP+Station, then this event will arise. Upon receiving this event, the event task will release the station's IP address, stop the DHCP client, remove TCP/UDP-related connections and clear the LwIP station netif, etc. The application event callback generally does not need to do anything.

WIFI_EVENT_STA_CONNECTED

If `esp_wifi_connect()` returns `ESP_OK` and the station successfully connects to the target AP, the connection event will arise. Upon receiving this event, the event task starts the DHCP client and begins the DHCP process of getting the IP address. Then, the Wi-Fi driver is ready for sending and receiving data. This moment is good for beginning the application work, provided that the application does not depend on LwIP, namely the IP address. However, if the application is LwIP-based, then you need to wait until the `got ip` event comes in.

WIFI_EVENT_STA_DISCONNECTED

This event can be generated in the following scenarios:

- When `esp_wifi_disconnect()`, or `esp_wifi_stop()`, or `esp_wifi_deinit()` is called and the station is already connected to the AP.
- When `esp_wifi_connect()` is called, but the Wi-Fi driver fails to set up a connection with the AP due to certain reasons, e.g. the scan fails to find the target AP, authentication times out, etc. If there are more than one AP with the same SSID, the disconnected event is raised after the station fails to connect all of the found APs.
- When the Wi-Fi connection is disrupted because of specific reasons, e.g., the station continuously loses N beacons, the AP kicks off the station, the AP's authentication mode is changed, etc.

Upon receiving this event, the default behavior of the event task is:

- Shuts down the station's LwIP netif.
- Notifies the LwIP task to clear the UDP/TCP connections which cause the wrong status to all sockets. For socket-based applications, the application callback can choose to close all sockets and re-create them, if necessary, upon receiving this event.

The most common event handle code for this event in application is to call `esp_wifi_connect()` to reconnect the Wi-Fi. However, if the event is raised because `esp_wifi_disconnect()` is called, the application should not call `esp_wifi_connect()` to reconnect. It's application's responsibility to distinguish whether the event is caused by `esp_wifi_disconnect()` or other reasons. Sometimes a better reconnect strategy is required, refer to *Wi-Fi Reconnect* and *Scan When Wi-Fi Is Connecting*.

Another thing deserves our attention is that the default behavior of LwIP is to abort all TCP socket connections on receiving the disconnect. Most of time it is not a problem. However, for some special application, this may not be what they want, consider following scenarios:

- The application creates a TCP connection to maintain the application-level keep-alive data that is sent out every 60 seconds.

- Due to certain reasons, the Wi-Fi connection is cut off, and the *WIFI_EVENT_STA_DISCONNECTED* is raised. According to the current implementation, all TCP connections will be removed and the keep-alive socket will be in a wrong status. However, since the application designer believes that the network layer should NOT care about this error at the Wi-Fi layer, the application does not close the socket.
- Five seconds later, the Wi-Fi connection is restored because *esp_wifi_connect()* is called in the application event callback function. **Moreover, the station connects to the same AP and gets the same IPV4 address as before.**
- Sixty seconds later, when the application sends out data with the keep-alive socket, the socket returns an error and the application closes the socket and re-creates it when necessary.

In above scenarios, ideally, the application sockets and the network layer should not be affected, since the Wi-Fi connection only fails temporarily and recovers very quickly. The application can enable “Keep TCP connections when IP changed” via LwIP menuconfig.

IP_EVENT_STA_GOT_IP

This event arises when the DHCP client successfully gets the IPV4 address from the DHCP server, or when the IPV4 address is changed. The event means that everything is ready and the application can begin its tasks (e.g., creating sockets).

The IPV4 may be changed because of the following reasons:

- The DHCP client fails to renew/rebind the IPV4 address, and the station’s IPV4 is reset to 0.
- The DHCP client rebinds to a different address.
- The static-configured IPV4 address is changed.

Whether the IPV4 address is changed or NOT is indicated by field *ip_change* of *ip_event_got_ip_t*.

The socket is based on the IPV4 address, which means that, if the IPV4 changes, all sockets relating to this IPV4 will become abnormal. Upon receiving this event, the application needs to close all sockets and recreate the application when the IPV4 changes to a valid one.

IP_EVENT_GOT_IP6

This event arises when the IPV6 SLAAC support auto-configures an address for the ESP32-C3, or when this address changes. The event means that everything is ready and the application can begin its tasks (e.g., creating sockets).

IP_EVENT_STA_LOST_IP

This event arises when the IPV4 address become invalid.

IP_EVENT_STA_LOST_IP doesn’t arise immediately after the Wi-Fi disconnects, instead it starts an IPV4 address lost timer, if the IPV4 address is got before ip lost timer expires, *IP_EVENT_STA_LOST_IP* doesn’t happen. Otherwise, the event arises when IPV4 address lost timer expires.

Generally the application don’t need to care about this event, it is just a debug event to let the application know that the IPV4 address is lost.

WIFI_EVENT_AP_START

Similar to *WIFI_EVENT_STA_START*.

WIFI_EVENT_AP_STOP

Similar to *WIFI_EVENT_STA_STOP*.

WIFI_EVENT_AP_STACONNECTED

Every time a station is connected to ESP32-C3 AP, the `WIFI_EVENT_AP_STACONNECTED` will arise. Upon receiving this event, the event task will do nothing, and the application callback can also ignore it. However, you may want to do something, for example, to get the info of the connected STA, etc.

WIFI_EVENT_AP_STADISCONNECTED

This event can happen in the following scenarios:

- The application calls `esp_wifi_disconnect()`, or `esp_wifi_death_sta()`, to manually disconnect the station.
- The Wi-Fi driver kicks off the station, e.g., because the AP has not received any packets in the past five minutes. The time can be modified by `esp_wifi_set_inactive_time()`.
- The station kicks off the AP.

When this event happens, the event task will do nothing, but the application event callback needs to do something, e.g., close the socket which is related to this station, etc.

WIFI_EVENT_AP_PROBEREQRCVD

This event is disabled by default. The application can enable it via API `esp_wifi_set_event_mask()`. When this event is enabled, it will be raised each time the AP receives a probe request.

WIFI_EVENT_STA_BEACON_TIMEOUT

If the station does not receive the beacon of the connected AP within the inactive time, the beacon timeout happens, the `WIFI_EVENT_STA_BEACON_TIMEOUT` will arise. The application can set inactive time via API `esp_wifi_set_inactive_time()`.

4.27.7 ESP32-C3 Wi-Fi Station General Scenario

Below is a “big scenario” which describes some small scenarios in Station mode:

1. Wi-Fi/LwIP Init Phase

- s1.1: The main task calls `esp_netif_init()` to create an LwIP core task and initialize LwIP-related work.
- s1.2: The main task calls `esp_event_loop_create()` to create a system Event task and initialize an application event's callback function. In the scenario above, the application event's callback function does nothing but relaying the event to the application task.
- s1.3: The main task calls `esp_netif_create_default_wifi_ap()` or `esp_netif_create_default_wifi_sta()` to create default network interface instance binding station or AP with TCP/IP stack.
- s1.4: The main task calls `esp_wifi_init()` to create the Wi-Fi driver task and initialize the Wi-Fi driver.
- s1.5: The main task calls OS API to create the application task.

Step 1.1 ~ 1.5 is a recommended sequence that initializes a Wi-Fi-/LwIP-based application. However, it is **NOT** a must-follow sequence, which means that you can create the application task in step 1.1 and put all other initializations in the application task. Moreover, you may not want to create the application task in the initialization phase if the application task depends on the sockets. Rather, you can defer the task creation until the IP is obtained.

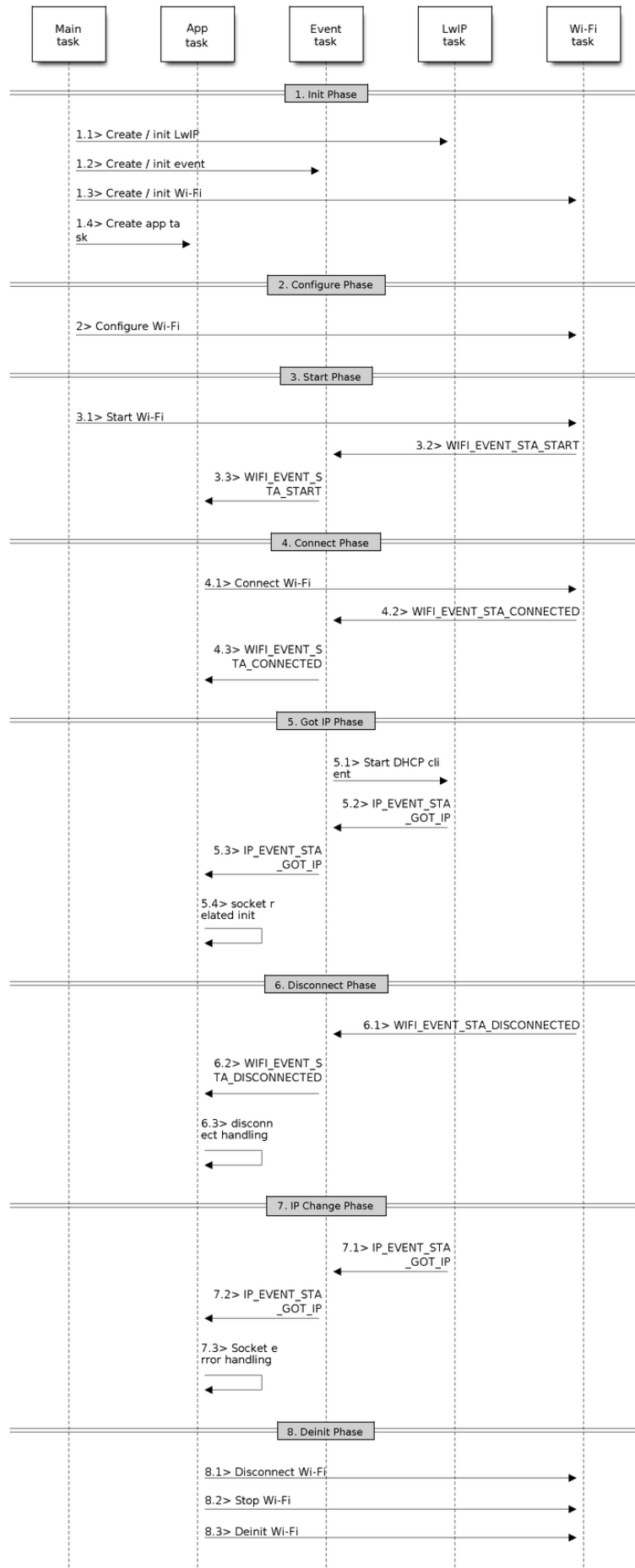

Fig. 51: Sample Wi-Fi Event Scenarios in Station Mode

2. Wi-Fi Configuration Phase

Once the Wi-Fi driver is initialized, you can start configuring the Wi-Fi driver. In this scenario, the mode is Station, so you may need to call `esp_wifi_set_mode()` (`WIFI_MODE_STA`) to configure the Wi-Fi mode as Station. You can call other `esp_wifi_set_XXX` APIs to configure more settings, such as the protocol mode, country code, bandwidth, etc. Refer to [ESP32-C3 Wi-Fi Configuration](#).

Generally, the Wi-Fi driver should be configured before the Wi-Fi connection is set up. But this is **NOT** mandatory, which means that you can configure the Wi-Fi connection anytime, provided that the Wi-Fi driver is initialized successfully. However, if the configuration does not need to change after the Wi-Fi connection is set up, you should configure the Wi-Fi driver at this stage, because the configuration APIs (such as `esp_wifi_set_protocol()`) will cause the Wi-Fi to reconnect, which may not be desirable.

If the Wi-Fi NVS flash is enabled by menuconfig, all Wi-Fi configuration in this phase, or later phases, will be stored into flash. When the board powers on/reboots, you do not need to configure the Wi-Fi driver from scratch. You only need to call `esp_wifi_get_XXX` APIs to fetch the configuration stored in flash previously. You can also configure the Wi-Fi driver if the previous configuration is not what you want.

3. Wi-Fi Start Phase

- s3.1: Call `esp_wifi_start()` to start the Wi-Fi driver.
- s3.2: The Wi-Fi driver posts `WIFI_EVENT_STA_START` to the event task; then, the event task will do some common things and will call the application event callback function.
- s3.3: The application event callback function relays the `WIFI_EVENT_STA_START` to the application task. We recommend that you call `esp_wifi_connect()`. However, you can also call `esp_wifi_connect()` in other phrases after the `WIFI_EVENT_STA_START` arises.

4. Wi-Fi Connect Phase

- s4.1: Once `esp_wifi_connect()` is called, the Wi-Fi driver will start the internal scan/connection process.
- s4.2: If the internal scan/connection process is successful, the `WIFI_EVENT_STA_CONNECTED` will be generated. In the event task, it starts the DHCP client, which will finally trigger the DHCP process.
- s4.3: In the above-mentioned scenario, the application event callback will relay the event to the application task. Generally, the application needs to do nothing, and you can do whatever you want, e.g., print a log, etc.

In step 4.2, the Wi-Fi connection may fail because, for example, the password is wrong, the AP is not found, etc. In a case like this, `WIFI_EVENT_STA_DISCONNECTED` will arise and the reason for such a failure will be provided. For handling events that disrupt Wi-Fi connection, please refer to phase 6.

5. Wi-Fi ‘Got IP’ Phase

- s5.1: Once the DHCP client is initialized in step 4.2, the *got IP* phase will begin.
- s5.2: If the IP address is successfully received from the DHCP server, then `IP_EVENT_STA_GOT_IP` will arise and the event task will perform common handling.
- s5.3: In the application event callback, `IP_EVENT_STA_GOT_IP` is relayed to the application task. For LwIP-based applications, this event is very special and means that everything is ready for the application to begin its tasks, e.g. creating the TCP/UDP socket, etc. A very common mistake is to initialize the socket before `IP_EVENT_STA_GOT_IP` is received. **DO NOT start the socket-related work before the IP is received.**

6. Wi-Fi Disconnect Phase

- s6.1: When the Wi-Fi connection is disrupted, e.g. because the AP is powered off, the RSSI is poor, etc., `WIFI_EVENT_STA_DISCONNECTED` will arise. This event may also arise in phase 3. Here, the event task will notify the LwIP task to clear/remove all UDP/TCP connections. Then, all application sockets will be in a wrong status. In other words, no socket can work properly when this event happens.

- s6.2: In the scenario described above, the application event callback function re-relays `WIFI_EVENT_STA_DISCONNECTED` to the application task. We recommend that `esp_wifi_connect()` be called to reconnect the Wi-Fi, close all sockets and re-create them if necessary. Refer to `WIFI_EVENT_STA_DISCONNECTED`.

7. Wi-Fi IP Change Phase

- s7.1: If the IP address is changed, the `IP_EVENT_STA_GOT_IP` will arise with “ip_change” set to true.
- s7.2: **This event is important to the application. When it occurs, the timing is good for closing all created sockets and recreating them.**

8. Wi-Fi Deinit Phase

- s8.1: Call `esp_wifi_disconnect()` to disconnect the Wi-Fi connectivity.
- s8.2: Call `esp_wifi_stop()` to stop the Wi-Fi driver.
- s8.3: Call `esp_wifi_deinit()` to unload the Wi-Fi driver.

4.27.8 ESP32-C3 Wi-Fi AP General Scenario

Below is a “big scenario” which describes some small scenarios in AP mode:

4.27.9 ESP32-C3 Wi-Fi Scan

Currently, the `esp_wifi_scan_start()` API is supported only in Station or Station+AP mode.

Scan Type

Mode	Description
Active Scan	Scan by sending a probe request. The default scan is an active scan.
Passive Scan	No probe request is sent out. Just switch to the specific channel and wait for a beacon. Application can enable it via the <code>scan_type</code> field of <code>wifi_scan_config_t</code> .
Foreground Scan	This scan is applicable when there is no Wi-Fi connection in station mode. Foreground or background scanning is controlled by the Wi-Fi driver and cannot be configured by the application.
Background Scan	This scan is applicable when there is a Wi-Fi connection in station mode or in station/AP mode. Whether it is a foreground scan or background scan depends on the Wi-Fi driver and cannot be configured by the application.
All-Channel Scan	It scans all of the channels. If the <code>channel</code> field of <code>wifi_scan_config_t</code> is set to 0, it is an all-channel scan.
Specific Channel Scan	It scans specific channels only. If the <code>channel</code> field of <code>wifi_scan_config_t</code> set to 1-14, it is a specific-channel scan.

The scan modes in above table can be combined arbitrarily, so we totally have 8 different scans:

- All-Channel Background Active Scan
- All-Channel Background Passive Scan
- All-Channel Foreground Active Scan
- All-Channel Foreground Passive Scan
- Specific-Channel Background Active Scan
- Specific-Channel Background Passive Scan
- Specific-Channel Foreground Active Scan
- Specific-Channel Foreground Passive Scan

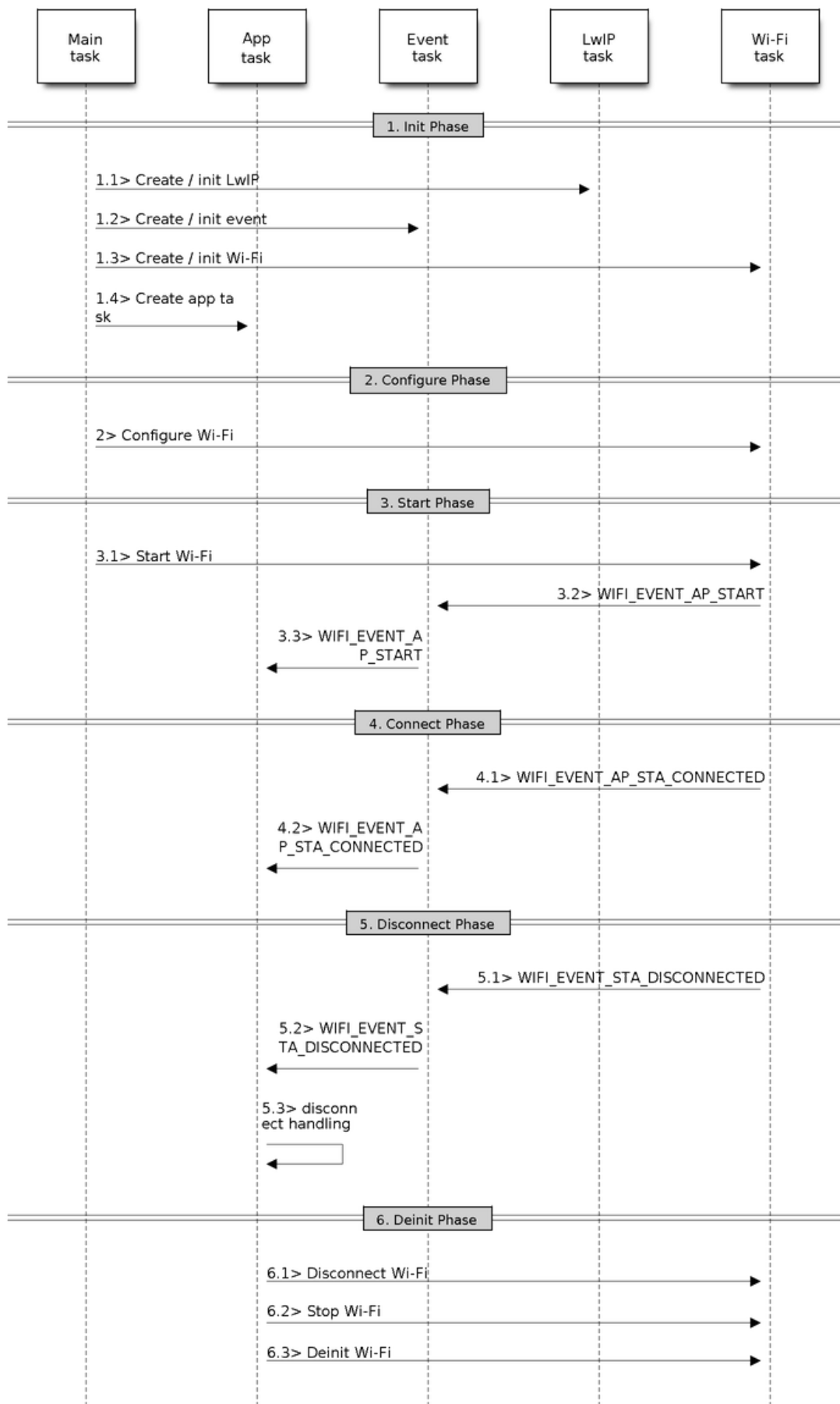

Fig. 52: Sample Wi-Fi Event Scenarios in AP Mode

Scan Configuration

The scan type and other per-scan attributes are configured by `esp_wifi_scan_start()`. The table below provides a detailed description of `wifi_scan_config_t`.

Field	Description
ssid	If the SSID is not NULL, it is only the AP with the same SSID that can be scanned.
bssid	If the BSSID is not NULL, it is only the AP with the same BSSID that can be scanned.
channel	If “channel” is 0, there will be an all-channel scan; otherwise, there will be a specific-channel scan.
show_hidden	If “show_hidden” is 0, the scan ignores the AP with a hidden SSID; otherwise, the scan considers the hidden AP a normal one.
scan_type	If “scan_type” is <code>WIFI_SCAN_TYPE_ACTIVE</code> , the scan is “active” ; otherwise, it is a “passive” one.
scan_time	<p>This field is used to control how long the scan dwells on each channel.</p> <p>For passive scans, <code>scan_time.passive</code> designates the dwell time for each channel.</p> <p>For active scans, dwell times for each channel are listed in the table below. Here, <code>min</code> is short for <code>scan_time.active.min</code> and <code>max</code> is short for <code>scan_time.active.max</code>.</p> <ul style="list-style-type: none"> • <code>min=0, max=0</code>: scan dwells on each channel for 120 ms. • <code>min>0, max=0</code>: scan dwells on each channel for 120 ms. • <code>min=0, max>0</code>: scan dwells on each channel for <code>max</code> ms. • <code>min>0, max>0</code>: the minimum time the scan dwells on each channel is <code>min</code> ms. If no AP is found during this time frame, the scan switches to the next channel. Otherwise, the scan dwells on the channel for <code>max</code> ms. <p>If you want to improve the performance of the scan, you can try to modify these two parameters.</p>

There are also some global scan attributes which are configured by API `esp_wifi_set_config()`, refer to [Station Basic Configuration](#)

Scan All APs on All Channels (Foreground)

Scenario:

The scenario above describes an all-channel, foreground scan. The foreground scan can only occur in Station mode where the station does not connect to any AP. Whether it is a foreground or background scan is totally determined by the Wi-Fi driver, and cannot be configured by the application.

Detailed scenario description:

Scan Configuration Phase

- s1.1: Call `esp_wifi_set_country()` to set the country info if the default country info is not what you want, refer to [Wi-Fi Country Code](#).
- s1.2: Call `esp_wifi_scan_start()` to configure the scan. To do so, you can refer to [Scan Configuration](#). Since this is an all-channel scan, just set the SSID/BSSID/channel to 0.

Wi-Fi Driver's Internal Scan Phase

- s2.1: The Wi-Fi driver switches to channel 1, in case the scan type is `WIFI_SCAN_TYPE_ACTIVE`, and broadcasts a probe request. Otherwise, the Wi-Fi will wait for a beacon from the APs. The Wi-Fi driver will stay in channel 1 for some time. The dwell time is configured in `min/max` time, with default value being 120 ms.
- s2.2: The Wi-Fi driver switches to channel 2 and performs the same operation as in step 2.1.
- s2.3: The Wi-Fi driver scans the last channel N, where N is determined by the country code which is configured in step 1.1.

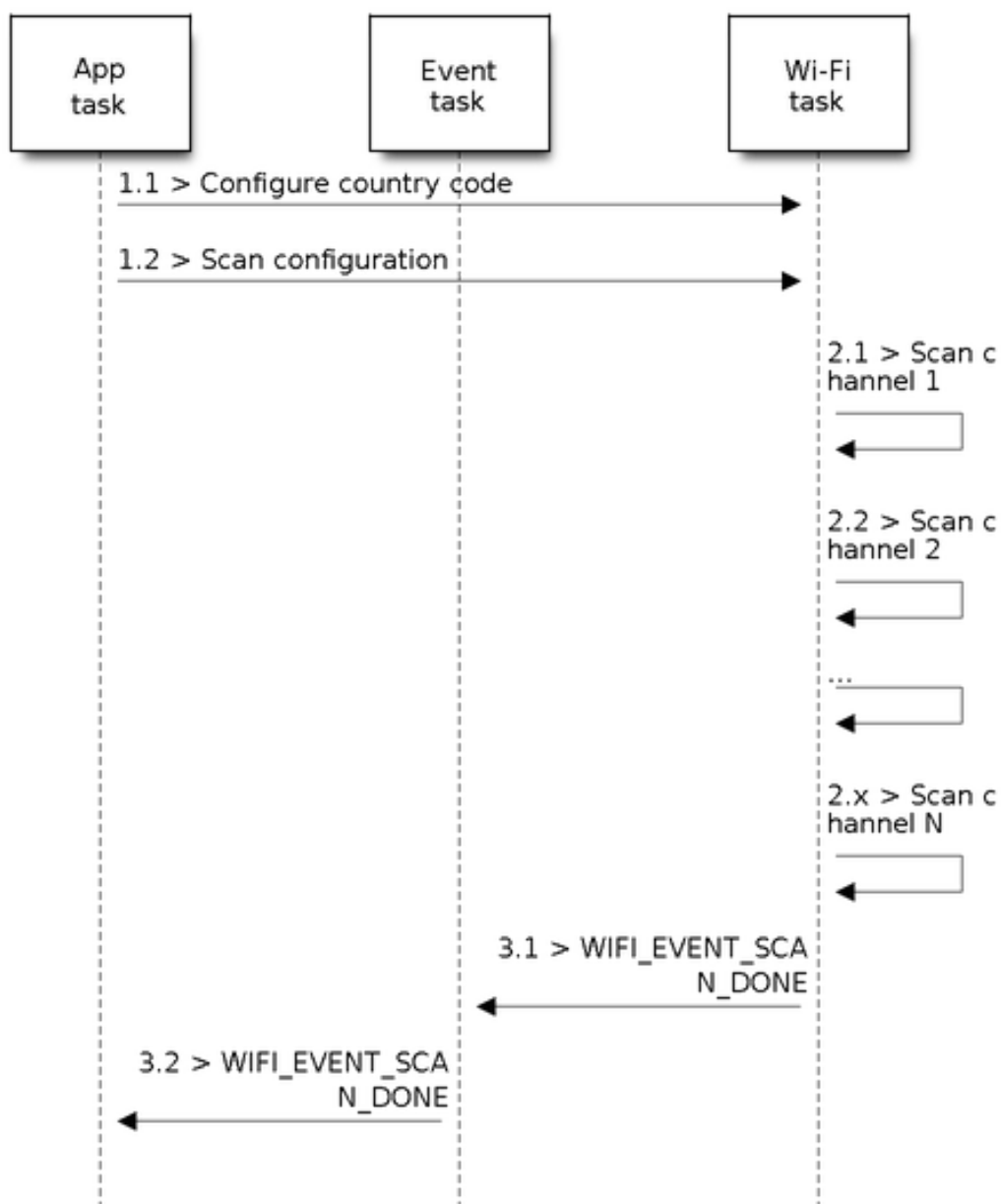

Fig. 53: Foreground Scan of all Wi-Fi Channels

Scan-Done Event Handling Phase

- s3.1: When all channels are scanned, `WIFI_EVENT_SCAN_DONE` will arise.
- s3.2: The application's event callback function notifies the application task that `WIFI_EVENT_SCAN_DONE` is received. `esp_wifi_scan_get_ap_num()` is called to get the number of APs that have been found in this scan. Then, it allocates enough entries and calls `esp_wifi_scan_get_ap_records()` to get the AP records. Please note that the AP records in the Wi-Fi driver will be freed, once `esp_wifi_scan_get_ap_records()` is called. Do not call `esp_wifi_scan_get_ap_records()` twice for a single scan-done event. If `esp_wifi_scan_get_ap_records()` is not called when the scan-done event occurs, the AP records allocated by the Wi-Fi driver will not be freed. So, make sure you call `esp_wifi_scan_get_ap_records()`, yet only once.

Scan All APs on All Channels (Background)

Scenario:

The scenario above is an all-channel background scan. Compared to *Scan All APs on All Channels (Foreground)*, the difference in the all-channel background scan is that the Wi-Fi driver will scan the back-to-home channel for 30 ms before it switches to the next channel to give the Wi-Fi connection a chance to transmit/receive data.

Scan for Specific AP on All Channels

Scenario:

This scan is similar to *Scan All APs on All Channels (Foreground)*. The differences are:

- s1.1: In step 1.2, the target AP will be configured to SSID/BSSID.
- s2.1~s2.N: Each time the Wi-Fi driver scans an AP, it will check whether it is a target AP or not. If the scan is `WIFI_FAST_SCAN` scan and the target AP is found, then the scan-done event will arise and scanning will end; otherwise, the scan will continue. Please note that the first scanned channel may not be channel 1, because the Wi-Fi driver optimizes the scanning sequence.

If there are multiple APs which match the target AP info, for example, if we happen to scan two APs whose SSID is "ap". If the scan is `WIFI_FAST_SCAN`, then only the first scanned "ap" will be found, if the scan is `WIFI_ALL_CHANNEL_SCAN`, both "ap" will be found and the station will connect the "ap" according to the configured strategy, refer to *Station Basic Configuration*.

You can scan a specific AP, or all of them, in any given channel. These two scenarios are very similar.

Scan in Wi-Fi Connect

When `esp_wifi_connect()` is called, the Wi-Fi driver will try to scan the configured AP first. The scan in "Wi-Fi Connect" is the same as *Scan for Specific AP On All Channels*, except that no scan-done event will be generated when the scan is completed. If the target AP is found, the Wi-Fi driver will start the Wi-Fi connection; otherwise, `WIFI_EVENT_STA_DISCONNECTED` will be generated. Refer to *Scan for Specific AP On All Channels*.

Scan In Blocked Mode

If the block parameter of `esp_wifi_scan_start()` is true, then the scan is a blocked one, and the application task will be blocked until the scan is done. The blocked scan is similar to an unblocked one, except that no scan-done event will arise when the blocked scan is completed.

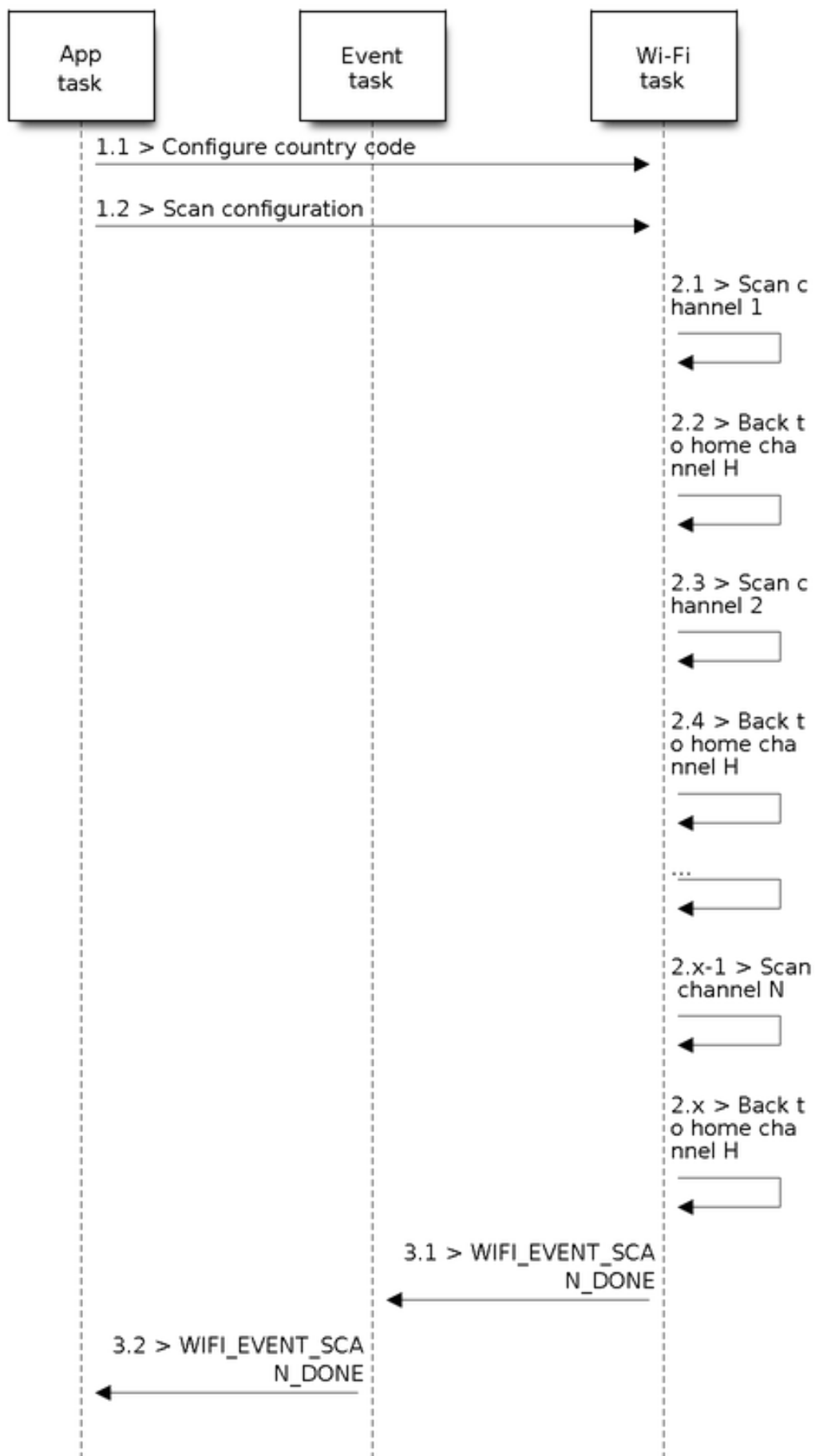

Fig. 54: Background Scan of all Wi-Fi Channels

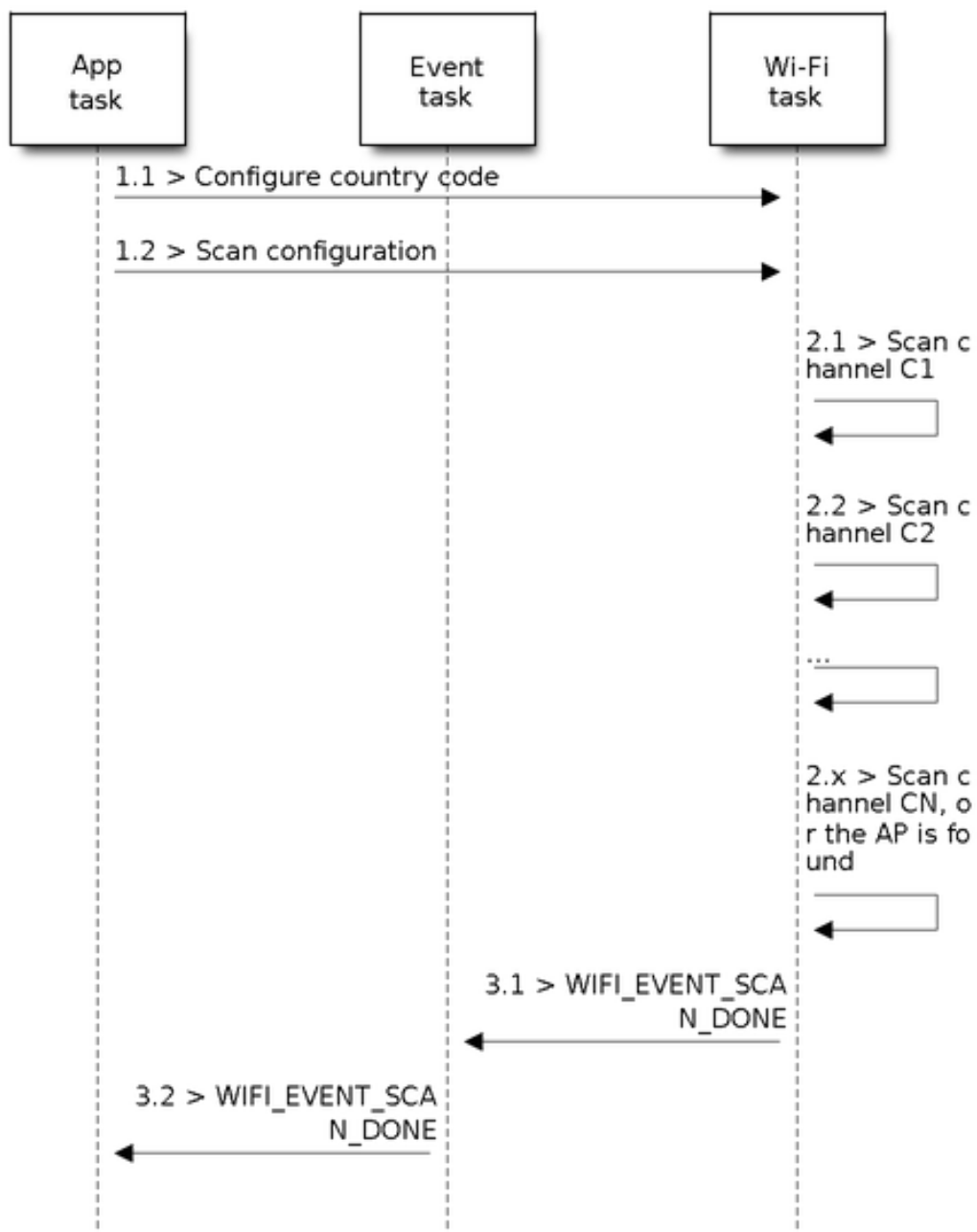

Fig. 55: Scan of specific Wi-Fi Channels

Parallel Scan

Two application tasks may call `esp_wifi_scan_start()` at the same time, or the same application task calls `esp_wifi_scan_start()` before it gets a scan-done event. Both scenarios can happen. **However, the Wi-Fi driver does not support multiple concurrent scans adequately. As a result, concurrent scans should be avoided.** Support for concurrent scan will be enhanced in future releases, as the ESP32-C3's Wi-Fi functionality improves continuously.

Scan When Wi-Fi is Connecting

The `esp_wifi_scan_start()` fails immediately if the Wi-Fi is in connecting process because the connecting has higher priority than the scan. If scan fails because of connecting, the recommended strategy is to delay sometime and retry scan again, the scan will succeed once the connecting is completed.

However, the retry/delay strategy may not work all the time. Considering following scenario:

- The station is connecting a non-existed AP or if the station connects the existed AP with a wrong password, it always raises the event `WIFI_EVENT_STA_DISCONNECTED`.
- The application call `esp_wifi_connect()` to do reconnection on receiving the disconnect event.
- Another application task, e.g. the console task, call `esp_wifi_scan_start()` to do scan, the scan always fails immediately because the station is keeping connecting.
- When scan fails, the application simply delay sometime and retry the scan.

In above scenario the scan will never succeed because the connecting is in process. So if the application supports similar scenario, it needs to implement a better reconnect strategy. E.g.

- The application can choose to define a maximum continuous reconnect counter, stop reconnect once the reconnect reaches the max counter.
- The application can choose to do reconnect immediately in the first N continuous reconnect, then give a delay sometime and reconnect again.

The application can define its own reconnect strategy to avoid the scan starve to death. Refer to [<Wi-Fi Reconnect>](#).

4.27.10 ESP32-C3 Wi-Fi Station Connecting Scenario

This scenario only depicts the case when there is only one target AP are found in scan phase, for the scenario that more than one AP with the same SSID are found, refer to [ESP32-C3 Wi-Fi Station Connecting When Multiple APs Are Found](#).

Generally, the application does not need to care about the connecting process. Below is a brief introduction to the process for those who are really interested.

Scenario:

Scan Phase

- s1.1, The Wi-Fi driver begins scanning in “Wi-Fi Connect” . Refer to [Scan in Wi-Fi Connect](#) for more details.
- s1.2, If the scan fails to find the target AP, `WIFI_EVENT_STA_DISCONNECTED` will arise and the reason-code will be `WIFI_REASON_NO_AP_FOUND`. Refer to [Wi-Fi Reason Code](#).

Auth Phase

- s2.1, The authentication request packet is sent and the auth timer is enabled.
- s2.2, If the authentication response packet is not received before the authentication timer times out, `WIFI_EVENT_STA_DISCONNECTED` will arise and the reason-code will be `WIFI_REASON_AUTH_EXPIRE`. Refer to [Wi-Fi Reason Code](#).
- s2.3, The auth-response packet is received and the auth-timer is stopped.

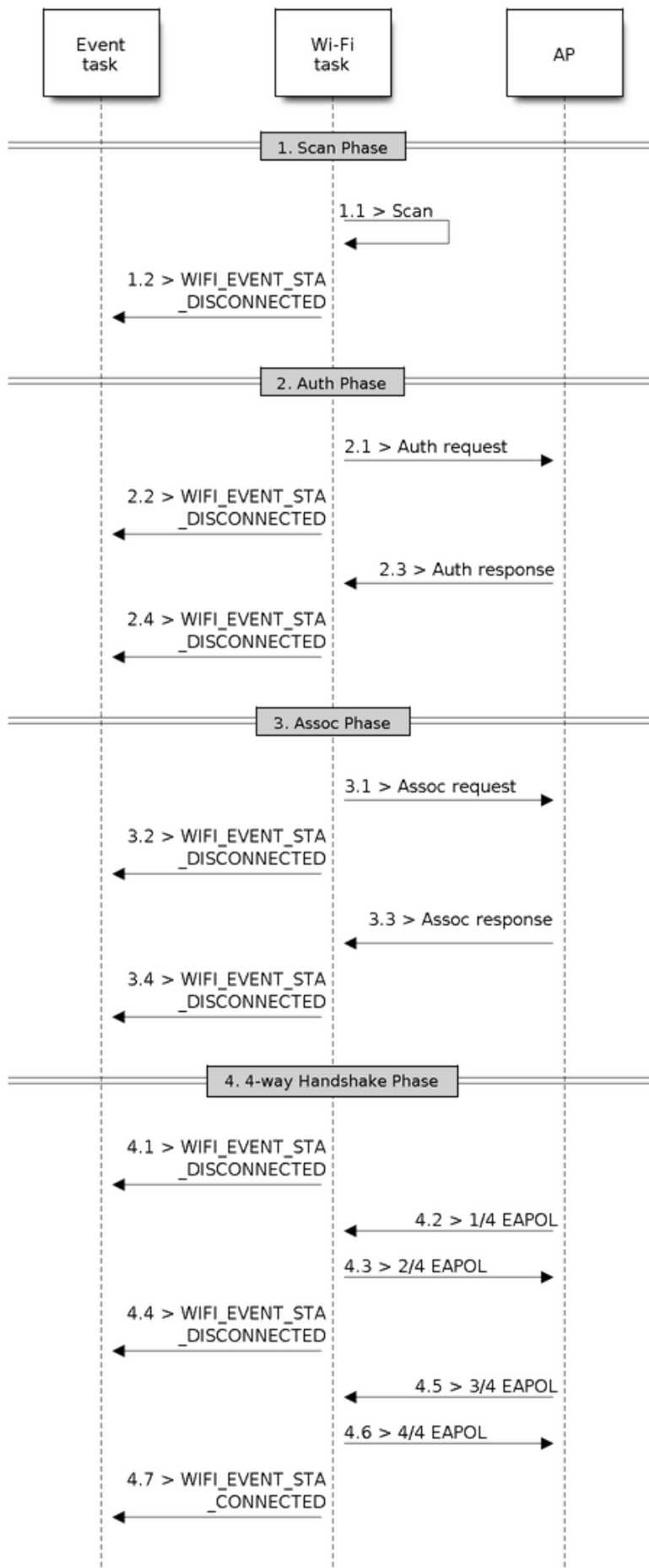

Fig. 56: Wi-Fi Station Connecting Process

- s2.4, The AP rejects authentication in the response and *WIFI_EVENT_STA_DISCONNECTED* arises, while the reason-code is *WIFI_REASON_AUTH_FAIL* or the reasons specified by the AP. Refer to *Wi-Fi Reason Code*.

Association Phase

- s3.1, The association request is sent and the association timer is enabled.
- s3.2, If the association response is not received before the association timer times out, *WIFI_EVENT_STA_DISCONNECTED* will arise and the reason-code will be *WIFI_REASON_ASSOC_EXPIRE*. Refer to *Wi-Fi Reason Code*.
- s3.3, The association response is received and the association timer is stopped.
- s3.4, The AP rejects the association in the response and *WIFI_EVENT_STA_DISCONNECTED* arises, while the reason-code is the one specified in the association response. Refer to *Wi-Fi Reason Code*.

Four-way Handshake Phase

- s4.1, The handshake timer is enabled, the 1/4 EAPOL is not received before the handshake timer expires, *WIFI_EVENT_STA_DISCONNECTED* will arise and the reason-code will be *WIFI_REASON_HANDSHAKE_TIMEOUT*. Refer to *Wi-Fi Reason Code*.
- s4.2, The 1/4 EAPOL is received.
- s4.3, The STA replies 2/4 EAPOL.
- s4.4, If the 3/4 EAPOL is not received before the handshake timer expires, *WIFI_EVENT_STA_DISCONNECTED* will arise and the reason-code will be *WIFI_REASON_HANDSHAKE_TIMEOUT*. Refer to *Wi-Fi Reason Code*.
- s4.5, The 3/4 EAPOL is received.
- s4.6, The STA replies 4/4 EAPOL.
- s4.7, The STA raises *WIFI_EVENT_STA_CONNECTED*.

Wi-Fi Reason Code

The table below shows the reason-code defined in ESP32-C3. The first column is the macro name defined in *esp_wifi_types.h*. The common prefix *WIFI_REASON* is removed, which means that *UNSPECIFIED* actually stands for *WIFI_REASON_UNSPECIFIED* and so on. The second column is the value of the reason. The third column is the standard value to which this reason is mapped in section 8.4.1.7 of IEEE 802.11-2012. (For more information, refer to the standard mentioned above.) The last column is a description of the reason.

ReasonValue code	Mapped To	Description
UNSPECIFIED	1	Generally, it means an internal failure, e.g., the memory runs out, the internal TX fails, or the reason is received from the remote side, etc.
AUTH_EXPIRE	2	The previous authentication is no longer valid. For the ESP station, this reason is reported when: <ul style="list-style-type: none"> • auth is timed out. • the reason is received from the AP. For the ESP AP, this reason is reported when: <ul style="list-style-type: none"> • the AP has not received any packets from the station in the past five minutes. • the AP is stopped by calling <code>esp_wifi_stop()</code>. • the station is de-authed by calling <code>esp_wifi_deauth_sta()</code>.
AUTH_BEAVE	3	De-authenticated, because the sending station is leaving (or has left). For the ESP station, this reason is reported when: <ul style="list-style-type: none"> • it is received from the AP.
ASSOC_EXPIRE	4	Disassociated due to inactivity. For the ESP station, this reason is reported when: <ul style="list-style-type: none"> • it is received from the AP. For the ESP AP, this reason is reported when: <ul style="list-style-type: none"> • the AP has not received any packets from the station in the past five minutes. • the AP is stopped by calling <code>esp_wifi_stop()</code>. • the station is de-authed by calling <code>esp_wifi_deauth_sta()</code>.
ASSOC_TOO_MANY	5	Disassociated, because the AP is unable to handle all currently associated STAs at the same time. For the ESP station, this reason is reported when: <ul style="list-style-type: none"> • it is received from the AP. For the ESP AP, this reason is reported when: <ul style="list-style-type: none"> • the stations associated with the AP reach the maximum number that the AP can support.
NOT_AUTHED	6	Class-2 frame received from a non-authenticated STA. For the ESP station, this reason is reported when: <ul style="list-style-type: none"> • it is received from the AP. For the ESP AP, this reason is reported when: <ul style="list-style-type: none"> • the AP receives a packet with data from a non-authenticated station.
NOT_ASSOCED	7	Class-3 frame received from a non-associated STA. For the ESP station, this reason is reported when: <ul style="list-style-type: none"> • it is received from the AP. For the ESP AP, this reason is reported when: <ul style="list-style-type: none"> • the AP receives a packet with data from a non-associated station.
ASSOC_LEAVE	8	Disassociated, because the sending station is leaving (or has left) BSS. For the ESP station, this reason is reported when: <ul style="list-style-type: none"> • it is received from the AP. • the station is disconnected by <code>esp_wifi_disconnect()</code> and other APIs.

4.27.11 ESP32-C3 Wi-Fi Station Connecting When Multiple APs Are Found

This scenario is similar as [ESP32-C3 Wi-Fi Station Connecting Scenario](#), the difference is the station will not raise the event `WIFI_EVENT_STA_DISCONNECTED` unless it fails to connect all of the found APs.

4.27.12 Wi-Fi Reconnect

The station may disconnect due to many reasons, e.g. the connected AP is restarted etc. It's the application's responsibility to do the reconnect. The recommended reconnect strategy is to call `esp_wifi_connect()` on receiving event `WIFI_EVENT_STA_DISCONNECTED`.

Sometimes the application needs more complex reconnect strategy:

- If the disconnect event is raised because the `esp_wifi_disconnect()` is called, the application may not want to do reconnect.
- If the `esp_wifi_scan_start()` may be called at anytime, a better reconnect strategy is necessary, refer to [Scan When Wi-Fi is Connecting](#).

Another thing we need to consider is the reconnect may not connect the same AP if there are more than one APs with the same SSID. The reconnect always select current best APs to connect.

4.27.13 Wi-Fi Beacon Timeout

The beacon timeout mechanism is used by ESP32-C3 station to detect whether the AP is alive or not. If the station does not receive the beacon of the connected AP within the inactive time, the beacon timeout happens. The application can set inactive time via API `esp_wifi_set_inactive_time()`.

After the beacon timeout happens, the station sends 5 probe requests to AP, it disconnects the AP and raises the event `WIFI_EVENT_STA_DISCONNECTED` if still no probe response or beacon is received from AP.

It should be considered that the timer used for beacon timeout will be reset during the scanning process. It means that the scan process will affect the triggering of the event `WIFI_EVENT_STA_BEACON_TIMEOUT`.

4.27.14 ESP32-C3 Wi-Fi Configuration

All configurations will be stored into flash when the Wi-Fi NVS is enabled; otherwise, refer to [Wi-Fi NVS Flash](#).

Wi-Fi Mode

Call `esp_wifi_set_mode()` to set the Wi-Fi mode.

Mode	Description
WIFI_MODE_NULL	NULL mode: in this mode, the internal data struct is not allocated to the station and the AP, while both the station and AP interfaces are not initialized for RX/TX Wi-Fi data. Generally, this mode is used for Sniffer, or when you only want to stop both the station and the AP without calling <code>esp_wifi_deinit()</code> to unload the whole Wi-Fi driver.
WIFI_MODE_STA	Station mode: in this mode, <code>esp_wifi_start()</code> will init the internal station data, while the station's interface is ready for the RX and TX Wi-Fi data. After <code>esp_wifi_connect()</code> , the station will connect to the target AP.
WIFI_MODE_AP	AP mode: in this mode, <code>esp_wifi_start()</code> will init the internal AP data, while the AP's interface is ready for RX/TX Wi-Fi data. Then, the Wi-Fi driver starts broad-casting beacons, and the AP is ready to get connected to other stations.
WIFI_MODE_APSTA	Station/AP coexistence mode: in this mode, <code>esp_wifi_start()</code> will simultaneously init both the station and the AP. This is done in station mode and AP mode. Please note that the channel of the external AP, which the ESP station is connected to, has higher priority over the ESP AP channel.

Station Basic Configuration

API `esp_wifi_set_config()` can be used to configure the station. The table below describes the fields in detail.

Field	Description
ssid	This is the SSID of the target AP, to which the station wants to connect to.
password	Password of the target AP.
scan_method	For <code>WIFI_FAST_SCAN</code> scan, the scan ends when the first matched AP is found. For <code>WIFI_ALL_CHANNEL_SCAN</code> , the scan finds all matched APs on all channels. The default scan is <code>WIFI_FAST_SCAN</code> .
bssid_set	If <code>bssid_set</code> is 0, the station connects to the AP whose SSID is the same as the field “ssid”, while the field “bssid” is ignored. In all other cases, the station connects to the AP whose SSID is the same as the “ssid” field, while its BSSID is the same as the “bssid” field.
bssid	This is valid only when <code>bssid_set</code> is 1; see field “bssid_set”.
channel	If the channel is 0, the station scans the channel 1 ~ N to search for the target AP; otherwise, the station starts by scanning the channel whose value is the same as that of the “channel” field, and then scans others to find the target AP. If you do not know which channel the target AP is running on, set it to 0.
sort_method	This field is only for <code>WIFI_ALL_CHANNEL_SCAN</code> . If the <code>sort_method</code> is <code>WIFI_CONNECT_AP_BY_SIGNAL</code> , all matched APs are sorted by signal, for AP with best signal will be connected firstly. E.g. if the station want to connect AP whose ssid is “apxx”, the scan finds two AP whose ssid equals to “apxx”, the first AP’s signal is -90 dBm, the second AP’s signal is -30 dBm, the station connects the second AP firstly, it doesn’t connect the first one unless it fails to connect the second one. If the <code>sort_method</code> is <code>WIFI_CONNECT_AP_BY_SECURITY</code> , all matched APs are sorted by security. E.g. if the station wants to connect AP whose ssid is “apxx”, the scan finds two AP whose ssid is “apxx”, the security of the first found AP is open while the second one is WPA2, the stations connects to the second AP firstly, it doesn’t connect the second one unless it fails to connect the first one.
threshold	The threshold is used to filter the found AP, if the RSSI or security mode is less than the configured threshold, the AP will be discard. If the RSSI set to 0, it means default threshold, the default RSSI threshold is -127 dBm. If the authmode threshold is set to 0, it means default threshold, the default authmode threshold is open.

Attention: WEP/WPA security modes are deprecated in IEEE 802.11-2016 specifications and are recommended not to be used. These modes can be rejected using authmode threshold by setting threshold as WPA2 by `threshold.authmode` as `WIFI_AUTH_WPA2_PSK`.

AP Basic Configuration

API `esp_wifi_set_config()` can be used to configure the AP. The table below describes the fields in detail.

Field	Description
ssid	SSID of AP; if the ssid[0] is 0xFF and ssid[1] is 0xFF, the AP defaults the SSID to ESP_aabbcc, where “aabbcc” is the last three bytes of the AP MAC.
password	Password of AP; if the auth mode is WIFI_AUTH_OPEN, this field will be ignored.
ssid_len	Length of SSID; if ssid_len is 0, check the SSID until there is a termination character. If ssid_len > 32, change it to 32; otherwise, set the SSID length according to ssid_len.
channel	Channel of AP; if the channel is out of range, the Wi-Fi driver defaults the channel to channel 1. So, please make sure the channel is within the required range. For more details, refer to <i>Wi-Fi Country Code</i> .
authmode	Auth mode of ESP AP; currently, ESP Wi-Fi does not support AUTH_WEP. If the authmode is an invalid value, AP defaults the value to WIFI_AUTH_OPEN.
ssid_hidden	If ssid_hidden is 1, AP does not broadcast the SSID; otherwise, it does broadcast the SSID.
max_connection	Currently, ESP Wi-Fi supports up to 10 Wi-Fi connections. If max_connection > 10, AP defaults the value to 10.
beacon_interval	Beacon interval; the value is 100 ~ 60000 ms, with default value being 100 ms. If the value is out of range, AP defaults it to 100 ms.

Wi-Fi Protocol Mode

Currently, the IDF supports the following protocol modes:

Protocol Mode	Description
802.11b	Call <code>esp_wifi_set_protocol(ifx, WIFI_PROTOCOL_11B)</code> to set the station/AP to 802.11b-only mode.
802.11bg	Call <code>esp_wifi_set_protocol(ifx, WIFI_PROTOCOL_11B WIFI_PROTOCOL_11G)</code> to set the station/AP to 802.11bg mode.
802.11g	Call <code>esp_wifi_set_protocol(ifx, WIFI_PROTOCOL_11B WIFI_PROTOCOL_11G)</code> and <code>esp_wifi_config_11b_rate(ifx, true)</code> to set the station/AP to 802.11g mode.
802.11bgn	Call <code>esp_wifi_set_protocol(ifx, WIFI_PROTOCOL_11B WIFI_PROTOCOL_11G WIFI_PROTOCOL_11N)</code> to set the station/AP to BGN mode.
802.11gn	Call <code>esp_wifi_set_protocol(ifx, WIFI_PROTOCOL_11B WIFI_PROTOCOL_11G WIFI_PROTOCOL_11N)</code> and <code>esp_wifi_config_11b_rate(ifx, true)</code> to set the station/AP to 802.11gn mode.
802.11 BGNLR	Call <code>esp_wifi_set_protocol(ifx, WIFI_PROTOCOL_11B WIFI_PROTOCOL_11G WIFI_PROTOCOL_11N WIFI_PROTOCOL_LR)</code> to set the station/AP to BGN and the LR mode.
802.11 LR	Call <code>esp_wifi_set_protocol(ifx, WIFI_PROTOCOL_LR)</code> to set the station/AP only to the LR mode. This mode is an Espressif-patented mode which can achieve a one-kilometer line of sight range. Please, make sure both the station and the AP are connected to an ESP device.

Long Range (LR)

Long Range (LR) mode is an Espressif-patented Wi-Fi mode which can achieve a one-kilometer line of sight range. It has better reception sensitivity, stronger anti-interference ability and longer transmission distance than the traditional 802.11B mode.

LR Compatibility Since LR is Espressif unique Wi-Fi mode, only ESP32-C3 devices can transmit and receive the LR data. In other words, the ESP32-C3 device should NOT transmit the data in LR data rate if the connected device doesn't support LR. The application can achieve this by configuring suitable Wi-Fi mode. If the negotiated mode supports LR, the ESP32-C3 may transmit data in LR rate, otherwise, ESP32-C3 will transmit all data in traditional Wi-Fi data rate.

Following table depicts the Wi-Fi mode negotiation:

APSTA	BGN	BG	B	BGNLR	BGLR	BLR	LR
BGN	BGN	BG	B	BGN	BG	B	•
BG	BG	BG	B	BG	BG	B	•
B	B	B	B	B	B	B	•
BGNLR	•	•	•	BGNLR	BGLR	BLR	LR
BGLR	•	•	•	BGLR	BGLR	BLR	LR
BLR	•	•	•	BLR	BLR	BLR	LR
LR	•	•	•	LR	LR	LR	LR

In above table, the row is the Wi-Fi mode of AP and the column is the Wi-Fi mode of station. The “-” indicates Wi-Fi mode of the AP and station are not compatible.

According to the table, we can conclude that:

- For LR enabled in ESP32-C3 AP, it’ s incompatible with traditional 802.11 mode because the beacon is sent in LR mode.
- For LR enabled in ESP32-C3 station and the mode is NOT LR only mode, it’ s compatible with traditional 802.11 mode.
- If both station and AP are ESP32-C3 devices and both of them enable LR mode, the negotiated mode supports LR.

If the negotiated Wi-Fi mode supports both traditional 802.11 mode and LR mode, it’ s the Wi-Fi driver’ s responsibility to automatically select the best data rate in different Wi-Fi mode and the application don’ t need to care about it.

LR Impacts to Traditional Wi-Fi device The data transmission in LR rate has no impacts on the traditional Wi-Fi device because:

- The CCA and backoff process in LR mode are consistent with 802.11 specification.
- The traditional Wi-Fi device can detect the LR signal via CCA and do backoff.

In other words, the impact transmission in LR mode is similar as the impact in 802.11B mode.

LR Transmission Distance The reception sensitivity of LR has about 4 dB gain than the traditional 802.11B mode, theoretically the transmission distance is about 2 to 2.5 times the distance of 11B.

LR Throughput The LR rate has very limited throughput, because the raw PHY data rate are 1/2 Mbps and 1/4 Mbps.

When to Use LR The general conditions for using LR are:

- Both the AP and station are devices.
- Long distance Wi-Fi connection and data transmission is required.
- Data throughput requirements are very small, such as remote device control, etc.

Wi-Fi Country Code

Call `esp_wifi_set_country()` to set the country info. The table below describes the fields in detail, please consult local 2.4 GHz RF operating regulations before configuring these fields.

Field	Description
cc[3]	Country code string, this attributes identify the country or noncountry entity in which the station/AP is operating. If it's a country, the first two octets of this string is the two character country info as described in document ISO/IEC3166-1. The third octet is one of the following: <ul style="list-style-type: none"> • an ASCII space character, if the regulations under which the station/AP is operating encompass all environments for the current frequency band in the country. • an ASCII 'O' character if the regulations under which the station/AP is operating are for an outdoor environment only. • an ASCII 'I' character if the regulations under which the station/AP is operating are for an indoor environment only. • an ASCII 'X' character if the station/AP is operating under a noncountry entity. The first two octets of the noncountry entity is two ASCII 'XX' characters. • the binary representation of the Operating Class table number currently in use. Refer to Annex E, IEEE Std 802.11-2012.
schan	Start channel, it's the minimum channel number of the regulations under which the station/AP can operate.
nchan	Total number of channels as per the regulations, e.g. if the schan=1, nchan=13, it means the station/AP can send data from channel 1 to 13.
policy	Country policy, this field control which country info will be used if the configured country info is conflict with the connected AP's. More description about policy is provided in following section.

The default country info is `{.cc="CN", .schan=1, .nchan=13, policy=WIFI_COUNTRY_POLICY_AUTO}`, if the Wi-Fi Mode is station/AP coexist mode, they share the same configured country info. Sometimes, the country info of AP, to which the station is connected, is different from the country info of configured. For example, the configured station has country info `{.cc="JP", .schan=1, .nchan=14, policy=WIFI_COUNTRY_POLICY_AUTO}`, but the connected AP has country info `{.cc="CN", .schan=1, .nchan=13}`, then country info of connected AP's is used.

Following table depicts which country info is used in different Wi-Fi Mode and different country policy, also describe the impact to active scan.

Wi-Fi Mode	Policy	Description
Station	WIFI_COUNTRY_POLICY_AUTO	On the affected AP has country IE in its beacon, the country info equals to the country info in beacon, otherwise, use default country info. For scan: <ul style="list-style-type: none"> If $\text{schan} + \text{nchan} - 1 > 11$: Use active scan from schan to 11 and use passive scan from 12 to $\text{schan} + \text{nchan} - 1$. If $\text{schan} + \text{nchan} - 1 \leq 11$: Use active scan from schan to $\text{schan} + \text{nchan} - 1$. Always keep in mind that if an AP with hidden SSID and station is set to a passive scan channel, the passive scan will not find it. In other words, if the application hopes to find the AP with hidden SSID in every channel, the policy of country info should be configured to WIFI_COUNTRY_POLICY_MANUAL.
Station	WIFI_COUNTRY_POLICY_MANUAL	Always use the configured country info. For scan, scans channel “schan” to “schan+nchan-1” with active scan.
AP	WIFI_COUNTRY_POLICY_AUTO	Always use the configured country info.
AP	WIFI_COUNTRY_POLICY_MANUAL	Always use the configured country info.
Station/AP-coexistence	WIFI_COUNTRY_POLICY_AUTO	If the station doesn't connect to any external AP, the AP use the configured country info. If the station connects to an external AP, the AP has the same country info as the station. Same as station mode with policy WIFI_COUNTRY_POLICY_AUTO.

Home Channel In AP mode, the home channel is defined as the AP channel. In Station mode, home channel is defined as the channel of AP which the station is connected to. In Station/AP-coexistence mode, the home channel of AP and station must be the same, if they are different, the station's home channel is always in priority. Take the following as an example: the AP is on channel 6, and the station connects to an AP whose channel is 9. Since the station's home channel has higher priority, the AP needs to switch its channel from 6 to make sure that it has the same home channel as the station. While switching channel, the ESP32-C3 in SoftAP mode will notify the connected stations about the channel migration using a Channel Switch Announcement (CSA). Station that supports channel switching will transit without disconnecting and reconnecting to the SoftAP.

Wi-Fi Vendor IE Configuration

By default, all Wi-Fi management frames are processed by the Wi-Fi driver, and the application does not need to care about them. Some applications, however, may have to handle the beacon, probe request, probe response and other management frames. For example, if you insert some vendor-specific IE into the management frames, it is only the management frames which contain this vendor-specific IE that will be processed. In ESP32-C3, `esp_wifi_set_vendor_ie()` and `esp_wifi_set_vendor_ie_cb()` are responsible for this kind of tasks.

4.27.15 Wi-Fi Easy Connect™ (DPP)

Wi-Fi Easy Connect™ (or Device Provisioning Protocol) is a secure and standardized provisioning protocol for configuration of Wi-Fi Devices. More information can be found on the API reference page [esp_dpp](#).

WPA2-Enterprise

WPA2-Enterprise is the secure authentication mechanism for enterprise wireless networks. It uses RADIUS server for authentication of network users before connecting to the Access Point. The authentication process is based on 802.1X policy and comes with different Extended Authentication Protocol (EAP) methods like TLS, TTLS, PEAP

etc. RADIUS server authenticates the users based on their credentials (username and password), digital certificates or both. When ESP32-C3 in Station mode tries to connect to an AP in enterprise mode, it sends authentication request to AP which is sent to RADIUS server by AP for authenticating the Station. Based on different EAP methods, the parameters can be set in configuration which can be opened using `idf.py menuconfig`. WPA2_Enterprise is supported by ESP32-C3 only in Station mode.

For establishing a secure connection, AP and Station negotiate and agree on the best possible cipher suite to be used. ESP32-C3 supports 802.1X/EAP (WPA) method of AKM and Advanced encryption standard with Counter Mode Cipher Block Chaining Message Authentication protocol (AES-CCM) cipher suite. It also supports the cipher suites supported by mbedtls if `USE_MBEDTLS_CRYPT` flag is set.

ESP32-C3 currently supports the following EAP methods:

- EAP-TLS: This is certificate based method and only requires SSID and EAP-IDF.
- PEAP: This is Protected EAP method. Username and Password are mandatory.
- **EAP-TTLS: This is credentials based method. Only server authentication is mandatory while user authentication**
 - PAP: Password Authentication Protocol.
 - CHAP: Challenge Handshake Authentication Protocol.
 - MSCHAP and MSCHAP-V2.
- EAP-FAST: This is a Protected Access Credentials (PAC) based authentication method which also uses identity and password. Currently, `USE_MBEDTLS_CRYPT` flag should be disabled to use this feature.

Detailed information on creating certificates and how to run `wpa2_enterprise` example on ESP32-C3 can be found in [wifi/wpa2_enterprise](#).

4.27.16 Wireless Network Management

Wireless Network Management allows client devices to exchange information about the network topology, including information related to RF environment. This makes each client network-aware, facilitating overall improvement in the performance of the wireless network. It is part of 802.11v specification. It also enables client to support Network assisted Roaming.

Network assisted Roaming: Enables WLAN to send messages to associated clients, resulting clients to associate with APs with better link metrics. This is useful for both load balancing and in directing poorly connected clients.

Current implementation of 802.11v includes support for BSS transition management frames.

4.27.17 Radio Resource Measurement

Radio Resource Measurement (802.11k) is intended to improve the way traffic is distributed within a network. In a wireless LAN, each device normally connects to the access point (AP) that provides the strongest signal. Depending on the number and geographic locations of the subscribers, this arrangement can sometimes lead to excessive demand on one AP and underutilization of others, resulting in degradation of overall network performance. In a network conforming to 802.11k, if the AP having the strongest signal is loaded to its full capacity, a wireless device can be moved to one of the underutilized APs. Even though the signal may be weaker, the overall throughput is greater because more efficient use is made of the network resources.

Current implementation of 802.11k includes support for beacon measurement report, link measurement report and neighbor request.

Refer IDF example [examples/wifi/roaming/README.md](#) to set up and use these APIs. Example code only demonstrates how these APIs can be used, the application should define its own algorithm and cases as required.

4.27.18 Wi-Fi Location

Wi-Fi Location will improve the accuracy of a device's location data beyond the Access Point, which will enable creation of new, feature-rich applications and services such as geo-fencing, network management, navigation and others. One of the protocols used to determine the device location with respect to the Access Point is Fine Timing Measurement which calculates Time-of-Flight of a WiFi frame.

Fine Timing Measurement (FTM)

FTM is used to measure Wi-Fi Round Trip Time (Wi-Fi RTT) which is the time a Wi-Fi signal takes to travel from a device to another device and back again. Using Wi-Fi RTT the distance between the devices can be calculated with a simple formula of $RTT * c / 2$, where c is the speed of light.

FTM uses timestamps given by Wi-Fi interface hardware at the time of arrival or departure of frames exchanged between a pair of devices. One entity called FTM Initiator (mostly a Station device) discovers the FTM Responder (can be a Station or an Access Point) and negotiates to start an FTM procedure. The procedure uses multiple Action frames sent in bursts and its ACK's to gather the timestamps data. FTM Initiator gathers the data in the end to calculate an average Round-Trip-Time.

ESP32-C3 supports FTM in below configuration:

- ESP32-C3 as FTM Initiator in Station mode.
- ESP32-C3 as FTM Responder in SoftAP mode.

Distance measurement using RTT is not accurate, factors such as RF interference, multi-path travel, antenna orientation and lack of calibration increase these inaccuracies. For better results it is suggested to perform FTM between two ESP32-C3 devices as Station and SoftAP.

Refer to IDF example <examples/wifi/ftm/README.md> for steps on how to setup and perform FTM.

4.27.19 ESP32-C3 Wi-Fi Power-saving Mode

Station Sleep

Currently, ESP32-C3 Wi-Fi supports the Modem-sleep mode which refers to the legacy power-saving mode in the IEEE 802.11 protocol. Modem-sleep mode works in Station-only mode and the station must connect to the AP first. If the Modem-sleep mode is enabled, station will switch between active and sleep state periodically. In sleep state, RF, PHY and BB are turned off in order to reduce power consumption. Station can keep connection with AP in modem-sleep mode.

Modem-sleep mode includes minimum and maximum power save modes. In minimum power save mode, station wakes up every DTIM to receive beacon. Broadcast data will not be lost because it is transmitted after DTIM. However, it can not save much more power if DTIM is short for DTIM is determined by AP.

In maximum power-saving mode, station wakes up in every listen interval to receive beacon. This listen interval can be set to be longer than the AP DTIM period. Broadcast data may be lost because station may be in sleep state at DTIM time. If listen interval is longer, more power is saved, but broadcast data is more easy to lose. Listen interval can be configured by calling API `esp_wifi_set_config()` before connecting to AP.

Call `esp_wifi_set_ps(WIFI_PS_MIN_MODEM)` to enable Modem-sleep minimum power-saving mode or `esp_wifi_set_ps(WIFI_PS_MAX_MODEM)` to enable Modem-sleep maximum power-saving mode after calling `esp_wifi_init()`. When station connects to AP, Modem-sleep will start. When station disconnects from AP, Modem-sleep will stop.

Call `esp_wifi_set_ps(WIFI_PS_NONE)` to disable modem sleep entirely. This has much higher power consumption, but provides minimum latency for receiving Wi-Fi data in real time. When modem sleep is enabled, received Wi-Fi data can be delayed for as long as the DTIM period (minimum power save mode) or the listen interval (maximum power save mode). Disabling modem sleep entirely is not possible for Wi-Fi and Bluetooth coexist mode.

The default Modem-sleep mode is `WIFI_PS_MIN_MODEM`.

AP Sleep

Currently ESP32-C3 AP doesn't support all of the power save feature defined in Wi-Fi specification. To be specific, the AP only caches unicast data for the stations connect to this AP, but doesn't cache the multicast data for the stations. If stations connected to the ESP32-C3 AP are power save enabled, they may experience multicast packet loss.

In the future, all power save features will be supported on ESP32-C3 AP.

4.27.20 ESP32-C3 Wi-Fi Throughput

The table below shows the best throughput results we got in Espressif's lab and in a shield box.

类型/吞吐量	实验室空气状况	屏蔽箱	测试工具	IDF 版本 (commit ID)
原始 802.11 数据包接收数据	N/A	130 MBit/s	内部工具	N/A
原始 802.11 数据包发送数据	N/A	130 MBit/s	内部工具	N/A
UDP 接收数据	30 MBit/s	50 MBit/s	iperf example	15575346
UDP 发送数据	30 MBit/s	40 MBit/s	iperf example	15575346
TCP 接收数据	20 MBit/s	35 MBit/s	iperf example	15575346
TCP 发送数据	20 MBit/s	37 MBit/s	iperf example	15575346

When the throughput is tested by iperf example, the sdkconfig is [examples/wifi/iperf/sdkconfig.defaults.esp32c3](#).

4.27.21 Wi-Fi 80211 Packet Send

The `esp_wifi_80211_tx()` API can be used to:

- Send the beacon, probe request, probe response, action frame.
- Send the non-QoS data frame.

It cannot be used for sending encrypted or QoS frames.

Preconditions of Using `esp_wifi_80211_tx()`

- The Wi-Fi mode is station, or AP, or station/AP.
- Either `esp_wifi_set_promiscuous(true)`, or `esp_wifi_start()`, or both of these APIs return ESP_OK. This is because Wi-Fi hardware must be initialized before `esp_wifi_80211_tx()` is called. In ESP32-C3, both `esp_wifi_set_promiscuous(true)` and `esp_wifi_start()` can trigger the initialization of Wi-Fi hardware.
- The parameters of `esp_wifi_80211_tx()` are hereby correctly provided.

Data rate

- The default data rate is 1 Mbps.
- Can set any rate through `esp_wifi_config_80211_tx_rate()` API.
- Can set any bandwidth through `esp_wifi_set_bandwidth()` API.

Side-Effects to Avoid in Different Scenarios

Theoretically, if the side-effects the API imposes on the Wi-Fi driver or other stations/APs are not considered, a raw 802.11 packet can be sent over the air with any destination MAC, any source MAC, any BSSID, or any other types

of packet. However, robust or useful applications should avoid such side-effects. The table below provides some tips and recommendations on how to avoid the side-effects of `esp_wifi_80211_tx()` in different scenarios.

Scenario	Description
No Wi-Fi connection	<p>In this scenario, no Wi-Fi connection is set up, so there are no side-effects on the Wi-Fi driver. If <code>en_sys_seq==true</code>, the Wi-Fi driver is responsible for the sequence control. If <code>en_sys_seq==false</code>, the application needs to ensure that the buffer has the correct sequence. Theoretically, the MAC address can be any address. However, this may impact other stations/APs with the same MAC/BSSID.</p> <p>Side-effect example#1 The application calls <code>esp_wifi_80211_tx</code> to send a beacon with <code>BSSID == mac_x</code> in AP mode, but the <code>mac_x</code> is not the MAC of the AP interface. Moreover, there is another AP, say “other-AP”, whose bssid is <code>mac_x</code>. If this happens, an “unexpected behavior” may occur, because the stations which connect to the “other-AP” cannot figure out whether the beacon is from the “other-AP” or the <code>esp_wifi_80211_tx</code>.</p> <p>To avoid the above-mentioned side-effects, we recommend that:</p> <ul style="list-style-type: none"> • If <code>esp_wifi_80211_tx</code> is called in station mode, the first MAC should be a multicast MAC or the exact target-device’s MAC, while the second MAC should be that of the station interface. • If <code>esp_wifi_80211_tx</code> is called in AP mode, the first MAC should be a multicast MAC or the exact target-device’s MAC, while the second MAC should be that of the AP interface. <p>The recommendations above are only for avoiding side-effects and can be ignored when there are good reasons for doing this.</p>
Have Wi-Fi connection	<p>When the Wi-Fi connection is already set up, and the sequence is controlled by the application, the latter may impact the sequence control of the Wi-Fi connection, as a whole. So, the <code>en_sys_seq</code> need to be true, otherwise <code>ESP_ERR_WIFI_ARG</code> is returned. The MAC-address recommendations in the “No Wi-Fi connection” scenario also apply to this scenario.</p> <p>If the Wi-Fi mode is station mode and the MAC address1 is the MAC of AP to which the station is connected, the MAC address2 is the MAC of station interface, we say the packets is from the station to AP. On the other hand, if the Wi-Fi mode is AP mode and the MAC address1 is the MAC of the station who connects to this AP, the MAC address2 is the MAC of AP interface, we say the packet is from the AP to station. To avoid conflicting with Wi-Fi connections, the following checks are applied:</p> <ul style="list-style-type: none"> • If the packet type is data and is from the station to AP, the ToDS bit in IEEE 80211 frame control should be 1, the FromDS bit should be 0, otherwise the packet will be discarded by Wi-Fi driver. • If the packet type is data and is from the AP to station, the ToDS bit in IEEE 80211 frame control should be 0, the FromDS bit should be 1, otherwise the packet will be discarded by Wi-Fi driver. • If the packet is from station to AP or from AP to station, the Power Management, More Data, Re-Transmission bits should be 0, otherwise the packet will be discarded by Wi-Fi driver. <p><code>ESP_ERR_WIFI_ARG</code> is returned if any check fails.</p>

4.27.22 Wi-Fi Sniffer Mode

The Wi-Fi sniffer mode can be enabled by `esp_wifi_set_promiscuous()`. If the sniffer mode is enabled, the following packets **can** be dumped to the application:

- 802.11 Management frame.
- 802.11 Data frame, including MPDU, AMPDU, AMSDU, etc.
- 802.11 MIMO frame, for MIMO frame, the sniffer only dumps the length of the frame.
- 802.11 Control frame.

The following packets will **NOT** be dumped to the application:

- 802.11 error frame, such as the frame with a CRC error, etc.

For frames that the sniffer **can** dump, the application can additionally decide which specific type of packets can be filtered to the application by using `esp_wifi_set_promiscuous_filter()` and `esp_wifi_set_promiscuous_ctrl_filter()`. By default, it will filter all 802.11 data and management frames to the application.

The Wi-Fi sniffer mode can be enabled in the Wi-Fi mode of `WIFI_MODE_NULL`, or `WIFI_MODE_STA`, or `WIFI_MODE_AP`, or `WIFI_MODE_APSTA`. In other words, the sniffer mode is active when the station is connected to the AP, or when the AP has a Wi-Fi connection. Please note that the sniffer has a **great impact** on the throughput of the station or AP Wi-Fi connection. Generally, we should **NOT** enable the sniffer, when the station/AP Wi-Fi connection experiences heavy traffic unless we have special reasons.

Another noteworthy issue about the sniffer is the callback `wifi_promiscuous_cb_t`. The callback will be called directly in the Wi-Fi driver task, so if the application has a lot of work to do for each filtered packet, the recommendation is to post an event to the application task in the callback and defer the real work to the application task.

4.27.23 Wi-Fi Multiple Antennas

The Wi-Fi multiple antennas selecting can be depicted as following picture:

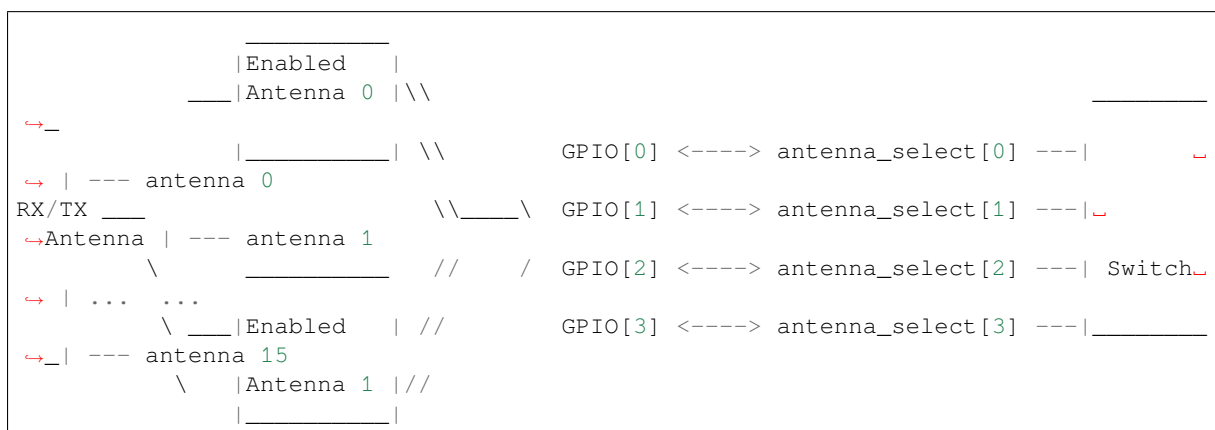

ESP32-C3 supports up to sixteen antennas through external antenna switch. The antenna switch can be controlled by up to four address pins - `antenna_select[0:3]`. Different input value of `antenna_select[0:3]` means selecting different antenna. E.g. the value '0b1011' means the antenna 11 is selected. The default value of `antenna_select[3:0]` is '0b0000', it means the antenna 0 is selected by default.

Up to four GPIOs are connected to the four active high antenna_select pins. ESP32-C3 can select the antenna by control the GPIO[0:3]. The API `esp_wifi_set_ant_gpio()` is used to configure which GPIOs are connected to antenna_selects. If `GPIO[x]` is connected to `antenna_select[x]`, then `gpio_config->gpio_cfg[x].gpio_select` should be set to 1 and `gpio_config->gpio_cfg[x].gpio_num` should be provided.

For the specific implementation of the antenna switch, there may be illegal values in `antenna_select[0:3]`. It means that ESP32-C3 may support less than sixteen antennas through the switch. For example, ESP32-WROOM-DA which uses RTC6603SP as the antenna switch, supports two antennas. Two GPIOs are connected to two active high antenna selection inputs. The value '0b01' means the antenna 0 is selected, the value '0b10' means the antenna 1 is selected. Values '0b00' and '0b11' are illegal.

Although up to sixteen antennas are supported, only one or two antennas can be simultaneously enabled for RX/TX. The API `esp_wifi_set_ant()` is used to configure which antennas are enabled.

The enabled antennas selecting algorithm is also configured by `esp_wifi_set_ant()`. The RX/TX antenna mode can be `WIFI_ANT_MODE_ANT0`, `WIFI_ANT_MODE_ANT1` or `WIFI_ANT_MODE_AUTO`. If the antenna mode is `WIFI_ANT_MODE_ANT0`, the enabled antenna 0 is selected for RX/TX data. If the antenna mode is `WIFI_ANT_MODE_ANT1`, the enabled antenna 1 is selected for RX/TX data. Otherwise, Wi-Fi automatically selects the antenna that has better signal from the enabled antennas.

If the RX antenna mode is `WIFI_ANT_MODE_AUTO`, the default antenna mode also needs to be set. Because the RX antenna switching only happens when some conditions are met, e.g. the RX antenna starts to switch if the RSSI is lower than -65 dBm and if another antenna has better signal etc, RX uses the default antenna if the conditions are

not met. If the default antenna mode is `WIFI_ANT_MODE_ANT1`, the enabled antenna 1 is used as the default RX antenna, otherwise the enabled antenna 0 is used as the default RX antenna.

Some limitations need to be considered:

- The TX antenna can be set to `WIFI_ANT_MODE_AUTO` only if the RX antenna mode is `WIFI_ANT_MODE_AUTO` because TX antenna selecting algorithm is based on RX antenna in `WIFI_ANT_MODE_AUTO` type.
- Currently Bluetooth® doesn't support the multiple antennas feature, please don't use multiple antennas related APIs.

Following is the recommended scenarios to use the multiple antennas:

- In Wi-Fi mode `WIFI_MODE_STA`, both RX/TX antenna modes are configured to `WIFI_ANT_MODE_AUTO`. The Wi-Fi driver selects the better RX/TX antenna automatically.
- The RX antenna mode is configured to `WIFI_ANT_MODE_AUTO`. The TX antenna mode is configured to `WIFI_ANT_MODE_ANT0` or `WIFI_ANT_MODE_ANT1`. The applications can choose to always select a specified antenna for TX, or implement their own TX antenna selecting algorithm, e.g. selecting the TX antenna mode based on the channel switch information etc.
- Both RX/TX antenna modes are configured to `WIFI_ANT_MODE_ANT0` or `WIFI_ANT_MODE_ANT1`.

Wi-Fi Multiple Antennas Configuration

Generally, following steps can be taken to configure the multiple antennas:

- Configure which GPIOs are connected to the antenna_selects, for example, if four antennas are supported and GPIO20/GPIO21 are connected to antenna_select[0]/antenna_select[1], the configurations look like:

```
wifi_ant_gpio_config_t config = {
    { .gpio_select = 1, .gpio_num = 20 },
    { .gpio_select = 1, .gpio_num = 21 }
};
```

- Configure which antennas are enabled and how RX/TX use the enabled antennas, for example, if antenna1 and antenna3 are enabled, the RX needs to select the better antenna automatically and uses antenna1 as its default antenna, the TX always selects the antenna3. The configuration looks like:

```
wifi_ant_config_t config = {
    .rx_ant_mode = WIFI_ANT_MODE_AUTO,
    .rx_ant_default = WIFI_ANT_ANT0,
    .tx_ant_mode = WIFI_ANT_MODE_ANT1,
    .enabled_ant0 = 1,
    .enabled_ant1 = 3
};
```

4.27.24 Wi-Fi Channel State Information

Channel state information (CSI) refers to the channel information of a Wi-Fi connection. In ESP32-C3, this information consists of channel frequency responses of sub-carriers and is estimated when packets are received from the transmitter. Each channel frequency response of sub-carrier is recorded by two bytes of signed characters. The first one is imaginary part and the second one is real part. There are up to three fields of channel frequency responses according to the type of received packet. They are legacy long training field (LLTF), high throughput LTF (HT-LTF) and space time block code HT-LTF (STBC-HT-LTF). For different types of packets which are received on channels with different state, the sub-carrier index and total bytes of signed characters of CSI is shown in the following table.

channel	secondary channel	none			below					above				
		packet information	signal mode	non HT	HT	non HT	HT	non HT	HT	non HT	HT	non HT	HT	
channel bandwidth	STBC	20 MHz	20 MHz	20 MHz	20 MHz	20 MHz	40 MHz	20 MHz	20 MHz	40 MHz	20 MHz	20 MHz	40 MHz	
		non STBC	non STBC	STBC	non STBC	non STBC	STBC	non STBC	STBC	non STBC	non STBC	STBC	non STBC	STBC
sub-carrier index	LLTF	0~31, - 32~ 1	0~31, - 32~ 1	0~31, - 32~ 1	0~63	0~63	0~63	0~63	0~63	- 64~ 1	- 64~ 1	- 64~ 1	- 64~ 1	- 64~ 1
	HT-LTF	•	0~31, - 32~ 1	0~31, - 32~ 1	•	0~63	0~62	0~63, - 64~ 1	0~60, - 60~ 1	•	- 64~ 1	- 62~ 1	0~63, - 64~ 1	0~60, - 60~ 1
	STBC-HT-LTF	•	•	0~31, - 32~ 1	•	•	0~62	•	0~60, - 60~ 1	•	•	- 62~ 1	•	0~60, - 60~ 1
total bytes		128	256	384	128	256	380	384	612	128	256	376	384	612

All of the information in the table can be found in the structure `wifi_csi_info_t`.

- Secondary channel refers to `secondary_channel` field of `rx_ctrl` field.
- Signal mode of packet refers to `sig_mode` field of `rx_ctrl` field.
- Channel bandwidth refers to `cwb` field of `rx_ctrl` field.
- STBC refers to `stbc` field of `rx_ctrl` field.
- Total bytes refers to `len` field.
- The CSI data corresponding to each Long Training Field(LTF) type is stored in a buffer starting from the `buf` field. Each item is stored as two bytes: imaginary part followed by real part. The order of each item is the same as the sub-carrier in the table. The order of LTF is: LLTF, HT-LTF, STBC-HT-LTF. However all 3 LTFs may not be present, depending on the channel and packet information (see above).
- If `first_word_invalid` field of `wifi_csi_info_t` is true, it means that the first four bytes of CSI data is invalid due to a hardware limitation in ESP32-C3.
- More information like RSSI, noise floor of RF, receiving time and antenna is in the `rx_ctrl` field.

When imaginary part and real part data of sub-carrier are used, please refer to the table below.

PHY standard	Sub-carrier range	Pilot sub-carrier	Sub-carrier(total/data)
802.11a/g	-26 to +26	-21, -7, +7, +21	52 total, 48 usable
802.11n, 20MHz	-28 to +28	-21, -7, +7, +21	56 total, 52 usable
802.11n, 40MHz	-57 to +57	-53, -25, -11, +11, +25, +53	114 total, 108 usable

Note:

- For STBC packet, CSI is provided for every space-time stream without CSD (cyclic shift delay). As each cyclic shift on the additional chains shall be -200 ns, only the CSD angle of first space-time stream is recorded in sub-carrier 0 of HT-LTF and STBC-HT-LTF for there is no channel frequency response in sub-carrier 0. CSD[10:0] is 11 bits, ranging from -pi to pi.
- If LLTF, HT-LTF, or STBC-HT-LTF is not enabled by calling API `esp_wifi_set_csi_config()`, the total bytes of CSI data will be fewer than that in the table. For example, if LLTF and HT-LTF is not enabled and STBC-HT-LTF is enabled, when a packet is received with the condition above/HT/40MHz/STBC, the total bytes of CSI data is 244 $((61 + 60) * 2 + 2 = 244$. The result is aligned to four bytes, and the last two bytes are invalid).

4.27.25 Wi-Fi Channel State Information Configure

To use Wi-Fi CSI, the following steps need to be done.

- Select Wi-Fi CSI in menuconfig. Go to `Menuconfig > Components config > Wi-Fi > Wi-Fi CSI (Channel State Information)`.
- Set CSI receiving callback function by calling API `esp_wifi_set_csi_rx_cb()`.
- Configure CSI by calling API `esp_wifi_set_csi_config()`.
- Enable CSI by calling API `esp_wifi_set_csi()`.

The CSI receiving callback function runs from Wi-Fi task. So, do not do lengthy operations in the callback function. Instead, post necessary data to a queue and handle it from a lower priority task. Because station does not receive any packet when it is disconnected and only receives packets from AP when it is connected, it is suggested to enable sniffer mode to receive more CSI data by calling `esp_wifi_set_promiscuous()`.

4.27.26 Wi-Fi HT20/40

ESP32-C3 supports Wi-Fi bandwidth HT20 or HT40 and does not support HT20/40 coexist. `esp_wifi_set_bandwidth()` can be used to change the default bandwidth of station or AP. The default bandwidth for ESP32-C3 station and AP is HT40.

In station mode, the actual bandwidth is firstly negotiated during the Wi-Fi connection. It is HT40 only if both the station and the connected AP support HT40, otherwise it's HT20. If the bandwidth of connected AP is changes, the actual bandwidth is negotiated again without Wi-Fi disconnecting.

Similarly, in AP mode, the actual bandwidth is negotiated between AP and the stations that connect to the AP. It's HT40 if the AP and one of the stations support HT40, otherwise it's HT20.

In station/AP coexist mode, the station/AP can configure HT20/40 separately. If both station and AP are negotiated to HT40, the HT40 channel should be the channel of station because the station always has higher priority than AP in ESP32-C3. E.g. the configured bandwidth of AP is HT40, the configured primary channel is 6 and the configured secondary channel is 10. The station is connected to an router whose primary channel is 6 and secondary channel is 2, then the actual channel of AP is changed to primary 6 and secondary 2 automatically.

Theoretically the HT40 can gain better throughput because the maximum raw physical (PHY) data rate for HT40 is 150Mbps while it's 72Mbps for HT20. However, if the device is used in some special environment, e.g. there are too many other Wi-Fi devices around the ESP32-C3 device, the performance of HT40 may be degraded. So if the applications need to support same or similar scenarios, it's recommended that the bandwidth is always configured to HT20.

4.27.27 Wi-Fi QoS

ESP32-C3 supports all the mandatory features required in WFA Wi-Fi QoS Certification.

Four ACs (Access Category) are defined in Wi-Fi specification, each AC has a its own priority to access the Wi-Fi channel. Moreover a map rule is defined to map the QoS priority of other protocol, such as 802.11D or TCP/IP precedence to Wi-Fi AC.

Below is a table describes how the IP Precedences are mapped to Wi-Fi ACs in ESP32-C3, it also indicates whether the AMPDU is supported for this AC. The table is sorted with priority descending order, namely, the AC_VO has highest priority.

IP Precedence	Wi-Fi AC	Support AMPDU?
6, 7	AC_VO (Voice)	No
4, 5	AC_VI (Video)	Yes
3, 0	AC_BE (Best Effort)	Yes
1, 2	AC_BK (Background)	Yes

The application can make use of the QoS feature by configuring the IP precedence via socket option IP_TOS. Here is an example to make the socket to use VI queue:

```
const int ip_precedence_vi = 4;
const int ip_precedence_offset = 5;
int priority = (ip_precedence_vi << ip_precedence_offset);
setsockopt(socket_id, IPPROTO_IP, IP_TOS, &priority, sizeof(priority));
```

Theoretically the higher priority AC has better performance than the low priority AC, however, it's not always be true, here are some suggestions about how to use the Wi-Fi QoS:

- For some really important application traffic, can put it into AC_VO queue. Avoid sending big traffic via AC_VO queue. On one hand, the AC_VO queue doesn't support AMPDU and it can't get better performance than other queue if the traffic is big, on the other hand, it may impact the the management frames that also use AC_VO queue.
- Avoid using more than two different AMPDU supported precedences, e.g. socket A uses precedence 0, socket B uses precedence 1, socket C uses precedence 2, this is a bad design because it may need much more memory. To be detailed, the Wi-Fi driver may generate a Block Ack session for each precedence and it needs more memory if the Block Ack session is setup.

4.27.28 Wi-Fi AMSDU

ESP32-C3 supports receiving and transmitting AMSDU.

4.27.29 Wi-Fi Fragment

ESP32C3 supports Wi-Fi receiving and transmitting fragment.

4.27.30 WPS Enrollee

ESP32-C3 supports WPS enrollee feature in Wi-Fi mode WIFI_MODE_STA or WIFI_MODE_APSTA. Currently ESP32-C3 supports WPS enrollee type PBC and PIN.

4.27.31 Wi-Fi Buffer Usage

This section is only about the dynamic buffer configuration.

Why Buffer Configuration Is Important

In order to get a , high-performance system, we need to consider the memory usage/configuration very carefully, because:

- the available memory in ESP32-C3 is limited.
- currently, the default type of buffer in LwIP and Wi-Fi drivers is “dynamic” , **which means that both the LwIP and Wi-Fi share memory with the application**. Programmers should always keep this in mind; otherwise, they will face a memory issue, such as “running out of heap memory” .
- it is very dangerous to run out of heap memory, as this will cause ESP32-C3 an “undefined behavior” . Thus, enough heap memory should be reserved for the application, so that it never runs out of it.
- the Wi-Fi throughput heavily depends on memory-related configurations, such as the TCP window size, Wi-Fi RX/TX dynamic buffer number, etc.
- the peak heap memory that the ESP32-C3 LwIP/Wi-Fi may consume depends on a number of factors, such as the maximum TCP/UDP connections that the application may have, etc.
- the total memory that the application requires is also an important factor when considering memory configuration.

Due to these reasons, there is not a good-for-all application configuration. Rather, we have to consider memory configurations separately for every different application.

Dynamic vs. Static Buffer

The default type of buffer in Wi-Fi drivers is “dynamic” . Most of the time the dynamic buffer can significantly save memory. However, it makes the application programming a little more difficult, because in this case the application needs to consider memory usage in Wi-Fi.

lwIP also allocates buffers at the TCP/IP layer, and this buffer allocation is also dynamic. See [lwIP documentation section about memory use and performance](#).

Peak Wi-Fi Dynamic Buffer

The Wi-Fi driver supports several types of buffer (refer to [Wi-Fi Buffer Configure](#)). However, this section is about the usage of the dynamic Wi-Fi buffer only. The peak heap memory that Wi-Fi consumes is the **theoretically-maximum memory** that the Wi-Fi driver consumes. Generally, the peak memory depends on:

- the number of dynamic rx buffers that are configured: `wifi_rx_dynamic_buf_num`
- the number of dynamic tx buffers that are configured: `wifi_tx_dynamic_buf_num`
- the maximum packet size that the Wi-Fi driver can receive: `wifi_rx_pkt_size_max`
- the maximum packet size that the Wi-Fi driver can send: `wifi_tx_pkt_size_max`

So, the peak memory that the Wi-Fi driver consumes can be calculated with the following formula:

$$\text{wifi_dynamic_peek_memory} = (\text{wifi_rx_dynamic_buf_num} * \text{wifi_rx_pkt_size_max}) + (\text{wifi_tx_dynamic_buf_num} * \text{wifi_tx_pkt_size_max})$$

Generally, we do not need to care about the dynamic tx long buffers and dynamic tx long long buffers, because they are management frames which only have a small impact on the system.

4.27.32 How to improve Wi-Fi performance

The performance of ESP32-C3 Wi-Fi is affected by many parameters, and there are mutual constraints between each parameter. A proper configuration can not only improve performance but also increase available memory for applications and improve stability.

In this section, we will briefly explain the operating mode of the Wi-Fi/LWIP protocol stack and explain the role of each parameter. We will give several recommended configuration ranks, user can choose the appropriate rank according to the usage scenario.

Protocol stack operation mode

The ESP32-C3 protocol stack is divided into four layers: Application, LWIP, Wi-Fi, and Hardware.

- During receiving, hardware puts the received packet into DMA buffer, and then transfers it into the RX buffer of Wi-Fi, LWIP in turn for related protocol processing, and finally to the application layer. The Wi-Fi RX buffer and the LWIP RX buffer shares the same buffer by default. In other words, the Wi-Fi forwards the packet to LWIP by reference by default.
- During sending, the application copies the messages to be sent into the TX buffer of the LWIP layer for TCP/IP encapsulation. The messages will then be passed to the TX buffer of the Wi-Fi layer for MAC encapsulation and wait to be sent.

Parameters

Increasing the size or number of the buffers mentioned above properly can improve Wi-Fi performance. Meanwhile, it will reduce available memory to the application. The following is an introduction to the parameters that users need to configure:

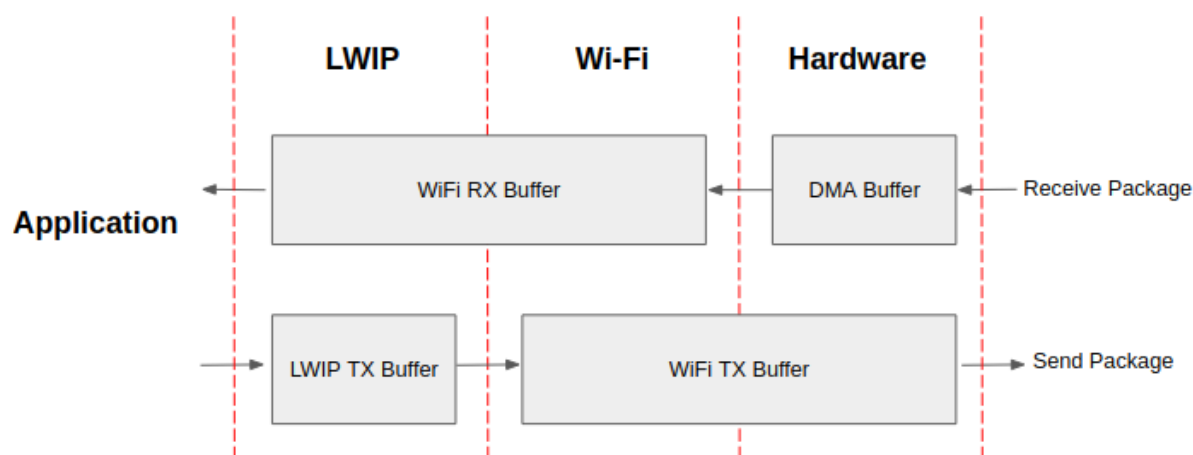

Fig. 57: ESP32-C3 datapath

RX direction:

- ***CONFIG_ESP32_WIFI_STATIC_RX_BUFFER_NUM*** This parameter indicates the number of DMA buffer at the hardware layer. Increasing this parameter will increase the sender's one-time receiving throughput, thereby improving the Wi-Fi protocol stack ability to handle burst traffic.
- ***CONFIG_ESP32_WIFI_DYNAMIC_RX_BUFFER_NUM*** This parameter indicates the number of RX buffer in the Wi-Fi layer. Increasing this parameter will improve the performance of packet reception. This parameter needs to match the RX buffer size of the LWIP layer.
- ***CONFIG_ESP32_WIFI_RX_BA_WIN*** This parameter indicates the size of the AMPDU BA Window at the receiving end. This parameter should be configured to the smaller value between twice of ***CONFIG_ESP32_WIFI_STATIC_RX_BUFFER_NUM*** and ***CONFIG_ESP32_WIFI_DYNAMIC_RX_BUFFER_NUM***.
- ***CONFIG_LWIP_TCP_WND_DEFAULT*** This parameter represents the RX buffer size of the LWIP layer for each TCP stream. Its value should be configured to the value of ***WIFI_DYNAMIC_RX_BUFFER_NUM***(KB) to reach a high and stable performance. Meanwhile, in case of multiple streams, this value needs to be reduced proportionally.

TX direction:

- ***CONFIG_ESP32_WIFI_STATIC_TX_BUFFER_NUM*** This parameter indicates the type of TX buffer, it is recommended to configure it as a dynamic buffer, which can make full use of memory.
- ***CONFIG_ESP32_WIFI_DYNAMIC_TX_BUFFER_NUM*** This parameter indicates the number of TX buffer on the Wi-Fi layer. Increasing this parameter will improve the performance of packet sending. The parameter value needs to match the TX buffer size of the LWIP layer.
- ***CONFIG_LWIP_TCP_SND_BUF_DEFAULT*** This parameter represents the TX buffer size of the LWIP layer for each TCP stream. Its value should be configured to the value of ***WIFI_DYNAMIC_TX_BUFFER_NUM***(KB) to reach a high and stable performance. In case of multiple streams, this value needs to be reduced proportionally.

Throughput optimization by placing code in IRAM:

Note: The buffer size mentioned above is fixed as 1.6 KB.

How to configure parameters

ESP32-C3's memory is shared by protocol stack and applications.

Here, we have given several configuration ranks. In most cases, the user should select a suitable rank for parameter configuration according to the size of the memory occupied by the application.

The parameters not mentioned in the following table should be set to the default.

Rank	lperf	Default	Minimum
Available memory (KB)	59	160	180
WIFI_STATIC_RX_BUFFER_NUM	8	8	3
WIFI_DYNAMIC_RX_BUFFER_NUM	16	16	6
WIFI_DYNAMIC_TX_BUFFER_NUM	16	16	6
WIFI_RX_BA_WIN	32	16	6
TCP_SND_BUF_DEFAULT (KB)	40	16	6
TCP_WND_DEFAULT (KB)	40	16	6
LWIP_IRAM_OPTIMIZATION	13	13	0
TCP TX throughput (Mbit/s)	38.1	27.2	20.4
TCP RX throughput (Mbit/s)	35.3	24.2	17.4
UDP TX throughput (Mbit/s)	40.6	38.9	34.1
UDP RX throughput (Mbit/s)	52.4	44.5	44.2

Ranks:

- **Iperf rank** ESP32-C3 extreme performance rank used to test extreme performance.
- **Default rank** ESP32-C3's default configuration rank, the available memory, and performance are in balance.
- **Minimum rank** This is the minimum configuration rank of ESP32-C3. The protocol stack only uses the necessary memory for running. It is suitable for scenarios that have no requirement for performance and the application requires lots of space.

4.27.33 Wi-Fi Menuconfig

Wi-Fi Buffer Configure

If you are going to modify the default number or type of buffer, it would be helpful to also have an overview of how the buffer is allocated/freed in the data path. The following diagram shows this process in the TX direction:

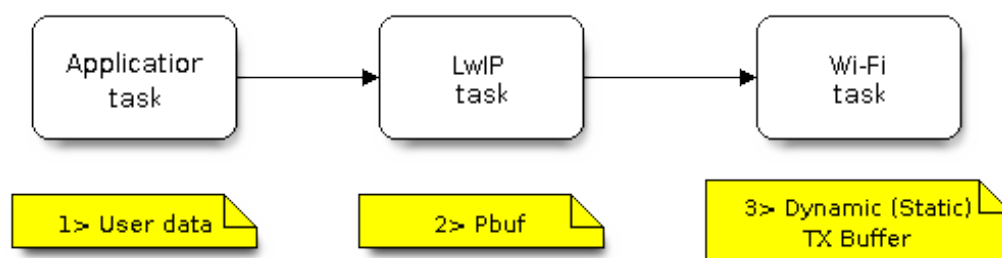

Fig. 58: TX Buffer Allocation

Description:

- The application allocates the data which needs to be sent out.
- The application calls TCP/IP-/Socket-related APIs to send the user data. These APIs will allocate a PBUF used in LwIP, and make a copy of the user data.

- When LwIP calls a Wi-Fi API to send the PBUF, the Wi-Fi API will allocate a “Dynamic Tx Buffer” or “Static Tx Buffer” , make a copy of the LwIP PBUF, and finally send the data.

The following diagram shows how buffer is allocated/freed in the RX direction:

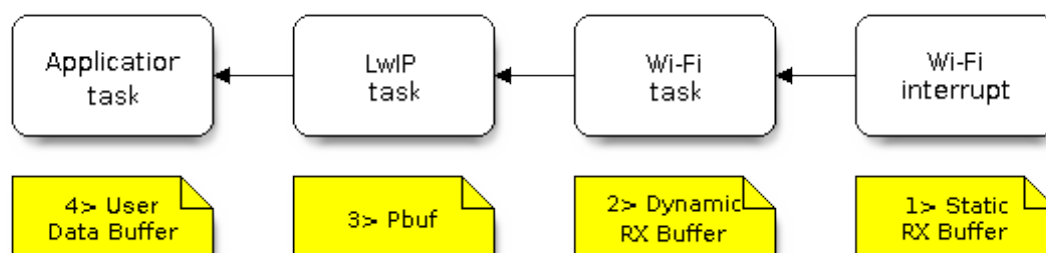

Fig. 59: RX Buffer Allocation

Description:

- The Wi-Fi hardware receives a packet over the air and puts the packet content to the “Static Rx Buffer” , which is also called “RX DMA Buffer” .
- The Wi-Fi driver allocates a “Dynamic Rx Buffer” , makes a copy of the “Static Rx Buffer” , and returns the “Static Rx Buffer” to hardware.
- The Wi-Fi driver delivers the packet to the upper-layer (LwIP), and allocates a PBUF for holding the “Dynamic Rx Buffer” .
- The application receives data from LwIP.

The diagram shows the configuration of the Wi-Fi internal buffer.

Buffer Type	Alloc Type	Default	Configurable	Description
Static RX Buffer (Hardware RX Buffer)	Static	10 * 1600 Bytes	Yes	<p>This is a kind of DMA memory. It is initialized in <code>esp_wifi_init()</code> and freed in <code>esp_wifi_deinit()</code>. The ‘Static Rx Buffer’ forms the hardware receiving list. Upon receiving a frame over the air, hardware writes the frame into the buffer and raises an interrupt to the CPU. Then, the Wi-Fi driver reads the content from the buffer and returns the buffer back to the list.</p> <p>If the application want to reduce the the memory statically allocated by Wi-Fi, they can reduce this value from 10 to 6 to save 6400 Bytes memory. It’s not recommended to reduce the configuration to a value less than 6 unless the AMPDU feature is disabled.</p>
Dynamic RX Buffer	Dynamic	32	Yes	<p>The buffer length is variable and it depends on the received frames’ length. When the Wi-Fi driver receives a frame from the ‘Hardware Rx Buffer’, the ‘Dynamic Rx Buffer’ needs to be allocated from the heap. The number of the Dynamic Rx Buffer, configured in the menu-config, is used to limit the total un-freed Dynamic Rx Buffer number.</p>
Dynamic TX Buffer	Dynamic	32	Yes	<p>This is a kind of DMA memory. It is allocated to the heap. When the upper-layer (LwIP) sends packets to the Wi-Fi driver, it firstly allocates a ‘Dynamic TX Buffer’ and makes a copy of the upper-layer buffer.</p> <p>The Dynamic and Static TX Buffers are mutually exclusive.</p>
Static TX Buffer	Static	16 * 1600Bytes	Yes	<p>This is a kind of DMA memory. It is initialized in <code>esp_wifi_init()</code> and freed in <code>esp_wifi_deinit()</code>. When the upper-layer (LwIP) sends packets to the Wi-Fi driver, it firstly allocates a ‘Static TX Buffer’ and makes a copy of the upper-layer buffer.</p> <p>The Dynamic and Static TX Buffer are mutually exclusive.</p> <p>Since the TX buffer must be DMA buffer, so when PSRAM is enabled, the TX buffer must be static.</p>
Management Short Buffer	Dynamic	8	NO	Wi-Fi driver’ s internal buffer.
Management Long Buffer	Dynamic	32	NO	Wi-Fi driver’ s internal buffer.
Management Long Long Buffer	Dynamic	32	NO	Wi-Fi driver’ s internal buffer.

Wi-Fi NVS Flash

If the Wi-Fi NVS flash is enabled, all Wi-Fi configurations set via the Wi-Fi APIs will be stored into flash, and the Wi-Fi driver will start up with these configurations next time it powers on/reboots. However, the application can choose to disable the Wi-Fi NVS flash if it does not need to store the configurations into persistent memory, or has its own persistent storage, or simply due to debugging reasons, etc.

Wi-Fi AMPDU

ESP32-C3 supports both receiving and transmitting AMPDU, the AMPDU can greatly improve the Wi-Fi throughput.

Generally, the AMPDU should be enabled. Disabling AMPDU is usually for debugging purposes.

4.27.34 Troubleshooting

Please refer to a separate document with [Espressif Wireshark User Guide](#).

Espressif Wireshark User Guide

1. Overview

1.1 What is Wireshark? [Wireshark](#) (originally named “Ethereal”) is a network packet analyzer that captures network packets and displays the packet data as detailed as possible. It uses WinPcap as its interface to directly capture network traffic going through a network interface controller (NIC).

You could think of a network packet analyzer as a measuring device used to examine what is going on inside a network cable, just like a voltmeter is used by an electrician to examine what is going on inside an electric cable.

In the past, such tools were either very expensive, proprietary, or both. However, with the advent of Wireshark, all that has changed.

Wireshark is released under the terms of the GNU General Public License, which means you can use the software and the source code free of charge. It also allows you to modify and customize the source code.

Wireshark is, perhaps, one of the best open source packet analyzers available today.

1.2 Some Intended Purposes Here are some examples of how Wireshark is typically used:

- Network administrators use it to troubleshoot network problems.
- Network security engineers use it to examine security problems.
- Developers use it to debug protocol implementations.
- People use it to learn more about network protocol internals.

Beside these examples, Wireshark can be used for many other purposes.

1.3 Features The main features of Wireshark are as follows:

- Available for UNIX and Windows
- Captures live packet data from a network interface
- Displays packets along with detailed protocol information
- Opens/saves the captured packet data
- Imports/exports packets into a number of file formats, supported by other capture programs
- Advanced packet filtering
- Searches for packets based on multiple criteria
- Colorizes packets according to display filters
- Calculates statistics
- ...and a lot more!

1.4 Wireshark Can or Can't Do

- **Live capture from different network media.**
Wireshark can capture traffic from different network media, including wireless LAN.
- **Import files from many other capture programs.**
Wireshark can import data from a large number of file formats, supported by other capture programs.
- **Export files for many other capture programs.**
Wireshark can export data into a large number of file formats, supported by other capture programs.
- **Numerous protocol dissectors.**
Wireshark can dissect, or decode, a large number of protocols.
- **Wireshark is not an intrusion detection system.**
It will not warn you if there are any suspicious activities on your network. However, if strange things happen, Wireshark might help you figure out what is really going on.
- **Wireshark does not manipulate processes on the network, it can only perform “measurements” within it.**
Wireshark does not send packets on the network or influence it in any other way, except for resolving names (converting numerical address values into a human readable format), but even that can be disabled.

2. Where to Get Wireshark You can get Wireshark from the official website: <https://www.wireshark.org/download.html>

Wireshark can run on various operating systems. Please download the correct version according to the operating system you are using.

3. Step-by-step Guide This demonstration uses **Wireshark 2.2.6 on Linux.**

a) Start Wireshark

On Linux, you can run the shell script provided below. It starts Wireshark, then configures NIC and the channel for packet capture.

```
ifconfig $1 down
iwconfig $1 mode monitor
iwconfig $1 channel $2
ifconfig $1 up
Wireshark&
```

In the above script, the parameter \$1 represents NIC and \$2 represents channel. For example, wlan0 in ./xxx.sh wlan0 6, specifies the NIC for packet capture, and 6 identifies the channel of an AP or Soft-AP.

b) Run the Shell Script to Open Wireshark and Display Capture Interface

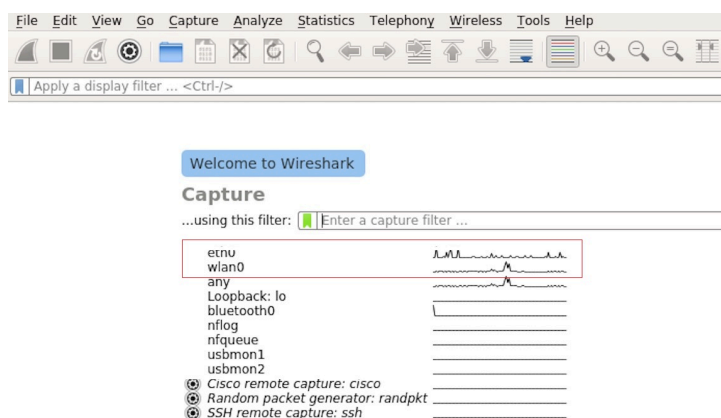

Fig. 60: Wireshark Capture Interface

c) Select the Interface to Start Packet Capture

As the red markup shows in the picture above, many interfaces are available. The first one is a local NIC and the second one is a wireless NIC.

Please select the NIC according to your requirements. This document will use the wireless NIC to demonstrate packet capture.

Double click `wlan0` to start packet capture.

d) Set up Filters

Since all packets in the channel will be captured, and many of them are not needed, you have to set up filters to get the packets that you need.

Please find the picture below with the red markup, indicating where the filters should be set up.

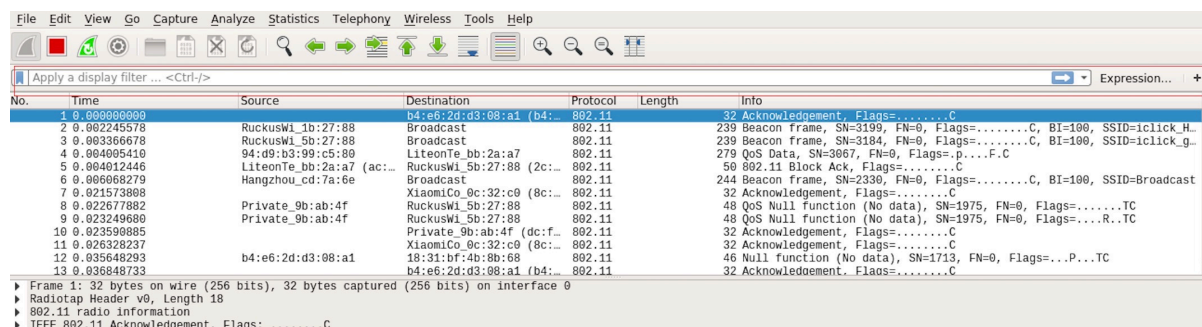

Fig. 61: Setting up Filters in Wireshark

Click *Filter*, the top left blue button in the picture below. The *display filter* dialogue box will appear.



Fig. 62: Display Filter Dialogue Box

Click the *Expression* button to bring up the *Filter Expression* dialogue box and set the filter according to your requirements.

The quickest way: enter the filters directly in the toolbar.

Click on this area to enter or modify the filters. If you enter a wrong or unfinished filter, the built-in syntax check turns the background red. As soon as the correct expression is entered, the background becomes green.

The previously entered filters are automatically saved. You can access them anytime by opening the drop down list.

For example, as shown in the picture below, enter two MAC addresses as the filters and click *Apply* (the blue arrow). In this case, only the packet data transmitted between these two MAC addresses will be captured.

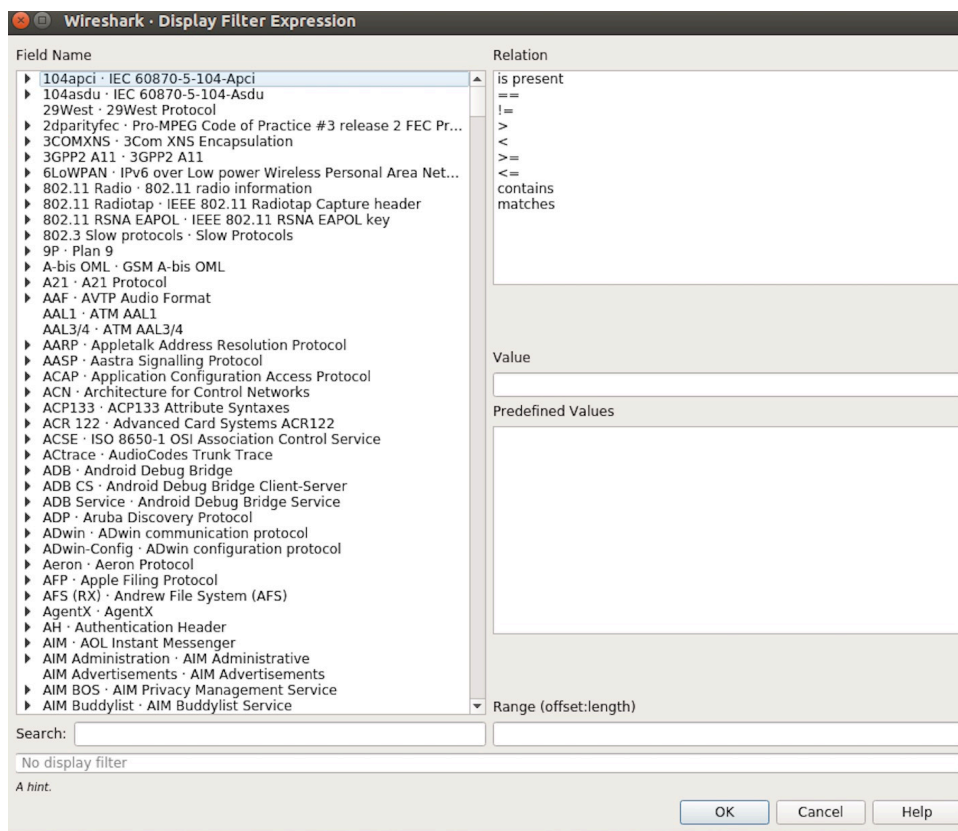

Fig. 63: Filter Expression Dialogue Box



Fig. 64: Filter Toolbar

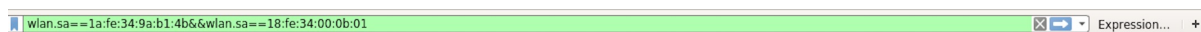

Fig. 65: Example of MAC Addresses applied in the Filter Toolbar

e) Packet List

You can click any packet in the packet list and check the detailed information about it in the box below the list. For example, if you click the first packet, its details will appear in that box.

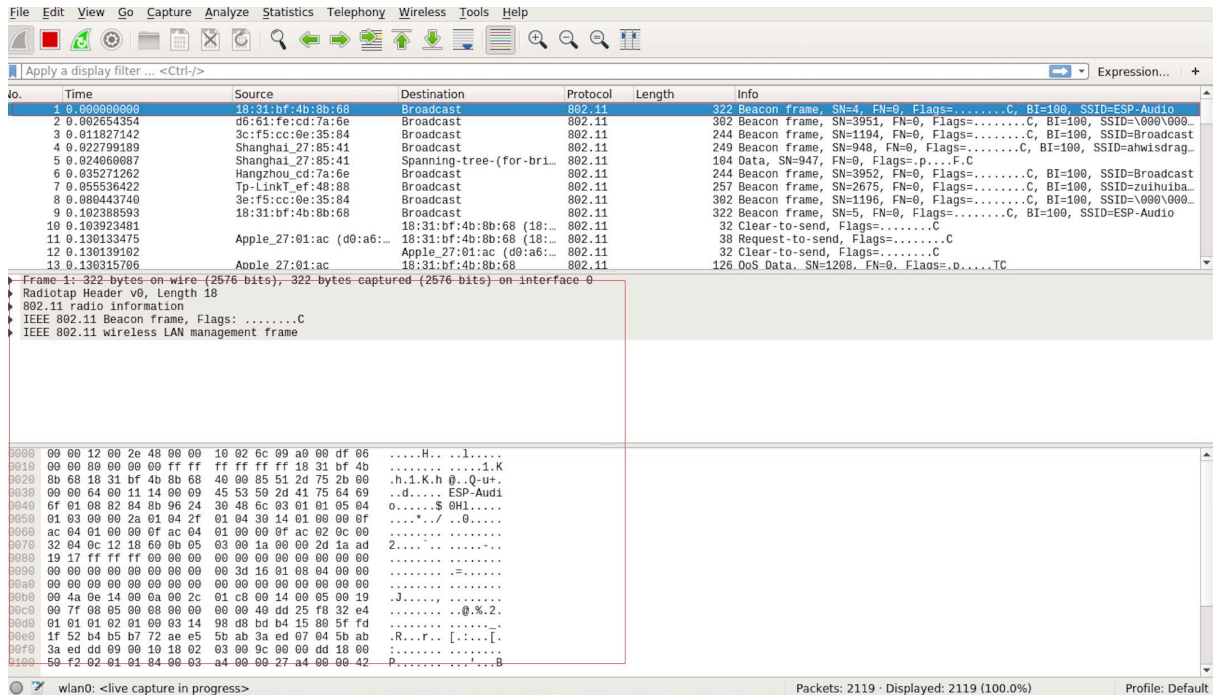

Fig. 66: Example of Packet List Details

f) Stop/Start Packet Capture

As shown in the picture below, click the red button to stop capturing the current packet.

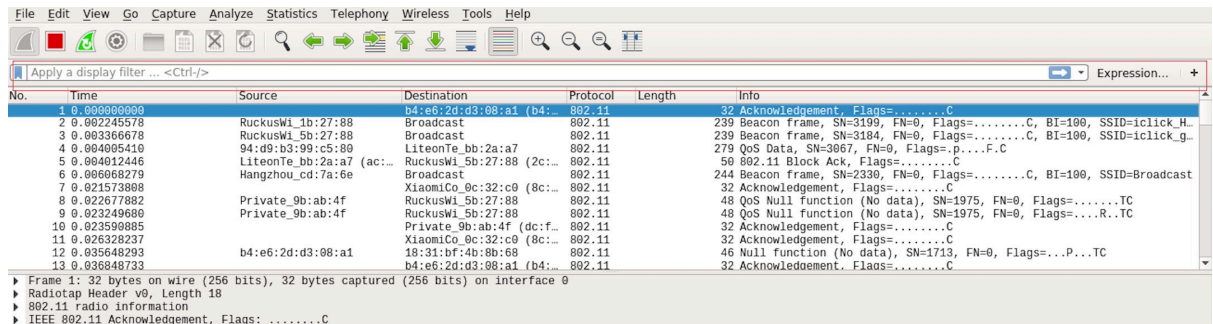

Fig. 67: Stopping Packet Capture

Click the top left blue button to start or resume packet capture.

g) Save the Current Packet

On Linux, go to *File -> Export Packet Dissections -> As Plain Text File* to save the packet.

Please note that *All packets, Displayed* and *All expanded* must be selected.

By default, Wireshark saves the captured packet in a libpcap file. You can also save the file in other formats, e.g. txt, to analyze it in other tools.

4.28 Wi-Fi Security

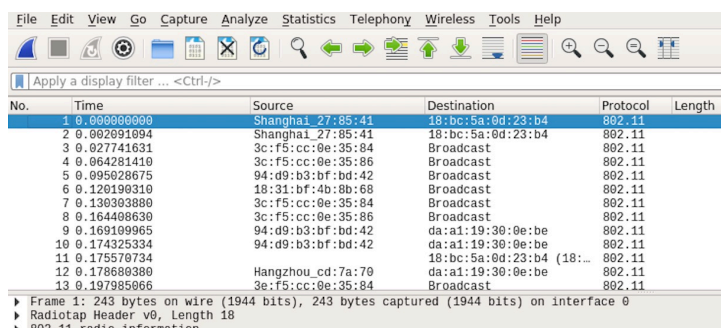

Fig. 68: Starting or Resuming the Packets Capture

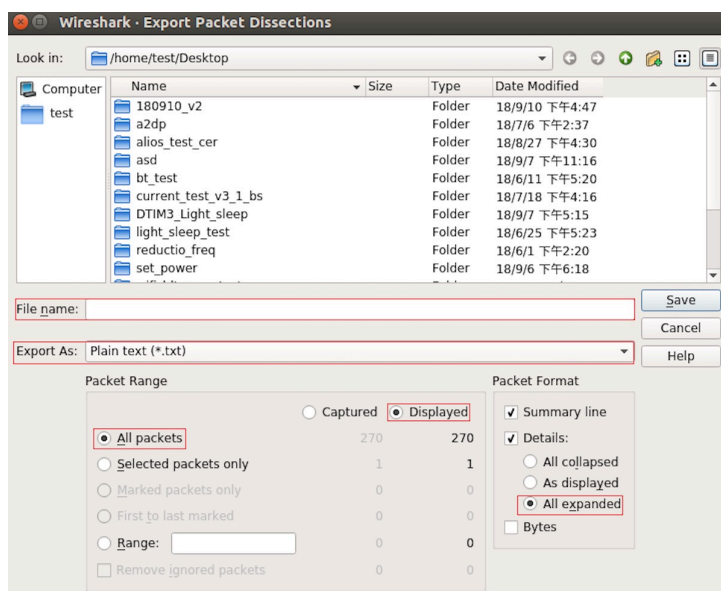

Fig. 69: Saving Captured Packets

4.28.1 ESP32-C3 Wi-Fi Security Features

- Support for Protected Management Frames (PMF)
- Support for WPA3-Personal

In addition to traditional security methods (WEP/WPA-TKIP/WPA2-CCMP), ESP32-C3 Wi-Fi supports state-of-the-art security protocols, namely Protected Management Frames based on 802.11w standard and Wi-Fi Protected Access 3 (WPA3-Personal). Together, PMF and WPA3 provide better privacy and robustness against known attacks on traditional modes.

4.28.2 Protected Management Frames (PMF)

Introduction

In Wi-Fi, management frames such as beacons, probes, (de)authentication, (dis)association are used by non-AP stations to scan and connect to an AP. Unlike data frames, these frames are sent unencrypted. An attacker can use eavesdropping and packet injection to send spoofed (de)authentication/(dis)association frames at the right time, leading to the following attacks in case of unprotected management frame exchanges.

- DOS attack on one or all clients in the range of the attacker.
- Tearing down existing association on AP side by sending association request.
- Forcing a client to perform 4-way handshake again in case PSK is compromised in order to get PTK.
- Getting SSID of hidden network from association request.
- Launching man-in-the-middle attack by forcing clients to deauth from legitimate AP and associating to a rogue one.

PMF provides protection against these attacks by encrypting unicast management frames and providing integrity checks for broadcast management frames. These include deauthentication, disassociation and robust management frames. It also provides Secure Association (SA) teardown mechanism to prevent spoofed association/authentication frames from disconnecting already connected clients.

There are 3 types of PMF configuration modes on both Station and AP side -

- PMF Optional
- PMF Required
- PMF Disabled

Depending on the PMF configuration on Station and AP side, the resulting connection will behave differently. Below table summarises all possible outcomes.

STA Setting	AP Setting	Outcome
PMF Optional	PMF Optional/Required	Mgmt Frames Protected
PMF Optional	PMF Disabled	Mgmt Frames Not Protected
PMF Required	PMF Optional/Required	Mgmt Frames Protected
PMF Required	PMF Disabled	STA refuses Connection
PMF Disabled	PMF Optional/Disabled	Mgmt Frames Not Protected
PMF Disabled	PMF Required	AP refuses Connection

API & Usage

ESP32-C3 supports PMF only in Station mode. Station defaults to PMF Optional mode and disabling PMF is not possible. For even higher security, PMF required mode can be enabled by setting the `required` flag in `pmf_cfg` while using the `esp_wifi_set_config()` API. This will result in Station only connecting to a PMF enabled AP and rejecting all other AP's. An example of this configuration is given below.

```
wifi_config_t wifi_config = {
    .sta = {
        .ssid = EXAMPLE_WIFI_SSID,
        .password = EXAMPLE_WIFI_PASSWORD,
```

(continues on next page)

(continued from previous page)

```
.pmf_cfg = {  
    .required = true  
}  
};
```

Attention: `capable` flag in `pmf_cfg` is deprecated and set to true internally. This is to take the additional security benefit of PMF whenever possible.

4.28.3 WPA3-Personal

Introduction

Wi-Fi Protected Access-3 (WPA3) is a set of enhancements to Wi-Fi access security intended to replace the current WPA2 standard. It includes new features and capabilities that offer significantly better protection against different types of attacks. It improves upon WPA2-Personal in following ways:

- WPA3 uses Simultaneous Authentication of Equals (SAE), which is password-authenticated key agreement method based on Diffie-Hellman key exchange. Unlike WPA2, the technology is resistant to offline-dictionary attack, where the attacker attempts to determine shared password based on captured 4-way handshake without any further network interaction.
- Disallows outdated protocols such as TKIP, which is susceptible to simple attacks like MIC key recovery attack.
- Mandates Protected Management Frames (PMF), which provides protection for unicast and multicast robust management frames which include Disassoc and Deauth frames. This means that the attacker cannot disrupt an established WPA3 session by sending forged Assoc frames to the AP or Deauth/Disassoc frames to the Station.
- Provides forward secrecy, which means the captured data cannot be decrypted even if password is compromised after data transmission.

Please refer to [Security](#) section of Wi-Fi Alliance's official website for further details.

Setting up WPA3 with ESP32-C3

In IDF Menuconfig under Wi-Fi component, a config option “Enable WPA3-Personal” is provided to Enable/Disable WPA3. By default it is kept enabled, if disabled ESP32-C3 will not be able to establish a WPA3 connection. Currently, WPA3 is supported only in the Station mode. Additionally, since PMF is mandated by WPA3 protocol, PMF Mode should be set to either Optional or Required while setting WiFi config.

Refer to [Protected Management Frames \(PMF\)](#) on how to set this mode.

After these settings are done, Station is ready to use WPA3-Personal. Application developers need not worry about the underlying security mode of the AP. WPA3-Personal is now the highest supported protocol in terms of security, so it will be automatically selected for the connection whenever available. For example, if an AP is configured to be in WPA3 Transition Mode, where it will advertise as both WPA2 and WPA3 capable, Station will choose WPA3 for the connection with above settings. Note that Wi-Fi stack size requirement will increase 3kB when WPA3 is used.

Chapter 5

Libraries and Frameworks

5.1 Cloud Frameworks

ESP32-C3 supports multiple cloud frameworks using agents built on top of ESP-IDF. Here are the pointers to various supported cloud frameworks' agents and examples:

5.1.1 AWS IoT

<https://github.com/espressif/esp-aws-iot> is an open source repository for ESP32-C3 based on Amazon Web Services' `aws-iot-device-sdk-embedded-C`.

5.1.2 Azure IoT

<https://github.com/espressif/esp-azure> is an open source repository for ESP32-C3 based on Microsoft Azure' s `azure-iot-sdk-c` SDK.

5.1.3 Google IoT Core

<https://github.com/espressif/esp-google-iot> is an open source repository for ESP32-C3 based on Google' s `iot-device-sdk-embedded-c` SDK.

5.1.4 Aliyun IoT

<https://github.com/espressif/esp-aliyun> is an open source repository for ESP32-C3 based on Aliyun' s `iotkit-embedded` SDK.

5.1.5 Joylink IoT

<https://github.com/espressif/esp-joylink> is an open source repository for ESP32-C3 based on Joylink' s `joylink_dev_sdk` SDK.

5.1.6 Tencent IoT

<https://github.com/espressif/esp-welink> is an open source repository for ESP32-C3 based on Tencent' s `welink` SDK.

5.1.7 Tencentyun IoT

<https://github.com/espressif/esp-qcloud> is an open source repository for ESP32-C3 based on Tencentyun' s `qcloud-iot-sdk-embedded-c` SDK.

5.1.8 Baidu IoT

<https://github.com/espressif/esp-baidu-iot> is an open source repository for ESP32-C3 based on Baidu' s `iot-sdk-c` SDK.

Chapter 6

Contributions Guide

We welcome contributions to the esp-idf project!

6.1 How to Contribute

Contributions to esp-idf - fixing bugs, adding features, adding documentation - are welcome. We accept contributions via [Github Pull Requests](#).

6.2 Before Contributing

Before sending us a Pull Request, please consider this list of points:

- Is the contribution entirely your own work, or already licensed under an Apache License 2.0 compatible Open Source License? If not then we unfortunately cannot accept it.
- Does any new code conform to the esp-idf *Style Guide*?
- Have you installed the *pre-commit hook* for esp-idf project?
- Does the code documentation follow requirements in *Documenting Code*?
- Is the code adequately commented for people to understand how it is structured?
- Is there documentation or examples that go with code contributions? There are additional suggestions for writing good examples in [examples](#) readme.
- Are comments and documentation written in clear English, with no spelling or grammar errors?
- Example contributions are also welcome. Please check the *Creating Examples* guide for these.
- If the contribution contains multiple commits, are they grouped together into logical changes (one major change per pull request)? Are any commits with names like “fixed typo” [squashed into previous commits](#)?
- If you’re unsure about any of these points, please open the Pull Request anyhow and then ask us for feedback.

6.3 Pull Request Process

After you open the Pull Request, there will probably be some discussion in the comments field of the request itself.

Once the Pull Request is ready to merge, it will first be merged into our internal git system for in-house automated testing.

If this process passes, it will be merged onto the public github repository.

6.4 Legal Part

Before a contribution can be accepted, you will need to sign our *Contributor Agreement*. You will be prompted for this automatically as part of the Pull Request process.

6.5 Related Documents

6.5.1 Espressif IoT Development Framework Style Guide

About This Guide

Purpose of this style guide is to encourage use of common coding practices within the ESP-IDF.

Style guide is a set of rules which are aimed to help create readable, maintainable, and robust code. By writing code which looks the same way across the code base we help others read and comprehend the code. By using same conventions for spaces and newlines we reduce chances that future changes will produce huge unreadable diffs. By following common patterns for module structure and by using language features consistently we help others understand code behavior.

We try to keep rules simple enough, which means that they can not cover all potential cases. In some cases one has to bend these simple rules to achieve readability, maintainability, or robustness.

When doing modifications to third-party code used in ESP-IDF, follow the way that particular project is written. That will help propose useful changes for merging into upstream project.

C Code Formatting

Naming

- Any variable or function which is only used in a single source file should be declared `static`.
- Public names (non-static variables and functions) should be namespaced with a per-component or per-unit prefix, to avoid naming collisions. ie `esp_vfs_register()` or `esp_console_run()`. Starting the prefix with `esp_` for Espressif-specific names is optional, but should be consistent with any other names in the same component.
- Static variables should be prefixed with `s_` for easy identification. For example, `static bool s_invert`.
- Avoid unnecessary abbreviations (ie shortening `data` to `dat`), unless the resulting name would otherwise be very long.

Indentation Use 4 spaces for each indentation level. Don't use tabs for indentation. Configure the editor to emit 4 spaces each time you press tab key.

Vertical Space Place one empty line between functions. Don't begin or end a function with an empty line.

```
void function1()
{
    do_one_thing();
    do_another_thing();
}
// INCORRECT, don't place empty line here
// place empty line here
void function2()
{
    // INCORRECT, don't use an empty line here
    int var = 0;
    while (var < SOME_CONSTANT) {
        do_stuff(&var);
    }
}
```

(continues on next page)

(continued from previous page)

```

}
}

```

The maximum line length is 120 characters as long as it doesn't seriously affect the readability.

Horizontal Space Always add single space after conditional and loop keywords:

```

if (condition) {    // correct
    // ...
}

switch (n) {        // correct
    case 0:
        // ...
}

for(int i = 0; i < CONST; ++i) {    // INCORRECT
    // ...
}

```

Add single space around binary operators. No space is necessary for unary operators. It is okay to drop space around multiply and divide operators:

```

const int y = y0 + (x - x0) * (y1 - y0) / (x1 - x0);    // correct

const int y = y0 + (x - x0)*(y1 - y0)/(x1 - x0);        // also okay

int y_cur = -y;                                         // correct
++y_cur;

const int y = y0+(x-x0)*(y1-y0)/(x1-x0);                // INCORRECT

```

No space is necessary around `.` and `->` operators.

Sometimes adding horizontal space within a line can help make code more readable. For example, you can add space to align function arguments:

```

esp_rom_gpio_connect_in_signal(PIN_CAM_D6,    I2S0I_DATA_IN14_IDX, false);
esp_rom_gpio_connect_in_signal(PIN_CAM_D7,    I2S0I_DATA_IN15_IDX, false);
esp_rom_gpio_connect_in_signal(PIN_CAM_HREF,   I2S0I_H_ENABLE_IDX,  false);
esp_rom_gpio_connect_in_signal(PIN_CAM_PCLK,   I2S0I_DATA_IN15_IDX, false);

```

Note however that if someone goes to add new line with a longer identifier as first argument (e.g. `PIN_CAM_VSYNC`), it will not fit. So other lines would have to be realigned, adding meaningless changes to the commit.

Therefore, use horizontal alignment sparingly, especially if you expect new lines to be added to the list later.

Never use TAB characters for horizontal alignment.

Never add trailing whitespace at the end of the line.

Braces

- Function definition should have a brace on a separate line:

```

// This is correct:
void function(int arg)
{
}

```

(continues on next page)

(continued from previous page)

```
// NOT like this:
void function(int arg) {
}

```

- Within a function, place opening brace on the same line with conditional and loop statements:

```
if (condition) {
    do_one();
} else if (other_condition) {
    do_two();
}

```

Comments Use `//` for single line comments. For multi-line comments it is okay to use either `//` on each line or a `/* */` block.

Although not directly related to formatting, here are a few notes about using comments effectively.

- Don't use single comments to disable some functionality:

```
void init_something()
{
    setup_dma();
    // load_resources(); // WHY is this thing commented, asks_
    ↪the reader?
    start_timer();
}

```

- If some code is no longer required, remove it completely. If you need it you can always look it up in git history of this file. If you disable some call because of temporary reasons, with an intention to restore it in the future, add explanation on the adjacent line:

```
void init_something()
{
    setup_dma();
    // TODO: we should load resources here, but loader is not fully integrated_
    ↪yet.
    // load_resources();
    start_timer();
}

```

- Same goes for `#if 0 ... #endif` blocks. Remove code block completely if it is not used. Otherwise, add comment explaining why the block is disabled. Don't use `#if 0 ... #endif` or comments to store code snippets which you may need in the future.
- Don't add trivial comments about authorship and change date. You can always look up who modified any given line using git. E.g. this comment adds clutter to the code without adding any useful information:

```
void init_something()
{
    setup_dma();
    // XXX add 2016-09-01
    init_dma_list();
    fill_dma_item(0);
    // end XXX add
    start_timer();
}

```

Line Endings Commits should only contain files with LF (Unix style) endings.

Windows users can configure git to check out CRLF (Windows style) endings locally and commit LF endings by setting the `core.autocrlf` setting. *GitHub has a document about setting this option* <[github-line-endings](#)>. However

because MSYS2 uses Unix-style line endings, it is often easier to configure your text editor to use LF (Unix style) endings when editing ESP-IDF source files.

If you accidentally have some commits in your branch that add LF endings, you can convert them to Unix by running this command in an MSYS2 or Unix terminal (change directory to the IDF working directory and check the correct branch is currently checked out, beforehand):

```
git rebase --exec 'git diff-tree --no-commit-id --name-only -r HEAD | xargs ↵
↳dos2unix && git commit -a --amend --no-edit --allow-empty' master
```

(Note that this line rebases on master, change the branch name at the end to rebase on another branch.)

For updating a single commit, it's possible to run `dos2unix FILENAME` and then run `git commit --amend`

Formatting Your Code You can use `astyle` program to format your code according to the above recommendations.

If you are writing a file from scratch, or doing a complete rewrite, feel free to re-format the entire file. If you are changing a small portion of file, don't re-format the code you didn't change. This will help others when they review your changes.

To re-format a file, run:

```
tools/format.sh components/my_component/file.c
```

Type Definitions Should be snake_case, ending with `_t` suffix:

```
typedef int signed_32_bit_t;
```

Enum Enums should be defined through the `typedef` and be namespaced:

```
typedef enum
{
    MODULE_FOO_ONE,
    MODULE_FOO_TWO,
    MODULE_FOO_THREE
} module_foo_t;
```

C++ Code Formatting

The same rules as for C apply. Where they are not enough, apply the following rules.

File Naming C++ Header files have the extension `.hpp`. C++ source files have the extension `.cpp`. The latter is important for the compiler to distinguish them from normal C source files.

Naming

- **Class and struct** names shall be written in CamelCase with a capital letter as beginning. Member variables and methods shall be in snake_case.
- **Namespaces** shall be in lower snake_case.
- **Templates** are specified in the line above the function declaration.
- Interfaces in terms of Object-Oriented Programming shall be named without the suffix `...Interface`. Later, this makes it easier to extract interfaces from normal classes and vice versa without making a breaking change.

Member Order in Classes In order of precedence:

- First put the public members, then the protected, then private ones. Omit public, protected or private sections without any members.
- First put constructors/destructors, then member functions, then member variables.

For example:

```
class ForExample {
public:
    // first constructors, then default constructor, then destructor
    ForExample(double example_factor_arg);
    ForExample();
    ~ForExample();

    // then remaining public methods
    set_example_factor(double example_factor_arg);

    // then public member variables
    uint32_t public_data_member;

private:
    // first private methods
    void internal_method();

    // then private member variables
    double example_factor;
};
```

Spacing

- Don't indent inside namespaces.
- Put public, protected and private labels at the same indentation level as the corresponding class label.

Simple Example

```
// file spaceship.h
#ifndef SPACESHIP_H_
#define SPACESHIP_H_
#include <cstdlib>

namespace spaceships {

class SpaceShip {
public:
    SpaceShip(size_t crew);
    size_t get_crew_size() const;

private:
    const size_t crew;
};

class SpaceShuttle : public SpaceShip {
public:
    SpaceShuttle();
};

class Sojuz : public SpaceShip {
public:
    Sojuz();
};

};
```

(continues on next page)

```
template <typename T>
class CargoShip {
public:
    CargoShip(const T &cargo);

private:
    T cargo;
};

} // namespace spaceships

#endif // SPACESHIP_H_

// file spaceship.cpp
#include "spaceship.h"

namespace spaceships {

// Putting the curly braces in the same line for constructors is OK if it only
↳initializes
// values in the initializer list
SpaceShip::SpaceShip(size_t crew) : crew(crew) { }

size_t SpaceShip::get_crew_size() const
{
    return crew;
}

SpaceShuttle::SpaceShuttle() : SpaceShip(7)
{
    // doing further initialization
}

Sojuz::Sojuz() : SpaceShip(3)
{
    // doing further initialization
}

template <typename T>
CargoShip<T>::CargoShip(const T &cargo) : cargo(cargo) { }

} // namespace spaceships
```

CMake Code Style

- Indent with four spaces.
- Maximum line length 120 characters. When splitting lines, try to focus on readability where possible (for example, by pairing up keyword/argument pairs on individual lines).
- Don't put anything in the optional parentheses after `endforeach()`, `endif()`, etc.
- Use lowercase (`with_underscores`) for command, function, and macro names.
- For locally scoped variables, use lowercase (`with_underscores`).
- For globally scoped variables, use uppercase (`WITH_UNDERSCORES`).
- Otherwise follow the defaults of the [cmake-lint](#) project.

Configuring the Code Style for a Project Using EditorConfig

EditorConfig helps developers define and maintain consistent coding styles between different editors and IDEs. The EditorConfig project consists of a file format for defining coding styles and a collection of text editor plugins that enable editors to read the file format and adhere to defined styles. EditorConfig files are easily readable and they work nicely with version control systems.

For more information, see [EditorConfig Website](#).

Documenting Code

Please see the guide here: [Documenting Code](#).

Structure

To be written.

Language Features

To be written.

6.5.2 Install pre-commit Hook for ESP-IDF Project

Required Dependency

Python 3.6.1 or above. This is our recommendation python version for IDF developers.

If you still have versions not compatible, please do not install pre-commit hook and update your python versions.

Install pre-commit

```
Run pip install pre-commit
```

Install pre-commit hook

1. Go to the IDF Project Directory
2. Run `pre-commit install --allow-missing-config`. Install hook by this approach will let you commit successfully even in branches without the `.pre-commit-config.yaml`
3. pre-commit hook will run automatically when you're running `git commit` command

What's More?

For detailed usage, Please refer to the documentation of [pre-commit](#).

Common Problems For Windows Users

1. `/usr/bin/env: python: Permission denied.`
If you're in Git Bash or MSYS terminal, please check the python executable location by run `which python`. If the executable is under `~/AppData/Local/Microsoft/WindowsApps/`, then it's a link to Windows AppStore, not a real one.
Please install python manually and update this in your `PATH` environment variable.

6.5.3 Documenting Code

The purpose of this description is to provide quick summary on documentation style used in [espressif/esp-idf](#) repository and how to add new documentation.

Introduction

When documenting code for this repository, please follow [Doxygen style](#). You are doing it by inserting special commands, for instance `@param`, into standard comments blocks, for example:

```
/**
 * @param ratio this is oxygen to air ratio
 */
```

Doxygen is phrasing the code, extracting the commands together with subsequent text, and building documentation out of it.

Typical comment block, that contains documentation of a function, looks like below.

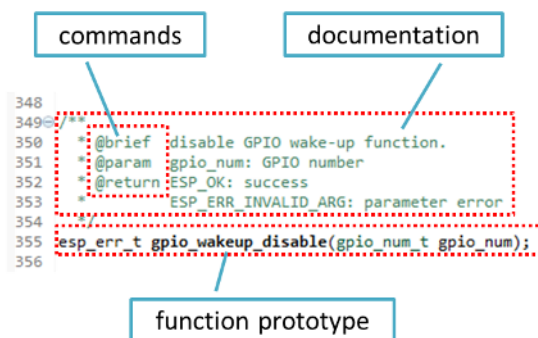

Doxygen supports couple of formatting styles. It also gives you great flexibility on level of details to include in documentation. To get familiar with available features, please check data rich and very well organized [Doxygen Manual](#).

Why we need it?

The ultimate goal is to ensure that all the code is consistently documented, so we can use tools like [Sphinx](#) and [Breathe](#) to aid preparation and automatic updates of API documentation when the code changes.

With these tools the above piece of code renders like below:

```

348
349 /**
350  * @brief disable GPIO wake-up function.
351  * @param gpio_num: GPIO number
352  * @return ESP_OK: success
353  *         ESP_ERR_INVALID_ARG: parameter error
354  */
355 esp_err_t gpio_wakeup_disable(gpio_num_t gpio_num);
356

```

`esp_err_t gpio_wakeup_disable(gpio_num_t gpio_num)`

disable GPIO wake-up function.

Return

ESP_OK: success ESP_ERR_INVALID_ARG: parameter error

Parameters

- `gpio_num` - GPIO number

Go for it!

When writing code for this repository, please follow guidelines below.

1. Document all building blocks of code: functions, structs, typedefs, enums, macros, etc. Provide enough information on purpose, functionality and limitations of documented items, as you would like to see them documented when reading the code by others.
2. Documentation of function should describe what this function does. If it accepts input parameters and returns some value, all of them should be explained.
3. Do not add a data type before parameter or any other characters besides spaces. All spaces and line breaks are compressed into a single space. If you like to break a line, then break it twice.

do not add data type

white spaces are compressed

a line break that will render

```

41 /**
42  * @brief Set log level for given tag
43  *
44  * If logging for given component has already been enabled, changes previous setting.
45  *
46  * @param tag Tag of the log entries to enable. Must be a non-NULL zero terminated string.
47  *           Value "" resets log level for all tags to the given value.
48  *
49  * @param level Selects log level to enable.
50  *             Only logs at this and lower levels will be shown.
51  */
52 void esp_log_level_set(const char *tag, esp_log_level_t level);

```

this line break will not render

`void esp_log_level_set(const char *tag, esp_log_level_t level)`

Set log level for given tag.

If logging for given component has already been enabled, changes previous setting.

Parameters

- `tag` - Tag of the log entries to enable. Must be a non-NULL zero terminated string. Value "" resets log level for all tags to the given value.
- `level` - Selects log level to enable. Only logs at this and lower levels will be shown.

4. If function has void input or does not return any value, then skip @param or @return

```

26@ /**
27  * @brief Initialize BT controller
28  *
29  * This function should be called only once,
30  * before any other BT functions are called.
31  */
32 void bt_controller_init(void);

```

```
void bt_controller_init(void)
```

Initialize BT controller.

This function should be called only once, before any other BT functions are called.

- When documenting a define as well as members of a struct or enum, place specific comment like below after each member.

```

45@ /**
46  * Mode of opening the non-volatile storage
47  *
48  */
49@ typedef enum {
50     NVS_READONLY, /*!< Read only */
51     NVS_READWRITE /*!< Read and write */
52 } nvs_open_mode;

```

```
enum nvs_open_mode
```

Mode of opening the non-volatile storage.

Values:

```
NVS_READONLY
```

Read only

```
NVS_READWRITE
```

Read and write

```
/*!< how to documented members */
```

- To provide well formatted lists, break the line after command (like @return in example below).

```

*
* @return
* - ESP_OK if erase operation was successful
* - ESP_ERR_NVS_INVALID_HANDLE if handle has been closed or is NULL
* - ESP_ERR_NVS_READ_ONLY if handle was opened as read only
* - ESP_ERR_NVS_NOT_FOUND if the requested key doesn't exist
* - other error codes from the underlying storage driver
*

```

- Overview of functionality of documented header file, or group of files that make a library, should be placed in the same directory in a separate README.rst file. If directory contains header files for different APIs, then the file name should be apiname-readme.rst.

Go one extra mile

There is couple of tips, how you can make your documentation even better and more useful to the reader.

- Add code snippets to illustrate implementation. To do so, enclose snippet using @code{c} and @endcode commands.

```

*
* @code{c}
* // Example of using nvs_get_i32:
* int32_t max_buffer_size = 4096; // default value
* esp_err_t err = nvs_get_i32(my_handle, "max_buffer_size", &max_buffer_size);
* assert(err == ESP_OK || err == ESP_ERR_NVS_NOT_FOUND);
* // if ESP_ERR_NVS_NOT_FOUND was returned, max_buffer_size will still
* // have its default value.
* @endcode
*

```

The code snippet should be enclosed in a comment block of the function that it illustrates.

- To highlight some important information use command @attention or @note.

```
*
* @attention
* 1. This API only impact WIFI_MODE_STA or WIFI_MODE_APSTA mode
* 2. If the ESP32 is connected to an AP, call esp_wifi_disconnect to
↳ disconnect.
*
```

Above example also shows how to use a numbered list.

- To provide common description to a group of similar functions, enclose them using `/**@{ */` and `/**@} */` markup commands:

```
/**@{ */
/**
* @brief common description of similar functions
*
*/
void first_similar_function (void);
void second_similar_function (void);
/**@} */
```

For practical example see [nvs_flash/include/nvs.h](#).

- You may want to go even further and skip some code like repetitive defines or enumerations. In such case, enclose the code within `/** @cond */` and `/** @endcond */` commands. Example of such implementation is provided in [driver/include/driver/gpio.h](#).
- Use markdown to make your documentation even more readable. You will add headers, links, tables and more.

```
*
* [ESP32-C3 Technical Reference Manual] (https://www.espressif.com/sites/default/files/documentation/esp32-c3\_technical\_reference\_manual\_en.pdf)
*
```

Note: Code snippets, notes, links, etc. will not make it to the documentation, if not enclosed in a comment block associated with one of documented objects.

- Prepare one or more complete code examples together with description. Place description in a separate file `README.md` in specific folder of `examples` directory.

Linking Examples

When linking to examples on GitHub, do not use absolute/hardcoded URLs. Instead, use docutils custom roles that will generate links for you. These auto-generated links point to the tree or blob for the git commit ID (or tag) of the repository. This is needed to ensure that links do not get broken when files in master branch are moved around or deleted. The roles will transparently handle files that are located in submodules and will link to the submodule's repository with the correct commit ID.

The following roles are provided:

- `:idf:`path`` - points to directory inside ESP-IDF
- `:idf_file:`path`` - points to file inside ESP-IDF
- `:idf_raw:`path`` - points to raw view of the file inside ESP-IDF
- `:component:`path`` - points to directory inside ESP-IDF components dir
- `:component_file:`path`` - points to file inside ESP-IDF components dir
- `:component_raw:`path`` - points to raw view of the file inside ESP-IDF components dir
- `:example:`path`` - points to directory inside ESP-IDF examples dir
- `:example_file:`path`` - points to file inside ESP-IDF examples dir
- `:example_raw:`path`` - points to raw view of the file inside ESP-IDF examples dir

Example implementation:

```
* :example:`get-started/hello_world`  
* :example:`Hello World! <get-started/hello_world>`
```

How it renders:

- [get-started/hello_world](#)
- [Hello World!](#)

A check is added to the CI build script, which searches RST files for presence of hard-coded links (identified by `tree/master`, `blob/master`, or `raw/master` part of the URL). This check can be run manually: `cd docs` and then `make gh-linkcheck`.

Linking Language Versions

Switching between documentation in different languages may be done using `:link_to_translation:` custom role. The role placed on a page of documentation provides a link to the same page in a language specified as a parameter. Examples below show how to enter links to Chinese and English versions of documentation:

```
:link_to_translation:`zh_CN: 中文版`  
:link_to_translation:`en:English`
```

The language is specified using standard abbreviations like `en` or `zh_CN`. The text after last semicolon is not standardized and may be entered depending on the context where the link is placed, e.g.:

```
:link_to_translation:`en:see description in English`
```

Add Illustrations

Consider adding diagrams and pictures to illustrate described concepts.

Sometimes it is better to add an illustration than writing a lengthy paragraph to describe a complex idea, a data structure or an algorithm. This repository is using [blockdiag](#) suite of tools to generate diagram images from simple text files.

The following types of diagrams are supported:

- [Block diagram](#)
- [Sequence diagram](#)
- [Activity diagram](#)
- [Logical network diagram](#)

With this suite of tools, it is possible to generate beautiful diagram images from simple text format (similar to `graphviz`'s DOT format). The diagram elements are laid out automatically. The diagram code is then converted into “.png” graphics and integrated “behind the scenes” into **Sphinx** documents.

For the diagram preparation, you can use an on-line [interactive shell](#) that instantly shows the rendered image.

Below are couple of diagram examples:

- Simple **block diagram** / `blockdiag` - [Wi-Fi Buffer Configuration](#)
- Slightly more complicated **block diagram** - [Wi-Fi programming model](#)
- **Sequence diagram** / `seqdiag` - [Scan for a Specific AP in All Channels](#)
- **Packet diagram** / `packetdiag` - [NVS Page Structure](#)

Try them out by modifying the source code and see the diagram instantly rendering below.

Note: There may be slight differences in rendering of font used by the [interactive shell](#) compared to the font used in the `esp-idf` documentation.

Add Notes

Working on a document, you might need to:

- Place some suggestions on what should be added or modified in future.
- Leave a reminder for yourself or somebody else to follow up.

In this case, add a todo note to your reST file using the directive `.. todo::`. For example:

```
.. todo::  
  
    Add a package diagram.
```

If you add `.. todolist::` to a reST file, the directive will be replaced by a list of all todo notes from the whole documentation.

By default, the directives `.. todo::` and `.. todolist::` are ignored by documentation builders. If you want the notes and the list of notes to be visible in your locally built documentation, do the following:

1. Open your local `conf_common.py` file.
2. Find the parameter `todo_include_todos`.
3. Change its value from `False` to `True`.

Before pushing your changes to origin, please set the value of `todo_include_todos` back to `False`.

For more details about the extension, see [sphinx.ext.todo](#) documentation.

Writing generic documentation for multiple chips

The documentation for all of Espressif's chips is built from the same files. To facilitate the writing of documents that can be re-used for multiple different chips (called below "targets"), we provide you with the following functionality:

Exclusion of content based on chip-target Occasionally there will be content that is only relevant for one of targets. When this is the case, you can exclude that content by using the `.. only:: TAG` directive, where you replace 'TAG' with one of the following names:

Chip name:

- `esp32`
- `esp32s2`
- `esp32c3`

Define identifiers from `'sdkconfig.h'`, generated by the default menuconfig settings for the target, e.g:

- `CONFIG_FREERTOS_UNICORE`

Define identifiers from the soc `'*_caps'` headers, e.g:

- `SOC_BT_SUPPORTED`
- `SOC_CAN_SUPPORTED`

Example:

```
.. only:: esp32  
  
    ESP32 specific content.
```

This directive also supports the boolean operators `'and'`, `'or'` and `'not'`. Example:

```
.. only:: SOC_BT_SUPPORTED and CONFIG_FREERTOS_UNICORE  
  
    BT specific content only relevant for single-core targets.
```

This functionality is provided by the [Sphinx selective exclude](#) extension.

A weakness in this extension is that it does not correctly handle the case where you exclude a section, that is directly followed by a labeled new section. In these cases everything will render correctly, but the label will not correctly link to the section that follows. A temporary work-around for the cases where this can't be avoided is the following:

```
.. only:: esp32
    .. _section_1_label:

    Section 1
    ^^^^^^^^^

    Section one content

    .. _section_2_label:
.. only:: not esp32
    .. _section_2_label:

Section 2
^^^^^^^^
Section 2 content
```

The `:TAG:` role is used for excluding content from a table of content tree. For example:

```
.. toctree::
    :maxdepth: 1

    :esp32: configure-wrover
    configure-other-jtag
```

When building the documents, Sphinx will use the above mentioned directive and role to include or exclude content based on the target tag it was called with.

Note: If excluding an entire document from the toctree based on targets, it's necessary to also update the `exclude_patterns` list in [docs/conf_common.py](#) to exclude the file for other targets, or a Sphinx warning "WARNING: document isn't included in any toctree" will be generated..

The recommended way of doing it is adding the document to one of the list that gets included in `conditional_include_dict` in [docs/conf_common.py](#), e.g. a document which should only be shown for BT capable targets should be added to `BT_DOCS`. [docs/idf_extensions/exclude_docs.py](#) will then take care of adding it to `exclude_patterns` if the corresponding tag is not set.

If you need to exclude content inside a list or bullet points, then this should be done by using the `^ :TAG: ^` role inside the `^ .. list:: ^` directive.

```
.. list::

    :esp32: - ESP32 specific content
    :SOC_BT_SUPPORTED: - BT specific content
    - Common bullet point
    - Also common bullet point
```

Substitution macros When you need to refer to the chip's name, toolchain name, path or other common names that depend on the target type you can consider using the substitution macros supplied by [docs/idf_extensions/format_idf_target.py](#).

For example, the following reStructuredText content:

```
This is a {IDF_TARGET_NAME}, with /{IDF_TARGET_PATH_NAME}/soc.c,  
compiled with {IDF_TARGET_TOOLCHAIN_PREFIX}-gcc with CON-  
FIG_{IDF_TARGET_CFG_PREFIX}_MULTI_DOC
```

Would render in the documentation as:

```
This is a ESP32-C3, with /esp32c3/soc.c, compiled with riscv32-esp-elf-gcc with CON-  
FIG_ESP32C3_MULTI_DOC.
```

This extension also supports markup for defining local (within a single source file) substitutions. Place a definition like the following into a single line of the RST file:

```
{IDF_TARGET_SUFFIX:default=" DEFAULT_VALUE" , esp32=" ESP32_VALUE" , esp32s2="  
ESP32S2_VALUE" , esp32c3=" ESP32C3_VALUE" }
```

This will define a target-dependent substitution of the tag {IDF_TARGET_SUFFIX} in the current RST file. For example:

```
{IDF_TARGET_TX_PIN:default=" IO3" , esp32=" IO4" , esp32s2=" IO5" , esp32c3=" IO6" }
```

Will define a substitution for the tag {IDF_TARGET_TX_PIN}, which would be replaced by the text IO5 if sphinx was called with the tag esp32s2.

Note: These single-file definitions can be placed anywhere in the .rst file (on their own line), but the name of the directive must start with `IDF_TARGET_`.

Put it all together

Once documentation is ready, follow instruction in [API Documentation Template](#) and create a single file, that will merge all individual pieces of prepared documentation. Finally add a link to this file to respective `.. toctree::` in `index.rst` file located in `/docs` folder or subfolders.

OK, but I am new to Sphinx!

1. No worries. All the software you need is well documented. It is also open source and free. Start by checking [Sphinx](#) documentation. If you are not clear how to write using rst markup language, see [reStructuredText Primer](#). You can also use markdown (.md) files, and find out more about the specific markdown syntax that we use on [Recommonmark parser's documentation page](#).
2. Check the source files of this documentation to understand what is behind of what you see now on the screen. Sources are maintained on GitHub in [espressif/esp-idf](#) repository in `docs` folder. You can go directly to the source file of this page by scrolling up and clicking the link in the top right corner. When on GitHub, see what's really inside, open source files by clicking `Raw` button.
3. You will likely want to see how documentation builds and looks like before posting it on the GitHub. There are two options to do so:
 - Install [Sphinx](#), [Breathe](#), [Blockdiag](#) and [Doxygen](#) to build it locally, see chapter below.
 - Set up an account on [Read the Docs](#) and build documentation in the cloud. [Read the Docs](#) provides document building and hosting for free and their service works really quick and great.
4. To preview documentation before building, use [Sublime Text](#) editor together with [OmniMarkupPreviewer](#) plugin.

Setup for building documentation locally

Install Dependencies You can setup environment to build documentation locally on your PC by installing:

1. Doxygen - <http://doxygen.nl/>
2. Sphinx - <https://github.com/sphinx-doc/sphinx/#readme-for-sphinx>
3. Breathe - <https://github.com/michaeljones/breathe#breathe>
4. Document theme "sphinx_idf_theme" - https://github.com/espressif/sphinx_idf_theme

5. Custom 404 page “sphinx-notfound-page” - <https://github.com/readthedocs/sphinx-notfound-page>
6. Blockdiag - <http://blockdiag.com/en/index.html>
7. Recommonmark - <https://github.com/rtfd/recommonmark>

The package “sphinx_idf_theme” is added to have the same “look and feel” of [ESP-IDF Programming Guide](#).

Do not worry about being confronted with several packages to install. Besides Doxygen, all remaining packages are written in pure Python. Therefore installation of all of them is combined into one simple step.

Important: Docs building now supports Python 3 only. Python 2 installations will not work.

Doxygen Installation of Doxygen is OS dependent:

Linux

```
sudo apt-get install doxygen
```

Windows - install in MSYS2 console

```
pacman -S doxygen
```

MacOS

```
brew install doxygen
```

Note: If you are installing on Windows MSYS2 system (Linux and MacOS users should skip this note, Windows users who don't use MSYS2 will need to find other alternatives), **before** going further, execute two extra steps below. These steps are required to install dependencies of “blockdiag” discussed under [Add Illustrations](#).

1. Update all the system packages:

```
$ pacman -Syu
```

This process will likely require restarting of the MSYS2 MINGW32 console and repeating above commands, until update is complete.

2. Install *pillow*, that is one of dependences of the *blockdiag*:

```
$ pacman -S mingw32/mingw-w64-i686-python-pillow
```

Check the log on the screen that `mingw-w64-i686-python-pillow-4.3.0-1` or newer is installed. Previous versions of *pillow* will not work.

A downside of Windows installation is that fonts of the *blockdiag pictures* [<add-illustrations>](#) do not render correctly, you will see some random characters instead. Until this issue is fixed, you can use the [interactive shell](#) to see how the complete picture looks like.

Remaining applications All remaining applications are [Python](#) packages and you can install them in one step as follows:

```
cd ~/esp/esp-idf/docs
pip install --user -r requirements.txt
```

Note: Installation steps assume that ESP-IDF is placed in `~/esp/esp-idf` directory, that is default location of ESP-IDF used in documentation.

Building Documentation

```
cd ~/esp/esp-idf/docs
```

Now you should be ready to build documentation by invoking:

```
./build_docs.py build
```

This will build docs for all supported ESP-IDF languages & targets. This can take some time, although jobs will run in parallel up to the number of CPU cores you have (can modify this with the `--sphinx-parallel-builds` option, see `./build_docs.py --help` for details).

To build for a single language and target combination only:

```
./build_docs.py -l en -t esp32 build
```

Choices for language (`-l`) are `en` and `zh_CN`. Choices for target (`-t`) are any supported ESP-IDF build system target (for example `esp32` and `esp32s2`).

Build documentation will be placed in `_build/<language>/<target>/html` folder. To see it, open the `index.html` inside this directory in a web browser.

Building a subset of the documentation Since building the full documentation can be quite slow, it might be useful to just build just the subset of the documentation you are interested in.

This can be achieved by listing the document you want to build:

```
./build_docs.py -l en -t esp32 -i api-reference/peripherals/can.rst build
```

Building multiple documents is also possible:

```
./build_docs.py -l en -t esp32 -i api-reference/peripherals/can.rst api-reference/  
↳peripherals/adc.rst build
```

As well as wildcards:

```
./build_docs.py -l en -t esp32 -i api-reference/peripherals/* build
```

Note that this is a feature intended to simply testing and debugging during writing of documentation. The HTML output won't be perfect, i.e. it will not build a proper index that lists all the documents, and any references to documents that are not built will result in warnings.

Building PDF It is also possible to build latex files and a PDF of the documentation using `build_docs.py`. To do this the following Latex packages are required to be installed:

- `latexmk`
- `texlive-latex-recommended`
- `texlive-fonts-recommended`
- `texlive-xetex`

The following fonts are also required to be installed:

- Freefont Serif, Sans and Mono OpenType fonts, available as the package `fonts-freefont-otf` on Ubuntu
- Lmodern, available as the package `fonts-lmodern` on Ubuntu
- Fandol, can be downloaded from [here](#)

Now you can build the PDF for a target by invoking:

```
./build_docs.py -bs latex -l en -t esp32 build
```

Or alternatively build both html and PDF:

```
./build_docs.py -bs html latex -l en -t esp32 build
```

Latex files and the PDF will be placed in `_build/<language>/<target>/latex` folder.

Wrap up

We love good code that is doing cool things. We love it even better, if it is well documented, so we can quickly make it run and also do the cool things.

Go ahead, contribute your code and documentation!

Related Documents

- [API Documentation Template](#)
- [Documentation Add-ons and Extensions Reference](#)

6.5.4 Documentation Add-ons and Extensions Reference

This documentation is created using [Sphinx](#) application that renders text source files in [reStructuredText](#) (`.rst`) format located in `docs` directory. For some more details on that process, please refer to section [Documenting Code](#).

Besides Sphinx, there are several other applications that help to provide nicely formatted and easy to navigate documentation. These applications are listed in section [Setup for building documentation locally](#) with the installed version numbers provided in file `docs/requirements.txt`.

We build ESP-IDF documentation for two languages (English, Simplified Chinese) and for multiple chips. Therefore we don't run `sphinx` directly, there is a wrapper Python program `build_docs.py` that runs Sphinx.

On top of that, we have created a couple of custom add-ons and extensions to help integrate documentation with underlining [ESP-IDF](#) repository and further improve navigation as well as maintenance of documentation.

The purpose of this section is to provide a quick reference to the add-ons and the extensions.

Documentation Folder Structure

- The ESP-IDF repository contains a dedicated documentation folder `docs` in the root.
- The `docs` folder contains localized documentation in `docs/en` (English) and `docs/zh_CN` (simplified Chinese) subfolders.
- Graphics files and fonts common to localized documentation are contained in `docs/_static` subfolder.
- Remaining files in the root of `docs` as well as `docs/en` and `docs/zh_CN` provide configuration and scripts used to automate documentation processing including the add-ons and extensions.
- Sphinx extensions are provided in two directories, `extensions` and `idf_extensions`.
- A `_build` directory is created in the `docs` folder by `build_docs.py`. This directory is not added to the [ESP-IDF](#) repository.

Add-ons and Extensions Reference

Config Files

`docs/conf_common.py` This file contains configuration common to each localized documentation (e.g. English, Chinese). The contents of this file is imported to standard Sphinx configuration file `conf.py` located in respective language folders (e.g. `docs/en`, `docs/zh_CN`) during build for each language.

`docs/sphinx-known-warnings.txt` There are couple of spurious Sphinx warnings that cannot be resolved without doing update to the Sphinx source code itself. For such specific cases, respective warnings are documented in `sphinx-known-warnings.txt` file, that is checked during documentation build, to ignore the spurious warnings.

Scripts `docs/build_docs.py`

Top-level executable program which runs a Sphinx build for one or more language/target combinations. Run `build_docs.py --help` for full command line options.

When `build_docs.py` runs Sphinx it sets the `idf_target` configuration variable, sets a Sphinx tag with the same name as the configuration variable, and uses some environment variables to communicate paths to *IDF-Specific Extensions*.

`docs/check_lang_folder_sync.sh` To reduce potential discrepancies when maintaining concurrent language version, the structure and filenames of language folders `docs/en` and `docs/zh_CN` folders should be kept identical. The script `check_lang_folder_sync.sh` is run on each documentation build to verify if this condition is met.

Note: If a new content is provided in e.g. English, and there is no any translation yet, then the corresponding file in `zh_CN` folder should contain an `.. include::` directive pointing to the source file in English. This will automatically include the English version visible to Chinese readers. For example if a file `docs/zh_CN/contribute/documenting-code.rst` does not have a Chinese translation, then it should contain `.. include:: ../../en/contribute/documenting-code.rst` instead.

Non-Docs Scripts These scripts are used to build docs but also used for other purposes:

`tools/gen_esp_err_to_name.py` This script is traversing the ESP-IDF directory structure looking for error codes and messages in source code header files to generate an `.inc` file to include in documentation under *Error Codes Reference*.

`tools/kconfig_new/configgen.py` Options to configure ESP-IDF's *components* are contained in `Kconfig` files located inside directories of individual components, e.g. `components/bt/Kconfig`. This script is traversing the component directories to collect configuration options and generate an `.inc` file to include in documentation under *Configuration Options Reference*.

Generic Extensions These are Sphinx extensions developed for IDF that don't rely on any IDF-docs-specific behaviour or configuration:

`docs/extensions/toctree_filter.py` Sphinx extensions overrides the `:toctree:` directive to allow filtering entries based on whether a tag is set, as `:tagname: toctree_entry`. See the Python file for a more complete description.

`docs/extensions/list_filter.py` Sphinx extensions that provides a `.. list::` directive that allows filtering of entries in lists based on whether a tag is set, as `:tagname: - list content`. See the Python file for a more complete description.

`docs/extensions/html_redirects.py` During documentation lifetime, some source files are moved between folders or renamed. This Sphinx extension adds a mechanism to redirect documentation pages that have changed URL by generating in the Sphinx output static HTML redirect pages. The script is used together with a redirection list `html_redirect_pages.conf_common.py` builds this list from `docs/page_redirects.txt`.

Third Party Extensions

- `sphinxcontrib` extensions for `blockdiag`, `seqdiag`, `actdiag`, `nwdiag`, `rackdiag` & `packetdiag` diagrams.
- `Sphinx selective exclude` `eager_only` extension.

IDF-Specific Extensions**Build System Integration** `docs/idf_extensions/build_system/`

Python package implementing a Sphinx extension to pull IDF build system information into the docs build.

- Creates a dummy CMake IDF project and runs CMake to generate metadata.
- Registers some new configuration variables and emits a new Sphinx event, both for use by other extensions.

Configuration Variables

- `docs_root` - The absolute path of the `$IDF_PATH/docs` directory
- `idf_path` - The value of `IDF_PATH` variable, or the absolute path of `IDF_PATH` if environment unset
- `build_dir` - The build directory passed in by `build_docs.py`, default will be like `_build/<lang>/<target>`
- `idf_target` - The `IDF_TARGET` value. Expected that `build_docs.py` set this on the Sphinx command line

New Event `idf-info` event is emitted early in the build, after the dummy project CMake run is complete.

Arguments are `(app, project_description)`, where `project_description` is a dict containing the values parsed from `project_description.json` in the CMake build directory.

Other IDF-specific extensions subscribe to this event and use it to set up some docs parameters based on build system info.

Other Extensions

docs/idf_extensions/include_build_file.py The `include-build-file` directive is like the built-in `include-file` directive, but file path is evaluated relative to `build_dir`.

docs/idf_extensions/kconfig_reference.py Subscribes to `idf-info` event and uses `confgen` to generate `kconfig.inc` from the components included in the default project build. This file is then included into *Project Configuration*.

docs/idf_extensions/link_roles.py This is an implementation of a custom [Sphinx Roles](#) to help linking from documentation to specific files and folders in *ESP-IDF*. For description of implemented roles, please see *Linking Examples* and *Linking Language Versions*.

docs/idf_extensions/esp_err_definitions.py Small wrapper extension that calls `gen_esp_err_to_name.py` and updates the included `.rst` file if it has changed.

docs/idf_extensions/gen_toolchain_links.py There couple of places in documentation that provide links to download the toolchain. To provide one source of this information and reduce effort to manually update several files, this script generates toolchain download links and toolchain unpacking code snippets based on information found in `tools/toolchain_versions.mk`.

docs/idf_extensions/gen_version_specific_includes.py Another extension to automatically generate reStructuredText `.inc` snippets with version-based content for this *ESP-IDF* version.

docs/idf_extensions/util.py A collection of utility functions useful primarily when building documentation locally (see *Setup for building documentation locally*) to reduce the time to generate documentation on a second and subsequent builds.

docs/idf_extensions/format_idf_target.py An extension for replacing generic target related names with the `idf_target` passed to the Sphinx command line. This is a `{IDF_TARGET_NAME}`, with `{IDF_TARGET_PATH_NAME}/soc.c`, compiled with `{IDF_TARGET_TOOLCHAIN_PREFIX}-gcc` with `CONFIG_{IDF_TARGET_CFG_PREFIX}_MULTI_DOC` will, if the backspaces are removed, render as This is a *ESP32-C3*, with `/esp32c3/soc.c`, compiled with `riscv32-esp-elf-gcc` with `CONFIG_ESP32C3_MULTI_DOC`. Also supports markup for defining local (single `.rst`-file) substitutions with the following syntax: `{IDF_TARGET_TX_PIN:default=" IO3" ,esp32=" IO4" ,esp32s2=" IO5" }` This will define a replacement of the tag `{IDF_TARGET_TX_PIN}` in the current `.rst`-file. The extension also overrides the default `.. include::` directive in order to format any included content using the same rules.

These replacements cannot be used inside markup that rely on alignment of characters, e.g. tables.

docs/idf_extensions/latex_builder.py An extension for adding *ESP-IDF* specific functionality to the latex builder. Overrides the default Sphinx latex builder.

Creates and adds the `espidf.sty` latex package to the output directory, which contains some macros for run-time variables such as *IDF-Target*.

docs/idf_extensions/gen_defines.py Sphinx extension to integrate defines from *IDF* into the Sphinx build, runs after the *IDF* dummy project has been built.

Parses defines and adds them as sphinx tags.

Emits the new `'idf-defines-generated'` event which has a dictionary of raw text define values that other extensions can use to generate relevant data.

docs/idf_extensions/exclude_docs.py Sphinx extension that updates the excluded documents according to the conditional_include_dict {tag:documents}. If the tag is set, then the list of documents will be included.

Also responsible for excluding documents when building with the config value docs_to_build set. In these cases all documents not listed in docs_to_build will be excluded.

Subscribes to idf-defines-generated as it relies on the sphinx tags to determine which documents to exclude

docs/idf_extensions/run_doxygen.py Subscribes to idf-defines-generated event and runs Doxygen (docs/doxygen/Doxyfile_common) to generate XML files describing key headers, and then runs Breathe to convert these to .inc files which can be included directly into API reference pages.

Pushes a number of target-specific custom environment variables into Doxygen, including all macros defined in the project's default sdkconfig.h file and all macros defined in all soc component xxx_caps.h headers. This means that public API headers can depend on target-specific configuration options or soc capabilities headers options as #ifdef & #if preprocessor selections in the header.

This means we can generate different Doxygen files, depending on the target we are building docs for.

Please refer to *Documenting Code* and *API Documentation Template*, section **API Reference** for additional details on this process.

Related Documents

- [Documenting Code](#)

6.5.5 Creating Examples

Each ESP-IDF example is a complete project that someone else can copy and adapt the code to solve their own problem. Examples should demonstrate ESP-IDF functionality, while keeping this purpose in mind.

Structure

- The main directory should contain a source file named (something)_example_main.c with the main functionality.
- If the example has additional functionality, split it logically into separate C or C++ source files under main and place a corresponding header file in the same directory.
- If the example has a lot of additional functionality, consider adding a components directory to the example project and make some example-specific components with library functionality. Only do this if the components are specific to the example, if they're generic or common functionality then they should be added to ESP-IDF itself.
- The example should have a README.md file. Use the [template example README](#) and adapt it for your particular example.
- Examples should have an example_test.py file for running an automated example test. If submitting a GitHub Pull Request which includes an example, it's OK not to include this file initially. The details can be discussed as part of the [Pull Request](#).

General Guidelines

Example code should follow the *Espressif IoT Development Framework Style Guide*.

Checklist

Checklist before submitting a new example:

- Example project name (in Makefile and README.md) uses the word "example". Use "example" instead of "demo", "test" or similar words.
- Example does one distinct thing. If the example does more than one thing at a time, split it into two or more examples.
- Example has a README.md file which is similar to the [template example README](#).

- Functions and variables in the example are named according to *naming section of the style guide*. (For non-static names which are only specific to the example's source files, you can use `example` or something similar as a prefix.)
- All code in the example is well structured and commented.
- Any unnecessary code (old debugging logs, commented-out code, etc.) is removed from the example.
- Options in the example (like network names, addresses, etc) are not hard-coded. Use configuration items if possible, or otherwise declare macros or constants)
- Configuration items are provided in a `KConfig.projbuild` file with a menu named "Example Configuration". See existing example projects to see how this is done.
- All original example code has a license header saying it is "in the public domain / CC0", and a warranty disclaimer clause. Alternatively, the example is licensed under Apache License 2.0. See existing examples for headers to adapt from.
- Any adapted or third party example code has the original license header on it. This code must be licensed compatible with Apache License 2.0.

6.5.6 API Documentation Template

Note: INSTRUCTIONS

1. Use this file ([docs/en/api-reference/template.rst](#)) as a template to document API.
 2. Change the file name to the name of the header file that represents documented API.
 3. Include respective files with descriptions from the API folder using `..include::`
 - `README.rst`
 - `example.rst`
 - ...
 4. Optionally provide description right in this file.
 5. Once done, remove all instructions like this one and any superfluous headers.
-

Overview

Note: INSTRUCTIONS

1. Provide overview where and how this API may be used.
 2. Where applicable include code snippets to illustrate functionality of particular functions.
 3. To distinguish between sections, use the following **heading levels**:
 - `#` with overline, for parts
 - `*` with overline, for chapters
 - `=`, for sections
 - `-`, for subsections
 - `^`, for subsubsections
 - `"`, for paragraphs
-

Application Example

Note: INSTRUCTIONS

1. Prepare one or more practical examples to demonstrate functionality of this API.
2. Each example should follow pattern of projects located in `esp-idf/examples/` folder.
3. Place example in this folder complete with `README.md` file.
4. Provide overview of demonstrated functionality in `README.md`.
5. With good overview reader should be able to understand what example does without opening the source code.

6. Depending on complexity of example, break down description of code into parts and provide overview of functionality of each part.
7. Include flow diagram and screenshots of application output if applicable.
8. Finally add in this section synopsis of each example together with link to respective folder in `esp-idf/examples/`.

API Reference

Note: INSTRUCTIONS

1. This repository provides for automatic update of API reference documentation using *code markup retrieved by Doxygen from header files*.
1. Update is done on each documentation build by invoking Sphinx extension `docs/idf_extensions/run_doxygen.py` for all header files listed in the `INPUT` statement of `docs/doxygen/Doxyfile_common`.
1. Each line of the `INPUT` statement (other than a comment that begins with `##`) contains a path to header file `*.h` that will be used to generate corresponding `*.inc` files:

```
##
## Wi-Fi - API Reference
##
../components/esp32/include/esp_wifi.h \
../components/esp32/include/esp_smartconfig.h \
```

1. When the headers are expanded, any macros defined by default in `sdkconfig.h` as well as any macros defined in SOC-specific `include/soc/*_caps.h` headers will be expanded. This allows the headers to include/exclude material based on the `IDF_TARGET` value.
1. The `*.inc` files contain formatted reference of API members generated automatically on each documentation build. All `*.inc` files are placed in Sphinx `_build` directory. To see directives generated for e.g. `esp_wifi.h`, run `python gen-dxd.py esp32/include/esp_wifi.h`.
1. To show contents of `*.inc` file in documentation, include it as follows:

```
.. include-build-file:: inc/esp_wifi.inc
```

For example see docs/en/api-reference/network/esp_wifi.rst

1. Optionally, rather than using `*.inc` files, you may want to describe API in your own way. See <docs/en/api-guides/ulp.rst> for example.

Below is the list of common `.. doxygen...:: directives`:

- Functions - `.. doxygenfunction:: name_of_function`
- Unions - `.. doxygenunion:: name_of_union`
- Structures - `.. doxygenstruct:: name_of_structure together with :members:`
- Macros - `.. doxygendefine:: name_of_define`
- Type Definitions - `.. doxygentypedef:: name_of_type`
- Enumerations - `.. doxygenenum:: name_of_enumeration`

See [Breathe documentation](#) for additional information.

To provide a link to header file, use the *link custom role* as follows:

```
* :component_file:`path_to/header_file.h`
```

1. In any case, to generate API reference, the file `docs/doxygen/Doxyfile_common` should be updated with paths to `*.h` headers that are being documented.
1. When changes are committed and documentation is build, check how this section has been rendered. *Correct annotations* in respective header files, if required.

6.5.7 Contributor Agreement

Individual Contributor Non-Exclusive License Agreement

including the Traditional Patent License OPTION

Thank you for your interest in contributing to Espressif IoT Development Framework (esp-idf) (“We” or “Us”).

The purpose of this contributor agreement (“Agreement”) is to clarify and document the rights granted by contributors to Us. To make this document effective, please follow the instructions at [CONTRIBUTING.rst](#)

1. DEFINITIONS “You” means the Individual Copyright owner who submits a Contribution to Us. If You are an employee and submit the Contribution as part of your employment, You have had Your employer approve this Agreement or sign the Entity version of this document.

“**Contribution**” means any original work of authorship (software and/or documentation) including any modifications or additions to an existing work, Submitted by You to Us, in which You own the Copyright. If You do not own the Copyright in the entire work of authorship, please contact Us at angus@espressif.com.

“**Copyright**” means all rights protecting works of authorship owned or controlled by You, including copyright, moral and neighboring rights, as appropriate, for the full term of their existence including any extensions by You.

“**Material**” means the software or documentation made available by Us to third parties. When this Agreement covers more than one software project, the Material means the software or documentation to which the Contribution was Submitted. After You Submit the Contribution, it may be included in the Material.

“**Submit**” means any form of physical, electronic, or written communication sent to Us, including but not limited to electronic mailing lists, source code control systems, and issue tracking systems that are managed by, or on behalf of, Us, but excluding communication that is conspicuously marked or otherwise designated in writing by You as “Not a Contribution.”

“**Submission Date**” means the date You Submit a Contribution to Us.

“**Documentation**” means any non-software portion of a Contribution.

2. LICENSE GRANT 2.1 Copyright License to Us

Subject to the terms and conditions of this Agreement, You hereby grant to Us a worldwide, royalty-free, NON-exclusive, perpetual and irrevocable license, with the right to transfer an unlimited number of non-exclusive licenses or to grant sublicenses to third parties, under the Copyright covering the Contribution to use the Contribution by all means, including, but not limited to:

- to publish the Contribution,
- to modify the Contribution, to prepare derivative works based upon or containing the Contribution and to combine the Contribution with other software code,
- to reproduce the Contribution in original or modified form,
- to distribute, to make the Contribution available to the public, display and publicly perform the Contribution in original or modified form.

2.2 Moral Rights remain unaffected to the extent they are recognized and not waivable by applicable law. Notwithstanding, You may add your name in the header of the source code files of Your Contribution and We will respect this attribution when using Your Contribution.

3. PATENTS 3.1 Patent License

Subject to the terms and conditions of this Agreement You hereby grant to us a worldwide, royalty-free, non-exclusive, perpetual and irrevocable (except as stated in Section 3.2) patent license, with the right to transfer an unlimited number of non-exclusive licenses or to grant sublicenses to third parties, to make, have made, use, sell, offer for sale, import and otherwise transfer the Contribution and the Contribution in combination with the Material (and portions of such combination). This license applies to all patents owned or controlled by You, whether already acquired or hereafter

acquired, that would be infringed by making, having made, using, selling, offering for sale, importing or otherwise transferring of Your Contribution(s) alone or by combination of Your Contribution(s) with the Material.

3.2 Revocation of Patent License

You reserve the right to revoke the patent license stated in section 3.1 if we make any infringement claim that is targeted at your Contribution and not asserted for a Defensive Purpose. An assertion of claims of the Patents shall be considered for a “Defensive Purpose” if the claims are asserted against an entity that has filed, maintained, threatened, or voluntarily participated in a patent infringement lawsuit against Us or any of Our licensees.

4. DISCLAIMER THE CONTRIBUTION IS PROVIDED “AS IS” . MORE PARTICULARLY, ALL EXPRESS OR IMPLIED WARRANTIES INCLUDING, WITHOUT LIMITATION, ANY IMPLIED WARRANTY OF MERCHANTABILITY, FITNESS FOR A PARTICULAR PURPOSE AND NON-INFRINGEMENT ARE EXPRESSLY DISCLAIMED BY YOU TO US AND BY US TO YOU. TO THE EXTENT THAT ANY SUCH WARRANTIES CANNOT BE DISCLAIMED, SUCH WARRANTY IS LIMITED IN DURATION TO THE MINIMUM PERIOD PERMITTED BY LAW.

5. Consequential Damage Waiver TO THE MAXIMUM EXTENT PERMITTED BY APPLICABLE LAW, IN NO EVENT WILL YOU OR US BE LIABLE FOR ANY LOSS OF PROFITS, LOSS OF ANTICIPATED SAVINGS, LOSS OF DATA, INDIRECT, SPECIAL, INCIDENTAL, CONSEQUENTIAL AND EXEMPLARY DAMAGES ARISING OUT OF THIS AGREEMENT REGARDLESS OF THE LEGAL OR EQUITABLE THEORY (CONTRACT, TORT OR OTHERWISE) UPON WHICH THE CLAIM IS BASED.

6. Approximation of Disclaimer and Damage Waiver IF THE DISCLAIMER AND DAMAGE WAIVER MENTIONED IN SECTION 4 AND SECTION 5 CANNOT BE GIVEN LEGAL EFFECT UNDER APPLICABLE LOCAL LAW, REVIEWING COURTS SHALL APPLY LOCAL LAW THAT MOST CLOSELY APPROXIMATES AN ABSOLUTE WAIVER OF ALL CIVIL LIABILITY IN CONNECTION WITH THE CONTRIBUTION.

7. Term 7.1 This Agreement shall come into effect upon Your acceptance of the terms and conditions.

7.2 In the event of a termination of this Agreement Sections 4, 5, 6, 7 and 8 shall survive such termination and shall remain in full force thereafter. For the avoidance of doubt, Contributions that are already licensed under a free and open source license at the date of the termination shall remain in full force after the termination of this Agreement.

8. Miscellaneous 8.1 This Agreement and all disputes, claims, actions, suits or other proceedings arising out of this agreement or relating in any way to it shall be governed by the laws of People’s Republic of China excluding its private international law provisions.

8.2 This Agreement sets out the entire agreement between You and Us for Your Contributions to Us and overrides all other agreements or understandings.

8.3 If any provision of this Agreement is found void and unenforceable, such provision will be replaced to the extent possible with a provision that comes closest to the meaning of the original provision and that is enforceable. The terms and conditions set forth in this Agreement shall apply notwithstanding any failure of essential purpose of this Agreement or any limited remedy to the maximum extent possible under law.

8.4 You agree to notify Us of any facts or circumstances of which you become aware that would make this Agreement inaccurate in any respect.

You

Date:	
Name:	
Title:	
Address:	

Us

Date:	
Name:	
Title:	
Address:	

Chapter 7

ESP-IDF Versions

The ESP-IDF GitHub repository is updated regularly, especially the master branch where new development takes place.

For production use, there are also stable releases available.

7.1 Releases

The documentation for the current stable release version can always be found at this URL:

<https://docs.espressif.com/projects/esp-idf/en/stable/>

Documentation for the latest version (master branch) can always be found at this URL:

<https://docs.espressif.com/projects/esp-idf/en/latest/>

The full history of releases can be found on the GitHub repository [Releases page](#). There you can find release notes, links to each version of the documentation, and instructions for obtaining each version.

7.2 Which Version Should I Start With?

- For production purposes, use the [current stable version](#). Stable versions have been manually tested, and are updated with “bugfix releases” which fix bugs without changing other functionality (see [Versioning Scheme](#) for more details). Every stable release version can be found on the [Releases page](#).
- For prototyping, experimentation or for developing new ESP-IDF features, use the [latest version \(master branch in Git\)](#). The latest version in the master branch has all the latest features and has passed automated testing, but has not been completely manually tested (“bleeding edge”).
- If a required feature is not yet available in a stable release, but you do not want to use the master branch, it is possible to check out a pre-release version or a release branch. It is recommended to start from a stable version and then follow the instructions for [Updating to a Pre-Release Version](#) or [Updating to a Release Branch](#).

See [Updating ESP-IDF](#) if you already have a local copy of ESP-IDF and wish to update it.

7.3 Versioning Scheme

ESP-IDF uses [Semantic Versioning](#). This means that:

- Major Releases, like `v3.0`, add new functionality and may change functionality. This includes removing deprecated functionality.

If updating to a new major release (for example, from v2.1 to v3.0), some of your project's code may need updating and functionality may need to be re-tested. The release notes on the [Releases page](#) include lists of Breaking Changes to refer to.

- Minor Releases like v3.1 add new functionality and fix bugs but will not change or remove documented functionality, or make incompatible changes to public APIs.

If updating to a new minor release (for example, from v3.0 to v3.1), your project's code does not require updating, but you should re-test your project. Pay particular attention to the items mentioned in the release notes on the [Releases page](#).

- Bugfix Releases like v3.0.1 only fix bugs and do not add new functionality.

If updating to a new bugfix release (for example, from v3.0 to v3.0.1), you do not need to change any code in your project, and you only need to re-test the functionality directly related to bugs listed in the release notes on the [Releases page](#).

7.4 Support Periods

Each ESP-IDF major and minor release version has an associated support period. After this period, the release is End of Life and no longer supported.

The [ESP-IDF Support Period Policy](#) explains this in detail, and describes how the support periods for each release are determined.

Each release on the [Releases page](#) includes information about the support period for that particular release.

As a general guideline:

- If starting a new project, use the latest stable release.
- If you have a GitHub account, click the “Watch” button in the top-right of the [Releases page](#) and choose “Releases only”. GitHub will notify you whenever a new release is available. Whenever a bug fix release is available for the version you are using, plan to update to it.
- If possible, periodically update the project to a new major or minor ESP-IDF version (for example, once a year.) The update process should be straightforward for Minor updates, but may require some planning and checking of the release notes for Major updates.
- Always plan to update to a newer release before the release you are using becomes End of Life.

Each ESP-IDF major and minor release (V4.1, V4.2, etc) is supported for 30 months after the initial stable release date.

Supported means that the ESP-IDF team will continue to apply bug fixes, security fixes, etc to the release branch on GitHub, and periodically make new bugfix releases as needed.

Support period is divided into “Service” and “Maintenance” period:

Period	Duration	Recommended for new projects?
Service	12 months	Yes
Maintenance	18 months	No

During the Service period, bugfixes releases are more frequent. In some cases, support for new features may be added during the Service period (this is reserved for features which are needed to meet particular regulatory requirements or standards for new products, and which carry a very low risk of introducing regressions.)

During the Maintenance period, the version is still supported but only bugfixes for high severity issues or security issues will be applied.

Using an “In Service” version is recommended when starting a new project.

Users are encouraged to upgrade all projects to a newer ESP-IDF release before the support period finishes and the release becomes End of Life (EOL). It is our policy to not continue fixing bugs in End of Life releases.

Pre-release versions (betas, previews, *-rc* and *-dev* versions, etc) are not covered by any support period. Sometimes a particular feature is marked as “Preview” in a release, which means it is also not covered by the support period.

The ESP-IDF Programming Guide has information about the [different versions of ESP-IDF](#) (major, minor, bugfix, etc).

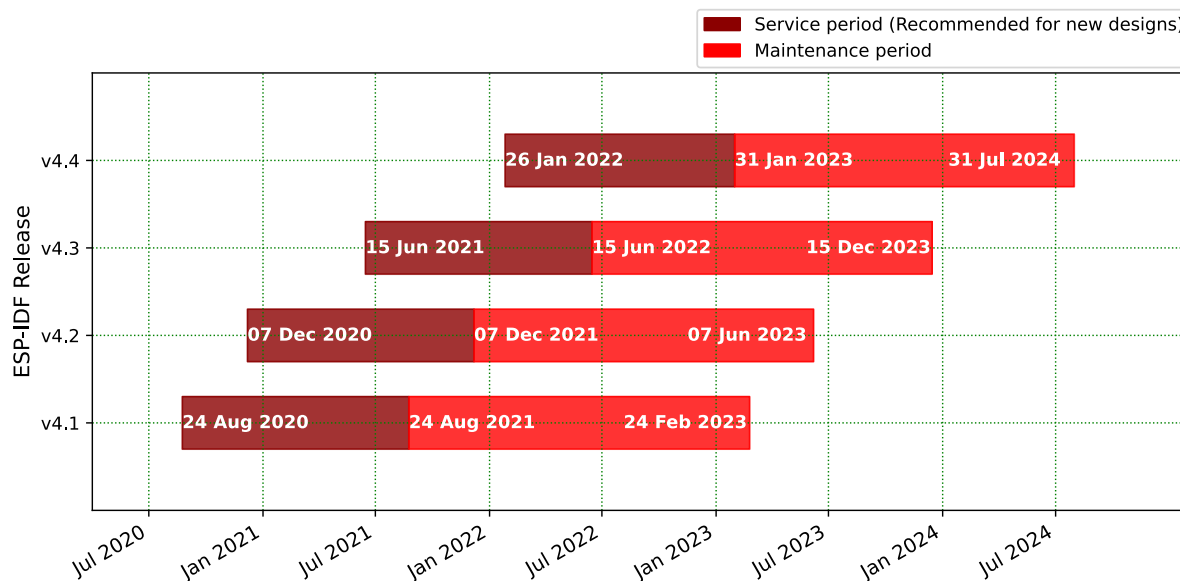

7.5 Checking the Current Version

The local ESP-IDF version can be checked by using `idf.py`:

```
idf.py --version
```

The ESP-IDF version is also compiled into the firmware and can be accessed (as a string) via the macro `IDF_VER`. The default ESP-IDF bootloader will print the version on boot (the version information is not always updated if the code in the GitHub repo is updated, it only changes if there is a clean build or if that particular source file is recompiled).

If writing code that needs to support multiple ESP-IDF versions, the version can be checked at compile time using [compile-time macros](#).

Examples of ESP-IDF versions:

Version String	Meaning
v3.2-dev-306-gbeb3611ca	Master branch pre-release. - v3.2-dev - in development for version 3.2. - 306 - number of commits after v3.2 development started. - beb3611ca - commit identifier.
v3.0.2	Stable release, tagged v3.0.2.
v3.1-beta1-75-g346d6b0ea	Beta version in development (on a <i>release branch</i>). - v3.1-beta1 - pre-release tag. - 75 - number of commits after the pre-release beta tag was assigned. - 346d6b0ea - commit identifier.
v3.0.1-dirty	Stable release, tagged v3.0.1. - dirty means that there are modifications in the local ESP-IDF directory.

7.6 Git Workflow

The development (Git) workflow of the Espressif ESP-IDF team is as follows:

- New work is always added on the master branch (latest version) first. The ESP-IDF version on `master` is always tagged with `-dev` (for “in development”), for example `v3.1-dev`.
- Changes are first added to an internal Git repository for code review and testing but are pushed to GitHub after automated testing passes.
- When a new version (developed on `master`) becomes feature complete and “beta” quality, a new branch is made for the release, for example `release/v3.1`. A pre-release tag is also created, for example `v3.1-beta1`. You can see a full [list of branches](#) and a [list of tags](#) on GitHub. Beta pre-releases have release notes which may include a significant number of Known Issues.
- As testing of the beta version progresses, bug fixes will be added to both the `master` branch and the release branch. New features for the next release may start being added to `master` at the same time.
- Once testing is nearly complete a new release candidate is tagged on the release branch, for example `v3.1-rc1`. This is still a pre-release version.
- If no more significant bugs are found or reported, then the final Major or Minor Version is tagged, for example `v3.1`. This version appears on the [Releases page](#).
- As bugs are reported in released versions, the fixes will continue to be committed to the same release branch.
- Regular bugfix releases are made from the same release branch. After manual testing is complete, a bugfix release is tagged (i.e. `v3.1.1`) and appears on the [Releases page](#).

7.7 Updating ESP-IDF

Updating ESP-IDF depends on which version(s) you wish to follow:

- [Updating to Stable Release](#) is recommended for production use.

- [Updating to Master Branch](#) is recommended for the latest features, development use, and testing.
- [Updating to a Release Branch](#) is a compromise between the first two.

Note: These guides assume that you already have a local copy of ESP-IDF cloned. To get one, check Step 2 in the [Getting Started](#) guide for any ESP-IDF version.

7.7.1 Updating to Stable Release

To update to a new ESP-IDF release (recommended for production use), this is the process to follow:

- Check the [Releases page](#) regularly for new releases.
- When a bugfix release for the version you are using is released (for example, if using v3.0.1 and v3.0.2 is released), check out the new bugfix version into the existing ESP-IDF directory:

```
cd $IDF_PATH
git fetch
git checkout vX.Y.Z
git submodule update --init --recursive
```

- When major or minor updates are released, check the Release Notes on the releases page and decide if you want to update or to stay with your current release. Updating is via the same Git commands shown above.

Note: If you installed the stable release via zip file instead of using git, it might not be possible to update versions using the commands. In this case, update by downloading a new zip file and replacing the entire `IDF_PATH` directory with its contents.

7.7.2 Updating to a Pre-Release Version

It is also possible to `git checkout` a tag corresponding to a pre-release version or release candidate, the process is the same as [Updating to Stable Release](#).

Pre-release tags are not always found on the [Releases page](#). Consult the [list of tags](#) on GitHub for a full list. Caveats for using a pre-release are similar to [Updating to a Release Branch](#).

7.7.3 Updating to Master Branch

Note: Using Master branch means living “on the bleeding edge” with the latest ESP-IDF code.

To use the latest version on the ESP-IDF master branch, this is the process to follow:

- Check out the master branch locally:

```
cd $IDF_PATH
git checkout master
git pull
git submodule update --init --recursive
```

- Periodically, re-run `git pull` to pull the latest version of master. Note that you may need to change your project or report bugs after updating your master branch.
- To switch from master to a release branch or stable version, run `git checkout` as shown in the other sections.

Important: It is strongly recommended to regularly run `git pull` and then `git submodule update --init --recursive` so a local copy of master does not get too old. Arbitrary old master branch revisions are effectively unsupported “snapshots” that may have undocumented bugs. For a semi-stable version, try [Updating to a Release Branch](#) instead.

7.7.4 Updating to a Release Branch

In terms of stability, using a release branch is part-way between using the master branch and only using stable releases. A release branch is always beta quality or better, and receives bug fixes before they appear in each stable release.

You can find a [list of branches](#) on GitHub.

For example, to follow the branch for ESP-IDF v3.1, including any bugfixes for future releases like v3.1.1, etc:

```
cd $IDF_PATH
git fetch
git checkout release/v3.1
git pull
git submodule update --init --recursive
```

Each time you `git pull` this branch, ESP-IDF will be updated with fixes for this release.

Note: There is no dedicated documentation for release branches. It is recommended to use the documentation for the closest version to the branch which is currently checked out.

Chapter 8

Resources

8.1 PlatformIO



- [What is PlatformIO?](#)
- [Installation](#)
- [Configuration](#)
- [Tutorials](#)
- [Project Examples](#)
- [Next Steps](#)

8.1.1 What is PlatformIO?

PlatformIO is a cross-platform embedded development environment with out-of-the-box support for ESP-IDF.

Since ESP-IDF support within PlatformIO is not maintained by the Espressif team, please report any issues with PlatformIO directly to its developers in [the official PlatformIO repositories](#).

A detailed overview of the PlatformIO ecosystem and its philosophy can be found in [the official PlatformIO documentation](#).

8.1.2 Installation

- [PlatformIO IDE](#) is a toolset for embedded C/C++ development available on Windows, macOS and Linux platforms
- [PlatformIO Core \(CLI\)](#) is a command-line tool that consists of multi-platform build system, platform and library managers and other integration components. It can be used with a variety of code development environments and allows integration with cloud platforms and web services

8.1.3 Configuration

Please go through [the official PlatformIO configuration guide](#) for ESP-IDF.

8.1.4 Tutorials

- [ESP-IDF and ESP32-DevKitC: debugging, unit testing, project analysis](#)

8.1.5 Project Examples

Please check ESP-IDF page in [the official PlatformIO documentation](#)

8.1.6 Next Steps

Here are some useful links for exploring the PlatformIO ecosystem:

- Learn more about [integrations with other IDEs/Text Editors](#)
- Get help from [PlatformIO community](#)

8.2 Useful Links

- The [esp32.com forum](#) is a place to ask questions and find community resources.
- Check the [Issues](#) section on GitHub if you find a bug or have a feature request. Please check existing [Issues](#) before opening a new one.
- A comprehensive collection of [solutions](#), [practical applications](#), [components and drivers](#) based on ESP-IDF is available in [ESP IoT Solution](#) repository. In most of cases descriptions are provided both in English and in 中文.
- To develop applications using Arduino platform, refer to [Arduino core for ESP32 WiFi chip](#).
- Several [books](#) have been written about ESP32 and they are listed on [Espressif](#) web site.
- If you' re interested in contributing to ESP-IDF, please check the [Contributions Guide](#).
- For additional ESP32-C3 product related information, please refer to [documentation](#) section of [Espressif](#) site.
- [Download](#) latest and previous versions of this documentation in PDF and HTML format.

Chapter 9

Copyrights and Licenses

9.1 Software Copyrights

All original source code in this repository is Copyright (C) 2015-2022 Espressif Systems. This source code is licensed under the Apache License 2.0 as described in the file LICENSE.

Additional third party copyrighted code is included under the following licenses.

Where source code headers specify Copyright & License information, this information takes precedence over the summaries made here.

9.1.1 Firmware Components

These third party libraries can be included into the application (firmware) produced by ESP-IDF.

- [Newlib](#) is licensed under the BSD License and is Copyright of various parties, as described in [COPYING.NEWLIB](#).
- [Xtensa header files](#) are Copyright (C) 2013 Tensilica Inc and are licensed under the MIT License as reproduced in the individual header files.
- Original parts of [FreeRTOS](#) (components/freertos) are Copyright (C) 2017 Amazon.com, Inc. or its affiliates are licensed under the MIT License, as described in [license.txt](#).
- Original parts of [LWIP](#) (components/lwip) are Copyright (C) 2001, 2002 Swedish Institute of Computer Science and are licensed under the BSD License as described in [COPYING file](#).
- [wpa_supplicant](#) Copyright (c) 2003-2005 Jouni Malinen and licensed under the BSD license.
- [FreeBSD net80211](#) Copyright (c) 2004-2008 Sam Leffler, Errno Consulting and licensed under the BSD license.
- [JSMN](#) JSON Parser (components/jsmn) Copyright (c) 2010 Serge A. Zaitsev and licensed under the MIT license.
- [argtable3](#) argument parsing library Copyright (C) 1998-2001,2003-2011,2013 Stewart Heitmann and licensed under 3-clause BSD license.
- [linenoise](#) line editing library Copyright (c) 2010-2014 Salvatore Sanfilippo, Copyright (c) 2010-2013 Pieter Noordhuis, licensed under 2-clause BSD license.
- [libcoap](#) COAP library Copyright (c) 2010-2017 Olaf Bergmann and others, is licensed under 2-clause BSD license as described in [LICENSE file](#) and [COPYING file](#) .
- [libexpat](#) XML parsing library Copyright (c) 1998-2000 Thai Open Source Software Center Ltd and Clark Cooper, Copyright (c) 2001-2017 Expat maintainers, is licensed under MIT license as described in [COPYING file](#) .
- [FatFS](#) library, Copyright (C) 2017 ChaN, is licensed under [a BSD-style license](#) .
- [cJSON](#) library, Copyright (c) 2009-2017 Dave Gamble and cJSON contributors, is licensed under MIT license as described in [LICENSE file](#) .
- [libsodium](#) library, Copyright (c) 2013-2018 Frank Denis, is licensed under ISC license as described in [LICENSE file](#) .
- [micro-ecc](#) library, Copyright (c) 2014 Kenneth MacKay, is licensed under 2-clause BSD license.

- [nghttp2](#) library, Copyright (c) 2012, 2014, 2015, 2016 Tatsuhiro Tsujikawa, Copyright (c) 2012, 2014, 2015, 2016 nghttp2 contributors, is licensed under MIT license as described in [COPYING file](#) .
- [Mbed TLS](#) library, Copyright (C) 2006-2018 ARM Limited, is licensed under Apache License 2.0 as described in [LICENSE file](#) .
- [SPIFFS](#) library, Copyright (c) 2013-2017 Peter Andersson, is licensed under MIT license as described in [LICENSE file](#) .
- [TinyCBOR](#) library, Copyright (c) 2017 Intel Corporation, is licensed under MIT License as described in [LICENSE file](#) .
- [SD/MMC driver](#) is derived from [OpenBSD SD/MMC driver](#), Copyright (c) 2006 Uwe Stuehler, and is licensed under BSD license.
- [Asio](#) , Copyright (c) 2003-2018 Christopher M. Kohlhoff is licensed under the Boost Software License as described in [COPYING file](#).
- [ESP-MQTT](#) MQTT Package (contiki-mqtt) - Copyright (c) 2014, Stephen Robinson, MQTT-ESP - Tuan PM <tuanpm at live dot com> is licensed under Apache License 2,0 as described in [LICENSE file](#) .
- [BLE Mesh](#) is adapted from Zephyr Project, Copyright (c) 2017-2018 Intel Corporation and licensed under Apache License 2.0
- [mynewt-nimble](#) Apache Mynewt NimBLE, Copyright 2015-2018, The Apache Software Foundation, is licensed under Apache License 2.0 as described in [LICENSE file](#).
- [cryptoauthlib](#) Microchip CryptoAuthentication Library - Copyright (c) 2015 - 2018 Microchip Technology Inc, is licensed under common Microchip software License as described in [LICENSE file](#)
- `:component_file:` TLSF allocator <heap/heap_tlsf.c>` Two Level Segregated Fit memory allocator, Copyright (c) 2006-2016, Matthew Conte, and licensed under the BSD license.`
- [qrcode](#) QR Code generator library Copyright (c) Project Nayuki, is licensed under MIT license.
- [freemodbus](#) Copyright (c) 2006-2013 Christian Walter, Armink and licensed under the BSD license.

9.1.2 Build Tools

This is the list of licenses for tools included in this repository, which are used to build applications. The tools do not become part of the application (firmware), so their license does not affect licensing of the application.

- [esptool.py](#) is Copyright (C) 2014-2016 Fredrik Ahlberg, Angus Gratton and is licensed under the GNU General Public License v2, as described in [LICENSE file](#).
- [KConfig](#) is Copyright (C) 2002 Roman Zippel and others, and is licensed under the GNU General Public License V2.

9.1.3 Documentation

- HTML version of the [ESP-IDF Programming Guide](#) uses the Sphinx theme [sphinx_idf_theme](#), which is Copyright (c) 2013-2020 Dave Snider, Read the Docs, Inc. & contributors, and Espressif Systems (Shanghai) CO., LTD. It is based on [sphinx_rtd_theme](#). Both are licensed under MIT license.

9.2 ROM Source Code Copyrights

ESP32 mask ROM hardware includes binaries compiled from portions of the following third party software:

- [Newlib](#) , licensed under the BSD License and is Copyright of various parties, as described in [COPYING.NEWLIB](#).
- Xtensa libhal, Copyright (c) Tensilica Inc and licensed under the MIT license (see below).
- [TinyBasic](#) Plus, Copyright Mike Field & Scott Lawrence and licensed under the MIT license (see below).
- [miniz](#), by Rich Geldreich - placed into the public domain.
- [wpa_supplicant](#) Copyright (c) 2003-2005 Jouni Malinen and licensed under the BSD license.
- [TJpgDec](#) Copyright (C) 2011, ChaN, all right reserved. See below for license.

9.3 Xtensa libhal MIT License

Copyright (c) 2003, 2006, 2010 Tensilica Inc.

Permission is hereby granted, free of charge, to any person obtaining a copy of this software and associated documentation files (the “Software”), to deal in the Software without restriction, including without limitation the rights to use, copy, modify, merge, publish, distribute, sublicense, and/or sell copies of the Software, and to permit persons to whom the Software is furnished to do so, subject to the following conditions:

The above copyright notice and this permission notice shall be included in all copies or substantial portions of the Software.

THE SOFTWARE IS PROVIDED “AS IS”, WITHOUT WARRANTY OF ANY KIND, EXPRESS OR IMPLIED, INCLUDING BUT NOT LIMITED TO THE WARRANTIES OF MERCHANTABILITY, FITNESS FOR A PARTICULAR PURPOSE AND NONINFRINGEMENT. IN NO EVENT SHALL THE AUTHORS OR COPYRIGHT HOLDERS BE LIABLE FOR ANY CLAIM, DAMAGES OR OTHER LIABILITY, WHETHER IN AN ACTION OF CONTRACT, TORT OR OTHERWISE, ARISING FROM, OUT OF OR IN CONNECTION WITH THE SOFTWARE OR THE USE OR OTHER DEALINGS IN THE SOFTWARE.

9.4 TinyBasic Plus MIT License

Copyright (c) 2012-2013

Permission is hereby granted, free of charge, to any person obtaining a copy of this software and associated documentation files (the “Software”), to deal in the Software without restriction, including without limitation the rights to use, copy, modify, merge, publish, distribute, sublicense, and/or sell copies of the Software, and to permit persons to whom the Software is furnished to do so, subject to the following conditions:

The above copyright notice and this permission notice shall be included in all copies or substantial portions of the Software.

THE SOFTWARE IS PROVIDED “AS IS”, WITHOUT WARRANTY OF ANY KIND, EXPRESS OR IMPLIED, INCLUDING BUT NOT LIMITED TO THE WARRANTIES OF MERCHANTABILITY, FITNESS FOR A PARTICULAR PURPOSE AND NONINFRINGEMENT. IN NO EVENT SHALL THE AUTHORS OR COPYRIGHT HOLDERS BE LIABLE FOR ANY CLAIM, DAMAGES OR OTHER LIABILITY, WHETHER IN AN ACTION OF CONTRACT, TORT OR OTHERWISE, ARISING FROM, OUT OF OR IN CONNECTION WITH THE SOFTWARE OR THE USE OR OTHER DEALINGS IN THE SOFTWARE.

9.5 TJpgDec License

TJpgDec - Tiny JPEG Decompressor R0.01 (C)ChaN, 2011 The TJpgDec is a generic JPEG decompressor module for tiny embedded systems. This is a free software that opened for education, research and commercial developments under license policy of following terms.

Copyright (C) 2011, ChaN, all right reserved.

- The TJpgDec module is a free software and there is NO WARRANTY.
- No restriction on use. You can use, modify and redistribute it for personal, non-profit or commercial products UNDER YOUR RESPONSIBILITY.
- Redistributions of source code must retain the above copyright notice.

Chapter 10

About

This is documentation of [ESP-IDF](#), the framework to develop applications for ESP32-C3.

The ESP32-C3 is a 2.4 GHz Wi-Fi Bluetooth Low Energy combo, which integrates a 32-bit RISC-V RV32IMC single-core processor.

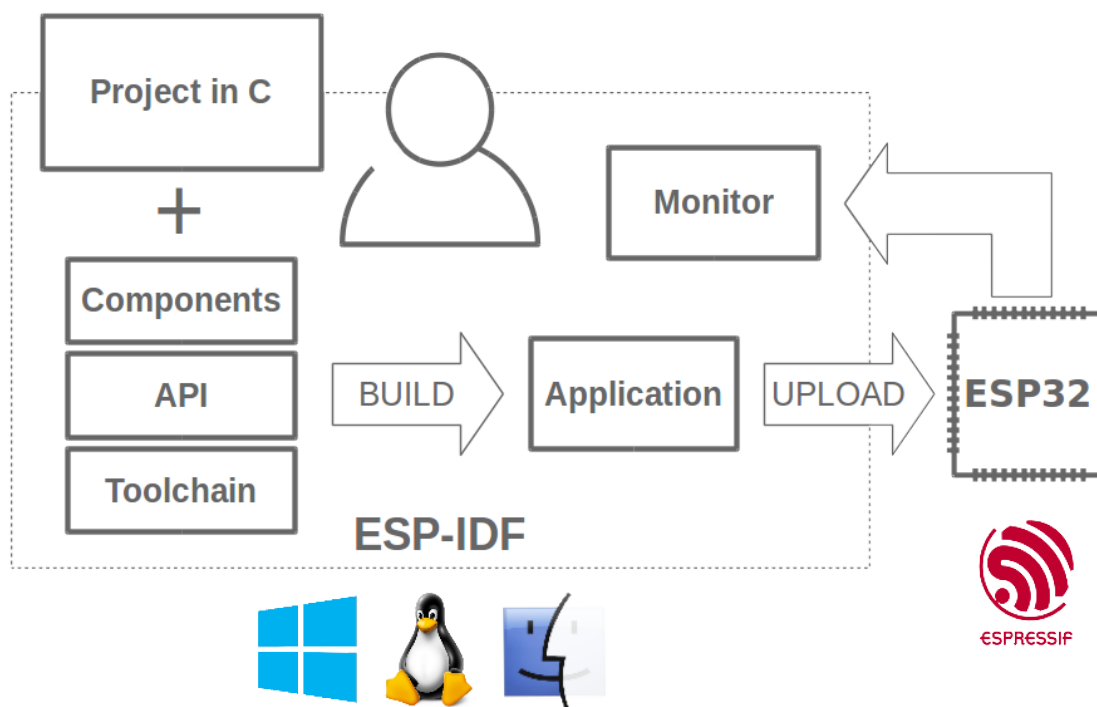

Fig. 1: Espressif IoT Integrated Development Framework

The ESP-IDF, Espressif IoT Development Framework, provides toolchain, API, components and workflows to develop applications for ESP32-C3 using Windows, Linux and Mac OS operating systems.

Chapter 11

Switch Between Languages

The ESP-IDF Programming Guide is now available in two languages. Please refer to the English version if there is any discrepancy.

- English
- Chinese

You can easily change from one language to another by clicking the language link you can find at the top of every document that has a translation.

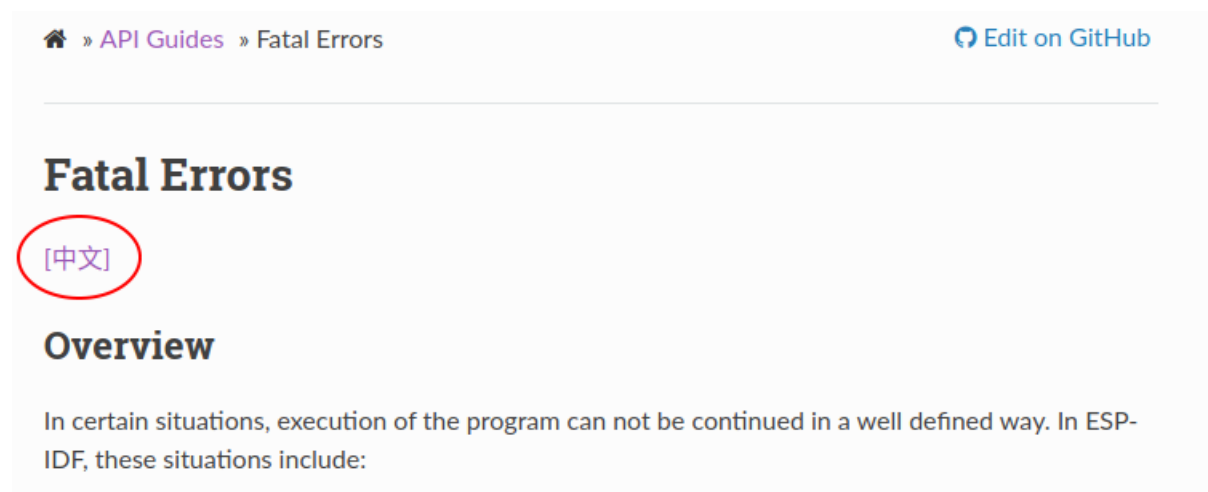

The screenshot shows a breadcrumb trail: [Home](#) » [API Guides](#) » [Fatal Errors](#). On the right, there is a link [Edit on GitHub](#). Below the breadcrumb, the title **Fatal Errors** is displayed. A link [\[中文\]](#) is circled in red, indicating the Chinese language option. Below this, the section **Overview** is shown, followed by the text: "In certain situations, execution of the program can not be continued in a well defined way. In ESP-IDF, these situations include:"

- [genindex](#)

Index

Symbols

`_ESP_NETIF_SUPPRESS_LEGACY_WARNING_` (C macro), 481

[anonymous] (C++ enum), 52, 206

A

`ADC1_CHANNEL_0` (C++ enumerator), 500

`ADC1_CHANNEL_0_GPIO_NUM` (C macro), 503

`ADC1_CHANNEL_1` (C++ enumerator), 500

`ADC1_CHANNEL_1_GPIO_NUM` (C macro), 503

`ADC1_CHANNEL_2` (C++ enumerator), 500

`ADC1_CHANNEL_2_GPIO_NUM` (C macro), 503

`ADC1_CHANNEL_3` (C++ enumerator), 500

`ADC1_CHANNEL_3_GPIO_NUM` (C macro), 503

`ADC1_CHANNEL_4` (C++ enumerator), 500

`ADC1_CHANNEL_4_GPIO_NUM` (C macro), 503

`ADC1_CHANNEL_MAX` (C++ enumerator), 500

`adc1_channel_t` (C++ enum), 500

`adc1_config_channel_atten` (C++ function), 496

`adc1_config_width` (C++ function), 496

`adc1_get_raw` (C++ function), 496

`ADC1_GPIO1_CHANNEL` (C macro), 503

`ADC1_GPIO2_CHANNEL` (C macro), 503

`ADC1_GPIO3_CHANNEL` (C macro), 503

`ADC1_GPIO4_CHANNEL` (C macro), 503

`ADC1_GPIO5_CHANNEL` (C macro), 503

`adc1_pad_get_io_num` (C++ function), 495

`ADC2_CHANNEL_0` (C++ enumerator), 500

`ADC2_CHANNEL_0_GPIO_NUM` (C macro), 503

`ADC2_CHANNEL_MAX` (C++ enumerator), 500

`adc2_channel_t` (C++ enum), 500

`adc2_config_channel_atten` (C++ function), 497

`adc2_get_raw` (C++ function), 498

`ADC2_GPIO5_CHANNEL` (C macro), 503

`adc2_pad_get_io_num` (C++ function), 497

`adc2_vref_to_gpio` (C++ function), 498

`ADC_ARB_MODE_FIX` (C++ enumerator), 494

`ADC_ARB_MODE_LOOP` (C++ enumerator), 494

`ADC_ARB_MODE_SHIELD` (C++ enumerator), 494

`ADC_ARBITER_CONFIG_DEFAULT` (C macro), 492

`adc_arbiter_mode_t` (C++ enum), 494

`adc_arbiter_t` (C++ class), 491

`adc_arbiter_t::dig_pri` (C++ member), 491

`adc_arbiter_t::mode` (C++ member), 491

`adc_arbiter_t::pwdet_pri` (C++ member), 491

`adc_arbiter_t::rtc_pri` (C++ member), 491

`ADC_ATTEN_0db` (C macro), 500

`ADC_ATTEN_11db` (C macro), 500

`ADC_ATTEN_2_5db` (C macro), 500

`ADC_ATTEN_6db` (C macro), 500

`ADC_ATTEN_DB_0` (C++ enumerator), 493

`ADC_ATTEN_DB_11` (C++ enumerator), 493

`ADC_ATTEN_DB_2_5` (C++ enumerator), 493

`ADC_ATTEN_DB_6` (C++ enumerator), 493

`ADC_ATTEN_MAX` (C++ enumerator), 493

`adc_atten_t` (C++ enum), 493

`adc_bits_width_t` (C++ enum), 493

`ADC_CHANNEL_0` (C++ enumerator), 492

`ADC_CHANNEL_1` (C++ enumerator), 492

`ADC_CHANNEL_2` (C++ enumerator), 492

`ADC_CHANNEL_3` (C++ enumerator), 492

`ADC_CHANNEL_4` (C++ enumerator), 492

`ADC_CHANNEL_5` (C++ enumerator), 492

`ADC_CHANNEL_6` (C++ enumerator), 492

`ADC_CHANNEL_7` (C++ enumerator), 492

`ADC_CHANNEL_8` (C++ enumerator), 492

`ADC_CHANNEL_9` (C++ enumerator), 492

`ADC_CHANNEL_MAX` (C++ enumerator), 492

`adc_channel_t` (C++ enum), 492

`ADC_CONV_ALTER_UNIT` (C++ enumerator), 493

`ADC_CONV_BOTH_UNIT` (C++ enumerator), 493

`ADC_CONV_SINGLE_UNIT_1` (C++ enumerator), 493

`ADC_CONV_SINGLE_UNIT_2` (C++ enumerator), 493

`ADC_CONV_UNIT_MAX` (C++ enumerator), 493

`adc_digi_clk_t` (C++ class), 489

`adc_digi_clk_t::div_a` (C++ member), 490

`adc_digi_clk_t::div_b` (C++ member), 490

`adc_digi_clk_t::div_num` (C++ member), 489

`adc_digi_clk_t::use_apll` (C++ member), 489

`adc_digi_config_t` (C++ class), 490

`adc_digi_config_t::adc_pattern` (C++ member), 490

`adc_digi_config_t::adc_pattern_len` (C++ member), 490

`adc_digi_config_t::conv_limit_en` (C++ member), 490

`adc_digi_config_t::conv_limit_num`

- (C++ member), 490
- adc_digi_config_t::sample_freq_hz (C++ member), 490
- adc_digi_controller_config (C++ function), 498
- adc_digi_convert_mode_t (C++ enum), 493
- adc_digi_deinitialize (C++ function), 499
- ADC_DIGI_FILTER_DIS (C++ enumerator), 494
- adc_digi_filter_enable (C++ function), 488
- adc_digi_filter_get_config (C++ function), 488
- ADC_DIGI_FILTER_IDX0 (C++ enumerator), 494
- ADC_DIGI_FILTER_IDX1 (C++ enumerator), 494
- ADC_DIGI_FILTER_IDX_MAX (C++ enumerator), 494
- adc_digi_filter_idx_t (C++ enum), 494
- ADC_DIGI_FILTER_IIR_16 (C++ enumerator), 494
- ADC_DIGI_FILTER_IIR_2 (C++ enumerator), 494
- ADC_DIGI_FILTER_IIR_4 (C++ enumerator), 494
- ADC_DIGI_FILTER_IIR_64 (C++ enumerator), 495
- ADC_DIGI_FILTER_IIR_8 (C++ enumerator), 494
- ADC_DIGI_FILTER_IIR_MAX (C++ enumerator), 495
- adc_digi_filter_mode_t (C++ enum), 494
- adc_digi_filter_reset (C++ function), 488
- adc_digi_filter_set_config (C++ function), 488
- adc_digi_filter_t (C++ class), 491
- adc_digi_filter_t::adc_unit (C++ member), 491
- adc_digi_filter_t::channel (C++ member), 491
- adc_digi_filter_t::mode (C++ member), 491
- ADC_DIGI_FORMAT_11BIT (C++ enumerator), 494
- ADC_DIGI_FORMAT_12BIT (C++ enumerator), 494
- ADC_DIGI_FORMAT_MAX (C++ enumerator), 494
- adc_digi_init_config_s (C++ class), 499
- adc_digi_init_config_s::adc1_chan_mask (C++ member), 499
- adc_digi_init_config_s::adc2_chan_mask (C++ member), 499
- adc_digi_init_config_s::conv_num_each_index (C++ member), 499
- adc_digi_init_config_s::max_store_buf_size (C++ member), 499
- adc_digi_init_config_t (C++ type), 500
- adc_digi_initialize (C++ function), 498
- ADC_DIGI_MONITOR_DIS (C++ enumerator), 495
- ADC_DIGI_MONITOR_EN (C++ enumerator), 495
- adc_digi_monitor_enable (C++ function), 488
- ADC_DIGI_MONITOR_IDX0 (C++ enumerator), 495
- ADC_DIGI_MONITOR_IDX1 (C++ enumerator), 495
- ADC_DIGI_MONITOR_IDX_MAX (C++ enumerator), 495
- adc_digi_monitor_idx_t (C++ enum), 495
- ADC_DIGI_MONITOR_MAX (C++ enumerator), 495
- adc_digi_monitor_mode_t (C++ enum), 495
- adc_digi_monitor_set_config (C++ function), 488
- adc_digi_monitor_t (C++ class), 491
- adc_digi_monitor_t::adc_unit (C++ member), 491
- adc_digi_monitor_t::channel (C++ member), 491
- adc_digi_monitor_t::h_threshold (C++ member), 491
- adc_digi_monitor_t::l_threshold (C++ member), 491
- adc_digi_monitor_t::mode (C++ member), 491
- adc_digi_output_data_t (C++ class), 489
- adc_digi_output_data_t::channel (C++ member), 489
- adc_digi_output_data_t::data (C++ member), 489
- adc_digi_output_data_t::reserved12 (C++ member), 489
- adc_digi_output_data_t::reserved17_31 (C++ member), 489
- adc_digi_output_data_t::type2 (C++ member), 489
- adc_digi_output_data_t::unit (C++ member), 489
- adc_digi_output_data_t::val (C++ member), 489
- adc_digi_output_format_t (C++ enum), 494
- adc_digi_pattern_table_t (C++ class), 489
- adc_digi_pattern_table_t::atten (C++ member), 489
- adc_digi_pattern_table_t::channel (C++ member), 489
- adc_digi_pattern_table_t::reserved (C++ member), 489
- adc_digi_pattern_table_t::unit (C++ member), 489
- adc_digi_pattern_table_t::val (C++ member), 489
- adc_digi_read_bytes (C++ function), 499
- adc_digi_start (C++ function), 499
- adc_digi_stop (C++ function), 499
- ADC_ENCODE_11BIT (C++ enumerator), 501
- ADC_ENCODE_12BIT (C++ enumerator), 500
- ADC_ENCODE_MAX (C++ enumerator), 501
- ADC_I2S_DATA_SRC_ADC (C++ enumerator), 493
- ADC_I2S_DATA_SRC_IO_SIG (C++ enumerator), 493
- ADC_I2S_DATA_SRC_MAX (C++ enumerator), 493
- adc_i2s_encode_t (C++ enum), 500
- adc_i2s_source_t (C++ enum), 493
- ADC_MAX_DELAY (C macro), 500
- adc_power_acquire (C++ function), 495
- adc_power_off (C++ function), 495
- adc_power_on (C++ function), 495
- adc_power_release (C++ function), 495

- ADC_UNIT_1 (C++ enumerator), 492
 ADC_UNIT_2 (C++ enumerator), 492
 ADC_UNIT_ALTER (C++ enumerator), 492
 ADC_UNIT_BOTH (C++ enumerator), 492
 ADC_UNIT_MAX (C++ enumerator), 492
 adc_unit_t (C++ enum), 492
 adc_vref_to_gpio (C++ function), 498
 ADC_WIDTH_10Bit (C macro), 500
 ADC_WIDTH_11Bit (C macro), 500
 ADC_WIDTH_12Bit (C macro), 500
 ADC_WIDTH_9Bit (C macro), 500
 ADC_WIDTH_BIT_12 (C++ enumerator), 493
 ADC_WIDTH_BIT_DEFAULT (C macro), 500
 ADC_WIDTH_MAX (C++ enumerator), 493
 ADD_DEV_FLUSHABLE_DEV_FLAG (C macro), 188
 ADD_DEV_RM_AFTER_PROV_FLAG (C macro), 188
 ADD_DEV_START_PROV_NOW_FLAG (C macro), 188
 ADV_CHNL_37 (C++ enumerator), 100
 ADV_CHNL_38 (C++ enumerator), 100
 ADV_CHNL_39 (C++ enumerator), 100
 ADV_CHNL_ALL (C++ enumerator), 100
 ADV_FILTER_ALLOW_SCAN_ANY_CON_ANY (C++ enumerator), 100
 ADV_FILTER_ALLOW_SCAN_ANY_CON_WLST (C++ enumerator), 100
 ADV_FILTER_ALLOW_SCAN_WLST_CON_ANY (C++ enumerator), 100
 ADV_FILTER_ALLOW_SCAN_WLST_CON_WLST (C++ enumerator), 100
 ADV_TYPE_DIRECT_IND_HIGH (C++ enumerator), 99
 ADV_TYPE_DIRECT_IND_LOW (C++ enumerator), 100
 ADV_TYPE_IND (C++ enumerator), 99
 ADV_TYPE_NONCONN_IND (C++ enumerator), 100
 ADV_TYPE_SCAN_IND (C++ enumerator), 99
 async_memcpy_config_t (C++ class), 890
 async_memcpy_config_t::backlog (C++ member), 890
 async_memcpy_config_t::flags (C++ member), 890
 ASYNC_MEMCPY_DEFAULT_CONFIG (C macro), 890
 async_memcpy_event_t (C++ class), 890
 async_memcpy_event_t::data (C++ member), 890
 async_memcpy_isr_cb_t (C++ type), 891
 async_memcpy_t (C++ type), 891
- ## B
- BD_ADDR (C++ type), 200
 BD_ADDR_LEN (C macro), 188
 BLE_ADDR_TYPE_PUBLIC (C++ enumerator), 57
 BLE_ADDR_TYPE_RANDOM (C++ enumerator), 57
 BLE_ADDR_TYPE_RPA_PUBLIC (C++ enumerator), 57
 BLE_ADDR_TYPE_RPA_RANDOM (C++ enumerator), 57
 BLE_BIT (C macro), 95
 BLE_HCI_UART_H4_ACL (C macro), 153
 BLE_HCI_UART_H4_CMD (C macro), 153
 BLE_HCI_UART_H4_EVT (C macro), 153
 BLE_HCI_UART_H4_NONE (C macro), 153
 BLE_HCI_UART_H4_SCO (C macro), 153
 BLE_SCAN_DUPLICATE_DISABLE (C++ enumerator), 101
 BLE_SCAN_DUPLICATE_ENABLE (C++ enumerator), 101
 BLE_SCAN_DUPLICATE_MAX (C++ enumerator), 101
 BLE_SCAN_FILTER_ALLOW_ALL (C++ enumerator), 101
 BLE_SCAN_FILTER_ALLOW_ONLY_WLST (C++ enumerator), 101
 BLE_SCAN_FILTER_ALLOW_UND_RPA_DIR (C++ enumerator), 101
 BLE_SCAN_FILTER_ALLOW_WLIST_RPA_DIR (C++ enumerator), 101
 BLE_SCAN_TYPE_ACTIVE (C++ enumerator), 101
 BLE_SCAN_TYPE_PASSIVE (C++ enumerator), 101
 BLE_UUID128_VAL_LENGTH (C macro), 773
 BLE_WL_ADDR_TYPE_PUBLIC (C++ enumerator), 57
 BLE_WL_ADDR_TYPE_RANDOM (C++ enumerator), 57
 BT_CONTROLLER_INIT_CONFIG_DEFAULT (C macro), 52
 BT_OCTET32 (C++ type), 200
 BT_OCTET32_LEN (C macro), 188
- ## C
- CHIP_ESP32 (C++ enumerator), 1093
 CHIP_ESP32C3 (C++ enumerator), 1094
 CHIP_ESP32S2 (C++ enumerator), 1094
 CHIP_ESP32S3 (C++ enumerator), 1094
 CHIP_FEATURE_BLE (C macro), 1093
 CHIP_FEATURE_BT (C macro), 1093
 CHIP_FEATURE_EMB_FLASH (C macro), 1092
 CHIP_FEATURE_WIFI_BGN (C macro), 1093
 CONFIG_ESPTOOLPY_FLASHSIZE, 838
 CONFIG_FEATURE_CACHE_TX_BUF_BIT (C macro), 382
 CONFIG_FEATURE_FTM_INITIATOR_BIT (C macro), 382
 CONFIG_FEATURE_FTM_RESPONDER_BIT (C macro), 382
 CONFIG_FEATURE_WPA3_SAE_BIT (C macro), 382
 CONFIG_HEAP_TRACING_STACK_DEPTH (C macro), 1071
 CONFIG_LOG_DEFAULT_LEVEL, 1082, 1083
 CONFIG_LWIP_SNTP_UPDATE_DELAY, 1123
 CONFIG_LWIP_USE_ONLY_LWIP_SELECT, 865

D

DEFAULT_HTTP_BUF_SIZE (*C macro*), 688
 DEL_DEV_ADDR_FLAG (*C macro*), 188
 DEL_DEV_UUID_FLAG (*C macro*), 188
 DPP_BOOTSTRAP_NFC_URI (*C++ enumerator*), 448
 DPP_BOOTSTRAP_PKEX (*C++ enumerator*), 448
 DPP_BOOTSTRAP_QR_CODE (*C++ enumerator*), 448
 dpp_bootstrap_type (*C++ enum*), 448

E

eAbortSleep (*C++ enumerator*), 963
 eBlocked (*C++ enumerator*), 963
 eDeleted (*C++ enumerator*), 963
 eIncrement (*C++ enumerator*), 963
 eInvalid (*C++ enumerator*), 963
 eNoAction (*C++ enumerator*), 963
 eNoTasksWaitingTimeout (*C++ enumerator*), 963
 eNotifyAction (*C++ enum*), 963
 environment variable
 CONFIG_ESPTOOLPY_FLASHSIZE, 838
 CONFIG_LOG_DEFAULT_LEVEL, 1082, 1083
 CONFIG_LWIP_SNTP_UPDATE_DELAY, 1123
 CONFIG_LWIP_USE_ONLY_LWIP_SELECT, 865
 eReady (*C++ enumerator*), 963
 eRunning (*C++ enumerator*), 963
 eSetBits (*C++ enumerator*), 963
 eSetValueWithoutOverwrite (*C++ enumerator*), 963
 eSetValueWithOverwrite (*C++ enumerator*), 963
 eSleepModeStatus (*C++ enum*), 963
 esp_adc_cal_characteristics_t (*C++ class*), 502
 esp_adc_cal_characteristics_t::adc_num (*C++ member*), 502
 esp_adc_cal_characteristics_t::atten (*C++ member*), 502
 esp_adc_cal_characteristics_t::bit_width (*C++ member*), 502
 esp_adc_cal_characteristics_t::coeff_a (*C++ member*), 502
 esp_adc_cal_characteristics_t::coeff_b (*C++ member*), 502
 esp_adc_cal_characteristics_t::high_curve (*C++ member*), 502
 esp_adc_cal_characteristics_t::low_curve (*C++ member*), 502
 esp_adc_cal_characteristics_t::vref (*C++ member*), 502
 esp_adc_cal_characterize (*C++ function*), 501
 esp_adc_cal_check_efuse (*C++ function*), 501
 esp_adc_cal_get_voltage (*C++ function*), 502
 esp_adc_cal_raw_to_voltage (*C++ function*), 501
 ESP_ADC_CAL_VAL_DEFAULT_VREF (*C++ enumerator*), 503
 ESP_ADC_CAL_VAL_EFUSE_TP (*C++ enumerator*), 503
 ESP_ADC_CAL_VAL_EFUSE_VREF (*C++ enumerator*), 502
 ESP_ADC_CAL_VAL_MAX (*C++ enumerator*), 503
 ESP_ADC_CAL_VAL_NOT_SUPPORTED (*C++ enumerator*), 503
 esp_adc_cal_value_t (*C++ enum*), 502
 esp_alloc_failed_hook_t (*C++ type*), 1057
 ESP_APP_DESC_MAGIC_WORD (*C macro*), 882
 esp_app_desc_t (*C++ class*), 882
 esp_app_desc_t::app_elf_sha256 (*C++ member*), 882
 esp_app_desc_t::date (*C++ member*), 882
 esp_app_desc_t::idf_ver (*C++ member*), 882
 esp_app_desc_t::magic_word (*C++ member*), 882
 esp_app_desc_t::project_name (*C++ member*), 882
 esp_app_desc_t::reserv1 (*C++ member*), 882
 esp_app_desc_t::reserv2 (*C++ member*), 882
 esp_app_desc_t::secure_version (*C++ member*), 882
 esp_app_desc_t::time (*C++ member*), 882
 esp_app_desc_t::version (*C++ member*), 882
 ESP_APP_ID_MAX (*C macro*), 56
 ESP_APP_ID_MIN (*C macro*), 56
 esp_apptrace_buffer_get (*C++ function*), 884
 esp_apptrace_buffer_put (*C++ function*), 884
 ESP_APPTRACE_DEST_JTAG (*C++ enumerator*), 887
 ESP_APPTRACE_DEST_MAX (*C++ enumerator*), 887
 ESP_APPTRACE_DEST_NUM (*C++ enumerator*), 887
 esp_apptrace_dest_t (*C++ enum*), 887
 ESP_APPTRACE_DEST_TRAX (*C++ enumerator*), 887
 ESP_APPTRACE_DEST_UART0 (*C++ enumerator*), 887
 esp_apptrace_down_buffer_config (*C++ function*), 884
 esp_apptrace_down_buffer_get (*C++ function*), 885
 esp_apptrace_down_buffer_put (*C++ function*), 886
 esp_apptrace_fclose (*C++ function*), 886
 esp_apptrace_flush (*C++ function*), 885
 esp_apptrace_flush_nolock (*C++ function*), 885
 esp_apptrace_fopen (*C++ function*), 886
 esp_apptrace_fread (*C++ function*), 886
 esp_apptrace_fseek (*C++ function*), 887
 esp_apptrace_fstop (*C++ function*), 887
 esp_apptrace_ftell (*C++ function*), 887
 esp_apptrace_fwrite (*C++ function*), 886
 esp_apptrace_host_is_connected (*C++ function*), 886

- esp_apprtrace_init (C++ function), 884
 esp_apprtrace_read (C++ function), 885
 esp_apprtrace_vprintf (C++ function), 885
 esp_apprtrace_vprintf_to (C++ function), 885
 esp_apprtrace_write (C++ function), 885
 esp_async_memcpy (C++ function), 890
 esp_async_memcpy_install (C++ function), 889
 esp_async_memcpy_uninstall (C++ function), 890
 esp_attr_control_t (C++ class), 104
 esp_attr_control_t::auto_rsp (C++ member), 104
 esp_attr_desc_t (C++ class), 104
 esp_attr_desc_t::length (C++ member), 104
 esp_attr_desc_t::max_length (C++ member), 104
 esp_attr_desc_t::perm (C++ member), 104
 esp_attr_desc_t::uuid_length (C++ member), 104
 esp_attr_desc_t::uuid_p (C++ member), 104
 esp_attr_desc_t::value (C++ member), 104
 esp_attr_value_t (C++ class), 104
 esp_attr_value_t::attr_len (C++ member), 105
 esp_attr_value_t::attr_max_len (C++ member), 105
 esp_attr_value_t::attr_value (C++ member), 105
 esp_base_mac_addr_get (C++ function), 1091
 esp_base_mac_addr_set (C++ function), 1091
 ESP_BD_ADDR_HEX (C macro), 56
 ESP_BD_ADDR_LEN (C macro), 56
 ESP_BD_ADDR_STR (C macro), 56
 esp_bd_addr_t (C++ type), 56
 ESP_BLE_AD_MANUFACTURER_SPECIFIC_TYPE (C++ enumerator), 99
 ESP_BLE_AD_TYPE_128SERVICE_DATA (C++ enumerator), 99
 ESP_BLE_AD_TYPE_128SOL_SRV_UUID (C++ enumerator), 99
 ESP_BLE_AD_TYPE_128SRV_CMPL (C++ enumerator), 99
 ESP_BLE_AD_TYPE_128SRV_PART (C++ enumerator), 99
 ESP_BLE_AD_TYPE_16SRV_CMPL (C++ enumerator), 99
 ESP_BLE_AD_TYPE_16SRV_PART (C++ enumerator), 98
 ESP_BLE_AD_TYPE_32SERVICE_DATA (C++ enumerator), 99
 ESP_BLE_AD_TYPE_32SOL_SRV_UUID (C++ enumerator), 99
 ESP_BLE_AD_TYPE_32SRV_CMPL (C++ enumerator), 99
 ESP_BLE_AD_TYPE_32SRV_PART (C++ enumerator), 99
 ESP_BLE_AD_TYPE_ADV_INT (C++ enumerator), 99
 ESP_BLE_AD_TYPE_APPEARANCE (C++ enumerator), 99
 ESP_BLE_AD_TYPE_CHAN_MAP_UPDATE (C++ enumerator), 99
 ESP_BLE_AD_TYPE_DEV_CLASS (C++ enumerator), 99
 ESP_BLE_AD_TYPE_FLAG (C++ enumerator), 98
 ESP_BLE_AD_TYPE_INDOOR_POSITION (C++ enumerator), 99
 ESP_BLE_AD_TYPE_INT_RANGE (C++ enumerator), 99
 ESP_BLE_AD_TYPE_LE_DEV_ADDR (C++ enumerator), 99
 ESP_BLE_AD_TYPE_LE_ROLE (C++ enumerator), 99
 ESP_BLE_AD_TYPE_LE_SECURE_CONFIRM (C++ enumerator), 99
 ESP_BLE_AD_TYPE_LE_SECURE_RANDOM (C++ enumerator), 99
 ESP_BLE_AD_TYPE_LE_SUPPORT_FEATURE (C++ enumerator), 99
 ESP_BLE_AD_TYPE_NAME_CMPL (C++ enumerator), 99
 ESP_BLE_AD_TYPE_NAME_SHORT (C++ enumerator), 99
 ESP_BLE_AD_TYPE_PUBLIC_TARGET (C++ enumerator), 99
 ESP_BLE_AD_TYPE_RANDOM_TARGET (C++ enumerator), 99
 ESP_BLE_AD_TYPE_SERVICE_DATA (C++ enumerator), 99
 ESP_BLE_AD_TYPE_SM_OOB_FLAG (C++ enumerator), 99
 ESP_BLE_AD_TYPE_SM_TK (C++ enumerator), 99
 ESP_BLE_AD_TYPE_SOL_SRV_UUID (C++ enumerator), 99
 ESP_BLE_AD_TYPE_SPAIR_C256 (C++ enumerator), 99
 ESP_BLE_AD_TYPE_SPAIR_R256 (C++ enumerator), 99
 ESP_BLE_AD_TYPE_TRANS_DISC_DATA (C++ enumerator), 99
 ESP_BLE_AD_TYPE_TX_PWR (C++ enumerator), 99
 ESP_BLE_AD_TYPE_URI (C++ enumerator), 99
 esp_ble_addr_type_t (C++ enum), 57
 esp_ble_adv_channel_t (C++ enum), 100
 ESP_BLE_ADV_DATA_LEN_MAX (C macro), 94
 esp_ble_adv_data_t (C++ class), 83
 esp_ble_adv_data_t::appearance (C++ member), 83
 esp_ble_adv_data_t::flag (C++ member), 84
 esp_ble_adv_data_t::include_name (C++ member), 83
 esp_ble_adv_data_t::include_txpower (C++ member), 83
 esp_ble_adv_data_t::manufacturer_len (C++ member), 83

- esp_ble_adv_data_t::max_interval (C++ member), 83
 esp_ble_adv_data_t::min_interval (C++ member), 83
 esp_ble_adv_data_t::p_manufacturer_data (C++ member), 83
 esp_ble_adv_data_t::p_service_data (C++ member), 83
 esp_ble_adv_data_t::p_service_uuid (C++ member), 84
 esp_ble_adv_data_t::service_data_len (C++ member), 83
 esp_ble_adv_data_t::service_uuid_len (C++ member), 84
 esp_ble_adv_data_t::set_scan_rsp (C++ member), 83
 esp_ble_adv_data_type (C++ enum), 98
 esp_ble_adv_filter_t (C++ enum), 100
 ESP_BLE_ADV_FLAG_BREDR_NOT_SPT (C macro), 92
 ESP_BLE_ADV_FLAG_DMT_CONTROLLER_SPT (C macro), 92
 ESP_BLE_ADV_FLAG_DMT_HOST_SPT (C macro), 92
 ESP_BLE_ADV_FLAG_GEN_DISC (C macro), 92
 ESP_BLE_ADV_FLAG_LIMIT_DISC (C macro), 92
 ESP_BLE_ADV_FLAG_NON_LIMIT_DISC (C macro), 92
 esp_ble_adv_params_t (C++ class), 82
 esp_ble_adv_params_t::adv_filter_policy (C++ member), 83
 esp_ble_adv_params_t::adv_int_max (C++ member), 83
 esp_ble_adv_params_t::adv_int_min (C++ member), 83
 esp_ble_adv_params_t::adv_type (C++ member), 83
 esp_ble_adv_params_t::channel_map (C++ member), 83
 esp_ble_adv_params_t::own_addr_type (C++ member), 83
 esp_ble_adv_params_t::peer_addr (C++ member), 83
 esp_ble_adv_params_t::peer_addr_type (C++ member), 83
 ESP_BLE_ADV_REPORT_EXT_ADV_IND (C macro), 95
 ESP_BLE_ADV_REPORT_EXT_DIRECT_ADV (C macro), 95
 ESP_BLE_ADV_REPORT_EXT_SCAN_IND (C macro), 95
 ESP_BLE_ADV_REPORT_EXT_SCAN_RSP (C macro), 96
 esp_ble_adv_type_t (C++ enum), 99
 ESP_BLE_APP_ENC_KEY_SIZE (C++ enumerator), 100
 ESP_BLE_APPEARANCE_BLOOD_PRESSURE_ARM (C macro), 93
 ESP_BLE_APPEARANCE_BLOOD_PRESSURE_WRIST (C macro), 93
 ESP_BLE_APPEARANCE_CYCLING_CADENCE (C macro), 94
 ESP_BLE_APPEARANCE_CYCLING_COMPUTER (C macro), 94
 ESP_BLE_APPEARANCE_CYCLING_POWER (C macro), 94
 ESP_BLE_APPEARANCE_CYCLING_SPEED (C macro), 94
 ESP_BLE_APPEARANCE_CYCLING_SPEED_CADENCE (C macro), 94
 ESP_BLE_APPEARANCE_GENERIC_BARCODE_SCANNER (C macro), 93
 ESP_BLE_APPEARANCE_GENERIC_BLOOD_PRESSURE (C macro), 93
 ESP_BLE_APPEARANCE_GENERIC_CLOCK (C macro), 93
 ESP_BLE_APPEARANCE_GENERIC_COMPUTER (C macro), 93
 ESP_BLE_APPEARANCE_GENERIC_CONTINUOUS_GLUCOSE_MONITORING (C macro), 94
 ESP_BLE_APPEARANCE_GENERIC_CYCLING (C macro), 94
 ESP_BLE_APPEARANCE_GENERIC_DISPLAY (C macro), 93
 ESP_BLE_APPEARANCE_GENERIC_EYEGLASSES (C macro), 93
 ESP_BLE_APPEARANCE_GENERIC_GLUCOSE (C macro), 94
 ESP_BLE_APPEARANCE_GENERIC_HEART_RATE (C macro), 93
 ESP_BLE_APPEARANCE_GENERIC_HID (C macro), 93
 ESP_BLE_APPEARANCE_GENERIC_INSULIN_PUMP (C macro), 94
 ESP_BLE_APPEARANCE_GENERIC_KEYRING (C macro), 93
 ESP_BLE_APPEARANCE_GENERIC_MEDIA_PLAYER (C macro), 93
 ESP_BLE_APPEARANCE_GENERIC_MEDICATION_DELIVERY (C macro), 94
 ESP_BLE_APPEARANCE_GENERIC_OUTDOOR_SPORTS (C macro), 94
 ESP_BLE_APPEARANCE_GENERIC_PERSONAL_MOBILITY_DEVICE (C macro), 94
 ESP_BLE_APPEARANCE_GENERIC_PHONE (C macro), 93
 ESP_BLE_APPEARANCE_GENERIC_PULSE_OXIMETER (C macro), 94
 ESP_BLE_APPEARANCE_GENERIC_REMOTE (C macro), 93
 ESP_BLE_APPEARANCE_GENERIC_TAG (C macro), 93
 ESP_BLE_APPEARANCE_GENERIC_THERMOMETER (C macro), 93
 ESP_BLE_APPEARANCE_GENERIC_WALKING (C macro), 94

ESP_BLE_APPEARANCE_GENERIC_WATCH (C macro), 93	esp_ble_auth_cmpl_t::auth_mode (C++ member), 88
ESP_BLE_APPEARANCE_GENERIC_WEIGHT (C macro), 94	esp_ble_auth_cmpl_t::bd_addr (C++ member), 88
ESP_BLE_APPEARANCE_HEART_RATE_BELT (C macro), 93	esp_ble_auth_cmpl_t::dev_type (C++ member), 88
ESP_BLE_APPEARANCE_HID_BARCODE_SCANNER (C macro), 94	esp_ble_auth_cmpl_t::fail_reason (C++ member), 88
ESP_BLE_APPEARANCE_HID_CARD_READER (C macro), 94	esp_ble_auth_cmpl_t::key (C++ member), 88
ESP_BLE_APPEARANCE_HID_DIGITAL_PEN (C macro), 94	esp_ble_auth_cmpl_t::key_present (C++ member), 88
ESP_BLE_APPEARANCE_HID_DIGITIZER_TABLET (C macro), 94	esp_ble_auth_cmpl_t::key_type (C++ member), 88
ESP_BLE_APPEARANCE_HID_GAMEPAD (C macro), 94	esp_ble_auth_cmpl_t::success (C++ member), 88
ESP_BLE_APPEARANCE_HID_JOYSTICK (C macro), 93	esp_ble_auth_req_t (C++ type), 96
ESP_BLE_APPEARANCE_HID_KEYBOARD (C macro), 93	esp_ble_bond_dev_t (C++ class), 87
ESP_BLE_APPEARANCE_HID_MOUSE (C macro), 93	esp_ble_bond_dev_t::bd_addr (C++ member), 87
ESP_BLE_APPEARANCE_INSULIN_PEN (C macro), 94	esp_ble_bond_dev_t::bond_key (C++ member), 87
ESP_BLE_APPEARANCE_INSULIN_PUMP_DURABLE_PUMP (C macro), 94	esp_ble_bond_key_info_t (C++ class), 87
ESP_BLE_APPEARANCE_INSULIN_PUMP_PATCH_PUMP (C macro), 94	esp_ble_bond_key_info_t::key_mask (C++ member), 87
ESP_BLE_APPEARANCE_MOBILITY_SCOOTER (C macro), 94	esp_ble_bond_key_info_t::pcsrk_key (C++ member), 87
ESP_BLE_APPEARANCE_OUTDOOR_SPORTS_LOCATION (C macro), 94	esp_ble_bond_key_info_t::penc_key (C++ member), 87
ESP_BLE_APPEARANCE_OUTDOOR_SPORTS_LOCATION (C macro), 94	esp_ble_bond_key_info_t::pid_key (C++ member), 87
ESP_BLE_APPEARANCE_OUTDOOR_SPORTS_LOCATION (C macro), 94	esp_ble_confirm_reply (C++ function), 64
ESP_BLE_APPEARANCE_OUTDOOR_SPORTS_LOCATION (C macro), 94	ESP_BLE_CONN_INT_MAX (C macro), 55
ESP_BLE_APPEARANCE_OUTDOOR_SPORTS_LOCATION (C macro), 94	ESP_BLE_CONN_INT_MIN (C macro), 55
ESP_BLE_APPEARANCE_OUTDOOR_SPORTS_LOCATION (C macro), 94	ESP_BLE_CONN_LATENCY_MAX (C macro), 55
ESP_BLE_APPEARANCE_OUTDOOR_SPORTS_LOCATION (C macro), 94	ESP_BLE_CONN_PARAM_UNDEF (C macro), 55
ESP_BLE_APPEARANCE_OUTDOOR_SPORTS_LOCATION (C macro), 94	ESP_BLE_CONN_SUP_TOUT_MAX (C macro), 55
ESP_BLE_APPEARANCE_OUTDOOR_SPORTS_LOCATION (C macro), 94	ESP_BLE_CONN_SUP_TOUT_MIN (C macro), 55
ESP_BLE_APPEARANCE_POWERED_WHEELCHAIR (C macro), 94	esp_ble_conn_update_params_t (C++ class), 84
ESP_BLE_APPEARANCE_PULSE_OXIMETER_FINGERTIP (C macro), 94	esp_ble_conn_update_params_t::bda (C++ member), 85
ESP_BLE_APPEARANCE_PULSE_OXIMETER_WRIST (C macro), 94	esp_ble_conn_update_params_t::latency (C++ member), 85
ESP_BLE_APPEARANCE_SPORTS_WATCH (C macro), 93	esp_ble_conn_update_params_t::max_int (C++ member), 85
ESP_BLE_APPEARANCE_THERMOMETER_EAR (C macro), 93	esp_ble_conn_update_params_t::min_int (C++ member), 85
ESP_BLE_APPEARANCE_UNKNOWN (C macro), 93	esp_ble_conn_update_params_t::timeout (C++ member), 85
ESP_BLE_APPEARANCE_WALKING_IN_SHOE (C macro), 94	ESP_BLE_CSR_KEY_MASK (C macro), 56
ESP_BLE_APPEARANCE_WALKING_ON_HIP (C macro), 94	esp_ble_duplicate_exceptional_info_type_t (C++ enum), 102
ESP_BLE_APPEARANCE_WALKING_ON_SHOE (C macro), 94	ESP_BLE_DUPLICATE_EXCEPTIONAL_LIST_ADD (C++ enumerator), 102
esp_ble_auth_cmpl_t (C++ class), 87	ESP_BLE_DUPLICATE_EXCEPTIONAL_LIST_CLEAN (C++ enumerator), 102
esp_ble_auth_cmpl_t::addr_type (C++ member), 88	ESP_BLE_DUPLICATE_EXCEPTIONAL_LIST_REMOVE (C++ enumerator), 102

- ESP_BLE_DUPLICATE_SCAN_EXCEPTIONAL_ADDR_LIST esp_ble_gap_all_phys_t (C++ type), 96
(C++ enumerator), 103 esp_ble_gap_cb_param_t (C++ union), 70
- ESP_BLE_DUPLICATE_SCAN_EXCEPTIONAL_ALL_LIST esp_ble_gap_cb_param_t::adv_data_cmpl
(C++ enumerator), 103 (C++ member), 70
- ESP_BLE_DUPLICATE_SCAN_EXCEPTIONAL_INFO_ADDR_LIST esp_ble_gap_cb_param_t::adv_data_raw_cmpl
(C++ enumerator), 102 (C++ member), 70
- ESP_BLE_DUPLICATE_SCAN_EXCEPTIONAL_INFO_MESH_BEACON_TYPE esp_ble_gap_cb_param_t::adv_start_cmpl
(C++ enumerator), 102 (C++ member), 70
- ESP_BLE_DUPLICATE_SCAN_EXCEPTIONAL_INFO_MESH_LINK_ID esp_ble_gap_cb_param_t::adv_stop_cmpl
(C++ enumerator), 102 (C++ member), 70
- ESP_BLE_DUPLICATE_SCAN_EXCEPTIONAL_INFO_MESH_PROXY_SRV_ADDR esp_ble_gap_cb_param_t::adv_terminate
(C++ enumerator), 102 (C++ member), 72
- ESP_BLE_DUPLICATE_SCAN_EXCEPTIONAL_INFO_MESH_PROXY_SRV_PARAM esp_ble_gap_cb_param_t::ble_adv_data_cmpl_evt_param
(C++ enumerator), 103 (C++ class), 72
- ESP_BLE_DUPLICATE_SCAN_EXCEPTIONAL_MESH_BEACON_GAP_FILTER esp_ble_gap_cb_param_t::ble_adv_data_cmpl_evt_param
(C++ enumerator), 103 (C++ member), 72
- ESP_BLE_DUPLICATE_SCAN_EXCEPTIONAL_MESH_LINK_ID_LIST esp_ble_gap_cb_param_t::ble_adv_data_raw_cmpl_evt
(C++ enumerator), 103 (C++ class), 72
- ESP_BLE_DUPLICATE_SCAN_EXCEPTIONAL_MESH_PROXY_SRV_ADDR_LIST esp_ble_gap_cb_param_t::ble_adv_data_raw_cmpl_evt
(C++ enumerator), 103 (C++ member), 73
- ESP_BLE_DUPLICATE_SCAN_EXCEPTIONAL_MESH_PROXY_SRV_PARAM esp_ble_gap_cb_param_t::ble_adv_start_cmpl_evt_param
(C++ enumerator), 103 (C++ class), 73
- ESP_BLE_ENC_KEY_MASK (C macro), 56 esp_ble_gap_cb_param_t::ble_adv_start_cmpl_evt_param
(C++ member), 73
- ESP_BLE_EVT_CONN_ADV (C++ enumerator), 102 esp_ble_gap_cb_param_t::ble_adv_stop_cmpl_evt_param
(C++ class), 73
- ESP_BLE_EVT_CONN_DIR_ADV (C++ enumerator), 102 esp_ble_gap_cb_param_t::ble_adv_stop_cmpl_evt_param
(C++ member), 73
- ESP_BLE_EVT_DISC_ADV (C++ enumerator), 102 esp_ble_gap_cb_param_t::ble_adv_stop_cmpl_evt_param
(C++ member), 73
- ESP_BLE_EVT_NON_CONN_ADV (C++ enumerator), 102 esp_ble_gap_cb_param_t::ble_adv_terminate_param
(C++ class), 73
- ESP_BLE_EVT_SCAN_RSP (C++ enumerator), 102 esp_ble_gap_cb_param_t::ble_adv_terminate_param:
(C++ member), 73
- esp_ble_evt_type_t (C++ enum), 102 esp_ble_gap_cb_param_t::ble_adv_terminate_param:
(C++ member), 73
- esp_ble_ext_adv_type_mask_t (C++ type), 96 esp_ble_gap_cb_param_t::ble_adv_terminate_param:
(C++ member), 73
- esp_ble_ext_scan_cfg_mask_t (C++ type), 96 esp_ble_gap_cb_param_t::ble_adv_terminate_param:
(C++ member), 73
- esp_ble_ext_scan_cfg_t (C++ class), 89 esp_ble_gap_cb_param_t::ble_adv_terminate_param:
(C++ member), 73
- esp_ble_ext_scan_cfg_t::scan_interval esp_ble_gap_cb_param_t::ble_adv_terminate_param:
(C++ member), 89 (C++ member), 73
- esp_ble_ext_scan_cfg_t::scan_type esp_ble_gap_cb_param_t::ble_channel_sel_alg_param
(C++ member), 89 (C++ class), 73
- esp_ble_ext_scan_cfg_t::scan_window esp_ble_gap_cb_param_t::ble_channel_sel_alg_param
(C++ member), 89 (C++ member), 73
- esp_ble_ext_scan_params_t (C++ class), 89 esp_ble_gap_cb_param_t::ble_channel_sel_alg_param
(C++ member), 73
- esp_ble_ext_scan_params_t::cfg_mask esp_ble_gap_cb_param_t::ble_clear_bond_dev_cmpl_evt
(C++ member), 89 (C++ class), 73
- esp_ble_ext_scan_params_t::coded_cfg esp_ble_gap_cb_param_t::ble_clear_bond_dev_cmpl_evt
(C++ member), 89 (C++ member), 73
- esp_ble_ext_scan_params_t::filter_policy (C++ member), 89 esp_ble_gap_cb_param_t::ble_ext_adv_data_set_cmpl_evt
(C++ member), 73
- esp_ble_ext_scan_params_t::own_addr_type (C++ class), 73 esp_ble_gap_cb_param_t::ble_ext_adv_data_set_cmpl_evt
(C++ member), 74
- esp_ble_ext_scan_params_t::scan_duplicate (C++ member), 89 esp_ble_gap_cb_param_t::ble_ext_adv_report_param
(C++ member), 74
- esp_ble_ext_scan_params_t::uncoded_cfg (C++ class), 74 esp_ble_gap_cb_param_t::ble_ext_adv_report_param:
(C++ member), 74
- esp_ble_gap_add_duplicate_scan_exceptional_dev (C++ function), 62 esp_ble_gap_cb_param_t::ble_ext_adv_report_param:
(C++ member), 74
- esp_ble_gap_adv_type_t (C++ type), 96 (C++ class), 74

esp_ble_gap_cb_param_t::ble_phy_update_esp_ble_gap_cb_param_t::ble_scan_result_evt_param
 (C++ class), 78 (C++ member), 80
 esp_ble_gap_cb_param_t::ble_phy_update_esp_ble_gap_cb_param_t::ble_scan_result_evt_param
 (C++ member), 78 (C++ member), 80
 esp_ble_gap_cb_param_t::ble_phy_update_esp_ble_gap_cb_param_t::ble_scan_result_evt_param
 (C++ member), 78 (C++ member), 80
 esp_ble_gap_cb_param_t::ble_phy_update_esp_ble_gap_cb_param_t::ble_scan_result_evt_param
 (C++ member), 78 (C++ member), 80
 esp_ble_gap_cb_param_t::ble_phy_update_esp_ble_gap_cb_param_t::ble_scan_result_evt_param
 (C++ member), 78 (C++ member), 80
 esp_ble_gap_cb_param_t::ble_pkt_data_len_esp_ble_gap_cb_param_t::ble_scan_result_evt_param
 (C++ class), 78 (C++ member), 80
 esp_ble_gap_cb_param_t::ble_pkt_data_len_esp_ble_gap_cb_param_t::ble_scan_result_evt_param
 (C++ member), 78 (C++ member), 80
 esp_ble_gap_cb_param_t::ble_pkt_data_len_esp_ble_gap_cb_param_t::ble_scan_result_evt_param
 (C++ member), 78 (C++ member), 80
 esp_ble_gap_cb_param_t::ble_read_phy_cmpl_start_esp_ble_gap_cb_param_t::ble_scan_result_evt_param
 (C++ class), 78 (C++ member), 80
 esp_ble_gap_cb_param_t::ble_read_phy_cmpl_start_esp_ble_gap_cb_param_t::ble_scan_result_evt_param
 (C++ member), 79 (C++ member), 80
 esp_ble_gap_cb_param_t::ble_read_phy_cmpl_start_esp_ble_gap_cb_param_t::ble_scan_rsp_data_cmpl_ev
 (C++ member), 79 (C++ class), 80
 esp_ble_gap_cb_param_t::ble_read_phy_cmpl_start_esp_ble_gap_cb_param_t::ble_scan_rsp_data_cmpl_ev
 (C++ member), 79 (C++ member), 80
 esp_ble_gap_cb_param_t::ble_read_phy_cmpl_start_esp_ble_gap_cb_param_t::ble_scan_rsp_data_raw_cmpl
 (C++ member), 79 (C++ class), 80
 esp_ble_gap_cb_param_t::ble_read_rssi_cmpl_evt_param_esp_ble_gap_cb_param_t::ble_scan_rsp_data_raw_cmpl
 (C++ class), 79 (C++ member), 80
 esp_ble_gap_cb_param_t::ble_read_rssi_cmpl_evt_param_esp_ble_gap_cb_param_t::ble_scan_start_cmpl_evt_p
 (C++ member), 79 (C++ class), 80
 esp_ble_gap_cb_param_t::ble_read_rssi_cmpl_evt_param_esp_ble_gap_cb_param_t::ble_scan_start_cmpl_evt_p
 (C++ member), 79 (C++ member), 81
 esp_ble_gap_cb_param_t::ble_read_rssi_cmpl_evt_param_esp_ble_gap_cb_param_t::ble_scan_stop_cmpl_evt_pa
 (C++ member), 79 (C++ class), 81
 esp_ble_gap_cb_param_t::ble_remove_bond_req_esp_ble_gap_cb_param_t::ble_scan_stop_cmpl_evt_pa
 (C++ class), 79 (C++ member), 81
 esp_ble_gap_cb_param_t::ble_remove_bond_req_esp_ble_gap_cb_param_t::ble_security
 (C++ member), 79 (C++ member), 70
 esp_ble_gap_cb_param_t::ble_remove_bond_req_esp_ble_gap_cb_param_t::ble_set_channels
 (C++ member), 79 (C++ member), 71
 esp_ble_gap_cb_param_t::ble_scan_param_esp_ble_gap_cb_param_t::ble_set_channels_evt_para
 (C++ class), 79 (C++ class), 81
 esp_ble_gap_cb_param_t::ble_scan_param_esp_ble_gap_cb_param_t::ble_set_channels_evt_para
 (C++ member), 79 (C++ member), 81
 esp_ble_gap_cb_param_t::ble_scan_req_req_esp_ble_gap_cb_param_t::ble_set_ext_scan_params_c
 (C++ class), 79 (C++ class), 81
 esp_ble_gap_cb_param_t::ble_scan_req_req_esp_ble_gap_cb_param_t::ble_set_ext_scan_params_c
 (C++ member), 79 (C++ member), 81
 esp_ble_gap_cb_param_t::ble_scan_req_req_esp_ble_gap_cb_param_t::ble_set_perf_def_phy_cmpl
 (C++ member), 79 (C++ class), 81
 esp_ble_gap_cb_param_t::ble_scan_req_req_esp_ble_gap_cb_param_t::ble_set_perf_def_phy_cmpl
 (C++ member), 79 (C++ member), 81
 esp_ble_gap_cb_param_t::ble_scan_result_evt_param_esp_ble_gap_cb_param_t::ble_set_perf_phy_cmpl_evt
 (C++ class), 80 (C++ class), 81
 esp_ble_gap_cb_param_t::ble_scan_result_evt_param_esp_ble_gap_cb_param_t::ble_set_perf_phy_cmpl_evt
 (C++ member), 80 (C++ member), 81
 esp_ble_gap_cb_param_t::ble_scan_result_evt_param_esp_ble_gap_cb_param_t::ble_set_rand_cmpl_evt_par
 (C++ member), 80 (C++ class), 81

esp_ble_gap_cb_param_t::ble_set_rand_csr_esp_ble_gap_cb_param_t::ext_scan_stop
 (C++ member), 81 (C++ member), 72
 esp_ble_gap_cb_param_t::ble_update_connesp_ble_gap_cb_param_t::get_bond_dev_cmpl
 (C++ class), 81 (C++ member), 71
 esp_ble_gap_cb_param_t::ble_update_connesp_ble_gap_cb_param_t::local_privacy_cmpl
 (C++ member), 82 (C++ member), 71
 esp_ble_gap_cb_param_t::ble_update_connesp_ble_gap_cb_param_t::period_adv_add_dev
 (C++ member), 82 (C++ member), 72
 esp_ble_gap_cb_param_t::ble_update_connesp_ble_gap_cb_param_t::period_adv_clear_dev
 (C++ member), 82 (C++ member), 72
 esp_ble_gap_cb_param_t::ble_update_connesp_ble_gap_cb_param_t::period_adv_create_sync
 (C++ member), 82 (C++ member), 71
 esp_ble_gap_cb_param_t::ble_update_connesp_ble_gap_cb_param_t::period_adv_data_set
 (C++ member), 82 (C++ member), 71
 esp_ble_gap_cb_param_t::ble_update_connesp_ble_gap_cb_param_t::period_adv_remove_dev
 (C++ member), 82 (C++ member), 72
 esp_ble_gap_cb_param_t::ble_update_connesp_ble_gap_cb_param_t::period_adv_report
 (C++ member), 82 (C++ member), 72
 esp_ble_gap_cb_param_t::ble_update_duplesp_ble_gap_cb_param_t::periodic_adv_start
 (C++ class), 82 (C++ member), 71
 esp_ble_gap_cb_param_t::ble_update_duplesp_ble_gap_cb_param_t::periodic_adv_start_device_info
 (C++ member), 82 (C++ member), 71
 esp_ble_gap_cb_param_t::ble_update_duplesp_ble_gap_cb_param_t::periodic_adv_sync_learned
 (C++ member), 82 (C++ member), 72
 esp_ble_gap_cb_param_t::ble_update_duplesp_ble_gap_cb_param_t::periodic_adv_sync_status
 (C++ member), 82 (C++ member), 72
 esp_ble_gap_cb_param_t::ble_update_duplesp_ble_gap_cb_param_t::periodic_adv_sync_subscribed
 (C++ member), 82 (C++ member), 72
 esp_ble_gap_cb_param_t::ble_update_whitesp_ble_gap_cb_param_t::periodic_adv_sync_lost
 (C++ class), 82 (C++ member), 72
 esp_ble_gap_cb_param_t::ble_update_whitesp_ble_gap_cb_param_t::status_id_adv_set_params
 (C++ member), 82 (C++ member), 71
 esp_ble_gap_cb_param_t::ble_update_whitesp_ble_gap_cb_param_t::wplp_notify
 (C++ member), 82 (C++ member), 72
 esp_ble_gap_cb_param_t::channel_sel_algesp_ble_gap_cb_param_t::pkt_data_lenth_cmpl
 (C++ member), 72 (C++ member), 70
 esp_ble_gap_cb_param_t::clear_bond_dev_esp_ble_gap_cb_param_t::read_phy (C++
 (C++ member), 71 member), 71
 esp_ble_gap_cb_param_t::ext_adv_clear esp_ble_gap_cb_param_t::read_rssi_cmpl
 (C++ member), 71 (C++ member), 71
 esp_ble_gap_cb_param_t::ext_adv_data_set esp_ble_gap_cb_param_t::remove_bond_dev_cmpl
 (C++ member), 71 (C++ member), 71
 esp_ble_gap_cb_param_t::ext_adv_remove esp_ble_gap_cb_param_t::scan_param_cmpl
 (C++ member), 71 (C++ member), 70
 esp_ble_gap_cb_param_t::ext_adv_report esp_ble_gap_cb_param_t::scan_req_received
 (C++ member), 72 (C++ member), 72
 esp_ble_gap_cb_param_t::ext_adv_set_param esp_ble_gap_cb_param_t::scan_rsp_data_cmpl
 (C++ member), 71 (C++ member), 70
 esp_ble_gap_cb_param_t::ext_adv_set_ran esp_ble_gap_cb_param_t::scan_rsp_data_raw_cmpl
 (C++ member), 71 (C++ member), 70
 esp_ble_gap_cb_param_t::ext_adv_start esp_ble_gap_cb_param_t::scan_rsp_set
 (C++ member), 71 (C++ member), 71
 esp_ble_gap_cb_param_t::ext_adv_stop esp_ble_gap_cb_param_t::scan_rst (C++
 (C++ member), 71 member), 70
 esp_ble_gap_cb_param_t::ext_conn_params esp_ble_gap_cb_param_t::scan_start_cmpl
 (C++ member), 72 (C++ member), 70
 esp_ble_gap_cb_param_t::ext_scan_start esp_ble_gap_cb_param_t::scan_stop_cmpl
 (C++ member), 72 (C++ member), 70

esp_ble_gap_cb_param_t::set_ext_scan_params (C++ member), 72
 esp_ble_gap_cb_param_t::set_perf_def_phy (C++ member), 71
 esp_ble_gap_cb_param_t::set_perf_phy (C++ member), 71
 esp_ble_gap_cb_param_t::set_rand_addr (C++ member), 70
 esp_ble_gap_cb_param_t::update_conn_params (C++ member), 70
 esp_ble_gap_cb_param_t::update_duplicates_exception_list (C++ member), 71
 esp_ble_gap_cb_param_t::update_whitelist (C++ member), 71
 esp_ble_gap_clean_duplicate_scan_exceptions (C++ function), 63
 esp_ble_gap_clear_rand_addr (C++ function), 60
 esp_ble_gap_clear_whitelist (C++ function), 61
 esp_ble_gap_config_adv_data (C++ function), 59
 esp_ble_gap_config_adv_data_raw (C++ function), 62
 esp_ble_gap_config_ext_adv_data_raw (C++ function), 66
 esp_ble_gap_config_ext_scan_rsp_data_raw (C++ function), 66
 esp_ble_gap_config_local_icon (C++ function), 61
 esp_ble_gap_config_local_privacy (C++ function), 60
 esp_ble_gap_config_periodic_adv_data_raw (C++ function), 67
 esp_ble_gap_config_scan_rsp_data_raw (C++ function), 62
 esp_ble_gap_conn_params_t (C++ class), 89
 esp_ble_gap_conn_params_t::interval_max (C++ member), 89
 esp_ble_gap_conn_params_t::interval_min (C++ member), 89
 esp_ble_gap_conn_params_t::latency (C++ member), 90
 esp_ble_gap_conn_params_t::max_ce_len (C++ member), 90
 esp_ble_gap_conn_params_t::min_ce_len (C++ member), 90
 esp_ble_gap_conn_params_t::scan_interval (C++ member), 89
 esp_ble_gap_conn_params_t::scan_window (C++ member), 89
 esp_ble_gap_conn_params_t::supervision_timeout (C++ member), 90
 esp_ble_gap_disconnect (C++ function), 65
 ESP_BLE_GAP_EXT_ADV_DATA_COMPLETE (C macro), 95
 ESP_BLE_GAP_EXT_ADV_DATA_INCOMPLETE (C macro), 95
 esp_ble_gap_ext_adv_data_status_t (C++ type), 96
 ESP_BLE_GAP_EXT_ADV_DATA_TRUNCATED (C macro), 95
 esp_ble_gap_ext_adv_params_t (C++ class), 88
 esp_ble_gap_ext_adv_params_t::channel_map (C++ member), 88
 esp_ble_gap_ext_adv_params_t::filter_policy (C++ member), 88
 esp_ble_gap_ext_adv_params_t::interval_max (C++ member), 88
 esp_ble_gap_ext_adv_params_t::interval_min (C++ member), 88
 esp_ble_gap_ext_adv_params_t::max_skip (C++ member), 89
 esp_ble_gap_ext_adv_params_t::own_addr_type (C++ member), 88
 esp_ble_gap_ext_adv_params_t::peer_addr (C++ member), 88
 esp_ble_gap_ext_adv_params_t::peer_addr_type (C++ member), 88
 esp_ble_gap_ext_adv_params_t::primary_phy (C++ member), 88
 esp_ble_gap_ext_adv_params_t::scan_req_notif (C++ member), 89
 esp_ble_gap_ext_adv_params_t::secondary_phy (C++ member), 89
 esp_ble_gap_ext_adv_params_t::sid (C++ member), 89
 esp_ble_gap_ext_adv_params_t::tx_power (C++ member), 88
 esp_ble_gap_ext_adv_params_t::type (C++ member), 88
 esp_ble_gap_ext_adv_reprot_t (C++ class), 91
 esp_ble_gap_ext_adv_reprot_t::addr (C++ member), 91
 esp_ble_gap_ext_adv_reprot_t::addr_type (C++ member), 91
 esp_ble_gap_ext_adv_reprot_t::adv_data (C++ member), 91
 esp_ble_gap_ext_adv_reprot_t::adv_data_len (C++ member), 91
 esp_ble_gap_ext_adv_reprot_t::data_status (C++ member), 91
 esp_ble_gap_ext_adv_reprot_t::dir_addr (C++ member), 91
 esp_ble_gap_ext_adv_reprot_t::dir_addr_type (C++ member), 91
 esp_ble_gap_ext_adv_reprot_t::event_type (C++ member), 91
 esp_ble_gap_ext_adv_reprot_t::per_adv_interval (C++ member), 91
 esp_ble_gap_ext_adv_reprot_t::primary_phy (C++ member), 91
 esp_ble_gap_ext_adv_reprot_t::rssi (C++ member), 91

esp_ble_gap_ext_adv_reprot_t::secondly_adv (C++ member), 91
 esp_ble_gap_ext_adv_reprot_t::sid (C++ member), 91
 esp_ble_gap_ext_adv_reprot_t::tx_power (C++ member), 91
 esp_ble_gap_ext_adv_set_clear (C++ function), 67
 esp_ble_gap_ext_adv_set_params (C++ function), 66
 esp_ble_gap_ext_adv_set_rand_addr (C++ function), 66
 esp_ble_gap_ext_adv_set_remove (C++ function), 67
 esp_ble_gap_ext_adv_start (C++ function), 66
 esp_ble_gap_ext_adv_stop (C++ function), 67
 esp_ble_gap_ext_adv_t (C++ class), 90
 esp_ble_gap_ext_adv_t::duration (C++ member), 90
 esp_ble_gap_ext_adv_t::instance (C++ member), 90
 esp_ble_gap_ext_adv_t::max_events (C++ member), 90
 ESP_BLE_GAP_EXT_SCAN_CFG_CODE_MASK (C macro), 95
 ESP_BLE_GAP_EXT_SCAN_CFG_UNCODE_MASK (C macro), 95
 esp_ble_gap_get_local_used_addr (C++ function), 62
 esp_ble_gap_get_whitelist_size (C++ function), 61
 ESP_BLE_GAP_NO_PREFER_RECEIVE_PHY (C macro), 95
 ESP_BLE_GAP_NO_PREFER_TRANSMIT_PHY (C macro), 95
 esp_ble_gap_periodic_adv_add_dev_to_list (C++ function), 68
 esp_ble_gap_periodic_adv_clear_dev (C++ function), 69
 esp_ble_gap_periodic_adv_create_sync (C++ function), 68
 esp_ble_gap_periodic_adv_params_t (C++ class), 90
 esp_ble_gap_periodic_adv_params_t::interval (C++ member), 90
 esp_ble_gap_periodic_adv_params_t::interval_min (C++ member), 90
 esp_ble_gap_periodic_adv_params_t::proprietaries (C++ member), 90
 esp_ble_gap_periodic_adv_remove_dev_from_list (C++ function), 68
 esp_ble_gap_periodic_adv_report_t (C++ class), 91
 esp_ble_gap_periodic_adv_report_t::data (C++ member), 92
 esp_ble_gap_periodic_adv_report_t::data_len (C++ member), 92
 esp_ble_gap_periodic_adv_report_t::data_status (C++ member), 91
 esp_ble_gap_periodic_adv_report_t::rssi (C++ member), 91
 esp_ble_gap_periodic_adv_report_t::sync_handle (C++ member), 91
 esp_ble_gap_periodic_adv_report_t::tx_power (C++ member), 91
 esp_ble_gap_periodic_adv_set_params (C++ function), 67
 esp_ble_gap_periodic_adv_start (C++ function), 67
 esp_ble_gap_periodic_adv_stop (C++ function), 67
 esp_ble_gap_periodic_adv_sync_cancel (C++ function), 68
 esp_ble_gap_periodic_adv_sync_estab_t (C++ class), 92
 esp_ble_gap_periodic_adv_sync_estab_t::addr_type (C++ member), 92
 esp_ble_gap_periodic_adv_sync_estab_t::adv_addr (C++ member), 92
 esp_ble_gap_periodic_adv_sync_estab_t::adv_clk_ac (C++ member), 92
 esp_ble_gap_periodic_adv_sync_estab_t::adv_phy (C++ member), 92
 esp_ble_gap_periodic_adv_sync_estab_t::period_adv (C++ member), 92
 esp_ble_gap_periodic_adv_sync_estab_t::sid (C++ member), 92
 esp_ble_gap_periodic_adv_sync_estab_t::status (C++ member), 92
 esp_ble_gap_periodic_adv_sync_estab_t::sync_handle (C++ member), 92
 esp_ble_gap_periodic_adv_sync_params_t (C++ class), 90
 esp_ble_gap_periodic_adv_sync_params_t::addr (C++ member), 90
 esp_ble_gap_periodic_adv_sync_params_t::addr_type (C++ member), 90
 esp_ble_gap_periodic_adv_sync_params_t::filter_pos (C++ member), 90
 esp_ble_gap_periodic_adv_sync_params_t::sid (C++ member), 90
 esp_ble_gap_periodic_adv_sync_params_t::skip (C++ member), 90
 esp_ble_gap_periodic_adv_sync_params_t::sync_time (C++ member), 90
 esp_ble_gap_periodic_adv_sync_terminate (C++ function), 68
 ESP_BLE_GAP_PHY_1M (C macro), 95
 ESP_BLE_GAP_PHY_1M_PREF_MASK (C macro), 95
 ESP_BLE_GAP_PHY_2M (C macro), 95
 ESP_BLE_GAP_PHY_2M_PREF_MASK (C macro), 95
 ESP_BLE_GAP_PHY_CODED (C macro), 95
 ESP_BLE_GAP_PHY_CODED_PREF_MASK (C macro), 95

- macro*), 95
 esp_ble_gap_phy_mask_t (C++ type), 96
 ESP_BLE_GAP_PHY_OPTIONS_NO_PREF (C
macro), 95
 ESP_BLE_GAP_PHY_OPTIONS_PREF_S2_CODING
 (C macro), 95
 ESP_BLE_GAP_PHY_OPTIONS_PREF_S8_CODING
 (C macro), 95
 esp_ble_gap_phy_t (C++ type), 96
 esp_ble_gap_prefer_ext_connect_params (C++
 function), 69
 esp_ble_gap_prefer_phy_options_t (C++
 type), 96
 ESP_BLE_GAP_PRI_PHY_1M (C macro), 95
 ESP_BLE_GAP_PRI_PHY_CODED (C macro), 95
 esp_ble_gap_pri_phy_t (C++ type), 96
 esp_ble_gap_read_phy (C++ function), 65
 esp_ble_gap_read_rssi (C++ function), 62
 esp_ble_gap_register_callback (C++ func-
 tion), 59
 esp_ble_gap_remove_duplicate_scan_exception-
 al (C++ function), 63
 esp_ble_gap_security_rsp (C++ function), 63
 esp_ble_gap_set_device_name (C++ func-
 tion), 61
 ESP_BLE_GAP_SET_EXT_ADV_PROP_ANON_ADV
 (C macro), 95
 ESP_BLE_GAP_SET_EXT_ADV_PROP_CONNECTABLE
 (C macro), 95
 ESP_BLE_GAP_SET_EXT_ADV_PROP_DIRECTED
 (C macro), 95
 ESP_BLE_GAP_SET_EXT_ADV_PROP_HD_DIRECTED
 (C macro), 95
 ESP_BLE_GAP_SET_EXT_ADV_PROP_INCLUDE_TX_PWR
 (C macro), 95
 ESP_BLE_GAP_SET_EXT_ADV_PROP_LEGACY (C
 macro), 95
 ESP_BLE_GAP_SET_EXT_ADV_PROP_LEGACY_HD
 (C macro), 95
 ESP_BLE_GAP_SET_EXT_ADV_PROP_LEGACY_IND
 (C macro), 95
 ESP_BLE_GAP_SET_EXT_ADV_PROP_LEGACY_LD
 (C macro), 95
 ESP_BLE_GAP_SET_EXT_ADV_PROP_LEGACY_NON-
 CONN (C macro), 95
 ESP_BLE_GAP_SET_EXT_ADV_PROP_LEGACY_SCAN-
 NABLE (C macro), 95
 ESP_BLE_GAP_SET_EXT_ADV_PROP_MASK (C
 macro), 95
 ESP_BLE_GAP_SET_EXT_ADV_PROP_NONCONN_NON-
 SCANNABLE (C macro), 95
 ESP_BLE_GAP_SET_EXT_ADV_PROP_SCANNABLE
 (C macro), 95
 esp_ble_gap_set_ext_scan_params (C++
 function), 68
 esp_ble_gap_set_pkt_data_len (C++ func-
 tion), 60
 esp_ble_gap_set_prefer_conn_params
 (C++ function), 61
 esp_ble_gap_set_prefered_default_phy
 (C++ function), 65
 esp_ble_gap_set_prefered_phy (C++ func-
 tion), 65
 esp_ble_gap_set_rand_addr (C++ function),
 60
 esp_ble_gap_set_scan_params (C++ func-
 tion), 59
 esp_ble_gap_set_security_param (C++
 function), 63
 esp_ble_gap_start_advertising (C++ func-
 tion), 60
 esp_ble_gap_start_ext_scan (C++ function),
 68
 esp_ble_gap_start_scanning (C++ function),
 59
 esp_ble_gap_stop_advertising (C++ func-
 tion), 60
 esp_ble_gap_stop_ext_scan (C++ function),
 68
 esp_ble_gap_stop_scanning (C++ function),
 60
 ESP_BLE_GAP_SYNC_POLICY_BY_ADV_INFO (C
 macro), 95
 ESP_BLE_GAP_SYNC_POLICY_BY_PERIODIC_LIST
 (C macro), 95
 esp_ble_gap_sync_t (C++ type), 96
 esp_ble_gap_update_conn_params (C++
 function), 60
 esp_ble_gap_update_whitelist (C++ func-
 tion), 61
 esp_ble_gattc_app_register (C++ function),
 126
 esp_ble_gattc_app_unregister (C++ func-
 tion), 126
 esp_ble_gattc_aux_open (C++ function), 126
 esp_ble_gattc_cache_assoc (C++ function),
 133
 esp_ble_gattc_cache_clean (C++ function),
 133
 esp_ble_gattc_cache_get_addr_list
 (C++ function), 133
 esp_ble_gattc_cache_refresh (C++ func-
 tion), 133
 esp_ble_gattc_cb_param_t (C++ union), 134
 esp_ble_gattc_cb_param_t::cfg_mtu
 (C++ member), 134
 esp_ble_gattc_cb_param_t::close (C++
 member), 134
 esp_ble_gattc_cb_param_t::congest
 (C++ member), 134
 esp_ble_gattc_cb_param_t::connect
 (C++ member), 134
 esp_ble_gattc_cb_param_t::dis_srvc_cmpl
 (C++ member), 134
 esp_ble_gattc_cb_param_t::disconnect
 (C++ member), 134

esp_ble_gattc_cb_param_t::gattc_reg_for_notify_gattc_param_handle: reg (C++
 (C++ member), 138 member), 134
 esp_ble_gattc_cb_param_t::gattc_reg_for_notify_gattc_param_status: reg_for_notify
 (C++ member), 138 (C++ member), 134
 esp_ble_gattc_cb_param_t::gattc_search_evt_gattc_cb_param_t::search_cmpl
 (C++ class), 138 (C++ member), 134
 esp_ble_gattc_cb_param_t::gattc_search_evt_gattc_cb_param_t::search_res
 (C++ member), 138 (C++ member), 134
 esp_ble_gattc_cb_param_t::gattc_search_evt_gattc_cb_param_t::search_res::search_res
 (C++ member), 138 (C++ member), 134
 esp_ble_gattc_cb_param_t::gattc_search_evt_gattc_cb_param_t::start::srvc_chg
 (C++ member), 138 (C++ member), 134
 esp_ble_gattc_cb_param_t::gattc_search_evt_gattc_cb_param_t::unreg_for_notify
 (C++ class), 138 (C++ member), 134
 esp_ble_gattc_cb_param_t::gattc_search_evt_gattc_cb_param_t::write (C++
 (C++ member), 138 member), 134
 esp_ble_gattc_cb_param_t::gattc_search_evt_gattc_cb_param_t::write (C++ func-
 (C++ member), 138 tion), 127
 esp_ble_gattc_cb_param_t::gattc_search_res_evt_gattc_cb_param_t::is_primary
 (C++ member), 138 esp_ble_gattc_execute_write (C++ func-
 (C++ member), 138 tion), 132
 esp_ble_gattc_cb_param_t::gattc_search_res_evt_gattc_cb_param_t::param::srvc_id
 (C++ member), 138 esp_ble_gattc_get_all_char (C++ function),
 (C++ member), 138 127
 esp_ble_gattc_cb_param_t::gattc_search_res_evt_gattc_cb_param_t::start_handle
 (C++ member), 138 esp_ble_gattc_get_all_descr (C++ func-
 (C++ member), 138 tion), 128
 esp_ble_gattc_cb_param_t::gattc_set_assoc_addr_evt_param
 (C++ class), 138 esp_ble_gattc_get_attr_count (C++ func-
 (C++ member), 139 function), 130
 esp_ble_gattc_cb_param_t::gattc_set_assoc_addr_evt_param::status
 (C++ member), 139 esp_ble_gattc_get_char_by_uuid (C++
 (C++ member), 139 function), 128
 esp_ble_gattc_cb_param_t::gattc_srvc_chg_evt_param
 (C++ class), 139 esp_ble_gattc_get_db (C++ function), 130
 esp_ble_gattc_cb_param_t::gattc_srvc_chg_evt_param::get_desc_by_char_handle
 (C++ member), 139 (C++ function), 129
 esp_ble_gattc_cb_param_t::gattc_srvc_chg_evt_param::get_desc_by_uuid (C++
 (C++ member), 139 function), 128
 esp_ble_gattc_cb_param_t::gattc_unreg_for_notify_evt_param::include_service
 (C++ class), 139 (C++ function), 129
 esp_ble_gattc_cb_param_t::gattc_unreg_for_notify_evt_param::service_handle (C++
 (C++ member), 139 function), 127
 esp_ble_gattc_cb_param_t::gattc_unreg_for_notify_evt_param::param (C++ function), 126
 (C++ member), 139 esp_ble_gattc_prepare_write (C++ func-
 (C++ member), 139 tion), 132
 esp_ble_gattc_cb_param_t::gattc_write_evt_param
 (C++ class), 139 esp_ble_gattc_prepare_write_char_descr
 (C++ member), 139 (C++ function), 132
 esp_ble_gattc_cb_param_t::gattc_write_evt_param::addr
 (C++ member), 139 (C++ member), 130
 esp_ble_gattc_cb_param_t::gattc_write_evt_param::handle
 (C++ member), 139 (C++ member), 130
 esp_ble_gattc_cb_param_t::gattc_write_evt_param::read_char_descr (C++ func-
 (C++ member), 139 tion), 131
 esp_ble_gattc_cb_param_t::gattc_write_evt_param::read_multiple (C++ func-
 (C++ member), 139 tion), 131
 esp_ble_gattc_cb_param_t::get_addr_list esp_ble_gattc_register_callback (C++
 (C++ member), 134 function), 126
 esp_ble_gattc_cb_param_t::notify (C++ esp_ble_gattc_register_for_notify
 member), 134 (C++ function), 132
 esp_ble_gattc_cb_param_t::open (C++ esp_ble_gattc_search_service (C++ func-
 member), 134 tion), 127
 esp_ble_gattc_cb_param_t::queue_full esp_ble_gattc_send_mtu_req (C++ function),
 (C++ member), 134 127
 esp_ble_gattc_cb_param_t::read (C++ esp_ble_gattc_unregister_for_notify
 member), 134 (C++ function), 133

- esp_ble_gatts_cb_param_t::mtu (C++ member), 117
 esp_ble_gatts_cb_param_t::open (C++ member), 118
 esp_ble_gatts_cb_param_t::read (C++ member), 117
 esp_ble_gatts_cb_param_t::reg (C++ member), 117
 esp_ble_gatts_cb_param_t::rsp (C++ member), 118
 esp_ble_gatts_cb_param_t::service_change (C++ member), 118
 esp_ble_gatts_cb_param_t::set_attr_val (C++ member), 118
 esp_ble_gatts_cb_param_t::start (C++ member), 118
 esp_ble_gatts_cb_param_t::stop (C++ member), 118
 esp_ble_gatts_cb_param_t::write (C++ member), 117
 esp_ble_gatts_close (C++ function), 117
 esp_ble_gatts_create_attr_tab (C++ function), 114
 esp_ble_gatts_create_service (C++ function), 114
 esp_ble_gatts_delete_service (C++ function), 115
 esp_ble_gatts_get_attr_value (C++ function), 116
 esp_ble_gatts_open (C++ function), 117
 esp_ble_gatts_register_callback (C++ function), 114
 esp_ble_gatts_send_indicate (C++ function), 116
 esp_ble_gatts_send_response (C++ function), 116
 esp_ble_gatts_send_service_change_indicate (C++ function), 117
 esp_ble_gatts_set_attr_value (C++ function), 116
 esp_ble_gatts_start_service (C++ function), 115
 esp_ble_gatts_stop_service (C++ function), 115
 esp_ble_get_bond_device_list (C++ function), 64
 esp_ble_get_bond_device_num (C++ function), 64
 esp_ble_get_current_conn_params (C++ function), 65
 ESP_BLE_ID_KEY_MASK (C macro), 56
 esp_ble_io_cap_t (C++ type), 96
 ESP_BLE_IS_VALID_PARAM (C macro), 55
 esp_ble_key_mask_t (C++ type), 56
 esp_ble_key_t (C++ class), 87
 esp_ble_key_t::bd_addr (C++ member), 87
 esp_ble_key_t::key_type (C++ member), 87
 esp_ble_key_t::p_key_value (C++ member), 87
 esp_ble_key_type_t (C++ type), 96
 esp_ble_key_value_t (C++ union), 69
 esp_ble_key_value_t::lcsr_key (C++ member), 69
 esp_ble_key_value_t::lenc_key (C++ member), 69
 esp_ble_key_value_t::pcsr_key (C++ member), 69
 esp_ble_key_value_t::penc_key (C++ member), 69
 esp_ble_key_value_t::pid_key (C++ member), 69
 esp_ble_lcsr_keys (C++ class), 86
 esp_ble_lcsr_keys::counter (C++ member), 86
 esp_ble_lcsr_keys::csr_key (C++ member), 86
 esp_ble_lcsr_keys::div (C++ member), 86
 esp_ble_lcsr_keys::sec_level (C++ member), 86
 ESP_BLE_LEGACY_ADV_TYPE_DIRECT_IND (C macro), 96
 ESP_BLE_LEGACY_ADV_TYPE_IND (C macro), 96
 ESP_BLE_LEGACY_ADV_TYPE_NONCON_IND (C macro), 96
 ESP_BLE_LEGACY_ADV_TYPE_SCAN_IND (C macro), 96
 ESP_BLE_LEGACY_ADV_TYPE_SCAN_RSP_TO_ADV_IND (C macro), 96
 ESP_BLE_LEGACY_ADV_TYPE_SCAN_RSP_TO_ADV_SCAN_IND (C macro), 96
 esp_ble_lenc_keys_t (C++ class), 86
 esp_ble_lenc_keys_t::div (C++ member), 86
 esp_ble_lenc_keys_t::key_size (C++ member), 86
 esp_ble_lenc_keys_t::ltk (C++ member), 86
 esp_ble_lenc_keys_t::sec_level (C++ member), 86
 ESP_BLE_LINK_KEY_MASK (C macro), 56
 esp_ble_local_id_keys_t (C++ class), 87
 esp_ble_local_id_keys_t::dhk (C++ member), 87
 esp_ble_local_id_keys_t::irk (C++ member), 87
 esp_ble_local_id_keys_t::ltk (C++ member), 87
 ESP_BLE_MESH_ACTUATOR_BLOCKED_ERROR (C macro), 255
 ESP_BLE_MESH_ACTUATOR_BLOCKED_WARNING (C macro), 255
 ESP_BLE_MESH_ADDR_ALL_NODES (C macro), 186
 ESP_BLE_MESH_ADDR_FRIENDS (C macro), 186
 ESP_BLE_MESH_ADDR_IS_GROUP (C macro), 186
 ESP_BLE_MESH_ADDR_IS_RFU (C macro), 186
 ESP_BLE_MESH_ADDR_IS_UNICAST (C macro), 186
 ESP_BLE_MESH_ADDR_IS_VIRTUAL (C macro), 186

- 186
- ESP_BLE_MESH_ADDR_PROXIES (*C macro*), 186
- ESP_BLE_MESH_ADDR_RELAYS (*C macro*), 186
- ESP_BLE_MESH_ADDR_TYPE_PUBLIC (*C macro*), 188
- ESP_BLE_MESH_ADDR_TYPE_RANDOM (*C macro*), 188
- ESP_BLE_MESH_ADDR_TYPE_RPA_PUBLIC (*C macro*), 188
- ESP_BLE_MESH_ADDR_TYPE_RPA_RANDOM (*C macro*), 188
- esp_ble_mesh_addr_type_t (*C++ type*), 200
- ESP_BLE_MESH_ADDR_UNASSIGNED (*C macro*), 186
- ESP_BLE_MESH_BATTERY_LOW_ERROR (*C macro*), 254
- ESP_BLE_MESH_BATTERY_LOW_WARNING (*C macro*), 254
- esp_ble_mesh_bd_addr_t (*C++ type*), 200
- ESP_BLE_MESH_BEACON_DISABLED (*C macro*), 186
- ESP_BLE_MESH_BEACON_ENABLED (*C macro*), 186
- ESP_BLE_MESH_BEEP (*C++ enumerator*), 201
- ESP_BLE_MESH_BLINK (*C++ enumerator*), 201
- esp_ble_mesh_cb_t (*C++ type*), 200
- esp_ble_mesh_cb_type_t (*C++ enum*), 201
- esp_ble_mesh_cfg_app_key_add_t (*C++ class*), 233
- esp_ble_mesh_cfg_app_key_add_t::app_idx (*C++ member*), 233
- esp_ble_mesh_cfg_app_key_add_t::app_key (*C++ member*), 233
- esp_ble_mesh_cfg_app_key_add_t::net_idx (*C++ member*), 233
- esp_ble_mesh_cfg_app_key_delete_t (*C++ class*), 237
- esp_ble_mesh_cfg_app_key_delete_t::app_idx (*C++ member*), 237
- esp_ble_mesh_cfg_app_key_delete_t::net_idx (*C++ member*), 237
- esp_ble_mesh_cfg_app_key_get_t (*C++ class*), 231
- esp_ble_mesh_cfg_app_key_get_t::net_idx (*C++ member*), 231
- esp_ble_mesh_cfg_app_key_list_cb_t (*C++ class*), 242
- esp_ble_mesh_cfg_app_key_list_cb_t::app_idx (*C++ member*), 242
- esp_ble_mesh_cfg_app_key_list_cb_t::net_idx (*C++ member*), 242
- esp_ble_mesh_cfg_app_key_list_cb_t::status (*C++ member*), 242
- esp_ble_mesh_cfg_app_key_status_cb_t (*C++ class*), 240
- esp_ble_mesh_cfg_app_key_status_cb_t::app_idx (*C++ member*), 240
- esp_ble_mesh_cfg_app_key_status_cb_t::net_idx (*C++ member*), 240
- (*C++ member*), 240
- esp_ble_mesh_cfg_app_key_status_cb_t::status (*C++ member*), 240
- esp_ble_mesh_cfg_app_key_update_t (*C++ class*), 236
- esp_ble_mesh_cfg_app_key_update_t::app_idx (*C++ member*), 236
- esp_ble_mesh_cfg_app_key_update_t::app_key (*C++ member*), 236
- esp_ble_mesh_cfg_app_key_update_t::net_idx (*C++ member*), 236
- esp_ble_mesh_cfg_beacon_set_t (*C++ class*), 232
- esp_ble_mesh_cfg_beacon_set_t::beacon (*C++ member*), 232
- esp_ble_mesh_cfg_beacon_status_cb_t (*C++ class*), 238
- esp_ble_mesh_cfg_beacon_status_cb_t::beacon (*C++ member*), 238
- esp_ble_mesh_cfg_client_cb_event_t (*C++ enum*), 248
- esp_ble_mesh_cfg_client_cb_param_t (*C++ class*), 243
- esp_ble_mesh_cfg_client_cb_param_t::error_code (*C++ member*), 244
- esp_ble_mesh_cfg_client_cb_param_t::params (*C++ member*), 244
- esp_ble_mesh_cfg_client_cb_param_t::status_cb (*C++ member*), 244
- esp_ble_mesh_cfg_client_cb_t (*C++ type*), 247
- esp_ble_mesh_cfg_client_common_cb_param_t (*C++ union*), 227
- esp_ble_mesh_cfg_client_common_cb_param_t::appkey (*C++ member*), 228
- esp_ble_mesh_cfg_client_common_cb_param_t::appkey (*C++ member*), 227
- esp_ble_mesh_cfg_client_common_cb_param_t::beacon (*C++ member*), 227
- esp_ble_mesh_cfg_client_common_cb_param_t::comp_d (*C++ member*), 227
- esp_ble_mesh_cfg_client_common_cb_param_t::default (*C++ member*), 227
- esp_ble_mesh_cfg_client_common_cb_param_t::friend (*C++ member*), 227
- esp_ble_mesh_cfg_client_common_cb_param_t::gatt_p (*C++ member*), 227
- esp_ble_mesh_cfg_client_common_cb_param_t::heartb (*C++ member*), 228
- esp_ble_mesh_cfg_client_common_cb_param_t::heartb (*C++ member*), 228
- esp_ble_mesh_cfg_client_common_cb_param_t::kr pha (*C++ member*), 228
- esp_ble_mesh_cfg_client_common_cb_param_t::lpn ti (*C++ member*), 228
- esp_ble_mesh_cfg_client_common_cb_param_t::model (*C++ member*), 228
- esp_ble_mesh_cfg_client_common_cb_param_t::model (*C++ member*), 228

(C++ member), 227
 esp_ble_mesh_cfg_client_common_cb_params_model_sub_cfg_status_set_state_t::friend_set
 (C++ member), 227
 esp_ble_mesh_cfg_client_common_cb_params_model_sub_cfg_status_set_state_t::gatt_proxy_s
 (C++ member), 228
 esp_ble_mesh_cfg_client_common_cb_params_model_sub_cfg_status_set_state_t::heartbeat_pu
 (C++ member), 227
 esp_ble_mesh_cfg_client_common_cb_params_model_sub_cfg_status_set_state_t::heartbeat_su
 (C++ member), 228
 esp_ble_mesh_cfg_client_common_cb_params_model_sub_cfg_status_set_state_t::kr_phase_set
 (C++ member), 228
 esp_ble_mesh_cfg_client_common_cb_params_model_sub_cfg_status_set_state_t::model_app_bi
 (C++ member), 227
 esp_ble_mesh_cfg_client_common_cb_params_model_sub_cfg_status_set_state_t::model_app_un
 (C++ member), 228
 esp_ble_mesh_cfg_client_common_cb_params_model_sub_cfg_status_set_state_t::model_pub_se
 (C++ member), 227
 ESP_BLE_MESH_CFG_CLIENT_EVT_MAX (C++ esp_ble_mesh_cfg_client_set_state_t::model_pub_va
 enumerator), 248
 ESP_BLE_MESH_CFG_CLIENT_GET_STATE_EVT esp_ble_mesh_cfg_client_set_state_t::model_sub_ad
 (C++ enumerator), 248
 esp_ble_mesh_cfg_client_get_state_t esp_ble_mesh_cfg_client_set_state_t::model_sub_de
 (C++ union), 225
 esp_ble_mesh_cfg_client_get_state_t::app_key_get esp_ble_mesh_cfg_client_set_state_t::model_sub_de
 (C++ member), 225
 esp_ble_mesh_cfg_client_get_state_t::comp_data_mesh esp_ble_mesh_cfg_client_set_state_t::model_sub_ov
 (C++ member), 225
 esp_ble_mesh_cfg_client_get_state_t::kr_phase_get esp_ble_mesh_cfg_client_set_state_t::model_sub_va
 (C++ member), 225
 esp_ble_mesh_cfg_client_get_state_t::lps_pill_get esp_ble_mesh_cfg_client_set_state_t::model_sub_va
 (C++ member), 225
 esp_ble_mesh_cfg_client_get_state_t::model_pub_mesh esp_ble_mesh_cfg_client_set_state_t::model_sub_va
 (C++ member), 225
 esp_ble_mesh_cfg_client_get_state_t::net_key_add esp_ble_mesh_cfg_client_set_state_t::net_key_add
 (C++ member), 225
 esp_ble_mesh_cfg_client_get_state_t::net_key_delete esp_ble_mesh_cfg_client_set_state_t::net_key_dele
 (C++ member), 225
 esp_ble_mesh_cfg_client_get_state_t::net_key_update esp_ble_mesh_cfg_client_set_state_t::net_key_upda
 (C++ member), 225
 esp_ble_mesh_cfg_client_get_state_t::net_transmit esp_ble_mesh_cfg_client_set_state_t::net_transmit
 (C++ member), 225
 esp_ble_mesh_cfg_client_get_state_t::node_identify esp_ble_mesh_cfg_client_set_state_t::node_identit
 (C++ member), 225
 ESP_BLE_MESH_CFG_CLIENT_PUBLISH_EVT esp_ble_mesh_cfg_client_set_state_t::relay_set
 (C++ enumerator), 248
 ESP_BLE_MESH_CFG_CLIENT_SET_STATE_EVT ESP_BLE_MESH_CFG_CLIENT_TIMEOUT_EVT
 (C++ enumerator), 248
 esp_ble_mesh_cfg_client_set_state_t esp_ble_mesh_cfg_comp_data_status_cb_t
 (C++ union), 226
 esp_ble_mesh_cfg_client_set_state_t::app_key_add esp_ble_mesh_cfg_comp_data_status_cb_t::compositi
 (C++ member), 226
 esp_ble_mesh_cfg_client_set_state_t::app_key_delete esp_ble_mesh_cfg_comp_data_status_cb_t::page
 (C++ member), 227
 esp_ble_mesh_cfg_client_set_state_t::app_key_update esp_ble_mesh_cfg_comp_data_status_cb_t::page
 (C++ member), 227
 esp_ble_mesh_cfg_client_set_state_t::broadcast esp_ble_mesh_cfg_comp_data_status_cb_t::page
 (C++ member), 226
 esp_ble_mesh_cfg_client_set_state_t::default_ttl esp_ble_mesh_cfg_comp_data_status_cb_t::page
 (C++ member), 226
 esp_ble_mesh_cfg_client_set_state_t::default_ttl_set esp_ble_mesh_cfg_comp_data_status_cb_t::page
 (C++ member), 226

(C++ class), 232
 esp_ble_mesh_cfg_default_ttl_set_t::ttl (C++ member), 232
 esp_ble_mesh_cfg_default_ttl_status_cb_t (C++ class), 238
 esp_ble_mesh_cfg_default_ttl_status_cb_t::ttl (C++ member), 239
 esp_ble_mesh_cfg_friend_set_t (C++ class), 232
 esp_ble_mesh_cfg_friend_set_t::friend_status (C++ member), 232
 esp_ble_mesh_cfg_friend_status_cb_t (C++ class), 241
 esp_ble_mesh_cfg_friend_status_cb_t::friend_status (C++ member), 241
 esp_ble_mesh_cfg_gatt_proxy_set_t (C++ class), 232
 esp_ble_mesh_cfg_gatt_proxy_set_t::gatt_proxy (C++ member), 232
 esp_ble_mesh_cfg_gatt_proxy_status_cb_t (C++ class), 239
 esp_ble_mesh_cfg_gatt_proxy_status_cb_t::gatt_proxy (C++ member), 239
 esp_ble_mesh_cfg_hb_pub_status_cb_t (C++ class), 241
 esp_ble_mesh_cfg_hb_pub_status_cb_t::complete (C++ member), 241
 esp_ble_mesh_cfg_hb_pub_status_cb_t::data (C++ member), 241
 esp_ble_mesh_cfg_hb_pub_status_cb_t::feature (C++ member), 241
 esp_ble_mesh_cfg_hb_pub_status_cb_t::net_idx (C++ member), 241
 esp_ble_mesh_cfg_hb_pub_status_cb_t::period (C++ member), 241
 esp_ble_mesh_cfg_hb_pub_status_cb_t::transition (C++ member), 241
 esp_ble_mesh_cfg_hb_pub_status_cb_t::feature (C++ member), 243
 esp_ble_mesh_cfg_hb_pub_status_cb_t::net_idx (C++ member), 243
 esp_ble_mesh_cfg_hb_pub_status_cb_t::phase (C++ member), 243
 esp_ble_mesh_cfg_hb_pub_status_cb_t::status (C++ member), 243
 esp_ble_mesh_cfg_hb_pub_status_cb_t::ttl (C++ member), 241
 esp_ble_mesh_cfg_hb_sub_status_cb_t (C++ class), 241
 esp_ble_mesh_cfg_hb_sub_status_cb_t::complete (C++ member), 241
 esp_ble_mesh_cfg_hb_sub_status_cb_t::data (C++ member), 241
 esp_ble_mesh_cfg_hb_sub_status_cb_t::max_poll_time (C++ member), 241
 esp_ble_mesh_cfg_hb_sub_status_cb_t::min_poll_time (C++ member), 241
 esp_ble_mesh_cfg_hb_sub_status_cb_t::period (C++ member), 241
 esp_ble_mesh_cfg_hb_sub_status_cb_t::status (C++ member), 241
 esp_ble_mesh_cfg_hb_sub_status_cb_t::ttl (C++ member), 241
 esp_ble_mesh_cfg_heartbeat_pub_set_t (C++ class), 238
 esp_ble_mesh_cfg_heartbeat_pub_set_t::dst (C++ member), 238
 esp_ble_mesh_cfg_heartbeat_pub_set_t::feature (C++ member), 238
 esp_ble_mesh_cfg_heartbeat_pub_set_t::net_idx (C++ member), 238
 esp_ble_mesh_cfg_heartbeat_pub_set_t::period (C++ member), 238
 esp_ble_mesh_cfg_heartbeat_pub_set_t::ttl (C++ member), 238
 esp_ble_mesh_cfg_heartbeat_sub_set_t (C++ class), 238
 esp_ble_mesh_cfg_heartbeat_sub_set_t::dst (C++ member), 238
 esp_ble_mesh_cfg_heartbeat_sub_set_t::period (C++ member), 238
 esp_ble_mesh_cfg_heartbeat_sub_set_t::src (C++ member), 238
 esp_ble_mesh_cfg_kr_phase_get_t (C++ class), 231
 esp_ble_mesh_cfg_kr_phase_get_t::net_idx (C++ member), 232
 esp_ble_mesh_cfg_kr_phase_set_t (C++ class), 237
 esp_ble_mesh_cfg_kr_phase_set_t::net_idx (C++ member), 237
 esp_ble_mesh_cfg_kr_phase_status_cb_t (C++ class), 243
 esp_ble_mesh_cfg_kr_phase_status_cb_t::net_idx (C++ member), 243
 esp_ble_mesh_cfg_lpn_polltimeout_get_t (C++ class), 232
 esp_ble_mesh_cfg_lpn_polltimeout_get_t::lpn_addr (C++ member), 232
 esp_ble_mesh_cfg_lpn_pollto_status_cb_t (C++ class), 243
 esp_ble_mesh_cfg_lpn_pollto_status_cb_t::lpn_addr (C++ member), 243
 esp_ble_mesh_cfg_lpn_pollto_status_cb_t::poll_time (C++ member), 243
 esp_ble_mesh_cfg_mod_app_status_cb_t (C++ class), 240
 esp_ble_mesh_cfg_mod_app_status_cb_t::app_idx (C++ member), 240
 esp_ble_mesh_cfg_mod_app_status_cb_t::company_id (C++ member), 240
 esp_ble_mesh_cfg_mod_app_status_cb_t::element_addr (C++ member), 240
 esp_ble_mesh_cfg_mod_app_status_cb_t::model_id (C++ member), 240
 esp_ble_mesh_cfg_mod_app_status_cb_t::status (C++ member), 240

(C++ member), 236
 esp_ble_mesh_cfg_model_sub_delete_all_tesp_ble_mesh_cfg_model_sub_va_delete_t
 (C++ member), 236 (C++ class), 235
 esp_ble_mesh_cfg_model_sub_delete_all_tesp_ble_mesh_cfg_model_sub_va_delete_t::company_id
 (C++ member), 236 (C++ member), 235
 esp_ble_mesh_cfg_model_sub_delete_t esp_ble_mesh_cfg_model_sub_va_delete_t::element_id
 (C++ class), 234 (C++ member), 235
 esp_ble_mesh_cfg_model_sub_delete_t::company_id esp_ble_mesh_cfg_model_sub_va_delete_t::label_uid
 (C++ member), 234 (C++ member), 235
 esp_ble_mesh_cfg_model_sub_delete_t::element_id esp_ble_mesh_cfg_model_sub_va_delete_t::model_id
 (C++ member), 234 (C++ member), 235
 esp_ble_mesh_cfg_model_sub_delete_t::model_id esp_ble_mesh_cfg_model_sub_va_overwrite_t
 (C++ member), 234 (C++ class), 235
 esp_ble_mesh_cfg_model_sub_delete_t::sub_addr esp_ble_mesh_cfg_model_sub_va_overwrite_t::company_id
 (C++ member), 234 (C++ member), 235
 esp_ble_mesh_cfg_model_sub_list_cb_t esp_ble_mesh_cfg_model_sub_va_overwrite_t::element_id
 (C++ class), 242 (C++ member), 235
 esp_ble_mesh_cfg_model_sub_list_cb_t::company_id esp_ble_mesh_cfg_model_sub_va_overwrite_t::label_uid
 (C++ member), 242 (C++ member), 235
 esp_ble_mesh_cfg_model_sub_list_cb_t::element_id esp_ble_mesh_cfg_model_sub_va_overwrite_t::model_id
 (C++ member), 242 (C++ member), 235
 esp_ble_mesh_cfg_model_sub_list_cb_t::model_id esp_ble_mesh_cfg_net_key_add_t (C++
 (C++ member), 242 class), 232
 esp_ble_mesh_cfg_model_sub_list_cb_t::status esp_ble_mesh_cfg_net_key_add_t::net_idx
 (C++ member), 242 (C++ member), 233
 esp_ble_mesh_cfg_model_sub_list_cb_t::sub_addr esp_ble_mesh_cfg_net_key_add_t::net_key
 (C++ member), 242 (C++ member), 233
 esp_ble_mesh_cfg_model_sub_overwrite_t esp_ble_mesh_cfg_net_key_delete_t
 (C++ class), 234 (C++ class), 236
 esp_ble_mesh_cfg_model_sub_overwrite_t::company_id esp_ble_mesh_cfg_net_key_delete_t::net_idx
 (C++ member), 234 (C++ member), 236
 esp_ble_mesh_cfg_model_sub_overwrite_t::element_id esp_ble_mesh_cfg_net_key_list_cb_t
 (C++ member), 234 (C++ class), 242
 esp_ble_mesh_cfg_model_sub_overwrite_t::model_id esp_ble_mesh_cfg_net_key_list_cb_t::net_idx
 (C++ member), 234 (C++ member), 242
 esp_ble_mesh_cfg_model_sub_overwrite_t::sub_addr esp_ble_mesh_cfg_net_key_status_cb_t
 (C++ member), 234 (C++ class), 240
 esp_ble_mesh_cfg_model_sub_status_cb_t esp_ble_mesh_cfg_net_key_status_cb_t::net_idx
 (C++ class), 240 (C++ member), 240
 esp_ble_mesh_cfg_model_sub_status_cb_t::company_id esp_ble_mesh_cfg_net_key_status_cb_t::status
 (C++ member), 240 (C++ member), 240
 esp_ble_mesh_cfg_model_sub_status_cb_t::element_id esp_ble_mesh_cfg_net_key_update_t
 (C++ member), 240 (C++ class), 236
 esp_ble_mesh_cfg_model_sub_status_cb_t::model_id esp_ble_mesh_cfg_net_key_update_t::net_idx
 (C++ member), 240 (C++ member), 236
 esp_ble_mesh_cfg_model_sub_status_cb_t::status esp_ble_mesh_cfg_net_key_update_t::net_key
 (C++ member), 240 (C++ member), 236
 esp_ble_mesh_cfg_model_sub_status_cb_t::sub_addr esp_ble_mesh_cfg_net_trans_status_cb_t
 (C++ member), 240 (C++ class), 241
 esp_ble_mesh_cfg_model_sub_va_add_t esp_ble_mesh_cfg_net_trans_status_cb_t::net_trans
 (C++ class), 234 (C++ member), 242
 esp_ble_mesh_cfg_model_sub_va_add_t::company_id esp_ble_mesh_cfg_net_trans_status_cb_t::net_trans
 (C++ member), 235 (C++ member), 242
 esp_ble_mesh_cfg_model_sub_va_add_t::element_id esp_ble_mesh_cfg_net_transmit_set_t
 (C++ member), 235 (C++ class), 237
 esp_ble_mesh_cfg_model_sub_va_add_t::label_uid esp_ble_mesh_cfg_net_transmit_set_t::net_transmit
 (C++ member), 235 (C++ member), 238
 esp_ble_mesh_cfg_model_sub_va_add_t::model_id esp_ble_mesh_cfg_node_id_status_cb_t

- (C++ class), 242
- esp_ble_mesh_cfg_node_id_status_cb_t::identity (C++ member), 243
- esp_ble_mesh_cfg_node_id_status_cb_t::mesh_id (C++ member), 243
- esp_ble_mesh_cfg_node_id_status_cb_t::status (C++ member), 243
- esp_ble_mesh_cfg_node_identity_get_t (C++ class), 231
- esp_ble_mesh_cfg_node_identity_get_t::mesh_id (C++ member), 231
- esp_ble_mesh_cfg_node_identity_set_t (C++ class), 237
- esp_ble_mesh_cfg_node_identity_set_t::identity (C++ member), 237
- esp_ble_mesh_cfg_node_identity_set_t::mesh_id (C++ member), 237
- esp_ble_mesh_cfg_relay_set_t (C++ class), 232
- esp_ble_mesh_cfg_relay_set_t::relay (C++ member), 232
- esp_ble_mesh_cfg_relay_set_t::relay_retention (C++ member), 232
- esp_ble_mesh_cfg_relay_status_cb_t (C++ class), 239
- esp_ble_mesh_cfg_relay_status_cb_t::relay (C++ member), 239
- esp_ble_mesh_cfg_relay_status_cb_t::retention (C++ member), 239
- esp_ble_mesh_cfg_server_cb_event_t (C++ enum), 248
- esp_ble_mesh_cfg_server_cb_param_t (C++ class), 247
- esp_ble_mesh_cfg_server_cb_param_t::ctx (C++ member), 247
- esp_ble_mesh_cfg_server_cb_param_t::model (C++ member), 247
- esp_ble_mesh_cfg_server_cb_param_t::value (C++ member), 247
- esp_ble_mesh_cfg_server_cb_t (C++ type), 247
- esp_ble_mesh_cfg_server_cb_value_t (C++ union), 229
- esp_ble_mesh_cfg_server_cb_value_t::state_change (C++ member), 229
- ESP_BLE_MESH_CFG_SERVER_EVT_MAX (C++ enumerator), 248
- ESP_BLE_MESH_CFG_SERVER_STATE_CHANGE_EVT (C++ enumerator), 248
- esp_ble_mesh_cfg_server_state_change_t (C++ union), 228
- esp_ble_mesh_cfg_server_state_change_t::appkey (C++ member), 228
- esp_ble_mesh_cfg_server_state_change_t::appkey_index (C++ member), 228
- esp_ble_mesh_cfg_server_state_change_t::appkey_value (C++ member), 228
- esp_ble_mesh_cfg_server_state_change_t::kr_ph (C++ member), 229
- esp_ble_mesh_cfg_server_state_change_t::identity (C++ member), 229
- esp_ble_mesh_cfg_server_state_change_t::mod_app_b (C++ member), 228
- esp_ble_mesh_cfg_server_state_change_t::mod_app_u (C++ member), 228
- esp_ble_mesh_cfg_server_state_change_t::mod_pub_s (C++ member), 228
- esp_ble_mesh_cfg_server_state_change_t::mod_sub_a (C++ member), 228
- esp_ble_mesh_cfg_server_state_change_t::mod_sub_d (C++ member), 228
- esp_ble_mesh_cfg_server_state_change_t::netkey_ad (C++ member), 228
- esp_ble_mesh_cfg_server_state_change_t::netkey_de (C++ member), 228
- esp_ble_mesh_cfg_server_state_change_t::netkey_up (C++ member), 228
- esp_ble_mesh_cfg_sig_model_app_get_t (C++ class), 231
- esp_ble_mesh_cfg_sig_model_app_get_t::element_add (C++ member), 231
- esp_ble_mesh_cfg_sig_model_app_get_t::model_id (C++ member), 231
- esp_ble_mesh_cfg_sig_model_sub_get_t (C++ class), 230
- esp_ble_mesh_cfg_sig_model_sub_get_t::element_add (C++ member), 230
- esp_ble_mesh_cfg_sig_model_sub_get_t::model_id (C++ member), 230
- esp_ble_mesh_cfg_srv (C++ class), 229
- esp_ble_mesh_cfg_srv::beacon (C++ member), 229
- esp_ble_mesh_cfg_srv::count (C++ member), 229
- esp_ble_mesh_cfg_srv::default_ttl (C++ member), 229
- esp_ble_mesh_cfg_srv::dst (C++ member), 229
- esp_ble_mesh_cfg_srv::expiry (C++ member), 230
- esp_ble_mesh_cfg_srv::feature (C++ member), 229
- esp_ble_mesh_cfg_srv::friend_state (C++ member), 229
- esp_ble_mesh_cfg_srv::gatt_proxy (C++ member), 229
- esp_ble_mesh_cfg_srv::heartbeat_pub (C++ member), 230
- esp_ble_mesh_cfg_srv::heartbeat_recv_cb (C++ member), 230
- esp_ble_mesh_cfg_srv::heartbeat_sub (C++ member), 230
- esp_ble_mesh_cfg_srv::max_hops (C++ member), 230
- esp_ble_mesh_cfg_srv::min_hops (C++ member), 230
- esp_ble_mesh_cfg_srv::model (C++ member), 229

- esp_ble_mesh_cfg_srv::net_idx (C++ member), 229
 esp_ble_mesh_cfg_srv::net_transmit (C++ member), 229
 esp_ble_mesh_cfg_srv::period (C++ member), 229
 esp_ble_mesh_cfg_srv::relay (C++ member), 229
 esp_ble_mesh_cfg_srv::relay_retransmit (C++ member), 229
 esp_ble_mesh_cfg_srv::src (C++ member), 230
 esp_ble_mesh_cfg_srv::timer (C++ member), 229
 esp_ble_mesh_cfg_srv::ttl (C++ member), 229
 esp_ble_mesh_cfg_srv_t (C++ type), 247
 ESP_BLE_MESH_CFG_STATUS_CANNOT_BIND (C macro), 193
 ESP_BLE_MESH_CFG_STATUS_CANNOT_REMOVE (C macro), 193
 ESP_BLE_MESH_CFG_STATUS_CANNOT_SET (C macro), 193
 ESP_BLE_MESH_CFG_STATUS_CANNOT_UPDATE (C macro), 193
 ESP_BLE_MESH_CFG_STATUS_FEATURE_NOT_SUPPORTED (C macro), 193
 ESP_BLE_MESH_CFG_STATUS_INSUFFICIENT_RESOURCES (C macro), 193
 ESP_BLE_MESH_CFG_STATUS_INVALID_ADDRESSES (C macro), 193
 ESP_BLE_MESH_CFG_STATUS_INVALID_APPKEY (C macro), 193
 ESP_BLE_MESH_CFG_STATUS_INVALID_BINDING (C macro), 193
 ESP_BLE_MESH_CFG_STATUS_INVALID_MODEL (C macro), 193
 ESP_BLE_MESH_CFG_STATUS_INVALID_NETKEY (C macro), 193
 ESP_BLE_MESH_CFG_STATUS_INVALID_PUBLISH_PARAMS (C macro), 193
 ESP_BLE_MESH_CFG_STATUS_KEY_INDEX_ALREADY_STORED (C macro), 193
 ESP_BLE_MESH_CFG_STATUS_NOT_A_SUBSCRIBE_MODEL (C macro), 193
 ESP_BLE_MESH_CFG_STATUS_STORAGE_FAILURE (C macro), 193
 ESP_BLE_MESH_CFG_STATUS_SUCCESS (C macro), 193
 esp_ble_mesh_cfg_status_t (C++ type), 200
 ESP_BLE_MESH_CFG_STATUS_TEMP_UNABLE_TO_CHANGE_STATE (C macro), 193
 ESP_BLE_MESH_CFG_STATUS_UNSPECIFIED_ERROR (C macro), 193
 esp_ble_mesh_cfg_vnd_model_app_get_t (C++ class), 231
 esp_ble_mesh_cfg_vnd_model_app_get_t::company_id (C++ member), 231
 esp_ble_mesh_cfg_vnd_model_app_get_t::element_add (C++ member), 231
 esp_ble_mesh_cfg_vnd_model_app_get_t::model_id (C++ member), 231
 esp_ble_mesh_cfg_vnd_model_sub_get_t (C++ class), 230
 esp_ble_mesh_cfg_vnd_model_sub_get_t::company_id (C++ member), 231
 esp_ble_mesh_cfg_vnd_model_sub_get_t::element_add (C++ member), 231
 esp_ble_mesh_cfg_vnd_model_sub_get_t::model_id (C++ member), 231
 ESP_BLE_MESH_CID_NVAL (C macro), 185
 esp_ble_mesh_client_common_param_t (C++ class), 183
 esp_ble_mesh_client_common_param_t::ctx (C++ member), 183
 esp_ble_mesh_client_common_param_t::model (C++ member), 183
 esp_ble_mesh_client_common_param_t::msg_role (C++ member), 184
 esp_ble_mesh_client_common_param_t::msg_timeout (C++ member), 184
 esp_ble_mesh_client_common_param_t::opcode (C++ member), 183
 esp_ble_mesh_client_model_deinit (C++ function), 211
 esp_ble_mesh_client_model_init (C++ function), 211
 ESP_BLE_MESH_CLIENT_MODEL_RECV_PUBLISH_MSG_EVT (C++ enumerator), 207
 esp_ble_mesh_client_model_send_msg (C++ function), 212
 ESP_BLE_MESH_CLIENT_MODEL_SEND_TIMEOUT_EVT (C++ enumerator), 207
 esp_ble_mesh_client_op_pair_t (C++ class), 183
 esp_ble_mesh_client_op_pair_t::cli_op (C++ member), 183
 esp_ble_mesh_client_op_pair_t::status_op (C++ member), 183
 esp_ble_mesh_client_t (C++ class), 183
 esp_ble_mesh_client_t::internal_data (C++ member), 183
 esp_ble_mesh_client_t::model (C++ member), 183
 esp_ble_mesh_client_t::msg_role (C++ member), 183
 esp_ble_mesh_client_t::op_pair (C++ member), 183
 esp_ble_mesh_client_t::op_pair_size (C++ member), 183
 esp_ble_mesh_client_t::publish_status (C++ member), 183
 esp_ble_mesh_comp_t (C++ class), 180
 esp_ble_mesh_comp_t::cid (C++ member), 180
 esp_ble_mesh_comp_t::element_count (C++ member), 180

- (C++ member), 180
- esp_ble_mesh_comp_t::elements (C++ member), 180
- esp_ble_mesh_comp_t::pid (C++ member), 180
- esp_ble_mesh_comp_t::vid (C++ member), 180
- ESP_BLE_MESH_CONDENSATION_ERROR (C macro), 254
- ESP_BLE_MESH_CONDENSATION_WARNING (C macro), 254
- esp_ble_mesh_config_client_get_state (C++ function), 224
- esp_ble_mesh_config_client_set_state (C++ function), 225
- ESP_BLE_MESH_CONFIGURATION_ERROR (C macro), 255
- ESP_BLE_MESH_CONFIGURATION_WARNING (C macro), 255
- esp_ble_mesh_deinit (C++ function), 208
- ESP_BLE_MESH_DEINIT_MESH_COMP_EVT (C++ enumerator), 206
- esp_ble_mesh_deinit_param_t (C++ class), 177
- esp_ble_mesh_deinit_param_t::erase_flash (C++ member), 177
- esp_ble_mesh_dev_add_flag_t (C++ type), 200
- esp_ble_mesh_dev_role_t (C++ enum), 202
- esp_ble_mesh_device_delete_t (C++ class), 181
- esp_ble_mesh_device_delete_t::addr (C++ member), 181
- esp_ble_mesh_device_delete_t::addr_type (C++ member), 181
- esp_ble_mesh_device_delete_t::flag (C++ member), 181
- esp_ble_mesh_device_delete_t::uuid (C++ member), 181
- ESP_BLE_MESH_DEVICE_DROPPED_ERROR (C macro), 255
- ESP_BLE_MESH_DEVICE_DROPPED_WARNING (C macro), 255
- ESP_BLE_MESH_DEVICE_MOVED_ERROR (C macro), 255
- ESP_BLE_MESH_DEVICE_MOVED_WARNING (C macro), 255
- ESP_BLE_MESH_DEVICE_NAME_MAX_LEN (C macro), 185
- ESP_BLE_MESH_DISPLAY_NUMBER (C++ enumerator), 201
- ESP_BLE_MESH_DISPLAY_STRING (C++ enumerator), 201
- esp_ble_mesh_elem_t (C++ class), 177
- esp_ble_mesh_elem_t::element_addr (C++ member), 177
- esp_ble_mesh_elem_t::location (C++ member), 177
- esp_ble_mesh_elem_t::sig_model_count (C++ member), 177
- esp_ble_mesh_elem_t::sig_models (C++ member), 177
- esp_ble_mesh_elem_t::vnd_model_count (C++ member), 177
- esp_ble_mesh_elem_t::vnd_models (C++ member), 177
- ESP_BLE_MESH_ELEMENT (C macro), 188
- ESP_BLE_MESH_ELEMENT_NOT_CALIBRATED_ERROR (C macro), 255
- ESP_BLE_MESH_ELEMENT_NOT_CALIBRATED_WARNING (C macro), 255
- ESP_BLE_MESH_EMPTY_ERROR (C macro), 255
- ESP_BLE_MESH_EMPTY_WARNING (C macro), 255
- ESP_BLE_MESH_ENTER_NUMBER (C++ enumerator), 202
- ESP_BLE_MESH_ENTER_STRING (C++ enumerator), 202
- esp_ble_mesh_fast_prov_action_t (C++ enum), 202
- esp_ble_mesh_fast_prov_info_t (C++ class), 182
- esp_ble_mesh_fast_prov_info_t::flags (C++ member), 182
- esp_ble_mesh_fast_prov_info_t::iv_index (C++ member), 182
- esp_ble_mesh_fast_prov_info_t::match_len (C++ member), 182
- esp_ble_mesh_fast_prov_info_t::match_val (C++ member), 182
- esp_ble_mesh_fast_prov_info_t::net_idx (C++ member), 182
- esp_ble_mesh_fast_prov_info_t::offset (C++ member), 182
- esp_ble_mesh_fast_prov_info_t::unicast_max (C++ member), 182
- esp_ble_mesh_fast_prov_info_t::unicast_min (C++ member), 182
- ESP_BLE_MESH_FEATURE_ALL_SUPPORTED (C macro), 186
- ESP_BLE_MESH_FEATURE_FRIEND (C macro), 186
- ESP_BLE_MESH_FEATURE_LOW_POWER (C macro), 186
- ESP_BLE_MESH_FEATURE_PROXY (C macro), 186
- ESP_BLE_MESH_FEATURE_RELAY (C macro), 186
- esp_ble_mesh_find_element (C++ function), 208
- esp_ble_mesh_find_sig_model (C++ function), 209
- esp_ble_mesh_find_vendor_model (C++ function), 209
- ESP_BLE_MESH_FRIEND_DISABLED (C macro), 186
- ESP_BLE_MESH_FRIEND_ENABLED (C macro), 186
- ESP_BLE_MESH_FRIEND_FRIENDSHIP_ESTABLISH_EVT

(C++ class), 267
 esp_ble_mesh_gen_loc_global_status_cb_t esp_ble_mesh_gen_loc_location_state_t::local_east
 (C++ member), 267 (C++ member), 273
 esp_ble_mesh_gen_loc_global_status_cb_t esp_ble_mesh_gen_loc_location_state_t::local_north
 (C++ member), 267 (C++ member), 273
 esp_ble_mesh_gen_loc_global_status_cb_t esp_ble_mesh_gen_loc_location_state_t::uncertainty
 (C++ member), 267 (C++ member), 273
 esp_ble_mesh_gen_loc_local_set_t (C++ ESP_BLE_MESH_GEN_MANU_ACCESS_READ
 class), 263 (C++ enumerator), 287
 esp_ble_mesh_gen_loc_local_set_t::floor ESP_BLE_MESH_GEN_MANU_NOT_USER_PROP
 (C++ member), 264 (C++ enumerator), 286
 esp_ble_mesh_gen_loc_local_set_t::local esp_ble_mesh_gen_manu_prop_access_t
 (C++ member), 264 (C++ enum), 286
 esp_ble_mesh_gen_loc_local_set_t::local esp_ble_mesh_gen_manu_prop_srv_t (C++
 class), 264 (C++ member), 274
 esp_ble_mesh_gen_loc_local_set_t::local esp_ble_mesh_gen_manu_prop_srv_t::model
 (C++ member), 264 (C++ member), 275
 esp_ble_mesh_gen_loc_local_set_t::uncertainty esp_ble_mesh_gen_manu_prop_srv_t::properties
 (C++ member), 264 (C++ member), 275
 esp_ble_mesh_gen_loc_local_status_cb_t esp_ble_mesh_gen_manu_prop_srv_t::property_count
 (C++ class), 267 (C++ member), 275
 esp_ble_mesh_gen_loc_local_status_cb_t esp_ble_mesh_gen_manu_prop_srv_t::rsp_ctrl
 (C++ member), 267 (C++ member), 275
 esp_ble_mesh_gen_loc_local_status_cb_t esp_ble_mesh_gen_manufacturer_properties_status_c
 (C++ member), 267 (C++ class), 268
 esp_ble_mesh_gen_loc_local_status_cb_t esp_ble_mesh_gen_manufacturer_properties_status_c
 (C++ member), 267 (C++ member), 268
 esp_ble_mesh_gen_loc_local_status_cb_t esp_ble_mesh_gen_manufacturer_property_get_t
 (C++ member), 267 (C++ class), 264
 esp_ble_mesh_gen_loc_local_status_cb_t esp_ble_mesh_gen_manufacturer_property_get_t::pro
 (C++ member), 267 (C++ member), 265
 esp_ble_mesh_gen_location_setup_srv_t esp_ble_mesh_gen_manufacturer_property_set_t
 (C++ class), 273 (C++ class), 265
 esp_ble_mesh_gen_location_setup_srv_t::model esp_ble_mesh_gen_manufacturer_property_set_t::pro
 (C++ member), 273 (C++ member), 265
 esp_ble_mesh_gen_location_setup_srv_t::rsp_ctrl esp_ble_mesh_gen_manufacturer_property_set_t::use
 (C++ member), 273 (C++ member), 265
 esp_ble_mesh_gen_location_setup_srv_t::state esp_ble_mesh_gen_manufacturer_property_status_cb
 (C++ member), 274 (C++ class), 268
 esp_ble_mesh_gen_location_srv_t (C++ esp_ble_mesh_gen_manufacturer_property_status_cb
 class), 273 (C++ member), 268
 esp_ble_mesh_gen_location_srv_t::model esp_ble_mesh_gen_manufacturer_property_status_cb
 (C++ member), 273 (C++ member), 268
 esp_ble_mesh_gen_location_srv_t::rsp_ctrl esp_ble_mesh_gen_manufacturer_property_status_cb
 (C++ member), 273 (C++ member), 268
 esp_ble_mesh_gen_location_srv_t::state esp_ble_mesh_gen_manufacturer_property_status_cb
 (C++ member), 273 (C++ member), 268
 esp_ble_mesh_gen_location_state_t esp_ble_mesh_gen_move_set_t (C++ class),
 (C++ class), 273 262
 esp_ble_mesh_gen_location_state_t::floor esp_ble_mesh_gen_move_set_t::delay
 (C++ member), 273 (C++ member), 262
 esp_ble_mesh_gen_location_state_t::global esp_ble_mesh_gen_move_set_t::delta_level
 (C++ member), 273 (C++ member), 262
 esp_ble_mesh_gen_location_state_t::global esp_ble_mesh_gen_move_set_t::op_en
 (C++ member), 273 (C++ member), 262
 esp_ble_mesh_gen_location_state_t::global esp_ble_mesh_gen_move_set_t::tid (C++
 member), 273 member), 262
 esp_ble_mesh_gen_location_state_t::local esp_ble_mesh_gen_move_set_t::trans_time
 (C++ member), 273 (C++ member), 262

- (C++ member), 262
- esp_ble_mesh_gen_onoff_set_t (C++ class), 261
- esp_ble_mesh_gen_onoff_set_t::delay (C++ member), 261
- esp_ble_mesh_gen_onoff_set_t::onoff (C++ member), 261
- esp_ble_mesh_gen_onoff_set_t::op_en (C++ member), 261
- esp_ble_mesh_gen_onoff_set_t::tid (C++ member), 261
- esp_ble_mesh_gen_onoff_set_t::trans_time (C++ member), 261
- esp_ble_mesh_gen_onoff_srv_t (C++ class), 269
- esp_ble_mesh_gen_onoff_srv_t::last (C++ member), 269
- esp_ble_mesh_gen_onoff_srv_t::model (C++ member), 269
- esp_ble_mesh_gen_onoff_srv_t::rsp_ctrl (C++ member), 269
- esp_ble_mesh_gen_onoff_srv_t::state (C++ member), 269
- esp_ble_mesh_gen_onoff_srv_t::transition (C++ member), 269
- esp_ble_mesh_gen_onoff_state_t (C++ class), 269
- esp_ble_mesh_gen_onoff_state_t::onoff (C++ member), 269
- esp_ble_mesh_gen_onoff_state_t::target_onoff (C++ member), 269
- esp_ble_mesh_gen_onoff_status_cb_t (C++ class), 265
- esp_ble_mesh_gen_onoff_status_cb_t::op_en (C++ member), 265
- esp_ble_mesh_gen_onoff_status_cb_t::presbtle_onoffs (C++ member), 265
- esp_ble_mesh_gen_onoff_status_cb_t::remesbtle_onoffs (C++ member), 265
- esp_ble_mesh_gen_onoff_status_cb_t::target_onoff (C++ member), 265
- esp_ble_mesh_gen_onpowerup_set_t (C++ class), 262
- esp_ble_mesh_gen_onpowerup_set_t::onpowerup (C++ member), 263
- esp_ble_mesh_gen_onpowerup_state_t (C++ class), 271
- esp_ble_mesh_gen_onpowerup_state_t::onpowerup (C++ member), 271
- esp_ble_mesh_gen_onpowerup_status_cb_t (C++ class), 266
- esp_ble_mesh_gen_onpowerup_status_cb_t::onpowerup (C++ member), 266
- esp_ble_mesh_gen_power_default_set_t (C++ class), 263
- esp_ble_mesh_gen_power_default_set_t::power (C++ member), 263
- esp_ble_mesh_gen_power_default_status_cb_t (C++ class), 266
- esp_ble_mesh_gen_power_default_status_cb_t::power (C++ member), 266
- esp_ble_mesh_gen_power_last_status_cb_t (C++ class), 266
- esp_ble_mesh_gen_power_last_status_cb_t::power (C++ member), 266
- esp_ble_mesh_gen_power_level_set_t (C++ class), 263
- esp_ble_mesh_gen_power_level_set_t::delay (C++ member), 263
- esp_ble_mesh_gen_power_level_set_t::op_en (C++ member), 263
- esp_ble_mesh_gen_power_level_set_t::power (C++ member), 263
- esp_ble_mesh_gen_power_level_set_t::tid (C++ member), 263
- esp_ble_mesh_gen_power_level_set_t::trans_time (C++ member), 263
- esp_ble_mesh_gen_power_level_setup_srv_t (C++ class), 272
- esp_ble_mesh_gen_power_level_setup_srv_t::model (C++ member), 272
- esp_ble_mesh_gen_power_level_setup_srv_t::rsp_ctrl (C++ member), 272
- esp_ble_mesh_gen_power_level_setup_srv_t::state (C++ member), 272
- esp_ble_mesh_gen_power_level_srv_t (C++ class), 272
- esp_ble_mesh_gen_power_level_srv_t::last (C++ member), 272
- esp_ble_mesh_gen_power_level_srv_t::model (C++ member), 272
- esp_ble_mesh_gen_power_level_srv_t::rsp_ctrl (C++ member), 272
- esp_ble_mesh_gen_power_level_srv_t::state (C++ member), 272
- esp_ble_mesh_gen_power_level_srv_t::transition (C++ member), 272
- esp_ble_mesh_gen_power_level_srv_t::tt_delta_level (C++ member), 272
- esp_ble_mesh_gen_power_level_state_t (C++ class), 271
- esp_ble_mesh_gen_power_level_state_t::power_actual (C++ member), 271
- esp_ble_mesh_gen_power_level_state_t::power_default (C++ member), 271
- esp_ble_mesh_gen_power_level_state_t::power_last (C++ member), 271
- esp_ble_mesh_gen_power_level_state_t::power_range (C++ member), 272
- esp_ble_mesh_gen_power_level_state_t::power_range_min (C++ member), 271
- esp_ble_mesh_gen_power_level_state_t::status_code (C++ member), 271
- esp_ble_mesh_gen_power_level_state_t::target_power (C++ member), 271
- esp_ble_mesh_gen_power_level_status_cb_t (C++ class), 271

(C++ class), 266
 esp_ble_mesh_gen_power_level_status_cb_t (C++ member), 266
 esp_ble_mesh_gen_power_level_status_cb_t::present_power (C++ member), 266
 esp_ble_mesh_gen_power_level_status_cb_t::retain_mesh_gen_user_property_get_t (C++ member), 266
 esp_ble_mesh_gen_power_level_status_cb_t::take_get_power_gen_user_property_get_t::property_id (C++ member), 264
 esp_ble_mesh_gen_power_onoff_setup_srv_t (C++ class), 271
 esp_ble_mesh_gen_power_onoff_setup_srv_t::mode (C++ member), 271
 esp_ble_mesh_gen_power_onoff_setup_srv_t::rsp (C++ member), 271
 esp_ble_mesh_gen_power_onoff_setup_srv_t::state (C++ member), 271
 esp_ble_mesh_gen_power_onoff_srv_t (C++ class), 271
 esp_ble_mesh_gen_power_onoff_srv_t::mode (C++ member), 271
 esp_ble_mesh_gen_power_onoff_srv_t::rsp (C++ member), 271
 esp_ble_mesh_gen_power_onoff_srv_t::state (C++ member), 271
 esp_ble_mesh_gen_power_range_set_t (C++ class), 263
 esp_ble_mesh_gen_power_range_set_t::range (C++ member), 263
 esp_ble_mesh_gen_power_range_set_t::range (C++ member), 263
 esp_ble_mesh_gen_power_range_status_cb_t (C++ class), 266
 esp_ble_mesh_gen_power_range_status_cb_t::range (C++ member), 266
 esp_ble_mesh_gen_power_range_status_cb_t::range (C++ member), 266
 esp_ble_mesh_gen_power_range_status_cb_t::range (C++ member), 266
 esp_ble_mesh_gen_power_range_status_cb_t::range (C++ member), 266
 ESP_BLE_MESH_GENERIC_CLIENT_EVT_MAX (C++ enumerator), 286
 ESP_BLE_MESH_GENERIC_CLIENT_EVT_MAX (C++ enumerator), 286
 ESP_BLE_MESH_GENERIC_CLIENT_EVT_MAX (C++ enumerator), 286
 ESP_BLE_MESH_GENERIC_CLIENT_EVT_MAX (C++ enumerator), 286
 ESP_BLE_MESH_GENERIC_CLIENT_EVT_MAX (C++ enumerator), 286
 ESP_BLE_MESH_GENERIC_CLIENT_EVT_MAX (C++ enumerator), 286
 ESP_BLE_MESH_GENERIC_CLIENT_GET_STATE (C++ function), 257
 ESP_BLE_MESH_GENERIC_CLIENT_GET_STATE_EVT (C++ enumerator), 286
 esp_ble_mesh_generic_client_get_state_t (C++ union), 257
 esp_ble_mesh_generic_client_get_state_t::admin_pr (C++ member), 257
 esp_ble_mesh_generic_client_get_state_t::client_p (C++ member), 257
 esp_ble_mesh_generic_client_get_state_t::manufact (C++ member), 257
 esp_ble_mesh_generic_client_get_state_t::user_pro (C++ member), 257
 ESP_BLE_MESH_GENERIC_CLIENT_PUBLISH_EVT (C++ enumerator), 286
 esp_ble_mesh_generic_client_set_state (C++ function), 257
 ESP_BLE_MESH_GENERIC_CLIENT_SET_STATE_EVT (C++ enumerator), 286

- (C++ *enumerator*), 286
- esp_ble_mesh_generic_client_set_state_t (C++ *union*), 257
- esp_ble_mesh_generic_client_set_state_t::admin_message_received (C++ *member*), 258
- esp_ble_mesh_generic_client_set_state_t::delta_mesh_timer_set (C++ *member*), 258
- esp_ble_mesh_generic_client_set_state_t::delta_mesh_timer_set_server_cb_param_t::value (C++ *member*), 282
- esp_ble_mesh_generic_client_set_state_t::delta_mesh_timer_set_server_cb_t (C++ *member*), 258
- esp_ble_mesh_generic_client_set_state_t::delta_mesh_timer_set_server_cb_value_t (C++ *union*), 261
- esp_ble_mesh_generic_client_set_state_t::delta_mesh_timer_set_server_cb_value_t::get (C++ *member*), 258
- esp_ble_mesh_generic_client_set_state_t::delta_mesh_timer_set_server_cb_value_t::set (C++ *member*), 261
- esp_ble_mesh_generic_client_set_state_t::delta_mesh_timer_set_server_cb_value_t::state_change (C++ *member*), 261
- ESP_BLE_MESH_GENERIC_SERVER_EVT_MAX (C++ *enumerator*), 287
- ESP_BLE_MESH_GENERIC_SERVER_RECV_GET_MSG_EVT (C++ *enumerator*), 287
- esp_ble_mesh_generic_client_set_state_t::delta_mesh_timer_set_server_recv_get_msg_t (C++ *union*), 260
- esp_ble_mesh_generic_client_set_state_t::delta_mesh_timer_set_server_recv_get_msg_t::admin (C++ *member*), 258
- esp_ble_mesh_generic_client_set_state_t::delta_mesh_timer_set_server_recv_get_msg_t::client (C++ *member*), 260
- esp_ble_mesh_generic_client_set_state_t::delta_mesh_timer_set_server_recv_get_msg_t::manual (C++ *member*), 260
- esp_ble_mesh_generic_client_set_state_t::delta_mesh_timer_set_server_recv_get_msg_t::user (C++ *member*), 260
- ESP_BLE_MESH_GENERIC_CLIENT_TIMEOUT_EVT (C++ *enumerator*), 286
- ESP_BLE_MESH_GENERIC_SERVER_RECV_SET_MSG_EVT (C++ *enumerator*), 287
- ESP_BLE_MESH_GENERIC_LEVEL_STATE (C++ *enumerator*), 206
- esp_ble_mesh_generic_message_opcode_t (C++ *type*), 200
- ESP_BLE_MESH_GENERIC_ONOFF_STATE (C++ *enumerator*), 206
- ESP_BLE_MESH_GENERIC_ONPOWERUP_STATE (C++ *enumerator*), 206
- ESP_BLE_MESH_GENERIC_POWER_ACTUAL_STATE (C++ *enumerator*), 206
- esp_ble_mesh_generic_property_t (C++ *class*), 274
- esp_ble_mesh_generic_property_t::admin_message_received (C++ *member*), 274
- esp_ble_mesh_generic_property_t::id (C++ *member*), 274
- esp_ble_mesh_generic_property_t::manual_message_received (C++ *member*), 274
- esp_ble_mesh_generic_property_t::user_message_received (C++ *member*), 274
- esp_ble_mesh_generic_property_t::value (C++ *member*), 274
- esp_ble_mesh_generic_server_cb_event_t (C++ *enum*), 287
- esp_ble_mesh_generic_server_cb_param_t (C++ *class*), 282
- esp_ble_mesh_generic_server_cb_param_t::ctx (C++ *member*), 282
- esp_ble_mesh_generic_server_cb_param_t::model (C++ *member*), 282
- esp_ble_mesh_generic_server_cb_param_t::value (C++ *member*), 282
- esp_ble_mesh_generic_server_cb_t (C++ *type*), 286
- esp_ble_mesh_generic_server_cb_value_t (C++ *union*), 261
- esp_ble_mesh_generic_server_cb_value_t::get (C++ *member*), 261
- esp_ble_mesh_generic_server_cb_value_t::set (C++ *member*), 261
- esp_ble_mesh_generic_server_cb_value_t::state_change (C++ *member*), 261
- ESP_BLE_MESH_GENERIC_SERVER_RECV_GET_MSG_EVT (C++ *enumerator*), 287
- ESP_BLE_MESH_GENERIC_SERVER_RECV_GET_MSG_EVT (C++ *enumerator*), 287
- esp_ble_mesh_generic_client_set_state_t::delta_mesh_timer_set_server_recv_get_msg_t (C++ *union*), 260
- esp_ble_mesh_generic_client_set_state_t::delta_mesh_timer_set_server_recv_get_msg_t::admin (C++ *member*), 260
- esp_ble_mesh_generic_client_set_state_t::delta_mesh_timer_set_server_recv_get_msg_t::client (C++ *member*), 260
- esp_ble_mesh_generic_client_set_state_t::delta_mesh_timer_set_server_recv_get_msg_t::manual (C++ *member*), 260
- esp_ble_mesh_generic_client_set_state_t::delta_mesh_timer_set_server_recv_get_msg_t::user (C++ *member*), 260
- ESP_BLE_MESH_GENERIC_SERVER_RECV_SET_MSG_EVT (C++ *enumerator*), 287
- esp_ble_mesh_generic_server_recv_set_msg_t (C++ *union*), 260
- esp_ble_mesh_generic_server_recv_set_msg_t::admin (C++ *member*), 261
- esp_ble_mesh_generic_server_recv_set_msg_t::default (C++ *member*), 260
- esp_ble_mesh_generic_server_recv_set_msg_t::delta (C++ *member*), 260
- esp_ble_mesh_generic_server_recv_set_msg_t::level (C++ *member*), 260
- esp_ble_mesh_generic_server_recv_set_msg_t::local (C++ *member*), 261
- esp_ble_mesh_generic_server_recv_set_msg_t::local (C++ *member*), 261
- esp_ble_mesh_generic_server_recv_set_msg_t::manual (C++ *member*), 261
- esp_ble_mesh_generic_server_recv_set_msg_t::manual (C++ *member*), 260
- esp_ble_mesh_generic_server_recv_set_msg_t::move (C++ *member*), 260
- esp_ble_mesh_generic_server_recv_set_msg_t::onoff (C++ *member*), 260
- esp_ble_mesh_generic_server_recv_set_msg_t::onpowerup (C++ *member*), 260
- esp_ble_mesh_generic_server_recv_set_msg_t::power (C++ *member*), 260
- esp_ble_mesh_generic_server_recv_set_msg_t::power (C++ *member*), 260

- (C++ member), 260
- esp_ble_mesh_generic_server_rcv_set_msp (C++ member), 260
- esp_ble_mesh_generic_server_rcv_set_msp (C++ member), 261
- ESP_BLE_MESH_GENERIC_SERVER_STATE_CHANGE_EVT (C++ enumerator), 287
- esp_ble_mesh_generic_server_state_change (C++ union), 259
- esp_ble_mesh_generic_server_state_change (C++ member), 260
- esp_ble_mesh_generic_server_state_change (C++ member), 259
- esp_ble_mesh_generic_server_state_change (C++ member), 259
- esp_ble_mesh_generic_server_state_change (C++ member), 260
- esp_ble_mesh_generic_server_state_change (C++ member), 260
- esp_ble_mesh_generic_server_state_change (C++ member), 260
- esp_ble_mesh_generic_server_state_change (C++ member), 259
- esp_ble_mesh_generic_server_state_change (C++ member), 259
- esp_ble_mesh_generic_server_state_change (C++ member), 259
- esp_ble_mesh_generic_server_state_change (C++ member), 260
- esp_ble_mesh_generic_server_state_change (C++ member), 260
- esp_ble_mesh_generic_server_state_change (C++ member), 259
- esp_ble_mesh_generic_server_state_change (C++ member), 259
- esp_ble_mesh_generic_server_state_change (C++ member), 259
- esp_ble_mesh_generic_server_state_change (C++ member), 259
- esp_ble_mesh_get_composition_data (C++ function), 209
- esp_ble_mesh_get_element_count (C++ function), 208
- esp_ble_mesh_get_fast_prov_app_key (C++ function), 218
- esp_ble_mesh_get_model_publish_period (C++ function), 208
- esp_ble_mesh_get_primary_element_address (C++ function), 208
- ESP_BLE_MESH_GET_PUBLISH_TRANSMIT_COUNT (C macro), 187
- ESP_BLE_MESH_GET_PUBLISH_TRANSMIT_INTERVAL (C macro), 187
- ESP_BLE_MESH_GET_SENSOR_DATA_FORMAT (C macro), 300
- ESP_BLE_MESH_GET_SENSOR_DATA_LENGTH (C macro), 300
- ESP_BLE_MESH_GET_SENSOR_DATA_PROPERTY_ID (C macro), 300
- ESP_BLE_MESH_GET_TRANSMIT_COUNT (C macro), 187
- ESP_BLE_MESH_GET_TRANSMIT_INTERVAL (C macro), 187
- ESP_BLE_MESH_HEALTH_ATTENTION_OFF_CB_T (C++ class), 253
- ESP_BLE_MESH_HEALTH_ATTENTION_ON_CB_T (C++ class), 253
- ESP_BLE_MESH_HEALTH_ATTENTION_ON_CB_T::model (C++ member), 253
- ESP_BLE_MESH_HEALTH_ATTENTION_ON_CB_T::time (C++ member), 253
- ESP_BLE_MESH_HEALTH_ATTENTION_SET_T (C++ class), 251
- ESP_BLE_MESH_HEALTH_ATTENTION_SET_T::attention (C++ member), 251
- ESP_BLE_MESH_HEALTH_ATTENTION_STATUS_CB_T (C++ class), 252
- ESP_BLE_MESH_HEALTH_ATTENTION_STATUS_CB_T::attention (C++ member), 252
- ESP_BLE_MESH_HEALTH_CLIENT_CB_EVENT_T (C++ enum), 256
- ESP_BLE_MESH_HEALTH_CLIENT_CB_PARAM_T (C++ class), 252
- ESP_BLE_MESH_HEALTH_CLIENT_CB_PARAM_T::error_code (C++ member), 253
- ESP_BLE_MESH_HEALTH_CLIENT_CB_PARAM_T::params (C++ member), 253
- ESP_BLE_MESH_HEALTH_CLIENT_CB_PARAM_T::status_cb (C++ member), 253
- ESP_BLE_MESH_HEALTH_CLIENT_CB_T (C++ type), 256
- ESP_BLE_MESH_HEALTH_CLIENT_COMMON_CB_PARAM_T (C++ union), 249
- ESP_BLE_MESH_HEALTH_CLIENT_COMMON_CB_PARAM_T::att (C++ member), 250
- ESP_BLE_MESH_HEALTH_CLIENT_COMMON_CB_PARAM_T::cur (C++ member), 249
- ESP_BLE_MESH_HEALTH_CLIENT_COMMON_CB_PARAM_T::faul (C++ member), 249
- ESP_BLE_MESH_HEALTH_CLIENT_COMMON_CB_PARAM_T::per (C++ member), 250
- ESP_BLE_MESH_HEALTH_CLIENT_GET_STATE (C++ function), 248
- ESP_BLE_MESH_HEALTH_CLIENT_GET_STATE_EVT (C++ enumerator), 256
- ESP_BLE_MESH_HEALTH_CLIENT_GET_STATE_T (C++ union), 249
- ESP_BLE_MESH_HEALTH_CLIENT_GET_STATE_T::fault_get (C++ member), 249
- ESP_BLE_MESH_HEALTH_CLIENT_PUBLISH_EVT (C++ enumerator), 256
- ESP_BLE_MESH_HEALTH_CLIENT_SET_STATE (C++ function), 248
- ESP_BLE_MESH_HEALTH_CLIENT_SET_STATE_EVT (C++ function), 248

(C++ enumerator), 256

esp_ble_mesh_health_client_set_state_t (C++ union), 249

esp_ble_mesh_health_client_set_state_t::error (C++ member), 249

esp_ble_mesh_health_client_set_state_t::fault_clear (C++ member), 249

esp_ble_mesh_health_client_set_state_t::fault_test (C++ member), 249

ESP_BLE_MESH_HEALTH_CLIENT_TIMEOUT_EVT (C++ enumerator), 256

esp_ble_mesh_health_current_status_cb_t (C++ class), 252

esp_ble_mesh_health_current_status_cb_t::fast_period_div (C++ member), 252

ESP_BLE_MESH_HEALTH_FAULT_ARRAY_SIZE (C macro), 255

esp_ble_mesh_health_fault_clear_cb_t (C++ class), 253

esp_ble_mesh_health_fault_clear_cb_t::attention (C++ member), 253

esp_ble_mesh_health_fault_clear_t (C++ class), 251

esp_ble_mesh_health_fault_clear_t::compare (C++ member), 252

esp_ble_mesh_health_fault_get_t (C++ class), 251

esp_ble_mesh_health_fault_get_t::compare (C++ member), 251

esp_ble_mesh_health_fault_status_cb_t (C++ class), 252

esp_ble_mesh_health_fault_status_cb_t::ESP_BLE_MESH_HEALTH_SERVER_EVT_MAX (C++ member), 252

esp_ble_mesh_health_fault_status_cb_t::ESP_BLE_MESH_HEALTH_SERVER_FAULT_CLEAR_EVT (C++ member), 252

esp_ble_mesh_health_fault_status_cb_t::ESP_BLE_MESH_HEALTH_SERVER_FAULT_TEST_EVT (C++ member), 252

esp_ble_mesh_health_fault_test_cb_t (C++ class), 253

esp_ble_mesh_health_fault_test_cb_t::compare (C++ member), 253

esp_ble_mesh_health_fault_test_cb_t::test (C++ member), 253

esp_ble_mesh_health_fault_test_t (C++ class), 251

esp_ble_mesh_health_fault_test_t::compare (C++ member), 251

esp_ble_mesh_health_fault_test_t::test (C++ member), 251

(C++ member), 251

esp_ble_mesh_health_fault_update_comp_cb_t (C++ class), 253

esp_ble_mesh_health_fault_update_comp_cb_t::element (C++ member), 253

esp_ble_mesh_health_fault_update_comp_cb_t::error (C++ member), 253

esp_ble_mesh_health_model_status_t (C++ type), 200

esp_ble_mesh_health_period_set_t (C++ class), 251

esp_ble_mesh_health_period_set_t::fast_period_div (C++ member), 251

esp_ble_mesh_health_period_status_cb_t (C++ class), 252

esp_ble_mesh_health_period_status_cb_t::fast_peri (C++ member), 252

ESP_BLE_MESH_HEALTH_PUB_DEFINE (C macro), 254

ESP_BLE_MESH_HEALTH_SERVER_ATTENTION_OFF_EVT (C++ enumerator), 256

ESP_BLE_MESH_HEALTH_SERVER_ATTENTION_ON_EVT (C++ enumerator), 256

esp_ble_mesh_health_server_cb_event_t (C++ enum), 256

esp_ble_mesh_health_server_cb_param_t (C++ union), 250

esp_ble_mesh_health_server_cb_param_t::attention (C++ member), 250

esp_ble_mesh_health_server_cb_param_t::attention (C++ member), 250

esp_ble_mesh_health_server_cb_param_t::fault_clea (C++ member), 250

esp_ble_mesh_health_server_cb_param_t::fault_test (C++ member), 250

esp_ble_mesh_health_server_cb_param_t::fault_upda (C++ member), 250

esp_ble_mesh_health_server_cb_t (C++ type), 256

ESP_BLE_MESH_HEALTH_SERVER_EVT_MAX (C++ enumerator), 256

ESP_BLE_MESH_HEALTH_SERVER_FAULT_CLEAR_EVT (C++ enumerator), 256

ESP_BLE_MESH_HEALTH_SERVER_FAULT_TEST_EVT (C++ enumerator), 256

esp_ble_mesh_health_server_fault_update (C++ function), 249

ESP_BLE_MESH_HEALTH_SERVER_FAULT_UPDATE_COMP_EVT (C++ enumerator), 256

esp_ble_mesh_health_srv_cb_t (C++ class), 250

esp_ble_mesh_health_srv_cb_t::attention_off (C++ member), 250

esp_ble_mesh_health_srv_cb_t::attention_on (C++ member), 250

esp_ble_mesh_health_srv_cb_t::fault_clear (C++ member), 250

esp_ble_mesh_health_srv_cb_t::fault_test

- (C++ member), 250
- esp_ble_mesh_health_srv_t (C++ class), 251
- esp_ble_mesh_health_srv_t::attention_timer (C++ member), 251
- esp_ble_mesh_health_srv_t::attention_timer_start (C++ member), 251
- esp_ble_mesh_health_srv_t::health_cb (C++ member), 251
- esp_ble_mesh_health_srv_t::health_test (C++ member), 251
- esp_ble_mesh_health_srv_t::model (C++ member), 251
- ESP_BLE_MESH_HEALTH_STANDARD_TEST (C macro), 254
- esp_ble_mesh_health_test_t (C++ class), 250
- esp_ble_mesh_health_test_t::company_id (C++ member), 250
- esp_ble_mesh_health_test_t::current_faults (C++ member), 250
- esp_ble_mesh_health_test_t::id_count (C++ member), 250
- esp_ble_mesh_health_test_t::prev_test_id (C++ member), 250
- esp_ble_mesh_health_test_t::registered_faults (C++ member), 251
- esp_ble_mesh_health_test_t::test_ids (C++ member), 250
- ESP_BLE_MESH_HEARTBEAT_FILTER_ACCEPTLIST (C macro), 189
- ESP_BLE_MESH_HEARTBEAT_FILTER_ADD (C macro), 189
- esp_ble_mesh_heartbeat_filter_info_t (C++ class), 183
- esp_ble_mesh_heartbeat_filter_info_t::hb_dst (C++ member), 183
- esp_ble_mesh_heartbeat_filter_info_t::hb_src (C++ member), 183
- ESP_BLE_MESH_HEARTBEAT_FILTER_REJECTLIST (C macro), 189
- ESP_BLE_MESH_HEARTBEAT_FILTER_REMOVE (C macro), 189
- ESP_BLE_MESH_HEARTBEAT_MESSAGE_RECV_EVENT (C++ enumerator), 205
- ESP_BLE_MESH_HOUSING_OPENED_ERROR (C macro), 255
- ESP_BLE_MESH_HOUSING_OPENED_WARNING (C macro), 255
- esp_ble_mesh_init (C++ function), 208
- esp_ble_mesh_input_action_t (C++ enum), 201
- ESP_BLE_MESH_INPUT_NO_CHANGE_ERROR (C macro), 255
- ESP_BLE_MESH_INPUT_NO_CHANGE_WARNING (C macro), 255
- ESP_BLE_MESH_INPUT_OOB (C++ enumerator), 201
- ESP_BLE_MESH_INPUT_TOO_HIGH_ERROR (C macro), 255
- ESP_BLE_MESH_INPUT_TOO_HIGH_WARNING (C macro), 255
- ESP_BLE_MESH_INPUT_TOO_LOW_ERROR (C macro), 255
- ESP_BLE_MESH_INPUT_TOO_LOW_WARNING (C macro), 255
- ESP_BLE_MESH_INTERNAL_BUS_ERROR (C macro), 255
- ESP_BLE_MESH_INTERNAL_BUS_WARNING (C macro), 255
- ESP_BLE_MESH_INVALID_NODE_INDEX (C macro), 186
- ESP_BLE_MESH_INVALID_SCENE_NUMBER (C macro), 321
- ESP_BLE_MESH_INVALID_SENSOR_PROPERTY_ID (C macro), 299
- ESP_BLE_MESH_INVALID_SENSOR_SETTING_PROPERTY_ID (C macro), 299
- ESP_BLE_MESH_INVALID_SETTINGS_IDX (C macro), 185
- esp_ble_mesh_is_model_subscribed_to_group (C++ function), 208
- ESP_BLE_MESH_KEY_ANY (C macro), 186
- ESP_BLE_MESH_KEY_DEV (C macro), 186
- ESP_BLE_MESH_KEY_PRIMARY (C macro), 186
- ESP_BLE_MESH_KEY_UNUSED (C macro), 186
- esp_ble_mesh_last_msg_info_t (C++ class), 184
- esp_ble_mesh_last_msg_info_t::dst (C++ member), 184
- esp_ble_mesh_last_msg_info_t::src (C++ member), 184
- esp_ble_mesh_last_msg_info_t::tid (C++ member), 184
- esp_ble_mesh_last_msg_info_t::timestamp (C++ member), 185
- ESP_BLE_MESH_LC_FADE (C++ enumerator), 365
- ESP_BLE_MESH_LC_FADE_ON (C++ enumerator), 365
- ESP_BLE_MESH_LC_FADE_STANDBY_AUTO (C++ enumerator), 365
- ESP_BLE_MESH_LC_FADE_STANDBY_MANUAL (C++ enumerator), 365
- ESP_BLE_MESH_LC_OFF (C++ enumerator), 365
- ESP_BLE_MESH_LC_PROLONG (C++ enumerator), 365
- ESP_BLE_MESH_LC_RUN (C++ enumerator), 365
- ESP_BLE_MESH_LC_STANDBY (C++ enumerator), 365
- esp_ble_mesh_lc_state_t (C++ enum), 365
- esp_ble_mesh_light_client_cb_event_t (C++ enum), 364
- esp_ble_mesh_light_client_cb_param_t (C++ class), 341
- esp_ble_mesh_light_client_cb_param_t::error_code (C++ member), 341
- esp_ble_mesh_light_client_cb_param_t::params (C++ member), 341

- (C++ member), 350
- esp_ble_mesh_light_control_t::state (C++ member), 350
- esp_ble_mesh_light_control_t::state_machine (C++ member), 350
- esp_ble_mesh_light_ctl_default_set_t (C++ class), 331
- esp_ble_mesh_light_ctl_default_set_t::delta_uv (C++ member), 331
- esp_ble_mesh_light_ctl_default_set_t::lightness (C++ member), 331
- esp_ble_mesh_light_ctl_default_set_t::temperature (C++ member), 331
- esp_ble_mesh_light_ctl_default_status_set_t (C++ class), 337
- esp_ble_mesh_light_ctl_default_status_set_t::delta_uv (C++ member), 337
- esp_ble_mesh_light_ctl_default_status_set_t::lightness (C++ member), 337
- esp_ble_mesh_light_ctl_default_status_set_t::lightness_default (C++ member), 337
- esp_ble_mesh_light_ctl_default_status_set_t::lightness_min (C++ member), 337
- esp_ble_mesh_light_ctl_default_status_set_t::lightness_max (C++ member), 337
- ESP_BLE_MESH_LIGHT_CTL_LIGHTNESS_STATE (C++ enumerator), 207
- esp_ble_mesh_light_ctl_set_t (C++ class), 330
- esp_ble_mesh_light_ctl_set_t::ctl_delta_uv (C++ member), 331
- esp_ble_mesh_light_ctl_set_t::ctl_lightness (C++ member), 330
- esp_ble_mesh_light_ctl_set_t::ctl_temperature (C++ member), 330
- esp_ble_mesh_light_ctl_set_t::delay (C++ member), 331
- esp_ble_mesh_light_ctl_set_t::op_en (C++ member), 330
- esp_ble_mesh_light_ctl_set_t::tid (C++ member), 331
- esp_ble_mesh_light_ctl_set_t::trans_time (C++ member), 331
- esp_ble_mesh_light_ctl_setup_srv_t (C++ class), 343
- esp_ble_mesh_light_ctl_setup_srv_t::mode (C++ member), 343
- esp_ble_mesh_light_ctl_setup_srv_t::rsp_ctrl (C++ member), 343
- esp_ble_mesh_light_ctl_setup_srv_t::state (C++ member), 343
- esp_ble_mesh_light_ctl_srv_t (C++ class), 343
- esp_ble_mesh_light_ctl_srv_t::last (C++ member), 343
- esp_ble_mesh_light_ctl_srv_t::model (C++ member), 343
- esp_ble_mesh_light_ctl_srv_t::rsp_ctrl (C++ member), 343
- esp_ble_mesh_light_ctl_srv_t::state (C++ member), 343
- esp_ble_mesh_light_ctl_srv_t::transition (C++ member), 343
- esp_ble_mesh_light_ctl_srv_t::tt_delta_delta_uv (C++ member), 343
- esp_ble_mesh_light_ctl_srv_t::tt_delta_lightness (C++ member), 343
- esp_ble_mesh_light_ctl_srv_t::tt_delta_temperature (C++ member), 343
- esp_ble_mesh_light_ctl_state_t (C++ class), 342
- esp_ble_mesh_light_ctl_state_t::delta_uv (C++ member), 342
- esp_ble_mesh_light_ctl_state_t::delta_uv_default (C++ member), 343
- esp_ble_mesh_light_ctl_state_t::lightness (C++ member), 342
- esp_ble_mesh_light_ctl_state_t::lightness_default (C++ member), 343
- esp_ble_mesh_light_ctl_state_t::status_code (C++ member), 343
- esp_ble_mesh_light_ctl_state_t::target_delta_uv (C++ member), 342
- esp_ble_mesh_light_ctl_state_t::target_lightness (C++ member), 342
- esp_ble_mesh_light_ctl_state_t::target_temperature (C++ member), 342
- esp_ble_mesh_light_ctl_state_t::temperature (C++ member), 342
- esp_ble_mesh_light_ctl_state_t::temperature_default (C++ member), 343
- esp_ble_mesh_light_ctl_state_t::temperature_range (C++ member), 343
- esp_ble_mesh_light_ctl_state_t::temperature_range_min (C++ member), 343
- esp_ble_mesh_light_ctl_state_t::temperature_range_max (C++ member), 343
- esp_ble_mesh_light_ctl_status_cb_t (C++ class), 336
- esp_ble_mesh_light_ctl_status_cb_t::op_en (C++ member), 336
- esp_ble_mesh_light_ctl_status_cb_t::present_ctl_lightness (C++ member), 336
- esp_ble_mesh_light_ctl_status_cb_t::present_ctl_temperature (C++ member), 336
- esp_ble_mesh_light_ctl_status_cb_t::remain_time (C++ member), 336
- esp_ble_mesh_light_ctl_status_cb_t::target_ctl_lightness (C++ member), 336
- esp_ble_mesh_light_ctl_status_cb_t::target_ctl_temperature (C++ member), 336
- ESP_BLE_MESH_LIGHT_CTL_TEMP_DELTA_UV_STATE (C++ enumerator), 207
- esp_ble_mesh_light_ctl_temp_srv_t (C++ class), 343
- esp_ble_mesh_light_ctl_temp_srv_t::last (C++ member), 344
- esp_ble_mesh_light_ctl_temp_srv_t::model (C++ member), 344
- esp_ble_mesh_light_ctl_temp_srv_t::rsp_ctrl (C++ member), 344
- esp_ble_mesh_light_ctl_temp_srv_t::state (C++ member), 344

(C++ member), 344

esp_ble_mesh_light_ctl_temp_srv_t::transition esp_ble_mesh_light_hsl_default_status_cb_t::hue
(C++ member), 344 (C++ member), 338

esp_ble_mesh_light_ctl_temp_srv_t::tt_delta_hue esp_ble_mesh_light_hsl_default_status_cb_t::light
(C++ member), 344 (C++ member), 338

esp_ble_mesh_light_ctl_temp_srv_t::tt_delta_temperature esp_ble_mesh_light_hsl_default_status_cb_t::saturation
(C++ member), 344 (C++ member), 338

esp_ble_mesh_light_ctl_temperature_range_set_t esp_ble_mesh_light_hsl_hue_set_t (C++
(C++ class), 331 class), 332

esp_ble_mesh_light_ctl_temperature_range_set_t::delay esp_ble_mesh_light_hsl_hue_set_t::delay
(C++ member), 331 (C++ member), 332

esp_ble_mesh_light_ctl_temperature_range_set_t::hue esp_ble_mesh_light_hsl_hue_set_t::hue
(C++ member), 331 (C++ member), 332

esp_ble_mesh_light_ctl_temperature_range_set_t::open esp_ble_mesh_light_hsl_hue_set_t::open
(C++ class), 337 (C++ member), 332

esp_ble_mesh_light_ctl_temperature_range_set_t::range_max esp_ble_mesh_light_hsl_hue_set_t::tid
(C++ member), 337 (C++ member), 332

esp_ble_mesh_light_ctl_temperature_range_set_t::range_min esp_ble_mesh_light_hsl_hue_set_t::trans_time
(C++ member), 337 (C++ member), 332

esp_ble_mesh_light_ctl_temperature_range_set_t::start esp_ble_mesh_light_hsl_hue_set_t::transition
(C++ member), 337 (C++ member), 332

esp_ble_mesh_light_ctl_temperature_set esp_ble_mesh_light_hsl_hue_srv_t (C++
(C++ class), 331 class), 345

esp_ble_mesh_light_ctl_temperature_set::last esp_ble_mesh_light_hsl_hue_srv_t::last
(C++ member), 331 (C++ member), 345

esp_ble_mesh_light_ctl_temperature_set::delta_hue esp_ble_mesh_light_hsl_hue_srv_t::model
(C++ member), 331 (C++ member), 345

esp_ble_mesh_light_ctl_temperature_set::temperature esp_ble_mesh_light_hsl_hue_srv_t::rsp_ctrl
(C++ member), 331 (C++ member), 345

esp_ble_mesh_light_ctl_temperature_set::delay esp_ble_mesh_light_hsl_hue_srv_t::state
(C++ member), 331 (C++ member), 345

esp_ble_mesh_light_ctl_temperature_set::op esp_ble_mesh_light_hsl_hue_srv_t::transition
(C++ member), 331 (C++ member), 345

esp_ble_mesh_light_ctl_temperature_set::tt_delta_hue esp_ble_mesh_light_hsl_hue_srv_t::tt_delta_hue
(C++ member), 331 (C++ member), 346

esp_ble_mesh_light_ctl_temperature_set ESP_BLE_MESH_LIGHT_HSL_HUE_STATE (C++
(C++ member), 331 enumerator), 207

esp_ble_mesh_light_ctl_temperature_status esp_ble_mesh_light_hsl_hue_status_cb_t
(C++ class), 336 (C++ class), 338

esp_ble_mesh_light_ctl_temperature_status::open esp_ble_mesh_light_hsl_hue_status_cb_t::open
(C++ member), 336 (C++ member), 338

esp_ble_mesh_light_ctl_temperature_status::present esp_ble_mesh_light_hsl_hue_status_cb_t::present
(C++ member), 336 (C++ member), 338

esp_ble_mesh_light_ctl_temperature_status::remain esp_ble_mesh_light_hsl_hue_status_cb_t::remain
(C++ member), 336 (C++ member), 338

esp_ble_mesh_light_ctl_temperature_status::target esp_ble_mesh_light_hsl_hue_status_cb_t::target
(C++ member), 337 (C++ member), 338

esp_ble_mesh_light_ctl_temperature_status ESP_BLE_MESH_LIGHT_HSL_TEMPERATURE_STATE
(C++ member), 337 (C++ enumerator), 207

esp_ble_mesh_light_ctl_temperature_status::target esp_ble_mesh_light_hsl_temperature_set
(C++ member), 337 (C++ class), 333

esp_ble_mesh_light_hsl_default_set_t esp_ble_mesh_light_hsl_range_set_t::hue_range_max
(C++ class), 333 (C++ member), 333

esp_ble_mesh_light_hsl_default_set_t::hue esp_ble_mesh_light_hsl_range_set_t::hue_range_min
(C++ member), 333 (C++ member), 333

esp_ble_mesh_light_hsl_default_set_t::saturation esp_ble_mesh_light_hsl_range_set_t::saturation
(C++ member), 333 (C++ member), 333

esp_ble_mesh_light_hsl_default_set_t::saturation esp_ble_mesh_light_hsl_range_set_t::saturation
(C++ member), 333 (C++ member), 333

esp_ble_mesh_light_hsl_default_status_cb_t esp_ble_mesh_light_hsl_range_status_cb_t

(C++ member), 348
 esp_ble_mesh_light_lc_property_state_t::estimate_mesh_light_lc_state_t::occupancy_mode
 (C++ member), 348
 esp_ble_mesh_light_lc_property_state_t::estimate_mesh_light_lc_state_t::target_light_onoff
 (C++ member), 348
 esp_ble_mesh_light_lc_property_status_cb_t ESP_BLE_MESH_LIGHT_LIGHTNESS_ACTUAL_STATE
 (C++ class), 341 (C++ enumerator), 206
 esp_ble_mesh_light_lc_property_status_cb_t::light_lightness_default_set_t
 (C++ member), 341 (C++ class), 330
 esp_ble_mesh_light_lc_property_status_cb_t::light_lightness_default_set_t::light
 (C++ member), 341 (C++ member), 330
 esp_ble_mesh_light_lc_setup_srv_t esp_ble_mesh_light_lightness_default_status_cb_t
 (C++ class), 350 (C++ class), 336
 esp_ble_mesh_light_lc_setup_srv_t::lc esp_ble_mesh_light_lightness_default_status_cb_t:
 (C++ member), 351 (C++ member), 336
 esp_ble_mesh_light_lc_setup_srv_t::model esp_ble_mesh_light_lightness_last_status_cb_t
 (C++ member), 351 (C++ class), 335
 esp_ble_mesh_light_lc_setup_srv_t::rsp esp_ble_mesh_light_lightness_last_status_cb_t::li
 (C++ member), 351 (C++ member), 336
 esp_ble_mesh_light_lc_srv_t (C++ class), esp_ble_mesh_light_lightness_linear_set_t
 350 (C++ class), 330
 esp_ble_mesh_light_lc_srv_t::last esp_ble_mesh_light_lightness_linear_set_t::delay
 (C++ member), 350 (C++ member), 330
 esp_ble_mesh_light_lc_srv_t::lc (C++ esp_ble_mesh_light_lightness_linear_set_t::lightn
 member), 350 (C++ member), 330
 esp_ble_mesh_light_lc_srv_t::model esp_ble_mesh_light_lightness_linear_set_t::op_en
 (C++ member), 350 (C++ member), 330
 esp_ble_mesh_light_lc_srv_t::rsp_ctrl esp_ble_mesh_light_lightness_linear_set_t::tid
 (C++ member), 350 (C++ member), 330
 esp_ble_mesh_light_lc_srv_t::transition esp_ble_mesh_light_lightness_linear_set_t::trans
 (C++ member), 350 (C++ member), 330
 esp_ble_mesh_light_lc_state_machine_t ESP_BLE_MESH_LIGHT_LIGHTNESS_LINEAR_STATE
 (C++ class), 349 (C++ enumerator), 207
 esp_ble_mesh_light_lc_state_machine_t::esp_ble_mesh_light_lightness_linear_status_cb_t
 (C++ member), 350 (C++ class), 335
 esp_ble_mesh_light_lc_state_machine_t::esp_ble_mesh_light_lightness_linear_status_cb_t::
 (C++ member), 350 (C++ member), 335
 esp_ble_mesh_light_lc_state_machine_t::esp_ble_mesh_light_lightness_linear_status_cb_t::
 (C++ member), 350 (C++ member), 335
 esp_ble_mesh_light_lc_state_machine_t::esp_ble_mesh_light_lightness_linear_status_cb_t::
 (C++ member), 350 (C++ member), 335
 esp_ble_mesh_light_lc_state_machine_t::esp_ble_mesh_light_lightness_linear_status_cb_t::
 (C++ member), 350 (C++ member), 335
 esp_ble_mesh_light_lc_state_machine_t::estimate esp_ble_mesh_light_lightness_range_set_t
 (C++ member), 350 (C++ class), 330
 esp_ble_mesh_light_lc_state_machine_t::estimate esp_ble_mesh_light_lightness_range_set_t::range_m
 (C++ member), 350 (C++ member), 330
 esp_ble_mesh_light_lc_state_t (C++ esp_ble_mesh_light_lightness_range_set_t::range_m
 class), 347 (C++ member), 330
 esp_ble_mesh_light_lc_state_t::ambient esp_ble_mesh_light_lightness_range_status_cb_t
 (C++ member), 348 (C++ class), 336
 esp_ble_mesh_light_lc_state_t::light_onoff esp_ble_mesh_light_lightness_range_status_cb_t::r
 (C++ member), 348 (C++ member), 336
 esp_ble_mesh_light_lc_state_t::linear_output esp_ble_mesh_light_lightness_range_status_cb_t::r
 (C++ member), 348 (C++ member), 336
 esp_ble_mesh_light_lc_state_t::mode esp_ble_mesh_light_lightness_range_status_cb_t::s
 (C++ member), 347 (C++ member), 336
 esp_ble_mesh_light_lc_state_t::occupancy esp_ble_mesh_light_lightness_set_t

(C++ class), 329
 esp_ble_mesh_light_lightness_set_t::delay (C++ member), 330
 esp_ble_mesh_light_lightness_set_t::lightness (C++ member), 329
 esp_ble_mesh_light_lightness_set_t::open (C++ member), 329
 esp_ble_mesh_light_lightness_set_t::tid (C++ member), 330
 esp_ble_mesh_light_lightness_set_t::transport (C++ member), 330
 esp_ble_mesh_light_lightness_setup_srv_t (C++ class), 342
 esp_ble_mesh_light_lightness_setup_srv_t::mode (C++ member), 342
 esp_ble_mesh_light_lightness_setup_srv_t::role (C++ member), 342
 esp_ble_mesh_light_lightness_setup_srv_t::state (C++ member), 342
 esp_ble_mesh_light_lightness_srv_t (C++ class), 341
 esp_ble_mesh_light_lightness_srv_t::actual_position (C++ member), 342
 esp_ble_mesh_light_lightness_srv_t::last_position (C++ member), 342
 esp_ble_mesh_light_lightness_srv_t::linear_position (C++ member), 342
 esp_ble_mesh_light_lightness_srv_t::mode (C++ member), 342
 esp_ble_mesh_light_lightness_srv_t::response (C++ member), 342
 esp_ble_mesh_light_lightness_srv_t::status (C++ member), 342
 esp_ble_mesh_light_lightness_srv_t::tt_actual_linear_range_set_t::xyl_x_range_min (C++ member), 342
 esp_ble_mesh_light_lightness_srv_t::tt_actual_linear_range_set_t::xyl_y_range_min (C++ member), 342
 esp_ble_mesh_light_lightness_state_t (C++ class), 341
 esp_ble_mesh_light_lightness_state_t::lightness (C++ member), 341
 esp_ble_mesh_light_lightness_state_t::lightness_default (C++ member), 341
 esp_ble_mesh_light_lightness_state_t::lightness_min (C++ member), 341
 esp_ble_mesh_light_lightness_state_t::lightness_max (C++ member), 341
 esp_ble_mesh_light_lightness_state_t::lightness_min_linear (C++ member), 341
 esp_ble_mesh_light_lightness_state_t::status_code (C++ member), 341
 esp_ble_mesh_light_lightness_state_t::transport_linear_set_t::delay (C++ member), 341
 esp_ble_mesh_light_lightness_state_t::transport_linear_set_t::open (C++ member), 341
 esp_ble_mesh_light_lightness_status_cb_t (C++ class), 335
 esp_ble_mesh_light_lightness_status_cb_t::open (C++ member), 335
 esp_ble_mesh_light_lightness_status_cb_t::present (C++ member), 335
 esp_ble_mesh_light_lightness_status_cb_t::remain (C++ member), 335
 esp_ble_mesh_light_lightness_status_cb_t::target (C++ member), 335
 esp_ble_mesh_light_message_opcode_t (C++ type), 201
 esp_ble_mesh_light_xyl_default_set_t (C++ class), 333
 esp_ble_mesh_light_xyl_default_set_t::lightness (C++ member), 334
 esp_ble_mesh_light_xyl_default_set_t::xyl_x (C++ member), 334
 esp_ble_mesh_light_xyl_default_set_t::xyl_y (C++ member), 334
 esp_ble_mesh_light_xyl_default_status_cb_t (C++ class), 339
 esp_ble_mesh_light_xyl_default_status_cb_t::lightness (C++ member), 340
 esp_ble_mesh_light_xyl_default_status_cb_t::xyl_x (C++ member), 340
 esp_ble_mesh_light_xyl_default_status_cb_t::xyl_y (C++ member), 340
 ESP_BLE_MESH_LIGHT_XYL_LIGHTNESS_STATE (C++ enumerator), 207
 esp_ble_mesh_light_xyl_range_set_t (C++ class), 334
 esp_ble_mesh_light_xyl_range_set_t::xyl_x_range_min (C++ member), 334
 esp_ble_mesh_light_xyl_range_set_t::xyl_x_range_max (C++ member), 334
 esp_ble_mesh_light_xyl_range_set_t::xyl_y_range_min (C++ member), 334
 esp_ble_mesh_light_xyl_range_set_t::xyl_y_range_max (C++ member), 334
 esp_ble_mesh_light_xyl_range_status_cb_t (C++ class), 340
 esp_ble_mesh_light_xyl_range_status_cb_t::status (C++ member), 340
 esp_ble_mesh_light_xyl_range_status_cb_t::xyl_x_min (C++ member), 340
 esp_ble_mesh_light_xyl_range_status_cb_t::xyl_x_max (C++ member), 340
 esp_ble_mesh_light_xyl_range_status_cb_t::xyl_y_min (C++ member), 340
 esp_ble_mesh_light_xyl_range_status_cb_t::xyl_y_max (C++ member), 340
 esp_ble_mesh_light_xyl_set_t (C++ class), 333
 esp_ble_mesh_light_xyl_set_t::delay (C++ member), 333
 esp_ble_mesh_light_xyl_set_t::open (C++ member), 333
 esp_ble_mesh_light_xyl_set_t::tid (C++ member), 333

(C++ member), 333
 esp_ble_mesh_light_xyl_set_t::trans_time (C++ member), 333
 esp_ble_mesh_light_xyl_set_t::xyl_lightness (C++ member), 333
 esp_ble_mesh_light_xyl_set_t::xyl_x (C++ member), 333
 esp_ble_mesh_light_xyl_set_t::xyl_y (C++ member), 333
 esp_ble_mesh_light_xyl_setup_srv_t (C++ class), 347
 esp_ble_mesh_light_xyl_setup_srv_t::model (C++ member), 347
 esp_ble_mesh_light_xyl_setup_srv_t::rsp_ctrl (C++ member), 347
 esp_ble_mesh_light_xyl_setup_srv_t::state (C++ member), 347
 esp_ble_mesh_light_xyl_setup_srv_t::transition (C++ member), 347
 esp_ble_mesh_light_xyl_setup_srv_t::tt_delta_lightness (C++ member), 347
 esp_ble_mesh_light_xyl_setup_srv_t::tt_delta_x (C++ member), 347
 esp_ble_mesh_light_xyl_setup_srv_t::tt_delta_y (C++ member), 347
 esp_ble_mesh_light_xyl_state_t (C++ class), 346
 esp_ble_mesh_light_xyl_state_t::lightness (C++ member), 346
 esp_ble_mesh_light_xyl_state_t::lightness_delta (C++ member), 346
 esp_ble_mesh_light_xyl_state_t::status_code (C++ member), 346
 esp_ble_mesh_light_xyl_state_t::target_lightness (C++ member), 346
 esp_ble_mesh_light_xyl_state_t::target_x (C++ member), 346
 esp_ble_mesh_light_xyl_state_t::target_y (C++ member), 346
 esp_ble_mesh_light_xyl_state_t::x (C++ member), 346
 esp_ble_mesh_light_xyl_state_t::x_default (C++ member), 346
 esp_ble_mesh_light_xyl_state_t::x_range_max (C++ member), 347
 esp_ble_mesh_light_xyl_state_t::x_range_min (C++ member), 346
 esp_ble_mesh_light_xyl_state_t::y (C++ member), 346
 (C++ member), 346
 esp_ble_mesh_light_xyl_state_t::y_default (C++ member), 346
 esp_ble_mesh_light_xyl_state_t::y_range_max (C++ member), 347
 esp_ble_mesh_light_xyl_state_t::y_range_min (C++ member), 347
 esp_ble_mesh_light_xyl_status_cb_t (C++ class), 339
 esp_ble_mesh_light_xyl_status_cb_t::op_en (C++ member), 339
 esp_ble_mesh_light_xyl_status_cb_t::remain_time (C++ member), 339
 esp_ble_mesh_light_xyl_status_cb_t::xyl_lightness (C++ member), 339
 esp_ble_mesh_light_xyl_status_cb_t::xyl_x (C++ member), 339
 esp_ble_mesh_light_xyl_status_cb_t::xyl_y (C++ member), 339
 esp_ble_mesh_light_xyl_target_status_cb_t (C++ class), 339
 esp_ble_mesh_light_xyl_target_status_cb_t::op_en (C++ member), 339
 esp_ble_mesh_light_xyl_target_status_cb_t::remain_time (C++ member), 339
 esp_ble_mesh_light_xyl_target_status_cb_t::target_lightness (C++ member), 339
 esp_ble_mesh_light_xyl_target_status_cb_t::target_x (C++ member), 339
 esp_ble_mesh_light_xyl_target_status_cb_t::target_y (C++ member), 339
 esp_ble_mesh_lighting_server_cb_event_t (C++ enum), 365
 esp_ble_mesh_lighting_server_cb_param_t (C++ class), 360
 esp_ble_mesh_lighting_server_cb_param_t::ctx (C++ member), 361
 esp_ble_mesh_lighting_server_cb_param_t::model (C++ member), 361
 esp_ble_mesh_lighting_server_cb_param_t::value (C++ member), 361
 esp_ble_mesh_lighting_server_cb_t (C++ type), 364
 esp_ble_mesh_lighting_server_cb_value_t (C++ union), 329
 esp_ble_mesh_lighting_server_cb_value_t::get (C++ member), 329
 esp_ble_mesh_lighting_server_cb_value_t::set (C++ member), 329
 esp_ble_mesh_lighting_server_cb_value_t::state_change (C++ member), 329
 esp_ble_mesh_lighting_server_cb_value_t::status (C++ member), 329
 ESP_BLE_MESH_LIGHTING_SERVER_EVT_MAX (C++ enumerator), 365
 ESP_BLE_MESH_LIGHTING_SERVER_RECV_GET_MSG_EVT (C++ enumerator), 365
 esp_ble_mesh_lighting_server_rcv_get_msg_t

- ESP_BLE_MESH_MODEL_CFG_SRV (*C macro*), 247
- ESP_BLE_MESH_MODEL_EVT_MAX (*C++ enumerator*), 207
- ESP_BLE_MESH_MODEL_GEN_ADMIN_PROP_SRV (*C macro*), 285
- ESP_BLE_MESH_MODEL_GEN_BATTERY_CLI (*C macro*), 283
- ESP_BLE_MESH_MODEL_GEN_BATTERY_SRV (*C macro*), 284
- ESP_BLE_MESH_MODEL_GEN_CLIENT_PROP_SRV (*C macro*), 285
- ESP_BLE_MESH_MODEL_GEN_DEF_TRANS_TIME_CLI (*C macro*), 282
- ESP_BLE_MESH_MODEL_GEN_DEF_TRANS_TIME_SRV (*C macro*), 283
- ESP_BLE_MESH_MODEL_GEN_LEVEL_CLI (*C macro*), 282
- ESP_BLE_MESH_MODEL_GEN_LEVEL_SRV (*C macro*), 283
- ESP_BLE_MESH_MODEL_GEN_LOCATION_CLI (*C macro*), 283
- ESP_BLE_MESH_MODEL_GEN_LOCATION_SETUP_SRV (*C macro*), 285
- ESP_BLE_MESH_MODEL_GEN_LOCATION_SRV (*C macro*), 285
- ESP_BLE_MESH_MODEL_GEN_MANUFACTURER_PROP_SRV (*C macro*), 285
- ESP_BLE_MESH_MODEL_GEN_ONOFF_CLI (*C macro*), 282
- ESP_BLE_MESH_MODEL_GEN_ONOFF_SRV (*C macro*), 283
- ESP_BLE_MESH_MODEL_GEN_POWER_LEVEL_CLI (*C macro*), 282
- ESP_BLE_MESH_MODEL_GEN_POWER_LEVEL_SETUP_SRV (*C macro*), 284
- ESP_BLE_MESH_MODEL_GEN_POWER_LEVEL_SRV (*C macro*), 284
- ESP_BLE_MESH_MODEL_GEN_POWER_ONOFF_CLI (*C macro*), 282
- ESP_BLE_MESH_MODEL_GEN_POWER_ONOFF_SETUP_SRV (*C macro*), 284
- ESP_BLE_MESH_MODEL_GEN_POWER_ONOFF_SRV (*C macro*), 284
- ESP_BLE_MESH_MODEL_GEN_POWER_ONOFF_CLI (*C macro*), 282
- ESP_BLE_MESH_MODEL_GEN_POWER_ONOFF_SETUP_SRV (*C macro*), 284
- ESP_BLE_MESH_MODEL_GEN_POWER_ONOFF_SRV (*C macro*), 284
- ESP_BLE_MESH_MODEL_GEN_PROP_CLI (*C macro*), 282
- ESP_BLE_MESH_MODEL_GEN_USER_PROP_SRV (*C macro*), 283
- ESP_BLE_MESH_MODEL_GEN_POWER_ONOFF_SRV (*C macro*), 284
- ESP_BLE_MESH_MODEL_ID_CONFIG_CLI (*C macro*), 189
- ESP_BLE_MESH_MODEL_ID_CONFIG_SRV (*C macro*), 189
- ESP_BLE_MESH_MODEL_ID_GEN_ADMIN_PROP_SRV (*C macro*), 189
- ESP_BLE_MESH_MODEL_ID_GEN_BATTERY_SRV (*C macro*), 189
- ESP_BLE_MESH_MODEL_ID_GEN_CLIENT_PROP_SRV (*C macro*), 189
- ESP_BLE_MESH_MODEL_ID_GEN_DEF_TRANS_TIME_CLI (*C macro*), 189
- ESP_BLE_MESH_MODEL_ID_GEN_DEF_TRANS_TIME_SRV (*C macro*), 189
- ESP_BLE_MESH_MODEL_ID_GEN_LEVEL_CLI (*C macro*), 189
- ESP_BLE_MESH_MODEL_ID_GEN_LEVEL_SRV (*C macro*), 189
- ESP_BLE_MESH_MODEL_ID_GEN_LOCATION_CLI (*C macro*), 189
- ESP_BLE_MESH_MODEL_ID_GEN_LOCATION_SETUP_SRV (*C macro*), 189
- ESP_BLE_MESH_MODEL_ID_GEN_LOCATION_SRV (*C macro*), 189
- ESP_BLE_MESH_MODEL_ID_GEN_MANUFACTURER_PROP_SRV (*C macro*), 189
- ESP_BLE_MESH_MODEL_ID_GEN_ONOFF_CLI (*C macro*), 189
- ESP_BLE_MESH_MODEL_ID_GEN_ONOFF_SRV (*C macro*), 189
- ESP_BLE_MESH_MODEL_ID_GEN_POWER_LEVEL_CLI (*C macro*), 189
- ESP_BLE_MESH_MODEL_ID_GEN_POWER_LEVEL_SETUP_SRV (*C macro*), 189
- ESP_BLE_MESH_MODEL_ID_GEN_POWER_LEVEL_SRV (*C macro*), 189
- ESP_BLE_MESH_MODEL_ID_GEN_POWER_ONOFF_CLI (*C macro*), 189
- ESP_BLE_MESH_MODEL_ID_GEN_POWER_ONOFF_SETUP_SRV (*C macro*), 189
- ESP_BLE_MESH_MODEL_ID_GEN_POWER_ONOFF_SRV (*C macro*), 189
- ESP_BLE_MESH_MODEL_ID_GEN_PROP_CLI (*C macro*), 189
- ESP_BLE_MESH_MODEL_ID_GEN_USER_PROP_SRV (*C macro*), 189
- ESP_BLE_MESH_MODEL_ID_HEALTH_CLI (*C macro*), 189
- ESP_BLE_MESH_MODEL_ID_HEALTH_SRV (*C macro*), 189
- ESP_BLE_MESH_MODEL_ID_LIGHT_CTL_CLI (*C macro*), 190
- ESP_BLE_MESH_MODEL_ID_LIGHT_CTL_SETUP_SRV (*C macro*), 190
- ESP_BLE_MESH_MODEL_ID_LIGHT_CTL_SRV (*C macro*), 190
- ESP_BLE_MESH_MODEL_ID_LIGHT_CTL_TEMP_SRV (*C macro*), 190
- ESP_BLE_MESH_MODEL_ID_LIGHT_HSL_CLI (*C macro*), 190
- ESP_BLE_MESH_MODEL_ID_LIGHT_HSL_HUE_SRV (*C macro*), 190
- ESP_BLE_MESH_MODEL_ID_LIGHT_HSL_SAT_SRV

(*C macro*), 190

ESP_BLE_MESH_MODEL_ID_LIGHT_HSL_SETUP_SRV (*C macro*), 190

ESP_BLE_MESH_MODEL_ID_LIGHT_HSL_SRV (*C macro*), 190

ESP_BLE_MESH_MODEL_ID_LIGHT_LC_CLI (*C macro*), 190

ESP_BLE_MESH_MODEL_ID_LIGHT_LC_SETUP_SRV (*C macro*), 190

ESP_BLE_MESH_MODEL_ID_LIGHT_LC_SRV (*C macro*), 190

ESP_BLE_MESH_MODEL_ID_LIGHT_LIGHTNESS_CLI (*C macro*), 190

ESP_BLE_MESH_MODEL_ID_LIGHT_LIGHTNESS_SETUP_SRV (*C macro*), 190

ESP_BLE_MESH_MODEL_ID_LIGHT_LIGHTNESS_SRV (*C macro*), 190

ESP_BLE_MESH_MODEL_ID_LIGHT_XYL_CLI (*C macro*), 190

ESP_BLE_MESH_MODEL_ID_LIGHT_XYL_SETUP_SRV (*C macro*), 190

ESP_BLE_MESH_MODEL_ID_LIGHT_XYL_SRV (*C macro*), 190

ESP_BLE_MESH_MODEL_ID_SCENE_CLI (*C macro*), 190

ESP_BLE_MESH_MODEL_ID_SCENE_SETUP_SRV (*C macro*), 190

ESP_BLE_MESH_MODEL_ID_SCENE_SRV (*C macro*), 190

ESP_BLE_MESH_MODEL_ID_SCHEDULER_CLI (*C macro*), 190

ESP_BLE_MESH_MODEL_ID_SCHEDULER_SETUP_SRV (*C macro*), 190

ESP_BLE_MESH_MODEL_ID_SCHEDULER_SRV (*C macro*), 190

ESP_BLE_MESH_MODEL_ID_SENSOR_CLI (*C macro*), 189

ESP_BLE_MESH_MODEL_ID_SENSOR_SETUP_SRV (*C macro*), 189

ESP_BLE_MESH_MODEL_ID_SENSOR_SRV (*C macro*), 189

ESP_BLE_MESH_MODEL_ID_TIME_CLI (*C macro*), 189

ESP_BLE_MESH_MODEL_ID_TIME_SETUP_SRV (*C macro*), 189

ESP_BLE_MESH_MODEL_ID_TIME_SRV (*C macro*), 189

ESP_BLE_MESH_MODEL_LIGHT_CTL_CLI (*C macro*), 361

ESP_BLE_MESH_MODEL_LIGHT_CTL_SETUP_SRV (*C macro*), 362

ESP_BLE_MESH_MODEL_LIGHT_CTL_SRV (*C macro*), 362

ESP_BLE_MESH_MODEL_LIGHT_CTL_TEMP_SRV (*C macro*), 362

ESP_BLE_MESH_MODEL_LIGHT_HSL_CLI (*C macro*), 361

ESP_BLE_MESH_MODEL_LIGHT_HSL_HUE_SRV (*C macro*), 363

ESP_BLE_MESH_MODEL_LIGHT_HSL_SAT_SRV (*C macro*), 363

ESP_BLE_MESH_MODEL_LIGHT_HSL_SETUP_SRV (*C macro*), 363

ESP_BLE_MESH_MODEL_LIGHT_HSL_SRV (*C macro*), 362

ESP_BLE_MESH_MODEL_LIGHT_LC_CLI (*C macro*), 361

ESP_BLE_MESH_MODEL_LIGHT_LC_SETUP_SRV (*C macro*), 364

ESP_BLE_MESH_MODEL_LIGHT_LC_SRV (*C macro*), 364

ESP_BLE_MESH_MODEL_LIGHT_LIGHTNESS_CLI (*C macro*), 361

ESP_BLE_MESH_MODEL_LIGHT_LIGHTNESS_SETUP_SRV (*C macro*), 362

ESP_BLE_MESH_MODEL_LIGHT_LIGHTNESS_SRV (*C macro*), 361

ESP_BLE_MESH_MODEL_LIGHT_XYL_CLI (*C macro*), 361

ESP_BLE_MESH_MODEL_LIGHT_XYL_SETUP_SRV (*C macro*), 363

ESP_BLE_MESH_MODEL_LIGHT_XYL_SRV (*C macro*), 363

esp_ble_mesh_model_msg_opcode_init (*C++ function*), 211

ESP_BLE_MESH_MODEL_NONE (*C macro*), 188

ESP_BLE_MESH_MODEL_OP (*C macro*), 188

ESP_BLE_MESH_MODEL_OP_1 (*C macro*), 187

ESP_BLE_MESH_MODEL_OP_2 (*C macro*), 187

ESP_BLE_MESH_MODEL_OP_3 (*C macro*), 187

ESP_BLE_MESH_MODEL_OP_APP_KEY_ADD (*C macro*), 191

ESP_BLE_MESH_MODEL_OP_APP_KEY_DELETE (*C macro*), 192

ESP_BLE_MESH_MODEL_OP_APP_KEY_GET (*C macro*), 191

ESP_BLE_MESH_MODEL_OP_APP_KEY_LIST (*C macro*), 192

ESP_BLE_MESH_MODEL_OP_APP_KEY_STATUS (*C macro*), 192

ESP_BLE_MESH_MODEL_OP_APP_KEY_UPDATE (*C macro*), 192

ESP_BLE_MESH_MODEL_OP_ATTENTION_GET (*C macro*), 193

ESP_BLE_MESH_MODEL_OP_ATTENTION_SET (*C macro*), 194

ESP_BLE_MESH_MODEL_OP_ATTENTION_SET_UNACK (*C macro*), 194

ESP_BLE_MESH_MODEL_OP_ATTENTION_STATUS (*C macro*), 194

ESP_BLE_MESH_MODEL_OP_BEACON_GET (*C macro*), 190

ESP_BLE_MESH_MODEL_OP_BEACON_SET (*C macro*), 191

ESP_BLE_MESH_MODEL_OP_BEACON_STATUS (*C macro*), 192

ESP_BLE_MESH_MODEL_OP_COMPOSITION_DATA_GET (C macro), 190

ESP_BLE_MESH_MODEL_OP_COMPOSITION_DATA_STATUS (C macro), 192

ESP_BLE_MESH_MODEL_OP_DEFAULT_TTL_GET (C macro), 190

ESP_BLE_MESH_MODEL_OP_DEFAULT_TTL_SET (C macro), 191

ESP_BLE_MESH_MODEL_OP_DEFAULT_TTL_STATUS (C macro), 192

ESP_BLE_MESH_MODEL_OP_END (C macro), 188

ESP_BLE_MESH_MODEL_OP_FRIEND_GET (C macro), 190

ESP_BLE_MESH_MODEL_OP_FRIEND_SET (C macro), 192

ESP_BLE_MESH_MODEL_OP_FRIEND_STATUS (C macro), 193

ESP_BLE_MESH_MODEL_OP_GATT_PROXY_GET (C macro), 190

ESP_BLE_MESH_MODEL_OP_GATT_PROXY_SET (C macro), 191

ESP_BLE_MESH_MODEL_OP_GATT_PROXY_STATUS (C macro), 192

ESP_BLE_MESH_MODEL_OP_GEN_ADMIN_PROPERTIES_GET (C macro), 195

ESP_BLE_MESH_MODEL_OP_GEN_ADMIN_PROPERTIES_SET (C macro), 195

ESP_BLE_MESH_MODEL_OP_GEN_ADMIN_PROPERTIES_STATUS (C macro), 195

ESP_BLE_MESH_MODEL_OP_GEN_ADMIN_PROPERTIES_UNACK (C macro), 195

ESP_BLE_MESH_MODEL_OP_GEN_BATTERY_GET (C macro), 195

ESP_BLE_MESH_MODEL_OP_GEN_BATTERY_STATUS (C macro), 195

ESP_BLE_MESH_MODEL_OP_GEN_CLIENT_PROPERTIES_GET (C macro), 196

ESP_BLE_MESH_MODEL_OP_GEN_CLIENT_PROPERTIES_SET (C macro), 196

ESP_BLE_MESH_MODEL_OP_GEN_CLIENT_PROPERTIES_STATUS (C macro), 196

ESP_BLE_MESH_MODEL_OP_GEN_CLIENT_PROPERTIES_UNACK (C macro), 196

ESP_BLE_MESH_MODEL_OP_GEN_DEF_TRANS_TIME_GET (C macro), 194

ESP_BLE_MESH_MODEL_OP_GEN_DEF_TRANS_TIME_SET (C macro), 194

ESP_BLE_MESH_MODEL_OP_GEN_DEF_TRANS_TIME_STATUS (C macro), 194

ESP_BLE_MESH_MODEL_OP_GEN_DELTA_SET (C macro), 194

ESP_BLE_MESH_MODEL_OP_GEN_DELTA_SET_UNACK (C macro), 194

ESP_BLE_MESH_MODEL_OP_GEN_LEVEL_GET (C macro), 194

ESP_BLE_MESH_MODEL_OP_GEN_LEVEL_SET (C macro), 194

ESP_BLE_MESH_MODEL_OP_GEN_LEVEL_SET_UNACK (C macro), 194

ESP_BLE_MESH_MODEL_OP_GEN_LEVEL_STATUS (C macro), 194

ESP_BLE_MESH_MODEL_OP_GEN_LOC_GLOBAL_GET (C macro), 195

ESP_BLE_MESH_MODEL_OP_GEN_LOC_GLOBAL_SET (C macro), 195

ESP_BLE_MESH_MODEL_OP_GEN_LOC_GLOBAL_SET_UNACK (C macro), 195

ESP_BLE_MESH_MODEL_OP_GEN_LOC_GLOBAL_STATUS (C macro), 195

ESP_BLE_MESH_MODEL_OP_GEN_LOC_LOCAL_GET (C macro), 195

ESP_BLE_MESH_MODEL_OP_GEN_LOC_LOCAL_SET (C macro), 195

ESP_BLE_MESH_MODEL_OP_GEN_LOC_LOCAL_SET_UNACK (C macro), 195

ESP_BLE_MESH_MODEL_OP_GEN_LOC_LOCAL_STATUS (C macro), 195

ESP_BLE_MESH_MODEL_OP_GEN_MANUFACTURER_PROPERTIES_GET (C macro), 195

ESP_BLE_MESH_MODEL_OP_GEN_MANUFACTURER_PROPERTIES_SET (C macro), 195

ESP_BLE_MESH_MODEL_OP_GEN_MANUFACTURER_PROPERTIES_STATUS (C macro), 195

ESP_BLE_MESH_MODEL_OP_GEN_MANUFACTURER_PROPERTIES_UNACK (C macro), 195

ESP_BLE_MESH_MODEL_OP_GEN_MOVE_SET (C macro), 194

ESP_BLE_MESH_MODEL_OP_GEN_MOVE_SET_UNACK (C macro), 194

ESP_BLE_MESH_MODEL_OP_GEN_ONOFF_GET (C macro), 194

ESP_BLE_MESH_MODEL_OP_GEN_ONOFF_SET (C macro), 194

ESP_BLE_MESH_MODEL_OP_GEN_ONOFF_SET_UNACK (C macro), 194

ESP_BLE_MESH_MODEL_OP_GEN_ONOFF_STATUS (C macro), 194

ESP_BLE_MESH_MODEL_OP_GEN_ONPOWERUP_GET (C macro), 194

ESP_BLE_MESH_MODEL_OP_GEN_ONPOWERUP_SET (C macro), 194

ESP_BLE_MESH_MODEL_OP_GEN_ONPOWERUP_SET_UNACK (C macro), 194

ESP_BLE_MESH_MODEL_OP_GEN_ONPOWERUP_STATUS (C macro), 194

ESP_BLE_MESH_MODEL_OP_GEN_POWER_DEFAULT_GET (C macro), 195

ESP_BLE_MESH_MODEL_OP_GEN_POWER_DEFAULT_SET (C macro), 195

ESP_BLE_MESH_MODEL_OP_GEN_POWER_DEFAULT_SET_UNACK (C macro), 195

(C macro), 195
 ESP_BLE_MESH_MODEL_OP_GEN_POWER_DEFAULT_STATUS (C macro), 190
 ESP_BLE_MESH_MODEL_OP_GEN_POWER_DEFAULT_STATUS (C macro), 195
 ESP_BLE_MESH_MODEL_OP_GEN_POWER_LAST_GET ESP_BLE_MESH_MODEL_OP_HEARTBEAT_PUB_SET
 (C macro), 195 (C macro), 192
 ESP_BLE_MESH_MODEL_OP_GEN_POWER_LAST_GET ESP_BLE_MESH_MODEL_OP_HEARTBEAT_PUB_STATUS
 (C macro), 195 (C macro), 193
 ESP_BLE_MESH_MODEL_OP_GEN_POWER_LAST_STATUS ESP_BLE_MESH_MODEL_OP_HEARTBEAT_SUB_GET
 (C macro), 195 (C macro), 190
 ESP_BLE_MESH_MODEL_OP_GEN_POWER_LEVEL_GET ESP_BLE_MESH_MODEL_OP_HEARTBEAT_SUB_SET
 (C macro), 194 (C macro), 192
 ESP_BLE_MESH_MODEL_OP_GEN_POWER_LEVEL_GET ESP_BLE_MESH_MODEL_OP_HEARTBEAT_SUB_STATUS
 (C macro), 194 (C macro), 193
 ESP_BLE_MESH_MODEL_OP_GEN_POWER_LEVEL_SET ESP_BLE_MESH_MODEL_OP_KEY_REFRESH_PHASE_GET
 (C macro), 195 (C macro), 191
 ESP_BLE_MESH_MODEL_OP_GEN_POWER_LEVEL_SET ESP_BLE_MESH_MODEL_OP_KEY_REFRESH_PHASE_SET
 (C macro), 195 (C macro), 192
 ESP_BLE_MESH_MODEL_OP_GEN_POWER_RANGE_GET ESP_BLE_MESH_MODEL_OP_KEY_REFRESH_PHASE_STATUS
 (C macro), 195 (C macro), 193
 ESP_BLE_MESH_MODEL_OP_GEN_POWER_RANGE_SET ESP_BLE_MESH_MODEL_OP_LIGHT_CTL_DEFAULT_GET
 (C macro), 195 (C macro), 198
 ESP_BLE_MESH_MODEL_OP_GEN_POWER_RANGE_SET ESP_BLE_MESH_MODEL_OP_LIGHT_CTL_DEFAULT_SET
 (C macro), 195 (C macro), 198
 ESP_BLE_MESH_MODEL_OP_GEN_POWER_RANGE_SET_UNACK ESP_BLE_MESH_MODEL_OP_LIGHT_CTL_DEFAULT_SET_UNACK
 (C macro), 195 (C macro), 198
 ESP_BLE_MESH_MODEL_OP_GEN_USER_PROPERTY_GET ESP_BLE_MESH_MODEL_OP_LIGHT_CTL_DEFAULT_STATUS
 (C macro), 195 (C macro), 198
 ESP_BLE_MESH_MODEL_OP_GEN_USER_PROPERTY_GET ESP_BLE_MESH_MODEL_OP_LIGHT_CTL_GET (C
 (C macro), 196 macro), 197
 ESP_BLE_MESH_MODEL_OP_GEN_USER_PROPERTY_SET ESP_BLE_MESH_MODEL_OP_LIGHT_CTL_SET (C
 (C macro), 196 macro), 198
 ESP_BLE_MESH_MODEL_OP_GEN_USER_PROPERTY_SET ESP_BLE_MESH_MODEL_OP_LIGHT_CTL_SET_UNACK
 (C macro), 196 (C macro), 198
 ESP_BLE_MESH_MODEL_OP_GEN_USER_PROPERTY_SET_UNACK ESP_BLE_MESH_MODEL_OP_LIGHT_CTL_STATUS
 (C macro), 196 (C macro), 198
 ESP_BLE_MESH_MODEL_OP_GEN_USER_PROPERTY_SET_UNACK ESP_BLE_MESH_MODEL_OP_LIGHT_CTL_TEMPERATURE_GET
 (C macro), 196 (C macro), 198
 ESP_BLE_MESH_MODEL_OP_HEALTH_CURRENT_STATUS ESP_BLE_MESH_MODEL_OP_LIGHT_CTL_TEMPERATURE_RANGE
 (C macro), 194 (C macro), 198
 ESP_BLE_MESH_MODEL_OP_HEALTH_FAULT_CLEAR ESP_BLE_MESH_MODEL_OP_LIGHT_CTL_TEMPERATURE_RANGE
 (C macro), 193 (C macro), 198
 ESP_BLE_MESH_MODEL_OP_HEALTH_FAULT_CLEAR_UNACK ESP_BLE_MESH_MODEL_OP_LIGHT_CTL_TEMPERATURE_RANGE
 (C macro), 193 (C macro), 198
 ESP_BLE_MESH_MODEL_OP_HEALTH_FAULT_GET ESP_BLE_MESH_MODEL_OP_LIGHT_CTL_TEMPERATURE_RANGE
 (C macro), 193 (C macro), 198
 ESP_BLE_MESH_MODEL_OP_HEALTH_FAULT_STATUS ESP_BLE_MESH_MODEL_OP_LIGHT_CTL_TEMPERATURE_SET
 (C macro), 194 (C macro), 198
 ESP_BLE_MESH_MODEL_OP_HEALTH_FAULT_TEST ESP_BLE_MESH_MODEL_OP_LIGHT_CTL_TEMPERATURE_SET_U
 (C macro), 193 (C macro), 198
 ESP_BLE_MESH_MODEL_OP_HEALTH_FAULT_TEST_UNACK ESP_BLE_MESH_MODEL_OP_LIGHT_CTL_TEMPERATURE_STATU
 (C macro), 194 (C macro), 198
 ESP_BLE_MESH_MODEL_OP_HEALTH_PERIOD_GET ESP_BLE_MESH_MODEL_OP_LIGHT_HSL_DEFAULT_GET
 (C macro), 193 (C macro), 198
 ESP_BLE_MESH_MODEL_OP_HEALTH_PERIOD_SET ESP_BLE_MESH_MODEL_OP_LIGHT_HSL_DEFAULT_SET
 (C macro), 194 (C macro), 198
 ESP_BLE_MESH_MODEL_OP_HEALTH_PERIOD_SET_UNACK ESP_BLE_MESH_MODEL_OP_LIGHT_HSL_DEFAULT_SET_UNACK
 (C macro), 194 (C macro), 198
 ESP_BLE_MESH_MODEL_OP_HEALTH_PERIOD_STATUS ESP_BLE_MESH_MODEL_OP_LIGHT_HSL_DEFAULT_STATUS
 (C macro), 194 (C macro), 198
 ESP_BLE_MESH_MODEL_OP_HEARTBEAT_PUB_GET ESP_BLE_MESH_MODEL_OP_LIGHT_HSL_GET (C

macro), 198
 ESP_BLE_MESH_MODEL_OP_LIGHT_HSL_HUE_GET (*C macro*), 198
 ESP_BLE_MESH_MODEL_OP_LIGHT_HSL_HUE_SET (*C macro*), 198
 ESP_BLE_MESH_MODEL_OP_LIGHT_HSL_HUE_SET_UNACK (*C macro*), 198
 ESP_BLE_MESH_MODEL_OP_LIGHT_HSL_HUE_STATUS (*C macro*), 198
 ESP_BLE_MESH_MODEL_OP_LIGHT_HSL_RANGE_GET (*C macro*), 198
 ESP_BLE_MESH_MODEL_OP_LIGHT_HSL_RANGE_SET (*C macro*), 198
 ESP_BLE_MESH_MODEL_OP_LIGHT_HSL_RANGE_SET_UNACK (*C macro*), 198
 ESP_BLE_MESH_MODEL_OP_LIGHT_HSL_RANGE_STATUS (*C macro*), 198
 ESP_BLE_MESH_MODEL_OP_LIGHT_HSL_SATURATION_GET (*C macro*), 198
 ESP_BLE_MESH_MODEL_OP_LIGHT_HSL_SATURATION_SET (*C macro*), 198
 ESP_BLE_MESH_MODEL_OP_LIGHT_HSL_SATURATION_SET_UNACK (*C macro*), 198
 ESP_BLE_MESH_MODEL_OP_LIGHT_HSL_SATURATION_STATUS (*C macro*), 198
 ESP_BLE_MESH_MODEL_OP_LIGHT_HSL_SET (*C macro*), 198
 ESP_BLE_MESH_MODEL_OP_LIGHT_HSL_SET_UNACK (*C macro*), 198
 ESP_BLE_MESH_MODEL_OP_LIGHT_HSL_STATUS (*C macro*), 198
 ESP_BLE_MESH_MODEL_OP_LIGHT_HSL_TARGET_GET (*C macro*), 198
 ESP_BLE_MESH_MODEL_OP_LIGHT_HSL_TARGET_SET (*C macro*), 198
 ESP_BLE_MESH_MODEL_OP_LIGHT_HSL_TARGET_SET_UNACK (*C macro*), 198
 ESP_BLE_MESH_MODEL_OP_LIGHT_HSL_TARGET_STATUS (*C macro*), 198
 ESP_BLE_MESH_MODEL_OP_LIGHT_LC_LIGHT_ONOFF_GET (*C macro*), 199
 ESP_BLE_MESH_MODEL_OP_LIGHT_LC_LIGHT_ONOFF_SET (*C macro*), 199
 ESP_BLE_MESH_MODEL_OP_LIGHT_LC_LIGHT_ONOFF_SET_UNACK (*C macro*), 199
 ESP_BLE_MESH_MODEL_OP_LIGHT_LC_LIGHT_ONOFF_STATUS (*C macro*), 199
 ESP_BLE_MESH_MODEL_OP_LIGHT_LC_MODE_GET (*C macro*), 199
 ESP_BLE_MESH_MODEL_OP_LIGHT_LC_MODE_SET (*C macro*), 199
 ESP_BLE_MESH_MODEL_OP_LIGHT_LC_MODE_SET_UNACK (*C macro*), 199
 ESP_BLE_MESH_MODEL_OP_LIGHT_LC_MODE_STATUS (*C macro*), 199
 ESP_BLE_MESH_MODEL_OP_LIGHT_LC_OM_GET (*C macro*), 199
 ESP_BLE_MESH_MODEL_OP_LIGHT_LC_OM_SET (*C macro*), 199
 ESP_BLE_MESH_MODEL_OP_LIGHT_LC_OM_SET_UNACK (*C macro*), 199
 ESP_BLE_MESH_MODEL_OP_LIGHT_LC_OM_STATUS (*C macro*), 199
 ESP_BLE_MESH_MODEL_OP_LIGHT_LC_PROPERTY_GET (*C macro*), 199
 ESP_BLE_MESH_MODEL_OP_LIGHT_LC_PROPERTY_SET (*C macro*), 199
 ESP_BLE_MESH_MODEL_OP_LIGHT_LC_PROPERTY_SET_UNACK (*C macro*), 199
 ESP_BLE_MESH_MODEL_OP_LIGHT_LC_PROPERTY_STATUS (*C macro*), 199
 ESP_BLE_MESH_MODEL_OP_LIGHT_LIGHTNESS_DEFAULT_GET (*C macro*), 197
 ESP_BLE_MESH_MODEL_OP_LIGHT_LIGHTNESS_DEFAULT_SET (*C macro*), 197
 ESP_BLE_MESH_MODEL_OP_LIGHT_LIGHTNESS_DEFAULT_SET_UNACK (*C macro*), 197
 ESP_BLE_MESH_MODEL_OP_LIGHT_LIGHTNESS_DEFAULT_STATUS (*C macro*), 197
 ESP_BLE_MESH_MODEL_OP_LIGHT_LIGHTNESS_GET (*C macro*), 197
 ESP_BLE_MESH_MODEL_OP_LIGHT_LIGHTNESS_LAST_GET (*C macro*), 197
 ESP_BLE_MESH_MODEL_OP_LIGHT_LIGHTNESS_LAST_STATUS (*C macro*), 197
 ESP_BLE_MESH_MODEL_OP_LIGHT_LIGHTNESS_LINEAR_GET (*C macro*), 197
 ESP_BLE_MESH_MODEL_OP_LIGHT_LIGHTNESS_LINEAR_SET (*C macro*), 197
 ESP_BLE_MESH_MODEL_OP_LIGHT_LIGHTNESS_LINEAR_SET_UNACK (*C macro*), 197
 ESP_BLE_MESH_MODEL_OP_LIGHT_LIGHTNESS_LINEAR_STATUS (*C macro*), 197
 ESP_BLE_MESH_MODEL_OP_LIGHT_LIGHTNESS_RANGE_GET (*C macro*), 197
 ESP_BLE_MESH_MODEL_OP_LIGHT_LIGHTNESS_RANGE_SET (*C macro*), 197
 ESP_BLE_MESH_MODEL_OP_LIGHT_LIGHTNESS_RANGE_SET_UNACK (*C macro*), 197
 ESP_BLE_MESH_MODEL_OP_LIGHT_LIGHTNESS_RANGE_STATUS (*C macro*), 197
 ESP_BLE_MESH_MODEL_OP_LIGHT_LIGHTNESS_SET (*C macro*), 197
 ESP_BLE_MESH_MODEL_OP_LIGHT_LIGHTNESS_SET_UNACK (*C macro*), 197
 ESP_BLE_MESH_MODEL_OP_LIGHT_LIGHTNESS_STATUS (*C macro*), 197
 ESP_BLE_MESH_MODEL_OP_LIGHT_XYL_DEFAULT_GET (*C macro*), 199
 ESP_BLE_MESH_MODEL_OP_LIGHT_XYL_DEFAULT_SET (*C macro*), 199
 ESP_BLE_MESH_MODEL_OP_LIGHT_XYL_DEFAULT_SET_UNACK (*C macro*), 199
 ESP_BLE_MESH_MODEL_OP_LIGHT_XYL_DEFAULT_STATUS (*C macro*), 199
 ESP_BLE_MESH_MODEL_OP_LIGHT_XYL_GET (*C macro*), 199
 ESP_BLE_MESH_MODEL_OP_LIGHT_XYL_RANGE_GET (*C macro*), 199
 ESP_BLE_MESH_MODEL_OP_LIGHT_XYL_RANGE_SET (*C macro*), 199

(*C macro*), 199

ESP_BLE_MESH_MODEL_OP_LIGHT_XYL_RANGE_UNACK (*C macro*), 192

ESP_BLE_MESH_MODEL_OP_LIGHT_XYL_RANGE_STATUS (*C macro*), 192

ESP_BLE_MESH_MODEL_OP_LIGHT_XYL_SET (*C macro*), 199

ESP_BLE_MESH_MODEL_OP_LIGHT_XYL_SET_UNACK (*C macro*), 192

ESP_BLE_MESH_MODEL_OP_LIGHT_XYL_STATUS (*C macro*), 199

ESP_BLE_MESH_MODEL_OP_LIGHT_XYL_TARGET_GET (*C macro*), 199

ESP_BLE_MESH_MODEL_OP_LIGHT_XYL_TARGET_GET_STATUS (*C macro*), 199

ESP_BLE_MESH_MODEL_OP_LPN_POLLTIMEOUT_GET (*C macro*), 191

ESP_BLE_MESH_MODEL_OP_LPN_POLLTIMEOUT_STATUS (*C macro*), 193

ESP_BLE_MESH_MODEL_OP_MODEL_APP_BIND (*C macro*), 192

ESP_BLE_MESH_MODEL_OP_MODEL_APP_STATUS (*C macro*), 193

ESP_BLE_MESH_MODEL_OP_MODEL_APP_UNBIND (*C macro*), 192

ESP_BLE_MESH_MODEL_OP_MODEL_PUB_GET (*C macro*), 190

ESP_BLE_MESH_MODEL_OP_MODEL_PUB_SET (*C macro*), 191

ESP_BLE_MESH_MODEL_OP_MODEL_PUB_STATUS (*C macro*), 192

ESP_BLE_MESH_MODEL_OP_MODEL_PUB_VIRTUAL_ADD (*C macro*), 192

ESP_BLE_MESH_MODEL_OP_MODEL_SUB_ADD (*C macro*), 191

ESP_BLE_MESH_MODEL_OP_MODEL_SUB_DELETE (*C macro*), 191

ESP_BLE_MESH_MODEL_OP_MODEL_SUB_DELETE_OVERWRITE (*C macro*), 192

ESP_BLE_MESH_MODEL_OP_MODEL_SUB_STATUS (*C macro*), 192

ESP_BLE_MESH_MODEL_OP_MODEL_SUB_VIRTUAL_DELETE (*C macro*), 191

ESP_BLE_MESH_MODEL_OP_MODEL_SUB_VIRTUAL_DELETE_OVERWRITE (*C macro*), 191

ESP_BLE_MESH_MODEL_OP_NET_KEY_ADD (*C macro*), 191

ESP_BLE_MESH_MODEL_OP_NET_KEY_DELETE (*C macro*), 192

ESP_BLE_MESH_MODEL_OP_NET_KEY_GET (*C macro*), 191

ESP_BLE_MESH_MODEL_OP_NET_KEY_LIST (*C macro*), 192

ESP_BLE_MESH_MODEL_OP_NET_KEY_STATUS (*C macro*), 192

(*C macro*), 192

ESP_BLE_MESH_MODEL_OP_NETWORK_TRANSMIT_GET (*C macro*), 191

ESP_BLE_MESH_MODEL_OP_NETWORK_TRANSMIT_SET (*C macro*), 192

ESP_BLE_MESH_MODEL_OP_NETWORK_TRANSMIT_STATUS (*C macro*), 193

ESP_BLE_MESH_MODEL_OP_NODE_IDENTITY_GET (*C macro*), 191

ESP_BLE_MESH_MODEL_OP_NODE_IDENTITY_SET (*C macro*), 192

ESP_BLE_MESH_MODEL_OP_NODE_IDENTITY_STATUS (*C macro*), 193

ESP_BLE_MESH_MODEL_OP_NODE_RESET (*C macro*), 192

ESP_BLE_MESH_MODEL_OP_NODE_RESET_STATUS (*C macro*), 193

ESP_BLE_MESH_MODEL_OP_RELAY_GET (*C macro*), 190

ESP_BLE_MESH_MODEL_OP_RELAY_SET (*C macro*), 191

ESP_BLE_MESH_MODEL_OP_RELAY_STATUS (*C macro*), 192

ESP_BLE_MESH_MODEL_OP_SCENE_DELETE (*C macro*), 197

ESP_BLE_MESH_MODEL_OP_SCENE_DELETE_UNACK (*C macro*), 197

ESP_BLE_MESH_MODEL_OP_SCENE_GET (*C macro*), 197

ESP_BLE_MESH_MODEL_OP_SCENE_RECALL (*C macro*), 197

ESP_BLE_MESH_MODEL_OP_SCENE_RECALL_UNACK (*C macro*), 197

ESP_BLE_MESH_MODEL_OP_SCENE_REGISTER_GET (*C macro*), 197

ESP_BLE_MESH_MODEL_OP_SCENE_REGISTER_STATUS (*C macro*), 197

ESP_BLE_MESH_MODEL_OP_SCENE_STATUS (*C macro*), 197

ESP_BLE_MESH_MODEL_OP_SCENE_STORE (*C macro*), 197

ESP_BLE_MESH_MODEL_OP_SCENE_STORE_UNACK (*C macro*), 197

ESP_BLE_MESH_MODEL_OP_SCHEDULER_ACT_GET (*C macro*), 197

ESP_BLE_MESH_MODEL_OP_SCHEDULER_ACT_SET (*C macro*), 197

ESP_BLE_MESH_MODEL_OP_SCHEDULER_ACT_SET_UNACK (*C macro*), 197

ESP_BLE_MESH_MODEL_OP_SCHEDULER_ACT_STATUS (*C macro*), 197

ESP_BLE_MESH_MODEL_OP_SCHEDULER_GET (*C macro*), 197

ESP_BLE_MESH_MODEL_OP_SCHEDULER_STATUS (*C macro*), 197

ESP_BLE_MESH_MODEL_OP_SENSOR_CADENCE_GET (*C macro*), 197

- (*C macro*), 196
- ESP_BLE_MESH_MODEL_OP_SENSOR_CADENCE_SET (*C macro*), 196
- ESP_BLE_MESH_MODEL_OP_SENSOR_CADENCE_SET_UNACKNOWLEDGED (*C macro*), 196
- ESP_BLE_MESH_MODEL_OP_SENSOR_CADENCE_STATUS (*C macro*), 196
- ESP_BLE_MESH_MODEL_OP_SENSOR_COLUMN_GET (*C macro*), 196
- ESP_BLE_MESH_MODEL_OP_SENSOR_COLUMN_STATUS (*C macro*), 196
- ESP_BLE_MESH_MODEL_OP_SENSOR_DESCRIPTOR_GET (*C macro*), 196
- ESP_BLE_MESH_MODEL_OP_SENSOR_DESCRIPTOR_STATUS (*C macro*), 196
- ESP_BLE_MESH_MODEL_OP_SENSOR_GET (*C macro*), 196
- ESP_BLE_MESH_MODEL_OP_SENSOR_SERIES_GET (*C macro*), 196
- ESP_BLE_MESH_MODEL_OP_SENSOR_SERIES_STATUS (*C macro*), 196
- ESP_BLE_MESH_MODEL_OP_SENSOR_SETTING_GET (*C macro*), 196
- ESP_BLE_MESH_MODEL_OP_SENSOR_SETTING_SET (*C macro*), 196
- ESP_BLE_MESH_MODEL_OP_SENSOR_SETTING_SET_UNACKNOWLEDGED (*C macro*), 196
- ESP_BLE_MESH_MODEL_OP_SENSOR_SETTING_STATUS (*C macro*), 196
- ESP_BLE_MESH_MODEL_OP_SENSOR_SETTINGS_GET (*C macro*), 196
- ESP_BLE_MESH_MODEL_OP_SENSOR_SETTINGS_STATUS (*C macro*), 196
- ESP_BLE_MESH_MODEL_OP_SENSOR_STATUS (*C macro*), 196
- ESP_BLE_MESH_MODEL_OP_SIG_MODEL_APP_GET (*C macro*), 191
- ESP_BLE_MESH_MODEL_OP_SIG_MODEL_APP_LIST (*C macro*), 193
- ESP_BLE_MESH_MODEL_OP_SIG_MODEL_SUB_GET (*C macro*), 191
- ESP_BLE_MESH_MODEL_OP_SIG_MODEL_SUB_LIST (*C macro*), 192
- esp_ble_mesh_model_op_t (*C++ class*), 178
- esp_ble_mesh_model_op_t::min_len (*C++ member*), 179
- esp_ble_mesh_model_op_t::opcode (*C++ member*), 179
- esp_ble_mesh_model_op_t::param_cb (*C++ member*), 179
- ESP_BLE_MESH_MODEL_OP_TAI.UTC_DELTA_GET (*C macro*), 196
- ESP_BLE_MESH_MODEL_OP_TAI.UTC_DELTA_SET (*C macro*), 196
- ESP_BLE_MESH_MODEL_OP_TAI.UTC_DELTA_STATUS (*C macro*), 196
- ESP_BLE_MESH_MODEL_OP_TIME_GET (*C macro*), 196
- ESP_BLE_MESH_MODEL_OP_TIME_ROLE_GET (*C macro*), 196
- ESP_BLE_MESH_MODEL_OP_TIME_ROLE_SET (*C macro*), 196
- ESP_BLE_MESH_MODEL_OP_TIME_ROLE_STATUS (*C macro*), 196
- ESP_BLE_MESH_MODEL_OP_TIME_SET (*C macro*), 196
- ESP_BLE_MESH_MODEL_OP_TIME_STATUS (*C macro*), 196
- ESP_BLE_MESH_MODEL_OP_TIME_ZONE_GET (*C macro*), 196
- ESP_BLE_MESH_MODEL_OP_TIME_ZONE_SET (*C macro*), 196
- ESP_BLE_MESH_MODEL_OP_TIME_ZONE_STATUS (*C macro*), 196
- ESP_BLE_MESH_MODEL_OP_VENDOR_MODEL_APP_GET (*C macro*), 191
- ESP_BLE_MESH_MODEL_OP_VENDOR_MODEL_APP_LIST (*C macro*), 193
- ESP_BLE_MESH_MODEL_OP_VENDOR_MODEL_SUB_GET (*C macro*), 191
- ESP_BLE_MESH_MODEL_OP_VENDOR_MODEL_SUB_LIST (*C macro*), 192
- ESP_BLE_MESH_MODEL_OPERATION_EVT (*C++ enumerator*), 207
- ESP_BLE_MESH_MODEL_PUB_DEFINE (*C macro*), 188
- esp_ble_mesh_model_pub_t (*C++ class*), 177
- esp_ble_mesh_model_pub_t::app_idx (*C++ member*), 178
- esp_ble_mesh_model_pub_t::count (*C++ member*), 178
- esp_ble_mesh_model_pub_t::cred (*C++ member*), 178
- esp_ble_mesh_model_pub_t::dev_role (*C++ member*), 178
- esp_ble_mesh_model_pub_t::fast_period (*C++ member*), 178
- esp_ble_mesh_model_pub_t::model (*C++ member*), 178
- esp_ble_mesh_model_pub_t::msg (*C++ member*), 178
- esp_ble_mesh_model_pub_t::period (*C++ member*), 178
- esp_ble_mesh_model_pub_t::period_div (*C++ member*), 178
- esp_ble_mesh_model_pub_t::period_start (*C++ member*), 178
- esp_ble_mesh_model_pub_t::publish_addr (*C++ member*), 178
- esp_ble_mesh_model_pub_t::retransmit (*C++ member*), 178
- esp_ble_mesh_model_pub_t::send_rel (*C++ member*), 178
- esp_ble_mesh_model_pub_t::timer (*C++ member*), 178
- esp_ble_mesh_model_pub_t::ttl (*C++ member*), 178

- member*), 178
 esp_ble_mesh_model_pub_t::update (C++ *member*), 178
 esp_ble_mesh_model_publish (C++ *function*), 212
 ESP_BLE_MESH_MODEL_PUBLISH_COMP_EVT (C++ *enumerator*), 207
 ESP_BLE_MESH_MODEL_PUBLISH_UPDATE_EVT (C++ *enumerator*), 207
 ESP_BLE_MESH_MODEL_SCENE_CLI (C *macro*), 320
 ESP_BLE_MESH_MODEL_SCENE_SETUP_SRV (C *macro*), 321
 ESP_BLE_MESH_MODEL_SCENE_SRV (C *macro*), 320
 ESP_BLE_MESH_MODEL_SCHEDULER_CLI (C *macro*), 320
 ESP_BLE_MESH_MODEL_SCHEDULER_SETUP_SRV (C *macro*), 321
 ESP_BLE_MESH_MODEL_SCHEDULER_SRV (C *macro*), 321
 ESP_BLE_MESH_MODEL_SEND_COMP_EVT (C++ *enumerator*), 207
 ESP_BLE_MESH_MODEL_SENSOR_CLI (C *macro*), 299
 ESP_BLE_MESH_MODEL_SENSOR_SETUP_SRV (C *macro*), 299
 ESP_BLE_MESH_MODEL_SENSOR_SRV (C *macro*), 299
 ESP_BLE_MESH_MODEL_STATUS_CANNOT_SET_RANGE_MAX (C *macro*), 199
 ESP_BLE_MESH_MODEL_STATUS_CANNOT_SET_RANGE_MIN (C *macro*), 199
 ESP_BLE_MESH_MODEL_STATUS_SUCCESS (C *macro*), 199
 esp_ble_mesh_model_status_t (C++ *type*), 201
 esp_ble_mesh_model_subscribe_group_addr (C++ *function*), 209
 ESP_BLE_MESH_MODEL_SUBSCRIBE_GROUP_ADDR_COMP_EVT (C++ *enumerator*), 206
 esp_ble_mesh_model_t (C++ *type*), 200
 ESP_BLE_MESH_MODEL_TIME_CLI (C *macro*), 320
 ESP_BLE_MESH_MODEL_TIME_SETUP_SRV (C *macro*), 320
 ESP_BLE_MESH_MODEL_TIME_SRV (C *macro*), 320
 esp_ble_mesh_model_unsubscribe_group_addr (C++ *function*), 209
 ESP_BLE_MESH_MODEL_UNSUBSCRIBE_GROUP_ADDR_COMP_EVT (C++ *enumerator*), 206
 esp_ble_mesh_msg_ctx_t (C++ *class*), 180
 esp_ble_mesh_msg_ctx_t::addr (C++ *member*), 180
 esp_ble_mesh_msg_ctx_t::app_idx (C++ *member*), 180
 esp_ble_mesh_msg_ctx_t::model (*member*), 180
 esp_ble_mesh_msg_ctx_t::net_idx (C++ *member*), 180
 esp_ble_mesh_msg_ctx_t::recv_dst (C++ *member*), 180
 esp_ble_mesh_msg_ctx_t::recv_op (C++ *member*), 180
 esp_ble_mesh_msg_ctx_t::recv_rssi (C++ *member*), 180
 esp_ble_mesh_msg_ctx_t::recv_ttl (C++ *member*), 180
 esp_ble_mesh_msg_ctx_t::send_rel (C++ *member*), 180
 esp_ble_mesh_msg_ctx_t::send_ttl (C++ *member*), 180
 esp_ble_mesh_msg_ctx_t::srv_send (C++ *member*), 180
 ESP_BLE_MESH_NET_PRIMARY (C *macro*), 186
 ESP_BLE_MESH_NO_FAULT (C *macro*), 254
 ESP_BLE_MESH_NO_INPUT (C++ *enumerator*), 201
 ESP_BLE_MESH_NO_LOAD_ERROR (C *macro*), 254
 ESP_BLE_MESH_NO_LOAD_WARNING (C *macro*), 254
 ESP_BLE_MESH_NO_OOB (C++ *enumerator*), 201
 ESP_BLE_MESH_NO_OUTPUT (C++ *enumerator*), 201
 esp_ble_mesh_node_add_local_app_key (C++ *function*), 210
 ESP_BLE_MESH_NODE_ADD_LOCAL_APP_KEY_COMP_EVT (C++ *enumerator*), 203
 esp_ble_mesh_node_add_local_net_key (C++ *function*), 210
 ESP_BLE_MESH_NODE_ADD_LOCAL_NET_KEY_COMP_EVT (C++ *enumerator*), 203
 esp_ble_mesh_node_bind_app_key_to_local_model (C++ *function*), 210
 ESP_BLE_MESH_NODE_BIND_APP_KEY_TO_MODEL_COMP_EVT (C++ *enumerator*), 203
 esp_ble_mesh_node_get_local_app_key (C++ *function*), 209
 esp_ble_mesh_node_get_local_net_key (C++ *function*), 209
 ESP_BLE_MESH_NODE_IDENTITY_NOT_SUPPORTED (C *macro*), 186
 ESP_BLE_MESH_NODE_IDENTITY_RUNNING (C *macro*), 186
 ESP_BLE_MESH_NODE_IDENTITY_STOPPED (C *macro*), 186
 esp_ble_mesh_node_input_number (C++ *function*), 219
 esp_ble_mesh_node_input_string (C++ *function*), 219
 esp_ble_mesh_node_is_provisioned (C++ *function*), 218
 esp_ble_mesh_node_local_reset (C++ *function*), 213
 ESP_BLE_MESH_NODE_NAME_MAX_LEN (C *macro*), 185

- ESP_BLE_MESH_NODE_PROV_COMPLETE_EVT
(C++ enumerator), 203
- esp_ble_mesh_node_prov_disable (C++
function), 218
- ESP_BLE_MESH_NODE_PROV_DISABLE_COMP_EVT
(C++ enumerator), 203
- esp_ble_mesh_node_prov_enable (C++ func-
tion), 218
- ESP_BLE_MESH_NODE_PROV_ENABLE_COMP_EVT
(C++ enumerator), 203
- ESP_BLE_MESH_NODE_PROV_INPUT_EVT (C++
enumerator), 203
- ESP_BLE_MESH_NODE_PROV_INPUT_NUMBER_COMP_EVT
(C++ enumerator), 203
- ESP_BLE_MESH_NODE_PROV_INPUT_STRING_COMP_EVT
(C++ enumerator), 203
- ESP_BLE_MESH_NODE_PROV_LINK_CLOSE_EVT
(C++ enumerator), 203
- ESP_BLE_MESH_NODE_PROV_LINK_OPEN_EVT
(C++ enumerator), 203
- ESP_BLE_MESH_NODE_PROV_OOB_PUB_KEY_EVT
(C++ enumerator), 203
- ESP_BLE_MESH_NODE_PROV_OUTPUT_NUMBER_EVT
(C++ enumerator), 203
- ESP_BLE_MESH_NODE_PROV_OUTPUT_STRING_EVT
(C++ enumerator), 203
- ESP_BLE_MESH_NODE_PROV_RESET_EVT (C++
enumerator), 203
- ESP_BLE_MESH_NODE_PROV_SET_OOB_PUB_KEY_COMP_EVT
(C++ enumerator), 203
- ESP_BLE_MESH_NODE_PROXY_GATT_DISABLE_COMP_EVT
(C++ enumerator), 203
- ESP_BLE_MESH_NODE_PROXY_GATT_ENABLE_COMP_EVT
(C++ enumerator), 203
- ESP_BLE_MESH_NODE_PROXY_IDENTITY_ENABLE_COMP_EVT
(C++ enumerator), 203
- esp_ble_mesh_node_set_oob_pub_key
(C++ function), 218
- ESP_BLE_MESH_NODE_SET_UNPROV_DEV_NAME_COMP_EVT
(C++ enumerator), 203
- esp_ble_mesh_node_t (C++ class), 181
- esp_ble_mesh_node_t::addr (C++ member),
182
- esp_ble_mesh_node_t::addr_type (C++
member), 182
- esp_ble_mesh_node_t::comp_data (C++
member), 182
- esp_ble_mesh_node_t::comp_length (C++
member), 182
- esp_ble_mesh_node_t::dev_key (C++ mem-
ber), 182
- esp_ble_mesh_node_t::dev_uuid (C++
member), 182
- esp_ble_mesh_node_t::element_num (C++
member), 182
- esp_ble_mesh_node_t::flags (C++ member),
182
- esp_ble_mesh_node_t::iv_index (C++
member), 182
- esp_ble_mesh_node_t::name (C++ member),
182
- esp_ble_mesh_node_t::net_idx (C++ mem-
ber), 182
- esp_ble_mesh_node_t::oob_info (C++
member), 182
- esp_ble_mesh_node_t::unicast_addr
(C++ member), 182
- ESP_BLE_MESH_OCTET16_LEN (C macro), 185
- esp_ble_mesh_octet16_t (C++ type), 200
- ESP_BLE_MESH_OCTET8_LEN (C macro), 185
- esp_ble_mesh_octet8_t (C++ type), 200
- esp_ble_mesh_oob_method_t (C++ enum), 201
- esp_ble_mesh_opcode_config_client_get_t
(C++ type), 200
- esp_ble_mesh_opcode_config_client_set_t
(C++ type), 200
- esp_ble_mesh_opcode_config_status_t
(C++ type), 200
- esp_ble_mesh_opcode_health_client_get_t
(C++ type), 200
- esp_ble_mesh_opcode_health_client_set_t
(C++ type), 200
- esp_ble_mesh_opcode_t (C++ type), 201
- esp_ble_mesh_output_action_t (C++ enum),
201
- ESP_BLE_MESH_OUTPUT_OOB (C++ enumerator),
201
- ESP_BLE_MESH_OVERFLOW_ERROR (C macro),
255
- ESP_BLE_MESH_OVERFLOW_WARNING (C macro),
255
- ESP_BLE_MESH_OVERHEAT_ERROR (C macro),
254
- ESP_BLE_MESH_OVERHEAT_WARNING (C macro),
254
- ESP_BLE_MESH_OVERLOAD_ERROR (C macro),
254
- ESP_BLE_MESH_OVERLOAD_WARNING (C macro),
254
- ESP_BLE_MESH_POWER_SUPPLY_INTERRUPTED_ERROR
(C macro), 254
- ESP_BLE_MESH_POWER_SUPPLY_INTERRUPTED_WARNING
(C macro), 254
- ESP_BLE_MESH_PROV (C macro), 188
- ESP_BLE_MESH_PROV_ADV (C++ enumerator), 202
- esp_ble_mesh_prov_adv_cb_t (C++ type), 222
- esp_ble_mesh_prov_bearer_t (C++ enum),
202
- esp_ble_mesh_prov_cb_event_t (C++ enum),
202
- esp_ble_mesh_prov_cb_param_t (C++
union), 154
- esp_ble_mesh_prov_cb_param_t::ble_mesh_deinit_mes
(C++ class), 159
- esp_ble_mesh_prov_cb_param_t::ble_mesh_deinit_mes
(C++ member), 159

esp_ble_mesh_prov_cb_param_t::ESP_BLE_MESH_FRND_FSH_FRIENDSHIP_TERMINATE_RECV_FRND_CHEAT (C++ enumerator), 160
 esp_ble_mesh_prov_cb_param_t::ESP_BLE_MESH_FRND_FSH_FRIENDSHIP_TERMINATE_RECV_FRND_REQ (C++ enumerator), 160
 esp_ble_mesh_prov_cb_param_t::feature esp_ble_mesh_prov_cb_param_t::node_prov_reset (C++ member), 157
 esp_ble_mesh_prov_cb_param_t::frnd_friendship_establish_cb_param_t::node_prov_set_oob_p (C++ member), 158
 esp_ble_mesh_prov_cb_param_t::frnd_friendship_terminate_cb_param_t::node_proxy_gatt_dis (C++ member), 158
 esp_ble_mesh_prov_cb_param_t::hb_dst esp_ble_mesh_prov_cb_param_t::node_proxy_gatt_ena (C++ member), 157
 esp_ble_mesh_prov_cb_param_t::hb_src esp_ble_mesh_prov_cb_param_t::node_proxy_identity (C++ member), 157
 esp_ble_mesh_prov_cb_param_t::heartbeats esp_ble_mesh_prov_cb_param_t::node_set_unprov_dev (C++ member), 158
 esp_ble_mesh_prov_cb_param_t::hops esp_ble_mesh_prov_cb_param_t::op (C++ member), 157
 esp_ble_mesh_prov_cb_param_t::index esp_ble_mesh_prov_cb_param_t::prov_register_comp (C++ member), 157
 esp_ble_mesh_prov_cb_param_t::init_ttl esp_ble_mesh_prov_cb_param_t::provisioner_add_app (C++ member), 157
 esp_ble_mesh_prov_cb_param_t::lpn_disable esp_ble_mesh_prov_cb_param_t::provisioner_add_net (C++ member), 158
 esp_ble_mesh_prov_cb_param_t::lpn_enable esp_ble_mesh_prov_cb_param_t::provisioner_add_unp (C++ member), 158
 esp_ble_mesh_prov_cb_param_t::lpn_friendship_establish_cb_param_t::provisioner_bind_ap (C++ member), 158
 esp_ble_mesh_prov_cb_param_t::lpn_friendship_terminate_cb_param_t::provisioner_close_s (C++ member), 158
 esp_ble_mesh_prov_cb_param_t::lpn_poll esp_ble_mesh_prov_cb_param_t::provisioner_close_s (C++ member), 158
 esp_ble_mesh_prov_cb_param_t::model_subscribe esp_ble_mesh_prov_cb_param_t::provisioner_delete (C++ member), 159
 esp_ble_mesh_prov_cb_param_t::model_unsubscribe esp_ble_mesh_prov_cb_param_t::provisioner_delete (C++ member), 159
 esp_ble_mesh_prov_cb_param_t::node_add_app_key_mesh esp_ble_mesh_prov_cb_param_t::provisioner_delete (C++ member), 155
 esp_ble_mesh_prov_cb_param_t::node_add_ext_key_mesh esp_ble_mesh_prov_cb_param_t::provisioner_delete (C++ member), 155
 esp_ble_mesh_prov_cb_param_t::node_bind_app_key_mesh_model_comp esp_ble_mesh_prov_cb_param_t::provisioner_delete (C++ member), 155
 esp_ble_mesh_prov_cb_param_t::node_provision_complete esp_ble_mesh_prov_cb_param_t::provisioner_direct (C++ member), 155
 esp_ble_mesh_prov_cb_param_t::node_provision_start esp_ble_mesh_prov_cb_param_t::provisioner_enable (C++ member), 154
 esp_ble_mesh_prov_cb_param_t::node_provisionable esp_ble_mesh_prov_cb_param_t::provisioner_open_se (C++ member), 154
 esp_ble_mesh_prov_cb_param_t::node_provisioning esp_ble_mesh_prov_cb_param_t::provisioner_open_se (C++ member), 155
 esp_ble_mesh_prov_cb_param_t::node_provisioning_num_req esp_ble_mesh_prov_cb_param_t::provisioner_prov_co (C++ member), 155
 esp_ble_mesh_prov_cb_param_t::node_provisioning_status_req esp_ble_mesh_prov_cb_param_t::provisioner_prov_de (C++ member), 155
 esp_ble_mesh_prov_cb_param_t::node_provisioning_start esp_ble_mesh_prov_cb_param_t::provisioner_prov_di (C++ member), 155
 esp_ble_mesh_prov_cb_param_t::node_provisioning_stop esp_ble_mesh_prov_cb_param_t::provisioner_prov_en (C++ member), 155

- merator), 202
- ESP_BLE_MESH_PROV_OOB_URI (C++ enumerator), 202
- ESP_BLE_MESH_PROV_OUTPUT_OOB_MAX_LEN (C macro), 187
- ESP_BLE_MESH_PROV_REGISTER_COMP_EVT (C++ enumerator), 202
- ESP_BLE_MESH_PROV_STATIC_OOB_MAX_LEN (C macro), 187
- esp_ble_mesh_prov_t (C++ class), 180
- esp_ble_mesh_provisioner_add_local_app_key (C++ function), 214
- ESP_BLE_MESH_PROVISIONER_ADD_LOCAL_APP_KEY (C++ enumerator), 204
- esp_ble_mesh_provisioner_add_local_net_key (C++ function), 215
- ESP_BLE_MESH_PROVISIONER_ADD_LOCAL_NET_KEY (C++ enumerator), 204
- esp_ble_mesh_provisioner_add_unprov_dev (C++ function), 220
- ESP_BLE_MESH_PROVISIONER_ADD_UNPROV_DEV (C++ enumerator), 204
- esp_ble_mesh_provisioner_bind_app_key_to_app (C++ function), 215
- ESP_BLE_MESH_PROVISIONER_BIND_APP_KEY_TO_APP (C++ enumerator), 204
- esp_ble_mesh_provisioner_close_settings (C++ function), 216
- ESP_BLE_MESH_PROVISIONER_CLOSE_SETTINGS (C++ enumerator), 205
- esp_ble_mesh_provisioner_close_settings_with_index (C++ function), 217
- ESP_BLE_MESH_PROVISIONER_CLOSE_SETTINGS_WITH_INDEX (C++ enumerator), 205
- esp_ble_mesh_provisioner_delete_dev (C++ function), 221
- ESP_BLE_MESH_PROVISIONER_DELETE_DEV (C++ enumerator), 204
- esp_ble_mesh_provisioner_delete_node_with_addr (C++ function), 214
- ESP_BLE_MESH_PROVISIONER_DELETE_NODE_WITH_ADDR (C++ enumerator), 204
- esp_ble_mesh_provisioner_delete_node_with_uuid (C++ function), 220
- ESP_BLE_MESH_PROVISIONER_DELETE_NODE_WITH_UUID (C++ enumerator), 204
- esp_ble_mesh_provisioner_delete_settings (C++ function), 217
- ESP_BLE_MESH_PROVISIONER_DELETE_SETTINGS (C++ enumerator), 205
- esp_ble_mesh_provisioner_delete_settings_with_index (C++ function), 217
- ESP_BLE_MESH_PROVISIONER_DELETE_SETTINGS_WITH_INDEX (C++ enumerator), 205
- esp_ble_mesh_provisioner_direct_erase_settings (C++ function), 216
- ESP_BLE_MESH_PROVISIONER_DIRECT_ERASE_SETTINGS (C++ enumerator), 205
- ESP_BLE_MESH_PROVISIONER_ENABLE_HEARTBEAT_RECV_COUNT (C++ enumerator), 205
- esp_ble_mesh_provisioner_get_free_settings_count (C++ function), 217
- esp_ble_mesh_provisioner_get_local_app_key (C++ function), 214
- esp_ble_mesh_provisioner_get_local_net_key (C++ function), 215
- esp_ble_mesh_provisioner_get_node_index (C++ function), 213
- esp_ble_mesh_provisioner_get_node_name (C++ function), 213
- esp_ble_mesh_provisioner_get_node_table_entry (C++ function), 214
- esp_ble_mesh_provisioner_get_node_with_addr (C++ function), 213
- esp_ble_mesh_provisioner_get_node_with_name (C++ function), 213
- esp_ble_mesh_provisioner_get_node_with_uuid (C++ function), 213
- esp_ble_mesh_provisioner_get_prov_node_count (C++ function), 214
- esp_ble_mesh_provisioner_get_settings_index (C++ function), 217
- esp_ble_mesh_provisioner_get_settings_uid (C++ function), 217
- esp_ble_mesh_provisioner_input_number (C++ function), 219
- esp_ble_mesh_provisioner_input_string (C++ function), 219
- esp_ble_mesh_provisioner_open_settings_with_index (C++ function), 216
- ESP_BLE_MESH_PROVISIONER_OPEN_SETTINGS_WITH_INDEX (C++ enumerator), 205
- esp_ble_mesh_provisioner_open_settings_with_uuid (C++ function), 216
- ESP_BLE_MESH_PROVISIONER_OPEN_SETTINGS_WITH_UUID (C++ enumerator), 205
- ESP_BLE_MESH_PROVISIONER_PROV_COMPLETE_EVT (C++ enumerator), 204
- ESP_BLE_MESH_PROVISIONER_PROV_DEV_WITH_ADDR_COMPLETED_EVT (C++ enumerator), 204
- esp_ble_mesh_provisioner_prov_device_with_addr (C++ function), 220
- ESP_BLE_MESH_PROVISIONER_PROV_DISABLE (C++ function), 220
- ESP_BLE_MESH_PROVISIONER_PROV_DISABLE_COMP_EVT (C++ enumerator), 203
- esp_ble_mesh_provisioner_prov_enable (C++ function), 219
- ESP_BLE_MESH_PROVISIONER_PROV_ENABLE_COMP_EVT (C++ enumerator), 203
- ESP_BLE_MESH_PROVISIONER_PROV_INPUT_EVT (C++ enumerator), 204
- esp_ble_mesh_provisioner_prov_input_number (C++ function), 204
- ESP_BLE_MESH_PROVISIONER_PROV_INPUT_STRING_COMPLETED_EVT (C++ enumerator), 204

ESP_BLE_MESH_PROVISIONER_PROV_LINK_CLOSE_EVT (*C++ enumerator*), 204
 ESP_BLE_MESH_PROVISIONER_PROV_LINK_OPEN_EVT (*C++ enumerator*), 204
 ESP_BLE_MESH_PROVISIONER_PROV_OUTPUT_EVT (*C++ enumerator*), 204
 ESP_BLE_MESH_PROVISIONER_PROV_READ_OOB_EVT (*C++ enumerator*), 204
 ESP_BLE_MESH_PROVISIONER_PROV_READ_OOB_EVT (*C++ enumerator*), 204
 esp_ble_mesh_provisioner_read_oob_pub_key (*C++ function*), 219
 esp_ble_mesh_provisioner_rcv_heartbeat (*C++ function*), 215
 ESP_BLE_MESH_PROVISIONER_RECV_HEARTBEAT_EVT (*C++ enumerator*), 205
 ESP_BLE_MESH_PROVISIONER_RECV_UNPROV_ADV_PKT_EVT (*C++ enumerator*), 203
 esp_ble_mesh_provisioner_set_dev_uuid (*C++ function*), 221
 ESP_BLE_MESH_PROVISIONER_SET_DEV_UUID_EVT (*C++ enumerator*), 204
 esp_ble_mesh_provisioner_set_heartbeat (*C++ function*), 216
 ESP_BLE_MESH_PROVISIONER_SET_HEARTBEAT_EVT (*C++ enumerator*), 205
 esp_ble_mesh_provisioner_set_heartbeat (*C++ function*), 215
 ESP_BLE_MESH_PROVISIONER_SET_HEARTBEAT_EVT (*C++ enumerator*), 205
 esp_ble_mesh_provisioner_set_node_name (*C++ function*), 213
 ESP_BLE_MESH_PROVISIONER_SET_NODE_NAME_EVT (*C++ enumerator*), 204
 esp_ble_mesh_provisioner_set_primary_element (*C++ function*), 222
 ESP_BLE_MESH_PROVISIONER_SET_PRIMARY_ELEMENT_EVT (*C++ enumerator*), 204
 esp_ble_mesh_provisioner_set_prov_data (*C++ function*), 221
 ESP_BLE_MESH_PROVISIONER_SET_PROV_DATA_EVT (*C++ enumerator*), 204
 ESP_BLE_MESH_PROVISIONER_SET_PROV_DATA_PUBLISH_TRANSMIT (*C macro*), 187
 esp_ble_mesh_provisioner_set_static_oob_value (*C++ function*), 221
 ESP_BLE_MESH_PUSH (*C++ enumerator*), 202
 ESP_BLE_MESH_PROVISIONER_SET_STATIC_OOB_VALUE_EVT (*C++ enumerator*), 204
 esp_ble_mesh_provisioner_store_node_comp_data (*C++ function*), 213
 ESP_BLE_MESH_PROVISIONER_STORE_NODE_COMP_DATA_EVT (*C++ enumerator*), 204
 esp_ble_mesh_provisioner_update_local_app_key (*C++ function*), 214
 ESP_BLE_MESH_PROVISIONER_UPDATE_LOCAL_APP_KEY_EVT (*C++ enumerator*), 204
 esp_ble_mesh_provisioner_update_local_net_key (*C++ function*), 215
 ESP_BLE_MESH_PROVISIONER_UPDATE_LOCAL_NET_KEY_EVT (*C++ enumerator*), 204
 esp_ble_mesh_proxy_client_add_filter_addr (*C++ function*), 223
 ESP_BLE_MESH_PROXY_CLIENT_ADD_FILTER_ADDR_COMP_EVT (*C++ enumerator*), 206
 esp_ble_mesh_proxy_client_connect (*C++ function*), 223
 ESP_BLE_MESH_PROXY_CLIENT_CONNECT_COMP_EVT (*C++ enumerator*), 206
 esp_ble_mesh_proxy_client_disconnect (*C++ function*), 223
 ESP_BLE_MESH_PROXY_CLIENT_DISCONNECT_COMP_EVT (*C++ enumerator*), 206
 esp_ble_mesh_proxy_client_disconnected (*C++ function*), 223
 ESP_BLE_MESH_PROXY_CLIENT_DISCONNECTED_EVT (*C++ enumerator*), 206
 esp_ble_mesh_proxy_client_remove_filter_addr (*C++ function*), 224
 ESP_BLE_MESH_PROXY_CLIENT_REMOVE_FILTER_ADDR_COMP_EVT (*C++ enumerator*), 206
 esp_ble_mesh_proxy_client_set_filter_type (*C++ function*), 223
 ESP_BLE_MESH_PROXY_CLIENT_SET_FILTER_TYPE_COMP_EVT (*C++ enumerator*), 206
 esp_ble_mesh_proxy_client_set_filter_type (*C++ function*), 223
 ESP_BLE_MESH_PROXY_CLIENT_SET_FILTER_TYPE_COMP_EVT (*C++ enumerator*), 206
 esp_ble_mesh_proxy_client_set_filter_type (*C++ function*), 223
 ESP_BLE_MESH_PROXY_CLIENT_SET_FILTER_TYPE_COMP_EVT (*C++ enumerator*), 206
 esp_ble_mesh_proxy_gatt_disable (*C++ function*), 223
 ESP_BLE_MESH_PROXY_GATT_DISABLE_EVT (*C++ enumerator*), 204
 esp_ble_mesh_proxy_gatt_enable (*C++ function*), 223
 ESP_BLE_MESH_PROXY_GATT_ENABLE_EVT (*C++ enumerator*), 204
 esp_ble_mesh_proxy_identity_enable (*C++ function*), 223
 ESP_BLE_MESH_PROXY_IDENTITY_ENABLE_EVT (*C++ enumerator*), 204
 ESP_BLE_MESH_PROXY_SERVER_CONNECTED_EVT (*C++ enumerator*), 206
 ESP_BLE_MESH_PROXY_SERVER_DISCONNECTED_EVT (*C++ enumerator*), 206
 ESP_BLE_MESH_PROXY_SERVER_PUBLISH_TRANSMIT (*C macro*), 187
 esp_ble_mesh_register_config_client_callback (*C++ function*), 224
 esp_ble_mesh_register_config_server_callback (*C++ function*), 224
 esp_ble_mesh_register_custom_model_callback (*C++ function*), 211
 esp_ble_mesh_register_generic_client_callback (*C++ function*), 256
 esp_ble_mesh_register_generic_server_callback (*C++ function*), 257
 esp_ble_mesh_register_health_client_callback (*C++ function*), 248
 esp_ble_mesh_register_health_server_callback (*C++ function*), 248
 esp_ble_mesh_register_light_client_callback (*C++ function*), 248

- (C++ function), 324
- esp_ble_mesh_register_lighting_server_callback (C++ member), 309
- (C++ function), 324
- esp_ble_mesh_register_prov_callback (C++ function), 218
- esp_ble_mesh_register_sensor_client_callback (C++ member), 309
- (C++ function), 287
- esp_ble_mesh_register_sensor_server_callback (C++ function), 287
- (C++ member), 312
- esp_ble_mesh_register_time_scene_client_callback (C++ member), 312
- (C++ function), 302
- esp_ble_mesh_register_time_scene_server_callback (C++ member), 312
- (C++ function), 303
- ESP_BLE_MESH_RELAY_DISABLED (C macro), 186
- ESP_BLE_MESH_RELAY_ENABLED (C macro), 186
- ESP_BLE_MESH_RELAY_NOT_SUPPORTED (C macro), 186
- ESP_BLE_MESH_SAMPLE_FUNC_ACCUMULATED (C++ enumerator), 302
- ESP_BLE_MESH_SAMPLE_FUNC_ARITHMETIC_MEAN (C++ enumerator), 302
- ESP_BLE_MESH_SAMPLE_FUNC_COUNT (C++ enumerator), 302
- ESP_BLE_MESH_SAMPLE_FUNC_INSTANTANEOUS (C++ enumerator), 302
- ESP_BLE_MESH_SAMPLE_FUNC_MAXIMUM (C++ enumerator), 302
- ESP_BLE_MESH_SAMPLE_FUNC_MINIMUM (C++ enumerator), 302
- ESP_BLE_MESH_SAMPLE_FUNC_RMS (C++ enumerator), 302
- ESP_BLE_MESH_SAMPLE_FUNC_UNSPECIFIED (C++ enumerator), 302
- esp_ble_mesh_scene_delete_t (C++ class), 307
- esp_ble_mesh_scene_delete_t::scene_number (C++ member), 307
- ESP_BLE_MESH_SCENE_NOT_FOUND (C macro), 323
- ESP_BLE_MESH_SCENE_NUMBER_LEN (C macro), 321
- esp_ble_mesh_scene_recall_t (C++ class), 307
- esp_ble_mesh_scene_recall_t::delay (C++ member), 307
- esp_ble_mesh_scene_recall_t::op_en (C++ member), 307
- esp_ble_mesh_scene_recall_t::scene_number (C++ member), 307
- esp_ble_mesh_scene_recall_t::tid (C++ member), 307
- esp_ble_mesh_scene_recall_t::trans_time (C++ member), 307
- ESP_BLE_MESH_SCENE_REG_FULL (C macro), 322
- esp_ble_mesh_scene_register_status_cb_t (C++ class), 309
- esp_ble_mesh_scene_register_status_cb_t::current_scene (C++ member), 309
- esp_ble_mesh_scene_register_status_cb_t::scenes (C++ member), 309
- esp_ble_mesh_scene_register_status_cb_t::status_code (C++ member), 309
- esp_ble_mesh_scene_register_t (C++ class), 311
- esp_ble_mesh_scene_register_t::scene_number (C++ member), 312
- esp_ble_mesh_scene_register_t::scene_type (C++ member), 312
- esp_ble_mesh_scene_register_t::scene_value (C++ member), 312
- esp_ble_mesh_scene_setup_srv_t (C++ class), 313
- esp_ble_mesh_scene_setup_srv_t::model (C++ member), 313
- esp_ble_mesh_scene_setup_srv_t::rsp_ctrl (C++ member), 313
- esp_ble_mesh_scene_setup_srv_t::state (C++ member), 313
- esp_ble_mesh_scene_srv_t (C++ class), 313
- esp_ble_mesh_scene_srv_t::last (C++ member), 313
- esp_ble_mesh_scene_srv_t::model (C++ member), 313
- esp_ble_mesh_scene_srv_t::rsp_ctrl (C++ member), 313
- esp_ble_mesh_scene_srv_t::state (C++ member), 313
- esp_ble_mesh_scene_srv_t::transition (C++ member), 313
- esp_ble_mesh_scene_status_cb_t (C++ class), 309
- esp_ble_mesh_scene_status_cb_t::current_scene (C++ member), 309
- esp_ble_mesh_scene_status_cb_t::op_en (C++ member), 309
- esp_ble_mesh_scene_status_cb_t::remain_time (C++ member), 309
- esp_ble_mesh_scene_status_cb_t::status_code (C++ member), 309
- esp_ble_mesh_scene_status_cb_t::target_scene (C++ member), 309
- esp_ble_mesh_scene_store_t (C++ class), 306
- esp_ble_mesh_scene_store_t::scene_number (C++ member), 307
- ESP_BLE_MESH_SCENE_SUCCESS (C macro), 322
- esp_ble_mesh_scenes_state_t (C++ class), 312
- esp_ble_mesh_scenes_state_t::current_scene (C++ member), 312
- esp_ble_mesh_scenes_state_t::in_progress (C++ member), 313
- esp_ble_mesh_scenes_state_t::scene_count (C++ member), 312

esp_ble_mesh_scenes_state_t::scenes (C++ member), 312
 esp_ble_mesh_scenes_state_t::status_code (C++ member), 313
 esp_ble_mesh_scenes_state_t::target_scene (C++ member), 312
 ESP_BLE_MESH_SCHEDULE_ACT_NO_ACTION (C macro), 322
 ESP_BLE_MESH_SCHEDULE_ACT_SCENE_RECALL (C macro), 322
 ESP_BLE_MESH_SCHEDULE_ACT_TURN_OFF (C macro), 322
 ESP_BLE_MESH_SCHEDULE_ACT_TURN_ON (C macro), 322
 ESP_BLE_MESH_SCHEDULE_DAY_ANY_DAY (C macro), 322
 ESP_BLE_MESH_SCHEDULE_ENTRY_MAX_INDEX (C macro), 322
 ESP_BLE_MESH_SCHEDULE_HOUR_ANY_HOUR (C macro), 322
 ESP_BLE_MESH_SCHEDULE_HOUR_ONCE_A_DAY (C macro), 322
 esp_ble_mesh_schedule_register_t (C++ class), 313
 esp_ble_mesh_schedule_register_t::action (C++ member), 314
 esp_ble_mesh_schedule_register_t::day (C++ member), 313
 esp_ble_mesh_schedule_register_t::day_of_week (C++ member), 314
 esp_ble_mesh_schedule_register_t::hour (C++ member), 313
 esp_ble_mesh_schedule_register_t::in_use (C++ member), 313
 esp_ble_mesh_schedule_register_t::minutes (C++ member), 313
 esp_ble_mesh_schedule_register_t::months (C++ member), 313
 esp_ble_mesh_schedule_register_t::scene_number (C++ member), 314
 esp_ble_mesh_schedule_register_t::seconds (C++ member), 314
 esp_ble_mesh_schedule_register_t::trans_time (C++ member), 314
 esp_ble_mesh_schedule_register_t::year (C++ member), 313
 ESP_BLE_MESH_SCHEDULE_SCENE_NO_SCENE (C macro), 322
 ESP_BLE_MESH_SCHEDULE_SEC_ANY_OF_HOUR (C macro), 322
 ESP_BLE_MESH_SCHEDULE_SEC_ANY_OF_MIN (C macro), 322
 ESP_BLE_MESH_SCHEDULE_SEC_EVERY_15_MIN (C macro), 322
 ESP_BLE_MESH_SCHEDULE_SEC_EVERY_15_SEC (C macro), 322
 ESP_BLE_MESH_SCHEDULE_SEC_EVERY_20_MIN (C macro), 322
 ESP_BLE_MESH_SCHEDULE_SEC_EVERY_20_SEC (C macro), 322
 ESP_BLE_MESH_SCHEDULE_SEC_ONCE_AN_HOUR (C macro), 322
 ESP_BLE_MESH_SCHEDULE_SEC_ONCE_AN_MIN (C macro), 322
 ESP_BLE_MESH_SCHEDULE_YEAR_ANY_YEAR (C macro), 322
 esp_ble_mesh_scheduler_act_get_t (C++ class), 307
 esp_ble_mesh_scheduler_act_get_t::index (C++ member), 307
 esp_ble_mesh_scheduler_act_set_t (C++ class), 307
 esp_ble_mesh_scheduler_act_set_t::action (C++ member), 308
 esp_ble_mesh_scheduler_act_set_t::day (C++ member), 307
 esp_ble_mesh_scheduler_act_set_t::day_of_week (C++ member), 308
 esp_ble_mesh_scheduler_act_set_t::hour (C++ member), 307
 esp_ble_mesh_scheduler_act_set_t::index (C++ member), 307
 esp_ble_mesh_scheduler_act_set_t::minute (C++ member), 307
 esp_ble_mesh_scheduler_act_set_t::month (C++ member), 307
 esp_ble_mesh_scheduler_act_set_t::scene_number (C++ member), 308
 esp_ble_mesh_scheduler_act_set_t::second (C++ member), 308
 esp_ble_mesh_scheduler_act_set_t::trans_time (C++ member), 308
 esp_ble_mesh_scheduler_act_set_t::year (C++ member), 307
 esp_ble_mesh_scheduler_act_status_cb_t (C++ class), 309
 esp_ble_mesh_scheduler_act_status_cb_t::action (C++ member), 310
 esp_ble_mesh_scheduler_act_status_cb_t::day (C++ member), 310
 esp_ble_mesh_scheduler_act_status_cb_t::day_of_week (C++ member), 310
 esp_ble_mesh_scheduler_act_status_cb_t::hour (C++ member), 310
 esp_ble_mesh_scheduler_act_status_cb_t::index (C++ member), 310
 esp_ble_mesh_scheduler_act_status_cb_t::minute (C++ member), 310
 esp_ble_mesh_scheduler_act_status_cb_t::month (C++ member), 310
 esp_ble_mesh_scheduler_act_status_cb_t::scene_number (C++ member), 310
 esp_ble_mesh_scheduler_act_status_cb_t::second (C++ member), 310
 esp_ble_mesh_scheduler_act_status_cb_t::trans_time (C++ member), 310

- esp_ble_mesh_scheduler_act_status_cb_t::year (C++ member), 292
 (C++ member), 310
 esp_ble_mesh_scheduler_setup_srv_t (C++ class), 314
 esp_ble_mesh_scheduler_setup_srv_t::model (C++ member), 314
 esp_ble_mesh_scheduler_setup_srv_t::rsp_ctrl (C++ member), 294
 (C++ member), 314
 esp_ble_mesh_scheduler_setup_srv_t::state (C++ member), 294
 (C++ member), 314
 esp_ble_mesh_scheduler_srv_t (C++ class), 314
 esp_ble_mesh_scheduler_srv_t::model (C++ member), 314
 esp_ble_mesh_scheduler_srv_t::rsp_ctrl (C++ member), 314
 esp_ble_mesh_scheduler_srv_t::state (C++ member), 314
 esp_ble_mesh_scheduler_state_t (C++ class), 314
 esp_ble_mesh_scheduler_state_t::schedule_count (C++ enum), 301
 (C++ member), 314
 esp_ble_mesh_scheduler_state_t::schedules (C++ class), 293
 (C++ member), 314
 esp_ble_mesh_scheduler_status_cb_t (C++ class), 309
 esp_ble_mesh_scheduler_status_cb_t::schedules (C++ member), 293
 (C++ member), 309
 ESP_BLE_MESH_SDU_MAX_LEN (C macro), 185
 ESP_BLE_MESH_SELF_TEST_ERROR (C macro), 255
 ESP_BLE_MESH_SELF_TEST_WARNING (C macro), 255
 esp_ble_mesh_sensor_cadence_get_t (C++ class), 290
 esp_ble_mesh_sensor_cadence_get_t::prop_type (C++ member), 290
 esp_ble_mesh_sensor_cadence_set_t (C++ class), 290
 esp_ble_mesh_sensor_cadence_set_t::fast_cadence_high (C++ member), 290
 esp_ble_mesh_sensor_cadence_set_t::fast_cadence_low (C++ member), 290
 esp_ble_mesh_sensor_cadence_set_t::fast_cadence_min_interval (C++ member), 290
 esp_ble_mesh_sensor_cadence_set_t::prop_type (C++ member), 290
 esp_ble_mesh_sensor_cadence_set_t::status_min_interval (C++ member), 290
 esp_ble_mesh_sensor_cadence_set_t::status_trigger_delta_down (C++ member), 290
 esp_ble_mesh_sensor_cadence_set_t::status_trigger_delta_up (C++ member), 290
 esp_ble_mesh_sensor_cadence_set_t::status_trigger_type (C++ member), 290
 esp_ble_mesh_sensor_cadence_status_cb_t (C++ class), 292
 esp_ble_mesh_sensor_cadence_status_cb_t::sensor_cadence (C++ member), 292
 esp_ble_mesh_sensor_cadence_t (C++ class), 294
 esp_ble_mesh_sensor_cadence_t::fast_cadence_high (C++ member), 294
 esp_ble_mesh_sensor_cadence_t::fast_cadence_low (C++ member), 294
 esp_ble_mesh_sensor_cadence_t::min_interval (C++ member), 294
 esp_ble_mesh_sensor_cadence_t::period_divisor (C++ member), 294
 esp_ble_mesh_sensor_cadence_t::trigger_delta_down (C++ member), 294
 esp_ble_mesh_sensor_cadence_t::trigger_delta_up (C++ member), 294
 esp_ble_mesh_sensor_cadence_t::trigger_type (C++ member), 294
 esp_ble_mesh_sensor_client_cb_event_t (C++ enum), 301
 esp_ble_mesh_sensor_client_cb_param_t (C++ class), 293
 esp_ble_mesh_sensor_client_cb_param_t::error_code (C++ member), 293
 esp_ble_mesh_sensor_client_cb_param_t::params (C++ member), 293
 esp_ble_mesh_sensor_client_cb_param_t::status_cb (C++ member), 293
 esp_ble_mesh_sensor_client_cb_t (C++ type), 301
 ESP_BLE_MESH_SENSOR_CLIENT_EVT_MAX (C++ enumerator), 301
 esp_ble_mesh_sensor_client_get_state (C++ function), 287
 ESP_BLE_MESH_SENSOR_CLIENT_GET_STATE_EVT (C++ enumerator), 301
 esp_ble_mesh_sensor_client_get_state_t (C++ union), 288
 esp_ble_mesh_sensor_client_get_state_t::cadence_get_state (C++ member), 288
 esp_ble_mesh_sensor_client_get_state_t::column_get_state (C++ member), 288
 esp_ble_mesh_sensor_client_get_state_t::descriptor_get_state (C++ member), 288
 esp_ble_mesh_sensor_client_get_state_t::sensor_get_state (C++ member), 288
 esp_ble_mesh_sensor_client_get_state_t::series_get_state (C++ member), 288
 esp_ble_mesh_sensor_client_get_state_t::setting_get_state (C++ member), 288
 esp_ble_mesh_sensor_client_get_state_t::settings_get_state (C++ member), 288
 ESP_BLE_MESH_SENSOR_CLIENT_PUBLISH_EVT (C++ enumerator), 301
 esp_ble_mesh_sensor_client_set_state (C++ function), 287
 ESP_BLE_MESH_SENSOR_CLIENT_SET_STATE_EVT (C++ enumerator), 301

- (C++ *enumerator*), 301
- esp_ble_mesh_sensor_client_set_state_t (C++ *union*), 288
- esp_ble_mesh_sensor_client_set_state_t::op_en (C++ *member*), 288
- esp_ble_mesh_sensor_client_set_state_t::property_id (C++ *member*), 288
- esp_ble_mesh_sensor_client_status_cb_t (C++ *union*), 288
- esp_ble_mesh_sensor_client_status_cb_t::desc (C++ *member*), 289
- esp_ble_mesh_sensor_client_status_cb_t::measure_period (C++ *member*), 289
- esp_ble_mesh_sensor_client_status_cb_t::negative_tolerance (C++ *member*), 289
- esp_ble_mesh_sensor_client_status_cb_t::positive_tolerance (C++ *member*), 288
- esp_ble_mesh_sensor_client_status_cb_t::sampling_function (C++ *member*), 288
- ESP_BLE_MESH_SENSOR_CLIENT_TIMEOUT_EVT (C++ *enumerator*), 301
- esp_ble_mesh_sensor_column_get_t (C++ *class*), 291
- esp_ble_mesh_sensor_column_get_t::property_id (C++ *member*), 291
- esp_ble_mesh_sensor_column_get_t::raw_value_x (C++ *member*), 291
- esp_ble_mesh_sensor_column_status_cb_t (C++ *class*), 293
- esp_ble_mesh_sensor_column_status_cb_t::property_id (C++ *member*), 293
- esp_ble_mesh_sensor_column_status_cb_t::sensor_value (C++ *member*), 293
- ESP_BLE_MESH_SENSOR_DATA_FORMAT_A (C *macro*), 300
- ESP_BLE_MESH_SENSOR_DATA_FORMAT_A_MPID (C *macro*), 300
- ESP_BLE_MESH_SENSOR_DATA_FORMAT_A_MPID_LEN (C *macro*), 300
- ESP_BLE_MESH_SENSOR_DATA_FORMAT_B (C *macro*), 300
- ESP_BLE_MESH_SENSOR_DATA_FORMAT_B_MPID (C *macro*), 301
- ESP_BLE_MESH_SENSOR_DATA_FORMAT_B_MPID_LEN (C *macro*), 300
- esp_ble_mesh_sensor_data_t (C++ *class*), 294
- esp_ble_mesh_sensor_data_t::format (C++ *member*), 294
- esp_ble_mesh_sensor_data_t::length (C++ *member*), 295
- esp_ble_mesh_sensor_data_t::raw_value (C++ *member*), 295
- ESP_BLE_MESH_SENSOR_DATA_ZERO_LEN (C *macro*), 300
- esp_ble_mesh_sensor_descriptor_get_t (C++ *class*), 290
- esp_ble_mesh_sensor_descriptor_get_t::op_en (C++ *member*), 290
- esp_ble_mesh_sensor_descriptor_get_t::property_id (C++ *member*), 290
- ESP_BLE_MESH_SENSOR_DESCRIPTOR_LEN (C *macro*), 299
- esp_ble_mesh_sensor_descriptor_status_cb_t (C++ *class*), 292
- esp_ble_mesh_sensor_descriptor_status_cb_t::desc (C++ *member*), 292
- esp_ble_mesh_sensor_descriptor_t (C++ *class*), 293
- esp_ble_mesh_sensor_descriptor_t::measure_period (C++ *member*), 294
- esp_ble_mesh_sensor_descriptor_t::negative_tolerance (C++ *member*), 293
- esp_ble_mesh_sensor_descriptor_t::positive_tolerance (C++ *member*), 293
- esp_ble_mesh_sensor_descriptor_t::sampling_function (C++ *member*), 294
- esp_ble_mesh_sensor_descriptor_t::update_interval (C++ *member*), 294
- ESP_BLE_MESH_SENSOR_DIVISOR_TRIGGER_TYPE_LEN (C *macro*), 300
- esp_ble_mesh_sensor_get_t (C++ *class*), 291
- esp_ble_mesh_sensor_get_t::op_en (C++ *member*), 291
- esp_ble_mesh_sensor_get_t::property_id (C++ *member*), 291
- esp_ble_mesh_sensor_message_opcode_t (C++ *type*), 200
- ESP_BLE_MESH_SENSOR_NOT_APPL_MEASURE_PERIOD (C *macro*), 299
- ESP_BLE_MESH_SENSOR_NOT_APPL_UPDATE_INTERVAL (C *macro*), 299
- ESP_BLE_MESH_SENSOR_PERIOD_DIVISOR_MAX_VALUE (C *macro*), 300
- ESP_BLE_MESH_SENSOR_PROPERTY_ID_LEN (C *macro*), 299
- esp_ble_mesh_sensor_sample_func (C++ *enum*), 302
- esp_ble_mesh_sensor_series_column_t (C++ *class*), 295
- esp_ble_mesh_sensor_series_column_t::column_width (C++ *member*), 295
- esp_ble_mesh_sensor_series_column_t::raw_value_x (C++ *member*), 295
- esp_ble_mesh_sensor_series_column_t::raw_value_y (C++ *member*), 295
- esp_ble_mesh_sensor_series_get_t (C++ *class*), 291
- esp_ble_mesh_sensor_series_get_t::op_en (C++ *member*), 292
- esp_ble_mesh_sensor_series_get_t::property_id (C++ *member*), 292

esp_ble_mesh_sensor_series_get_t::raw_value ESP_BLE_MESH_SENSOR_SERVER_STATE_CHANGE_EVT
 (C++ member), 292 (C++ enumerator), 302
 esp_ble_mesh_sensor_series_get_t::raw_value2 esp_ble_mesh_sensor_server_state_change_t
 (C++ member), 292 (C++ union), 289
 esp_ble_mesh_sensor_series_status_cb_t esp_ble_mesh_sensor_server_state_change_t::sensor
 (C++ class), 293 (C++ member), 289
 esp_ble_mesh_sensor_series_status_cb_t::esp_ble_mesh_sensor_server_state_change_t::sensor
 (C++ member), 293 (C++ member), 289
 esp_ble_mesh_sensor_series_status_cb_t::ESP_BLE_MESH_SENSOR_SETTING_ACCESS_LEN
 (C++ member), 293 (C macro), 299
 esp_ble_mesh_sensor_server_cb_event_t ESP_BLE_MESH_SENSOR_SETTING_ACCESS_READ
 (C++ enum), 302 (C macro), 299
 esp_ble_mesh_sensor_server_cb_param_t ESP_BLE_MESH_SENSOR_SETTING_ACCESS_READ_WRITE
 (C++ class), 298 (C macro), 299
 esp_ble_mesh_sensor_server_cb_param_t::esp_ble_mesh_sensor_setting_get_t
 (C++ member), 298 (C++ class), 291
 esp_ble_mesh_sensor_server_cb_param_t::middle_mesh_sensor_setting_get_t::sensor_property
 (C++ member), 298 (C++ member), 291
 esp_ble_mesh_sensor_server_cb_param_t::update_mesh_sensor_setting_get_t::sensor_setting
 (C++ member), 298 (C++ member), 291
 esp_ble_mesh_sensor_server_cb_t (C++ ESP_BLE_MESH_SENSOR_SETTING_PROPERTY_ID_LEN
 type), 301 (C macro), 299
 esp_ble_mesh_sensor_server_cb_value_t esp_ble_mesh_sensor_setting_set_t
 (C++ union), 289 (C++ class), 291
 esp_ble_mesh_sensor_server_cb_value_t::esp_ble_mesh_sensor_setting_set_t::sensor_property
 (C++ member), 290 (C++ member), 291
 esp_ble_mesh_sensor_server_cb_value_t::esp_ble_mesh_sensor_setting_set_t::sensor_setting
 (C++ member), 290 (C++ member), 291
 esp_ble_mesh_sensor_server_cb_value_t::state_change esp_ble_mesh_sensor_setting_set_t::sensor_setting
 (C++ member), 290 (C++ member), 291
 ESP_BLE_MESH_SENSOR_SERVER_EVT_MAX esp_ble_mesh_sensor_setting_status_cb_t
 (C++ enumerator), 302 (C++ class), 292
 ESP_BLE_MESH_SENSOR_SERVER_RECV_GET_MSG_EVT esp_ble_mesh_sensor_setting_status_cb_t::open
 (C++ enumerator), 302 (C++ member), 292
 esp_ble_mesh_sensor_server_recv_get_msg_t esp_ble_mesh_sensor_setting_status_cb_t::sensor_p
 (C++ union), 289 (C++ member), 292
 esp_ble_mesh_sensor_server_recv_get_msg_t::esp_ble_mesh_sensor_setting_status_cb_t::sensor_s
 (C++ member), 289 (C++ member), 292
 esp_ble_mesh_sensor_server_recv_get_msg_t::esp_ble_mesh_sensor_setting_status_cb_t::sensor_s
 (C++ member), 289 (C++ member), 292
 esp_ble_mesh_sensor_server_recv_get_msg_t::esp_ble_mesh_sensor_setting_status_cb_t::sensor_s
 (C++ member), 289 (C++ member), 293
 esp_ble_mesh_sensor_server_recv_get_msg_t::esp_ble_mesh_sensor_setting_t (C++
 (C++ member), 289 class), 294
 esp_ble_mesh_sensor_server_recv_get_msg_t::esp_ble_mesh_sensor_setting_t::access
 (C++ member), 289 (C++ member), 294
 esp_ble_mesh_sensor_server_recv_get_msg_t::esp_ble_mesh_sensor_setting_t::property_id
 (C++ member), 289 (C++ member), 294
 esp_ble_mesh_sensor_server_recv_get_msg_t::esp_ble_mesh_sensor_setting_t::raw
 (C++ member), 289 (C++ member), 294
 ESP_BLE_MESH_SENSOR_SERVER_RECV_SET_MSG_EVT esp_ble_mesh_sensor_settings_get_t
 (C++ enumerator), 302 (C++ class), 290
 esp_ble_mesh_sensor_server_recv_set_msg_t esp_ble_mesh_sensor_settings_get_t::sensor_proper
 (C++ union), 289 (C++ member), 291
 esp_ble_mesh_sensor_server_recv_set_msg_t::esp_ble_mesh_sensor_settings_status_cb_t
 (C++ member), 289 (C++ class), 292
 esp_ble_mesh_sensor_server_recv_set_msg_t::esp_ble_mesh_sensor_settings_status_cb_t::sensor
 (C++ member), 289 (C++ member), 292

- esp_ble_mesh_sensor_settings_status_cb_t::send (C++ function), 292
 (C++ member), 292
 esp_ble_mesh_sensor_setup_srv_t (C++ class), 296
 esp_ble_mesh_sensor_setup_srv_t::model (C++ member), 296
 esp_ble_mesh_sensor_setup_srv_t::rsp_ctrl (C++ member), 296
 esp_ble_mesh_sensor_setup_srv_t::state_count (C++ member), 296
 esp_ble_mesh_sensor_setup_srv_t::states (C++ member), 296
 esp_ble_mesh_sensor_srv_t (C++ class), 295
 esp_ble_mesh_sensor_srv_t::model (C++ member), 295
 esp_ble_mesh_sensor_srv_t::rsp_ctrl (C++ member), 295
 esp_ble_mesh_sensor_srv_t::state_count (C++ member), 295
 esp_ble_mesh_sensor_srv_t::states (C++ member), 296
 esp_ble_mesh_sensor_state_t (C++ class), 295
 esp_ble_mesh_sensor_state_t::cadence (C++ member), 295
 esp_ble_mesh_sensor_state_t::descriptor (C++ member), 295
 esp_ble_mesh_sensor_state_t::sensor_data (C++ member), 295
 esp_ble_mesh_sensor_state_t::sensor_properties (C++ member), 295
 esp_ble_mesh_sensor_state_t::series_color (C++ member), 295
 esp_ble_mesh_sensor_state_t::setting_count (C++ member), 295
 esp_ble_mesh_sensor_state_t::settings (C++ member), 295
 esp_ble_mesh_sensor_status_cb_t (C++ class), 293
 esp_ble_mesh_sensor_status_cb_t::marshal_ble_mesh_data (C++ member), 293
 ESP_BLE_MESH_SENSOR_STATUS_MIN_INTERVAL (C macro), 300
 ESP_BLE_MESH_SENSOR_STATUS_MIN_INTERVAL_MAX (C macro), 300
 ESP_BLE_MESH_SENSOR_STATUS_TRIGGER_TYPE_SINGLE (C macro), 300
 ESP_BLE_MESH_SENSOR_STATUS_TRIGGER_TYPE_SINGLE_INTERVAL (C macro), 300
 ESP_BLE_MESH_SENSOR_UNSPECIFIED_NEG_TOLERANCE (C macro), 299
 ESP_BLE_MESH_SENSOR_UNSPECIFIED_POS_TOLERANCE (C macro), 299
 ESP_BLE_MESH_SERVER_AUTO_RSP (C macro), 199
 ESP_BLE_MESH_SERVER_FLAG_MAX (C++ enumerator), 206
 esp_ble_mesh_server_model_send_msg (C++ function), 212
 property_ids (C++ function), 212
 ESP_BLE_MESH_SERVER_MODEL_STATE_MAX (C++ enumerator), 207
 esp_ble_mesh_server_model_update_state (C++ function), 212
 ESP_BLE_MESH_SERVER_MODEL_UPDATE_STATE_COMP_EVT (C++ enumerator), 207
 esp_ble_mesh_server_rcv_gen_admin_property_get_t (C++ class), 278
 esp_ble_mesh_server_rcv_gen_admin_property_get_t (C++ member), 278
 esp_ble_mesh_server_rcv_gen_admin_property_set_t (C++ class), 281
 esp_ble_mesh_server_rcv_gen_admin_property_set_t (C++ member), 281
 esp_ble_mesh_server_rcv_gen_admin_property_set_t (C++ member), 281
 esp_ble_mesh_server_rcv_gen_admin_property_set_t (C++ member), 281
 esp_ble_mesh_server_rcv_gen_admin_property_set_t (C++ member), 281
 esp_ble_mesh_server_rcv_gen_client_properties_get_t (C++ class), 278
 esp_ble_mesh_server_rcv_gen_client_properties_get_t (C++ member), 278
 esp_ble_mesh_server_rcv_gen_def_trans_time_set_t (C++ class), 279
 esp_ble_mesh_server_rcv_gen_def_trans_time_set_t (C++ member), 280
 esp_ble_mesh_server_rcv_gen_delta_set_t (C++ class), 279
 esp_ble_mesh_server_rcv_gen_delta_set_t::delay (C++ member), 279
 esp_ble_mesh_server_rcv_gen_delta_set_t::delta_level (C++ member), 279
 esp_ble_mesh_server_rcv_gen_delta_set_t::open (C++ member), 279
 esp_ble_mesh_server_rcv_gen_delta_set_t::tid (C++ member), 279
 esp_ble_mesh_server_rcv_gen_delta_set_t::trans_time (C++ member), 279
 esp_ble_mesh_server_rcv_gen_level_set_t (C++ class), 278
 esp_ble_mesh_server_rcv_gen_level_set_t::delay (C++ member), 279
 esp_ble_mesh_server_rcv_gen_level_set_t::level (C++ member), 279
 esp_ble_mesh_server_rcv_gen_level_set_t::open (C++ member), 279
 esp_ble_mesh_server_rcv_gen_level_set_t::tid (C++ member), 279
 esp_ble_mesh_server_rcv_gen_level_set_t::trans_time (C++ member), 279
 esp_ble_mesh_server_rcv_gen_loc_global_set_t (C++ class), 280
 esp_ble_mesh_server_rcv_gen_loc_global_set_t::global (C++ member), 281
 esp_ble_mesh_server_rcv_gen_loc_global_set_t::global (C++ member), 281
 esp_ble_mesh_server_rcv_gen_loc_global_set_t::global (C++ member), 281

(C++ member), 281
 esp_ble_mesh_server_rcv_gen_loc_local_esp_ble_mesh_server_rcv_gen_power_level_set_t::o
 (C++ class), 281
 esp_ble_mesh_server_rcv_gen_loc_local_esp_ble_mesh_server_rcv_gen_power_level_set_t::p
 (C++ member), 281
 esp_ble_mesh_server_rcv_gen_loc_local_esp_ble_mesh_server_rcv_gen_power_level_set_t::t
 (C++ member), 281
 esp_ble_mesh_server_rcv_gen_loc_local_esp_ble_mesh_server_rcv_gen_power_level_set_t::t
 (C++ member), 281
 esp_ble_mesh_server_rcv_gen_loc_local_esp_ble_mesh_server_rcv_gen_power_range_set_t
 (C++ member), 281
 esp_ble_mesh_server_rcv_gen_loc_local_esp_ble_mesh_server_rcv_gen_power_range_set_t::r
 (C++ member), 281
 esp_ble_mesh_server_rcv_gen_manufacture_esp_ble_mesh_server_rcv_gen_power_range_set_t::r
 (C++ class), 278
 esp_ble_mesh_server_rcv_gen_manufacture_esp_ble_mesh_server_rcv_gen_power_range_set_t::r
 (C++ member), 278
 esp_ble_mesh_server_rcv_gen_manufacture_esp_ble_mesh_server_rcv_gen_user_property_get_t
 (C++ class), 281
 esp_ble_mesh_server_rcv_gen_manufacture_esp_ble_mesh_server_rcv_gen_user_property_get_t
 (C++ member), 282
 esp_ble_mesh_server_rcv_gen_manufacture_esp_ble_mesh_server_rcv_gen_user_property_set_t
 (C++ member), 282
 esp_ble_mesh_server_rcv_gen_move_set_esp_ble_mesh_server_rcv_gen_user_property_set_t
 (C++ class), 279
 esp_ble_mesh_server_rcv_gen_move_set_esp_ble_mesh_server_rcv_light_ctl_default_set_t
 (C++ member), 279
 esp_ble_mesh_server_rcv_gen_move_set_esp_ble_mesh_server_rcv_light_ctl_default_set_t
 (C++ member), 279
 esp_ble_mesh_server_rcv_gen_move_set_esp_ble_mesh_server_rcv_light_ctl_default_set_t
 (C++ member), 279
 esp_ble_mesh_server_rcv_gen_move_set_esp_ble_mesh_server_rcv_light_ctl_default_set_t
 (C++ member), 279
 esp_ble_mesh_server_rcv_gen_move_set_esp_ble_mesh_server_rcv_light_ctl_set_t
 (C++ member), 279
 esp_ble_mesh_server_rcv_gen_onoff_set_esp_ble_mesh_server_rcv_light_ctl_set_t::delay
 (C++ class), 278
 esp_ble_mesh_server_rcv_gen_onoff_set_esp_ble_mesh_server_rcv_light_ctl_set_t::delta_u
 (C++ member), 278
 esp_ble_mesh_server_rcv_gen_onoff_set_esp_ble_mesh_server_rcv_light_ctl_set_t::lightne
 (C++ member), 278
 esp_ble_mesh_server_rcv_gen_onoff_set_esp_ble_mesh_server_rcv_light_ctl_set_t::open
 (C++ member), 278
 esp_ble_mesh_server_rcv_gen_onoff_set_esp_ble_mesh_server_rcv_light_ctl_set_t::tempera
 (C++ member), 278
 esp_ble_mesh_server_rcv_gen_onoff_set_esp_ble_mesh_server_rcv_light_ctl_set_t::tid
 (C++ member), 278
 esp_ble_mesh_server_rcv_gen_onpowerup_esp_ble_mesh_server_rcv_light_ctl_set_t::trans t
 (C++ class), 280
 esp_ble_mesh_server_rcv_gen_onpowerup_esp_ble_mesh_server_rcv_light_ctl_temperature_ra
 (C++ member), 280
 esp_ble_mesh_server_rcv_gen_power_default_esp_ble_mesh_server_rcv_light_ctl_temperature_ra
 (C++ class), 280
 esp_ble_mesh_server_rcv_gen_power_default_esp_ble_mesh_server_rcv_light_ctl_temperature_ra
 (C++ member), 280
 esp_ble_mesh_server_rcv_gen_power_level_set_esp_ble_mesh_server_rcv_light_ctl_temperature_se
 (C++ class), 280
 esp_ble_mesh_server_rcv_gen_power_level_set_esp_ble_mesh_server_rcv_light_ctl_temperature_se

esp_ble_mesh_state_change_light_ctl_defesp_ble_mesh_lightness_change_light_lc_light_onoff_set
 (C++ member), 352 (C++ class), 354
 esp_ble_mesh_state_change_light_ctl_defesp_ble_mesh_lightness_change_light_lc_light_onoff_set
 (C++ member), 352 (C++ member), 354
 esp_ble_mesh_state_change_light_ctl_setesp_ble_mesh_state_change_light_lc_mode_set_t
 (C++ class), 351 (C++ class), 354
 esp_ble_mesh_state_change_light_ctl_setesp_ble_mesh_state_change_light_lc_mode_set_t::mode
 (C++ member), 351 (C++ member), 354
 esp_ble_mesh_state_change_light_ctl_setesp_ble_mesh_state_change_light_lc_om_set_t
 (C++ member), 351 (C++ class), 354
 esp_ble_mesh_state_change_light_ctl_setesp_ble_mesh_state_change_light_lc_om_set_t::mode
 (C++ member), 351 (C++ member), 354
 esp_ble_mesh_state_change_light_ctl_temperatures_get_state_change_light_lc_property_set_t
 (C++ class), 352 (C++ class), 354
 esp_ble_mesh_state_change_light_ctl_temperatures_get_state_change_light_lc_property_set_t
 (C++ member), 352 (C++ member), 354
 esp_ble_mesh_state_change_light_ctl_temperatures_get_state_change_light_lc_property_set_t
 (C++ member), 352 (C++ member), 354
 esp_ble_mesh_state_change_light_ctl_temperatures_get_state_change_light_lightness_default
 (C++ class), 351 (C++ class), 351
 esp_ble_mesh_state_change_light_ctl_temperatures_get_state_change_light_lightness_default
 (C++ member), 352 (C++ member), 351
 esp_ble_mesh_state_change_light_ctl_temperatures_get_state_change_light_lightness_linear
 (C++ member), 352 (C++ class), 351
 esp_ble_mesh_state_change_light_hsl_defesp_ble_mesh_state_change_light_lightness_linear
 (C++ class), 353 (C++ member), 351
 esp_ble_mesh_state_change_light_hsl_defesp_ble_mesh_state_change_light_lightness_range_s
 (C++ member), 353 (C++ class), 351
 esp_ble_mesh_state_change_light_hsl_defesp_ble_mesh_lightness_change_light_lightness_range_s
 (C++ member), 353 (C++ member), 351
 esp_ble_mesh_state_change_light_hsl_defesp_ble_mesh_saturation_change_light_lightness_range_s
 (C++ member), 353 (C++ member), 351
 esp_ble_mesh_state_change_light_hsl_hue_setesp_ble_mesh_state_change_light_lightness_set_t
 (C++ class), 352 (C++ class), 351
 esp_ble_mesh_state_change_light_hsl_hue_setesp_ble_mesh_state_change_light_lightness_set_t::
 (C++ member), 352 (C++ member), 351
 esp_ble_mesh_state_change_light_hsl_rangeesp_ble_mesh_state_change_light_xyl_default_set_t
 (C++ class), 353 (C++ class), 353
 esp_ble_mesh_state_change_light_hsl_rangeesp_ble_mesh_state_change_light_xyl_default_set_t
 (C++ member), 353 (C++ member), 353
 esp_ble_mesh_state_change_light_hsl_rangeesp_ble_mesh_state_change_light_xyl_default_set_t
 (C++ member), 353 (C++ member), 353
 esp_ble_mesh_state_change_light_hsl_rangeesp_ble_mesh_state_change_light_xyl_default_set_t
 (C++ member), 353 (C++ member), 353
 esp_ble_mesh_state_change_light_hsl_rangeesp_ble_mesh_state_change_light_xyl_range_set_t
 (C++ member), 353 (C++ class), 354
 esp_ble_mesh_state_change_light_hsl_saturation_esp_ble_mesh_state_change_light_xyl_range_set_t::
 (C++ class), 352 (C++ member), 354
 esp_ble_mesh_state_change_light_hsl_saturation_esp_ble_mesh_state_change_light_xyl_range_set_t::
 (C++ member), 353 (C++ member), 354
 esp_ble_mesh_state_change_light_hsl_setesp_ble_mesh_state_change_light_xyl_range_set_t::
 (C++ class), 352 (C++ member), 354
 esp_ble_mesh_state_change_light_hsl_setesp_ble_mesh_state_change_light_xyl_range_set_t::
 (C++ member), 352 (C++ member), 354
 esp_ble_mesh_state_change_light_hsl_setesp_ble_mesh_state_change_light_xyl_set_t
 (C++ member), 352 (C++ class), 353
 esp_ble_mesh_state_change_light_hsl_setesp_ble_mesh_state_change_light_xyl_set_t::lightn
 (C++ member), 352 (C++ member), 353

esp_ble_mesh_state_change_time_zone_set_t (C++ class), 315
 esp_ble_mesh_state_change_time_zone_set_t::padding_2 (C++ member), 309
 esp_ble_mesh_state_change_time_zone_set_t::tai_mesh_time_change_delta_status_cb_t::tai_delta (C++ member), 315
 esp_ble_mesh_state_change_time_zone_set_t::tai_mesh_time_change_delta_status_cb_t::tai_delta (C++ member), 309
 esp_ble_mesh_state_change_time_zone_set_t::tai_mesh_time_of_finet_delta_status_cb_t::tai_utc_delta (C++ member), 315
 esp_ble_mesh_state_change_time_zone_set_t::tai_mesh_time_of_finet_delta_status_cb_t::tai_utc_delta (C++ member), 308
 esp_ble_mesh_state_transition_t (C++ class), 184
 esp_ble_mesh_state_transition_t (C++ member), 309
 esp_ble_mesh_state_transition_t::BLE_MESH_STATIC_MESH_TAMPER_ERROR (C macro), 255
 esp_ble_mesh_state_transition_t (C++ function), 184
 ESP_BLE_MESH_TAMPER_WARNING (C macro), 255
 esp_ble_mesh_state_transition_t::counter (C++ member), 184
 ESP_BLE_MESH_TIME_AUTHORITY (C macro), 322
 esp_ble_mesh_state_transition_t::delay (C++ member), 184
 ESP_BLE_MESH_TIME_CLINET (C macro), 322
 esp_ble_mesh_state_transition_t::just_start (C++ member), 184
 ESP_BLE_MESH_TIME_NONE (C macro), 322
 esp_ble_mesh_state_transition_t::just_start (C++ member), 184
 ESP_BLE_MESH_TIME_RELAY (C macro), 322
 esp_ble_mesh_state_transition_t::quote_start (C++ member), 184
 esp_ble_mesh_time_role_set_t (C++ class), 306
 esp_ble_mesh_state_transition_t::quote_start (C++ member), 184
 esp_ble_mesh_time_role_set_t::time_role (C++ member), 306
 esp_ble_mesh_state_transition_t::start_time_stamp (C++ member), 184
 esp_ble_mesh_time_role_status_cb_t (C++ class), 309
 esp_ble_mesh_state_transition_t::timer (C++ member), 184
 esp_ble_mesh_time_role_status_cb_t::time_role (C++ member), 309
 esp_ble_mesh_state_transition_t::total_time_stamp (C++ member), 184
 esp_ble_mesh_time_scene_client_cb_event_t (C++ enum), 323
 esp_ble_mesh_state_transition_t::trans_time_stamp (C++ member), 184
 esp_ble_mesh_time_scene_client_cb_param_t (C++ class), 310
 ESP_BLE_MESH_STATIC_OOB (C++ enumerator), 201
 esp_ble_mesh_time_scene_client_cb_param_t::error (C++ member), 310
 ESP_BLE_MESH_SUPPLY_VOLTAGE_TOO_HIGH_ERROR (C macro), 254
 esp_ble_mesh_time_scene_client_cb_param_t::params (C++ member), 310
 ESP_BLE_MESH_SUPPLY_VOLTAGE_TOO_HIGH_WARNING (C macro), 254
 esp_ble_mesh_time_scene_client_cb_param_t::status (C++ member), 310
 ESP_BLE_MESH_SUPPLY_VOLTAGE_TOO_LOW_ERROR (C macro), 254
 esp_ble_mesh_time_scene_client_cb_t (C++ type), 323
 ESP_BLE_MESH_SUPPLY_VOLTAGE_TOO_LOW_WARNING (C macro), 254
 ESP_BLE_MESH_TIME_SCENE_CLIENT_EVT_MAX (C++ enumerator), 323
 ESP_BLE_MESH_TAI_OF_DELTA_CHANGE_LEN (C macro), 321
 esp_ble_mesh_time_scene_client_get_state (C++ function), 302
 ESP_BLE_MESH_TAI_OF_ZONE_CHANGE_LEN (C macro), 321
 ESP_BLE_MESH_TIME_SCENE_CLIENT_GET_STATE_EVT (C++ enumerator), 323
 ESP_BLE_MESH_TAI_SECONDS_LEN (C macro), 321
 esp_ble_mesh_time_scene_client_get_state_t (C++ union), 303
 ESP_BLE_MESH_TAI_UTC_DELTA_MAX_VALUE (C macro), 321
 esp_ble_mesh_time_scene_client_get_state_t::sched (C++ member), 303
 esp_ble_mesh_tai_utc_delta_set_t (C++ class), 306
 ESP_BLE_MESH_TIME_SCENE_CLIENT_PUBLISH_EVT (C++ enumerator), 323
 esp_ble_mesh_tai_utc_delta_set_t::padding_2 (C++ member), 306
 esp_ble_mesh_time_scene_client_set_state (C++ function), 303
 esp_ble_mesh_tai_utc_delta_set_t::tai_delta (C++ member), 306
 ESP_BLE_MESH_TIME_SCENE_CLIENT_SET_STATE_EVT (C++ enumerator), 323
 esp_ble_mesh_tai_utc_delta_set_t::tai_utc_delta (C++ member), 306
 esp_ble_mesh_time_scene_client_set_state_t (C++ union), 303
 esp_ble_mesh_tai_utc_delta_status_cb_t (C++ class), 308
 esp_ble_mesh_time_scene_client_set_state_t::scene (C++ member), 303
 esp_ble_mesh_tai_utc_delta_status_cb_t::padding_2 (C++ member), 308
 esp_ble_mesh_time_scene_client_set_state_t::scene (C++ member), 303

(C++ member), 306

esp_ble_mesh_time_set_t::tai_utc_delta (C++ member), 306

esp_ble_mesh_time_set_t::time_authority (C++ member), 306

esp_ble_mesh_time_set_t::time_zone_offset (C++ member), 306

esp_ble_mesh_time_set_t::uncertainty (C++ member), 306

esp_ble_mesh_time_setup_srv_t (C++ class), 311

esp_ble_mesh_time_setup_srv_t::model (C++ member), 311

esp_ble_mesh_time_setup_srv_t::rsp_ctrl (C++ member), 311

esp_ble_mesh_time_setup_srv_t::state (C++ member), 311

esp_ble_mesh_time_srv_t (C++ class), 311

esp_ble_mesh_time_srv_t::model (C++ member), 311

esp_ble_mesh_time_srv_t::rsp_ctrl (C++ member), 311

esp_ble_mesh_time_srv_t::state (C++ member), 311

esp_ble_mesh_time_state_t (C++ class), 310

esp_ble_mesh_time_state_t::subsecond (C++ member), 310

esp_ble_mesh_time_state_t::tai_delta_change (C++ member), 311

esp_ble_mesh_time_state_t::tai_seconds (C++ member), 310

esp_ble_mesh_time_state_t::tai_utc_delta (C++ member), 311

esp_ble_mesh_time_state_t::tai_utc_delta_change (C++ member), 311

esp_ble_mesh_time_state_t::tai_zone_change (C++ member), 311

esp_ble_mesh_time_state_t::time (C++ member), 311

esp_ble_mesh_time_state_t::time_authority (C++ member), 311

esp_ble_mesh_time_state_t::time_role (C++ member), 311

esp_ble_mesh_time_state_t::time_zone_offset (C++ member), 311

esp_ble_mesh_time_state_t::time_zone_offset_new (C++ member), 311

esp_ble_mesh_time_state_t::uncertainty (C++ member), 310

esp_ble_mesh_time_status_cb_t (C++ class), 308

esp_ble_mesh_time_status_cb_t::sub_second (C++ member), 308

esp_ble_mesh_time_status_cb_t::tai_seconds (C++ member), 308

esp_ble_mesh_time_status_cb_t::tai_utc_delta (C++ member), 308

esp_ble_mesh_time_status_cb_t::time_authority (C++ member), 308

esp_ble_mesh_time_status_cb_t::time_zone_offset (C++ member), 308

esp_ble_mesh_time_status_cb_t::uncertainty (C++ member), 308

esp_ble_mesh_time_zone_set_t (C++ class), 306

esp_ble_mesh_time_zone_set_t::tai_zone_change (C++ member), 306

esp_ble_mesh_time_zone_set_t::time_zone_offset_new (C++ member), 306

esp_ble_mesh_time_zone_status_cb_t (C++ class), 308

esp_ble_mesh_time_zone_status_cb_t::tai_zone_change (C++ member), 308

esp_ble_mesh_time_zone_status_cb_t::time_zone_offset (C++ member), 308

ESP_BLE_MESH_TRANSMIT (C macro), 187

ESP_BLE_MESH_TTL_DEFAULT (C macro), 185

ESP_BLE_MESH_TTL_MAX (C macro), 185

ESP_BLE_MESH_TWIST (C++ enumerator), 202

ESP_BLE_MESH_TYPE_COMPLETE_CB (C++ enumerator), 201

ESP_BLE_MESH_TYPE_INTPUT_CB (C++ enumerator), 201

ESP_BLE_MESH_TYPE_LINK_CLOSE_CB (C++ enumerator), 201

ESP_BLE_MESH_TYPE_LINK_OPEN_CB (C++ enumerator), 201

ESP_BLE_MESH_TYPE_OUTPUT_NUM_CB (C++ enumerator), 201

ESP_BLE_MESH_TYPE_OUTPUT_STR_CB (C++ enumerator), 201

ESP_BLE_MESH_TYPE_PROV_CB (C++ enumerator), 201

ESP_BLE_MESH_TYPE_RESET_CB (C++ enumerator), 201

ESP_BLE_MESH_UNKNOWN_TAI_DELTA_CHANGE (C macro), 321

ESP_BLE_MESH_UNKNOWN_TAI_SECONDS (C macro), 321

ESP_BLE_MESH_UNKNOWN_TAI_ZONE_CHANGE (C macro), 321

esp_ble_mesh_unprov_dev_add_t (C++ class), 181

esp_ble_mesh_unprov_dev_add_t::addr (C++ member), 181

esp_ble_mesh_unprov_dev_add_t::addr_type (C++ member), 181

esp_ble_mesh_unprov_dev_add_t::bearer (C++ member), 181

esp_ble_mesh_unprov_dev_add_t::oob_info (C++ member), 181

esp_ble_mesh_unprov_dev_add_t::uuid (C++ member), 181

ESP_BLE_MESH_VENDOR_MODEL (C macro), 188

- ESP_BLE_MESH_VIBRATE (C++ enumerator), 201
- ESP_BLE_MESH_VIBRATION_ERROR (C macro), 255
- ESP_BLE_MESH_VIBRATION_WARNING (C macro), 255
- ESP_BLE_ONLY_ACCEPT_SPECIFIED_AUTH_DISABLE (C macro), 93
- ESP_BLE_ONLY_ACCEPT_SPECIFIED_AUTH_ENABLE (C macro), 93
- ESP_BLE_OOB_DISABLE (C macro), 93
- ESP_BLE_OOB_ENABLE (C macro), 93
- esp_ble_oob_req_reply (C++ function), 64
- esp_ble_passkey_reply (C++ function), 64
- esp_ble_pcsrkeys_t (C++ class), 85
- esp_ble_pcsrkeys_t::counter (C++ member), 85
- esp_ble_pcsrkeys_t::csrk (C++ member), 85
- esp_ble_pcsrkeys_t::sec_level (C++ member), 85
- esp_ble_penc_keys_t (C++ class), 85
- esp_ble_penc_keys_t::ediv (C++ member), 85
- esp_ble_penc_keys_t::key_size (C++ member), 85
- esp_ble_penc_keys_t::ltk (C++ member), 85
- esp_ble_penc_keys_t::rand (C++ member), 85
- esp_ble_penc_keys_t::sec_level (C++ member), 85
- esp_ble_pid_keys_t (C++ class), 85
- esp_ble_pid_keys_t::addr_type (C++ member), 86
- esp_ble_pid_keys_t::irk (C++ member), 86
- esp_ble_pid_keys_t::static_addr (C++ member), 86
- esp_ble_pkt_data_length_params_t (C++ class), 85
- esp_ble_pkt_data_length_params_t::rx_len (C++ member), 85
- esp_ble_pkt_data_length_params_t::tx_len (C++ member), 85
- esp_ble_power_type_t (C++ enum), 53
- ESP_BLE_PRIM_ADV_INT_MAX (C macro), 55
- ESP_BLE_PRIM_ADV_INT_MIN (C macro), 55
- ESP_BLE_PWR_TYPE_ADV (C++ enumerator), 53
- ESP_BLE_PWR_TYPE_CONN_HDL0 (C++ enumerator), 53
- ESP_BLE_PWR_TYPE_CONN_HDL1 (C++ enumerator), 53
- ESP_BLE_PWR_TYPE_CONN_HDL2 (C++ enumerator), 53
- ESP_BLE_PWR_TYPE_CONN_HDL3 (C++ enumerator), 53
- ESP_BLE_PWR_TYPE_CONN_HDL4 (C++ enumerator), 53
- ESP_BLE_PWR_TYPE_CONN_HDL5 (C++ enumerator), 53
- ESP_BLE_PWR_TYPE_CONN_HDL6 (C++ enumerator), 53
- ESP_BLE_PWR_TYPE_CONN_HDL7 (C++ enumerator), 53
- ESP_BLE_PWR_TYPE_CONN_HDL8 (C++ enumerator), 53
- ESP_BLE_PWR_TYPE_DEFAULT (C++ enumerator), 53
- ESP_BLE_PWR_TYPE_NUM (C++ enumerator), 53
- ESP_BLE_PWR_TYPE_SCAN (C++ enumerator), 53
- esp_ble_remove_bond_device (C++ function), 64
- esp_ble_resolve_adv_data (C++ function), 62
- ESP_BLE_SCA_100PPM (C++ enumerator), 52
- ESP_BLE_SCA_150PPM (C++ enumerator), 52
- ESP_BLE_SCA_20PPM (C++ enumerator), 52
- ESP_BLE_SCA_250PPM (C++ enumerator), 52
- ESP_BLE_SCA_30PPM (C++ enumerator), 52
- ESP_BLE_SCA_500PPM (C++ enumerator), 52
- ESP_BLE_SCA_50PPM (C++ enumerator), 52
- ESP_BLE_SCA_75PPM (C++ enumerator), 52
- esp_ble_scan_duplicate_list_flush (C++ function), 50
- esp_ble_scan_duplicate_t (C++ enum), 101
- esp_ble_scan_filter_t (C++ enum), 101
- ESP_BLE_SCAN_PARAM_UNDEF (C macro), 55
- esp_ble_scan_params_t (C++ class), 84
- esp_ble_scan_params_t::own_addr_type (C++ member), 84
- esp_ble_scan_params_t::scan_duplicate (C++ member), 84
- esp_ble_scan_params_t::scan_filter_policy (C++ member), 84
- esp_ble_scan_params_t::scan_interval (C++ member), 84
- esp_ble_scan_params_t::scan_type (C++ member), 84
- esp_ble_scan_params_t::scan_window (C++ member), 84
- ESP_BLE_SCAN_RSP_DATA_LEN_MAX (C macro), 95
- esp_ble_scan_type_t (C++ enum), 100
- esp_ble_sec_act_t (C++ enum), 100
- ESP_BLE_SEC_ENCRYPT (C++ enumerator), 100
- ESP_BLE_SEC_ENCRYPT_MITM (C++ enumerator), 100
- ESP_BLE_SEC_ENCRYPT_NO_MITM (C++ enumerator), 100
- esp_ble_sec_key_notif_t (C++ class), 86
- esp_ble_sec_key_notif_t::bd_addr (C++ member), 86
- esp_ble_sec_key_notif_t::passkey (C++ member), 86
- esp_ble_sec_req_t (C++ class), 86
- esp_ble_sec_req_t::bd_addr (C++ member), 87
- esp_ble_sec_t (C++ union), 70
- esp_ble_sec_t::auth_cmpl (C++ member), 70

- esp_ble_sec_t::ble_id_keys (C++ member), 70
 esp_ble_sec_t::ble_key (C++ member), 70
 esp_ble_sec_t::ble_req (C++ member), 70
 esp_ble_sec_t::key_notif (C++ member), 70
 esp_ble_set_encryption (C++ function), 63
 ESP_BLE_SM_AUTHEN_REQ_MODE (C++ enumerator), 100
 ESP_BLE_SM_CLEAR_STATIC_PASSKEY (C++ enumerator), 100
 ESP_BLE_SM_IOCAP_MODE (C++ enumerator), 100
 ESP_BLE_SM_MAX_KEY_SIZE (C++ enumerator), 100
 ESP_BLE_SM_MAX_PARAM (C++ enumerator), 100
 ESP_BLE_SM_MIN_KEY_SIZE (C++ enumerator), 100
 ESP_BLE_SM_ONLY_ACCEPT_SPECIFIED_SEC_AUTHEN (C++ enumerator), 100
 ESP_BLE_SM_OOB_SUPPORT (C++ enumerator), 100
 esp_ble_sm_param_t (C++ enum), 100
 ESP_BLE_SM_PASSKEY (C++ enumerator), 100
 ESP_BLE_SM_SET_INIT_KEY (C++ enumerator), 100
 ESP_BLE_SM_SET_RSP_KEY (C++ enumerator), 100
 ESP_BLE_SM_SET_STATIC_PASSKEY (C++ enumerator), 100
 esp_ble_tx_power_get (C++ function), 47
 esp_ble_tx_power_set (C++ function), 47
 ESP_BLE_WHITELIST_ADD (C++ enumerator), 102
 ESP_BLE_WHITELIST_REMOVE (C++ enumerator), 102
 esp_ble_wl_addr_type_t (C++ enum), 57
 esp_ble_wl_opration_t (C++ enum), 102
 esp_bluedroid_deinit (C++ function), 58
 esp_bluedroid_disable (C++ function), 58
 esp_bluedroid_enable (C++ function), 57
 esp_bluedroid_get_status (C++ function), 57
 esp_bluedroid_init (C++ function), 58
 ESP_BLUEDROID_STATUS_CHECK (C macro), 55
 ESP_BLUEDROID_STATUS_ENABLED (C++ enumerator), 58
 ESP_BLUEDROID_STATUS_INITIALIZED (C++ enumerator), 58
 esp_bluedroid_status_t (C++ enum), 58
 ESP_BLUEDROID_STATUS_UNINITIALIZED (C++ enumerator), 58
 esp_blufi_ap_record_t (C++ class), 148
 esp_blufi_ap_record_t::rssi (C++ member), 148
 esp_blufi_ap_record_t::ssid (C++ member), 148
 ESP_BLUFI_BD_ADDR_LEN (C macro), 149
 esp_blufi_bd_addr_t (C++ type), 149
 esp_blufi_callbacks_t (C++ class), 148
 esp_blufi_callbacks_t::checksum_func (C++ member), 149
 esp_blufi_callbacks_t::decrypt_func (C++ member), 148
 esp_blufi_callbacks_t::encrypt_func (C++ member), 148
 esp_blufi_callbacks_t::event_cb (C++ member), 148
 esp_blufi_callbacks_t::negotiate_data_handler (C++ member), 148
 esp_blufi_cb_event_t (C++ enum), 150
 esp_blufi_cb_param_t (C++ union), 143
 esp_blufi_cb_param_t::blufi_connect_evt_param (C++ class), 144
 esp_blufi_cb_param_t::blufi_connect_evt_param::checksum (C++ member), 144
 esp_blufi_cb_param_t::blufi_connect_evt_param::rssi (C++ member), 144
 esp_blufi_cb_param_t::blufi_connect_evt_param::ssid (C++ member), 144
 esp_blufi_cb_param_t::blufi_deinit_finish_evt_param (C++ class), 144
 esp_blufi_cb_param_t::blufi_deinit_finish_evt_param::checksum (C++ member), 144
 esp_blufi_cb_param_t::blufi_disconnect_evt_param (C++ class), 144
 esp_blufi_cb_param_t::blufi_disconnect_evt_param::checksum (C++ member), 144
 esp_blufi_cb_param_t::blufi_get_error_evt_param (C++ class), 144
 esp_blufi_cb_param_t::blufi_get_error_evt_param::checksum (C++ member), 144
 esp_blufi_cb_param_t::blufi_init_finish_evt_param (C++ class), 144
 esp_blufi_cb_param_t::blufi_init_finish_evt_param::checksum (C++ member), 144
 esp_blufi_cb_param_t::blufi_rcv_ca_evt_param (C++ class), 144
 esp_blufi_cb_param_t::blufi_rcv_ca_evt_param::checksum (C++ member), 145
 esp_blufi_cb_param_t::blufi_rcv_ca_evt_param::ssid (C++ member), 145
 esp_blufi_cb_param_t::blufi_rcv_client_cert_evt_param (C++ class), 145
 esp_blufi_cb_param_t::blufi_rcv_client_cert_evt_param::checksum (C++ member), 145
 esp_blufi_cb_param_t::blufi_rcv_client_cert_evt_param::ssid (C++ member), 145
 esp_blufi_cb_param_t::blufi_rcv_client_pkey_evt_param (C++ class), 145
 esp_blufi_cb_param_t::blufi_rcv_client_pkey_evt_param::checksum (C++ member), 145
 esp_blufi_cb_param_t::blufi_rcv_client_pkey_evt_param::ssid (C++ member), 145
 esp_blufi_cb_param_t::blufi_rcv_custom_data_evt_param (C++ class), 145
 esp_blufi_cb_param_t::blufi_rcv_custom_data_evt_param::checksum (C++ member), 145
 esp_blufi_cb_param_t::blufi_rcv_custom_data_evt_param::ssid (C++ member), 145

esp_blufi_cb_param_t::blufi_rcv_server_evt_blufi_chan_param_t::blufi_set_wifi_mode_evt_param
 (C++ class), 145 (C++ class), 147
 esp_blufi_cb_param_t::blufi_rcv_server_evt_blufi_chan_param_t::blufi_set_wifi_mode_evt_param
 (C++ member), 145 (C++ member), 147
 esp_blufi_cb_param_t::blufi_rcv_server_evt_blufi_chan_param_t::daen(C++ member),
 (C++ member), 145 143
 esp_blufi_cb_param_t::blufi_rcv_server_evt_blufi_chan_param_t::client_cert
 (C++ class), 145 (C++ member), 143
 esp_blufi_cb_param_t::blufi_rcv_server_evt_blufi_chan_param_t::client_pkey
 (C++ member), 146 (C++ member), 143
 esp_blufi_cb_param_t::blufi_rcv_server_evt_blufi_chan_param_t::connect (C++
 (C++ member), 146 member), 143
 esp_blufi_cb_param_t::blufi_rcv_softap_evt_blufi_chan_param_t::custom_data
 (C++ class), 146 (C++ member), 144
 esp_blufi_cb_param_t::blufi_rcv_softap_evt_blufi_chan_param_t::deinit_finish
 (C++ member), 146 (C++ member), 143
 esp_blufi_cb_param_t::blufi_rcv_softap_evt_blufi_chan_param_t::disconnect (C++
 (C++ class), 146 member), 143
 esp_blufi_cb_param_t::blufi_rcv_softap_evt_blufi_chan_param_t::chamitelfinish
 (C++ member), 146 (C++ member), 143
 esp_blufi_cb_param_t::blufi_rcv_softap_evt_blufi_chan_param_t::report_error
 (C++ class), 146 (C++ member), 144
 esp_blufi_cb_param_t::blufi_rcv_softap_evt_blufi_chan_param_t::server_max_conn_num
 (C++ member), 146 (C++ member), 143
 esp_blufi_cb_param_t::blufi_rcv_softap_evt_blufi_chan_param_t::server_pkey
 (C++ class), 146 (C++ member), 144
 esp_blufi_cb_param_t::blufi_rcv_softap_evt_blufi_chan_param_t::softap_auth_mode
 (C++ member), 146 (C++ member), 143
 esp_blufi_cb_param_t::blufi_rcv_softap_evt_blufi_chan_param_t::softap_channel
 (C++ member), 146 (C++ member), 143
 esp_blufi_cb_param_t::blufi_rcv_softap_evt_blufi_chan_param_t::softap_max_conn_num
 (C++ class), 146 (C++ member), 143
 esp_blufi_cb_param_t::blufi_rcv_softap_evt_blufi_chan_param_t::softap_passwd
 (C++ member), 146 (C++ member), 143
 esp_blufi_cb_param_t::blufi_rcv_softap_evt_blufi_chan_param_t::softap_ssid
 (C++ member), 146 (C++ member), 143
 esp_blufi_cb_param_t::blufi_rcv_sta_bssid_evt_blufi_chan_param_t::sta_bssid (C++
 (C++ class), 146 member), 143
 esp_blufi_cb_param_t::blufi_rcv_sta_bssid_evt_blufi_chan_param_t::sta_passwd (C++
 (C++ member), 147 member), 143
 esp_blufi_cb_param_t::blufi_rcv_sta_passwd_evt_blufi_chan_param_t::sta_ssid (C++
 (C++ class), 147 member), 143
 esp_blufi_cb_param_t::blufi_rcv_sta_passwd_evt_blufi_chan_param_t::username (C++
 (C++ member), 147 member), 143
 esp_blufi_cb_param_t::blufi_rcv_sta_passwd_evt_blufi_chan_param_t::wifi_mode (C++
 (C++ member), 147 member), 143
 esp_blufi_cb_param_t::blufi_rcv_sta_ssid_evt_blufi_chan_param_t::ESP_BLUFI_CHAN_CHECKSUM_ERROR (C++ enumerator),
 (C++ class), 147 151
 esp_blufi_cb_param_t::blufi_rcv_sta_ssid_evt_blufi_chan_param_t::esp_deinit_func_t (C++ type), 149
 (C++ member), 147 ESP_BLUFI_DATA_FORMAT_ERROR (C++ enumer-
 esp_blufi_cb_param_t::blufi_rcv_sta_ssid_evt_param, 151 :ssid_len
 (C++ member), 147 ESP_BLUFI_DECRYPT_ERROR (C++ enumerator),
 esp_blufi_cb_param_t::blufi_rcv_username_evt_param
 (C++ class), 147 esp_blufi_decrypt_func_t (C++ type), 149
 esp_blufi_cb_param_t::blufi_rcv_username_evt_param::ESP_BLUFI_CHAN_FAILED (C++ enumerator),
 (C++ member), 147 151
 esp_blufi_cb_param_t::blufi_rcv_username_evt_param::ESP_BLUFI_CHAN_FAILED (C++ enumerator), 151
 (C++ member), 147 esp_blufi_deinit_state_t (C++ enum), 150

- ESP_BLUFI_DH_MALLOCC_ERROR (C++ *enumerator*), 151
- ESP_BLUFI_DH_PARAM_ERROR (C++ *enumerator*), 151
- ESP_BLUFI_ENCRYPT_ERROR (C++ *enumerator*), 151
- esp_blufi_encrypt_func_t (C++ *type*), 149
- esp_blufi_error_state_t (C++ *enum*), 151
- ESP_BLUFI_EVENT_BLE_CONNECT (C++ *enumerator*), 150
- ESP_BLUFI_EVENT_BLE_DISCONNECT (C++ *enumerator*), 150
- esp_blufi_event_cb_t (C++ *type*), 149
- ESP_BLUFI_EVENT_DEAUTHENTICATE_STA (C++ *enumerator*), 150
- ESP_BLUFI_EVENT_DEINIT_FINISH (C++ *enumerator*), 150
- ESP_BLUFI_EVENT_GET_WIFI_LIST (C++ *enumerator*), 150
- ESP_BLUFI_EVENT_GET_WIFI_STATUS (C++ *enumerator*), 150
- ESP_BLUFI_EVENT_INIT_FINISH (C++ *enumerator*), 150
- ESP_BLUFI_EVENT_RECV_CA_CERT (C++ *enumerator*), 150
- ESP_BLUFI_EVENT_RECV_CLIENT_CERT (C++ *enumerator*), 150
- ESP_BLUFI_EVENT_RECV_CLIENT_PRIV_KEY (C++ *enumerator*), 150
- ESP_BLUFI_EVENT_RECV_CUSTOM_DATA (C++ *enumerator*), 150
- ESP_BLUFI_EVENT_RECV_SERVER_CERT (C++ *enumerator*), 150
- ESP_BLUFI_EVENT_RECV_SERVER_PRIV_KEY (C++ *enumerator*), 150
- ESP_BLUFI_EVENT_RECV_SLAVE_DISCONNECT_BLE (C++ *enumerator*), 150
- ESP_BLUFI_EVENT_RECV_SOFTAP_AUTH_MODE (C++ *enumerator*), 150
- ESP_BLUFI_EVENT_RECV_SOFTAP_CHANNEL (C++ *enumerator*), 150
- ESP_BLUFI_EVENT_RECV_SOFTAP_MAX_CONN_NUM (C++ *enumerator*), 150
- ESP_BLUFI_EVENT_RECV_SOFTAP_PASSWD (C++ *enumerator*), 150
- ESP_BLUFI_EVENT_RECV_SOFTAP_SSID (C++ *enumerator*), 150
- ESP_BLUFI_EVENT_RECV_STA_BSSID (C++ *enumerator*), 150
- ESP_BLUFI_EVENT_RECV_STA_PASSWD (C++ *enumerator*), 150
- ESP_BLUFI_EVENT_RECV_STA_SSID (C++ *enumerator*), 150
- ESP_BLUFI_EVENT_RECV_USERNAME (C++ *enumerator*), 150
- ESP_BLUFI_EVENT_REPORT_ERROR (C++ *enumerator*), 150
- ESP_BLUFI_EVENT_REQ_CONNECT_TO_AP (C++ *enumerator*), 150
- ESP_BLUFI_EVENT_REQ_DISCONNECT_FROM_AP (C++ *enumerator*), 150
- ESP_BLUFI_EVENT_SET_WIFI_OPMODE (C++ *enumerator*), 150
- esp_blufi_extra_info_t (C++ *class*), 147
- esp_blufi_extra_info_t::softap_authmode (C++ *member*), 148
- esp_blufi_extra_info_t::softap_authmode_set (C++ *member*), 148
- esp_blufi_extra_info_t::softap_channel (C++ *member*), 148
- esp_blufi_extra_info_t::softap_channel_set (C++ *member*), 148
- esp_blufi_extra_info_t::softap_max_conn_num (C++ *member*), 148
- esp_blufi_extra_info_t::softap_max_conn_num_set (C++ *member*), 148
- esp_blufi_extra_info_t::softap_passwd (C++ *member*), 148
- esp_blufi_extra_info_t::softap_passwd_len (C++ *member*), 148
- esp_blufi_extra_info_t::softap_ssid (C++ *member*), 148
- esp_blufi_extra_info_t::softap_ssid_len (C++ *member*), 148
- esp_blufi_extra_info_t::sta_bssid (C++ *member*), 147
- esp_blufi_extra_info_t::sta_bssid_set (C++ *member*), 147
- esp_blufi_extra_info_t::sta_passwd (C++ *member*), 148
- esp_blufi_extra_info_t::sta_passwd_len (C++ *member*), 148
- esp_blufi_extra_info_t::sta_ssid (C++ *member*), 147
- esp_blufi_extra_info_t::sta_ssid_len (C++ *member*), 148
- esp_blufi_get_version (C++ *function*), 142
- ESP_BLUFI_INIT_FAILED (C++ *enumerator*), 150
- ESP_BLUFI_INIT_OK (C++ *enumerator*), 150
- ESP_BLUFI_INIT_SECURITY_ERROR (C++ *enumerator*), 151
- esp_blufi_init_state_t (C++ *enum*), 150
- ESP_BLUFI_MAKE_PUBLIC_ERROR (C++ *enumerator*), 151
- esp_blufi_negotiate_data_handler_t (C++ *type*), 149
- esp_blufi_profile_deinit (C++ *function*), 142
- esp_blufi_profile_init (C++ *function*), 142
- ESP_BLUFI_READ_PARAM_ERROR (C++ *enumerator*), 151
- esp_blufi_register_callbacks (C++ *function*), 142
- esp_blufi_send_custom_data (C++ *function*), 142
- esp_blufi_send_error_info (C++ *function*),

- 142
- esp_blufi_send_wifi_conn_report (C++ function), 142
- esp_blufi_send_wifi_list (C++ function), 142
- ESP_BLUFI_SEQUENCE_ERROR (C++ enumerator), 151
- ESP_BLUFI_STA_CONN_FAIL (C++ enumerator), 150
- esp_blufi_sta_conn_state_t (C++ enum), 150
- ESP_BLUFI_STA_CONN_SUCCESS (C++ enumerator), 150
- esp_bredr_sco_datapath_set (C++ function), 48
- esp_bredr_tx_power_get (C++ function), 48
- esp_bredr_tx_power_set (C++ function), 47
- ESP_BT_CONTROLLER_CONFIG_MAGIC_VAL (C macro), 52
- esp_bt_controller_config_t (C++ class), 50
- esp_bt_controller_config_t::auto_latency (C++ member), 51
- esp_bt_controller_config_t::ble_max_conn (C++ member), 51
- esp_bt_controller_config_t::ble_sca (C++ member), 51
- esp_bt_controller_config_t::bt_legacy_auth_vs_vt (C++ member), 51
- esp_bt_controller_config_t::bt_max_acl_entries (C++ member), 51
- esp_bt_controller_config_t::bt_max_sync_conn (C++ member), 51
- esp_bt_controller_config_t::bt_sco_datapath (C++ member), 51
- esp_bt_controller_config_t::controller_debug_flag (C++ member), 51
- esp_bt_controller_config_t::controller_mode (C++ member), 51
- esp_bt_controller_config_t::controller_status_size (C++ member), 51
- esp_bt_controller_config_t::hci_uart_base_rate (C++ member), 51
- esp_bt_controller_config_t::hci_uart_nops (C++ member), 51
- esp_bt_controller_config_t::hli (C++ member), 51
- esp_bt_controller_config_t::magic (C++ member), 51
- esp_bt_controller_config_t::mesh_adv_size (C++ member), 51
- esp_bt_controller_config_t::mode (C++ member), 51
- esp_bt_controller_config_t::normal_adv_size (C++ member), 51
- esp_bt_controller_config_t::pcm_polar (C++ member), 51
- esp_bt_controller_config_t::pcm_role (C++ member), 51
- esp_bt_controller_config_t::scan_duplicate_mode (C++ member), 51
- esp_bt_controller_config_t::scan_duplicate_type (C++ member), 51
- esp_bt_controller_config_t::send_adv_reserved_size (C++ member), 51
- esp_bt_controller_deinit (C++ function), 48
- esp_bt_controller_disable (C++ function), 48
- esp_bt_controller_enable (C++ function), 48
- esp_bt_controller_get_status (C++ function), 48
- esp_bt_controller_init (C++ function), 48
- esp_bt_controller_mem_release (C++ function), 49
- ESP_BT_CONTROLLER_STATUS_ENABLED (C++ enumerator), 53
- ESP_BT_CONTROLLER_STATUS_IDLE (C++ enumerator), 53
- ESP_BT_CONTROLLER_STATUS_INITED (C++ enumerator), 53
- ESP_BT_CONTROLLER_STATUS_NUM (C++ enumerator), 53
- esp_bt_controller_status_t (C++ enum), 53
- esp_bt_dev_get_address (C++ function), 58
- esp_bt_dev_set_device_name (C++ function), 58
- esp_bt_dev_type_t (C++ enum), 57
- ESP_BT_DEVICE_TYPE_BLE (C++ enumerator), 57
- ESP_BT_DEVICE_TYPE_BREDR (C++ enumerator), 57
- ESP_BT_DEVICE_TYPE_DUMO (C++ enumerator), 57
- esp_bt_duplicate_exceptional_subcode_type_t (C++ enum), 102
- esp_bt_mem_release (C++ function), 49
- ESP_BT_MODE_BLE (C++ enumerator), 52
- ESP_BT_MODE_BTDM (C++ enumerator), 52
- ESP_BT_MODE_CLASSIC_BT (C++ enumerator), 52
- ESP_BT_MODE_IDLE (C++ enumerator), 52
- esp_bt_mode_t (C++ enum), 52
- ESP_BT_OCTET16_LEN (C macro), 55
- esp_bt_octet16_t (C++ type), 56
- ESP_BT_OCTET8_LEN (C macro), 55
- esp_bt_octet8_t (C++ type), 56
- esp_bt_sleep_disable (C++ function), 50
- esp_bt_sleep_enable (C++ function), 50
- ESP_BT_STATUS_AUTH_FAILURE (C++ enumerator), 56
- ESP_BT_STATUS_AUTH_REJECTED (C++ enumerator), 56
- ESP_BT_STATUS_BUSY (C++ enumerator), 56
- ESP_BT_STATUS_CONTROL_LE_DATA_LEN_UNSUPPORTED (C++ enumerator), 57
- ESP_BT_STATUS_DONE (C++ enumerator), 56
- ESP_BT_STATUS_EIR_TOO_LARGE (C++ enumerator), 57
- ESP_BT_STATUS_ERR_ILLEGAL_PARAMETER_FMT

- (C++ enumerator), 57
- ESP_BT_STATUS_FAIL (C++ enumerator), 56
- ESP_BT_STATUS_INVALID_STATIC_RAND_ADDR (C++ enumerator), 56
- ESP_BT_STATUS_MEMORY_FULL (C++ enumerator), 57
- ESP_BT_STATUS_NOMEM (C++ enumerator), 56
- ESP_BT_STATUS_NOT_READY (C++ enumerator), 56
- ESP_BT_STATUS_PARAM_OUT_OF_RANGE (C++ enumerator), 57
- ESP_BT_STATUS_PARM_INVALID (C++ enumerator), 56
- ESP_BT_STATUS_PEER_LE_DATA_LEN_UNSUPPORTED (C++ enumerator), 57
- ESP_BT_STATUS_PENDING (C++ enumerator), 56
- ESP_BT_STATUS_RMT_DEV_DOWN (C++ enumerator), 56
- ESP_BT_STATUS_SUCCESS (C++ enumerator), 56
- esp_bt_status_t (C++ enum), 56
- ESP_BT_STATUS_TIMEOUT (C++ enumerator), 57
- ESP_BT_STATUS_UNACCEPT_CONN_INTERVAL (C++ enumerator), 57
- ESP_BT_STATUS_UNHANDLED (C++ enumerator), 56
- ESP_BT_STATUS_UNSUPPORTED (C++ enumerator), 56
- esp_bt_uuid_t (C++ class), 55
- esp_bt_uuid_t::len (C++ member), 55
- esp_bt_uuid_t::uuid (C++ member), 55
- esp_bt_uuid_t::uuid128 (C++ member), 55
- esp_bt_uuid_t::uuid16 (C++ member), 55
- esp_bt_uuid_t::uuid32 (C++ member), 55
- ESP_CHIP_ID_ESP32 (C++ enumerator), 882
- ESP_CHIP_ID_ESP32C3 (C++ enumerator), 883
- ESP_CHIP_ID_ESP32S2 (C++ enumerator), 883
- ESP_CHIP_ID_ESP32S3 (C++ enumerator), 883
- ESP_CHIP_ID_INVALID (C++ enumerator), 883
- esp_chip_id_t (C++ enum), 882
- esp_chip_info (C++ function), 1092
- esp_chip_info_t (C++ class), 1092
- esp_chip_info_t::cores (C++ member), 1092
- esp_chip_info_t::features (C++ member), 1092
- esp_chip_info_t::model (C++ member), 1092
- esp_chip_info_t::revision (C++ member), 1092
- esp_chip_model_t (C++ enum), 1093
- esp_console_cmd_func_t (C++ type), 898
- esp_console_cmd_register (C++ function), 894
- esp_console_cmd_t (C++ class), 898
- esp_console_cmd_t::argtable (C++ member), 898
- esp_console_cmd_t::command (C++ member), 898
- esp_console_cmd_t::func (C++ member), 898
- esp_console_cmd_t::help (C++ member), 898
- esp_console_cmd_t::hint (C++ member), 898
- ESP_CONSOLE_CONFIG_DEFAULT (C macro), 898
- esp_console_config_t (C++ class), 897
- esp_console_config_t::hint_bold (C++ member), 897
- esp_console_config_t::hint_color (C++ member), 897
- esp_console_config_t::max_cmdline_args (C++ member), 897
- esp_console_config_t::max_cmdline_length (C++ member), 897
- esp_console_deinit (C++ function), 894
- ESP_CONSOLE_DEV_CDC_CONFIG_DEFAULT (C macro), 898
- ESP_CONSOLE_DEV_UART_CONFIG_DEFAULT (C macro), 898
- esp_console_dev_uart_config_t (C++ class), 897
- esp_console_dev_uart_config_t::baud_rate (C++ member), 897
- esp_console_dev_uart_config_t::channel (C++ member), 897
- esp_console_dev_uart_config_t::rx_gpio_num (C++ member), 897
- esp_console_dev_uart_config_t::tx_gpio_num (C++ member), 897
- esp_console_dev_usb_cdc_config_t (C++ class), 897
- esp_console_get_completion (C++ function), 895
- esp_console_get_hint (C++ function), 895
- esp_console_init (C++ function), 894
- esp_console_new_repl_uart (C++ function), 896
- esp_console_new_repl_usb_cdc (C++ function), 896
- esp_console_register_help_command (C++ function), 896
- ESP_CONSOLE_REPL_CONFIG_DEFAULT (C macro), 898
- esp_console_repl_config_t (C++ class), 897
- esp_console_repl_config_t::history_save_path (C++ member), 897
- esp_console_repl_config_t::max_history_len (C++ member), 897
- esp_console_repl_config_t::prompt (C++ member), 897
- esp_console_repl_config_t::task_priority (C++ member), 897
- esp_console_repl_config_t::task_stack_size (C++ member), 897
- esp_console_repl_s (C++ class), 898
- esp_console_repl_s::del (C++ member), 898
- esp_console_repl_t (C++ type), 898
- esp_console_run (C++ function), 895
- esp_console_split_argv (C++ function), 895
- esp_console_start_repl (C++ function), 896
- esp_crt_bundle_attach (C++ function), 762

- esp_crt_bundle_detach (C++ function), 762
 esp_crt_bundle_set (C++ function), 762
 esp_deep_sleep (C++ function), 1115
 esp_deep_sleep_disable_rom_logging (C++ function), 1115
 esp_deep_sleep_enable_gpio_wakeup (C++ function), 1113
 esp_deep_sleep_start (C++ function), 1114
 esp_deep_sleep_wake_stub_fn_t (C++ type), 1116
 esp_deepsleep_gpio_wake_up_mode_t (C++ enum), 1116
 ESP_DEFAULT_GATT_IF (C macro), 55
 esp_default_wake_deep_sleep (C++ function), 1115
 esp_deregister_freertos_idle_hook (C++ function), 1050
 esp_deregister_freertos_idle_hook_for_cpu (C++ function), 1050
 esp_deregister_freertos_tick_hook (C++ function), 1050
 esp_deregister_freertos_tick_hook_for_cpu (C++ function), 1050
 esp_derive_local_mac (C++ function), 1092
 esp_digital_signature_data (C++ class), 532
 esp_digital_signature_data::c (C++ member), 532
 esp_digital_signature_data::iv (C++ member), 532
 esp_digital_signature_data::rsa_length (C++ member), 532
 esp_digital_signature_length_t (C++ enum), 533
 ESP_DRAM_LOGD (C macro), 1087
 ESP_DRAM_LOGE (C macro), 1086
 ESP_DRAM_LOGI (C macro), 1087
 ESP_DRAM_LOGV (C macro), 1087
 ESP_DRAM_LOGW (C macro), 1087
 ESP_DS_C_LEN (C macro), 533
 esp_ds_context_t (C++ type), 533
 esp_ds_data_t (C++ type), 533
 esp_ds_encrypt_params (C++ function), 532
 esp_ds_finish_sign (C++ function), 532
 esp_ds_is_busy (C++ function), 531
 ESP_DS_IV_LEN (C macro), 533
 esp_ds_p_data_t (C++ class), 533
 esp_ds_p_data_t::length (C++ member), 533
 esp_ds_p_data_t::M (C++ member), 533
 esp_ds_p_data_t::M_prime (C++ member), 533
 esp_ds_p_data_t::Rb (C++ member), 533
 esp_ds_p_data_t::Y (C++ member), 533
 ESP_DS_RSA_1024 (C++ enumerator), 533
 ESP_DS_RSA_2048 (C++ enumerator), 533
 ESP_DS_RSA_3072 (C++ enumerator), 533
 ESP_DS_RSA_4096 (C++ enumerator), 533
 esp_ds_sign (C++ function), 531
 esp_ds_start_sign (C++ function), 531
 esp_duplicate_info_t (C++ type), 96
 esp_duplicate_scan_exceptional_list_type_t (C++ enum), 103
 ESP_EARLY_LOGD (C macro), 1086
 ESP_EARLY_LOGE (C macro), 1086
 ESP_EARLY_LOGI (C macro), 1086
 ESP_EARLY_LOGV (C macro), 1086
 ESP_EARLY_LOGW (C macro), 1086
 esp_efuse_batch_write_begin (C++ function), 912
 esp_efuse_batch_write_cancel (C++ function), 913
 esp_efuse_batch_write_commit (C++ function), 913
 esp_efuse_burn_new_values (C++ function), 911
 esp_efuse_check_errors (C++ function), 916
 esp_efuse_check_secure_version (C++ function), 912
 esp_efuse_count_unused_key_blocks (C++ function), 915
 esp_efuse_desc_t (C++ class), 917
 esp_efuse_desc_t::bit_count (C++ member), 917
 esp_efuse_desc_t::bit_start (C++ member), 917
 esp_efuse_desc_t::efuse_block (C++ member), 917
 esp_efuse_disable_rom_download_mode (C++ function), 911
 esp_efuse_enable_rom_secure_download_mode (C++ function), 911
 esp_efuse_find_purpose (C++ function), 915
 esp_efuse_find_unused_key_block (C++ function), 915
 esp_efuse_get_chip_ver (C++ function), 910
 esp_efuse_get_coding_scheme (C++ function), 910
 esp_efuse_get_digest_revoke (C++ function), 915
 esp_efuse_get_field_size (C++ function), 909
 esp_efuse_get_key (C++ function), 913
 esp_efuse_get_key_dis_read (C++ function), 913
 esp_efuse_get_key_dis_write (C++ function), 914
 esp_efuse_get_key_purpose (C++ function), 914
 esp_efuse_get_keypurpose_dis_write (C++ function), 914
 esp_efuse_get_pkg_ver (C++ function), 911
 esp_efuse_get_purpose_field (C++ function), 913
 esp_efuse_get_write_protect_of_digest_revoke (C++ function), 915
 esp_efuse_init (C++ function), 912

- esp_efuse_key_block_unused (C++ function), 915
- ESP_EFUSE_KEY_PURPOSE_HMAC_DOWN_ALL (C++ enumerator), 917
- ESP_EFUSE_KEY_PURPOSE_HMAC_DOWN_DIGITAL_SIGNATURE (C++ enumerator), 917
- ESP_EFUSE_KEY_PURPOSE_HMAC_DOWN_JTAG (C++ enumerator), 917
- ESP_EFUSE_KEY_PURPOSE_HMAC_UP (C++ enumerator), 917
- ESP_EFUSE_KEY_PURPOSE_MAX (C++ enumerator), 917
- ESP_EFUSE_KEY_PURPOSE_RESERVED (C++ enumerator), 917
- ESP_EFUSE_KEY_PURPOSE_SECURE_BOOT_DIGEST0 (C++ enumerator), 917
- ESP_EFUSE_KEY_PURPOSE_SECURE_BOOT_DIGEST1 (C++ enumerator), 917
- ESP_EFUSE_KEY_PURPOSE_SECURE_BOOT_DIGEST2 (C++ enumerator), 917
- ESP_EFUSE_KEY_PURPOSE_USER (C++ enumerator), 917
- ESP_EFUSE_KEY_PURPOSE_XTS_AES_128_KEY (C++ enumerator), 917
- ESP_EFUSE_KEY_PURPOSE_XTS_AES_256_KEY_1 (C++ enumerator), 917
- ESP_EFUSE_KEY_PURPOSE_XTS_AES_256_KEY_2 (C++ enumerator), 917
- esp_efuse_mac_get_custom (C++ function), 1091
- esp_efuse_mac_get_default (C++ function), 1091
- esp_efuse_purpose_t (C++ enum), 917
- esp_efuse_read_block (C++ function), 910
- esp_efuse_read_field_bit (C++ function), 908
- esp_efuse_read_field_blob (C++ function), 907
- esp_efuse_read_field_cnt (C++ function), 908
- esp_efuse_read_reg (C++ function), 909
- esp_efuse_read_secure_version (C++ function), 912
- esp_efuse_reset (C++ function), 911
- esp_efuse_set_digest_revoke (C++ function), 915
- esp_efuse_set_key_dis_read (C++ function), 913
- esp_efuse_set_key_dis_write (C++ function), 914
- esp_efuse_set_key_purpose (C++ function), 914
- esp_efuse_set_keypurpose_dis_write (C++ function), 914
- esp_efuse_set_read_protect (C++ function), 909
- esp_efuse_set_write_protect (C++ function), 909
- esp_efuse_set_write_protect_of_digest_revoke (C++ function), 916
- esp_efuse_update_secure_version (C++ function), 912
- ESP_ERR_ALREADY_EXISTS (C macro), 448
- esp_efuse_write_block (C++ function), 910
- esp_efuse_write_field_bit (C++ function), 909
- esp_efuse_write_field_blob (C++ function), 908
- esp_efuse_write_field_cnt (C++ function), 908
- esp_efuse_write_key (C++ function), 916
- esp_efuse_write_keys (C++ function), 916
- esp_efuse_write_random_key (C++ function), 911
- esp_efuse_write_reg (C++ function), 910
- ESP_ERR_CODING (C macro), 917
- ESP_ERR_DPP_FAILURE (C macro), 448
- ESP_ERR_DPP_INVALID_ATTR (C macro), 448
- ESP_ERR_DPP_TX_FAILURE (C macro), 448
- ESP_ERR_EFUSE (C macro), 917
- ESP_ERR_EFUSE_CNT_IS_FULL (C macro), 917
- ESP_ERR_EFUSE_REPEATED_PROG (C macro), 917
- ESP_ERR_ESP_TLS_BASE (C macro), 675
- ESP_ERR_ESP_TLS_CANNOT_CREATE_SOCKET (C macro), 675
- ESP_ERR_ESP_TLS_CANNOT_RESOLVE_HOSTNAME (C macro), 675
- ESP_ERR_ESP_TLS_CONNECTION_TIMEOUT (C macro), 676
- ESP_ERR_ESP_TLS_FAILED_CONNECT_TO_HOST (C macro), 675
- ESP_ERR_ESP_TLS_SE_FAILED (C macro), 676
- ESP_ERR_ESP_TLS_SOCKET_SETOPT_FAILED (C macro), 675
- ESP_ERR_ESP_TLS_UNSUPPORTED_PROTOCOL_FAMILY (C macro), 675
- ESP_ERR_ESPNOW_ARG (C macro), 413
- ESP_ERR_ESPNOW_BASE (C macro), 413
- ESP_ERR_ESPNOW_EXIST (C macro), 413
- ESP_ERR_ESPNOW_FULL (C macro), 413
- ESP_ERR_ESPNOW_IF (C macro), 413
- ESP_ERR_ESPNOW_INTERNAL (C macro), 413
- ESP_ERR_ESPNOW_NO_MEM (C macro), 413
- ESP_ERR_ESPNOW_NOT_FOUND (C macro), 413
- ESP_ERR_ESPNOW_NOT_INIT (C macro), 413
- ESP_ERR_FLASH_BASE (C macro), 919
- ESP_ERR_HTTP_BASE (C macro), 688
- ESP_ERR_HTTP_CONNECT (C macro), 688
- ESP_ERR_HTTP_CONNECTING (C macro), 688
- ESP_ERR_HTTP_EAGAIN (C macro), 688
- ESP_ERR_HTTP_FETCH_HEADER (C macro), 688
- ESP_ERR_HTTP_INVALID_TRANSPORT (C macro), 688
- ESP_ERR_HTTP_MAX_REDIRECT (C macro), 688
- ESP_ERR_HTTP_WRITE_DATA (C macro), 688
- ESP_ERR_HTTPD_ALLOC_MEM (C macro), 709

- ESP_ERR_HTTPD_BASE (C macro), 709
- ESP_ERR_HTTPD_HANDLER_EXISTS (C macro), 709
- ESP_ERR_HTTPD_HANDLERS_FULL (C macro), 709
- ESP_ERR_HTTPD_INVALID_REQ (C macro), 709
- ESP_ERR_HTTPD_RESP_HDR (C macro), 709
- ESP_ERR_HTTPD_RESP_SEND (C macro), 709
- ESP_ERR_HTTPD_RESULT_TRUNC (C macro), 709
- ESP_ERR_HTTPD_TASK (C macro), 709
- ESP_ERR_HTTPS_OTA_BASE (C macro), 922
- ESP_ERR_HTTPS_OTA_IN_PROGRESS (C macro), 922
- ESP_ERR_HW_CRYPTTO_BASE (C macro), 919
- ESP_ERR_HW_CRYPTTO_DS_HMAC_FAIL (C macro), 533
- ESP_ERR_HW_CRYPTTO_DS_INVALID_DIGEST (C macro), 533
- ESP_ERR_HW_CRYPTTO_DS_INVALID_KEY (C macro), 533
- ESP_ERR_HW_CRYPTTO_DS_INVALID_PADDING (C macro), 533
- ESP_ERR_INVALID_ARG (C macro), 918
- ESP_ERR_INVALID_CRC (C macro), 919
- ESP_ERR_INVALID_MAC (C macro), 919
- ESP_ERR_INVALID_RESPONSE (C macro), 919
- ESP_ERR_INVALID_SIZE (C macro), 918
- ESP_ERR_INVALID_STATE (C macro), 918
- ESP_ERR_INVALID_VERSION (C macro), 919
- ESP_ERR_MBEDTLS_CERT_PARTLY_OK (C macro), 675
- ESP_ERR_MBEDTLS_CTR_DRBG_SEED_FAILED (C macro), 675
- ESP_ERR_MBEDTLS_PK_PARSE_KEY_FAILED (C macro), 676
- ESP_ERR_MBEDTLS_SSL_CONF_ALPN_PROTOCOLS_FAILED (C macro), 675
- ESP_ERR_MBEDTLS_SSL_CONF_OWN_CERT_FAILED (C macro), 675
- ESP_ERR_MBEDTLS_SSL_CONF_PSK_FAILED (C macro), 676
- ESP_ERR_MBEDTLS_SSL_CONFIG_DEFAULTS_FAILED (C macro), 675
- ESP_ERR_MBEDTLS_SSL_HANDSHAKE_FAILED (C macro), 676
- ESP_ERR_MBEDTLS_SSL_SET_HOSTNAME_FAILED (C macro), 675
- ESP_ERR_MBEDTLS_SSL_SETUP_FAILED (C macro), 676
- ESP_ERR_MBEDTLS_SSL_WRITE_FAILED (C macro), 676
- ESP_ERR_MBEDTLS_X509_CERT_PARSE_FAILED (C macro), 675
- ESP_ERR_MESH_ARGUMENT (C macro), 441
- ESP_ERR_MESH_BASE (C macro), 919
- ESP_ERR_MESH_DISCARD (C macro), 442
- ESP_ERR_MESH_DISCARD_DUPLICATE (C macro), 441
- ESP_ERR_MESH_DISCONNECTED (C macro), 441
- ESP_ERR_MESH_EXCEED_MTU (C macro), 441
- ESP_ERR_MESH_INTERFACE (C macro), 441
- ESP_ERR_MESH_NO_MEMORY (C macro), 441
- ESP_ERR_MESH_NO_PARENT_FOUND (C macro), 441
- ESP_ERR_MESH_NO_ROUTE_FOUND (C macro), 441
- ESP_ERR_MESH_NOT_ALLOWED (C macro), 441
- ESP_ERR_MESH_NOT_CONFIG (C macro), 441
- ESP_ERR_MESH_NOT_INIT (C macro), 441
- ESP_ERR_MESH_NOT_START (C macro), 441
- ESP_ERR_MESH_NOT_SUPPORT (C macro), 441
- ESP_ERR_MESH_OPTION_NULL (C macro), 441
- ESP_ERR_MESH_OPTION_UNKNOWN (C macro), 441
- ESP_ERR_MESH_PS (C macro), 442
- ESP_ERR_MESH_QUEUE_FAIL (C macro), 441
- ESP_ERR_MESH_QUEUE_FULL (C macro), 441
- ESP_ERR_MESH_QUEUE_READ (C macro), 442
- ESP_ERR_MESH_RECV_RELEASE (C macro), 442
- ESP_ERR_MESH_TIMEOUT (C macro), 441
- ESP_ERR_MESH_VOTING (C macro), 442
- ESP_ERR_MESH_WIFI_NOT_START (C macro), 441
- ESP_ERR_MESH_XMIT (C macro), 442
- ESP_ERR_MESH_XON_NO_WINDOW (C macro), 441
- ESP_ERR_NO_MEM (C macro), 918
- ESP_ERR_NOT_ENOUGH_UNUSED_KEY_BLOCKS (C macro), 917
- ESP_ERR_NOT_FINISHED (C macro), 755
- ESP_ERR_NOT_FOUND (C macro), 918
- ESP_ERR_NOT_SUPPORTED (C macro), 919
- ESP_ERR_NVS_BASE (C macro), 820
- ESP_ERR_NVS_CONTENT_DIFFERS (C macro), 820
- ESP_ERR_NVS_CORRUPT_KEY_PART (C macro), 821
- ESP_ERR_NVS_ENCR_NOT_SUPPORTED (C macro), 820
- ESP_ERR_NVS_INVALID_HANDLE (C macro), 820
- ESP_ERR_NVS_INVALID_LENGTH (C macro), 820
- ESP_ERR_NVS_INVALID_NAME (C macro), 820
- ESP_ERR_NVS_INVALID_STATE (C macro), 820
- ESP_ERR_NVS_KEY_TOO_LONG (C macro), 820
- ESP_ERR_NVS_KEYS_NOT_INITIALIZED (C macro), 820
- ESP_ERR_NVS_NEW_VERSION_FOUND (C macro), 820
- ESP_ERR_NVS_NO_FREE_PAGES (C macro), 820
- ESP_ERR_NVS_NOT_ENOUGH_SPACE (C macro), 820
- ESP_ERR_NVS_NOT_FOUND (C macro), 820
- ESP_ERR_NVS_NOT_INITIALIZED (C macro), 820
- ESP_ERR_NVS_PAGE_FULL (C macro), 820
- ESP_ERR_NVS_PART_NOT_FOUND (C macro), 820
- ESP_ERR_NVS_READ_ONLY (C macro), 820

- ESP_ERR_NV_S_REMOVE_FAILED (*C macro*), 820
- ESP_ERR_NV_S_TYPE_MISMATCH (*C macro*), 820
- ESP_ERR_NV_S_VALUE_TOO_LONG (*C macro*), 820
- ESP_ERR_NV_S_WRONG_ENCRYPTION (*C macro*), 821
- ESP_ERR_NV_S_XTS_CFG_FAILED (*C macro*), 820
- ESP_ERR_NV_S_XTS_CFG_NOT_FOUND (*C macro*), 820
- ESP_ERR_NV_S_XTS_DECR_FAILED (*C macro*), 820
- ESP_ERR_NV_S_XTS_ENCR_FAILED (*C macro*), 820
- ESP_ERR_OTA_BASE (*C macro*), 1104
- ESP_ERR_OTA_PARTITION_CONFLICT (*C macro*), 1104
- ESP_ERR_OTA_ROLLBACK_FAILED (*C macro*), 1104
- ESP_ERR_OTA_ROLLBACK_INVALID_STATE (*C macro*), 1104
- ESP_ERR_OTA_SELECT_INFO_INVALID (*C macro*), 1104
- ESP_ERR_OTA_SMALL_SEC_VER (*C macro*), 1104
- ESP_ERR_OTA_VALIDATE_FAILED (*C macro*), 1104
- esp_err_t (*C++ type*), 919
- ESP_ERR_TIMEOUT (*C macro*), 919
- esp_err_to_name (*C++ function*), 918
- esp_err_to_name_r (*C++ function*), 918
- ESP_ERR_WIFI_BASE (*C macro*), 919
- ESP_ERR_WIFI_CONN (*C macro*), 381
- ESP_ERR_WIFI_IF (*C macro*), 381
- ESP_ERR_WIFI_INIT_STATE (*C macro*), 382
- ESP_ERR_WIFI_MAC (*C macro*), 381
- ESP_ERR_WIFI_MODE (*C macro*), 381
- ESP_ERR_WIFI_NOT_ASSOC (*C macro*), 382
- ESP_ERR_WIFI_NOT_CONNECT (*C macro*), 381
- ESP_ERR_WIFI_NOT_INIT (*C macro*), 381
- ESP_ERR_WIFI_NOT_STARTED (*C macro*), 381
- ESP_ERR_WIFI_NOT_STOPPED (*C macro*), 381
- ESP_ERR_WIFI_NV_S (*C macro*), 381
- ESP_ERR_WIFI_PASSWORD (*C macro*), 381
- ESP_ERR_WIFI_POST (*C macro*), 382
- ESP_ERR_WIFI_SSID (*C macro*), 381
- ESP_ERR_WIFI_STATE (*C macro*), 381
- ESP_ERR_WIFI_STOP_STATE (*C macro*), 382
- ESP_ERR_WIFI_TIMEOUT (*C macro*), 381
- ESP_ERR_WIFI_TX_DISALLOW (*C macro*), 382
- ESP_ERR_WIFI_WAKE_FAIL (*C macro*), 381
- ESP_ERR_WIFI_WOULD_BLOCK (*C macro*), 381
- ESP_ERR_WOLFSSL_CERT_VERIFY_SETUP_FAILED (*C macro*), 676
- ESP_ERR_WOLFSSL_CTX_SETUP_FAILED (*C macro*), 676
- ESP_ERR_WOLFSSL_KEY_VERIFY_SETUP_FAILED (*C macro*), 676
- ESP_ERR_WOLFSSL_SSL_CONF_ALPN_PROTOCOLS_FAILED (*C macro*), 676
- ESP_ERR_WOLFSSL_SSL_HANDSHAKE_FAILED (*C macro*), 676
- ESP_ERR_WOLFSSL_SSL_SET_HOSTNAME_FAILED (*C macro*), 676
- ESP_ERR_WOLFSSL_SSL_SETUP_FAILED (*C macro*), 676
- ESP_ERR_WOLFSSL_SSL_WRITE_FAILED (*C macro*), 676
- ESP_ERROR_CHECK (*C macro*), 919
- ESP_ERROR_CHECK_WITHOUT_ABORT (*C macro*), 919
- esp_esptouch_set_timeout (*C++ function*), 405
- esp_eth_clear_default_handlers (*C++ function*), 469
- esp_eth_config_t (*C++ class*), 458
- esp_eth_config_t::check_link_period_ms (*C++ member*), 458
- esp_eth_config_t::mac (*C++ member*), 458
- esp_eth_config_t::on_lowlevel_deinit_done (*C++ member*), 458
- esp_eth_config_t::on_lowlevel_init_done (*C++ member*), 458
- esp_eth_config_t::phy (*C++ member*), 458
- esp_eth_config_t::stack_input (*C++ member*), 458
- esp_eth_decrease_reference (*C++ function*), 457
- esp_eth_del_netif_glue (*C++ function*), 469
- esp_eth_detect_phy_addr (*C++ function*), 459
- esp_eth_driver_install (*C++ function*), 455
- esp_eth_driver_uninstall (*C++ function*), 456
- esp_eth_handle_t (*C++ type*), 458
- esp_eth_increase_reference (*C++ function*), 457
- esp_eth_io_cmd_t (*C++ enum*), 460
- esp_eth_ioctl (*C++ function*), 457
- esp_eth_mac_s (*C++ class*), 462
- esp_eth_mac_s::deinit (*C++ member*), 462
- esp_eth_mac_s::del (*C++ member*), 465
- esp_eth_mac_s::enable_flow_ctrl (*C++ member*), 464
- esp_eth_mac_s::get_addr (*C++ member*), 464
- esp_eth_mac_s::init (*C++ member*), 462
- esp_eth_mac_s::read_phy_reg (*C++ member*), 463
- esp_eth_mac_s::receive (*C++ member*), 463
- esp_eth_mac_s::set_addr (*C++ member*), 463
- esp_eth_mac_s::set_duplex (*C++ member*), 464
- esp_eth_mac_s::set_link (*C++ member*), 464
- esp_eth_mac_s::set_mediator (*C++ member*), 462
- esp_eth_mac_s::set_peer_pause_ability (*C++ member*), 465
- esp_eth_mac_s::set_promiscuous (*C++ member*), 464

- esp_eth_mac_s::set_speed (C++ member), 464
- esp_eth_mac_s::start (C++ member), 462
- esp_eth_mac_s::stop (C++ member), 462
- esp_eth_mac_s::transmit (C++ member), 462
- esp_eth_mac_s::write_phy_reg (C++ member), 463
- esp_eth_mac_t (C++ type), 465
- esp_eth_mediator_s (C++ class), 459
- esp_eth_mediator_s::on_state_changed (C++ member), 459
- esp_eth_mediator_s::phy_reg_read (C++ member), 459
- esp_eth_mediator_s::phy_reg_write (C++ member), 459
- esp_eth_mediator_s::stack_input (C++ member), 459
- esp_eth_mediator_t (C++ type), 460
- esp_eth_new_netif_glue (C++ function), 469
- ESP_ETH_PHY_ADDR_AUTO (C macro), 469
- esp_eth_phy_new_dp83848 (C++ function), 466
- esp_eth_phy_new_ip101 (C++ function), 466
- esp_eth_phy_new_ksz8041 (C++ function), 466
- esp_eth_phy_new_lan8720 (C++ function), 466
- esp_eth_phy_new_rtl8201 (C++ function), 466
- esp_eth_phy_s (C++ class), 466
- esp_eth_phy_s::advertise_pause_ability (C++ member), 468
- esp_eth_phy_s::deinit (C++ member), 467
- esp_eth_phy_s::del (C++ member), 468
- esp_eth_phy_s::get_addr (C++ member), 468
- esp_eth_phy_s::get_link (C++ member), 467
- esp_eth_phy_s::init (C++ member), 467
- esp_eth_phy_s::negotiate (C++ member), 467
- esp_eth_phy_s::pwrctl (C++ member), 467
- esp_eth_phy_s::reset (C++ member), 467
- esp_eth_phy_s::reset_hw (C++ member), 467
- esp_eth_phy_s::set_addr (C++ member), 468
- esp_eth_phy_s::set_mediator (C++ member), 466
- esp_eth_phy_t (C++ type), 469
- esp_eth_receive (C++ function), 457
- esp_eth_set_default_handlers (C++ function), 469
- esp_eth_start (C++ function), 456
- esp_eth_state_t (C++ enum), 460
- esp_eth_stop (C++ function), 456
- esp_eth_transmit (C++ function), 456
- esp_eth_update_input_path (C++ function), 456
- ESP_EVENT_ANY_BASE (C macro), 936
- ESP_EVENT_ANY_ID (C macro), 936
- esp_event_base_t (C++ type), 936
- ESP_EVENT_DECLARE_BASE (C macro), 936
- ESP_EVENT_DEFINE_BASE (C macro), 936
- esp_event_dump (C++ function), 934
- esp_event_handler_instance_register (C++ function), 931
- esp_event_handler_instance_register_with (C++ function), 930
- esp_event_handler_instance_t (C++ type), 936
- esp_event_handler_instance_unregister (C++ function), 933
- esp_event_handler_instance_unregister_with (C++ function), 932
- esp_event_handler_register (C++ function), 929
- esp_event_handler_register_with (C++ function), 930
- esp_event_handler_t (C++ type), 936
- esp_event_handler_unregister (C++ function), 931
- esp_event_handler_unregister_with (C++ function), 932
- esp_event_isr_post (C++ function), 934
- esp_event_isr_post_to (C++ function), 934
- esp_event_loop_args_t (C++ class), 935
- esp_event_loop_args_t::queue_size (C++ member), 935
- esp_event_loop_args_t::task_core_id (C++ member), 935
- esp_event_loop_args_t::task_name (C++ member), 935
- esp_event_loop_args_t::task_priority (C++ member), 935
- esp_event_loop_args_t::task_stack_size (C++ member), 935
- esp_event_loop_create (C++ function), 928
- esp_event_loop_create_default (C++ function), 929
- esp_event_loop_delete (C++ function), 929
- esp_event_loop_delete_default (C++ function), 929
- esp_event_loop_handle_t (C++ type), 936
- esp_event_loop_init (C++ function), 937
- esp_event_loop_run (C++ function), 929
- esp_event_loop_set_cb (C++ function), 937
- esp_event_post (C++ function), 933
- esp_event_post_to (C++ function), 933
- esp_event_process_default (C++ function), 937
- esp_event_send (C++ function), 936
- esp_event_send_internal (C++ function), 936
- esp_event_set_default_eth_handlers (C++ function), 937
- esp_event_set_default_wifi_handlers (C++ function), 937
- ESP_EXECUTE_EXPRESSION_WITH_STACK (C macro), 1077
- esp_execute_shared_stack_function (C++ function), 1077
- ESP_EXT1_WAKEUP_ALL_LOW (C++ enumerator), 1116

- ESP_EXT1_WAKEUP_ANY_HIGH (C++ enumerator), 1116
- ESP_FAIL (C macro), 918
- esp_fill_random (C++ function), 1091
- ESP_FLASH_10MHZ (C++ enumerator), 851
- ESP_FLASH_20MHZ (C++ enumerator), 851
- ESP_FLASH_26MHZ (C++ enumerator), 852
- ESP_FLASH_40MHZ (C++ enumerator), 852
- ESP_FLASH_5MHZ (C++ enumerator), 851
- ESP_FLASH_80MHZ (C++ enumerator), 852
- esp_flash_chip_driver_initialized (C++ function), 843
- ESP_FLASH_ENC_MODE_DEVELOPMENT (C++ enumerator), 859
- ESP_FLASH_ENC_MODE_DISABLED (C++ enumerator), 859
- ESP_FLASH_ENC_MODE_RELEASE (C++ enumerator), 859
- esp_flash_enc_mode_t (C++ enum), 859
- esp_flash_encrypt_check_and_update (C++ function), 859
- esp_flash_encrypt_region (C++ function), 859
- esp_flash_encryption_enabled (C++ function), 859
- esp_flash_encryption_init_checks (C++ function), 859
- esp_flash_erase_chip (C++ function), 844
- esp_flash_erase_region (C++ function), 844
- esp_flash_get_chip_write_protect (C++ function), 844
- esp_flash_get_protectable_regions (C++ function), 845
- esp_flash_get_protected_region (C++ function), 845
- esp_flash_get_size (C++ function), 844
- esp_flash_init (C++ function), 843
- esp_flash_io_mode_t (C++ enum), 852
- esp_flash_is_quad_mode (C++ function), 847
- esp_flash_os_functions_t (C++ class), 847
- esp_flash_os_functions_t::check_yield (C++ member), 847
- esp_flash_os_functions_t::delay_us (C++ member), 847
- esp_flash_os_functions_t::end (C++ member), 847
- esp_flash_os_functions_t::get_system_time (C++ member), 847
- esp_flash_os_functions_t::get_temp_buffer (C++ member), 847
- esp_flash_os_functions_t::region_protected (C++ member), 847
- esp_flash_os_functions_t::release_temp_buffer (C++ member), 847
- esp_flash_os_functions_t::start (C++ member), 847
- esp_flash_os_functions_t::yield (C++ member), 847
- esp_flash_read (C++ function), 845
- esp_flash_read_encrypted (C++ function), 846
- esp_flash_read_id (C++ function), 843
- esp_flash_region_t (C++ class), 847
- esp_flash_region_t::offset (C++ member), 847
- esp_flash_region_t::size (C++ member), 847
- esp_flash_set_chip_write_protect (C++ function), 844
- esp_flash_set_protected_region (C++ function), 845
- ESP_FLASH_SPEED_MAX (C++ enumerator), 852
- ESP_FLASH_SPEED_MIN (C macro), 851
- esp_flash_speed_t (C++ enum), 851
- esp_flash_spi_device_config_t (C++ class), 843
- esp_flash_spi_device_config_t::cs_id (C++ member), 843
- esp_flash_spi_device_config_t::cs_io_num (C++ member), 843
- esp_flash_spi_device_config_t::host_id (C++ member), 843
- esp_flash_spi_device_config_t::input_delay_ns (C++ member), 843
- esp_flash_spi_device_config_t::io_mode (C++ member), 843
- esp_flash_spi_device_config_t::speed (C++ member), 843
- esp_flash_t (C++ class), 847
- esp_flash_t (C++ type), 848
- esp_flash_t::busy (C++ member), 848
- esp_flash_t::chip_drv (C++ member), 848
- esp_flash_t::chip_id (C++ member), 848
- esp_flash_t::host (C++ member), 848
- esp_flash_t::os_func (C++ member), 848
- esp_flash_t::os_func_data (C++ member), 848
- esp_flash_t::read_mode (C++ member), 848
- esp_flash_t::reserved_flags (C++ member), 848
- esp_flash_t::size (C++ member), 848
- esp_flash_write (C++ function), 846
- esp_flash_write_encrypted (C++ function), 846
- esp_flash_write_protect_crypt_cnt (C++ function), 859
- esp_freertos_idle_cb_t (C++ type), 1050
- esp_freertos_tick_cb_t (C++ type), 1050
- ESP_GAP_BLE_ADD_WHITELIST_COMPLETE_EVT (C macro), 94
- ESP_GAP_BLE_ADV_DATA_RAW_SET_COMPLETE_EVT (C++ enumerator), 97
- ESP_GAP_BLE_ADV_DATA_SET_COMPLETE_EVT (C++ enumerator), 96
- ESP_GAP_BLE_ADV_START_COMPLETE_EVT (C++ enumerator), 97

- ESP_GAP_BLE_ADV_STOP_COMPLETE_EVT (C++ enumerator), 97
- ESP_GAP_BLE_ADV_TERMINATED_EVT (C++ enumerator), 98
- ESP_GAP_BLE_AUTH_CMPL_EVT (C++ enumerator), 97
- esp_gap_ble_cb_event_t (C++ enum), 96
- esp_gap_ble_cb_t (C++ type), 96
- ESP_GAP_BLE_CHANNEL_SELETE_ALGORITHM_EVT (C++ enumerator), 98
- esp_gap_ble_channels (C++ type), 96
- ESP_GAP_BLE_CHANNELS_LEN (C macro), 94
- ESP_GAP_BLE_CLEAR_BOND_DEV_COMPLETE_EVT (C++ enumerator), 97
- ESP_GAP_BLE_EVT_MAX (C++ enumerator), 98
- ESP_GAP_BLE_EXT_ADV_DATA_SET_COMPLETE_EVT (C++ enumerator), 98
- ESP_GAP_BLE_EXT_ADV_REPORT_EVT (C++ enumerator), 98
- ESP_GAP_BLE_EXT_ADV_SET_CLEAR_COMPLETE_EVT (C++ enumerator), 98
- ESP_GAP_BLE_EXT_ADV_SET_PARAMS_COMPLETE_EVT (C++ enumerator), 98
- ESP_GAP_BLE_EXT_ADV_SET_RAND_ADDR_COMPLETE_EVT (C++ enumerator), 98
- ESP_GAP_BLE_EXT_ADV_SET_REMOVE_COMPLETE_EVT (C++ enumerator), 98
- ESP_GAP_BLE_EXT_ADV_START_COMPLETE_EVT (C++ enumerator), 98
- ESP_GAP_BLE_EXT_ADV_STOP_COMPLETE_EVT (C++ enumerator), 98
- ESP_GAP_BLE_EXT_SCAN_RSP_DATA_SET_COMPLETE_EVT (C++ enumerator), 98
- ESP_GAP_BLE_EXT_SCAN_START_COMPLETE_EVT (C++ enumerator), 98
- ESP_GAP_BLE_EXT_SCAN_STOP_COMPLETE_EVT (C++ enumerator), 98
- ESP_GAP_BLE_GET_BOND_DEV_COMPLETE_EVT (C++ enumerator), 97
- ESP_GAP_BLE_KEY_EVT (C++ enumerator), 97
- ESP_GAP_BLE_LOCAL_ER_EVT (C++ enumerator), 97
- ESP_GAP_BLE_LOCAL_IR_EVT (C++ enumerator), 97
- ESP_GAP_BLE_NC_REQ_EVT (C++ enumerator), 97
- ESP_GAP_BLE_OOB_REQ_EVT (C++ enumerator), 97
- ESP_GAP_BLE_PASSKEY_NOTIF_EVT (C++ enumerator), 97
- ESP_GAP_BLE_PASSKEY_REQ_EVT (C++ enumerator), 97
- ESP_GAP_BLE_PERIODIC_ADV_ADD_DEV_COMPLETE_EVT (C++ enumerator), 98
- ESP_GAP_BLE_PERIODIC_ADV_CLEAR_DEV_COMPLETE_EVT (C++ enumerator), 98
- ESP_GAP_BLE_PERIODIC_ADV_CREATE_SYNC_COMPLETE_EVT (C++ enumerator), 98
- ESP_GAP_BLE_PERIODIC_ADV_DATA_SET_COMPLETE_EVT (C++ enumerator), 97
- ESP_GAP_BLE_PERIODIC_ADV_REMOVE_DEV_COMPLETE_EVT (C++ enumerator), 98
- ESP_GAP_BLE_PERIODIC_ADV_REPORT_EVT (C++ enumerator), 98
- ESP_GAP_BLE_PERIODIC_ADV_SET_PARAMS_COMPLETE_EVT (C++ enumerator), 98
- ESP_GAP_BLE_PERIODIC_ADV_START_COMPLETE_EVT (C++ enumerator), 98
- ESP_GAP_BLE_PERIODIC_ADV_STOP_COMPLETE_EVT (C++ enumerator), 98
- ESP_GAP_BLE_PERIODIC_ADV_SYNC_CANCEL_COMPLETE_EVT (C++ enumerator), 98
- ESP_GAP_BLE_PERIODIC_ADV_SYNC_ESTAB_EVT (C++ enumerator), 98
- ESP_GAP_BLE_PERIODIC_ADV_SYNC_LOST_EVT (C++ enumerator), 98
- ESP_GAP_BLE_PERIODIC_ADV_SYNC_TERMINATE_COMPLETE_EVT (C++ enumerator), 98
- ESP_GAP_BLE_PHY_UPDATE_COMPLETE_EVT (C++ enumerator), 98
- ESP_GAP_BLE_PREFER_EXT_CONN_PARAMS_SET_COMPLETE_EVT (C++ enumerator), 98
- ESP_GAP_BLE_READ_PHY_COMPLETE_EVT (C++ enumerator), 97
- ESP_GAP_BLE_READ_RSSI_COMPLETE_EVT (C++ enumerator), 97
- ESP_GAP_BLE_REMOVE_BOND_DEV_COMPLETE_EVT (C++ enumerator), 97
- ESP_GAP_BLE_SCAN_PARAM_SET_COMPLETE_EVT (C++ enumerator), 96
- ESP_GAP_BLE_SCAN_REQ_RECEIVED_EVT (C++ enumerator), 98
- ESP_GAP_BLE_SCAN_RESULT_EVT (C++ enumerator), 96
- ESP_GAP_BLE_SCAN_RSP_DATA_RAW_SET_COMPLETE_EVT (C++ enumerator), 97
- ESP_GAP_BLE_SCAN_RSP_DATA_SET_COMPLETE_EVT (C++ enumerator), 96
- ESP_GAP_BLE_SCAN_START_COMPLETE_EVT (C++ enumerator), 97
- ESP_GAP_BLE_SCAN_STOP_COMPLETE_EVT (C++ enumerator), 97
- ESP_GAP_BLE_SCAN_TIMEOUT_EVT (C++ enumerator), 98
- ESP_GAP_BLE_SEC_REQ_EVT (C++ enumerator), 97
- esp_gap_ble_set_authorization (C++ function), 65
- esp_gap_ble_set_channels (C++ function), 65
- ESP_GAP_BLE_SET_CHANNELS_EVT (C++ enumerator), 97
- ESP_GAP_BLE_SET_EXT_SCAN_PARAMS_COMPLETE_EVT (C++ enumerator), 98
- ESP_GAP_BLE_SET_LOCAL_PRIVACY_COMPLETE_EVT (C++ enumerator), 97
- ESP_GAP_BLE_SET_PKT_LENGTH_COMPLETE_EVT (C++ enumerator), 97

- ESP_GAP_BLE_SET_PREFERED_DEFAULT_PHY_COMPLETE_EVT
(C++ *enumerator*), 98
- ESP_GAP_BLE_SET_PREFERED_PHY_COMPLETE_EVT
(C++ *enumerator*), 98
- ESP_GAP_BLE_SET_STATIC_RAND_ADDR_EVT
(C++ *enumerator*), 97
- ESP_GAP_BLE_UPDATE_CONN_PARAMS_EVT
(C++ *enumerator*), 97
- ESP_GAP_BLE_UPDATE_DUPLICATE_EXCEPTIONAL_LIST_COMPLETE_EVT
(C++ *enumerator*), 97
- ESP_GAP_BLE_UPDATE_WHITELIST_COMPLETE_EVT
(C++ *enumerator*), 97
- esp_gap_conn_params_t (C++ *class*), 84
- esp_gap_conn_params_t::interval (C++
member), 84
- esp_gap_conn_params_t::latency (C++
member), 84
- esp_gap_conn_params_t::timeout (C++
member), 84
- ESP_GAP_SEARCH_DI_DISC_CMPL_EVT (C++
enumerator), 102
- ESP_GAP_SEARCH_DISC_BLE_RES_EVT (C++
enumerator), 101
- ESP_GAP_SEARCH_DISC_CMPL_EVT (C++ *enu-
merator*), 102
- ESP_GAP_SEARCH_DISC_RES_EVT (C++ *enumer-
ator*), 101
- esp_gap_search_evt_t (C++ *enum*), 101
- ESP_GAP_SEARCH_INQ_CMPL_EVT (C++ *enumer-
ator*), 101
- ESP_GAP_SEARCH_INQ_DISCARD_NUM_EVT
(C++ *enumerator*), 102
- ESP_GAP_SEARCH_INQ_RES_EVT (C++ *enumer-
ator*), 101
- ESP_GAP_SEARCH_SEARCH_CANCEL_CMPL_EVT
(C++ *enumerator*), 102
- ESP_GATT_ALREADY_OPEN (C++ *enumerator*), 112
- ESP_GATT_APP_RSP (C++ *enumerator*), 112
- ESP_GATT_ATTR_HANDLE_MAX (C *macro*), 110
- ESP_GATT_AUTH_FAIL (C++ *enumerator*), 112
- ESP_GATT_AUTH_REQ_MITM (C++ *enumerator*),
113
- ESP_GATT_AUTH_REQ_NO_MITM (C++ *enumer-
ator*), 113
- ESP_GATT_AUTH_REQ_NONE (C++ *enumerator*),
112
- ESP_GATT_AUTH_REQ_SIGNED_MITM (C++ *enu-
merator*), 113
- ESP_GATT_AUTH_REQ_SIGNED_NO_MITM (C++
enumerator), 113
- esp_gatt_auth_req_t (C++ *enum*), 112
- ESP_GATT_AUTO_RSP (C *macro*), 110
- ESP_GATT_BODY_SENSOR_LOCATION (C *macro*),
109
- ESP_GATT_BUSY (C++ *enumerator*), 111
- ESP_GATT_CANCEL (C++ *enumerator*), 112
- ESP_GATT_CCC_CFG_ERR (C++ *enumerator*), 112
- ESP_GATT_CHAR_PROP_BIT_AUTH (C *macro*),
- ESP_GATT_CHAR_PROP_BIT_BROADCAST (C
macro), 110
- ESP_GATT_CHAR_PROP_BIT_EXT_PROP (C
macro), 110
- ESP_GATT_CHAR_PROP_BIT_INDICATE (C
macro), 110
- ESP_GATT_CHAR_PROP_BIT_NOTIFY (C *macro*),
- ESP_GATT_CHAR_PROP_BIT_READ (C *macro*),
- ESP_GATT_CHAR_PROP_BIT_WRITE (C *macro*),
110
- ESP_GATT_CHAR_PROP_BIT_WRITE_NR (C
macro), 110
- esp_gatt_char_prop_t (C++ *type*), 111
- ESP_GATT_CMD_STARTED (C++ *enumerator*), 111
- ESP_GATT_CONGESTED (C++ *enumerator*), 112
- ESP_GATT_CONN_CONN_CANCEL (C++ *enumer-
ator*), 112
- ESP_GATT_CONN_FAIL_ESTABLISH (C++ *enu-
merator*), 112
- ESP_GATT_CONN_L2C_FAILURE (C++ *enumer-
ator*), 112
- ESP_GATT_CONN_LMP_TIMEOUT (C++ *enumer-
ator*), 112
- ESP_GATT_CONN_NONE (C++ *enumerator*), 112
- esp_gatt_conn_params_t (C++ *class*), 105
- esp_gatt_conn_params_t::interval (C++
member), 106
- esp_gatt_conn_params_t::latency (C++
member), 106
- esp_gatt_conn_params_t::timeout (C++
member), 106
- esp_gatt_conn_reason_t (C++ *enum*), 112
- ESP_GATT_CONN_TERMINATE_LOCAL_HOST
(C++ *enumerator*), 112
- ESP_GATT_CONN_TERMINATE_PEER_USER
(C++ *enumerator*), 112
- ESP_GATT_CONN_TIMEOUT (C++ *enumerator*), 112
- ESP_GATT_CONN_UNKNOWN (C++ *enumerator*), 112
- ESP_GATT_DB_ALL (C++ *enumerator*), 113
- esp_gatt_db_attr_type_t (C++ *enum*), 113
- ESP_GATT_DB_CHARACTERISTIC (C++ *enumer-
ator*), 113
- ESP_GATT_DB_DESCRIPTOR (C++ *enumerator*),
113
- ESP_GATT_DB_FULL (C++ *enumerator*), 111
- ESP_GATT_DB_INCLUDED_SERVICE (C++ *enu-
merator*), 113
- ESP_GATT_DB_PRIMARY_SERVICE (C++ *enumer-
ator*), 113
- ESP_GATT_DB_SECONDARY_SERVICE (C++ *enu-
merator*), 113
- ESP_GATT_DUP_REG (C++ *enumerator*), 112
- ESP_GATT_ENCRYPED_MITM (C++ *enumerator*),
112
- ESP_GATT_ENCRYPED_NO_MITM (C++ *enumer-
ator*), 112

- tor), 112
- ESP_GATT_ERR_UNLIKELY (C++ enumerator), 111
- ESP_GATT_ERROR (C++ enumerator), 111
- ESP_GATT_HEART_RATE_CNTL_POINT (C macro), 109
- ESP_GATT_HEART_RATE_MEAS (C macro), 109
- esp_gatt_id_t (C++ class), 103
- esp_gatt_id_t::inst_id (C++ member), 103
- esp_gatt_id_t::uuid (C++ member), 103
- ESP_GATT_IF_NONE (C macro), 110
- esp_gatt_if_t (C++ type), 111
- ESP_GATT_ILLEGAL_HANDLE (C macro), 110
- ESP_GATT_ILLEGAL_PARAMETER (C++ enumerator), 111
- ESP_GATT_ILLEGAL_UUID (C macro), 110
- ESP_GATT_INSUF_AUTHENTICATION (C++ enumerator), 111
- ESP_GATT_INSUF_AUTHORIZATION (C++ enumerator), 111
- ESP_GATT_INSUF_ENCRYPTION (C++ enumerator), 111
- ESP_GATT_INSUF_KEY_SIZE (C++ enumerator), 111
- ESP_GATT_INSUF_RESOURCE (C++ enumerator), 111
- ESP_GATT_INTERNAL_ERROR (C++ enumerator), 111
- ESP_GATT_INVALID_ATTR_LEN (C++ enumerator), 111
- ESP_GATT_INVALID_CFG (C++ enumerator), 112
- ESP_GATT_INVALID_HANDLE (C++ enumerator), 111
- ESP_GATT_INVALID_OFFSET (C++ enumerator), 111
- ESP_GATT_INVALID_PDU (C++ enumerator), 111
- ESP_GATT_MAX_ATTR_LEN (C macro), 110
- ESP_GATT_MAX_READ_MULTI_HANDLES (C macro), 110
- ESP_GATT_MORE (C++ enumerator), 112
- ESP_GATT_NO_RESOURCES (C++ enumerator), 111
- ESP_GATT_NOT_ENCRYPTED (C++ enumerator), 112
- ESP_GATT_NOT_FOUND (C++ enumerator), 111
- ESP_GATT_NOT_LONG (C++ enumerator), 111
- ESP_GATT_OK (C++ enumerator), 111
- ESP_GATT_OUT_OF_RANGE (C++ enumerator), 112
- ESP_GATT_PENDING (C++ enumerator), 112
- ESP_GATT_PERM_READ (C macro), 110
- ESP_GATT_PERM_READ_AUTHORIZATION (C macro), 110
- ESP_GATT_PERM_READ_ENC_MITM (C macro), 110
- ESP_GATT_PERM_READ_ENCRYPTED (C macro), 110
- esp_gatt_perm_t (C++ type), 111
- ESP_GATT_PERM_WRITE (C macro), 110
- ESP_GATT_PERM_WRITE_AUTHORIZATION (C macro), 110
- ESP_GATT_PERM_WRITE_ENC_MITM (C macro), 110
- ESP_GATT_PERM_WRITE_ENCRYPTED (C macro), 110
- ESP_GATT_PERM_WRITE_SIGNED (C macro), 110
- ESP_GATT_PERM_WRITE_SIGNED_MITM (C macro), 110
- ESP_GATT_PRC_IN_PROGRESS (C++ enumerator), 112
- ESP_GATT_PREP_WRITE_CANCEL (C macro), 124
- ESP_GATT_PREP_WRITE_CANCEL (C++ enumerator), 111
- ESP_GATT_PREP_WRITE_EXEC (C macro), 124
- ESP_GATT_PREP_WRITE_EXEC (C++ enumerator), 111
- esp_gatt_prep_write_type (C++ enum), 111
- ESP_GATT_PREPARE_Q_FULL (C++ enumerator), 111
- ESP_GATT_READ_NOT_PERMIT (C++ enumerator), 111
- ESP_GATT_REQ_NOT_SUPPORTED (C++ enumerator), 111
- ESP_GATT_RSP_BY_APP (C macro), 110
- esp_gatt_rsp_t (C++ union), 103
- esp_gatt_rsp_t::attr_value (C++ member), 103
- esp_gatt_rsp_t::handle (C++ member), 103
- ESP_GATT_SERVICE_FROM_NVS_FLASH (C++ enumerator), 113
- ESP_GATT_SERVICE_FROM_REMOTE_DEVICE (C++ enumerator), 113
- ESP_GATT_SERVICE_FROM_UNKNOWN (C++ enumerator), 113
- ESP_GATT_SERVICE_STARTED (C++ enumerator), 112
- esp_gatt_srvc_id_t (C++ class), 104
- esp_gatt_srvc_id_t::id (C++ member), 104
- esp_gatt_srvc_id_t::is_primary (C++ member), 104
- ESP_GATT_STACK_RSP (C++ enumerator), 112
- esp_gatt_status_t (C++ enum), 111
- ESP_GATT_UNKNOWN_ERROR (C++ enumerator), 112
- ESP_GATT_UNSUPPORT_GRP_TYPE (C++ enumerator), 111
- ESP_GATT_UUID_ALERT_LEVEL (C macro), 109
- ESP_GATT_UUID_ALERT_NTF_SVC (C macro), 108
- ESP_GATT_UUID_ALERT_STATUS (C macro), 109
- ESP_GATT_UUID_Automation_IO_SVC (C macro), 108
- ESP_GATT_UUID_BATTERY_LEVEL (C macro), 109
- ESP_GATT_UUID_BATTERY_SERVICE_SVC (C macro), 108
- ESP_GATT_UUID_BLOOD_PRESSURE_SVC (C macro), 108
- ESP_GATT_UUID_BODY_COMPOSITION (C

- macro*), 108
- ESP_GATT_UUID_BOND_MANAGEMENT_SVC (C *macro*), 108
- ESP_GATT_UUID_CHAR_AGG_FORMAT (C *macro*), 108
- ESP_GATT_UUID_CHAR_CLIENT_CONFIG (C *macro*), 108
- ESP_GATT_UUID_CHAR_DECLARE (C *macro*), 108
- ESP_GATT_UUID_CHAR_DESCRIPTION (C *macro*), 108
- ESP_GATT_UUID_CHAR_EXT_PROP (C *macro*), 108
- ESP_GATT_UUID_CHAR_PRESENT_FORMAT (C *macro*), 108
- ESP_GATT_UUID_CHAR_SRV_CONFIG (C *macro*), 108
- ESP_GATT_UUID_CHAR_VALID_RANGE (C *macro*), 108
- ESP_GATT_UUID_CONT_GLUCOSE_MONITOR_SVC (C *macro*), 108
- ESP_GATT_UUID_CSC_FEATURE (C *macro*), 110
- ESP_GATT_UUID_CSC_MEASUREMENT (C *macro*), 110
- ESP_GATT_UUID_CURRENT_TIME (C *macro*), 109
- ESP_GATT_UUID_CURRENT_TIME_SVC (C *macro*), 107
- ESP_GATT_UUID_CYCLING_POWER_SVC (C *macro*), 108
- ESP_GATT_UUID_CYCLING_SPEED_CADENCE_SVC (C *macro*), 108
- ESP_GATT_UUID_DEVICE_INFO_SVC (C *macro*), 107
- ESP_GATT_UUID_ENV_SENSING_CONFIG_DESCR (C *macro*), 108
- ESP_GATT_UUID_ENV_SENSING_MEASUREMENT_DESCR (C *macro*), 108
- ESP_GATT_UUID_ENV_SENSING_TRIGGER_DESCR (C *macro*), 108
- ESP_GATT_UUID_ENVIRONMENTAL_SENSING_SVC (C *macro*), 108
- ESP_GATT_UUID_EXT_RPT_REF_DESCR (C *macro*), 108
- ESP_GATT_UUID_FW_VERSION_STR (C *macro*), 109
- ESP_GATT_UUID_GAP_CENTRAL_ADDR_RESOL (C *macro*), 109
- ESP_GATT_UUID_GAP_DEVICE_NAME (C *macro*), 108
- ESP_GATT_UUID_GAP_ICON (C *macro*), 108
- ESP_GATT_UUID_GAP_PREF_CONN_PARAM (C *macro*), 108
- ESP_GATT_UUID_GATT_SRV_CHGD (C *macro*), 109
- ESP_GATT_UUID_GLUCOSE_SVC (C *macro*), 107
- ESP_GATT_UUID_GM_CONTEXT (C *macro*), 109
- ESP_GATT_UUID_GM_CONTROL_POINT (C *macro*), 109
- ESP_GATT_UUID_GM_FEATURE (C *macro*), 109
- ESP_GATT_UUID_GM_MEASUREMENT (C *macro*), 109
- ESP_GATT_UUID_HEALTH_THERMOM_SVC (C *macro*), 107
- ESP_GATT_UUID_HEART_RATE_SVC (C *macro*), 107
- ESP_GATT_UUID_HID_BT_KB_INPUT (C *macro*), 109
- ESP_GATT_UUID_HID_BT_KB_OUTPUT (C *macro*), 109
- ESP_GATT_UUID_HID_BT_MOUSE_INPUT (C *macro*), 109
- ESP_GATT_UUID_HID_CONTROL_POINT (C *macro*), 109
- ESP_GATT_UUID_HID_INFORMATION (C *macro*), 109
- ESP_GATT_UUID_HID_PROTO_MODE (C *macro*), 109
- ESP_GATT_UUID_HID_REPORT (C *macro*), 109
- ESP_GATT_UUID_HID_REPORT_MAP (C *macro*), 109
- ESP_GATT_UUID_HID_SVC (C *macro*), 108
- ESP_GATT_UUID_HW_VERSION_STR (C *macro*), 109
- ESP_GATT_UUID_IEEE_DATA (C *macro*), 109
- ESP_GATT_UUID_IMMEDIATE_ALERT_SVC (C *macro*), 107
- ESP_GATT_UUID_INCLUDE_SERVICE (C *macro*), 108
- ESP_GATT_UUID_LINK_LOSS_SVC (C *macro*), 107
- ESP_GATT_UUID_LOCAL_TIME_INFO (C *macro*), 109
- ESP_GATT_UUID_LOCATION_AND_NAVIGATION_SVC (C *macro*), 108
- ESP_GATT_UUID_MANU_NAME (C *macro*), 109
- ESP_GATT_UUID_MODEL_NUMBER_STR (C *macro*), 109
- ESP_GATT_UUID_NEXT_DST_CHANGE_SVC (C *macro*), 107
- ESP_GATT_UUID_NUM_DIGITALS_DESCR (C *macro*), 108
- ESP_GATT_UUID_NW_STATUS (C *macro*), 109
- ESP_GATT_UUID_NW_TRIGGER (C *macro*), 109
- ESP_GATT_UUID_PHONE_ALERT_STATUS_SVC (C *macro*), 108
- ESP_GATT_UUID_PNP_ID (C *macro*), 109
- ESP_GATT_UUID_PRI_SERVICE (C *macro*), 108
- ESP_GATT_UUID_REF_TIME_INFO (C *macro*), 109
- ESP_GATT_UUID_REF_TIME_UPDATE_SVC (C *macro*), 107
- ESP_GATT_UUID_RINGER_CP (C *macro*), 109
- ESP_GATT_UUID_RINGER_SETTING (C *macro*), 109
- ESP_GATT_UUID_RPT_REF_DESCR (C *macro*), 108
- ESP_GATT_UUID_RSC_FEATURE (C *macro*), 110

- ESP_GATT_UUID_RSC_MEASUREMENT (*C macro*), 110
- ESP_GATT_UUID_RUNNING_SPEED_CADENCE_SVC (*C macro*), 108
- ESP_GATT_UUID_SC_CONTROL_POINT (*C macro*), 110
- ESP_GATT_UUID_SCAN_INT_WINDOW (*C macro*), 110
- ESP_GATT_UUID_SCAN_PARAMETERS_SVC (*C macro*), 108
- ESP_GATT_UUID_SCAN_REFRESH (*C macro*), 110
- ESP_GATT_UUID_SEC_SERVICE (*C macro*), 108
- ESP_GATT_UUID_SENSOR_LOCATION (*C macro*), 110
- ESP_GATT_UUID_SERIAL_NUMBER_STR (*C macro*), 109
- ESP_GATT_UUID_SW_VERSION_STR (*C macro*), 109
- ESP_GATT_UUID_SYSTEM_ID (*C macro*), 109
- ESP_GATT_UUID_TIME_TRIGGER_DESCR (*C macro*), 108
- ESP_GATT_UUID_TX_POWER_LEVEL (*C macro*), 109
- ESP_GATT_UUID_TX_POWER_SVC (*C macro*), 107
- ESP_GATT_UUID_USER_DATA_SVC (*C macro*), 108
- ESP_GATT_UUID_VALUE_TRIGGER_DESCR (*C macro*), 108
- ESP_GATT_UUID_WEIGHT_SCALE_SVC (*C macro*), 108
- esp_gatt_value_t (*C++ class*), 105
- esp_gatt_value_t::auth_req (*C++ member*), 105
- esp_gatt_value_t::handle (*C++ member*), 105
- esp_gatt_value_t::len (*C++ member*), 105
- esp_gatt_value_t::offset (*C++ member*), 105
- esp_gatt_value_t::value (*C++ member*), 105
- ESP_GATT_WRITE_NOT_PERMIT (*C++ enumerator*), 111
- ESP_GATT_WRITE_TYPE_NO_RSP (*C++ enumerator*), 113
- ESP_GATT_WRITE_TYPE_RSP (*C++ enumerator*), 113
- esp_gatt_write_type_t (*C++ enum*), 113
- ESP_GATT_WRONG_STATE (*C++ enumerator*), 111
- ESP_GATTC_ACL_EVT (*C++ enumerator*), 140
- ESP_GATTC_ADV_DATA_EVT (*C++ enumerator*), 140
- ESP_GATTC_ADV_VSC_EVT (*C++ enumerator*), 141
- ESP_GATTC_BTH_SCAN_CFG_EVT (*C++ enumerator*), 141
- ESP_GATTC_BTH_SCAN_DIS_EVT (*C++ enumerator*), 141
- ESP_GATTC_BTH_SCAN_ENB_EVT (*C++ enumerator*), 141
- ESP_GATTC_BTH_SCAN_PARAM_EVT (*C++ enumerator*), 141
- ESP_GATTC_BTH_SCAN_RD_EVT (*C++ enumerator*), 141
- ESP_GATTC_BTH_SCAN_THR_EVT (*C++ enumerator*), 141
- ESP_GATTC_CANCEL_OPEN_EVT (*C++ enumerator*), 140
- esp_gattc_cb_event_t (*C++ enum*), 139
- esp_gattc_cb_t (*C++ type*), 139
- ESP_GATTC_CFG_MTU_EVT (*C++ enumerator*), 140
- esp_gattc_char_elem_t (*C++ class*), 107
- esp_gattc_char_elem_t::char_handle (*C++ member*), 107
- esp_gattc_char_elem_t::properties (*C++ member*), 107
- esp_gattc_char_elem_t::uuid (*C++ member*), 107
- ESP_GATTC_CLOSE_EVT (*C++ enumerator*), 140
- ESP_GATTC_CONGEST_EVT (*C++ enumerator*), 140
- ESP_GATTC_CONNECT_EVT (*C++ enumerator*), 141
- esp_gattc_db_elem_t (*C++ class*), 106
- esp_gattc_db_elem_t::attribute_handle (*C++ member*), 106
- esp_gattc_db_elem_t::end_handle (*C++ member*), 106
- esp_gattc_db_elem_t::properties (*C++ member*), 106
- esp_gattc_db_elem_t::start_handle (*C++ member*), 106
- esp_gattc_db_elem_t::type (*C++ member*), 106
- esp_gattc_db_elem_t::uuid (*C++ member*), 106
- esp_gattc_descr_elem_t (*C++ class*), 107
- esp_gattc_descr_elem_t::handle (*C++ member*), 107
- esp_gattc_descr_elem_t::uuid (*C++ member*), 107
- ESP_GATTC_DIS_SRVC_CMPL_EVT (*C++ enumerator*), 141
- ESP_GATTC_DISCONNECT_EVT (*C++ enumerator*), 141
- ESP_GATTC_ENC_CMPL_CB_EVT (*C++ enumerator*), 140
- ESP_GATTC_EXEC_EVT (*C++ enumerator*), 140
- ESP_GATTC_GET_ADDR_LIST_EVT (*C++ enumerator*), 141
- esp_gattc_incl_svc_elem_t (*C++ class*), 107
- esp_gattc_incl_svc_elem_t::handle (*C++ member*), 107
- esp_gattc_incl_svc_elem_t::incl_srvc_e_handle (*C++ member*), 107
- esp_gattc_incl_svc_elem_t::incl_srvc_s_handle (*C++ member*), 107
- esp_gattc_incl_svc_elem_t::uuid (*C++ member*), 107
- ESP_GATTC_MULT_ADV_DATA_EVT (*C++ enumerator*), 140

- ESP_GATTC_MULT_ADV_DIS_EVT (C++ *enumerator*), 140
- ESP_GATTC_MULT_ADV_ENB_EVT (C++ *enumerator*), 140
- ESP_GATTC_MULT_ADV_UPD_EVT (C++ *enumerator*), 140
- esp_gattc_multi_t (C++ *class*), 106
- esp_gattc_multi_t::handles (C++ *member*), 106
- esp_gattc_multi_t::num_attr (C++ *member*), 106
- ESP_GATTC_NOTIFY_EVT (C++ *enumerator*), 140
- ESP_GATTC_OPEN_EVT (C++ *enumerator*), 140
- ESP_GATTC_PREP_WRITE_EVT (C++ *enumerator*), 140
- ESP_GATTC_QUEUE_FULL_EVT (C++ *enumerator*), 141
- ESP_GATTC_READ_CHAR_EVT (C++ *enumerator*), 140
- ESP_GATTC_READ_DESCR_EVT (C++ *enumerator*), 140
- ESP_GATTC_READ_MULTIPLE_EVT (C++ *enumerator*), 141
- ESP_GATTC_REG_EVT (C++ *enumerator*), 139
- ESP_GATTC_REG_FOR_NOTIFY_EVT (C++ *enumerator*), 141
- ESP_GATTC_SCAN_FLT_CFG_EVT (C++ *enumerator*), 141
- ESP_GATTC_SCAN_FLT_PARAM_EVT (C++ *enumerator*), 141
- ESP_GATTC_SCAN_FLT_STATUS_EVT (C++ *enumerator*), 141
- ESP_GATTC_SEARCH_CMPL_EVT (C++ *enumerator*), 140
- ESP_GATTC_SEARCH_RES_EVT (C++ *enumerator*), 140
- esp_gattc_service_elem_t (C++ *class*), 106
- esp_gattc_service_elem_t::end_handle (C++ *member*), 106
- esp_gattc_service_elem_t::is_primary (C++ *member*), 106
- esp_gattc_service_elem_t::start_handle (C++ *member*), 106
- esp_gattc_service_elem_t::uuid (C++ *member*), 106
- ESP_GATTC_SET_ASSOC_EVT (C++ *enumerator*), 141
- ESP_GATTC_SRVC_CHG_EVT (C++ *enumerator*), 140
- ESP_GATTC_UNREG_EVT (C++ *enumerator*), 140
- ESP_GATTC_UNREG_FOR_NOTIFY_EVT (C++ *enumerator*), 141
- ESP_GATTC_WRITE_CHAR_EVT (C++ *enumerator*), 140
- ESP_GATTC_WRITE_DESCR_EVT (C++ *enumerator*), 140
- ESP_GATTS_ADD_CHAR_DESCR_EVT (C++ *enumerator*), 125
- ESP_GATTS_ADD_CHAR_EVT (C++ *enumerator*), 125
- ESP_GATTS_ADD_INCL_SRVC_EVT (C++ *enumerator*), 125
- esp_gatts_attr_db_t (C++ *class*), 104
- esp_gatts_attr_db_t::att_desc (C++ *member*), 104
- esp_gatts_attr_db_t::attr_control (C++ *member*), 104
- ESP_GATTS_CANCEL_OPEN_EVT (C++ *enumerator*), 125
- esp_gatts_cb_event_t (C++ *enum*), 124
- esp_gatts_cb_t (C++ *type*), 124
- ESP_GATTS_CLOSE_EVT (C++ *enumerator*), 125
- ESP_GATTS_CONF_EVT (C++ *enumerator*), 125
- ESP_GATTS_CONGEST_EVT (C++ *enumerator*), 125
- ESP_GATTS_CONNECT_EVT (C++ *enumerator*), 125
- ESP_GATTS_CREAT_ATTR_TAB_EVT (C++ *enumerator*), 125
- ESP_GATTS_CREATE_EVT (C++ *enumerator*), 125
- ESP_GATTS_DELETE_EVT (C++ *enumerator*), 125
- ESP_GATTS_DISCONNECT_EVT (C++ *enumerator*), 125
- ESP_GATTS_EXEC_WRITE_EVT (C++ *enumerator*), 124
- esp_gatts_incl128_svc_desc_t (C++ *class*), 105
- esp_gatts_incl128_svc_desc_t::end_hdl (C++ *member*), 105
- esp_gatts_incl128_svc_desc_t::start_hdl (C++ *member*), 105
- esp_gatts_incl_svc_desc_t (C++ *class*), 105
- esp_gatts_incl_svc_desc_t::end_hdl (C++ *member*), 105
- esp_gatts_incl_svc_desc_t::start_hdl (C++ *member*), 105
- esp_gatts_incl_svc_desc_t::uuid (C++ *member*), 105
- ESP_GATTS_LISTEN_EVT (C++ *enumerator*), 125
- ESP_GATTS_MTU_EVT (C++ *enumerator*), 124
- ESP_GATTS_OPEN_EVT (C++ *enumerator*), 125
- ESP_GATTS_READ_EVT (C++ *enumerator*), 124
- ESP_GATTS_REG_EVT (C++ *enumerator*), 124
- ESP_GATTS_RESPONSE_EVT (C++ *enumerator*), 125
- ESP_GATTS_SEND_SERVICE_CHANGE_EVT (C++ *enumerator*), 125
- ESP_GATTS_SET_ATTR_VAL_EVT (C++ *enumerator*), 125
- ESP_GATTS_START_EVT (C++ *enumerator*), 125
- ESP_GATTS_STOP_EVT (C++ *enumerator*), 125
- ESP_GATTS_UNREG_EVT (C++ *enumerator*), 125
- ESP_GATTS_WRITE_EVT (C++ *enumerator*), 124
- esp_gcov_dump (C++ *function*), 887
- esp_get_deep_sleep_wake_stub (C++ *function*), 1115
- esp_get_flash_encryption_mode (C++ *function*), 859

- [esp_get_free_heap_size \(C++ function\), 1090](#)
[esp_get_free_internal_heap_size \(C++ function\), 1090](#)
[esp_get_idf_version \(C++ function\), 1094](#)
[esp_get_minimum_free_heap_size \(C++ function\), 1090](#)
[ESP_GPIO_WAKEUP_GPIO_HIGH \(C++ enumerator\), 1116](#)
[ESP_GPIO_WAKEUP_GPIO_LOW \(C++ enumerator\), 1116](#)
[esp_hmac_calculate \(C++ function\), 528](#)
[esp_hmac_jtag_disable \(C++ function\), 528](#)
[esp_hmac_jtag_enable \(C++ function\), 528](#)
[esp_http_client_add_auth \(C++ function\), 685](#)
[esp_http_client_auth_type_t \(C++ enum\), 690](#)
[esp_http_client_cleanup \(C++ function\), 685](#)
[esp_http_client_close \(C++ function\), 684](#)
[esp_http_client_config_t \(C++ class\), 687](#)
[esp_http_client_config_t::auth_type \(C++ member\), 687](#)
[esp_http_client_config_t::buffer_size \(C++ member\), 688](#)
[esp_http_client_config_t::buffer_size_text \(C++ member\), 688](#)
[esp_http_client_config_t::cert_pem \(C++ member\), 687](#)
[esp_http_client_config_t::client_cert_pem \(C++ member\), 687](#)
[esp_http_client_config_t::client_key_password \(C++ member\), 687](#)
[esp_http_client_config_t::client_key_password_hex \(C++ member\), 686](#)
[esp_http_client_config_t::client_key_pem \(C++ member\), 687](#)
[esp_http_client_config_t::crt_bundle_attach \(C++ member\), 688](#)
[esp_http_client_config_t::disable_auto_redirect \(C++ member\), 687](#)
[esp_http_client_config_t::event_handler \(C++ member\), 687](#)
[esp_http_client_config_t::host \(C++ member\), 687](#)
[esp_http_client_config_t::is_async \(C++ member\), 688](#)
[esp_http_client_config_t::keep_alive_count \(C++ member\), 688](#)
[esp_http_client_config_t::keep_alive_enable \(C++ member\), 688](#)
[esp_http_client_config_t::keep_alive_id \(C++ member\), 688](#)
[esp_http_client_config_t::keep_alive_interval \(C++ member\), 688](#)
[esp_http_client_config_t::max_authorization_token_reuse \(C++ member\), 687](#)
[esp_http_client_config_t::max_redirect_count \(C++ member\), 687](#)
[esp_http_client_config_t::method \(C++ member\), 687](#)
[esp_http_client_config_t::password \(C++ member\), 687](#)
[esp_http_client_config_t::path \(C++ member\), 687](#)
[esp_http_client_config_t::port \(C++ member\), 687](#)
[esp_http_client_config_t::query \(C++ member\), 687](#)
[esp_http_client_config_t::skip_cert_common_name_check \(C++ member\), 688](#)
[esp_http_client_config_t::timeout_ms \(C++ member\), 687](#)
[esp_http_client_config_t::transport_type \(C++ member\), 688](#)
[esp_http_client_config_t::url \(C++ member\), 687](#)
[esp_http_client_config_t::use_global_ca_store \(C++ member\), 688](#)
[esp_http_client_config_t::user_agent \(C++ member\), 687](#)
[esp_http_client_config_t::user_data \(C++ member\), 688](#)
[esp_http_client_config_t::username \(C++ member\), 687](#)
[esp_http_client_delete_header \(C++ function\), 683](#)
[esp_http_client_event \(C++ class\), 686](#)
[esp_http_client_event::client \(C++ member\), 686](#)
[esp_http_client_event::data \(C++ member\), 686](#)
[esp_http_client_event::data_len \(C++ member\), 686](#)
[esp_http_client_event::event_id \(C++ member\), 686](#)
[esp_http_client_event::header_key \(C++ member\), 686](#)
[esp_http_client_event::header_value \(C++ member\), 687](#)
[esp_http_client_event::user_data \(C++ member\), 686](#)
[esp_http_client_event_handle_t \(C++ type\), 689](#)
[esp_http_client_event_id_t \(C++ enum\), 689](#)
[esp_http_client_event_t \(C++ type\), 689](#)
[esp_http_client_fetch_headers \(C++ function\), 684](#)
[esp_http_client_flush_response \(C++ function\), 686](#)
[esp_http_client_get_chunk_length \(C++ function\), 686](#)
[esp_http_client_get_content_length \(C++ function\), 684](#)
[esp_http_client_get_header \(C++ function\), 682](#)

- [esp_http_client_get_password \(C++ function\), 683](#)
[esp_http_client_get_post_field \(C++ function\), 682](#)
[esp_http_client_get_status_code \(C++ function\), 684](#)
[esp_http_client_get_transport_type \(C++ function\), 685](#)
[esp_http_client_get_url \(C++ function\), 686](#)
[esp_http_client_get_username \(C++ function\), 682](#)
[esp_http_client_handle_t \(C++ type\), 689](#)
[esp_http_client_init \(C++ function\), 681](#)
[esp_http_client_is_chunked_response \(C++ function\), 684](#)
[esp_http_client_is_complete_data_received \(C++ function\), 685](#)
[esp_http_client_method_t \(C++ enum\), 689](#)
[esp_http_client_open \(C++ function\), 683](#)
[esp_http_client_perform \(C++ function\), 681](#)
[esp_http_client_read \(C++ function\), 684](#)
[esp_http_client_read_response \(C++ function\), 685](#)
[esp_http_client_set_authtype \(C++ function\), 683](#)
[esp_http_client_set_header \(C++ function\), 682](#)
[esp_http_client_set_method \(C++ function\), 683](#)
[esp_http_client_set_password \(C++ function\), 683](#)
[esp_http_client_set_post_field \(C++ function\), 682](#)
[esp_http_client_set_redirection \(C++ function\), 685](#)
[esp_http_client_set_url \(C++ function\), 681](#)
[esp_http_client_set_username \(C++ function\), 682](#)
[esp_http_client_transport_t \(C++ enum\), 689](#)
[esp_http_client_write \(C++ function\), 684](#)
[esp_https_ota \(C++ function\), 920](#)
[esp_https_ota_abort \(C++ function\), 921](#)
[esp_https_ota_begin \(C++ function\), 920](#)
[esp_https_ota_config_t \(C++ class\), 922](#)
[esp_https_ota_config_t::bulk_flash_erase \(C++ member\), 922](#)
[esp_https_ota_config_t::http_client_init \(C++ member\), 922](#)
[esp_https_ota_config_t::http_config \(C++ member\), 922](#)
[esp_https_ota_finish \(C++ function\), 921](#)
[esp_https_ota_get_image_len_read \(C++ function\), 922](#)
[esp_https_ota_get_img_desc \(C++ function\), 922](#)
[esp_https_ota_handle_t \(C++ type\), 922](#)
[esp_https_ota_is_complete_data_received \(C++ function\), 921](#)
[ESP_IDF_VERSION \(C macro\), 1094](#)
[ESP_IDF_VERSION_MAJOR \(C macro\), 1094](#)
[ESP_IDF_VERSION_MINOR \(C macro\), 1094](#)
[ESP_IDF_VERSION_PATCH \(C macro\), 1094](#)
[ESP_IDF_VERSION_VAL \(C macro\), 1094](#)
[ESP_IMAGE_FLASH_SIZE_16MB \(C++ enumerator\), 883](#)
[ESP_IMAGE_FLASH_SIZE_1MB \(C++ enumerator\), 883](#)
[ESP_IMAGE_FLASH_SIZE_2MB \(C++ enumerator\), 883](#)
[ESP_IMAGE_FLASH_SIZE_4MB \(C++ enumerator\), 883](#)
[ESP_IMAGE_FLASH_SIZE_8MB \(C++ enumerator\), 883](#)
[ESP_IMAGE_FLASH_SIZE_MAX \(C++ enumerator\), 884](#)
[esp_image_flash_size_t \(C++ enum\), 883](#)
[ESP_IMAGE_HEADER_MAGIC \(C macro\), 882](#)
[esp_image_header_t \(C++ class\), 881](#)
[esp_image_header_t::chip_id \(C++ member\), 881](#)
[esp_image_header_t::entry_addr \(C++ member\), 881](#)
[esp_image_header_t::hash_appended \(C++ member\), 881](#)
[esp_image_header_t::magic \(C++ member\), 881](#)
[esp_image_header_t::min_chip_rev \(C++ member\), 881](#)
[esp_image_header_t::reserved \(C++ member\), 881](#)
[esp_image_header_t::segment_count \(C++ member\), 881](#)
[esp_image_header_t::spi_mode \(C++ member\), 881](#)
[esp_image_header_t::spi_pin_drv \(C++ member\), 881](#)
[esp_image_header_t::spi_size \(C++ member\), 881](#)
[esp_image_header_t::spi_speed \(C++ member\), 881](#)
[esp_image_header_t::wp_pin \(C++ member\), 881](#)
[ESP_IMAGE_MAX_SEGMENTS \(C macro\), 882](#)
[esp_image_segment_header_t \(C++ class\), 882](#)
[esp_image_segment_header_t::data_len \(C++ member\), 882](#)
[esp_image_segment_header_t::load_addr \(C++ member\), 882](#)
[esp_image_spi_freq_t \(C++ enum\), 883](#)
[ESP_IMAGE_SPI_MODE_DIO \(C++ enumerator\), 883](#)
[ESP_IMAGE_SPI_MODE_DOUT \(C++ enumerator\), 883](#)

- ESP_IMAGE_SPI_MODE_FAST_READ (C++ *enumerator*), 883
- ESP_IMAGE_SPI_MODE_QIO (C++ *enumerator*), 883
- ESP_IMAGE_SPI_MODE_QOUT (C++ *enumerator*), 883
- ESP_IMAGE_SPI_MODE_SLOW_READ (C++ *enumerator*), 883
- esp_image_spi_mode_t (C++ *enum*), 883
- ESP_IMAGE_SPI_SPEED_20M (C++ *enumerator*), 883
- ESP_IMAGE_SPI_SPEED_26M (C++ *enumerator*), 883
- ESP_IMAGE_SPI_SPEED_40M (C++ *enumerator*), 883
- ESP_IMAGE_SPI_SPEED_80M (C++ *enumerator*), 883
- esp_int_wdt_init (C++ *function*), 1119
- esp_intr_alloc (C++ *function*), 1079
- esp_intr_alloc_intrstatus (C++ *function*), 1079
- ESP_INTR_DISABLE (C *macro*), 1082
- esp_intr_disable (C++ *function*), 1080
- esp_intr_disable_source (C++ *function*), 1081
- ESP_INTR_ENABLE (C *macro*), 1082
- esp_intr_enable (C++ *function*), 1080
- esp_intr_enable_source (C++ *function*), 1081
- ESP_INTR_FLAG_EDGE (C *macro*), 1081
- ESP_INTR_FLAG_HIGH (C *macro*), 1082
- ESP_INTR_FLAG_INTRDISABLED (C *macro*), 1081
- ESP_INTR_FLAG_IRAM (C *macro*), 1081
- ESP_INTR_FLAG_LEVEL1 (C *macro*), 1081
- ESP_INTR_FLAG_LEVEL2 (C *macro*), 1081
- ESP_INTR_FLAG_LEVEL3 (C *macro*), 1081
- ESP_INTR_FLAG_LEVEL4 (C *macro*), 1081
- ESP_INTR_FLAG_LEVEL5 (C *macro*), 1081
- ESP_INTR_FLAG_LEVEL6 (C *macro*), 1081
- ESP_INTR_FLAG_LEVELMASK (C *macro*), 1082
- ESP_INTR_FLAG_LOWMED (C *macro*), 1082
- ESP_INTR_FLAG_NMI (C *macro*), 1081
- ESP_INTR_FLAG_SHARED (C *macro*), 1081
- esp_intr_flags_to_level (C++ *function*), 1081
- esp_intr_free (C++ *function*), 1080
- esp_intr_get_cpu (C++ *function*), 1080
- esp_intr_get_intno (C++ *function*), 1080
- esp_intr_mark_shared (C++ *function*), 1078
- esp_intr_noniram_disable (C++ *function*), 1081
- esp_intr_noniram_enable (C++ *function*), 1081
- esp_intr_reserve (C++ *function*), 1079
- esp_intr_set_in_iram (C++ *function*), 1081
- ESP_IO_CAP_IN (C *macro*), 93
- ESP_IO_CAP_IO (C *macro*), 93
- ESP_IO_CAP_KBDISP (C *macro*), 93
- ESP_IO_CAP_NONE (C *macro*), 93
- ESP_IO_CAP_OUT (C *macro*), 93
- esp_ip4addr_aton (C++ *function*), 479
- esp_ip4addr_ntoa (C++ *function*), 479
- ESP_LE_AUTH_BOND (C *macro*), 92
- ESP_LE_AUTH_NO_BOND (C *macro*), 92
- ESP_LE_AUTH_REQ_BOND_MITM (C *macro*), 93
- ESP_LE_AUTH_REQ_MITM (C *macro*), 93
- ESP_LE_AUTH_REQ_SC_BOND (C *macro*), 93
- ESP_LE_AUTH_REQ_SC_MITM (C *macro*), 93
- ESP_LE_AUTH_REQ_SC_MITM_BOND (C *macro*), 93
- ESP_LE_AUTH_REQ_SC_ONLY (C *macro*), 93
- ESP_LE_KEY_LCSRK (C *macro*), 92
- ESP_LE_KEY_LENC (C *macro*), 92
- ESP_LE_KEY_LID (C *macro*), 92
- ESP_LE_KEY_LLK (C *macro*), 92
- ESP_LE_KEY_NONE (C *macro*), 92
- ESP_LE_KEY_PCSRK (C *macro*), 92
- ESP_LE_KEY_PENC (C *macro*), 92
- ESP_LE_KEY_PID (C *macro*), 92
- ESP_LE_KEY_PLK (C *macro*), 92
- esp_light_sleep_start (C++ *function*), 1115
- esp_link_key (C++ *type*), 56
- esp_local_ctrl_add_property (C++ *function*), 723
- esp_local_ctrl_config (C++ *class*), 726
- esp_local_ctrl_config::handlers (C++ *member*), 726
- esp_local_ctrl_config::max_properties (C++ *member*), 726
- esp_local_ctrl_config::proto_sec (C++ *member*), 726
- esp_local_ctrl_config::transport (C++ *member*), 726
- esp_local_ctrl_config::transport_config (C++ *member*), 726
- esp_local_ctrl_config_t (C++ *type*), 727
- esp_local_ctrl_get_property (C++ *function*), 723
- esp_local_ctrl_get_transport_ble (C++ *function*), 723
- esp_local_ctrl_get_transport_httpd (C++ *function*), 723
- esp_local_ctrl_handlers (C++ *class*), 725
- esp_local_ctrl_handlers::get_prop_values (C++ *member*), 725
- esp_local_ctrl_handlers::set_prop_values (C++ *member*), 725
- esp_local_ctrl_handlers::usr_ctx (C++ *member*), 726
- esp_local_ctrl_handlers::usr_ctx_free_fn (C++ *member*), 726
- esp_local_ctrl_handlers_t (C++ *type*), 727
- esp_local_ctrl_prop (C++ *class*), 724
- esp_local_ctrl_prop::ctx (C++ *member*), 724
- esp_local_ctrl_prop::ctx_free_fn (C++ *member*), 724

- esp_local_ctrl_prop::flags (C++ member), 724
 esp_local_ctrl_prop::name (C++ member), 724
 esp_local_ctrl_prop::size (C++ member), 724
 esp_local_ctrl_prop::type (C++ member), 724
 esp_local_ctrl_prop_t (C++ type), 726
 esp_local_ctrl_prop_val (C++ class), 725
 esp_local_ctrl_prop_val::data (C++ member), 725
 esp_local_ctrl_prop_val::free_fn (C++ member), 725
 esp_local_ctrl_prop_val::size (C++ member), 725
 esp_local_ctrl_prop_val_t (C++ type), 727
 esp_local_ctrl_proto_sec (C++ enum), 727
 esp_local_ctrl_proto_sec_cfg (C++ class), 726
 esp_local_ctrl_proto_sec_cfg::custom_handler (C++ member), 726
 esp_local_ctrl_proto_sec_cfg::pop (C++ member), 726
 esp_local_ctrl_proto_sec_cfg::version (C++ member), 726
 esp_local_ctrl_proto_sec_cfg_t (C++ type), 727
 esp_local_ctrl_proto_sec_t (C++ type), 727
 esp_local_ctrl_remove_property (C++ function), 723
 esp_local_ctrl_set_handler (C++ function), 723
 esp_local_ctrl_start (C++ function), 723
 esp_local_ctrl_stop (C++ function), 723
 ESP_LOCAL_CTRL_TRANSPORT_BLE (C macro), 726
 esp_local_ctrl_transport_config_ble_t (C++ type), 727
 esp_local_ctrl_transport_config_httpd_t (C++ type), 727
 esp_local_ctrl_transport_config_t (C++ union), 724
 esp_local_ctrl_transport_config_t::ble (C++ member), 724
 esp_local_ctrl_transport_config_t::httpd (C++ member), 724
 ESP_LOCAL_CTRL_TRANSPORT_HTTPD (C macro), 726
 esp_local_ctrl_transport_t (C++ type), 727
 ESP_LOG_BUFFER_CHAR (C macro), 1086
 ESP_LOG_BUFFER_CHAR_LEVEL (C macro), 1085
 ESP_LOG_BUFFER_HEX (C macro), 1085
 ESP_LOG_BUFFER_HEX_LEVEL (C macro), 1085
 ESP_LOG_BUFFER_HEXDUMP (C macro), 1085
 ESP_LOG_DEBUG (C++ enumerator), 1087
 ESP_LOG_EARLY_IMPL (C macro), 1086
 esp_log_early_timestamp (C++ function), 1084
 ESP_LOG_ERROR (C++ enumerator), 1087
 ESP_LOG_INFO (C++ enumerator), 1087
 ESP_LOG_LEVEL (C macro), 1086
 ESP_LOG_LEVEL_LOCAL (C macro), 1086
 esp_log_level_set (C++ function), 1084
 esp_log_level_t (C++ enum), 1087
 ESP_LOG_NONE (C++ enumerator), 1087
 esp_log_set_vprintf (C++ function), 1084
 esp_log_system_timestamp (C++ function), 1084
 esp_log_timestamp (C++ function), 1084
 ESP_LOG_VERBOSE (C++ enumerator), 1087
 ESP_LOG_WARN (C++ enumerator), 1087
 esp_log_write (C++ function), 1085
 esp_log_writev (C++ function), 1085
 ESP_LOGD (C macro), 1086
 ESP_LOGE (C macro), 1086
 ESP_LOGI (C macro), 1086
 ESP_LOGV (C macro), 1086
 ESP_LOGW (C macro), 1086
 ESP_MAC_BT (C++ enumerator), 1093
 ESP_MAC_ETH (C++ enumerator), 1093
 esp_mac_type_t (C++ enum), 1093
 ESP_MAC_WIFI_SOFTAP (C++ enumerator), 1093
 ESP_MAC_WIFI_STA (C++ enumerator), 1093
 esp_mesh_allow_root_conflicts (C++ function), 428
 esp_mesh_available_txupQ_num (C++ function), 427
 esp_mesh_connect (C++ function), 431
 esp_mesh_deinit (C++ function), 420
 esp_mesh_delete_group_id (C++ function), 428
 esp_mesh_disable_ps (C++ function), 432
 esp_mesh_disconnect (C++ function), 431
 esp_mesh_enable_ps (C++ function), 432
 esp_mesh_fix_root (C++ function), 430
 esp_mesh_flush_scan_result (C++ function), 431
 esp_mesh_flush_upstream_packets (C++ function), 431
 esp_mesh_get_active_duty_cycle (C++ function), 433
 esp_mesh_get_ap_assoc_expire (C++ function), 427
 esp_mesh_get_ap_authmode (C++ function), 425
 esp_mesh_get_ap_connections (C++ function), 425
 esp_mesh_get_capacity_num (C++ function), 429
 esp_mesh_get_config (C++ function), 423
 esp_mesh_get_group_list (C++ function), 428
 esp_mesh_get_group_num (C++ function), 428
 esp_mesh_get_id (C++ function), 423
 esp_mesh_get_ie_crypto_key (C++ function), 429

- `esp_mesh_get_layer` (C++ function), 425
- `esp_mesh_get_max_layer` (C++ function), 424
- `esp_mesh_get_network_duty_cycle` (C++ function), 434
- `esp_mesh_get_non_mesh_connections` (C++ function), 425
- `esp_mesh_get_parent_bssid` (C++ function), 425
- `esp_mesh_get_root_healing_delay` (C++ function), 429
- `esp_mesh_get_router` (C++ function), 423
- `esp_mesh_get_router_bssid` (C++ function), 432
- `esp_mesh_get_routing_table` (C++ function), 427
- `esp_mesh_get_routing_table_size` (C++ function), 427
- `esp_mesh_get_running_active_duty_cycle` (C++ function), 434
- `esp_mesh_get_rx_pending` (C++ function), 427
- `esp_mesh_get_self_organized` (C++ function), 426
- `esp_mesh_get_subnet_nodes_list` (C++ function), 431
- `esp_mesh_get_subnet_nodes_num` (C++ function), 431
- `esp_mesh_get_topology` (C++ function), 432
- `esp_mesh_get_total_node_num` (C++ function), 427
- `esp_mesh_get_tsf_time` (C++ function), 432
- `esp_mesh_get_tx_pending` (C++ function), 427
- `esp_mesh_get_type` (C++ function), 424
- `esp_mesh_get_vote_percentage` (C++ function), 426
- `esp_mesh_get_xon_qsize` (C++ function), 428
- `esp_mesh_init` (C++ function), 419
- `esp_mesh_is_device_active` (C++ function), 432
- `esp_mesh_is_my_group` (C++ function), 429
- `esp_mesh_is_ps_enabled` (C++ function), 432
- `esp_mesh_is_root` (C++ function), 425
- `esp_mesh_is_root_conflicts_allowed` (C++ function), 428
- `esp_mesh_is_root_fixed` (C++ function), 430
- `esp_mesh_post_toDS_state` (C++ function), 427
- `esp_mesh_ps_duty_signaling` (C++ function), 434
- `esp_mesh_recv` (C++ function), 421
- `esp_mesh_recv_toDS` (C++ function), 422
- `esp_mesh_scan_get_ap_ie_len` (C++ function), 430
- `esp_mesh_scan_get_ap_record` (C++ function), 430
- `esp_mesh_send` (C++ function), 420
- `esp_mesh_send_block_time` (C++ function), 421
- `esp_mesh_set_active_duty_cycle` (C++ function), 433
- `esp_mesh_set_ap_assoc_expire` (C++ function), 426
- `esp_mesh_set_ap_authmode` (C++ function), 424
- `esp_mesh_set_ap_connections` (C++ function), 425
- `esp_mesh_set_ap_password` (C++ function), 424
- `esp_mesh_set_capacity_num` (C++ function), 429
- `esp_mesh_set_config` (C++ function), 422
- `esp_mesh_set_group_id` (C++ function), 428
- `esp_mesh_set_id` (C++ function), 423
- `esp_mesh_set_ie_crypto_funcs` (C++ function), 429
- `esp_mesh_set_ie_crypto_key` (C++ function), 429
- `esp_mesh_set_max_layer` (C++ function), 424
- `esp_mesh_set_network_duty_cycle` (C++ function), 433
- `esp_mesh_set_parent` (C++ function), 430
- `esp_mesh_set_root_healing_delay` (C++ function), 429
- `esp_mesh_set_router` (C++ function), 423
- `esp_mesh_set_self_organized` (C++ function), 425
- `esp_mesh_set_topology` (C++ function), 432
- `esp_mesh_set_type` (C++ function), 424
- `esp_mesh_set_vote_percentage` (C++ function), 426
- `esp_mesh_set_xon_qsize` (C++ function), 428
- `esp_mesh_start` (C++ function), 420
- `esp_mesh_stop` (C++ function), 420
- `esp_mesh_switch_channel` (C++ function), 431
- `esp_mesh_topology_t` (C++ enum), 446
- `esp_mesh_waive_root` (C++ function), 426
- `esp_mqtt_client_config_t` (C++ class), 661
- `esp_mqtt_client_config_t::alpn_protos` (C++ member), 662
- `esp_mqtt_client_config_t::buffer_size` (C++ member), 662
- `esp_mqtt_client_config_t::cert_len` (C++ member), 662
- `esp_mqtt_client_config_t::cert_pem` (C++ member), 662
- `esp_mqtt_client_config_t::client_cert_len` (C++ member), 662
- `esp_mqtt_client_config_t::client_cert_pem` (C++ member), 662
- `esp_mqtt_client_config_t::client_id` (C++ member), 661
- `esp_mqtt_client_config_t::client_key_len` (C++ member), 662
- `esp_mqtt_client_config_t::client_key_pem` (C++ member), 662
- `esp_mqtt_client_config_t::clientkey_password` (C++ member), 662

esp_mqtt_client_config_t::clientkey_password (C++ member), 663
 esp_mqtt_client_config_t::clientkey_password (C++ member), 663
 esp_mqtt_client_config_t::crt_bundle_attach (C++ member), 662
 esp_mqtt_client_config_t::crt_bundle_attach (C++ member), 662
 esp_mqtt_client_config_t::disable_auto_reconnect (C++ member), 662
 esp_mqtt_client_config_t::disable_auto_reconnect (C++ member), 662
 esp_mqtt_client_config_t::disable_clear_session (C++ member), 661
 esp_mqtt_client_config_t::disable_clear_session (C++ member), 661
 esp_mqtt_client_config_t::disable_keepalive (C++ member), 663
 esp_mqtt_client_config_t::disable_keepalive (C++ member), 663
 esp_mqtt_client_config_t::ds_data (C++ member), 663
 esp_mqtt_client_config_t::ds_data (C++ member), 663
 esp_mqtt_client_config_t::event_handle (C++ member), 661
 esp_mqtt_client_config_t::event_handle (C++ member), 661
 esp_mqtt_client_config_t::event_loop_handle (C++ member), 661
 esp_mqtt_client_config_t::event_loop_handle (C++ member), 661
 esp_mqtt_client_config_t::host (C++ member), 661
 esp_mqtt_client_config_t::host (C++ member), 661
 esp_mqtt_client_config_t::keepalive (C++ member), 661
 esp_mqtt_client_config_t::keepalive (C++ member), 661
 esp_mqtt_client_config_t::lwt_msg (C++ member), 661
 esp_mqtt_client_config_t::lwt_msg (C++ member), 661
 esp_mqtt_client_config_t::lwt_msg_len (C++ member), 661
 esp_mqtt_client_config_t::lwt_msg_len (C++ member), 661
 esp_mqtt_client_config_t::lwt_qos (C++ member), 661
 esp_mqtt_client_config_t::lwt_qos (C++ member), 661
 esp_mqtt_client_config_t::lwt_retain (C++ member), 661
 esp_mqtt_client_config_t::lwt_retain (C++ member), 661
 esp_mqtt_client_config_t::lwt_topic (C++ member), 661
 esp_mqtt_client_config_t::lwt_topic (C++ member), 661
 esp_mqtt_client_config_t::message_retransmit_interval (C++ member), 663
 esp_mqtt_client_config_t::message_retransmit_interval (C++ member), 663
 esp_mqtt_client_config_t::network_timeout_ms (C++ member), 663
 esp_mqtt_client_config_t::network_timeout_ms (C++ member), 663
 esp_mqtt_client_config_t::out_buffer_size (C++ member), 663
 esp_mqtt_client_config_t::out_buffer_size (C++ member), 663
 esp_mqtt_client_config_t::password (C++ member), 661
 esp_mqtt_client_config_t::password (C++ member), 661
 esp_mqtt_client_config_t::path (C++ member), 663
 esp_mqtt_client_config_t::path (C++ member), 663
 esp_mqtt_client_config_t::port (C++ member), 661
 esp_mqtt_client_config_t::port (C++ member), 661
 esp_mqtt_client_config_t::protocol_version (C++ member), 663
 esp_mqtt_client_config_t::protocol_version (C++ member), 663
 esp_mqtt_client_config_t::psk_hint_key (C++ member), 662
 esp_mqtt_client_config_t::psk_hint_key (C++ member), 662
 esp_mqtt_client_config_t::reconnect_timeout_ms (C++ member), 662
 esp_mqtt_client_config_t::reconnect_timeout_ms (C++ member), 662
 esp_mqtt_client_config_t::refresh_connection_after_ms (C++ member), 662
 esp_mqtt_client_config_t::refresh_connection_after_ms (C++ member), 662
 esp_mqtt_client_config_t::set_null_client_id (C++ member), 661
 esp_mqtt_client_config_t::set_null_client_id (C++ member), 661
 esp_mqtt_client_config_t::skip_cert_check (C++ member), 663
 esp_mqtt_client_config_t::skip_cert_check (C++ member), 663
 esp_mqtt_client_config_t::task_prio (C++ member), 662
 esp_mqtt_client_config_t::task_prio (C++ member), 662
 esp_mqtt_client_config_t::task_stack (C++ member), 662
 esp_mqtt_client_config_t::task_stack (C++ member), 662
 esp_mqtt_client_config_t::transport (C++ member), 662
 esp_mqtt_client_config_t::transport (C++ member), 662
 esp_mqtt_client_config_t::uri (C++ member), 661
 esp_mqtt_client_config_t::uri (C++ member), 661
 esp_mqtt_client_config_t::use_global_ca_store (C++ member), 662
 esp_mqtt_client_config_t::use_global_ca_store (C++ member), 662
 esp_mqtt_client_config_t::use_secure_element (C++ member), 663
 esp_mqtt_client_config_t::use_secure_element (C++ member), 663
 esp_mqtt_client_config_t::user_context (C++ member), 662
 esp_mqtt_client_config_t::user_context (C++ member), 662
 esp_mqtt_client_config_t::username (C++ member), 661
 esp_mqtt_client_config_t::username (C++ member), 661
 esp_mqtt_client_destroy (C++ function), 659
 esp_mqtt_client_disconnect (C++ function), 657
 esp_mqtt_client_enqueue (C++ function), 658
 esp_mqtt_client_get_outbox_size (C++ function), 659
 esp_mqtt_client_handle_t (C++ type), 663
 esp_mqtt_client_init (C++ function), 657
 esp_mqtt_client_publish (C++ function), 658
 esp_mqtt_client_reconnect (C++ function), 657
 esp_mqtt_client_register_event (C++ function), 659
 esp_mqtt_client_set_uri (C++ function), 657
 esp_mqtt_client_start (C++ function), 657
 esp_mqtt_client_stop (C++ function), 658
 esp_mqtt_client_subscribe (C++ function), 658
 esp_mqtt_client_unsubscribe (C++ function), 658
 esp_mqtt_connect_return_code_t (C++ enum), 664
 esp_mqtt_error_codes (C++ class), 659
 esp_mqtt_error_codes::connect_return_code (C++ member), 660
 esp_mqtt_error_codes::error_type (C++ member), 660
 esp_mqtt_error_codes::esp_tls_cert_verify_flags (C++ member), 660
 esp_mqtt_error_codes::esp_tls_last_esp_err (C++ member), 660
 esp_mqtt_error_codes::esp_tls_stack_err (C++ member), 660
 esp_mqtt_error_codes::esp_transport_sock_errno (C++ member), 660
 esp_mqtt_error_codes_t (C++ type), 663
 esp_mqtt_event_types_type_t (C++ enum), 665
 esp_mqtt_event_handle_t (C++ type), 663
 esp_mqtt_event_id_t (C++ enum), 664
 esp_mqtt_event_t (C++ class), 660
 esp_mqtt_event_t::client (C++ member), 660
 esp_mqtt_event_t::current_data_offset (C++ member), 660
 esp_mqtt_event_t::data (C++ member), 660
 esp_mqtt_event_t::data_len (C++ member), 660

- 660
- `esp_mqtt_event_t::dup` (C++ member), 661
- `esp_mqtt_event_t::error_handle` (C++ member), 661
- `esp_mqtt_event_t::event_id` (C++ member), 660
- `esp_mqtt_event_t::msg_id` (C++ member), 660
- `esp_mqtt_event_t::qos` (C++ member), 661
- `esp_mqtt_event_t::retain` (C++ member), 661
- `esp_mqtt_event_t::session_present` (C++ member), 661
- `esp_mqtt_event_t::topic` (C++ member), 660
- `esp_mqtt_event_t::topic_len` (C++ member), 660
- `esp_mqtt_event_t::total_data_len` (C++ member), 660
- `esp_mqtt_event_t::user_context` (C++ member), 660
- `esp_mqtt_protocol_ver_t` (C++ enum), 665
- `esp_mqtt_set_config` (C++ function), 659
- `esp_mqtt_transport_t` (C++ enum), 665
- `esp_netif_action_connected` (C++ function), 473
- `esp_netif_action_disconnected` (C++ function), 473
- `esp_netif_action_got_ip` (C++ function), 474
- `esp_netif_action_start` (C++ function), 473
- `esp_netif_action_stop` (C++ function), 473
- `esp_netif_attach` (C++ function), 472
- `esp_netif_attach_wifi_ap` (C++ function), 481
- `esp_netif_attach_wifi_station` (C++ function), 481
- `esp_netif_create_default_wifi_ap` (C++ function), 482
- `esp_netif_create_default_wifi_mesh_netif` (C++ function), 482
- `esp_netif_create_default_wifi_sta` (C++ function), 482
- `esp_netif_create_ip6_linklocal` (C++ function), 478
- `esp_netif_create_wifi` (C++ function), 482
- `esp_netif_deinit` (C++ function), 472
- `esp_netif_destroy` (C++ function), 472
- `esp_netif_dhcpc_get_status` (C++ function), 477
- `esp_netif_dhcpc_option` (C++ function), 476
- `esp_netif_dhcpc_start` (C++ function), 477
- `esp_netif_dhcpc_stop` (C++ function), 477
- `esp_netif_dhcps_get_status` (C++ function), 477
- `esp_netif_dhcps_option` (C++ function), 476
- `esp_netif_dhcps_start` (C++ function), 477
- `esp_netif_dhcps_stop` (C++ function), 477
- `esp_netif_free_rx_buffer` (C++ function), 485
- `esp_netif_get_all_ip6` (C++ function), 479
- `esp_netif_get_desc` (C++ function), 480
- `esp_netif_get_dns_info` (C++ function), 478
- `esp_netif_get_event_id` (C++ function), 480
- `esp_netif_get_flags` (C++ function), 480
- `esp_netif_get_handle_from_ifkey` (C++ function), 480
- `esp_netif_get_handle_from_netif_impl` (C++ function), 485
- `esp_netif_get_hostname` (C++ function), 474
- `esp_netif_get_ifkey` (C++ function), 480
- `esp_netif_get_io_driver` (C++ function), 480
- `esp_netif_get_ip6_global` (C++ function), 479
- `esp_netif_get_ip6_linklocal` (C++ function), 479
- `esp_netif_get_ip_info` (C++ function), 475
- `esp_netif_get_mac` (C++ function), 474
- `esp_netif_get_netif_impl` (C++ function), 485
- `esp_netif_get_netif_impl_index` (C++ function), 476
- `esp_netif_get_netif_impl_name` (C++ function), 476
- `esp_netif_get_nr_of_ifs` (C++ function), 481
- `esp_netif_get_old_ip_info` (C++ function), 475
- `esp_netif_get_route_prio` (C++ function), 480
- `esp_netif_init` (C++ function), 472
- `esp_netif_is_netif_up` (C++ function), 475
- `esp_netif_netstack_buf_free` (C++ function), 481
- `esp_netif_netstack_buf_ref` (C++ function), 481
- `esp_netif_new` (C++ function), 472
- `esp_netif_next` (C++ function), 481
- `esp_netif_receive` (C++ function), 473
- `esp_netif_set_dns_info` (C++ function), 478
- `esp_netif_set_driver_config` (C++ function), 472
- `esp_netif_set_hostname` (C++ function), 474
- `esp_netif_set_ip4_addr` (C++ function), 479
- `esp_netif_set_ip_info` (C++ function), 475
- `esp_netif_set_mac` (C++ function), 474
- `esp_netif_set_old_ip_info` (C++ function), 475
- `esp_netif_str_to_ip4` (C++ function), 479
- `esp_netif_str_to_ip6` (C++ function), 480
- `esp_netif_transmit` (C++ function), 485
- `esp_netif_transmit_wrap` (C++ function), 485
- `esp_nimble_hci_and_controller_deinit` (C++ function), 153
- `esp_nimble_hci_and_controller_init` (C++ function), 152
- `esp_nimble_hci_deinit` (C++ function), 153
- `esp_nimble_hci_init` (C++ function), 152
- `esp_now_add_peer` (C++ function), 410

- esp_now_deinit (C++ function), 409
- esp_now_del_peer (C++ function), 410
- ESP_NOW_ETH_ALEN (C macro), 413
- esp_now_fetch_peer (C++ function), 411
- esp_now_get_peer (C++ function), 411
- esp_now_get_peer_num (C++ function), 411
- esp_now_get_version (C++ function), 409
- esp_now_init (C++ function), 409
- esp_now_is_peer_exist (C++ function), 411
- ESP_NOW_KEY_LEN (C macro), 413
- ESP_NOW_MAX_DATA_LEN (C macro), 413
- ESP_NOW_MAX_ENCRYPT_PEER_NUM (C macro), 413
- ESP_NOW_MAX_TOTAL_PEER_NUM (C macro), 413
- esp_now_mod_peer (C++ function), 410
- esp_now_peer_info (C++ class), 412
- esp_now_peer_info::channel (C++ member), 412
- esp_now_peer_info::encrypt (C++ member), 412
- esp_now_peer_info::ifidx (C++ member), 412
- esp_now_peer_info::lmk (C++ member), 412
- esp_now_peer_info::peer_addr (C++ member), 412
- esp_now_peer_info::priv (C++ member), 412
- esp_now_peer_info_t (C++ type), 413
- esp_now_peer_num (C++ class), 412
- esp_now_peer_num::encrypt_num (C++ member), 413
- esp_now_peer_num::total_num (C++ member), 413
- esp_now_peer_num_t (C++ type), 413
- esp_now_rcv_cb_t (C++ type), 413
- esp_now_register_rcv_cb (C++ function), 409
- esp_now_register_send_cb (C++ function), 410
- esp_now_send (C++ function), 410
- esp_now_send_cb_t (C++ type), 413
- ESP_NOW_SEND_FAIL (C++ enumerator), 414
- esp_now_send_status_t (C++ enum), 414
- ESP_NOW_SEND_SUCCESS (C++ enumerator), 414
- esp_now_set_pmk (C++ function), 412
- esp_now_set_wake_window (C++ function), 412
- esp_now_unregister_rcv_cb (C++ function), 409
- esp_now_unregister_send_cb (C++ function), 410
- ESP_OK (C macro), 918
- ESP_OK_EFUSE_CNT (C macro), 917
- esp_ota_abort (C++ function), 1101
- esp_ota_begin (C++ function), 1100
- esp_ota_check_rollback_is_possible (C++ function), 1103
- esp_ota_end (C++ function), 1101
- esp_ota_erase_last_boot_app_partition (C++ function), 1103
- esp_ota_get_app_description (C++ function), 1100
- esp_ota_get_app_elf_sha256 (C++ function), 1100
- esp_ota_get_boot_partition (C++ function), 1102
- esp_ota_get_last_invalid_partition (C++ function), 1103
- esp_ota_get_next_update_partition (C++ function), 1102
- esp_ota_get_partition_description (C++ function), 1102
- esp_ota_get_running_partition (C++ function), 1102
- esp_ota_get_state_partition (C++ function), 1103
- esp_ota_handle_t (C++ type), 1104
- esp_ota_mark_app_invalid_rollback_and_reboot (C++ function), 1103
- esp_ota_mark_app_valid_cancel_rollback (C++ function), 1103
- esp_ota_revoke_secure_boot_public_key (C++ function), 1104
- esp_ota_secure_boot_public_key_index_t (C++ enum), 1104
- esp_ota_set_boot_partition (C++ function), 1102
- esp_ota_write (C++ function), 1101
- esp_ota_write_with_offset (C++ function), 1101
- esp_partition_check_identity (C++ function), 855
- esp_partition_deregister_external (C++ function), 856
- esp_partition_erase_range (C++ function), 854
- esp_partition_find (C++ function), 852
- esp_partition_find_first (C++ function), 852
- esp_partition_get (C++ function), 853
- esp_partition_get_sha256 (C++ function), 855
- esp_partition_iterator_release (C++ function), 853
- esp_partition_iterator_t (C++ type), 857
- esp_partition_mmap (C++ function), 855
- esp_partition_next (C++ function), 853
- esp_partition_read (C++ function), 853
- esp_partition_read_raw (C++ function), 854
- esp_partition_register_external (C++ function), 856
- ESP_PARTITION_SUBTYPE_ANY (C++ enumerator), 858
- ESP_PARTITION_SUBTYPE_APP_FACTORY (C++ enumerator), 857
- ESP_PARTITION_SUBTYPE_APP_OTA_0 (C++ enumerator), 857
- ESP_PARTITION_SUBTYPE_APP_OTA_1 (C++

- enumerator*), 857
- ESP_PARTITION_SUBTYPE_APP_OTA_10 (C++ *enumerator*), 858
- ESP_PARTITION_SUBTYPE_APP_OTA_11 (C++ *enumerator*), 858
- ESP_PARTITION_SUBTYPE_APP_OTA_12 (C++ *enumerator*), 858
- ESP_PARTITION_SUBTYPE_APP_OTA_13 (C++ *enumerator*), 858
- ESP_PARTITION_SUBTYPE_APP_OTA_14 (C++ *enumerator*), 858
- ESP_PARTITION_SUBTYPE_APP_OTA_15 (C++ *enumerator*), 858
- ESP_PARTITION_SUBTYPE_APP_OTA_2 (C++ *enumerator*), 857
- ESP_PARTITION_SUBTYPE_APP_OTA_3 (C++ *enumerator*), 857
- ESP_PARTITION_SUBTYPE_APP_OTA_4 (C++ *enumerator*), 857
- ESP_PARTITION_SUBTYPE_APP_OTA_5 (C++ *enumerator*), 857
- ESP_PARTITION_SUBTYPE_APP_OTA_6 (C++ *enumerator*), 858
- ESP_PARTITION_SUBTYPE_APP_OTA_7 (C++ *enumerator*), 858
- ESP_PARTITION_SUBTYPE_APP_OTA_8 (C++ *enumerator*), 858
- ESP_PARTITION_SUBTYPE_APP_OTA_9 (C++ *enumerator*), 858
- ESP_PARTITION_SUBTYPE_APP_OTA_MAX (C++ *enumerator*), 858
- ESP_PARTITION_SUBTYPE_APP_OTA_MIN (C++ *enumerator*), 857
- ESP_PARTITION_SUBTYPE_APP_TEST (C++ *enumerator*), 858
- ESP_PARTITION_SUBTYPE_DATA_COREDUMP (C++ *enumerator*), 858
- ESP_PARTITION_SUBTYPE_DATA_EFUSE_EM (C++ *enumerator*), 858
- ESP_PARTITION_SUBTYPE_DATA_ESPHTTPD (C++ *enumerator*), 858
- ESP_PARTITION_SUBTYPE_DATA_FAT (C++ *enumerator*), 858
- ESP_PARTITION_SUBTYPE_DATA_NVS (C++ *enumerator*), 858
- ESP_PARTITION_SUBTYPE_DATA_NVS_KEYS (C++ *enumerator*), 858
- ESP_PARTITION_SUBTYPE_DATA_OTA (C++ *enumerator*), 858
- ESP_PARTITION_SUBTYPE_DATA_PHY (C++ *enumerator*), 858
- ESP_PARTITION_SUBTYPE_DATA_SPIFFS (C++ *enumerator*), 858
- ESP_PARTITION_SUBTYPE_DATA_UNDEFINED (C++ *enumerator*), 858
- ESP_PARTITION_SUBTYPE_OTA (C macro), 857
- esp_partition_subtype_t (C++ *enum*), 857
- esp_partition_t (C++ *class*), 856
 - esp_partition_t::address (C++ *member*), 856
 - esp_partition_t::encrypted (C++ *member*), 857
 - esp_partition_t::flash_chip (C++ *member*), 856
 - esp_partition_t::label (C++ *member*), 857
 - esp_partition_t::size (C++ *member*), 857
 - esp_partition_t::subtype (C++ *member*), 856
 - esp_partition_t::type (C++ *member*), 856
- ESP_PARTITION_TYPE_APP (C++ *enumerator*), 857
- ESP_PARTITION_TYPE_DATA (C++ *enumerator*), 857
- esp_partition_type_t (C++ *enum*), 857
- esp_partition_verify (C++ *function*), 853
- esp_partition_write (C++ *function*), 853
- esp_partition_write_raw (C++ *function*), 854
- ESP_PD_DOMAIN_CPU (C++ *enumerator*), 1116
- ESP_PD_DOMAIN_MAX (C++ *enumerator*), 1116
- ESP_PD_DOMAIN_RTC8M (C++ *enumerator*), 1116
- ESP_PD_DOMAIN_RTC_FAST_MEM (C++ *enumerator*), 1116
- ESP_PD_DOMAIN_RTC_PERIPH (C++ *enumerator*), 1116
- ESP_PD_DOMAIN_RTC_SLOW_MEM (C++ *enumerator*), 1116
- ESP_PD_DOMAIN_VDDSDIO (C++ *enumerator*), 1116
- ESP_PD_DOMAIN_XTAL (C++ *enumerator*), 1116
- ESP_PD_OPTION_AUTO (C++ *enumerator*), 1117
- ESP_PD_OPTION_OFF (C++ *enumerator*), 1117
- ESP_PD_OPTION_ON (C++ *enumerator*), 1117
- esp_ping_callbacks_t (C++ *class*), 717
 - esp_ping_callbacks_t::cb_args (C++ *member*), 718
 - esp_ping_callbacks_t::on_ping_end (C++ *member*), 718
 - esp_ping_callbacks_t::on_ping_success (C++ *member*), 718
 - esp_ping_callbacks_t::on_ping_timeout (C++ *member*), 718
- esp_ping_config_t (C++ *class*), 718
 - esp_ping_config_t::count (C++ *member*), 718
 - esp_ping_config_t::data_size (C++ *member*), 718
 - esp_ping_config_t::interface (C++ *member*), 718
 - esp_ping_config_t::interval_ms (C++ *member*), 718
 - esp_ping_config_t::target_addr (C++ *member*), 718
 - esp_ping_config_t::task_prio (C++ *member*), 718
 - esp_ping_config_t::task_stack_size (C++ *member*), 718

- esp_ping_config_t::timeout_ms (C++ member), 718
 esp_ping_config_t::tos (C++ member), 718
 esp_ping_config_t::ttl (C++ member), 718
 ESP_PING_COUNT_INFINITE (C macro), 718
 ESP_PING_DEFAULT_CONFIG (C macro), 718
 esp_ping_delete_session (C++ function), 717
 esp_ping_get_profile (C++ function), 717
 esp_ping_handle_t (C++ type), 718
 esp_ping_new_session (C++ function), 717
 ESP_PING_PROF_DURATION (C++ enumerator), 719
 ESP_PING_PROF_IPADDR (C++ enumerator), 719
 ESP_PING_PROF_REPLY (C++ enumerator), 719
 ESP_PING_PROF_REQUEST (C++ enumerator), 719
 ESP_PING_PROF_SEQNO (C++ enumerator), 719
 ESP_PING_PROF_SIZE (C++ enumerator), 719
 ESP_PING_PROF_TIMEGAP (C++ enumerator), 719
 ESP_PING_PROF_TOS (C++ enumerator), 719
 ESP_PING_PROF_TTL (C++ enumerator), 719
 esp_ping_profile_t (C++ enum), 719
 esp_ping_start (C++ function), 717
 esp_ping_stop (C++ function), 717
 ESP_PM_APB_FREQ_MAX (C++ enumerator), 1110
 esp_pm_config_esp32c3_t (C++ class), 1110
 esp_pm_config_esp32c3_t::light_sleep_enable (C++ member), 1110
 esp_pm_config_esp32c3_t::max_freq_mhz (C++ member), 1110
 esp_pm_config_esp32c3_t::min_freq_mhz (C++ member), 1110
 esp_pm_configure (C++ function), 1108
 ESP_PM_CPU_FREQ_MAX (C++ enumerator), 1110
 esp_pm_dump_locks (C++ function), 1109
 esp_pm_get_configuration (C++ function), 1108
 esp_pm_lock_acquire (C++ function), 1109
 esp_pm_lock_create (C++ function), 1108
 esp_pm_lock_delete (C++ function), 1109
 esp_pm_lock_handle_t (C++ type), 1110
 esp_pm_lock_release (C++ function), 1109
 esp_pm_lock_type_t (C++ enum), 1110
 ESP_PM_NO_LIGHT_SLEEP (C++ enumerator), 1110
 esp_power_level_t (C++ enum), 53
 esp_pthread_cfg_t (C++ class), 924
 esp_pthread_cfg_t::inherit_cfg (C++ member), 924
 esp_pthread_cfg_t::pin_to_core (C++ member), 924
 esp_pthread_cfg_t::prio (C++ member), 924
 esp_pthread_cfg_t::stack_size (C++ member), 924
 esp_pthread_cfg_t::thread_name (C++ member), 924
 esp_pthread_get_cfg (C++ function), 924
 esp_pthread_get_default_config (C++ function), 924
 esp_pthread_init (C++ function), 924
 esp_pthread_set_cfg (C++ function), 924
 ESP_PWR_LVL_N0 (C++ enumerator), 54
 ESP_PWR_LVL_N11 (C++ enumerator), 54
 ESP_PWR_LVL_N12 (C++ enumerator), 53
 ESP_PWR_LVL_N14 (C++ enumerator), 54
 ESP_PWR_LVL_N2 (C++ enumerator), 54
 ESP_PWR_LVL_N3 (C++ enumerator), 54
 ESP_PWR_LVL_N5 (C++ enumerator), 54
 ESP_PWR_LVL_N6 (C++ enumerator), 54
 ESP_PWR_LVL_N8 (C++ enumerator), 54
 ESP_PWR_LVL_N9 (C++ enumerator), 54
 ESP_PWR_LVL_P1 (C++ enumerator), 54
 ESP_PWR_LVL_P3 (C++ enumerator), 54
 ESP_PWR_LVL_P4 (C++ enumerator), 54
 ESP_PWR_LVL_P6 (C++ enumerator), 54
 ESP_PWR_LVL_P7 (C++ enumerator), 54
 ESP_PWR_LVL_P9 (C++ enumerator), 54
 esp_random (C++ function), 1091
 esp_read_mac (C++ function), 1092
 esp_register_freertos_idle_hook (C++ function), 1049
 esp_register_freertos_idle_hook_for_cpu (C++ function), 1049
 esp_register_freertos_tick_hook (C++ function), 1050
 esp_register_freertos_tick_hook_for_cpu (C++ function), 1049
 esp_register_shutdown_handler (C++ function), 1090
 esp_reset_reason (C++ function), 1090
 esp_reset_reason_t (C++ enum), 1093
 esp_restart (C++ function), 1090
 esp_rom_delay_us (C++ function), 1125
 esp_rom_disable_logging (C++ function), 1125
 esp_rom_install_channel_putc (C++ function), 1125
 esp_rom_install_uart_printf (C++ function), 1125
 esp_rom_printf (C++ function), 1125
 ESP_RST_BROWNOUT (C++ enumerator), 1093
 ESP_RST_DEEPSLEEP (C++ enumerator), 1093
 ESP_RST_EXT (C++ enumerator), 1093
 ESP_RST_INT_WDT (C++ enumerator), 1093
 ESP_RST_PANIC (C++ enumerator), 1093
 ESP_RST_POWERON (C++ enumerator), 1093
 ESP_RST_SDIO (C++ enumerator), 1093
 ESP_RST_SW (C++ enumerator), 1093
 ESP_RST_TASK_WDT (C++ enumerator), 1093
 ESP_RST_UNKNOWN (C++ enumerator), 1093
 ESP_RST_WDT (C++ enumerator), 1093
 ESP_SCO_DATA_PATH_HCI (C++ enumerator), 54
 ESP_SCO_DATA_PATH_PCM (C++ enumerator), 54
 esp_sco_data_path_t (C++ enum), 54
 esp_service_source_t (C++ enum), 113
 esp_set_deep_sleep_wake_stub (C++ function), 1115

- `esp_sleep_config_gpio_isolate` (C++ function), 1116
- `esp_sleep_disable_wakeup_source` (C++ function), 1113
- `esp_sleep_disable_wifi_wakeup` (C++ function), 1114
- `esp_sleep_enable_gpio_switch` (C++ function), 1116
- `esp_sleep_enable_gpio_wakeup` (C++ function), 1113
- `esp_sleep_enable_timer_wakeup` (C++ function), 1113
- `esp_sleep_enable_uart_wakeup` (C++ function), 1114
- `esp_sleep_enable_wifi_wakeup` (C++ function), 1114
- `esp_sleep_ext1_wakeup_mode_t` (C++ enum), 1116
- `esp_sleep_get_ext1_wakeup_status` (C++ function), 1114
- `esp_sleep_get_gpio_wakeup_status` (C++ function), 1114
- `esp_sleep_get_wakeup_cause` (C++ function), 1115
- `esp_sleep_is_valid_wakeup_gpio` (C++ function), 1113
- `esp_sleep_pd_config` (C++ function), 1114
- `esp_sleep_pd_domain_t` (C++ enum), 1116
- `esp_sleep_pd_option_t` (C++ enum), 1116
- `esp_sleep_source_t` (C++ enum), 1117
- `ESP_SLEEP_WAKEUP_ALL` (C++ enumerator), 1117
- `ESP_SLEEP_WAKEUP_BT` (C++ enumerator), 1117
- `esp_sleep_wakeup_cause_t` (C++ type), 1116
- `ESP_SLEEP_WAKEUP_COCPU` (C++ enumerator), 1117
- `ESP_SLEEP_WAKEUP_COCPU_TRAP_TRIG` (C++ enumerator), 1117
- `ESP_SLEEP_WAKEUP_EXT0` (C++ enumerator), 1117
- `ESP_SLEEP_WAKEUP_EXT1` (C++ enumerator), 1117
- `ESP_SLEEP_WAKEUP_GPIO` (C++ enumerator), 1117
- `ESP_SLEEP_WAKEUP_TIMER` (C++ enumerator), 1117
- `ESP_SLEEP_WAKEUP_TOUCHPAD` (C++ enumerator), 1117
- `ESP_SLEEP_WAKEUP_UART` (C++ enumerator), 1117
- `ESP_SLEEP_WAKEUP_ULP` (C++ enumerator), 1117
- `ESP_SLEEP_WAKEUP_UNDEFINED` (C++ enumerator), 1117
- `ESP_SLEEP_WAKEUP_WIFI` (C++ enumerator), 1117
- `esp_smartconfig_fast_mode` (C++ function), 406
- `esp_smartconfig_get_rvd_data` (C++ function), 406
- `esp_smartconfig_get_version` (C++ function), 405
- `esp_smartconfig_set_type` (C++ function), 405
- `esp_smartconfig_start` (C++ function), 405
- `esp_smartconfig_stop` (C++ function), 405
- `esp_spiffs_format` (C++ function), 863
- `esp_spiffs_info` (C++ function), 863
- `esp_spiffs_mounted` (C++ function), 862
- `esp_supp_dpp_bootstrap_gen` (C++ function), 447
- `esp_supp_dpp_bootstrap_t` (C++ type), 448
- `ESP_SUPP_DPP_CFG_RECVD` (C++ enumerator), 448
- `esp_supp_dpp_deinit` (C++ function), 447
- `esp_supp_dpp_event_cb_t` (C++ type), 448
- `esp_supp_dpp_event_t` (C++ enum), 448
- `ESP_SUPP_DPP_FAIL` (C++ enumerator), 448
- `esp_supp_dpp_init` (C++ function), 447
- `esp_supp_dpp_start_listen` (C++ function), 447
- `esp_supp_dpp_stop_listen` (C++ function), 447
- `ESP_SUPP_DPP_URI_READY` (C++ enumerator), 448
- `esp_system_abort` (C++ function), 1092
- `esp_sysview_flush` (C++ function), 887
- `esp_sysview_heap_trace_alloc` (C++ function), 888
- `esp_sysview_heap_trace_free` (C++ function), 888
- `esp_sysview_heap_trace_start` (C++ function), 888
- `esp_sysview_heap_trace_stop` (C++ function), 888
- `esp_sysview_vprintf` (C++ function), 888
- `esp_task_wdt_add` (C++ function), 1120
- `esp_task_wdt_deinit` (C++ function), 1120
- `esp_task_wdt_delete` (C++ function), 1120
- `esp_task_wdt_init` (C++ function), 1119
- `esp_task_wdt_reset` (C++ function), 1120
- `esp_task_wdt_status` (C++ function), 1120
- `esp_timer_cb_t` (C++ type), 1076
- `esp_timer_create` (C++ function), 1074
- `esp_timer_create_args_t` (C++ class), 1075
- `esp_timer_create_args_t::arg` (C++ member), 1076
- `esp_timer_create_args_t::callback` (C++ member), 1076
- `esp_timer_create_args_t::dispatch_method` (C++ member), 1076
- `esp_timer_create_args_t::name` (C++ member), 1076
- `esp_timer_create_args_t::skip_unhandled_events` (C++ member), 1076
- `esp_timer_deinit` (C++ function), 1074
- `esp_timer_delete` (C++ function), 1074
- `esp_timer_dispatch_t` (C++ enum), 1076

- `esp_timer_dump` (C++ function), 1075
- `esp_timer_early_init` (C++ function), 1073
- `esp_timer_get_next_alarm` (C++ function), 1075
- `esp_timer_get_time` (C++ function), 1075
- `esp_timer_handle_t` (C++ type), 1076
- `esp_timer_init` (C++ function), 1073
- `esp_timer_is_active` (C++ function), 1075
- `esp_timer_start_once` (C++ function), 1074
- `esp_timer_start_periodic` (C++ function), 1074
- `esp_timer_stop` (C++ function), 1074
- `ESP_TIMER_TASK` (C++ enumerator), 1076
- `esp_tls` (C++ class), 674
- `esp_tls::cacert` (C++ member), 674
- `esp_tls::cacert_ptr` (C++ member), 674
- `esp_tls::clientcert` (C++ member), 674
- `esp_tls::clientkey` (C++ member), 674
- `esp_tls::conf` (C++ member), 674
- `esp_tls::conn_state` (C++ member), 675
- `esp_tls::ctr_drbg` (C++ member), 674
- `esp_tls::entropy` (C++ member), 674
- `esp_tls::error_handle` (C++ member), 675
- `esp_tls::is_tls` (C++ member), 675
- `esp_tls::read` (C++ member), 675
- `esp_tls::role` (C++ member), 675
- `esp_tls::rset` (C++ member), 675
- `esp_tls::server_fd` (C++ member), 674
- `esp_tls::sockfd` (C++ member), 674
- `esp_tls::ssl` (C++ member), 674
- `esp_tls::write` (C++ member), 675
- `esp_tls::wset` (C++ member), 675
- `esp_tls_cfg` (C++ class), 672
- `esp_tls_cfg::alpn_protos` (C++ member), 673
- `esp_tls_cfg::cacert_buf` (C++ member), 673
- `esp_tls_cfg::cacert_bytes` (C++ member), 673
- `esp_tls_cfg::cacert_pem_buf` (C++ member), 673
- `esp_tls_cfg::cacert_pem_bytes` (C++ member), 673
- `esp_tls_cfg::clientcert_buf` (C++ member), 673
- `esp_tls_cfg::clientcert_bytes` (C++ member), 673
- `esp_tls_cfg::clientcert_pem_buf` (C++ member), 673
- `esp_tls_cfg::clientcert_pem_bytes` (C++ member), 673
- `esp_tls_cfg::clientkey_buf` (C++ member), 673
- `esp_tls_cfg::clientkey_bytes` (C++ member), 673
- `esp_tls_cfg::clientkey_password` (C++ member), 673
- `esp_tls_cfg::clientkey_password_len` (C++ member), 673
- `esp_tls_cfg::clientkey_pem_buf` (C++ member), 673
- `esp_tls_cfg::clientkey_pem_bytes` (C++ member), 673
- `esp_tls_cfg::common_name` (C++ member), 674
- `esp_tls_cfg::crt_bundle_attach` (C++ member), 674
- `esp_tls_cfg::ds_data` (C++ member), 674
- `esp_tls_cfg::keep_alive_cfg` (C++ member), 674
- `esp_tls_cfg::non_block` (C++ member), 673
- `esp_tls_cfg::psk_hint_key` (C++ member), 674
- `esp_tls_cfg::skip_common_name` (C++ member), 674
- `esp_tls_cfg::timeout_ms` (C++ member), 674
- `esp_tls_cfg::use_global_ca_store` (C++ member), 674
- `esp_tls_cfg::use_secure_element` (C++ member), 674
- `esp_tls_cfg_t` (C++ type), 676
- `ESP_TLS_CLIENT` (C++ enumerator), 677
- `esp_tls_conn_delete` (C++ function), 670
- `esp_tls_conn_destroy` (C++ function), 670
- `esp_tls_conn_http_new` (C++ function), 669
- `esp_tls_conn_http_new_async` (C++ function), 669
- `esp_tls_conn_new` (C++ function), 668
- `esp_tls_conn_new_async` (C++ function), 669
- `esp_tls_conn_new_sync` (C++ function), 668
- `esp_tls_conn_read` (C++ function), 670
- `esp_tls_conn_state` (C++ enum), 677
- `esp_tls_conn_state_t` (C++ type), 676
- `esp_tls_conn_write` (C++ function), 669
- `ESP_TLS_CONNECTING` (C++ enumerator), 677
- `ESP_TLS_DONE` (C++ enumerator), 677
- `ESP_TLS_ERR_SSL_TIMEOUT` (C macro), 676
- `ESP_TLS_ERR_SSL_WANT_READ` (C macro), 676
- `ESP_TLS_ERR_SSL_WANT_WRITE` (C macro), 676
- `ESP_TLS_ERR_TYPE_ESP` (C++ enumerator), 677
- `ESP_TLS_ERR_TYPE_MAX` (C++ enumerator), 677
- `ESP_TLS_ERR_TYPE_MBEDTLS` (C++ enumerator), 677
- `ESP_TLS_ERR_TYPE_MBEDTLS_CERT_FLAGS` (C++ enumerator), 677
- `ESP_TLS_ERR_TYPE_SYSTEM` (C++ enumerator), 677
- `ESP_TLS_ERR_TYPE_UNKNOWN` (C++ enumerator), 677
- `ESP_TLS_ERR_TYPE_WOLFSSL` (C++ enumerator), 677
- `ESP_TLS_ERR_TYPE_WOLFSSL_CERT_FLAGS` (C++ enumerator), 677
- `esp_tls_error_handle_t` (C++ type), 676
- `esp_tls_error_type_t` (C++ enum), 677
- `ESP_TLS_FAIL` (C++ enumerator), 677

- [esp_tls_free_global_ca_store \(C++ function\), 671](#)
[esp_tls_get_and_clear_error_type \(C++ function\), 671](#)
[esp_tls_get_and_clear_last_error \(C++ function\), 671](#)
[esp_tls_get_bytes_avail \(C++ function\), 670](#)
[esp_tls_get_conn_sockfd \(C++ function\), 670](#)
[esp_tls_get_global_ca_store \(C++ function\), 671](#)
[ESP_TLS_HANDSHAKE \(C++ enumerator\), 677](#)
[ESP_TLS_INIT \(C++ enumerator\), 677](#)
[esp_tls_init \(C++ function\), 668](#)
[esp_tls_init_global_ca_store \(C++ function\), 670](#)
[esp_tls_last_error \(C++ class\), 672](#)
[esp_tls_last_error::esp_tls_error_code \(C++ member\), 672](#)
[esp_tls_last_error::esp_tls_flags \(C++ member\), 672](#)
[esp_tls_last_error::last_error \(C++ member\), 672](#)
[esp_tls_last_error_t \(C++ type\), 676](#)
[esp_tls_role \(C++ enum\), 677](#)
[esp_tls_role_t \(C++ type\), 676](#)
[ESP_TLS_SERVER \(C++ enumerator\), 677](#)
[esp_tls_set_global_ca_store \(C++ function\), 671](#)
[esp_tls_t \(C++ type\), 677](#)
[esp_unregister_shutdown_handler \(C++ function\), 1090](#)
[ESP_UUID_LEN_128 \(C macro\), 55](#)
[ESP_UUID_LEN_16 \(C macro\), 55](#)
[ESP_UUID_LEN_32 \(C macro\), 55](#)
[esp_vendor_ie_cb_t \(C++ type\), 382](#)
[esp_vfs_close \(C++ function\), 867](#)
[esp_vfs_dev_uart_port_set_rx_line_endings \(C++ function\), 874](#)
[esp_vfs_dev_uart_port_set_tx_line_endings \(C++ function\), 874](#)
[esp_vfs_dev_uart_register \(C++ function\), 874](#)
[esp_vfs_dev_uart_set_rx_line_endings \(C++ function\), 874](#)
[esp_vfs_dev_uart_set_tx_line_endings \(C++ function\), 874](#)
[esp_vfs_dev_uart_use_driver \(C++ function\), 875](#)
[esp_vfs_dev_uart_use_nonblocking \(C++ function\), 875](#)
[esp_vfs_fat_mount_config_t \(C++ class\), 796, 877](#)
[esp_vfs_fat_mount_config_t::allocation_unit_size \(C++ member\), 796, 877](#)
[esp_vfs_fat_mount_config_t::format_if_mount_failed \(C++ member\), 796, 877](#)
[esp_vfs_fat_mount_config_t::max_files \(C++ member\), 796, 877](#)
[esp_vfs_fat_rawflash_mount \(C++ function\), 797](#)
[esp_vfs_fat_rawflash_unmount \(C++ function\), 797](#)
[esp_vfs_fat_register \(C++ function\), 794](#)
[esp_vfs_fat_sdcard_unmount \(C++ function\), 796](#)
[esp_vfs_fat_sdmmc_mount \(C++ function\), 795](#)
[esp_vfs_fat_sdspi_mount \(C++ function\), 795](#)
[esp_vfs_fat_spiflash_mount \(C++ function\), 876](#)
[esp_vfs_fat_spiflash_unmount \(C++ function\), 877](#)
[esp_vfs_fat_unregister_path \(C++ function\), 794](#)
[ESP_VFS_FLAG_CONTEXT_PTR \(C macro\), 873](#)
[ESP_VFS_FLAG_DEFAULT \(C macro\), 873](#)
[esp_vfs_fstat \(C++ function\), 867](#)
[esp_vfs_id_t \(C++ type\), 874](#)
[esp_vfs_link \(C++ function\), 867](#)
[esp_vfs_lseek \(C++ function\), 867](#)
[esp_vfs_open \(C++ function\), 867](#)
[ESP_VFS_PATH_MAX \(C macro\), 873](#)
[esp_vfs_pread \(C++ function\), 869](#)
[esp_vfs_pwrite \(C++ function\), 869](#)
[esp_vfs_read \(C++ function\), 867](#)
[esp_vfs_register \(C++ function\), 867](#)
[esp_vfs_register_fd \(C++ function\), 868](#)
[esp_vfs_register_fd_range \(C++ function\), 868](#)
[esp_vfs_register_with_id \(C++ function\), 868](#)
[esp_vfs_rename \(C++ function\), 867](#)
[esp_vfs_select \(C++ function\), 868](#)
[esp_vfs_select_sem_t \(C++ class\), 870](#)
[esp_vfs_select_sem_t::is_sem_local \(C++ member\), 870](#)
[esp_vfs_select_sem_t::sem \(C++ member\), 870](#)
[esp_vfs_select_triggered \(C++ function\), 869](#)
[esp_vfs_select_triggered_isr \(C++ function\), 869](#)
[esp_vfs_spiffs_conf_t \(C++ class\), 863](#)
[esp_vfs_spiffs_conf_t::base_path \(C++ member\), 863](#)
[esp_vfs_spiffs_conf_t::format_if_mount_failed \(C++ member\), 863](#)
[esp_vfs_spiffs_conf_t::max_files \(C++ member\), 863](#)
[esp_vfs_spiffs_conf_t::partition_label \(C++ member\), 863](#)
[esp_vfs_spiffs_conf_t::spiffs_register \(C++ function\), 862](#)
[esp_vfs_spiffs_unregister \(C++ function\), 862](#)
[esp_vfs_stat \(C++ function\), 867](#)
[esp_vfs_t \(C++ class\), 870](#)
[esp_vfs_t::access \(C++ member\), 872](#)

- esp_vfs_t::access_p (C++ member), 872
 esp_vfs_t::close (C++ member), 871
 esp_vfs_t::close_p (C++ member), 871
 esp_vfs_t::closedir (C++ member), 872
 esp_vfs_t::closedir_p (C++ member), 871
 esp_vfs_t::end_select (C++ member), 873
 esp_vfs_t::fcntl (C++ member), 872
 esp_vfs_t::fcntl_p (C++ member), 872
 esp_vfs_t::flags (C++ member), 870
 esp_vfs_t::fstat (C++ member), 871
 esp_vfs_t::fstat_p (C++ member), 871
 esp_vfs_t::fsync (C++ member), 872
 esp_vfs_t::fsync_p (C++ member), 872
 esp_vfs_t::get_socket_select_semaphore (C++ member), 873
 esp_vfs_t::ioctl (C++ member), 872
 esp_vfs_t::ioctl_p (C++ member), 872
 esp_vfs_t::link (C++ member), 871
 esp_vfs_t::link_p (C++ member), 871
 esp_vfs_t::lseek (C++ member), 870
 esp_vfs_t::lseek_p (C++ member), 870
 esp_vfs_t::mkdir (C++ member), 872
 esp_vfs_t::mkdir_p (C++ member), 872
 esp_vfs_t::open (C++ member), 870
 esp_vfs_t::open_p (C++ member), 870
 esp_vfs_t::opendir (C++ member), 871
 esp_vfs_t::opendir_p (C++ member), 871
 esp_vfs_t::pread (C++ member), 870
 esp_vfs_t::pread_p (C++ member), 870
 esp_vfs_t::pwrite (C++ member), 870
 esp_vfs_t::pwrite_p (C++ member), 870
 esp_vfs_t::read (C++ member), 870
 esp_vfs_t::read_p (C++ member), 870
 esp_vfs_t::readdir (C++ member), 871
 esp_vfs_t::readdir_p (C++ member), 871
 esp_vfs_t::readdir_r (C++ member), 871
 esp_vfs_t::readdir_r_p (C++ member), 871
 esp_vfs_t::rename (C++ member), 871
 esp_vfs_t::rename_p (C++ member), 871
 esp_vfs_t::rmdir (C++ member), 872
 esp_vfs_t::rmdir_p (C++ member), 872
 esp_vfs_t::seekdir (C++ member), 871
 esp_vfs_t::seekdir_p (C++ member), 871
 esp_vfs_t::socket_select (C++ member), 873
 esp_vfs_t::start_select (C++ member), 873
 esp_vfs_t::stat (C++ member), 871
 esp_vfs_t::stat_p (C++ member), 871
 esp_vfs_t::stop_socket_select (C++ member), 873
 esp_vfs_t::stop_socket_select_isr (C++ member), 873
 esp_vfs_t::tcdrain (C++ member), 872
 esp_vfs_t::tcdrain_p (C++ member), 872
 esp_vfs_t::tcflow (C++ member), 873
 esp_vfs_t::tcflow_p (C++ member), 873
 esp_vfs_t::tcflush (C++ member), 873
 esp_vfs_t::tcflush_p (C++ member), 873
 esp_vfs_t::tcgetattr (C++ member), 872
 esp_vfs_t::tcgetattr_p (C++ member), 872
 esp_vfs_t::tcgetsid (C++ member), 873
 esp_vfs_t::tcgetsid_p (C++ member), 873
 esp_vfs_t::tcsendbreak (C++ member), 873
 esp_vfs_t::tcsendbreak_p (C++ member), 873
 esp_vfs_t::tcsetattr (C++ member), 872
 esp_vfs_t::tcsetattr_p (C++ member), 872
 esp_vfs_t::telldir (C++ member), 871
 esp_vfs_t::telldir_p (C++ member), 871
 esp_vfs_t::truncate (C++ member), 872
 esp_vfs_t::truncate_p (C++ member), 872
 esp_vfs_t::unlink (C++ member), 871
 esp_vfs_t::unlink_p (C++ member), 871
 esp_vfs_t::utime (C++ member), 872
 esp_vfs_t::utime_p (C++ member), 872
 esp_vfs_t::write (C++ member), 870
 esp_vfs_t::write_p (C++ member), 870
 esp_vfs_unlink (C++ function), 867
 esp_vfs_unregister (C++ function), 868
 esp_vfs_unregister_fd (C++ function), 868
 esp_vfs_usb_serial_jtag_use_driver (C++ function), 875
 esp_vfs_usb_serial_jtag_use_nonblocking (C++ function), 875
 esp_vfs_utime (C++ function), 867
 esp_vfs_write (C++ function), 867
 esp_vhci_host_callback (C++ class), 52
 esp_vhci_host_callback::notify_host_recv (C++ member), 52
 esp_vhci_host_callback::notify_host_send_available (C++ member), 52
 esp_vhci_host_callback_t (C++ type), 52
 esp_vhci_host_check_send_available (C++ function), 48
 esp_vhci_host_register_callback (C++ function), 49
 esp_vhci_host_send_packet (C++ function), 48
 esp_wake_deep_sleep (C++ function), 1115
 esp_websocket_client_close (C++ function), 744
 esp_websocket_client_close_with_code (C++ function), 745
 esp_websocket_client_config_t (C++ class), 746
 esp_websocket_client_config_t::buffer_size (C++ member), 746
 esp_websocket_client_config_t::cert_len (C++ member), 746
 esp_websocket_client_config_t::cert_pem (C++ member), 746
 esp_websocket_client_config_t::client_cert (C++ member), 746
 esp_websocket_client_config_t::client_cert_len (C++ member), 746
 esp_websocket_client_config_t::client_key

- (C++ member), 746
- esp_websocket_client_config_t::client_key_bin (C++ member), 746
- esp_websocket_client_config_t::disable_esp_websocket_client_send_bin (C++ member), 746
- esp_websocket_client_config_t::disable_esp_websocket_client_send_text (C++ member), 746
- esp_websocket_client_config_t::disable_esp_websocket_client_set_uri (C++ member), 747
- esp_websocket_client_config_t::headers (C++ member), 747
- esp_websocket_client_config_t::host (C++ member), 746
- esp_websocket_client_config_t::keep_alive (C++ member), 747
- esp_websocket_client_config_t::keep_alive_enable (C++ member), 747
- esp_websocket_client_config_t::keep_alive_idle (C++ member), 747
- esp_websocket_client_config_t::keep_alive_interval (C++ member), 747
- esp_websocket_client_config_t::password (C++ member), 746
- esp_websocket_client_config_t::path (C++ member), 746
- esp_websocket_client_config_t::ping_interval (C++ member), 747
- esp_websocket_client_config_t::pingpong_timeout (C++ member), 747
- esp_websocket_client_config_t::port (C++ member), 746
- esp_websocket_client_config_t::skip_cert_check (C++ member), 747
- esp_websocket_client_config_t::subprotocol (C++ member), 747
- esp_websocket_client_config_t::task_priority (C++ member), 746
- esp_websocket_client_config_t::task_stack (C++ member), 746
- esp_websocket_client_config_t::transport (C++ member), 747
- esp_websocket_client_config_t::uri (C++ member), 746
- esp_websocket_client_config_t::use_global_wifi_driver (C++ member), 747
- esp_websocket_client_config_t::user_agent (C++ member), 747
- esp_websocket_client_config_t::user_context (C++ member), 746
- esp_websocket_client_config_t::username (C++ member), 746
- esp_websocket_client_destroy (C++ function), 743
- esp_websocket_client_handle_t (C++ type), 747
- esp_websocket_client_init (C++ function), 743
- esp_websocket_client_is_connected (C++ function), 745
- esp_websocket_client_send (C++ function), 744
- esp_websocket_client_send_bin (C++ function), 744
- esp_websocket_client_send_text (C++ function), 744
- esp_websocket_client_set_uri (C++ function), 743
- esp_websocket_client_start (C++ function), 743
- esp_websocket_client_stop (C++ function), 743
- esp_websocket_event_data_t (C++ class), 745
- esp_websocket_event_data_t::client (C++ member), 745
- esp_websocket_event_data_t::data_len (C++ member), 745
- esp_websocket_event_data_t::data_ptr (C++ member), 745
- esp_websocket_event_data_t::op_code (C++ member), 745
- esp_websocket_event_data_t::payload_len (C++ member), 745
- esp_websocket_event_data_t::payload_offset (C++ member), 746
- esp_websocket_event_data_t::user_context (C++ member), 745
- esp_websocket_event_id_t (C++ enum), 747
- esp_websocket_register_events (C++ function), 746
- esp_websocket_transport_t (C++ enum), 748
- esp_wifi_80211_tx (C++ function), 375
- esp_wifi_ap_get_sta_aid (C++ function), 374
- esp_wifi_ap_get_sta_list (C++ function), 374
- esp_wifi_bt_power_domain_off (C++ function), 50
- esp_wifi_bt_power_domain_on (C++ function), 50
- esp_wifi_clear_default_wifi_driver_and_handlers (C++ function), 482
- esp_wifi_clear_fast_connect (C++ function), 368
- esp_wifi_config_11b_rate (C++ function), 378
- esp_wifi_config_80211_tx_rate (C++ function), 379
- esp_wifi_config_espnw_rate (C++ function), 411
- esp_wifi_connect (C++ function), 367
- esp_wifi_death_sta (C++ function), 368
- esp_wifi_deinit (C++ function), 366
- esp_wifi_disable_pmf_config (C++ function), 380
- esp_wifi_disconnect (C++ function), 368
- esp_wifi_ftm_end_session (C++ function), 378
- esp_wifi_ftm_initiate_session (C++ function), 378

- tion), 378
- esp_wifi_ftm_resp_set_offset (C++ function), 378
- esp_wifi_get_ant (C++ function), 377
- esp_wifi_get_ant_gpio (C++ function), 377
- esp_wifi_get_bandwidth (C++ function), 370
- esp_wifi_get_channel (C++ function), 371
- esp_wifi_get_config (C++ function), 373
- esp_wifi_get_country (C++ function), 371
- esp_wifi_get_country_code (C++ function), 379
- esp_wifi_get_event_mask (C++ function), 375
- esp_wifi_get_inactive_time (C++ function), 377
- esp_wifi_get_mac (C++ function), 372
- esp_wifi_get_max_tx_power (C++ function), 375
- esp_wifi_get_mode (C++ function), 367
- esp_wifi_get_promiscuous (C++ function), 372
- esp_wifi_get_promiscuous_ctrl_filter (C++ function), 373
- esp_wifi_get_promiscuous_filter (C++ function), 372
- esp_wifi_get_protocol (C++ function), 370
- esp_wifi_get_ps (C++ function), 369
- esp_wifi_get_tsf_time (C++ function), 377
- esp_wifi_init (C++ function), 366
- ESP_WIFI_MAX_CONN_NUM (C macro), 395
- esp_wifi_restore (C++ function), 367
- esp_wifi_scan_get_ap_num (C++ function), 369
- esp_wifi_scan_get_ap_records (C++ function), 369
- esp_wifi_scan_start (C++ function), 368
- esp_wifi_scan_stop (C++ function), 368
- esp_wifi_set_ant (C++ function), 377
- esp_wifi_set_ant_gpio (C++ function), 376
- esp_wifi_set_bandwidth (C++ function), 370
- esp_wifi_set_channel (C++ function), 370
- esp_wifi_set_config (C++ function), 373
- esp_wifi_set_connectionless_wake_interval (C++ function), 379
- esp_wifi_set_country (C++ function), 371
- esp_wifi_set_country_code (C++ function), 379
- esp_wifi_set_csi (C++ function), 376
- esp_wifi_set_csi_config (C++ function), 376
- esp_wifi_set_csi_rx_cb (C++ function), 376
- esp_wifi_set_default_wifi_ap_handlers (C++ function), 481
- esp_wifi_set_default_wifi_sta_handlers (C++ function), 481
- esp_wifi_set_event_mask (C++ function), 375
- esp_wifi_set_inactive_time (C++ function), 377
- esp_wifi_set_mac (C++ function), 371
- esp_wifi_set_max_tx_power (C++ function), 375
- esp_wifi_set_mode (C++ function), 366
- esp_wifi_set_promiscuous (C++ function), 372
- esp_wifi_set_promiscuous_ctrl_filter (C++ function), 373
- esp_wifi_set_promiscuous_filter (C++ function), 372
- esp_wifi_set_promiscuous_rx_cb (C++ function), 372
- esp_wifi_set_protocol (C++ function), 369
- esp_wifi_set_ps (C++ function), 369
- esp_wifi_set_rssi_threshold (C++ function), 378
- esp_wifi_set_storage (C++ function), 374
- esp_wifi_set_vendor_ie (C++ function), 374
- esp_wifi_set_vendor_ie_cb (C++ function), 374
- esp_wifi_sta_get_ap_info (C++ function), 369
- esp_wifi_start (C++ function), 367
- esp_wifi_status_dump (C++ function), 378
- esp_wifi_stop (C++ function), 367
- essl_clear_intr (C++ function), 754
- essl_get_intr (C++ function), 754
- essl_get_intr_ena (C++ function), 755
- essl_get_packet (C++ function), 753
- essl_get_rx_data_size (C++ function), 753
- essl_get_tx_buffer_num (C++ function), 752
- essl_handle_t (C++ type), 755
- essl_init (C++ function), 752
- essl_read_reg (C++ function), 754
- essl_reset_cnt (C++ function), 753
- essl_sdio_config_t (C++ class), 756
- essl_sdio_config_t::card (C++ member), 756
- essl_sdio_config_t::recv_buffer_size (C++ member), 756
- essl_sdio_deinit_dev (C++ function), 756
- essl_sdio_init_dev (C++ function), 755
- essl_send_packet (C++ function), 753
- essl_send_slave_intr (C++ function), 755
- essl_set_intr_ena (C++ function), 755
- essl_spi_config_t (C++ class), 760
- essl_spi_config_t::rx_sync_reg (C++ member), 760
- essl_spi_config_t::spi (C++ member), 760
- essl_spi_config_t::tx_buf_size (C++ member), 760
- essl_spi_config_t::tx_sync_reg (C++ member), 760
- essl_spi_deinit_dev (C++ function), 756
- essl_spi_get_packet (C++ function), 757
- essl_spi_init_dev (C++ function), 756
- essl_spi_rdbuf (C++ function), 758
- essl_spi_rdbuf_polling (C++ function), 758
- essl_spi_rddma (C++ function), 759
- essl_spi_rddma_done (C++ function), 759

- essl_spi_rddma_seg (C++ function), 759
 essl_spi_read_reg (C++ function), 756
 essl_spi_reset_cnt (C++ function), 757
 essl_spi_send_packet (C++ function), 757
 essl_spi_wrbuf (C++ function), 758
 essl_spi_wrbuf_polling (C++ function), 758
 essl_spi_wrdma (C++ function), 759
 essl_spi_wrdma_done (C++ function), 760
 essl_spi_wrdma_seg (C++ function), 760
 essl_spi_write_reg (C++ function), 757
 essl_wait_for_ready (C++ function), 752
 essl_wait_int (C++ function), 754
 essl_write_reg (C++ function), 754
 eStandardSleep (C++ enumerator), 963
 eSuspended (C++ enumerator), 963
 eTaskGetState (C++ function), 947
 eTaskState (C++ enum), 963
 ETH_CMD_G_DUPLEX_MODE (C++ enumerator), 461
 ETH_CMD_G_MAC_ADDR (C++ enumerator), 460
 ETH_CMD_G_PHY_ADDR (C++ enumerator), 461
 ETH_CMD_G_SPEED (C++ enumerator), 461
 ETH_CMD_S_FLOW_CTRL (C++ enumerator), 461
 ETH_CMD_S_MAC_ADDR (C++ enumerator), 460
 ETH_CMD_S_PHY_ADDR (C++ enumerator), 461
 ETH_CMD_S_PROMISCUOUS (C++ enumerator), 461
 ETH_CRC_LEN (C macro), 460
 ETH_DEFAULT_CONFIG (C macro), 458
 ETH_DUPLEX_FULL (C++ enumerator), 461
 ETH_DUPLEX_HALF (C++ enumerator), 461
 eth_duplex_t (C++ enum), 461
 eth_event_t (C++ enum), 461
 ETH_HEADER_LEN (C macro), 460
 ETH_JUMBO_FRAME_PAYLOAD_LEN (C macro), 460
 ETH_LINK_DOWN (C++ enumerator), 461
 eth_link_t (C++ enum), 461
 ETH_LINK_UP (C++ enumerator), 461
 eth_mac_config_t (C++ class), 465
 eth_mac_config_t::flags (C++ member), 465
 eth_mac_config_t::rx_task_prio (C++ member), 465
 eth_mac_config_t::rx_task_stack_size (C++ member), 465
 eth_mac_config_t::smi_mdc_gpio_num (C++ member), 465
 eth_mac_config_t::smi_mdio_gpio_num (C++ member), 465
 eth_mac_config_t::sw_reset_timeout_ms (C++ member), 465
 ETH_MAC_DEFAULT_CONFIG (C macro), 465
 ETH_MAC_FLAG_PIN_TO_CORE (C macro), 465
 ETH_MAC_FLAG_WORK_WITH_CACHE_DISABLE (C macro), 465
 ETH_MAX_PACKET_SIZE (C macro), 460
 ETH_MAX_PAYLOAD_LEN (C macro), 460
 ETH_MIN_PACKET_SIZE (C macro), 460
 ETH_MIN_PAYLOAD_LEN (C macro), 460
 eth_phy_config_t (C++ class), 468
 eth_phy_config_t::autonego_timeout_ms (C++ member), 468
 eth_phy_config_t::phy_addr (C++ member), 468
 eth_phy_config_t::reset_gpio_num (C++ member), 468
 eth_phy_config_t::reset_timeout_ms (C++ member), 468
 ETH_PHY_DEFAULT_CONFIG (C macro), 469
 ETH_SPEED_100M (C++ enumerator), 461
 ETH_SPEED_10M (C++ enumerator), 461
 eth_speed_t (C++ enum), 461
 ETH_STATE_DEINIT (C++ enumerator), 460
 ETH_STATE_DUPLEX (C++ enumerator), 460
 ETH_STATE_LINK (C++ enumerator), 460
 ETH_STATE_LLINIT (C++ enumerator), 460
 ETH_STATE_PAUSE (C++ enumerator), 460
 ETH_STATE_SPEED (C++ enumerator), 460
 ETH_VLAN_TAG_LEN (C macro), 460
 ETHERNET_EVENT_CONNECTED (C++ enumerator), 461
 ETHERNET_EVENT_DISCONNECTED (C++ enumerator), 461
 ETHERNET_EVENT_START (C++ enumerator), 461
 ETHERNET_EVENT_STOP (C++ enumerator), 461
 ETS_INTERNAL_INTR_SOURCE_OFF (C macro), 1082
 ETS_INTERNAL_PROFILING_INTR_SOURCE (C macro), 1082
 ETS_INTERNAL_SW0_INTR_SOURCE (C macro), 1082
 ETS_INTERNAL_SW1_INTR_SOURCE (C macro), 1082
 ETS_INTERNAL_TIMER0_INTR_SOURCE (C macro), 1082
 ETS_INTERNAL_TIMER1_INTR_SOURCE (C macro), 1082
 ETS_INTERNAL_TIMER2_INTR_SOURCE (C macro), 1082
 EventBits_t (C++ type), 1018
 EventGroupHandle_t (C++ type), 1018
- ## F
- FAST_PROV_ACT_ENTER (C++ enumerator), 202
 FAST_PROV_ACT_EXIT (C++ enumerator), 202
 FAST_PROV_ACT_MAX (C++ enumerator), 202
 FAST_PROV_ACT_NONE (C++ enumerator), 202
 FAST_PROV_ACT_SUSPEND (C++ enumerator), 202
 ff_diskio_impl_t (C++ class), 797
 ff_diskio_impl_t::init (C++ member), 798
 ff_diskio_impl_t::ioctl (C++ member), 798
 ff_diskio_impl_t::read (C++ member), 798
 ff_diskio_impl_t::status (C++ member), 798
 ff_diskio_impl_t::write (C++ member), 798
 ff_diskio_register (C++ function), 797
 ff_diskio_register_raw_partition (C++ function), 798

- `ff_diskio_register_sdmmc` (C++ function), 798
- `ff_diskio_register_wl_partition` (C++ function), 798
- `FTM_STATUS_CONF_REJECTED` (C++ enumerator), 404
- `FTM_STATUS_FAIL` (C++ enumerator), 404
- `FTM_STATUS_NO_RESPONSE` (C++ enumerator), 404
- `FTM_STATUS_SUCCESS` (C++ enumerator), 404
- `FTM_STATUS_UNSUPPORTED` (C++ enumerator), 404
- ## G
- `gpio_config` (C++ function), 513
- `gpio_config_t` (C++ class), 520
- `gpio_config_t::intr_type` (C++ member), 520
- `gpio_config_t::mode` (C++ member), 520
- `gpio_config_t::pin_bit_mask` (C++ member), 520
- `gpio_config_t::pull_down_en` (C++ member), 520
- `gpio_config_t::pull_up_en` (C++ member), 520
- `gpio_deep_sleep_hold_dis` (C++ function), 518
- `gpio_deep_sleep_hold_en` (C++ function), 518
- `gpio_deep_sleep_wakeup_disable` (C++ function), 519
- `gpio_deep_sleep_wakeup_enable` (C++ function), 519
- `GPIO_DRIVE_CAP_0` (C++ enumerator), 525
- `GPIO_DRIVE_CAP_1` (C++ enumerator), 525
- `GPIO_DRIVE_CAP_2` (C++ enumerator), 525
- `GPIO_DRIVE_CAP_3` (C++ enumerator), 525
- `GPIO_DRIVE_CAP_DEFAULT` (C++ enumerator), 525
- `GPIO_DRIVE_CAP_MAX` (C++ enumerator), 525
- `gpio_drive_cap_t` (C++ enum), 525
- `GPIO_FLOATING` (C++ enumerator), 525
- `gpio_force_hold_all` (C++ function), 518
- `gpio_force_unhold_all` (C++ function), 518
- `gpio_get_drive_capability` (C++ function), 517
- `gpio_get_level` (C++ function), 514
- `gpio_hold_dis` (C++ function), 518
- `gpio_hold_en` (C++ function), 517
- `gpio_install_isr_service` (C++ function), 516
- `gpio_int_type_t` (C++ enum), 524
- `GPIO_INTR_ANYEDGE` (C++ enumerator), 524
- `GPIO_INTR_DISABLE` (C++ enumerator), 524
- `gpio_intr_disable` (C++ function), 514
- `gpio_intr_enable` (C++ function), 514
- `GPIO_INTR_HIGH_LEVEL` (C++ enumerator), 524
- `GPIO_INTR_LOW_LEVEL` (C++ enumerator), 524
- `GPIO_INTR_MAX` (C++ enumerator), 524
- `GPIO_INTR_NEGEDGE` (C++ enumerator), 524
- `GPIO_INTR_POSEDGE` (C++ enumerator), 524
- `gpio_iomux_in` (C++ function), 518
- `gpio_iomux_out` (C++ function), 518
- `GPIO_IS_DEEP_SLEEP_WAKEUP_VALID_GPIO` (C macro), 520
- `GPIO_IS_VALID_GPIO` (C macro), 519
- `GPIO_IS_VALID_OUTPUT_GPIO` (C macro), 519
- `gpio_isr_handle_t` (C++ type), 520
- `gpio_isr_handler_add` (C++ function), 517
- `gpio_isr_handler_remove` (C++ function), 517
- `gpio_isr_register` (C++ function), 515
- `gpio_isr_t` (C++ type), 523
- `GPIO_MODE_DISABLE` (C++ enumerator), 524
- `GPIO_MODE_INPUT` (C++ enumerator), 524
- `GPIO_MODE_INPUT_OUTPUT` (C++ enumerator), 525
- `GPIO_MODE_INPUT_OUTPUT_OD` (C++ enumerator), 525
- `GPIO_MODE_OUTPUT` (C++ enumerator), 525
- `GPIO_MODE_OUTPUT_OD` (C++ enumerator), 525
- `gpio_mode_t` (C++ enum), 524
- `GPIO_NUM_0` (C++ enumerator), 523
- `GPIO_NUM_1` (C++ enumerator), 523
- `GPIO_NUM_10` (C++ enumerator), 524
- `GPIO_NUM_11` (C++ enumerator), 524
- `GPIO_NUM_12` (C++ enumerator), 524
- `GPIO_NUM_13` (C++ enumerator), 524
- `GPIO_NUM_14` (C++ enumerator), 524
- `GPIO_NUM_15` (C++ enumerator), 524
- `GPIO_NUM_16` (C++ enumerator), 524
- `GPIO_NUM_17` (C++ enumerator), 524
- `GPIO_NUM_18` (C++ enumerator), 524
- `GPIO_NUM_19` (C++ enumerator), 524
- `GPIO_NUM_2` (C++ enumerator), 523
- `GPIO_NUM_20` (C++ enumerator), 524
- `GPIO_NUM_21` (C++ enumerator), 524
- `GPIO_NUM_3` (C++ enumerator), 523
- `GPIO_NUM_4` (C++ enumerator), 523
- `GPIO_NUM_5` (C++ enumerator), 523
- `GPIO_NUM_6` (C++ enumerator), 523
- `GPIO_NUM_7` (C++ enumerator), 523
- `GPIO_NUM_8` (C++ enumerator), 523
- `GPIO_NUM_9` (C++ enumerator), 523
- `GPIO_NUM_MAX` (C++ enumerator), 524
- `GPIO_NUM_NC` (C++ enumerator), 523
- `gpio_num_t` (C++ enum), 523
- `GPIO_PIN_COUNT` (C macro), 519
- `GPIO_PIN_REG_0` (C macro), 522
- `GPIO_PIN_REG_1` (C macro), 522
- `GPIO_PIN_REG_10` (C macro), 522
- `GPIO_PIN_REG_11` (C macro), 522
- `GPIO_PIN_REG_12` (C macro), 522
- `GPIO_PIN_REG_13` (C macro), 522
- `GPIO_PIN_REG_14` (C macro), 522
- `GPIO_PIN_REG_15` (C macro), 522
- `GPIO_PIN_REG_16` (C macro), 522
- `GPIO_PIN_REG_17` (C macro), 522

- GPIO_PIN_REG_18 (C macro), 522
 - GPIO_PIN_REG_19 (C macro), 522
 - GPIO_PIN_REG_2 (C macro), 522
 - GPIO_PIN_REG_20 (C macro), 522
 - GPIO_PIN_REG_21 (C macro), 522
 - GPIO_PIN_REG_22 (C macro), 522
 - GPIO_PIN_REG_23 (C macro), 522
 - GPIO_PIN_REG_24 (C macro), 522
 - GPIO_PIN_REG_25 (C macro), 522
 - GPIO_PIN_REG_26 (C macro), 522
 - GPIO_PIN_REG_27 (C macro), 522
 - GPIO_PIN_REG_28 (C macro), 522
 - GPIO_PIN_REG_29 (C macro), 522
 - GPIO_PIN_REG_3 (C macro), 522
 - GPIO_PIN_REG_30 (C macro), 522
 - GPIO_PIN_REG_31 (C macro), 522
 - GPIO_PIN_REG_32 (C macro), 522
 - GPIO_PIN_REG_33 (C macro), 522
 - GPIO_PIN_REG_34 (C macro), 522
 - GPIO_PIN_REG_35 (C macro), 523
 - GPIO_PIN_REG_36 (C macro), 523
 - GPIO_PIN_REG_37 (C macro), 523
 - GPIO_PIN_REG_38 (C macro), 523
 - GPIO_PIN_REG_39 (C macro), 523
 - GPIO_PIN_REG_4 (C macro), 522
 - GPIO_PIN_REG_40 (C macro), 523
 - GPIO_PIN_REG_41 (C macro), 523
 - GPIO_PIN_REG_42 (C macro), 523
 - GPIO_PIN_REG_43 (C macro), 523
 - GPIO_PIN_REG_44 (C macro), 523
 - GPIO_PIN_REG_45 (C macro), 523
 - GPIO_PIN_REG_46 (C macro), 523
 - GPIO_PIN_REG_5 (C macro), 522
 - GPIO_PIN_REG_6 (C macro), 522
 - GPIO_PIN_REG_7 (C macro), 522
 - GPIO_PIN_REG_8 (C macro), 522
 - GPIO_PIN_REG_9 (C macro), 522
 - GPIO_PORT_0 (C++ enumerator), 523
 - GPIO_PORT_MAX (C++ enumerator), 523
 - gpio_port_t (C++ enum), 523
 - gpio_pull_mode_t (C++ enum), 525
 - gpio_pulldown_dis (C++ function), 516
 - GPIO_PULLDOWN_DISABLE (C++ enumerator), 525
 - gpio_pulldown_en (C++ function), 516
 - GPIO_PULLDOWN_ENABLE (C++ enumerator), 525
 - GPIO_PULLDOWN_ONLY (C++ enumerator), 525
 - gpio_pulldown_t (C++ enum), 525
 - gpio_pullup_dis (C++ function), 516
 - GPIO_PULLUP_DISABLE (C++ enumerator), 525
 - gpio_pullup_en (C++ function), 516
 - GPIO_PULLUP_ENABLE (C++ enumerator), 525
 - GPIO_PULLUP_ONLY (C++ enumerator), 525
 - GPIO_PULLUP_PULLDOWN (C++ enumerator), 525
 - gpio_pullup_t (C++ enum), 525
 - gpio_reset_pin (C++ function), 514
 - GPIO_SEL_0 (C macro), 520
 - GPIO_SEL_1 (C macro), 520
 - GPIO_SEL_10 (C macro), 521
 - GPIO_SEL_11 (C macro), 521
 - GPIO_SEL_12 (C macro), 521
 - GPIO_SEL_13 (C macro), 521
 - GPIO_SEL_14 (C macro), 521
 - GPIO_SEL_15 (C macro), 521
 - GPIO_SEL_16 (C macro), 521
 - GPIO_SEL_17 (C macro), 521
 - GPIO_SEL_18 (C macro), 521
 - GPIO_SEL_19 (C macro), 521
 - GPIO_SEL_2 (C macro), 520
 - GPIO_SEL_20 (C macro), 521
 - GPIO_SEL_21 (C macro), 521
 - GPIO_SEL_26 (C macro), 521
 - GPIO_SEL_27 (C macro), 521
 - GPIO_SEL_28 (C macro), 521
 - GPIO_SEL_29 (C macro), 521
 - GPIO_SEL_3 (C macro), 520
 - GPIO_SEL_30 (C macro), 521
 - GPIO_SEL_31 (C macro), 521
 - GPIO_SEL_32 (C macro), 521
 - GPIO_SEL_33 (C macro), 521
 - GPIO_SEL_34 (C macro), 521
 - GPIO_SEL_35 (C macro), 521
 - GPIO_SEL_36 (C macro), 521
 - GPIO_SEL_37 (C macro), 521
 - GPIO_SEL_38 (C macro), 522
 - GPIO_SEL_39 (C macro), 522
 - GPIO_SEL_4 (C macro), 520
 - GPIO_SEL_5 (C macro), 520
 - GPIO_SEL_6 (C macro), 520
 - GPIO_SEL_7 (C macro), 520
 - GPIO_SEL_8 (C macro), 520
 - GPIO_SEL_9 (C macro), 520
 - gpio_set_direction (C++ function), 515
 - gpio_set_drive_capability (C++ function), 517
 - gpio_set_intr_type (C++ function), 514
 - gpio_set_level (C++ function), 514
 - gpio_set_pull_mode (C++ function), 515
 - gpio_sleep_sel_dis (C++ function), 519
 - gpio_sleep_sel_en (C++ function), 518
 - gpio_sleep_set_direction (C++ function), 519
 - gpio_sleep_set_pull_mode (C++ function), 519
 - gpio_uninstall_isr_service (C++ function), 516
 - gpio_wakeup_disable (C++ function), 515
 - gpio_wakeup_enable (C++ function), 515
- ## H
- heap_caps_add_region (C++ function), 1058
 - heap_caps_add_region_with_caps (C++ function), 1058
 - heap_caps_aligned_alloc (C++ function), 1053
 - heap_caps_aligned_calloc (C++ function), 1053

- heap_caps_aligned_free (C++ function), 1053
 heap_caps_calloc (C++ function), 1053
 heap_caps_calloc_prefer (C++ function), 1055
 heap_caps_check_integrity (C++ function), 1055
 heap_caps_check_integrity_addr (C++ function), 1055
 heap_caps_check_integrity_all (C++ function), 1054
 heap_caps_dump (C++ function), 1056
 heap_caps_dump_all (C++ function), 1056
 heap_caps_enable_nonos_stack_heaps (C++ function), 1058
 heap_caps_free (C++ function), 1052
 heap_caps_get_allocated_size (C++ function), 1056
 heap_caps_get_free_size (C++ function), 1054
 heap_caps_get_info (C++ function), 1054
 heap_caps_get_largest_free_block (C++ function), 1054
 heap_caps_get_minimum_free_size (C++ function), 1054
 heap_caps_get_total_size (C++ function), 1053
 heap_caps_init (C++ function), 1057
 heap_caps_malloc (C++ function), 1052
 heap_caps_malloc_extmem_enable (C++ function), 1055
 heap_caps_malloc_prefer (C++ function), 1055
 heap_caps_print_heap_info (C++ function), 1054
 heap_caps_realloc (C++ function), 1052
 heap_caps_realloc_prefer (C++ function), 1055
 heap_caps_register_failed_alloc_callback (C++ function), 1052
 HEAP_TRACE_ALL (C++ enumerator), 1071
 heap_trace_dump (C++ function), 1071
 heap_trace_get (C++ function), 1071
 heap_trace_get_count (C++ function), 1071
 heap_trace_init_standalone (C++ function), 1070
 heap_trace_init_tohost (C++ function), 1070
 HEAP_TRACE_LEAKS (C++ enumerator), 1071
 heap_trace_mode_t (C++ enum), 1071
 heap_trace_record_t (C++ class), 1071
 heap_trace_record_t::address (C++ member), 1071
 heap_trace_record_t::allocated_by (C++ member), 1071
 heap_trace_record_t::ccount (C++ member), 1071
 heap_trace_record_t::freed_by (C++ member), 1071
 heap_trace_record_t::size (C++ member), 1071
 heap_trace_resume (C++ function), 1070
 heap_trace_start (C++ function), 1070
 heap_trace_stop (C++ function), 1070
 HMAC_KEY0 (C++ enumerator), 529
 HMAC_KEY1 (C++ enumerator), 529
 HMAC_KEY2 (C++ enumerator), 529
 HMAC_KEY3 (C++ enumerator), 529
 HMAC_KEY4 (C++ enumerator), 529
 HMAC_KEY5 (C++ enumerator), 529
 hmac_key_id_t (C++ enum), 529
 HMAC_KEY_MAX (C++ enumerator), 529
 HTTP_AUTH_TYPE_BASIC (C++ enumerator), 690
 HTTP_AUTH_TYPE_DIGEST (C++ enumerator), 690
 HTTP_AUTH_TYPE_NONE (C++ enumerator), 690
 http_client_init_cb_t (C++ type), 922
 HTTP_EVENT_DISCONNECTED (C++ enumerator), 689
 HTTP_EVENT_ERROR (C++ enumerator), 689
 http_event_handle_cb (C++ type), 689
 HTTP_EVENT_HEADER_SENT (C++ enumerator), 689
 HTTP_EVENT_HEADERS_SENT (C++ enumerator), 689
 HTTP_EVENT_ON_CONNECTED (C++ enumerator), 689
 HTTP_EVENT_ON_DATA (C++ enumerator), 689
 HTTP_EVENT_ON_FINISH (C++ enumerator), 689
 HTTP_EVENT_ON_HEADER (C++ enumerator), 689
 HTTP_METHOD_COPY (C++ enumerator), 690
 HTTP_METHOD_DELETE (C++ enumerator), 689
 HTTP_METHOD_GET (C++ enumerator), 689
 HTTP_METHOD_HEAD (C++ enumerator), 690
 HTTP_METHOD_LOCK (C++ enumerator), 690
 HTTP_METHOD_MAX (C++ enumerator), 690
 HTTP_METHOD_MKCOL (C++ enumerator), 690
 HTTP_METHOD_MOVE (C++ enumerator), 690
 HTTP_METHOD_NOTIFY (C++ enumerator), 690
 HTTP_METHOD_OPTIONS (C++ enumerator), 690
 HTTP_METHOD_PATCH (C++ enumerator), 689
 HTTP_METHOD_POST (C++ enumerator), 689
 HTTP_METHOD_PROPFIND (C++ enumerator), 690
 HTTP_METHOD_PROPPATCH (C++ enumerator), 690
 HTTP_METHOD_PUT (C++ enumerator), 689
 HTTP_METHOD_SUBSCRIBE (C++ enumerator), 690
 HTTP_METHOD_UNLOCK (C++ enumerator), 690
 HTTP_METHOD_UNSUBSCRIBE (C++ enumerator), 690
 HTTP_TRANSPORT_OVER_SSL (C++ enumerator), 689
 HTTP_TRANSPORT_OVER_TCP (C++ enumerator), 689
 HTTP_TRANSPORT_UNKNOWN (C++ enumerator), 689
 HTTPD_200 (C macro), 709
 HTTPD_204 (C macro), 709
 HTTPD_207 (C macro), 709
 HTTPD_400 (C macro), 709

- [HTTPD_400_BAD_REQUEST \(C++ enumerator\), 712](#)
[HTTPD_401_UNAUTHORIZED \(C++ enumerator\), 712](#)
[HTTPD_403_FORBIDDEN \(C++ enumerator\), 712](#)
[HTTPD_404 \(C macro\), 709](#)
[HTTPD_404_NOT_FOUND \(C++ enumerator\), 712](#)
[HTTPD_405_METHOD_NOT_ALLOWED \(C++ enumerator\), 712](#)
[HTTPD_408 \(C macro\), 709](#)
[HTTPD_408_REQ_TIMEOUT \(C++ enumerator\), 712](#)
[HTTPD_411_LENGTH_REQUIRED \(C++ enumerator\), 712](#)
[HTTPD_414_URI_TOO_LONG \(C++ enumerator\), 712](#)
[HTTPD_431_REQ_HDR_FIELDS_TOO_LARGE \(C++ enumerator\), 712](#)
[HTTPD_500 \(C macro\), 709](#)
[HTTPD_500_INTERNAL_SERVER_ERROR \(C++ enumerator\), 712](#)
[HTTPD_501_METHOD_NOT_IMPLEMENTED \(C++ enumerator\), 712](#)
[HTTPD_505_VERSION_NOT_SUPPORTED \(C++ enumerator\), 712](#)
[httpd_close_func_t \(C++ type\), 711](#)
[httpd_config \(C++ class\), 706](#)
[httpd_config::backlog_conn \(C++ member\), 706](#)
[httpd_config::close_fn \(C++ member\), 707](#)
[httpd_config::core_id \(C++ member\), 706](#)
[httpd_config::ctrl_port \(C++ member\), 706](#)
[httpd_config::global_transport_ctx \(C++ member\), 707](#)
[httpd_config::global_transport_ctx_free_fn \(C++ member\), 707](#)
[httpd_config::global_user_ctx \(C++ member\), 707](#)
[httpd_config::global_user_ctx_free_fn \(C++ member\), 707](#)
[httpd_config::lru_purge_enable \(C++ member\), 706](#)
[httpd_config::max_open_sockets \(C++ member\), 706](#)
[httpd_config::max_resp_headers \(C++ member\), 706](#)
[httpd_config::max_uri_handlers \(C++ member\), 706](#)
[httpd_config::open_fn \(C++ member\), 707](#)
[httpd_config::recv_wait_timeout \(C++ member\), 706](#)
[httpd_config::send_wait_timeout \(C++ member\), 706](#)
[httpd_config::server_port \(C++ member\), 706](#)
[httpd_config::stack_size \(C++ member\), 706](#)
[httpd_config::task_priority \(C++ member\), 706](#)
[httpd_config::uri_match_fn \(C++ member\), 707](#)
[httpd_config_t \(C++ type\), 712](#)
[HTTPD_DEFAULT_CONFIG \(C macro\), 709](#)
[HTTPD_ERR_CODE_MAX \(C++ enumerator\), 712](#)
[httpd_err_code_t \(C++ enum\), 712](#)
[httpd_err_handler_func_t \(C++ type\), 710](#)
[httpd_free_ctx_fn_t \(C++ type\), 711](#)
[httpd_get_client_list \(C++ function\), 706](#)
[httpd_get_global_transport_ctx \(C++ function\), 705](#)
[httpd_get_global_user_ctx \(C++ function\), 705](#)
[httpd_handle_t \(C++ type\), 711](#)
[HTTPD_MAX_REQ_HDR_LEN \(C macro\), 708](#)
[HTTPD_MAX_URI_LEN \(C macro\), 708](#)
[httpd_method_t \(C++ type\), 711](#)
[httpd_open_func_t \(C++ type\), 711](#)
[httpd_pending_func_t \(C++ type\), 710](#)
[httpd_query_key_value \(C++ function\), 697](#)
[httpd_queue_work \(C++ function\), 704](#)
[httpd_recv_func_t \(C++ type\), 710](#)
[httpd_register_err_handler \(C++ function\), 703](#)
[httpd_register_uri_handler \(C++ function\), 694](#)
[httpd_req \(C++ class\), 707](#)
[httpd_req::aux \(C++ member\), 708](#)
[httpd_req::content_len \(C++ member\), 708](#)
[httpd_req::free_ctx \(C++ member\), 708](#)
[httpd_req::handle \(C++ member\), 707](#)
[httpd_req::ignore_sess_ctx_changes \(C++ member\), 708](#)
[httpd_req::method \(C++ member\), 707](#)
[httpd_req::sess_ctx \(C++ member\), 708](#)
[httpd_req::uri \(C++ member\), 708](#)
[httpd_req::user_ctx \(C++ member\), 708](#)
[httpd_req_get_hdr_value_len \(C++ function\), 696](#)
[httpd_req_get_hdr_value_str \(C++ function\), 696](#)
[httpd_req_get_url_query_len \(C++ function\), 697](#)
[httpd_req_get_url_query_str \(C++ function\), 697](#)
[httpd_req_recv \(C++ function\), 696](#)
[httpd_req_t \(C++ type\), 710](#)
[httpd_req_to_sockfd \(C++ function\), 695](#)
[httpd_resp_send \(C++ function\), 698](#)
[httpd_resp_send_404 \(C++ function\), 701](#)
[httpd_resp_send_408 \(C++ function\), 701](#)
[httpd_resp_send_500 \(C++ function\), 701](#)
[httpd_resp_send_chunk \(C++ function\), 698](#)
[httpd_resp_send_err \(C++ function\), 700](#)
[httpd_resp_sendstr \(C++ function\), 699](#)
[httpd_resp_sendstr_chunk \(C++ function\), 699](#)
[httpd_resp_set_hdr \(C++ function\), 700](#)
[httpd_resp_set_status \(C++ function\), 699](#)

- [httpd_resp_set_type \(C++ function\), 700](#)
[HTTPD_RESP_USE_STRLEN \(C macro\), 709](#)
[httpd_send \(C++ function\), 702](#)
[httpd_send_func_t \(C++ type\), 710](#)
[httpd_sess_get_ctx \(C++ function\), 704](#)
[httpd_sess_get_transport_ctx \(C++ function\), 705](#)
[httpd_sess_set_ctx \(C++ function\), 704](#)
[httpd_sess_set_pending_override \(C++ function\), 695](#)
[httpd_sess_set_recv_override \(C++ function\), 695](#)
[httpd_sess_set_send_override \(C++ function\), 695](#)
[httpd_sess_set_transport_ctx \(C++ function\), 705](#)
[httpd_sess_trigger_close \(C++ function\), 705](#)
[httpd_sess_update_lru_counter \(C++ function\), 705](#)
[HTTPD_SOCK_ERR_FAIL \(C macro\), 708](#)
[HTTPD_SOCK_ERR_INVALID \(C macro\), 709](#)
[HTTPD_SOCK_ERR_TIMEOUT \(C macro\), 709](#)
[httpd_socket_recv \(C++ function\), 702](#)
[httpd_socket_send \(C++ function\), 702](#)
[httpd_ssl_config \(C++ class\), 713](#)
[httpd_ssl_config::cacert_len \(C++ member\), 714](#)
[httpd_ssl_config::cacert_pem \(C++ member\), 714](#)
[httpd_ssl_config::client_verify_cert_len \(C++ member\), 714](#)
[httpd_ssl_config::client_verify_cert_pem \(C++ member\), 714](#)
[httpd_ssl_config::httpd \(C++ member\), 714](#)
[httpd_ssl_config::port_insecure \(C++ member\), 714](#)
[httpd_ssl_config::port_secure \(C++ member\), 714](#)
[httpd_ssl_config::prvtkey_len \(C++ member\), 714](#)
[httpd_ssl_config::prvtkey_pem \(C++ member\), 714](#)
[httpd_ssl_config::transport_mode \(C++ member\), 714](#)
[HTTPD_SSL_CONFIG_DEFAULT \(C macro\), 714](#)
[httpd_ssl_config_t \(C++ type\), 714](#)
[httpd_ssl_start \(C++ function\), 713](#)
[httpd_ssl_stop \(C++ function\), 713](#)
[HTTPD_SSL_TRANSPORT_INSECURE \(C++ enumerator\), 714](#)
[httpd_ssl_transport_mode_t \(C++ enum\), 714](#)
[HTTPD_SSL_TRANSPORT_SECURE \(C++ enumerator\), 714](#)
[httpd_start \(C++ function\), 703](#)
[httpd_stop \(C++ function\), 704](#)
[HTTPD_TYPE_JSON \(C macro\), 709](#)
[HTTPD_TYPE_OCTET \(C macro\), 709](#)
[HTTPD_TYPE_TEXT \(C macro\), 709](#)
[httpd_unregister_uri \(C++ function\), 694](#)
[httpd_unregister_uri_handler \(C++ function\), 694](#)
[httpd_uri \(C++ class\), 708](#)
[httpd_uri::handler \(C++ member\), 708](#)
[httpd_uri::method \(C++ member\), 708](#)
[httpd_uri::uri \(C++ member\), 708](#)
[httpd_uri::user_ctx \(C++ member\), 708](#)
[httpd_uri_match_func_t \(C++ type\), 711](#)
[httpd_uri_match_wildcard \(C++ function\), 698](#)
[httpd_uri_t \(C++ type\), 710](#)
[httpd_work_fn_t \(C++ type\), 712](#)
[HttpStatus_BadRequest \(C++ enumerator\), 691](#)
[HttpStatus_Code \(C++ enum\), 690](#)
[HttpStatus_Forbidden \(C++ enumerator\), 691](#)
[HttpStatus_Found \(C++ enumerator\), 690](#)
[HttpStatus_InternalError \(C++ enumerator\), 691](#)
[HttpStatus_MovedPermanently \(C++ enumerator\), 690](#)
[HttpStatus_MultipleChoices \(C++ enumerator\), 690](#)
[HttpStatus_NotFound \(C++ enumerator\), 691](#)
[HttpStatus_Ok \(C++ enumerator\), 690](#)
[HttpStatus_PermanentRedirect \(C++ enumerator\), 690](#)
[HttpStatus_SeeOther \(C++ enumerator\), 690](#)
[HttpStatus_TemporaryRedirect \(C++ enumerator\), 690](#)
[HttpStatus_Unauthorized \(C++ enumerator\), 691](#)
- I**
[i2c_ack_type_t \(C++ enum\), 547](#)
[I2C_ADDR_BIT_10 \(C++ enumerator\), 547](#)
[I2C_ADDR_BIT_7 \(C++ enumerator\), 547](#)
[I2C_ADDR_BIT_MAX \(C++ enumerator\), 547](#)
[i2c_addr_mode_t \(C++ enum\), 547](#)
[I2C_APB_CLK_FREQ \(C macro\), 545](#)
[I2C_CLK_FREQ_MAX \(C macro\), 546](#)
[i2c_cmd_handle_t \(C++ type\), 546](#)
[i2c_cmd_link_create \(C++ function\), 541](#)
[i2c_cmd_link_delete \(C++ function\), 541](#)
[i2c_config_t \(C++ class\), 546](#)
[i2c_config_t::addr_10bit_en \(C++ member\), 546](#)
[i2c_config_t::clk_flags \(C++ member\), 546](#)
[i2c_config_t::clk_speed \(C++ member\), 546](#)
[i2c_config_t::master \(C++ member\), 546](#)
[i2c_config_t::mode \(C++ member\), 546](#)
[i2c_config_t::scl_io_num \(C++ member\), 546](#)
[i2c_config_t::scl_pullup_en \(C++ member\), 546](#)

- `i2c_config_t::sda_io_num` (C++ member), 546
- `i2c_config_t::sda_pullup_en` (C++ member), 546
- `i2c_config_t::slave` (C++ member), 546
- `i2c_config_t::slave_addr` (C++ member), 546
- `I2C_DATA_MODE_LSB_FIRST` (C++ enumerator), 547
- `I2C_DATA_MODE_MAX` (C++ enumerator), 547
- `I2C_DATA_MODE_MSB_FIRST` (C++ enumerator), 547
- `i2c_driver_delete` (C++ function), 539
- `i2c_driver_install` (C++ function), 539
- `i2c_filter_disable` (C++ function), 543
- `i2c_filter_enable` (C++ function), 543
- `i2c_get_data_mode` (C++ function), 545
- `i2c_get_data_timing` (C++ function), 544
- `i2c_get_period` (C++ function), 543
- `i2c_get_start_timing` (C++ function), 544
- `i2c_get_stop_timing` (C++ function), 544
- `i2c_get_timeout` (C++ function), 545
- `i2c_isr_free` (C++ function), 540
- `i2c_isr_register` (C++ function), 540
- `I2C_MASTER_ACK` (C++ enumerator), 547
- `I2C_MASTER_ACK_MAX` (C++ enumerator), 547
- `i2c_master_cmd_begin` (C++ function), 542
- `I2C_MASTER_LAST_NACK` (C++ enumerator), 547
- `I2C_MASTER_NACK` (C++ enumerator), 547
- `I2C_MASTER_READ` (C++ enumerator), 547
- `i2c_master_read` (C++ function), 542
- `i2c_master_read_byte` (C++ function), 541
- `i2c_master_start` (C++ function), 541
- `i2c_master_stop` (C++ function), 542
- `I2C_MASTER_WRITE` (C++ enumerator), 547
- `i2c_master_write` (C++ function), 541
- `i2c_master_write_byte` (C++ function), 541
- `I2C_MODE_MASTER` (C++ enumerator), 547
- `I2C_MODE_MAX` (C++ enumerator), 547
- `I2C_MODE_SLAVE` (C++ enumerator), 547
- `i2c_mode_t` (C++ enum), 547
- `I2C_NUM_0` (C macro), 545
- `I2C_NUM_1` (C macro), 545
- `I2C_NUM_MAX` (C macro), 545
- `i2c_param_config` (C++ function), 539
- `i2c_port_t` (C++ type), 547
- `i2c_reset_rx_fifo` (C++ function), 540
- `i2c_reset_tx_fifo` (C++ function), 540
- `i2c_rw_t` (C++ enum), 547
- `I2C_SCLK_DEFAULT` (C++ enumerator), 547
- `I2C_SCLK_MAX` (C++ enumerator), 548
- `I2C_SCLK_RTC` (C++ enumerator), 548
- `I2C_SCLK_SRC_FLAG_AWARE_DFS` (C macro), 546
- `I2C_SCLK_SRC_FLAG_FOR_NOMAL` (C macro), 546
- `I2C_SCLK_SRC_FLAG_LIGHT_SLEEP` (C macro), 546
- `i2c_sclk_t` (C++ enum), 547
- `I2C_SCLK_XTAL` (C++ enumerator), 547
- `i2c_set_data_mode` (C++ function), 545
- `i2c_set_data_timing` (C++ function), 544
- `i2c_set_period` (C++ function), 543
- `i2c_set_pin` (C++ function), 540
- `i2c_set_start_timing` (C++ function), 544
- `i2c_set_stop_timing` (C++ function), 544
- `i2c_set_timeout` (C++ function), 545
- `i2c_slave_read_buffer` (C++ function), 543
- `i2c_slave_write_buffer` (C++ function), 542
- `i2c_trans_mode_t` (C++ enum), 547
- `I2S_BITS_PER_SAMPLE_16BIT` (C++ enumerator), 556
- `I2S_BITS_PER_SAMPLE_24BIT` (C++ enumerator), 556
- `I2S_BITS_PER_SAMPLE_32BIT` (C++ enumerator), 556
- `I2S_BITS_PER_SAMPLE_8BIT` (C++ enumerator), 555
- `i2s_bits_per_sample_t` (C++ enum), 555
- `I2S_CHANNEL_FMT_ALL_LEFT` (C++ enumerator), 557
- `I2S_CHANNEL_FMT_ALL_RIGHT` (C++ enumerator), 557
- `I2S_CHANNEL_FMT_ONLY_LEFT` (C++ enumerator), 557
- `I2S_CHANNEL_FMT_ONLY_RIGHT` (C++ enumerator), 557
- `I2S_CHANNEL_FMT_RIGHT_LEFT` (C++ enumerator), 557
- `i2s_channel_fmt_t` (C++ enum), 556
- `I2S_CHANNEL_MONO` (C++ enumerator), 556
- `I2S_CHANNEL_STEREO` (C++ enumerator), 556
- `i2s_channel_t` (C++ enum), 556
- `I2S_CLK_APLL` (C++ enumerator), 557
- `I2S_CLK_D2CLK` (C++ enumerator), 557
- `i2s_clock_src_t` (C++ enum), 557
- `I2S_COMM_FORMAT_I2S` (C++ enumerator), 556
- `I2S_COMM_FORMAT_I2S_LSB` (C++ enumerator), 556
- `I2S_COMM_FORMAT_I2S_MSB` (C++ enumerator), 556
- `I2S_COMM_FORMAT_PCM` (C++ enumerator), 556
- `I2S_COMM_FORMAT_PCM_LONG` (C++ enumerator), 556
- `I2S_COMM_FORMAT_PCM_SHORT` (C++ enumerator), 556
- `I2S_COMM_FORMAT_STAND_I2S` (C++ enumerator), 556
- `I2S_COMM_FORMAT_STAND_MAX` (C++ enumerator), 556
- `I2S_COMM_FORMAT_STAND_MSB` (C++ enumerator), 556
- `I2S_COMM_FORMAT_STAND_PCM_LONG` (C++ enumerator), 556
- `I2S_COMM_FORMAT_STAND_PCM_SHORT` (C++ enumerator), 556

- `i2s_comm_format_t` (C++ enum), 556
 - `i2s_config_t` (C++ class), 554
 - `i2s_config_t::bits_per_sample` (C++ member), 554
 - `i2s_config_t::channel_format` (C++ member), 554
 - `i2s_config_t::communication_format` (C++ member), 554
 - `i2s_config_t::dma_buf_count` (C++ member), 555
 - `i2s_config_t::dma_buf_len` (C++ member), 555
 - `i2s_config_t::fixed_mclk` (C++ member), 555
 - `i2s_config_t::intr_alloc_flags` (C++ member), 554
 - `i2s_config_t::mode` (C++ member), 554
 - `i2s_config_t::sample_rate` (C++ member), 554
 - `i2s_config_t::tx_desc_auto_clear` (C++ member), 555
 - `i2s_config_t::use_apll` (C++ member), 555
 - `I2S_DAC_CHANNEL_BOTH_EN` (C++ enumerator), 558
 - `I2S_DAC_CHANNEL_DISABLE` (C++ enumerator), 557
 - `I2S_DAC_CHANNEL_LEFT_EN` (C++ enumerator), 557
 - `I2S_DAC_CHANNEL_MAX` (C++ enumerator), 558
 - `I2S_DAC_CHANNEL_RIGHT_EN` (C++ enumerator), 557
 - `i2s_dac_mode_t` (C++ enum), 557
 - `i2s_driver_install` (C++ function), 551
 - `i2s_driver_uninstall` (C++ function), 552
 - `I2S_EVENT_DMA_ERROR` (C++ enumerator), 557
 - `I2S_EVENT_MAX` (C++ enumerator), 557
 - `I2S_EVENT_RX_DONE` (C++ enumerator), 557
 - `i2s_event_t` (C++ class), 555
 - `i2s_event_t::size` (C++ member), 555
 - `i2s_event_t::type` (C++ member), 555
 - `I2S_EVENT_TX_DONE` (C++ enumerator), 557
 - `i2s_event_type_t` (C++ enum), 557
 - `i2s_get_clk` (C++ function), 554
 - `i2s_isr_handle_t` (C++ type), 554
 - `I2S_MODE_MASTER` (C++ enumerator), 557
 - `I2S_MODE_RX` (C++ enumerator), 557
 - `I2S_MODE_SLAVE` (C++ enumerator), 557
 - `i2s_mode_t` (C++ enum), 557
 - `I2S_MODE_TX` (C++ enumerator), 557
 - `I2S_NUM_0` (C++ enumerator), 555
 - `I2S_NUM_MAX` (C++ enumerator), 555
 - `i2s_pin_config_t` (C++ class), 555
 - `i2s_pin_config_t::bck_io_num` (C++ member), 555
 - `i2s_pin_config_t::data_in_num` (C++ member), 555
 - `i2s_pin_config_t::data_out_num` (C++ member), 555
 - `i2s_pin_config_t::ws_io_num` (C++ member), 555
 - `I2S_PIN_NO_CHANGE` (C macro), 554
 - `i2s_port_t` (C++ enum), 555
 - `i2s_read` (C++ function), 552
 - `i2s_set_clk` (C++ function), 554
 - `i2s_set_dac_mode` (C++ function), 551
 - `i2s_set_pin` (C++ function), 551
 - `i2s_set_sample_rates` (C++ function), 553
 - `i2s_start` (C++ function), 553
 - `i2s_stop` (C++ function), 553
 - `i2s_write` (C++ function), 552
 - `i2s_write_expand` (C++ function), 552
 - `i2s_zero_dma_buffer` (C++ function), 553
 - `intr_handle_data_t` (C++ type), 1082
 - `intr_handle_t` (C++ type), 1082
 - `intr_handler_t` (C++ type), 1082
- ## L
- `LEDC_APB_CLK` (C++ enumerator), 569
 - `LEDC_APB_CLK_HZ` (C macro), 567
 - `LEDC_AUTO_CLK` (C++ enumerator), 569
 - `ledc_bind_channel_timer` (C++ function), 564
 - `LEDC_CHANNEL_0` (C++ enumerator), 569
 - `LEDC_CHANNEL_1` (C++ enumerator), 569
 - `LEDC_CHANNEL_2` (C++ enumerator), 569
 - `LEDC_CHANNEL_3` (C++ enumerator), 569
 - `LEDC_CHANNEL_4` (C++ enumerator), 569
 - `LEDC_CHANNEL_5` (C++ enumerator), 569
 - `ledc_channel_config` (C++ function), 561
 - `ledc_channel_config_t` (C++ class), 567
 - `ledc_channel_config_t::channel` (C++ member), 567
 - `ledc_channel_config_t::duty` (C++ member), 567
 - `ledc_channel_config_t::gpio_num` (C++ member), 567
 - `ledc_channel_config_t::hpoint` (C++ member), 567
 - `ledc_channel_config_t::intr_type` (C++ member), 567
 - `ledc_channel_config_t::speed_mode` (C++ member), 567
 - `ledc_channel_config_t::timer_sel` (C++ member), 567
 - `LEDC_CHANNEL_MAX` (C++ enumerator), 569
 - `ledc_channel_t` (C++ enum), 569
 - `ledc_clk_cfg_t` (C++ enum), 568
 - `ledc_clk_src_t` (C++ enum), 569
 - `LEDC_DUTY_DIR_DECREASE` (C++ enumerator), 568
 - `LEDC_DUTY_DIR_INCREASE` (C++ enumerator), 568
 - `LEDC_DUTY_DIR_MAX` (C++ enumerator), 568
 - `ledc_duty_direction_t` (C++ enum), 568
 - `LEDC_ERR_DUTY` (C macro), 567
 - `LEDC_ERR_VAL` (C macro), 567
 - `ledc_fade_func_install` (C++ function), 565

- ledc_fade_func_uninstall (C++ function), 565
 LEDC_FADE_MAX (C++ enumerator), 570
 ledc_fade_mode_t (C++ enum), 570
 LEDC_FADE_NO_WAIT (C++ enumerator), 570
 ledc_fade_start (C++ function), 565
 LEDC_FADE_WAIT_DONE (C++ enumerator), 570
 ledc_get_duty (C++ function), 563
 ledc_get_freq (C++ function), 562
 ledc_get_hpoint (C++ function), 562
 LEDC_INTR_DISABLE (C++ enumerator), 568
 LEDC_INTR_FADE_END (C++ enumerator), 568
 LEDC_INTR_MAX (C++ enumerator), 568
 ledc_intr_type_t (C++ enum), 568
 ledc_isr_handle_t (C++ type), 567
 ledc_isr_register (C++ function), 563
 LEDC_LOW_SPEED_MODE (C++ enumerator), 568
 ledc_mode_t (C++ enum), 568
 LEDC_REF_CLK_HZ (C macro), 567
 LEDC_REF_TICK (C++ enumerator), 569
 ledc_set_duty (C++ function), 562
 ledc_set_duty_and_update (C++ function), 566
 ledc_set_duty_with_hpoint (C++ function), 562
 ledc_set_fade (C++ function), 563
 ledc_set_fade_step_and_start (C++ function), 566
 ledc_set_fade_time_and_start (C++ function), 566
 ledc_set_fade_with_step (C++ function), 565
 ledc_set_fade_with_time (C++ function), 565
 ledc_set_freq (C++ function), 562
 ledc_set_pin (C++ function), 561
 LEDC_SLOW_CLK_APB (C++ enumerator), 568
 LEDC_SLOW_CLK_RTC8M (C++ enumerator), 568
 ledc_slow_clk_sel_t (C++ enum), 568
 LEDC_SLOW_CLK_XTAL (C++ enumerator), 568
 LEDC_SPEED_MODE_MAX (C++ enumerator), 568
 ledc_stop (C++ function), 561
 LEDC_TIMER_0 (C++ enumerator), 569
 LEDC_TIMER_1 (C++ enumerator), 569
 LEDC_TIMER_10_BIT (C++ enumerator), 570
 LEDC_TIMER_11_BIT (C++ enumerator), 570
 LEDC_TIMER_12_BIT (C++ enumerator), 570
 LEDC_TIMER_13_BIT (C++ enumerator), 570
 LEDC_TIMER_14_BIT (C++ enumerator), 570
 LEDC_TIMER_1_BIT (C++ enumerator), 570
 LEDC_TIMER_2 (C++ enumerator), 569
 LEDC_TIMER_2_BIT (C++ enumerator), 570
 LEDC_TIMER_3 (C++ enumerator), 569
 LEDC_TIMER_3_BIT (C++ enumerator), 570
 LEDC_TIMER_4_BIT (C++ enumerator), 570
 LEDC_TIMER_5_BIT (C++ enumerator), 570
 LEDC_TIMER_6_BIT (C++ enumerator), 570
 LEDC_TIMER_7_BIT (C++ enumerator), 570
 LEDC_TIMER_8_BIT (C++ enumerator), 570
 LEDC_TIMER_9_BIT (C++ enumerator), 570
 LEDC_TIMER_BIT_MAX (C++ enumerator), 570
 ledc_timer_bit_t (C++ enum), 569
 ledc_timer_config (C++ function), 561
 ledc_timer_config_t (C++ class), 567
 ledc_timer_config_t::bit_num (C++ member), 568
 ledc_timer_config_t::clk_cfg (C++ member), 568
 ledc_timer_config_t::duty_resolution (C++ member), 568
 ledc_timer_config_t::freq_hz (C++ member), 568
 ledc_timer_config_t::speed_mode (C++ member), 568
 ledc_timer_config_t::timer_num (C++ member), 568
 LEDC_TIMER_MAX (C++ enumerator), 569
 ledc_timer_pause (C++ function), 564
 ledc_timer_resume (C++ function), 564
 ledc_timer_rst (C++ function), 564
 ledc_timer_set (C++ function), 564
 ledc_timer_t (C++ enum), 569
 ledc_update_duty (C++ function), 561
 LEDC_USE_APB_CLK (C++ enumerator), 569
 LEDC_USE_REF_TICK (C++ enumerator), 569
 LEDC_USE_RTC8M_CLK (C++ enumerator), 569
 LEDC_USE_XTAL_CLK (C++ enumerator), 569
 linenoiseCompletions (C++ type), 898
- ## M
- MALLOC_CAP_32BIT (C macro), 1056
 MALLOC_CAP_8BIT (C macro), 1056
 MALLOC_CAP_DEFAULT (C macro), 1057
 MALLOC_CAP_DMA (C macro), 1056
 MALLOC_CAP_EXEC (C macro), 1056
 MALLOC_CAP_INTERNAL (C macro), 1057
 MALLOC_CAP_INVALID (C macro), 1057
 MALLOC_CAP_IRAM_8BIT (C macro), 1057
 MALLOC_CAP_PID2 (C macro), 1056
 MALLOC_CAP_PID3 (C macro), 1056
 MALLOC_CAP_PID4 (C macro), 1056
 MALLOC_CAP_PID5 (C macro), 1056
 MALLOC_CAP_PID6 (C macro), 1056
 MALLOC_CAP_PID7 (C macro), 1056
 MALLOC_CAP_RETENTION (C macro), 1057
 MALLOC_CAP_SPIRAM (C macro), 1057
 MAX_BLE_DEVNAME_LEN (C macro), 773
 MAX_BLE_MANUFACTURER_DATA_LEN (C macro), 773
 MAX_FDS (C macro), 873
 MAX_PASSPHRASE_LEN (C macro), 396
 MAX_SSID_LEN (C macro), 396
 MAX_WPS_AP_CRED (C macro), 397
 mbc_master_destroy (C++ function), 738
 mbc_master_get_cid_info (C++ function), 739
 mbc_master_get_parameter (C++ function), 740
 mbc_master_init (C++ function), 736

- `mbc_master_init_tcp` (C++ function), 737
- `mbc_master_send_request` (C++ function), 739
- `mbc_master_set_descriptor` (C++ function), 739
- `mbc_master_set_parameter` (C++ function), 740
- `mbc_master_setup` (C++ function), 737
- `mbc_master_start` (C++ function), 738
- `mbc_slave_check_event` (C++ function), 738
- `mbc_slave_destroy` (C++ function), 738
- `mbc_slave_get_param_info` (C++ function), 738
- `mbc_slave_init` (C++ function), 736
- `mbc_slave_init_tcp` (C++ function), 737
- `mbc_slave_set_descriptor` (C++ function), 738
- `mbc_slave_setup` (C++ function), 737
- `mbc_slave_start` (C++ function), 737
- `mdns_free` (C++ function), 730
- `mdns_handle_system_event` (C++ function), 734
- `mdns_hostname_set` (C++ function), 730
- `MDNS_IF_AP` (C++ enumerator), 736
- `MDNS_IF_ETH` (C++ enumerator), 736
- `mdns_if_internal` (C++ enum), 736
- `MDNS_IF_MAX` (C++ enumerator), 736
- `MDNS_IF_STA` (C++ enumerator), 736
- `mdns_if_t` (C++ type), 735
- `mdns_init` (C++ function), 730
- `mdns_instance_name_set` (C++ function), 731
- `mdns_ip_addr_s` (C++ class), 734
- `mdns_ip_addr_s::addr` (C++ member), 734
- `mdns_ip_addr_s::next` (C++ member), 734
- `mdns_ip_addr_t` (C++ type), 735
- `MDNS_IP_PROTOCOL_MAX` (C++ enumerator), 736
- `mdns_ip_protocol_t` (C++ enum), 735
- `MDNS_IP_PROTOCOL_V4` (C++ enumerator), 735
- `MDNS_IP_PROTOCOL_V6` (C++ enumerator), 735
- `mdns_query` (C++ function), 732
- `mdns_query_a` (C++ function), 734
- `mdns_query_aaaa` (C++ function), 734
- `mdns_query_ptr` (C++ function), 733
- `mdns_query_results_free` (C++ function), 733
- `mdns_query_srv` (C++ function), 733
- `mdns_query_txt` (C++ function), 733
- `mdns_result_s` (C++ class), 734
- `mdns_result_s::addr` (C++ member), 735
- `mdns_result_s::hostname` (C++ member), 735
- `mdns_result_s::instance_name` (C++ member), 735
- `mdns_result_s::ip_protocol` (C++ member), 735
- `mdns_result_s::next` (C++ member), 735
- `mdns_result_s::port` (C++ member), 735
- `mdns_result_s::tcpip_if` (C++ member), 735
- `mdns_result_s::txt` (C++ member), 735
- `mdns_result_s::txt_count` (C++ member), 735
- `mdns_result_t` (C++ type), 735
- `mdns_service_add` (C++ function), 731
- `mdns_service_instance_name_set` (C++ function), 731
- `mdns_service_port_set` (C++ function), 731
- `mdns_service_remove` (C++ function), 731
- `mdns_service_remove_all` (C++ function), 732
- `mdns_service_txt_item_remove` (C++ function), 732
- `mdns_service_txt_item_set` (C++ function), 732
- `mdns_service_txt_set` (C++ function), 732
- `mdns_txt_item_t` (C++ class), 734
- `mdns_txt_item_t::key` (C++ member), 734
- `mdns_txt_item_t::value` (C++ member), 734
- `MDNS_TYPE_A` (C macro), 735
- `MDNS_TYPE_AAAA` (C macro), 735
- `MDNS_TYPE_ANY` (C macro), 735
- `MDNS_TYPE_NSEC` (C macro), 735
- `MDNS_TYPE_OPT` (C macro), 735
- `MDNS_TYPE_PTR` (C macro), 735
- `MDNS_TYPE_SRV` (C macro), 735
- `MDNS_TYPE_TXT` (C macro), 735
- `mesh_addr_t` (C++ union), 434
- `mesh_addr_t::addr` (C++ member), 434
- `mesh_addr_t::mip` (C++ member), 434
- `mesh_ap_cfg_t` (C++ class), 439
- `mesh_ap_cfg_t::max_connection` (C++ member), 439
- `mesh_ap_cfg_t::nonmesh_max_connection` (C++ member), 439
- `mesh_ap_cfg_t::password` (C++ member), 439
- `MESH_ASSOC_FLAG_NETWORK_FREE` (C macro), 442
- `MESH_ASSOC_FLAG_ROOT_FIXED` (C macro), 442
- `MESH_ASSOC_FLAG_ROOTS_FOUND` (C macro), 442
- `MESH_ASSOC_FLAG_VOTE_IN_PROGRESS` (C macro), 442
- `mesh_cfg_t` (C++ class), 439
- `mesh_cfg_t::allow_channel_switch` (C++ member), 439
- `mesh_cfg_t::channel` (C++ member), 439
- `mesh_cfg_t::crypto_funcs` (C++ member), 440
- `mesh_cfg_t::mesh_ap` (C++ member), 440
- `mesh_cfg_t::mesh_id` (C++ member), 439
- `mesh_cfg_t::router` (C++ member), 439
- `MESH_DATA_DROP` (C macro), 442
- `MESH_DATA_ENC` (C macro), 442
- `MESH_DATA_FROMMDS` (C macro), 442
- `MESH_DATA_GROUP` (C macro), 442
- `MESH_DATA_NONBLOCK` (C macro), 442
- `MESH_DATA_P2P` (C macro), 442
- `mesh_data_t` (C++ class), 438
- `mesh_data_t::data` (C++ member), 438
- `mesh_data_t::proto` (C++ member), 439
- `mesh_data_t::size` (C++ member), 438

- `mesh_data_t::tos` (C++ member), 439
`MESH_DATA_TODS` (C macro), 442
`mesh_disconnect_reason_t` (C++ enum), 445
`MESH_EVENT_CHANNEL_SWITCH` (C++ enumerator), 443
`mesh_event_channel_switch_t` (C++ class), 436
`mesh_event_channel_switch_t::channel` (C++ member), 436
`MESH_EVENT_CHILD_CONNECTED` (C++ enumerator), 443
`mesh_event_child_connected_t` (C++ type), 443
`MESH_EVENT_CHILD_DISCONNECTED` (C++ enumerator), 443
`mesh_event_child_disconnected_t` (C++ type), 443
`mesh_event_connected_t` (C++ class), 436
`mesh_event_connected_t::connected` (C++ member), 436
`mesh_event_connected_t::duty` (C++ member), 436
`mesh_event_connected_t::self_layer` (C++ member), 436
`mesh_event_disconnected_t` (C++ type), 443
`MESH_EVENT_FIND_NETWORK` (C++ enumerator), 444
`mesh_event_find_network_t` (C++ class), 437
`mesh_event_find_network_t::channel` (C++ member), 437
`mesh_event_find_network_t::router_bssid` (C++ member), 437
`mesh_event_id_t` (C++ enum), 443
`mesh_event_info_t` (C++ union), 434
`mesh_event_info_t::channel_switch` (C++ member), 435
`mesh_event_info_t::child_connected` (C++ member), 435
`mesh_event_info_t::child_disconnected` (C++ member), 435
`mesh_event_info_t::connected` (C++ member), 435
`mesh_event_info_t::disconnected` (C++ member), 435
`mesh_event_info_t::find_network` (C++ member), 435
`mesh_event_info_t::layer_change` (C++ member), 435
`mesh_event_info_t::network_state` (C++ member), 435
`mesh_event_info_t::no_parent` (C++ member), 435
`mesh_event_info_t::ps_duty` (C++ member), 435
`mesh_event_info_t::root_addr` (C++ member), 435
`mesh_event_info_t::root_conflict` (C++ member), 435
`mesh_event_info_t::root_fixed` (C++ member), 435
`mesh_event_info_t::router_switch` (C++ member), 435
`mesh_event_info_t::routing_table` (C++ member), 435
`mesh_event_info_t::scan_done` (C++ member), 435
`mesh_event_info_t::switch_req` (C++ member), 435
`mesh_event_info_t::toDS_state` (C++ member), 435
`mesh_event_info_t::vote_started` (C++ member), 435
`MESH_EVENT_LAYER_CHANGE` (C++ enumerator), 443
`mesh_event_layer_change_t` (C++ class), 436
`mesh_event_layer_change_t::new_layer` (C++ member), 436
`MESH_EVENT_MAX` (C++ enumerator), 444
`MESH_EVENT_NETWORK_STATE` (C++ enumerator), 444
`mesh_event_network_state_t` (C++ class), 438
`mesh_event_network_state_t::is_rootless` (C++ member), 438
`MESH_EVENT_NO_PARENT_FOUND` (C++ enumerator), 443
`mesh_event_no_parent_found_t` (C++ class), 436
`mesh_event_no_parent_found_t::scan_times` (C++ member), 436
`MESH_EVENT_PARENT_CONNECTED` (C++ enumerator), 443
`MESH_EVENT_PARENT_DISCONNECTED` (C++ enumerator), 443
`MESH_EVENT_PS_CHILD_DUTY` (C++ enumerator), 444
`MESH_EVENT_PS_DEVICE_DUTY` (C++ enumerator), 444
`mesh_event_ps_duty_t` (C++ class), 438
`mesh_event_ps_duty_t::child_connected` (C++ member), 438
`mesh_event_ps_duty_t::duty` (C++ member), 438
`MESH_EVENT_PS_PARENT_DUTY` (C++ enumerator), 444
`MESH_EVENT_ROOT_ADDRESS` (C++ enumerator), 444
`mesh_event_root_address_t` (C++ type), 443
`MESH_EVENT_ROOT_ASKED_YIELD` (C++ enumerator), 444
`mesh_event_root_conflict_t` (C++ class), 437
`mesh_event_root_conflict_t::addr` (C++ member), 437
`mesh_event_root_conflict_t::capacity` (C++ member), 437

- mesh_event_root_conflict_t::rssi (C++ member), 437
 MESH_EVENT_ROOT_FIXED (C++ enumerator), 444
 mesh_event_root_fixed_t (C++ class), 437
 mesh_event_root_fixed_t::is_fixed (C++ member), 438
 MESH_EVENT_ROOT_SWITCH_ACK (C++ enumerator), 444
 MESH_EVENT_ROOT_SWITCH_REQ (C++ enumerator), 444
 mesh_event_root_switch_req_t (C++ class), 437
 mesh_event_root_switch_req_t::rc_addr (C++ member), 437
 mesh_event_root_switch_req_t::reason (C++ member), 437
 MESH_EVENT_ROUTER_SWITCH (C++ enumerator), 444
 mesh_event_router_switch_t (C++ type), 443
 MESH_EVENT_ROUTING_TABLE_ADD (C++ enumerator), 443
 mesh_event_routing_table_change_t (C++ class), 437
 mesh_event_routing_table_change_t::rt_size_change (C++ member), 437
 mesh_event_routing_table_change_t::rt_size (C++ member), 437
 MESH_EVENT_ROUTING_TABLE_REMOVE (C++ enumerator), 443
 MESH_EVENT_SCAN_DONE (C++ enumerator), 444
 mesh_event_scan_done_t (C++ class), 438
 mesh_event_scan_done_t::number (C++ member), 438
 MESH_EVENT_STARTED (C++ enumerator), 443
 MESH_EVENT_STOP_RECONNECTION (C++ enumerator), 444
 MESH_EVENT_STOPPED (C++ enumerator), 443
 MESH_EVENT_TODS_STATE (C++ enumerator), 444
 mesh_event_toDS_state_t (C++ enum), 446
 MESH_EVENT_VOTE_STARTED (C++ enumerator), 444
 mesh_event_vote_started_t (C++ class), 436
 mesh_event_vote_started_t::attempts (C++ member), 437
 mesh_event_vote_started_t::rc_addr (C++ member), 437
 mesh_event_vote_started_t::reason (C++ member), 437
 MESH_EVENT_VOTE_STOPPED (C++ enumerator), 444
 MESH_IDLE (C++ enumerator), 444
 MESH_INIT_CONFIG_DEFAULT (C macro), 443
 MESH_LEAF (C++ enumerator), 445
 MESH_MPS (C macro), 441
 MESH_MTU (C macro), 441
 MESH_NODE (C++ enumerator), 445
 MESH_OPT_RECV_DS_ADDR (C macro), 442
 MESH_OPT_SEND_GROUP (C macro), 442
 mesh_opt_t (C++ class), 438
 mesh_opt_t::len (C++ member), 438
 mesh_opt_t::type (C++ member), 438
 mesh_opt_t::val (C++ member), 438
 MESH_PROTO_AP (C++ enumerator), 445
 MESH_PROTO_BIN (C++ enumerator), 445
 MESH_PROTO_HTTP (C++ enumerator), 445
 MESH_PROTO_JSON (C++ enumerator), 445
 MESH_PROTO_MQTT (C++ enumerator), 445
 MESH_PROTO_STA (C++ enumerator), 445
 mesh_proto_t (C++ enum), 445
 MESH_PS_DEVICE_DUTY_DEMAND (C macro), 443
 MESH_PS_DEVICE_DUTY_REQUEST (C macro), 442
 MESH_PS_NETWORK_DUTY_APPLIED_ENTIRE (C macro), 443
 MESH_PS_NETWORK_DUTY_APPLIED_UPLINK (C macro), 443
 MESH_PS_NETWORK_DUTY_MASTER (C macro), 443
 mesh_rc_config_t (C++ union), 435
 mesh_rc_config_t::attempts (C++ member), 436
 mesh_rc_config_t::rc_addr (C++ member), 436
 MESH_REASON_CYCLIC (C++ enumerator), 445
 MESH_REASON_DIFF_ID (C++ enumerator), 446
 MESH_REASON_EMPTY_PASSWORD (C++ enumerator), 446
 MESH_REASON_IE_UNKNOWN (C++ enumerator), 446
 MESH_REASON_LEAF (C++ enumerator), 445
 MESH_REASON_PARENT_IDLE (C++ enumerator), 445
 MESH_REASON_PARENT_STOPPED (C++ enumerator), 446
 MESH_REASON_PARENT_UNENCRYPTED (C++ enumerator), 446
 MESH_REASON_PARENT_WORSE (C++ enumerator), 446
 MESH_REASON_ROOTS (C++ enumerator), 446
 MESH_REASON_SCAN_FAIL (C++ enumerator), 446
 MESH_REASON_WAIVE_ROOT (C++ enumerator), 446
 MESH_ROOT (C++ enumerator), 444
 MESH_ROOT_LAYER (C macro), 441
 mesh_router_t (C++ class), 439
 mesh_router_t::allow_router_switch (C++ member), 439
 mesh_router_t::bssid (C++ member), 439
 mesh_router_t::password (C++ member), 439
 mesh_router_t::ssid (C++ member), 439
 mesh_router_t::ssid_len (C++ member), 439
 mesh_rx_pending_t (C++ class), 440
 mesh_rx_pending_t::toDS (C++ member), 440
 mesh_rx_pending_t::toSelf (C++ member), 440
 MESH_STA (C++ enumerator), 445

- MESH_TODS_REACHABLE (C++ enumerator), 446
- MESH_TODS_UNREACHABLE (C++ enumerator), 446
- MESH_TOPO_CHAIN (C++ enumerator), 446
- MESH_TOPO_TREE (C++ enumerator), 446
- MESH_TOS_DEF (C++ enumerator), 445
- MESH_TOS_E2E (C++ enumerator), 445
- MESH_TOS_P2P (C++ enumerator), 445
- mesh_tos_t (C++ enum), 445
- mesh_tx_pending_t (C++ class), 440
- mesh_tx_pending_t::broadcast (C++ member), 440
- mesh_tx_pending_t::mgmt (C++ member), 440
- mesh_tx_pending_t::to_child (C++ member), 440
- mesh_tx_pending_t::to_child_p2p (C++ member), 440
- mesh_tx_pending_t::to_parent (C++ member), 440
- mesh_tx_pending_t::to_parent_p2p (C++ member), 440
- mesh_type_t (C++ enum), 444
- MESH_VOTE_REASON_CHILD_INITIATED (C++ enumerator), 445
- MESH_VOTE_REASON_ROOT_INITIATED (C++ enumerator), 445
- mesh_vote_reason_t (C++ enum), 445
- mesh_vote_t (C++ class), 440
- mesh_vote_t::config (C++ member), 440
- mesh_vote_t::is_rc_specified (C++ member), 440
- mesh_vote_t::percentage (C++ member), 440
- MessageBufferHandle_t (C++ type), 1034
- mip_t (C++ class), 436
- mip_t::ip4 (C++ member), 436
- mip_t::port (C++ member), 436
- MQTT_CONNECTION_ACCEPTED (C++ enumerator), 664
- MQTT_CONNECTION_REFUSE_BAD_USERNAME (C++ enumerator), 665
- MQTT_CONNECTION_REFUSE_ID_REJECTED (C++ enumerator), 665
- MQTT_CONNECTION_REFUSE_NOT_AUTHORIZED (C++ enumerator), 665
- MQTT_CONNECTION_REFUSE_PROTOCOL (C++ enumerator), 665
- MQTT_CONNECTION_REFUSE_SERVER_UNAVAILABLE (C++ enumerator), 665
- MQTT_ERROR_TYPE_CONNECTION_REFUSED (C++ enumerator), 665
- MQTT_ERROR_TYPE_ESP_TLS (C macro), 663
- MQTT_ERROR_TYPE_NONE (C++ enumerator), 665
- MQTT_ERROR_TYPE_TCP_TRANSPORT (C++ enumerator), 665
- MQTT_EVENT_ANY (C++ enumerator), 664
- MQTT_EVENT_BEFORE_CONNECT (C++ enumerator), 664
- mqtt_event_callback_t (C++ type), 663
- MQTT_EVENT_CONNECTED (C++ enumerator), 664
- MQTT_EVENT_DATA (C++ enumerator), 664
- MQTT_EVENT_DELETED (C++ enumerator), 664
- MQTT_EVENT_DISCONNECTED (C++ enumerator), 664
- MQTT_EVENT_ERROR (C++ enumerator), 664
- MQTT_EVENT_PUBLISHED (C++ enumerator), 664
- MQTT_EVENT_SUBSCRIBED (C++ enumerator), 664
- MQTT_EVENT_UNSUBSCRIBED (C++ enumerator), 664
- MQTT_PROTOCOL_UNDEFINED (C++ enumerator), 665
- MQTT_PROTOCOL_V_3_1 (C++ enumerator), 665
- MQTT_PROTOCOL_V_3_1_1 (C++ enumerator), 665
- MQTT_TRANSPORT_OVER_SSL (C++ enumerator), 665
- MQTT_TRANSPORT_OVER_TCP (C++ enumerator), 665
- MQTT_TRANSPORT_OVER_WS (C++ enumerator), 665
- MQTT_TRANSPORT_OVER_WSS (C++ enumerator), 665
- MQTT_TRANSPORT_UNKNOWN (C++ enumerator), 665
- multi_heap_aligned_alloc (C++ function), 1059
- multi_heap_aligned_free (C++ function), 1059
- multi_heap_check (C++ function), 1060
- multi_heap_dump (C++ function), 1060
- multi_heap_free (C++ function), 1059
- multi_heap_free_size (C++ function), 1060
- multi_heap_get_allocated_size (C++ function), 1059
- multi_heap_get_info (C++ function), 1061
- multi_heap_handle_t (C++ type), 1061
- multi_heap_info_t (C++ class), 1061
- multi_heap_info_t::allocated_blocks (C++ member), 1061
- multi_heap_info_t::free_blocks (C++ member), 1061
- multi_heap_info_t::largest_free_block (C++ member), 1061
- multi_heap_info_t::minimum_free_bytes (C++ member), 1061
- multi_heap_info_t::total_allocated_bytes (C++ member), 1061
- multi_heap_info_t::total_blocks (C++ member), 1061
- multi_heap_info_t::total_free_bytes (C++ member), 1061
- multi_heap_malloc (C++ function), 1059
- multi_heap_minimum_free_size (C++ function), 1061
- multi_heap_realloc (C++ function), 1059
- multi_heap_register (C++ function), 1060
- multi_heap_set_lock (C++ function), 1060

N

- name_uuid (C++ class), 772
- name_uuid::name (C++ member), 772
- name_uuid::uuid (C++ member), 772
- nvs_close (C++ function), 817
- nvs_commit (C++ function), 817
- NVS_DEFAULT_PART_NAME (C macro), 821
- nvs_entry_find (C++ function), 818
- nvs_entry_info (C++ function), 819
- nvs_entry_info_t (C++ class), 819
- nvs_entry_info_t::key (C++ member), 819
- nvs_entry_info_t::namespace_name (C++ member), 819
- nvs_entry_info_t::type (C++ member), 819
- nvs_entry_next (C++ function), 819
- nvs_erase_all (C++ function), 817
- nvs_erase_key (C++ function), 816
- nvs_flash_deinit (C++ function), 810
- nvs_flash_deinit_partition (C++ function), 810
- nvs_flash_erase (C++ function), 810
- nvs_flash_erase_partition (C++ function), 810
- nvs_flash_erase_partition_ptr (C++ function), 811
- nvs_flash_generate_keys (C++ function), 811
- nvs_flash_init (C++ function), 809
- nvs_flash_init_partition (C++ function), 810
- nvs_flash_init_partition_ptr (C++ function), 810
- nvs_flash_read_security_cfg (C++ function), 812
- nvs_flash_secure_init (C++ function), 811
- nvs_flash_secure_init_partition (C++ function), 811
- nvs_get_blob (C++ function), 815
- nvs_get_i16 (C++ function), 814
- nvs_get_i32 (C++ function), 814
- nvs_get_i64 (C++ function), 814
- nvs_get_i8 (C++ function), 813
- nvs_get_stats (C++ function), 817
- nvs_get_str (C++ function), 814
- nvs_get_u16 (C++ function), 814
- nvs_get_u32 (C++ function), 814
- nvs_get_u64 (C++ function), 814
- nvs_get_u8 (C++ function), 814
- nvs_get_used_entry_count (C++ function), 818
- nvs_handle (C++ type), 821
- nvs_handle_t (C++ type), 821
- nvs_iterator_t (C++ type), 821
- NVS_KEY_NAME_MAX_SIZE (C macro), 821
- NVS_KEY_SIZE (C macro), 812
- nvs_open (C++ function), 815
- nvs_open_from_partition (C++ function), 815
- nvs_open_mode (C++ type), 821
- nvs_open_mode_t (C++ enum), 821
- NVS_PART_NAME_MAX_SIZE (C macro), 821
- NVS_READONLY (C++ enumerator), 821
- NVS_READWRITE (C++ enumerator), 821
- nvs_release_iterator (C++ function), 819
- nvs_sec_cfg_t (C++ class), 812
- nvs_sec_cfg_t::eky (C++ member), 812
- nvs_sec_cfg_t::tky (C++ member), 812
- nvs_set_blob (C++ function), 816
- nvs_set_i16 (C++ function), 813
- nvs_set_i32 (C++ function), 813
- nvs_set_i64 (C++ function), 813
- nvs_set_i8 (C++ function), 812
- nvs_set_str (C++ function), 813
- nvs_set_u16 (C++ function), 813
- nvs_set_u32 (C++ function), 813
- nvs_set_u64 (C++ function), 813
- nvs_set_u8 (C++ function), 813
- nvs_stats_t (C++ class), 819
- nvs_stats_t::free_entries (C++ member), 819
- nvs_stats_t::namespace_count (C++ member), 819
- nvs_stats_t::total_entries (C++ member), 819
- nvs_stats_t::used_entries (C++ member), 819
- NVS_TYPE_ANY (C++ enumerator), 822
- NVS_TYPE_BLOB (C++ enumerator), 822
- NVS_TYPE_I16 (C++ enumerator), 821
- NVS_TYPE_I32 (C++ enumerator), 821
- NVS_TYPE_I64 (C++ enumerator), 822
- NVS_TYPE_I8 (C++ enumerator), 821
- NVS_TYPE_STR (C++ enumerator), 822
- nvs_type_t (C++ enum), 821
- NVS_TYPE_U16 (C++ enumerator), 821
- NVS_TYPE_U32 (C++ enumerator), 821
- NVS_TYPE_U64 (C++ enumerator), 821
- NVS_TYPE_U8 (C++ enumerator), 821

O

- OTA_SIZE_UNKNOWN (C macro), 1104
- OTA_WITH_SEQUENTIAL_WRITES (C macro), 1104

P

- pcQueueGetName (C++ function), 970
- pcTaskGetName (C++ function), 952
- pcTimerGetName (C++ function), 1001
- PendedFunction_t (C++ type), 1010
- PROTocom_SEC0 (C++ enumerator), 727
- PROTocom_SEC1 (C++ enumerator), 727
- PROTocom_SEC_CUSTOM (C++ enumerator), 727
- protocomm_add_endpoint (C++ function), 766
- protocomm_ble_config (C++ class), 772
- protocomm_ble_config::ble_bonding (C++ member), 772
- protocomm_ble_config::ble_sm_sc (C++ member), 772

- protocomm_ble_config::device_name (C++ member), 772
 protocomm_ble_config::manufacturer_data (C++ member), 772
 protocomm_ble_config::manufacturer_data_ptr (C++ member), 772
 protocomm_ble_config::nu_lookup (C++ member), 772
 protocomm_ble_config::nu_lookup_count (C++ member), 772
 protocomm_ble_config::service_uuid (C++ member), 772
 protocomm_ble_config_t (C++ type), 773
 protocomm_ble_name_uuid_t (C++ type), 773
 protocomm_ble_start (C++ function), 771
 protocomm_ble_stop (C++ function), 772
 protocomm_close_session (C++ function), 767
 protocomm_delete (C++ function), 766
 protocomm_http_server_config_t (C++ class), 771
 protocomm_http_server_config_t::port (C++ member), 771
 protocomm_http_server_config_t::stack_size (C++ member), 771
 protocomm_http_server_config_t::task_priority (C++ member), 771
 protocomm_httpd_config_data_t (C++ union), 771
 protocomm_httpd_config_data_t::config (C++ member), 771
 protocomm_httpd_config_data_t::handle (C++ member), 771
 protocomm_httpd_config_t (C++ class), 771
 protocomm_httpd_config_t::data (C++ member), 771
 protocomm_httpd_config_t::ext_handle_ptr (C++ member), 771
 PROTOCOL_HTTPD_DEFAULT_CONFIG (C macro), 771
 protocomm_httpd_start (C++ function), 770
 protocomm_httpd_stop (C++ function), 770
 protocomm_new (C++ function), 766
 protocomm_open_session (C++ function), 767
 protocomm_remove_endpoint (C++ function), 766
 protocomm_req_handle (C++ function), 767
 protocomm_req_handler_t (C++ type), 769
 protocomm_security (C++ class), 769
 protocomm_security::cleanup (C++ member), 769
 protocomm_security::close_transport_session (C++ member), 769
 protocomm_security::decrypt (C++ member), 769
 protocomm_security::encrypt (C++ member), 769
 protocomm_security::init (C++ member), 769
 protocomm_security::new_transport_session (C++ member), 769
 protocomm_security::security_req_handler (C++ member), 769
 protocomm_security::ver (C++ member), 769
 protocomm_security_handle_t (C++ type), 770
 protocomm_security_pop (C++ class), 769
 protocomm_security_pop::data (C++ member), 769
 protocomm_security_pop::len (C++ member), 769
 protocomm_security_pop_t (C++ type), 770
 protocomm_security_t (C++ type), 770
 protocomm_set_security (C++ function), 767
 protocomm_set_version (C++ function), 768
 protocomm_t (C++ type), 769
 protocomm_unset_security (C++ function), 768
 protocomm_unset_version (C++ function), 768
 PROV_DATA_FLAGS_FLAG (C macro), 188
 PROV_DATA_IV_INDEX_FLAG (C macro), 188
 PROV_DATA_NET_IDX_FLAG (C macro), 188
 PROXY_FILTER_BLACKLIST (C++ enumerator), 202
 PROXY_FILTER_WHITELIST (C++ enumerator), 202
 psk_hint_key_t (C++ type), 676
 psk_key_hint (C++ class), 672
 psk_key_hint::hint (C++ member), 672
 psk_key_hint::key (C++ member), 672
 psk_key_hint::key_size (C++ member), 672
 PTHREAD_STACK_MIN (C macro), 925
 pvTaskGetThreadLocalStoragePointer (C++ function), 953
 pvTimerGetTimerID (C++ function), 998
 pxTaskGetStackStart (C++ function), 953
- ## Q
- QueueHandle_t (C++ type), 981
 QueueSetHandle_t (C++ type), 981
 QueueSetMemberHandle_t (C++ type), 981
- ## R
- RINGBUF_TYPE_ALLOWSPLIT (C++ enumerator), 1048
 RINGBUF_TYPE_BYTEBUF (C++ enumerator), 1048
 RINGBUF_TYPE_MAX (C++ enumerator), 1048
 RINGBUF_TYPE_NOSPLIT (C++ enumerator), 1048
 RingbufferType_t (C++ enum), 1048
 RingbufHandle_t (C++ type), 1048
 rmt_add_channel_to_group (C++ function), 583
 RMT_BASECLK_APB (C++ enumerator), 587
 RMT_BASECLK_MAX (C++ enumerator), 587
 RMT_BASECLK_XTAL (C++ enumerator), 587
 RMT_CARRIER_LEVEL_HIGH (C++ enumerator), 588

- RMT_CARRIER_LEVEL_LOW (C++ enumerator), 588
RMT_CARRIER_LEVEL_MAX (C++ enumerator), 588
rmt_carrier_level_t (C++ enum), 588
RMT_CHANNEL_0 (C++ enumerator), 587
RMT_CHANNEL_1 (C++ enumerator), 587
RMT_CHANNEL_2 (C++ enumerator), 587
RMT_CHANNEL_3 (C++ enumerator), 587
RMT_CHANNEL_BUSY (C++ enumerator), 588
RMT_CHANNEL_FLAGS_AWARE_DFS (C macro), 586
RMT_CHANNEL_IDLE (C++ enumerator), 588
RMT_CHANNEL_MAX (C++ enumerator), 587
rmt_channel_status_result_t (C++ class), 586
rmt_channel_status_result_t::status (C++ member), 587
rmt_channel_status_t (C++ enum), 588
rmt_channel_t (C++ enum), 587
RMT_CHANNEL_UNINIT (C++ enumerator), 588
rmt_clr_intr_enable_mask (C++ function), 584
rmt_config (C++ function), 580
rmt_config_t (C++ class), 585
rmt_config_t::channel (C++ member), 585
rmt_config_t::clk_div (C++ member), 585
rmt_config_t::flags (C++ member), 585
rmt_config_t::gpio_num (C++ member), 585
rmt_config_t::mem_block_num (C++ member), 585
rmt_config_t::rmt_mode (C++ member), 585
rmt_config_t::rx_config (C++ member), 585
rmt_config_t::tx_config (C++ member), 585
RMT_DATA_MODE_FIFO (C++ enumerator), 587
RMT_DATA_MODE_MAX (C++ enumerator), 587
RMT_DATA_MODE_MEM (C++ enumerator), 587
rmt_data_mode_t (C++ enum), 587
RMT_DEFAULT_CONFIG_RX (C macro), 586
RMT_DEFAULT_CONFIG_TX (C macro), 586
rmt_driver_install (C++ function), 581
rmt_driver_uninstall (C++ function), 581
rmt_fill_tx_items (C++ function), 581
rmt_get_channel_status (C++ function), 581
rmt_get_clk_div (C++ function), 575
rmt_get_counter_clock (C++ function), 581
rmt_get_idle_level (C++ function), 579
rmt_get_mem_block_num (C++ function), 576
rmt_get_mem_pd (C++ function), 576
rmt_get_memory_owner (C++ function), 578
rmt_get_ringbuf_handle (C++ function), 582
rmt_get_rx_idle_thresh (C++ function), 575
rmt_get_source_clk (C++ function), 579
rmt_get_status (C++ function), 579
rmt_get_tx_loop_mode (C++ function), 578
RMT_IDLE_LEVEL_HIGH (C++ enumerator), 588
RMT_IDLE_LEVEL_LOW (C++ enumerator), 588
RMT_IDLE_LEVEL_MAX (C++ enumerator), 588
rmt_idle_level_t (C++ enum), 588
rmt_isr_deregister (C++ function), 581
rmt_isr_handle_t (C++ type), 586
rmt_isr_register (C++ function), 580
RMT_MEM_ITEM_NUM (C macro), 586
RMT_MEM_OWNER_MAX (C++ enumerator), 587
RMT_MEM_OWNER_RX (C++ enumerator), 587
rmt_mem_owner_t (C++ enum), 587
RMT_MEM_OWNER_TX (C++ enumerator), 587
rmt_memory_rw_rst (C++ function), 584
RMT_MODE_MAX (C++ enumerator), 588
RMT_MODE_RX (C++ enumerator), 588
rmt_mode_t (C++ enum), 587
RMT_MODE_TX (C++ enumerator), 587
rmt_register_tx_end_callback (C++ function), 583
rmt_remove_channel_from_group (C++ function), 584
rmt_rx_config_t (C++ class), 585
rmt_rx_config_t::carrier_duty_percent (C++ member), 585
rmt_rx_config_t::carrier_freq_hz (C++ member), 585
rmt_rx_config_t::carrier_level (C++ member), 585
rmt_rx_config_t::filter_en (C++ member), 585
rmt_rx_config_t::filter_ticks_thresh (C++ member), 585
rmt_rx_config_t::idle_threshold (C++ member), 585
rmt_rx_config_t::rm_carrier (C++ member), 585
rmt_rx_memory_reset (C++ function), 577
rmt_rx_start (C++ function), 577
rmt_rx_stop (C++ function), 577
rmt_set_clk_div (C++ function), 575
rmt_set_err_intr_en (C++ function), 579
rmt_set_idle_level (C++ function), 579
rmt_set_intr_enable_mask (C++ function), 584
rmt_set_mem_block_num (C++ function), 575
rmt_set_mem_pd (C++ function), 576
rmt_set_memory_owner (C++ function), 577
rmt_set_pin (C++ function), 580
rmt_set_rx_filter (C++ function), 578
rmt_set_rx_idle_thresh (C++ function), 575
rmt_set_rx_intr_en (C++ function), 579
rmt_set_rx_thr_intr_en (C++ function), 583
rmt_set_source_clk (C++ function), 578
rmt_set_tx_carrier (C++ function), 576
rmt_set_tx_intr_en (C++ function), 580
rmt_set_tx_loop_count (C++ function), 584
rmt_set_tx_loop_mode (C++ function), 578
rmt_set_tx_thr_intr_en (C++ function), 580
rmt_source_clk_t (C++ enum), 587
rmt_translator_get_context (C++ function), 583
rmt_translator_init (C++ function), 582

- [rmt_translator_set_context \(C++ function\), 583](#)
[rmt_tx_config_t \(C++ class\), 584](#)
[rmt_tx_config_t::carrier_duty_percent \(C++ member\), 584](#)
[rmt_tx_config_t::carrier_en \(C++ member\), 585](#)
[rmt_tx_config_t::carrier_freq_hz \(C++ member\), 584](#)
[rmt_tx_config_t::carrier_level \(C++ member\), 584](#)
[rmt_tx_config_t::idle_level \(C++ member\), 584](#)
[rmt_tx_config_t::idle_output_en \(C++ member\), 585](#)
[rmt_tx_config_t::loop_count \(C++ member\), 585](#)
[rmt_tx_config_t::loop_en \(C++ member\), 585](#)
[rmt_tx_end_callback_t \(C++ class\), 586](#)
[rmt_tx_end_callback_t::arg \(C++ member\), 586](#)
[rmt_tx_end_callback_t::function \(C++ member\), 586](#)
[rmt_tx_end_fn_t \(C++ type\), 586](#)
[rmt_tx_memory_reset \(C++ function\), 577](#)
[rmt_tx_start \(C++ function\), 577](#)
[rmt_tx_stop \(C++ function\), 577](#)
[rmt_wait_tx_done \(C++ function\), 582](#)
[rmt_write_items \(C++ function\), 582](#)
[rmt_write_sample \(C++ function\), 583](#)
[ROLE_FAST_PROV \(C++ enumerator\), 202](#)
[ROLE_NODE \(C++ enumerator\), 202](#)
[ROLE_PROVISIONER \(C++ enumerator\), 202](#)
- ## S
- [sample_to_rmt_t \(C++ type\), 586](#)
[SC_EVENT_FOUND_CHANNEL \(C++ enumerator\), 407](#)
[SC_EVENT_GOT_SSID_PSWD \(C++ enumerator\), 407](#)
[SC_EVENT_SCAN_DONE \(C++ enumerator\), 407](#)
[SC_EVENT_SEND_ACK_DONE \(C++ enumerator\), 407](#)
[SC_TYPE_AIRKISS \(C++ enumerator\), 407](#)
[SC_TYPE_ESPTOUCH \(C++ enumerator\), 407](#)
[SC_TYPE_ESPTOUCH_AIRKISS \(C++ enumerator\), 407](#)
[SC_TYPE_ESPTOUCH_V2 \(C++ enumerator\), 407](#)
[sdmmc_card_init \(C++ function\), 829](#)
[sdmmc_card_print_info \(C++ function\), 829](#)
[sdmmc_card_t \(C++ class\), 835](#)
[sdmmc_card_t::cid \(C++ member\), 835](#)
[sdmmc_card_t::csd \(C++ member\), 835](#)
[sdmmc_card_t::ext_csd \(C++ member\), 836](#)
[sdmmc_card_t::host \(C++ member\), 835](#)
[sdmmc_card_t::is_ddr \(C++ member\), 836](#)
[sdmmc_card_t::is_mem \(C++ member\), 836](#)
[sdmmc_card_t::is_mmc \(C++ member\), 836](#)
[sdmmc_card_t::is_sdio \(C++ member\), 836](#)
[sdmmc_card_t::log_bus_width \(C++ member\), 836](#)
[sdmmc_card_t::max_freq_khz \(C++ member\), 836](#)
[sdmmc_card_t::num_io_functions \(C++ member\), 836](#)
[sdmmc_card_t::ocr \(C++ member\), 835](#)
[sdmmc_card_t::raw_cid \(C++ member\), 835](#)
[sdmmc_card_t::rca \(C++ member\), 836](#)
[sdmmc_card_t::reserved \(C++ member\), 836](#)
[sdmmc_card_t::scr \(C++ member\), 835](#)
[sdmmc_cid_t \(C++ class\), 833](#)
[sdmmc_cid_t::date \(C++ member\), 833](#)
[sdmmc_cid_t::mfg_id \(C++ member\), 833](#)
[sdmmc_cid_t::name \(C++ member\), 833](#)
[sdmmc_cid_t::oem_id \(C++ member\), 833](#)
[sdmmc_cid_t::revision \(C++ member\), 833](#)
[sdmmc_cid_t::serial \(C++ member\), 833](#)
[sdmmc_command_t \(C++ class\), 834](#)
[sdmmc_command_t::arg \(C++ member\), 834](#)
[sdmmc_command_t::blklen \(C++ member\), 834](#)
[sdmmc_command_t::data \(C++ member\), 834](#)
[sdmmc_command_t::datalen \(C++ member\), 834](#)
[sdmmc_command_t::error \(C++ member\), 834](#)
[sdmmc_command_t::flags \(C++ member\), 834](#)
[sdmmc_command_t::opcode \(C++ member\), 834](#)
[sdmmc_command_t::response \(C++ member\), 834](#)
[sdmmc_command_t::timeout_ms \(C++ member\), 834](#)
[sdmmc_csd_t \(C++ class\), 833](#)
[sdmmc_csd_t::capacity \(C++ member\), 833](#)
[sdmmc_csd_t::card_command_class \(C++ member\), 833](#)
[sdmmc_csd_t::csd_ver \(C++ member\), 833](#)
[sdmmc_csd_t::mmc_ver \(C++ member\), 833](#)
[sdmmc_csd_t::read_block_len \(C++ member\), 833](#)
[sdmmc_csd_t::sector_size \(C++ member\), 833](#)
[sdmmc_csd_t::tr_speed \(C++ member\), 833](#)
[sdmmc_ext_csd_t \(C++ class\), 834](#)
[sdmmc_ext_csd_t::power_class \(C++ member\), 834](#)
[SDMMC_FREQ_26M \(C macro\), 836](#)
[SDMMC_FREQ_52M \(C macro\), 836](#)
[SDMMC_FREQ_DEFAULT \(C macro\), 836](#)
[SDMMC_FREQ_HIGHSPEED \(C macro\), 836](#)
[SDMMC_FREQ_PROBING \(C macro\), 836](#)
[SDMMC_HOST_FLAG_1BIT \(C macro\), 836](#)
[SDMMC_HOST_FLAG_4BIT \(C macro\), 836](#)
[SDMMC_HOST_FLAG_8BIT \(C macro\), 836](#)
[SDMMC_HOST_FLAG_DDR \(C macro\), 836](#)
[SDMMC_HOST_FLAG_DEINIT_ARG \(C macro\), 836](#)
[SDMMC_HOST_FLAG_SPI \(C macro\), 836](#)

- sdmmc_host_t (C++ class), 834
- sdmmc_host_t::command_timeout_ms (C++ member), 835
- sdmmc_host_t::deinit (C++ member), 835
- sdmmc_host_t::deinit_p (C++ member), 835
- sdmmc_host_t::do_transaction (C++ member), 835
- sdmmc_host_t::flags (C++ member), 835
- sdmmc_host_t::get_bus_width (C++ member), 835
- sdmmc_host_t::init (C++ member), 835
- sdmmc_host_t::io_int_enable (C++ member), 835
- sdmmc_host_t::io_int_wait (C++ member), 835
- sdmmc_host_t::io_voltage (C++ member), 835
- sdmmc_host_t::max_freq_khz (C++ member), 835
- sdmmc_host_t::set_bus_ddr_mode (C++ member), 835
- sdmmc_host_t::set_bus_width (C++ member), 835
- sdmmc_host_t::set_card_clk (C++ member), 835
- sdmmc_host_t::slot (C++ member), 835
- sdmmc_io_enable_int (C++ function), 832
- sdmmc_io_get_cis_data (C++ function), 832
- sdmmc_io_print_cis_info (C++ function), 832
- sdmmc_io_read_blocks (C++ function), 831
- sdmmc_io_read_byte (C++ function), 830
- sdmmc_io_read_bytes (C++ function), 830
- sdmmc_io_wait_int (C++ function), 832
- sdmmc_io_write_blocks (C++ function), 831
- sdmmc_io_write_byte (C++ function), 830
- sdmmc_io_write_bytes (C++ function), 831
- sdmmc_read_sectors (C++ function), 830
- sdmmc_response_t (C++ type), 837
- sdmmc_scr_t (C++ class), 833
- sdmmc_scr_t::bus_width (C++ member), 834
- sdmmc_scr_t::sd_spec (C++ member), 834
- sdmmc_switch_func_rsp_t (C++ class), 834
- sdmmc_switch_func_rsp_t::data (C++ member), 834
- sdmmc_write_sectors (C++ function), 830
- SDSPI_DEFAULT_HOST (C macro), 592
- sdspi_dev_handle_t (C++ type), 592
- SDSPI_DEVICE_CONFIG_DEFAULT (C macro), 592
- sdspi_device_config_t (C++ class), 591
- sdspi_device_config_t::gpio_cd (C++ member), 591
- sdspi_device_config_t::gpio_cs (C++ member), 591
- sdspi_device_config_t::gpio_int (C++ member), 591
- sdspi_device_config_t::gpio_wp (C++ member), 591
- sdspi_device_config_t::host_id (C++ member), 591
- SDSPI_HOST_DEFAULT (C macro), 592
- sdspi_host_deinit (C++ function), 590
- sdspi_host_do_transaction (C++ function), 590
- sdspi_host_init (C++ function), 589
- sdspi_host_init_device (C++ function), 589
- sdspi_host_init_slot (C++ function), 590
- sdspi_host_io_int_enable (C++ function), 590
- sdspi_host_io_int_wait (C++ function), 590
- sdspi_host_remove_device (C++ function), 590
- sdspi_host_set_card_clk (C++ function), 590
- SDSPI_SLOT_CONFIG_DEFAULT (C macro), 592
- sdspi_slot_config_t (C++ class), 591
- sdspi_slot_config_t::dma_channel (C++ member), 591
- sdspi_slot_config_t::gpio_cd (C++ member), 591
- sdspi_slot_config_t::gpio_cs (C++ member), 591
- sdspi_slot_config_t::gpio_int (C++ member), 591
- sdspi_slot_config_t::gpio_miso (C++ member), 591
- sdspi_slot_config_t::gpio_mosi (C++ member), 591
- sdspi_slot_config_t::gpio_sck (C++ member), 591
- sdspi_slot_config_t::gpio_wp (C++ member), 591
- SDSPI_SLOT_NO_CD (C macro), 592
- SDSPI_SLOT_NO_INT (C macro), 592
- SDSPI_SLOT_NO_WP (C macro), 592
- SECURE_BOOT_PUBLIC_KEY_INDEX_0 (C++ enumerator), 1104
- SECURE_BOOT_PUBLIC_KEY_INDEX_1 (C++ enumerator), 1105
- SECURE_BOOT_PUBLIC_KEY_INDEX_2 (C++ enumerator), 1105
- SemaphoreHandle_t (C++ type), 994
- semBINARY_SEMAPHORE_QUEUE_LENGTH (C macro), 982
- semGIVE_BLOCK_TIME (C macro), 982
- semSEMAPHORE_QUEUE_ITEM_LENGTH (C macro), 982
- shared_stack_function (C++ type), 1077
- shutdown_handler_t (C++ type), 1093
- SIGMADELTA_CHANNEL_0 (C++ enumerator), 595
- SIGMADELTA_CHANNEL_1 (C++ enumerator), 595
- SIGMADELTA_CHANNEL_2 (C++ enumerator), 595
- SIGMADELTA_CHANNEL_3 (C++ enumerator), 595
- SIGMADELTA_CHANNEL_MAX (C++ enumerator), 595
- sigmadelta_channel_t (C++ enum), 595
- sigmadelta_config (C++ function), 593

- sigmadelta_config_t (C++ class), 594
- sigmadelta_config_t::channel (C++ member), 594
- sigmadelta_config_t::sigmadelta_duty (C++ member), 594
- sigmadelta_config_t::sigmadelta_gpio (C++ member), 594
- sigmadelta_config_t::sigmadelta_prescaler (C++ member), 594
- SIGMADELTA_PORT_0 (C++ enumerator), 595
- SIGMADELTA_PORT_MAX (C++ enumerator), 595
- sigmadelta_port_t (C++ enum), 595
- sigmadelta_set_duty (C++ function), 593
- sigmadelta_set_pin (C++ function), 594
- sigmadelta_set_prescale (C++ function), 594
- slave_transaction_cb_t (C++ type), 617
- smartconfig_event_got_ssid_pswd_t (C++ class), 406
- smartconfig_event_got_ssid_pswd_t::bssid (C++ member), 406
- smartconfig_event_got_ssid_pswd_t::bssid_set (C++ member), 406
- smartconfig_event_got_ssid_pswd_t::cellular (C++ member), 406
- smartconfig_event_got_ssid_pswd_t::password (C++ member), 406
- smartconfig_event_got_ssid_pswd_t::ssid (C++ member), 406
- smartconfig_event_got_ssid_pswd_t::token (C++ member), 406
- smartconfig_event_got_ssid_pswd_t::types (C++ member), 406
- smartconfig_event_t (C++ enum), 407
- SMARTCONFIG_START_CONFIG_DEFAULT (C macro), 407
- smartconfig_start_config_t (C++ class), 406
- smartconfig_start_config_t::enable_log (C++ member), 406
- smartconfig_start_config_t::esp_touch_wv (C++ member), 406
- smartconfig_start_config_t::esp_touch_wv_key (C++ member), 407
- smartconfig_type_t (C++ enum), 407
- sntp_get_sync_interval (C++ function), 1124
- sntp_get_sync_mode (C++ function), 1123
- sntp_get_sync_status (C++ function), 1123
- sntp_restart (C++ function), 1124
- sntp_set_sync_interval (C++ function), 1124
- sntp_set_sync_mode (C++ function), 1123
- sntp_set_sync_status (C++ function), 1124
- sntp_set_time_sync_notification_cb (C++ function), 1124
- SNTP_SYNC_MODE_IMMED (C++ enumerator), 1124
- SNTP_SYNC_MODE_SMOOTH (C++ enumerator), 1124
- sntp_sync_mode_t (C++ enum), 1124
- SNTP_SYNC_STATUS_COMPLETED (C++ enumerator), 1125
- SNTP_SYNC_STATUS_IN_PROGRESS (C++ enumerator), 1125
- SNTP_SYNC_STATUS_RESET (C++ enumerator), 1125
- sntp_sync_status_t (C++ enum), 1125
- sntp_sync_time (C++ function), 1123
- sntp_sync_time_cb_t (C++ type), 1124
- SPI1_HOST (C++ enumerator), 601
- SPI2_HOST (C++ enumerator), 601
- SPI3_HOST (C++ enumerator), 601
- spi_bus_add_device (C++ function), 604
- spi_bus_add_flash_device (C++ function), 842
- spi_bus_config_t (C++ class), 602
- spi_bus_config_t::flags (C++ member), 603
- spi_bus_config_t::intr_flags (C++ member), 603
- spi_bus_config_t::max_transfer_sz (C++ member), 603
- spi_bus_config_t::miso_io_num (C++ member), 602
- spi_bus_config_t::mosi_io_num (C++ member), 602
- spi_bus_config_t::quadhd_io_num (C++ member), 603
- spi_bus_config_t::quadwp_io_num (C++ member), 602
- spi_bus_config_t::sclk_io_num (C++ member), 602
- spi_bus_free (C++ function), 602
- spi_bus_initialize (C++ function), 602
- spi_bus_remove_device (C++ function), 604
- spi_bus_remove_flash_device (C++ function), 843
- spi_cal_clock (C++ function), 606
- spi_common_dma_t (C++ enum), 604
- SPI_DEVICE_3WIRE (C macro), 610
- spi_device_acquire_bus (C++ function), 606
- SPI_DEVICE_BYTE_LSBFIRST (C macro), 610
- SPI_DEVICE_CLK_AS_CS (C macro), 610
- SPI_DEVICE_DDRCLK (C macro), 610
- spi_device_get_trans_result (C++ function), 605
- SPI_DEVICE_HALFDUPLEX (C macro), 610
- spi_device_handle_t (C++ type), 611
- spi_device_interface_config_t (C++ class), 607
- spi_device_interface_config_t::address_bits (C++ member), 607
- spi_device_interface_config_t::clock_speed_hz (C++ member), 608
- spi_device_interface_config_t::command_bits (C++ member), 607
- spi_device_interface_config_t::cs_ena_posttrans (C++ member), 608
- spi_device_interface_config_t::cs_ena_pretrans (C++ member), 608

- [spi_device_interface_config_t::dummy_bits](#) (C++ member), 850
 (C++ member), 607
- [spi_device_interface_config_t::duty_cycle_pos](#) (C++ member), 850
 (C++ member), 608
- [spi_device_interface_config_t::flags](#) (C++ member), 850
 (C++ member), 608
- [spi_device_interface_config_t::input_delay_ns](#) (C++ member), 851
 (C++ member), 608
- [spi_device_interface_config_t::mode](#) (C++ member), 850
 (C++ member), 607
- [spi_device_interface_config_t::post_cb](#) (C++ member), 851
 (C++ member), 608
- [spi_device_interface_config_t::pre_cb](#) (C++ member), 850
 (C++ member), 608
- [spi_device_interface_config_t::queue_size](#) (C++ member), 850
 (C++ member), 608
- [spi_device_interface_config_t::spics_io_num](#) (C++ member), 850
 (C++ member), 608
- [SPI_DEVICE_NO_DUMMY](#) (C macro), 610
- [spi_device_polling_end](#) (C++ function), 606
- [spi_device_polling_start](#) (C++ function), 605
- [spi_device_polling_transmit](#) (C++ function), 606
- [SPI_DEVICE_POSITIVE_CS](#) (C macro), 610
- [spi_device_queue_trans](#) (C++ function), 605
- [spi_device_release_bus](#) (C++ function), 606
- [SPI_DEVICE_RXBIT_LSBFIRST](#) (C macro), 610
- [spi_device_transmit](#) (C++ function), 605
- [SPI_DEVICE_TXBIT_LSBFIRST](#) (C macro), 610
- [SPI_DMA_CH_AUTO](#) (C++ enumerator), 604
- [spi_dma_chan_t](#) (C++ type), 604
- [SPI_DMA_DISABLED](#) (C++ enumerator), 604
- [SPI_EV_BUF_RX](#) (C++ enumerator), 601
- [SPI_EV_BUF_TX](#) (C++ enumerator), 601
- [SPI_EV_CMD9](#) (C++ enumerator), 601
- [SPI_EV_CMDA](#) (C++ enumerator), 601
- [SPI_EV_RECV](#) (C++ enumerator), 601
- [SPI_EV_RECV_DMA_READY](#) (C++ enumerator), 601
- [SPI_EV_SEND](#) (C++ enumerator), 601
- [SPI_EV_SEND_DMA_READY](#) (C++ enumerator), 601
- [SPI_EV_TRANS](#) (C++ enumerator), 601
- [spi_event_t](#) (C++ enum), 601
- [spi_flash_chip_t](#) (C++ type), 848
- [SPI_FLASH_CONFIG_CONF_BITS](#) (C macro), 851
- [SPI_FLASH_DIO](#) (C++ enumerator), 852
- [SPI_FLASH_DOUT](#) (C++ enumerator), 852
- [SPI_FLASH_FASTRD](#) (C++ enumerator), 852
- [spi_flash_host_driver_s](#) (C++ class), 849
- [spi_flash_host_driver_s::check_suspend](#) (C++ member), 851
- [spi_flash_host_driver_s::common_command](#) (C++ member), 850
- [spi_flash_host_driver_s::configure_host_io_mode](#) (C++ member), 849
- [spi_flash_host_driver_s::dev_config](#) (C++ member), 850
- [spi_flash_host_driver_s::erase_block](#) (C++ member), 850
- [spi_flash_host_driver_s::erase_chip](#) (C++ member), 850
- [spi_flash_host_driver_s::erase_sector](#) (C++ member), 850
- [spi_flash_host_driver_s::flush_cache](#) (C++ member), 850
- [spi_flash_host_driver_s::host_status](#) (C++ member), 850
- [spi_flash_host_driver_s::poll_cmd_done](#) (C++ member), 851
- [spi_flash_host_driver_s::program_page](#) (C++ member), 850
- [spi_flash_host_driver_s::read](#) (C++ member), 850
- [spi_flash_host_driver_s::read_data_slicer](#) (C++ member), 850
- [spi_flash_host_driver_s::read_id](#) (C++ member), 850
- [spi_flash_host_driver_s::read_status](#) (C++ member), 850
- [spi_flash_host_driver_s::resume](#) (C++ member), 851
- [spi_flash_host_driver_s::set_write_protect](#) (C++ member), 850
- [spi_flash_host_driver_s::supports_direct_read](#) (C++ member), 850
- [spi_flash_host_driver_s::supports_direct_write](#) (C++ member), 850
- [spi_flash_host_driver_s::sus_setup](#) (C++ member), 851
- [spi_flash_host_driver_s::suspend](#) (C++ member), 851
- [spi_flash_host_driver_s::write_data_slicer](#) (C++ member), 850
- [spi_flash_host_driver_t](#) (C++ type), 851
- [spi_flash_host_inst_t](#) (C++ class), 849
- [spi_flash_host_inst_t::driver](#) (C++ member), 849
- [SPI_FLASH_QIO](#) (C++ enumerator), 852
- [SPI_FLASH_QOUT](#) (C++ enumerator), 852
- [SPI_FLASH_READ_MODE_MAX](#) (C++ enumerator), 852
- [SPI_FLASH_READ_MODE_MIN](#) (C macro), 851
- [SPI_FLASH_SLOWRD](#) (C++ enumerator), 852
- [spi_flash_sus_cmd_conf](#) (C++ class), 849
- [spi_flash_sus_cmd_conf::cmd_rdsr](#) (C++ member), 849
- [spi_flash_sus_cmd_conf::res_cmd](#) (C++ member), 849
- [spi_flash_sus_cmd_conf::reserved](#) (C++ member), 849
- [spi_flash_sus_cmd_conf::sus_cmd](#) (C++ member), 849
- [spi_flash_sus_cmd_conf::sus_mask](#) (C++ member), 849
- [SPI_FLASH_TRANS_FLAG_BYTE_SWAP](#) (C macro), 851

- SPI_FLASH_TRANS_FLAG_CMD16 (*C macro*), 851
- SPI_FLASH_TRANS_FLAG_IGNORE_BASEIO (*C macro*), 851
- spi_flash_trans_t (*C++ class*), 848
- spi_flash_trans_t::address (*C++ member*), 849
- spi_flash_trans_t::address_bitlen (*C++ member*), 849
- spi_flash_trans_t::command (*C++ member*), 849
- spi_flash_trans_t::dummy_bitlen (*C++ member*), 849
- spi_flash_trans_t::flags (*C++ member*), 849
- spi_flash_trans_t::miso_data (*C++ member*), 849
- spi_flash_trans_t::miso_len (*C++ member*), 849
- spi_flash_trans_t::mosi_data (*C++ member*), 849
- spi_flash_trans_t::mosi_len (*C++ member*), 849
- spi_flash_trans_t::reserved (*C++ member*), 849
- SPI_FLASH_YIELD_REQ_SUSPEND (*C macro*), 848
- SPI_FLASH_YIELD_REQ_YIELD (*C macro*), 848
- SPI_FLASH_YIELD_STA_RESUME (*C macro*), 848
- spi_get_actual_clock (*C++ function*), 607
- spi_get_freq_limit (*C++ function*), 607
- spi_get_timing (*C++ function*), 607
- spi_host_device_t (*C++ enum*), 601
- SPI_MASTER_FREQ_10M (*C macro*), 609
- SPI_MASTER_FREQ_11M (*C macro*), 609
- SPI_MASTER_FREQ_13M (*C macro*), 609
- SPI_MASTER_FREQ_16M (*C macro*), 609
- SPI_MASTER_FREQ_20M (*C macro*), 610
- SPI_MASTER_FREQ_26M (*C macro*), 610
- SPI_MASTER_FREQ_40M (*C macro*), 610
- SPI_MASTER_FREQ_80M (*C macro*), 610
- SPI_MASTER_FREQ_8M (*C macro*), 609
- SPI_MASTER_FREQ_9M (*C macro*), 609
- SPI_MAX_DMA_LEN (*C macro*), 603
- SPI_SLAVE_BIT_LSBFIRST (*C macro*), 616
- spi_slave_free (*C++ function*), 614
- spi_slave_get_trans_result (*C++ function*), 615
- spi_slave_initialize (*C++ function*), 614
- spi_slave_interface_config_t (*C++ class*), 615
- spi_slave_interface_config_t::flags (*C++ member*), 616
- spi_slave_interface_config_t::mode (*C++ member*), 616
- spi_slave_interface_config_t::post_setup_cb (*C++ member*), 616
- spi_slave_interface_config_t::post_trans_cb (*C++ member*), 616
- spi_slave_interface_config_t::queue_size (*C++ member*), 616
- spi_slave_interface_config_t::spics_io_num (*C++ member*), 616
- spi_slave_queue_trans (*C++ function*), 615
- SPI_SLAVE_RXBIT_LSBFIRST (*C macro*), 616
- spi_slave_transaction_t (*C++ class*), 616
- spi_slave_transaction_t (*C++ type*), 617
- spi_slave_transaction_t::length (*C++ member*), 616
- spi_slave_transaction_t::rx_buffer (*C++ member*), 616
- spi_slave_transaction_t::trans_len (*C++ member*), 616
- spi_slave_transaction_t::tx_buffer (*C++ member*), 616
- spi_slave_transaction_t::user (*C++ member*), 616
- spi_slave_transmit (*C++ function*), 615
- SPI_SLAVE_TXBIT_LSBFIRST (*C macro*), 616
- SPI_SWAP_DATA_RX (*C macro*), 603
- SPI_SWAP_DATA_TX (*C macro*), 603
- SPI_TRANS_MODE_DIO (*C macro*), 610
- SPI_TRANS_MODE_DIOQIO_ADDR (*C macro*), 610
- SPI_TRANS_MODE_QIO (*C macro*), 610
- SPI_TRANS_USE_RXDATA (*C macro*), 610
- SPI_TRANS_USE_TXDATA (*C macro*), 610
- SPI_TRANS_VARIABLE_ADDR (*C macro*), 610
- SPI_TRANS_VARIABLE_CMD (*C macro*), 610
- SPI_TRANS_VARIABLE_DUMMY (*C macro*), 611
- spi_transaction_ext_t (*C++ class*), 609
- spi_transaction_ext_t::address_bits (*C++ member*), 609
- spi_transaction_ext_t::base (*C++ member*), 609
- spi_transaction_ext_t::command_bits (*C++ member*), 609
- spi_transaction_ext_t::dummy_bits (*C++ member*), 609
- spi_transaction_t (*C++ class*), 608
- spi_transaction_t (*C++ type*), 611
- spi_transaction_t::addr (*C++ member*), 608
- spi_transaction_t::cmd (*C++ member*), 608
- spi_transaction_t::flags (*C++ member*), 608
- spi_transaction_t::length (*C++ member*), 609
- spi_transaction_t::rx_buffer (*C++ member*), 609
- spi_transaction_t::rx_data (*C++ member*), 609
- spi_transaction_t::rxlength (*C++ member*), 609
- spi_transaction_t::tx_buffer (*C++ member*), 609
- spi_transaction_t::tx_data (*C++ member*), 609
- spi_transaction_t::user (*C++ member*), 609

- SPICOMMON_BUSFLAG_DUAL (*C macro*), 603
- SPICOMMON_BUSFLAG_GPIO_PINS (*C macro*), 603
- SPICOMMON_BUSFLAG_IOMUX_PINS (*C macro*), 603
- SPICOMMON_BUSFLAG_MASTER (*C macro*), 603
- SPICOMMON_BUSFLAG_MISO (*C macro*), 603
- SPICOMMON_BUSFLAG_MOSI (*C macro*), 603
- SPICOMMON_BUSFLAG_NATIVE_PINS (*C macro*), 604
- SPICOMMON_BUSFLAG_QUAD (*C macro*), 604
- SPICOMMON_BUSFLAG_SCLK (*C macro*), 603
- SPICOMMON_BUSFLAG_SLAVE (*C macro*), 603
- SPICOMMON_BUSFLAG_WPHD (*C macro*), 604
- StaticRingbuffer_t (*C++ type*), 1048
- StreamBufferHandle_t (*C++ type*), 1026
- SYSTEM_EVENT_ACTION_TX_STATUS (*C++ enumerator*), 940
- system_event_ap_probe_req_rx_t (*C++ type*), 939
- SYSTEM_EVENT_AP_PROBEREQRCVED (*C++ enumerator*), 940
- SYSTEM_EVENT_AP_STA_GOT_IP6 (*C macro*), 938
- SYSTEM_EVENT_AP_STACONNECTED (*C++ enumerator*), 940
- system_event_ap_staconnected_t (*C++ type*), 939
- SYSTEM_EVENT_AP_STADISCONNECTED (*C++ enumerator*), 940
- system_event_ap_stadisconnected_t (*C++ type*), 939
- SYSTEM_EVENT_AP_STAIPASSIGNED (*C++ enumerator*), 940
- system_event_ap_staipassigned_t (*C++ type*), 939
- SYSTEM_EVENT_AP_START (*C++ enumerator*), 940
- SYSTEM_EVENT_AP_STOP (*C++ enumerator*), 940
- system_event_cb_t (*C++ type*), 939
- SYSTEM_EVENT_ETH_CONNECTED (*C++ enumerator*), 940
- SYSTEM_EVENT_ETH_DISCONNECTED (*C++ enumerator*), 941
- SYSTEM_EVENT_ETH_GOT_IP (*C++ enumerator*), 941
- SYSTEM_EVENT_ETH_START (*C++ enumerator*), 940
- SYSTEM_EVENT_ETH_STOP (*C++ enumerator*), 940
- SYSTEM_EVENT_FTM_REPORT (*C++ enumerator*), 940
- system_event_ftm_report_t (*C++ type*), 939
- SYSTEM_EVENT_GOT_IP6 (*C++ enumerator*), 940
- system_event_got_ip6_t (*C++ type*), 939
- system_event_handler_t (*C++ type*), 939
- system_event_id_t (*C++ enum*), 939
- system_event_info_t (*C++ union*), 937
- system_event_info_t::ap_probereqrcv (*C++ member*), 938
- system_event_info_t::ap_staipassigned (*C++ member*), 938
- system_event_info_t::auth_change (*C++ member*), 938
- system_event_info_t::connected (*C++ member*), 937
- system_event_info_t::disconnected (*C++ member*), 937
- system_event_info_t::ftm_report (*C++ member*), 938
- system_event_info_t::got_ip (*C++ member*), 938
- system_event_info_t::got_ip6 (*C++ member*), 938
- system_event_info_t::scan_done (*C++ member*), 937
- system_event_info_t::sta_connected (*C++ member*), 938
- system_event_info_t::sta_disconnected (*C++ member*), 938
- system_event_info_t::sta_er_fail_reason (*C++ member*), 938
- system_event_info_t::sta_er_pin (*C++ member*), 938
- system_event_info_t::sta_er_success (*C++ member*), 938
- SYSTEM_EVENT_MAX (*C++ enumerator*), 941
- SYSTEM_EVENT_ROC_DONE (*C++ enumerator*), 940
- SYSTEM_EVENT_SCAN_DONE (*C++ enumerator*), 939
- SYSTEM_EVENT_STA_AUTHMODE_CHANGE (*C++ enumerator*), 940
- system_event_sta_authmode_change_t (*C++ type*), 938
- SYSTEM_EVENT_STA_BEACON_TIMEOUT (*C++ enumerator*), 940
- SYSTEM_EVENT_STA_BSS_RSSI_LOW (*C++ enumerator*), 940
- SYSTEM_EVENT_STA_CONNECTED (*C++ enumerator*), 939
- system_event_sta_connected_t (*C++ type*), 938
- SYSTEM_EVENT_STA_DISCONNECTED (*C++ enumerator*), 939
- system_event_sta_disconnected_t (*C++ type*), 938
- SYSTEM_EVENT_STA_GOT_IP (*C++ enumerator*), 940
- system_event_sta_got_ip_t (*C++ type*), 939
- SYSTEM_EVENT_STA_LOST_IP (*C++ enumerator*), 940
- system_event_sta_scan_done_t (*C++ type*), 938
- SYSTEM_EVENT_STA_START (*C++ enumerator*), 939
- SYSTEM_EVENT_STA_STOP (*C++ enumerator*), 939
- SYSTEM_EVENT_STA_WPS_ER_FAILED (*C++ enumerator*), 940

- SYSTEM_EVENT_STA_WPS_ER_PBC_OVERLAP (C++ enumerator), 940
- SYSTEM_EVENT_STA_WPS_ER_PIN (C++ enumerator), 940
- system_event_sta_wps_er_pin_t (C++ type), 939
- SYSTEM_EVENT_STA_WPS_ER_SUCCESS (C++ enumerator), 940
- system_event_sta_wps_er_success_t (C++ type), 939
- SYSTEM_EVENT_STA_WPS_ER_TIMEOUT (C++ enumerator), 940
- system_event_sta_wps_fail_reason_t (C++ type), 938
- system_event_t (C++ class), 938
- system_event_t::event_id (C++ member), 938
- system_event_t::event_info (C++ member), 938
- SYSTEM_EVENT_WIFI_READY (C++ enumerator), 939
- ## T
- taskDISABLE_INTERRUPTS (C macro), 962
- taskENABLE_INTERRUPTS (C macro), 962
- taskENTER_CRITICAL (C macro), 962
- taskENTER_CRITICAL_FROM_ISR (C macro), 962
- taskENTER_CRITICAL_ISR (C macro), 962
- taskEXIT_CRITICAL (C macro), 962
- taskEXIT_CRITICAL_FROM_ISR (C macro), 962
- taskEXIT_CRITICAL_ISR (C macro), 962
- TaskHandle_t (C++ type), 963
- TaskHookFunction_t (C++ type), 963
- taskSCHEDULER_NOT_STARTED (C macro), 962
- taskSCHEDULER_RUNNING (C macro), 962
- taskSCHEDULER_SUSPENDED (C macro), 962
- taskYIELD (C macro), 962
- TIMER_0 (C++ enumerator), 512
- TIMER_ALARM_DIS (C++ enumerator), 512
- TIMER_ALARM_EN (C++ enumerator), 512
- TIMER_ALARM_MAX (C++ enumerator), 512
- timer_alarm_t (C++ enum), 512
- TIMER_AUTORELOAD_DIS (C++ enumerator), 513
- TIMER_AUTORELOAD_EN (C++ enumerator), 513
- TIMER_AUTORELOAD_MAX (C++ enumerator), 513
- timer_autoreload_t (C++ enum), 513
- TIMER_BASE_CLK (C macro), 511
- timer_config_t (C++ class), 511
- timer_config_t::alarm_en (C++ member), 511
- timer_config_t::auto_reload (C++ member), 511
- timer_config_t::clk_src (C++ member), 511
- timer_config_t::counter_dir (C++ member), 511
- timer_config_t::counter_en (C++ member), 511
- timer_config_t::divider (C++ member), 511
- timer_config_t::intr_type (C++ member), 511
- timer_count_dir_t (C++ enum), 512
- TIMER_COUNT_DOWN (C++ enumerator), 512
- TIMER_COUNT_MAX (C++ enumerator), 512
- TIMER_COUNT_UP (C++ enumerator), 512
- timer_deinit (C++ function), 508
- timer_disable_intr (C++ function), 509
- timer_enable_intr (C++ function), 509
- timer_get_alarm_value (C++ function), 507
- timer_get_config (C++ function), 508
- timer_get_counter_time_sec (C++ function), 505
- timer_get_counter_value (C++ function), 505
- TIMER_GROUP_0 (C++ enumerator), 511
- TIMER_GROUP_1 (C++ enumerator), 512
- timer_group_clr_intr_sta_in_isr (C++ function), 510
- timer_group_clr_intr_status_in_isr (C++ function), 509
- timer_group_enable_alarm_in_isr (C++ function), 509
- timer_group_get_auto_reload_in_isr (C++ function), 510
- timer_group_get_counter_value_in_isr (C++ function), 509
- timer_group_get_intr_status_in_isr (C++ function), 510
- timer_group_intr_clr_in_isr (C++ function), 509
- timer_group_intr_disable (C++ function), 509
- timer_group_intr_enable (C++ function), 508
- timer_group_intr_get_in_isr (C++ function), 510
- TIMER_GROUP_MAX (C++ enumerator), 512
- timer_group_set_alarm_value_in_isr (C++ function), 510
- timer_group_set_counter_enable_in_isr (C++ function), 510
- timer_group_t (C++ enum), 511
- timer_idx_t (C++ enum), 512
- timer_init (C++ function), 508
- TIMER_INTR_LEVEL (C++ enumerator), 512
- TIMER_INTR_MAX (C++ enumerator), 513
- timer_intr_mode_t (C++ enum), 512
- TIMER_INTR_NONE (C++ enumerator), 512
- timer_intr_t (C++ enum), 512
- TIMER_INTR_T0 (C++ enumerator), 512
- TIMER_INTR_WDT (C++ enumerator), 512
- timer_isr_callback_add (C++ function), 507
- timer_isr_callback_remove (C++ function), 507
- timer_isr_handle_t (C++ type), 511
- timer_isr_register (C++ function), 507
- timer_isr_t (C++ type), 511
- TIMER_MAX (C++ enumerator), 512

- TIMER_PAUSE (C++ enumerator), 512
- timer_pause (C++ function), 506
- timer_set_alarm (C++ function), 507
- timer_set_alarm_value (C++ function), 506
- timer_set_auto_reload (C++ function), 506
- timer_set_counter_mode (C++ function), 506
- timer_set_counter_value (C++ function), 505
- timer_set_divider (C++ function), 506
- timer_spinlock_give (C++ function), 510
- timer_spinlock_take (C++ function), 510
- TIMER_SRC_CLK_APB (C++ enumerator), 513
- timer_src_clk_t (C++ enum), 513
- TIMER_SRC_CLK_XTAL (C++ enumerator), 513
- TIMER_START (C++ enumerator), 512
- timer_start (C++ function), 505
- timer_start_t (C++ enum), 512
- TimerCallbackFunction_t (C++ type), 1010
- TimerHandle_t (C++ type), 1010
- tls_keep_alive_cfg (C++ class), 672
- tls_keep_alive_cfg::keep_alive_count (C++ member), 672
- tls_keep_alive_cfg::keep_alive_enable (C++ member), 672
- tls_keep_alive_cfg::keep_alive_idle (C++ member), 672
- tls_keep_alive_cfg::keep_alive_interval (C++ member), 672
- tls_keep_alive_cfg_t (C++ type), 676
- TlsDeleteCallbackFunction_t (C++ type), 963
- tmrCOMMAND_CHANGE_PERIOD (C macro), 1002
- tmrCOMMAND_CHANGE_PERIOD_FROM_ISR (C macro), 1002
- tmrCOMMAND_DELETE (C macro), 1002
- tmrCOMMAND_EXECUTE_CALLBACK (C macro), 1001
- tmrCOMMAND_EXECUTE_CALLBACK_FROM_ISR (C macro), 1001
- tmrCOMMAND_RESET (C macro), 1002
- tmrCOMMAND_RESET_FROM_ISR (C macro), 1002
- tmrCOMMAND_START (C macro), 1001
- tmrCOMMAND_START_DONT_TRACE (C macro), 1001
- tmrCOMMAND_START_FROM_ISR (C macro), 1002
- tmrCOMMAND_STOP (C macro), 1002
- tmrCOMMAND_STOP_FROM_ISR (C macro), 1002
- tmrFIRST_FROM_ISR_COMMAND (C macro), 1002
- transaction_cb_t (C++ type), 611
- tskIDLE_PRIORITY (C macro), 962
- tskKERNEL_VERSION_BUILD (C macro), 961
- tskKERNEL_VERSION_MAJOR (C macro), 961
- tskKERNEL_VERSION_MINOR (C macro), 961
- tskKERNEL_VERSION_NUMBER (C macro), 961
- tskMPU_REGION_DEVICE_MEMORY (C macro), 962
- tskMPU_REGION_EXECUTE_NEVER (C macro), 961
- tskMPU_REGION_NORMAL_MEMORY (C macro), 961
- tskMPU_REGION_READ_ONLY (C macro), 961
- tskMPU_REGION_READ_WRITE (C macro), 961
- tskNO_AFFINITY (C macro), 962
- twai_clear_receive_queue (C++ function), 630
- twai_clear_transmit_queue (C++ function), 630
- twai_driver_install (C++ function), 628
- twai_driver_uninstall (C++ function), 628
- TWAI_ERR_PASS_THRESH (C macro), 627
- TWAI_EXTD_ID_MASK (C macro), 627
- twai_filter_config_t (C++ class), 627
- twai_filter_config_t::acceptance_code (C++ member), 627
- twai_filter_config_t::acceptance_mask (C++ member), 627
- twai_filter_config_t::single_filter (C++ member), 627
- TWAI_FRAME_EXTD_ID_LEN_BYTES (C macro), 627
- TWAI_FRAME_MAX_DLC (C macro), 627
- TWAI_FRAME_STD_ID_LEN_BYTES (C macro), 627
- twai_general_config_t (C++ class), 630
- twai_general_config_t::alerts_enabled (C++ member), 631
- twai_general_config_t::bus_off_io (C++ member), 631
- twai_general_config_t::clkout_divider (C++ member), 631
- twai_general_config_t::clkout_io (C++ member), 631
- twai_general_config_t::intr_flags (C++ member), 631
- twai_general_config_t::mode (C++ member), 630
- twai_general_config_t::rx_io (C++ member), 630
- twai_general_config_t::rx_queue_len (C++ member), 631
- twai_general_config_t::tx_io (C++ member), 630
- twai_general_config_t::tx_queue_len (C++ member), 631
- twai_get_status_info (C++ function), 630
- twai_initiate_recovery (C++ function), 630
- TWAI_IO_UNUSED (C macro), 631
- twai_message_t (C++ class), 626
- twai_message_t::data (C++ member), 626
- twai_message_t::data_length_code (C++ member), 626
- twai_message_t::dlc_non_comp (C++ member), 626
- twai_message_t::extd (C++ member), 626
- twai_message_t::flags (C++ member), 626
- twai_message_t::identifier (C++ member),

- 626
- twai_message_t::reserved (C++ member), 626
- twai_message_t::rtr (C++ member), 626
- twai_message_t::self (C++ member), 626
- twai_message_t::ss (C++ member), 626
- TWAI_MODE_LISTEN_ONLY (C++ enumerator), 627
- TWAI_MODE_NO_ACK (C++ enumerator), 627
- TWAI_MODE_NORMAL (C++ enumerator), 627
- twai_mode_t (C++ enum), 627
- twai_read_alerts (C++ function), 629
- twai_receive (C++ function), 629
- twai_reconfigure_alerts (C++ function), 629
- twai_start (C++ function), 628
- TWAI_STATE_BUS_OFF (C++ enumerator), 632
- TWAI_STATE_RECOVERING (C++ enumerator), 632
- TWAI_STATE_RUNNING (C++ enumerator), 632
- TWAI_STATE_STOPPED (C++ enumerator), 632
- twai_state_t (C++ enum), 632
- twai_status_info_t (C++ class), 631
- twai_status_info_t::arb_lost_count (C++ member), 631
- twai_status_info_t::bus_error_count (C++ member), 631
- twai_status_info_t::msgs_to_rx (C++ member), 631
- twai_status_info_t::msgs_to_tx (C++ member), 631
- twai_status_info_t::rx_error_counter (C++ member), 631
- twai_status_info_t::rx_missed_count (C++ member), 631
- twai_status_info_t::rx_overrun_count (C++ member), 631
- twai_status_info_t::state (C++ member), 631
- twai_status_info_t::tx_error_counter (C++ member), 631
- twai_status_info_t::tx_failed_count (C++ member), 631
- TWAI_STD_ID_MASK (C macro), 627
- twai_stop (C++ function), 628
- twai_timing_config_t (C++ class), 626
- twai_timing_config_t::brp (C++ member), 626
- twai_timing_config_t::sjw (C++ member), 627
- twai_timing_config_t::triple_sampling (C++ member), 627
- twai_timing_config_t::tseg_1 (C++ member), 626
- twai_timing_config_t::tseg_2 (C++ member), 626
- twai_transmit (C++ function), 628
- U**
- uart_at_cmd_t (C++ class), 650
- uart_at_cmd_t::char_num (C++ member), 650
- uart_at_cmd_t::cmd_char (C++ member), 650
- uart_at_cmd_t::gap_tout (C++ member), 650
- uart_at_cmd_t::post_idle (C++ member), 650
- uart_at_cmd_t::pre_idle (C++ member), 650
- UART_BITRATE_MAX (C macro), 649
- UART_BREAK (C++ enumerator), 649
- UART_BUFFER_FULL (C++ enumerator), 649
- uart_clear_intr_status (C++ function), 641
- uart_config_t (C++ class), 650
- uart_config_t::baud_rate (C++ member), 650
- uart_config_t::data_bits (C++ member), 650
- uart_config_t::flow_ctrl (C++ member), 651
- uart_config_t::parity (C++ member), 650
- uart_config_t::rx_flow_ctrl_thresh (C++ member), 651
- uart_config_t::source_clk (C++ member), 651
- uart_config_t::stop_bits (C++ member), 650
- uart_config_t::use_ref_tick (C++ member), 651
- UART_DATA (C++ enumerator), 649
- UART_DATA_5_BITS (C++ enumerator), 651
- UART_DATA_6_BITS (C++ enumerator), 651
- UART_DATA_7_BITS (C++ enumerator), 651
- UART_DATA_8_BITS (C++ enumerator), 651
- UART_DATA_BITS_MAX (C++ enumerator), 651
- UART_DATA_BREAK (C++ enumerator), 649
- uart_disable_intr_mask (C++ function), 641
- uart_disable_pattern_det_intr (C++ function), 645
- uart_disable_rx_intr (C++ function), 641
- uart_disable_tx_intr (C++ function), 641
- uart_driver_delete (C++ function), 638
- uart_driver_install (C++ function), 638
- uart_enable_intr_mask (C++ function), 641
- uart_enable_pattern_det_baud_intr (C++ function), 645
- uart_enable_rx_intr (C++ function), 641
- uart_enable_tx_intr (C++ function), 641
- UART_EVENT_MAX (C++ enumerator), 649
- uart_event_t (C++ class), 648
- uart_event_t::size (C++ member), 649
- uart_event_t::timeout_flag (C++ member), 649
- uart_event_t::type (C++ member), 649
- uart_event_type_t (C++ enum), 649
- UART_FIFO_LEN (C macro), 649
- UART_FIFO_OVF (C++ enumerator), 649
- uart_flush (C++ function), 644
- uart_flush_input (C++ function), 644
- UART_FRAME_ERR (C++ enumerator), 649
- uart_get_baudrate (C++ function), 640

- uart_get_buffered_data_len (C++ function), 645
- uart_get_collision_flag (C++ function), 647
- uart_get_hw_flow_ctrl (C++ function), 640
- uart_get_parity (C++ function), 639
- uart_get_stop_bits (C++ function), 639
- uart_get_wakeup_threshold (C++ function), 647
- uart_get_word_length (C++ function), 639
- UART_GPIO20_DIRECT_CHANNEL (C macro), 653
- UART_GPIO21_DIRECT_CHANNEL (C macro), 653
- uart_hw_flowcontrol_t (C++ enum), 652
- UART_HW_FLOWCTRL_CTS (C++ enumerator), 652
- UART_HW_FLOWCTRL_CTS_RTS (C++ enumerator), 652
- UART_HW_FLOWCTRL_DISABLE (C++ enumerator), 652
- UART_HW_FLOWCTRL_MAX (C++ enumerator), 652
- UART_HW_FLOWCTRL_RTS (C++ enumerator), 652
- uart_intr_config (C++ function), 643
- uart_intr_config_t (C++ class), 648
- uart_intr_config_t::intr_enable_mask (C++ member), 648
- uart_intr_config_t::rx_timeout_thresh (C++ member), 648
- uart_intr_config_t::rxfifo_full_thresh (C++ member), 648
- uart_intr_config_t::txfifo_empty_intr_thresh (C++ member), 648
- uart_is_driver_installed (C++ function), 638
- uart_isr_free (C++ function), 642
- uart_isr_handle_t (C++ type), 649
- uart_isr_register (C++ function), 642
- UART_MODE_IRDA (C++ enumerator), 651
- UART_MODE_RS485_APP_CTRL (C++ enumerator), 651
- UART_MODE_RS485_COLLISION_DETECT (C++ enumerator), 651
- UART_MODE_RS485_HALF_DUPLEX (C++ enumerator), 651
- uart_mode_t (C++ enum), 651
- UART_MODE_UART (C++ enumerator), 651
- UART_NUM_0 (C macro), 649
- UART_NUM_0_RXD_DIRECT_GPIO_NUM (C macro), 653
- UART_NUM_0_TXD_DIRECT_GPIO_NUM (C macro), 653
- UART_NUM_1 (C macro), 649
- UART_NUM_MAX (C macro), 649
- uart_param_config (C++ function), 643
- UART_PARITY_DISABLE (C++ enumerator), 652
- UART_PARITY_ERR (C++ enumerator), 649
- UART_PARITY_EVEN (C++ enumerator), 652
- UART_PARITY_ODD (C++ enumerator), 652
- uart_parity_t (C++ enum), 652
- UART_PATTERN_DET (C++ enumerator), 649
- uart_pattern_get_pos (C++ function), 646
- uart_pattern_pop_pos (C++ function), 645
- uart_pattern_queue_reset (C++ function), 646
- UART_PIN_NO_CHANGE (C macro), 649
- uart_port_t (C++ type), 651
- uart_read_bytes (C++ function), 644
- UART_RXD_GPIO20_DIRECT_CHANNEL (C macro), 653
- UART_SCLK_APB (C++ enumerator), 653
- UART_SCLK_RTC (C++ enumerator), 653
- uart_sclk_t (C++ enum), 653
- UART_SCLK_XTAL (C++ enumerator), 653
- uart_set_always_rx_timeout (C++ function), 648
- uart_set_baudrate (C++ function), 640
- uart_set_dtr (C++ function), 642
- uart_set_hw_flow_ctrl (C++ function), 640
- uart_set_line_inverse (C++ function), 640
- uart_set_loop_back (C++ function), 648
- uart_set_mode (C++ function), 646
- uart_set_parity (C++ function), 639
- uart_set_pin (C++ function), 642
- uart_set_rts (C++ function), 642
- uart_set_rx_full_threshold (C++ function), 646
- uart_set_rx_timeout (C++ function), 647
- uart_set_stop_bits (C++ function), 639
- uart_set_sw_flow_ctrl (C++ function), 640
- uart_set_tx_empty_threshold (C++ function), 646
- uart_set_tx_idle_num (C++ function), 643
- uart_set_wakeup_threshold (C++ function), 647
- uart_set_word_length (C++ function), 639
- UART_SIGNAL_CTS_INV (C++ enumerator), 652
- UART_SIGNAL_DSR_INV (C++ enumerator), 652
- UART_SIGNAL_DTR_INV (C++ enumerator), 652
- UART_SIGNAL_INV_DISABLE (C++ enumerator), 652
- uart_signal_inv_t (C++ enum), 652
- UART_SIGNAL_IRDA_RX_INV (C++ enumerator), 652
- UART_SIGNAL_IRDA_TX_INV (C++ enumerator), 652
- UART_SIGNAL_RTS_INV (C++ enumerator), 652
- UART_SIGNAL_RXD_INV (C++ enumerator), 652
- UART_SIGNAL_TXD_INV (C++ enumerator), 652
- UART_STOP_BITS_1 (C++ enumerator), 651
- UART_STOP_BITS_1_5 (C++ enumerator), 651
- UART_STOP_BITS_2 (C++ enumerator), 652
- UART_STOP_BITS_MAX (C++ enumerator), 652
- uart_stop_bits_t (C++ enum), 651
- uart_sw_flowctrl_t (C++ class), 650
- uart_sw_flowctrl_t::xoff_char (C++ member), 650
- uart_sw_flowctrl_t::xoff_thrd (C++ member), 650

- uart_sw_flowctrl_t::xon_char (C++ member), 650
 - uart_sw_flowctrl_t::xon_thr (C++ member), 650
 - uart_tx_chars (C++ function), 643
 - UART_TXD_GPIO21_DIRECT_CHANNEL (C macro), 653
 - uart_wait_tx_done (C++ function), 643
 - uart_wait_tx_idle_polling (C++ function), 648
 - uart_word_length_t (C++ enum), 651
 - uart_write_bytes (C++ function), 643
 - uart_write_bytes_with_break (C++ function), 644
 - UINT16 (C++ type), 200
 - UINT32 (C++ type), 200
 - UINT64 (C++ type), 200
 - UINT8 (C++ type), 200
 - ulTaskGetIdleRunTimeCounter (C++ function), 957
 - ulTaskNotifyTake (C++ function), 960
 - uxQueueMessagesWaiting (C++ function), 968
 - uxQueueMessagesWaitingFromISR (C++ function), 970
 - uxQueueSpacesAvailable (C++ function), 968
 - uxSemaphoreGetCount (C macro), 994
 - uxTaskGetNumberOfTasks (C++ function), 952
 - uxTaskGetStackHighWaterMark (C++ function), 952
 - uxTaskGetStackHighWaterMark2 (C++ function), 952
 - uxTaskGetSystemState (C++ function), 954
 - uxTaskPriorityGet (C++ function), 946
 - uxTaskPriorityGetFromISR (C++ function), 947
- ## V
- vendor_ie_data_t (C++ class), 387
 - vendor_ie_data_t::element_id (C++ member), 388
 - vendor_ie_data_t::length (C++ member), 388
 - vendor_ie_data_t::payload (C++ member), 388
 - vendor_ie_data_t::vendor_oui (C++ member), 388
 - vendor_ie_data_t::vendor_oui_type (C++ member), 388
 - vEventGroupDelete (C++ function), 1017
 - vMessageBufferDelete (C macro), 1032
 - vprintf_like_t (C++ type), 1087
 - vQueueAddToRegistry (C++ function), 970
 - vQueueDelete (C++ function), 968
 - vQueueUnregisterQueue (C++ function), 970
 - vRingbufferDelete (C++ function), 1046
 - vRingbufferGetInfo (C++ function), 1047
 - vRingbufferReturnItem (C++ function), 1046
 - vRingbufferReturnItemFromISR (C++ function), 1046
 - vSemaphoreDelete (C macro), 994
 - vStreamBufferDelete (C++ function), 1023
 - vTaskAllocateMPURegions (C++ function), 945
 - vTaskDelay (C++ function), 945
 - vTaskDelayUntil (C++ function), 946
 - vTaskDelete (C++ function), 945
 - vTaskGetInfo (C++ function), 947
 - vTaskGetRunTimeStats (C++ function), 956
 - vTaskList (C++ function), 956
 - vTaskNotifyGiveFromISR (C++ function), 960
 - vTaskPrioritySet (C++ function), 948
 - vTaskResume (C++ function), 949
 - vTaskSetApplicationTaskTag (C++ function), 953
 - vTaskSetThreadLocalStoragePointer (C++ function), 953
 - vTaskSetThreadLocalStoragePointerAndDelCallback (C++ function), 954
 - vTaskSuspend (C++ function), 949
 - vTaskSuspendAll (C++ function), 950
 - vTimerSetReloadMode (C++ function), 1001
 - vTimerSetTimerID (C++ function), 998
- ## W
- WEBSOCKET_EVENT_ANY (C++ enumerator), 747
 - WEBSOCKET_EVENT_CLOSED (C++ enumerator), 747
 - WEBSOCKET_EVENT_CONNECTED (C++ enumerator), 747
 - WEBSOCKET_EVENT_DATA (C++ enumerator), 747
 - WEBSOCKET_EVENT_DISCONNECTED (C++ enumerator), 747
 - WEBSOCKET_EVENT_ERROR (C++ enumerator), 747
 - WEBSOCKET_EVENT_MAX (C++ enumerator), 747
 - WEBSOCKET_TRANSPORT_OVER_SSL (C++ enumerator), 748
 - WEBSOCKET_TRANSPORT_OVER_TCP (C++ enumerator), 748
 - WEBSOCKET_TRANSPORT_UNKNOWN (C++ enumerator), 748
 - wifi_action_rx_cb_t (C++ type), 397
 - wifi_action_tx_req_t (C++ class), 391
 - wifi_action_tx_req_t::data (C++ member), 391
 - wifi_action_tx_req_t::data_len (C++ member), 391
 - wifi_action_tx_req_t::dest_mac (C++ member), 391
 - wifi_action_tx_req_t::ifx (C++ member), 391
 - wifi_action_tx_req_t::no_ack (C++ member), 391
 - wifi_action_tx_req_t::rx_cb (C++ member), 391
 - wifi_active_scan_time_t (C++ class), 383

- wifi_active_scan_time_t::max (C++ member), 384
- wifi_active_scan_time_t::min (C++ member), 384
- WIFI_ALL_CHANNEL_SCAN (C++ enumerator), 400
- WIFI_AMPDU_RX_ENABLED (C macro), 382
- WIFI_AMPDU_TX_ENABLED (C macro), 382
- WIFI_AMSDU_TX_ENABLED (C macro), 382
- WIFI_ANT_ANT0 (C++ enumerator), 399
- WIFI_ANT_ANT1 (C++ enumerator), 400
- wifi_ant_config_t (C++ class), 391
- wifi_ant_config_t::enabled_ant0 (C++ member), 391
- wifi_ant_config_t::enabled_ant1 (C++ member), 391
- wifi_ant_config_t::rx_ant_default (C++ member), 391
- wifi_ant_config_t::rx_ant_mode (C++ member), 391
- wifi_ant_config_t::tx_ant_mode (C++ member), 391
- wifi_ant_gpio_config_t (C++ class), 391
- wifi_ant_gpio_config_t::gpio_cfg (C++ member), 391
- wifi_ant_gpio_t (C++ class), 391
- wifi_ant_gpio_t::gpio_num (C++ member), 391
- wifi_ant_gpio_t::gpio_select (C++ member), 391
- WIFI_ANT_MAX (C++ enumerator), 400
- WIFI_ANT_MODE_ANT0 (C++ enumerator), 401
- WIFI_ANT_MODE_ANT1 (C++ enumerator), 401
- WIFI_ANT_MODE_AUTO (C++ enumerator), 401
- WIFI_ANT_MODE_MAX (C++ enumerator), 401
- wifi_ant_mode_t (C++ enum), 401
- wifi_ant_t (C++ enum), 399
- wifi_ap_config_t (C++ class), 385
- wifi_ap_config_t::authmode (C++ member), 386
- wifi_ap_config_t::beacon_interval (C++ member), 386
- wifi_ap_config_t::channel (C++ member), 386
- wifi_ap_config_t::ftm_responder (C++ member), 386
- wifi_ap_config_t::max_connection (C++ member), 386
- wifi_ap_config_t::pairwise_cipher (C++ member), 386
- wifi_ap_config_t::password (C++ member), 386
- wifi_ap_config_t::ssid (C++ member), 386
- wifi_ap_config_t::ssid_hidden (C++ member), 386
- wifi_ap_config_t::ssid_len (C++ member), 386
- wifi_ap_record_t (C++ class), 384
- wifi_ap_record_t::ant (C++ member), 385
- wifi_ap_record_t::authmode (C++ member), 384
- wifi_ap_record_t::bssid (C++ member), 384
- wifi_ap_record_t::country (C++ member), 385
- wifi_ap_record_t::ftm_initiator (C++ member), 385
- wifi_ap_record_t::ftm_responder (C++ member), 385
- wifi_ap_record_t::group_cipher (C++ member), 385
- wifi_ap_record_t::pairwise_cipher (C++ member), 385
- wifi_ap_record_t::phy_11b (C++ member), 385
- wifi_ap_record_t::phy_11g (C++ member), 385
- wifi_ap_record_t::phy_11n (C++ member), 385
- wifi_ap_record_t::phy_lr (C++ member), 385
- wifi_ap_record_t::primary (C++ member), 384
- wifi_ap_record_t::reserved (C++ member), 385
- wifi_ap_record_t::rssi (C++ member), 384
- wifi_ap_record_t::second (C++ member), 384
- wifi_ap_record_t::ssid (C++ member), 384
- wifi_ap_record_t::wps (C++ member), 385
- WIFI_AUTH_MAX (C++ enumerator), 398
- wifi_auth_mode_t (C++ enum), 397
- WIFI_AUTH_OPEN (C++ enumerator), 397
- WIFI_AUTH_WAPI_PSK (C++ enumerator), 398
- WIFI_AUTH_WEP (C++ enumerator), 397
- WIFI_AUTH_WPA2_ENTERPRISE (C++ enumerator), 398
- WIFI_AUTH_WPA2_PSK (C++ enumerator), 398
- WIFI_AUTH_WPA2_WPA3_PSK (C++ enumerator), 398
- WIFI_AUTH_WPA3_PSK (C++ enumerator), 398
- WIFI_AUTH_WPA_PSK (C++ enumerator), 397
- WIFI_AUTH_WPA_WPA2_PSK (C++ enumerator), 398
- wifi_bandwidth_t (C++ enum), 400
- WIFI_BW_HT20 (C++ enumerator), 400
- WIFI_BW_HT40 (C++ enumerator), 400
- WIFI_CACHE_TX_BUFFER_NUM (C macro), 382
- WIFI_CIPHER_TYPE_AES_CMAC128 (C++ enumerator), 399
- WIFI_CIPHER_TYPE_CCMP (C++ enumerator), 399
- WIFI_CIPHER_TYPE_NONE (C++ enumerator), 399
- WIFI_CIPHER_TYPE_SMS4 (C++ enumerator), 399
- wifi_cipher_type_t (C++ enum), 399
- WIFI_CIPHER_TYPE_TKIP (C++ enumerator), 399
- WIFI_CIPHER_TYPE_TKIP_CCMP (C++ enumerator), 399
- WIFI_CIPHER_TYPE_UNKNOWN (C++ enumerator),

- 399
- WIFI_CIPHER_TYPE_WEP104 (C++ enumerator), 399
- WIFI_CIPHER_TYPE_WEP40 (C++ enumerator), 399
- wifi_config_t (C++ union), 383
- wifi_config_t::ap (C++ member), 383
- wifi_config_t::sta (C++ member), 383
- WIFI_CONNECT_AP_BY_SECURITY (C++ enumerator), 400
- WIFI_CONNECT_AP_BY_SIGNAL (C++ enumerator), 400
- WIFI_COUNTRY_POLICY_AUTO (C++ enumerator), 397
- WIFI_COUNTRY_POLICY_MANUAL (C++ enumerator), 397
- wifi_country_policy_t (C++ enum), 397
- wifi_country_t (C++ class), 383
- wifi_country_t::cc (C++ member), 383
- wifi_country_t::max_tx_power (C++ member), 383
- wifi_country_t::nchan (C++ member), 383
- wifi_country_t::policy (C++ member), 383
- wifi_country_t::schan (C++ member), 383
- wifi_csi_cb_t (C++ type), 383
- wifi_csi_config_t (C++ class), 390
- wifi_csi_config_t::channel_filter_en (C++ member), 390
- wifi_csi_config_t::htlftf_en (C++ member), 390
- wifi_csi_config_t::lltf_en (C++ member), 390
- wifi_csi_config_t::lftf_merge_en (C++ member), 390
- wifi_csi_config_t::manu_scale (C++ member), 390
- wifi_csi_config_t::shift (C++ member), 390
- wifi_csi_config_t::stbc_htlftf2_en (C++ member), 390
- WIFI_CSI_ENABLED (C macro), 382
- wifi_csi_info_t (C++ class), 390
- wifi_csi_info_t::buf (C++ member), 390
- wifi_csi_info_t::first_word_invalid (C++ member), 390
- wifi_csi_info_t::len (C++ member), 390
- wifi_csi_info_t::mac (C++ member), 390
- wifi_csi_info_t::rx_ctrl (C++ member), 390
- WIFI_DEFAULT_RX_BA_WIN (C macro), 382
- WIFI_DYNAMIC_TX_BUFFER_NUM (C macro), 382
- wifi_err_reason_t (C++ enum), 398
- WIFI_EVENT_ACTION_TX_STATUS (C++ enumerator), 404
- wifi_event_action_tx_status_t (C++ class), 395
- wifi_event_action_tx_status_t::context (C++ member), 395
- wifi_event_action_tx_status_t::da (C++ member), 395
- wifi_event_action_tx_status_t::ifx (C++ member), 395
- wifi_event_action_tx_status_t::status (C++ member), 395
- wifi_event_ap_probe_req_rx_t (C++ class), 394
- wifi_event_ap_probe_req_rx_t::mac (C++ member), 394
- wifi_event_ap_probe_req_rx_t::rssi (C++ member), 394
- WIFI_EVENT_AP_PROBEREQRECVD (C++ enumerator), 404
- WIFI_EVENT_AP_STACONNECTED (C++ enumerator), 404
- wifi_event_ap_staconnected_t (C++ class), 393
- wifi_event_ap_staconnected_t::aid (C++ member), 393
- wifi_event_ap_staconnected_t::is_mesh_child (C++ member), 393
- wifi_event_ap_staconnected_t::mac (C++ member), 393
- WIFI_EVENT_AP_STADISCONNECTED (C++ enumerator), 404
- wifi_event_ap_stadisconnected_t (C++ class), 393
- wifi_event_ap_stadisconnected_t::aid (C++ member), 394
- wifi_event_ap_stadisconnected_t::is_mesh_child (C++ member), 394
- wifi_event_ap_stadisconnected_t::mac (C++ member), 394
- WIFI_EVENT_AP_START (C++ enumerator), 403
- WIFI_EVENT_AP_STOP (C++ enumerator), 404
- wifi_event_bss_rssi_low_t (C++ class), 394
- wifi_event_bss_rssi_low_t::rssi (C++ member), 394
- WIFI_EVENT_FTM_REPORT (C++ enumerator), 404
- wifi_event_ftm_report_t (C++ class), 394
- wifi_event_ftm_report_t::dist_est (C++ member), 395
- wifi_event_ftm_report_t::ftm_report_data (C++ member), 395
- wifi_event_ftm_report_t::ftm_report_num_entries (C++ member), 395
- wifi_event_ftm_report_t::peer_mac (C++ member), 395
- wifi_event_ftm_report_t::rtt_est (C++ member), 395
- wifi_event_ftm_report_t::rtt_raw (C++ member), 395
- wifi_event_ftm_report_t::status (C++ member), 395
- WIFI_EVENT_MASK_ALL (C macro), 396
- WIFI_EVENT_MASK_AP_PROBEREQRECVD (C macro), 396

- WIFI_EVENT_MASK_NONE (*C macro*), 396
 WIFI_EVENT_MAX (*C++ enumerator*), 404
 WIFI_EVENT_ROC_DONE (*C++ enumerator*), 404
 wifi_event_roc_done_t (*C++ class*), 395
 wifi_event_roc_done_t::context (*C++ member*), 395
 WIFI_EVENT_SCAN_DONE (*C++ enumerator*), 403
 WIFI_EVENT_STA_AUTHMODE_CHANGE (*C++ enumerator*), 403
 wifi_event_sta_authmode_change_t (*C++ class*), 393
 wifi_event_sta_authmode_change_t::new_mode (*C++ member*), 393
 wifi_event_sta_authmode_change_t::old_mode (*C++ member*), 393
 WIFI_EVENT_STA_BEACON_TIMEOUT (*C++ enumerator*), 404
 WIFI_EVENT_STA_BSS_RSSI_LOW (*C++ enumerator*), 404
 WIFI_EVENT_STA_CONNECTED (*C++ enumerator*), 403
 wifi_event_sta_connected_t (*C++ class*), 392
 wifi_event_sta_connected_t::authmode (*C++ member*), 392
 wifi_event_sta_connected_t::bssid (*C++ member*), 392
 wifi_event_sta_connected_t::channel (*C++ member*), 392
 wifi_event_sta_connected_t::ssid (*C++ member*), 392
 wifi_event_sta_connected_t::ssid_len (*C++ member*), 392
 WIFI_EVENT_STA_DISCONNECTED (*C++ enumerator*), 403
 wifi_event_sta_disconnected_t (*C++ class*), 392
 wifi_event_sta_disconnected_t::bssid (*C++ member*), 393
 wifi_event_sta_disconnected_t::reason (*C++ member*), 393
 wifi_event_sta_disconnected_t::ssid (*C++ member*), 392
 wifi_event_sta_disconnected_t::ssid_len (*C++ member*), 392
 wifi_event_sta_scan_done_t (*C++ class*), 392
 wifi_event_sta_scan_done_t::number (*C++ member*), 392
 wifi_event_sta_scan_done_t::scan_id (*C++ member*), 392
 wifi_event_sta_scan_done_t::status (*C++ member*), 392
 WIFI_EVENT_STA_START (*C++ enumerator*), 403
 WIFI_EVENT_STA_STOP (*C++ enumerator*), 403
 WIFI_EVENT_STA_WPS_ER_FAILED (*C++ enumerator*), 403
 WIFI_EVENT_STA_WPS_ER_PBC_OVERLAP (*C++ enumerator*), 403
 WIFI_EVENT_STA_WPS_ER_PIN (*C++ enumerator*), 403
 wifi_event_sta_wps_er_pin_t (*C++ class*), 393
 wifi_event_sta_wps_er_pin_t::pin_code (*C++ member*), 393
 WIFI_EVENT_STA_WPS_ER_SUCCESS (*C++ enumerator*), 403
 wifi_event_sta_wps_er_success_t (*C++ class*), 393
 wifi_event_sta_wps_er_success_t::ap_cred (*C++ member*), 393
 wifi_event_sta_wps_er_success_t::ap_cred_cnt (*C++ member*), 393
 wifi_event_sta_wps_er_success_t::passphrase (*C++ member*), 393
 wifi_event_sta_wps_er_success_t::ssid (*C++ member*), 393
 WIFI_EVENT_STA_WPS_ER_TIMEOUT (*C++ enumerator*), 403
 wifi_event_sta_wps_fail_reason_t (*C++ enum*), 404
 wifi_event_t (*C++ enum*), 403
 WIFI_EVENT_WIFI_READY (*C++ enumerator*), 403
 WIFI_FAST_SCAN (*C++ enumerator*), 400
 wifi_ftm_initiator_cfg_t (*C++ class*), 392
 wifi_ftm_initiator_cfg_t::burst_period (*C++ member*), 392
 wifi_ftm_initiator_cfg_t::channel (*C++ member*), 392
 wifi_ftm_initiator_cfg_t::frm_count (*C++ member*), 392
 wifi_ftm_initiator_cfg_t::resp_mac (*C++ member*), 392
 wifi_ftm_report_entry_t (*C++ class*), 394
 wifi_ftm_report_entry_t::dlog_token (*C++ member*), 394
 wifi_ftm_report_entry_t::rssi (*C++ member*), 394
 wifi_ftm_report_entry_t::rtt (*C++ member*), 394
 wifi_ftm_report_entry_t::t1 (*C++ member*), 394
 wifi_ftm_report_entry_t::t2 (*C++ member*), 394
 wifi_ftm_report_entry_t::t3 (*C++ member*), 394
 wifi_ftm_report_entry_t::t4 (*C++ member*), 394
 wifi_ftm_status_t (*C++ enum*), 404
 WIFI_IF_AP (*C++ enumerator*), 397
 WIFI_IF_STA (*C++ enumerator*), 397
 WIFI_INIT_CONFIG_DEFAULT (*C macro*), 382
 WIFI_INIT_CONFIG_MAGIC (*C macro*), 382
 wifi_init_config_t (*C++ class*), 380
 wifi_init_config_t::ampdu_rx_enable (*C++ member*), 380

- wifi_init_config_t::ampdu_tx_enable (C++ member), 380
- wifi_init_config_t::amsdu_tx_enable (C++ member), 380
- wifi_init_config_t::beacon_max_len (C++ member), 381
- wifi_init_config_t::cache_tx_buf_num (C++ member), 380
- wifi_init_config_t::csi_enable (C++ member), 380
- wifi_init_config_t::dynamic_rx_buf_num (C++ member), 380
- wifi_init_config_t::dynamic_tx_buf_num (C++ member), 380
- wifi_init_config_t::event_handler (C++ member), 380
- wifi_init_config_t::feature_caps (C++ member), 381
- wifi_init_config_t::magic (C++ member), 381
- wifi_init_config_t::mgmt_sbuf_num (C++ member), 381
- wifi_init_config_t::nano_enable (C++ member), 380
- wifi_init_config_t::nvs_enable (C++ member), 380
- wifi_init_config_t::osi_funcs (C++ member), 380
- wifi_init_config_t::rx_ba_win (C++ member), 381
- wifi_init_config_t::sta_disconnected_pm (C++ member), 381
- wifi_init_config_t::static_rx_buf_num (C++ member), 380
- wifi_init_config_t::static_tx_buf_num (C++ member), 380
- wifi_init_config_t::tx_buf_type (C++ member), 380
- wifi_init_config_t::wifi_task_core_id (C++ member), 381
- wifi_init_config_t::wpa_crypto_funcs (C++ member), 380
- wifi_interface_t (C++ enum), 397
- WIFI_MGMT_SBUF_NUM (C macro), 382
- WIFI_MODE_AP (C++ enumerator), 397
- WIFI_MODE_APSTA (C++ enumerator), 397
- WIFI_MODE_MAX (C++ enumerator), 397
- WIFI_MODE_NULL (C++ enumerator), 397
- WIFI_MODE_STA (C++ enumerator), 397
- wifi_mode_t (C++ enum), 397
- WIFI_NANO_FORMAT_ENABLED (C macro), 382
- WIFI_NVS_ENABLED (C macro), 382
- WIFI_OFFCHAN_TX_CANCEL (C macro), 395
- WIFI_OFFCHAN_TX_REQ (C macro), 395
- WIFI_PHY_RATE_11M_L (C++ enumerator), 402
- WIFI_PHY_RATE_11M_S (C++ enumerator), 402
- WIFI_PHY_RATE_12M (C++ enumerator), 402
- WIFI_PHY_RATE_18M (C++ enumerator), 402
- WIFI_PHY_RATE_1M_L (C++ enumerator), 401
- WIFI_PHY_RATE_24M (C++ enumerator), 402
- WIFI_PHY_RATE_2M_L (C++ enumerator), 401
- WIFI_PHY_RATE_2M_S (C++ enumerator), 402
- WIFI_PHY_RATE_36M (C++ enumerator), 402
- WIFI_PHY_RATE_48M (C++ enumerator), 402
- WIFI_PHY_RATE_54M (C++ enumerator), 402
- WIFI_PHY_RATE_5M_L (C++ enumerator), 402
- WIFI_PHY_RATE_5M_S (C++ enumerator), 402
- WIFI_PHY_RATE_6M (C++ enumerator), 402
- WIFI_PHY_RATE_9M (C++ enumerator), 402
- WIFI_PHY_RATE_LORA_250K (C++ enumerator), 403
- WIFI_PHY_RATE_LORA_500K (C++ enumerator), 403
- WIFI_PHY_RATE_MAX (C++ enumerator), 403
- WIFI_PHY_RATE_MCS0_LGI (C++ enumerator), 402
- WIFI_PHY_RATE_MCS0_SGI (C++ enumerator), 402
- WIFI_PHY_RATE_MCS1_LGI (C++ enumerator), 402
- WIFI_PHY_RATE_MCS1_SGI (C++ enumerator), 402
- WIFI_PHY_RATE_MCS2_LGI (C++ enumerator), 402
- WIFI_PHY_RATE_MCS2_SGI (C++ enumerator), 403
- WIFI_PHY_RATE_MCS3_LGI (C++ enumerator), 402
- WIFI_PHY_RATE_MCS3_SGI (C++ enumerator), 403
- WIFI_PHY_RATE_MCS4_LGI (C++ enumerator), 402
- WIFI_PHY_RATE_MCS4_SGI (C++ enumerator), 403
- WIFI_PHY_RATE_MCS5_LGI (C++ enumerator), 402
- WIFI_PHY_RATE_MCS5_SGI (C++ enumerator), 403
- WIFI_PHY_RATE_MCS6_LGI (C++ enumerator), 402
- WIFI_PHY_RATE_MCS6_SGI (C++ enumerator), 403
- WIFI_PHY_RATE_MCS7_LGI (C++ enumerator), 402
- WIFI_PHY_RATE_MCS7_SGI (C++ enumerator), 403
- wifi_phy_rate_t (C++ enum), 401
- WIFI_PKT_CTRL (C++ enumerator), 401
- WIFI_PKT_DATA (C++ enumerator), 401
- WIFI_PKT_MGMT (C++ enumerator), 401
- WIFI_PKT_MISC (C++ enumerator), 401
- wifi_pkt_rx_ctrl_t (C++ class), 388
- wifi_pkt_rx_ctrl_t::__pad0__ (C++ member), 388
- wifi_pkt_rx_ctrl_t::__pad10__ (C++ member), 389

- wifi_pkt_rx_ctrl_t::__pad11__ (C++ member), 389
- wifi_pkt_rx_ctrl_t::__pad12__ (C++ member), 389
- wifi_pkt_rx_ctrl_t::__pad13__ (C++ member), 389
- wifi_pkt_rx_ctrl_t::__pad1__ (C++ member), 388
- wifi_pkt_rx_ctrl_t::__pad2__ (C++ member), 388
- wifi_pkt_rx_ctrl_t::__pad3__ (C++ member), 388
- wifi_pkt_rx_ctrl_t::__pad4__ (C++ member), 389
- wifi_pkt_rx_ctrl_t::__pad5__ (C++ member), 389
- wifi_pkt_rx_ctrl_t::__pad6__ (C++ member), 389
- wifi_pkt_rx_ctrl_t::__pad7__ (C++ member), 389
- wifi_pkt_rx_ctrl_t::__pad8__ (C++ member), 389
- wifi_pkt_rx_ctrl_t::__pad9__ (C++ member), 389
- wifi_pkt_rx_ctrl_t::aggregation (C++ member), 388
- wifi_pkt_rx_ctrl_t::ampdu_cnt (C++ member), 389
- wifi_pkt_rx_ctrl_t::ant (C++ member), 389
- wifi_pkt_rx_ctrl_t::channel (C++ member), 389
- wifi_pkt_rx_ctrl_t::cwb (C++ member), 388
- wifi_pkt_rx_ctrl_t::fec_coding (C++ member), 389
- wifi_pkt_rx_ctrl_t::mcs (C++ member), 388
- wifi_pkt_rx_ctrl_t::noise_floor (C++ member), 389
- wifi_pkt_rx_ctrl_t::not_sounding (C++ member), 388
- wifi_pkt_rx_ctrl_t::rate (C++ member), 388
- wifi_pkt_rx_ctrl_t::rssi (C++ member), 388
- wifi_pkt_rx_ctrl_t::rx_state (C++ member), 389
- wifi_pkt_rx_ctrl_t::secondary_channel (C++ member), 389
- wifi_pkt_rx_ctrl_t::sgi (C++ member), 389
- wifi_pkt_rx_ctrl_t::sig_len (C++ member), 389
- wifi_pkt_rx_ctrl_t::sig_mode (C++ member), 388
- wifi_pkt_rx_ctrl_t::smoothing (C++ member), 388
- wifi_pkt_rx_ctrl_t::stbc (C++ member), 388
- wifi_pkt_rx_ctrl_t::timestamp (C++ member), 389
- wifi_pmf_config_t (C++ class), 385
- wifi_pmf_config_t::capable (C++ member), 385
- wifi_pmf_config_t::required (C++ member), 385
- WIFI_PROMIS_CTRL_FILTER_MASK_ACK (C macro), 396
- WIFI_PROMIS_CTRL_FILTER_MASK_ALL (C macro), 396
- WIFI_PROMIS_CTRL_FILTER_MASK_BA (C macro), 396
- WIFI_PROMIS_CTRL_FILTER_MASK_BAR (C macro), 396
- WIFI_PROMIS_CTRL_FILTER_MASK_CFEND (C macro), 396
- WIFI_PROMIS_CTRL_FILTER_MASK_CFENDACK (C macro), 396
- WIFI_PROMIS_CTRL_FILTER_MASK_CTS (C macro), 396
- WIFI_PROMIS_CTRL_FILTER_MASK_PSPOLL (C macro), 396
- WIFI_PROMIS_CTRL_FILTER_MASK_RTS (C macro), 396
- WIFI_PROMIS_CTRL_FILTER_MASK_WRAPPER (C macro), 396
- WIFI_PROMIS_FILTER_MASK_ALL (C macro), 396
- WIFI_PROMIS_FILTER_MASK_CTRL (C macro), 396
- WIFI_PROMIS_FILTER_MASK_DATA (C macro), 396
- WIFI_PROMIS_FILTER_MASK_DATA_AMPDU (C macro), 396
- WIFI_PROMIS_FILTER_MASK_DATA_MPDU (C macro), 396
- WIFI_PROMIS_FILTER_MASK_FCSFAIL (C macro), 396
- WIFI_PROMIS_FILTER_MASK_MGMT (C macro), 396
- WIFI_PROMIS_FILTER_MASK_MISC (C macro), 396
- wifi_promiscuous_cb_t (C++ type), 382
- wifi_promiscuous_filter_t (C++ class), 390
- wifi_promiscuous_filter_t::filter_mask (C++ member), 390
- wifi_promiscuous_pkt_t (C++ class), 389
- wifi_promiscuous_pkt_t::payload (C++ member), 390
- wifi_promiscuous_pkt_t::rx_ctrl (C++ member), 390
- wifi_promiscuous_pkt_type_t (C++ enum), 401
- WIFI_PROTOCOL_11B (C macro), 395
- WIFI_PROTOCOL_11G (C macro), 395
- WIFI_PROTOCOL_11N (C macro), 395
- WIFI_PROTOCOL_LR (C macro), 395
- wifi_prov_cb_event_t (C++ enum), 789
- wifi_prov_cb_func_t (C++ type), 789

- wifi_prov_config_data_handler (C++ function), 791
- wifi_prov_config_get_data_t (C++ class), 792
- wifi_prov_config_get_data_t::conn_info (C++ member), 792
- wifi_prov_config_get_data_t::fail_reason (C++ member), 792
- wifi_prov_config_get_data_t::wifi_state (C++ member), 792
- wifi_prov_config_handlers (C++ class), 792
- wifi_prov_config_handlers::apply_config_handler (C++ member), 792
- wifi_prov_config_handlers::ctx (C++ member), 792
- wifi_prov_config_handlers::get_status_handler (C++ member), 792
- wifi_prov_config_handlers::set_config_handler (C++ member), 792
- wifi_prov_config_handlers_t (C++ type), 793
- wifi_prov_config_set_data_t (C++ class), 792
- wifi_prov_config_set_data_t::bssid (C++ member), 792
- wifi_prov_config_set_data_t::channel (C++ member), 792
- wifi_prov_config_set_data_t::password (C++ member), 792
- wifi_prov_config_set_data_t::ssid (C++ member), 792
- WIFI_PROV_CRED_FAIL (C++ enumerator), 789
- WIFI_PROV_CRED_RECV (C++ enumerator), 789
- WIFI_PROV_CRED_SUCCESS (C++ enumerator), 789
- wifi_prov_ctx_t (C++ type), 793
- WIFI_PROV_DEINIT (C++ enumerator), 790
- WIFI_PROV_END (C++ enumerator), 790
- WIFI_PROV_EVENT_HANDLER_NONE (C macro), 789
- wifi_prov_event_handler_t (C++ class), 788
- wifi_prov_event_handler_t::event_cb (C++ member), 788
- wifi_prov_event_handler_t::user_data (C++ member), 788
- WIFI_PROV_INIT (C++ enumerator), 789
- wifi_prov_mgr_config_t (C++ class), 788
- wifi_prov_mgr_config_t::app_event_handler (C++ member), 789
- wifi_prov_mgr_config_t::scheme (C++ member), 788
- wifi_prov_mgr_config_t::scheme_event_handler (C++ member), 789
- wifi_prov_mgr_configure_sta (C++ function), 787
- wifi_prov_mgr_deinit (C++ function), 784
- wifi_prov_mgr_disable_auto_stop (C++ function), 785
- wifi_prov_mgr_endpoint_create (C++ function), 786
- wifi_prov_mgr_endpoint_register (C++ function), 786
- wifi_prov_mgr_endpoint_unregister (C++ function), 786
- wifi_prov_mgr_event_handler (C++ function), 787
- wifi_prov_mgr_get_wifi_disconnect_reason (C++ function), 787
- wifi_prov_mgr_get_wifi_state (C++ function), 787
- wifi_prov_mgr_init (C++ function), 783
- wifi_prov_mgr_is_provisioned (C++ function), 784
- wifi_prov_mgr_reset_sm_state_on_failure (C++ function), 787
- wifi_prov_mgr_set_app_info (C++ function), 785
- wifi_prov_mgr_start_provisioning (C++ function), 784
- wifi_prov_mgr_stop_provisioning (C++ function), 785
- wifi_prov_mgr_wait (C++ function), 785
- wifi_prov_scheme (C++ class), 788
- wifi_prov_scheme::delete_config (C++ member), 788
- wifi_prov_scheme::new_config (C++ member), 788
- wifi_prov_scheme::prov_start (C++ member), 788
- wifi_prov_scheme::prov_stop (C++ member), 788
- wifi_prov_scheme::set_config_endpoint (C++ member), 788
- wifi_prov_scheme::set_config_service (C++ member), 788
- wifi_prov_scheme::wifi_mode (C++ member), 788
- wifi_prov_scheme_ble_event_cb_free_ble (C++ function), 790
- wifi_prov_scheme_ble_event_cb_free_bt (C++ function), 790
- wifi_prov_scheme_ble_event_cb_free_bt_dm (C++ function), 790
- WIFI_PROV_SCHEME_BLE_EVENT_HANDLER_FREE_BLE (C macro), 791
- WIFI_PROV_SCHEME_BLE_EVENT_HANDLER_FREE_BT (C macro), 791
- WIFI_PROV_SCHEME_BLE_EVENT_HANDLER_FREE_BTDM (C macro), 791
- wifi_prov_scheme_ble_set_mfg_data (C++ function), 790
- wifi_prov_scheme_ble_set_service_uuid (C++ function), 790
- wifi_prov_scheme_softap_set_httpd_handle (C++ function), 791
- wifi_prov_scheme_t (C++ type), 789

- wifi_prov_security (C++ enum), 790
WIFI_PROV_SECURITY_0 (C++ enumerator), 790
WIFI_PROV_SECURITY_1 (C++ enumerator), 790
wifi_prov_security_t (C++ type), 789
WIFI_PROV_STA_AP_NOT_FOUND (C++ enumerator), 793
WIFI_PROV_STA_AUTH_ERROR (C++ enumerator), 793
wifi_prov_sta_conn_info_t (C++ class), 791
wifi_prov_sta_conn_info_t::auth_mode (C++ member), 792
wifi_prov_sta_conn_info_t::bssid (C++ member), 791
wifi_prov_sta_conn_info_t::channel (C++ member), 792
wifi_prov_sta_conn_info_t::ip_addr (C++ member), 791
wifi_prov_sta_conn_info_t::ssid (C++ member), 792
WIFI_PROV_STA_CONNECTED (C++ enumerator), 793
WIFI_PROV_STA_CONNECTING (C++ enumerator), 793
WIFI_PROV_STA_DISCONNECTED (C++ enumerator), 793
wifi_prov_sta_fail_reason_t (C++ enum), 793
wifi_prov_sta_state_t (C++ enum), 793
WIFI_PROV_START (C++ enumerator), 789
WIFI_PS_MAX_MODEM (C++ enumerator), 400
WIFI_PS_MIN_MODEM (C++ enumerator), 400
WIFI_PS_NONE (C++ enumerator), 400
wifi_ps_type_t (C++ enum), 400
WIFI_REASON_4WAY_HANDSHAKE_TIMEOUT (C++ enumerator), 398
WIFI_REASON_802_1X_AUTH_FAILED (C++ enumerator), 398
WIFI_REASON_AKMP_INVALID (C++ enumerator), 398
WIFI_REASON_AP_TSF_RESET (C++ enumerator), 399
WIFI_REASON_ASSOC_EXPIRE (C++ enumerator), 398
WIFI_REASON_ASSOC_FAIL (C++ enumerator), 399
WIFI_REASON_ASSOC_LEAVE (C++ enumerator), 398
WIFI_REASON_ASSOC_NOT_AUTHED (C++ enumerator), 398
WIFI_REASON_ASSOC_TOOMANY (C++ enumerator), 398
WIFI_REASON_AUTH_EXPIRE (C++ enumerator), 398
WIFI_REASON_AUTH_FAIL (C++ enumerator), 399
WIFI_REASON_AUTH_LEAVE (C++ enumerator), 398
WIFI_REASON_BEACON_TIMEOUT (C++ enumerator), 398
WIFI_REASON_CIPHER_SUITE_REJECTED (C++ enumerator), 398
WIFI_REASON_CONNECTION_FAIL (C++ enumerator), 399
WIFI_REASON_DISASSOC_PWRCAP_BAD (C++ enumerator), 398
WIFI_REASON_DISASSOC_SUPCHAN_BAD (C++ enumerator), 398
WIFI_REASON_GROUP_CIPHER_INVALID (C++ enumerator), 398
WIFI_REASON_GROUP_KEY_UPDATE_TIMEOUT (C++ enumerator), 398
WIFI_REASON_HANDSHAKE_TIMEOUT (C++ enumerator), 399
WIFI_REASON_IE_IN_4WAY_DIFFERS (C++ enumerator), 398
WIFI_REASON_IE_INVALID (C++ enumerator), 398
WIFI_REASON_INVALID_PMKID (C++ enumerator), 398
WIFI_REASON_INVALID_RSN_IE_CAP (C++ enumerator), 398
WIFI_REASON_MIC_FAILURE (C++ enumerator), 398
WIFI_REASON_NO_AP_FOUND (C++ enumerator), 399
WIFI_REASON_NOT_ASSOCED (C++ enumerator), 398
WIFI_REASON_NOT_AUTHED (C++ enumerator), 398
WIFI_REASON_PAIRWISE_CIPHER_INVALID (C++ enumerator), 398
WIFI_REASON_ROAMING (C++ enumerator), 399
WIFI_REASON_UNSPECIFIED (C++ enumerator), 398
WIFI_REASON_UNSUPP_RSN_IE_VERSION (C++ enumerator), 398
WIFI_ROC_CANCEL (C macro), 395
WIFI_ROC_REQ (C macro), 395
wifi_sae_pwe_method_t (C++ enum), 400
wifi_scan_config_t (C++ class), 384
wifi_scan_config_t::bssid (C++ member), 384
wifi_scan_config_t::channel (C++ member), 384
wifi_scan_config_t::scan_time (C++ member), 384
wifi_scan_config_t::scan_type (C++ member), 384
wifi_scan_config_t::show_hidden (C++ member), 384
wifi_scan_config_t::ssid (C++ member), 384
wifi_scan_method_t (C++ enum), 400
wifi_scan_threshold_t (C++ class), 385
wifi_scan_threshold_t::authmode (C++ member), 385
wifi_scan_threshold_t::rssi (C++ mem-

- ber*), 385
- wifi_scan_time_t (C++ class), 384
- wifi_scan_time_t::active (C++ member), 384
- wifi_scan_time_t::passive (C++ member), 384
- WIFI_SCAN_TYPE_ACTIVE (C++ enumerator), 399
- WIFI_SCAN_TYPE_PASSIVE (C++ enumerator), 399
- wifi_scan_type_t (C++ enum), 399
- WIFI_SECOND_CHAN_ABOVE (C++ enumerator), 399
- WIFI_SECOND_CHAN_BELOW (C++ enumerator), 399
- WIFI_SECOND_CHAN_NONE (C++ enumerator), 399
- wifi_second_chan_t (C++ enum), 399
- WIFI_SOFTAP_BEACON_MAX_LEN (C macro), 382
- wifi_sort_method_t (C++ enum), 400
- wifi_sta_config_t (C++ class), 386
- wifi_sta_config_t::bssid (C++ member), 386
- wifi_sta_config_t::bssid_set (C++ member), 386
- wifi_sta_config_t::btm_enabled (C++ member), 387
- wifi_sta_config_t::channel (C++ member), 386
- wifi_sta_config_t::listen_interval (C++ member), 386
- wifi_sta_config_t::password (C++ member), 386
- wifi_sta_config_t::pmf_cfg (C++ member), 387
- wifi_sta_config_t::reserved (C++ member), 387
- wifi_sta_config_t::rm_enabled (C++ member), 387
- wifi_sta_config_t::sae_pwe_h2e (C++ member), 387
- wifi_sta_config_t::scan_method (C++ member), 386
- wifi_sta_config_t::sort_method (C++ member), 387
- wifi_sta_config_t::ssid (C++ member), 386
- wifi_sta_config_t::threshold (C++ member), 387
- WIFI_STA_DISCONNECTED_PM_ENABLED (C macro), 382
- wifi_sta_info_t (C++ class), 387
- wifi_sta_info_t::is_mesh_child (C++ member), 387
- wifi_sta_info_t::mac (C++ member), 387
- wifi_sta_info_t::phy_11b (C++ member), 387
- wifi_sta_info_t::phy_11g (C++ member), 387
- wifi_sta_info_t::phy_11n (C++ member), 387
- wifi_sta_info_t::phy_lr (C++ member), 387
- wifi_sta_info_t::reserved (C++ member), 387
- wifi_sta_info_t::rssi (C++ member), 387
- wifi_sta_list_t (C++ class), 387
- wifi_sta_list_t::num (C++ member), 387
- wifi_sta_list_t::sta (C++ member), 387
- WIFI_STATIC_TX_BUFFER_NUM (C macro), 382
- WIFI_STATIS_ALL (C macro), 397
- WIFI_STATIS_BUFFER (C macro), 397
- WIFI_STATIS_DIAG (C macro), 397
- WIFI_STATIS_HW (C macro), 397
- WIFI_STATIS_PS (C macro), 397
- WIFI_STATIS_RXTX (C macro), 397
- WIFI_STORAGE_FLASH (C++ enumerator), 400
- WIFI_STORAGE_RAM (C++ enumerator), 400
- wifi_storage_t (C++ enum), 400
- WIFI_TASK_CORE_ID (C macro), 382
- WIFI_VENDOR_IE_ELEMENT_ID (C macro), 396
- wifi_vendor_ie_id_t (C++ enum), 401
- wifi_vendor_ie_type_t (C++ enum), 400
- WIFI_VND_IE_ID_0 (C++ enumerator), 401
- WIFI_VND_IE_ID_1 (C++ enumerator), 401
- WIFI_VND_IE_TYPE_ASSOC_REQ (C++ enumerator), 401
- WIFI_VND_IE_TYPE_ASSOC_RESP (C++ enumerator), 401
- WIFI_VND_IE_TYPE_BEACON (C++ enumerator), 401
- WIFI_VND_IE_TYPE_PROBE_REQ (C++ enumerator), 401
- WIFI_VND_IE_TYPE_PROBE_RESP (C++ enumerator), 401
- wl_erase_range (C++ function), 877
- wl_handle_t (C++ type), 879
- WL_INVALID_HANDLE (C macro), 878
- wl_mount (C++ function), 877
- wl_read (C++ function), 878
- wl_sector_size (C++ function), 878
- wl_size (C++ function), 878
- wl_unmount (C++ function), 877
- wl_write (C++ function), 878
- WPA3_SAE_PWE_BOTH (C++ enumerator), 400
- WPA3_SAE_PWE_HASH_TO_ELEMENT (C++ enumerator), 400
- WPA3_SAE_PWE_HUNT_AND_PECK (C++ enumerator), 400
- WPA3_SAE_PWE_UNSPECIFIED (C++ enumerator), 400
- WPS_FAIL_REASON_MAX (C++ enumerator), 404
- WPS_FAIL_REASON_NORMAL (C++ enumerator), 404
- WPS_FAIL_REASON_RECV_M2D (C++ enumerator), 404

X

- xEventGroupClearBits (C++ function), 1013

- `xEventGroupClearBitsFromISR` (*C macro*), 1017
- `xEventGroupCreate` (*C++ function*), 1011
- `xEventGroupCreateStatic` (*C++ function*), 1011
- `xEventGroupGetBits` (*C macro*), 1018
- `xEventGroupGetBitsFromISR` (*C++ function*), 1016
- `xEventGroupSetBits` (*C++ function*), 1014
- `xEventGroupSetBitsFromISR` (*C macro*), 1017
- `xEventGroupSync` (*C++ function*), 1015
- `xEventGroupWaitBits` (*C++ function*), 1012
- `xMessageBufferCreate` (*C macro*), 1026
- `xMessageBufferCreateStatic` (*C macro*), 1027
- `xMessageBufferIsEmpty` (*C macro*), 1033
- `xMessageBufferIsFull` (*C macro*), 1032
- `xMessageBufferNextLengthBytes` (*C macro*), 1033
- `xMessageBufferReceive` (*C macro*), 1030
- `xMessageBufferReceiveCompletedFromISR` (*C macro*), 1033
- `xMessageBufferReceiveFromISR` (*C macro*), 1031
- `xMessageBufferReset` (*C macro*), 1033
- `xMessageBufferSend` (*C macro*), 1028
- `xMessageBufferSendCompletedFromISR` (*C macro*), 1033
- `xMessageBufferSendFromISR` (*C macro*), 1029
- `xMessageBufferSpaceAvailable` (*C macro*), 1033
- `xMessageBufferSpacesAvailable` (*C macro*), 1033
- `xQueueAddToSet` (*C++ function*), 971
- `xQueueCreate` (*C macro*), 972
- `xQueueCreateSet` (*C++ function*), 970
- `xQueueCreateStatic` (*C macro*), 973
- `xQueueGenericCreate` (*C++ function*), 970
- `xQueueGenericCreateStatic` (*C++ function*), 970
- `xQueueGenericSend` (*C++ function*), 965
- `xQueueGenericSendFromISR` (*C++ function*), 964
- `xQueueGiveFromISR` (*C++ function*), 965
- `xQueueIsQueueEmptyFromISR` (*C++ function*), 970
- `xQueueIsQueueFullFromISR` (*C++ function*), 970
- `xQueueOverwrite` (*C macro*), 977
- `xQueueOverwriteFromISR` (*C macro*), 979
- `xQueuePeek` (*C++ function*), 966
- `xQueuePeekFromISR` (*C++ function*), 967
- `xQueueReceive` (*C++ function*), 967
- `xQueueReceiveFromISR` (*C++ function*), 968
- `xQueueRemoveFromSet` (*C++ function*), 971
- `xQueueReset` (*C macro*), 981
- `xQueueSelectFromSet` (*C++ function*), 972
- `xQueueSelectFromSetFromISR` (*C++ function*), 972
- `xQueueSend` (*C macro*), 976
- `xQueueSendFromISR` (*C macro*), 981
- `xQueueSendToBack` (*C macro*), 975
- `xQueueSendToBackFromISR` (*C macro*), 979
- `xQueueSendToFront` (*C macro*), 974
- `xQueueSendToFrontFromISR` (*C macro*), 978
- `xRingbufferAddToQueueSetRead` (*C++ function*), 1047
- `xRingbufferCanRead` (*C++ function*), 1047
- `xRingbufferCreate` (*C++ function*), 1042
- `xRingbufferCreateNoSplit` (*C++ function*), 1043
- `xRingbufferCreateStatic` (*C++ function*), 1043
- `xRingbufferGetCurFreeSize` (*C++ function*), 1046
- `xRingbufferGetMaxItemSize` (*C++ function*), 1046
- `xRingbufferPrintInfo` (*C++ function*), 1047
- `xRingbufferReceive` (*C++ function*), 1044
- `xRingbufferReceiveFromISR` (*C++ function*), 1044
- `xRingbufferReceiveSplit` (*C++ function*), 1045
- `xRingbufferReceiveSplitFromISR` (*C++ function*), 1045
- `xRingbufferReceiveUpTo` (*C++ function*), 1045
- `xRingbufferReceiveUpToFromISR` (*C++ function*), 1046
- `xRingbufferRemoveFromQueueSetRead` (*C++ function*), 1047
- `xRingbufferSend` (*C++ function*), 1043
- `xRingbufferSendAcquire` (*C++ function*), 1044
- `xRingbufferSendComplete` (*C++ function*), 1044
- `xRingbufferSendFromISR` (*C++ function*), 1043
- `xSemaphoreCreateBinary` (*C macro*), 982
- `xSemaphoreCreateBinaryStatic` (*C macro*), 982
- `xSemaphoreCreateCounting` (*C macro*), 992
- `xSemaphoreCreateCountingStatic` (*C macro*), 993
- `xSemaphoreCreateMutex` (*C macro*), 989
- `xSemaphoreCreateMutexStatic` (*C macro*), 989
- `xSemaphoreCreateRecursiveMutex` (*C macro*), 990
- `xSemaphoreCreateRecursiveMutexStatic` (*C macro*), 991
- `xSemaphoreGetMutexHolder` (*C macro*), 994
- `xSemaphoreGetMutexHolderFromISR` (*C macro*), 994
- `xSemaphoreGive` (*C macro*), 985
- `xSemaphoreGiveFromISR` (*C macro*), 987
- `xSemaphoreGiveRecursive` (*C macro*), 986
- `xSemaphoreTake` (*C macro*), 983
- `xSemaphoreTakeFromISR` (*C macro*), 989
- `xSemaphoreTakeRecursive` (*C macro*), 984

- xSTATIC_RINGBUFFER (C++ class), 1048
- xStreamBufferBytesAvailable (C++ function), 1023
- xStreamBufferCreate (C macro), 1024
- xStreamBufferCreateStatic (C macro), 1025
- xStreamBufferIsEmpty (C++ function), 1023
- xStreamBufferIsFull (C++ function), 1023
- xStreamBufferReceive (C++ function), 1021
- xStreamBufferReceiveCompletedFromISR (C++ function), 1024
- xStreamBufferReceiveFromISR (C++ function), 1022
- xStreamBufferReset (C++ function), 1023
- xStreamBufferSend (C++ function), 1019
- xStreamBufferSendCompletedFromISR (C++ function), 1023
- xStreamBufferSendFromISR (C++ function), 1020
- xStreamBufferSetTriggerLevel (C++ function), 1023
- xStreamBufferSpacesAvailable (C++ function), 1023
- xTaskAbortDelay (C++ function), 946
- xTaskCallApplicationTaskHook (C++ function), 954
- xTaskCreate (C++ function), 942
- xTaskCreatePinnedToCore (C++ function), 941
- xTaskCreateStatic (C++ function), 943
- xTaskCreateStaticPinnedToCore (C++ function), 943
- xTaskGenericNotify (C++ function), 957
- xTaskGenericNotifyFromISR (C++ function), 958
- xTaskGetApplicationTaskTag (C++ function), 953
- xTaskGetApplicationTaskTagFromISR (C++ function), 953
- xTaskGetHandle (C++ function), 952
- xTaskGetIdleTaskHandle (C++ function), 954
- xTaskGetTickCount (C++ function), 952
- xTaskGetTickCountFromISR (C++ function), 952
- xTaskNotify (C macro), 962
- xTaskNotifyAndQuery (C macro), 962
- xTaskNotifyAndQueryFromISR (C macro), 962
- xTaskNotifyFromISR (C macro), 962
- xTaskNotifyGive (C macro), 962
- xTaskNotifyStateClear (C++ function), 961
- xTaskNotifyWait (C++ function), 959
- xTaskResumeAll (C++ function), 951
- xTaskResumeFromISR (C++ function), 950
- xTimerChangePeriod (C macro), 1003
- xTimerChangePeriodFromISR (C macro), 1008
- xTimerCreate (C++ function), 994
- xTimerCreateStatic (C++ function), 996
- xTimerDelete (C macro), 1004
- xTimerGetExpiryTime (C++ function), 1001
- xTimerGetPeriod (C++ function), 1001
- xTimerGetTimerDaemonTaskHandle (C++ function), 999
- xTimerIsTimerActive (C++ function), 999
- xTimerPendFunctionCall (C++ function), 1000
- xTimerPendFunctionCallFromISR (C++ function), 999
- xTimerReset (C macro), 1004
- xTimerResetFromISR (C macro), 1009
- xTimerStart (C macro), 1002
- xTimerStartFromISR (C macro), 1006
- xTimerStop (C macro), 1002
- xTimerStopFromISR (C macro), 1007